

BYTE

the small systems journal

APRIL 1984 Vol. 9, No. 4
\$3.50 in U.S.A.
\$3.95 in Canada/E2.10 in U.K.
A McGraw-Hill Publication
ISSN 0890-5280



Real-World Interfacing

Introducing Macintosh. What makes it tick. And talk.

Well, to begin with, 110 volts of alternating current.

Secondly, some of the hottest hardware to come down the pike in the last 3 years.

The garden variety 16-bit 8088 microprocessor.



Macintosh's 32-bit MC68000 microprocessor.



Some hard facts may be in order at this point:

Macintosh's brain is the same blindingly-fast 32-bit microprocessor we gave our other brainchild, the Lisa™ Personal Computer. Far more powerful than the 16-bit 8088 found in current generation computers.

Its heart is the same Lisa Technology of windows, pull-down menus, mouse commands and icons. All of which make that 32-bit power far more useful by making the Macintosh™ Personal Computer far easier to use than current generation computers. In fact, if you can point without hurting yourself, you can use it.

Now for some small talk.

Thanks to its size, if you can't bring the problem to a Macintosh, you can always

bring a Macintosh to the problem. (It weighs 9 pounds less than the most popular "portable.")

Another miracle of miniaturization is Macintosh's built-in 3½" drive. Its disks store 400K—more than conventional 5¼" floppies. So while they're big enough to hold a desk full of work, they're small enough to fit in a shirt pocket. And, they're totally encased in a rigid plastic so they're totally protected.

And talk about programming.

There are already plenty of programs to keep a Macintosh busy. Like MacPaint™

And with Macintosh BASIC, Macintosh Pascal and our Macintosh Toolbox for writing your own mouse-driven programs, you, too, could make big bucks in your spare time.

You can even program Macintosh to talk in other languages, like Yiddish or Serbo-Croatian, because it has a built-in polyphonic sound generator capable of producing high quality speech or music.

The Mouse itself. Replaces typed-in computer commands with a form of communication you already understand — pointing.

Some mice have two buttons. Macintosh has one. So it's extremely difficult to push the wrong button.



The inside story — a rotating ball and optical sensors translate movements of the mouse to Macintosh's screen pointer with pin-point accuracy.



a program that, for the first time, lets a personal computer produce virtually any image the human hand can create. There's more software on the way from developers like Microsoft®, Lotus™ and Software Publishing Corp., to mention a few.

All the right connections.

On the back of the machine, you'll find built-in RS232 and RS422 AppleBus serial communication ports. Which means you can connect printers, modems and other peripherals without adding \$150 cards. It also means that Macintosh is ready to hook in to a local area network. (With AppleBus, you will be able to interconnect up to 16 different Apple computers and peripherals.)

Should you wish to double Macintosh's storage with an external disk



Macintosh automatically makes room for your illustrations in the text.



MacPaint produces virtually any image the human hand can create.



Microsoft's Multiplan for Macintosh.

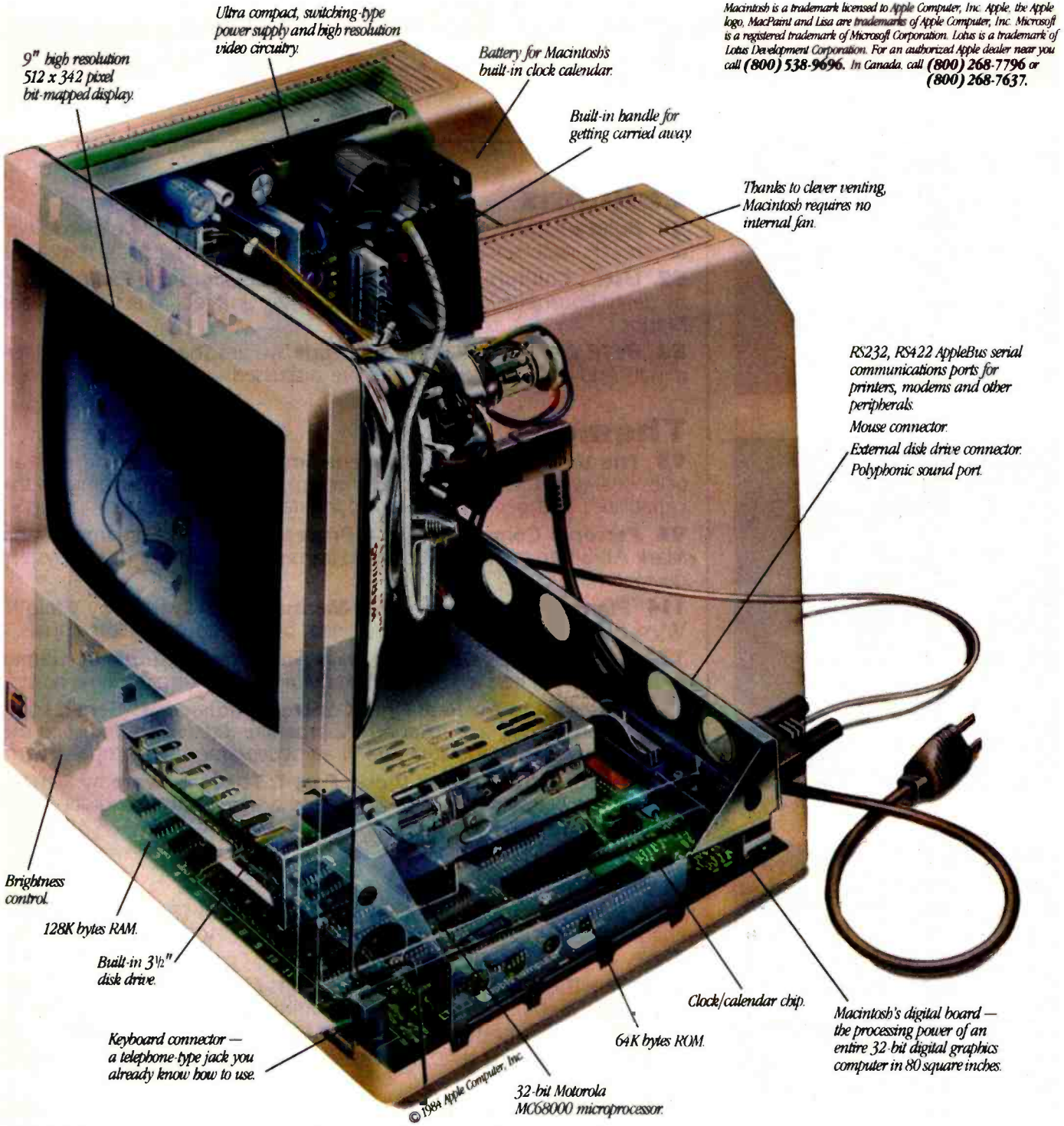

Macintosh is a trademark licensed to Apple Computer, Inc. Apple, the Apple logo, MacPaint and Lisa are trademarks of Apple Computer, Inc. Microsoft is a registered trademark of Microsoft Corporation. Lotus is a trademark of Lotus Development Corporation. For an authorized Apple dealer near you call (800) 538-9696. In Canada, call (800) 268-7796 or (800) 268-7637.

drive, you can do so without paying for a disk controller card—that connector's built-in, too.

There's also a built-in connector for Macintosh's mouse, a feature that costs up to \$300 on computers that can't even run mouse-controlled software.

One last pointer.

Now that you've seen some of the logic, the technology, the engineering genius and the software wizardry that separates

Macintosh from conventional computers, we'd like to point you in the direction of your nearest authorized Apple dealer.

Over 1500 of them are eagerly waiting to put a mouse in your hand. As one point-and-click makes perfectly clear, the real genius of Macintosh isn't

its 32-bit Lisa Technology, or its 3 1/2" floppy disks, or its serial ports, or its software, or its polyphonic sound generator.

The real genius is that you don't have to be a genius to use a Macintosh.

You just have to be smart enough to buy one.

Soon there'll be just two kinds of people. Those who use computers. And those who use Apples. 

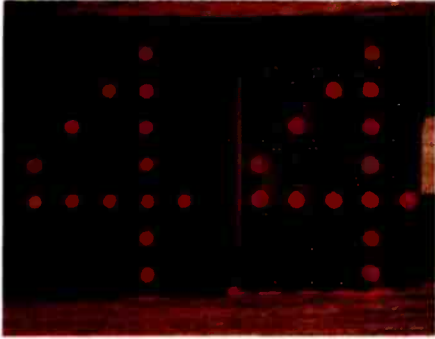

Page 32

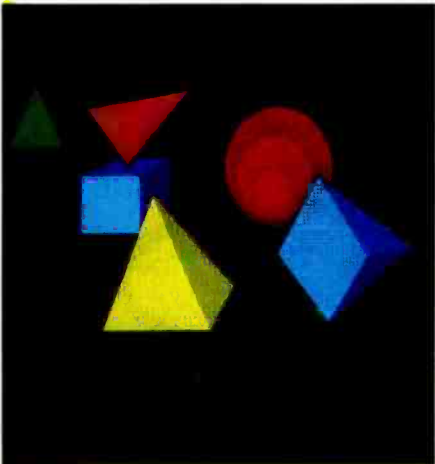

Page 82

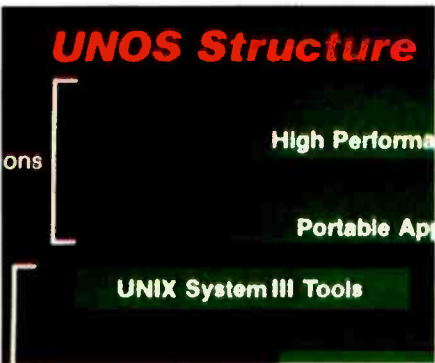

Page 127

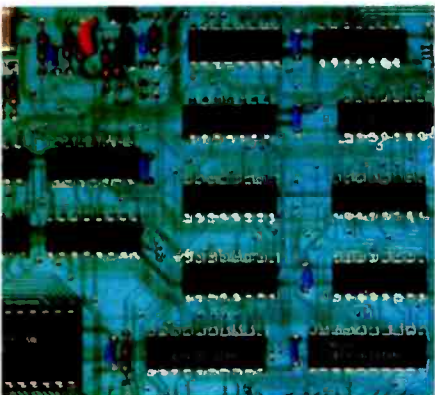

Page 137

Columns

32 Build a Scrolling Alphanumeric LED Display by Steve Ciarcia / Individual character arrays can be linked together to show lengthy messages.

57 User's Column: The Most Fabulous Object in the Entire World by Jerry Pournelle / Ain't love grand, Diser, and lots more from Chaos Manor.

82 BYTE West Coast: Stylish Output by Ezra Shapiro / Graphics terminals and a quiet ink-jet printer are discussed.

Themes

93 The World of Micros by Gene Smarte / This month's theme articles deal with theory, system descriptions, and projects touching on the capabilities and perils of real-world interfacing with microcomputers.

94 Personal Computer Signal Processing by Bill Englemann and Mark Abraham / An introduction to transducers, interfacing, and system development.

114 Planning a Computerized Measurement System by Craig R. Wyss / The author offers tips on digital processing of analog signals.

127 Designing Systems for Real-Time Applications by James Isaak / Some pointers to keep in mind before you tackle a real-time design.

137 Interfacing for Real-Time Control by Russell M. Genet, Louis J. Boyd, and Douglass J. Sauer / Appropriate interfacing simplified the design of hardware and software in an observatory's telescope system.

152 Putting the Apple II Work, Part 1: The Hardware by Richard C. Hallgren / How to create a high-speed system for the acquisition and analysis of data.

Reviews

169 Reviewer's Notebook by Rich Malloy / BYTE's product-review editor comments on Panasonic's Sr. Partner, the ACT Apricot, the Smart Cable, and this month's reviews.

170 The Rainbow 100 by David B. Suits / It runs CP/M-80, CP/M-86, and MS-DOS, but only on Rainbow-format disks.

186 Peachtext 5000 by Stevanne Ruth Lehrman / A collection of five business applications that are confederated—not integrated—into one package.

206 The Coleco Adam by Jules H. Gilder / This inexpensive home computer includes all the necessary peripherals, but using it is no Garden of Eden.

224 Micro-Logic by Richard Krajewski / With this software you can design digital circuits with your Apple II or IBM PC.

234 Statistical Software for Microcomputers by James Carpenter, Dennis Deloria, and David Morganstein / A comparative analysis of 24 packages.

BYTE is published monthly by McGraw-Hill Inc., with offices at 70 Main St., Peterborough, NH 03458, phone (603) 924-9281. Office hours: Mon—Thur 8:30 AM — 4:30 PM, Friday 8:30 AM — Noon, Eastern Time. Address subscriptions to BYTE Subscriptions, POB 590, Martinsville, NJ 08836. Address changes of address, USPS Form 3579, and fulfillment questions to BYTE Subscriptions, POB 596, Martinsville, NJ 08836. Second-class postage paid at Peterborough, NH 03458 and additional mailing offices. USPS Publication No. 528890 (ISSN 0360-5280). Postage paid at Winnipeg, Manitoba. Registration number 9321. Subscriptions are \$21 for one year, \$38 for two years, and \$55 for three years in the USA and its possessions. In Canada and Mexico, \$23 for one year, \$42



Features

269 This Month's Features by G. Michael Vose / Several new versions of BASIC are covered as well as the Mindset Personal Computer, Soviet microprocessors, and more.

270 The Mindset Personal Computer by Gregg Williams / A promising graphics-oriented system that's partially compatible with the IBM PC.

298 Is BASIC Getting Better? by G. Michael Vose / The language that made early microcomputers accessible is maturing to match the sophistication of a new generation of hardware.

300 True BASIC by Brig Elliott / A company founded by BASIC's original authors announces a new version of the language.

302 BetterBASIC by G. Michael Vose / One of the unique features of this BASIC variant is its modularity.

318 Macintosh BASIC by Scot Kamins / Apple's new computer uses a semicompiled language with tools designed to simplify code writing.

334 Professional BASIC by Donald P. George / Providing both support for the 8087 coprocessor and an array of debugging aids, this programming system makes BASIC a serious 16-bit tool.

344 BASIC-09 by Brian Capouch / A structured, incrementally compiled BASIC for Motorola MC6809-based microcomputers.

351 Soviet Microprocessors and Microcomputers by Ruth Heuertz / A review of Soviet literature indicates that most microcomputers in the U.S.S.R. are based on older American microprocessors.

365 Toward Standardized Video Terminals: ANSI X3.64 Device Control by Mark L. Siegel / A set of codes that promises to alleviate incompatibility.

379 A VIC-20/Commodore 64 Terminal Emulator by John P. Russo / This versatile program puts you in touch with mainframes.

422 Special April Supplement / A potpourri of features, including a preview of the Smart Blankie diurnal environmental control system.

Nucleus

4 Editorial: A Call for Ethical Standards for Personal Computer Magazines

9 MICROBYTES

15 Letters

392 Programming Quickie

398 BYTE's User to User

410 Ask BYTE

428, 432 Book Reviews

436 Clubs and Newsletters

442 Books Received

448 Software Received

465 Event Queue

479 What's New?

541 Unclassified Ads

542 BYTE's Ongoing Monitor Box, BOMB Results

543 Reader Service

Cover painting by Robert Tinney

for two years, \$61 for three years. \$53 for one year air delivery to Europe. 17,100 yen for one year surface delivery to Japan. \$37 surface delivery elsewhere. Air delivery to selected areas at additional rates upon request. Single copy price is \$3.50 in the USA and its possessions, \$3.95 in Canada and Mexico, \$4.50 in Europe, and \$5.00 elsewhere. Foreign subscriptions and sales should be remitted in United States funds drawn on a US bank. Printed in the United States of America.

Subscription questions or problems should be addressed to:
 BYTE Subscriber Service, POB 328, Hancock, NH 03449



Page 170



Page 206



Page 270

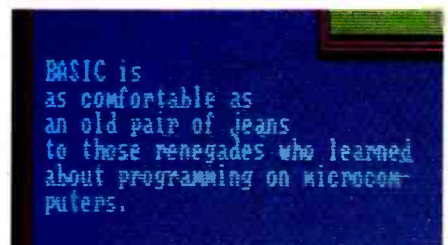

Page 298

Editor in Chief: Philip Lemmons

Senior Technical Editors: Gregg Williams;
Richard Malloy, Reviews: G. Michael Vose,
Features

Technical Editors: Richard S. Shuford, Arthur A. Little, Stanley Wszola, Bruce Roberts, Gene Smarte, Richard Krajewski, Jane Morrill Tazelaar, Glenn Hartwig; Alan Easton, Drafting
Consulting Editors: Steve Ciarcia, Jerry Pournelle
West Coast Editors: Ezra Shapiro, Technical Editor: Donna Osgood, Associate Editor.
McGraw-Hill, 425 Battery Street, San Francisco, CA 94111, (415) 362-4600. John Markoff, Senior Technical Editor. McGraw-Hill, 1000 Elwell Court, Palo Alto, CA 94303, (415) 964-0624

Managing Editor, User News: George Bond

User News Editors: Anthony J. Lockwood, What's New?; Mark Welch, MICROBYTES

Copy Editors: Elizabeth R. Cooper, Chief; Warren Williamson, Nancy Hayes, Joan V. Roy, Dennis E. Barker, Anne L. Fischer, Bud Sadler, Margaret Cook, Paula Noonan
Assistants: Faith Kluntz, Beverly Jackson, Lisa Jo Steiner, Peggy Dunham

Production: David R. Anderson, Associate Director; Virginia Reardon, Production Manager; Jan Muller, Michael J. Lonsky; Sherry McCarthy, Chief Typographer; Donna Sweeney, Valerie Horn, Len Lorette, Nan Fornal

Advertising: Deborah Porter, Supervisor; Marlon Carlson, Rob Hannings, Cathy A. R. Drew, Lisa Wozmak, Jeanne Cilley, Jeanina Reenstierna; Wai Chiu Li, Quality Control Manager; Linda J. Sweeney, Advertising/Production Coordinator; Julie Nelson

Advertising Sales: J. Peter Huestis, Sales Manager; Sandra Foster, Administrative Assistant
Circulation: Gregory Spitzfaden, Director; Andrew Jackson, Subscriptions Manager; Barbara Varnum, Assistant Manager; Agnes E. Perry, Louise Menegus, Jennifer Price, Jane Varnum, Phil Dechert, Mary Emerson; James Bingham, Single-Copy Sales Manager; Linda Turner, Assistant Manager; Carol Aho, Edson Ware
Marketing Communications: Horace T. Howland, Director; Doug Webster, Director of Public Relations; Vicki Reynolds, Marketing Associate; Nancy Giacalone, Assistant; Stephanie Warnesky, Graphic Arts/Production Supervisor; Sharon Price, Graphic Arts Designer; Michele P. Verville, Research Manager; Patricia Akerley, Market Research Analyst; Cynthia Damato, Reader Service Coordinator

Business Manager: Daniel Rodrigues

Controller's Office: Kenneth A. King, Assistant Controller, Mary E. Fluhr, Accounting & DIP Manager; Karen Burgess, Linda Short, Vicki Bennett, Vern Rockwell, Lyda Clark, Janet Pritchard, JoAnn Walter, Julie Ferry, Patricia Burke

Traffic: N. Scott Gagnon, Manager; Brian Higgins, Anthony Bennett

Receptionist: L. Ryan McCombs

Personnel/Office Manager: Cheryl A. Hurd
Associate Publisher/Production Director: John E. Hayes

Publisher: Gene W. Simpson;
Doris R. Gamble, Publisher's Assistant

Editorial and Business Office: 70 Main Street, Peterborough, New Hampshire 03458, (603) 924-9281

Officers of McGraw-Hill Publications Company:
President: John G. Wrede. Executive Vice Presidents: Paul F. McPherson, Operations; Walter D. Serwatka, Finance & Services. Senior Vice President-Editorial: Ralph R. Schulz. Senior Vice President Publishers: Harry L. Brown, David J. McGrath, James R. Pierce, Gene W. Simpson, John E. Slater. Vice President Publishers: Charlton H. Calhoun III, Richard H. Larsen, John W. Patten. Vice Presidents: Kemp Anderson, Business Systems Development; Shel F. Asen, Manufacturing; John A. Bunyan, Electronic Information Services; George R. Eisinger, Circulation; Michael K. Hehir, Controller; Eric B. Herr, Planning and Development; H. John Sweger, Jr., Marketing.

Officers of the Corporation: Harold W. McGraw, Jr., Chairman; Joseph L. Dionne, President and Chief Executive Officer; Robert N. Landes, Senior Vice President and Secretary; Ralph J. Webb, Treasurer.

A Call for Ethical Standards for Personal Computer Magazines

As a reader and a consumer, you have the right to know whether you can rely on the honesty and objectivity of articles in this and other personal computer magazines. Some common but unpublicized practices in this field raise serious ethical issues and can compromise a magazine's integrity. We want to inform you of these practices and to state our policies on them.

No "Editorial" Discounts for BYTE Staff Members

Some computer manufacturers and public relations agencies offer editors of personal computer magazines discounts of as much as 50 percent on both equipment and software. As a result, informed readers must wonder if a glowing article on a new computer was inspired by an honest evaluation or feelings of profound gratitude.

Discounts on hot new computers are a serious temptation for people who are as interested in computers as BYTE editors are, but we can't accept anything more valuable than a meal. We simply don't think that we or anyone else could remain objective after receiving such a favor.

Although staff members are not allowed to accept the loan of any equipment for their personal use, the magazine itself will accept long-term loans of single computers of each make in order to run software written for them. This policy applies equally to all manufacturers and is intended to help us extend coverage to more machines than we are able to buy. We return review machines unless the manufacturer offers to extend the loan to us, which seldom happens. To date, we have returned review disks of software, but the volume is now so enormous that we are considering keeping disks unless the publisher specifically requests return.

No Expense-Paid Trips

On occasion, BYTE receives invitations to send an editor on an expense-paid trip to a resort, a European capital, or some other almost irresistible setting for a "press conference." In principle, we can go on such a press excursion provided we pay our own way, all our competitors are going as well, and the trip has a legitimate journalistic purpose. But we don't believe that we can write objectively after flying free of charge to Paris or London and contemplating a new computer through a cloud of champagne bubbles. In practice, we just don't go on junkets, not even when told that all our competitors are going and that advertisements will be canceled if we don't go.

No Fat Speaker's Fees

BYTE staff members can't take money from advertisers or anyone likely to be the subject of coverage in BYTE. This applies to remuneration for speaking engagements. BYTE editors can accept paid transportation to the site of a speech but no fee for the speech beyond an honorarium of \$50 or \$100.

Disqualification from Stories because of Stock Ownership

No BYTE staff member can write about the products of any company in which he or she owns stock. For maximum journalistic freedom and objec-

68000-based systems. Just tell us what you need.

68000-based systems to fit your application.

Right from the pages of our catalog, we can deliver 68000-based supermicro systems to match virtually any application.

Including yours.

Here's how.

Built on the IEEE-696 (S-100) bus, Cromemco systems offer up to 21-board slots. And a family of 35 boards — CPU, memory and specialized I/O — to fill the slots any way you choose.

At the heart of each system is our 68000/Z-80 dual processor. Backed by as much as 16 Mb of error-correcting RAM. Full multi-tasking capability. I/O to handle up to 16 terminals.

And that's just the beginning.

You can select single or dual floppies, 5 1/4" or 8". A 21 Mb 5 1/4" Winchester hard disk. And a nine-track tape drive.

We can accommodate your taste for the exotic, too. With boards like our SMD interface that supports up to 1200 Mb of disk storage. An NTSC standard color graphics interface. A TV camera digitizer. A/D and D/A converters. An IEEE-488 bus interface. Communications. And more.

Intelligent workstations.

Then, if you're designing a distributed-processing system, you'll want to take a look at our C-10 personal computer. The Z-80-based C-10 can serve our 68000-based systems

as a powerful intelligent workstation in a distributed processing mode. Or as an independent personal computer with its own floppy storage.

High-level languages and applications software.

That brings us to software. It starts with CROMIX[®], our UNIX[™]-like operating system that you're free to tailor to your application.

CROMIX can execute both 68000- and Z-80-based programs. So right along with your 68000-based packages, your system will accommodate a wide selection of CP/M[®] software written for the Z-80.

And our high-level language support is second to none. From a 68000 Macro Assembler. To 68000 FORTRAN 77, PASCAL, GSA-certified high-level COBOL, C and BASIC.

Cromemco means business. Your business.

You see, when we say, "Just tell us what you need," we're not kidding.

You won't find another family of 68000-based microcomputers that can fit your needs as exactly as ours.

So if you're in the business of providing specialized computing solutions, you really should be doing business with Cromemco.

For a copy of our Systems Catalog, contact: Cromemco, Inc., 280 Bernardo Avenue, P.O. Box 7400, Mountain View, CA 94039. (415) 964-7400.

In Europe: Cromemco GmbH, 6236 Eschborne 1, Frankfurter Str. 33-35, P.O. 5267, Frankfurt Main, Germany or Cromemco Ltd.,

The Cambridge House, 178-182 Upper Richmond Rd., Putney, London SW15 England.

Cromemco[®]

[®] Cromemco and CROMIX are registered trademarks of Cromemco, Inc. [™] UNIX is a trademark of Bell Laboratories. [®] CP/M is a registered trademark of Digital Research. © 1983, Cromemco, Inc.

Circle 108 on inquiry card.

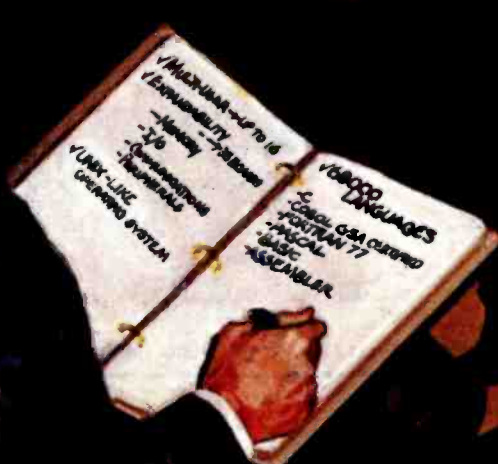
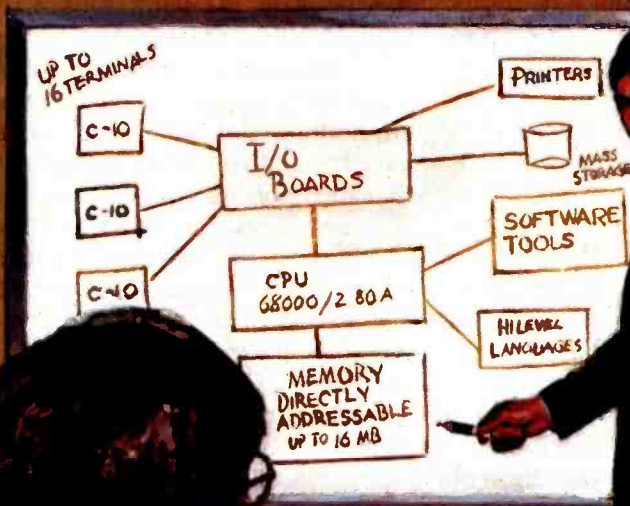

tivity, BYTE staff members should avoid owning stock in any company that is part of the industry we cover.

An Author's Connections Must Be Clear

Many of the people who are doing interesting things with computers work in the personal computer industry. We want such people to write nonpromotional articles for BYTE that shed light on some interesting aspect of technology, but we require that the authors' company affiliations be stated with the article. This policy sometimes prevents us from publishing an article that we like. A case in point: one author works for a major manufacturer of personal computers but is writing as an enthusiast about aspects of personal computing that are not involved in his job. The manufacturer forbids the employee to mention the company name unless the article is job-related. We can't publish the article without stating the company name. The author is caught in between, but we value this policy more than any single article.

No Favoritism to Advertisers in Editorial Coverage

We write about products when we think that our readers will find them interesting. Decisions about editorial coverage are made without regard to whether related advertisements have been or will be placed in BYTE. Once in a great while, an advertiser who is accustomed to standards different

from BYTE's will demand so-called "editorial support" and say that some other publications provide it and we don't. This is particularly awkward when we are planning to cover the related product anyway; we don't want the advertiser to think that we have bowed to pressure and will allot coverage on demand.

Editors Determine the Editorial Themes

Some editors at other publications have told us that the advertising department or business office sometimes tells them to do, let's say, an issue on "peripherals." Such issue themes are evidently wonderful frameworks around which to assemble advertisements. The editors of BYTE determine the themes of its issues independently. Our issues on simulation, real-world interfacing, computers and the disabled, benchmarks, Smalltalk, and so on, may not relate as directly to some advertisers' products as salespeople like. These themes do, however, attract readers who are intensely interested in computers. From the business standpoint, the hope is that these readers will see and act on the advertisements; reader surveys seem to bear this out. From the editorial standpoint, we choose themes based on their inherent interest and their appeal to our readers.

No Privileged Relationships with Companies in the Field

Although we enjoy working with

companies well in advance of product announcements, we are glad that BYTE's welfare doesn't depend on the cooperation or the success of any single company in the industry. We prize our independence, our objectivity, and our freedom to cover what we choose in the manner we choose.

This is not to begrudge any company or companies their success or to say that machine-specific publications are necessarily bad. Nevertheless, we enjoy being exempt from the whole set of ethical issues confronting magazines that cover a single computer or a single company's computers. We can state our opinions without wondering what The Only Company will think. We can point out that The Only Machine has too little memory or a comparatively weak central processing unit or a power supply with hardly a milli-ampere to spare. Machine-specific magazines risk the loss of readers if they point out too many faults in The Only Machine. We serve our readers by pointing out all the faults we find.

The BYTE policies described above are nothing more than your due as a reader, and you may have believed that such policies go without saying at every magazine. But this is yet another area in which this young industry lacks standards. We pledge to do our best to safeguard our editorial integrity and to serve your interests as a personal computer user, and we call upon other magazines to do so as well.

—Phil Lemmons, Editor in Chief



FUTECH 2000 SERIES

**ADVANCED INDUSTRIAL GRADE
S-100 MAIN FRAMES**

The most advanced industrial grade high-tech, high quality, sleek style S-100 bus main frame.

- Front panel LED display for TIME/DATE and temperature of internal system air flow...
- Heavy duty power supply meeting today's standards for multi-user multi-tasking high speed CPU applications...
- A variety of front panels for floppy and winchester configurations...
- Synthesized warning voice indicator...



2100 N. Hwy. 360, Suite 1807, Grand Prairie, Texas 75050, (214) 660-1955, Telex 703033

HOW TO GET AN IBM[®] PC FOR JUST \$1995.

BUY A CHAMELEON.



The Chameleon by Seequa does everything an IBM PC does. For about \$2000 less than an IBM.

The Chameleon lets you run popular IBM software like Lotus[®] 1-2-3[™] and Wordstar.[®] It has a full 83 key keyboard just like an IBM. Disk drives like an IBM. And a bright 80 × 25 character screen just like an IBM.

But it's not just the Chameleon's similarities to the IBM that should interest you. Its advantages should, too. The Chameleon also has an 8 bit microprocessor that

lets you run any of the thousands of CP/M-80[®] programs available. It comes complete with two of the best programs around, Perfect Writer[™] and Perfect Calc.[™] It's portable. And you can plug it in and start computing the moment you unwrap it.

So if you've been interested in an IBM personal computer, now you know where you can get one for \$1995. Wherever they sell Chameleons.

The Chameleon by



For the location of the Seequa dealer nearest you, call (800) 638-6066 or (301) 672-3600.

Get A HeadStart[™] On The Other Guys.



HeadStart Features:

Size: 15" wide, 11" deep, 10½" high.

Weight: 25 lbs.

Processors: Z80A (8 bit) and 8086 (16 bit).

Memory: 128K to 1MB depending on model. All models are expandable.

Disk Storage: 500K to 1MB (unformatted) on a 3½" Micro-Disk.

Display: 12" (diagonal) P31 phosphor, non-glare screen. 25 lines x 80 or 132 columns.

Keyboard: Detachable with 105 total keys. An optional portable version snaps onto the front screen area for easy transportability.

Disk Operating Software: *CP/M 80 for 8 bit. **MS DOS for 16 bit. LAN DOS for multi-user 8 or 16 bit operation.

Networking: Up to 255 HeadStart VPUs may be connected via coaxial interface into one of 2 optional data storage systems.

Interfaces: One RS449/RS232 compatible serial port. One Centronics compatible parallel printer port. External data bus. Coaxial communications interface. External disk I/O interface.

Optional Data Storage Systems: 2 models available. A 10MB, 5¼" system is expandable to 20MB. A 50MB, 8" system (25MB fixed, 25MB removable) is expandable to 200MB.

*CP/M is a registered trademark of Digital Research.

**MS DOS is a registered trademark of Microsoft.

Intertec's HeadStart is the smallest, smartest, fastest, most powerful business computer money can buy. And the most expandable (it's networkable up to 255 user stations).

Great Ideas Come In Small Packages.

Instead of three bulky components, HeadStart needs only two—the keyboard and CRT. There's no need for a cumbersome disk and processor cabinet. With HeadStart, it's all in the CRT enclosure.

HeadStart's small but powerful 3½" disk drive offers as much storage as larger 5¼" disks. Its 8 and 16 bit processors make software availability no problem.

And HeadStart's small size permits easy transportability with no sacrifice in performance. Each Video Processing Unit (VPU) comes with its

own easy-carrying handle. A portable keyboard option is also available.

How Fast Is Fast?

HeadStart's RAM Disk, an electronic emulation of the typical second drive, responds up to fifty times faster than conventional microcomputers.

Depress a key and you get a response within a split second. Literally before your finger leaves the key.

And HeadStart is incredibly powerful, too. Up to one megabyte of internal memory can tackle even the most sophisticated applications.

Some Ideas Are Bigger Than Others.

Because HeadStart is designed to be both a single *and* multi-user computer, you buy only as much computer as you need today.

But as your business grows, it grows with you.

Each HeadStart Video Processing Unit comes with its own memory, processors, disk and multi-user interfaces.

Just add a 10 or 50 megabyte Data Storage System and up to 255 users can share a common data base in an incredibly powerful, multi-user network.

HeadStart is available in three different models. All offer full performance, transportability, and are easily expandable.

Unlike conventional, single-user-only computers, HeadStart is here today with the designed-in technology to be here tomorrow.

So get a HeadStart on the other guys. For more information, call (803) 798-9100 or write: Intertec, 2300 Broad River Road, Columbia, SC 29210.

intertec[™]

Staff-written highlights of late developments in the microcomputer industry.

IBM ANNOUNCES PORTABLE COMPUTER, PC CLUSTER, AND NEW VERSION OF SYSTEM 9000

IBM has introduced its own transportable version of the IBM PC. The IBM Portable Personal Computer (PPC) includes 256K bytes of RAM and a single disk drive for \$2795; a second drive costs \$425. The PPC includes five expansion slots to add optional printer and communications ports, but it includes a built-in 9-inch amber graphics monitor and interface for a color display. The PPC measures 20 by 17 by 8 inches, weighs 30 pounds, and includes a carrying case. While the PPC runs most software written for the PC, it can't run programs that are available only for MS-DOS 1.1 or that require an external monochrome monitor.

IBM also announced products that allow up to 64 IBM PCs, PPCs, PC XTs, and PCjr's to be interconnected. Each computer needs a \$92 Cluster Program license and software, cables, and an interface device to the cluster. For the PC, PPC, and PC XT, a \$375 Cluster Adapter can be installed in one of the expansion slots. A \$400 Cluster Attachment fastens to the side of the PCjr entry level model, but because of power-supply limitations, it cannot be used with enhanced versions unless the disk drive, modem, and/or printer interface are disconnected. IBM says it will eventually offer a cluster interface for the enhanced PCjr; the other cluster products will be available in May.

A 9-foot cable connects each computer to a main cluster cable, which can be up to 3280 feet long. The hard disk on one PC XT or PC with a hard-disk expansion unit can be used as a master file server for the cluster. IBM sells a \$110 cable kit, including two 9-foot cables and a 32-foot main cable, but says users are free to buy the 75-ohm cable and adapters elsewhere.

IBM also announced the 9002, a new version of its 68000-based IBM CS-9000 Lab Computer (see February 1984 BYTE, page 278). A base version of the 9002 is priced at \$6495, while a four-user machine with a 10-megabyte hard disk and Microsoft's UNIX-based XENIX operating system is \$15,960.

Also announced were graphics adapter cards and "image view" capabilities for IBM 3270 terminals and the 3270-PC. IBM says the image view software, which is for host computers, allows images input through IBM's Scanmaster to be displayed by 3270 terminals.

Unannounced: IBM is also said to be developing a multiuser computer based on Intel's 80186 chip, after reportedly abandoning plans to use Intel's 80286 due to that chip's production problems.

Perhaps most significant are reports that IBM is developing a proprietary operating environment, code-named "Glass." A direct competitor to Microsoft's Windows and VisiCorp's Visi On, Glass is said to use a mouse and include windowing while able to run major application programs. Reports differ on whether Glass runs under PC-DOS or a proprietary operating system IBM is said to be developing.

FOUR JAPANESE COMPANIES DISCUSS MEGABIT CHIPS AT SOLID-STATE CONFERENCE

Researchers from four Japanese corporations described experimental 1-megabit RAM devices at this year's International Solid-State Circuit Conference in San Francisco, while conference chairman Peter Verhofstadt of Fairchild Semiconductor stated that 4-megabit chips were now on the horizon.

Engineers from NTT, Hitachi, NEC, and Toshiba presented papers on 1-megabit chips with access times as low as 90 nanoseconds and on-chip error-checking and error-correction circuitry. The NEC design was laid out in a 128 by 8-bit configuration. NEC also discussed a megabit EPROM. Despite these experimental results, production of megabit RAMs is probably still several years away.

National Semiconductor and Texas Instruments presented papers on single-chip 1200-bps modems that respectively met Bell 202 and 212 standards.

ROSE BOWL SCOREBOARD SNAFU DONE WITH PORTABLE COMPUTER

During January's Rose Bowl, a scoreboard prank by two CalTech students was made possible by two computers and radio modems. The students, who are now being prosecuted for trespassing, used an Epson HX-20 notebook-size portable computer with an RF modem to tap into an 8086 breadboard they'd attached between the scoreboard and its operators. The students put several messages on the scoreboard's scratch-pad area and finally changed the names of the teams to show CalTech trouncing rival MIT, instead of UCLA beating Illinois. The students later held a seminar called "Packet RF Control of Remote Digital Displays."

FLAT-PANEL DISPLAY WILL COST SAME AS CRT

Binary Star Inc. has developed an incandescent flat-panel display that it says will be available for prices comparable to the cost of similar-sized CRT displays. The display will have both color and monochrome versions and can also display three-dimensional images. Flat-panel displays, which are thinner and lighter than CRTs but offer higher resolution than LCDs, permit greater portability. Binary Star hopes to begin production late this year.

NYNEX WILL SELL COMPUTERS, PHONES THROUGH RETAIL STORES

NYNEX, the regional operating company that includes New England Telephone and New York Telephone, will open two retail stores to sell computers, telephones, and other small-business equipment. Included will be IBM, Wang, and Compaq computers; NEC and Mannesmann Tally printers; and Tallgrass, Quadram, and Bizcomp peripherals. NYNEX's DataGo stores will stress training and in-house service centers.

NEW DATABASE SOFTWARE FLOODS SOFTCON FLOOR

Although quite a few integrated software packages were introduced or shown at Softcon, a software trade show held in late February, new database-management software for the IBM PC seemed to dominate the floor.

Microstuf showed Infoscope, a \$225 program boasting speed and user-friendliness. Leading Edge Products showed its \$395 Nutshell Information Manager, which it says is not a true database manager but is easier to learn and use. ASAP Systems introduced ASAP Five, also \$395.

Advanced Business Computing Inc. unveiled Data Spectrum, with on-disk tutorials, for \$239. Metasoft Corp. added several products to its Benchmark integrated software line, including data-management, spreadsheet, and telecommunications features.

NANOBYTES

Joystick maker **Amiga Corp.** is developing a 68000-based home computer with a custom graphics coprocessor. With 128K bytes of RAM and a floppy-disk drive, the computer will reportedly sell for less than \$1000 late this year. . . . **Hewlett-Packard** is reportedly developing a 9-pound briefcase-size computer compatible with the HP 150. . . . **IBM, Sears, and CBS** announced that they are working on a joint videotex venture. The service would be made available to owners of many personal computers but will probably not be ready for several years. . . . **Ashton-Tate** has unveiled a multiuser version of dBASE II, its database-management software. . . . **Intel** has dropped the price of its BPK70-4 1-megabit bubble-memory subsystem from \$199 to \$149 (in 10,000-lot quantities). Intel said the price will drop to \$99 by year-end. . . . Two companies have announced add-on array processor products for the IBM PC. **Helionetics Inc.** has a single-board array processor it says can increase the IBM's arithmetic speed up to 10,000 times for less than \$2000. **Mercury Computer Systems** introduced the ZIP 3216, a \$6000 three-board coprocessor subsystem that can be used with a number of microcomputers and minicomputers. . . . **The National Association of Working Women (9 to 5)** said that half of the pregnancies of VDT operators at a United Airlines office suffered adverse outcomes. The organization said that of 48 known pregnancies among the 300 persons working there, 24 were problem pregnancies. Ten to 15 other clusters of VDT operators with pregnancy problems have been reported by 9 to 5, which is seeking investigations into the health risks posed by VDTs. . . . **Hewlett-Packard** has introduced ThinkJet, a \$495 ink-jet printer. . . . **Zenith Data Systems** has added five IBM PC-compatible desktop and portable computers to its Z-100 family. The Z-150 and Z-160 PCs include 128K bytes of RAM, two serial ports, one parallel port, RGB output, and four IBM-compatible expansion slots, with prices ranging from \$2699 with one floppy-disk drive to \$4799 with one floppy-disk drive and one hard-disk drive. . . . **Honeywell** announced plans to use the NCR/32, NCR's 32-bit microprocessor, in a future computer product. . . . **Digital Research Inc.** and **Motorola Inc.** have announced that DRI will produce a version of Concurrent DOS for Motorola's 68000 microprocessor. Concurrent DOS, which is version 3.1 of Concurrent CP/M-86, includes windowing and networking features, multiuser capabilities, and a "PC mode" that allows most PC-DOS software to run under Concurrent DOS. . . . **Diser**, the only commercial maker of Wirth's Lilith, a computer optimized for Modula-2, has stopped production and hopes to instead develop Modula-2 software for other systems. . . . **Kaypro Corp.** will sell a notebook-size computer made by Mitsui. The IBM-compatible portable was developed by a team including Microsoft's Kazuhiko Nishi, who helped develop Radio Shack's Kyocera-built Model 100 computer.

Net Results ...



Net results are what you get with **PerComNet™** ... the sophisticated, user-installable Local Area Network from PERCOM DATA CORPORATION.

PerComNet IBM® interface cards are available *now* to provide true networking capabilities for IBM and most IBM compatible personal computers. This includes the sharing of peripheral devices such as printers, modems, floppy disk drives, and all PERCOM DATA High Performance PHD™ Hard Disk Drives.

PerComNet provides these **net results**:

- Token passing reliability.
- Built-in 64K FIFO buffer, to speed data transmissions.
- Signal regeneration at each node to eliminate noise, regardless of network size.
- User installation simplicity.
- Optional NBS encryption for data security.
- Support for simultaneous voice/data transmissions.
- Operating system compatibility for MS-DOS™, CP/M®, UNIX™, and uNETix™. uNETix for PerComNet is distributed by Percom Data.

If you want **net results** ... PerComNet is the logical, economical and reliable choice. PERCOM DATA has a PerComNet OEM Evaluation Package* ready for your immediate use. The package includes all the hardware, and communications and file transfer utilities you need for configuring a network of three IBM PC computers. Package price is only \$1695.

To order your evaluation package or to get more information contact us today!

PERCOM DATA CORPORATION
11220 Pagemill Road • Dallas, Texas 75243

Name: _____ Title: _____

Company: _____

Address: _____

City: _____ State: _____ ZIP: _____

I'd like you to send me more information.

I'm very interested, please have your rep call me at _____

I'd like to know more about your PHD Hard Disk.

PERCOM DATA
CORPORATION

Expanding Your Peripheral Vision

DRIVES • NETWORKS • SOFTWARE

11220 Pagemill Road, Dallas, Texas 75243 (214) 340-5800

1-800-527-1222

*Does not include operating system or application software.

PerComNet and PHD are trademarks of Percom Data Corporation. • IBM is a registered trademark of International Business Machines. • MS-DOS is a trademark of Microsoft, Inc.

CP/M is a registered trademark of Digital Research. • UNIX is a trademark of Bell Laboratories. • uNETix is a registered trademark of Lantech Systems, Incorporated.

COPYRIGHT Percom Data Corporation 1983 • All prices, and descriptions subject to change with notice.

PAID 659-6683

90001

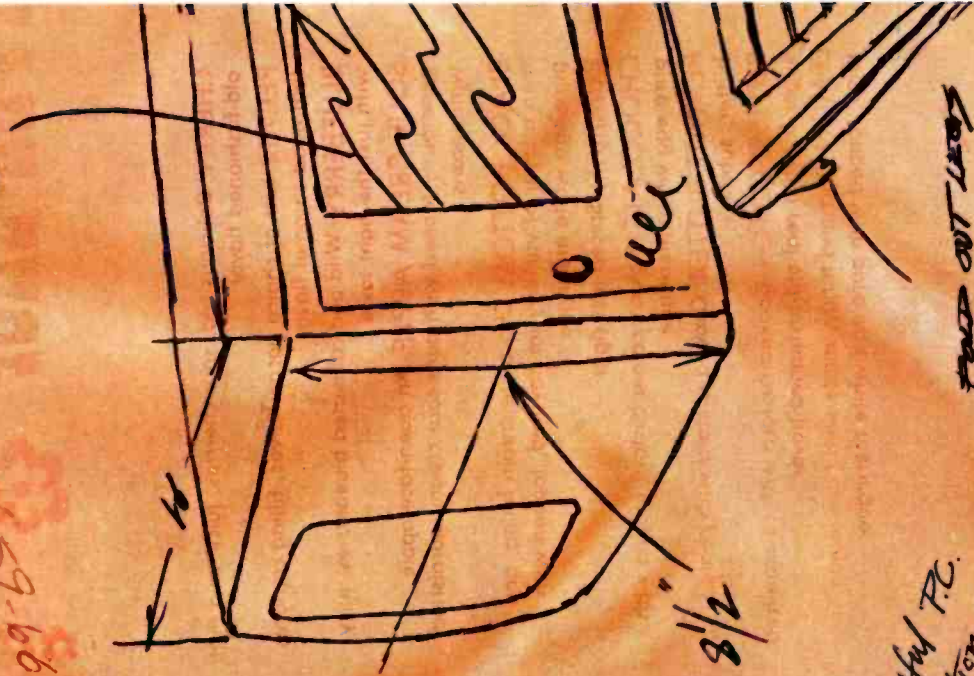
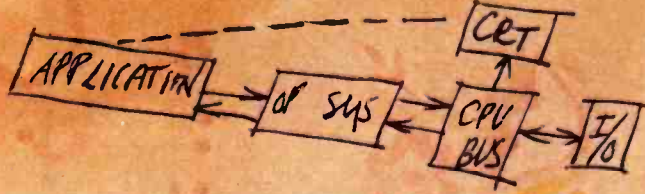

- Most useful PC.
- (1) Full function portable
 - (2) Truly IBM Compatible
 - (3) Rugged.

A picture worth \$111,000,000.

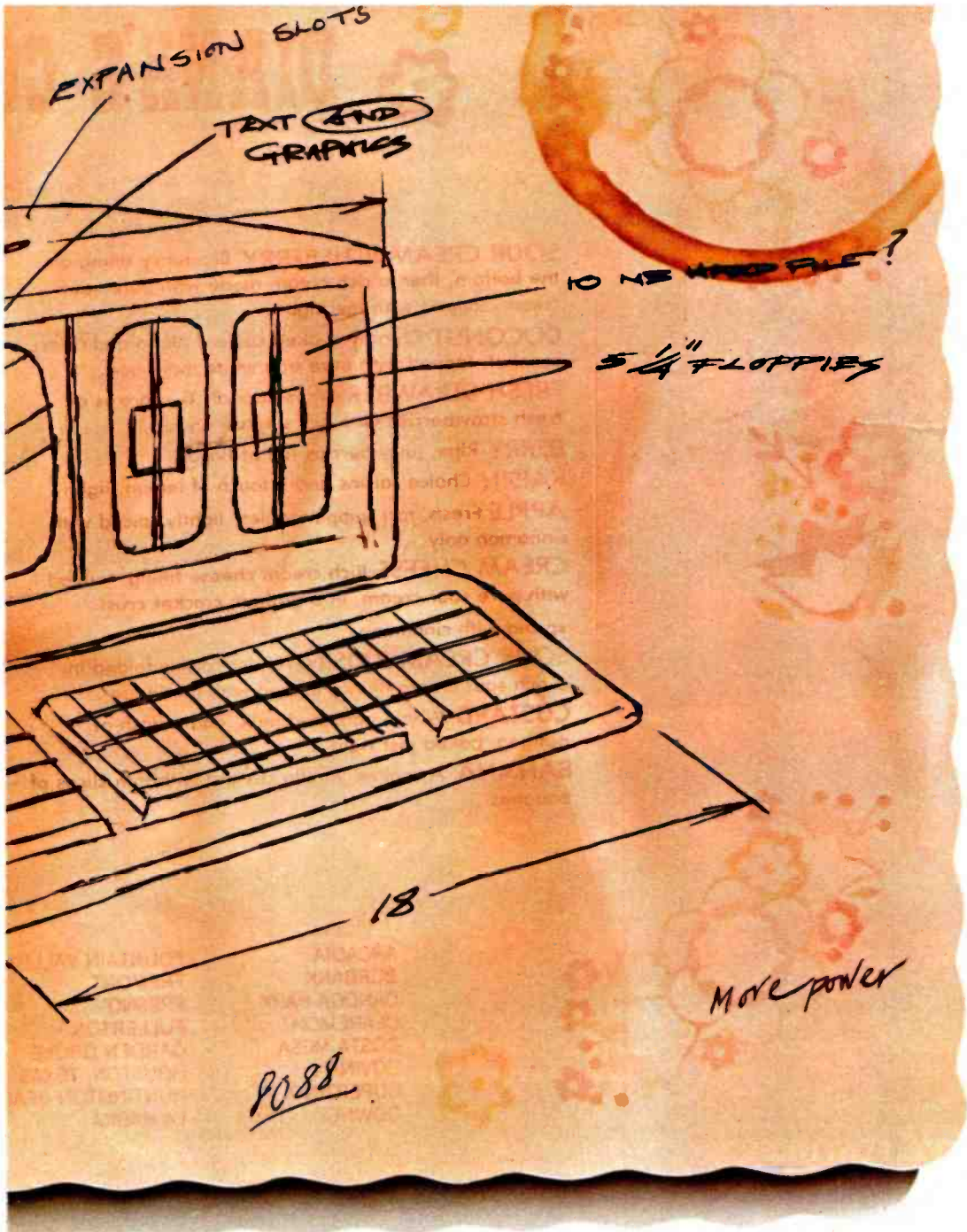

Not long ago, three businessmen met in a coffee shop to talk about an idea for a new personal computer. They made a rough design on the back of a place mat.

A lot of companies were already making personal computers, but they thought theirs just might work better.

The next year, they sold \$111 million worth of their new computers, the COMPAQ® Portable and the COMPAQ

PLUS™. No company in America had ever grown that fast. Why?

Simply because they offer, in a rugged, portable package, more capability than most other PC's. They're truly IBM®-compatible, so all the most productive software runs as is. They display high-resolution text and graphics on the same screen. And they grow. Expansion slots take IBM-compatible boards, and a kit converts the COMPAQ

Portable into the COMPAQ PLUS with its integrated ten-megabyte disk drive.

How does the future look? We look at it this way: If we came this far on the back of a place mat, just think of what we can do now.

For the location of your nearest Authorized Dealer, call 1-800-231-0900.

©1984 COMPAQ Computer Corporation. COMPAQ® is a Registered Trademark and COMPAQ PLUS™ is a Trademark of COMPAQ Computer Corporation. IBM® is a Registered Trademark of International Business Machines Corporation.

COMPAQ®

It simply works better.

In the Hard Disk Jungle Tallgrass Clears A Path



In today's hard disk jungle, Tallgrass clears a path by offering high performance, integrated mass storage solutions for the IBM® PC/XT, the T.I. Professional and related computers.

TALLGRASS INNOVATIVE FEATURES

MASS STORAGE SYSTEMS with formatted HardFile™ capacities of 6, 12, 20, 35 and 70 Mb, all with built-in tape backup.

CONVENIENT INTEGRAL TAPE BACKUP SYSTEM allows rapid tape "image" streaming, or incremental file-by-file backup and restore on ANSI standard inexpensive data cartridges, instead of the usual floppies, video cassettes, or low-capacity removable Winchester devices.

NETWORK READY and fully compatible with networks such as PCnet® and EtherShare™.

HIGH RELIABILITY with dual directory and read-after-write verify options. A dedicated landing zone, where the read/write heads reside when the disk is idle, provides data protection during powerdowns and transportation.

Follow the Tallgrass path to your local computer dealer and watch your personal computer transform into a powerful data processing system.

Available from COMPUTERLAND®, Entré® Computer Centers, MicroAge® Computer Stores and other participating computer dealers.

New! IBM-XT Cartridge Tape Backup

World Headquarters: Tallgrass Technologies Corp. / 11100 W. 82nd St.
Overland Park, KS 66214 / 913 / 492-6002 Telex: 215406 TBYT UR

Canadian Headquarters: Tallgrass Technologies (Canada), 1775 Meyerside Drive
Mississauga, Ontario, Canada L4V 1H2 416-673-3244

European Distributor: CPS Computer Group, LTD
Birmingham, England B276BH (021) 7073866

Australian Headquarters: Tallgrass Technologies (Australia) / Five Dock Plaza,
Suite 12 / 50 Great North Road / Five Dock / Sydney, N.S.W. 2046 / (02) 712-2010



**Tallgrass
Technologies
Corporation**

Oversimplified?

I read with interest Martin Dean's article "Simplify, Simplify, Simplify" (December 1983, page 161). Although many of his points are well taken, I think in his analysis of command-driven versus menu-driven programs he simplified too much.

He condemns command-driven programs, using the amusing analogy of a menuless restaurant in which the diner must describe to the chef the components of the meal. But Dean fails to see that command-driven and menu-driven is a false dichotomy.

A menu is a list of *commands*. The commands are typically context-sensitive, so that a "1" at one point in the program does something different than a "1" at another point, with the context being communicated by the menu itself. The menu lists all valid commands for the particular context, and the user thus can read from the menu the command she or he wants.

A so-called command-driven program normally (but not always) makes the user rely on memory (or a help card) for the command list, and usually also makes each command unique rather than interpreting the command by context: in effect, the main menu is the only menu, and it is not displayed.

But *not* displaying the menu in a command-driven program is not required. Wordstar is an example of a command-driven program, but it lists the commands in menus until the user knows them, whereupon the user can drop the menus. Wordstar constructs many of its commands by using two characters, with the first character defining the context and the second the action. (In the "Opening Menu" (formerly the "No-File Menu"), the menu defines the context and the command is a single character.)

I think the Wordstar approach is excellent: the commands are listed in a menu for new users, but those who know the package well can skip the menu and use the commands directly. To return to Dean's analogy, customers new to a good restaurant may go strictly by the menu, but people who know the restaurant can successfully request substitutions or even an entrée not on the menu. Good programs should allow their users the same flexibility of response: command menus

should be at the user's discretion, not the designer's.

Michael Ham
3110 Alpine Ct.
Iowa City, IA 52240

The Ultimate Allegory

Tom Houston's article "The Allegory of Software" (December 1983, page 210) was thought-provoking. After many seconds of intensive research, I believe I have developed the ultimate in icon screens—one that would permit every function currently imaginable and allow for future expansion.

I propose that each computer have screen icons that show a map of a city, complete with roads, businesses, and public services. The area of the city displayed would relate to the cost of the computer, with low-cost systems displaying the poor side of town, and high-cost systems on the rich side of town. Mainframes would be in large cities, microcomputers in smaller cities with more limited services. Sixteen- or 32-bit processors would be located on roads with quick access, while 8-bit machines would be on back streets. Parking garages would be provided for hard-disk systems, while floppy-disk-based system users would have to contend for on-street parking space. Systems used by office workers would probably be in the business district, while those used by managers would probably be located near golf courses.

Application programs would provide the necessary services (businesses within the city) and instructions on how to get from your office to them. For example, for accounting you would go to the accountant's office, while to build your database you might go to the library. Advertising copy would be sent to the advertising agency, financial spreadsheets kept in the bank, old files stored in the warehouse, etc.

To power up the system you would point to the electric utility. To print your program you would go to one of the printers in town, depending on the quality of work you needed and how much you wanted to pay. (The poor side of town might only have low-quality printers.) Computer programs would be

ordered from the computer store, and supplies from the stationery store. When you went to lunch, you would park the cursor at the restaurant of your choice, stopping by the answering service on the way.

For modem communications you would go to the telephone company, for mail you would go to the post office, and high-speed full-duplex traffic would be via the divided highway. Networked systems could shift their screens to different parts of the city, or perhaps to a different city, where they would have access to that city's services. On the other hand, attempting to get too much traffic through a small system (on a back street, remember) would result in traffic jams and excessive delays.

In a big city (mini or mainframe system), there would be a wide variety of services for program development. The best graphics programs would be developed at the fine arts museum, while low-budget ones might be done at the local high school. Scientific programming could be done at the college. Low-cost programs could be developed in the low-rent district, where overhead is cheap.

There should be provision for general services as well; traffic cops for multiuser systems, clean-up crews for old data littering the streets, a city dump to dispose of obsolete programs, a towing service for occasional system crashes, a hospital where you would take your sick hardware, a city morgue for dead systems, and a cemetery for old ideas.

The city would probably offer routine spraying for bugs, but only on the rich side of town. The poor side of town is more likely to have detours (program patches) than the good side of town, and more potholes for your program to get lost in. The better systems, on the rich side of town, would have empty lots for future expansion, while the poor side of town would be too congested and wouldn't have room for expansion without demolishing some older programs.

These icons represent everyday occurrences for most people, rendering their computer experiences lifelike. Hardware failures could be represented by such things as stuck traffic lights or flat tires. Running a pirated program would lock up the cursor in the city jail for 30 days. And with today's sound effects, you could even give the cursor a simulated horn, so

the operator could vent his frustrations at a stalled cursor. And might not we all feel on more familiar ground with our cursor stuck in a traffic jam between icons, while waiting for the system to complete a disk sort?

Gary Sanford
Measurement Engineering
 POB 1689
 Lowell, MA 01853

A TI User Reports

I am a Texas Instruments Professional Computer user. I read "The Texas Instruments Professional Computer" by Mark Haas (December 1983, page 286) and I agree with some of the things the author said about it. It does stand a good chance of surviving in this competitive field.

I have the BASIC version 1.1 and Easywriter 1.1. The BASIC version 1.1 does have its faults, as the author described, but it suits my needs. I am a 14-year-old, high school freshman, and I am very much into computers. As you mentioned, the "motor" function (the Ctrl-Alt-Del command) does work to start the system over again. You don't have to turn the machine off and then back on again.

I have found that if I try to buy something from TI, it takes a long time to get a delivery. For instance, I had a new fan put in this machine because the one it came with was too noisy. I learned that TI put the noisy fans in because they didn't have the quieter ones. It took almost three months and at least a dozen calls to TI to get the fan delivered.

At the place I bought the Professional Computer, the service is not the best. The salespeople don't know how to operate some of the hardware nor some of the

software. I went to look at the Omni 850 printer and they couldn't get it to work. I think it is awful that many salespeople do not know how to operate some of the things they are trying to sell.

Right now I am waiting for delivery of TI's 300/1200 internal modem and the software that comes with it. The salesperson I ordered it from said it wouldn't be in until February 1984. I can understand that it takes some time to send it, but I think three months is ridiculous (I ordered it in November).

Overall, I think the Texas Instruments Professional Computer is excellent, but the support and service could be greatly improved. Maybe after the computer has been out for a while, they'll get all the bugs straightened out.

David Solomons
 11 Dalewood Ln.
 Kings Park, NY 11754

Expanding² on the PC

I would like to bring to your attention two omissions regarding Persyst's Time-Spectrum product that appeared in Mark Welch's article "Expanding on the PC" (November 1983, page 168).

In table 14, on page 176, the listing for the Time-Spectrum board does not indicate that a print-spooler package and parallel port are available for the product. Persyst's Time-Spectrum product includes a print-spooler package called "Wait-Less Printing," a RAM-disk simulator program called "Insta-Drive," a clock, one serial port, and one parallel port.

I think your readers would also find Persyst's DCP-88 front-end "soft" communications board to be of great interest. With this product and the communica-

tions software available from Persyst, users can support HASP, 3780, and 3270 communications on an IBM PC, PC XT, Columbia desktop and portable, Compaq, and other IBM PC look-alike products.

Ralph Bond
Persyst/Personal Systems Technology Inc.
 15801 Rockfield Blvd., Suite A
 Irvine, CA 92714

I note that the article, "Expanding on the PC" did not include the expansion boards of Sritek Inc., which were mentioned in BYTE a few months ago. I wonder if you know something I don't. Because I am considering buying one of Sritek's boards with a 16- or 32-bit processor, and because they are very expensive, I would appreciate it if you could pass on any negative comments you might have heard about these products.

R. D. Small
University of New Brunswick
Dept. of Mathematics and Statistics
POB 4400
Fredericton, New Brunswick
Canada E3B 5A3

Mark Welch responds:

Unfortunately, information on some products was not available to me at the time the article was written, and I simply missed other products. The latter was the case for Sritek's Microcards, which were mentioned in Sudha Kavuru's article "Modular Architecture" (June 1983, page 194). As far as I know, the company is producing the boards; a review of the 16032 Microcard is planned for a future issue. Readers interested in Sritek can write to them

DATA TRANSFER PROBLEMS?

Your Simple Solution is **REFORMATTER**® Diskette Conversion Software

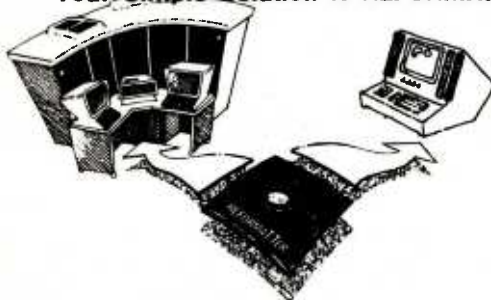

- Avoids serial communication protocols.
- Needs only one system to transfer data.
- Converts source code and data files.
- Allows 2-way transfer.
- Quick, reliable, and inexpensive.



| VERSIONS | |
|------------|--------------|
| Runs On | Reads/Writes |
| CP/M | ↔ IBM 3740 |
| CP/M | ↔ DEC RT-11 |
| CP/M-86 | ↔ IBM 3740 |
| CROMIX | ↔ DEC RT-11 |
| DEC RT-11 | ↔ CP/M |
| MS-DOS | ↔ IBM 3740 |
| TRSDOS II* | ↔ CP/M |
| TRSDOS II | ↔ DEC RT-11 |
| PRICE: | \$350 *\$249 |

Requires 8" floppy drive.

(415) 324-9114 TWX: 910-370-7457
 467 Hamilton Avenue, Suite 2, Palo Alto, Calif. 94301



“We bought an IBC Middy Cadet™ because no other system could do the job.”

Sue Kardas
 Director of Career Training
 Burlington Area Vocational-Technical Center



“When the Burlington Area Vocational-Technical Center needed a multi-user system for student training, we considered many multi-user systems, but in demo after demo there was too much of a user delay.

Then IBC contacted us, and offered to demonstrate the Middy Cadet’s multi-user capabilities—we were skeptical, but we gave it a try.

First, the Middy Cadet ran 9 users doing word processing without any delays. As a second test, we had the Middy operating 3 terminals each on word processing, accounting and BASIC programming. Again, no user delay. This was the multi-user, multi-tasking system we had been looking for.

With the Middy Cadet, we got a higher speed Z80B processor, a very fast hard disk drive and enough memory to do the job (512K Bytes).

On top of that, we felt that we got a very good price from an excellent vendor. Our system was delivered and installed two weeks later. Since then we’ve been so pleased with the Middy that we’re planning to buy another. With two systems providing 18 stations we will be equipped to offer training in all aspects of information processing.”

The Middy Cadet is a 10 user system that includes a 6MHz, Z80B CPU; 256 to 512K Bytes of RAM memory; a 20 MB, 5¼” hard disk drive and a one megabyte 5¼” floppy disk drive.



For more information on the Middy Cadet, see your local IBC dealer.

To locate the dealer nearest you, call or write:

OUTSIDE THE USA

IBC / Integrated Business Computers

21592 Marilla Street
 Chatsworth, CA 91311
 (213) 882-9007 TELEX NO. 215349

WITHIN THE USA

IBC / DISTRIBUTION

1140 36th Street, Suite 212
 Ogden, Utah 84403
 (801) 621-2294

We wrote the book on portability. In nine different languages.

| | 8080/8085/Z80 CP/M MP/MII | 8086/8088/8186 CP/M-86 Concurrent CP/M™ | 8086/8088 IBM PC DOS | 8086/8088 MS DOS | MC-68000 CP/M-68K |
|----------------------|---------------------------------|--|----------------------------|---------------------|----------------------|
| FORTRAN-77 | | ✓ | ✓ | ✓ | TBA |
| C BASIC Compiler | ✓ | ✓ | ✓ | ✓ | ✓ |
| Pascal/MT+ | ✓ | ✓ | ✓ | ✓ | ✓ |
| Level II COBOL | ✓ | ✓ | ✓ | ✓ | TBA |
| PL/I | ✓ | ✓ | ✓ | ✓ | TBA |
| C | | ✓ | ✓ | ✓ | ✓ |
| Assembler Plus Tools | ✓ | ✓ | ✓ | ✓ | TBA |
| Access Manager | ✓ | ✓ | ✓ | ✓ | TBA |
| Display Manager | ✓ | ✓ | ✓ | ✓ | TBA |
| micro/SPF | | ✓ | ✓ | ✓ | |
| COBOL Animator | ✓ | ✓ | ✓ | ✓ | TBA |
| Personal BASIC | | ✓ | | | TBA |
| Dr. Logo | | ✓ | TBA | | |

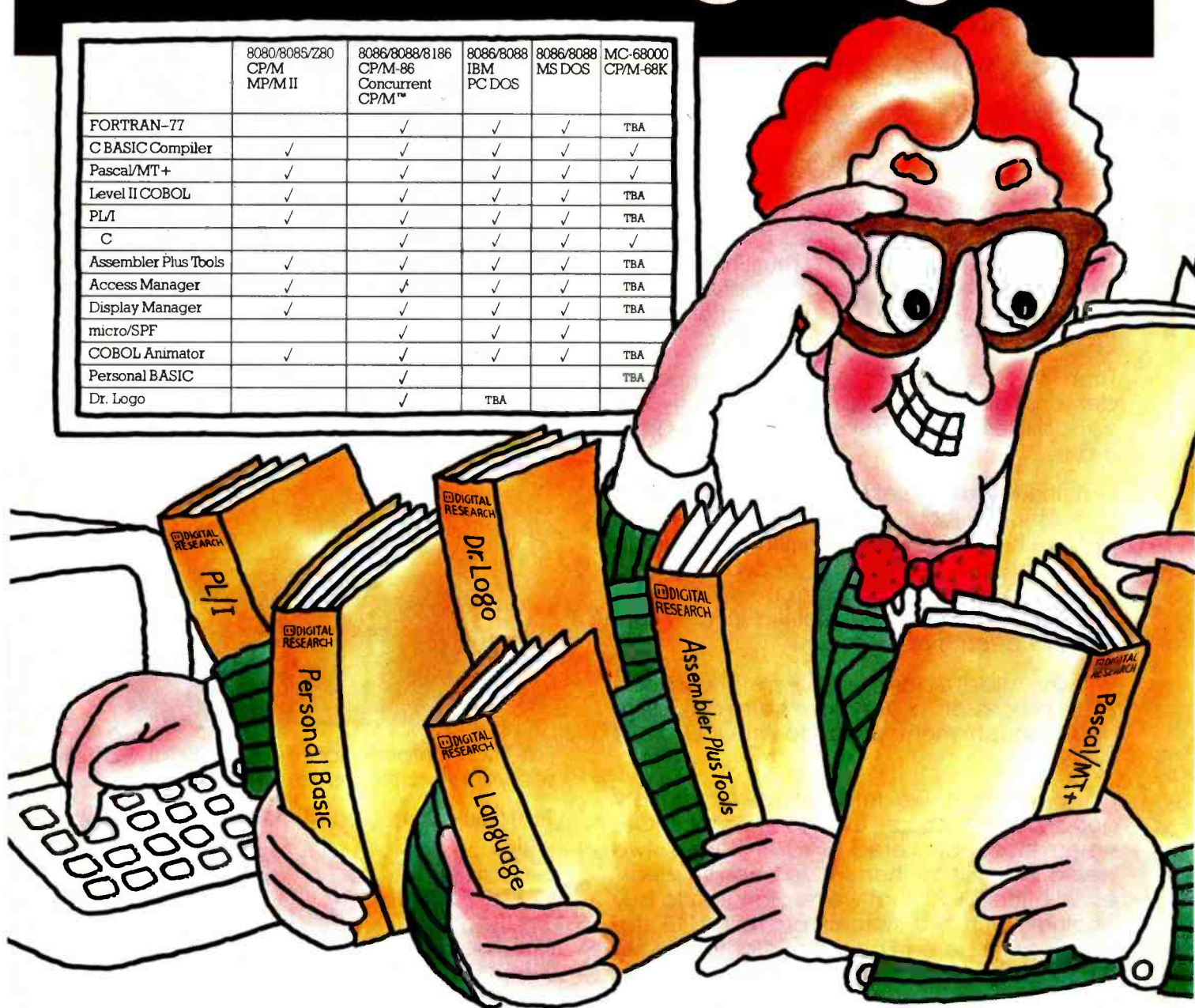

To every software developer who'd written off portability as an impossible dream, Digital Research humbly announces a few monumental breakthroughs.

We not only offer languages that are portable from 8 to 16 to the 32-bit chips of the future, they're portable across all popular operating systems, too. What's more, we supply the broadest range of quality languages and development tools available today. And will tomorrow.

So rest assured. Whether you design applications at a major corporation, plan to become a major corporation or just qualify as a hobbyist, you only have to write it once.

Simply pick the Digital Research language that's right for you. From Personal BASIC™ to Digital Research FORTRAN-77™. The newest member of our remarkable family.

To complement languages, we offer a complete workshop of development tools. Our Display Manager™ and Access Manager™ simplify the design of screen displays and data bases. So you spend less time and effort.

If you write in COBOL, our Animator™ source level debugger will get your software running in record time.

And for programmers skilled with IBM mainframe SPF, we offer micro/SPF™. An editor that helps turn your invaluable experience into valuable new software applications.

At Digital Research, we work as hard for you after the sale as we do to get the sale. With backup like quality documentation, software updates and a phone line to our technical support team.

With so much productivity and service to draw on, it's small wonder IBM chose our languages for its IBM®PC, XT and the new IBM 3270/PC.

For more information, call your IBM representative.

Or, for the Digital Research retailer nearest you, call 800-227-1617, ext. 400. In California, 800-772-3545, ext. 400.

micro/SPF is a trademark of Phaser Systems, Inc. Animator and Level II COBOL are trademarks of Micro Focus, Ltd. IBM is a registered trademark of International Business Machines Corporation. The Digital Research logo and products are either trademarks or registered trademarks of Digital Research Inc. ©1984 Digital Research Inc. All rights reserved.

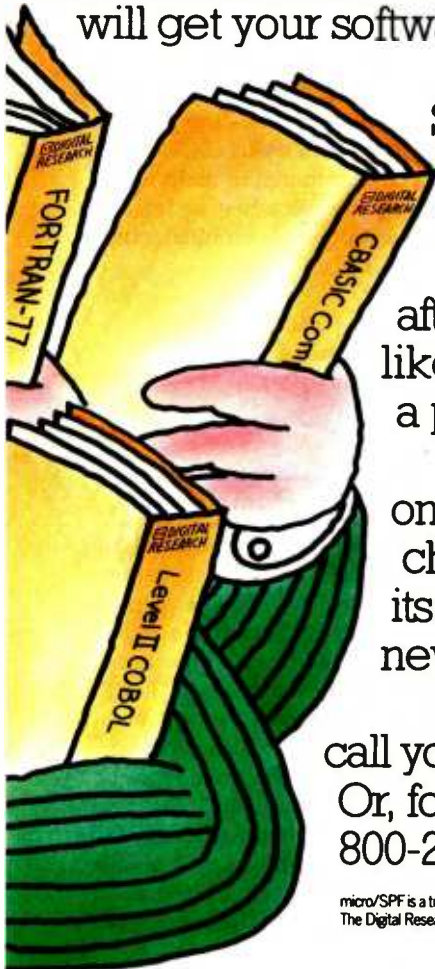

100%

CERTIFIED ERROR FREE

SENTINEL

 SENTINEL
DISKETTES

Guaranteed
when properly
used to
Read, Write
Error-Free as long
as you
own them.

QUALITY
YOU MAY NEVER NEED.
But it costs no more!

The expert technicians who produce and monitor the quality of our diskettes have developed new state-of-the-art technology using equipment we design and build ourselves, unlike any other diskette maker. That's why our burnishing method uses a unique, dual-sided technique which provides an advanced degree of surface smoothness, the key to consistent high quality



SENTINEL®

The Professional's Diskette — Ideal for Personal Use.

performance. In addition, a superior, high quality lubricant assuring extra long life and a quality control program which includes certifying every Sentinel Diskette are reasons we can offer you the industry's most exacting guarantee. For unsurpassed information security, choose Sentinel brand, and ask your dealer about the new 2-PACK in a resealable storage case.

Sentinel Computer Products, Division of Packaging Industries Group, Inc.,
Hyannis, MA 02601 Tel: 617-775-5220

Letters

at: 10230 Brecksville Rd., Cleveland, OH 44141.

Capital Equipment Corporation's CEC 01000 expansion card also was not included in the listing. This \$395 card allows the IBM PC to interface to the IEEE-488 GPIB bus. (Capital Equipment Corp., 10 Evergreen Ave., Burlington, MA 01803, (617) 273-1818.)

Computer Technology Innovations has gone through a number of changes not reflected in the article. The firm changed its name to Univation and no longer produces the ISDA-0 serial board (page 174) or the IMF-APGC and ISC5A multifunction boards (page 176). In addition, the price for the IC5/8C disk controller (page 172) is now \$199, not \$175. Univation's new address and phone number are: 1037 North Fair Oaks Ave., Sunnyvale, CA 94089, (408) 745-0180.

More Array Capabilities

"Array Capabilities for dBASE II" by Charles O. Hartman (November 1983, page 552) was a pleasure for me to read. The author presents a clever solution to the problem of programming languages that don't provide convenient array constructs.

There is at least one other way around the problem: namely, to use the vector power inside database-management systems (especially those quoted as relational). This solution offers the gigantic size of a vector defined as a file, but it is relatively slow compared to main memory and uses one file when so few are allowed to be opened simultaneously (two with dBASE).

Paul-Andre Des Jardins
Management Sciences for Health
1 Boul. Mohammed V
Rabat, Morocco

To Err Is Human

Douglas Davidson introduced his "forgotten sort" ("Address Calculation: The Forgotten Sort," November 1983, page 494) in your Technical Forum. He argues that the sort works in time proportional to the number of items to be sorted $[O(n)]$. On page 498, he states that the "full mathematical treatment (of his claim) is unnecessary." It is indeed unfortunate that he did not attempt the full mathematical treatment. If he had, he might have discovered not only that his algorithm fails to sort in the time he claims, but that, in fact, no sort can work in time less than

← Circle 327 on inquiry card.

Number One Add-On Products for IBM PC



The Multifunction Cards that let you get the most out of your IBM PC.

AST Research Number One Add-Ons let you realize the full potential of your IBM PC or PC-XT without wasting valuable slot space. By combining your memory and input/output requirements on a single card, you can take advantage of more of the capabilities IBM designed into the PC, while leaving space for future enhancements as they are introduced. AST Research multifunction boards can add user memory from 64K to 512K to your PC bringing your PC memory to its maximum of 640K. You also receive the added features of serial ports, parallel ports, a clock/calendar, game adapter port, and SuperPak™ — the utility diskette with the most powerful disk emulator and print spooler software available.

SixPakPlus™ — Up to 384K memory, serial port, printer port, optional game port, and clock/calendar on a single card.

I/O Plus II™ — Up to 2 serial ports, optional printer port, optional game port, clock/calendar on a single card. No memory.

MegaPlus II™ — Up to 512K memory, up to 2 serial ports, optional printer port, optional game port, and clock/calendar on a single card.

ComboPlus™ — Up to 256K memory, serial port, printer port, and clock/calendar on a single card.

Communication Products — Other AST Research Number One products include system enhancements and mainframe communications products such as 3270 SNA and 5251 terminal emulation, 3780 RJE support and AST-PCnet™ — the Local Area Network specifically designed for the IBM PC.

AST Quality

All AST Research multifunction boards come with the **AST "Plus"** — our unsurpassed reputation for quality, reliability, after-the-sales support, and overall design excellence — which give our products the best price/performance ratio in the industry.

AST Research Number One Add-On Products are available at Computerland, Entré, Businessland and other computer stores worldwide. Contact AST Research, Inc. for the dealer nearest you. (714) 540-1333/863-1333 TELEX: 295370ASTR UR

PCnet is a registered trademark of Orchid Technology, Inc.

Circle 5 on inquiry card.

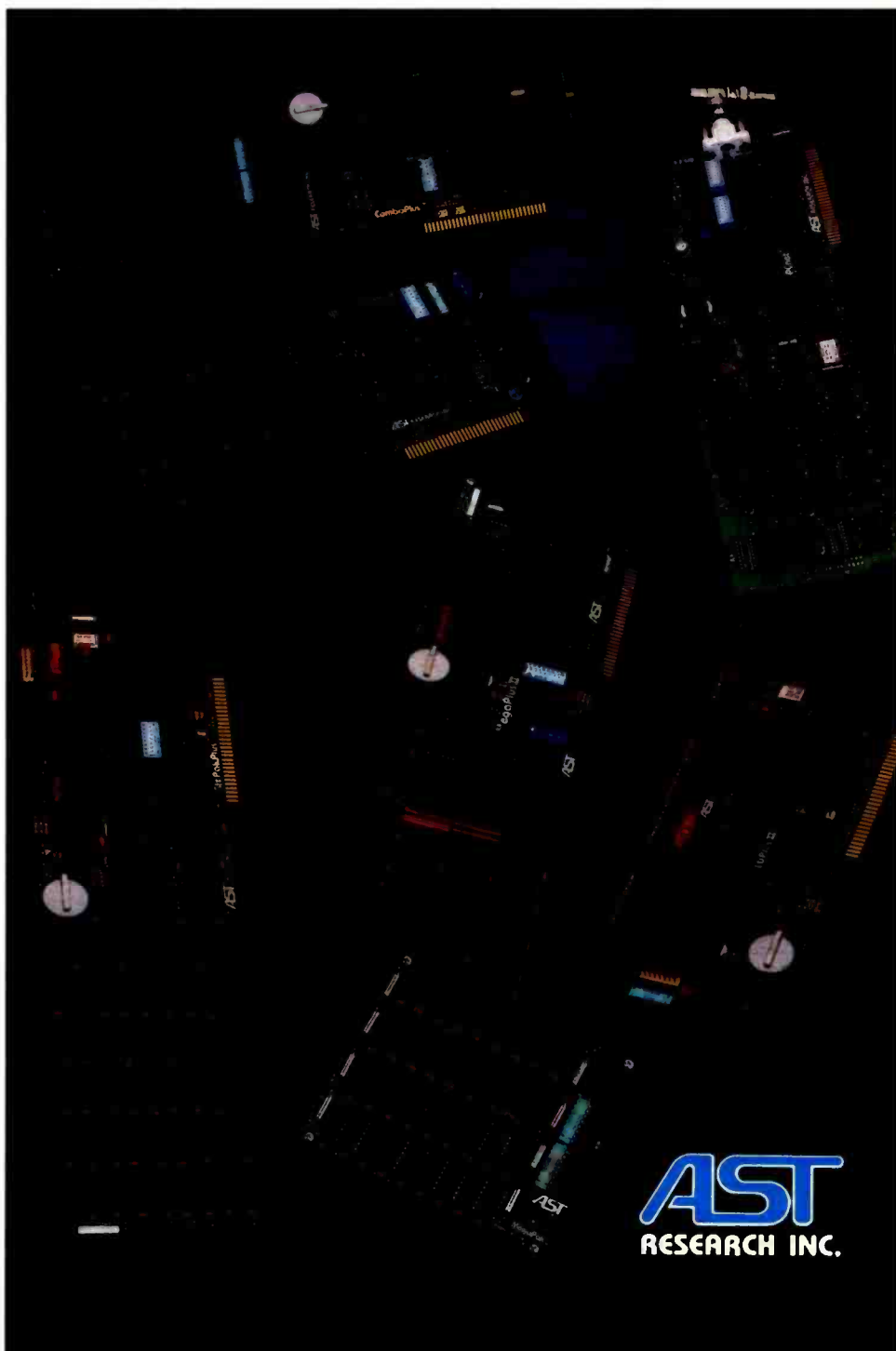

n times the log of n [$O(n \log n)$]. A proof of this "forgotten" truth can be found in any introductory text on algorithms (e.g., Horowitz and Sahni: *Fundamentals of Data Structures*, or Knuth: *The Art of Computer Programming*). Furthermore, the method of sorting in question does have a name (hash coding) and is well known. It is not, in any sense of the word, "forgotten" (except perhaps by BYTE and Mr. Davidson).

I can forgive Mr. Davidson for not knowing these facts. He is, after all, still in high school. However, I cannot forgive you, a well-known journal, for publishing such misinformation under the guise of a "technical forum."

Greg W. Scragg
Williams College
Williamstown, MA 01267

Douglas Davidson replies:

In reply to Mr. Scragg's criticism: I cannot and will not claim that the algorithm presented will require time proportional to n for any possible condition of the input. In fact, I believe that the article clearly states that this algorithm requires a uniform or near-uniform distribution of the keys for efficient operation. With this proviso, it seems to me that the algorithm operates in time proportional to n , and, in any case, that the program presented executes in a time proportional to the value of the variable N ; I present in my postscript an argument that may be convincing. These theoretical considerations, however, obscure the main point of the article. Both the placement of the article in an enthusiast magazine and the presentation itself should make it clear that my purpose was to present a practical technique to amateurs like myself who like to write programs but don't like to sit around and watch a bubble sort grind out a hundred elements. The sort presented is, in practical terms, fast; I consider this, rather than any theoretical arguments, to be its ultimate justification. The use of the word "forgotten" is perhaps unwarranted, but it is based on the fact that in several years of reading the literature of hobbyist and personal computing, I have seen many references to slower (bubble, Shell, etc.) and more complex (shuttle, quicksort, etc.) sorts, but none to this particular algorithm. If it is, as Mr. Scragg implies, widely known among computer scientists, then they have not communicated it to us amateurs. To recapitulate: the article presents a fast sorting algorithm for practical use, embodied in a program that can be seen to operate in time proportional to n ; any

theoretical carping, even if true—and I submit that it is not—is essentially irrelevant. I apologize for any misunderstanding I may inadvertently have caused.

P.S. It seems reasonable to conclude that the question of linearity rests on the number of passes through lines 160 to 180, as the other portions of the program are fairly straightforward. If the expected number of passes through lines 160 to 180 per list element is not a function of n , then the expected time taken by the program will be proportional to n . But the number of passes through these lines required by an element is purely a local property of the array A%, and so can depend only on the density of nonempty elements in A%; but this density varies from zero to (in this case) 1/2.36 and is not a function of n .

More Worries

I enjoyed the two articles about the new HP 150 personal computer and its development (October 1983, pages 36 and 51). After following this growing industry for the last 11 years, I finally feel that there is a machine on the market that meets my demands.

One comment about the HP touchscreen. Imagine the following situation: you have a disk in the drive holding a file with your bank statements and you are about to update them. A database program that makes heavy use of screen touch keys is up and running. Suddenly, a fly lands on a screen touch key labeled "Delete Record" (something not so impossible in countries with tropical climates). You wave the fly away, causing the function to be activated. Fortunately, the program asks for confirmation of a delete instruction by requiring you to touch a "Confirm" area. The fly, however, is still buzzing around and lands right there. If the fly leaves, the record is deleted; you are now at the mercy of a real bug.

Software that makes use of the touchscreen feature will have to consider rather strange situations.

Miguel Koren O'Brien de Lacy
Rua Duque de Caxias, III
18100 - Sorocaba - SP
Brazil

The Estridge Interview

It's too bad you had to ruin your magazine with an interview with Philip Estridge ("IBM's Estridge," November

1983, page 88). Two points come out loud and clear:

He can't type or he would have had an IBM Selectric on his desk and would have known where the keys went on the keyboard. (Why didn't he ask his secretary?)

He likes Easywriter! That proves he's a masochist.

Marvin Konopik
American Embassy
Box 1
APO San Francisco, CA 96356

I found your interview with Philip Estridge excellent and most of what he said on the mark. But I feel he missed the mark on the IBM PC keyboard. The need to please everyone has, of course, eluded us all, but you can please *somebody*. I do not know *anybody* that likes the PC keyboard. The keys are unreliable, particularly the "-" on all the keyboards I've tried; the keys are too small for large hands; and most people would prefer a different placing of the control keys. Dislike is most intense among professional "key pounders" who routinely work with other keyboard layouts.

My point is that IBM seems to ignore this universal commendation and wave it away with "you can't please everybody." Since the rest of the machine is a good effort, a little more recognition of *everyone's* dislike of the keyboard would be appreciated.

Robert A. Day
628 Nightingale St.
Livermore, CA 94550

Xenix/BASIC Performance

I was most interested in Sam Harp and Marvin Stone's letter (October 1983, page 20) regarding how slowly the Radio Shack Model 16 performed.

It seemed obvious from the results given that the problem is in Xenix or BASIC. To test this, I ran the same program on a 68000 running at 12.5 MHz with one wait state as an attached processor for an Apple II look-alike. My results were 29 seconds, the same as for the IBM PC, rather than the 132 seconds of the Model 16.

Because the 68000 (a Dtask Grande, from Digital Acoustics) was only doing the actual math processing and not interpreting the Applesoft program, the

Rana Systems. Always A Step Ahead.



And it's happening again with our IBM® compatible Rana 2000. This 320K double density drive offers a large centering cone for problem-free diskettes and our exclusive silencing mechanism to make it the quietest disk drive you can buy.

At Rana we know the key to our success is providing the highest technology, on the best possible products, while filling the most possible user needs. That is why we spend so much time on research and development. Our world-renowned engineers were the first to offer increased capacity. The first to design a write protect feature. The first to use a metal band positioner and get 100%

data integrity, and a 3 to 4 times improvement in access speed. And, the first to bring you all this performance, quality and dramatic styling.

This is why our Elite One got the #1 rating from Softalk Magazine. And our Atari® compatible Rana 1000 Slimline has turned a game computer into a sophisticated business tool. And soon we'll have a new Winchester drive and a new series of very high density minifloppies, for both IBM and Apple®.

So call or write for the nearest Rana retailer or computer store. We're Rana Systems. And we know that to keep a step ahead, we have to put you first.

RanaSystems



21300 Superior Street, Chatsworth, CA 91311 213-709-5484
Call toll free: 1-800-421-2207. In California only call: 1-800-262-1221
Source Number: TCT-654

The Texas Instruments makes the best software

Best-Seller List.



These best-sellers are among the most popular business software programs for microcomputers as reported in *Inc.* magazine, September, 1983.

Professional Computer perform even better.

See the difference the TI Professional Computer can make with these best-sellers and hundreds more software packages.

Literally hundreds of third-party software packages are available for the TI Professional Computer. So with the TI Professional Computer, whether you need word processing, accounting, spreadsheets, data base management or advanced integrated programs, the best — and best-selling — software can help you meet virtually every business and professional need. But before you consider software alone, you should weigh one other very important point: the better the hardware, the more you get out of your software.

It's no wonder critics have called it "the optimum personal computer."

*Popular Computing
October, 1983*

The TI Professional Computer's outstanding monitor resolution and 8-color graphics make best-selling programs like Lotus 1-2-3™ sharper, easier to work with. And the fact that you can put three times the graphic information on your screen — in both color and monochrome — means you'll be able to take even greater advantage of the best graphics programs. For best-selling word processing packages like WordStar™, TI's comfortable, typewriter-style keyboard is a natural. Anyone

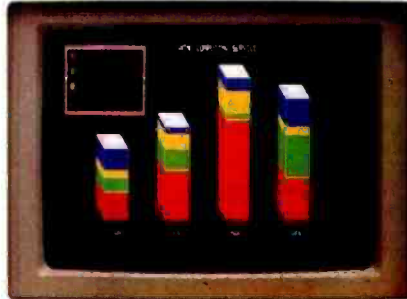

Our sharp, 8-color graphics give your displays even more visual impact.

familiar with a standard typewriter keyboard can start to work immediately, without re-learning key positions.

Texas Instruments has developed forward-looking programs to bring you innovative, easy-to-use technology.

One such package is Natural-Link™, TI's exclusive natural language interface program. NaturalLink lets you access information from subscription data base inquiry services, such as the Dow Jones News/Retrieval®

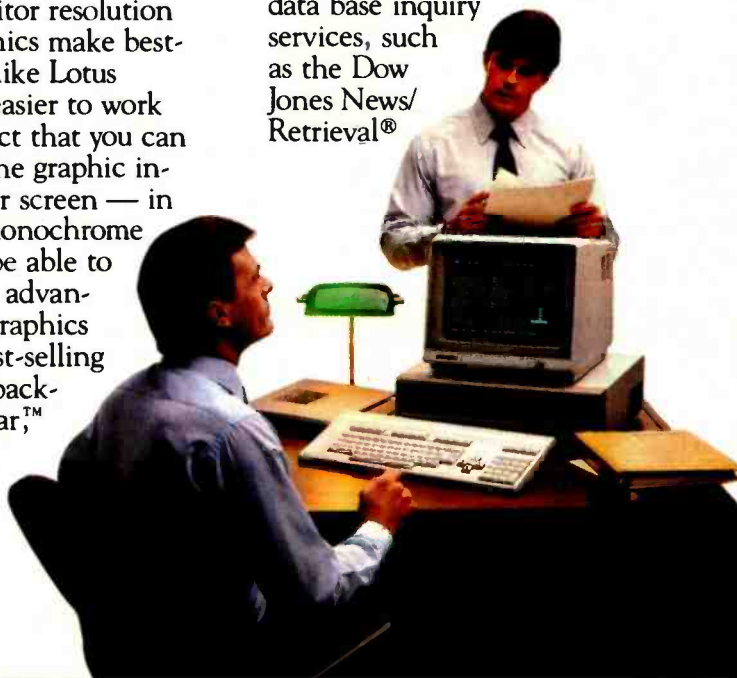

service, in plain English. So you don't have to memorize special codes to get the outside information your business depends on.

TI's revolutionary development of speech recognition is another way TI helps you get the most from your software.

Leading third-party software suppliers are developing new programs to take advantage of TI's speech technology. In early 1984, with Speech Command™ you'll be able to say things like, "Inventory analysis, please," and have a spreadsheet displayed instantly on your monitor. Voice-operation will make the TI Professional Computer easier to use than ever before.

If you're ready for the best — and best-selling — programs, you're ready for the Texas Instruments Professional Computer. Now at participating ComputerLand stores and independent dealers. For the location nearest you, and answers to questions about your computing needs, call 1-800-527-3500.



TEXAS INSTRUMENTS
Creating useful products
and services for you.

1-2-3 is a trademark of Lotus Development Corp.
Dow Jones News/Retrieval is a registered trademark of Dow Jones & Company, Inc.
WordStar is a trademark of MicroPro International Corp.
NaturalLink and Speech Command are trademarks of Texas Instruments Incorporated.
Copyright © 1983 Texas Instruments

LOOK NO FURTHER! we'll get you low prices and fast service, or else!



ALPHA OMEGA

COMPUTER PRODUCTS

COMPUTERS

| | |
|--|--------|
| CORONA Desktop, 128K, 2-320K Drives, Monitor | \$2645 |
| SANYO MBC 555 w/software | 1350 |
| ROMAR 64K Apple compatible | SAVE |
| IBM PC Systems | SAVE |
| KAYPRO II Portable | SAVE |

DISKETTES

| | |
|-----------------|------|
| SCOTCH 3M SSDD | \$23 |
| MAXELL MD2 DSDD | 39 |

PRINTERS

| | |
|------------------------------|-------|
| C. ITOH 8510 P. 120 cps | SAVE |
| EPSON FX80 160 cps | \$495 |
| EPSON FX100 160 cps | SAVE |
| OKIDATA Microline 92 160 cps | 445 |
| OKIDATA Microline 93 160 cps | 749 |
| DELTA 10 160 cps | SAVE |
| GEMINI 10X 120 cps | 279 |
| GEMINI 15X 120 cps | 425 |
| NEC 3550 35 cps L/Q | SAVE |
| JUKI 6100 L/Q 18 cps | 439 |
| PRINTER Pal | 24 |

MODEMS

| | |
|-----------------------------|-------|
| HAYES Smartmodem 1200 | \$489 |
| HAYES Smartmodem 1200B | 425 |
| HAYES Micromodem II | 265 |
| ANCHOR A. Mark I 300 BAUD | 81 |
| ANCHOR A. Mark XII 300/1200 | 269 |

MONITORS

| | |
|----------------------|-------|
| TAXAN 12" Amber | \$115 |
| GORILLA 12" Green | 85 |
| USI P13 12" Amber | 145 |
| AMDEK 300G 12" Green | 135 |
| AMDEK 300A 12" Amber | 145 |
| AMDEK Color I 13" | 305 |
| PRINCETON HX-12 RGB | 495 |
| BMC 13" Color | 219 |

APPLE PERIPHERALS & SOFTWARE

| | |
|----------------------------------|-------|
| VIDEX Videoterm 80C w/softswitch | \$209 |
| VIDEX Ultraterm | 279 |
| MICROSOFT 16K RAMcard | 69 |
| MICROSOFT 280 Softcard | 245 |
| MICROSOFT Premium Pack | 479 |
| MICROSOFT Premium Softcard IIE | 345 |
| KRAFT & TG Joystick | 45 |

| | |
|---------------------------------|------|
| HAYES Mach II Joystick | 33 |
| PROMETHIUS 1/2 Height Drives | 185 |
| WIZARD IPI Parallel Interface | 75 |
| PROMETHIUS Versacard | 149 |
| EPS Keyboard | 289 |
| KENSINGTON Systemsaver | 68 |
| COOL & TIME (fan, surge, clock) | 75 |
| KOALA Pad | 93 |
| PFS Filing System | 81 |
| PFS Report | 81 |
| DBase II | 389 |
| Wordstar | 249 |
| Home Accountant | SAVE |
| Multiplan | 165 |
| DB Master Version 4 | 249 |
| DB Utility 1 or 2 | 95 |
| Magic Window II | 109 |
| Zaxxon | 29 |
| Choplifter | 25 |
| Zork I/II/III | 28 |
| Wizardry | 39 |
| Sublogic Pinball | 27 |

IBM PERIPHERALS & SOFTWARE

| | |
|---------------------------------------|-------|
| TANDON TM100-2 | \$219 |
| SHUGART 1/2 Height | 229 |
| MICROSOFT Mouse | 139 |
| QUADRAM Quadboard w/64K | 269 |
| QUADRAM Quadlink | SAVE |
| QUADRAM Quadcolor I | 215 |
| 64K RAM Kit 200 ns | 55 |
| AST 6-pack plus | SAVE |
| STB w/64K clock, par, serial, game | 295 |
| HAYES Mach II Joystick | 35 |
| CORONA Int. 5MB Hard Disk | 1545 |
| Property Management | 335 |
| Home Accountant + | SAVE |
| Multimate | 329 |
| PFS Filing System | 89 |
| PFS Report | 81 |
| Lotus 1,2,3 | 325 |
| DBase II | 389 |
| Friday | 189 |
| Wordstar | 265 |
| Wordstar Propack w/Mallmrg, Spellstar | 395 |
| Multiplan | 165 |
| Flight Simulator | 33 |
| Deadline | 38 |
| Zork I/II/III | 28 |

Hundreds of available items. Call for complete pricing information.

We do not charge for VISA or MASTERCARD

(818) 345-4422



18612 Ventura Blvd., Tarzana, CA 91356

All products are in factory sealed packages. We guarantee all items for 30 days. Within this period, defective merchandise returns must be accompanied by RMA number. All other returns will be subject to a 10% restocking fee. For prepaid orders there will be a 3% shipping charge; 5% for UPS Blue Label; \$5.00 minimum; all orders outside U.S. at 15% shipping. There will be an additional \$4.00 surcharge on C.O.D. orders. Cash or Cashiers Check is required on C.O.D. orders. Calif. residents add 6.5% sales tax. Prices subject to change without notice.

Circle 25 on Inquiry card.

Letters

results are much slower than would otherwise be the case. Using the 68000 alone would reduce the time for the benchmark to less than 10 seconds.

Perhaps the problem is an inappropriate use of a high-level language to implement Xenix/BASIC. The obvious result is a crippled system. It is certainly possible to run the 68000 to produce benchmarks two or three times faster than any other personal computer currently on the market. This will become very obvious as soon as someone releases a well-designed BASIC for the Model 16.

Eric Lindsay
5 Hillcrest Avenue
Faulconbridge NSW 2776
Australia

Novices and the Morrow

As the owner of a Morrow MD-3, I must take issue with Tom Wadlow's views regarding the purchase of this computer by novice users ("The Morrow Micro Decision," October 1983, page 306). The author's contention that the software is not suitable for novice users creates the impression that the beginner would have a great deal of difficulty using the software.

I am a relative novice to computers, with only minimal experience using an Atari 400 with cassette interface, and (was) a complete novice in the use of floppy disks for software application. With total time on my system now at perhaps 40 hours, I feel that all of the software is accessible to and usable by me, with the exception of the uninstalled (read unlicensed) Quest Accounting software.

The Morrow Pilot software took the confusion out of making backups for the operational software and allowed installation of CP/M on all of the working disks without any problems whatsoever. I merely followed the directions in the Morrow documentation and the menus presented themselves on the screen. The documentation for Logicalc admittedly does not have much in the way of a tutorial; however, this menu-driven spreadsheet is much faster to learn than Supercalc (I was shown this subsequent to my exposure to Logicalc), despite Supercalc's rather extensive tutorial. Supercalc is perhaps a more powerful program, but for the occasional user, Logicalc has my vote for being user-friendly.

Circle 398 on Inquiry card. →

BLU CHIP PORTFOLIO MANAGER



FIRST CLASS SOFTWARE

FOR IBM® PC AND COMPATIBLES

Keeping track of your stock market investments can be time consuming and confusing. Blu Chip Portfolio Manager, your broker on a disk, helps you watch your portfolio grow.

Now you can have the ability to create hypothetical transactions before committing your hard-earned capital.



Blu Chip gives you the tax consequences of your next buy or sell decision with spreadsheet capabilities and instant portfolio retrieval.

Your investments are important. They deserve First Class Software by Xor Corporation.

Blu Chip Portfolio Manager — at fine computer stores near you.

IBM is a registered trademark of International Business Machines Corporation.

WAREHOUSE SOFTWARE

TECHNICAL INFORMATION (602) 842-1133

Call for programs not listed. We will try to meet or beat any legitimate price for CP/M or IBM PC Software. Most disk formats available.

DATA BASE MANAGEMENT SYSTEMS

UNBEATABLE PACKAGE PRICE!!

DBASEII + Instruction Book "Using DBASEII", Extra Diskette with Dbase Accounting, Mail list and Inventory Programs. For IBM PC and CP/M. Call for our special price.

| | |
|--|--------------|
| Fox and Geller Quickcode | \$175 |
| DB+SORT | \$89 |
| Condor III | \$340 |
| NWA Statpack | \$350 |
| TIM IV | \$259 |
| Infostar | \$259 |
| PFS File | \$95 |
| RBASE 4000 | \$299 |
| Personal Pearl | \$145 |
| Fast Facts for IBM PC | \$135 |
| WORD-PROCESSING | |
| Wordstar, Mail Merge, Spellstar, Index | \$399 |
| Wordstar | \$245 |
| Mail Merge or Spell Star | \$135 |
| Microsoft Word W/Mouse | \$295 |
| Word Perfect | \$295 |
| Volkswriter for IBM PC | \$115 |
| Wang Spellchecker | \$36 |
| Metasoft Benchmark | \$265 |
| Multimate | \$295 |
| Peachtext 5000 | \$219 |
| SPREADSHEETS | |
| Calcstar - IBM PC Spec. \$65 .. Others .. | \$95 |
| Supercalc II | \$159 |
| Supercalc III | \$199 |
| Microsoft Multiplan | \$159 |
| ACCOUNTING | |

TCS. Equivalent of Peachtree - Specially Augmented By Warehouse Software Customized For Your IBM PC Terminal and Printer - GL, AR, PA, AP, CP/M, for PC XT, DOS 1.1, 2.0
Each Module **\$75** For All Four **\$275**

| | |
|------------------------------------|--------------|
| CYMA | Call |
| Peachtree GL, AR, AP | \$245 |
| Home Accountant Howardsoft | \$95 |
| Real World, GL, AR, AP, PA .. each | \$350 |

TRANSFER PROGRAMS

| | |
|----------------------------|--------------|
| Move-It | \$85 |
| Microstuff Crosstalk | \$105 |

Best Price in U.S. for IBM PC or Clones
Multifunction Board—Includes Async Adapter, Parallel Adapter, Clock with battery back-up and Software, 64K Memory Expandable to 384K.
1 year warranty **\$265** |

LANGUAGES

| | |
|---------------------------------|--------------|
| Lifeboat C Compiler | \$295 |
| Microsoft C Compiler | \$335 |
| Microsoft Pascal Compiler | \$245 |
| Microsoft Basic Compiler | \$285 |
| Microsoft Basic Language | \$250 |
| CBASIC 86 for IBM PC | \$165 |
| CBASIC CP/M-80 | \$99 |

16 Pounds of IBM PC DOS Compatible Portable Computer-Hyperion-2 Disc Drives - Software.
List 3690 **Sale \$2665** |

FOR PC DOS

| | |
|----------------------------------|--------------|
| Norton Utilities | \$55 |
| Copy II PC | \$34 |
| Prokey | \$55 |
| Howardsoft Tax Preparer 84 | \$215 |
| Microsoft Flight Simulator | \$38 |

HARDWARE

| | |
|--|--------------|
| Hayes 1200 Modem | \$485 |
| Hayes 1200B Modem | \$430 |
| Anchor Signalman 1200baud Modem | \$285 |
| Plantronics Color + Board | \$365 |
| Koala pad for IBM PC | \$88 |
| Quadram Color I Board | \$199 |
| 256 K Ram Board | \$299 |
| Princeton RGB Hi-Res Monitor | \$495 |
| Gemini 15X, 10x Printers | Call |
| Corona Computer - Port. or Desk Top Call | |

TERMS: Prices include 3% cash discount. Add 3% for charge orders. Shipping on most items \$5.00.
AZ orders +6% sales tax. Prices subject to change.

TOLL FREE ORDER LINE 1-800-421-3135

WAREHOUSE SOFTWARE
4935 West Glendale Ave., Suite 12
Glendale, AZ 85301

Letters

As far as the terminal goes, most dealers I spoke with echoed the author's concerns that the Lear-Siegler terminal is very poor; each of them recommended the Freedom terminal, which appears to overcome all of the inherent problems of the Lear-Siegler.

I researched the midrange computer market for almost six months before purchasing the Morrow and I became convinced that this computer offered the most value and highest quality within this price range. My use of the computer in the past weeks has shown it to be everything I expected. It would be a shame for novice users to be scared away from such a fine product strictly because of the lack of a tutorial in two of the software packages.

Steven D. Edgett
541 Shasta Way
Mill Valley, CA 94941

Buyers Count Dollars

In the interview with the Macintosh design team (February, page 58), Steve Jobs appears to be hung up on the IBM video-board chip count. Great; as an engineer, I, too, appreciate an elegant design. Unfortunately, the Macintosh design elegance does not seem to be reflected in its price tag. It remains to be seen whether the mouseketeers of Bandy Drive have a winner or are once again a day late and a dollar long.

Steve is quoted as saying of the IBM video card, "... it basically does nothing. And it doesn't even do that very well." Wrong, Steve, it does something very well—it sells like hotcakes.

The bottom line is that engineers and hackers count chips but buyers count dollars, the number of available programs, and quality of support. At \$1500, the Macintosh could have been named the Volkslisa, but at \$2500—ho hum. With all the choices, I think I'll just shop around.

Joseph N. Mente
Federal Signal Corp.
2645 Federal Signal Dr.
University Park, IL 60466

On Fixing Things

After reading Tim Field's article "The IBM PC and the Intel 8087 Coprocessor, Part 2: Interfacing to IBM Pascal"

(September 1983, page 331) about using the 8087 in the IBM PC, I must ask, what is going on at IBM and Microsoft? Why must Mr. Field and all those who follow his apparently comprehensive instructions have to do so at all?

Is it so difficult for Microsoft, the self-proclaimed "standard," to add an 8087 library to its compiler? Years ago North Star obtained excellent performance by using a math chip. Digital Research provides 8087 libraries with Pascal MT+.

Why would anyone want to add FORTH-like routines to do arithmetic? Why doesn't IBM put some time and effort into providing a decent compiler for its hardware?

While I can understand Mr. Field's need to use two real storage units to store one real number, I pity the programmer who has to modify the code later.

It is as important that BYTE comment about incomplete products (such as IBM Pascal) as it is for BYTE to indicate how to get around the associated problems.

Mike Draper
Raxco Ltd.
18 Cowdy St.
Kingston, Ontario
Canada K7K 3V7

Microcomputer Study

At the Public Management Institute (PMI) of George Mason University, we are beginning a study on the use of microcomputers in the public sector. The purpose of our study is to establish basic information on both the uses to which micros are put in the public sector and management approaches to dealing with the introduction of micros in government offices.

If any of your readers have had experiences planning for, using, or managing microcomputers in a public-sector environment (excluding educational institutions), we would like to hear from them. All information provided will be kept in strict confidence and contributors will receive a copy of the study report. We may be contacted at the following address:

Microcomputer Study
Public Management Institute
George Mason University
4400 Mason University Dr.
Fairfax, VA 22030

In the longer run, we hope to build on

Self-dFENSE™ for EDP managers.

The micro invasion has begun. And, chances are, you've now got a lot of different people in a lot of different departments using a lot of different micros.

Now there's a way for you to control and maximize the benefits of all the different micros in your domain.



Fight back with dBASE II.®

dBASE II is the relational database management system from Ashton-Tate that enables you to manage your micro-based corporate data resources with the high level of consistency and sophistication you've enjoyed with mainframe and minicomputer systems.

Armed with dBASE II and the dBASE II RunTime™ program development module, you can write programs which will enable micro users in each department to "do their own thing" while creating complete database consistency throughout the company.

dBASE II is a powerful, flexible way for you to effectively manage the micro proliferation.

Help is here.

If you'd like to know more about how dBASE II and RunTime can help you win the micro management battle, contact Ashton-Tate today. 10150 West Jefferson Boulevard, Culver City, CA 90230. (800) 437-4329, ext. 212. In Colorado (303) 799-4900. In the U.K. (0908) 568866.

ASHTON · TATE ■™

dBASE II is a registered trademark and RunTime is a trademark of Ashton-Tate.
Suggested retail price for dBASE II is \$700.
© Ashton-Tate 1984

the experiences gathered for this study to establish a national information-sharing network for public-sector institutions that will enable public agencies to secure information and assistance with the task of microcomputer implementation.

John W. Ostrowski
George Mason University
Fairfax, VA 22030

Turbocharging

The January 1983 issue has a nice listing of benchmark timing figures for the Sieve of Eratosthenes program ("Eratosthenes Revisited: Once More through the Sieve," page 283, by Jim and Gary Gilbreath). Having recently brought up an 8-MHz Slicer computer (using the 80186) running CP/M-86 and a just-acquired copy of Borland's Turbo Pascal, I thought the time had come to do an experiment. I was somewhat staggered by the results:

Load Turbo from 8-inch single-sided, single-density disk: 12 seconds

Load Sieve into Turbo: < 1 second
Compile into Com file ready to run: 0.1 second!

Execute 10 iterations: 6.2 seconds
Bytes of code compiled: 288
Bytes of data: 8208
Bytes of stack/heap: 62176

The compile time seems to be some 300 times faster than the next fastest shown in table 3 in the article. The test/demo program that comes with Turbo Pascal contains 1200 lines of Pascal programming and compiles in 12 seconds into a Com file on this machine.

Edward S. Dayhoff
1618 Tilton Dr.
Silver Spring, MD 20902

The Ultimate Test

The feedback we've received from our article "An Operations Research Scheduling Program" (September 1983, page 549) was gratifying, more so perhaps because BYTE readers actually were ap-

plying the program therein to real problems.

However, precisely because other problems were attacked, several fatal bugs were uncovered by readers. The main bug, giving a "NEXT WITHOUT FOR ERROR" at line 3760, involved several logic errors; this problem may be patch by the following changes:

```
3620 GOSUB 4910: REM - FILTE
3730 IF FLAG = 0 THEN GOTO 3.
4720 IF RPT = 1 THEN HOME:PRIN
      PRINT "A GOOD SEQUENCE
IS:":GOTO 4770
```

Additionally, you must DELeTe lines 3890 through 3940, and in lines 4340, 4370, and 4390, change the variable FL to FG. These changes should make the program run correctly.

Walter A. Stark Jr.
POB 372
Los Alamos, NM 03449■

BYTE's Bits

Unique Dolphin Program

A program from Syntauri works with an Apple II/IIe and Mountain Computer's Music System to produce dolphin-like sounds. Dolphin Dialogue is used by a communications project at the Institute for Delphinid Research. Researchers there use this software to investigate language-like communications with dolphins.

The researchers synthesize sounds similar to a dolphin's distinctive whistles and trills. Program operation is simple: a sequence of letters entered via the keyboard triggers dolphin-like noises that are used to make a simple sentence that both man and dolphin can interpret. The dolphins are said to have learned words and to have achieved a limited understanding of word combinations. Communication is now one-way. Future plans call for an underwater link between the dolphins and the computer to let the dolphins produce their own combinations of words.

All profits will be donated to the Cetuman Foundation, which funds the Institute. The program costs \$39; \$44 overseas. A poster is \$10. Syntauri Corporation is located at 4962 El Camino Real, Los Altos, CA 94022, (415) 966-1273.■

BYTEWRITER®
DAISY WHEEL PRINTERS

| | |
|---|-------|
| Praxis 35 portable BYTEWRITER | \$495 |
| Praxis 40 office BYTEWRITER | \$595 |
| Model 900 (no keyboard) 900 day warranty | \$649 |
| Serial and parallel input. Tractor and friction feed. | |
| Interface only - wired and tested for Praxis 30, 35 and 40 | \$165 |
| for ET-111 | \$195 |

BYTEWRITER
125 NORTHVIEW RD., ITHACA, N.Y. 14850
(607) 272-1132

The Toughest Statistical Problems Now Have A Simple Solution.

ABstat.

Introduce yourself to ABstat.

It's the simplest solution to your statistical problems. And for several very good reasons, it may very well be the best statistical data analysis system on the market.

First, ABstat is comprehensive.

Whether your task is simple or complex, ABstat completes it quickly and efficiently. With powerful routines analyzing and manipulating your data. For starters, descriptive statistics for selected variables. Chi-square, analysis of variance, correlations, cross-tabulations, multiple regressions, and tests of hypothesis. Just to name a few.

ABstat is also very simple to use. And it's fast.

With ABstat, you don't need to enter a lot of commands to perform a function. And that means easier data manipulation, and more control. Plus, you've got a built-in editor that will simplify your data input. Or you can read data directly from your ASCII or dBase II files.

What's more, you don't need previous computer experience. ABstat is command driven. And even if you get stuck on a procedure, all you have to do is enter a "?" for immediate help.

ABstat is very much at home on the IBM PC. As well as many other makes of microcomputers. All you need is a CP/M, CP/M-86, MS-DOS, or PC-DOS operating system. And a reasonable \$395.

Right now, ABstat is solving problems in manufacturing, marketing, medical research, mining, petroleum, pharmaceuticals, and transportation. In major corporations from Xerox to Quaker Oats and British Petroleum. And in hundreds of small businesses, too.

One last bit of information. If you call 1-800-255-5550, ext 310, you'll get a free ABstat brochure and the name of your nearest ABstat dealer. Or write us at P.O. Box 191, Canon City, CO 81212, (303) 275-1661.

AndersonBell
TURNING INFORMATION INTO INSIGHT

Circle 477 on inquiry card.

dBASE II is a trademark of Ashton-Tate. IBM PC and PC-DOS are trademarks of International Business Machines Corp. CP/M and CP/M-86 are trademarks of Digital Research Corp. MS-DOS is a trademark of Microsoft Corp.

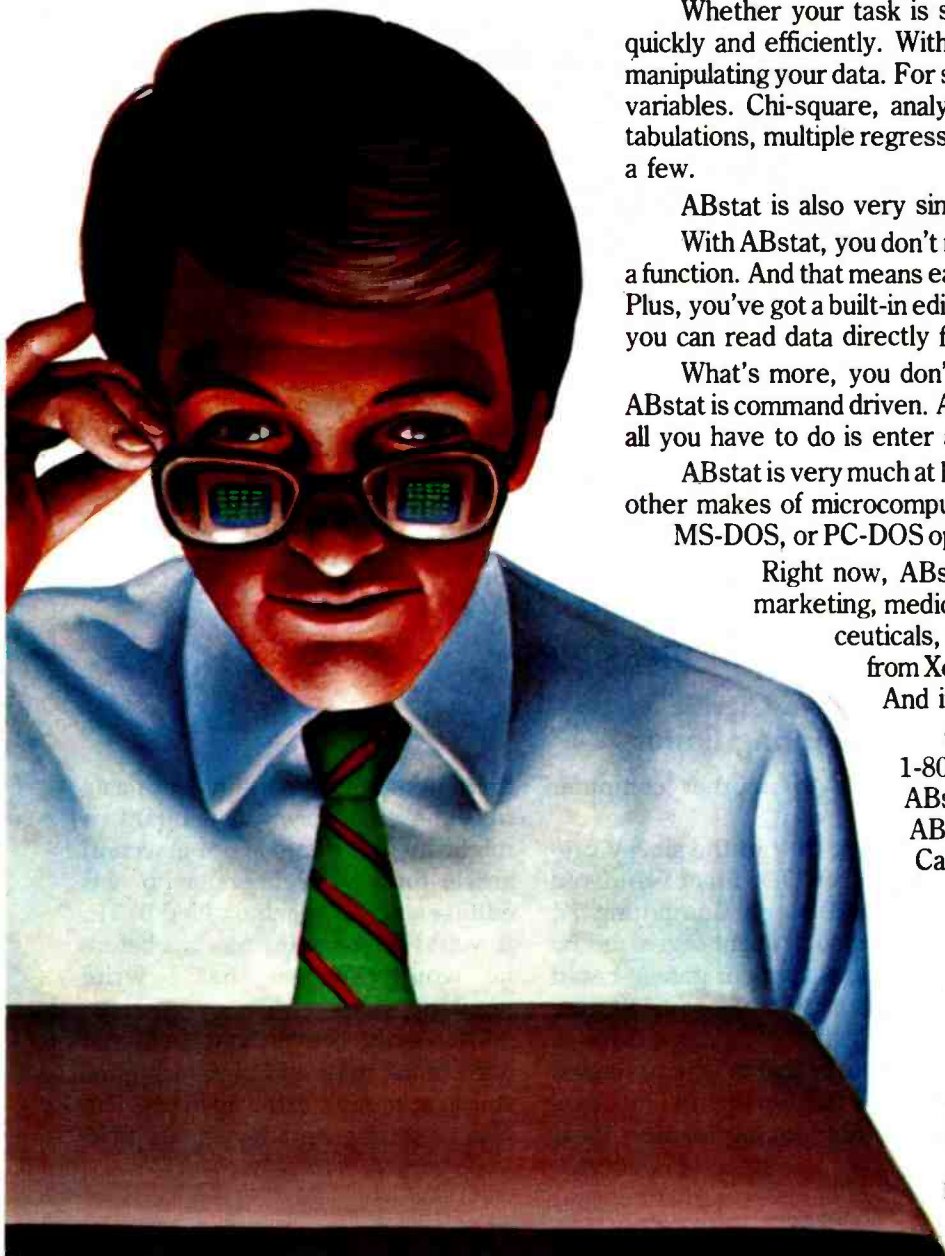

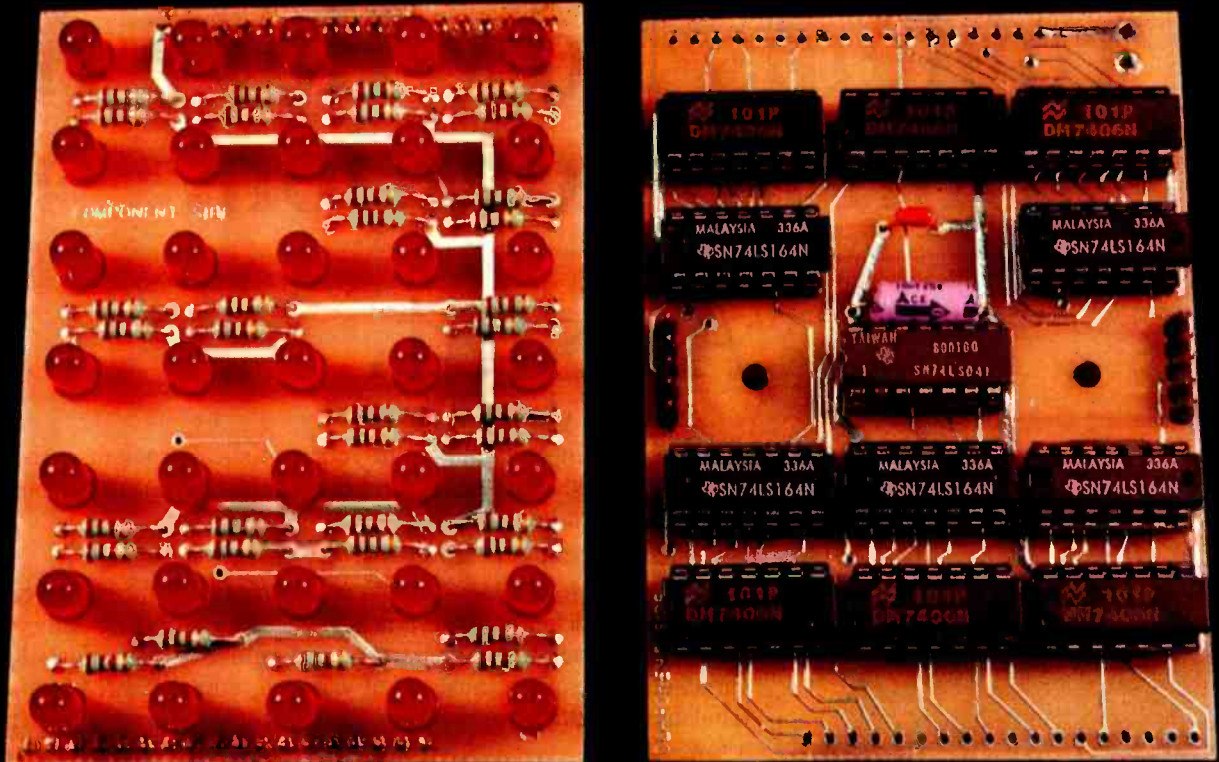

Photo 1: The two printed-circuit boards needed to form one character segment in the display. One board contains the 35 LEDs and the current-limiting resistors; the other holds the shift-register sections and buffer/drivers.

Build a Scrolling Alphanumeric LED Display

*Individual character arrays can be linked together
to show longer messages*

Steve Ciarcia
Consulting Editor

The helicopter banked around, and someone gasped audibly as we beheld the spectacle of the Grand Canyon. The computer-show exhibitor who had sponsored this special excursion for our group was getting his money's worth. But my thoughts, dulled by visits to seven hotel hospitality suites, strayed from

the scenery to another computer show. . . .

In Atlantic City in the sleepy pre-casino year of 1977, I had wandered the aisles of Personal Computing '77, the second such event organized by John Dilks. Dozens of garage-based entrepreneurs were showing off their answers to the MITS Altair 8800 in display booths that mostly contained prototypes propped up on card tables. I was looking for new ideas

that might help me in my work as a full-time engineering consultant or might inspire me to write a second article for Carl Helmers, who was editing a new magazine called BYTE. It would still be many months before he would suggest that I write regularly.

That early convention contained none of the hype and high-tech glossiness of today's extravaganzas. The idea of setting up a lavish hospital-

ity suite or of renting Disneyland for a night hadn't yet occurred to any microcomputer companies, none of which had hired image-conscious advertising executives.

But technical ideas came thick and furious in those days, I mused. Although a few clever inventors had used their inspirations to vault into prosperity, some ideas I had seen weren't the kind on which fortunes are built. Like the guy I had talked to that year who was convinced that his hand-soldered scrolling LED (light-emitting diode) display would make him a millionaire. . . .

Wait a minute! Maybe it did. Just yesterday I had seen scads of scrolling LED display signs in the exhibit hall. These signs, which are generally designed as a single message line 10 to 20 characters long, consist of a multitude of LEDs that are wired in such a way that the text scrolls in sequence from right to left.

I had stopped at one company's booth to admire its LED display. The LED unit consisted of twenty 5- by 7-element dot-matrix characters and a hand-held controller that allowed you to enter messages that would be displayed on the sign. It came housed in an attractive wooden enclosure with a power supply. The price was \$2000, and the exhibitor was doing land-office business—if I wanted one, I'd have to wait three months. Two aisles away the real piece de résistance resided: at the Hewlett-Packard booth was a 4- by 5-foot LED graphics display (not for sale). The LEDs in the character segments were spaced so that the characters could be expanded both horizontally and vertically. I had inspected HP's display and estimated that there were approximately 10,700 LEDs in it.

The helicopter pitched, and my thoughts were jerked back to the present. But my next project was decided. I wanted a scrolling LED sign for the Circuit Cellar.

Design Alternatives

You don't have to have an engineering degree to design a scrolling LED display. But when a project contains so many components, it's best to

(2a)



(2b)

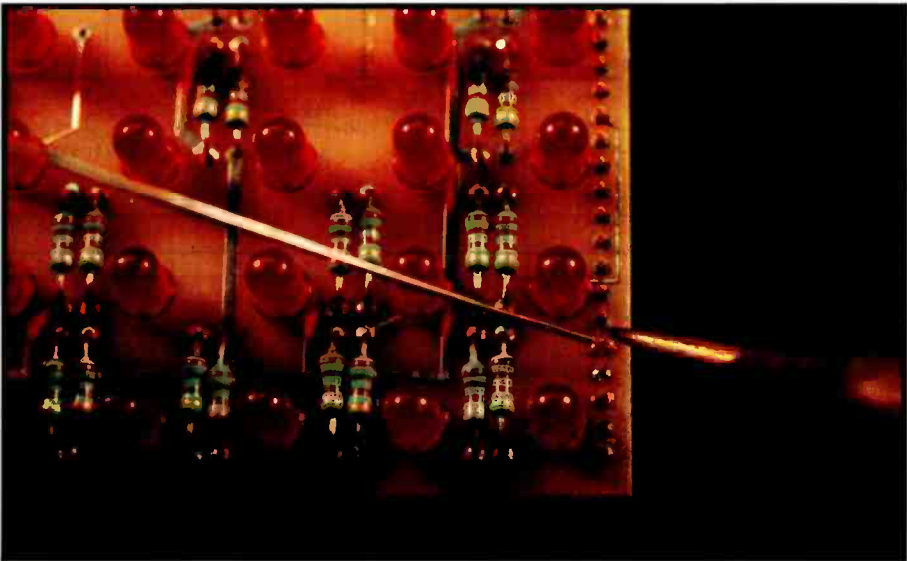

(2c)

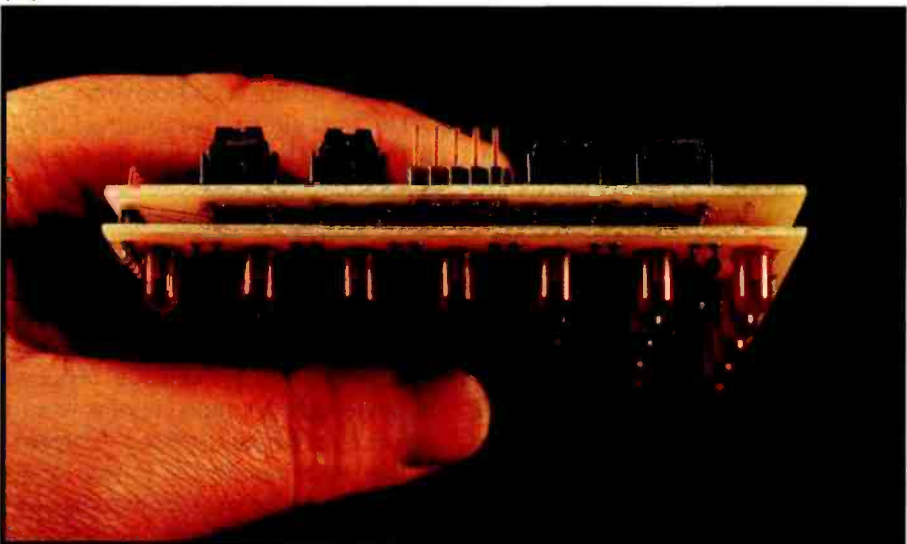

Photo 2: The two boards are mounted back to back (2a). Two 18-pin Berg-type connectors are soldered together (2b) to electrically and mechanically join the two halves into a sandwich (2c). The 35 LEDs in the character segment are placed on half-inch centers in both dimensions for possible use in graphics.

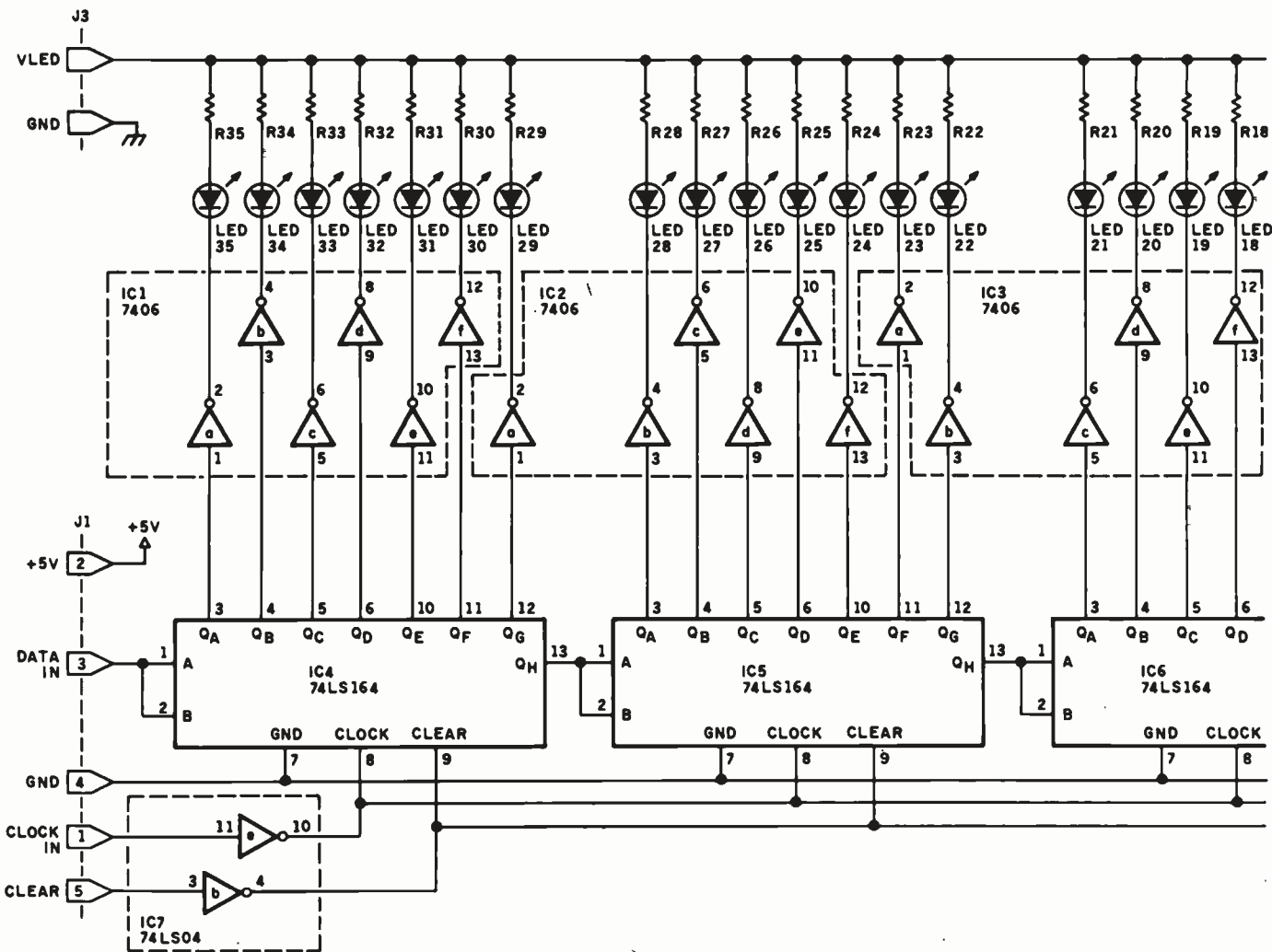

Figure 1: Schematic diagram of one of the character-segment subassemblies for the scrolling LED display.

spend some time early in the design process considering how to keep the final product easy to make and use.

When I looked at that first LED sign seven years ago, I thought, "What a simple product! How hard is it to drive a few LEDs?" But now that I was close to building a sign, I noticed the roadblock that had kept other people from doing the same: there are a lot of LEDs in it.

The most direct approach to controlling all those LEDs is *direct drive*, in which a wire for each individual LED is connected to one line of a parallel output port. When the appropriate bit in the output port is turned on, the LED connected to it (through an LED-driver component) will light up. A typical direct-drive setup requires little sophistication,

but it takes a lot of hardware. Controlling 100 LEDs requires 100 separate output lines and drivers.

The best alternative to direct drive is the *multiplexed display*. In this arrangement, the LEDs are wired at the intersections of a series of rows and columns. Each LED is illuminated when voltages appear on both its row connection and its column connection and current flows through it. Component count is thus reduced because only a single set of row and column drivers is required. Unfortunately, figuring out the proper scanning speed, the peak power dissipation, and the average intensity makes designing the control circuit relatively complicated. A few years ago I worked through a multiplexed display design and wrote an article en-

titled "Self-Refreshing LED Graphics Display" (see reference 2), which you can read if you want to know more on that topic.

The LED display I built for this article had to be simple enough to be wired by hand (by someone with time to spare) and yet also be sufficiently sophisticated to duplicate the intelligent features of commercial units. I decided to use a version of the direct-drive technique.

Design Specifics

Each character segment must consist of at least 35 LEDs (for a 5 by 7 matrix) to display a complete set of alphanumeric characters, even for a single-line display. A 6 by 9 matrix would need 54 LEDs. The support circuitry—drivers, current-limiting

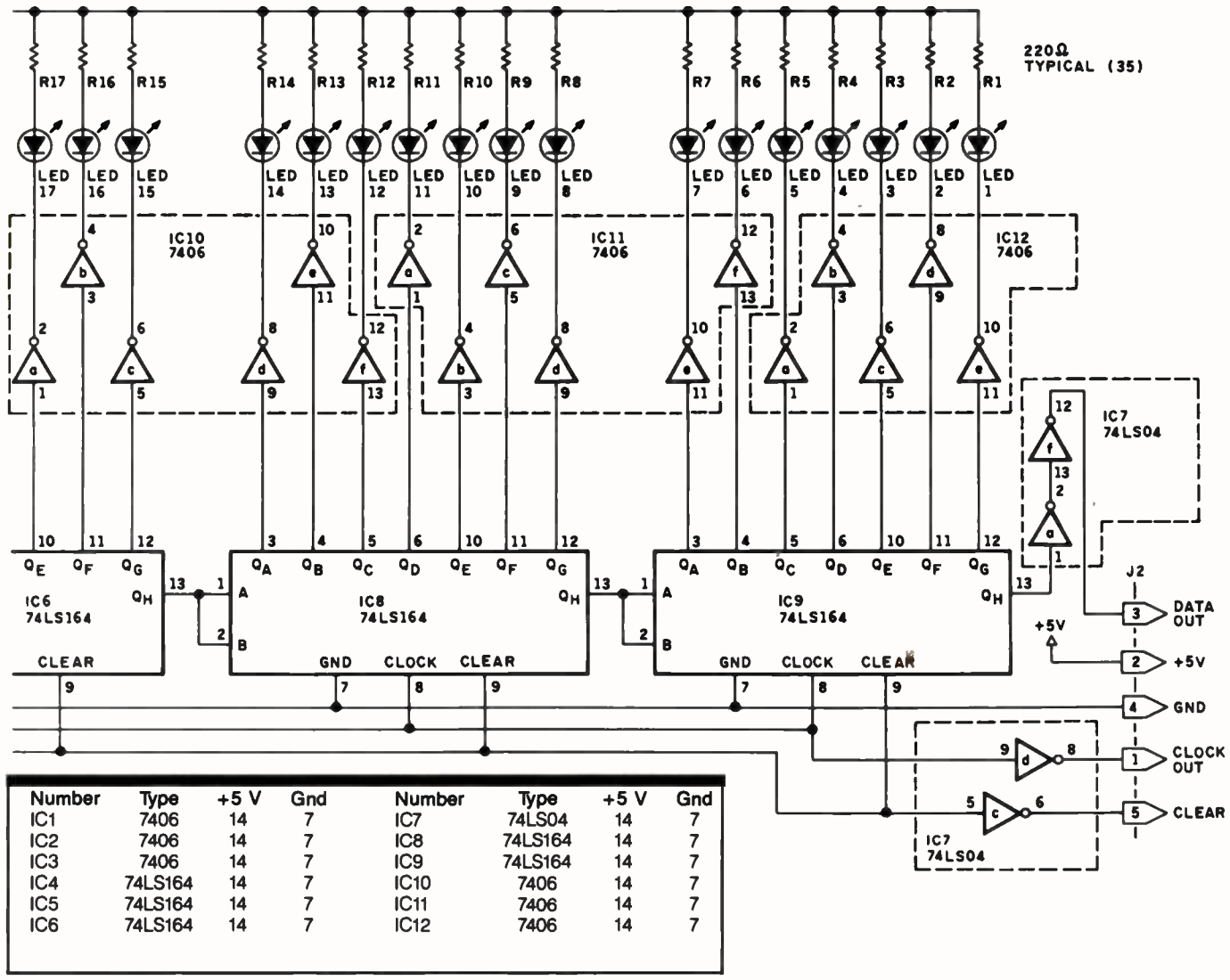

resistors, etc.—necessitates hundreds of connections for each segment. While I considered wiring one segment by hand, I didn't have the time to construct two, let alone 20. Even though an LED sign is relatively uncomplicated, the sheer number of connections makes it hard to put together. I definitely needed to display between 10 and 20 characters for most applications, so I decided to lay out a printed-circuit board even before building my first prototype. (I don't recommend this shortcut to anyone who doesn't possess years of experience with digital electronics.)

The configuration I came up with for a character segment, shown in photos 1 and 2, is an amalgam of two printed-circuit boards mounted back to back. The front board contains 35

LEDs and their current-limiting resistors, while the rear board contains 12 integrated circuits (the shift registers and drivers); all these parts form a 5- by 7-element character matrix. Segments are linked together in daisy-chain fashion to build linear arrays of many characters, as shown in photo 3. And while a single-line textual display is the most probable application, the LEDs are spaced on half-inch centers both horizontally and vertically so that graphics images can be displayed.

Instead of using conventional parallel direct-drive activation, I put in a serial shift register, effectively 35 bits long, to control the 35 LEDs. As a bit of data is shifted through the register, the LED to which it corresponds is illuminated or extin-

guished depending upon the bit's logic level, high or low.

Figure 1 is a schematic diagram of one of the character-segment sub-assemblies; figure 2 shows how the LEDs are placed to form the matrix. A serial shift register, physically 40 bits in length, is formed by IC4, IC5, IC6, IC8, and IC9: five type-74LS164 8-bit registers. The first seven positions in each of these chips (0 through 6) are connected to LEDs through the open-collector driver sections of IC1, IC2, and IC3 (type-7406 inverting buffer/drivers); the eighth position (bit 7) is not connected to an LED but is reserved for connecting adjacent register stages.

Data is entered into the shift register one bit at a time by setting the appropriate logic level for the bit

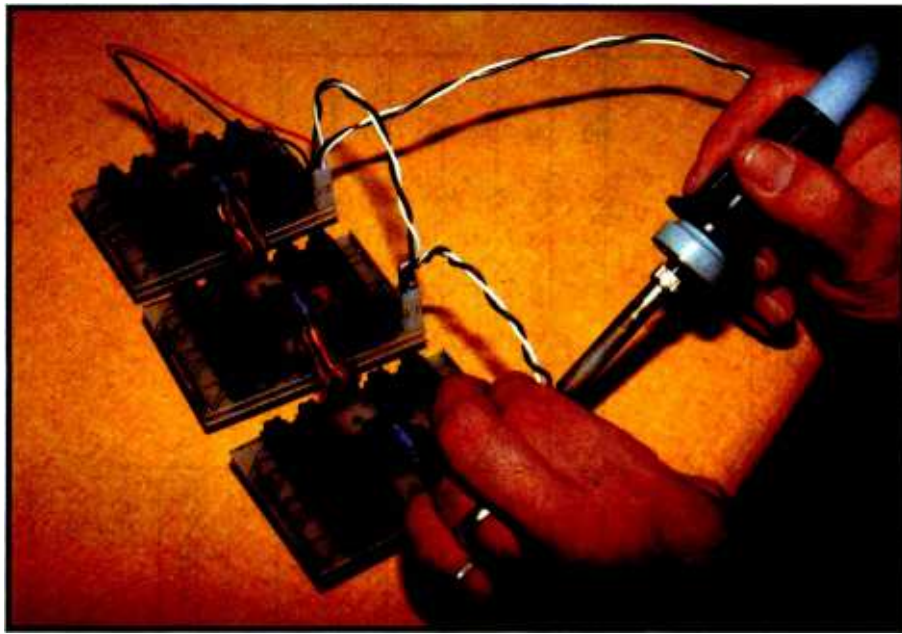

Photo 3: Multiple character segments are connected together in a daisy chain to form a linear display capable of holding several words at once. The red connectors at the center of the board edges carry the CLOCK and DATA signals, while the black and white wires carry the power to drive the LEDs.

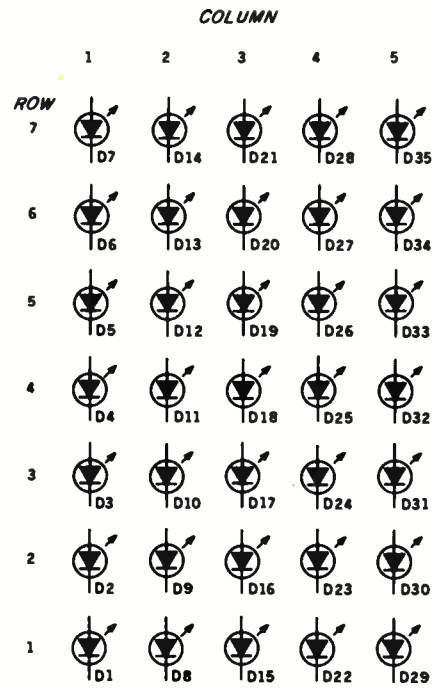

Figure 2: The LEDs are placed to form a 5-by-7-element matrix.

on the data input line and then pulsing the clock input line to a logic 0. Data is synchronously shifted through the register on the occurrence of the negative-going edge of the clock pulse, with the result that the light pattern on the LED matrix also shifts. To clear the display, a high level is set on the CLEAR line, which

normally operates at a logic 0 level. As figure 3 shows, the bits enter the rightmost column of the display (column 5), filling it from top to bottom. Once column 5 is filled, additional data entering the register causes the contents of column 5 to be shifted into column 4, again starting from the top. In essence, data enters the seg-

ment matrix from element D35, progressing through to D1.

Although 35 LEDs are in the display, it takes 40 clock pulses to fill the five 8-bit shift-register stages. Each 7-bit word of column data is preceded by a filler bit (usually a 0) that does not show up in the display. After eight clock pulses have occurred, the

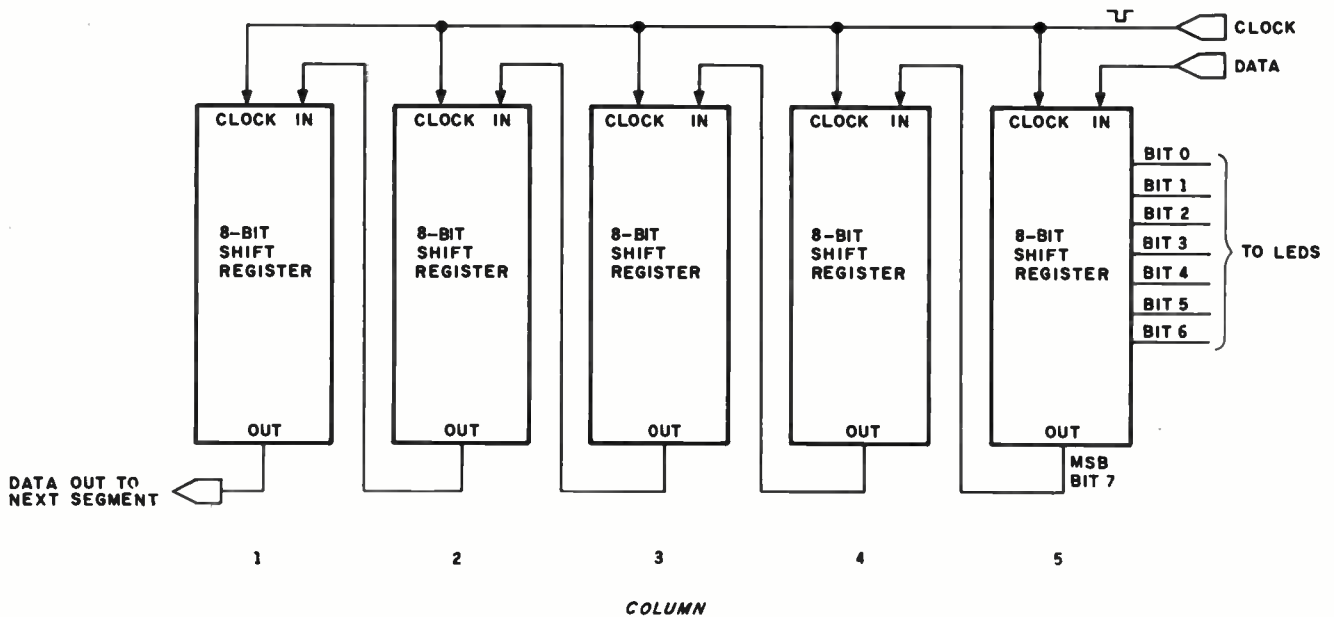

Figure 3: The shift-register sections are wired so that bits being shifted out of the rightmost column (at the most significant bit) enter the next column, and so on to the end of the character segment. Each low-order register position is connected to an LED driver. (Bits can also be shifted from one segment to another.)

7 data bits will be displayed in LEDs D29 through D35. After 8 more bits have been shifted in, the contents of column 5 have been completely moved to column 4, and so on. (To eliminate confusion, it is best to think of this as a column display where data is always entered 8 bits at a time.)

The shifting takes place too fast to see, so if the display contents are to be viewed by human eyes, the shifting must be halted occasionally for a viewing interval. If the 8 data bits are shifted in quickly relative to the amount of time they are left stationary for viewing, all the display contents will appear to scroll smoothly from right to left, one column at a time. How smoothly the display scrolls depends mostly on the speed of the program controlling it.

How to Use the Display

The Circuit Cellar LED display is simple to use. Because of its serial input, it requires use of only a single output bit from a computer. It's convenient to use one bit of a conventional parallel printer port as a source for this signal; figure 4 shows how the printer port on an IBM Personal Computer's Monochrome Display Adapter can be wired to the LED display.

Another benefit arises because of this arrangement: when a bit is output through the printer port, the port's 5-microsecond (μ s) STROBE signal is automatically triggered. These STROBE signals can be used as clock pulses to shift the bits through the registers. (I used only the least significant bit, bit 0 or the LSB, of the 8 available, but a second data line could have been connected to the display's CLEAR line to control that as well.) If multiple character segments are used, the data input of the first segment is connected to the computer; the other segment inputs are chained from the leftmost column of the preceding segments.

Once you're set up to send bits into the display, you need to know what bits to send. For textual displays, the bits should be set according to matrix patterns that form alphanumeric characters, such as the pattern of figure 5 that forms the numeral "2"

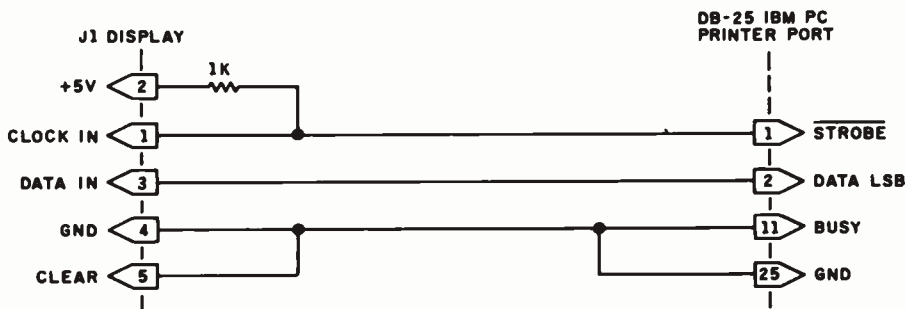

Figure 4: The parallel printer port on an IBM PC's Monochrome Display Adapter can be wired to drive the LED display using only the least significant data bit.

Listing 1: BASIC program that causes a "4" to appear on the scrolling LED display, sending data through a parallel printer port on the IBM PC. If you turn the page sideways, you can see the image pattern in the DATA values.

```

100 DIM X(50)
110 DATA 0,0,1,1,0,0,0,0
120 DATA 0,0,1,0,1,0,0,0
130 DATA 0,0,1,0,0,1,0,0
140 DATA 1,1,1,1,1,1,1,1
150 DATA 0,0,1,0,0,0,0,0
200 FOR C=1 TO 40
220 READ X(C)
240 NEXT C
250 FOR C=1 TO 40
260 LPRINT CHR$(36+X(C));
270 NEXT C
999 END

```

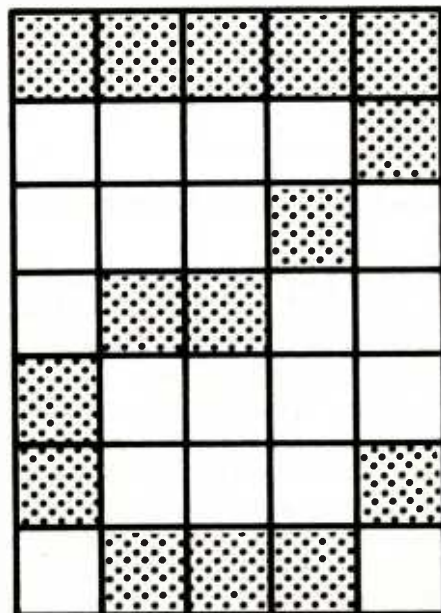

Figure 5: A bit pattern that forms the numeral "2" in a 5- by 7-element representation.

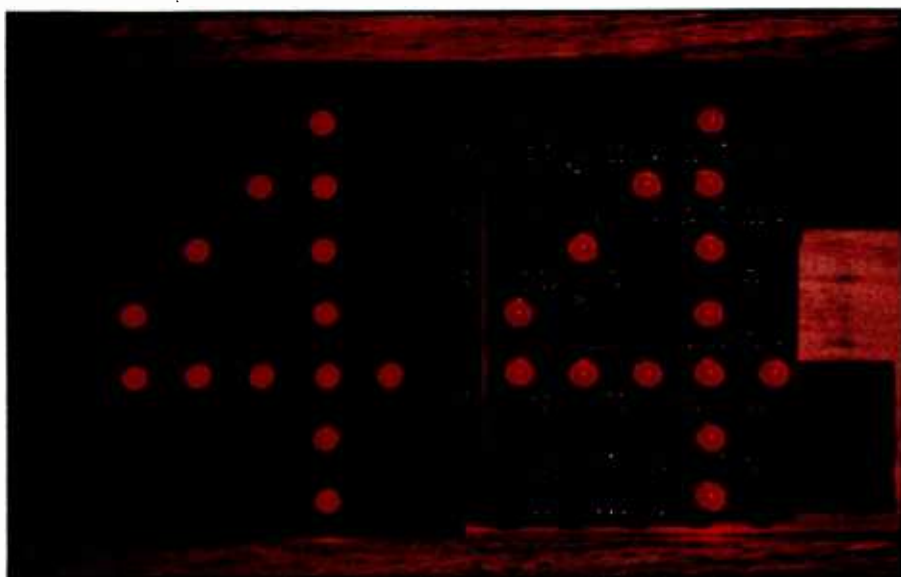

Photo 4: These examples of the numeral "4" were produced by the same bit pattern used in listing 1, but under the control of the Z8-BASIC System Controller. The red plastic filter over the left segment greatly improves the appearance of the display.

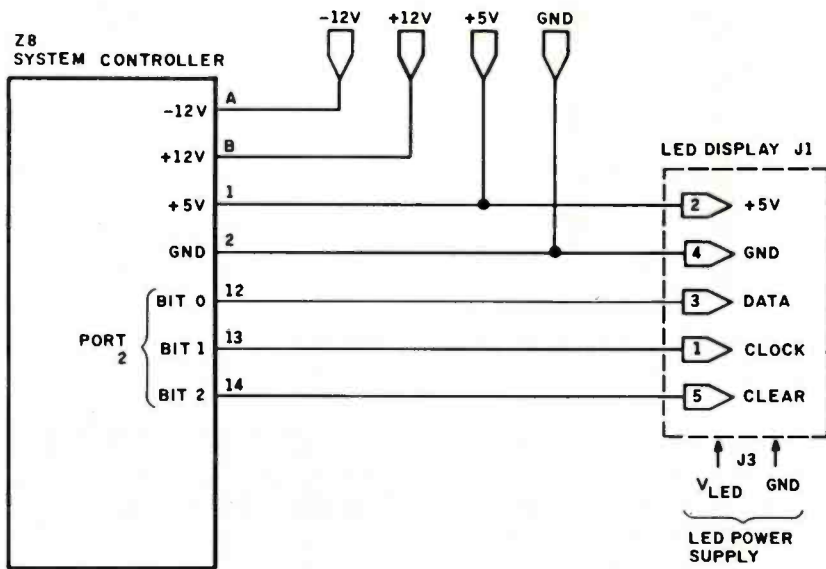

Figure 6: Diagram for connecting the scrolling LED display to the Z8-BASIC System Controller.

in a 5 by 7 representation. In the most simple case, data can be sent to the display using LPRINT statements from a BASIC interpreter.

A short BASIC program that displays "4" on the LEDs is shown in listing 1. The program begins with DATA statements that contain the bit patterns for each of the five columns. These values of 0 or 1 are read into the array X in lines 200, 220, and 240. The second FOR...NEXT loop sends the data to the display one bit at a time with an LPRINT statement. The

expression CHR\$(36 + X(C)) includes an offset value of 36, which does not affect the LSB but avoids the unpredictability of sending values in the control-code range. If the value of the current element of the X array is 0, the output value of decimal 36 ("\$\$") is emitted at the output port. If the X value is 1, a 37 ("%") is emitted. If a 36 is sent, the LSB is 0, a value that causes its corresponding LED to be darkened as the bit is shifted through the display. If a 37 is sent, the LSB is a logic 1, and the LED will be lit. Two

examples of a displayed "4" appear in photo 4.

This is admittedly a rudimentary way to drive the display. But the method is quite effective if you don't mind taking time to code the program. It allows use of the scrolling LED display in a very flexible and economical manner, using the power of your existing computer system.

Control by a Dedicated Processor

While you can tie the scrolling LED display to your main computer, as we have seen, using the display is much less trouble if a small, dedicated control processor running custom software is used. I decided to drive my display with a Z8-BASIC System Controller, the successor to the Z8-BASIC Control Computer I developed almost three years ago (see reference 1). Based on the Zilog Z8 self-contained microprocessor, this small computer is well suited for jobs like this. It has an on-board tiny-BASIC interpreter, space for 2K bytes of RAM (random-access read/write memory) and 4K bytes of EPROM (erasable programmable read-only memory), an RS-232C serial port, two parallel output ports, and one parallel input port.

The LED display is attached to one of the parallel output ports on the Z8 board, as shown in figure 6 and photo 5. The message-storage space can hold 256 characters using the unexpanded Z8 board. With the addition of one or more memory-expansion boards, messages up to 50,000 characters long can be stored.

The Z8 board can be programmed to provide several intelligent display features using a combination of tiny-BASIC statements, shown in listing 2, and assembly-language subroutines, shown in listing 3. (A flowchart of the controller software is shown in figure 7.) The software, which is modular in design, uses a table for storage of the character-display bit patterns. Shown in figure 8, these patterns can be easily modified to allow special characters to be displayed. Finally, listing 4 is a sample run of the controller software with the external-terminal mode selected.

You'll need to have a video-display

Text continued on page 52



Photo 5: In my first attempt, several display segments were attached to the Z8 board; the message content of the display can be changed interactively from the video terminal.

Figure 7: Flowchart of the display-controller software for the Z8-BASIC System Controller. Some modes of operation are selected by DIP-switch settings on the Z8 board.

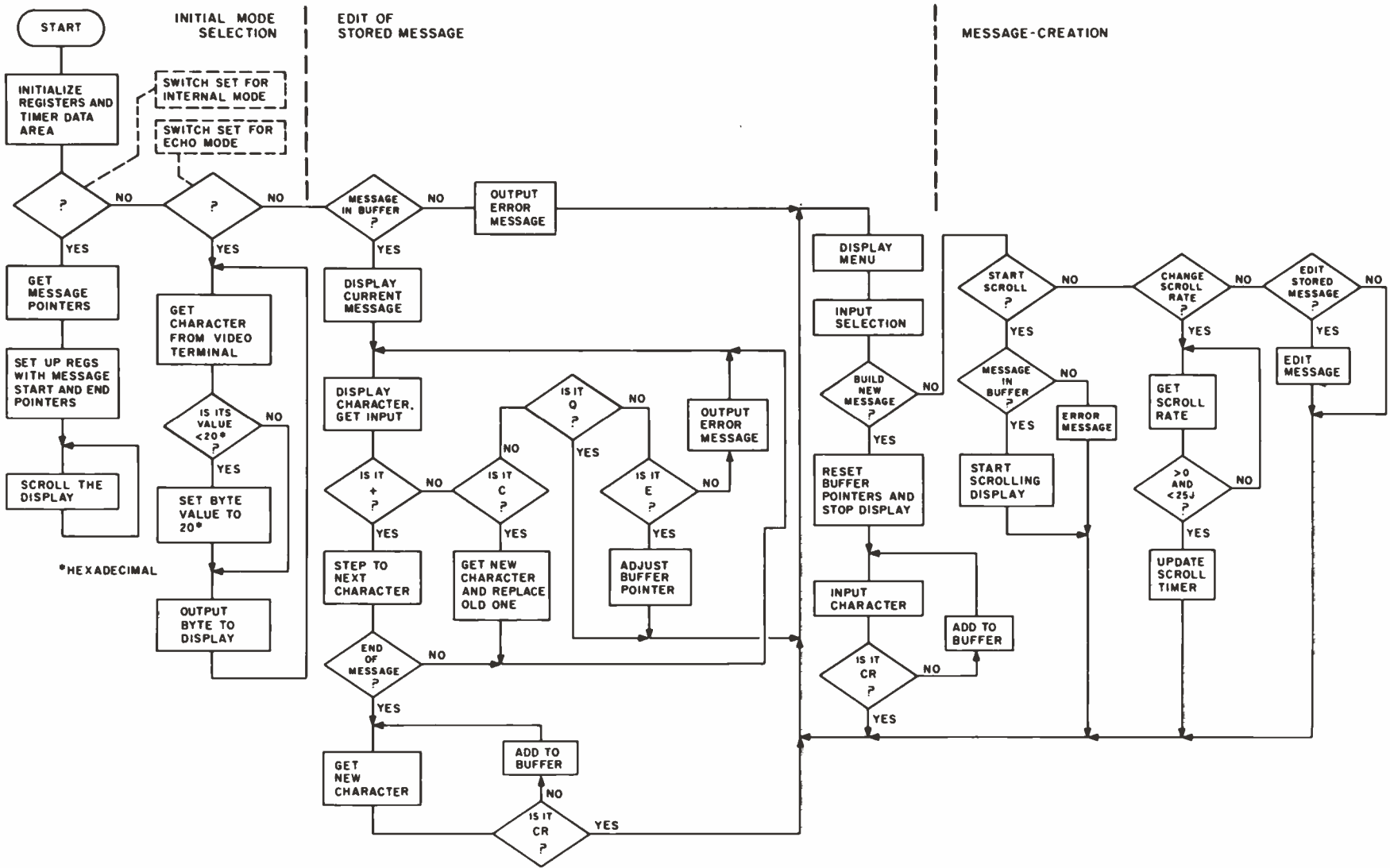

Listing 2: BASIC program written for the Z8-BASIC System Controller to control the scrolling LED display. Some actions are controlled by machine-language subroutines called by BASIC.

```

10 GO @%1900
15 B=%0810:E=%080F
20 REM IF I GOT HERE, EXTERNAL MODE IS SELECTED
30 @%F4=%40
40 IF AND(@%FFD,2)=0 THEN GOTO 10000
50 REM BUILD MESSAGE MENU
60 PRINT
70 PRINT "CREATE A DISPLAY MENU"
80 PRINT:PRINT "1 - BUILD A NEW MESSAGE"
90 PRINT "2 - START MESSAGE SCROLLING"
100 PRINT "3 - CHANGE SCROLL RATE OF DISPLAY"
110 PRINT "4 - EDIT THE STORED MESSAGE"
140 PRINT:INPUT A
150 IF A<1 THEN 50
160 IF A>4 THEN 50
170 GOSUB A*1000
180 GOTO 50
1000 REM ENTER NEW DATA FOR DISPLAY
1010 B=%0810:E=%080F
1015 GO @%1900
1020 PRINT "ENTER DISPLAY CHARACTORS. END WITH RETURN OR ENTER KEY"
1030 X=USR(%54)
1040 IF X=13 THEN 1070
1050 E=E+1:OE=X
1060 GOTO 1030
1070 RETURN
2000 REM START MESSAGE SCROLLING ON DISPLAY
2010 IF E<>%080F THEN 2040
2020 PRINT "NO MESSAGE IN BUFFER - DISPLAY NOT STARTED"
2030 RETURN
2040 ^%38=%0810
2050 @%0801=%08:@%0802=%10
2060 ^%3A=E
2070 GO @%190E
2080 RETURN
3000 REM CHANGE SCROLL RATE
3010 PRINT "ENTER NEW SCROLL RATE"
3020 INPUT A
3030 IF A<1 THEN 3010
3040 IF A>255 THEN 3010
3050 X=USR(%1A76,A)
3060 RETURN
4000 REM EDIT THE STORED MESSAGE
4010 GO @%1900
4020 IF E<>%080F THEN 4050
4030 PRINT "NO MESSAGE IN BUFFER - EDIT NOT POSSIBLE"
4040 RETURN
4050 PRINT "LISTING OF CURRENT MESSAGE"
4060 X=B
4070 C=@X:GO @%61.C
4080 X=X+1
4090 IF X>E THEN 4110
4100 GOTO 4070
4110 X=B
4120 PRINT:PRINT
4130 PRINT "AS EACH CHARACTER IS DISPLAYED, ENTER + TO SKIP,C TO CHANGE"
4135 PRINT "TYPE Q TO QUIT LEAVING REST OF MESSAGE,"
4137 PRINT "TYPE E TO QUIT ENDING MESSAGE AT THIS CHARACTER"

```

```

4140 GO @%61,@X
4150 PRINT " ? ";
4160 C=USR(%54)
4165 PRINT
4170 IF C=%2B THEN X=X+1:GOTO 4220
4180 IF C=%51 THEN RETURN
4190 IF C=%45 THEN E=X:RETURN
4200 IF C<>%43 THEN PRINT "PLEASE TYPE +,C,Q, OR E":GOTO 4140
4205 PRINT "NEW CHARACTER ? ";
4207 C=USR(%54):@X=C:PRINT:GOTO 4140
4210 PRINT "NEW CHARACTER ? ";:C=USR(%54):@X=C:GOTO 4140
4220 IF X<E THEN 4140
4230 PRINT "END OF ORIGINAL MESSAGE "
4240 PRINT "TYPE ADDITIONAL CHARACTORS AND END WITH RETURN OR ENTER"
4250 C=USR(%54)
4260 IF C=13 THEN RETURN
4270 E=E+1:OE=C
4280 GOTO 4250
10000 REM ECHO MODE
10010 @%38=%08
10020 @%39=%10
10030 X=USR(%54)
10035 IF X<%20 THEN X=%20
10040 @%0810=X
10050 GO @%1A12
10060 GOTO 10030

```

Listing 3: Assembly-language listing of the machine-language subroutines needed to control the LED display.

```

1900 0010 ;
1900 0020 ; Z-8 LED DISPLAY DRIVER PROGRAM
1900 0030 ; FOR THE Z-8 SYSTEM CONTROLLER ONLY
1900 0040 ; VERSION 1.1 12/31/83
1900 0045 ;
1900 0050 ; INITIALIZATION ROUTINE
1900 0060 ;
1900 0070 ORG 1900H
1900 0080 DINIT EQU $
1900 0090 DI ; DON'T BOTHER ME DURING SETUP
1901 0100 PUSH RP ; SAVE OLD REG POINTER
1903 0110 SRP #MYREG ; POINT TO MY WORK REGS
1905 0120 LD R12,#10H ; POINT TO IRQ 5 VECTOR ADDRESS
1907 0130 LD R13,#0FH ;
1909 0140 LD R15,#8DH ; PICK UP A JUMP COMAND
190B 0150 LDE @RR12,R15 ; WRITE TO VECTOR
190D 0160 INCW R12 ; STEP TO NEXT
190F 0170 LD R15,#SCROLL1H ; HIGH BYTE FOR JUMP ADDRESS
1911 0180 LDE @RR12,R15 ; WRITE TO VECTOR +1
1913 0190 INCW R12 ; STEP TO NEXT
1915 0200 LD R15,#SCROLL1L ; LOW BYTE OF JUMP ADDRESS
1917 0210 LDE @RR12,R15 ; WRITE IT AT VECTOR +2
1919 0220 ;
1919 0230 ; REGISTER LAYOUT -
1919 0240 ; RRO - POINTER TO COLUMN TO OUTPUT
1919 0250 ; R2 - COUNT OF COLUMNS LEFT TO DISPLAY
1919 0260 ; R3 - RIPPLE TIMER CONSTANT FOR SCROLLING
1919 0270 ; R4 - FLAGS BYTE :
1919 0280 ; BIT 0 - RUN MODE
1919 0290 ; BIT 1 - UNDEFINED
1919 0300 ; BIT 2 - BLANK COLUMN SUPPRESS IF SET
1919 0310 ; BITS 3-7 - UNDEFINED
1919 0320 ; RR6 - POINTER TO SWITCHES

```

Listing 3 continued on page 42

Bored Waiting? Here's The Board You've Been Waiting For.

Now
Available!

A hard disk and cartridge tape controller together on one board? Magic? Not really. It's Teletek's HD/CTC. The hard disk and cartridge tape drive controller provide the support necessary to interface both rigid-disk drives and a cartridge tape deck to the S-100 bus.

- A Z-80A CPU (optionally Z-80B) providing intelligent control of the rigid-disk and cartridge tape drives.
- Support of 5 $\frac{1}{4}$ " rigid-disk drives with transfer rates of

5 megabits per second. Minor changes of the on-board components allow the support of other drive types/sizes and transfer rates up to 15 megabits per second. (Interface to disk drive is defined by software/firmware on-board.)

- Controller communications with the host processor via 2K FIFO at any speed desirable (limited only by RAM access time) for a data block transfer. Thus the controller does not

constrain the host processor in any manner.

- Two 28-pin sockets allowing the use of up to 16K bytes of on-board EPROM and up to 8K bytes of on-board RAM.
- Individual software reset capability.
- Conforms to the proposed IEEE-696 S-100 standard.
- Controller can accommodate two rigid-disk drives and one cartridge tape drive. Expansion is made possible with an external card.

Teletek's HD/CTC Offers A Hard Disk
Controller, Plus Cartridge Tape Controller,
All On One Board.

TELETEK

Listing 3 continued:

```

1919 0330 ;
1919 0340 ;
1919 E6 F6 00 0350 LD QF6H,#0 ; SET PORT 2 AS ALL OUTPUT
191C E6 02 04 0360 LD 2,#4 ; DATA=0, CLOCK=0, CLEAR=1
191F E6 02 00 0370 LD 2,#0 ; DATA,CLOCK,CLEAR=0
1922 0380 ; MODE BYTE TO *RUN, BLANKS ENABLED
1922 4C 00 0390 LD R4,#0
1924 0400 ; SET BLANK FLAG FROM SWITCH
1924 82 F6 0410 LDE R15,ERR6 ; PICK UP SWITCHES
1926 76 EF 40 0420 TM R15,#40H ; IS BLANK SUPPRESS DESIRED ?
1929 6B 03 0430 JR Z,TIMER ; NO,PROCEED
192B 46 E4 04 0440 OR R4,#4H ; YES, SET BLANK SUPPRESS FLAG
192E 0450 ; SET UP TIMER, BUT CLEAR INTERRUPT MASK FOR IT
192E 0460 TIMER EQU $
192E 6C FF 0470 LD R6,#SWITCH1H ; HIGH ORDER BYTE OF SWITCHES
1930 7C FD 0480 LD R7,#SWITCH1L ; LOW ORDER BYTE OF SWITCHES
1932 82 36 0490 LDE R3,ERR6 ; GET THE BYTE
1934 56 E3 30 0500 AND R3,#30H ; ISOLATE RIPPLE RATE BITS
1937 06 E3 10 0510 ADD R3,#10H ; ADD 16 TO BYTE
193A CC 08 0520 LD R12,#TIME1H ; GET ADDRESS OF
193C DC 00 0530 LD R13,#TIME1L ; TIMER DATA AREA
193E 92 3C 0540 LDE @RR12,R3 ; STORE RATE THERE
1940 E6 F3 03 0550 LD PRE1,#03H ; SET PRESCALE1 TO 64
1943 E6 F2 20 0560 LD T1,#20H ; SET TIMER1 COUNT TO 32
1946 46 F1 0C 0570 OR TMR,#0CH ; START T1 A'COUNTIN'
1949 E6 FB 00 0580 LD IMR,#0 ; RESET ALL INTERRUPTS.
194C 0590 ; RESET BUFFER BEGIN DATA AREA TO 0
194C CC 08 0600 LD R12,@BGNBUF1H
194E DC 01 0610 LD R13,@BGNBUF1L
1950 FC 00 0620 LD R15,#0
1952 92 FC 0630 LDE @RR12,R15
1954 A0 EC 0640 INCW R12
1956 92 FC 0650 LDE @RR12,R15
1958 0660 ;
1958 D670 ; TEST FOR INTERNAL/EXTERNAL MODE
1958 0680 ;
1958 82 F6 0690 LDE R15,ERR6 ; GET SWITCHES
195A 76 EF 01 0700 TM R15,#1 ; TEST INT/EXT SWITCH
195D 6B 04 0710 JR Z,INTERNAL ; IF 0 THEN INTERNAL MODE
195F 0720 ;
195F 0730 ; EXTERNAL MODE MEANS JUST RETURN TO BASIC ?
195F 0740 ;
195F 50 FD 0750 POP RP ; RESTORE REG POINTER
1961 9F 0760 EI ; ENABLE INTERRUPTS BEFORE EXIT
1962 AF 0770 RET ; RETURN TO CALLER
1963 0820 ;
1963 0830 ;
1963 0840 INTER EQU $
1963 D6 19 66 0850 CALL INTMSG
1966 0860 ;
1966 0870 ;
1966 0880 ; END OF INIT ROUTINE
1966 0890 ;
1966 0900 ;
1966 0910 ;
1966 0920 ; INTMSG - SET UP AND SCROLL ONE OF
1966 0930 ; THE INTERNALLY STORED MESSAGES
1966 0940 ;
1966 0950 ; ASSUMES :
1966 0960 ;
1966 0970 ; INIT HAS BEEN EXECUTED, OR REGS SET
1966 0980 ; BY SOME OTHER PROGRAM
1966 0990 ;
1966 1000 ;
1966 1010 INTMS EQU $
1966 82 F6 1020 LDE R15,ERR6 ; PICK UP SWITCHES
1966 56 EF 0C 1030 AND R15,#0CH ; ISOLATE THE MESSAGE SELECT BITS
196B CC 1A 1040 LD R12,#INTTBL1H ; GET MESSAGE TABLE
196D DC 85 1050 LD R13,#INTTBL1L ; BASE ADDRESS

```

```

196F 02 DF 1060 ADD R13,R15 ; ADD IN MESSAGE # OFFSET
1971 1070 ;
1971 1080 ; NOTE: THE ABOVE CODE WILL ONLY WORK IF THE
1971 1090 ; LOW ORDER BYTE DOES NOT OVERFLOW WHEN
1971 1100 ; QFH IS ADDED TO IT.
1971 1110 ;
1971 82 8C 1120 LDE R8,@RR12 ; GET MESSAGE BEGIN AND
1973 A0 EC 1130 INCW RR12
1975 82 9C 1140 LDE R9,@RR12 ; END POINTERS
1977 A0 EC 1150 INCW RR12
1979 82 AC 1160 LDE R10,@RR12 ; INTO THEIR
197B A0 EC 1170 INCW RR12
197D 82 BC 1180 LDE R11,@RR12 ; RESPECTIVE REGISTERS
197F CC 08 1190 LD R12,@BGNBUF1H ; GET ADDRESS OF BEGIN
1981 DC 01 1200 LD R13,@BGNBUF1L ; MESSAGE SAVE AREA
1983 92 6C 1210 LDE @RR12,R8 ; AND SAVE THE
1985 A0 EC 1220 INCW RR12
1987 92 9C 1230 LDE @RR12,R9 ; POINTER THERE
1989 D6 19 8E 1240 CALL SCRST ; START THE SCROLL PROCESS
198C 1250 LOOP EQU $
198C 6B FE 1260 JR LOOP ; DO AN INFINITE LOOP
198E 1270 ;
198E 1280 ;
198E 1290 ;
198E 1300 ;
198E 1310 ; SCRST - SCROLL START ROUTINE
198E 1320 ;
198E 1330 ; ASSUMES :
198E 1340 ;
198E 1350 ; ALL REGS SET EXCEPT COLUMN POINTER
198E 1360 ; AND COLUMN COUNTER
198E 1370 ;
198E 1380 ;
198E 1390 SCRST EQU $
198E 70 FD 1400 PUSH RP ; SAVE OLD REG POINTER
1990 31 30 1410 SRP #MYREG ; POINT TO MY WORK REGS
1992 82 F8 1420 LDE R15,ERR8 ; GET 1ST DATA BYTE FROM BUFFER
1994 1430 COLSE EQU $
1994 56 EF 7F 1440 AND R15,#07FH ; STRIP OFF H.O. BIT
1997 0C 1A 1450 LD R0,#CHRTAB1H ; PICK UP CHRTAB
1999 1C 95 1460 LD R1,#CHRTAB1L ; BASE ADDRESS
199B A6 EF 00 1470 CP R15,#0 ; IS DATA BYTE = 0 ?
199E 6B 0E 1480 JR EQ,COLCMT ; YES, CHRTAB ADDRESS OK
19A0 1490 SKIP1 EQU $
19A0 A0 E0 1500 INCW RRO ; STEP OUT
19A2 A0 E0 1510 INCW RRO ; TO THIS BYTE'S
19A4 A0 E0 1520 INCW RRO ; TRANSLATE
19A6 A0 E0 1530 INCW RRO ; AREA
19A8 A0 E0 1540 INCW RRO ; IN THE
19AA A0 E0 1550 INCW RRO ; CHRTAB TABLE.
19AC FA F2 1560 DJNZ R15,SKIP1 ; DO UNTIL 0
19AE 1570 COLCN EQU $
19AE 2C 06 1580 LD R2,#6 ; ASSUME 6 COLUMNS FOR NOW
19B0 76 E4 04 1590 TM R4,#4H ; ARE WE BLANK SUPPRESSING ?
19B3 6B 04 1600 JR Z,START ; NO,ALL IS WELL. CRANK IT UP
19B5 00 E2 1610 DEC R2 ; ONLY 5 COLS PER CELL PLEASE
19B7 A0 E0 1620 INCW RRO ; SKIP BLANK COLUMN IN TABLE
19B9 1630 ;
19B9 1640 ; START THE INTERRUPTS FOR SCROLLING
19B9 1650 ;
19B9 1660 START EQU $
19B9 8F 1670 DI ; SHUT DOWN INTERRUPTS (SHOULD BE OFF ANYWAY)
19BA 46 FB 20 1680 OR IMR,#20H ; ALLOW INTERRUPT IRQ5 (T1)
19BD 50 FD 1690 POP RP ; RESTORE REG POINTER
19BF 9F 1700 EI ; TURN ON INTERRUPTS
19C0 AF 1710 RET ; RETURN TO CALLER
19C1 1720 ;
19C1 1730 ;
19C1 1740 ;

```

BYTE April 1984

Circle 27 on inquiry card.

BUILT FOR SILENCE & SPEED... AMDEK RELIABLE!

You want a letter quality printer that's fast and quiet. The new Amdek 5040 double daisy wheel printer is both. With only 50 decibels of sound, it's extremely quiet. Printing at 40 characters per second, it's fast. And, you get a 1 year warranty. As you would expect from Amdek, the competitively-priced 5040 features:

Amdek PERFORMANCE — Speed really counts in a commercial business. At over 400 words per minute, the new 5040 is the fastest quiet printer around.

Amdek VERSATILITY — Choose from a wide selection of double daisy wheels (two characters on one petal). Up to 19 different fonts. Get scientific notations... engineering symbols... foreign languages.

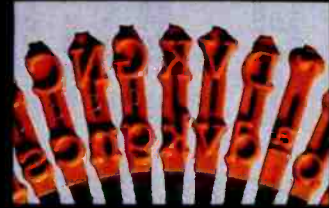

The new 5040 also offers both a serial and a parallel interface. That makes it compatible with just about any computer or word processor.

Amdek QUIET — Low noise is built in. A 50 decibel sound level is so quiet you can print all day long... without annoying background noise. You can even carry on normal telephone conversations right next to the printer.

Amdek PROTECTION — You get a full 1 year warranty (not just 90 days).



Because
it's built
by
Amdek,
you'll

print with confidence year
after year.



Stop At Your Local Computer Dealer Today!
See the new Amdek 5040 in action. Watch how
fast and quiet it prints for you.

AMDEK

2201 Lively Blvd. • Elk Grove Village, IL 60007 • (312) 364-1180 • TLX 25-4786
REGIONAL OFFICES: Southern Calif. (714) 662-3949 • Northern Calif. (408) 866-8134 • Texas (817) 498-2334 • Denver (303) 794-1497

Listing 3 continued:

```

19C1 1750 ; SCROLL - INTERRUPT DRIVEN SCROLL ROUTINE
19C1 1760 ;
19C1 1770 ; ASSUMES :
19C1 1780 ;
19C1 1790 ; ALL POINTER REGS CORRECTLY INITIALIZED
19C1 1800 ; REG 3 HAS TIME INCREMENTS REMAINING TO NEXT OUTPUT
19C1 1810 ; TIME CONSTANT IS STORED AT "TIME" DATA AREA
19C1 1820 ;
19C1 1830 ;
19C1 1840 SCROL EQU $
19C1 1850 PUSH RP ; SAVE OLD REG POINTER
19C3 1860 SRP #MYREG ; POINT TO MY REGS
19C5 1870 DJNZ R3,RETRN ; IF INTERVAL HAS NOT EXPIRED, GO AWAY
19C7 1880 LD R12,#TIMEIH ; POINT TO TIMER
19C9 1890 LD R13,#TIMEIL ; CONSTANT DATA AREA
19CB 1900 LDE R3,@RR12 ; RESTORE FULL COUNT
19CD 1910 CALL COLWRT ; WRITE A COLUMN OF DATA
19D0 1920 INCW RRO ; STEP TO NEXT COLUMN
19D2 1930 DJNZ R2,RETRN ; IF NOT LAST COLUMN, GO AWAY
19D4 1940 ;
19D4 1950 ; STEP TO NEXT CHARACTER IN BUFFER
19D4 1960 ;
19D4 1970 INCW R6 ; ADVANCE CURBUF BY 1
19D6 1980 CP R8,R10 ; COMPARE CURBUF AND ENDBUF HIGH BYTE
19D8 1990 JR ULT,SETCH ; IF NOT GE THEN NO WRAP
19DA 2000 CP R9,R11 ; COMPARE LOW BYTES
19DC 2010 JR ULE,SETCH ; IF NOT GT THEN NO WRAP
19DE 2020 ;
19DE 2030 ; WRAP TO BEGINNING OF MESSAGE
19DE 2040 ;
19DE 2050 LD R12,#BGNBUF1H ; PICK UP POINTER TO
19E0 2060 LD R13,#BGNBUF1L ; BEGIN BUFFER REMEMBRANCE
19E2 2070 LDE R8,@RR12 ; GET HIGH BYTE
19E4 2080 INCW RR12
19E6 2090 LDE R9,@RR12 ; AND LOW BYTE
19E8 2100 ;
19E6 2110 ; PICK UP CHARACTER AND PROCESS -
19E8 2120 ; SET UP POINTER TO TRANSLATE
19E6 2130 ; TABLE ADDRESS AS WELL AS # OF COLUMNS TO PROCESS
19E8 2140 ;
19E8 2150 ;
19E8 2160 SETCH EQU $
19E6 2170 LDE R15,@RR8 ; GET DATA BYTE FROM BUFFER
19EA 2180 LD R0,#CHRTAB1H ; SET UP POINTER TO
19EC 2190 LD R1,#CHRTAB1L ; DATA TABLE BASE
19EE 2200 AND R15,#7FH ; MASK OFF H.O. BIT
19F1 2210 CP R15,#0 ; IS DATA BYTE 0?
19F4 2220 JR EQ,SETCOL ; YES, POINTER IN TABLE IS OK.
19F6 2230 ;
19F6 2240 ; ADJUST CHRTAB POINTER
19F6 2250 ;
19F6 2260 SKIP2 EQU $
19F6 2270 INCW RRO
19F8 2280 INCW RRO
19FA 2290 INCW RRO
19FC 2300 INCW RRO
19FE 2310 INCW RRO
1A00 2320 INCW RRO
1A02 2330 DJNZ R15,SKIP2
1A04 2340 ;
1A04 2350 ; DETERMINE # OF COLUMNS TO WRITE
1A04 2360 ; ADJUST CHRTAB POINTER IF NECESSARY
1A04 2370 ;
1A04 2380 SETCO EQU $
1A04 2390 LD R2,#6 ; ASSUME 6 COLS TO START
1A06 2400 TM R4,#04H ; TEST COLUMN BLANK FLAG
1A08 2410 JR Z,RETRN ; IF 0. THEN BLANK. NO ADJUST

```

```

2420 DEC R2 ; IF 1, NO BLANK. ADJUST COL. COUNT
2430 INCW RRO ; AND CHRTAB POINTER
2440 RETRN EQU $
2450 POP RP ; RESTORE REG POINTER
2460 IRET ; RETURN FROM INTERRUPT
2470 ;
2490 ;
2500 ; CHARACTER OUTPUT ROUTINE - NON-INTERRUPT DRIVEN
2510 ;
2520 ; ASSUMES :
2530 ;
2540 ; BUFFER POINTER IS ON XTER TO BE OUTPUT.
2550 ; CHARACTER IS INDEX TO LED TABLE
2560 ; SWITCH POINTER REGS ARE INITIALIZED
2570 ;
2580 ;
2590 CHOUT EQU $
2600 PUSH RP ; SAVE OLD REG POINTER
2610 SRP #MYREG ; POINT TO MY WORK REGS
2620 LDE R15,@RR8 ; GET CHARACTER TO BE DISPLAYED
2630 CHFIX EQU $
2640 AND R15,#07FH ; STRIP OFF H.O. BIT
2650 ;
2660 ; BUILD INDEX INTO TABLE FOR COLUMNS OF DATA
2670 ;
2680 LD R0,#CHRTAB1H ; PICK UP TABLE
2690 LD R1,#CHRTAB1L ; BASE ADDRESS
2700 CP R15,#0 ; IS THIS CELL 0 ?
2710 JR EQ,SUPRS ; YES, GO TO BLANK SUPPRESS
2720 INDEX EQU $
2730 LD R14,#6 ; SET UP 6 COLUMNS PER CELL
2740 IDXP EQU $
2750 INCW RRO ; ADD 1 TO COLUMN POINTER
2760 DJNZ R14,IDXP ; DO FOR 6 COLUMNS
2770 DJNZ R15,INDEX ; DO FOR R15 TIMES
2780 ;
2790 ; NOW CHECK TO SEE IF FIRST COLUMN BLANK IS WANTED
2800 ;
2810 SUPRS EQU $
2820 LD R2,#6 ; ASSUME 6 COLUMNS PER CELL NOW
2830 TM R4,#04H ; TEST BLANK BIT
2840 JR Z,BLANK
2850 DEC R2 ; DROP 1 COLUMN COUNT
2860 INCW RRO ; SKIP BLANK COLUMN
2870 BLANK EQU $
2880 ;
2890 ; THIS IS THE OUTPUT ROUTINE FOR THE CELL
2900 ;
2910 CALL COLWRT ; WRITE THIS COLUMN
2920 INCW RRO ; STEP TO NEXT ONE
2930 DJNZ R2,BLANK ; IF NOT DONE, DO IT AGAIN
2940 POP RP ; RESTORE OLD REG POINTER
2950 RET ; RETURN TO CALLER
2960 ;
2970 ; ROUTINE TO WRITE A COLUMN OF LED INFORMATION
2980 ;
2990 ; ASSUMES :
3000 ; REGS R0+R1 POINT TO THE BYTE TO OUTPUT
3010 ; REG4 BIT 2 INDICATES INVERSE VIDEO IF SET
3020 ; THE CLOCK BIT IS 0 ON ENTRY
3030 ; REG 2 IS CORRECTLY SET FOR OUTPUT
3040 ;
3070 COLWR EQU $
3080 PUSH RP ; SAVE OLD REG POINTER
3090 SRP #MYREG ; POINT TO MY WORK REGS
3100 LDE R15,@RR0 ; PICK UP DATA BYTE
3110 RL R15 ; ADJUST COLUMN CORRECTLY
3120 LD R14,#6 ; DO THIS 8 TIMES

```

Now there's a real-time video image acquisition and display module that plugs directly into the IBM PC and PC-XT.

It's called the PCVISION™ Frame Grabber. From Imaging Technology —the leading OEM supplier of low cost, board level image processors.

The PCVISION Frame Grabber converts a standard analog video signal (RS-170) from a camera to digital data at 30 frames per second, and stores the resulting 6-bit pixel data in a 512 × 512 frame memory.

It allows your IBM PC or PC-XT to access stored images for process-

ing or manipulation, and features up to 64 gray scales per pixel, full color support, low cost, easy installation and high reliability.

The PCVISION Frame Grabber turns your IBM PC into a low cost, multi-featured image processing system for **teleconferencing, robotic vision, factory inspection, medical imaging, microscopy, X-ray analysis** and many other applications in business, industry, medicine and research.

The PCVISION Frame Grabber comes complete with demonstration software, cables and full documentation for fast, easy installation

and integration.

All for just **\$2995** (camera and display monitor not included).

To find out how the PCVISION Frame Grabber can provide your IBM PC with the high performance, multi-featured image processing capabilities of systems costing much more, call our Sales Department at (617) 938-8444. Or write to the address below.

IMAGING

Imaging Technology Incorporated
600 West Cummings Park, Woburn, MA 01801
Telex: 948263

Circle 193 on inquiry card.

PCVISION™

THE IBM PC PLUG-COMPATIBLE BOARD THAT TURNS YOUR PC INTO A REAL-TIME IMAGE PROCESSOR RIGHT BEFORE YOUR EYES.



Listing 3 continued:

```

1A4B BITLO EQU $
1A4B D8 EF LD R13,R15
1A4D 56 ED 01 AND R13,#1 ; SAVE DATA BIT. RESET ALL OTHERS
1A50 D9 02 LD 2,R13 ; AND PUT DATA BIT ON PORT 2
1A52 46 ED 02 OR R13,#2 ; TURN ON CLOCK BIT
1A55 FF 3180 NOP ; WAIT A LITTLE BIT
1A56 FF 3190 NOP
1A57 FF 3200 NOP
1A58 FF 3210 NOP
1A59 D9 02 LD 2,R13 ; AND WRITE TO PORT 2
1A5B 56 ED 01 AND R13,#1 ; TURN OFF CLOCK BIT
1A5E FF 3240 NOP ; WAIT A LITTLE BIT
1A5F FF 3250 NOP
1A60 FF 3260 NOP
1A61 FF 3270 NOP
1A62 D9 02 LD 2,R13 ; AND WRITE TO PORT 2
1A64 ED EF RR R15 ; SET REG 15 TO NEXT BIT
1A66 FF 3300 NOP ; WAIT A LITTLE WHILE
1A67 FF 3310 NOP
1A68 FF 3320 NOP
1A69 FF 3330 NOP
1A6A EA DF DJNZ R14,BITLOOP ; DO UNTIL ALL BITS FINISHED
1A6C 50 FD POP RP ; RESTORE OLD REG POINTER
1A6E AF 3360 RET ; GO BACK TO CALLER
1A6F 3370 ;
1A6F 3380 ;
1A6F 3390 ;
1A6F 3400 ;
1A6F 3410 ; CLEAR THE DISPLAY ROUTINE
1A6F 3420 ;
1A6F 3430 ; ASSUMES :
1A6F 3440 ;
1A6F 3450 ; PORT 2 IS CORRECTLY CONFIGURED FOR OUTPUT
1A6F 3460 ;
1A6F 3470 CLEAR EQU $
1A6F E0 02 04 LD 2,#04H ; CLEAR ON, CLOCK AND DATA LOW
1A72 E6 02 00 LD 2,#0H ; TURN OFF CLEAR
1A75 AF 3500 RET ; RETURN TO CALLER
1A76 3510 ;
1A76 3520 ;
1A76 3530 ;
1A76 3540 ; RIPPLE - SET RIPPLE CLOCK RATE FOR
1A76 3550 ; SCROLL MODE
1A76 3560 ;
1A76 3570 ; ASSUMES :
1A76 3580 ;
1A76 3590 ; NEW RIPPLE RATE IN REG 13 (ABSOLUTE)
1A76 3600 ;
1A76 3610 ;
1A76 3620 RIPPL EQU $
1A76 70 FD 3630 PUSH RP ; SAVE OLD REG POINTER
1A76 31 30 3640 SRP #MYREG ; SET REG POINTER TO MY REGS
1A7A EC 06 3650 LD R12,#TIME1H ; POINT TO TIMER
1A7C DC 00 3660 LD R13,#TIME1L ; DATA AREA
1A7E F6 13 3670 LD R15,13H ; GET PASSED PARAM. INTO WORK REG
1A80 92 FC 3680 LDE @RR12,R15 ; STORE NEW RIPPLE RATE
1A82 50 FD 3690 POP RP ; RESTORE OLD REG POINTER
1A84 AF 3700 RET ; RETURN TO CALLER
1A85 3710 ;
1A85 3720 ;
1A85 3730 ;
1A85 3740 ; DATA AREAS AND CONSTANTS
1A85 3750 ;
1A85 3760 MYREG EQU 30H
1A85 3770 SWITC EQU 0FFFDH
1A85 3780 TIME EQU 0800H
1A85 3800 BGNBU EQU TIME+1
1A85 3820 INTTB EQU $

```

```

1A85 1C D5 3830 DW #MSG1BGN
1A87 1C E6 3840 DW #MSG1END
1A89 1C E7 3850 DW #MSG2BGN
1A8B 1D 17 3860 DW #MSG2END
1A8D 1D 16 3870 DW #MSG3BGN
1A8F 1D 62 3880 DW #MSG3END
1A91 1D 63 3890 DW #MSG4BGN
1A93 1D AB 3900 DW #MSG4END
1A95 3910 CHRTA EQU $
1A95 3920 DS 192 ; (20H * 6)
1B55 00 00 00 00 00 3930 SPECI EQU $
1B55 00 00 00 00 00 3940 DB 0,0,0,0,0,0
00
1B5B 00 00 00 7D 00 3950 DB 0,0,0,7DH,0,0
00
1B61 00 00 70 00 70 3960 DB 0,0,70H,0,70H,0
00
1B67 00 14 7F 14 7F 3970 DB 0,14H,7FH,14H,7FH,14H
14
1B6D 00 12 2A 7F 2A 3980 DB 0,12H,2AH,7FH,2AH,24H
24
1B73 00 62 64 06 13 3990 DB 0,62H,64H,06H,13H,23H
23
1B79 00 36 49 35 02 4000 DB 0,36H,49H,35H,02H,05H
05
1B7F 00 00 00 70 00 4010 DB 0,00,00,70H,00,00
00
1B85 00 1C 22 41 00 4020 DB 0,1CH,22H,41H,0,0
00
1B8B 00 00 00 41 22 4030 DB 0,0,0,41H,22H,1CH
1C
1B91 00 22 14 7F 14 4040 DB 0,22H,14H,7FH,14H,22H
22
1B97 00 08 08 3E 08 4050 DB 0,08H,08H,3EH,08H,08H
08
1B9D 00 00 01 06 00 4060 DB 0,0,1,6,0,0
00
1BA3 00 06 06 06 06 4070 DB 0,6,6,6,6,6
06
1BA9 00 00 00 01 00 4080 DB 0,0,0,1,0,0
00
1BAF 00 02 04 06 10 4090 DB 0,2,4,6,10H,20H
20
1BB5 4100 ; NUMBERS
1BB5 00 3E 45 49 51 4110 DB 0,3EH,45H,49H,51H,3EH
3E
1BBB 00 00 21 7F 01 4120 DB 0,0,21H,7FH,01,0
00
1BC1 00 23 45 49 49 4130 DB 0,23H,45H,49H,49H,31H
31
1BC7 00 42 41 49 59 4140 DB 0,42H,41H,49H,59H,66H
66
1BCD 00 0C 14 24 7F 4150 DB 0,0CH,14H,24H,7FH,04H
04
1BD3 00 72 51 51 31 4160 DB 0,72H,51H,51H,51H,4EH
4E
1BD9 00 1E 29 49 49 4170 DB 0,1EH,29H,49H,49H,46H
46
1BDF 00 40 47 48 50 4180 DB 0,40H,47H,48H,50H,60H
60
1BE5 00 36 49 49 49 4190 DB 0,36H,49H,49H,49H,36H
36
1BEB 00 31 49 49 4A 4200 DB 0,31H,49H,49H,4AH,3CH
3C
1BF1 4210 ; MORE SPECIAL CHARACTORS
1BF1 00 00 00 14 00 4220 DB 0,0,0,14H,0,0
00
1BF7 00 00 01 16 00 4230 DB 0,0,1,16H,0,0
00
1BFD 00 06 14 22 41 4240 DB 0,8,14H,22H,41H,0

```

ENTER... THE FUTURE!

TURBO PASCAL

Introducing at
\$49.95

THIS IS THE PASCAL COMPILER
 EVERYBODY'S BEEN WAITING FOR...
 EVERYBODY EXCEPT THE COMPETITION!

Extended Pascal for your IBM
 APPLE CP/M, MS DOS, CP/M 86, CC/M
 88 or CP/M 80 computer features:

- Full screen interactive editor providing a complete menu driven program development environment.
- 11 significant digits in floating point arithmetic.
- Built-in transcendental functions.
- Dynamic strings with full set of string handling features.
- Program chaining with common variables.
- Random access data files.
- Full support of operating system facilities.
- And much more.

ORDER YOUR COPY OF TURBO PASCAL TODAY TO TAKE ADVANTAGE OF OUR INTRODUCTORY SPECIAL.
 For Visa and MasterCard orders call toll free
1-800-227-2400 X 968
IN CA: 1-800-772-2666 X 968
 (lines open 24 hrs. a day, 7 days a week)
Dealer & Distributor inquiries welcome.

| | Turbo Pascal | IBM Pascal | Pascal MT* |
|--|-----------------------------|------------------------------|-----------------------------|
| Price | \$49.95 | \$99.00 | \$66.00 |
| Execution speed | 1.2 seconds | 8.2 seconds | 8 seconds |
| Disk Specs: 16 bit / 8 bit | 33K w editor / 33K w editor | 33K + editor / Not Available | 24K + editor / 33K + editor |
| 8 string vars | YES | NO | YES |
| Built-in editor | YES | NO | NO |
| Generate object code | YES | YES | YES |
| One pass native code compiler | YES | NO | NO |
| Locates RunTime errors directly in source code | YES | NO | NO |

Benchmark data based on EightQueens in "Algorithms + Data Structures - Programs" by W. Wirth, run on an IBM PC.
 Turbo Pascal is a trademark of Borland International. MT* is a trademark of MT MicroSystems. IBM is a trademark of International Business Machines.

**LEARN TO WRITE
 A BREADCRUMB**

Our introductory offer includes MICROCALC, a spreadsheet program. This program is on a 5.25" floppy disk. It is on the same disk as Turbo Pascal.

Turbo Pascal includes a 256 page bound manual with extensive explanations and many program examples.

Turbo Pascal \$49.95 + \$5.00 shipping per copy.

Check _____ Money Order _____
 VISA _____ MasterCard _____

Card #: _____
 Exp date: _____ Shipped UPS

BORLAND INTERNATIONAL

Borland International
 4807 Scotts Valley Drive
 Scotts Valley, California 95006

My system is: 8 bit _____ 16 bit _____

Operating system: CP/M 80 _____

CP/M 86 _____ MS DOS _____ PC DOS _____

Computer: _____ Disk Format: _____

Please be sure model number and format are correct.

NAME: _____

ADDRESS: _____

CITY/STATE/ZIP: _____

TELEPHONE: _____

California residents add 6% sales tax. Outside North America add \$15.00. Checks must be on a U.S. bank, and in U.S. dollars. Sorry, no C.O.D.

Listing 3 continued:

| | | | | |
|------|----------------|------|----|----------------------------------|
| 1C03 | 00 14 14 14 14 | 4250 | DB | 0, 14H, 14H, 14H, 14H, 14H |
| 1C09 | 00 00 41 22 14 | 4260 | DB | 0, 0, 41H, 22H, 14H, 08H |
| 1C0F | 00 20 40 4D 50 | 4270 | DB | 0, 20H, 40H, 4DH, 50H, 20H |
| 1C15 | 00 3E 41 5D 4D | 4280 | DB | AT SIGN AND LETTERS (UPPER CASE) |
| 1C15 | 00 3E 41 5D 4D | 4290 | DB | 0, 3EH, 41H, 5DH, 4DH, 39H |
| 1C1B | 00 1F 24 44 24 | 4300 | DB | 0, 1FH, 24H, 44H, 24H, 1FH |
| 1C21 | 00 7F 49 49 49 | 4310 | DB | 0, 7FH, 49H, 49H, 49H, 36H |
| 1C27 | 00 3E 41 41 41 | 4320 | DB | 0, 3EH, 41H, 41H, 41H, 22H |
| 1C2D | 00 7F 41 41 41 | 4330 | DB | 0, 7FH, 41H, 41H, 41H, 3EH |
| 1C33 | 00 7F 49 49 49 | 4340 | DB | 0, 7FH, 49H, 49H, 49H, 41H |
| 1C39 | 00 7F 46 46 48 | 4350 | DB | 0, 7FH, 46H, 46H, 48H, 40H |
| 1C3F | 00 3E 41 41 45 | 4360 | DB | 0, 3EH, 41H, 41H, 45H, 47H |
| 1C45 | 00 7F 06 06 06 | 4370 | DB | 0, 7FH, 06H, 06H, 06H, 7FH |
| 1C4B | 00 00 41 7F 41 | 4380 | DB | 0, 00H, 41H, 7FH, 41H, 00H |
| 1C51 | 00 02 01 01 01 | 4390 | DB | 0, 02H, 01H, 01H, 01H, 7EH |
| 1C57 | 00 7F 06 14 22 | 4400 | DB | 0, 7FH, 06H, 14H, 22H, 41H |
| 1C5D | 00 7F 01 01 01 | 4410 | DB | 0, 7FH, 01H, 01H, 01H, 01H |
| 1C63 | 00 7F 20 16 20 | 4420 | DB | 0, 7FH, 20H, 16H, 20H, 7FH |
| 1C69 | 00 7F 10 06 04 | 4430 | DB | 0, 7FH, 10H, 06H, 04H, 7FH |
| 1C6F | 00 3E 41 41 41 | 4440 | DB | 0, 3EH, 41H, 41H, 41H, 3EH |
| 1C75 | 00 7F 46 46 46 | 4450 | DB | 0, 7FH, 46H, 46H, 46H, 30H |
| 1C7B | 00 3E 41 45 42 | 4460 | DB | 0, 3EH, 41H, 45H, 42H, 3DH |
| 1C81 | 00 7F 46 4C 4A | 4470 | DB | 0, 7FH, 46H, 4CH, 4AH, 31H |
| 1C8F | 00 3E 49 49 49 | 4480 | DB | 0, 3EH, 49H, 49H, 49H, 26H |
| 1C8D | 00 40 40 7F 40 | 4490 | DB | 0, 40H, 40H, 7FH, 40H, 40H |
| 1C93 | 00 7E 01 01 01 | 4500 | DB | 0, 7EH, 01H, 01H, 01H, 7EH |
| 1C99 | 00 7C 02 01 02 | 4510 | DB | 0, 7CH, 02H, 01H, 02H, 7CH |
| 1C9F | 00 7F 02 0C 02 | 4520 | DB | 0, 7FH, 02H, 0CH, 02H, 7FH |
| 1CA5 | 00 63 14 08 14 | 4530 | DB | 0, 63H, 14H, 08H, 14H, 63H |
| 1CAB | 00 60 10 0F 10 | 4540 | DB | 0, 60H, 10H, 0FH, 10H, 60H |
| 1CB1 | 00 43 45 49 51 | 4550 | DB | 0, 43H, 45H, 49H, 51H, 61H |
| 1CB7 | 00 7F 7F 41 41 | 4560 | DB | 0, 7FH, 7FH, 41H, 41H, 41H |
| 1CBD | 00 20 10 08 04 | 4570 | DB | 0, 20H, 10H, 08H, 04H, 02H |
| 1CC3 | 00 41 41 41 7F | 4580 | DB | 0, 41H, 41H, 41H, 7FH, 7FH |

| | | | | |
|------|----------------|------|-------|--|
| 1CC9 | 00 04 08 10 08 | 4590 | DB | 0, 04H, 08H, 10H, 08H, 04H |
| 1CCF | 00 01 01 01 01 | 4600 | DB | 0, 01H, 01H, 01H, 01H, 01H |
| 1CD5 | | 4610 | | ; |
| 1CD5 | | 4620 | | ; |
| 1CD5 | | 4630 | | END OF CHRTAB |
| 1CD5 | | 4640 | | ; |
| 1CD5 | | 4650 | | ; |
| 1CD5 | | 4660 | | ; |
| 1CD5 | | 4670 | | TEST MESSAGES FOR INTERNAL USE |
| 1CD5 | | 4680 | | ; |
| 1CD5 | | 4690 | MSG1B | EQU \$ |
| 1CD5 | 54 45 53 54 20 | 4700 | DB | 'TEST MESSAGE 1' |
| | 4D 45 53 53 41 | | | |
| | 47 45 20 31 | | | |
| 1CE3 | 2E 2E 2E 2E | 4705 | DB | '....' |
| 1CE7 | | 4710 | MSG1E | EQU \$-1 |
| 1CE7 | | 4720 | MSG2B | EQU \$ |
| 1CE7 | 54 48 45 20 51 | 4730 | DB | 'THE QUICK BROWN FOX JUMPED OVER THE LAZY DOG ' |
| | 55 49 43 4B 20 | | | |
| | 42 52 4F 57 4E | | | |
| | 20 46 4F 56 20 | | | |
| | 4A 55 4D 50 45 | | | |
| | 44 20 4F 56 45 | | | |
| | 52 20 54 48 45 | | | |
| | 20 4C 41 5A 59 | | | |
| | 20 44 4F 47 20 | | | |
| 1D14 | 2E 2E 2E 2E | 4735 | DB | '....' |
| 1D16 | | 4740 | MSG2E | EQU \$-1 |
| 1D16 | | 4750 | MSG3B | EQU \$ |
| 1D16 | 30 20 31 20 32 | 4760 | DB | '0 1 2 3 4 5 6 7 8 9 ' |
| | 20 33 20 34 20 | | | |
| | 35 20 36 20 37 | | | |
| | 20 36 20 39 20 | | | |
| 1D2C | 21 20 22 20 23 | 4770 | DB | '! " # \$ % & () * : = - @ + ; , . / ? ' |
| | 20 24 20 25 20 | | | |
| | 26 20 26 20 29 | | | |
| | 20 2A 20 3A 20 | | | |
| | 3D 20 2D 20 40 | | | |
| | 20 2B 20 3B 20 | | | |
| | 2C 20 2E 20 2F | | | |
| | 20 3F 20 | | | |
| 1D32 | 27 20 5B 20 5D | 4780 | DB | 027H, 020H, 05BH, 020H, 05DH, 020H |
| | 20 | | | |
| 1D58 | 3C 20 3D 20 2E | 4790 | DB | 03CH, 020H, 03DH, 020H, ' . . . ' |
| | 20 2E 20 2E 20 | | | |
| | 2E | | | |
| 1D63 | | 4800 | MSG3E | EQU \$-1 |
| 1D63 | | 4810 | MSG4B | EQU \$ |
| 1D63 | 20 43 49 41 52 | 4820 | DB | ' CIARCIA', 027H, 'S CIRCUIT CELLAR IS ' |
| | 43 49 41 27 53 | | | |
| | 20 43 49 52 43 | | | |
| | 55 49 54 20 43 | | | |
| | 45 4C 4C 41 52 | | | |
| | 20 49 53 20 | | | |
| 1D60 | 53 55 50 50 4F | 4830 | DB | 'SUPPORTED BY CURLEW', 027H, 'S SOFTWARE CELLAR ...' |
| | 52 54 45 44 20 | | | |
| | 42 59 20 43 55 | | | |
| | 52 4C 45 57 27 | | | |
| | 53 20 53 4F 46 | | | |
| | 54 57 41 52 45 | | | |
| | 20 43 45 4C 4C | | | |
| | 41 52 20 2E 2E | | | |
| | 2E | | | |
| 1DA9 | | 4840 | MSG4E | EQU \$-1 |
| 1DA9 | | 4850 | | ; |
| 1DA9 | | 4860 | | END OF TEST MESSAGES |
| 1DA9 | | 4870 | | ; |

SYMBOL TABLE

QUADBOARD BY QUADRAM

The new 384K Quadboard by Quadram is the most comprehensive board you can buy for the IBM PC or XT. Now with added hardware features and advanced software. But at a very low price.

New Expanded Quadboard

Quadboard now delivers 9 of the PC functions/features you need most. Including a Centronics compatible parallel port to drive most printers and other parallel devices.

A serial port to connect your computer with plotters, modems, and other serial devices. A chronograph (real time clock/calendar) keeps your system's

**THE WORLD'S
BEST SELLING
MULTIFUNCTION
BOARD IS NOW
EVEN BETTER**

EXPANDABLE TO
384K

clock up to date. A game port. Plug in a joystick or game paddles and fire away. And a special "snap-on" I/O bracket to organize your expansion port connectors.

Plus, the new Quadboard comes socketed for memory expansion up to 384K (in 64K increments). With Quadboard and a fully populated system board you can take your PC to its 640K limit.

New Advanced Software

The new Quadboard comes with advanced QuadMaster software, too. Including the QuadRAM Drive program, for setting up multiple RAM Drives in Quadboard memory. MasterSpool, the easy, powerful print buffer. QuadMaster disk caching, to access frequently used data. And Qswap, for switching line printers 1 and 2 back and forth electronically.

Quadboard Stands Out From the Pack

Now more than ever Quadboard gives you what you need most. More than any other board. Because Quadboard is designed for performance, engineered for dependability, and built in the continuing tradition of Quadram Quality. There are many imitators, but only one leader. So make sure you ask for the one and only. Quadboard by Quadram, the leader in microcomputer enhancement products.



4355 International Blvd., Norcross, Ga. 30093
(404) 923-6666 TWX 810-766-4915 (QUADRAM NCR)

Copyright 1983 Quadram Corporation
All rights reserved.



Quadboard is a registered trademark of Quadram Corporation.
IBM is a registered trademark of International Business Machines.
Circle 305 on inquiry card.

Listing 3 continued:

| | | | | |
|------------|------------|------------|------------|------------|
| HGNBU 0601 | BITLO 1A4B | BLANK 1A37 | CHFIX 1A18 | CHOUT 1A12 |
| CHRTA 1A95 | CLEAR 1A6F | COLCN 19AE | COLSE 1994 | COLWR 1A41 |
| DINIT 1900 | IDXLP 1A26 | INDEX 1A24 | INTER 1965 | INTMS 1966 |
| INTTB 1A85 | LOOP 196C | MSG1B 1C15 | MSG1E 1CE6 | MSG2B 1CE7 |
| MSG2E 1D17 | MSG3B 1D1b | MSG3E 1D65 | MSG4B 1D65 | MSG4E 1DA6 |
| MYREG 0050 | RETRN 1A0F | RIPPL 1A76 | SCROL 19C1 | SCRST 198E |
| SETCh 19E8 | SETCO 1A04 | SKIP1 19A0 | SKIP2 19F6 | SPECI 1B55 |
| START 19B9 | SUPRS 1A2C | SWITC FFFD | TIME 0300 | TIMER 192E |

Listing 4: The display-control program operating in the echo mode produces output on the video-display terminal like that shown here.

CREATE A DISPLAY MENU

1 - BUILD A NEW MESSAGE
 2 - START MESSAGE SCROLLING
 3 - CHANGE SCROLL RATE OF DISPLAY
 4 - EDIT THE STORED MESSAGE

? 1

ENTER DISPLAY CHARACTERS. END WITH RETURN OR ENTER KEY
 TUST

CREATE A DISPLAY MENU

1 - BUILD A NEW MESSAGE
 2 - START MESSAGE SCROLLING
 3 - CHANGE SCROLL RATE OF DISPLAY
 4 - EDIT THE STORED MESSAGE

? 4

LISTING OF CURRENT MESSAGE
 TUST

AS EACH CHARACTER IS DISPLAYED, ENTER + TO SKIP, C TO CHANGE
 TYPE Q TO QUIT LEAVING REST OF MESSAGE,
 TYPE E TO QUIT ENDING MESSAGE AT THIS CHARACTER

T ? +
 U ? C
 NEW CHARACTER ? E

E ? +
 S ? +
 T ? +

END OF ORIGINAL MESSAGE
 TYPE ADDITIONAL CHARACTERS AND END WITH RETURN OR ENTER
 MESSAGE FOR DISPLAY

CREATE A DISPLAY MENU

1 - BUILD A NEW MESSAGE
 2 - START MESSAGE SCROLLING
 3 - CHANGE SCROLL RATE OF DISPLAY
 4 - EDIT THE STORED MESSAGE

? 4

LISTING OF CURRENT MESSAGE
 TEST MESSAGE FOR DISPLAY

AS EACH CHARACTER IS DISPLAYED, ENTER + TO SKIP, C TO CHANGE
 TYPE Q TO QUIT LEAVING REST OF MESSAGE,
 TYPE E TO QUIT ENDING MESSAGE AT THIS CHARACTER
 T ? Q

CREATE A DISPLAY MENU

1 - BUILD A NEW MESSAGE
 2 - START MESSAGE SCROLLING
 3 - CHANGE SCROLL RATE OF DISPLAY
 4 - EDIT THE STORED MESSAGE

? 2

CREATE A DISPLAY MENU

1 - BUILD A NEW MESSAGE
 2 - START MESSAGE SCROLLING
 3 - CHANGE SCROLL RATE OF DISPLAY
 4 - EDIT THE STORED MESSAGE

? 3

ENTER NEW SCROLL RATE
 ? 2

CREATE A DISPLAY MENU

1 - BUILD A NEW MESSAGE
 2 - START MESSAGE SCROLLING
 3 - CHANGE SCROLL RATE OF DISPLAY
 4 - EDIT THE STORED MESSAGE

? 3

ENTER NEW SCROLL RATE
 ? 20

CREATE A DISPLAY MENU

1 - BUILD A NEW MESSAGE
 2 - START MESSAGE SCROLLING

Introducing the first computer games that pay you to own them.

Virtually all computer games provide entertainment value.

These new games from Blue Chip also give you practical value—of the most rewarding kind.

They put you in high-powered, real-world environments. Where you create strategies. React to constantly changing conditions. And learn solid skills in competing for extraordinary payoffs:

Millionaire™ You build a portfolio of actual NYSE companies, whose fortunes are tied to a universe of plausible events and variables to consider. Over 300,000 possible combinations of events mean you can play a lifetime without a repeat.

Baron™ Buy and sell all manner of real estate nationwide as you strive to amass a personal empire. Factors include realistic property values, overall economy and local idiosyncrasies.

Tycoon™ If gold, silver, foreign currencies or other commodities quicken your pulse, play Tycoon and learn the ins and outs of this most volatile of financial arenas.

Squire™ The object here is to retire, financially set, in short order. Game is so realistic you can plug in your personal parameters, choose a lifestyle then follow the guidelines to attain it.

Entertain your brain. Sharpen your financial acumen. For both fun and profit. With these practical new games from Blue Chip.



BLUE CHIP SOFTWARE • (213) 881-8288

Available wherever finer software is sold. On disk for DEC Rainbow 100, DECmate II, IBM PC II Professional, Apple, Commodore 64, Osborne, Atari, Kaypro, and others.

**McCormick,
Greenburg & Benz
Financial
Management**

Mr. Michael Greer
Cromwell Corporation
1712 Macover Avenue
Chicago, IL 60611

Dear Mike:

Congratulations! Your financial portfolio jumped another 1% in value last month.

I don't know what your secret is, but you've developed an uncanny sense for what to buy and sell and when to do it.

Again, my sincere congratulations always a pleasure to give such good news.

Sincerely,
Frank

MG
*Frank -
who said playing
computer games is
a waste of time?
I suggest you check out
the ones from
Blue Chip.
Mike*

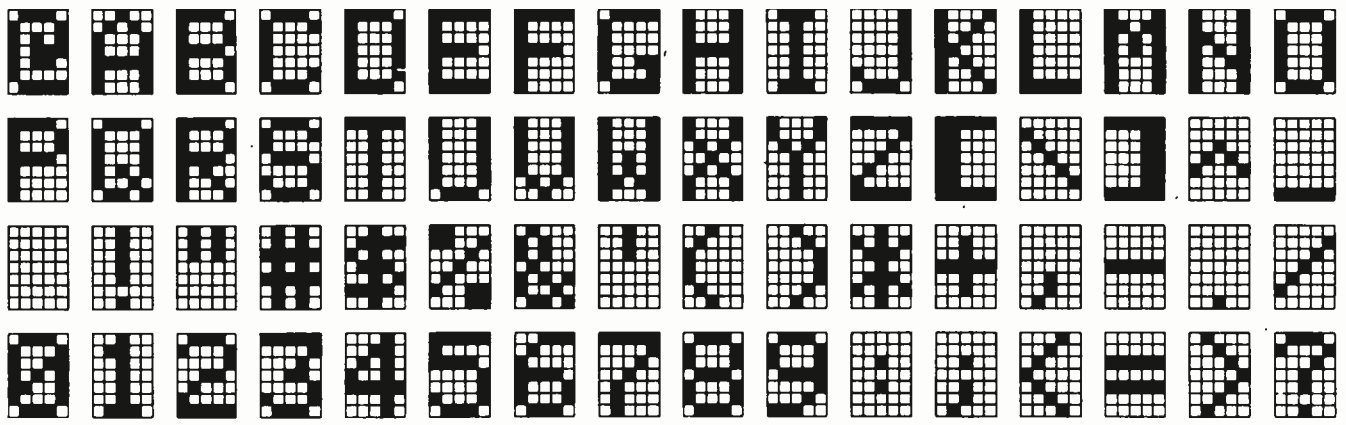

Figure 8: An entire set of alphanumeric characters can be represented by these bit patterns in a 5-by-7-element matrix, that formed by the LED arrangement in figure 2.

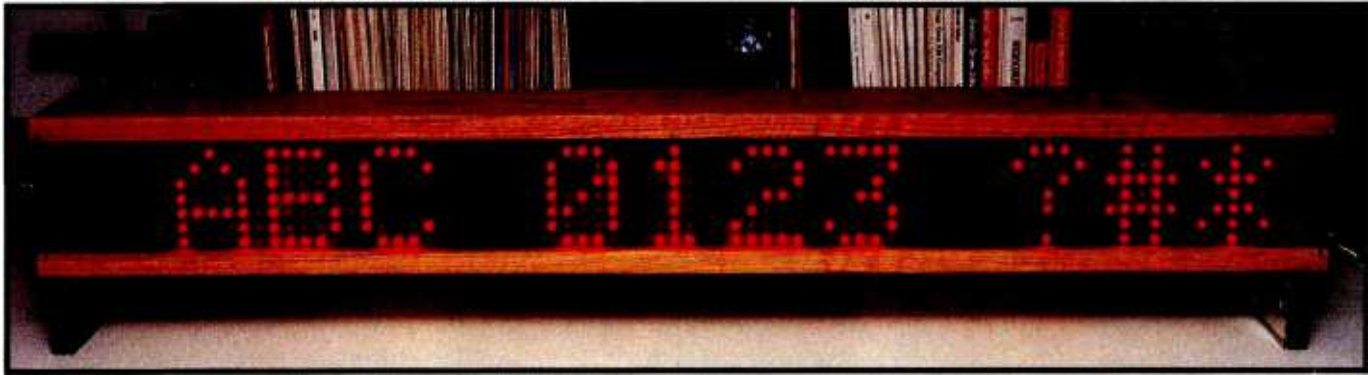

Photo 6: In the finished project, multiple character segments are linked and housed together in an attractive wooden enclosure. Either canned or live messages can be written or continuously scrolled across the array under control of the Z8 software.

Z8 SYSTEM CONTROLLER SWITCH

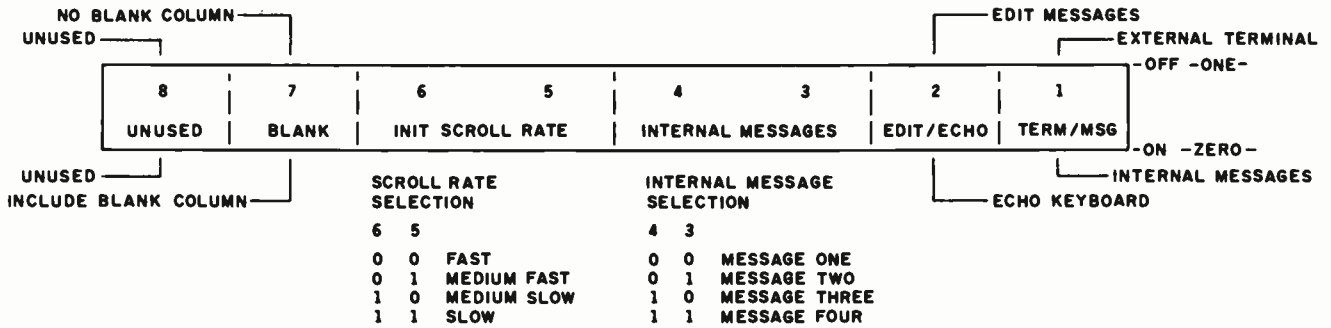

Figure 9: Options that can be selected by DIP-switch settings on the Z8 board. When used without a terminal, the controller can be thereby set up to start automatically and display one of four prestored messages at one of four scrolling rates.

Text continued from page 38:

terminal attached to the Z8 board to set up or change the scrolled message, but not for mere continuous operation with a single message. When a terminal is used and the echo mode is selected, input data or other keyboard entries appear in real time on the display. In the nonecho

mode, the terminal is used to enter complete messages for subsequent display, to set the scroll rate, or to edit existing messages.

Several options can be selected by DIP (dual-inline pin)-switch settings on the Z8 board, as shown in figure 9. When used without a terminal, the

controller can be switch-selected to start automatically and display one of four prestored messages at one of four scrolling rates. Automatic operation would be appropriate if the LED display were used for advertising, housed in an attractive wooden enclosure just like a commercial unit,

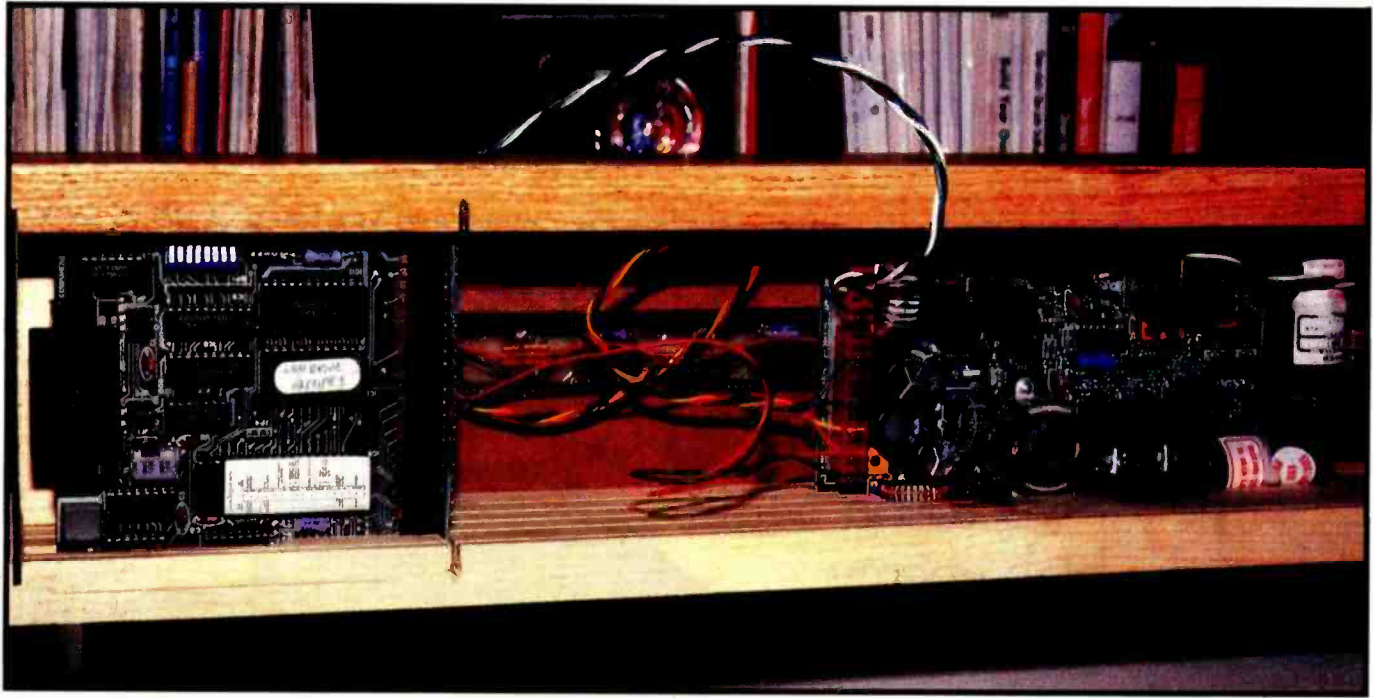

Photo 7: The Z8-BASIC System Controller and a hefty switching-type power supply reside in the rear of the wooden box.

as shown in photo 6. (In the rear of the box are the Z8 board and a high-current switching power supply, as photo 7 reveals.)

In Conclusion

The assembly-language routines written for the Z8 could be converted to other processors without too much trouble. If you get ambitious and perform this conversion or devise some clever ways to use the LED display, let me know. I'd like to see your ideas and make them available to others.

I've only begun to find uses for my scrolling LED display. In another month or so, I should be able to add 20 or 30 more character segments. I wonder if I'll ever get to build a 24-line by 80-character display screen?

Next Month:

If you'd like to speed up execution of high-level-language programs on your IBM PC, you'll be interested in a 16-bit coprocessor card you can build.

Steve Ciarcia (pronounced "see-ARE-see-ah") is an electronics engineer and computer consultant with experience in process control, digital design, nuclear instrumentation, product development, and marketing. In addition to writing for BYTE, he has published several books. He can be contacted at POB 582, Glastonbury, CT 06033.

Oops!

In last month's article, we said that this month's project would be the IBM PC coprocessor board. Steve had to delay that project, but your disappointment will be only temporary—you'll see it in May. . . . R.S.S.

Editor's Note: Steve often refers to previous *Circuit Cellar* articles. Most of these past articles are available in reprint books from BYTE Books, McGraw-Hill Book Company, POB 400, Hightstown, NJ 08250.

Ciarcia's *Circuit Cellar, Volume I* covers articles that appeared in *BYTE* from September 1977 through November 1978. *Ciarcia's Circuit Cellar, Volume II* contains articles from December 1978 through June 1980. *Ciarcia's Circuit Cellar, Volume III* contains articles from July 1980 through December 1981. *Ciarcia's Circuit Cellar, Volume IV*, soon to appear, will contain articles from January 1982 through June 1983.

References

1. Ciarcia, Steve. "Build a Z8-Based Control Computer with BASIC" Part 1, *BYTE*, July 1981, page 38. Part 2, *BYTE*, August 1981, page 50.
2. Ciarcia, Steve. "Self-Refreshing LED Graphics Display." *BYTE*, October 1979, page 58.

To receive a complete list of Ciarcia's *Circuit Cellar* project kits, circle 100 on the reader service inquiry card at the back of the magazine.

The following items are available from

The Micromint Inc.
561 Willow Ave.
Cedarhurst, NY 11516
(800) 645-3479 for orders
(516) 374-6793 for information

1. Kit for a single-character-segment LED display, 5 by 7 matrix. Includes LEDs, integrated circuits, printed-circuit boards, and all components necessary to display one 5 by 7 character.

single-segment kit SSK1, each...\$45
10 or more segment kits, each...\$42

2. Pair of blank printed-circuit boards for a single character segment, includes two Berg-type connectors.

single-segment board pair, PSS1...\$17

3. Z8-BASIC System Controller (scrolling LED software on EPROM optionally available).

BCC11, assembled and tested...\$149

Please add \$4 for shipping and insurance in the continental United States, \$16 elsewhere. New York residents please include 7 percent sales tax.

Special thanks to Bill Curlew and Ray Long for their contributions to this project.

Don't buy a spreadsheet

A lot of electronic spreadsheets can't cover your needs. They just don't go far enough.

They're unable to work like you or adapt to the way you think.

Time for Microsoft® Multiplan®, the high energy spread. Software that's rich with understanding. Full of high performance capabilities for IBM®, Apple® and more than eighty other personal computers.

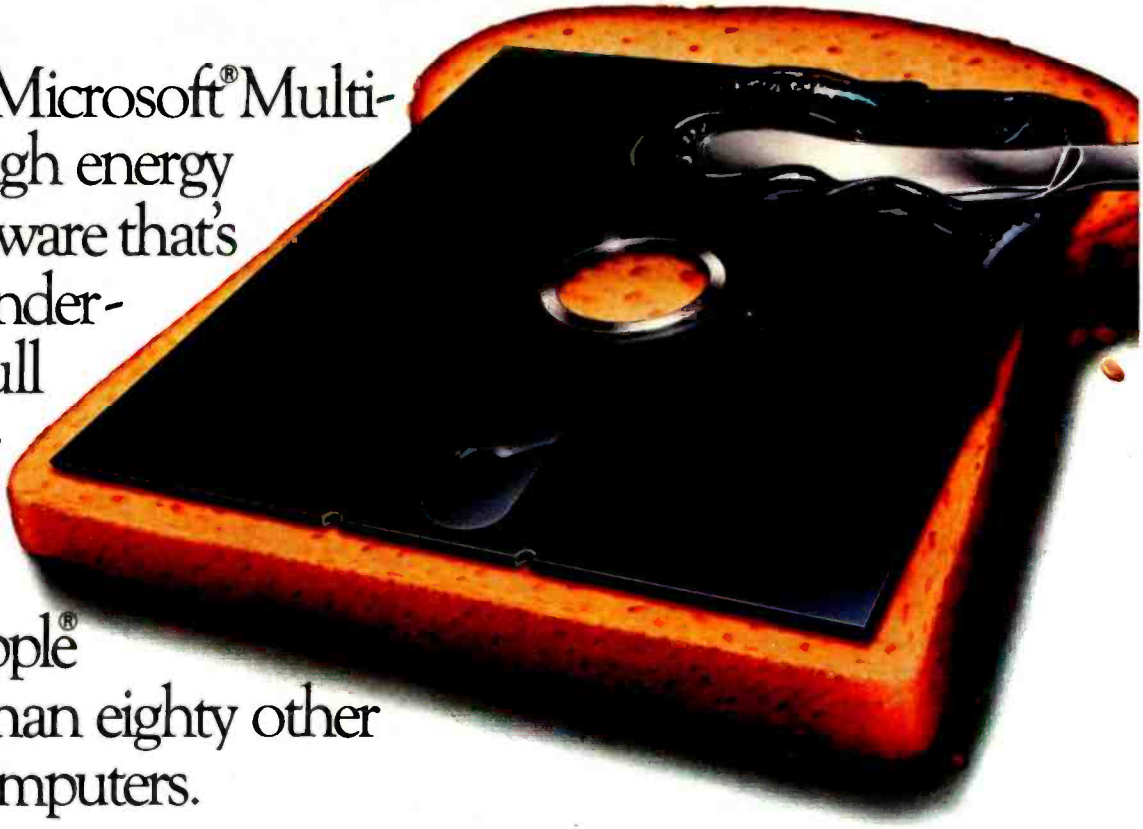

Multiplan loves you as you are.

Other spreadsheets force you to learn how they think. Multiplan learns how you think. It remembers the way you work. Anticipates frequent commands. Even offers suggestions on spreadsheet set-up.

Commands are in English. So are formulas. Instead of typing mysterious coordinates like H54-L73=BK154, you can name worksheet areas: Sales-Costs=Profit.

that spreads too thin.

Multiplan can link information in different spreadsheets. When you make a change on one, every related one is changed.

The wish list.

Only Multiplan has optional Multiplan Application Programs that work with you to design and build custom spreadsheets for Budget Analysis or Financial Statement Analysis in minutes.

MICROSOFT
The High Performance Software

Not hours. Or days.

Small wonder Microsoft gets more performance out of a spreadsheet. We designed the MS™-DOS operating system that tells the IBM PC how to think. And our BASIC is the language spoken by nine out of ten microcomputers worldwide.

To get the very best spread please call 800-426-9400 (in Washington State call 206-828-8088) for the name of your nearest Microsoft Multiplan dealer.



MULTIPLAN

Microsoft and Multiplan are registered trademarks and MS is a trademark of Microsoft Corporation. IBM is a registered trademark of International Business Machines Corporation. Apple is a registered trademark of Apple Computer, Inc.

Why buy a **VISUAL 102** instead of a DEC VT102?

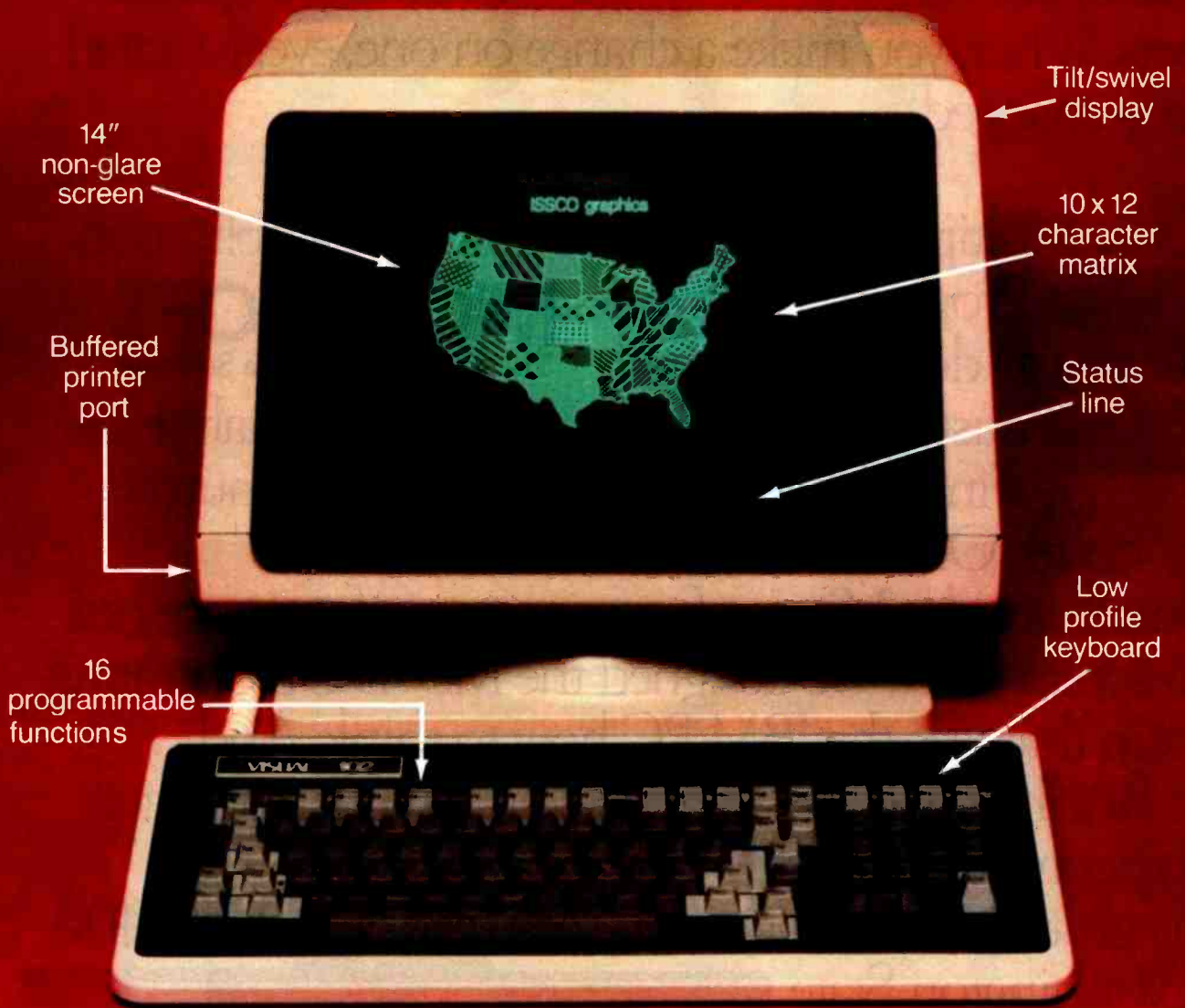

Plus...graphics now or graphics later.

The new **VISUAL 102** gives full DEC VT102[®] performance and more features at a much lower price. Plus, when you need it, a Graphics Option card turns the **VISUAL 102** into a 768 x 293 resolution graphics terminal emulating the Tektronix[®] 4010/4014. Just insert the card and immediately you have high resolution graphics compatible with a variety of available software packages.

VISUAL 102, The low cost, DEC VT102 compatible terminal that lets you graph now or graph later.

VISUAL See for yourself

The Most Fabulous Object in the Entire World

Ain't love grand, Diser, and lots more from Chaos Manor

Jerry Pournelle
Consulting Editor

We've just finished December.

It's axiomatic among writers that nothing happens during December. All the New York publishers vanish from about the first of December until the second week in January. No manuscripts are accepted, no contracts are issued, and no checks are mailed.

Computer companies seem to follow the same practice. Although people at COMDEX promised us a bundle of software and a whole slew of upgrade boards for the IBM PC, very little came in to Chaos Manor during December. I suppose that's just as well since I need to catch up with the backlog. But first—

The Most Fabulous Object in the Entire World

I fell in love at COMDEX.

One booth was occupied by the B. A. Pargh Company, which sells from an enormous catalog full of items ranging from calculating machines to cigars; apparently it carries whatever the company's president wants to carry. Pargh will sell you (if you're a dealer) a Darth Vader Speakerphone, or even a Kermit the Frog phone if you're mad enough to want one.

This interesting outfit shared its booth with a real showstopper. Imagine a clear glass globe about 18 inches in diameter. Fill it with blue-green lightning bolts springing from a sun-

red orb in the center. Touch the outside of the globe and the lightning comes to your hands and plays about on the inner surface.

I'm watching mine as I write this. Fingers of lightning leap and play—no. There's no real way to describe this in words. You'd have to see it. It's magnificent.

The Orb Corporation has created a new kind of art object, one that allows you to make ephemeral light sculptures by running your hands over the globe to control the lightning. It's called an Omnisphere. As I said, it's a clear, hollow glass globe on a black pedestal. Inside the globe is a carefully prepared mixture of 15 rare gases in a near vacuum. Three microprocessors (see, there *is* a connection!) control the generation of a high-voltage ultrahigh-frequency current that leaps to form a plasma. Controls on the front allow you to change the intensity, frequency, and other characteristics of the display.

The Omnisphere comes with a 20-year guarantee. It's like nothing you've ever seen. Not cheap, and certainly not for everyone; but you can't buy mine for any price.

Diser

Last year at the West Coast Computer Faire I was much impressed by Lilith, the machine developed in Europe and used by Niklaus Wirth to design Modula-2. Modula-2, for

those few who tuned in late, is a structured language best described as "Pascal with the bugs out."

Like most machines for graphics, Lilith is built around the AMD 2901 bit-slicer central processing unit. Alex says bit-slicer means the designers took a bunch of little chips and made them into one big one. The advantage is in the graphics capability: the machine can control a bit-mapped screen dot by dot and do it *fast*.

It turns out that the Diser Company is building a U.S. version of Lilith, which it introduced at COMDEX East last spring. Like Lilith's operating system, the one in the Diser is written in Modula-2, so that it's easy to tinker with and improve, and the machine is a nearly ideal development system for working with Modula-2. It's somewhat more expensive than the microcomputers I write about, so I paid it little attention.

Then I got more involved with Modula-2 and decided to write a book on the language. One thing led to another, and I found myself talking to Heinz Waldberger, president of Diser, and this afternoon one of the machines arrived.

The Diser is *big*; the main unit sits on casters on the floor and measures about 30 inches high by 15 inches wide by 30 inches deep. This contains a card cage, power supply, *four* fans, and a removable-cartridge 10-mega-

byte hard disk. There aren't any floppies yet, but that's due to change soon; in the meantime, I'll have to use the RS-232C serial port to exchange program source code with the Sage II.

The rest of the machine consists of a big bit-mapped screen similar to the Corvus Concept—like the Corvus, it's taller than it is wide—a Keytronic keyboard, and a Logitech mouse. The keyboard is laid out in the Selectric style. There aren't any arrow keys, but then it doesn't need them since

the mouse is intended for cursor control. It's essentially the same keyboard that Keytronic provides as an alternative to the IBM PC keyboard—see my review that follows.

The Diser arrived in three enormous boxes. On one was taped an envelope on how to assemble it. The first thing the instructions did was list the contents of one of the boxes: keyboard, mouse, three cables, two disk cartridges, and the system documents. Alas, there was only *one* disk cartridge, and no documents at all.

Given that the machine was rushed out on special order for me, this wasn't all that surprising, and a quick call to Orem, Utah, produced an apology and a promise of documents by Federal Express. The second disk cartridge would have been an exact duplicate of the first, intended for backup; we'll get one of those, too.

Assembly took a bit more than an hour, after which we fired it up. At first we couldn't do anything, but Alex continued to poke at the machine until he found that typing "?" produced some useful Help files. In poking around, we also found machine-readable text files of some of the system documents. I'm writing to catch a deadline; Alex is in the far corner poking the machine. Every now and then he shouts "Wow!" or words to that effect when he finds something new.

Control of the Diser has some similarities to Apple's Lisa but isn't such an insult to the intelligence. Pushing buttons on the mouse produces a miniwindow with a menu of options; moving the mouse within that miniwindow selects among the options. Some of the options have suboptions, also selectable by skillful use of the mouse. I can see how one could become quite adept with a little practice. For example, many editing functions, like insert, delete, and move text, are done with the mouse. Unlike Lisa, the Diser does all this *fast*.

We found illustrations of the machine's graphics capabilities under a file called DEM.COMDEX.DEMO; running that produces a dazzling display of three-dimensional graphics, including bit-map photographs of Swiss castles, as well as a pastoral scene with guernsey cows—I wonder if they've been to Peterborough lately? [Editor's Note: Here at BYTE we are ensconced in the former headquarters of the American Guernsey Cattle Club.]

Obviously, the Diser can store and display photographs. You can also draw pictures and diagrams with the mouse. Of course, you then need a printer capable of reproducing them on paper.

The Diser is intended for use with a laser printer. Diser has mated Canon's big and fancy laser printer to

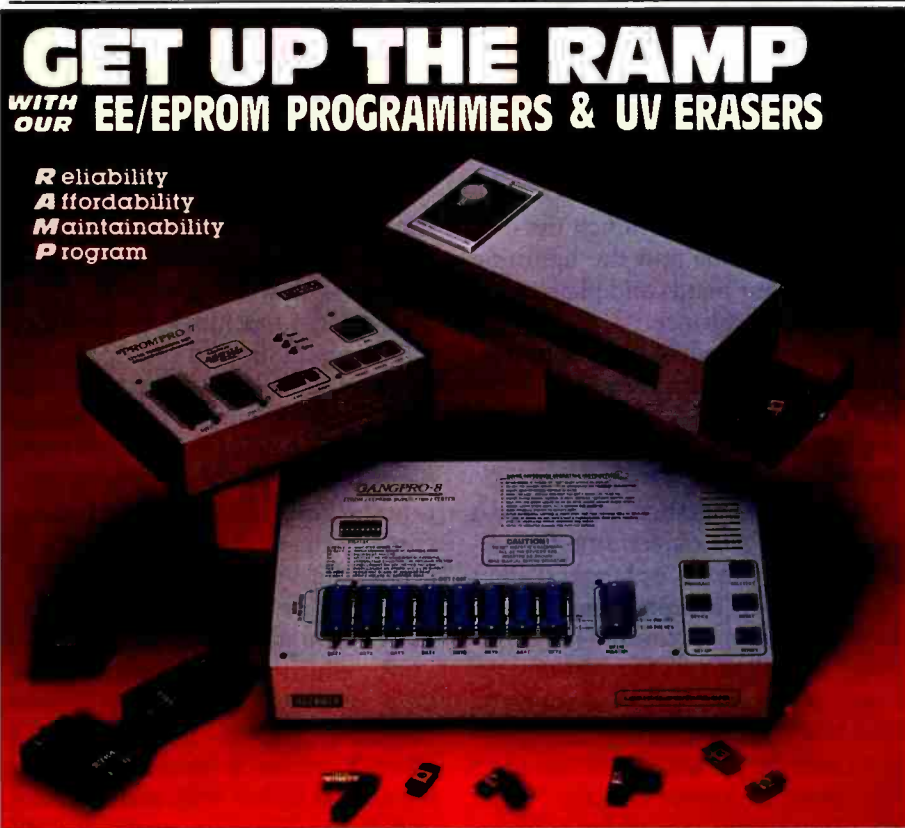

GET UP THE RAMP

WITH OUR EE/EPROM PROGRAMMERS & UV ERASERS

- R**eliability
- A**ffordability
- M**aintainability
- P**rogram

NOW AVAILABLE: PAL PROGRAMMERS (call)

GANGPRO-8™ MULTIPROGRAMMER \$995.00
 GANGPRO-8™ allows user to program up to 8 EE/EPROMs simultaneously using the latest state of the art programming algorithms. It can test and duplicate a wide variety of devices from 16K to 256K. There are no personality modules to buy. 8 digit alphanumeric display prompts user with messages. This unit is extremely easy to operate and is ideally suited for a production environment.

QUV-T8™ series UV EPROM ERASERS
QUV-T8/2T (\$97.50) is an industrial quality eraser designed in a steel enclosure with a 5" wide tray UV indicator lens, antistatic pad, 60 minute rugged timer and safety interlock switch are standard. Capacity is 24 EPROMs. 15-20 minutes erase time for 15 EPROMs.

QUV-T8 / Z (\$124.95) Similar to QUV-T8/2T (with 40% faster Erase Time).
QUV-T8/2N (\$68.95) Same as the QUV-T8/2T version without the timer and safety interlock switch.
QUV-T8/1 (\$49.95) Economy model in a molded two part plastic case. Erases 15 EPROMs in 15 minutes.

*MCS-48 is a registered trademark of Intel Co.

PROMPRO-7™ SERIAL RS-232 STAND-ALONE \$489.00
 MCS-48™ FAMILY PROGRAMMING WITH PROMPRO-7™ PROMPRO-7™ is an intelligent self-contained unit. Ideally suited for engineering development, or for field service & production. It can program and verify a wide variety of 8K to 128K EPROMs. This unit has a 32K (4K BYTES) internal RAM buffer that could be accessed by the user through a computer or terminal. This unit can also program the micro chips such as the 8478, 8749, 8751, 8741, 8742, 8755. The price includes all modules up to 32K EPROMs & The 8748 & 8749H Micros Upload/download is done by either Motorola or Intel Hex format.

PROMPRO-8™ SERIAL RS-232 STAND-ALONE \$689.00
 This extremely versatile programmer has as much as 128K (16Kx8) of internal RAM dedicated to the EE/EPROMs. This RAM buffer can be accessed either through a computer terminal or by user target system (EPROM emulation). PROMPRO-8 8 digit alphanumeric display prompts user with the system messages. A keypad option is available for standalone editing. An impressive range of devices are programmed (as standard feature).

SEE US AT COMDEX
 SPRING ATLANTA

ORDER TOLL FREE 1-800-EEL-PROM (331-7766)

- AVAILABLE SOFTWARE DRIVERS
- | | | | |
|--------------------|-----------------|-----------------|---------|
| 1. IBM PC | 2. APPLE II | 3. MDS-ISIS | 4. CPM |
| 5. TEKTRONICS 8002 | 6. COMMODORE 64 | 7. TRS-80 COLOR | 8. FLEX |



LOGICAL DEVICES, INC.
 DEPT. 6 1321-E N.W. 66th PLACE, FORT LAUDERDALE, FLORIDA 33309
 INFO. TEL. (305) 974-0967
 DISTRIBUTORS WELCOME FOR QUALIFICATIONS

Sprinter™



Portable



A new generation printer that combines portability, dependability and quality. **Sprinter** is travel convenience — lightweight and rugged with an easily removable travel cover and plenty of space for storage.



Personal

A friendly printer that is easy to operate. Ease of operation is top priority for this printer. A **SoftSwitch™ Control Pad** allows the user to control forms' length, print density, tabulations, baud rate and character sets.



Professional

A fast printer, the 160 CPS **Sprinter** comes standard with a 4K buffer expandable to 68K with MPI's **MemoryMate™** option. It comes equipped with an **EasyLoad™** front paper feed for quick paper insertion and handles everything from letterhead to multi-part forms.

Travel with the Best!

See the Sprinter at your local computer store or call us for the dealer nearest you. 1 (800) 821-8848

Circle 270 on Inquiry card.



Micro Peripherals, Inc.

4426 So. Century Dr. • SLC, UT. 84123
(801) 263-3081

Your computer's telephone.

Hayes™



What will counteract NDC
74-0054-60?



Gary: The pedigrees for next week's
auction are as follows...

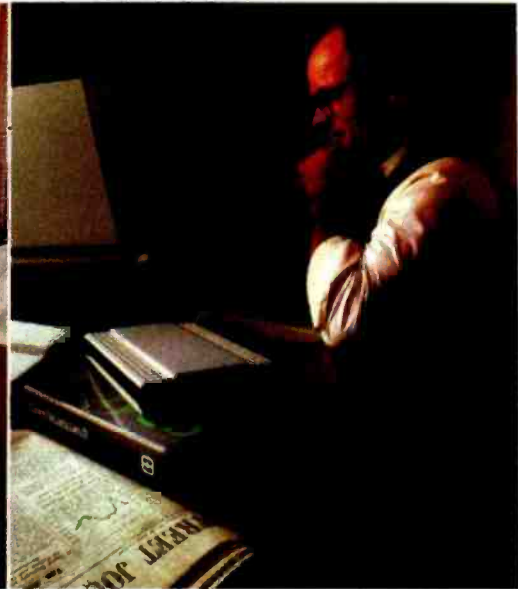

Sold 1000 shares at 33 for net profit
of 6000. Richard.

Wouldn't it be great if you could use your IBM®PC to tap into vast resource libraries across the country? To transfer files to your partner, upstate? Or from your broker, down the street?

It's possible. All you need is a modem, to connect your computer to others. Down the hall. Or thousands of miles away.

dial, answer and disconnect calls. Automatically. And without going through the telephone receiver, making them far superior to acoustic coupler modems.

Choose your speed; choose your price. The lower-priced Smartmodem 300 is ideal for local data swaps and communicates at 300 bps. For longer distance and larger volumes, Smartmodem 1200 operates at baud rates of 300 or 1200, with a built-in selector that automatically detects transmission speeds.

Both work with rotary dials, Touch-Tone® and key-set systems; connect to most time-sharing systems; and feature an audio speaker.

Smartmodem 1200B™ is also available as a plug-in board. Developed specifically for the PC, it comes packaged with Hayes' own communications software, Smartcom II™

Smartcom II. We spent a lot of time developing it, so you can spend less time using it. Smartcom II prompts you in the

simple steps required to create, send, receive, display, list, name and re-name files. It even receives data completely unattended—especially helpful when you're sending work from home to the office, or vice versa.

If you need it, there's always "help." This feature explains prompts, messages, etc. to make communicating extra easy.

With Smartcom II, it is. Case in point: Before you communicate with another system, you need to "set up" your computer to match the way the remote system transmits data. With Smartcom II, you do this only once. After that, parameters for 25 different remote systems are stored in a directory on Smartcom II.

Calling or answering a system listed in the directory requires just a few quick keystrokes.

You can store lengthy log-on sequences the same way. Press one key, and Smartcom II automatically connects you to a utility or information service.



Hayes Smartmodem. Think of it as your computer's telephone. Hayes Smartmodem 300™ and the faster Smartmodem 1200™ allow you to communicate over ordinary phone lines.

But any modem will send and receive data. Smartmodems also



Hayes®

Smartmodem 300, 1200 and 1200B are FCC approved in the U.S. and DOC approved in Canada. All require an IBM PC with minimum 96K bytes of memory; IBM DOS 1.10 or 1.00; one disk drive; and 80-column display.

Smartmodem 1200B. (Includes telephone cable. No serial card or separate power source is needed.)



Smartcom II communications software.

NOTE: Smartmodem 1200B may also be installed in the IBM Personal Computer XT or the Expansion Unit.

In those units, another board installed in the slot to the immediate right of the Smartmodem 1200B may not clear the modem; also, the brackets may not fit properly. If this occurs, the slot to the right of the modem should be left empty.

And, in addition to the IBM PC, Smartcom II is also available for the DEC Rainbow™ 100, Xerox 820-II™ and Kaypro II™ personal computers.

Backed by the experience and reputation of Hayes. A solid leader in the microcomputer industry, Hayes provides excellent documentation for all products. A limited two-year warranty on all hardware. And full support from us to your dealer.

So see him today. Break out of isolation. Get a telephone for your personal computer. From Hayes.

Hayes Microcomputer Products, Inc., 5923 Peachtree Industrial Blvd., Norcross, GA 30092. 404/441-1617.

Smartmodem 300, Smartmodem 1200, Smartmodem 1200B and Smartcom II are trademarks of Hayes Microcomputer Products, Inc. IBM is a registered trademark of International Business Machines, Corp. Touch-Tone is a registered service mark of American Telephone and Telegraph. Rainbow is a trademark of Digital Equipment Corporation. Xerox 820-II is a trademark of Xerox Corporation. Kaypro II is a registered trademark of Non-Linear Systems, Inc. ©1983 Hayes Microcomputer Products, Inc.

the machine, but I can't afford one of those. However, the company expects to have it working with Canon's new low-cost cartridge laser printer—see my COMDEX report in the March BYTE (page 352)—Real Soon Now. The delay is not Diser's. Canon hasn't yet delivered the printer. The Canon is only one of a whole bunch of new and comparatively low cost (less than \$4000) fast laser printers. Xerox and Fujitsu are also contenders. I certainly intend to get one of them.

You can also interface the Diser to a high-quality dot-matrix printer, such as the Printmate 150, and until we can get a laser printer that will just have to do.

Meanwhile, I'm already impressed with the Diser. I've seen it format text and then present it in fancy type fonts on screen. I've been playing with the text editor; it's certainly usable, although it will take a while to become skillful with the mouse.

I like Diser's character sets; it gives you a choice of about a dozen type fonts, including Helvetica, Gothic, and Times Roman. On the other hand, I'm not as fond of black on white as Diser is, and the letters on the screen are smaller than I'm used to; I find myself getting closer to it, which means I have to tilt my head back and look through the bottoms of my bifocals, which does my posture no good at all. No matter: you can change the default type font in the text editor to be as large as you like, and if I really fall in love with the machine, I'll get one of the *enormous* Dottronix bit-mapped screens we saw at COMDEX.

Meanwhile, this machine, plus a laser printer, can produce camera-ready copy, giving authors total control of their books. That could be important to me, especially if Larry Niven and I do any more novels requiring complex typography, as *Oath of Fealty* did. In *Oath* we used different typefaces to indicate various modes of communication: humans speaking to computers; computers speaking to humans; humans conversing with computers through implanted *transceivers*; humans conversing with each other by means of the implants; computers writing to

screens; and so forth. It got a bit complicated, and the typesetters didn't get it perfect even after a number of telephone calls. With the Diser and a good laser printer, I could send final page copy to my publisher.

Of course, it's no use counting one's chickens before they're hatched; after all, I've had the machine only a few hours, and we won't really know what it can do until we have the documents and get a chance to thrash it about. It will certainly have some pretty severe limits, since there's not much software for it. I suppose there is somewhere a Pascal compiler for the Diser, so I could recompile any Pascal programs I have source code for; but most of the programs I use every day would have to be rewritten in Modula-2.

On the other hand, Modula-2 is, in my judgment, the real language of the future, and it won't be long before there's a lot of software written in Modula-2, including accounting packages and the like; for that matter, it wouldn't be all that difficult to translate my own accounting programs from structured Compiling CBASIC to Modula-2, and the programs would be the better for the change.

What all this means, really, is that I'll certainly have a lot more to say about the Diser in months to come.

Desk Organizer

One reason I anxiously awaited our IBM PC was a program whose description made it appear to be precisely what I wanted: a combination telephone directory, notepad, desk calculator, and clock/calendar with scheduler and alarm. It's called Desk Organizer, from an outfit called Conceptual Instruments Company, and from the description I was sure it would be great. Moreover, it works under a sort of concurrent operating system: you boot up with the Desk Organizer disk, and once it's running you can bring up the regular IBM PC operating system and run other programs, such as a text editor. The Desk Organizer is said to be still in the system, ready to be called up—something like Concurrent CP/M-86. If you have lots of memory, you can freely



Era one.

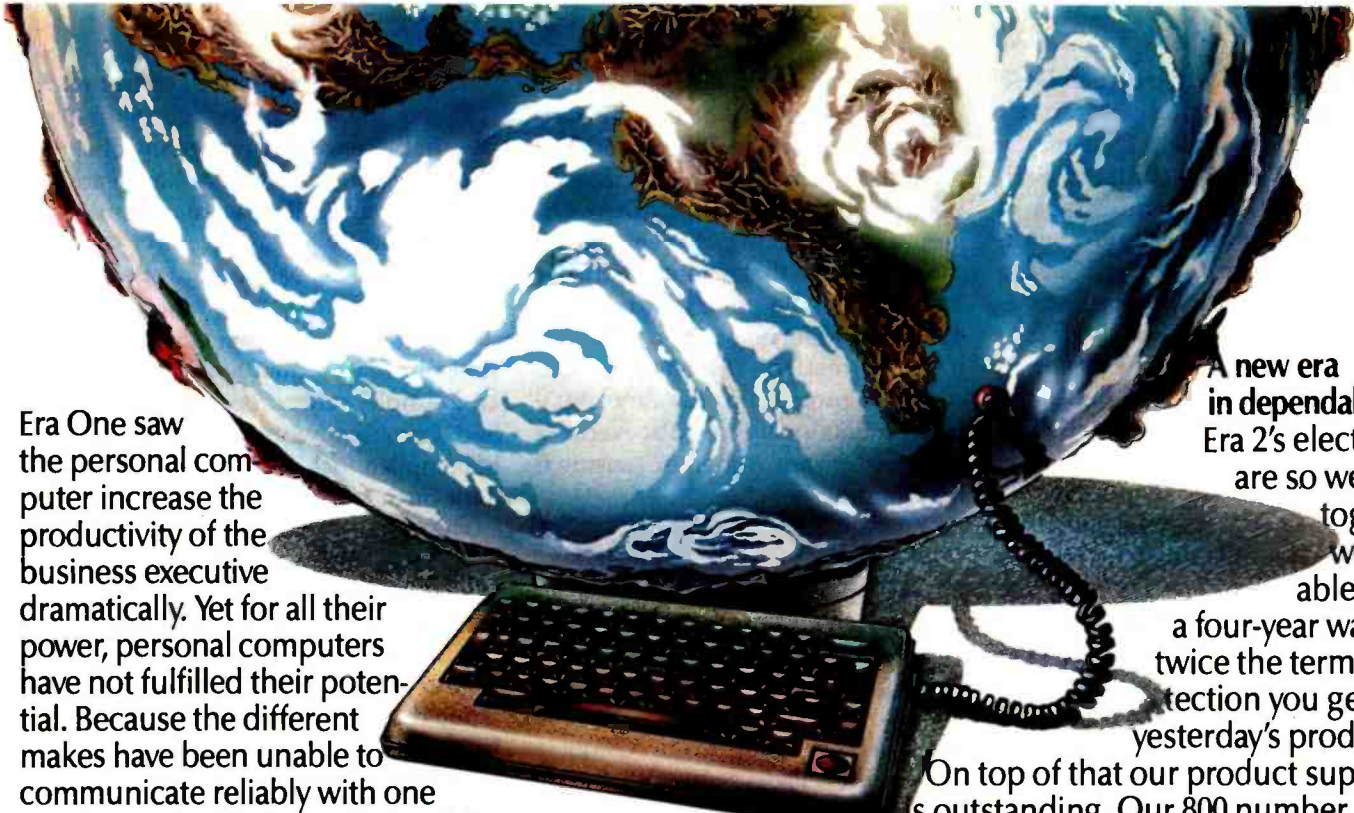

Era One saw the personal computer increase the productivity of the business executive dramatically. Yet for all their power, personal computers have not fulfilled their potential. Because the different makes have been unable to communicate reliably with one another and with the various public data networks.

But now, Microcom moves the personal computer into a new era of communications compatibility with Era 2—the first Personal Computer Communications System with the industry-standard communications protocol MNP. Era 2 finally enables dissimilar personal computers to communicate with one another reliably and cost effectively. It also allows the personal computer to access public data networks easily and error-free.

A closer look at Era 2.

Era 2 with MNP is a 1200 baud Communications System (software and inboard modem) designed to operate with the IBM PC, PC XT, compatibles and PCjr; Apple IIe, Apple II Plus and Apple II. Its features include IBM 3101, Digital VT-100 and VT-52 terminal emulations. Era 2 executes multiple functions with a single keystroke. Stores a virtually unlimited number of telephone numbers – each one up to 31 digits. Era 2 is Bell 212A compatible, works with Pulse or Touch-tone™ dialing. Its speaker alerts you to busy signals, wrong numbers, etc. Era 2 gives your personal computer error-free compatibility with other personal computers, data bases, mainframes, almost any information source that can be reached by telephone line.

Microcom, Era 2 and MNP are trademarks of Microcom, Inc. Apple is a trademark of Apple Computer Inc. Digital is a trademark of Digital Equipment Corporation. IBM is a trademark of International Business Machines Corporation.

Circle 245 on inquiry card.

Era two.

A new era in dependability. Era 2's electronics are so well put together we're able to offer a four-year warranty—twice the term of protection you get from yesterday's products. On top of that our product support is outstanding. Our 800 number operates 9AM to 8PM (EST), Mondays through Fridays, 9AM to 5PM Saturdays with experts available to solve any problem or answer any question.

The state of the price of the state of the art.

We're able to offer Era 2 for an amazing \$429. By any standard the price/value ratio of Era 2 is outstanding.

Move your personal computer forward into a new era of communications. Visit your Era 2 dealer soon. Call 800-322-ERA2 (in MA, 617-762-9310) for the name of one nearest you. Or write us, Microcom, Inc., 1400A Providence Highway, Norwood, MA 02062. We'll send you a brochure with complete information on Era 2. **Only from Microcom: The Personal Computer Communications System with MNP.**



switch back and forth between Desk Organizer and another program.

This sounded ideal. One of my problems is a desk cluttered with notes and calendars and scraps of paper, and I can never find my address book when I want it. Getting all that on line would be worth something. True, I don't use an IBM PC to write with, but that's a solvable problem: within weeks we'll have the Compupro 8085/8088 sufficiently PC-compatible to run that sort of program, or at least they keep telling me we will. Besides, even if I don't end up using it because I'm not willing to convert to the PC as my personal machine, others here could, and I've plenty of friends who *do* use PCs and PC clones.

Alas, it's not quite all I'd hoped for.

As far as I can tell, Desk Organizer does do all it promises; but it does it *very* slowly, and it's more complex to learn and use than I would have thought. The complexity isn't a real barrier. There's an excellent tutorial, perhaps a bit cumbersome, but complete enough.

On the other hand, the version the company sent me didn't do what it said it would. In particular, the documents say that various items will be "highlighted," which I suppose means that they'll appear in reverse video. I had to suppose it, because it didn't; there was no hint of any highlighting when I used the program, which made it quite difficult to be certain precisely what the program was going to do; the control scheme involves using the arrow keys to move the highlighting up and down within a list; if there's no highlighting, you've no choice but to try to set things up so the top or bottom item in the list is the one selected. This was hard enough work that I soon abandoned it.

However, just this morning a new disk arrived from Conceptual Instruments. I had Peter put it into the machine, and it does come up with highlighted (boldfaced, not reverse video) items, so I suppose I had a broken copy. Alas, I haven't had a chance to check for speed improvements.

To Conceptual Instruments' credit,

neither the program disk nor the data disks are copy-protected; in fact, there's a copy utility built into Desk Organizer, which figures, since you boot up the machine with Desk Organizer's operating system rather than the one that comes with the IBM PC. On the other hand, it took 4 minutes to format a disk, and after it was formatted, *11 minutes more* to copy the program disk. Conceptual Instruments may have discovered a new antipiracy scheme: terminal boredom.

Providing technical support is a job few computer companies enjoy.

Using the program is a bit like using Valdocs on the Epson QX-10: it works, but it takes so long that after a while you don't really care. There seems to be a lot of disk accessing. I don't suppose there's any help for it, given the amount of functions it performs and the data it stores. It could be unfamiliarity with the program, but I find it easier to hunt up my missing address book and look up the number.

There are nice features to Desk Organizer. The calculator is complete and fairly easy to use. There's a long section on "personalizing" the program. If you have the right kind of modem, the system will dial telephone numbers for you. There's a way to define the function keys as "stamps"; they could include your name and address, or the word CONFIDENTIAL, or indeed most anything you might have made into a rubber stamp.

In other words, I have mixed emotions about this program. I'd really like it to work, but I find trying to learn it a frustrating experience. Apparently I had a broken copy, since the manual is explicit about highlighting, and I saw no signs of it; moreover, from the serial number it was a very early copy. Perhaps the later version is speedier. If so, you'll hear about it. Meanwhile, if you're thinking about buying it, I'd advise you to get a demonstration from a dealer you trust.

The Technical-Support Dilemma

When the micro revolution first began, there weren't very many of us users. Most companies—hardware and software alike—were so small that typically there weren't any people specially assigned to answering customers' questions and solving their problems. The regular technical staff did that in their spare time. As an example, when some years ago I had a problem with Sorcim's Pascal/M compiler, Richard Frank, the president of the company, took the call.

That's pretty unlikely now. Any successful company sells thousands to tens of thousands of copies of its product, whether it be a computer or a program or, increasingly, both. Outfits like Digital Research, with many different versions of dozens of languages and compilers as well as the CP/M operating system, find they need large staffs to answer customer queries.

Providing technical support is an onerous job that few computer people enjoy. How could they? They're likely to get the same questions over and over again. An interesting question almost by definition means one they can't answer. Meanwhile, there are the dozens of callers, some asking superbly stupid questions, some with legitimate beefs, some irate, and nearly all unhappy. Anyone smart enough to answer the tough questions could be doing independent programming work, or, turning it around, in general if you don't know enough about computers to be doing development work, you probably shouldn't be answering users' questions. This makes for a vicious circle and a high turnover in the technical-support departments of many large micro suppliers.

On the other hand, there have to be technical-support people. Most microcomputer programs are not well designed and often have really poor documentation to boot. There's often no way to make the program run without correcting it and no way to tell the customer how to correct an older version except through direct telephone contact.

The expense of providing technical support is often used as justification

inmac™



**FOR EVEN FASTER SERVICE,
CALL 1-800-547-5444.**
In California
1(800) 547-5447.

PC users! Here are 6 products you need to get up and running, fast!

MicroMaster™ is the first truly complete PC support system.

It's revolutionary design integrates orderly paper and cable management like no other office furniture we know of. And, for maximum PC usage and functionality, mobile MicroMaster can be moved from one location to another easily and safely. Best of all, MicroMaster is so well-made, we guarantee it for life.



MicroMaster PC Workstation
Oak/Putty 3975-8T3
Walnut/Black 3975-7T3
\$349.00 (base unit)

**★ INMAC
EXCLUSIVE**

New – The world's most compact auto-answer/auto-search modem.

The Small Talk™ is our newest 300-baud modem. It features automatic search and automatic answer, at a very affordable price. Compatible with all other 103-type modems on the market, complies with FCC rules. Order yours today.
No. 8063T3 \$149.00

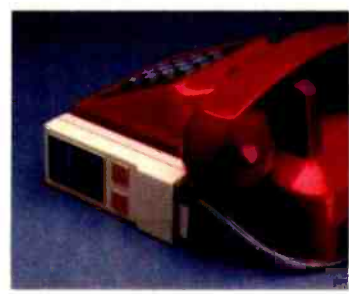

The ultimate solution for glare problems.

Our Glare Sentry™ II effectively reduces CRT-reflected light. Plus, the built-in contrast enhancement filter makes each character sharper and much easier to read. Specify your equipment and model number.
Glare Sentry™ II \$99.00



The Micro-T-Switch gives you instant access to 2 serial devices.

Save the cost of a second printer by allowing two users to share the same device. All components are mounted on a printed circuit board to reduce cross-talk and eliminate trouble-prone point-to-point wiring. Buy one today, put it to work tomorrow.
Micro-T-Switch for EIA RS-232 applications
No. 112T3 \$110.00



Plug 3 or 4 PC components into just 1 micro power bench.

Coordinate your PC hardware for neatness, convenience and safety. Flip 1 switch and turn on your entire system. And the micro power center has a built-in surge suppressor. Call in your order or return the postcard.
Apple Power Bench No. 2910T3 \$129.00
IBM PC Power Bench No. 2914T3 \$129.00



FREE DUST COVER IF YOU ORDER NOW.

This is no ordinary "office" dust cover. It's made of a unique vinyl containing special "anti-static" additives, to prevent static-charge buildup. A \$13.95 value. Limited time offer – order by April 30, 1984.



FREE INMAC CATALOG.

Every PC user needs this 120-page catalog, jam-packed with more supplies accessories and ideas. Includes over 2,000 specially selected products. Ask for a copy today.



inmac

Order now — direct from this ad. Just fill out and return the postpaid card, call toll-free or write us at 2465 Augustine Dr., Santa Clara, CA 95051.

Risk-free Double Protection Guarantee. Return any product within 45 days if you're not completely satisfied. All products are guaranteed for one year against defects in material and workmanship.

Your order shipped in 24 hours. Orders are sent UPS or USPS with freight and handling added to your invoice.

Visa, Mastercard, or we'll bill you. Indicate payment method with order.

CALL TOLL-FREE 1-800-547-5444.

for high software prices. I'm fond of telling programmers that it takes at least as much time and effort to write a novel as it does to write a big program; but we don't charge hundreds of dollars a copy for novels. The almost inevitable answer has been that novelists don't have to answer many telephone calls about their characters and plots.

Digital Research's Technical-Support System

I've had mixed reports about Digital Research's technical support. Some readers are enthusiasts. Others have horror stories. I suspect it has to do with whom they talked to at DR, and how long that technician had been on the support assignment, and quite possibly the time of day. I know I've had a variety of experiences talking with them.

Last week I was working on my silly Star Trek game. As an aside: my apologies to those who ordered the darned thing from Workman. Barry kept after me to get the final version out, but I kept wanting to add yet another feature, and eventually Barry had piles of orders and was getting frantic just as I had other deadlines and the Christmas holidays were nearly upon us—but when I assembled the thing, it would run fine on my big systems, but it used too much memory for most machines.

The game is written in Compiling CBASIC, which has the ability to do overlays and pass variables from one section of the program to another by use of COMMON declarations. This seemed ideally suited for my game: I could do the setup in one section of the program, then call in an overlay for the actual play of the game.

Alas, the DR documentation on how to use COMMON and the overlay feature with array variables is not precisely a model of clarity. Still in all, I puzzled out what I thought was meant and tried it.

The setup worked fine, but as soon as it called the overlay it blew up in a spectacular manner: suddenly there appeared on the screen a bunch of garbage that included not only control characters and random stuff, but also the text of every string in the

program, including not only messages but the prompts and error messages from functions. Disconcerting to say the least.

Logical analysis: either I was doing something wrong in the game itself, implementing the overlay feature improperly, or trying to do something that Compiling CBASIC can't do. Of course, we were in a hurry: there were my deadlines, and Mrs. Workman was unhappy because customers were calling about this stupid game. I needed a shortcut.

The simplest thing would be to eliminate one or more of the possibilities, and the easiest way to do that would be to call Digital Research. If I had assurance that Compiling CBASIC would do the job, then I'd be miles ahead, even if there wasn't anyone there able to tell me precisely how to do it; and if Compiling CBASIC wouldn't, then I could stop wasting time trying.

It used to be when I had questions about CBASIC I'd call Gordon Eubanks. After all, he wrote the program. Gordon, however, has set off on his own to produce some new software, so that wasn't an option. There was nothing for it, then, but to call the DR switchboard.

The result was weird. First, someone asked me if I were an end user. I could tell it wasn't a casual question. "As opposed to what?" I asked. "I write a software review column called The User's Column, so I suppose I am." Long silence, then I was shunted to another telephone. And another. I kept saying, with rising impatience, "Look, all I want to know is whether Compiling CBASIC can do this. I don't even need to know how, just whether I'm wasting my time trying." I must have said that 10 times. Eventually I tired of it and asked for the director of press relations, only to be told DR doesn't have one, and I should talk to a PR firm in Palo Alto. Then I was put on hold again, and another voice came on. This one told me her name was Mary Anne Brown, and I needed another person named Brown from a different department, and she'd try to get the other department for me.

By this time I'd been on the phone

Where to buy Toshiba's P1351 and P1340 printers:

EASTERN

R & D/CAMELOT ASSOCIATES, INC.
Northampton, MA (413) 253-7378

DIGITAL ENTRY SYSTEMS
Waltham, MA (617) 890-6111

MICROAMERICA
Frammingham, MA (800) 343-4411
In MA (617) 877-8500

CYBER/SOURCE
Southfield, MI (313) 353-8660

GENERAL BUSINESS COMPUTERS, INC.
Cherry Hill, NJ (609) 424-6500

MONROE DISTRIBUTING COMPANY
Cleveland, OH (216) 781-4600

ROBEC DISTRIBUTORS
Line Lexington, PA (215) 822-0700

SOUTHERN

SYSPRINT, INC.
Sarasota, FL (813) 924-8278

MICROAMERICA
Tampa, FL (813) 623-6526
In FL (800) 282-3385

Norcross, GA (800) 241-8566
In GA (404) 441-0515

Rockville, MD (800) 638-6621
In MD (800) 492-2949

CENTRAL

TEK-AIDS INDUSTRIES, INC.
Arlington Heights, IL (312) 870-7400
or (800) 323-4138

KALTRONICS DISTRIBUTORS, INC.
Northbrook, IL (312) 291-1220

MICROAMERICA
Schaumburg, IL (800) 323-6827
In IL (800) 942-4690

Richardson, TX (800) 527-3261
In TX (800) 442-5847

GENERAL MICROCOMPUTER
South Bend, IN (219) 277-4972

MIDTEC ASSOCIATES dba CRYSTAL COMPUTERS
Lenexa, KS (913) 541-1711

B & W DISTRIBUTORS
St. Louis, MO (314) 569-2450

SMC INTECH SYSTEMS CORP.
Carrollton, TX (214) 446-9055

COMPU SHOP
Richardson, TX (214) 783-1252

SYSPRINT, INC.
Richardson, TX (214) 669-3666

WESTERN

P.G.I. CORPORATION
Tempe, AZ (602) 967-1421
or (800) 528-1415

MICROAMERICA
Carson, CA (800) 421-1485
In CA (800) 262-4212

BYTE INDUSTRIES, INC.
Hayward, CA (415) 783-8272
or (800) 972-5948
outside CA (800) 227-2070

PREMIER SOURCE DISTRIBUTING
Irvine, CA (714) 261-2011

CYPRESS DISTRIBUTING COMPANY, INC.
San Jose, CA (408) 297-9800

MICROWARE DISTRIBUTORS, INC.
Aloha, OR (503) 642-7679

Bellevue, WA (206) 451-8586

ANACOMP, INC.
Salt Lake City, UT (801) 539-0158

Redmond, WA (206) 881-1113
or (800) 426-6244

CANADA

IRWIN ELECTRONICS
Etobicoke, Ontario (416) 626-6600

OR THESE TOSHIBA AMERICA, INC.

REGIONAL OFFICES:

177 Madison Avenue, Post Office Box 2331R
Morristown, NJ 07960 (201) 326-9777

662 Office Parkway, The Colonnade Building
St. Louis, MO 63141 (314) 991-0751

18017 Sky Park Circle, Suites P and Q
Irvine, CA 92714 (714) 250-0151

TOSHIBA

Circle 366 on Inquiry card.

Two ways to show off your IBM PC.™



There's no better way to show off your IBM PC – or any other micro – than with the new line of Toshiba printers. They offer state-of-the-art features, high reliability and low price.

P1351

The new Toshiba P1351 printer has a unique high-density 24-pin dot-matrix print head. It lets you print crisp, clean letter copy at 100 cps, draft copy at 192 cps. And with the software-selectable downloading fonts, you get to pick from a variety of type styles.

The P1351 has more stuff to show. Like 180 x 180 dots-per-

inch high-resolution graphics, 132-column-width platen (great for spreadsheets and Lotus™ 1-2-3™ data processing and graphics), Qume SPRINT 5™ emulation, and a choice of either a forms tractor or automatic sheet feeder.

P1340

For considerably less, the new P1340 gives you just a little less. But it still has the same high-density 24-pin dot-matrix print head, the 180 x 180 dots-per-inch graphics resolution, and the Qume SPRINT 5 emulation. In addition to true proportional spacing and a

built-in forms tractor. Whichever printer you choose, you also get nationwide service within 24 hours by Western Union technicians.

So the choice is yours. But when you choose Toshiba, you know you're putting on the best show possible.

For more information, call toll-free: 1-800-457-7777, Operator 32. Or call one of the distributors listed on the adjacent page.

IBM PC to P1340 and P1351 graphics utilizes PaperScreen and the IBM PC with color graphics adapter. IBM PC is a trademark of International Business Machines. Lotus and 1-2-3 are trademarks of Lotus Development Corporation. SPRINT 5 is a trademark of Qume Corporation.

©1984 Toshiba America, Inc.

In Touch with Tomorrow

TOSHIBA

Information Systems Division, TOSHIBA AMERICA, INC.

to DR for half an hour, and I'm certain I was neither civil nor coherent, and I want to commend Ms. Brown for her patience. In the unlikely event that Digital ever lets her go, she could get a job with the State Department anytime. Alas, it did no good: the other department would not speak to me; and there matters rested.

The next day Digital called me. It seems to have been changing its technical-support setup, and between the changes and the impending holidays the system wasn't properly imple-

mented, and I'd fallen between the cracks.

The new system is—well, before I express an opinion, I'll describe it.

DR has a new "Technical-Support Program for the Professional Programmer." Actually, it's not all that new; but I'd never heard of it, probably because in the past I'd always called program authors directly. Anyway, the program costs \$250 a year and entitles you to:

- a toll-free phone number to DR

- unlimited calls on that number regarding all DR products
- written software performance reports
- access to Microline, a DR support service on The Source
- free hookup fee to The Source
- a new quarterly technical newsletter

That's the theory, anyway. In practice, you apply by signing a form acknowledging that DR "does not guarantee support service results" and it denies "all expressed and implied warranties, including all implied warranties of merchantability and fitness for a particular purpose." In addition, you must (not unreasonably) be shown to be a valid owner of the software to be supported under the agreement. DR doesn't say what it will do if you sign up for the service and subsequently buy something else from it, but since it says the single fee entitles you to support for all the DR products you've bought, I presume it will cover the new ones when you get them.

DR says that there is still some free support for end users. That, however, is provided by an entirely different department of "generalists." The professional technical-support people are specialists, and they will talk to you only if you call on the (unlisted) toll-free technical-support line, which is why Ms. Brown couldn't get anyone to take my call. She should have referred me to the end-user support group. It was implied that if I'd clearly stated that I was an end user, I'd have gotten to someone who could answer my question.

That may be. On the other hand, I've heard complaints from end users who say that the generalists can't answer many questions. A few of my correspondents are hopping mad: they're sure DR has let them down.

I have mixed feelings.

First: DR has always been one of the leaders in providing support for its products. Its generalists in the free support department can still provide better support than is customary in the micro industry.

Second: as I said when I began this, technical support is a tough

Shake hands with the Video C-77!

Combines Color Computer Output With T.V. Camera Image Simultaneously On Your Present Monitor

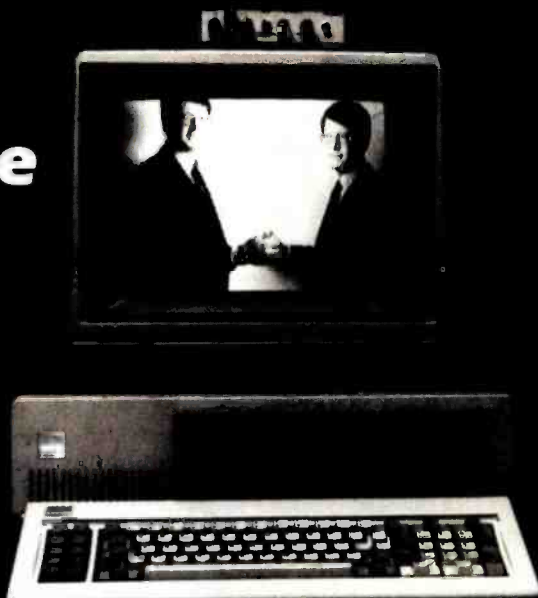

- Will work with any composite monitor
- Easy to operate: Can be set up in less than 10 minutes
- Features full window control: Place the window where you want it; make it any size.
- Outside the window—computer output & graphics. Inside the window—your choice of combined or superimposed images.

Special \$289 Introductory Offer Includes:

- All necessary cables
- Handling and shipping UPS (within continental USA)
- And for those who will use this as a character generator, utility software is included in the package. Specify IBM, Apple, or Atari.

TO ORDER: Call Our 24 Hr. Line 1-800-227-3800 ext. 7700

• Requires camera with external sync. capability (cameras with lens available—SGM 1348-5385) • IBM owners please note: Requires IBM, TECMAR, or comparable graphics board • VISA, Mastercard, or checks accepted (allow time to clear) • NY residents add sales tax • No risk. Ten day money back guarantee. Call for authorization * before returning • Dealer and Distributor Inquiries Invited •

For More Information Call 212-687-6255, Monday-Friday, 9-5 EST

**RAPID SOLUTIONS . . .
FROM RAPITECH**

IBM is a registered trademark of IBM Corp.
APPLE is a registered trademark of APPLE Corp.
ATARI is a registered trademark of ATARI Corp.

Rapitech
Systems
Inc.



565 Fifth Avenue, New York, N.Y. 10017

The truth about information management:

The Knowledge Manager beats dBASE over 250 ways.

"... the leading seller is no longer the best."

You get more from the Knowledge Manager. Relational data management, ad hoc queries (like IBM's SQL/DS), spreadsheet, math and statistics, printed forms management, screen I/O management, a full-scale programming language. All for less than the list price of dBASE. Plus you can now get a text processor, a forms painter, color graphics and a run-time version.

| Records | dBASE II | KnowledgeMan |
|---------|----------|--------------|
| 1,000 | 6.15 | 5.38 |
| 2,000 | 14.93 | 11.13 |
| 5,000 | 64.16 | 33.73 |
| 10,000 | 205.50 | 69.53 |

*K-MAN V1.05, dBASE II V2.3D, IBM XT, 256K RAM, heavily populated directory.

All completely integrated: So you can do just about anything you wish. Like financial modeling, order entry, job costing or decision support.

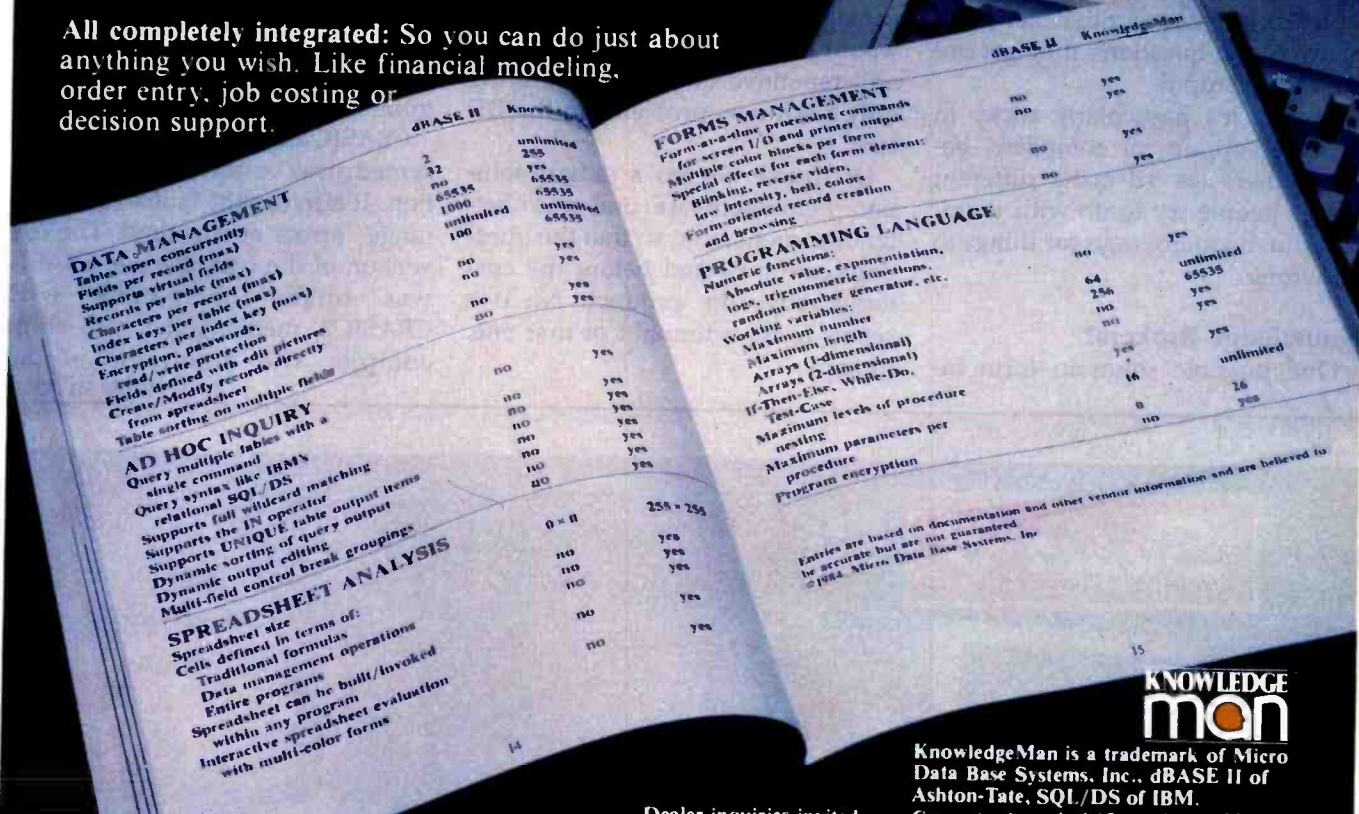

Dealer inquiries invited.

Please send me:

- Free feature-by-feature comparison
- Forms painter information
- Graphics information
- Text processor information
- Run-time package information
- Please accept my order for KnowledgeMan Package \$500.00
- Shipping and Handling* 10.00 (Indiana residents must add 5% sales tax—\$25.00)

Machine: _____

Operating Systems:

- PC DOS MSDOS CP/M-86

Disk Format:

- 8" IBM-3740 SS/SD

- 5 1/4" IBM PC SS
- 5 1/4" Victor/Sirius
- 5 1/4" DEC Rainbow (Dig. RX50)
- *Add \$20.00 if outside U.S., Canada or Mexico
- Check or money order enclosed (must be drawn from U.S. bank in U.S. currency)
- MasterCard No. _____
- VISA No. _____
- American Express No. _____
- Expiration Date _____
- Bank No. (if M.C.) _____
- Signature _____

VISA and MasterCard orders may be placed by phone (317) 463-2581.

Name _____
 Title _____
 Company _____
 Phone (____) _____
 Address _____
 City _____
 State _____ Zip _____

Send To:

 **MDBS/Consumer Products**
 P.O. Box 248
 Lafayette, IN 47902
 Phone: (317) 463-2581
 Telex: 209147 ISE UR

Or Contact Your Local Dealer.

PRICES SUBJECT TO CHANGE WITHOUT NOTICE

problem, and as the number of micro users grows, it's going to get worse, not better. A "Professional Technical-Support Service" is much needed, and DR should be applauded for providing it.

Third: the end user has been harmed by this move, but it's difficult to see what can be done about it. Once again: there are just too many customers, with too many questions, and it's cruel and unusual punishment to require highly skilled computer professionals to man phones in order to answer the same silly questions over and over again. I don't think my own question was silly, but a case can be made for that view; and many of the questions they get are genuinely stupid.

Fourth: it's particularly sticky to provide support for compilers, because there are so many different things people try to do with them, and thus so many ways for things to go wrong.

Knowledge Brokers?

One possible solution: form in-

dependent technical-support organizations. Alex suggested that a bright young entrepreneur might make a pretty good living advertising full support for DR products at \$100 a year. After all, such a third-party service has popped up for Kaypros; why not software? With enough customers, the charge might be even less than \$100 yearly. Naturally, one expense would be a subscription to the DR Professional Technical-Support Program. For DR products, our entrepreneur would be in effect a knowledge broker: tough questions would be referred to DR.

Indeed, this might work to DR's advantage, since the knowledge broker would filter out both silly questions and repetitive questions and bring only fresh new problems to the DR staff.

Of course, there's a radical solution: better software and *much* better documentation, so that the questions are answered before the customer buys the product. No one seems to have thought of that one, though.

What Was Really Wrong

As to my specific problem, Compiling CBASIC can indeed pass array variables in COMMON, and there aren't any restrictions on declarations and functions, either. It turns out that what I had done, alas, was miscopy my Dimension block, so that I had an undimensioned variable. The Compiling CBASIC compiler will not catch this error (see the January User's Column, page 80, for details). There's no run-time error either. The computer just gets lost, producing totally unpredictable results.

That's what had happened to me: the undimensioned array had managed to send the program off into a data area, so it tried to interpret data as program instructions, with disastrous results.

CBASIC used to catch "undimensioned array" errors during compilation. It also caught "subscript out of range" errors at run time. The first version of the compiler for CBASIC was totally compatible with CBASIC2, meaning that you could compile the programs under

Text continued on page 74



The Finest Quality Products for Apple and IBM





High Line Drives

- T40 TEAG Direct Shaft Drive for Apple
- C40 Clinch Direct Shaft Drive for Apple
- Double-sided Direct Shaft Drive for IBM
- VO Cards for Apple and IBM

Blank Matrix Printer

- CP40 Blank Dot-Head with Friction Feed

IBM is a registered trademark of IBM Corp.

Apple is a registered trademark of Apple Computer Inc.

High Resolution Monitors

- Amber with 20 MHz Video Response for Apple
- Green, Amber, RGB color with Rotary Stand for IBM

Mitsuba Corporation

657 Brea Canyon Rd. #200, Walnut, CA 91789
 TEL: (714) 594-6950 — 1-800-MITSUBA-648-7822
 Japan TLX: J23325 EI-EN ENT

MOST VALUABLE PERFORMER

CompuPro's System 816.[™]
One of the fastest,
most versatile
computers
on the market.



Reliability. It's crucial to OEMs and systems integrators. Without it, you can't generate business and a good reputation.

CompuPro's System 816 answers your needs for reliability. It's respected among OEMs because it not only outperforms the competition, but also operates with incredible dependability. The Most Valuable Performer... what you'd expect from a company with more than ten years of setting industry standards.

More Power to You

The System 816 series has the power and speed multiple workstations demand. We enhance this even more by offering a whole range of CPUs to select from and standard RAM memory expandable to 1 Mbyte or higher:

As for disk storage, the System 816 can handle up to 4.8 Mbytes on floppy

drives and as much as 320 Mbytes per controller on hard disk.

Incredible Flexibility

If that's not enough, CompuPro makes the System 816 even more attractive by structuring it on the IEEE 696/S-100 bus. For the systems integrator, this means amazing potential in arranging packages. Just select the appropriate components, you can't go wrong. And CompuPro makes sure of that, because we offer our components independently, in any combination you need. This bus also provides the flexibility to use compatible boards for graphics and other unique applications.

Built to Last

No matter what configuration you select, everything's housed in our famous enclosure. Unlike the plastic construction of most other computers,

ours is made of rugged metal for durability and shielding. A constant voltage power supply protects against brownouts. And the common modular architecture of our System 816 family makes upgrading or reconfiguring remarkably easy.

When you get right down to it, CompuPro speaks your language. With operating environments like CP/M[®] CP/M-86[®] MP/M-86,[™] CP/M-68K,[™] and our own CP/M[®]8-16,[™] MP/M[™]8-16[™] and CCP/M[™]8-16.[™] And the capability to support languages like Pascal, C, mapFORTH, BASIC, COBOL, PL/1 and FORTRAN 77[™] and much more.

Total Support

To show you the confidence we have in the System 816's reliability, CompuPro backs it with the industry's longest warranty coverage: from 12 to 24 months.

CompuPro[®]

A GODBOUT COMPANY

3506 Breakwater Court, Hayward, CA 94545
(415) 786-0909

CP/M and CP/M-86 are registered trademarks and MP/M-86, CP/M-68K and FORTRAN 77 are trademarks of Digital Research Inc. CP/M 8-16, MP/M 8-16 and CCP/M 8-16 are compound trademarks of Digital Research Inc. and CompuPro. System 816 is a trademark of CompuPro

Prices and specifications subject to change without notice. System 816 front panel design shown is available from Full Service CompuPro System Centers only.

©1984 COMPUPRO

Find out more about the CompuPro System 816... The Essential Computer[™]

Send me your OEM/systems integrator application package.

Send me your catalog with warranty information.

Name _____

Title _____

Address _____

City _____ State _____ Zip _____

Telephone Number _____

Mail to: CompuPro Attn: Sales Department 3506 Breakwater Court, Hayward, CA 94545

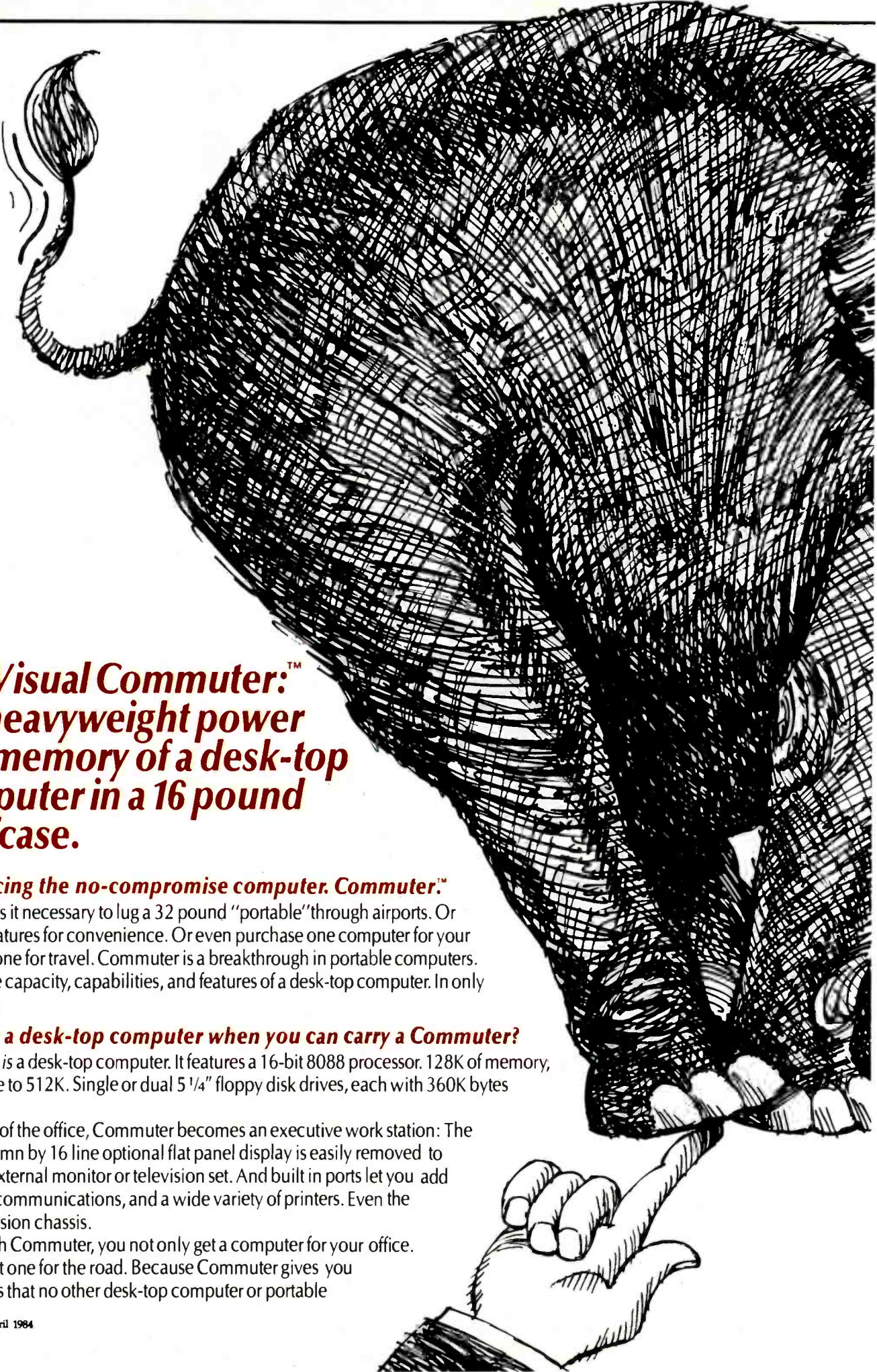

***The Visual Commuter:[™]
the heavyweight power
and memory of a desk-top
computer in a 16 pound
briefcase.***

Announcing the no-compromise computer. Commuter.[™]

No longer is it necessary to lug a 32 pound "portable" through airports. Or sacrifice features for convenience. Or even purchase one computer for your office and one for travel. Commuter is a breakthrough in portable computers. With all the capacity, capabilities, and features of a desk-top computer. In only 16 pounds.

Why buy a desk-top computer when you can carry a Commuter?

Commuter is a desk-top computer. It features a 16-bit 8088 processor. 128K of memory, expandable to 512K. Single or dual 5 1/4" floppy disk drives, each with 360K bytes of storage.

In or out of the office, Commuter becomes an executive work station: The full 80 column by 16 line optional flat panel display is easily removed to attach an external monitor or television set. And built in ports let you add hard disk, communications, and a wide variety of printers. Even the IBM expansion chassis.

But with Commuter, you not only get a computer for your office. You also get one for the road. Because Commuter gives you dimensions that no other desk-top computer or portable

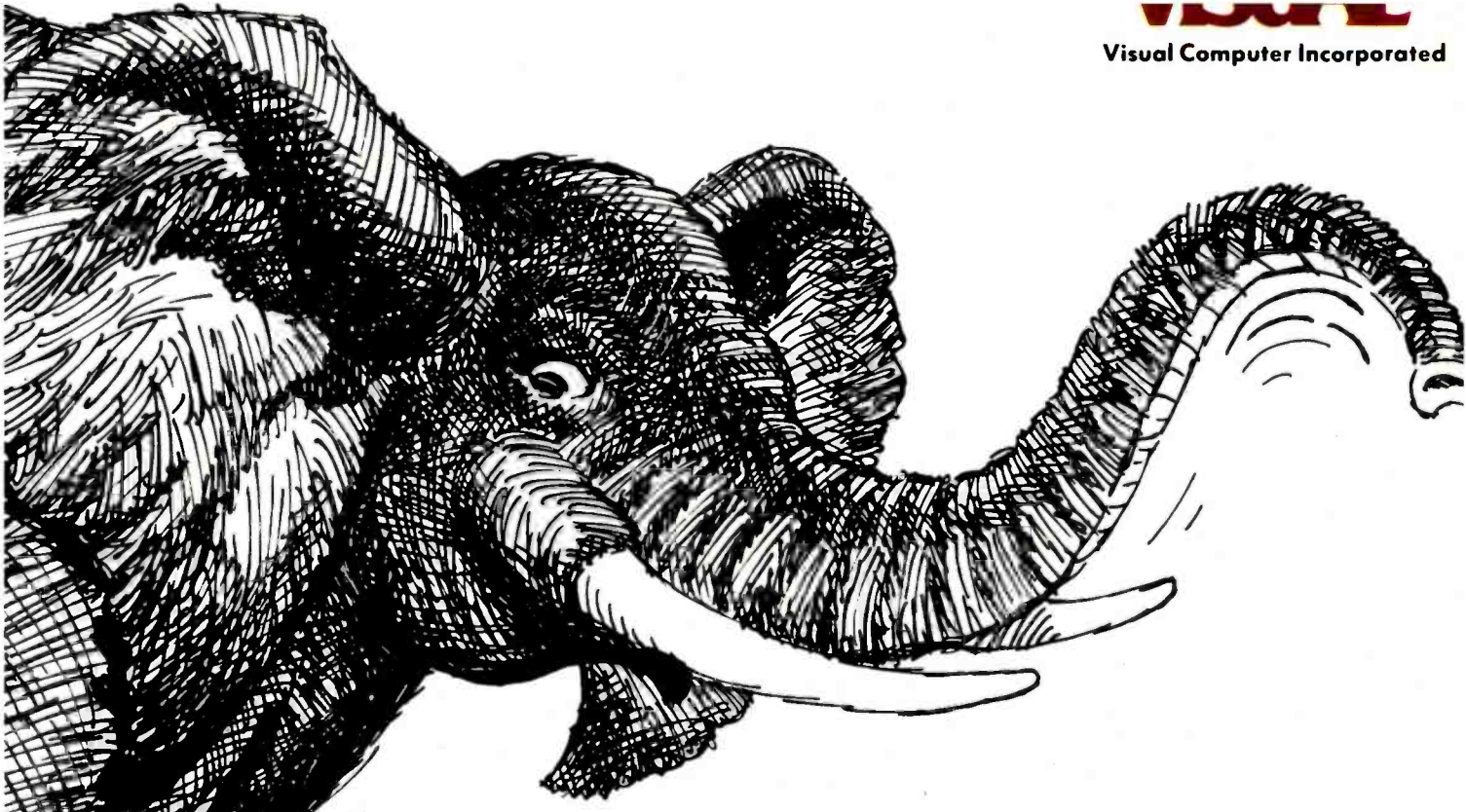

in its class can: 15" x 18" x 3 1/2", with built in handle and briefcase-sized carrying case.
Never has a powerful computer been easier to handle.

IBM® PC compatible. And downright sociable.

Commuter offers you a level of IBM PC compatibility unmatched in a portable computer. Commuter comes bundled with the MS-DOS™ operating system and GW Basic.™ Your commands are entered on a full 83 key keyboard with an IBM PC layout, including numeric pad and ten function keys. IBM compatible color graphics and monochrome support are built right in.

Unlike many so-called IBM PC compatible portables, Commuter can run virtually all of the software written specifically for the IBM PC. And Commuter's double-sided, double-density diskettes are directly transferable to and from the IBM PC. So you can take advantage of hundreds of available software programs: Business programs like Lotus® 1-2-3,™ VisiCalc,™ or WordPlus-PC.™ Games like Flight Simulator.™ Even educational software from Spinnaker.™ Right off the shelf. Without modifying a thing.

Pick up the perfect business partner for only \$1995.

Why compromise? With its heavyweight memory, desk-top power, and 16 pound weight, Commuter is clearly the practical choice. But the best part is, at only \$1995, you can pick it up for practically peanuts.

Try out Commuter at your local authorized dealer today. Or call Visual Computer at **1-800-847-8252**. (in Mass., call **1-800-462-5554**), or write Visual Computer Incorporated, 135 Maple Street, Marlboro, MA 01752 for more information.

Commuter. It can take your business places it's never been.

Visual Computer Incorporated is a wholly owned subsidiary of Visual Technology Incorporated. COMMUTER is a trademark of Visual Computer Incorporated. IBM is a registered trademark of International Business Machines Corporation. Lotus and 1-2-3 are trademarks of Lotus Development Corporation. VisiCalc is a trademark of VisiCorp. WordPlus PC is a trademark of Professional Software Incorporated. Spinnaker is a trademark of Spinnaker Software Corp. MS-DOS, GW Basic and Flight Simulator are trademarks of Microsoft Corporation.

Circle 382 on inquiry card.

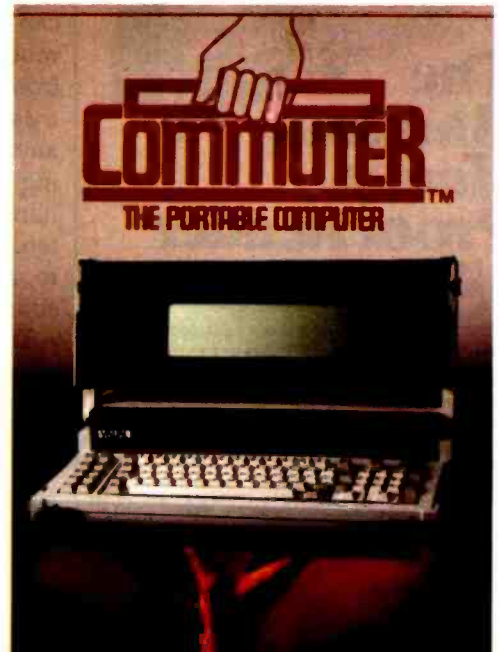

Less for Your Money

If you do word processing on your personal computer, you probably know that there are many programs for sale to help you with your spelling. But the biggest spelling error you'll ever make is paying too much for your spelling correction software. The Random House ProofReader gives you less for your money — less trouble, that is, and fewer spelling errors. The Random House ProofReader is based on the world famous Random House Dictionary. It contains up to 80,000 words, depending on your disk capacity. You can add new words with the touch of a key. It shows you the error and the sentence it's in. It instantly suggests corrections. It even re-checks your corrections. And it costs half as much as other programs with far less power. The Random House ProofReader is compatible with all CP/M 2.2[®], MS-DOS[®] and IBM Personal Computer[®] systems.

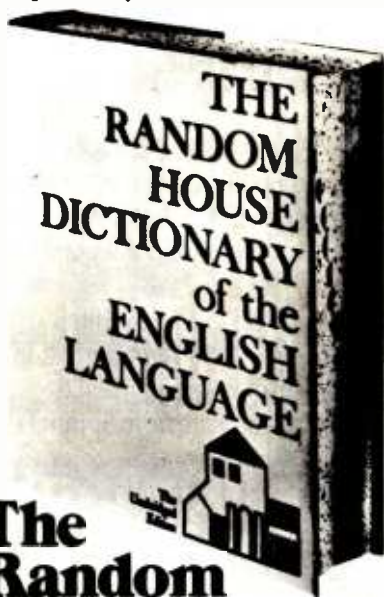

The Random House ProofReader
\$50

For orders or information, see your local dealer or call 505-281-3371. Master card and VISA accepted. Or write Wang Electronic Publishing, One Industrial Ave., Lowell, MA 01851. Please enclose \$50 and specify your computer model, disk size and memory.

Random House and the House design are registered trademarks of Random House, Inc. CP/M is a registered trademark of Digital Research, Inc. IBM and IBM Personal Computer are registered trademarks of International Business Machines, Inc. MS-DOS is a registered trademark of Microsoft, Inc.

Text continued from page 70:

CBASIC2 and run them for logic checkout; if everything worked, use the CB80 compiler to produce fast-running machine language. The CBASIC2 version, being interpreted, would be slow, but because of its range checking the debugging was easier.

I discussed this with Richard Lovelace, a supervisor in the DR technical-support division. "What we need," I said, "is to upgrade CBASIC2 so that it will accept the full Compiling CBASIC structures and functions. Then we can use the CBASIC2 pseudocompiler for checkout and debugging."

He allowed as how that was probably a good idea, but there wasn't much enthusiasm behind it. DR tells me that it is working on the problem, but I haven't found out what it is planning.

Oh, well. Let it be a lesson to me. The lesson is: use languages in which the compiler catches the errors; that way you won't be so baffled if the program doesn't work.

Databases

It's amazing how many outfits offer information nowadays. You can get on-line data on everything from horse breeds to agricultural production. The only problem is figuring out who has what information for sale and how to get at it.

Owen Davies and Mike Edelhart have published a book that will help. The *Omni Online Database Directory* (Macmillan, 1983) gives information on more than 1000 databases that you can access with a terminal and modem. The book covers everything from Compuserve and The Source to a database on wine selection. I doubt anyone would find the book interesting light reading, but it's sure a handy reference. It's also well written, with clear instructions on how to access the various information sources.

The \$19.95 hardback is a bit overpriced; get the \$10.95 trade paper edition. It's just as useful and will last as long as the information in it.

Incidentally, Owen Davies is doing another *Omni* book, this time on small computers. I'm doing a short

piece, Alex is reviewing some computers, and Barry Workman is doing a review of the Lobo Max-80. It ought to be out toward the end of 1984.

What's Right with Borland

Borland International sells a full-feature Pascal that looks to be at least as useful as Digital Research's Pascal MT+; I've heard reports that it's faster and more compact. I'm having Marty Massoglia check that out for the IBM PC 16-bit version. I know the Z80 version is darned good because we used it to compile some chunks of the Galactic Traders game I'm writing.

The only thing I've got against Borland is the name "Turbo Pascal," and I suppose I can survive that. At \$49.95 (\$149.95 if you want to sell products compiled with Turbo Pascal), it's one of the best deals in town.

Borland's president, Philippe Kahn, tells me the company has only one real problem: people confuse it with JRT Pascal, and since JRT had real distribution problems, potential customers wonder if they'll have the same difficulty with Turbo Pascal. "How," he asked, "can I convince people that I'm shipping the same day orders come in?" He even offered to fly me up to his location to inspect the facilities.

I didn't have time to do that, but I find the offer itself interesting. I can also say that I've heard no complaints about Borland, and people are usually pretty quick to write me if they feel they've been ripped off. I find Borland's package pretty impressive. The company also provides technical support by telephone.

It's about time for micro software prices to come down to reasonable levels. To the best of my knowledge, Borland's Turbo Pascal is a giant step in the right direction.

CP/M for Z-DOS

Walt Bilofsky's Software Toolworks has produced yet another useful program. It's called ZP/SIM, and it will run regular CP/M 8-bit programs under 16-bit Z-DOS. That's the good news.

The bad news is that it won't run all CP/M programs under Z-DOS,

CLEO

makes the mainframe connection.



New Features

- SNA 3276-12 protocol for the IBM PC
- Up to 32 device cluster activity
- Base color support

3780

3270

CLEO

CLEO 

The communications features of the CLEO-3270 Software package allow your microprocessor to emulate a cluster of IBM terminal devices.

You don't even need to change software on your mainframe computer, because for all it knows, it's communicating with a 3276-XX cluster. And the program will accommodate up to 32 terminals.

The CLEO software provides the cluster emulation and makes the ASCII devices look like an IBM 3278 CRT and 3287 printer.

If your IBM mainframe doesn't support remote 3270 clusters, you need remote batch communications. CLEO-3780 Software is your answer.

For full details contact CLEO Software, a division of Phone 1, Inc., 461 North Mulford Road, Rockford, IL 61107; Phone: (815) 397-8110.

Circle 203 on inquiry card.

Standard Features-CLEO 3270

- Bisynchronous 3276-2 protocol
- SNA 3276-12 protocol for the IBM PC
- Up to 32 device cluster activity
- Selectable control unit address
- User install program for various CRT's
- 3278 emulation for ASCII CRT's
- Available for CP/M™, MP/M™, MsDOS™, TurboDOS™, Unix™, and Xenix™
- Coded in C language
- Base color support

Standard Features-CLEO 3780

- Point-to-point and multipoint communications
- Available for CP/M™, MP/M™, MsDOS™, TurboDOS™, Unix™, and Xenix™
- Also supports transparent mode
- Coded in C language

CLEO 



NEW FOR '84!

| Quick C | | Uni-Tools | C Tutor | Z | Phact DB |
|---|--|---|---------|---|----------|
| COMMODORE C64 Cross Compilers | | | | | |
| AZTEC C86 8086/8088 new release 2.0 | | <input type="checkbox"/> Full C <input type="checkbox"/> Fast object code <input type="checkbox"/> Basic graphics <input type="checkbox"/> 8087 support <input type="checkbox"/> Large memory model <input type="checkbox"/> Fast I/O <input type="checkbox"/> Overlays <input type="checkbox"/> Relocating assembler <input type="checkbox"/> Linker & library <input type="checkbox"/> Library has I/O, screen I/O, graphics, PC DOS-CP/M/86 <input type="checkbox"/> Interfaces with DRI and MICROSOFT assemblers <input type="checkbox"/> Compatible with AZTEC C for CP/M, APPLE, C64, & TRS-80 | | | |
| PC DOS/MS DOS \$249 | | | | | |
| CP/M-86 \$249 | | | | | |
| BOTH \$399 | | | | | |
| /PRO extension \$249 | | /PRO includes optimizer, C86 debugger, and other tools | | | |
| C Grafx call | | Comprehensive color graphics for use with C or stand alone | | | |
| Uni-Tools I \$ 99 | | Tools I has make, diff, grep, & other UNIX inspired tools | | | |
| PHACT database call | | Phact is a comprehensive set of C database functions | | | |
| Z \$125 | | Z is a full screen C editor much like the UNIX Vi editor | | | |
| Quick C \$125 | | Quick C compiles C source into interpreted code in a flash | | | |
| AZTEC C II 8080/Z80 | | Full C compiler, assembler, linker, library utility, . . . PRO extensions include library source, utilities, ROM libraries, M-80 and RMAC interface | | | |
| CP/M-80 \$199 | | | | | |
| /PRO extensions \$150 | | | | | |
| AZTEC C80 TRS-80 | | The Model 4 system is full AZTEC C II and runs under TRSDOS or DOSPLUS, the Model III system does not support float. /PRO has float for III, Z, library source, . . . | | | |
| MODEL III or 4 \$199 | | | | | |
| /PRO III and 4 \$349 | | | | | |
| AZTEC C65 6502 | | A complete C development system for the APPLE II and IIe with assembler, linker, editor, SHELL, library, and library source. Binary files execute under DOS or SHELL | | | |
| APPLE DOS \$199 | | | | | |
| ProDOS call | | | | | |
| C CROSS DEVELOPMENT SYSTEMS | | Cross systems generate modules on a HOST system that are downloaded for execution on a target system. HOSTS include PDP-11 UNIX, 8086 UNIX ports, PC DOS, CP/M-86, CP/M, and APPLE. TARGETS include CP/M, APPLE, COMMODORE C64, & TRS-80. | | | |
| C cross compiler, assembler, & linker | | | | | |
| PDP-11 \$2000 other \$750 | | | | | |
| AZTEC C TUTOR APPLE or IBM \$99 | | PRENTICE-HALL and MANX SOFTWARE SYSTEMS joined forces to produce an unmatched "hands on" C tutorial. Includes lessons, text, fast compiling student C compiler, and . . . | | | |
| other systems call | | | | | |
| Quick C APPLE, CP/M, T-80 \$125 | | Quick C compiles C code into extremely compact interpreted code at blinding speed. Run time system has UNIX functions. | | | |

MANX
SOFTWARE SYSTEMS
P.O. Box 55
Shrewsbury, N.J. 07701

Order phone 800-221-0440 (outside NJ)
201-780-4004 (NJ and outside USA)
Telex (ITT): 4995812
Information: 201-530-7997
Tech support: 201-780-8374
Shipping: per compiler
Next day USA \$20, 2 days
USA \$5, 2 days worldwide \$75,
Canada \$10, airmail/outside
USA & Canada \$20

and unless you're a better programmer than I am, there's no way to infer from the Toolworks documents just which program *won't* run with it. We know that WRITE won't work with it. That's hardly surprising, since WRITE uses some very sophisticated tricks to get sorted directories and disk-file sizes and such.

On the good side again, ZP/SIM is easy to use, and the documentation is plenty good enough to get it running. The complexities come when you're trying to figure out what will and won't work under ZP/SIM; the simple solution to that is to try it and see.

This program would be useful to any Z-100 owner who has Z-DOS, doesn't care to buy the CP/M-85 package, and wants to run fairly simple 8-bit CP/M software on the machine.

That may be a limited market; but as I've said before, every Z-100 owner ought to know about Software Toolworks. Walt has some of the best software bargains in this business.

SIG/M

There's a lot of good free software out there, including, I'm told, a good Pascal interpreter. (I don't know whether it's the mystical public-domain UCSD Pascal they told me about at Cornell.)

Anyway, I've just been sent the latest SIG/M (Special Interest Group for Microcomputers) catalog that describes about 100 disks full of public-domain software. There are games, mailing-list maintainers, modem programs, tests for the Compupro Clock Board, ZCPR (a new command processor to substitute for CP/M's on systems using a Z80 chip), and myriads of other programs. There are Help programs, assembly-language macros, a LISP written in Pascal, calendars, things to set the margins for a Diablo printer, an editor to use for writing programs in the C language—well, you get the idea. There's just a ton of stuff.

Understand, there are no guarantees. Some of this free software is useful, but some is guaranteed to be boring. Also, the quality of this stuff varies enormously. Most of the pro-

UNIX is a trademark of Bell Labs. CP/M, CP/M-80 and CP/M-86 are trademarks of DRI. PC DOS is a trademark of IBM. MS DOS is a trademark of MICROSOFT. N.J. residents add 6% sales tax.

grams by Ward Christensen (a famous public benefactor) are very good to excellent, but some of the SIG/M programs are loaded with bugs. Moreover, much of it duplicates stuff available from the CP/M User's Group; but SIG/M charges significantly less per disk.

Incidentally, many of the programs offered by SIG/M are sold commercially. This specifically includes an "Unerase" utility that will restore erased files and a "Find Bad Sector" program that locks out bad disk sectors.

Many, but certainly not all, of the most useful of these programs (including Findbad and Unerase) are marketed by Workman and Associates. Workman adds a few programs from other sources and sometimes cleans up the documents; his four utility disks include programs selected from about 25 of the SIG/M disks.

The SIG/M catalog is \$3 mailed in the U.S. and \$4 to a foreign country. Program collectors and software addicts can't afford to be without it, and anyone seriously interested in getting the most out of a microcomputer will probably find it interesting.

Carry Me Away

One permanent new addition to the menagerie at Chaos Manor is the MPI Sprinter, which is a completely portable version of the Printmate 99 dot-matrix printer. Actually, it's somewhat more advanced than the model 99 in that there are provisions for a memory buffer card and some other features. Like all the MPI products we've tried, it's easy to set up, works fine, and produces an acceptable grade of dot-matrix print, not quite up to letter quality, but good enough for almost any reasonable purpose.

The main thing the Sprinter has going for it, though, is that it's *really* portable. It closes up in its own case. That case has room for some paper and manuals and all the cords and cables it needs. Once closed you can take it to the airport and send it as checked luggage. If sending it bare frightens you, there's also a black ballistic nylon outer carrying case with pockets and shoulder strap.

Softline

"WE'RE BUYER FRIENDLY"

TOP OF THE LINE
Titles from over 80 publishers and constantly growing. *If we don't already have it, we can get it for you.*

THE BOTTOM LINE
Why pay more? Our prices are the absolute rock bottom.

THE SOFTLINE HOTLINE
Our customer service hotline is backed by experienced technical staff.

THE SOFTLINE EXPRESS
Next day shipping on all orders from stock.

CORPORATE FRIENDLY
Our *Corporate Accounts Program* offers quantity discounts and evaluation copies for select software packages.

EXTRA \$\$\$ SAVINGS
With each order, we offer **discount coupons** worth up to **\$10** on your next order.

For more information on our complete line of software and accessories call our toll-free number for a FREE copy of The Softline Catalog

free!



Diskette Library Case

... with your order. This attractive case protects, indexes and stores 10 diskettes for quick retrieval. Normally a \$10 value, it is now available **FREE** to Softline customers

TERMS:
Checks—allow 14 days to clear. Credit processing—add 3%. **GOD orders**—cash, M.O. or certified check—add \$3.00. Shipping and handling UPS surface—add \$3.00 per item (UPS Blue \$6.00 per item). NY State Residents—add applicable sales tax. All prices subject to change.

| | |
|-----------------------------|---------------------------------------|
| dBase II \$369 | R:base 4000 \$299 |
| Lotus 1-2-3 \$319 | Microsoft Word \$239 |
| Multimate \$279 | EasyWriter II System \$219 |
| Multiplan \$159 | Accounting Partner \$269 |
| Final Word \$189 | PeachPak 4 \$239 |
| Microsoft C \$329 | BPS Business Graphics \$199 |
| Hayes 1200B \$439 | AST Six Pak Plus \$299 |

To Order call
1-800-221-1260
In New York State call (212) 438-6057

For technical support and information call
(212) 438-6057

Monday thru Friday
9:00 AM - 7:00 PM
Sundays
10:00 AM - 4:00 PM

Softline

Softline Corporation
3060 Bedford Ave., Brooklyn, N.Y. 11210
TELEX: 421047 ATLN UI



Getting the Sprinter hooked up was a snap: we uncrated it, connected it to the parallel printer port on the IBM PC, and turned both machines on. It worked. You can also get a serial interface for it.

I recommend it for anyone who needs a portable printer. It's a nearly ideal companion for an Otrona Attache. Mrs. Pournelle takes the Otrona and the Sprinter to meetings of the LA County Schools Micro Computer committee. I do much the same at shows, and meetings of the L-5 Society Board of Directors, and such like. The Otrona is unobtrusive while I make notes, and the Sprinter gives hard copy on the spot.

Ye Gods . . .

Every month, I start this column

wondering if there'll be enough to talk about. I make lists of topics and begin to write, and as I write things happen: phones ring, letters come, one of the staff has a bright idea, and each interruption generates another topic to write about.

The result is that I never get to finish the list I began with. I'd intended to say something about iAPX186 machines in general and the Slicer "no-frills hacker special" in particular (it's a good deal if you know hardware and like tinkering); the computer literacy controversy; the imbecilic notion that small computers are going to make poor people even poorer; the new TMX 8/16 BIOS for Compupro 8085/8088 Dual Processor machines (speeds disk operations up by a factor of two); and the

Game of the Month, which seems to be Wavy Navy by Sirius Software.

Alas, I'm out of space. At least I don't have any problem finding topics to write about. ■

Jerry Pournelle is a former aerospace engineer and current science-fiction writer who loves to play with computers.

Jerry Pournelle welcomes readers' comments and opinions. Send a self-addressed, stamped envelope to Jerry Pournelle, c/o BYTE Publications, POB 372, Hancock, NH 03449. Please put your address on the letter as well as on the envelope. Due to the high volume of letters, Jerry cannot guarantee a personal reply.

Items Reviewed

| | | | |
|---|---------------|---------------------------------------|----------|
| CP/M Utilities | \$32.50 | Public-Domain Software Catalog | U.S. \$3 |
| Pournelle's Star Trek | \$19.50 | SIG/Mforeign | \$4 |
| Workman and Associates | | POB 97 | |
| 112 Marion Ave. | | Iselin, NJ 08830 | |
| Pasadena, CA 91106 | | (201) 272-1793 | |
| (213) 796-4401 | | | |
| Desk Organizer | \$250 | Sprinter | \$795 |
| Conceptual Instruments Company | | MPI | |
| 4730 Warrington Ave. | | 4426 South Century Dr. | |
| Philadelphia, PA 19143 | | Salt Lake City, UT 84123 | |
| (215) 726-7856 | | (801) 263-3081 | |
| Diser Computer | \$14,900 | Turbo Pascal | \$49.95 |
| Diser Company | | Borland International | |
| 385 East 800 S. | | 4807 Scotts Valley Dr. | |
| Orem, UT 84058 | | Scotts Valley, CA 95066 | |
| (801) 227-2300 | | (408) 438-8400 | |
| Numerous Items | | Zenith Z-100 Computer | \$2899 |
| B. A. Pargh Company Inc. | | Zenith Data Systems | |
| 1283 Murfreesboro Rd. | | 1000 Milwaukee Ave. | |
| Nashville, TN 37217 | | Glenview, IL 60025 | |
| (615) 361-3600 | | (312) 391-8865 | |
| Omnisphere | Not available | ZP/SIM | \$29.95 |
| Orb Corporation | | Software Toolworks | |
| POB 1025 | | 15233 Ventura Blvd. | |
| Waitsfield, VT 05673 | | Sherman Oaks, CA 91403 | |
| (802) 496-6644 | | (818) 986-4885 | |
| Professional Technical-Support Service | \$250 a year | | |
| Digital Research | | | |
| POB 579 | | | |
| Pacific Grove, CA 93950 | | | |
| (408) 649-3896 | | | |

WAIT REDUCTION MADE EASY.

You know how hard it is to wait for the printer to finish before using the computer again. It's wasteful! Counter productive!

The solution: simply install Microbuffer™ printer buffer into the system, in seconds. And you can print and process simultaneously.

With one swift command, all printing data is dumped to the Microbuffer—it handles the printer and frees the computer for other functions.

Presto! Instant wait reduction.

Microbuffer II and II+ for the Apple II, II+, and IIE computers.

Microbuffer II comes in either a serial or a parallel version with 16K or 32K of RAM. Microbuffer II+, available with 16K, 32K or 64K, has both serial and parallel capabilities, so you can control two different printers at once. The Microbuffer II+ has on board high resolution graphics routines for 37 popular printers, and all include expanded graphics capabilities and text formatting in addition to the inherent benefit of letting you use your computer while your printer is working.

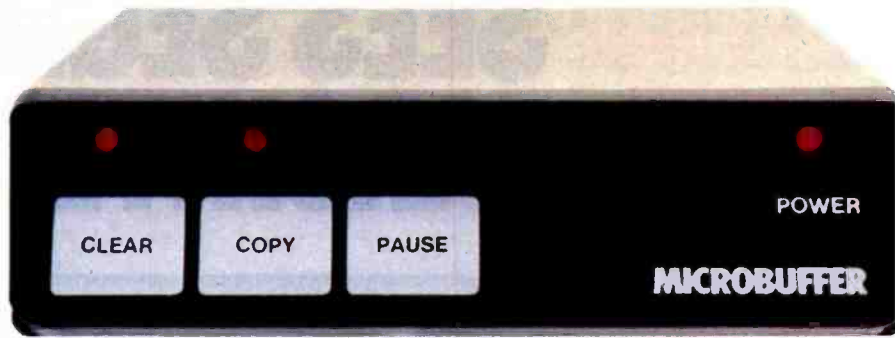
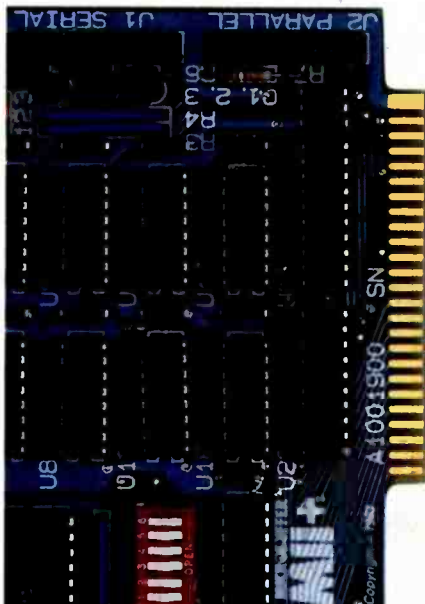

Microbuffer In-line for virtually any computer/printer combination.

These are stand-alone units that install In-line between virtually any computer and printer.

Besides printer buffering, the In-line serial interface (MBIS) can be used to efficiently transmit data from the computer to almost any device using a serial RS-232C interface. The parallel Microbuffer In-line (MBIP) is built exclusively for parallel interfacing, and works exceptionally well in virtually any parallel computer and any parallel printer.

Each of the stand-alone models have controls for making multiple copies (up to 255). With the pause control, printing may be halted at any point and continued later—it will pick up right where it left off. Even while you are printing copies of a document, additional files can be sent to the buffer and they will be processed in turn. Both

come with either 32K or 64K of RAM, and are easily upgradable up to 256K for processing greater amounts of data.

Microbuffer/E for Epson printers.

Fully compatible with Epson MX, FX, RX, and IBM-PC series printers, these easy-to-install boards simply plug inside the printer.

For parallel interfaces, the Microbuffer models MBP-16K and MBP-64K are available.

For serial interfacing, Microbuffer models MBS-8K and MBS-32/64K are available. The MBS-8K supports both hardware and software (X-ON/X-OFF) handshaking; the MBS-32/64K supports three handshaking configurations (hardware, software X-ON/X-OFF and ETX/ACK).

SO WHAT ARE YOU WAITING FOR?



PRACTICAL PERIPHERALS

31245 La Baya Drive
Westlake Village, CA 91362 USA
(213) 991-8200 • TWX 910-336-5431

© 1983 PRACTICAL PERIPHERALS

HOW VISICORP SEES SEGMENTED ARCHITECTURE.

MEMO
 Insert Page 1 Line 9 Text Document:
 TO: All Department Managers
 SUBJECT: Cash Flow Forecast

Based on the year end financials reported to this office last Wednesday afternoon (shown below) highlights

select start point in te
 graph clear-all done.

Services
 Calc
 Graph
 Word
 Query
 Archives

Services
 start install

TREND
 4 14.77% 5 1.
 3 17.06%

FORECAST

| | A | B |
|----|---------------|---------------|
| 1 | | |
| 2 | | |
| 3 | | |
| 4 | | January |
| 5 | | |
| 6 | | |
| 7 | Cash on Hand | 63,450 |
| 8 | Receipts | 335,000 |
| 9 | Disbursements | 265,484 |
| 10 | Interest | 555 |
| 11 | Taxes | 10,001 |
| 12 | ----- | ----- |
| 13 | Cash Flow | \$60,069 |
| 14 | | |
| 15 | | |
| 15 | > | Value: 107960 |

Calc/Enter
 value label name edit blank import

HELP CLOSE OPEN FULL FRAME OPTIONS TRANSFER STO

"Just beautiful."

That's what Bill Coleman of VisiCorp* calls our iAPX 86 architecture. He should know. He and his staff of over 50 people spent three years with it. Writing VisiOn,* the application software destined to become a multitasking

industry standard.

The key to creating VisiOn was memory management. Allowing Coleman and his team to create an efficient concurrent processing environment, where different processes are active all at once.

As Bill puts it, "The real beauty of this architecture is that you don't have to keep an entire program in memory at any one time. Just the active segments of code actually being run."

In the 8086 architecture, those memory segments are variably-sized and mapped as needed. So loading is very fast. And the resulting performance is very high, because you can load the exact memory you need. Which then gives you the highest performance from any given memory size.

That means some significant runtime advantages. Like faster switching from task to task and window to window. While keeping your mice from running wild.

Another advantage of the 8086 is its extended family, the members of which are perfectly compatible. So your product, and your investment, are protected longer.

The 8087 coprocessor, for example. It adds float-

ing point power, with calculations running up to 100 times faster than normal.

Or the new iAPX 286 microprocessor. In Coleman's words, "an optimal VisiOn machine."

The 286 handles some of VisiOn's multitasking chores in hardware, setting the software free for more powerful functions. Plus, it has on-chip memory management which protects one task from another and even helps prevent system crashes.

Best of all, you can experience all this for yourself. Because VisiOn is an open applications system. And VisiCorp is sharing information to encourage independent software development.

Which means you've got a wonderful opportunity to share in the forthcoming wealth.

But before you start building, study a little architecture. Call (800) 538-1876. In California, (800) 672-1833. Or write Intel, Lit. Dept. F-7, 3065 Bowers Ave., Santa Clara, CA 95051.

Who knows? You might find yourself looking at your own work in a whole new way.



William T. Coleman, VisiCorp's
Director of Product Development

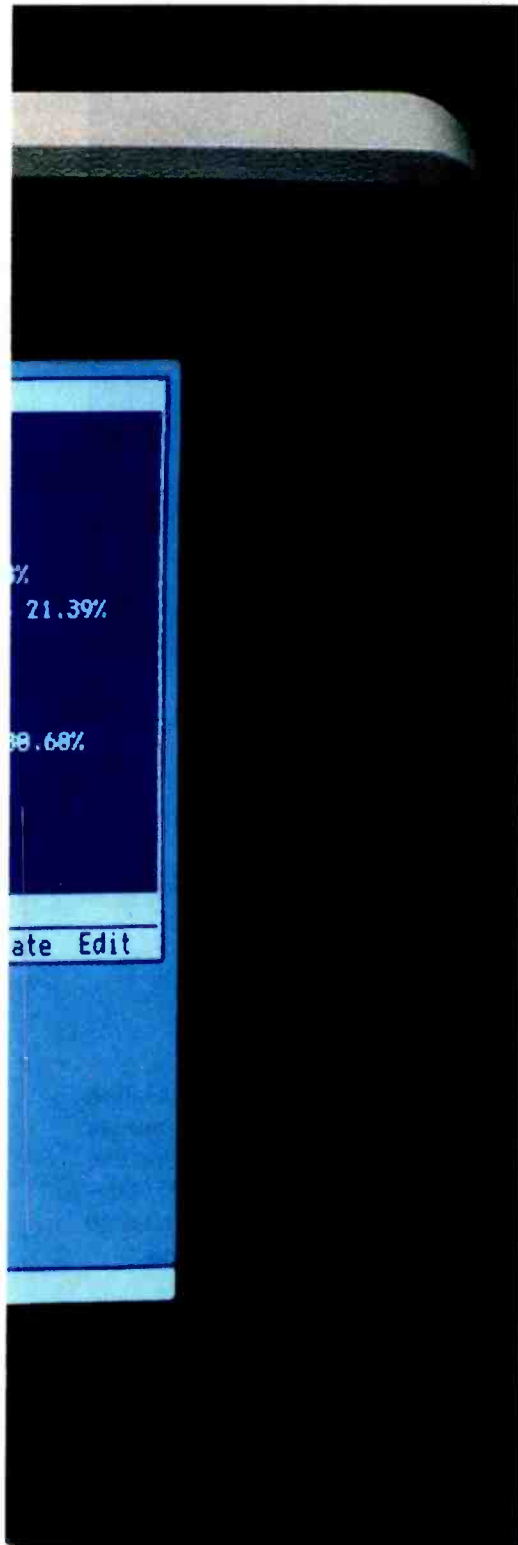

*VisiOn and VisiCorp are registered trademarks of VisiCorp. © 1984 Intel Corporation

intel®

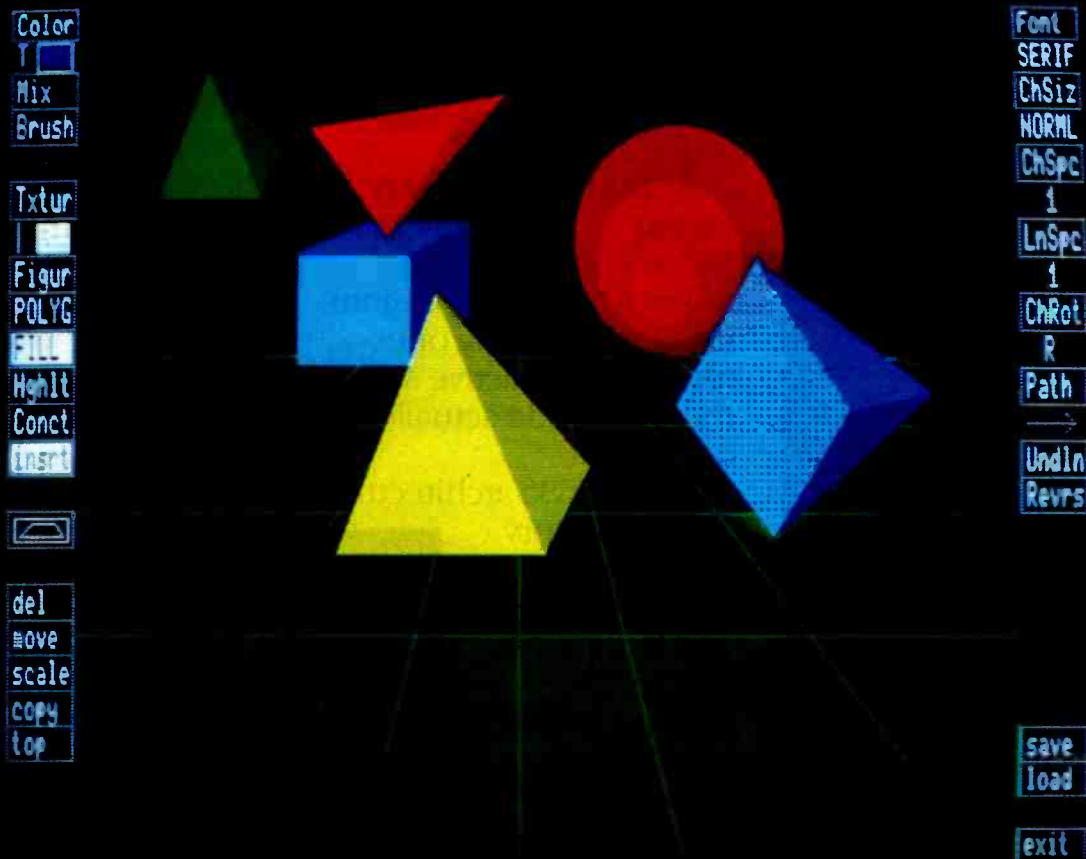

Photo 1: A high-resolution display on the Verticom terminal with editing menus at the edges of the screen.

Stylish Output

Graphics terminals and a quiet ink-jet printer

Ezra Shapiro
BYTE Technical Editor

The Verticom PLP100 and PLP200 NAPLPS-compatible (North American Presentation-Level-Protocol Syntax) color graphics terminals are designed for both the creation of videotex and applications in CAD (computer-aided design). As such, they are not really average consumer devices. However, the relatively low price tag (\$6450 for the PLP200 and \$5650 for the PLP100, a stripped-

down version) puts sophisticated graphics-generation potential into the hands of an audience that can't afford the tens of thousands of dollars typically required for equivalent systems. A basic installation, including the PLP200 terminal (high-resolution 13-inch RGB (red-green-blue) monitor, independent controller box with Multibus expansion slots, and Keytronic keyboard), an IBM PC XT com-

puter (or clone) for data manipulation and storage, either an optical mouse or a digitizing tablet, and interactive software, sells for around \$15,000—not cheap, but well within the range of affordable single-user prices.

Hardware

The guts of the Verticom terminals are based around twin Zilog Z80s controlling 320K bytes of dual-port

display memory, with 2K bytes of CMOS (complementary metal-oxide semiconductor) RAM (random-access read/write memory) with battery backup. Both units come with a Centronics-compatible parallel printer port and an RS-232C serial port for data transfer. The display monitor is capable of 640- by 480-pixel (picture element) resolution (more than double that of the IBM PC) with 16 colors displayable at one time, selected from a palette of 4096. On-line RAM can hold two pages of graphics, enabling simultaneous output of one page and the creation of another. Both devices can emulate DEC VT-100 and Tektronix 4010 terminals, support full NAPLPS coding, and operate in a mixed NAPLPS/VT-100 mode. A 19-inch monitor, light pen, and 32-bit parallel-port access to the display processor are options for either machine. Options for the PLP100 that are standard on the PLP200 include a second serial port for use with a mouse or other input device, integer zoom and panning, and firmware for page creation. Multibus expansion and host-resident software are optional for the PLP200, unavailable for the PLP100.

The Verticom terminals are among the first to adhere strictly to the proposed NAPLPS standards. NAPLPS, endorsed by some 20 manufacturers, including the major videotex producers, is a hardware-independent coding standard that lets you mix text and graphics in a compact ASCII (American National Standard Code for Information Interchange) data file suitable for easy transmission. NAPLPS supports a wide range of graphics primitive commands (draw a circle, fill an area with color, etc.) and a dynamically redefinable character set. The major purpose of NAPLPS is to establish a convention for display data that will enable videotex to be received on a wide variety of computers and terminals, regardless of monitor size and resolution. For a brief introduction to NAPLPS, see "NAPLPS Standard Graphics and the Microcomputer" by Leo Lax and Mark Olsen in the July 1983 BYTE, page 82. Greater detail can be found in "NAPLPS: A New

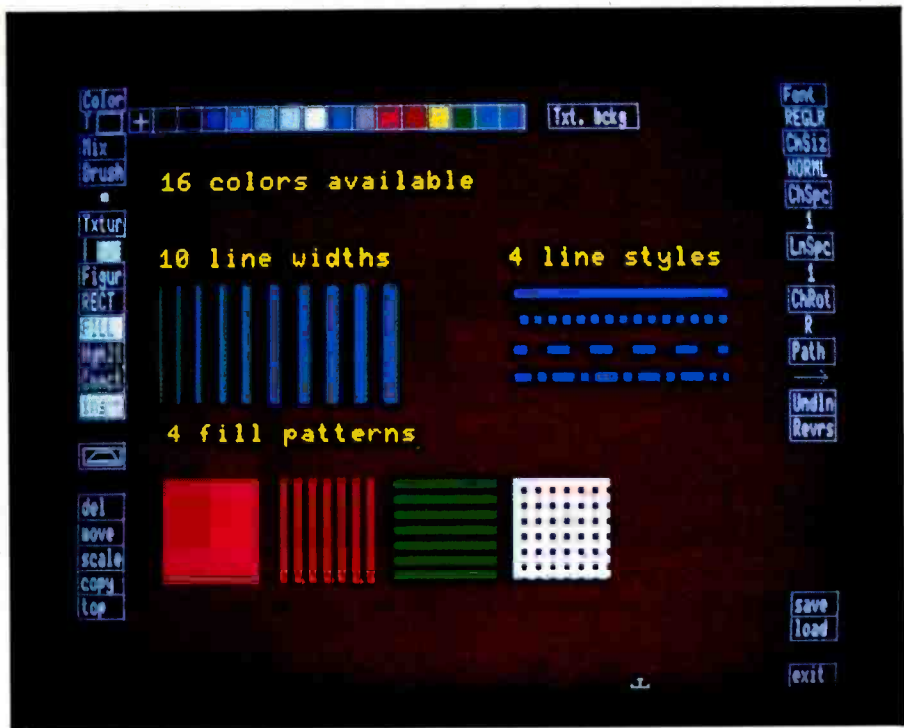

Photo 2: A demonstration of Frame Editor's available attributes for constructing videotex and CAD screens. The menu strip across the top shows 16 color possibilities.

Standard for Text and Graphics" by Jim Fleming and William Frezza in the February through May 1983 issues of BYTE.

Software

Using Verticom's software package, Frame Editor, on a host computer (currently supported: the IBM PC XT, DEC VAX, Plexus, and Onyx) linked to the PLP200, it's possible to generate full-screen graphics at remarkably high speed. The hardware can fill areas with color at a rate of 800 nanoseconds per pixel—and that's fast. The color possibilities are impressive, too. Although only 16 colors can be on line at one time, you have 4096 choices. You can create or modify colors by adjusting percentages of red, green, and blue from 0 to 100 percent in 7 percent steps. Future versions of the program will support an alternate selection process. You'll be able to determine color by varying hue, saturation, and intensity. Either way, you can produce frames that seem to allow a wider range of colors than the 16 on line. Three-dimensional shading effects can be simulated quite effectively. Of course, starting a new screen reopens

the selection process, and variation from screen to screen can be dazzling.

You select your drawing options from a simple menu that appears on the left and right edges of the screen. Choices that require further input, such as color selection, lead to menu strips across the screen that disappear as soon as you choose your answer. Four line styles, 11 brush widths, and four area-fill patterns are available. Lines, arcs, circles, rectangles, and polygons can be drawn singly or connected to each other. Using the connected-arc primitive, you can construct flexible curves with multiple radii. What are known as "rubber boxes" can be drawn around objects or groups of objects; the items enclosed can be moved or copied to a new cursor position, exploded or collapsed in scale, deleted, or brought to the top level of the display. At the time this article was written, neither freehand drawing (vital for fine arts and videotex applications) nor a snap grid was implemented, although Verticom's software engineers promised both features soon. (Snap grid is an important element in precision CAD packages, a stan-

(3a)

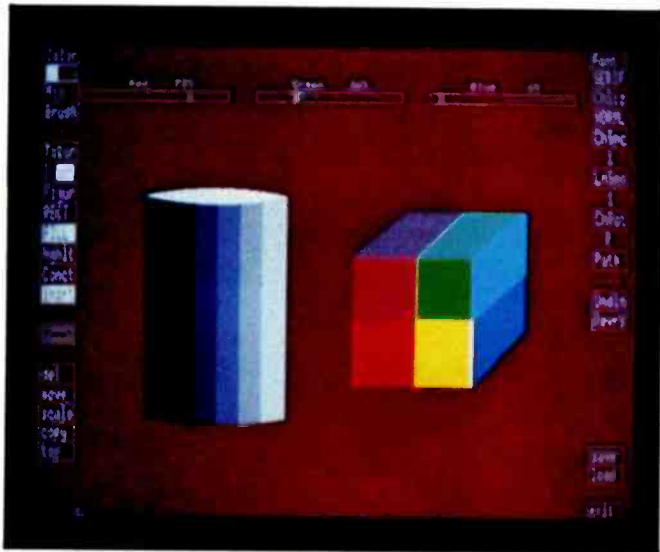

(3b)

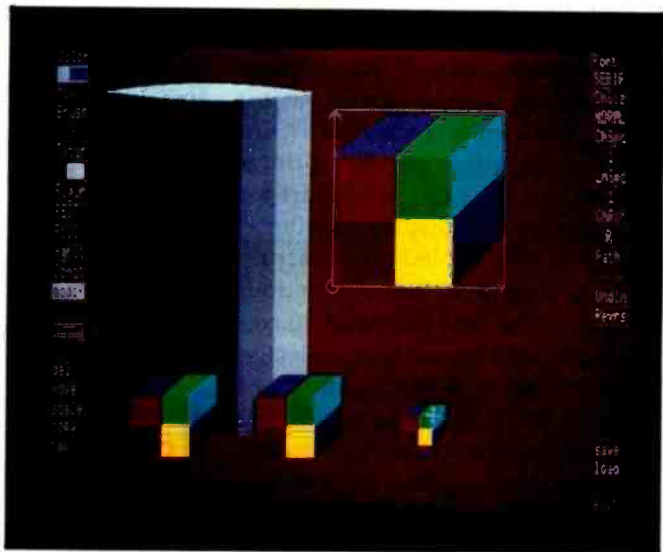

Photo 3: Object-oriented graphics flexibility is an integral part of the Frame Editor concept. Using "rubber boxes," the two objects in 3a have been resized, copied, or moved to produce 3b. The menu strip at the top of 3b is Frame Editor's RGB color-mixing menu.

standard graphics scheme that allows lines and objects placed approximately to be moved—snapped—to points in a fixed coordinate system.)

Text can be added to displays in three fonts or a "mosaic" font of block graphics symbols. It can run left to right, top to bottom, bottom to top, or upside down right to left. Character size, character spacing, and line spacing are all variable.

A second approach offered by Verticom is a selection of FORTRAN-based subroutines that can be used by programmers to gain access to all NAPLPS primitives without the use of a virtual editor such as Frame Editor.

In either case, the host computer is used to store the NAPLPS picture databases, which can be sent to any terminal employing the NAPLPS protocol.

Conclusions

William Chu, president and chief executive officer of Verticom, comments that the use of graphics will increase dramatically over the next few years as both videotex and NAPLPS gain wider acceptance. He sees the two terminals as a first step in the right direction. As people begin to explore the world of computer graphics, costs will come down and applications will multiply.

In the meantime, products such as the PLP100 and PLP200 will serve as

the testing ground for graphics at a reasonable price.

The HP 2225 Printer

If you've been longing for a dot-matrix printer that costs less than \$500 and doesn't sound like an extremely painful visit to the dentist, the HP 2225, to be marketed as Thinkjet, may well be for you. The first thing you'll notice about this new ink-jet printer from Hewlett-Packard is that it's amazingly *quiet*. It's also compact (somewhat smaller than a metropolitan phone directory), good looking, and well engineered. In many respects, it marks a real technological breakthrough in personal printers.

The HP 2225 is a bidirectional, logic-seeking, dot-matrix printer that runs at 150 cps (characters per second) and operates at a noise level below 50 decibels (dB). It can handle either standard single sheets of letter-size stationery or the equivalent pin-feed, fanfold computer paper. Interfaces available include the common Centronics-style parallel interface (making the HP 2225 compatible with most personal computers on the market) or one of two HP proprietary interfaces for use with Hewlett-Packard products. All three models come with a 1K-byte buffer.

Print quality is equal to or better than that of impact dot-matrix printers in the same price bracket.

Though it's possible to identify the HP 2225's output as coming from a dot-matrix printer, the dots are tightly spaced and the characters well drawn; copy is extremely easy to read. The character set is produced using a matrix of 11 by 12 dots in four pitches: normal (80 characters/line), compressed (142 characters/line), expanded (40 characters/line), and expanded compressed (71 characters/line). Eleven foreign-language character sets are user-selectable. Boldface and underlining controls eliminate the need for a second pass of the print head. Two dot-addressable graphics modes, at resolutions of 96 by 96 and 192 by 96 dots per inch, provide adequate capabilities for most types of business graphics.

The unit measures 11.5 inches wide, 8.1 inches deep, and 3.5 inches high. Its weight of a mere 5½ pounds (6 with an optional nicad battery pack for an HP interface) makes it a truly portable full-featured printer. The size and weight can be kept so low because the HP 2225 does not have to withstand the constant pounding of an impact printer; the only thing that touches the surface of the paper is ink. Other than the paper-feed mechanism, the only moving parts of the unit are in the print-head carrier that glides back and forth across the width of the carriage. Another benefit of this arrangement is the printer's tiny power consumption

DIMENSION. THE MOST POWERFUL, MOST COMPATIBLE PERSONAL COMPUTER YOU CAN BUY.

Introducing the capability the world has been waiting for. A single personal computer able to handle Apple,[®] IBM,[®] TRS-80,[®] UNIX[™] and CPM[®] based software.

The Dimension 68000 Professional Personal Computer does it all. It actually contains the microprocessors found in all of today's popular personal computers. And a dramatic innovation creates the environment that these systems function merely by plugging in the software.

Add to this the incredible power of a 32 bit MC68000 microprocessor with up to 16 megabytes of random access memory.

Dimension. At about the same price as the IBM[®] PC, it's obviously the best value you can find. For more information ask your dealer or call us at (214) 630-2562 for the name of your nearest dealer.

dimension™



68000

A product of
Micro Craft Corporation
4747 Irving Blvd., Suite 241
Dallas, Texas 75247. ©1983

(CRT not included)

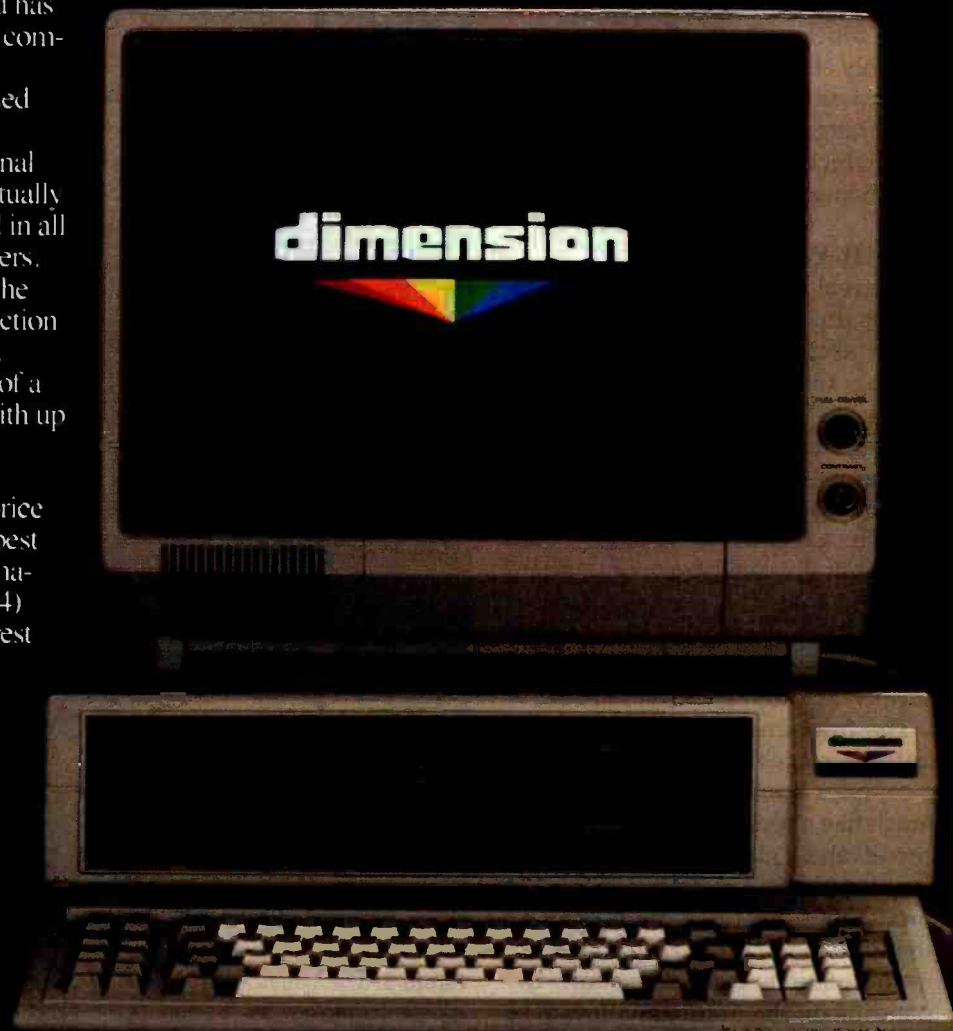

Apple is a registered trademark of Apple Computer, Inc.; IBM is a registered trademark of International Business Machines Corporation; TRS-80 is a registered trademark of Radio Shack, a Tandy Corporation company; UNIX is a trademark of Bell Laboratories, Inc.; CPM is a registered trademark of Digital Research Corporation.

DEALER INQUIRIES INVITED

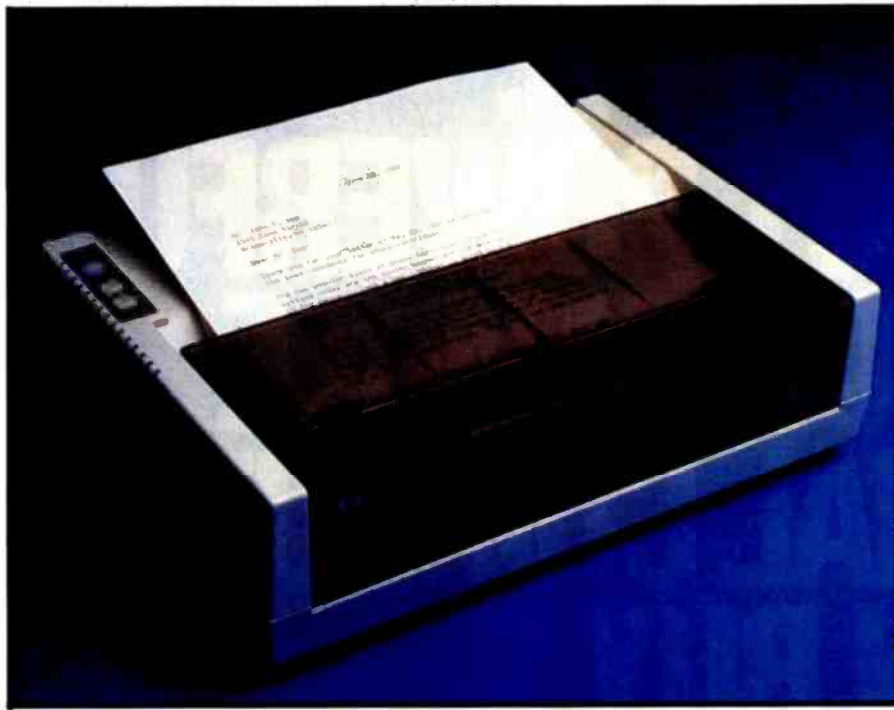

Photo 4: The Hewlett-Packard 2225 ink-jet printer. HP engineers claim a noise level below 50 decibels—quieter than normal conversation.

(less than 20 watts), which won't have much of an effect on your monthly electric bill, but makes a significant difference in the effective life of a charge of the battery-powered unit, which Hewlett-Packard rates at approximately 200 pages.

How It Works

The real touch of genius in the HP 2225 is the disposable print head, an object about the size of an oversize sewing thimble, that will sell for about \$8. The company claims the head should be good for 500 pages of average output.

The outer casing of the print head contains a bladder that holds a liquid ink about the consistency of standard drawing ink. The shell is made of transparent plastic to allow visual monitoring of the remaining ink supply as the bladder collapses.

The front end of the unit consists of three pieces: the cap of the shell, a complex layer of thin-film material much like a semiconductor integrated circuit, and a glass plate with 12 holes representing a single column of printer dots. Ink fills a chamber above the film and is drawn into the holes in the plate by capillary action. Depending on the number of dots to be

printed in a given column, resistors in the film directly beneath the appropriate holes are fed current, heating the ink above. The superheated ink forms gas bubbles that force the liquid ink held in the holes to burst

out of the head onto the paper. At this point, the resistors have long since cooled and the gas bubbles have contracted. The holes that have been emptied draw more ink, the head advances, and the cycle is ready to begin again. The head is assembled as a negative-pressure environment; that way, ink will not leak from the holes unless stimulated.

Unlike most current ink-jet printers, the HP 2225 uses no tubes and no nozzles, reducing the chances of fatal clogging. In fact, Hewlett-Packard sees paper dust and other foreign matter as the major source of operational difficulties in the ink delivery system. The company suggests that a fast wipe with a clean cloth is all that will be needed to cure any problems. But to provide insurance that all 12 dots are firing, the printer blasts a column of dots into an absorbent pad to the left of the paper margin at start-up. The pad is replaced every time the print head is changed. In the worst possible case, a damaged print head can be thrown away and a new one installed for a fraction of the cost of a conventional fabric printer ribbon—and without the dirty fingers.



Photo 5: The simplicity of the HP 2225's print head is evident in this disassembled view. All the technology for printing is contained in the thin-film strip at the right.

THE WY-50. PRETTY SMALL

A NEW GENERATION OF LOW-COST TERMINALS FROM WYSE.

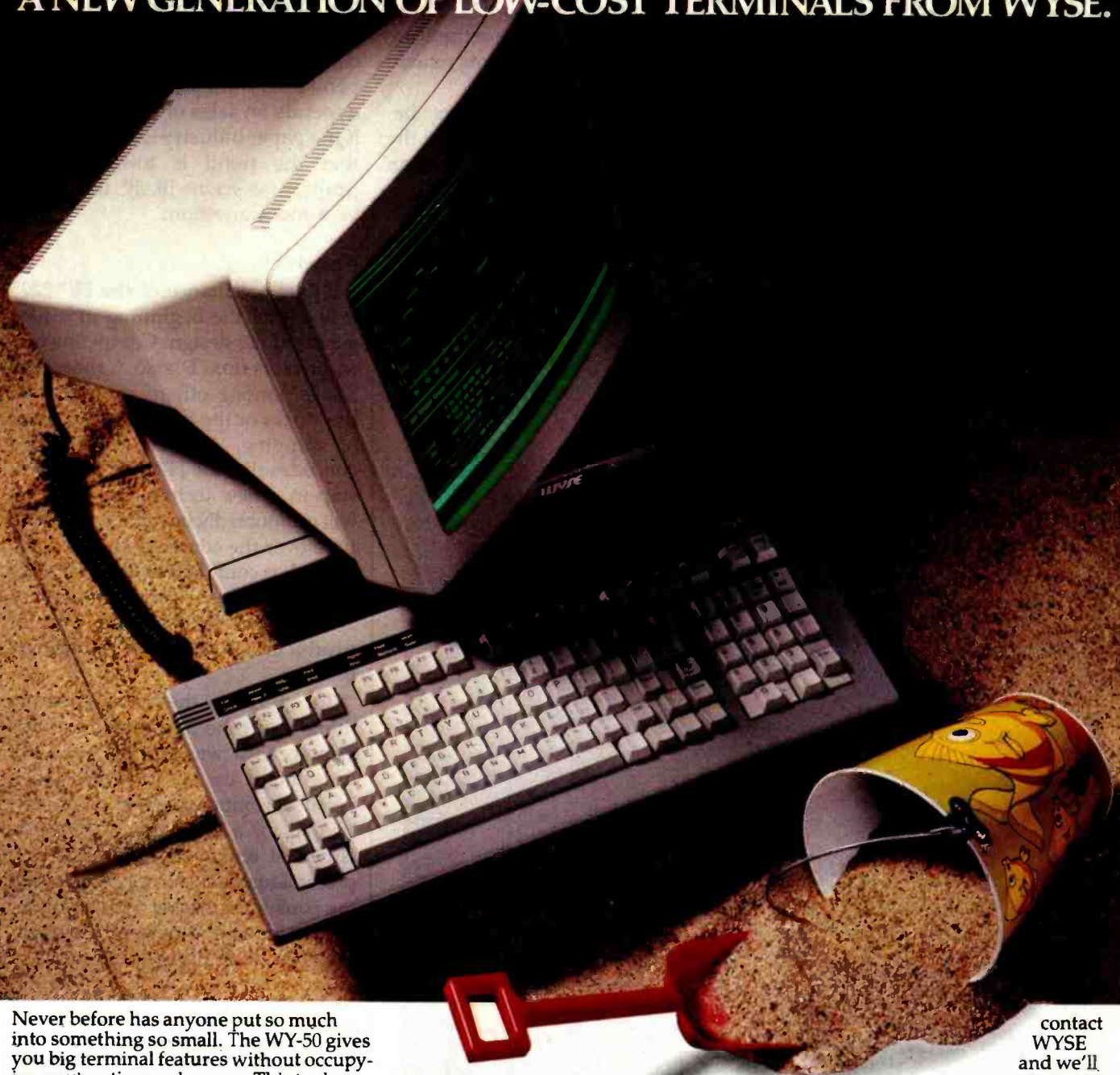

Never before has anyone put so much into something so small. The WY-50 gives you big terminal features without occupying your entire work-space. This took revolutionary design. Design a lot of people couldn't accomplish for the price. But we did.

In fact, the WY-50 introduces a new standard for low-cost terminals. You get a compact, full-featured design that meets the most advanced European ergonomic standards. 30% more viewing area than standard screens. And a price tag as small as they come.

The WY-50 sells for only \$695.00.

FEATURES:

- 14" screen.
- 80/132 column format.
- Soft-set up mode.
- High resolution characters.
- Low-profile keyboard.
- Industry compatible.
- Only \$695.00.

For more information on the revolutionary design, outstanding features and unique good looks of the new WY-50,

contact WYSE and we'll send you a brochure filled with everything you need to know. The WY-50. The full-featured terminal with the small price.

WYSE

Circle 395 on Inquiry card.

Make the Wyse Decision.

WYSE TECHNOLOGY 3040 N. First St., San Jose, CA 95134, 408/946-3075, TLX 910-338-2251, Outside CA call toll-free, 800/421-1058, in So. CA 213/340-2013.

The Paper Chase

The only major obstacle facing the HP 2225 is the availability of paper better suited to ink-jet technology than the current average computer stock. That's not to say that the 2225 won't print on standard paper; it most certainly will, although the acceptability of the printout is debatable.

Most of today's stock is made from relatively long fibers; the liquid ink that reaches the paper surface flows along these fibers until it is fully

absorbed—the longer the fibers, the greater degree of fuzziness that appears around the edges of the dots that make up the characters. Manufacturers of high-resolution four-color ink-jet printers recommend expensive clay-coated paper—ink is absorbed by the clay rather than by the paper underneath. Because there are no fibers in the clay, the dots remain crisp.

Hewlett-Packard's engineers believe that its ink doesn't demand the luxury of clay and will print well on

uncoated paper made from shorter fibers. The difference in cost between long- and short-fiber paper is almost negligible; the critical issue is availability in sufficient quantity to meet demand. Hewlett-Packard is working with paper manufacturers to ensure a good supply of appropriate stock, but it becomes something of a circular issue—sales of the printer depend on the availability of paper that depends on sales of the printer. But if the paper industry is willing to bet that the trend is toward ink-jet printers, as seems likely, this might be a moot question.

Conclusions

Public acceptance of the HP 2225 may signal the beginning of a new era in printer design. Competing ink-jet printers from Diablo, Canon, and Sharp, among others, are either in the works or the preliminary phases of shipping. And Hewlett-Packard concedes that the HP 2225 is the first step in a new technology, one that will undoubtedly be refined at a rapid pace over the course of the next few years. It is confident that the HP 2225 will be a success; it makes no bones about its intent to become a major producer of low-cost computer printers.

But perhaps the most cheering thing about the introduction of this printer, as it was last fall with the unveiling of the HP 150 touchscreen personal computer, is that a company known for a solid line of products aimed at engineers, scientists, and professionals can successfully invade the consumer market with startling, innovative technology and a refreshing attitude of independence. ■

A Microman Update

In the February BYTE West Coast (page 148), I reported on the Microman integrated software package from Noumenon Corporation (512 Westline Dr., Alameda, CA 94501). Microman has been renamed Intuit and is currently being shipped.

Ezra Shapiro is a technical editor at BYTE's West Coast bureau. He can be reached at McGraw-Hill, 425 Battery St., San Francisco, CA 94111.

Winchester power for your PC



The proven Winchester subsystem drives for your IBM or compatible PC. 10, 15, 25, or 33 megabytes of big system storage in a DiskSystem you simply plug into your system and it's ready to use. At prices that make the speed and storage of a Winchester practical. Only \$1495 for a 10 megabyte DiskSystem, \$1795 for 15 megabytes, \$2245 for 25 megabytes, or \$2795 for 33 megabytes. DiskSystems can be bootable from the Winchester. See your dealer today for DiskSystem power for your PC.

I² INTERFACE INC

I² Interface Inc
7630 Alabama Avenue
Canoga Park, CA 91304
(818) 341-7914 Telex: 662949

Dealer Inquiries Invited
DiskSystems is a copyright of Interface Inc. IBM is a registered trademark of IBM Corporation. Prices are suggested retail and are subject to change without notice.

Circle 466 for Dealer inquiries.

Circle 467 for End-User inquiries.

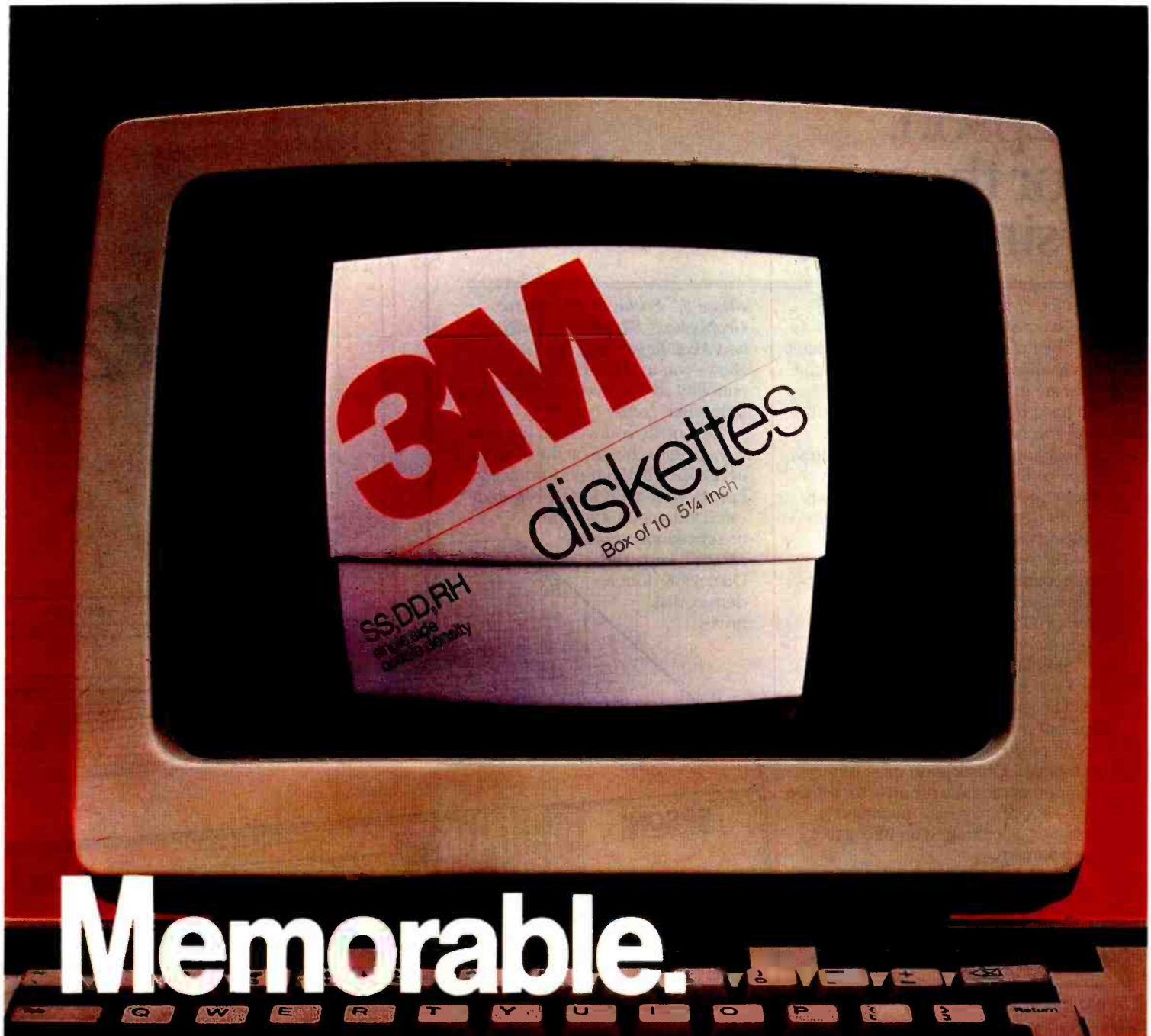

Memorable.

With 3M diskettes, your computer never forgets.

3M diskettes remember everything, every time. Because at 3M, reliability is built into every diskette. We've been in the computer media business for over 30 years. And we've never settled in. We're constantly improving and perfecting our product line, from computer tape and data cartridges to floppy disks.

3M diskettes are made at 3M. That way, we have complete control over the entire manufacturing process. And you can have complete confidence in the reliability of every 3M diskette you buy.

Look in the Yellow Pages under Computer Supplies and Parts for the 3M distributor nearest you. In Canada, write 3M Canada, Inc., London, Ontario. If it's worth remembering, it's worth 3M diskettes.



Circle 362 on inquiry card.

3M hears you...

3M

Epson. For those who need it, simplicity.

One computer.

Two points of view.

The Epson QX-10 personal computer.

To many, the Epson represents the ultimate in simplicity.

Just press a single key for the function you require: word processing, scheduling, business graphics, address book or file management. One key-stroke produces your program. There are no rigamaroles to remember. No disks to change.

The result: you start to work immediately. And you start being productive, immediately. With step-by-step prompts. In plain English, not computerese.

Simplicity itself.

Or is it?

The plain fact is that the ease of operation the Epson offers today is accomplished with a degree of technological sophistication most other computers can only promise for tomorrow — specifically, fully integrated software, operating in an interactive environment.

The few other computers offering such "simplicity" cost \$5,000 to \$15,000 more. And most other computers can't offer it at any price. Which makes one wonder exactly what they do offer, in terms of either simplicity, or performance.

HOW MUCH CAN YOU DO ON THE EPSON? HOW MUCH ARE YOU READY TO DO?

The Epson's ease of operation may spoil you, but it certainly won't limit you.

Case in point: every Epson comes complete with an integrated software system — *Valdocs** — to effortlessly provide the basic functions for which most people buy computers. The Epson also comes with *CP/M*®-80 2.2, so you can choose from the hundreds of programs in the CP/M library. And only Epson offers an exciting new collection of seven best-selling programs now specially enhanced to give you every powerful feature, plus Epson one-button simplicity. Included are

dBase II®, *Friday!*™, *Microplan*®, *Graphplan*™, *WordStar*®, *SpellStar*®, and *MailMerge*®. And the Epson also allows you to add *MS*™-DOS compatibility, so you have access to best-sellers like *Lotus*® 1-2-3®.

Best of all, you will run the software of your choice on the computer of choice. The high-performance Epson. With 256K RAM. 128K dedicated video memory. The breathtakingly sensible *HASCI*™ keyboard. Dual 380K double density disk drives.



Graphics capabilities unequalled in its price range. A high resolution monitor, 640 by 400 pixels, for clarity few computers in any price range can offer. Plus, an RS-232C interface, a parallel printer interface, and internal space for up to five peripheral cards so you can expand your Epson as your needs require.

One further point: all these features, and quite a few more, are included in the Epson's \$2,995 price. Some com-

Epson. For those who can handle it, performance.

puter companies ask you to pay extra for features like these. Most can not offer them at any price.

That, too, is performance. The kind of performance that can make choosing a personal computer very simple, indeed.

**EPSON QUALITY. OR, WHY
WONDER WHAT TERRIBLE
KLUDGES LURK IN WHICH
SLEEK BOXES.**

If you know computers, you know Epson. Epson printers set the industry standard for quality, reliability and value. Rest assured, the same can be said for the Epson personal computer.

The satisfying silence of the slim, Epson-designed disk drives is one way for you to judge or, for an inside-out perspective, here is an excerpt from a review by Jim Hanson in the April, 1983 issue of *Microcomputing**

"The Epson QX-10 is soundly designed and executed. I looked hard and found no evidence of kludging or shorting out anything in the name of economy. All the connectors have gold on them and are of quality manufacture. The printed circuit boards are heavy, with soldermarks on both sides of double-sided boards. The circuit boards are completely silk-screened with component labels, and the layout is as professional and clean as you will find anywhere."

Isn't this what you expect? After all, it's an Epson.

**A WORD TO THE WISE:
GET YOUR HANDS ON
THE EPSON.**

Is the Epson a simple, easy-to-use computer for beginners? Or a sophisticated high-performance computer for the experienced? The answer is "yes." And when you think about it, aren't those two computers the one you need now.

For technical specifications, and the complete, 3-part *Microcomputing* review, along with the name of your nearby Epson dealer, call toll-free (800) 421-5426. California residents, call (213) 539-9140.

*Excerpt reprinted by permission of *Microcomputing* Magazine. All rights reserved. CP/M, dBase II, Microplan, WordStar, SpellStar, MailMerge, Lotus, 1-2-3 are registered trademarks of Digital Research, Ashton-Tate, Chang Labs, MicroPro (3), and Lotus Development (2). Valdocs, Graphplan, MS, and HASCI are trademarks of Rising Star, Chang Labs, Microsoft, and Rising Star, respectively.

EPSON

STATE-OF-THE-ART.. SIMPLICITY.



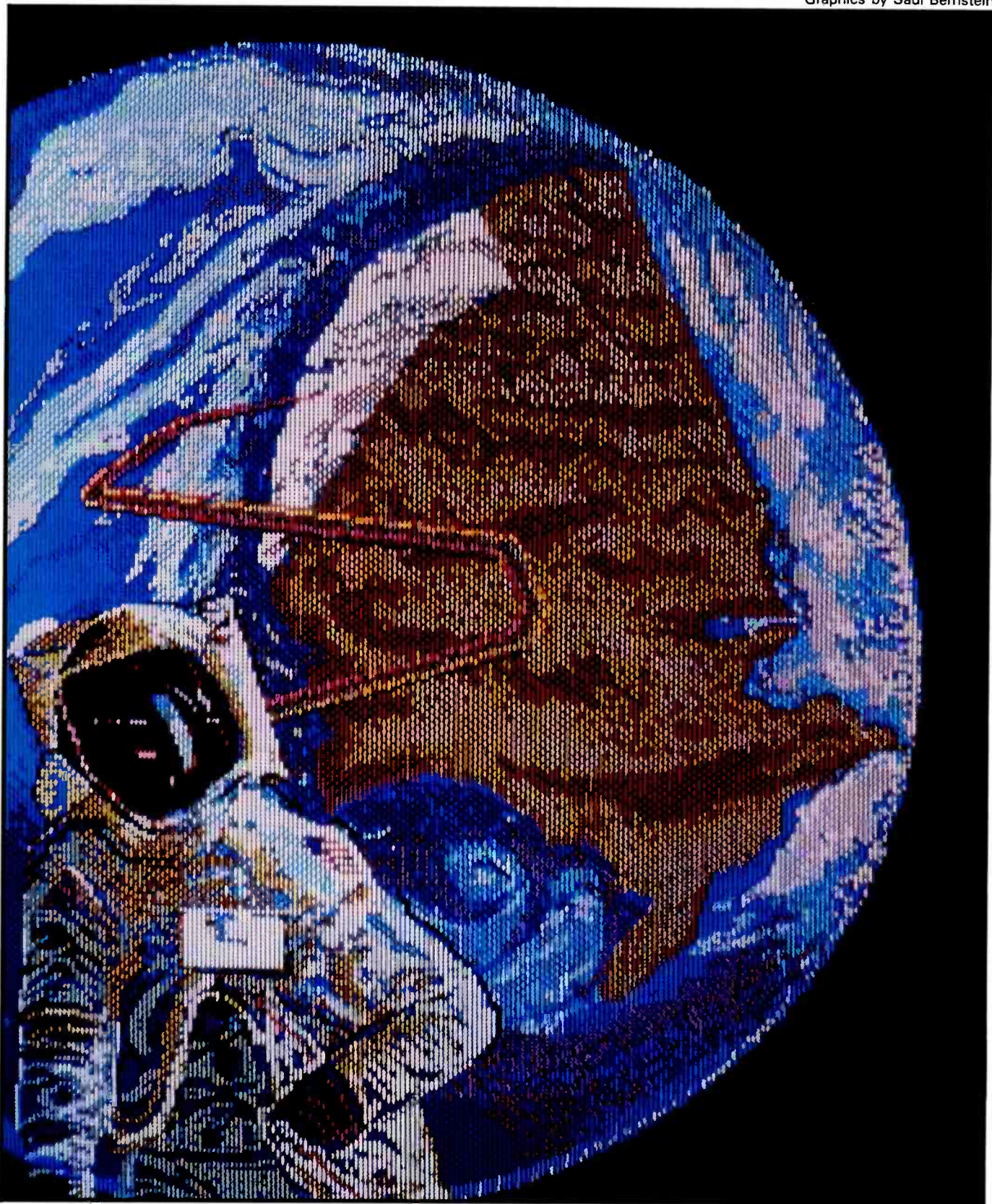

The World of Micros

Brush aside for the moment the excitement of the latest breakthrough in micro land and think back to your first exposure to a microcomputer. Among other things, you might have said, "That's kinda nifty, but what can I do with it?" If your memory goes back to the Altair and IMSAI days, you probably remember the alleged utility of all those front-panel toggle switches and LEDs. My first run-in with an IMSAI 8080 involved spending half an hour painstakingly toggling in a batch of (then) strange base-16 numbers and subsequently being told that the indecipherable (to me, at least) light pattern on the front panel did indeed display the correct "answer." I thought, "If this is all one of these things can do, then the 'real' computers don't have to worry about being replaced." Times have changed.

From sewing and driving an automobile, to sophisticated word processing and powerful number crunching, if a task can be done at all, there's a good chance that a microcomputer can do it. Minicomputer and mainframe power of a few years ago has moved into the workstations, offices, and homes of people around the world, and people everywhere are putting this power to work. Our theme articles for April include some theory, some system descriptions, and some projects that touch on the capabilities and perils of ongoing real-world interfacing.

For readers involved in systems development, "Personal Computer Signal Processing" by Bill Englemann and Mark Abraham from Analog Devices offers an introduction to some of the capabilities of today. For interfacing considerations, take a look at "Designing Systems for Real-Time Applications" by James Isaak of Charles River Data Systems and "Planning a Computerized Measurement System" by Craig R. Wyss. "Interfacing for Real-Time Control" by the technical staff at Fairborn Observatory shows how careful interface design simplified both hardware and software development in an astronomical environment and includes a discussion of several interfacing approaches. To round things out, we have part 1 of "Putting the Apple II Work" by Richard C. Hallgren as a practical example of an interfacing project you can build.

Moving hardware and software advances down to practical applications continues to be one of the most exciting aspects of microcomputing. And as microcomputer power finds its way into more and more of our daily activities, real-world interfacing continues to increase in importance.

—Gene Smarte, Technical Editor

94 **Personal Computer Signal Processing** by Bill Englemann and Mark Abraham

114 **Planning a Computerized Measurement System** by Craig R. Wyss

127 **Designing Systems for Real-Time Applications** by James Isaak

137 **Interfacing for Real-Time Control** by Russell M. Genet, Louis J. Boyd, and Douglass J. Sauer

152 **Putting the Apple II Work, Part 1: The Hardware** by Richard C. Hallgren

Personal Computer Signal Processing

*An introduction to transducers,
interfacing, and system development*

Bill Englemann and Mark Abraham
Analog Devices

Personal computers are moving into the laboratory and onto the factory floor to act as data-acquisition systems and industrial-process controllers. But many questions need to be answered to fully develop the concept of a low-cost computer system that controls processes many times more valuable than the computer itself.

This article explores the complexities of interfacing personal computers and real-world sensors. We'll look at the kinds of measurements that can be taken, the analyses that can be performed, and the control output that personal computers can generate. We'll examine the role of transducers, analog-to-digital (A/D) converters, parallel and serial communications, bus standards, and software for real-world applications. To fully understand the problems of getting real-world signals into the computer, we'll look at signal conditioning, protection of interfacing circuitry, and isolation of input signals. The accompanying text box, "Signal Processing—Its Uses Today" (on page 96), looks at the kinds of applications be-

ing undertaken today by microcomputer-based, real-world systems.

The simplest application of a personal computer in the real world is for data acquisition only (i.e., no outputs). Without a computer, there are two standard approaches to data acquisition—the manual method or using a dedicated data logger. The manual method consists of someone watching some type of meter or display and a clock while writing all of the desired readings on paper. Using a data logger entails hard-wiring the inputs to the box and allowing the system to print out readings at regular intervals or when some predetermined limits have been exceeded. Neither approach lends itself to easy access to the results for numerical analysis. In addition to automating this operation, a personal computer allows you to do better what you really want to do with the data—off-line numerical and graphical analysis (after the data acquisition is complete).

The next level up for a personal computer involves data acquisition with alarming. In this case, the data-

acquisition function is performed as before, but an alarm function is added. Alarms typically trigger by comparing the input values to a set of known limit values and driving some output when one of these conditions is met. The output can be any combination of digital outputs, screen messages, and voice outputs to an operator, or data streams to a printer and disk. Digital outputs can be directed to some type of operator alarm-panel display or some type of audible alarm.

On-line data analysis requires more work on the part of the computer. Specifically, in between taking samples it may have to do alarming, acknowledgment of trends, digital filtering, plotting, or storing to disk. Typical on-line analysis has some form of output much like alarming, but does not have the ability to affect the signals coming in.

Real-time control with a personal computer is one level up in complexity. In this type of application, all of the preceding must go on, plus there are additional outputs that directly or indirectly control the functions under

consideration. A digital output can directly control a driving device, like a heater can control the temperature. An analog output can "throttle" a variable-output drive like a DC (direct current) motor-driven fan. When DDC (direct digital control) is used, the inputs, algorithm calculations, and outputs are performed by the computer. When supervisory control is used, the computer communicates the desired value (or set point) to "smart" controlling devices and is free from doing the control itself. The actual communication may be via analog output, pulse trains, or communication signal.

Finally, full utilization of a personal computer in an application like this involves using other features of the computer as well. Primarily, the computer can be performing more analysis as well as logging all events and data to disk and printer. One display could include information on each loop, such as the measured value, set point, and control-output status; another display could show the trend of a group of measured values (for example, temperatures) over time; and yet another could show a tabular display of all of the relevant parameters for a particular loop—set point, type of output, control-algorithm parameters, limits, and functional identification. In this mode, the personal computer transforms itself from a replacement for other types of control equipment to an aid in managing the control function as a whole. It provides information and a basis for analysis that has heretofore not been available for this price.

The hardware and software choices made affect how the implementation is done and how well a system works. The operating system chosen should have provisions for real-time operation, efficiency in handling the I/O (input/output) requirements, support of multiple terminals, multitasking, and ideally should be widely used. Real-time operation is important and must be differentiated from time-sharing. While time-sharing operating systems guarantee that eventually all users get as much time as required for their applications, a real-time operating system provides

everyone with a regular, guaranteed slice of time.

Choice of programming languages depends on the preferences of the programmer as much as the requirements of the system. There is no language standard in data-acquisition and control applications. Compiled languages virtually are required for real-time operation, yet ease of use for "nonprogrammers" has directed some vendors to supply compiled versions of BASIC with the necessary extensions. The most important thing in choosing a language is to verify that the inputs and outputs are adequately and easily addressed. If at all possible, you should obtain a simple integrated software package. The language you choose must have built-in input and output functions so that you can write software that is application specific, not hardware specific.

A personal computer can not only replace control equipment but can also manage the control function.

Where performance requirements allow, try to purchase an application-software package, but only if you feel confident that you will never have to alter it in a language that doesn't lend itself to what you want to do.

The hardware you choose will be transparent to the application as long as some prerequisites are met. One of your key concerns when buying a personal computer should be dependability, especially if the operator and the programmer are different people. Industrial operators tend to have less respect for computer hardware than programmers do. Unless your performance requirements are minimal, or the external hardware is doing much of the work, you will need a 16-bit microprocessor. A software real-time clock is an asset, but a hardware clock that has battery backup is better. The system must have the capability to automatically load software from disk for unattended operation after a power failure and it must be user-friendly.

Data Acquisition and Control-System Architecture

Once an overall strategy for measuring and/or controlling real-world signals is determined, the architecture of the system must be chosen. The architecture defines the characteristics of how the information is processed: getting it from the real world to the computer and back again. Two common ways to establish communications between a computer and a real-world interface subsystem are parallel and serial interfacing.

A crude way of getting this information in and out of a computer is through an operator interface like a cathode-ray tube (CRT) terminal. An operator could look at a panel of analog meters, record the information on a chart, and later enter the data through the terminal. This method is slow and inaccurate. Errors can occur during the meter reading, the writing of data, or when the operator enters the data. The scan rate is determined by how fast the operator can perform the complete cycle and start over again, and it is extremely slow.

Parallel Communications

Every microprocessor, microcomputer, minicomputer, and mainframe has one or more parallel-bus structures. These buses provide a well-defined means of local communication among the processor, memory, storage devices, and I/O devices. For example, within the IBM PC, the 8088 microprocessor has an internal and an external bus. Also within the PC is the now-familiar IBM PC bus. These buses can have four groups of signals: data, address, control, and power. The sequence, timing, and control of these signals and the form-factor, connector type, and pin spacing are well defined for a given bus.

Once a bus-compatible device is designed and connected, the actual communication with it is controlled by the software of the computer. Three ways to communicate are via memory-mapping, I/O mapping, and DMA (direct memory access).

Memory-Mapped Interface

Certain software commands either

Signal Processing—Its Uses Today

Although some of the greatest advancements in real-world signal processing have been in the area of digital technology, the only things left in the real world that are not analog are fingers and toes. Applying digital technology to what has been traditionally the domain of analog devices brings a new set of problems and challenges.

The term "real world" as it is used in the context of this article refers to electrical signals generated by sensors, transducers, switches, and meters, as well as controllers of electrical or electromechanical devices. Sensors and transducers typically have electrical properties that vary with the physical properties they measure. Sometimes a sensor's output is as simple as a known resistance that varies with temperature, while at other times it outputs an analog signal proportional to the pH of a solution. A real-world signal input can also be a temperature switch that closes at a predetermined level or a series of pulses whose frequency varies with the flow of a fluid through a pipe.

In some cases, electrical phenomenon can be measured directly. In biological research, brain waves can be measured as electric pulses so that both the amplitude and the frequency components of the pulses can be quantified for later analysis. In applications where power is monitored, the amplitude, frequency, and phase of the power source are potential quantities of interest as the load on the power line changes.

Outputs to the real world can be either analog or digital. Digital outputs can be anywhere from transistor-transistor logic (TTL) level (0 to 5 V) to 24 V DC or 280 V AC. Analog outputs can be either current or voltage and may be either simple milliamp signals or power voltages to drive DC motors. Pulse and frequency signals are used to drive stepper motors and gate external events instead of the usual analog or digital outputs.

Why Personal Computers?

When real-world interfacing was primarily analog and even calculations were performed by analog circuits, it seemed that this homogeneous approach was sufficient; but some of these functions are better or more easily performed by digital technology. The advantages of using computer technology go beyond the functions previously possible, particularly in the areas of display, data analysis, and overall system flexibility.

An engine test stand is an example of a real-world interfacing application. The EPA

requires manufacturers to test internal-combustion engines. Any changes to an existing engine design, or use of new fuels and lubricants, are tested on an engine in a controlled environment. Without a computer, the test is manually controlled from a control panel where an operator starts and stops the test and performs all data acquisition and on-line calculations. The operator's tools for these tasks are switches and knobs, pocket calculator, pen, and clipboard. Also employed are emissions analysis equipment with output to analog panel meters, a manometer (glass tube with floating air bubble) to determine pressure, and a two-channel X-Y recorder to monitor two analog parameters over a specific period of time. The problems with this method include the inability to accurately recreate the operator's actual control sequence, inability of the controller to react quickly enough, lack of correlation between the control-room data (motors, speed, and pressure) and the analog data on the chart recorder, and no allowance for monitoring more than two analog parameters when there may actually be five or six of interest.

Using a computer-based data-acquisition and control system resolves all of these problems and provides functions never previously considered important. This system guarantees repeatability of control of the test, dynamic decision-making capability, a large database of multiple variables that can be used for more detailed graphical or numerical analysis, and a permanent record both on paper and on disk for audit later.

Personal computers acting as data acquisition and control systems stimulate new levels of analysis. Just as spreadsheet programs motivated people to do more detailed "what-if" analyses, computers applied in data-acquisition and control applications open the doors to more detailed numerical analysis and to different ways of analyzing data graphically.

In some industries, computers have been employed in real-world interfacing applications for some time. These users have become accustomed to high performance levels in real-world signal processing and digital computing. The price of personal computers has remained low as the performance of the machines has increased to the point where they can now replace minicomputers. Many companies are taking advantage of this opportunity by scaling down the software available for the larger systems and providing the same basic functions on microprocessor-based systems.

In turn, this trend of making large-scale performance available in small-scale, inexpensive systems allows the advantages of computer-controlled systems in applications where the cost formerly was prohibitive. In particular, process-control technology that formerly was available only in large process applications now can be effectively employed in a laboratory where the same functions are required. In addition, when a computer is employed, there are other hardware and software packages available that can be used in areas related to the specific application. Word processing programs are used in report writing, statistical analysis programs are used for off-line data analysis, and database programs are used to classify and compare the large quantity of data generated.

There are other benefits to using personal computers. In cases where specialized instrumentation is required, it is either built to specification on a custom basis or you pay for the exact piece of equipment you require. In either case, when the test for which it was designed is no longer required, the equipment is often not usable for any other purpose. Standard computing hardware provides alternative uses for the equipment on some other project or program. In addition, if one computer in particular can be determined to be both flexible and powerful enough for many applications, it will be easier and faster to get up and running.

Using Computer Features

When a personal computer is applied to a real-world interfacing situation, the standard features of a computer become new functions or replacements for old ways of performing the same function.

The inputs and outputs of the computer require an interface to the real world. Personal computers use standard buses to connect to a wide variety of I/O cards. Changing I/O cards enables the system to be used in a different application and, where space is a factor, expansion boxes are available. The flexibility of this kind of system is increased significantly by the fact that the characteristics of the system can be changed by the I/O cards employed.

The communications capabilities of personal computers are a major advantage in real-world interfacing applications. Besides the standard interfacing to external terminals and printers, a real-world interface box often communicates to the computer over one of the many communications standards available: RS-232C, RS-422A, RS-423A, 20-mA

current loop, or IEEE-488 GPIB (general-purpose interface bus) parallel communications. Distributed systems' architectures are sometimes used with I/O boxes throughout an installation, and all communicate to a personal computer host that does local processing and other necessary functions. Finally, in large installations, the local personal computers communicate to a mainframe host via serial communications, for permanent storage, detailed analysis, and calculations.

Data storage on a computer involves more than programs and data. A floppy disk may hold a number of different configurations for different tests, significantly simplifying the reconfiguring of test conditions. RAM (random-access read/write memory) is important for performing on-line calculations of recent data against predefined limits. Disks and other mass-storage devices also can be used to store long-term data to be used for historical trends or other analysis. Sometimes, particularly in discrete testing applications, storage of parameters for individual test units is maintained for traceability to the test at a later date. Mass-storage devices are also used for temporary storage in applications where raw data is first acquired at high speed, stored on disk, and then retrieved for later calculation and transformation off line, with the results stored as well. In these applications, even the rate of storage on a hard disk can be the limitation on high-speed sampling.

Computer calculations perform functions that previously had to be done with interface hardware (like thermocouple compensation) or by hand (determining short-term averages of signals). Because actual signals in volts are rarely significant alone, some type of conversion to engineering units (degrees of temperature, pounds of pressure, etc.) or simple conversion to percentage values is necessary. Statistical techniques are used to do many things, from simple rolling averages, to eliminating noise, to much more complex analyses of trends, and determining the characteristics of a process. Transformations are made to do frequency analysis like fast Fourier transforms (FFTs) to examine data in the frequency domain or just to invoke digital smoothing techniques. Process-control algorithms can involve large numbers of calculations for each loop controlled, especially when PID (proportional integral derivative) control is employed. These calculations are relatively simple but the speed at which they are performed is often critical.

write data from the processor into a given memory location or read data out of a memory location into a processor register. The memory locations do not have to be true memory devices such as RAM (random-access read/write memory) or ROM (read-only memory), but also can be serial communication devices such as USARTs (universal synchronous/asynchronous receiver/transmitters), numeric data processors, counters, timers, or real-world interface devices.

The memory map of a computer is a tabulation of all the memory locations that a processor can address and the devices that are present at those locations. To communicate with memory-mapped devices the computer needs to know the starting (base) address, the number of locations taken up, the function of each location, the format of data passed back and forth, and the communications timing required for proper operation.

A typical analog-input board designed for bus compatibility might occupy a total of 16 bytes of memory. These memory locations would include a multiplexer channel register used to control which input channel is measured, a command register used to initiate an A/D conversion, a status register that contains the status of the A/D converter, and data registers that contain the value of the analog input in digital format.

Older 8-bit processors could address only 64K bytes of memory, and poking a hole in this memory image for an analog I/O board seriously restricted the use of the space for more important things, like RAM. The IBM PC can address up to 1 megabyte, and therefore it is more willing to give up spaces for devices other than true memory. The sacrifice of memory space is avoided by using an I/O-mapped structure.

Other software commands read or write data to I/O locations (ports). The I/O ports are similar to memory locations, but memory devices typically are not placed in an I/O space. These ports are used for CRT, floppy-disk, or keyboard controllers. Analog I/O devices also can be I/O port-

mapped devices. A typical computer may have 256 I/O ports. The 8088 has 65,535 ports.

Bus-Compatible

Several analog and digital input and output boards and front-end systems are available for the popular computer bus standards. Some of these buses include the IBM PC bus, IEEE-488 GPIB (general-purpose interface bus), Digital Equipment Corporation's LSI-11 bus, STD Bus, and Multibus.

Use of bus-compatible products ensures a mechanical and electrical compatibility and a well-defined communications method, and also may include software packages that facilitate their purchase. The architecture of these buses is determined by the microprocessors supported and the intended use of the bus. The STD Bus, for example, is widely used with Z80 and 8085 microprocessors in small industrial-control applications.

Traditionally, the LSI-11, STD Bus, and Multibus products dominated industrial and laboratory bus-based computers. During the last two years, however, personal-computer-compatible data-acquisition products have grown tremendously. Systems designed around the STD Bus and Multibus are powerful and flexible but require more money and computer expertise than using a personal computer.

Serial Communications

Just about every computer, whether a home computer connected to a television or a large multiuser business system, has at least one RS-232C port. The huge number of I/O devices using this serial communications standard testify to its ease of use and processor independence. Printers, plotters, terminals, mass-storage devices, bar-code readers, and speech synthesizers are available with RS-232C interfaces, as are real-world interface systems. These include laboratory instrumentation data-acquisition front ends, industrial measurement and control subsystems, and specialized equipment such as high-speed vibration-analysis systems.

“Thoughtware, How Good A Manager Am I?”



Thoughtware is new, easy-to-use software that will help you see and understand how to become a better manager. It's a unique series of personal, computer-based management diagnostic and training programs.

® Thoughtware is a registered trademark of the Institute for Management Improvement.

How good a manager are you? Thoughtware Module 1.1 “Assessing Personal Management Skills” will tell you. This program is a three-part, comprehensive self-assessment of your personal attitudes, behavior and understanding as they relate to your effectiveness as a manager.

Unit 1 assesses your leadership style by examining the degree to which you are task- or people-oriented and how you use communication, teamwork, participation, initiative and support to get results. It also assesses your understanding of what motivates employees, promotes teamwork, and the extent to which you provide feedback.

Unit 2 assesses your attitudes about setting goals and objectives, clarifying roles and responsibilities, and delegating. It also assesses the methods you use to improve employee performance and the ways you conduct performance evaluations.

Unit 3 assesses your personal effectiveness by looking at how you manage time and stress, how you conduct meetings and solve problems. The programs conclude with specific recommendations designed to address the weaknesses identified.

To introduce you to Thoughtware, we'll send you “Assessing Personal Management Skills” (which normally sells for \$350), for only \$150. (See adjacent column for details.) Offer expires April 30, 1984.

Thoughtware programs run on the following: IBM® PC, PC XT, PCjr and compatible PC's, Apple® II Plus and IIe.



Thoughtware[®]

Expanding The Universe Of Learning.

Thoughtware Is The Future.

It's a new way to learn, a logical and innovative approach to management training. It will revolutionize management training now, and in the future.

Thoughtware utilizes the latest research in management development from leaders in the field, and has been tested nationally. The benefits of Thoughtware's computer-based Learning Programs are enormous.

Educationally, Thoughtware is self-paced and continuously interactive. Real situations are simulated. The animation and color graphics motivate and hold your interest. Skills are practiced until they're mastered. There's consistent quality of instruction and increased training effectiveness. And even the capability to test yourself.

Economically, Thoughtware reduces training time and cuts the cost of training dramatically. And the more it is used by you and those who work with you, the more cost-effective it becomes. It also eliminates travel, living and instructor costs.

Operationally, training fits the schedule of the student, not the trainer, thus facilitating increased usage. There's minimal job interruption as training can take place on or off site, during or after regular hours.

Other Thoughtware Programs include:

- 1.2 *Evaluating Organizational Effectiveness*
- 2.1 *Leading Effectively*
- 2.2 *Motivating To Achieve Results*
- 2.3 *Defining Goals And Objectives*

Become a better manager by visiting your local computer dealer or call us at our toll-free number, 1-800-THT-WARE, or write:

Thoughtware Inc.
Suite S, 2699 So. Bayshore Dr.
Coconut Grove, Florida 33133.

Serial communications methods afford several advantages over parallel interfacing. A major strong point is the large potential separation between devices. Parallel interfaces operate (if specially designed) up to a maximum distance of 60 feet, compared to several miles with some serial interfaces. This allows a personal computer host to be located in a controlled environment (protected against extremes in temperature, humidity, dust, chemicals, electrical interference, etc.) while an environmentally hardened front end in the industrial area can measure and control a chemical process and communicate all the relevant information back to the host.

Serial interfaces also avoid the intimate relationships of devices that are connected via parallel interface. If the host computer fails, or if you want to do something else besides monitor the process, the front end can operate alone, not depending on the intelligence of the computer.

Real-world interface front ends actually can contain their own computers and be programmed, using any computer or terminal. They are very flexible and easy to use when programmable in a high-level language such as BASIC. These front ends typically don't contain mass storage or display devices, which are better left to the personal computer world. The power of the computer comes into play when storing histories of data from real-world measurements and analyzing, graphing, and printing the data.

Universal Interfaces

In addition to the RS-232C serial-communication standard, there are several other interfaces including the RS-422A, RS-423A, and (informally) 20 mA (milliamperes). Actually, these standards refer only to the electrical levels and types of signals present on the communications link. They do not specify the protocol of the information. The information can be coded using an ASCII (American National Standard Code for Information Interchange), binary, BCD (binary-coded decimal), or hexadecimal format and can be transmitted using a

synchronous (including a clock) or asynchronous manner. When a device claims RS-232C compatibility, an ASCII asynchronous protocol is usually implied.

Standards such as HDLC (high-level data-link control), SDLC (synchronous data-link control), and X.25 are synchronous protocols that define not only the electrical interfacing (physical layer) but also the format of data, addresses, control, and error-checking codes that are transmitted.

Distributed Systems

A personal computer used as a host controller with several data-acquisition systems distributed from its serial-communication link (multi-dropped) is a widely used configuration. Each node has stand-alone capability and is located close to the real-world signals, minimizing signal loss, interference, and wiring costs. The host computer collects average and summary information from each node and downloads new set points, alarm limits, or programs to each node.

Large distributed-control systems that include application software ready to run the plant (turnkey systems) can cost several million dollars, include several operator consoles, and measure thousands of points. Today, many control-system engineers use personal computers with distributed data-acquisition front ends and write their own programs to approximate the performance of large turnkey systems on smaller applications. This trend is a result of the cost-effectiveness, power, and programming ease of today's personal computers.

Modem capability is another advantage of using serial communication schemes. Radio and telephone modems allow distribution of real-world interface front ends hundreds or thousands of miles away from the host computer. This approach is used in applications such as natural-gas pipeline monitoring, electric utility substation data acquisition, and data collection from oil fields.

One disadvantage of serial communication is its limited throughput of data. Many applications simply can-

not be measured or controlled unless a high-speed parallel interface is used, although this limitation is being overcome by putting more intelligence in the front end, thereby reducing the amount of data that must be transmitted.

Design Considerations

The cost of implementing an application solution based on a real-world interface board or system with a personal computer includes the cost of the device itself, its hardware and software packages, the cost of configuring, wiring, or connecting the devices, and the cost of making them perform through user-written software.

The time and effort of this process is inversely proportional to the completeness of the purchased solution. A turnkey system is designed, programmed, tested, installed, and operational before a user ever touches it. You also pay much more for this system. At the other extreme, a minimum solution requires that you make a large commitment to

hardware and software design. The attractiveness of this approach depends on the experience and time the user has and also on the level of support the vendor can supply.

Software

The class of analog I/O products designed to interface through a computer's parallel bus appears to the system software as a block of memory locations or I/O ports. Application software that can be included with these products can sample analog inputs, graph the information on the monitor, store historical data to disk, and do various data manipulations. This software is useful during the initial setup of the system, but may not be adequate for the actual application. Here's the catch: how do you find the memory locations the board is mapped into and how do you format the data, control the board, and control the timing? Unfortunately, typical users of these products are not assembly-language programmers, they're laboratory personnel who have many different specific

tests to run. Fortunately, the vendors of these analog I/O-board products generally recognize this and provide software "hooks" to access the board. Consisting of subroutines that can be called from high-level languages, they do not restrict you to just one language: they often can be used with BASIC, Pascal, and FORTRAN. Sophisticated users can bypass the formality of these subroutines and use just PEEKs and POKEs or write their own assembly-language routines.

Real-world interface systems that communicate over a serial link (front end) range from those that are completely programmable in a high-level language to those that understand only a few cryptic command codes. The software packages may include communications routines to be used in the application program or for developing programs on the front end. The most flexible products allow programs to be developed and downloaded from the other tasks while the stand-alone front end is measuring inputs, controlling outputs, etc.

THE SENSIBLE SPELLER™ IV CORRECTS SPELLING MISTAKES IMMEDIATELY.

The most popular new word-processing product introduced for the Apple computer in 1982 was not a word processor—it was the SENSIBLE SPELLER IV proofreading program.* A perfect complement to your current Apple word-processing program, the SENSIBLE SPELLER IV is fast, friendly, and gives you the features you need in a spelling checker.

First in features**

It only takes a minute or two for the SENSIBLE SPELLER to scan through a ten-page document and compare each word against its 80,000-word dictionary. Each misspelled word is shown to you in the middle of a small excerpt from your document, so you won't waste time trying to remember how you used the word.

You can immediately correct the misspelled word by replacing it with the proper spelling. The SENSIBLE SPELLER even suggests the correct spelling for your misspelled words!

First in dictionaries

The SENSIBLE SPELLER includes the largest, most authoritative dictionary available for the Apple computer. Over 80,000 words are supplied, direct from the official Random House Dictionary. And there is unlimited room to add your own special words. The official Black's Law Dictionary is available separately.

First in word-processor compatibility

The SENSIBLE SPELLER works with more Apple word processors than any other spelling program, including: DOS 3.2, DOS 3.3 (Apple Writer—all versions, Bank Street Writer, Magic Window, Screen Writer, etc.), SuperText, Word Handler, CP/M (Wordstar, etc.), and PFS: WRITE word processors.

The SENSIBLE SPELLER is available for \$125 and runs on all Apple IIe, II+, and Apple-compatible computers with one or two disk drives.



**Sensible®
Software, Inc.**

24011 Seneca
Oak Park, MI 48237
(313) 399-8877

Please add \$1.25 for shipping.
Visa/Mastercard/Check/COD welcome!

*April 1983, Softalk magazine reader survey.
**Not all features are available with CP/M, PFS: WRITE and Word Handler.

PFS: WRITE is a trademark of Software Publishing Inc. Apple, and Apple Writer are trademarks of Apple Computer, Inc.; Bank Street Writer — Brodebund; Black's Law Dictionary — West Publishing; CP/M — Digital Research Corp.; Screen Writer — Sierra On-Line, Inc.; SuperText — Muse Software; Word Handler — Silicon Valley Systems; WordStar — Micropro International

Now works with
PFS: WRITE

GREAT PRICES! GREAT SERVICE!

Looking for a great deal on business software?

800-SOFTWARE is hard to beat. You see, we became one of America's largest software marketers by offering great prices—and a lot more.

Here are some of the reasons to pick up the phone and pick up a bargain:

LOW DISCOUNT PRICES.

Our prices are fabulous! Generally 40-50% off suggested list price. How do we do it? By buying and selling in enormous volume. (All our programs are the very latest versions. And when "updates" appear, we'll get them for you, fast!)

FAST DELIVERY.

The key to our quick delivery is our giant inventory. We have what you want. Now. And we'll rush it to you like our business depends on it. (Because it does.)

FREE TECHNICAL SUPPORT.

That's right. We offer full technical support at no charge whatsoever.

That means if you have questions about any software you buy from us, just call us and we will answer them for free. Our technical support staff is made up of full-time experts who are helpful and patient. Their only job is helping you get the most out of your software.

- Quantity discounts available through our National Accounts Program.
- Purchase orders accepted. Please call in advance.
- Prompt U.P.S. or Federal Express shipping.
- Overnight delivery available.

CHECK OUT ALL OUR INCREDIBLE BUSINESS SOFTWARE PRICES:

| | |
|--------------------------------------|------------------|
| WordStar® | \$269 |
| WordStar® Pro. Pack. | \$389 |
| SuperCalc® 2 | \$169 |
| SuperCalc® 3 | \$279 |
| Lotus 1-2-3™ | CALL |
| dBase II™ | \$399 |
| Quickcode™ | \$199 |
| Crosstalk™ | \$119 |
| EasyWriter II System™ | \$229 |
| I.U.S. Accounting™ | \$299/mod |
| Norton Utilities™ | \$59 |
| Perfect Link™ | \$119 |
| Multiplan™ | \$149 |
| 4-Point Graphics™ | \$129 |
| Hayes SmartModems™ | CALL |
| Memorex™ or Maxell™ Diskettes | CALL |

WE ALSO CARRY SOFTWARE FROM:

Ashton-Tate, Aspen, ATI, CDEX, Digital Research, Fox and Geller, IMSI, I.U.S., Life-tree, MicroPro, Microsoft, Peachtree, Perfect, Software Publishers, Sorcim, Visi-Corp and much, much more!



CUSTOMERS TELL OUR STORY BEST.

"I very much appreciate your helpfulness and speed in filling my order. Rarely today do I have the opportunity to deal with a firm which shows such a high

degree of professional ability."
Joe Neil, Lihue, HA

"Thank you very much for the very prompt service you gave me. I would be delighted to do business with you anytime in the future that you have something I need."

William Drescher,
Lansing, MI

RELIABILITY AND REPUTATION.

When you buy from us, you're in good company. You see, some of our best customers are America's biggest corporations. Like IBM, Chevron, Hewlett-Packard, G.E., Price Waterhouse and Honeywell.

They order from us because they know we're not running our business from a phone booth (we have a million dollar inventory!). And because we offer extra discounts on quantity orders and other special services for our National Accounts customers.

Also, we fully guarantee every product we sell against defects. That's how we earned our membership in the respected Direct Mail Marketing Association.



800 SOFTWARE IS READY TO SERVE YOU.
TO ORDER CALL TOLL-FREE 800-227-4587 or 415-644-3611

800-SOFTWARE

940 Dwight Way, Berkeley, CA 94710



- Call for shipping charges, other low software prices or for a free catalog.
 - Prices may change.
 - International dealers and orders welcome: TELEX #751743 800-SOFTWARE UD.
- CA residents add sales tax.

© Copyright 800-SOFTWARE 1983

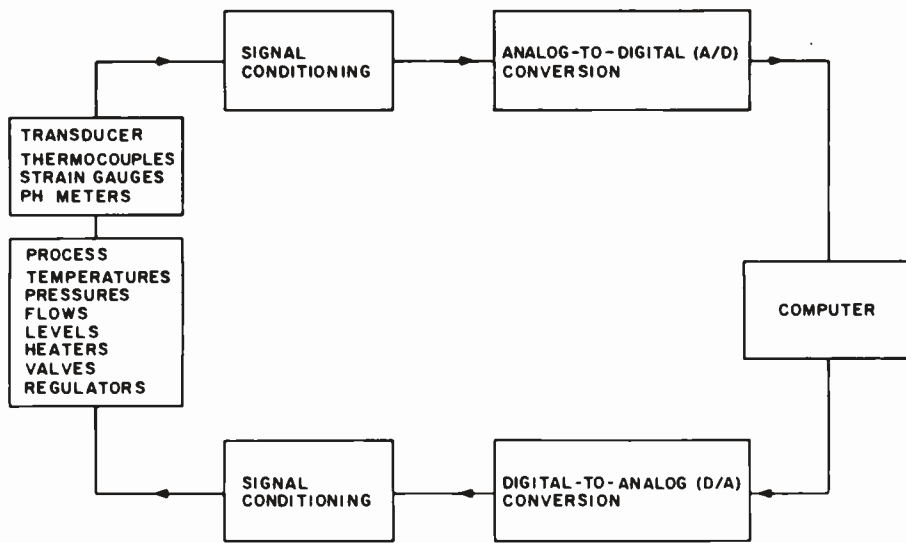

Figure 1: A example of a measurement and control loop.

Potential users of any type of real-world interface device should learn exactly how the application software is developed, what languages are used, what application-related software is included, and whether the front-end unit can stand alone or needs the host computer to supervise its activities.

Potential users also should question what types of real-world signals can be measured and how they are connected to the device. Systems that look great in ads and perform flawlessly in the demonstration often turn out to be a nightmare to implement. This happens because there are two different components connected: your computer and someone else's I/O board or front end. No one can predict all the computer's variables, such as memory size, operating-system revision, other manufacturers' boards used, type of monitor connected, or whether it is really compatible to that well-known brand of PC.

Interfacing with Analog Signals

Internally, a computer understands binary digital information. It is the job of the real-world interface instruments and systems to change real-world physical phenomena into this digital format.

As figure 1 shows, various physical phenomena such as temperature, humidity, pressure, level, and displacement can be converted to analog

voltages by transducers and appropriate signal conditioning. The function of signal conditioning is to translate the transducer output into a suitable standard form for the A/D converter, while filtering the signal and protecting the converter from high common-mode voltages and voltage transients. Similar functions are performed when a computer wants to output signals that control real-world phenomena.

The sensors and transducers actually are connected to the real world, converting physical phenomena into representations that can be changed into an analog voltage. Sensors may output a voltage directly or may produce or vary resistance, capacitance, or inductance.

Temperature

Mercury thermometers and bimetallic strips convert temperature into a visual form that humans can measure directly, but they are not suitable for conversion of temperature into voltage. Instead, thermocouples, thermistors, RTDs (resistance temperature detectors), and other devices are used.

Thermocouples are based on the physical principle that whenever two dissimilar metals come in contact, a voltage roughly proportional to temperature is formed across the junction. Various combinations of metals are used, depending on the overall temperature range to be measured.

An iron-constantan thermocouple, ANSI (American National Standards Institute) type J, has a 0-to-58-mV (millivolt) output for a temperature range of 0 to 1000 degrees Celsius. You may note that, to measure this output, electrical connections must be made to the thermocouple, forming two additional dissimilar-metal junctions. The errors that result are minimized by a circuit in the signal conditioner called cold-junction compensation. The output of a thermocouple is a highly nonlinear function of temperature. Software routines are often used to linearize this relationship and may use a fifth-order polynomial to do so.

Thermistors are semiconductor devices with a large, negative temperature coefficient of resistivity. The resistance is measured and converted back to temperature. Temperature also is measured by other semiconductor devices such as the AD590. This device is a current regulator that passes 1 μ A (microampere) per degree Kelvin. At room temperature (27 degrees Celsius), 300 μ A flows through it. In this case, the signal conditioning provides excitation and converts the low-level current into a voltage representation. RTDs are made of conductors, such as platinum and nickel-iron, whose resistances change with temperature. Signal conditioning provides a regulated current excitation, and the voltage that results is measured. The relationship between resistance and temperature is slightly nonlinear and must be corrected by a hardware- or software-linearization scheme.

Other Phenomena

Strain gauges are used to measure pressure, force, acceleration, displacement, and weight. They are small, thin resistors that are placed in direct contact with the object to be measured. As the object moves, the strain gauge also moves, stretching, compressing, or otherwise distorting the resistor and changing its value. Wheatstone bridges are typically used for excitation and conversion of the output to voltage. Pressure transducers and load cells are complete mechanical packages that contain the

SemiDisk™ and SemiSpool:™ SURE-FIRE WAIT-REDUCTION!



512Kbyte SemiDisk™ I \$1095

Time was, you thought you couldn't afford a SemiDisk. Now, you can't afford to be without one.

| | 256K | 512K | 1Mbyte |
|---------------------|-------|--------|--------|
| SemiDisk I, S-100 | \$895 | \$1095 | \$1795 |
| IBM PC | | \$1095 | \$1795 |
| TRS-80 Model II | | \$1095 | \$1795 |
| SemiDisk II, S-100 | | \$1395 | \$2095 |
| Battery Backup Unit | \$150 | | |

Time was, you had to wait for your disk drives. The SemiDisk changed all that, giving you large, extremely fast disk emulators specifically designed for your computer. Much faster than floppies or hard disks, SemiDisk squeezes the last drop of performance out of your computer.

Time was, disk emulators were afraid of the dark. When your computer was turned off, or a power outage occurred, all your valuable data was lost. But the SemiDisk changed all that. Now, the optional Battery Backup Unit helps take the worry out of power interruptions. It keeps the SemiDisk powered for up to 5 hours during a power failure.

Time was, you had to wait until your printer finished printing to use your computer. That's changed, too. Now, the SemiSpool print buffer in our Version 5.0 software, running under CP/M 2.2, frees your computer for other tasks while your data is printing. With a capacity up to the size of the SemiDisk itself, you could implement an 8 Mbyte spooler!

But one thing hasn't changed. That's our continuing commitment to supply the fastest, highest density, easiest to use, most compatible, and most cost-effective disk emulators in the world.

SemiDisk.
It's the disk the others are trying to copy.

SemiDisk Systems, Inc.

P.O. Box GG Beaverton, OR 97075 (503) 642-3100

Call 503-646-5510 for CBBS® NW, a SemiDisk-equipped computer bulletin board, 300/1200 BAUD
SemiDisk trademark of SemiDisk Systems, Inc. Copyright © 1983 SemiDisk Systems, Inc. CP/M Trademark Digital Research.



NO WAITING

HEROISM IN THE MODERN AGE

THE ROLE-PLAYING GAME OF TODAY

© Copyright 1983 Pacific Infotech Corp.



A sophisticated simulation of modern life and human psychology.

Includes: BASIC MODULE — create and guide characters through their lives... PROJECT CONTACT (Scenario #1) — save the U.S.A. from a mad scientist and terrorist plot... you have only 60 hours to complete your mission...

HEROISM IN THE MODERN AGE is expandable to other modules and exciting scenarios.

At your computer store.

\$58.95



10850 Wilshire Blvd.,
Suite 800
Los Angeles, CA 90024
U.S.A.

Pacific Infotech Corp. (213) 470-7590

SYSTEM REQUIREMENTS:

IBM PC* with one double-sided or two single-sided disk drives, an 80-column monitor, and 64K RAM (96K for DOS 2.0). Color graphics/adaptor optional.

*IBM PC is a trademark of International Business Machines Corp.

announcing

THE INSIDER!

A 10 Mega-byte Internal Hard Disk Drive System...

Only **\$995!**

Now Available!
TEAC Half High
Floppy Drives
Only \$265



Expand your IBM® PC so that it performs like the PC XT for a fraction of the cost.

Micro Design International announces a major breakthrough in peripheral technology — The Insider! It is the only hard disk drive system to offer you 10 Mega bytes of formatted capacity with complete internal installation, all for \$995. Now you can expand your IBM® PC to handle heavyweight data with the same ease and efficiency as the PC XT. By equipping your PC with The Insider you can save up to \$2,000 over the cost of a PC XT. The Insider is also compatible with most IBM PC look alike, and is DOS 2.0 compatible.

The Insider's engineering is far superior to any other hard disk drive system on the market. Unlike other internal drives which require an external power supply, The Insider uses available power on the PC, thereby eliminating overheating, a problem which has plagued other drives. Our drive and controllers carry a full one year parts warranty.

The Insider includes complete software with all needed utilities, cables, simple instructions for easy installation and is available in any of the following configurations: 1) With a Multitasking Card (\$995) 2) With a Floppy Disk Controller Card (\$1,295) 3) With a RAM Memory Card that holds up to 670K RAM (\$1,295). The following modules are available: 1) Parallel Port (\$59) 2) Serial Port (\$95) 3) Clock Calendar (\$65) and 4) XT ROM (\$95).

To expand your PC to the performance of a PC XT, CALL TODAY. Master Card and VISA accepted.

TO ORDER CALL COLLECT
800-788-3475

Micro Design International, Inc.
Suite 375 1100 Sylvia Ave.
Maitland, Florida 32751

bridge and are ready to screw into a tank to measure pressure or mount on a conveyor hook to measure weight.

Devices used for controlling real-world phenomena include heaters, valves, pressure regulators, and actuators. This instrumentation typically accepts a standard 4-to-20-mA process current from the controlling system.

Signal Conditioning

The term "signal conditioning" broadly refers to all the functions required to interface with real-world instrumentation and provide the proper voltage levels for the A/D converters, while processing the signals to maintain accuracy and protecting the equipment and operators from the dangers lurking in the real world. These functions include: amplification or attenuation, input and output protection, transducer excitation, filtering, isolation, cold-junction compensation (thermocouples), and voltage-to-current conversion.

Devices on the market known as signal conditioners may contain some or all of these functions and provide the interface from real-world instrumentation to A/D and D/A (digital-to-analog) converters. These converters operate with standard high-level analog voltage ranges such as -10 V (volts) to +10 V, or 0 V to +5 V. It is necessary to amplify low-level analog signals such as thermocouple outputs to high-level voltages. High-grade instrumentation amplifiers are used for this because of their temperature stability, accuracy, and high common-mode rejection. D/A outputs frequently are converted to 4-to-20-mA signals for transmission over long distances (many miles) without signal loss and for process-control instrumentation compatibility.

Protection

Many industrial applications absolutely require protection on all I/O connections against accidental connection to AC (alternating current) mains. This can happen when an operator makes a wiring error, when cables or terminal strips are mis-



Encounter REVELATION

For \$950, Revelation Software by Cosmos will give your PC capabilities that no microcomputer has ever had before. Through a versatile, high performance Relational Data Base Management System developed by Cosmos, Revelation will give your microcomputer all the power and sophistication of a minicomputer.

Revelation features a data base with variable-length fields and records, (up to 64K), and unlimited files and accounts. File size is

limited only by disk size.

Also featured: A powerful, hybrid programming language.

A fourth generation applications and program generator
Our programs write programs!

Communications functions that give your PC the power to utilize applications, programs, and data from thousands of existing mainframe and minicomputers.

8087 math chip support

Revelation co-exists with MS/DOS™ or PC/DOS™ 1.0, 1.1,

2.0 versions, and is compatible with the IBM PC™, XT™, COMPAQ™, Corona™, Columbia Multi-Personal® and the Eagle 1600™. It's also compatible with minicomputers utilizing the PICK Operating System™. Minimum configuration requires 320K memory and 8087 math chip.

MS/DOS™ of Microsoft Corp. IBM PC Registered TM of International Business Machines Corp. COMPAQ™ of COMPAQ Computer Corp. PICK Operating System™ of

PICK SYSTEMS, Eagle 1600™ of Eagle Computers, Corona PC™ of Corona Data Systems, Columbia Multi-Personal™ of Columbia Data Products Inc.

P. O. Box AH, Morton, WA 98356

COSMOS

Telephone 1-800-422-2511
Inside Washington 206-496-5974.

Circle 104 on inquiry card.

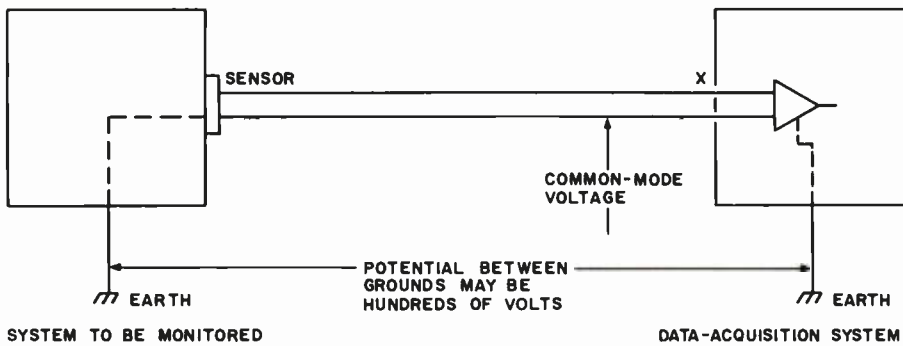

Figure 2: Very high common-mode voltages can appear on signal lines if isolation techniques are not employed.

Isolation

Isolation provides an input-to-output path for the signal to travel without a direct galvanic connection. This may sound magical, but it is needed when dangerous ground loops or large common-mode voltages are present (see figure 2). While the sensor output is low-level (perhaps mV), the common-mode voltage may be hundreds of volts.

Consider a battery-charging application. Hundreds of low-voltage batteries are placed in series and a large-voltage (possibly 500 V) battery is placed across the series string. Each battery has a differential voltage of 2 or 3 volts, but the common-mode voltage is 500 V on the last one in the series. If this last battery were connected to an analog-input system without isolation, a small fire could result. This is an extreme example, but many applications have 120 V AC floating around on all the signal lines (measured with respect to the computer's ground.)

Isolation is performed in basically three ways: magnetic linear modules (transformer), optical, and flying capacitor (see table 1). Magnetic isolation is accomplished by modulating a low-level AC signal by the incoming analog voltage, passing it through a transformer, and demodulating it on the output. Input-to-output isolation of several thousand volts is common using this technique.

Optical isolation depends on passing the signal information from an LED (light-emitting diode) to a light-sensitive transistor (opto-isolator). Isolation of several thousand volts is also available using this technique.

Flying-capacitor isolation is a technique in which a capacitor is alternately switched between the input, charging it up to the input voltage, and the output, which is measuring the charge. Traditionally, relays have been used to do the switching, and because this is a mechanical technique, the lifetime of these devices is not very long. Flying-capacitor isolation is a low-cost technique but is becoming outdated.

The cost for good-quality signal conditioning is small compared to the insurance it provides against elec-

| Characteristic | Magnetic Linear Modules | Optical | Flying Capacitor |
|--------------------------------|-------------------------|-------------------------|------------------------------------|
| Common-mode resistance ratings | Excellent | Excellent | Excellent (layout critical) |
| Common-mode voltage ratings | Excellent | Excellent | Fair |
| Bandwidth | Good | Good | Poor |
| Application difficulty | Easiest to apply | Requires isolated power | Extremely poor |
| Power-supply requirements | Usually single supply | Usually bipolar | Coil drive required |
| Multichannel applications | Yes | Yes | Yes |
| Isolated front-end power | Developed internally | Must be provided | Not required |
| Long-term stability | Excellent | Fair | High maintenance (relay failure) |
| Stability over temperature | Good | Good | Excellent (with expensive relays) |
| Leakage current | Excellent | Excellent | Good (at low common-mode voltages) |
| Input protection | Provided | Provided | Yes (with difficulty) |

Table 1: A comparison of isolation techniques.

labeled, or during an electrical malfunction. If a motor winding short-circuits to the housing, all connected instrumentation could be carrying large voltages to the analog interface system. If the system is not protected, it and possibly the computer can go up in smoke. Protection up to 240 V AC is common in today's industrial-grade signal-conditioning components and systems.

Excitation

As mentioned earlier, many transducers do not produce a voltage output directly; they require some sort of voltage or current excitation. RTDs can be supplied with a current (0.2 mA, typically) or can be placed in a Wheatstone bridge that is excited by a voltage (10 V, typically). Resistance

devices whose changes in resistance are measured rather than their absolute values, also are measured in bridges.

Filtering

Signal lines from transducers often contain extraneous signals that are not representative of the physical phenomena being measured. This is termed loosely as noise. Most noise associated with analog signals is of the 60-Hz (hertz) variety, which abounds in industrial environments. Noise can be reduced by analog filtering of the signal lines or by digital filtering accomplished in the computer's program. Integrating-type A/D schemes also reduce noise by averaging the signal over a period of time.

GenTech

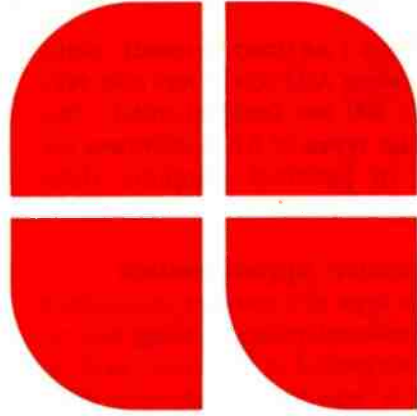

THIS MONTH'S SPECIALS

| | |
|---------------------------------------|-------------|
| LOTUS 1-2-3 | \$349 |
| MICROSOFT Multiplan (Apple II) | \$169 |
| C-I/OH Prowriter 1 8510AP | \$369 |
| C-I/OH Prowriter 2 1550P | \$659 |
| NEC Spinwriter 2030 (Centronics) | \$869 |
| U.S. ROBOTICS Password | |
| Modem (1200 Baud) | \$359 |
| TAXAN KG-12N (12" Green Monitor) | \$125 |
| BASIS 108 (128K, 2 Drives, CP/M 3.0) | \$1695 |
| TANDON Drive (IBM Compatible, 320K) | \$239 |
| FOURTH DIMENSION Super Drive (Apple) | \$219 |
| TALLGRASS TECHNOLOGIES | |
| 12 MB Hard Disk | \$2249 |
| 20 MB Hard Disk | \$Call |
| RANA ELITE I (Apple Compatible, 163K) | \$245 |
| RANA 1000 (For ATARI) | \$319 |
| HERCULES Graphics Board For IBM-PC | \$369 |
| MICROLOG Baby Blue (CP/M For IBM) | \$489 |
| MA SYSTEMS PC Peacock | \$Call |
| ORCHID PC Network Kit | \$Call |
| Color Graphics Board | \$Call |
| PLANTRONICS ColorPlus | \$429 |
| TECMAR | |
| 1st Mate Board For IBM (No RAM) | \$239 |
| 2nd Mate Board (2 Serial/2 Parallel) | \$229 |
| Graphics Master | \$549 |
| ORANGE MICRO | |
| Buffered Grappler+ 16K/64K | \$179/\$239 |
| Grappler CD (Commodore) | \$Call |

CUSTOMER SERVICE & TECH. SUPPORT

401-273-2420

ORDERS ONLY

800-843-4302

150 Broadway, Suite 2212, N.Y. NY 10038

Money Order, Cashier's Ck, Personal Ck (3 Weeks To Clear).
 Add 3% MC/VISA, 5% AMEX Charge. Add 2% On COD Orders.
 APD Orders Add 6%. Add 3% For Net Terms.
 All Returned Non-Defective Merchandise Are Subject To 20%
 Restocking Charge.
 GenTech Reserves the Right to Change Advertised Prices.



COMPUTERS

| | |
|---|--------|
| ALTOS All Models | \$Call |
| COLUMBIA | |
| Fully IBM Compatible, 128K, Parallel/ Serial Ports, Color Board, Super Pak (Over \$2000 Software) | |
| w/ 2 DSDD Drives | \$Call |
| w/ 10 MB Hard Disk & 1 DSDD Drive | \$Call |
| Portable VP w/ Super Pak | \$Call |



| | |
|--------------------------|--------|
| COMPUPRO All Models | \$Call |
| CORONA | |
| Desktop & Portable PC's. | \$Call |
| EAGLE | |
| PC-2 / PC-XL / Spirit-XL | \$Call |
| IIE Series All Models | \$Call |

| | |
|--|--------|
| FRANKLIN | |
| ACE 1000 w/ Color | \$799 |
| ACE PRO PLUS System (ACE 1000 w/color, ACE 10 Drive, 80-Column Card, 12" Monitor, ACE Writer II, ACE Calc, Data Perfect, Personal Financer) | \$Call |
| ACE 1000 PLUS FAMILY PAK | \$Call |
| ACE 1200 (6502/Z80B, 128K, ACE 10 Drive, 80 Column Card, CBASIC, CP/M 2.2) | \$1399 |
| ACE Office Management System (ACE 1200 w/ 2 ACE 10 Drives, Parallel/ Serial Card, WordStar, MailMerge, ACE Calc) | \$Call |

| | |
|-----------------------|--------|
| INTERTEC | |
| Head Start, CompuStar | \$Call |

| | |
|---|--------|
| MORROW DESIGNS | |
| MD2 (64K, 2 SSDD Drives, WordStar, Correct-It, LogiCalc, Personal Pearl, MBASIC, BaZic) | \$Call |
| MD3 (Same as Above except w/ 2 DSDD Drives & QUEST Accting Software) | \$Call |
| MD11 (128K, 1 1/2 MB Hard Disk & 1 OSDD Drive, Same Software as MD3) | \$Call |
| MD11 w/ MDT-60 Terminal | \$2549 |
| Multi-User DECISION Series | \$Call |
| NEC PC-8201A (w/ 16K RAM) | \$Call |

| | |
|--|--------|
| SANYO | |
| MBC 550 (IBM-Compatible, 8088, 128K, 1 SSDD Drive, WordStar, CalcStar, EasyWriter) | \$799 |
| MBC 555 (550 Plus 1 Add. Drive, MailMerge, SpellStar, InfoStar) | \$Call |
| SWP Micro Computer Products For Kaypro | |
| Co-Power-88 Board For Kaypro II & IV (8088 w/ 128K DR 256K, MS-DOS & CP/M 86) | \$Call |

FOR IBM PC

| | |
|---|-------|
| AST RESEARCH INC. | |
| MEGA PLUS II (64K, Serial & Clock/Cal) | \$295 |
| MEGAPAK 256K Module | \$299 |
| SIX PACK PLUS (64K, Serial/Par, Clock) | \$295 |
| COMBO PLUS (64K, Serial/Par, Clock) | \$295 |
| I/O PLUS II (Serial Port, Clock/Cal) | \$129 |

| | |
|--|------|
| ** OPTIONS ** | |
| Each 64K Increment For Expandable AST Boards Are \$65. (Price Includes Installation) | |
| Serial | \$45 |
| Parallel | \$45 |
| Game | \$45 |

| | |
|--|-------|
| QUADRAM | |
| QUADBOARD (Serial/Parallel, Clock/Cal) | |
| 64K | \$279 |
| 256K | \$419 |
| QUAD 512+ (Serial Port, Upgradable to 512K) | |
| 64K | \$239 |
| 128K | \$299 |
| 256K | \$399 |
| 512K | \$619 |
| QUADCOLOR I (Video Board) | \$239 |
| QUADLINK (6502 w/ 64K) | \$489 |

| | |
|---|-------|
| MICROFAZER | |
| Parallel/Parallel | |
| 8K | \$125 |
| 16K | \$139 |
| 64K | \$199 |
| 128K | \$289 |
| 256K | \$589 |
| 512K | \$899 |
| Serial/Serial, Serial/Parl, Parl/Serial | |
| 8K | \$145 |
| 16K | \$159 |
| 64K | \$219 |
| ** SPECIAL PRICES ON HERCULES ** | |
| ** TECMAR, MICROLOG (BABY BLUE) ** | |
| ** & PLANTRONICS PRODUCTS ** | |

FOR APPLE II/Ile, Franklin Ace

| | |
|---|-----------------|
| ALS CP/M Card | \$299 |
| Smarterm II (80 Column Card) | \$145 |
| Printer Mate (Printer Card) | \$59 |
| EPD Surge Protectors | \$Call |
| FOURTH DIMENSION 16K RAM Card | \$49 |
| 80 Column Card w/ 64K (Ile Only) | \$189 |
| INTERACT, STRU, PKASO Universal Shuffle Buffer | \$125 \$Call |
| KOALA TECH Koala Pad | \$95 |
| MICROTEK Dumping-16 | \$159 |
| ORANGE MICRO Grappler+ | \$119 |
| PROMETHEUS Graphitti | \$89 |

HARD DISK



| | |
|---|--------|
| COMREX ComFiler (FOR QX-10, 10MB) | \$1995 |
| CORVUS | |
| 6 MB | \$1695 |
| 10 MB | \$1645 |
| 11 MB | \$2350 |
| 15 MB | \$2095 |
| 20 MB | \$3150 |
| 21 MB | \$2495 |
| PEGASUS (GREAT LAKES) | |
| 10 MB Internal For IBM | \$1075 |
| 23 MB External (w/ Controller) | \$1845 |

CALL FOR PRICES ON CAMEO, DSS,
 FOURTH DIMENSION, FRANKLIN, CORONA,
 QCS, QUADRAM, SANTA CLARA,
 TALLGRASS & XCOMP

DOT MATRIX PRINTERS



| | |
|--------------|--------|
| EPSON | |
| RX-80 | \$269 |
| FX-80 | \$515 |
| FX-100 | \$709 |
| NX-100 | \$519 |
| LQ-1500 | \$Call |

| | |
|-------------------------|--------|
| MANNESMANN TALLY | |
| MT 160L | \$599 |
| MT 180L | \$839 |
| Spirit-80 | \$329 |
| 1602 | \$Call |

| | |
|----------------|--------|
| OKIDATA | |
| ML 92 | \$429 |
| ML 93 | \$729 |
| ML 84(P) | \$979 |
| ML 84(S) | \$1079 |

| | |
|------------------------------------|--------|
| STAR MICRONICS | |
| Delta 10 | \$529 |
| Radex 10 | \$659 |
| DATASOUTH All Models | \$Call |
| PANASONIC KX-P1090 | \$319 |
| TOSHIBA P1350 | \$1579 |
| TRANSTAR T315 Color Printer | \$469 |

LETTER QUALITY PRINTERS

| | |
|------------------------------------|--------|
| COMREX | |
| ComRiter II (12 CPS, 5K Buffer, P) | \$Call |
| ComRiter III | \$Call |

| | |
|-------------------------------|-------|
| DAISYWRITER | |
| 2000 EXP (25 CPS, 48K Buffer) | \$999 |

| | |
|---|--------|
| DIABLO 630 ECS/IBM | \$Call |
| JUKI 6100 (17 CPS, Diablo Compat.) | \$Call |
| NEC All Spinwriter Models | \$Call |

| | |
|-------------------------|--------|
| QUME Sprint 1140 | \$1345 |
| Sprint 1155 | \$Call |

| | |
|--------------------|--------|
| SILVER-REED | |
| EXP 550(P) | \$629 |
| EXP 500(P) | \$429 |
| EXP 770(P) | \$Call |
| EXP 500(S) | \$459 |

| | |
|---------------------------------------|--------|
| TRANSTAR T120, T130 & T140 | \$Call |
|---------------------------------------|--------|

PLOTTERS

| | |
|---------------------------------|--------|
| AMDEK DXY-100, Amplot II | \$Call |
| ENTER COMPUTERS Sweet-P | \$Call |
| HOUSTON INSTRUMENTS | |
| DMP 40 | \$839 |
| DMP 29 (8 COLOR 11x17 PAPER) | \$1945 |
| DMP 41 (SINGLE PEN 22x17 INCH) | \$2495 |
| MANNESMANN TALLY Pixy-3 | \$645 |
| ROLAND, STROBE | \$Call |

MONITORS



| | |
|--|---------------|
| AMDEK | |
| Video 300/300A/310A | \$139/149/169 |
| Color I+ | \$Call |
| Color II+ | \$449 |
| COMREX Color, Green, Amber | \$Call |
| GENTECH 9"/12" Green | \$99/\$109 |
| PRINCETON GRAPHICS HX-12 | \$489 |
| RGB Interface For Apple Ile | \$159 |
| SR-12, MAX-12 (New) | \$Call |
| QUADRAM Quadscreen (17", 96x512) | \$1595 |
| TAXAN | |
| KG12N (12" Green) | \$125 |
| RGBvision 210 (380 x 262) | \$299 |
| RGBvision 420 (640 x 262) | \$499 |

TERMINALS



| | |
|-------------------------------------|-------------|
| LIBERTY Freedom 100/200 | \$Call |
| QUME 102/102A | \$559/\$579 |
| 103/108 | \$879/\$729 |
| TELEVIDEO All Models | \$Call |
| Personal Terminal (All Models) | \$Call |
| VISUAL All Models | \$Call |
| WYSE All Models (Inc. Color) | \$Call |

MODEMS

| | |
|-------------------------------|--------|
| ANCHOR | |
| Mark VI (IBM) | \$189 |
| Mark VII | \$279 |
| HAYES | |
| Micromodem IIe (w/SmartCom I) | \$249 |
| Smartmodem 300 | \$Call |
| Smartmodem 1200 | \$Call |
| Smartmodem 1200B (IBM) | \$439 |

| | |
|------------------------------------|--------|
| NOVATION | |
| Access 1-2-3 | \$Call |
| Cat (Acoustic Coupler) | \$139 |
| J-Cat (Auto Orig/Answer, 300 Baud) | \$109 |
| Apple Cat II (300 Baud) | \$259 |
| 212 Apple Cat II (1200 Baud) | \$575 |
| 103 Smart Cat (300 Baud) | \$175 |
| 103/212 Smart Cat (1200 Baud) | \$409 |

| | |
|---------------------------------|-------|
| TRANSEND (Formerly SSM) | |
| Modemcard w/ Source (For Apple) | \$239 |
| PC Modem Card 300 (For IBM) | \$289 |
| PC Modem Card 1200 (For IBM) | \$429 |

| | |
|--|-------|
| U.S. ROBOTICS Password (1200 Baud) | \$359 |
| VEN-TEL MD212-3E (1200 Baud) | \$399 |

SOFTWARE

| | |
|---------------------------------------|--------|
| LIFETREE Volkswriter Deluxe | \$Call |
| MBSI, STAR Accounting Software | \$Call |
| MICROPRO WordStar (IBM, CP/M) | \$319 |
| WordStar Pro-Pack | \$439 |
| WordStar w/ AppliCAD (For Apple) | \$349 |
| MICROSOFT Word | \$Call |
| PS WordPlus-PC w/ BOSS | \$349 |
| SOFTWARE SYSTEMS Multimate | \$319 |

trical damage and erroneous data, and because of the operator protection it offers. Signal conditioning may be contained within a data-acquisition system or may be performed by a separate subsystem. Two-wire transmitters are single-channel signal conditioners that are mounted at the sensor and produce a 4-to-20-mA output for long-distance transmission to a central control room.

A/D Conversion

The interface between the analog

and digital worlds happens inside an A/D converter. It must convert a high-level (-10 V to $+10\text{ V}$) analog input into a digital representation with 10, 12, 14, or even 16 bits of resolution. The digital output can connect directly to a microprocessor's data bus and appear as a memory or I/O device. The processor must tell the A/D converter when to start a conversion and must monitor its status to determine when the conversion process is completed. High-speed "flash" converters convert in

less than $1\ \mu\text{s}$ (microsecond), while integrating A/D converters may take up to 100 ms (milliseconds). Two popular types of A/D converters are used in personal computer data-acquisition systems.

Successive Approximation

This type of converter measures a constant analog-input voltage and requires a period of between 1 to 25 μs while it "successively approximates" the digital bits until an internally generated D/A converter output equals the analog input. The analog input must be held constant during the conversion period by a sample-and-hold amplifier. This type of A/D conversion is used for high sampling rates and where noise rejection is not a major concern.

Integrating

This type of converter is used where noise, especially 60 Hz, is a problem and high sampling rates are not needed (less than 1000 readings/second). This A/D conversion integrates the analog input over a period of time, usually 16.66 ms or some other submultiple of the 60-Hz period. The result is an average value filtered of AC components.

A stable and accurate analog reference point voltage (usually $+10.00\text{ V}$) must be supplied to A/D converters. Circuits containing A/D converters are layout-critical, and inexperienced analog designers usually go through a period of trial and error before a design is finalized.

D/A Conversion

D/A converters are simpler devices than A/D converters and they work by summing current into an output node from a series of internal switches controlled by the digital inputs. The output current is usually converted to a signal in the range of -10 V to $+10\text{ V}$. The processor places a digital value at the input of the D/A converter and the output assumes the corresponding analog value within a specified "settling" time.

End users rarely design converter boards unless the volume is large or the application is unusual. Usually, there are too many cost-effective solu-

Comprehensive Graphics at Practical Prices

Imaginator 2 adds smart graphics to your H/Z-29 terminal. You gain high speed, high resolution graphics with Tektronix® 4010/4014 compatibility standard.

Check these outstanding features:

- Fast — 500,000 pixel per second vector drawing rate
- High Resolution — 672 x 500 pixel graphics
- Standard 1024 x 1024 memory plane
- Hardware "Pan" and "Zoom"
- Up to 24 pages of graphics memory, 6 standard
- Instantaneous paging facilitates animation
- Tektronix® 4010/4014 compatibility with GILN mode, standard
- High speed graphics character generator
- Commands may be directly output from any language
- Hard copy directly from terminal via optional port
- Dual processor architecture for greater efficiency
- Expandable to full color and/or gray scale

Also ask us about our Imaginator 1 upgrade for H/Z-19 terminals and H/Z-89 computers.

CLEVELAND CODONICS, INC.

18001 Englewood • Cleveland, OH 44130 • 216/243-1198

Your Z-29 Can Do This...



Tektronix® Registered trademark of Tektronix, Inc. Codonics and Imaginator are trademarks of Cleveland Codonics, Inc.

Introducing the world's first complete, self-contained, 16-bit portable computer system.

The Panasonic Sr. Partner with a built-in printer.

The Panasonic Sr. Partner is one of the most flexible and versatile portable computers on the market today. So there are many reasons to buy one.

Runs IBM PC Compatible Programs.

To begin with, the Sr. Partner runs IBM PC compatible programs. So you can pick from hundreds of popular programs from an existing software library. Including Lotus 1-2-3, Multiplan, and even Flight Simulator.

In addition, included with the Sr. Partner are five of the most respected business-related programs including VisiCalc, WordStar, PFS: Graph, File and Report plus G.W. BASIC.* All at no extra charge.

This "bundle" allows you to go to work immediately doing word processing, electronic spread sheets, file management, graph development and your own programming.

And because it also accepts IBM PC compatible hardware, the Sr. Partner's technical capabilities can be expanded even further.

Built-in Printer.

The Sr. Partner is the only portable in its class with a built-in printer. It has graphics capability and can provide you

or your customers with printouts of statistics, budget figures, conference notes, graphs and much, much more.

The printer is also extremely quiet and offers an 80-character line and the 132-character line that's perfect for spread sheets and other accounting programs. And its bi-directional logic design delivers fast printing.

A Complete System.

The Sr. Partner is an integrated system that doesn't require costly add-ons to be called complete.

It has 128K internal memory (RAM), expandable to 512K. A nine-inch, high-resolution CRT with monochrome screen. An 8088 microprocessor with a MS-DOS™ 2.11 operating system. An 8087 co-processor socket. A built-in, double-sided, double density, 360K, 5 1/4-inch disc drive and the capability of handling another one just like it. Built-in color and graphics at no extra cost. An option slot for IBM hardware. An RGB monitor output. A centronics parallel interface I/O port that accepts optional peripherals. And an RS-232 serial interface I/O port. All for a price that's surprisingly affordable.

The Sr. Partner is also backed up by a 12-month limited warranty. Most of the competition offers only 90 days.

And if the Sr. Partner should ever need servicing, we have a national network of authorized service dealers.

Over 60 Years of Dependability.

We're not one of those "here today, gone tomorrow" companies.

Our parent, Matsushita Electric Industrial Co., has been in business since 1918 and is one of the world's largest consumer electronics manufacturers.

Matsushita's recent contributions and innovations to computer and office technology include a data entry system that directly connects facsimile data to a computer. An online optical character reader. A "pocket terminal" telephone data entry system. And a 64K static memory chip.

For more information about the Sr. Partner, write to: Computer Department, Panasonic Industrial Company, Division of Matsushita Electric Corporation of America, One Panasonic Way, Secaucus, NJ 07094. Or call: (201) 392-4261.

The Panasonic Sr. Partner. It's everything you've always needed in a portable computer but never had before.

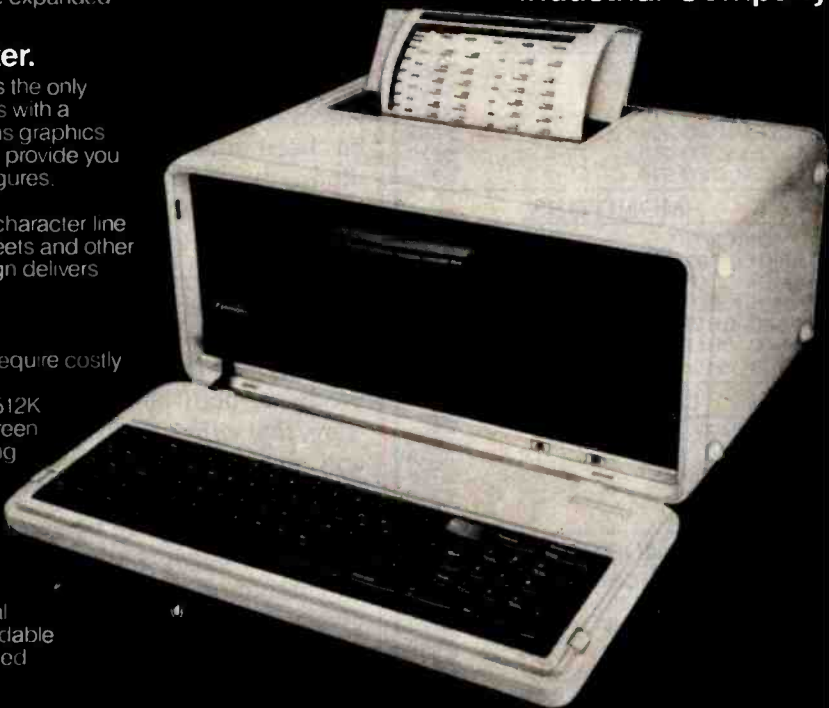
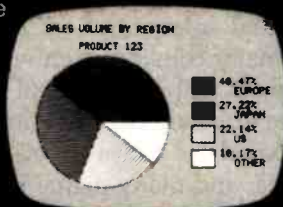

Panasonic
Industrial Company

*Software package subject to change.

Registered trademarks: WordStar, MicroPro International Corporation, PFS: Software Publishing Corporation, 1-2-3 and Lotus - Lotus Development Corporation, VisiCalc - VisiCorp, Flight Simulator, G.W. BASIC and Multiplan - Microsoft.

Circle 285 on inquiry card.

1st PLACE
COMPUTER SYSTEMS
 13422 N. CAVECREEK RD.
 PHOENIX, AZ. 85022

CALL FREE
1-800-841-2748

COMPUTERS

| | |
|----------------------|--------|
| ALTOS 580-10 | \$2945 |
| ALTOS 586-10 | \$4600 |
| ALTOS 586-20 | \$5565 |
| ATARI | \$CALL |
| APPLE LOOK-A-LIKE | \$CALL |
| COLUMBIA | \$CALL |
| PIED/PIER (PORTABLE) | \$CALL |
| SANYO 550-555 | \$CALL |

TELEVIDEO

| | | | |
|----------|--------|------|--------|
| 803 | \$1769 | 1603 | \$2019 |
| PORTABLE | | | \$CALL |

NORTHSTAR

| | |
|-----------|--------|
| ADVANTAGE | \$2099 |
|-----------|--------|

PRINTERS

| | |
|-----------------------|--------|
| BROTHER HR15P | \$479 |
| DAISYWRITER 48K | \$975 |
| DATASOUTH 180 | \$1095 |
| DATASOUTH DS220 | \$1499 |
| GEMNI 10X | \$280 |
| I.D.S. MICROPRISM 480 | \$399 |
| I.D.S. PRISM 132 | \$1340 |
| I.D.S. PRISM 132C | \$1489 |
| JUKI 6100 | \$459 |
| OKIDATA (LOW PRICES) | \$CALL |
| QUME 1140+ | \$1275 |
| QUME 1155+ | \$1475 |

CITOH

| | | | |
|------------|-------|-------|--------|
| 8510 | \$399 | 1550 | \$559 |
| F10-40C PS | \$970 | F1055 | \$1299 |

DIABLO

| | | | |
|-----|-------|-----|--------|
| 620 | \$860 | 630 | \$1689 |
|-----|-------|-----|--------|

NEC

| | | | |
|------|--------|------|-------|
| 3550 | \$1699 | 8025 | \$659 |
| 7710 | \$1849 | 2030 | \$799 |

TERMINALS

| | |
|---------------|-------|
| ALTOS II | \$850 |
| QUME 1026 | \$629 |
| TELEVIDEO 914 | \$540 |
| TELEVIDEO 924 | \$689 |
| TELEVIDEO 950 | \$929 |
| TELEVIDEO 970 | \$975 |

MONITORS

| | |
|-----------------|-------|
| AMDEK 300G | \$129 |
| AMDEK 300A | \$145 |
| AMDEK COLOR I+ | \$275 |
| AMDEK COLOR II+ | \$429 |
| B.M.C. GREEN | \$89 |
| B.M.C. COLOR | \$245 |
| N.E.C. 1216 | \$429 |



DISK DRIVES

| | |
|--------------|-------|
| INDUS APPLE | \$259 |
| MICRO SCI A2 | \$229 |
| ATARI 1050 | \$365 |
| INDUS ATARI | \$345 |
| RANA 1000 | \$310 |

MODEMS

| | |
|------------------------|-------|
| HAYS SMART MODEM | \$199 |
| SMARTMODEM 1200 | \$485 |
| SMARTMODEM 1200 B | \$429 |
| MICROMODEM II E | \$240 |
| RIXON 212A | \$449 |
| U.S. ROBOTICS PASSWORD | \$349 |

OTHER INFORMATION 602 867-9897

Send cash or money orders. All other checks will delay shipping two weeks.
 Prices & availability subject to change without notice.

tions already available to justify designing in house.

Interfacing with Digital Signals

It may seem that interfacing a computer with real-world digital signals does not require special consideration. They already speak the same language and, in many cases, the interface is simple. However, the real world possesses many anomalies not found in a computer bus.

Digital input signals are found coming from operator push buttons, limit and proximity switches, and flow and power meters. Digital outputs are used to perform on-off and time-proportional control of stepper motors and other devices such as valves and solenoids.

The major consideration when interfacing to real-world digital signals is to use isolation. Isolation can be accomplished by relays or by optical methods, and many digital I/O subsystems are available for this purpose. Industrial I/O front ends and subsystems include isolated-frequency measurement, pulse counting, and pulse-train and contact-closure output.

Conclusions

To industrial real-world interfacing applications, the revolution in personal computers has meant that the cost of adequate computing resources has been drastically reduced. In addition, the open nature of computer hardware and software is conducive to offering an end user many levels of "packaged solutions" to attack the real-world interfacing problem. Further development of standards in the industry will nurture more standard products, both hardware and software, that will make solutions easier and more cost-effective to implement.

To really penetrate these application areas, barriers other than price will become of greater importance as time goes on. One of these is ruggedness—a personal computer's ability to be used in industrial environments. In distributed architectures the computer can be located in a controlled environment while the front-end boxes reside in harsher environ-

ments. Ultimately, in these applications more intelligence will be required closer to the process or I/O, and, in small-scale operations when it won't be feasible to separate the two pieces, "hardened" computers will be required. Otherwise, the cost of industrial packaging will eclipse the cost of computing hardware.

The mechanical pieces of the computer must be improved—namely the keyboard, CRT, and disks. A standard QWERTY keyboard is intimidating to an industrial operator, and current key-switch technology is not practical for dirty or corrosive industrial applications. CRTs in industrial environments must be able to withstand great temperature variations, must be in a sealed package, and must be 19-inch rack-mountable. The use of removable sealed mass-storage media and backup will become more important; current floppy disks are the worst possible media for harsh environments. Bubble memory is certainly a possibility for this application when the cost becomes competitive. There are some vendors now with hardened peripherals that are intended for use in these applications, but cost limits their use (a touch-sensitive CRT for industrial environments can cost as much as the computer it connects to).

As is always the case in this field, technology advances coupled with price/performance improvements always can find new applications. The trend of applying personal computer technology to real-world interfacing industrial applications already has begun and will permeate the industry for years to come. Real-world interfacing is more than just connecting an A/D converter to a computer. The widespread use of computers will force vendors to come up with more complete and cost-effective means for providing this function. ■

Bill Englemann holds a BSEE from Worcester Polytechnical Institute and is a senior marketing applications engineer for Analog Devices' Measurement and Control Division (Rte. 1 Industrial Park, Norwood, MA 02062).

Mark Abraham holds a BSEE from Rutgers University and is a senior systems applications engineer for Analog Devices' Measurement and Control Division.

A Picture's Worth:

U.S. SHIPMENTS (\$ BILLIONS)

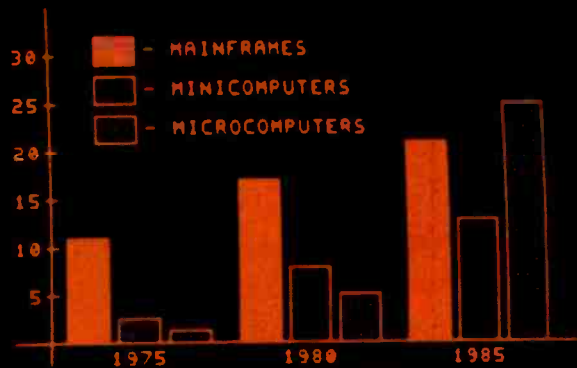

** GRAPHICS CAPABILITIES **

- ◆ HIGH PERFORMANCE GRAPHICS
- ◆ TEKTRONIX 4010 COMPATIBILITY
- ◆ AUTOMATIC SCALING (1023x1023) WITH 250x512 RESOLUTION
- ◆ ALPHA MODE (35 LINES x 73 COLS)
- ◆ OPTIONAL JOYSTICK
- ◆ CONNECTION TO LOW COST PRINTER FOR GRAPHICS HARDCOPY
- ◆ ASCII AND APL CHARACTER SETS
- ◆ BLOCK FILL, DOTTED/DASHED LINES

** DISPLAY TERMINAL CAPABILITIES **

- ◆ ANSI STANDARD CONFORMANCE
- ◆ DEC SOFTWARE COMPATIBILITY
- ◆ 80/132 COLUMNS, WINDOWING
- ◆ 4 PAGES OF MEMORY STANDARD (UP TO 8)
- ◆ 46 PROGRAMMABLE FUNCTIONS
- ◆ ASCII AND APL MODELS
- ◆ COMPACT ULTRA-THIN KEYBOARD
- ◆ HIGH RESOLUTION AMBER PHOSPHOR
- ◆ SETUP MODE

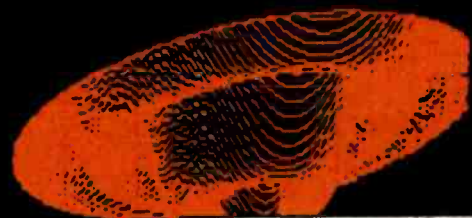

\$1895*

CONCEPT GVT+[™] Graphics Display Terminal

*Quantity one, end user price; substantial discounts available.

**human
designed
systems,
inc.**

Circle 187 on Inquiry card.

Whether used in video display mode or in its high-performance graphics mode, Human Designed Systems' GVT+[™] Graphics Display Terminal offers more user friendliness, more design features, and more advanced functionality to optimize productivity — and encourage creativity — for the terminal operator, interactive user, and applications developer than any other terminal available today.

Atlanta — (404) 391-9763; Boston — (617) 329-3510; Chicago — (312) 825-2960; Dallas — (214) 437-1888; Delaware — Infocon: (302) 239-2942; Denver — (303) 469-1953; Hawaii — Gray Associates: (808) 261-3751; Houston — (713) 962-1403; Los Angeles — (213) 410-9454; Northern New Jersey — Infocon: (201) 624-1372; New York City Area — Infocon: (212) 689-8833; New York State — Naco Electronics: Rochester: (716) 223-4490; Syracuse: (315) 699-2661; San Francisco — (415) 692-4184; Washington, DC — International Systems Marketing: (301) 279-5775; Argentina — Itron SA: (01) 774-9369; Australia — Computer Clarity Pty. Ltd.: (02) 241 3385; I. O. Peripherals Pty. Limited: (02) 427 3555; Belgium — BELCOMP: 091-31.52.22; Canada — CAIL Systems: Toronto: (416) 362-1063; Denmark — ADCOM Data Aps: 1-19 44 66; Finland — Evumatic: 0 594 141; France — Walton: (1) 226.06.90; Japan — Ampere: 03 (365) 0825; Singapore — DTS Singapore: (65) 33-88-566; Switzerland — Mitel: ag: 01/461 22 82; United Kingdom — Shandell Systems Ltd.: 02407-2027; Venezuela — E. Blohm SA: 2 541.21.22; West Germany — COMKO Computersysteme, mbH: 0221-48 30 51.

INTERNATIONAL DISTRIBUTORSHIP INQUIRIES INVITED.



SERIES 500
KEITHLEY

HOLD
MODE
RANGE
OFF

KEITHLEY

KEITHLEY | das
SERIES 500
DIGITAL MULTIMETER
CONTROL

SERIES 500
DIGITAL MULTIMETER
CONTROL

SERIES 500
DIGITAL MULTIMETER
CONTROL

DON'T WASTE YOUR MONEY ON A WORKSTATION DATA ACQUISITION SYSTEM.

As you conduct your search for the ideal data acquisition system, we think you'll find a number of capable systems, all from fine makers.

But we also think you'll find this: there is really only one system likely to meet, and perhaps exceed, your own personal standards for accuracy, flexibility, performance and power. And do so for a bottom line investment that is truly easy to justify.

That system is the Keithley DAS Series 500 for the IBM PC and Apple II families of microcomputers.

To begin with, even a basic Series 500 configuration, like the one shown in the chart, comes out of its carton with enough power and capacity for most lab and test bench applications. So you needn't trade up to more expensive options to get basic capabilities.

And because the Series 500 is completely modular, you can start out with just the capacity you need.

Then choose from our comprehensive library of plug-in function cards to instantly reconfigure your system for the most demanding applications—with up to 272 channels of discrete analog input, 50 channels of analog output, 160 channels of digital I/O, and AC/DC device control. With direct transducer connection and signal conditioning for each individual channel.

It's also the only system equipped with Soft500, the integrated measurement and control software that proves once and for all that easy doesn't have to mean simple.

Soft500 gives first time users the accessibility and friendliness they need to get excellent results the first time out. Yet it also provides experienced users with the depth and extended facilities needed for complex applications. Including unique features such as foreground/background architecture, powerful screen graphics and statistical analyses. Plus, automatic conversion of binary data to familiar engineering units.

In all, you'll find the features you need to make the Series 500 increasingly productive through years of new and more demanding applications.

| | Keithley Series 500 | ISAAC ISA | ISAAC 2080 | MACSYM 200 | HP 3497A |
|-----------------------------------|------------------------|-------------------------|-------------------------|-------------------------|--------------------------|
| System Base | \$4300 ⁽¹⁾ | \$3950 | \$4100 | \$3660 | \$2990 |
| Standard Input | | | | | |
| 16 Channels | Yes | Yes | + \$850 | + \$362 ⁽²⁾ | + \$2104 ⁽³⁾ |
| Instrumentation Amplifier | Yes | + \$700 | + \$700 | Yes | Yes |
| ± 0.035% Absolute System Accuracy | Yes | + \$1100 ⁽⁴⁾ | + \$1100 ⁽⁴⁾ | No | Yes ⁽⁵⁾ |
| 30 kHz Sampling | Yes ⁽⁶⁾ | No | Yes ⁽⁷⁾ | Yes | No |
| High Speed Programmable Ranges | Yes | No | No | Yes | No |
| Standard Output | | | | | |
| 5 12-Bit Voltage Outputs | Yes | + \$187 ⁽⁸⁾ | + \$937 ⁽⁹⁾ | + \$937 ⁽⁹⁾ | + \$2500 ⁽¹⁰⁾ |
| 16 Digital Inputs | Yes | Yes | + \$175 ⁽¹¹⁾ | + \$330 | + \$530 |
| 16 Digital Outputs | Yes | Yes | + \$175 ⁽¹¹⁾ | + \$350 | + \$710 |
| 4 120VAC Outputs | Yes | No | No | + \$638 ⁽¹²⁾ | + \$265 ⁽¹³⁾ |
| System Features | | | | | |
| Programmable Timers | Yes | Yes | Yes | Yes | + \$555 |
| Realtime Clock | Yes | Yes | No | Yes | Yes |
| Power Supply | Yes | + \$350 | Yes | Yes | Yes |
| Optional Features | | | | | |
| Data Acquisition BASIC | Yes | Yes | Yes | Yes | No |
| Foreground/Background | Yes | No | Yes ⁽¹⁴⁾ | Yes ⁽¹⁴⁾ | No |
| Data Analysis | Yes | No | No | No | No |
| Realtime Graphing | Yes | Yes | Yes | Yes | No |
| Engineering Units | Yes | No | No | No | No |
| Package Price | \$4300 | \$4285 | \$4837 | \$4277 | \$3654 |

1. System 520. 2. 16 channels of \$725 32 channel card. 3. \$1640 A/D card plus 16 channels of \$580 20 channel card. 4. ± 0.003% accuracy @ 200 Hz. 5. ± 0.006% accuracy @ 40 Hz. 6. Apple system 27 kHz, IBM system 31.4 kHz. 7. 200 kHz option available + \$3825. 8. 1 channel from \$750 4 channel card. 9. 5 channels from \$750 4 channel card. 10. 5 channels from \$1000 2 channel card. 11. 16 channels of \$350 32 channel card. 12. Price based on 16 channel rack @ \$550 plus 4 AC output relays @ \$22. 13. Four channels of \$525 8 channel card. 14. Or other multi-tasking structure.

Naturally, we'd like to suggest the Series 500 as the wisest choice in workstation data acquisition. But we also believe that as you compare and examine the facts, the Series 500 will eventually suggest itself.

For complete information on the Keithley DAS Series 500 workstation data acquisition system, call us toll-free at 1-800-552-1115. In Massachusetts call (617) 423-7691. Or write to us at Keithley DAS, 349 Congress Street, Boston, Massachusetts 02210.

SERIES 500



A JOINT VENTURE IN WORKSTATION DATA ACQUISITION

Information contained in the comparison chart is correct to the best of our knowledge as of October 1, 1983; however, Keithley DAS assumes no liability for its accuracy. IBM PC is a registered trademark of International Business Machines Corporation. Apple II is a registered trademark of Apple Computer, Inc. ISAAC is a registered trademark of Cyborg Corporation. MACSYM is a registered trademark of Analog Devices, Inc. HP is a registered trademark of Hewlett-Packard, Inc. © 1983 by Keithley DAS, Boston, Massachusetts

Planning a Computerized Measurement System

An introduction to digital processing of analog signals

Craig R. Wyss

University of Washington

Instead of peering at a wandering meter dial or at a squiggly line on a strip chart, why not let a computer get the eyestrain? Better yet, why not let the computer process that information as well as collect it?

The key to getting the most out of computerized measurement is careful planning. You need to: decide how often to sample the data signal and with what resolution, choose what computations will be performed by the computer and which ones by custom analog or digital circuitry, and decide what information to process in real time (while the measurements are being made) and what information to save for later processing.

Sampling Data

A measurement system must usually deal with a signal that is the voltage analog of some physical variable. To perfectly record such a signal, you would need to note its exact value at every moment. This isn't practical, so the task is to take samples of the signal with enough frequency and accuracy that you can store a reasonably close facsimile of the signal. However, how frequent is frequent enough?

The Nyquist sampling theorem says that the sampling rate (the number of data samples taken per second) should be at least twice the frequency of the sampled waveform. Consider, for example, a periodic signal with a fundamental frequency of about 3 Hz (e.g., the arterial blood-pressure waveform of someone exercising). If you were to accept a reconstruction consisting of the fundamental and up to the fifth harmonic (18 Hz), then you would need to sample the signal at least 36 times per second. As another example, consider a digital audio system. It would have to reconstruct signals of up to 20 kHz, so it would need to have a sampling rate of 40,000 per second.

Even a high sampling rate is not a guarantee of accurate signal reproduction. Accuracy also depends on the resolution of the A/D (analog-to-digital) conversion. In other words, if you have an A/D converter that cannot detect voltage differences of less than one-half volt, then you should not expect great accuracy when you feed it a signal that varies from 0 to 0.75 volt. A 12-bit A/D converter limits your ability to reconstruct a signal to 1 part in 4096 of the full

range of the converter. Thus, if the 12-bit converter has an input range of -10 to 10 volts (so that it has a resolution of about 4.9 millivolts) and your signal varies from 0 to 0.5 volt, your maximum accuracy is about 1 percent.

The choice of sampling rates is one of the really critical parts of planning a computerized measurement system because the choice sets the limits on the amount of signal processing that any particular computer can do. Doubling the sampling rate extracts two penalties: it doubles the overhead associated with servicing the A/D converter, saving raw data, and so on; and it can more than double the processing time associated with making computations on the data. Thus, you should always choose the lowest sampling rates that will allow acceptable resolution of the features of interest in signals.

Note that errors occur when your system monitors signals that have frequency components above twice the sampling frequency. Aliasing occurs when the sampling rate is slightly different than some multiple of a high frequency component of the signal. When that happens, a spurious low-

frequency signal appears to be present. Even if aliasing does not occur, frequencies in the signal above the sampling bandwidth appear as noise in the sampled data. The solution to these problems is not to increase the sampling rate, but rather to decrease the signal's bandwidth before it is sampled. I will discuss next how this and more may be accomplished.

Analog Preprocessing

Useful signal-processing systems existed before the advent of electronic digital computers. Millions of hours of effort have been directed at designing analog circuits that perform computations on the analog representation of measured variables; analog computers built from such circuits are still used for some types of modeling tasks.

Virtually all measurement systems do some analog processing. For example, the conversion of a physical variable into an electrical signal is an inherently analog process; this transformation is usually accomplished by a special-purpose device—a transducer—and associated electronics. The transducer and its electronics are often purchased as a package over which a user has little control. Consequently, most such packages do not produce the optimal signals for digestion by the computer in any particular setting.

The signal from the transducer electronics is unlikely to be the best size for your A/D converter, or you might be interested in only a restricted part of its full-scale range. Very often the transducer bandwidth will be too high for the appropriate sampling rate, or high-frequency noise will have crept into the signal. Thus, every A/D converter in a general-purpose measurement system should have some means of adjusting the range, offset, and bandwidth of signals. Figure 1 illustrates a simple analog circuit that performs these services for noncritical applications.

The operational amplifiers that you use in this circuit are not critical for the component values shown. The first stage of the circuit has a gain of negative one and provides input zero offsets from -10 to $+10$ volts. This

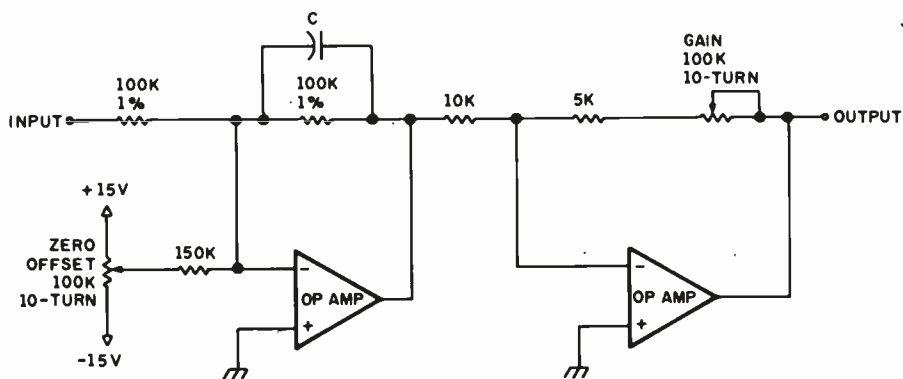

Figure 1: An analog signal-conditioning circuit.

stage also acts to limit high frequencies via the first-order, low-pass filter created by the capacitor, C, in the feedback loop; a value for C (in microfarads) of 3.2 times the sampling interval (in seconds) will result in 3-dB (about 30 percent) signal attenuation at one-half the sampling rate and 6-dB (one-half) per octave roll-off at higher frequencies. The second stage provides adjustable gain from 0.5 to 10; if zero offset is adjusted first, the gain and zero will not interact. Since each stage inverts the signal, the output has the same polarity as the input. Input impedance is 100 kilohms. For circuit-error analysis or more sophisticated designs, see references 3 and 4.

Analog processing can reduce the required sampling rate or relieve the computer's processing load. As an example where analog processing might be useful, consider a situation in which you need to know the peak pressure generated by an explosion. The required sampling rate might be more than 10 million samples per second and thus beyond the capacity of all but extremely expensive, special-purpose processors. An analog circuit called a peak detector would allow even a slow computer to sample the peak value at its leisure.

Analog processing can also improve accuracy in some cases. Suppose you are interested in the difference between two signals of almost equal magnitude. Using a computer to do the subtraction could leave only a few bits of accuracy left in the difference, and you have

doubled the computer's work load by making it sample two signals instead of one. An analog differential amplifier would perform the subtraction and preserve computer processing time and accuracy.

Hundreds of analog circuits have been designed to do all sorts of useful processing, and for very fast computations they are usually the method of choice. As a general rule, where an analog circuit is available to perform some calculation, it will do it faster, but less accurately and less flexibly, than a computer. References 1 and 2 will get you started with analog-circuit design, and references 3 and 4 give a number of circuit designs for analog processing.

One other class of signal preprocessing—event counting and timing—needs to be discussed. Using a computer for event counting and/or timing is like using a howitzer to kill flies. There are inexpensive digital circuits designed expressly for the purpose of counting and timing events and then feeding the results to a general-purpose computer. Many A/D converter cards for popular microcomputers contain at least one such circuit, and expansion cards designed to count and/or time multiple events are also available. It is generally appropriate to use a computer for event logging only when you have computer power to burn or when an unusual amount of signal processing needs to be done to determine what constitutes an event. In most situations, the simple 1-bit A/D circuit called a comparator (i.e., a level

detector) will suffice for identifying events.

Digital Signal Processing

The big advantages of digital over analog processing are accuracy and stability. Once a data value is present in a digital system it can be maintained or manipulated with no loss of accuracy. It is extremely difficult to design analog circuits that can preserve even 0.1 percent accuracy; noise, drift, and nonideal device properties are a constant challenge.

Computations that require the accumulation of information over long time periods are especially difficult to implement with analog circuits because electronic storage elements (capacitors) are limited in size and number for practical designs. Digital processing is almost always the way to go when data needs to be held for more than about 30 seconds. I once needed to generate a very slow (20 minute) voltage ramp for controlling an experiment; the analog circuit to do this is theoretically trivial, but the practical solution was not. It was easier to use a digital counter to produce a numerical ramp combined with a digital-to-analog converter to get the voltage.

Because digital circuits are so good at holding data, signal processing tasks are now possible that were impractical when only analog delay-lines or tape loops were available for storing data. These tasks are those that require looking back in time. Thus, a digital processor can conveniently make computations with respect to an event based on signal values sampled substantially before the event.

An example of digital processing that illustrates most of its strengths is the computation of average transients. In many real-world situations, the desired signal is buried in noise that cannot be eliminated by analog filtering (if the signal and noise have similar frequency spectra, there is no general way to filter out the noise without filtering out the signal as well). The average transients technique comes to the rescue when there are multiple chances to observe the same signal. By averaging many

observations of the signal plus noise, the signal gets reinforced while the noise is averaged out toward zero; the signal-to-noise ratio is improved in proportion to the square root of the number of observations. A neuro-physiologist might use such a system to help determine which neural pathways lead to the blink of an eye, and oil company geologists use them to separate experimentally generated seismic signals from background noise.

Using a programmable computer to do digital processing confers two vast advantages over custom-designed digital circuitry—flexibility and ease of development. These advantages save so much time and money that only defense contractors

It is extremely difficult to design analog circuits that can preserve even 0.1 percent accuracy.

are likely to be found designing custom digital circuitry when a programmable computer could do the job.

In the rest of this article I will assume that you are using a general-purpose mini- or microcomputer for signal processing. However, you should be aware that microprocessors designed specifically for real-time signal processing have been available for the past few years. These processors usually have on-chip 8-bit analog-to-digital and digital-to-analog converters, hardware multipliers, and very short cycle times. The processor designs are generally optimized for digital filtering (see reference 5), but they might also be used as an alternative to analog processing in numerous other applications where signals have frequency components up to about 100 kHz.

Real-Time versus Batch Signal Processing

Let us assume that you have decided what needs to be measured, applied appropriate analog and/or digital preprocessing, arranged for data sampling at close to the optimal

(i.e., lowest) rate, and have some data processing in mind for the computer to do. At this point you need to decide what calculations to do as the data is being collected (in real time) and what needs to be saved for later processing in off-line or batch mode.

Any result used for feedback during a measurement session clearly needs to be calculated in real time. These results might be used in experimental control or perhaps to provide a visual display as the data is being collected. At the other extreme are the situations where you haven't decided just what sort of analysis you will want to apply to the data or where the hardware or software necessary for an analysis is not available. In these cases, data must be saved for later analysis. When the choice between real-time and batch data processing is not clear, the following points should be considered.

The advantages of batch processing of measured data are twofold. First, you do not need to decide before every measurement just what analysis will be done. In most cases, data processing that occurs in real time (whether done by analog circuits, digital circuits, or a computer) reduces the information content in the signal and thus precludes some types of later analysis. Saving raw data for batch processing can therefore allow much greater flexibility and can possibly save having to rewrite a real-time data collection program every time a new type of data analysis is desired. The second major advantage of batch data processing is the ability to perform computations that require more time than is available in real time. Complex digital filtering, statistical or correlation analysis, and most types of mathematical transforms, for example, all require more processing time than is available in many measurement situations.

The advantages of real-time data processing are also twofold. First, the amount of data that needs to be printed or saved on mass-storage devices is usually greatly reduced, since only results need to be saved rather than all of the data that had to be sampled to resolve the features to be analyzed. If your required sam-

THE WHOLE ENCHILADA

\$1575

Compare this system to any offered by any manufacturer, any dealer. A 16-bit, 128K 8088 MS-DOS system (which by happy coincidence runs some IBM PC-DOS programs): The PC Deluxe™ includes the Sanyo MBC-555 computer with dual disk drives, MS-DOS, Sanyo Color Graphics Basic, Wordstar, Calcstar, Mailmerge, Spellstar, Infostar, PC Filer, a 12" green phosphor Sanyo display with a 640x200 resolution, a printer cable, and your choice of a Monnesmann Tally Spirit 80, Gemini 10X, or Scottsdale Systems' new LTR-1 letter quality printer. All for \$1575.

Of course you may not want the whole Enchilada, in which case we have other system packages based on the Sanyo 550 computer that may be more to your taste.

If you're thinking about buying the hottest micro of 1984 give us a call. Find out why our prices, inventory, product knowledge, and an insatiable appetite for Mexican food have made us Sanyo's largest U.S. dealer.

PC PLUS™ \$1099
PC DELUXE™ \$1575

10Mb. disk drive \$1927, networking systems . . . call
 No dealers please.



TELEVIDEO

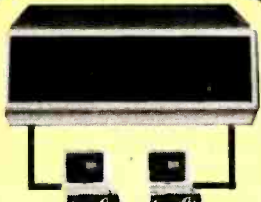

The single user 803's now include CP/M® and Graphplan from Chang Labs. You can save money by buying your multi-user Televideo system from us, and we can have it installed at your site through our agreement with T.A.W. (additional charge).

TPC-dual drive \$1709
 803 \$1849
 1603 \$2289
 802H \$4319
 806/20 mb. \$4859
 816/40 mb. \$9275

ALTOS



From the lowest-priced dual-floppy multi-user systems to true 16-bit 10 Mhz. multi user systems. Local service available via TRW. We will configure, test and install your systems for an additional charge (call for prices).

580-2 \$1998
 580-10 \$3629
 586-20 \$6539
 586-40 \$7995
 8000-10 \$4679
 8000-14 \$8118

EAGLE

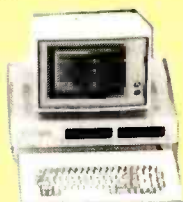

Our new Eagles have landed with more compatibility. The PC-2 has 128K RAM, two 320K floppy disks, a 12" green monitor, EagleWriter, EagleCalc, MS-DOS and CP/M 86. The new Spirit XL portable includes one 320K floppy and one 10 Mb. hard disk. Both come with two serial ports and one parallel port and are backed nationwide by Dell and Howell.

PC-2 \$2639
 Spirit XL \$3729
 PC Plus
 1600 series call

COLUMBIA



Each Columbia comes with Dosica (21st IBM-PC compatible color graphics), Perfect Writer™, Perfect Speller™, Perfect Calc™, Perfect Filer™, Fast Graphs, Home Acc't Plus, Space Commanders, Diagnostics and the Columbia Tutor. The VP is a 38 lb. portable, the 1600-1 is the desktop unit. Both have dual 320K drives and are backed nationwide by Dell and Howell. The VP has a 9" CRT, the 1600-1 price includes CRT controller and keyboard.

VP \$2298
 1600-1 \$2569
 1600-4 \$3849

TERMINALS



ADDS Viewpoint 3A+, now emulates the Viewpoint 1A and 2A, along with the ADM 3A (New model due April).

Viewpoint 60 \$449
 Wyse 50 \$499
 Wyse 100 \$694
 Televideo 914 \$559
 Televideo 924 \$689
 Televideo 970 \$1044
 Altos II \$724
 Zenith Z-29 \$656
 Zenith ZT-1 \$469
 Qume 102 \$544

HOUSTON INSTRUMENTS

DMP-29 \$1795
 DMP-40 \$745
 DMP-41 \$2340

Sanyo 8-bit Systems

new lower prices.

PRINTERS



Tally Spirit \$298
 Tally 160L/trac \$584
 Tally 180L/trac \$799
 Oki 92 \$174 Off List
 Oki 93 \$290 Off List
 Gemini 10X \$115 Off List
 Gemini 15X \$140 Off List
 Prism 132
 all opts. \$1449
 Transtar 315 \$469

LETTER QUALITY

Silver Reed 500 \$409
 Silver Reed 550 \$559
 Diablo 620 \$849
 NEC 2030 \$1791
 NEC 3550 \$1771
 NEC 7710 \$1949
 DTC 380Z \$1044

Scottsdale Systems Ltd.

617 N. Scottsdale Road, Suite B, Scottsdale, Arizona 85257



(602) 941-5856



Call 8-5 Mon.-Fri.



We participate in arbitration for business and customers through the Better Business Bureau of Maricopa County.

SERVICE/ORDERING

INTEGRATION: Prices listed are for new equipment in factory sealed boxes with manufacturer's warranty. We will pretest your equipment, integrate your system, configure your software, provide special cables, etc., for an additional charge. Call for prices.

ORDERING: MAIL ORDER ONLY. Prices listed are for cash. No C.O.D.'s. We sell on a Net 30 basis to Fortune 1000 companies and Universities with good credit. P.O.'s add 2% charge cards add 3%. Az. residents add 6%. Prices subject to change, product subject to availability. Personal checks take 3 weeks to clear. 0-20% restocking fee for returned merchandise. Shipping extra - products are F.O.B. point of shipment. CP/M and MP/M are registered trademarks of Digital Research. Wordstar is a registered trademark of MicroPro International. IBM and IBM PC are registered trademarks of International Business Machines Corporation. TeleVideo® is a registered trademark of TeleVideo Systems, Inc. SOFTWARE: Sold only w/systems, not warranted for suitability.

PASSWORD 300/1200

The best price on the best selling auto dial/answer, 300/1200 baud, auto speed, auto mode, full/half duplex, modem. Price includes power, phone, and RS-232 cables.

\$329



SCOTTSDALE SYSTEMS' LTR-1

NEW! A letter quality printer that weighs less than 7 lbs., only takes up as much desk space as a sheet of paper, 12 C.P.I., 12 C.P.S., single sheer, friction feed, 60 characters, bi-directional, the perfect 2nd printer or portable printer. Its box can double as a carrying case.

\$249



pling rate exceeds your capacity to save data, this consideration will mandate at least some real-time data processing.

The second advantage of real-time data analysis is that it relieves you from having to do it later. This may seem obvious and unimportant, but it can have a major impact on overall computer usage. In one application, I was able to reduce the batch-processing time for a 3-hour experiment from 6 hours to a few minutes by saving only data that had been partially preprocessed in real time. (The apparent magic involved in doing 6 hours worth of processing in 3 hours of real time resulted from the fact that the real-time program had to be efficient, while the batch program didn't have to be and wasn't.) As a rule of thumb, I normally consider any measurement situation with more than 100,000 data values per hour to be a good candidate for some real-time processing to reduce the burden of data storage and subsequent batch processing.

How do you determine if a par-

ticular analysis task can be done in real time? Time constraints will determine the answer, and I have a few simple rules to help you make an estimate. The first step is to estimate the minimum sample cycle time. This is the time required to collect a sample, save it somewhere, and do all associated housekeeping. This time depends on both hardware and software; it might be as low as 10 microseconds for a fast analog-to-digital converter being controlled by a well-written assembly-language program, or it might be 10 milliseconds for a simple converter being controlled from an interpreted BASIC program. This time sets an absolute upper limit on the total sampling rates of all sampled channels and, thus, on effective measurement bandwidths.

Next, you have to estimate the average processing time you need to execute your data-analysis algorithm. It is often easiest to do this by writing a test program that applies the algorithm to a known quantity of dummy data. The average sample cycle

time can then be computed as the sum of the minimum cycle time and the average algorithm-processing time needed for each sample. This time sets the absolute limit on the data sampling rates that can be maintained while still performing the desired analysis.

Finally, examine your algorithm and all real-time tasks that you plan to do to find the most time-consuming set of conditions that could be encountered; we'll call this the maximum sample cycle time. This time will normally be much longer than the average sample cycle time since occasional tasks, such as updating a screen display or dividing sums to get averages, can consume many machine cycles.

If you write only the most straightforward data-collection program, your sampling rates will be limited by the maximum sample cycle time. In this simplest programming approach, each sample is collected and analyzed before getting the next sample. Thus, you need to leave enough time between samples to do

Your PC can now "speak" C when using...

BASTOC™

A BASIC-To-C Translator

JMI's BASTOC is a versatile software tool which converts BASIC source programs to C source programs. BASTOC also translates multiple dialects of BASIC.

Registered Trademarks IBM—International Business Machines Corp., Microsoft, MS-XENIX—Microsoft Corp., Applesoft—Apple Computer, Inc., TRS-80—Tandy, Radio Shack Corp., CBASIC—Digital Research, Inc.
Distributors Australia Fawcitt Pty. Ltd. P.O.B. 224, Hurstville, NSW 2220 (612) 570-6100, Japan, Advanced Data Controls Corp., Chiyoda-ku, Tokyo (03) 263-0283, United Kingdom, Real Time Systems, Newcastle upon Tyne, 0632-733131



JMI SOFTWARE CONSULTANTS, INC.
1422 EASTON ROAD • ROSLYN, PA 19001 • 215-657-5660

BASTOC FEATURES

- Supports Microsoft Disk BASIC.
- Full run-time support library is provided.
- Provides conventional BASIC compiler when used in conjunction with a C compiler.
- Produces formatted and structured C code, easily maintained and modified.
- The output of BASTOC may be used directly as input to a standard C compiler.
- Several dialects of BASIC may be translated to C on the same system.
- BASTOC will soon translate CBASIC and Applesoft BASIC.

AVAILABLE NOW

JMI's BASTOC is available now for the IBM PC and PC-compatible computers using PC-DOS or MS-DOS, and the Radio Shack TRS-80, Model 16, running XENIX. BASTOC will be available for other systems soon!

ORDER NOW

The BASTOC single unit binary price is \$350, and includes documentation, media, and shipping. To order, or to get more information, write or call JMI Software Consultants, Inc., 215-657-5660. Check, Money Orders, VISA and MC are acceptable. Circle 202 on inquiry card.



**WITH THE PASSWORD™ MODEM AND
TELPAC™ PAUL REVERE COULD HAVE
WARNED 14 VILLAGES IN 40 WINKS.**

The Password™ modem and Telpac™ software can distribute an urgent message to 14 points—automatically. By saving time, work, and money, they are just as valuable for longer, less urgent messages. Another revolutionary example: They can transmit a text the length of the Declaration of Independence in a little more than a minute, while you sleep, when long distance rates are lowest.

And when you work with Telpac, you will find it typically USR friendly.

To do all this, team Telpac with your computer and with Password, the USR modem so advanced you just turn it on. Auto dial/answer, 300/1200 baud, and a two-year limited warranty for \$449.* Write or call for complete descriptions—both Telpac and Password do far more than this!



U.S. ROBOTICS INC.

1123 WEST WASHINGTON • CHICAGO, ILLINOIS 60607
(312) 733-0497

Circle 372 on inquiry card.

*Suggested list for Password complete with power adapter, phone cable, RS232 interface, Telpac software, \$299.

Password, Telpac, and USR logo are trademarks of U.S. Robotics Inc.

TOTAL CONTROL:

**FORTH: FOR Z-80®, 8086, 68000, and IBM® PC
GRAPHICS • GAMES • COMMUNICATIONS • ROBOTICS
DATA ACQUISITION • PROCESS CONTROL**

● **FORTH** programs are instantly portable across the four most popular microprocessors.

● **FORTH** is interactive and conversational, but 20 times faster than BASIC.

● **FORTH** programs are highly structured, modular, easy to maintain.

● **FORTH** affords direct control over all interrupts, memory locations, and i/o ports.

● **FORTH** allows full access to DOS files and functions.

● **FORTH** application programs can be compiled into turnkey COM files and distributed with no license fee.

● **FORTH** Cross Compilers are available for ROM'ed or disk based applications on most microprocessors.

Trademarks: IBM, International Business Machines Corp.; CP/M, Digital Research Inc.; PC/Forth+ and PC/GEN, Laboratory Microsystems, Inc.

FORTH Application Development Systems include interpreter/compiler with virtual memory management and multi-tasking, assembler, full screen editor, decompiler, utilities and 200 page manual. Standard random access files used for screen storage, extensions provided for access to all operating system functions.

Z-80 FORTH for CP/M® 2.2 or MP/M II, \$100.00;
8080 FORTH for CP/M 2.2 or MP/M II, \$100.00;
8086 FORTH for CP/M-86 or MS-DOS, \$100.00;
PC/FORTH for PC-DOS, CP/M-86, or CCPM, \$100.00; **68000 FORTH** for CP/M-68K, \$250.00.

FORTH + Systems are 32 bit implementations that allow creation of programs as large as 1 megabyte. The entire memory address space of the 68000 or 8086/88 is supported directly.

PC FORTH + \$250.00
8086 FORTH + for CP/M-86 or MS-DOS \$250.00
68000 FORTH + for CP/M-68K \$400.00

Extension Packages available include: software floating point, cross compilers, INTEL 8087 support, AMD 9511 support, advanced color graphics, custom character sets, symbolic debugger, telecommunications, cross reference utility, B-tree file manager. Write for brochure.



Laboratory Microsystems Incorporated
Post Office Box 10430, Marina del Rey, CA 90295
Phone credit card orders to (213) 306-7412



your most time-consuming jobs or you will lose data. An alternate but trickier programming approach lets the sampling interval approach the average sample cycle time by collecting and saving samples asynchronously with respect to other processing tasks. For more information about efficient real-time programming techniques, see references 6 and 7.

A Real-World Example

To illustrate and summarize the principles outlined in this article, I will briefly describe BEAT, a real-time program I wrote to monitor experiments in cardiovascular physiology. The overriding characteristic of cardiac signals is that many of the most interesting things happen very fast (as the heart contracts) but not very often (once per cardiac cycle). BEAT was designed to capture this information from each heartbeat.

I measured blood flow and pressure in the ascending aorta (the big artery leaving the heart) using specialized transducers with associated electronics. Analog circuits scaled and filtered the signals as needed by the 12-bit A/D converter and the sampling rates. The 12-bit accuracy of the converter was more than sufficient, since the transduction and analog processing left the signals with an accuracy of only 1 percent.

Ascending aortic flow is nonzero for a relatively brief part of the cardiac cycle (for about the 150 milliseconds when the left ventricle is contracting and the aortic valve is open). Since the peak flow is stable to within 1 percent for only about 4 milliseconds, I chose a sampling rate of 250 per second for this channel (a bandwidth from DC to 125 Hz). Due to the dynamic characteristics of the arterial tree, aortic blood pressure changes much more slowly than aortic flow; a bandwidth of only 30 Hz allowed reconstruction of the pressure waveform to well within 1 percent accuracy. Thus, the arterial pressure channel was sampled at one-fourth the rate of aortic flow samples. The raw sample rates for these two variables plus others I measured were about 1000 per second. The raw data from a typical 5-hour experiment would

Business as Usual?

Business as usual these days means a computer that's up and "humming." But if your computer were stolen or damaged, you wouldn't have business as usual.

YOU'D HAVE TROUBLE!

You can get fast replacement for your entire system and be back in business in a hurry by protecting your computer with SAFEWARE Personal Computer Insurance. It's the only coverage designed specifically for personal computers used for business — in your office, shop or home.

SAFEWARE protects ALL hardware, ALL purchased software and ALL media against theft, damage or any other kind of loss, regardless of use, after a low \$50 deductible.

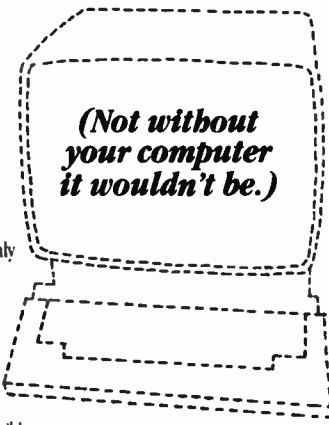

Fast, courteous claims handling prevents your losing valuable business computing time.

Find the premium price for the coverage you need listed in the table below, available for as low as \$35 per year. Fill in the coupon today. Your coverage will begin as soon as your coupon application is received. Or for even faster coverage, call our toll free number.

1-800-848-3469

(In Ohio call 1-614/262-4559)
Phones open 8 a.m. to 8 p.m.
Monday through Saturday

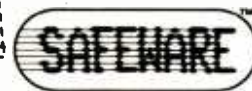

Mail to: SAFEWARE, P.O. Box 02211, Columbus, OH 43202

Before I'm out of business,

please issue my SAFEWARE Insurance Coverage

Name _____

Street _____

City _____ State _____ Zip _____

System value \$ _____ Check Enclosed VISA MasterCard

Card # _____ Exp. Date _____

BT

| Total Hardware, Media & Software System Value | Annual Premium |
|---|----------------|
| Up to \$ 2,000 | \$ 35 |
| \$ 2,001-\$ 5,000 | \$ 60 |
| \$ 5,001-\$ 8,000 | \$ 75 |
| \$ 8,001-\$11,000 | \$ 90 |
| \$11,001-\$14,000 | \$105 |

Call toll-free for rates on higher coverage. Coverage differs in Texas. It is an underwriting requirement that you insure your system for its full value.

VisiCalc[®], Lotus[™] 1-2-3[™] and Multiplan[®] users endorse Dow Jones Spreadsheet Link[™]...



"The analysis I do with Spreadsheet Link would be impossible any other way.

I track more than 200 securities. This software really gives me a handle on my investments. I can download stock quotes and fundamental information from Dow Jones News/Retrieval[®] directly into my spreadsheets, and analyze it using my own formulas."

Ronald Eldredge
Lockhart Financial Services



"The speed of collecting and entering data is invaluable.

Spreadsheet Link does exactly what I want it to do. It's a tremendous help in manipulating data. I think anyone who does spreadsheet analysis will find this an important addition to their software library."

Anne Freilich
Wensley Management Corporation



"The comprehensive information I get from Dow Jones News/Retrieval is a real plus.

Without Spreadsheet Link, I'd have to enter data keystroke by keystroke into my templates. This software makes spreadsheet analysis much easier and more useful to me. I'm getting very satisfactory results, and I'm still exploring the possibilities."

Douglas Gill
Grayson Gill, Inc.



DOW JONES SOFTWARE[™]

... Plan on it.

By Solutions, Inc. and Dow Jones & Co., Inc.
Compatible with Apple II and IBM PC and IBM XT personal computers.
For a free brochure, call
1-800-345-8500 ext. 165
(Alaska, Hawaii and foreign call 1-215-789-7008 ext. 165)

Copyright © Dow Jones & Co., Inc., 1983. All rights reserved.

VisiCalc is a registered trademark of VisiCorp.
Lotus and 1-2-3 are trademarks of Lotus Development Corporation.
Multiplan is a registered trademark of Microsoft Corporation.

have required about 36 megabytes of mass storage. It was a clear candidate for real-time processing.

I needed to calculate: the cardiac cycle length, the integral of aortic flow minus its value just prior to a heartbeat (the stroke volume), the average pressure, the systolic and diastolic pressures, the maximum rate of change of pressure, and similar sorts of information about other measured variables. BEAT extracted this information from the raw data samples for each heartbeat and then saved the computed values on a mass-storage device.

The analog and custom digital circuits I would have needed to duplicate my computerized system would have been complex, inflexible, and difficult to calibrate. For instance, the stroke volume computation required looking back after detecting a heartbeat to the period when aortic flow was known to be zero. Current flow transducers suffer from slow zero drift, so an analog circuit to compute stroke volume would have been an endless source of frustration.

Reference 8 outlines the problem in more detail and explains some other tricks we can do with the computer and aortic flow.

The processing time necessary to sample data, keep running sums, compute extrema, and so on, required about one-fourth of the available machine cycles. However, at the end of each cardiac cycle, BEAT had to perform tasks that required about 150 milliseconds. These tasks included preparing the extracted data for writing to mass storage and passing the data along to the device controller, computing a number of derived variables (heart rate, the current time, average pressure, etc.), converting the derived variables to engineering units and displaying them on a video monitor, echoing the derived values as analog voltages via a set of digital-to-analog converters, testing the keyboard for any special instructions from the user, and initializing in preparation for processing the next beat.

The time required for end-of-beat processing presented a programming

dilemma. I might have ignored 150 milliseconds of the measured variables after the end of each beat (thereby missing the most important part of the cardiac cycle), or I might have forgone some or all of the end-of-beat processing. Both of these unpalatable alternatives were avoided, however, because even at the highest observed heart rates, only about 85 percent of the computer's time was needed to do all sample and end-of-beat processing. The problem was to somehow keep sampling data at the proper times even when the computer was busy with the time-consuming end-of-beat tasks.

The job of independent data sampling was relatively easy for BEAT because the A/D converter was a smart device that could be programmed to collect samples and save values in its own memory. Analog-to-digital converter systems with this sort of independent processing capability are becoming commonly available; for example, Data Translation makes them for the IBM PC that sell for \$1200 and up. In the more usual

**UNIX
TIMESHARE+**

**UNIX System III POWER and sophistication are yours. Let THE SOLUTION turn your micro into all you dreamed it could be, bringing the Ultimate programming environment as close as your modem. Just a local call from over 300 cities nationwide via Telenet.*

THE SOLUTION™

- Expansive Software development facilities.
- Berkeley and local enhancements.
- Complete online Unix manuals.
- Extensive Text formatting capability.
- Communication with over 500 UNIX sites on over 150 subjects.
- Interuser mail.
- Online discount shopping for Hardware/Software.
- LOW COST and FAST response time.
 - \$24.95 = 1 hr. free system time + SOLUTION Newsletter subscription + BYTE BOOK (Introducing The Unix System 556 pp.).

*UNIX is a trademark of Bell Labs



Payment via VISA or MasterCard

Korsmeyer
ELECTRONIC DESIGN, INC.

5701 Prescott Avenue
Lincoln, NE 68506-5155
402/483-2238
10a-7p Central

case where a smart analog-to-digital converter is not available, the same independent effect can be achieved with a simple service routine that is called via hardware interrupts generated by a clock. The usual time cost for such servicing might be 50 to 100 microseconds for one channel plus 10 to 30 microseconds for each extra channel sampled.

The BEAT program was largely written in a relatively inefficient compiled version of BASIC; only one small routine to maintain the sample buffers needed to be written in assembly language. This illustrates the point that you don't need to be an expert assembly-language programmer to write useful measurement-monitoring programs. Once you have written (or gotten someone else to write) the possibly tricky routines to sample signals and maintain a well-organized buffer of sampled values, then, with only reasonable care and programming skills, you can turn your computer into a flexible data-collection and signal-processing tool. ■

References

1. Mileaf, H. *Electricity One—Seven*. Rochelle Park, NJ: Hayden, 1978.
2. Cirovic, M. *Integrated Circuits: A User's Handbook*. Englewood Cliffs, NJ: Prentice-Hall, 1977.
3. Sheingol, D., ed. *Transducer Interfacing Handbook: A Guide to Analog Signal Conditioning*. Norwood, MA: Analog Devices, 1980.
4. Stout, D., M. Kaufman. *Handbook of Op Amp Circuit Design*. New York: McGraw-Hill, 1976.
5. Grappel, R. "Digital Filters Utilizing Microprocessors". Ch. 11 in *Microprocessor Applications Handbook*. Edited by D. Stout. New York: McGraw-Hill, 1982.
6. Mellichamp, D., ed. *Real-Time Computing—With applications to data acquisition and control*. New York: Van Nostrand Reinhold, 1983.
7. Wyss, C. "A Conceptual Approach to Real-Time Programming". *BYTE*, May 1983, page 452.
8. Wyss, C., T. Bennett, A. Scher. "Beat-by-beat control of cardiac output in awake dogs with atrioventricular block." *American Journal of Physiology*. 242 (Heart Circ. Physiol. 11): H1118-H1121. 1982.

Craig Wyss (Dept. of Orthopedics; RK-10, University of Washington, Seattle, WA 98195) is a research assistant professor. He has a Ph.D. in cardiovascular physiology. His hobbies are reading, thinking, and computer programming. He uses an IBM PC.



PREVENT THE DISASTER OF HEAD CRASH AND DROPOUT.

The war against dust and dirt never ends. So before you boot-up your equipment, and everytime you replace a cassette, disk or drive filter, be sure to use Dust-Off II; it counteracts dust, grit and lint. Otherwise you're flirting with costly dropouts, head crashes and downtime.

Dust-Off II is most effective when used with Stat-Off II. Stat-Off II neutralizes dust-holding static electricity while Dust-Off II blasts loose dust away. There's also the Dual Extender and Mini-Vac for vacuuming dust out of hard-to-reach places.

Photographic professionals have used Dust-Off brand products consistently on their delicate lenses and expensive cameras for over ten years. They know it's the safe, dry, efficient way to contaminant-free cleaning.



Cleaning not provided by liquid cleaners.

Dust-Off II's remarkable pinpoint accuracy zeros in on the precise area being dusted. And you have total control—everything from a gentle breeze for



Stat-Off II neutralizes dust-holding static electricity from media and machines.

delicate computer mechanisms to a heavy blast for grimy dirt.

Don't let contamination disrupt your computer operation. Stock up on Dust-Off II—the advanced dry cleaning system, at your local computer or office supply dealer.

Or send \$1.00 (for postage and handling) for a 3 oz. trial size and literature today.



Dust-Off II

The safe dry cleaning system

Falcon Safety Products, Inc. 1065 Bristol Road, Mountainside, NJ 07092



DON'T PAY CASH USE YOUR COMPUCARD™

The Computer Line believes that it is important to be competitive by offering low prices; however, we regard service as the most important asset of a mail-order organization. All our lines are available so that you, the customer, are able to talk to fully qualified computer specialists trained to answer all your questions pertaining to our line of microcomputers. We are renowned for our excellent after-sales support and our promptness for delivery. Peace of mind and excellence in service is our pledge to all our customers.

NEW FRANKLIN SYSTEMS

Compatible with the Apple computer!

1000 Pro Pack Plus:

Featuring:

- 1000 CPU
- Franklin Monitor
- 80 Column Card
- Ace 10 Disk Drive + Controller
- Ace Calc.
- Ace Writer
- Data Perfect
- Welcome Package

**TOO LOW
TO PUBLISH**

1200 OMS Package:

Featuring:

- 1200 CPU
- 80 Column Card
- 2 Disk Drives + Controller
- CP/M Card + Software
- Parallel & Serial Interfaces
- Wordstar
- Mailmerge
- Ace Calc.
- Welcome Package

**TOO LOW
TO PUBLISH**

COLUMBIA DATA PRODUCTS

- IBM PC Compatible • 128K Main Memory • 8 Expansion Slots • 2 Serial and One Parallel Port Built In • 2 Double Sided/Double Density 320K Drives • Over \$3000 Free Software Including:

- Perfect Writer/Speller
- Perfect Filer/Calc.
- Home Accountant
- Fast Graphs
- MS DOS/CP/M and more!

**Too Low
To
Publish**

VP

PORTABLE UNIT

—Same as 1600-1 except this unit is truly portable

MPC-1600-4

HARD DISK UNIT

—Compatible to IBM PCXT
—Includes 12 megabyte hard disk

HAVOC

Great First Computer

- Apple Compatible
- Detached Keyboard
- Built-In Disk Drive
- Built-In Parallel Port
- Built-In Serial Port

**SUPER
LOW
PRICE
\$769.95**

APPLE IIe STARTER SYSTEM

Complete System Includes:

- Apple IIe w/64K
- Disk Drive w/Controller
- 80 Column Card
- Monitor
- DOS Disks & Manuals

**CALL FOR
OUR
LOW LOW
PRICE**

IBM PERSONAL COMPUTERS

Take A Demonstration on the IBM PC. Our System Includes:

- Two Double-Sided Drives
- 256K of Memory
- Color Graphics Adaptor

ONLY \$2899.00

Maximum of 4 weeks delivery on all IBM systems.

CORONA

- 128K Expandable to 512K
- 2 DS/DD 320K Disk Drives
- 4 Expansion Slots
- 1 Parallel Port
- 1 Serial Port
- Hi-Res Monitor

| | Green | Amber |
|----------|-----------|-----------|
| Desk Top | \$2695.00 | \$2725.00 |
| Portable | \$2579.95 | \$2595.00 |

EPSON QX-10
State of the Art Simplicity-
Complete Software Package
w/VALDOCS & CP+ CP/M
\$CALL

TAVA PC

- IBM Compatible
- 2 DS/DD 320K Disk Drives
- Serial Port
- Parallel Port
- Hi-Res Monitor

\$1995.00

PANASONIC
Portable with Built-in Printer
**CALL FOR
LOW PRICE**

PRINTERS

C. ITOH
NEW! HOT DOT Too Low
180 CPS. Excellent Quality To Publish

Prowriter I
8510 Parallel 120 CPS **\$359.95**
8510 Serial 120 CPS **\$479.95**

Prowriter II
1550 Parallel **\$599.95**
1550 Serial **\$679.95**

SUPER SPECIAL

F-10 Letter Quality Printer
—Fast 40 CPS **\$999.95**
—Parallel or Serial

F-1D Tractor Feeds Now In Stock!

EPSON
FX-80 160 CPS, Corr. Qual **\$CALL**
FX-100 160 CPS, 15" Wide **\$CALL**

OKIDATA

OKIDATA 82A \$319.95

- 120 CPS, 80 Col
- Parallel/serial Inter

OKIDATA 92P \$449.95

- 160 CPS, 80 Col
- Excellent Corr Quality
- Parallel

OKIDATA 93P \$739.95

- 160 CPS, 132 Col
- Same as 92P

OKIDATA 84 Par/ or Ser \$CALL

PACEMARK 2410 \$2499.95

OKIDATA Plug & Play \$43.95

OKIGRAPH \$39.95

STAR MICRONICS

GEMINI-10X

- 120 CPS
- Graphics, 80 Col
- Tractor and friction

TOO LOW TO PUBLISH

GEMINI-15X

- 15" Wide (132 Col)
- Same features as 10X

TOO LOW TO PUBLISH

NEW DELTA 10X \$CALL

**CABLES & INTERFACE
AVAILABLE**

LETTER QUALITY PRINTERS

JUKI
Juki 6100 Letter Quality **\$ 469.95**

BROTHER
Dynamx DX-15 **\$ 469.95**
Tractor for DX-15 **\$ 99.95**
Keyboard **\$ 149.95**
Dynamx DX-25 **\$ 779.95**

INTERGRAL DATA SYSTEMS
Micro Prism **\$ 499.95**
Color Prism 132, 4-color **\$1499.95**

TOSHIBA
Toshiba 1350 Dot Matrix **\$1599.95**

NEC SPINWRITER \$CALL

PAPER
9 1/2"x11" Lazer cut **\$28.95**
3000 Sheets
11"x15" Lazer Cut **\$38.95**

FOR IBM

| | |
|--|----------|
| QUADRAM | |
| Quadcolor I color & graphics board | \$249.95 |
| Quadboard I w/64K, Ser, Par, Clock | \$279.95 |
| Quadlink Apple Emulation System | \$479.95 |
| Microfazer P/P, P/S, S/P, S/S | SCALL |
| TECMAR | |
| Captain | SCALL |
| 1st Mate | SCALL |
| 2nd Mate | SCALL |
| Graphics Master | SCALL |
| AMDEK | |
| MAI-Monochrome & RGB | \$499.95 |
| KEYTRONICS KEYBOARD | \$229.95 |
| MICROSOFT SYSTEMS BOARD | SCALL |
| AST | |
| 6-PAK plus w/64K (384K max), Ser, Par, Clock | \$289.95 |
| Mega plus w/64K (512K), 2 Ser, Par, Clock | \$389.95 |
| Combo plus w/64K Ser, Par, Clock | \$289.95 |
| I/O plus 2 Ser, 1 Par, Clock | \$249.95 |
| MAYNARD | |
| Disk Drive Controller Card | SCALL |
| Controller w/Parallel Port | SCALL |
| Controller w/Serial Port | SCALL |
| BABY BLUE CP/m card w/z-80 | SCALL |

DISK DRIVES

| | | | |
|------------------------------------|-----------|--|----------|
| FOR IBM | | FOR APPLE | |
| PANASONIC/NATIONAL 320K 1/2 height | \$199.95 | ALPS 1/2 height for Apple | \$189.95 |
| TANDON | | RANA ELITE | |
| TM 100-2 | | Elite I | SCALL |
| DS/DD 320K | \$219.95 | Elite III | SCALL |
| TM 55-2 1/2 height | \$219.95 | RANA 1000 | |
| CDC | | For Atari | SCALL |
| CDC 320K DS/DD | \$239.95 | MICRO SCI | SCALL |
| WINCHESTERS | | MAYNARD WB-2 | |
| 10 MEG Internal or External | | Hard Disk For IBM | |
| for IBM | \$1195.00 | 10 MEG Internal 1/2 height, Controller & Power Supply | |
| DAVONG CORVUS | | BONUS—\$70 trade-in on your IBM controller card | |
| QUENTIN TALLGRASS | | ONLY \$1299.95 COMPLETE | |
| Hard Disk Drives | | | |

Special of the Month QUENTIN

DISK DRIVES FOR YOUR APPLE/FRANKLIN COMPUTER **\$199.95** limited quantities

SOFTWARE

| | | |
|---------------------------------------|--------------|------------|
| BUSINESS | APPLE | IBM |
| Lotus 1-2-3 | — | \$319.95 |
| DB Master (version 4) | \$269.95 | \$399.95 |
| DBASE II | \$449.95 | \$449.95 |
| Friday | — | \$199.95 |
| Multiplan | \$189.95 | \$189.95 |
| The General Manager | \$159.95 | — |
| TK Solver | SCALL | SCALL |
| BPI-Gen Acct/Inv/Payroll -Job Costing | \$279.95 | \$419.95 |
| Word w/Mouse | — | \$339.95 |
| WordStar Professional | \$439.95 | \$439.95 |
| Micro Cookbook | \$ 89.95 | — |
| Bank Street Writer | \$ 49.95 | \$ 46.95 |
| Tax Advantage | \$ 46.95 | \$ 46.95 |
| Zaxxon | \$ 29.95 | — |
| Lode Runner/Chopflitter | \$ 24.95 | — |
| Zork I, II, III | \$ 27.95 | \$ 27.95 |
| Deadline/Witness/Planet | \$ 35.95 | \$ 35.95 |
| Flight Simulator | \$ 34.95 | \$ 34.95 |
| Sargon III | \$ 34.95 | — |
| Frogger | \$ 26.95 | \$ 26.95 |
| Temple of Apsah | \$ 29.95 | \$ 29.95 |
| Master Type | \$ 29.95 | \$ 35.95 |
| Kinder Comp/Alphabet Zoo | \$ 23.95 | \$ 23.95 |
| Story Machine/Facemaker | \$ 24.95 | \$ 24.95 |
| Snooper Troops Case #1/#2 | \$ 34.95 | \$ 34.95 |
| HOME/GAMES/EDUCATION | | |
| Home Accountant | \$ 49.95 | \$109.95 |
| Dollars and Sense | \$ 74.95 | \$129.95 |
| Micro Cookbook | \$139.95 | \$139.95 |
| Bank Street Writer | \$ 49.95 | \$ 46.95 |
| Tax Advantage | \$ 46.95 | \$ 46.95 |
| Zaxxon | \$ 29.95 | — |
| Lode Runner/Chopflitter | \$ 24.95 | — |
| Zork I, II, III | \$ 27.95 | \$ 27.95 |
| Deadline/Witness/Planet | \$ 35.95 | \$ 35.95 |
| Flight Simulator | \$ 34.95 | \$ 34.95 |
| Sargon III | \$ 34.95 | — |
| Frogger | \$ 26.95 | \$ 26.95 |
| Temple of Apsah | \$ 29.95 | \$ 29.95 |
| Master Type | \$ 29.95 | \$ 35.95 |
| Kinder Comp/Alphabet Zoo | \$ 23.95 | \$ 23.95 |
| Story Machine/Facemaker | \$ 24.95 | \$ 24.95 |
| Snooper Troops Case #1/#2 | \$ 34.95 | \$ 34.95 |

FOR APPLE COMPUTERS

| | |
|------------------------------|--------------|
| MICROSOFT | |
| Softcard Z-80 | \$249.95 |
| Ram Card 16K | \$ 77.95 |
| ORANGE MICRO | |
| Grappler+ printer inter | \$109.95 |
| Buffered Grappler+ | \$159.95 |
| VIDEX | |
| Video Term 600/801 | SCALL |
| Function Strip | \$ 64.95 |
| Display Enhancer II | \$ 99.95 |
| MICROTEK | |
| Apple Dumping | SCALL |
| Dumping W/16K | SCALL |
| PRACTICAL PERIPHERALS | |
| Micro-Buffer II (16K plus) | \$199.95 |
| ***** | |
| GRAPHICS INTERFACE | |
| For Apple/Franklin | |
| Just Like Grappler | only \$89.95 |
| ***** | |
| KOALA TABLET | \$ 89.95 |
| HAYES | |
| Mach III Joystick | \$ 39.95 |
| T&G | |
| Joystick | \$ 44.95 |
| Paddles | \$ 29.95 |
| Select-a-Port | \$ 44.95 |
| KENSINGTON | |
| System Saver | \$ 69.95 |

MONITORS

| | |
|----------------------------------|-----------------|
| AMDEK | |
| Video 300 Med-Res Green | \$139.95 |
| Video 300A Med-Res Amber | \$149.95 |
| Video 310A Hi-Res Amber | \$179.95 |
| Color I+ Composite | \$299.95 |
| Color II+ RGB | \$399.95 |
| Color III+ Hi-Res Composite | \$419.95 |
| Color IV+ Hi-Res RGB | SCALL |
| USI | |
| PI-2 Med-Res Green | \$135.95 |
| PI-3 Med-Res Amber | \$149.95 |
| NEC | SCALL |
| ZENITH ZVM-123 | \$109.95 |
| ***** | |
| PRINCETON GRAPHICS | |
| HX-12 Hi-Res RGB \$469.95 | |
| for IBM PC | while they last |
| ***** | |
| LEADING EDGE | |
| Gorilla Hi-Res Green | \$ 89.95 |
| Gorilla Hi-Res Amber | \$ 95.95 |
| TAXAN | |
| KG-12N Hi-Res Green | \$139.95 |
| KG-12N-UY Hi-Res Amber | \$149.95 |
| KX-121 Hi-Res Green for IBM | \$169.95 |
| KX-122 Hi-Res Amber for IBM | \$179.95 |
| 420 Hi-Res RGB | \$559.95 |
| Tilt Swivel Base w/Clock | \$ 49.95 |

MODEMS

| | |
|---|--|
| NETWORKER™ | |
| Plug in single slot direct connect modem for Apple II family & Franklin computers with communications software includes subscription to the SOURCE™ | APPLE MODEM w/everything for \$119.95 |
| NETMASTER™ software package \$39.95 w/purchase of NETWORKER™ | |
| D.C. HAYES | |
| Smartmodem 300 BAUD | \$219.95 |
| Smartmodem 1200 BAUD | \$479.95 |
| Smartmodem 1200B W/SCII | \$419.95 |
| Smartmodem Ite W/SC II | \$249.95 |
| Chronograph | \$189.95 |
| U.S. ROBOTICS | |
| 300 BAUD | \$189.95 |
| Auto Dial 1200 | \$449.95 |
| Password 1220 BAUD | \$339.95 |
| NOVATION | |
| J-Cat | \$119.00 |
| Apple-Cat II | SCALL |
| COMPUTER FURNITURE | |
| BUSH | |
| Desk Oak Veneer | \$109.95 |
| Hutch Oak Veneer | \$ 64.95 |
| Printer Stand Oak Veneer | \$ 59.95 |

DISKS/SUPPLIES

| | |
|--|----------|
| Verbatim SS/DD 5 1/4 floppy | \$23.95 |
| Verbatim DS/DD 5 1/4 floppy | \$31.95 |
| Dysan SS/DD 5 1/4 floppy | \$27.95 |
| Dysan DS/DD 5 1/4 floppy | \$36.95 |
| ESK SS/DD 5 1/4 floppy | \$19.95 |
| ESK DS/DD 5 1/4 floppy | \$27.95 |
| Elephant SS/DD 5 1/4 floppy | SCALL |
| Elephant DS/DD 5 1/4 floppy | SCALL |
| Control Data SS/DD 5 1/4 floppy | \$22.95 |
| Control Data DS/DD 5 1/4 floppy | SCALL |
| Library cases holds 10 disks | \$ 1.95 |
| Disk Storage Box holds 70 disks | \$19.95 |
| Flip-n-file 25 holds 25 disks | SCALL |
| Flip-n-file 50 holds 50 disks | \$19.95 |
| Flip-n-file 70 holds 70 disks | \$23.95 |
| ***** | |
| 64K RAM MEMORY UPGRADE FOR IBM PC | |
| \$53.95 | |
| ***** | |
| SURGE SUPPRESSORS | |
| EDP | |
| Lemon | \$ 46.50 |
| Lime | \$ 67.00 |
| Peach | \$ 76.00 |
| Orange | \$105.00 |

NEW
48 HOUR SERVICE



THE COMPUTER-LINE™

Committed to bringing computers within the reach of all Americans

CALL (800) 255-4659 (Outside California)
CALL (800) 541-4300 (Inside California)

When in California, please visit us at:

21054 SHERMAN WAY
CANOGA PARK, CA 91303
CALL: (818) 716-1812

17791 FITCH ST.

IRVINE, CA 92714
CALL: (714) 863-9944

General/Mailorder (714) 863-9988
CUSTOMER SERVICE AND ORDER INQUIRY (714) 863-9933

When in Colorado, please visit us at:

1136 COLORADO BLVD.
DENVER, CO 80222
CALL: (303) 758-3261

TERMS: All prices reflect a 2.9% cash discount. All goods acknowledged faulty on receipt by the customer will be repaired or replaced at our discretion. Customers must call for an RMA number before returning any goods. This facilitates our quick attendance to faulty goods. We reserve the right to repair or return to the manufacturer for repair all goods becoming faulty within the specified warranty period. Any goods (hardware or software) returned for restocking are subject to a 15% restocking fee at our discretion. The charge for cancellation of orders is 20% at our discretion. No returns on software. We accept no responsibility for any false claims made by manufacturers. Prices quoted for stock on hand and subject to change without notice. Specialists in APO and International deliveries. Please add 3% (minimum \$3.00) for shipping. APO add to all prices 5% for shipping (minimum \$5.00). We will calculate exact freight. Please allow a minimum of 2 weeks plus mail time (if an order is mailed in) for receipt of all UPS delivered goods. All goods (other than APO or International) delivered UPS ground. All items listed available for 48 hour service provided products are readily available from the manufacturer.

ALL BRANDS ARE REGISTERED TRADEMARKS

Circle 92 on inquiry card.

computers wholesale

315-472-3055

Box 150 Brewerton, N.Y. 13029

Circle 95 on inquiry card.

We pay UPS shipping charges on prepaid orders.

-PRINTERS-

| | |
|---------------|--------|
| ANADEX | |
| DP-9501 | \$1049 |
| DP-9620 | 1129 |
| DP-9625 | 1225 |
| DP-6500 | 2399 |
| WP-6000 | 2159 |

TEXAS INSTRUMENTS

| | |
|-------------|------|
| TI 850 Par. | 499 |
| TI B55 | Call |

C. ITOH

| | |
|----------------------|-------|
| Prowriter 8510A Par. | \$345 |
| Prowriter B510A Ser. | 455 |
| Prowriter II Par. | 565 |
| Prowriter II Ser. | 739 |

EPSON

| | |
|---------|------|
| RX-80 | Call |
| RX-80FT | Call |
| FX-80 | Call |
| FX-100 | Call |

GEMINI

| | |
|-----|-------|
| 10X | \$295 |
| 15X | 435 |

MANNESMAN TALLEY

| | |
|----------|-------|
| MT-160 I | \$529 |
| MT-160 L | 579 |
| MT-180 L | 859 |
| SPIRIT | Call |

DIABLO

| | |
|---------------|-------|
| 620 RO 25 CPS | \$919 |
| 630 RO 40 CPS | 1769 |

OKIDATA

| | |
|---------------|------|
| ML-82A | Call |
| ML-83A | Call |
| ML-92 Par. | Call |
| ML-92 Ser. | Call |
| ML-93 Par. | Call |
| Pacemark 2350 | Call |
| Pacemark 2410 | Call |

PANASONIC

| | |
|----------|-------|
| KX-P1090 | \$319 |
|----------|-------|

NEC NEW/NEC 2050

| | | | |
|------|--------|------|--------|
| 3510 | \$1399 | 3530 | \$1490 |
| 3550 | 1849 | 7710 | 1899 |
| 7715 | 1949 | 8023 | 399 |

QUME

| | |
|--------------|--------|
| Sprint 11/40 | \$1299 |
| Sprint 11/55 | 1499 |

RITEMAN Informer

| | |
|--|-------|
| | \$229 |
|--|-------|

SILVER REED

| | |
|--------------|-------|
| EXP 500 Par. | \$459 |
| EXP 550 Par. | 659 |
| EXP 550 Ser. | 689 |

Advertised prices reflect a cash discount on prepaid orders only. Most items are in stock for immediate delivery in factory sealed cartons with full factory warranties.

-MONITORS-

AMDEK

| | |
|-------------------|-------|
| Color I | \$275 |
| Color I + | 319 |
| Color II (RGB) | 399 |
| Color III (RGB) | 349 |
| 300 G (12" green) | 135 |
| 300 A (12" amber) | 145 |
| 310 A (IBM PC) | 169 |

BMC

| | |
|--------------------|------|
| 15 MHz (12" green) | \$79 |
|--------------------|------|

NEC

| | |
|---------------------|-------|
| JB-1260 (12" amber) | \$109 |
| JB-1201 (12" green) | 135 |
| JC-1212 (12" color) | 339 |
| JC-1203 (12" RGB) | 549 |

PANASONIC

| | |
|----------------------|-------|
| 12" Green Monochrome | \$169 |
| 12" Amber Monochrome | 179 |
| 13" RGB | 389 |

SAKATA

| | |
|-------------------|------|
| SG-1000 12" Green | \$99 |
| SC-100 13" Color | 269 |
| SC-200 13" RGB | 499 |
| SC-300 13" RGB | 659 |

TAXAN

| | |
|--------------------------|-------|
| KG 12N (12" green) | \$129 |
| RGB Vision I (12" color) | 299 |
| RGB for Apple II E. | 299 |
| RGB for Apple II E BD | 99 |

ZENITH

| | |
|-------------------|-------|
| Z-122 (12" amber) | \$139 |
| Z-123 (12" green) | 109 |

-HARD DISKS-

CORVUS

| | |
|----------------|--------|
| Omninet 6 | \$1695 |
| Mirror Back-up | 670 |
| Print Server | 839 |

TALLGRASS TECHNOLOGIES

| | |
|-------------------------------|------|
| 20MB Hardfile Disk for IBM-PC | 2695 |
| 70MB Hardfile Disk for IBM-PC | Call |

-DISKETTES-

Maxell

| | |
|------------|---------|
| 5 1/4" MD1 | \$22.95 |
| 5 1/4" MD2 | 32.95 |

3M/Scotch

| | |
|-------------|---------|
| 5 1/4" SSDD | \$21.95 |
| 5 1/4" DSDD | 28.95 |

Educator

| | |
|------------------------------|---------|
| Lifetime Warranty | |
| 5 1/4" SSDD | \$16.95 |
| 5 1/4" DSDD | 22.95 |
| Flip 'n' File/holds 50 Disks | 17.95 |

-BOARDS-

IBM PC BOARDS

| | |
|------------------------------|-------|
| Amdek MAI Graphics Board | \$479 |
| AST Sixpak plus 64k | 299 |
| AST Megaplus 256k | 569 |
| CCS 132 Column Board | 589 |
| Microsoft 256k RAM Board | 399 |
| Plantronics Color + Board | 399 |
| Quadrarm New Quadboard | Call |
| Quadrarm Quadlink Board | Call |
| Tecmar 1st MATE Board | 229 |
| Tecmar Graphics Master Board | 569 |
| PC Peacock | 329 |
| 64k Chip Kit (9 Chips) | Call |

-SYSTEMS-

COLUMBIA

| | |
|-----------------|------|
| VP Portable | Call |
| MPC | Call |
| MPC w/Hard Disk | Call |

CROMEMCO

| | |
|--------|------|
| CS-1 | 3195 |
| CS-2 | 3755 |
| CS-3 | 5595 |
| 64 FDC | 475 |
| TUART | 255 |

EAGLE

| | | | |
|-------------|--------|-----------|---------|
| II E Series | | PC Series | |
| II E-1 | II E-2 | PC-12 | PC-1 + |
| II E-3 | II E-4 | PC-2 + | PC-XL + |
| 1600 Series | | SPIRIT | |
| 1620 | 1630 | Portable | |

Call us today for the best prices!

BMC If800

1395 COMPLETE BUSINESS SYSTEM!

MORROW

| | |
|------------------------------------|------|
| New Portable w/2 Drives & Software | Call |
| MD11 w/H Disc & Software | Call |

NEC

| | |
|---------------------------------|------|
| PC-8201 Portable | Call |
| PC 8800 Small Business System | 1669 |
| PC-8801 A Computer | Call |
| PC-8831A Dual 5 1/4" disk drive | Call |

NORTHSTAR

| | |
|-----------|------|
| Advantage | Call |
|-----------|------|

SANYO

| | |
|----------|--------|
| MBC 1200 | \$1299 |
| MBC 1150 | 1499 |
| MBC 550 | Call |
| MBC 555 | Call |

TELEVIDEO

| | |
|----------|--------|
| TS-803 | \$1989 |
| Portable | Call |

ZENITH

| | |
|-----------|--------|
| ZF-100-21 | \$2319 |
| ZF-120-22 | 2869 |
| ZF-120-32 | 4479 |

-TERMINALS-

ESPRIT SYSTEMS

| | |
|---------------|-------|
| Esprit | \$489 |
| Esprit II | 499 |
| Esprit III | 649 |
| Exec. 10/102 | 799 |
| Exec. 10/102G | 1249 |

New! Televideo Personal Terminal

| | |
|-------------------------------------|-------|
| Personal Terminal | \$399 |
| Personal Terminal w/300 band modem | 529 |
| Personal Terminal w/1200 band modem | 849 |

TELEVIDEO

| | |
|-----|-------|
| 910 | \$439 |
| 914 | 579 |
| 924 | 695 |
| 925 | 699 |
| 950 | 865 |
| 970 | 929 |

QUME

| | |
|-----|-------|
| 102 | \$569 |
| 108 | 715 |

WYSE

| | |
|----------|------|
| 50 | Call |
| 75 color | Call |

ZENITH

| | |
|--------|-------|
| Z-29 | \$659 |
| ZTX-10 | 319 |
| ZTX-11 | 389 |

-MODEMS-

HAYES

| | |
|------------------|------|
| Smartmodem 300 | 199 |
| Smartmodem 1200 | 498 |
| Smartmodem 1200B | Call |

NOVATION

| | |
|-------------------|-------|
| D-Cat | \$149 |
| J-Cat | 99 |
| Apple Cat II | 269 |
| 103 Smart Cat | 179 |
| 103/212 Smart Cat | 399 |
| Access 1-2-3 | 449 |

SIGNALMAN

| | | | |
|--------|------|-------------|------|
| Mk II | \$75 | Mk VII | \$95 |
| Mk XII | 279 | Volks-modem | 59 |

U.S. ROBOTICS

| | |
|-----------------------|-------|
| 300 Baud Password | \$149 |
| 1200 Baud Password | 329 |
| PC 1200 Baud Modem | 329 |
| S-100 1200 Baud Modem | 329 |

N.Y. residents, add appropriate sales tax. We accept VISA and MasterCard. Personal and Company checks, allow 2 weeks to clear. C.O.D.'s require a 25% deposit. All prices and offers may be withdrawn without notice.

Designing Systems for Real-Time Applications

Some pointers to keep in mind before you tackle a real-time design

James Isaak

Charles River Data Systems

A real-time system is one that responds immediately to your commands and processes data as soon as the data is produced. The opposite of a real-time system is a batch system, which batches commands together and processes them en masse, with no concern for immediate response.

Most personal computer users are familiar with applications that require some real-time operations. For instance, simple text editing or word processing must provide timely response to keystrokes and commands to prevent user frustration. Games require even more demanding real-time characteristics.

Applications that involve audio-frequency monitoring are quite demanding. To accurately sample data where the frequency is 15,000 Hz (moderately high fidelity—my stereo does 20 kHz, my ears do 12 kHz) requires 30,000 samples per second. Program-controlled sampling can often go no higher than 1000 to 5000 samples per second, so audio monitoring clearly requires specialized hardware and DMA (direct memory access) devices.

When designing a real-time system, you need to consider the performance of the hardware and the operating system. By hardware I mean the processor chip, the bus

structure, the memory-management scheme, and the interfaces to the outside world. By operating system I mean the program that directly controls your hardware and acts as the interface between your application program and the hardware.

Hardware

Eight-bit processor chips are ideal for character processing and low-precision analog work. However, they have limited performance when greater precision or address space in excess of 64K bytes is needed.

Sixteen-bit microprocessors match the precision of the most common A/D (analog-to-digital) converters (with 10-, 12-, and 14-bit A/D converters most common). Unfortunately, microprocessors often run into address-space limitations when a large volume of data is needed.

The popular 32-bit microprocessors offer a large, linear address space, fast cycle times, and efficient program-processing characteristics. These are *essential* to success in real-time operations.

A factor in performance that goes beyond the speed of the processor chip is the delays the processor encounters in fetching data from memory. One example of this is the TRS-80 Model 16, which has a

relatively slow 68000 processor but which encounters little delay in fetching data from memory because it has memory directly on board the processor. The Exormacs computer uses a higher-speed 68000 chip, but it has greater fetch delays due to the use of a standard (Versabus) memory interface and slower RAMs (random-access read/write memories). A second example is the Universe 68 computer. When using the memory bus (which is also a Versabus), it has one rate of processing. However, when using the 4K-byte cache memory, an onboard fast memory, it has double the instruction-processing rate.

The second hardware factor in designing a real-time system is the system bus. A good system bus allows a range of interfaces as well as sufficient bandwidth so that the system can accomplish all tasks within a reasonable time. If all the interfaces required are on the basic system (as in a single-board computer), the system bus is not an issue. But the variety of real-time applications and the special nature of some of the interfaces deem this unlikely.

Only three design choices are currently available for nonproprietary 32-bit buses: Versabus, VME, and Multibus. Versabus and VME have the largest number of available inter-

faces because they are older buses. Adapters permit the use of the smaller VME and Multibus boards in Versabus card cages, which gives this bus an additional short-term interfacing advantage.

A real-time system's memory-management design must be as carefully considered as the processor and system bus. Where performance is a critical issue, memory response time must be reduced. Some of the factors that influence memory response time are memory-management logic, bus drivers, dynamic-RAM refresh logic, and error-detection and error-correction circuits.

We shouldn't forget the real-time clock or timer circuit—traditional elements of real-time environments for good reasons. One of these is needed if time-related operations or rigid time intervals are involved. However, time-out logic is also needed to avoid deadlock and other error conditions. For example, in a game that uses multiple sprites (moving graphics image units), where the images associated with two different sprites attempt to affect the same item (say, eating a cookie) but only one can be allowed to do the task, a locking mechanism is needed. Either sprite A is locked out and sprite B has access, or vice versa. Given a bit more complexity, it's possible to have A locked out waiting for B, B locked out waiting for C, and C locked out waiting for A. With everything locked, all activity ceases. One way to detect this condition is a time-out that allows a program to regain control and determine if such a deadlock has occurred. Another way is for a task to release any items it has in case of time-out so that another task can continue.

In many real-time applications, the computer must be connected to a remote device (or another computer) via a serial port. This has become increasingly popular with the many low-cost processors being built into data-collection and display devices. RS-232C and RS-422A are the most common types of connections. RS-422A can operate over longer distances and with better noise immunity than can RS-232C. For exam-

ple, 50 feet is the limit on an RS-232C interface operating at 9600 baud, but an RS-422A interface can easily run up to 4000 feet at this same rate.

The control lines in RS-422A and RS-232C cables are heavily used in real-time applications to provide essential flow control over data transmission. For many system configurations, read, write, and ground are the only required lines in a connection.

Some real-time system designs employ software routines such as the XON/XOFF sequence (usually Control-S/Control-Q) to control data communication flow. This routine sends a character back up the line to instruct the transmitting system to stop sending data. A second character indicates that data transmission is to

Some real-time tasks can be accomplished only by programs that directly control the computer.

resume. Full-duplex data transmission (simultaneous data reception and transmission) requires multitasking capability to monitor the receive data line while transmitting to ensure that a control signal or message is not received that could change or affect the transmission in progress. For those communications ports that do not support full-duplex communications (which prevents the use of the XON/XOFF controls), slower baud rates ensure successful transfers but hurt the real-time power of the system.

The Operating System

Some real-time tasks can be accomplished only by programs that directly control the computer with no intervening operating system. However, as long as your task can tolerate the delay, it is better to use one of the standard operating systems now available.

The ideal operating system would have multiuser, multitasking, and real-time capabilities. Incidentally, multiuser development is advantageous even for single-user systems

because it allows the execution of several simultaneous tasks, for example, editing one program while another is being compiled. Unix is an example of an excellent multitasking operating system, although it is not suitable for many real-time tasks. However, modified Unix and Unix-compatible systems that do provide real-time facilities are available. An example is the HP/Unix system, which has a real-time kernel written by Hewlett-Packard that interfaces at the system-call level to Unix. Another example is the Unos operating system.

For real-time tasks, the operating system must let the programmer have control of I/O (input/output) devices, physical memory, task priorities, exception processing, and data integrity. A programmer must control I/O devices to monitor and control the computer's peripherals. PEEK/POKE control is one form of this, but often a task is set up to run when an external condition changes, such as when the user pushes a button or the fire alarm sounds. For this, the system must provide an interrupt facility and the ability to pass control back to a specific user task.

Control over physical memory is needed to avoid swapping and to control data flow. Swapping, the automatic exchange of information between memory and a mass-storage device, can result in a change of memory location or, worse, in significant delays when that fire alarm sounds and the service task cannot be swapped back into memory. The ideal operating system would let the programmer inhibit swapping and identify and control physical-memory areas for buffering data from I/O devices. Sharing these areas between tasks can be essential when one task performs data input, a second scales the data, a third records the normalized data to disk, a fourth analyzes data for statistical evaluation, and a fifth uses the current statistics to control an external device. Shared memory and asynchronous operations are needed for this to work efficiently.

In the preceding example, the programmer must be able to control the priorities of tasks to make sure that

UNOS Structure

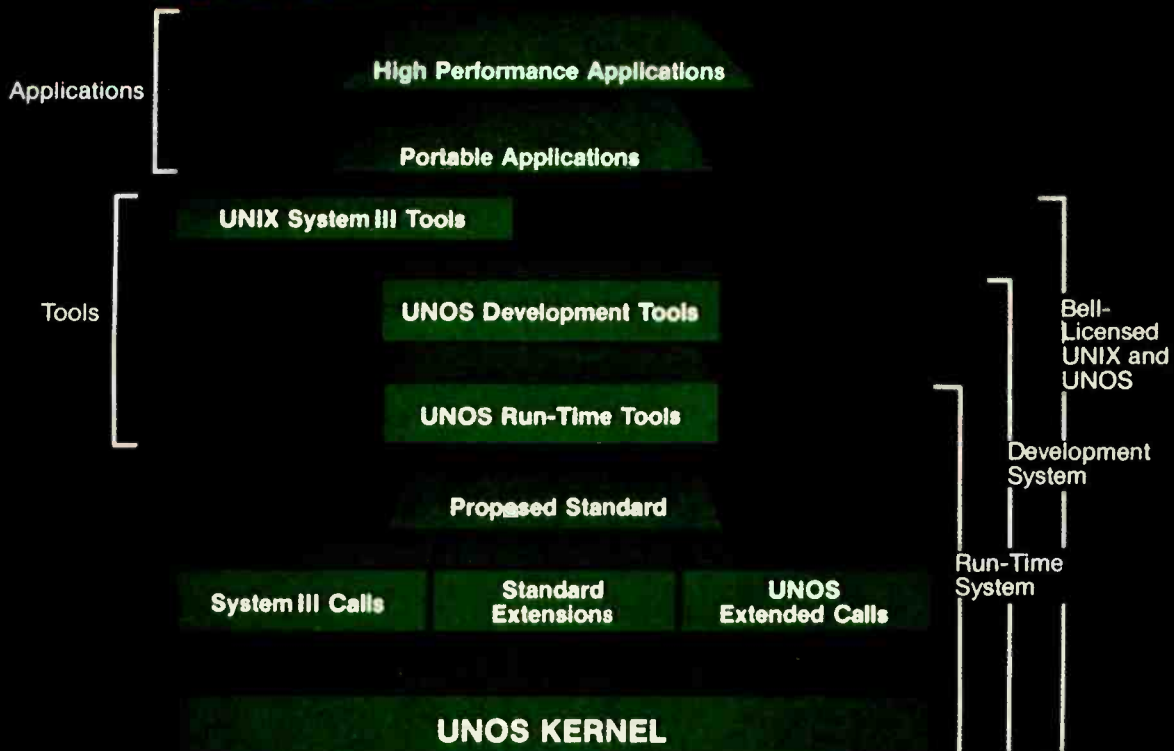

Figure 1: An example of task scheduling by the Unos operating system.

the real-time tasks are not stopped in favor of a less important task. Priority control mechanisms let the programmer decide and control which tasks get the processor. In the ultimate real-time system, each task is guaranteed a worst-case delay to ensure that the task has enough time to complete its job when activated. As with any other real-world situation, Murphy usually gets his way, and this has to be taken into consideration when setting task priorities. Some tasks simply may not be completed.

An operating system should provide dynamic priority-scheduling of tasks. In Unos, a Unix-like operating system, each task has a ceiling and floor priority with the numeric value of the ceiling greater than or equal to the floor. Normal timesharing users get a 100-10 assignment. A user can lower either value, but only privileged users can raise the values. If a timesharing task becomes compute-bound (completes a time slice with-

out waiting for I/O), it is automatically dropped in priority so it will not interfere with interactive users. The example in figure 1 starts with the real-time task running at priority 200. A real-time task would have the floor and ceiling equal and swapping disabled for that task. When the task at the higher 255 priority is ready to run, it preempts the 200-level task and starts running. When both of these block, the processor is again available to time-slice between the timesharing users at priority 100. With these tasks blocked, tasks at levels 10 and 5 get an occasional shot. For tasks on the same level, round-robin scheduling is used, with either time slicing or blocking being the method of passing control. If a real-time task becomes compute-bound, it can use all the resources it needs to the exclusion of other tasks. This is essential in giving real-time tasks the control they need and explains why the raising of priority levels is a privileged operation.

If no abnormal conditions existed, exceptions would not occur, and real-time programming would be incredibly simplified. But the nature of real time ensures that many error conditions may occur. These require an additional level of asynchronous control by the programmer. In process-control-related tasks, lost control is fatal to the success of the application. This means checking for all obvious error conditions related to program operations (e.g., I/O errors and arithmetic overflow/underflow). Also, the program must be prepared to trap a number of other error conditions that are not related to its immediate operations. This includes conditions such as communications-line errors, disk and/or memory errors, and power failures.

Programmers can maintain control over data integrity if the operating system forces critical data to a disk in the event of a system failure. A power failure is only one example of an external event that can have a severe

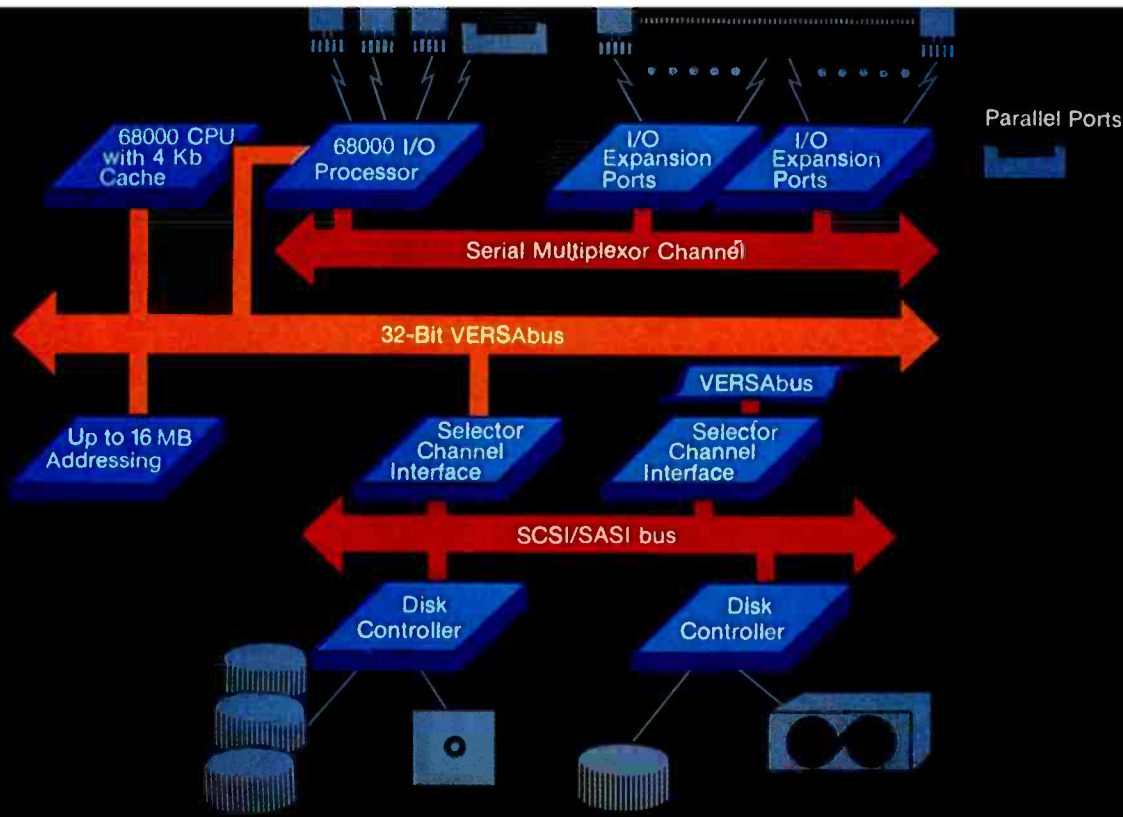

Figure 2: The components of delay in a computer as it attempts to respond to a real-time event.

impact on the integrity of the data being collected. You can expect to lose RAM to this or other failures; so, for real-time processes, a mechanism is needed for determining what data has been lost and what data is still valid. The worst case is exemplified by the many systems that have actually lost the integrity of their entire disk-file system after an abnormal termination. In that case, all data is lost, even that successfully written to and stored on disk. This can be avoided with data-integrity features in the operating system.

Performance Measurement

Two major areas of performance measurement are interrupt latency and context-switching time. Interrupt latency is the longest time that the computer takes to act on a single interrupt. Only the highest-priority interrupt (which is usually called non-maskable because it must be acted upon, that is, it cannot be "masked out") is always acknowledged within

the interrupt-latency period. Lower-priority interrupts must wait if a higher-priority interrupt is active.

Context-switching time is the time required to stop execution of task A, save that task state, and restore the state of and start task B. This switch might occur as a result of an interrupt, a synchronization signal between tasks, or a time slice. Note that the number quoted in some micro-processor ads simply reflects the switch between the user mode and system mode and does not include the overhead needed to enter a second user task.

If the real-time application requires sampling data at a high rate, the context-switch transition can be a limiting factor. A millisecond (ms) response time would limit processing to 1000 samples per second. To improve this, data can be buffered in the driver (with 50-microsecond (μs) overhead, or a limit of 20,000 samples per second) and the application task given control on every n th sample.

Notice that the limits of 1000 or 20,000 samples per second imply that the system performs no other functions, no time-of-day updates, no disk I/O, and no computations. This, then, does not provide a practical limit but rather a way to measure the percentage of utilization that a specific application requires.

The interrupt latency and context switching, along with other factors such as the application program, determine the elusive and overused term—response time. It entails a few measurable time delays and a number of application-code-related delays. The result is a response-time measure that becomes quite dependent on the actual application, and it cannot be predicted in advance.

In figure 2, the delays encountered by an external interrupt are

1. The hardware delay in signaling the processor. Daisy-chaining of interrupts can delay this, as can the current bus cycle. Interrupt

Bringing Information to light.™

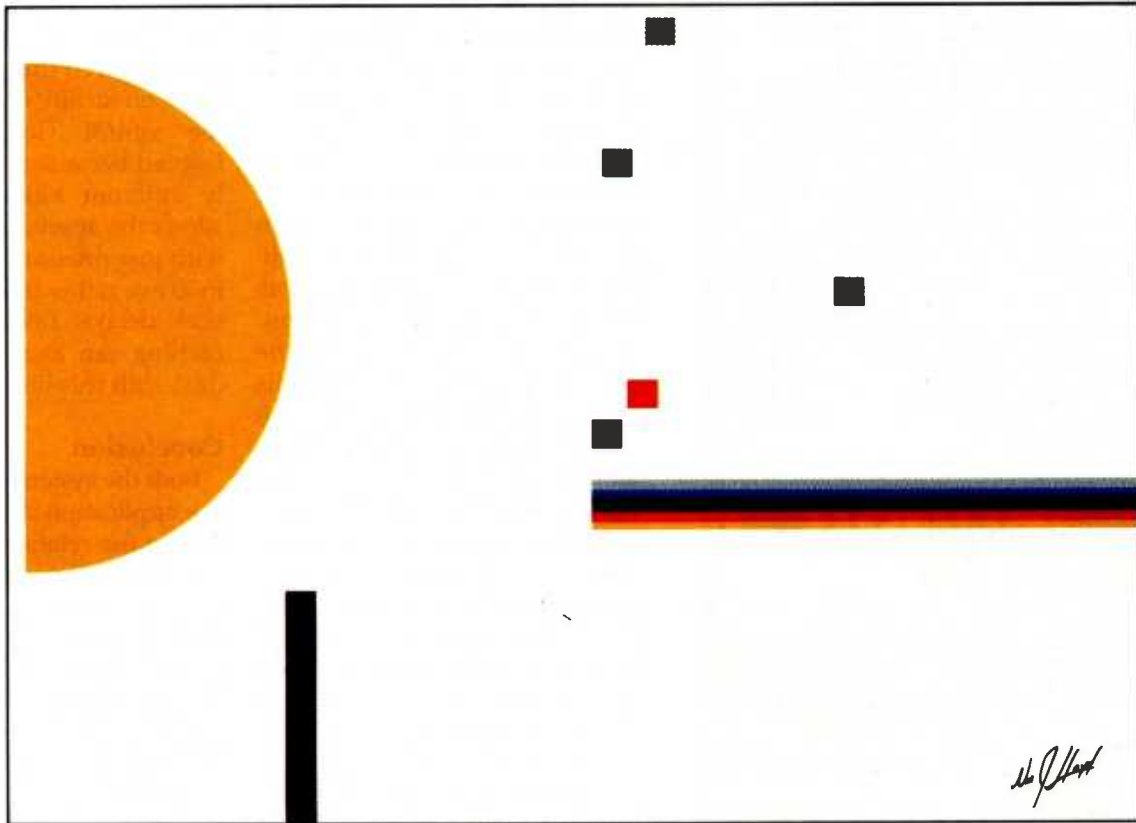

Would da Vinci have settled for a Crayon?

A great artist must command his tools and his medium to fully express his creativity...to solve his design problems. To solve information problems, you need to command an information management system that allows you the flexibility to design solutions tailored to your needs.

Data Spectrum™, is a comprehensive and powerful information management system for business and personal use that goes beyond "user friendly" to downright "people affectionate."

Data Spectrum is the master work of information management. It allows you to customize the organization of information to your specific needs. To search, sort, analyze, edit, evaluate and merge files as you want. And even to generate forms, reports, labels and standard letters.

All menu driven. All built in. With special features like "RAPID TRANSIT": A new file management approach that processes smaller files at blinding speed and automatically switches to "LARGER FILE ORIENTATION" to handle larger files.

Destined to set a new standard in the industry, Data Spectrum's on-screen tutorial blends text,

graphics, humor, sound and animation to lead the user through the concepts, uses and operating techniques of this innovative software package.

On-screen tutorial and powerful program functions make Data Spectrum the universal information management system and problem solver. And a work of art. Our program up-date service and information "Hot-Line" will keep it that way.

So if you are looking for solutions rather than just software, Data Spectrum will bring them to light.

Write or call us for your nearest computer dealer carrying Apple or IBM versions of Data Spectrum. If there is no dealer in your area, you can order Data Spectrum directly from us...with a full money back guarantee. 1-800-323-6902 Illinois Residents 312-298-0997. Advanced Business Computing, Inc. 1580 N. Northwest Highway, Park Ridge, IL 60068-1471.

Apple is a registered trademark of Apple Computer Inc.
IBM is a registered trademark of International Business Machines Corporation

Heart of TEXAS COMPUTER SYSTEMS

TRS-80

We carry the full line of TRS-80 computers, plus TCS upgrades. Call for our low discount prices.

Model 100 Briefcase size. **CALL**

Model IV Portable: CALL

Model 12, 16 at discount: **CALL**

TCS Model 12 with 2 drives: **\$2995**

Model 12/16 Accessories/discount.

TCS Model IV, 64k, 2 Drive, w/RS-232

\$1485 (40 track) \$1685 (80 track)

The New TRS-2000: CALL

Four times as fast as the IBM-PC, twice the floppy disk capacity. MSDOS compatible. A great machine and we have a great price. Call.

DISK EXPANSION

| | M-III | M-IV |
|--|-------|-------|
| 1 Controller, Pwr. Sup. Hdwr., Instruct. | \$249 | \$329 |
| 2 Kit 1, plus 1/40-trk. Tandon Dr. | \$429 | \$479 |
| 3 Kit 1, plus 2/40-trk. Tandon Dr. | \$589 | \$649 |
| 3a Kit 3 w/2 80 trk.drives (dual sided 40s) | \$698 | \$729 |

Model IV needs 64K to operate. For 64K Kit, CALL.

Tandon

Quality disk drives—O.E. brand on IBM
Available bare and in cabinets.

TM100-1: \$159

TM100-2: CALL CALL US IF YOU FIND LOWER PRICES!

CORVUS

25% OFF LIST PRICE!

OMNINET—A high speed multi-user network that connects several computers for instant communication up to 4,000 feet away.

Save over **\$1,000** on a 20 mg. Corvus Hard Disk system for IBM PC and other computers.

5mg. \$1649 10mg. \$2279 20mg. \$3049

DAVONG Systems, Inc.

Single user or networking hard disk system for IBM & Apple. Lowest prices anywhere. Priced from **\$1375**. 10, 15, 21, 32 mg. & cartridge tape backup—CALL.

Star PRINTERS

Fast, dependable, versatile, low price.

Gemini 10X 9in., 120cps, Friction/Tractor

Gemini 15X 15in., 120cps, Friction/Tractor

DISKETTES \$1.70

CompuDisk, high quality mini floppy disks from \$1.70. Compare our prices. Disks come complete with hub rings, protective envelopes, write protect tabs, adhesive labels. Fully tested. Certified 100% Error Free. Guaranteed. SSDD or DSDD. Boxed or in Bulk. CALL.

Heart of TEXAS COMPUTER SYSTEMS

P.O. Box 1327 Arlington, TX 76004

Toll Free 1-800-433-5184

Texas 1-817-274-5625

VISA, MC, cashier's check, Money Order. No tax out of state. Texans add 5%. Prices subject to change.

- masking, disable logic, and priorities can all add delays. If the interrupt is not of high enough priority, or if it is currently masked or disabled, it will wait.
2. Saving the previous state of the processor on a system stack somewhere. Operating systems often take control at this point to save even more information to make sure the previous state can be recovered and continued.
 3. The device driver, which uses some convention to indicate the occurrence of an event. It then releases control, with some additional overhead needed to restore the previous state of the system. The previous state may be the service of another interrupt; this could continue for a while, with various delays and additional interrupts, before any processing occurs at the user's task level.
 4. Operating-system housekeeping. These delays can be quite substantial. (One minicomputer "real-time" operating system I have used quite often can produce multiple minutes of delay at this point!) The highest-priority task that is ready to run needs to be identified now, and this may require a context switch. The context switch saves the state of the previous operating task and allows a new (presumably higher-priority) task to take control. This time is one that can be measured.
 5. The user's task itself. If swapping from disk is required to load the user's task, the delay may be greater than 100 ms.

A number of techniques can improve performance. By moving the sampling logic to a DMA controller and moving blocks of data to main memory with interrupts every 100th or 1000th sample, the host processor has more time for its operations. Similarly, addition of hardware to perform floating-point calculations or array processing can provide additional performance boost. Finally, the disk-interface hardware can limit the data logging and output rate. For a disk, system facilities that allow an

application direct control over disk blocking, and the creation and use of contiguous disk files, can significantly increase performance. For some microsystems, all the files are contiguous and are limited in size and dynamic growth by this characteristic. In larger systems such as Unix, this reverses, with dynamic growth given the preference and little or no facility for contiguous disk-file control. Contiguous files are favored because the use of physically adjacent blocks of disk space allows the application to transfer data with just rotational delays, usually 2 to 10 ms, rather than the 10- to 100-ms seek delays. Faster disks and disk caching can also provide a way to deal with this limit on performance.

Conclusion

Both the systems manufacturer and the application developer must fully realize the relationship between the hardware and operating system if they expect to develop products for the real-time world. While processor performance is only one element of this, careful hardware design using higher-performance buses and accelerators such as cache, memory management, and arithmetic processors is quite critical. Once the hardware is defined, the operating system (and language used) must be able to take advantage of that hardware and give the programmer efficient control over the real-time environment. Finally, the application program must take into consideration not only all the hardware characteristics but those exceptional conditions that are almost guaranteed to occur. This will ensure that the application does not get caught in slowdowns related to memory control, addressing, priority, device drivers, abnormal conditions, and/or other applications that should not be affecting the real-time process. ■

James Isaak (983 Concord St., Framingham, MA 01701), the director of product marketing for Charles River Data Systems, has an M.S.E.E. from Stanford University. He enjoys camping, skiing, and canoeing. He also likes to spend some of his leisure moments with personal computers as applied to genealogical work.

CAN YOU NAME THE WORLD'S THIRD LARGEST SUPPLIER OF PERSONAL COMPUTERS?



Naming the two largest suppliers of personal computers is easy.

The third one is a little harder. It's NEC.

That's right. NEC is the world's third largest PC supplier.*

We're not talking about video game players that double as computers.

We're talking about serious business computers that cost between \$1,000 and \$5,000. Like our APC Advanced Personal Computer.



THERE ARE HUNDREDS OF SOFTWARE PACKAGES THAT RUN ON NEC'S ADVANCED PERSONAL COMPUTER.

Our Advanced Personal Computer is graphically better.

The main reason we sell so many personal computers is that we offer so much.

Take, for example, our APC.

The APC is faster than both the IBM PC and Apple. It has more storage capacity.

And it offers the sharpest color graphics of any PC at any price.

The APC also has advanced communications capabilities that let it work with all major mainframes.

All in all, the APC is simply your best buy.

Every NEC APC personal computer comes with a \$6.1 billion company.

Buying an APC means you'll get the full support of a \$6.1 billion company. NEC.

And that means you get the service, technology and reliability that NEC is famous for.

decision, call NEC Information Systems at 1-800-343-4419.**



NEC'S PERSONAL COMPUTERS ARE BEING USED BY TENS OF THOUSANDS OF BUSINESSES WORLDWIDE.

The kind of service and support that's made our Spinwriter family the world's best selling letter quality printers for personal computers.

Is NEC on your bid list?

If we're not on your bid list, we should be.

But ask your Data Processing Manager to be sure. If you'd like more information to make your

You'll find out why more and more personal computer users are saying "NEC and me."

NEC AND ME



NEC Information Systems, Inc.

1414 Massachusetts Ave.
Boxborough, MA 01719



NEC'S ADVANCED PERSONAL COMPUTERS HAVE THE SHARPEST COLOR GRAPHICS IN THE INDUSTRY.

*Source: Dataquest
**In Massachusetts, 617-264-8635

© The Apple Logo is a registered trademark of Apple Computer, Inc.

Circle 276 on inquiry card.



Storage Master™
Is Here.

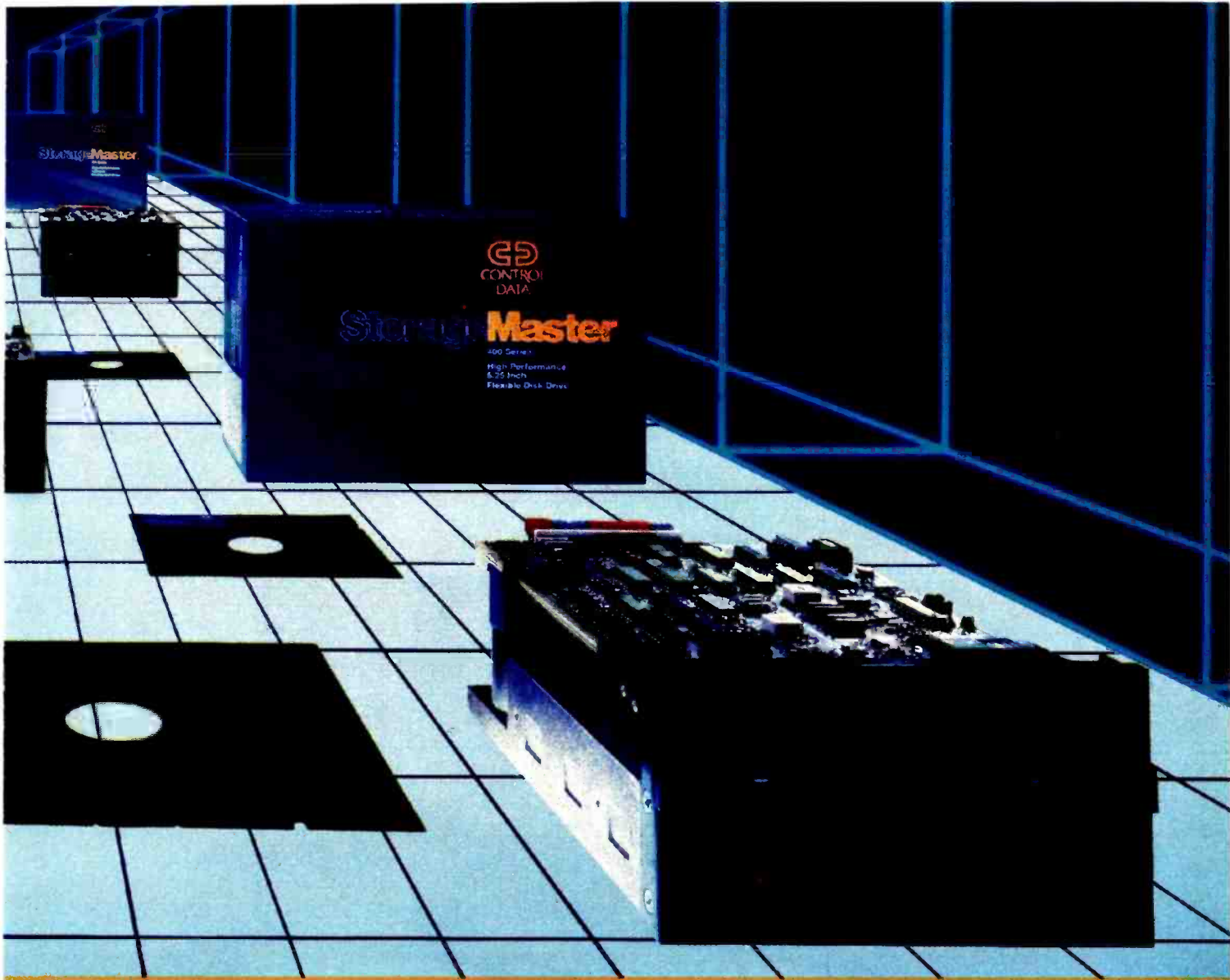

Now you can buy the flexible disk drives preferred by major computer manufacturers.

Introducing the perfect partner to the IBM PC—StorageMaster 400 Series 5.25 inch flexible disk drives. They're completely compatible with IBM PCs.

Now, for the first time you can own the whisper quiet flexible disk drive that's only been available to computer manufacturers. From Control Data, the leading independent supplier of peripherals. Which means that StorageMaster drives come to you user-tested in the toughest laboratory around—on the job, in hundreds

of thousands of computer systems worldwide.

That's one good reason to buy StorageMaster products. There are others. Control Data's been in the computer business for over 25 years. We've earned a solid reputation for quality and reliability—at prices that mean real value.

Look to StorageMaster diskettes for the best in flexible media too!

Control Data StorageMaster brand diskettes are known for their high quality and consistency. Each diskette is 100% certified and backed with a full

5-year warranty. Now with StorageMaster, you can use the top of the Control Data line in flexible diskettes—made to the same exacting standards as the StorageMaster disk drives. Look for StorageMaster products in your local computer store or for more information call toll-free 1-800/232-6789. In Minnesota call 612/921-4400 ext. 41.

**CONTROL
DATA**

BASF QUALIMETRIC™ FLEXYDISKS® BUILT FOR ETERNITY - WARRANTED FOR A LIFETIME.

BASF Qualimetric FlexyDisks® offer you more...an extraordinary new lifetime warranty. The BASF Qualimetric standard is a dramatic new international standard of quality in magnetic media...insurance that your most vital information will be secure for tomorrow when you enter it on BASF FlexyDisks today.*

We can offer this warranty with complete confidence because the Qualimetric standard reflects a continuing BASF commitment to perfection...a process which begins with materials selection and inspection, and continues through coating, polishing, lubricating, testing, and 100% error-free certification. Built into our FlexyDisk jacket is a unique two-piece liner. This BASF feature traps damaging debris away from the media surface, and creates extra space in the head access area, insuring optimum media-to-head alignment. The result is a lifetime of outstanding performance.

When your information must be secure for the future, look for the distinctive BASF package with the Qualimetric seal. Call 800-343-4600 for the name of your nearest supplier.

Circle 48 on inquiry card.

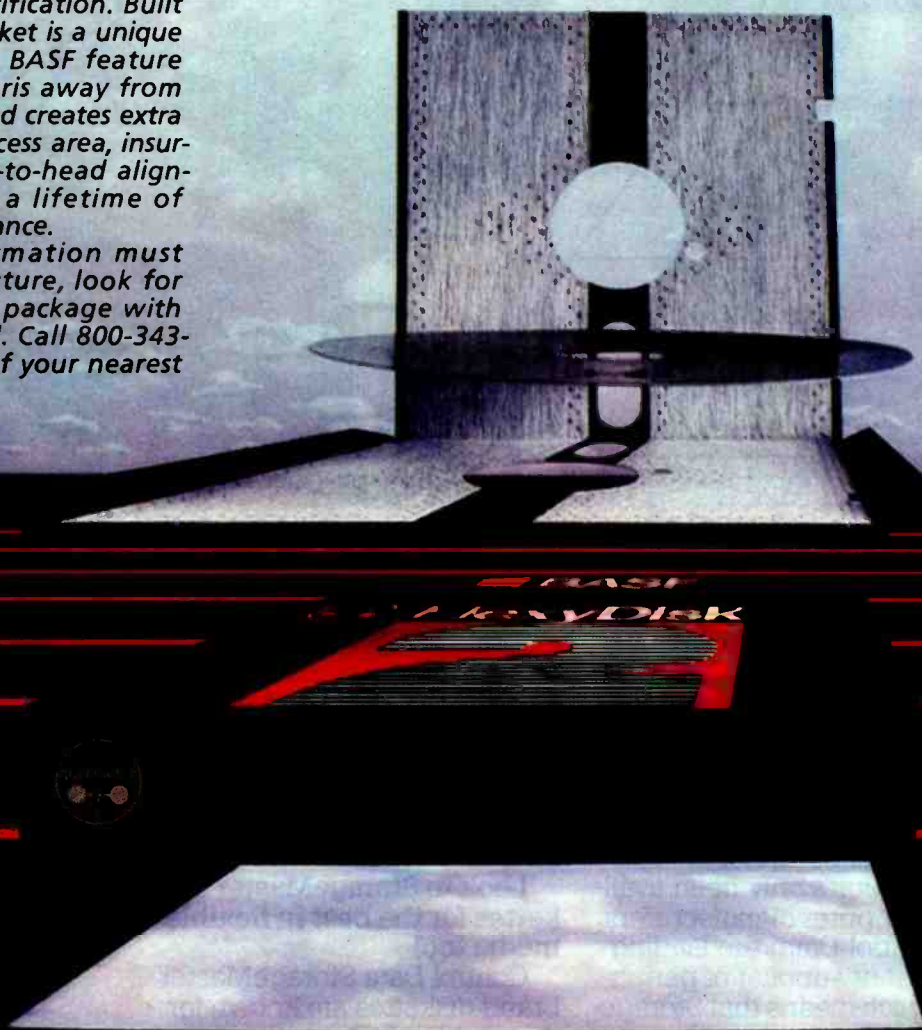

ENTER TOMORROW ON BASF TODAY



*Contact BASF for warranty details. © 1982 BASF Systems Corporation Bedford, MA

Interfacing for Real-Time Control

Appropriate interfacing simplifies design of a telescope system

Russell M. Genet, Louis J. Boyd, and Douglass J. Sauer
Fairborn Observatory

Interfacing microcomputers to external devices becomes more important when control signals must be generated in rapid response to external events in the real world. Although a nearly direct connection of microcomputers to external control devices is simplest from a hardware viewpoint, adding some hardware "smarts" to the interface often can reduce software complexity. A large variety of commercial plug-in cards facilitates the microcomputer-to-control-device interface, but use of these cards requires either a microcomputer with slots for cards (e.g., the Apple II or IBM Personal Computer) or a standardized bus such as the S-100, the STD bus, or the Q-bus.

Using smart interface hardware with a real-time control system often can reduce software work because a high-level language can be used. Without such an interface, much of the software may have to be done in assembly language due to the fast, time-critical requirements for system response. However, increasingly sophisticated non-bus single-board computers are giving bus-oriented systems competition in some applications.

In addition to the considerable

gains realized from traditional trade-offs between hardware and software in the microcomputer control system itself, further gains are possible if the real-world system to be controlled can be adapted somewhat to live gracefully within the limitations of microcomputer control systems. The ability to design from scratch the external system to be controlled and its microcomputer control system can significantly reduce the complexity of both the control system's hardware and software. With existing systems this is not always possible, but modifications in one or two critical areas are worth considering.

We will illustrate the trade-offs involved in real-time control interfaces with the two automatic telescopes at the Fairborn Observatory. The system at Fairborn Observatory West (in Arizona) is based on a non-bus single-board computer, and the system at Fairborn Observatory East (in Ohio) utilizes the STD bus. Both systems use interface hardware to simplify the software. The telescopes and instruments (photoelectric photometers) in both systems have been designed or modified to make microcomputer control as simple as possible.

Heretofore, the few automatic tele-

scopes in the world that could measure a sizable number of different stars were extremely expensive and utilized mainframes or minicomputers. By using microcomputers, designing the telescopes specifically for microcomputer control, and making a careful trade-off between control-system hardware and software, we reduced the effort and cost by one or two orders of magnitude. This is the bottom line of this article—trying to solve control-system problems with microcomputers and appropriate hardware/software trade-offs. You may find, as we have, that the low cost and simplicity of a well-designed microcomputer-controlled system can benefit an entirely new universe of users. In our case, microcomputer control has moved automatic telescopes from the large observatories to the realm of the small college and advanced amateur observatories.

Hardware and Software Trade-offs

There is a natural tendency, often expensive and occasionally disastrous, to make hardware as simple and inexpensive as possible and to place the burden on software development. Hardware costs are both im-

mediate and obvious; software costs are off in the future and less obvious, especially to optimists. Many real-time control projects have been abandoned in failure when it finally became clear that the software programming would take much more time and money than originally anticipated.

Taking the burden off software development and placing it on interface hardware is what standardized buses with plug-in slots are all about. Such bus-based microcomputers can cost more than those without standardized slots of some sort, but this investment can open up the world of ready-to-go plug-in interface cards. Such cards come fully assembled and debugged. The better ones have excellent documentation and have been burnt in.

Many of these interface cards are very intelligent, with their own microprocessors and machine-language programs in EPROM (erasable programmable read-only memory). The software work has been done by the card manufacturer, and the cost spread out over hundreds or thousands of users. Smart interface cards are often used by control-system designers to do the fast, repetitious, and mundane tasks such as controlling stepper motors and reading optical angle encoders. By delegating these nasty tasks to the off-the-shelf smart cards, it is often possible to program most or all of the "custom" software in a convenient, high-level language such as BASIC. Picking the right bus and the best interface cards available for the bus can often drastically reduce the cost and time spent in custom software development. This can be the difference between the success and failure of an entire project.

In making hardware/software trade-offs, it is not only the digital hardware of the control system and its software that are fair game, but also the hardware and the concepts behind the system being controlled. Often the greatest savings and simplifications in the total system will be made by "invading" these sacrosanct areas. This vital point is illustrated by our real-time control systems, the

Automatic Photoelectric Telescopes (APTs) at the Fairborn Observatory. (Details of the APT systems are described in the text box "Microcomputers and Variable Stars" on page 140.)

The Earth's rotation complicates the problem of locating stars and necessitates our tracking them as they appear to move across the sky. This problem can be somewhat simplified by making one of the two perpendicular axes of rotation of the telescope parallel with the rotational axis of the Earth. This axis of telescope motion is appropriately called the *polar axis*, and angular rotation about this axis

Taking the burden off software development and placing it on interface hardware is what standardized buses with plug-in slots are all about.

is measured as *right ascension*. Motion about the other axis is measured as *declination*. Once a star is found, it can be tracked by moving the telescope at a constant rate about the polar axis only.

The position of a conventional computer-controlled telescope is sensed by high-resolution (and expensive) optical angle encoders on each of the two axes of motion. However, for different positions of the telescope, there are pointing errors introduced in the portion of the telescope system beyond the optical encoders. These errors, which are a function of telescope position, include mechanical flexure of the optical assembly and varying atmospheric refraction. In the conventional control system, these errors, which can be quite complex mathematically, are modeled and repeatedly solved as the telescope changes its position. Repeating these complex calculations one or more times per second usually requires sophisticated machine-language routines, an interrupt-based control system, and 16-bit microcomputers or minicomputers.

In the Fairborn APTs, the expensive

optical encoders have been eliminated, there are no complex calculations to be made, programming is in BASIC, there are no interrupts, and 8-bit microprocessors are more than sufficient. We have achieved this by being willing to design an unusual telescope well suited to microcomputer control.

Three design decisions were particularly crucial. First, we needed a telescope mount totally free of backlash and a drive system without clutches. We used only a single stepper motor per axis, which enabled movement of the telescope in such a manner that the computer could track the telescope's position without feedback from optical encoders. Second, we used a permanently mounted photoelectric photometer not only to make the scientific measurements on variable stars but also to assist in locating the stars and centering them in the optical system. This meant that the complex calculations for accurate pointing were not needed because even if the telescope were not pointing near the star initially, the system could hunt for it with its photoelectric "eye." Finally, with a pulse adder, we electronically implemented the function of turning the telescope to follow stars, which significantly simplified the software. Although decidedly unconventional, the system can find any star and center it in the photometer with an accuracy of almost 1 part per million—just like systems costing 10 or even 100 times as much.

As an example of a more traditional hardware/software trade-off, consider microcomputer control of stepper motors. At one extreme, a microcomputer can calculate the bit pattern needed to drive each individual phase of the stepper motor. Typically, this machine-language routine might be embedded in a larger BASIC program or might be programmed in C or FORTH. Often, it is necessary to *ramp* the steppers up to a high speed and then ramp them down again. A chip or two added to the hardware can simplify the software considerably. For instance, Hurst Manufacturing makes a one-chip stepper controller/driver that

uses TTL (transistor-transistor logic) pulses for stepper motion and direction on input and has a direct connection for small steppers on output. Sigma Instruments makes a two-chip set (along with a few discrete components) that takes a pulse stream (of some length) as input and provides a ramped pulse stream as output. Pulses are "borrowed" from the beginning to provide the ramp up, and the exact number of borrowed pulses is "added" to the end to provide the ramp down.

At the smart extreme there are intelligent stepper controllers, of which the Whedco STD card is a prime example (see photo 1). From a high- or low-level language, the Whedco controller can be told the start speed for a stepper, the ramping acceleration, the top velocity, and the initial position. Any time thereafter, a simple command, such as move -1,235,476 steps, is executed exactly, including ramp up, slew, and ramp down, bringing the stepper to a smooth stop exactly where desired. Both hardware and software flags are available to signal when movement is complete. An onboard register keeps accurate track of the total moves and, hence, the current position. Unramped moves and single steps also can be commanded. In-motion stops, either ramped or immediate, can be commanded at any time. Although the Whedco controller has an onboard Z80 and its own program in EPROM, this is totally transparent to the user, and the controller appears just as an I/O (input/output) port to the user who issues the high-level commands.

As mentioned earlier, Fairborn APTs use two steppers, one on each of the perpendicular axes (right ascension and declination). Employing two smart stepper controllers, we can move the telescope directly between two stars by issuing two very brief commands. However, by enabling the telescope to go in one of eight directions at any one time and breaking up the move between two stars into two separate segments (with the telescope coming to a momentary stop between the segments), it is possible to get by with a single stepper controller. This is a

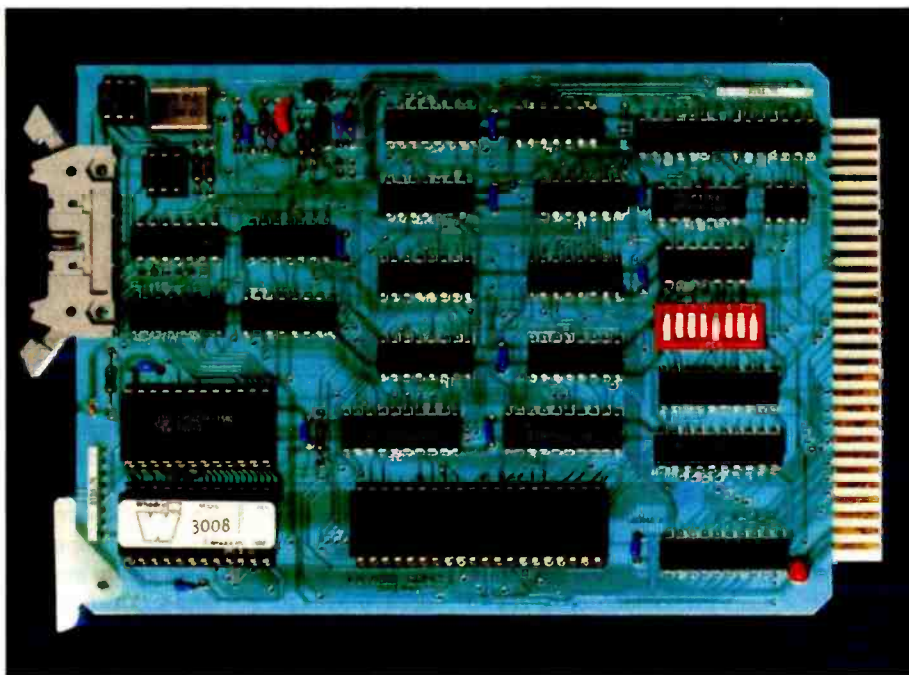

Photo 1: The smart stepper controller from Whedco Inc. for the STD bus contains its own Z80 microprocessor and machine-language program in EPROM. Such smart boards can do all the fast "dirty" work, letting the system's main processor loaf along in a high-level language on an 8-bit microcomputer.

case in which the overall concept, telescope movement, was made more complex, and the total system efficiency was reduced (imperceptibly) by adding a "waypoint" stop in every

per controllers, this saves hardware money; for systems with software ramping, the touchy simultaneous two-stepper motor problem is reduced to the easy one-stepper problem.

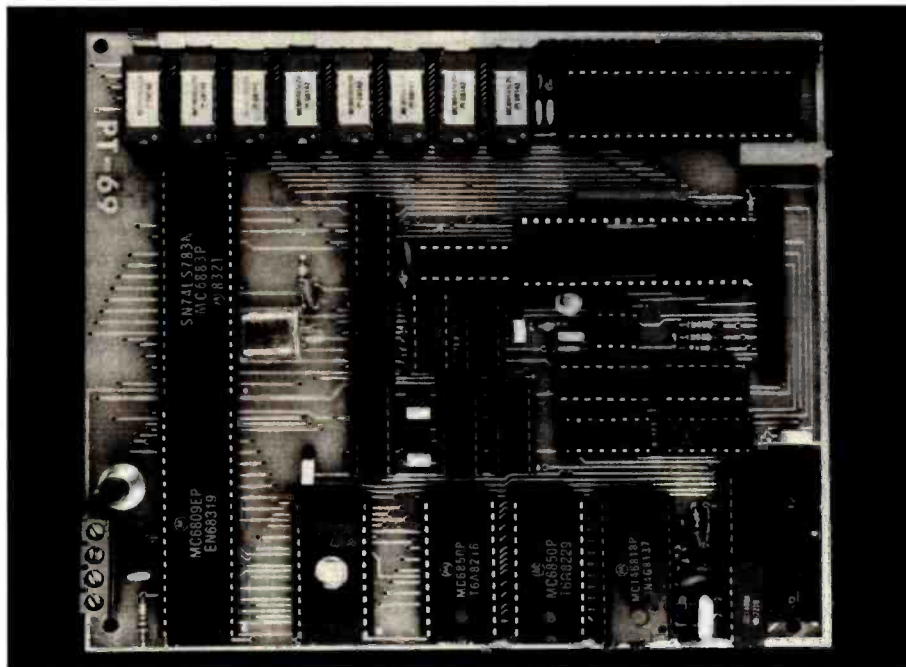

Photo 2: The single-board computer from Peripheral Technology has everything needed to run an automatic telescope—a rather complex control system. The board has a 6809E processor, RAM, floppy-disk controller, real-time clock/calendar, and two serial and two parallel ports.

Microcomputers and Variable Stars

Photoelectric photometry, a major area of astronomy, is concerned with the highly accurate measurement of the brightness of stars and other astronomical objects in relation to time. Due to the high quantum efficiency and wide bandwidth of the detectors used in astronomical photometry, smaller telescopes can obtain highly accurate results on stars as faint as tenth magnitude. As there are literally thousands of scientifically interesting stars this faint or brighter, astronomers at small colleges and advanced amateurs are observing variable stars from locations all over the world. Much of this is done on an international cooperative basis, with observations from many astronomers being consolidated at a central location, such as Douglas S. Hall's analysis operation at Vanderbilt University. Most of these observers, and many persons just interested

in this amazing backyard science, are members of the International Amateur-Professional Photoelectric Photometry Association (IAPPP). The IAPPP includes 500 people from 42 countries, almost evenly split between amateurs and professionals. The observational results of their activities are published in the leading astronomy journals.

A variety of astronomical objects is measured by these intrepid small-observatory photometrists. One of the most interesting classes of stars being observed is the RS CVn binary stars. These stars have very large groups of sunspots, or more accurately, starspots. These starspot groups move slowly around the stars and wax and wane like the spots on our sun, except much more dramatically. Discovering and tracking these stars requires observations spread over months and years. The large observatories simply do not have the necessary telescope time, so this exciting field has been pioneered mainly at small observatories in the backyards of amateurs and on small college campuses.

It is interesting to watch photoelectric observations being made at a small observatory. The variable star of interest is located and centered in a very small diaphragm (to exclude the light from all other stars), and the photons from the star are counted for 10 seconds and recorded. This may be repeated in several different color bands. The same procedure is repeated for a nearby nonvariable comparison star, another nonvariable check star, and one or more sky locations without stars. The entire sequence is repeated perhaps three times; after about 30 different measurements spread over 20 minutes or so, the astronomer moves the telescope to the next group of stars and does the same thing all over again. The process of photoelectric photometry is described in considerable detail in *Photoelectric Photometry of Variable Stars* (see reference 3).

No microcomputer devotee can watch this highly structured and repetitious observing process without immediately considering how microcomputers might be used to aid the busy astronomer. Within months of the first photoelectric observations at the Fairborn Observatory, one of the early TRS-80 microcomputers was used to record and analyze (on line) the photoelectric findings. This system has been described in great detail in *Real-Time Control with the TRS-80* (see reference

1). Four years passed before the much more challenging and difficult problem of completely automating the observations in a low-cost, microcomputer-controlled system was successfully completed by Louis Boyd. In early November 1983, the Automatic Photoelectric Telescope (APT) at Fairborn Observatory West made its first all-night observations without human assistance. (Figure 1 on the next page is a pictorial representation of the APT in photo 1.)

APTs are discussed in general in *Advances in Photoelectric Photometry* (see reference 5). The hardware and software details of the Fairborn Observatory APTs are described in *Microcomputer Control of Telescopes* (reference 4). The APT in photo 1 is moved by two Slo Syn steppers from Superior Electric Co. that drive small antibacklash worm gears. These in turn drive large disks (32 inches in diameter) with sprockets and chains. Without any preloading, there is no perceptible backlash in the drive system of this telescope—an important design consideration that led to significant simplifications in the control-system hardware and software. The APT derives its initial position information from limit switches in the southeast corner of its travel range. The conventional, and expensive, optical angle encoders have been eliminated from this system, and the permanently mounted photoelectric photometer (which is needed to make the actual measurements) does double duty by helping the system locate and center the stars. This latter feature of the APT resulted in the greatest hardware and software simplifications.

The operation of the APT can be most easily understood by considering its normal sequence of actions. In the early evening, the system repeatedly calculates how far the sun is below the horizon. When it is 10 degrees below, the main APT program is called. The system contains a database for all the groups of stars observed throughout the year, and the first task is to calculate which of these groups of stars will be within the night's "observing window" and when they will be there. A small subroutine then accurately positions the telescope on its limit switches in the southeast corner of its range. An electronically separate clock is then turned on and, at this precise time, the APT shifts into celestial coordinates and tracks the stars in their motion across the sky. Although providing a hard-wired stellar rate

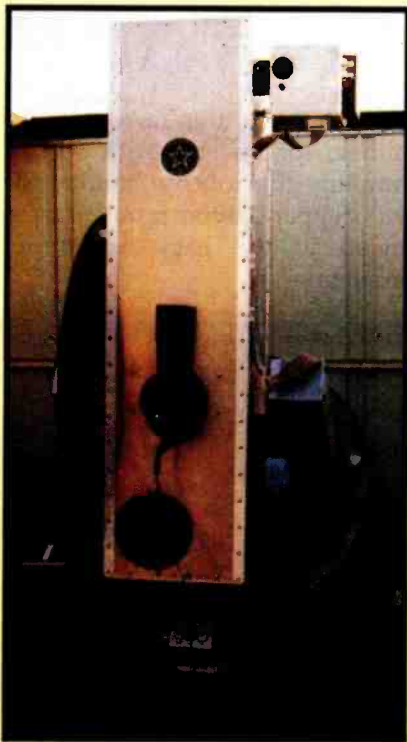

Photo 1: The original Automatic Photoelectric Telescope (APT) at the Fairborn Observatory West in Phoenix, Arizona. The photometer that "looks" at the stars is the box attached to the top right of the telescope. The large-diameter disk on the left side of the telescope moves the telescope in declination while the large disk at the bottom rear moves the telescope in right ascension. This telescope finds, centers, and measures stars automatically.

drive meant a slight hardware complication (an electronic pulse adder), making the sky "stand still" from the viewpoint of the software probably reduced the software task by approximately a factor of four.

The APT then moves to the first, westernmost, group of stars. As mentioned earlier, this movement is made in two distinct segments, with a very brief stop between each segment. When the telescope stops in the area of the sky near the first star, it actually may be some distance from the star. Conventional systems get much closer by measuring the exact position of the telescope at its two axes with highly precise optical angle encoders and then make complex corrections to this position to account for flexure of the telescope, refraction of the atmosphere, etc. However, the APT does not worry about not being almost exactly on the star; instead, it starts an immediate square spiral search using its photoelectric photometer eye. As soon as the star is found, the same eye is then used to center the star in the diaphragm, and the photoelectric measurements begin. As mentioned earlier, the final pointing accuracy of the APT is about 1 part in 1,000,000. This great economy is achieved by using a carefully designed microcomputer control system and photometer to "close the loop" directly on the stars themselves. Dawn finds the APT making its measurements on the last group of stars in the east. The telescope then returns to its home position and the roof is closed.

Not unexpectedly, the APT is having an impact on astronomy. One of the foremost designers and builders of large astronomical telescopes, Dr. Frank Melsheimer at DFM Engineering, announced the production of its first mount that costs less than \$100,000. DFM Engineering now produces the only modest-sized, commercially made telescope mount specifically designed for microcomputer control. It is a clear case of microcomputer control-system requirements affecting the basic design of the system being controlled; consequently, a completely new realm of applications has opened up.

Instead of using conventional worm gears, this mount uses steel friction disks 15 inches in diameter to achieve zero backlash without preloading. Large aluminum castings make the mount unusually rigid so that even the heaviest vibrations die out in a fraction of a second. As a result of these special features, steppers under microcom-

puter control can rapidly decelerate and stop exactly where desired without the uncertainties introduced by gear backlash or telescope vibration and flexure. Because APTs make many thousands of sudden starts and stops per hour, such a mount is really a necessity. And in less demanding applications, a highly rigid mount free of all backlash is always a pleasure to use.

APT's do not need a human eye to see and

center stars. As long as a photometer can "see" the stars, the system will work. Gerald Persha at Optec Inc. is developing a low-cost K-Band photometer that operates in the near infrared. The sky at this wavelength is about as dark during the day as it is at night, so an APT equipped with such a photometer can carry on its observations of late-type variable stars (such as

Textbox continued on page 142

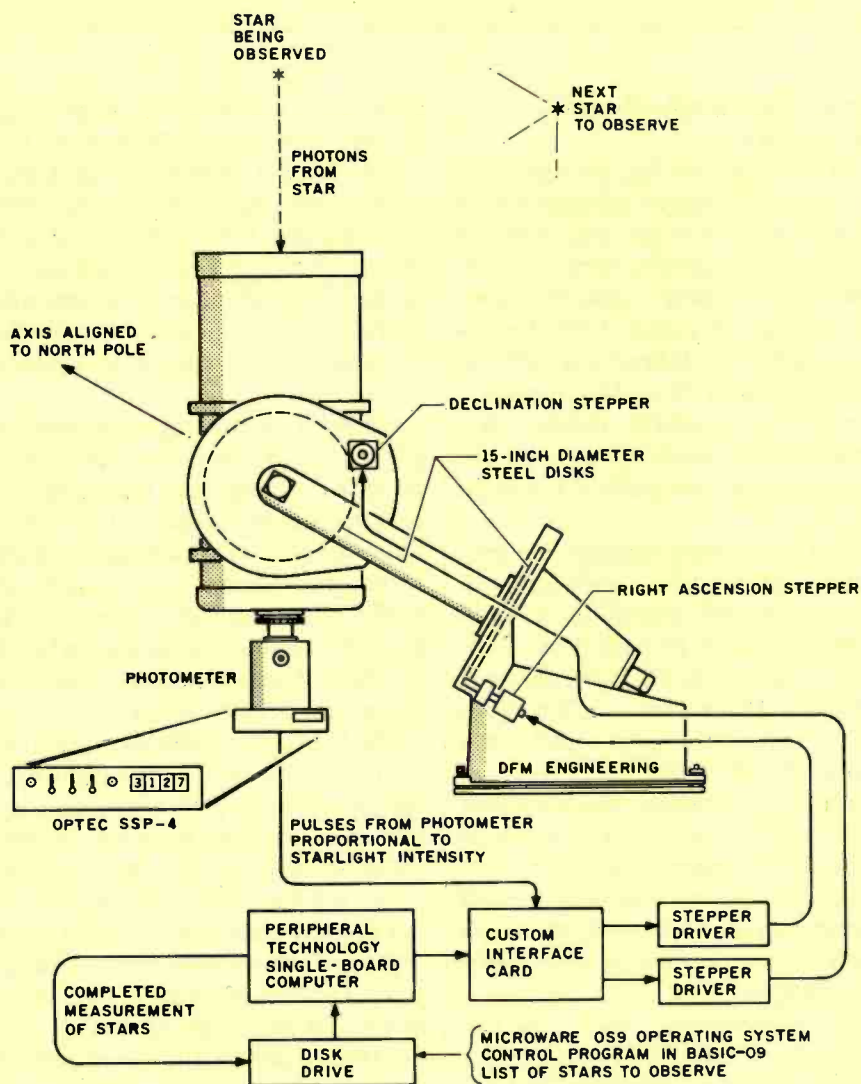

Figure 1: The second-generation Automatic Photoelectric Telescope (APT) designed at the Fairborn Observatory is controlled by a single-board computer. The telescope system uses a mount specifically designed for computer control. The mount uses direct-contact friction drive on steel disks to avoid the backlash and preloading problems associated with gears. This freedom from backlash greatly simplifies the software. The computer control system moves the telescope close to the star to be observed, and the photometer "eye" is then used in a search pattern to find the star and center it exactly. Measurements are then made of the brightness of the star. This procedure is repeated automatically on many stars each night, and gradually a record of the changes in the light intensity of the stars is built up.

Miras) in broad daylight. The combination of DFM Engineering's new mount, Optec's near-infrared photometer, and Schmidt-Cassegrain optics is being used in a new generation of APTs.

Finally, it should be noted that a large, 1-meter (primary mirror diameter) APT is being developed by a group of amateur and professional astronomers. The finished 1-meter mirror has been donated to the project by the University of Illinois, and DFM Engineering has completed the preliminary design of the mount. The control

system and software will be essentially identical to those that run the small APTs at the Fairborn Observatory. As at Fairborn, the observing will be done by a microcomputer rather than by a human astronomer. However, instead of observing variable stars, the 1-meter APT will make precise photoelectric measurements of variable quasars at the far edge of the observable universe. These most luminous of all objects in the universe pour out more energy than a hundred regular galaxies, yet they significantly vary their output of

light in a matter of weeks or months. This can only mean that the source of this energy must be very small. By tirelessly observing these variable quasars night after night, the 1-meter APT with its microcomputer real-time control system should make an important contribution to our understanding of the prodigious energy source of these mysterious quasars. Paying attention to real-world interfacing can have important dividends.

Buses and Single-Board Computers

We feel that selecting the right bus-based or single-board microcomputer for any given real-time control task is relatively straightforward if prejudices not related to real-time control can be set aside. If the task is reasonably well defined and will not be changing in the future, and if a number of essentially identical systems are to be made at low cost, use a single-board computer if it will do the job.

A single-board computer we particularly like and have used for automatic telescope control is a 6809-based one made by Peripheral Technology (see photo 2). This board has a 6809E microprocessor, 56K bytes of RAM (random-access read/write memory), 4K bytes of EPROM, a floppy-disk controller, two serial and two parallel ports, and a real-time clock. If this meets your needs, you can get a fully assembled and tested system; if you need more, then you might consider a bus-based system with plug-in slots.

For convenience, we'll discuss buses in three broad categories: hobby, personal computer, and industrial control. Hobby buses certainly include the very popular S-100, which has done much to make the 8080 and Z80 processors well known, and the SS-50 bus, which remains a favorite of fans of the 6800 series. Categorization as a "hobby bus" simply means that these buses often are favored by homebrewers.

People who want a personal com-

puter with a wide selection of plug-in cards are really limited to the Apple II, the IBM Personal Computer, and their very compatible counterparts. If the real-time control task at hand is not overly difficult, or if one of the microcomputer systems previously mentioned is adequate for the task, then it makes a lot of sense to use one.

However, if the real-time control job is a tough one, if the system is to be in an inhospitable environment, or if you desire to tap the full potential of what is available off the shelf for real-time control, you should turn to the buses used by industry in its control systems. Good examples of industrial buses are the STD bus, the Q-bus, and the Multibus.

The STD bus is probably supported by the greatest number of card manufacturers (about 100) and is compatible with the widest selection of cards (nearing 1000) of any bus or computer system. The card selection is particularly rich in the area of such real-time control tasks as smart stepper controllers, optical encoder interfaces, and DC servo interfaces. The STD bus is used mainly in industrial control, with one interesting exception: portable computers.

STD-bus cards are small in size, only 4½ by 6½ inches. Microstandard took advantage of this small size to build a 10-slot portable computer, the M-6000, and also the low-cost M-3000, which has four vacant STD-bus card slots. A large portion of our STD-bus development and all our word processing at the observatory is

done on a Microstandard M-6000.

Although there are 16-bit STD-bus systems, the STD bus is primarily an 8-bit bus that favors the Z80 processor and CP/M. It gets its power and popularity from its wide variety of smart peripheral cards.

For greater crunching power, the Q-bus and the Multibus are good choices. For those who have been brought up on DEC (Digital Equipment Corporation) operating systems, languages, and features, the Q-bus is a natural choice. Although the first LSI-11 microcomputers were somewhat slow compared with their minicomputer relatives, speeds have increased considerably with the LSI-11/23, the LSI-11/73, and now the MicroVAX. Cards for the Q-bus were somewhat expensive a few years back, but competition has brought prices down. The design of a Q-bus-based mobile telescope-control system is discussed in some detail in *Microcomputer Control of Telescopes* (see reference 4).

Interface Hardware

The large number and great variety of interface cards available to real-time control system developers precludes any sort of comprehensive treatment in this article. Rather than even attempt a broad look, we have chosen to consider STD-bus cards and, from the almost 1000 different STD-bus cards, only a dozen that we have had personal experience with at the observatory. For convenience, we have divided these cards into categories: onboard microprocessor, straight—

NOW! Choose From 3 Hard Disc Drive Systems That Convert Your IBM* PC To Perform Like The PC XT!



Our Winchester Hard Disc Drive Systems offer 10 Mega-bytes of formatted capacity, are internally installed and use available power!

Maynard Electronics introduces three Winchester Hard Disc Drive Systems — the only drive systems to offer you 10 Mega-bytes of formatted capacity with complete internal installation! These systems offer the user countless benefits and features: capability of booting off the hard disc; additional functions while requiring only one card slot in your PC; and, use of available power, thereby preventing overheating problems which have affected other drives. Handling heavyweight data was never easier.

All three systems are quality engineered and work with DOS

2.0 without any special software drivers and also run with other operating systems designed to make use of the XT hard drive system. All you need is the IBM* DOS 2.0 Manual and you're ready to run!

Each system is equipped with a low-power hard disc drive, complete software, cable, a SandStar™ Card and Hard Disc Controller Module. SandStar™ is the first family of modular peripherals created for the IBM* PC. Simple instructions for easy installation are included and all components are backed by an Unconditional One Year Parts and Labor Guarantee.

WS 1



This System is equipped with the SandStar™ Multi-function card. In addition to the Hard Disc Controller Module, you can add up to three other SandStar™ Modules while using only one card slot. The following modules are available: Serial Port, Parallel Port, Clock Calendar, Game Adaptor, and Prototyping Module.

WS 2



This System is equipped with the SandStar™ Floppy Drive Controller Card. The Card can control, in addition to the Hard Disc Drive, two floppy drives mounted inside your PC and optionally two additional 5¼" or 8" drives mounted externally. This leaves three system slots for other expansion boards.

WS 3



This System is equipped with the SandStar™ Memory Card. In addition to controlling the Hard Disc Drive, the Memory Card allows you to add 64K bytes to 576K bytes of memory using only one card slot.

expand your PC to perform like the PC XT, one of our Winchester Hard Disc Drive Systems is right for you. And if you have already made the wise decision to install any of Maynard's SandStar™ Cards, the SandStar™ Hard Disc Controller Module may be purchased separately. TO ORDER, CONTACT YOUR LOCAL DEALER OR DISTRIBUTOR.



MAYNARD ELECTRONICS

400 East Semoran Blvd.
Casselberry, Florida 32707
305/331-6402

We make modern times better.



*IBM is a trademark of IBM Corp.
**COMPAQ is a trademark of Compaq Inc.

Circle 238 on Reader Service

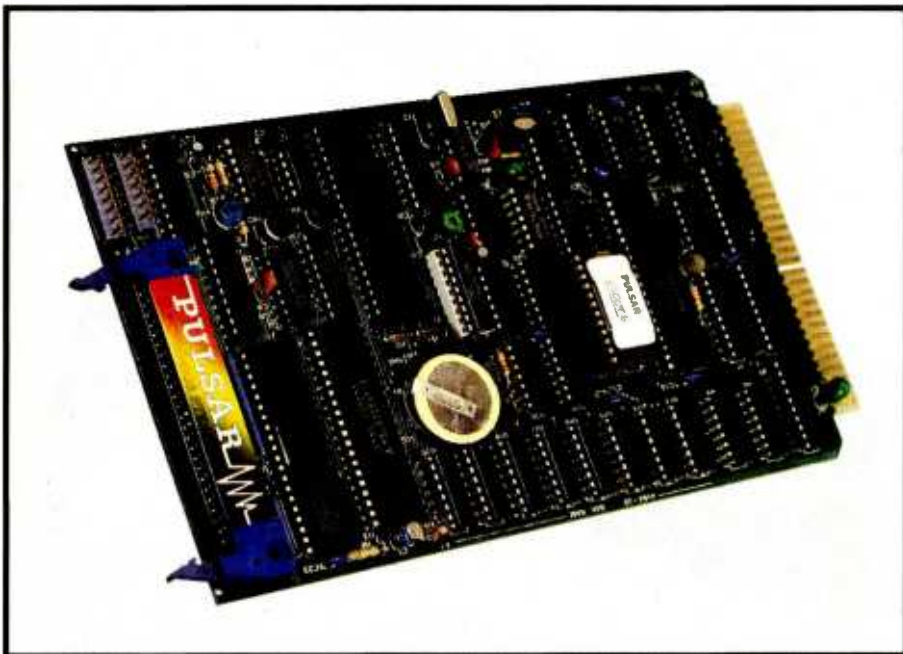

Photo 3: An entire computer can now be packed onto an STD-bus card. Shown is the Little Big Board made by Pulsar Electronics in Australia. The card features a full 64K bytes of RAM, floppy-disk controller, two RS-232C ports, and a battery-backed clock/calendar. It is available in the U.S. from Infinity Inc.

I/O, semismart I/O, and very smart controller.

Not so long ago, the first complete computer was put on an S-100 card. A couple of years later, Pulsar Electronics put an entire computer on an STD-bus card, which is about one-third the size of an S-100 card (see photo 3). In Australia, where it's made, the card is affectionately known as the Little Big Board. The Pulsar includes a 4-MHz Z80A, 64K bytes of RAM, 2K bytes of EPROM (boots CP/M 2.2), a floppy-disk controller, two serial ports, and a battery-backed clock/calendar. (In the United States, the Pulsar Single-Board Computer can be purchased from Infinity Inc., either alone or with a card cage, power supply, floppy-disk drive, and other STD-bus cards to form a basic STD-bus system.)

Another single-board STD-bus computer of note is the Transwave K-8073. It uses National Semiconductor's INS8073 processor with on-chip Tiny BASIC. A serial port communicates to a terminal. There are three 8-bit programmable ports (Intel 8255), an ART/RC (asynchronous receiver/transmitter/remote control) master to control up to 128 slave

units, a real-time clock/calendar, RAM, EPROM with a monitor, and EPROM for the user's own programs. There are two very unique things about this system. First, it has the most readable manual we've ever seen. Second, once a program is written in Tiny BASIC, you can store it immediately in the onboard EPROM without the fuss of an external EPROM burner.

Straight I/O can be at the TTL level, low-power AC or DC levels, or at high-power AC or DC levels unsafe to bring into the STD-bus card cage. A very flexible and versatile TTL-level I/O card is manufactured by Circuits and Systems. This card has four 8-bit ports that can be configured for either input or output, three 16-bit programmable counters (Intel 8253), a prescaler, and a small wire-wrap area for custom additions to the board. MCPI makes a number of medium-level I/O boards that use optoisolators to protect the STD-bus system. Electrollogic makes a 24-channel controller card that connects to Opto 22 control modules mounted externally to the STD-bus card cage to handle higher powers and voltages.

Of the many STD-bus cards made

by Enlode, we have used the nicely documented clock/calendar and keypad interface cards. The clock/calendar card, besides being quite smart, has two attractive features: an LED (light-emitting diode) time display that connects to the STD-bus card and operates independently of the main processor, and two push-buttons you can use to set the clock independently of the main processor. Of course, the main processor also can read and set the clock. The keypad interface card can handle up to four hexadecimal keypads in a priority scheme.

At the top of the interface line are the smart controller cards with their own microprocessors. We already have discussed the intelligent Whedco stepper controller. For control systems with optical encoder position feedback, Amtek makes an STD-bus card that handles two incremental encoders, including the "zero-track" initial positioning type. When the main processor wants to obtain position information, it simply obtains it from a few ports in this smart card. Analog Devices makes what could be the smartest A/D (analog-to-digital) converter in the world. Connect temperature sensors (and others) to the STD-bus card and the microprocessor can read temperatures (or other parameters) from the card's ports. The readings already have been sampled, averaged, corrected for offset, and transformed into engineering units.

In every system it seems there is always something that cannot be bought off the shelf. Even with the world's widest selection of real-time cards to choose from, we could not find a pulse adder or hard-wired limit-switch logic. (Would you totally trust your telescope to a computer?) Rather than make an STD-bus card from scratch, we used a Foundation Module from Contemporary Control Systems. This card contains all the address decoding and buffer logic needed for many applications and has a sizable and conveniently laid out area for wire-wrapping.

The benefits of plug-in cards and standardized buses are lost without a top-quality motherboard and card

LOTUS

123™

Lotus 1 2 3™ and Dataproducts P Series color printer are the best combination for any business assignment.

Everyone's talking about the best software package on the market, the Lotus 1 2 3. Dataproducts wants you to go one step further with their P Series color printer.

The versatile P Series translates the wealth of information generated by the Lotus 1 2 3 into brilliant full color charts, graphs and text.

It delivers a full page of text quality print in nothing flat while its sheet feeder automatically prevents loading hassles. And the P Series uses pin feed or plain paper and has the brains to fill every

appropriate line with crisp, sharp copy, even if it has to justify to do it. And the P Series color printer has dual speed capability for correspondence quality output for word processing applications, and high speed output for draft or spreadsheets.

The Dataproducts P Series color printer. And the Lotus 1 2 3. There's no better combination on the market. For more information go 1234 to your nearest computer store and ask about our P Series color printer, or call Dataproducts, 1-800-258-1386.

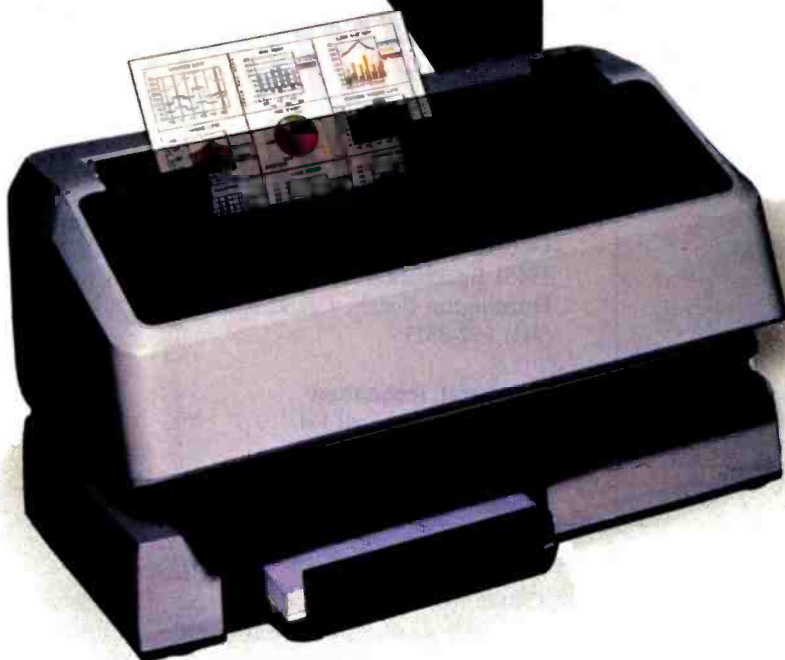

Dataproducts computer printers

Nobody puts ideas on paper so many ways.

1-2-3 and Lotus are trademarks of Lotus Development Corporation.

Manufacturers, Publishers, and Organizations

Amtek

12740 28th Ave. NE
POB 27128
Seattle, WA 98125
(206) 363-0217

Analog Devices

Rte. 1 Industrial Park
Norwood, MA 02062
(617) 329-4700

Circuits and Systems

2 Main St.
Hollis, NH 03049
(603) 465-7063

Contemporary Control Systems

4949 Forest Ave.
Downers Grove, IL 60515
(312) 963-7070

DFM Engineering Inc.

1812 Valtec Lane #3
Boulder, CO 80301
(303) 443-1527

Electrologic

1359 28th St.
Signal Hill, CA 90806
(213) 595-0551

Enlude Inc.

1728 Kingsley Ave.
Orange Park, FL 32073
(904) 264-4405

Fairborn Observatory East

1247 Folk Rd.
Fairborn, OH 45324
(513) 879-4583

Fairborn Observatory West

629 North 30th St.
Phoenix, AZ 85008
(602) 224-8380

Hurst Manufacturing

Box 326
Princeton, IN 47670
(812) 385-2564

IAPPP (International Amateur- Professional Photoelectric Photometry Association)

c/o Rolling Ridge Observatory
3621 Ridge Pkwy.
Erie, PA 16510
(814) 899-2560

Infinity Inc.

29429 Southfield Rd., Suite 5
Southfield, MI 48076
(313) 557-7230

MCPI

2306 American Ave.
Hayward, CA 94545
(415) 783-2866

Microware

5835 Grand Ave.
Des Moines, IA 50312
(515) 279-8844

Microstandard

619 West Main St.
New Lebanon, OH 45345
(513) 854-2327

Optec Inc.

199 Smith
Lowell, MI 49331
(616) 897-9351

Opto 22

15461 Springdale St.
Huntington Beach, CA 92649
(714) 892-3313

Peripheral Technology

3760 Lower Roswell Rd.
Marietta, GA 30067
(404) 973-0042

Pulsar Electronics

Lot 2 Melrose Dr.
Tullamarine, Victoria 3043
Australia
(03) 330-2555

Howard W. Sams & Co. Inc.

4300 West 62nd St.
Indianapolis, IN 46268
(317) 298-5400

Scanbe

3445 Fletcher Ave.
El Monte, CA 91731
(213) 686-1202

Sigma Instruments Inc.

170 Pearl Place
Braintree, MA 02184
(617) 843-5000

Superior Electric Co.

383 Middle St.
Bristol, CT 06010
(203) 582-9561

Transwave Corporation

Cedar Valley
Box 489
Vanderbilt, PA 15486
(412) 628-6303

Whedco Inc.

6107 Jackson Rd.
Ann Arbor, MI 48103
(313) 665-5473

Willmann-Bell

POB 3125
Richmond, VA 23235
(804) 320-7016

cage. Gold contacts, Faraday shielding, termination, and solid construction are all vital. The control system used on the 16-inch telescope at Fairborn Observatory East resides in a 24-slot Scanbe STD-bus cage, and the separate hardware-development system uses an 8-slot MCPI cage. This system is described in some detail in *Microcomputers in Astronomy* (see reference 2).

Interface Software

The question of software for real-time control systems is not critical if the control system is a simple one. Given a simple situation, straight machine-language programming can be done from the front-panel paddle switches if you have an old-style computer. It is the truly complex situations that make the approaches to software development critical.

However, there are few, if any, solid, quantitative comparisons of the efficiencies of different languages and operating systems in the programming of complex control systems. It's just not the sort of thing you program independently in six different languages with 36 different people in order to get valid intercomparisons. Consequently, unsubstantiated opinion is shared by many, including us.

QUARK COMBINES

WORD JUGGLERTM AND LEXICHECKTM

FOR HALF THE PRICE.

Now you can have the power of Quark's Word Juggler word processor. And the convenience of the Lexicheck spelling checker, with its 50,000 word dictionary and special Word Guess PlusTM feature. All in one package. For virtually half the price.

The new suggested retail for Word Juggler IIe is only \$189. Word Juggler for the Apple III and III Plus is only \$225*.

Ask for a demonstration today. For the name of the Quark dealer nearest you, call 1-(800) 543-7711. And be sure you look into Quark's other popular office automation tools for the Apple IIe, Apple III and Apple III Plus. Especially the CatalystTM program selector.

*Previous list prices: Word Juggler IIe, \$239; Lexicheck IIe, \$129; Word Juggler for the Apple III, \$295; Lexicheck for the Apple III, \$149. All prices suggested U.S. retail.

Quark, Word Juggler, Lexicheck, Word Guess Plus and Catalyst are trademarks of Quark Incorporated. Apple is a registered trademark of Apple Computer, Inc.

Circle 307 on inquiry card.

QuarkTM
INCORPORATED

Office Automation Tools
2525 West Evans, Suite 220
Denver CO 80219

Assembly language has its advantages. The best use in real-time control is by the contractors that put it in the EPROMs on their smart interface cards. There usually is no need to look at the manufacturer's assembly-language program listings. On rare occasions, a high-level language has to do a task that is simply beyond its speed capabilities. A very small and highly limited assembly-language subroutine is appropriate in this type of case. However, careful design of the system, and an appropriate selection of smart interface cards, often avoids the use of assembly language entirely.

Really good high-level languages are a pleasure to use, and we have gravitated toward the use of two BASICs. On our Z80-based CP/M systems we run Microsoft MBASIC in its interpreted and compiled versions. Programming in the interpreted version is convenient. If greater speed is needed, we use the compiled version. With the proper choice of smart interface cards, an 8-bit microprocessor can loaf along with interpreted MBASIC. Smart cards programmed in assembly language by the card manufacturers do all the hard work.

Our 6809-based systems use Motorola's BASIC-09 running in the OS9 operating system. For the true high-level control system aficionado, BASIC-09 is a delight to use. When

Joel Boney and Terry Ritter at Motorola started the design of the 6809 microprocessor, they contracted with Ken Kaplan at Microware to develop a language and an operating system that would fully utilize the many unique features of this advanced 8-bit microprocessor. Microware came up with a language that supported structured programming (sort of a cross between BASIC and Pascal), was completely modular (enabling independent programs to work together), and included an interactive compiler with very high level debugging functions. The multi-tasking OS9 operating system might best be described as Unix on a CP/M budget. The ability to develop software for a complex control system as a number of independent programs is extremely valuable. Programming 6809Es in BASIC-09 is very easy.

Summary

In closing, we would like to summarize our advice. First, don't consider the controlled system immune to change. It may be easier to make it more conducive to microcomputer control than go through interface or software contortions. Second, make a careful trade-off between interface hardware and the software you will have to write. Make it easy on yourself and put some burden on the interface hardware—that's why it was developed. Third, if you can use a

single-board computer in your application, do so. Otherwise, use a bus with a good selection of off-the-shelf interface cards. Fourth, do most of your programming in a language you feel comfortable with. BASIC is not a bad choice. Finally, don't be bashful. Go ahead and try some real-time control with your system. There is a special fascination in things that move by themselves under the direction of a microcomputer.

Russell M. Genet, Louis J. Boyd, and Douglass J. Sauer are the technical staff at Fairborn Observatory. Genet and Sauer work at the Observatory's eastern branch (1247 Folk Rd., Fairborn, OH 45324). Boyd works at the Observatory's western branch (629 North 30th St., Phoenix, AZ 85008). All three are electrical engineers and share the hobbies of astronomy and computers. Among them they have three STD-bus computers and four 6809-based systems.

References

1. Genet, R. M. *Real-Time Control with the TRS-80*. Indianapolis, IN: Howard W. Sams & Co. Inc., 1982.
2. Genet, R. M., ed. *Microcomputers in Astronomy*. Fairborn, OH: Fairborn Observatory, 1983.
3. Hall, D. S., and R. M. Genet. *Photoelectric Photometry of Variable Stars*. Fairborn, OH: Fairborn Observatory, 1982.
4. Trueblood, M., and R. M. Genet. *Microcomputer Control of Telescopes*. Richmond, VA: Willmann-Bell, 1984.
5. Wolpert, R. C., and R. M. Genet. *Advances in Photoelectric Photometry*. Fairborn, OH: Fairborn Observatory, 1983.

EPROM PROGRAMMER & UV ERASER FOR THE 80's \$15 PROGRAMS OVER 300 DEVICE TYPES

MOS (8K - 256 K, SINGLE & 3 VOLTAGES) BIPOLAR PROMS, 40 PIN MICROS

- Stand Alone
- 256K Buffer (200 ns)
- Integrated keypad
- EPROM simulation
- Fast algorithm
- Power down sockets
- Temp compensated Ref. voltages
- 16 formats & 8 baud rates
- Auto-user friendly-mode



S15F \$995

OVER 26 FUNCTIONS

- Edit
- CRC check
- Block Move
- Over Program
- Insert
- Delete
- 16 Diagnostic Functions
- And More !

(305) 994-3520

4089 S. Rogers Circle #7, Boca Raton, FL 33431

BUV-IIA \$95.50

- Heavy duty
- Timer
- Safety switch
- 110/220 voltage

BUV-IIB \$66.50

- Heavy duty
- Safety switch
- UV indicator

OTHER

COMPLETE SYSTEMS

| | |
|----------------|--------|
| S15R (remote) | \$695 |
| S15P (4 key) | \$795 |
| S15B (bipolar) | \$895 |
| S15G (gang) | \$1095 |

BYTEK

COMPUTER SYSTEMS CORP

BUY A BANK FOR \$15.95



The DiskBank® Media Mate.



Media Mate 3 for new micro diskettes.
Media Mate 5 for 5 1/4" diskettes.



Convenient easy-carry handle.

Introducing Media Mate... another affordable solution in diskette filing technology from DiskBank.

Media Mate combines an attractive desktop appearance with superior protection, organization and storing capability for 50 diskettes. All at a cost your budget will appreciate.

Available in sizes to accommodate both 5 1/4" and 3 1/2" diskettes, Media Mate includes a fortress of features:

- Sturdy, high impact styrene construction
- Attractive smoke see-thru cover

- Convenient adjustable tab dividers
- Self-locking cover with easy-carry handle
- Case on case stackability

For protecting, organizing and storing your valuable diskettes, make the little investment that pays off big. Buy a Bank. Buy DiskBank.

DISKBANK®
AMARAY CORPORATION
2251 Grant Road, Los Altos, CA 94022
(415) 968-2840, Telex 171627 Amaray-Ltos

How HP business graphics

Enhance your reputation for being more professional, persuasive, credible and effective than your competition with the new HP 7475A Business Professional's Plotter.

Make a first impression that lasts

The vital importance of graphics to today's business professional cannot be overstated. In survey after survey, statistics prove graphics can help you spot trends and relationships quickly, analyze data accurately, and communicate your ideas with more



clarity and power than in any other way.

Even more important, graphics can actually increase personal and company productivity. And create a first impression of quality and professionalism that lasts and lasts.

Graphics: the end to meetings that go nowhere

In a fascinating research project conducted by The University of Pennsylvania, 123 MBA candidates were involved in a study designed to test the effectiveness of business graphics in meeting situations. The results were startling. In the group where visual aids were used:

- **Meetings were shorter:** The study showed a 28% reduction in meeting length when transparencies were used.
- **Group consensus was faster:** Agreement was reached by 79% of the group using transparencies, compared with only 8% among the control group using no visual aids.
- **The decision process was accelerated:** 64% of study participants said they made their business decisions *immediately after the visual presentation*. When overheads were not used, the control group said they delayed decision-making until *some time after the group*

discussion following the presentation.

• Presenters with visual aids were perceived as being more professional, persuasive, credible and effective than those not using visual aids.

Now, with the new HP 7475A Business Professional's Plotter, your meetings can have immediate and productive results like these.

How the quality look of HP graphics can help

The way you present your information can be equally as important as the actual information you're presenting. And that's where the new HP 7475A Business Professional's Plotter lets your professionalism shine through.

Standards unsurpassed in the plotter business

The technical standards of the HP 7475A have no equal for producing quality graphics. With a resolution of one-thousandth-of-an-inch, curved lines are smooth, not jagged, and straight lines are consistently straight. Its exceptional repeatability (the ability of a pen to return *precisely* to a given point) assures that intersecting lines and circular shapes will meet *exactly*. The result is *high-quality* charts and graphs you'll be proud to present.

Why 6 pens when experts say 4 will do?

Graphics industry experts maintain that good graphics contain four colors per chart. But Hewlett-Packard goes the experts two better by providing a six-pen carousel, so you can store and use pens of different widths—thick pens for bold headings and thin pens for details. And with six pens, you won't have to waste valuable time changing them. That's important when "the boss wants to see your presentation in twenty minutes!"

With the HP 7475A, you also get automatic pen capping to prevent pens from drying out between uses, and special "pen damping" (gently lowering the pen to the paper or transparency) to increase pen life and ensure better line quality... use after use after use. You also get a rainbow of 10 colors to choose from, in two line widths.

Your choice: 2 paper sizes and today's most popular graphics software packages

While most professional business applications will be satisfied with standard 8½ x 11" paper or transparencies, the HP 7475A adds the



can be the key to your success.



capability of plotting on larger 11 x 17" media, too. The larger plots are especially well-suited for time lines, PERT charts, schematics and engineering drawings.

Best of all, you don't have to be a programmer to produce quality graphics on the HP 7475A. It's supported by a variety of professional graphics software packages for both HP and non-HP desktop and personal computers.

Naturally, speaking of software compatibility leads us to hardware compatibility....

Compatible with almost any personal computer in the marketplace today

With two interfaces available, the HP 7475A quickly "makes friends" with most models of today's most popular personal computers, including IBM[®], Apple,[™] Compaq,[™] Osborne[®] and Commodore[™] --as well as a host of HP computers.

The cost? Surprisingly affordable

The new HP 7475A Business Professional's Plotter is an amazingly affordable \$1895. When you consider that a typical fee for a single five-color transparency from a graphics service is \$50—and that the same transparency can be prepared for about \$1 in materials on the HP 7475A—the return on your investment is almost immediate.

Another choice: HP's low-cost, high performance Personal Computer Plotter

For the "business on a budget," you may also want a look at our 2-pen Personal Computer Plotter, the 7470A. Its low cost (only \$1095) is as remarkable as the quality of its plots. With many of the same features as the new HP 7475A, the HP 7470A plots on a single paper size (8½ x 11"). It stores and caps two pens,

and you can easily change the pens yourself for multi-color plotting. Best of all, the HP 7470A 2-pen plotter lets you turn your personal computer into a personal graphics workstation for only \$1095.

Send for your FREE "Better Presentations Package" today!

For a FREE sample plot, overhead transparency, and more details, mail the coupon below today. We'll also enclose a list of software packages you can use with the HP 7475A or HP 7470A.

For the name of your nearest Hewlett-Packard dealer call toll-free 800-547-3400.

1101303



YES! I'm ready to gain a reputation for being more professional, persuasive, credible and effective than my competition. Please send me your FREE "Better Presentations Package," so I can learn more about the new HP 7475A Business Professional's Plotter and the HP 7470A Personal Computer Plotter. I understand I will receive this valuable package without cost or obligation.

Name _____ Title _____

Company _____

Address _____

City/State & Zip _____

Phone Number (____) _____

My computer is _____

Send to: Hewlett-Packard
16399 W. Bernardo Drive, San Diego, CA 92127
Attn: Marketing Communications

11303 BT4

Putting the Apple II Work

Part 1: The Hardware

A high-speed system for the acquisition and analysis of data

Richard C. Hallgren
Michigan State University

The world we live in is anything but static. We are constantly exposed to a changing environment that our central nervous system samples, analyzes, and, when necessary, responds to. In many ways, computer systems are a lot like the human body, which is equipped with a number of specialized sensors that convert complex, time-dependent information into a form that can be sampled by the nervous system. The nervous system processes the incoming information and makes decisions that cause the system to respond appropriately. Computers, when equipped with specialized sensors, also can sample the surrounding environment, process this incoming information according to some predetermined algorithm, and effect an appropriate response.

Many commercially available transducers can be used to convert physical-energy variations into time-varying electrical voltages. For example, thermistors can be used to measure temperature, dimensional changes can be measured by resistive strain gauges, and PIN diodes can be used to measure changes in light intensity.

If a physical parameter changes very slowly and you have an abundance of time, you can use a digital voltmeter, a digital clock, and a pencil to record data and enter it into the computer by hand at some later time. However, if you desire an automated system or if the transducer output voltage changes at a rate that makes manual sampling impractical, you will need a computer-based data-collection scheme that will reduce the amount of operator interaction and still allow the collection of large amounts of data.

In part 1 of this article, I'll introduce the hardware required for such a system, discuss its operation and construction, and go through preliminary checkout and testing. In part 2, I'll provide the Applesoft and machine-language listings and discuss their development and use.

While most computers are quite proficient when it comes to handling binary (on/off) voltages, they usually are not capable of directly handling the analog voltages from the output of most transducers. Placing an analog-to-digital (A/D) converter between a transducer and the computer

enables the computer to monitor the changing physical parameter as well as to automate the sampling process.

An Apple II was selected several years ago for use in our laboratory. While many new computers have since been introduced into the marketplace, the Apple II continues to be my first choice for the following reasons:

1. The Apple II features eight built-in connectors that make adding external interface circuitry a relatively easy task.
2. An abundance of commercial software is available.
3. The multicolor, high-resolution graphics software enables several channels of data to be displayed simultaneously.
4. The logical structure of the 6502 and the existence of a miniassembler within the Apple firmware make machine-language programming relatively easy.
5. It is extremely reliable. When it has needed repair, service was easy to find and the repairs quickly completed.

Design Criteria

I designed the circuitry discussed in this article to perform the specific task of digitizing the complex voltage waveforms produced by a muscle being exercised. I needed to simultaneously sample three channels of this electromyographic (EMG) information so the data would be synchronized at specific points in time. Because I was preprocessing the EMG by taking the absolute value and then passing those signals through a low-pass filter, I knew that the input voltage to the A/D converter would always be positive, that it would never exceed a maximum value of 5 volts (V), and that the highest frequency component would be no greater than 100 Hz. With this information in mind, I determined the design specifications for the A/D converter.

Essentially, three factors create major limitations to the accuracy and usefulness of data collected through an A/D converter: loss of significance, resolution, and sampling rate.

Loss of significance is what occurs when the maximum magnitude of the input signal is much less than the A/D converter's maximum input range. As an example, suppose that you are using an 8-bit A/D converter that has a maximum input of 10 V. The input range of 10 V is then spanned by the 256 (2^8) possible voltage levels that the A/D converter can quantize. When the input voltage is equal to 10 V, the entire number of possible voltage levels is used. The signal-to-noise ratio then can be expressed as 20 times the logarithm of the ratio of the input voltage to the smallest quantized voltage level, or $20 \log_{10} (255/1) = 48$ decibels (dB). Suppose the input voltage had been only 2 V. The A/D converter would have then used only 50 of the 255 possible voltage levels, reducing the signal-to-noise ratio to $20 \log_{10} (50/1) = 34$ dB. Consequently, it is important to match the maximum input voltage to the maximum input range of the A/D converter whenever possible.

Resolution is related to the ability to distinguish between two voltage levels that are nearly equal. The smallest magnitude difference that can be

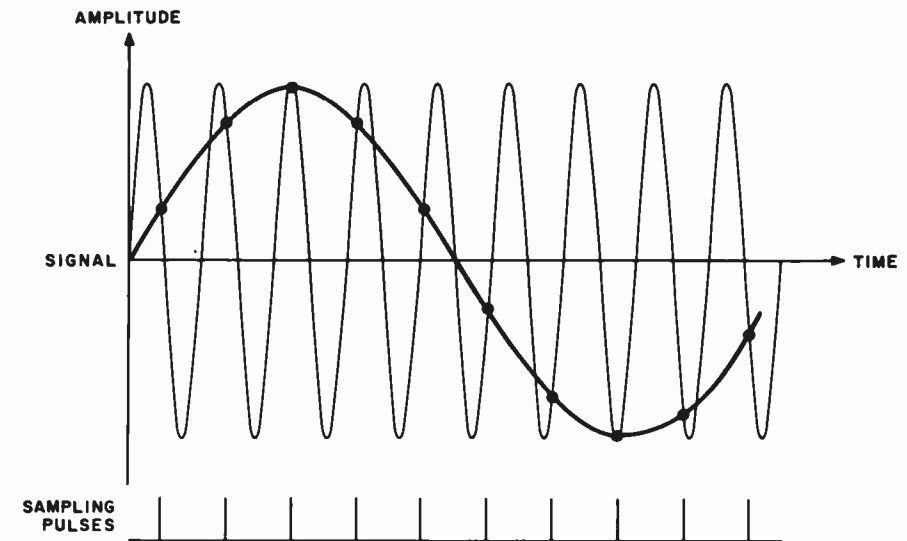

Figure 1: An example of aliasing caused by a sampling rate that's too low.

detected defines the resolution of the system. For an A/D converter that represents a 10-V analog input voltage by an 8-bit binary number, resolution is equal to $10/256 = 0.039$ V. Under ideal conditions, the system should be able to distinguish between two signals with a voltage difference of 0.039 V.

The sampling rate determines the computer's ability to detect time-dependent changes in the input voltage. As an example, consider an input signal that is changing at a rate

Loss of significance, resolution, and sampling rate are three factors involved in data collection through an A/D converter.

equal to 50 V/second. Suppose that you wanted to resolve the input signal with a 3 percent accuracy (within ± 0.3 V for an input equal to 10 V) at any point in time. An input voltage that is changing at a rate equal to 50 V/second changes by 0.3 V in 6 milliseconds (ms). Consequently, to achieve 3 percent accuracy, you must sample the input signal at least once every 6 ms.

If you don't have an intuitive feel for the accuracy you need, a good rule of thumb is to set the sampling rate to twice the maximum frequency component of the input signal. When

you sample too slowly, you can have problems with *aliasing*, which results when a high-frequency signal impersonates a low-frequency signal (see figure 1). For applications in which you will be sampling at rates that are less than twice the highest frequency component, you must insert a low-pass filter at the input of the A/D converter to limit the frequency content and to ensure faithful reproduction of the input signal. When you sample too quickly, you will quickly expend the available memory in the computer. However, it is generally better to have too much data than not enough.

System Hardware

The AD7570 from Analog Devices Inc. (Two Technology Way, Norwood, MA 02062, (617) 329-4700) is a successive-approximation-type A/D converter that requires only an external reference and a comparator to provide either an 8- or 10-bit output representation of the input signal. A three-state output register is used to buffer the digital output signals, enabling several AD7570s to be connected in parallel to a single data bus. This feature permits you to use a separate A/D converter for each input channel, thus providing increased system throughput rate.

The AD7570 uses a conversion scheme known as successive approximation to achieve the high resolution and conversion speed necessary for

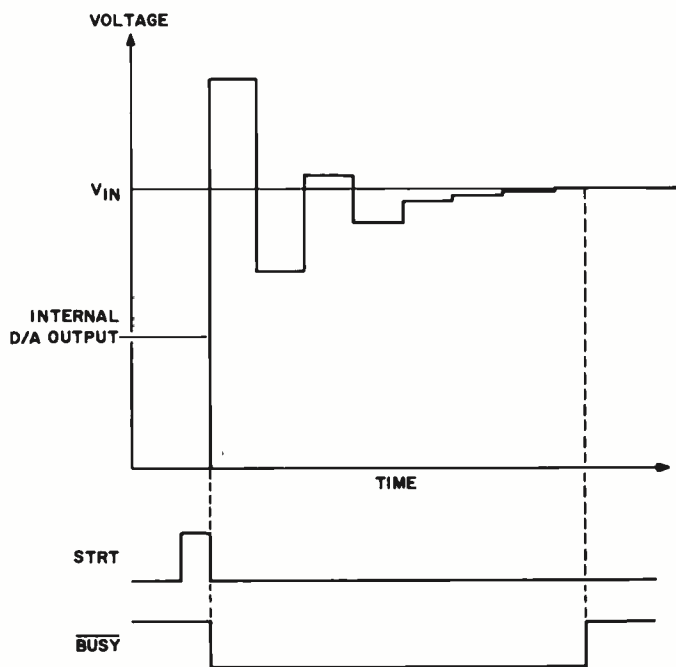

Figure 2: Analog-to-digital (A/D) conversion example using the successive-approximation technique. The A/D converter output makes several steps before matching the input voltage.

some computer applications. Successive approximation involves comparing the unknown input voltage with a preset series of voltage increments that are binary fractions of the maximum input range that the A/D converter can handle.

Initialization of the conversion sequence begins when the convert start (STRT) input goes to a logical 1 (see figure 2). At this time, the most significant bit (MSB) of the data latch is set to a logical 1, and the remaining bits of the data latch are set to a logical 0. When the STRT line is returned to a logical 0, the actual conversion process begins. The output of the internal digital-to-analog (D/A) converter is sequenced bit by bit from the MSB to the least significant bit (LSB).

The external comparator determines whether the addition of each successively weighted bit creates a voltage that is greater than or less than the input voltage. When the voltage is greater, the bit is turned off (set to a logical 0); when the voltage is less, the bit is left on (set to a logical 1). After this comparison is made between all bit combinations, the conversion is complete and the internal successive-approximation register contains the binary code that repre-

sents the converted input signal. Thus, for a converter circuit that can measure an input voltage varying between 0 and 10 V (10 V is full scale), the comparisons would be made between voltage levels that varied in 0.039-V increments (10 V divided by 256 discrete levels).

When an unknown input voltage is to be converted, first, the MSB of the internal D/A converter's output (one-half full scale) is turned on, comparing the input voltage to 5 V. If the input voltage is less than 5 V, the MSB is turned off, the next bit (one-fourth full scale) is turned on, and the input voltage is compared to 2.5 V. If the unknown input voltage is greater than 2.5 V, the second bit is left on, the next bit (one-eighth full scale) is turned on, and the input voltage is compared to 3.75 V. ($2.5 + 1.25$). If the unknown input voltage is less than 3.75 V, the third bit is turned off, the next bit (one-sixteenth full scale) is turned on, and the input is compared to 3.125 V ($2.5 + 0.625$). This process continues in order of descending bit weight until all bits have been tried. The conversion process is thus completed, and the 8-bit binary number representing the unknown input voltage is ready to be read by the computer.

I have divided the circuitry associated with the A/D converter into two classifications: circuitry that deals primarily with analog signals and circuitry that deals primarily with digital signals. Figure 3 shows the circuitry dealing with analog signals. IC1 is a three-terminal voltage regulator that provides -5 V to the reference voltage terminal (pin 2) of the AD7570s. I used a 5-V reference because the signals that I am digitizing do not exceed 5 V. The AD7570 is capable of accepting voltages from 0 to +10 V at the input terminal. Because the three input sections are identical to each other, I will describe only the circuitry associated with Input 1. The A/D converter (IC2a) works in conjunction with the comparator (IC5) to determine the binary representation of the input signal. As the internal successive-approximation register changes the weighted bit pattern, IC5 compares the output of the internal D/A converter with the input signal. The results of the comparison are fed back to pin 7 of the AD7570, and the successive-approximation register makes appropriate adjustments to the weighted bit pattern. The 1k-ohm resistor is connected across the comparator input terminals to reduce the settling time of the comparator, which ultimately reduces the conversion time.

Figure 4 shows the digital circuitry. As in the description of the analog circuitry, only one input channel will be discussed because the other two channels are identical. The AD7570 has a provision for what is called a short-cycle conversion. This is accomplished by connecting the SC8 (pin 26) control line to a logical 0, forcing the converter to stop the conversion cycle after 8 bits, and reducing the conversion by two clock cycles. Even more important than achieving the time savings of two clock cycles is the time saved by having to read in only 8 data bits per input channel. For my applications, the increase in sampling rate that could be achieved was considered to be worth the resolution that was lost.

Operating under the short-cycle format, the conversion process still starts with the MSB and works down

WORK SMARTER - NOT HARDER

WITH THE SMART-CARD™ MANAGEMENT SYSTEM™*
FROM EXEC-U-PLAN™

GET MORE DONE IN LESS TIME
Control 20-50—even hundreds of projects at a time with the smartest, easiest, most flexible method ever developed for planning and monitoring activities, schedules, appointments, performance, details and deadlines. The SMART-CARD Management System helps busy executives accomplish more in less time—by freeing the mind's memory banks and thought processes to focus where it counts! No matter how well organized you are, The SMART-CARD Management System will give you a better return on your time investment. **We guarantee it!**

CONTROL HUNDREDS OF PROJECTS WITH COMPUTER-LIKE EFFICIENCY
The SMART-CARD Management System is designed to function in many ways like a personal data processing center, but, with much greater flexibility and ease. Simply record all important information directly onto color-coded SMART-CARDS. Then insert them in the system's exclusive see-through panels—for visual control of hundreds of entries at-a-glance. Merge cards into the system after meetings. Move cards as projects are completed or priorities change. Retrieve information instantly. The SMART-CARD Management System's unique features and six special purpose cards help you plan and manage more effectively than ever before.

QUALITY CRAFTSMANSHIP
Individually crafted of the finest genuine leathers or rich leather grained vinyls, each SMART-CARD System comes personalized with your name or initials on the cover. Take the handsomely styled, highly portable EXEC-U-PLAN System with you to meetings, on business trips, or for a more productive daily commute.

WORKS FOR EVERYONE
Available in three styles to satisfy a wide range of needs and preferences, The EXEC-U-PLAN SMART-CARD Management System is ideal for all executives and professionals. With the system you're always so well organized, the time you save won't just be your own—it will increase the productivity of everyone around you. So, to Work Smarter, Not Harder, put the remarkable new EXEC-U-PLAN SMART-CARD Management System to work for you, and those around you, today!
***PATENT PENDING**

SPECIAL BONUS
Now—for a limited time only—receive a handsome, matching Pocket Organizer **FREE** with any model shown at left. This compact tuck-away version of the SMART-CARD Management System puts key data in your pocket—and lets you easily make new entries on-the-go. Retail value \$15.00.

**CREDIT CARD ORDERS
PHONE TOLL FREE**

1-800-USA-0700

OR WRITE: **EXEC-U-PLAN™ DEPT. 184**

31-17 QUEENS BLVD., LONG ISLAND CITY, N.Y. 11101
Circle 155 on Inquiry card.



DELUXE

Our most popular model

- Manages 288 projects: 2 panels—72 SMART-CARDS per side. Expands to 1440 w/purchase of extra panels
 - 750 asst'd SMART-CARDS
 - Color-coded signals
 - Name or initials on cover
 - Pen, tablet and business card storage
 - Deluxe lock
- Plus the SMART-CARD Management System Manual

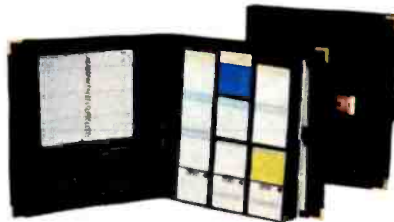

SUPER DELUXE

Our premier model

- Manages 576 projects: 4 panels—72 SMART-CARDS per side. Expands to 1440 w/purchase of extra panels
 - 4 tabbed dual pocket dividers
 - 1,000 asst'd SMART-CARDS
 - Multi-function calculator
 - Digital time piece and alarm
 - Calendar-phone-address book
 - Color-coded signals
 - Name or initials on cover
 - Pen, tablet and business card storage
 - Deluxe lock
- Plus the SMART-CARD Management System Manual

Leather grained vinyl **\$105.00**
Genuine leather **\$155.00**
Plus \$4 shipping and handling



All Models Available In:

LEATHER GRAINED VINYL

Chestnut Brown (dark), Willow Brown (medium), Black, Burgundy and Natural Tan Suede.

GENUINE LEATHER

Black, British Tan and Burgundy.

SATISFACTION GUARANTEED

If for any reason you are not completely satisfied with your EXEC-U-PLAN SMART-CARD System, simply return it within 30 days of purchase for a full and prompt refund.

Leather grained vinyl **\$44.50**
Genuine leather **\$84.50**
Plus \$4 shipping and handling



THE TRAVELER

Our streamlined model

- Manages 144 projects
 - 500 asst'd SMART-CARDS
 - Color-coded signals
 - Name or initials on cover
 - Pen holder
- Plus the SMART-CARD Management System Manual

Leather grained vinyl **\$27.50**
Genuine leather **\$52.50**
Plus \$4 shipping and handling

Add \$7.50 per model for shipments to Canada, Alaska, Hawaii and Puerto Rico, \$12 to Mexico and \$18 to all other countries.
Copyright 1983, Executive Management Systems, Inc. U.S. and International patents pending. EXEC-U-PLAN, SMART-CARD, SMART-CARD Management System and the products named herein are trademarks of Executive Management Systems, Inc.



GPIB ↔ PC

IEEE-488
High Speed Interfaces
for Personal Computers

IBM PC™
IBM PC Compatibles
RAINBOW 100™
Zenith Z-100™
TI professional

Language Support—BASIC,
C, FORTRAN, Pascal, Assembly

Operating Systems—PC DOS,
MS-DOS, CPM 86/80, Z DOS, UNIX

Software Compatible with our
family of IEEE-488 Interfaces
for VAX, PDP-11, LSI-11, S-100
BUS, STD BUS, SBX, and
Multibus computers.



**NATIONAL
INSTRUMENTS**

The Leader in IEEE-488
Computer Interfaces

12109 Technology Blvd.
Austin, Texas • 78727

800/531-5066 • 512/250-9119

Rainbow™ is a trademark of Digital Equipment Corp.
IBM PC™ is a trademark of International Business Machines.

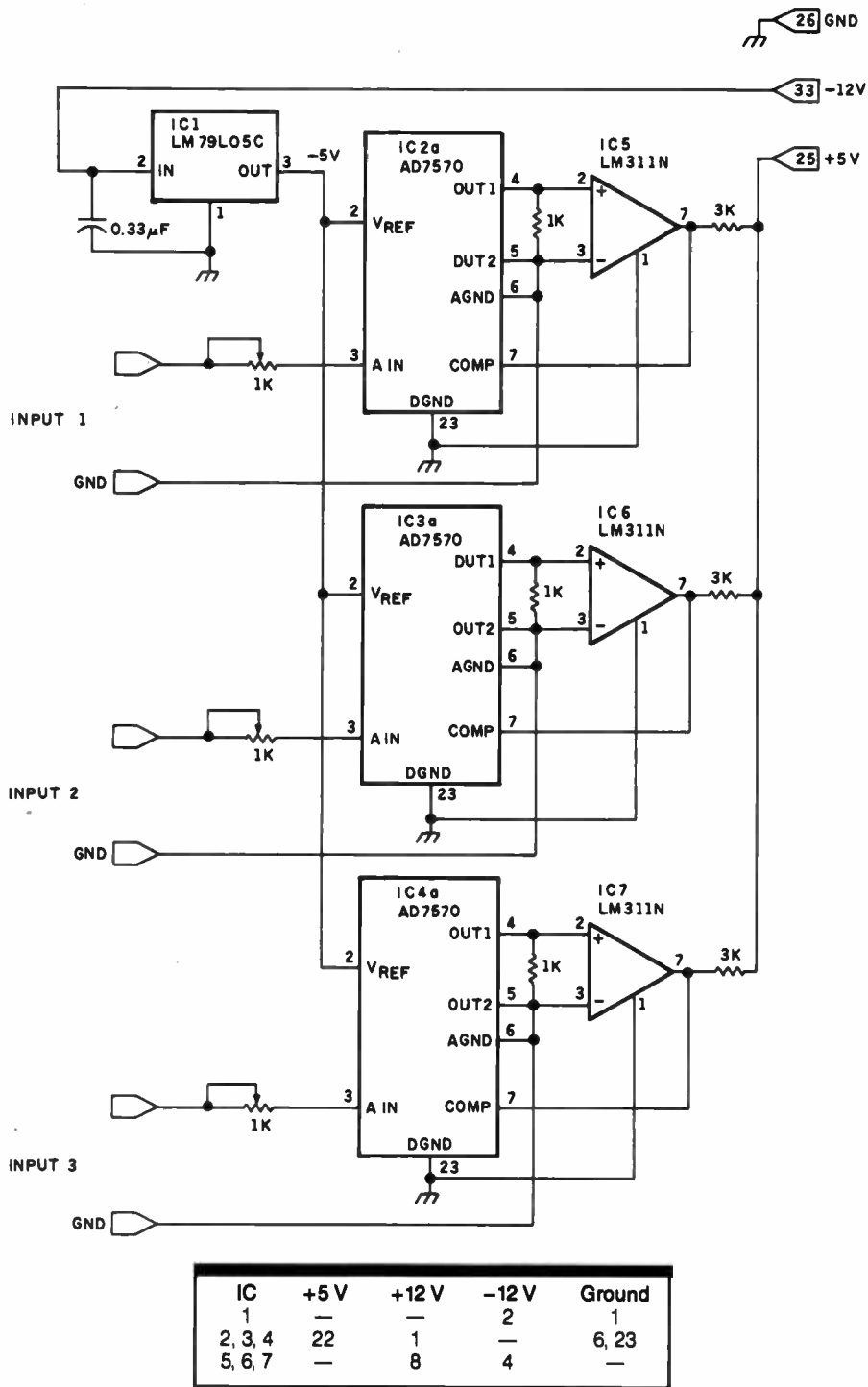

Figure 3: A/D converter analog input circuitry.

to DB2. The 8 bits of digitized data are then contained on data lines DB2 through DB9. The high-byte enable (HBEN) control line is a three-state enable for DB9 (MSB) and DB8. When HBEN is a logical 1, digital data from the internal latches appears on the data lines. The low-byte enable (LBEN) control line is a three-state enable for DB0 (LSB) through

DB7. When LBEN is a logical 1, digital data from the internal latches appears on the data lines. Because the short-cycle mode uses only data lines DB2 through DB9, HBEN and LBEN are connected together so that a logical 1 causes the digital data representing the converted input signal to appear on the data lines.

The busy enable (BSEN) control

Forget-Me-Not

\$995*
brother HR-25
DAISY WHEEL PRINTER

\$269
Auto Cut Sheet Feeder



**That's all it costs to make complete
your word processing system.**

Dynax is proud to present Brother HR-25, the best in its class offering you the finest letter-quality printing at speeds of 23cps and 132 columns paper width. And for a mere \$269 extra, the addition of our Auto Cut Sheet Feeder will give you all and more than can ever be expected for a word processing system. You can't afford not to have one!

Dynax, Inc.

*CENTRONICS PARALLEL
RC 232C SERIAL and optional TRACTOR
also available.

Circle 139 on inquiry card.
Above prices are Suggested Retail Price.

■ **HEADQUARTERS**
5698 Bandini Blvd.
Bell, CA 90201
(213) 260-7121

■ **NEW JERSEY**
One Madison St.
East Rutherford, NJ 07073
(201) 471-0100

■ **TEXAS**
6012 Campus Circle, Suite 250
Irving, TX 75062
(214) 257-1700

■ **ILLINOIS**
543 W. Algonquin Rd.
Arlington Heights, IL 60005
(312) 981-5633

■ **MASSACHUSETTS**
400 W. Cummings Park, Suite 5300
Woburn, MA 01801
(617) 933-8162

■ **N. CALIFORNIA**
1255 Oakmead Parkway
Sunnyvale, CA 94086
(408) 730-1712

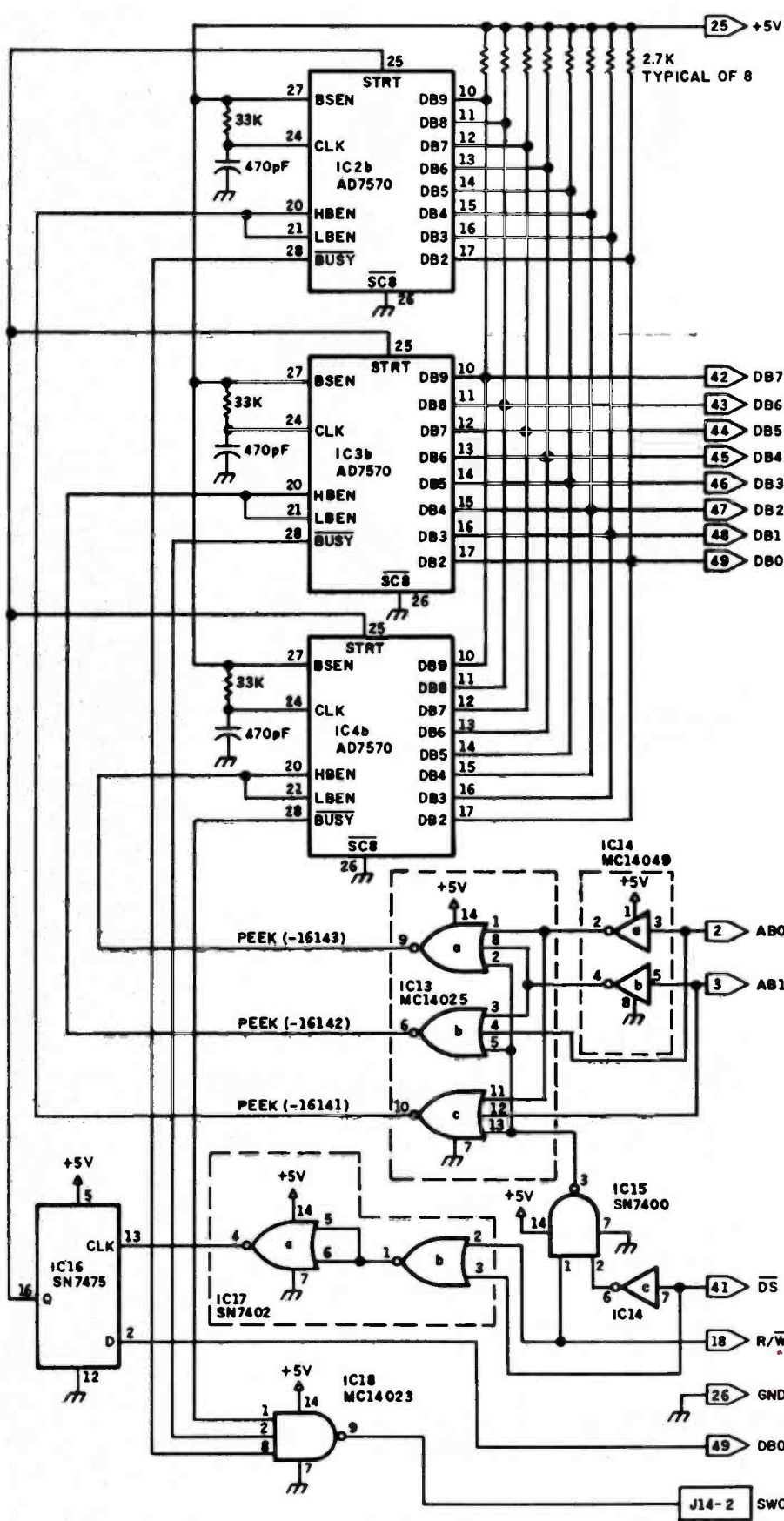

line (pin 27) is used to determine if the converter status line (BUSY) is enabled or if it is floating. In this application, I connected the BSEN line to a logical 1. Thus, the BUSY line always reflects the status of the converter. During the time that the conversion is being performed, the BUSY line is set to a logical 0. Upon completion of the conversion, BUSY is set to a logical 1.

The 33k-ohm resistor and the 470-picofarad (pF) capacitor are used to determine the internal clock frequency. With these values, the clock frequency is approximately 100 kHz. Clock activity begins upon receipt of a conversion start pulse and ceases upon completion of the conversion.

The remaining circuitry in figure 4 shows the control logic necessary to initiate the conversion cycles for all three converters, to sense when the conversion cycles have been completed, and to coordinate the transfer of data into the computer. The circuit is designed so that the peripheral card resides in I/O (input/output) slot 7 on the Apple II motherboard. The device-select signal goes to a logical 0 whenever memory locations (hexadecimal) C0F0 through C0FF are addressed. [Editor's Note: All addresses and number values are hexadecimal unless otherwise specified.] The least significant 2 bits of the address are decoded by IC13 and are used to transfer data from one of the three converters by enabling the three-state buffer of the appropriate converter. A conversion cycle is initiated by performing an LDA #01, STA C0F0 followed by an LDA #00, STA C0F0. This causes the output of the D-type flip-flop (IC16) to go from logical 0 to logical 1 and back to logical 0. This pulse is connected to each of the AD7570s, causing the three unknown input signals to be converted simultaneously. IC18 is used to indicate to the Apple II that all three converters have completed their conversion cycles. The output of IC18 is connected to one of the inputs on the game connector. Performing an LDA C061 loads the status of the game input into the 6502's accumulator; rotating the accumulator to the left and testing the carry bit enables the

Figure 4: A/D converter digital circuitry.

KEY TRONIC POLISHES THE APPLE II* KEYBOARD



Eleven Function Keys
Streamline Multiple
Key Operations

Full Shifting Capability

Keys in Familiar
Typewriter Locations

Numeric Pad

10 Foot Cable
For Portability

Enhance your APPLE II* Computer System with a Key Tronic keyboard peripheral. This detached, low-profile keyboard is plug-compatible with the existing keyboard socket of the Apple II. It also features reliable microprocessor electronics, solid-state capacitance switches, and positive tactile feedback.

Special keyboard available for the handicapped — factory direct.

* Apple II is a registered trademark of Apple Computer, Inc.

Suggested Retail Price: \$298.00

To order Model KB-200 call Toll Free 1-800-262-6006 for the retailer closest to you. (7am-3pm Pacific Time) Warranty information may be obtained, free of charge, by writing to the address below.



THE RESPONSIVE KEYBOARD COMPANY

DEPT. E1 • P. O. BOX 14687 • SPOKANE, WASHINGTON 99214 USA

RETAILERS: For the Distributor in your area, call Toll Free 1-800-262-6006 Dept. D (7am-3pm Pacific Time)



Innovation

State-of-the-Art products, such as UltraTerm® our 128-column display card, providing more of what you need when you need it.



Quality

Each Videx Product is fully tested, TWICE, before it ever reaches your computer. That's why Videoterm has the best track record in the business.



Support

Ask your Dealers and friends! Quick, Competent help, just a phone call away, has made Videx the recognized leader in customer support.



Excellence

Videx...It all adds up...for YOU!

You can't buy better products to enhance the power and ease-of-use of your personal computer.



For More Information Call us at
 (503) 758-0521
 1105 N.E. CIRCLE BLVD
 CORVALLIS, OR 97330

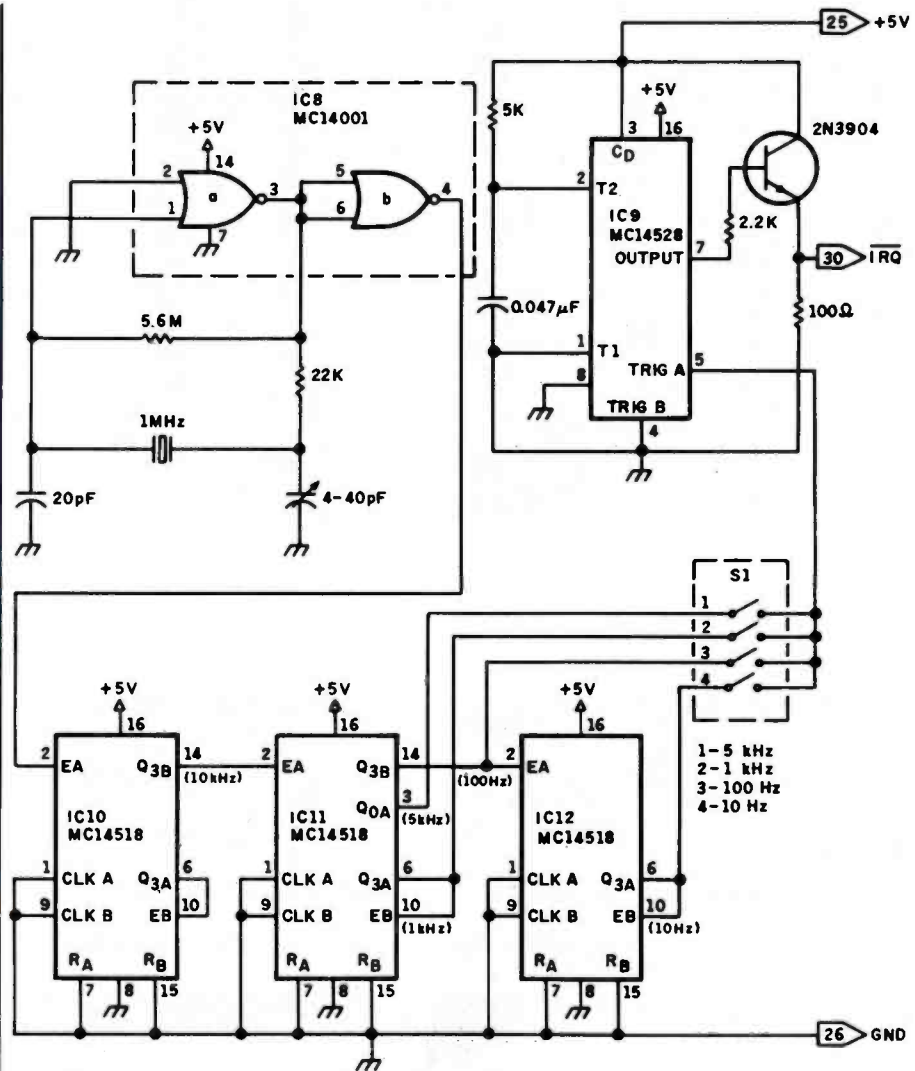

Figure 5: Crystal-controlled time base used in the A/D converter.

program to determine whether the conversions are complete.

It is desirable to take periodic data samples and to know the relationship between the magnitude of the data and time. This enables displaying the data as a function of time and permits the analysis of the data with respect to time. Some analysis techniques (such as fast Fourier analysis) require the data to be sampled periodically and the time between samples known. I used the interrupt-request line (IRQ) going to the 6502 micro-processor to control when a sample was to be taken. The IRQ control line is called a maskable interrupt because the system will jump to a given memory location if an interrupt request is received and if the interrupt system has been enabled. The CLI (clear interrupt-disable bit) com-

mand is used to arm the 6502 so that it will respond to the next interrupt request it receives.

Once a request is received, the 6502 first executes an indirect jump using the address contained in memory locations FFFE (LSBs) and FFFF (MSBs). The 6502 then executes a short subroutine that serves to handle the interrupt request. Ultimately, the 6502 is forced to jump to the memory location contained in memory locations 3FE (LSBs) and 3FF (MSBs). The Hello program, which is executed when the computer is first turned on, uses POKES to place the desired interrupt entry point into addresses 3FE and 3FF. Hello also disables the interrupt system so that an interrupt will not be prematurely executed. Once execution of the interrupt routine has been

ADDS STACKS UP BEST



**Designed for
Operator Enjoyment.**

The leader in quality and reliability now offers the Viewpoint family with all the most user-requested features:

- Earth-tone colors and small size to complement any office environment.
- Tilt and swivel display for operator comfort.
- Low profile keyboard with adjustable height for easier data entry.

ADDS
Applied Digital Data Systems Inc.
A Subsidiary of NCR Corporation

100 Marcus Boulevard, Hempstead, NY 11788 (516) 231-5400
Atlanta, GA (404) 458-7120 • Boston, MA (617) 875-2337
Dallas, TX (214) 387-2337 • Palo Alto, CA (415) 856-0580
Philadelphia, PA (215) 584-0135 • Phoenix, AZ (602) 868-0850
Shaumburg, IL (312) 843-7555 • Tustin, CA (714) 730-8700
ADDS, UK 44 01 848 1272.



VIEWPOINT®/Color.
The first truly low-cost color terminal.



VIEWPOINT®/90.
OEM's delight... double-high / double-wide, split screen, programmable function keys, down-line loadable, and more.



**VIEWPOINT®/78 and
VIEWPOINT®/78 Color.**
IBM functionality in mono-chrome and color.



VIEWPOINT®/60.
A fully featured editing terminal.



VIEWPOINT®.
Best price/performance in a conversational terminal.

VIEWPOINT is a registered trademark of Applied Digital Data Systems Inc.

IT ALL ADDS UP.

Look Again.

DEC
VT100
VT102
VT52

DASHER
D400
D200
D100



SMARTERM™ DOES IT!

You may have just bought your last DEC™ or DASHER™ terminal. Now, with a Persoft SMARTERM

software terminal emulator, you can join the thousands of users who have turned their IBM™ PCs (or compatibles) into DEC or DASHER CRTs.

SMARTERM offers more: 75 to 9600 baud operation, multiple setups, true 132 column VT100 display, "smart" softkeys and command files, online help screens, full printer support, and powerful ASCII and binary file transfer including an "error-free" mode. Combined with a complete manual, reference card, keytop chart, and unlimited telephone support, these features make **SMARTERM** unmatched!

Hard to believe? Try it!
If you're not satisfied, return it within 30 days for a full refund. Call us **NOW** for more information.

Ask About Versions For
PCjr.

Available through your local software dealer or directly from:



2740 Ski Lane (608) 273-6000
Madison, WI 53713 TELEX 759491

Software for Professionals . . .
by Professionals.

*On your monochrome monitor using the new SuperVision board. Ask about our special board prices.

SMARTERM is a trademark of Persoft, Inc.
DEC & VT are trademarks of Digital Equipment Corporation.
DASHER is a trademark of Data General Corporation.
SuperVision is a trademark of California Computer Systems, Inc.
IBM is a trademark of International Business Machines, Inc.

Listing 1: A/D converter system initialization routine.

```

10 REM HELLO
20 HOME: REM CLEAR SCREEN
30 PRINT "*****"
32 PRINT "*           A/D CONVERTER           *"
34 PRINT "*****"
50 REM DEFINE INTERRUPT JUMP ADDRESS
52 POKE 1022,64:POKE 1023,144
54 REM INTERRUPT DISABLE SUBROUTINE
56 POKE 1016,72:POKE 1017,8:POKE 1018,120:POKE 1019,40:
   POKE 1020,104:POKE 1021,96
58 CALL 1016: REM EXECUTE SUBROUTINE TO DISABLE INTERRUPT
   REQUEST LINE
80 D$="": REM DOS CONTROL CHARACTER
82 PRINT D$;"RUN TEST,D1": REM LOAD AND EXECUTE MAIN APPLESOFT
   PROGRAM
99 END
    
```

performed, an RTI (return from interrupt) command is executed to force the processor to return to the instruction that was being executed when the interrupt request was first received.

Figure 5 shows the circuit that controls when a sample is taken. IC8 and its associated resistors, capacitors, and 1-MHz crystal form a stable, accurate, square-wave oscillator time base. IC10, IC11, and IC12 divide the output frequency of the oscillator so that several different sampling frequencies can be obtained. IC9 is a monostable multivibrator that provides a fixed width pulse that is synchronized to the sampling frequency. The 2N3904 transistor is used to provide a low-impedance output to the $\overline{\text{IRQ}}$ going to the 6502. I designed the clock circuitry so that sampling rates of 5 kHz, 1 kHz, 100 Hz, and 10 Hz can be obtained by closing the appropriate contacts on S1.

Construction Hints

If you have built electronic circuits before, either from scratch or from a commercially available kit, you should consider building the high-speed A/D converter. If you are careful, the chances of damaging your Apple are low and the chances of the circuit working are high. I will try to increase your probability of success by providing some advice and some specific points to check as you finish building each section.

I recommend that you buy the hobby/prototype board for the Apple II and use wire-wrap construction. This type of construction goes together

fast and lends itself to easy correction of wiring errors. The cost of the wire-wrapping tools is a little high, but it is doubtful that you will ever wear them out. You can order the A/D converter ICs directly from the manufacturer; the rest of the components can be purchased from Jameco Electronics (1355 Shoreway Rd., Belmont, CA 94002, (415) 592-8097).

Start by building the crystal-controlled time-base oscillator shown in figure 5. Beg or borrow an oscilloscope and perform the following tests:

1. Initially, do not connect the $\overline{\text{IRQ}}$ line from the 2N3904 transistor to pin 30 on the hobby/prototype board.
2. With the computer turned off, plug the hobby/prototype board into peripheral I/O slot 7.
3. Turn the computer on. It should function normally. If the computer does not function normally, turn it off and pull out the hobby/prototype board. Turn the computer back on to see if normal operation has been restored. If so, you have made an error in wiring or you probably have inserted one of the ICs into a socket backward.
4. Once you get the Apple to work with the board plugged in, connect the oscilloscope to pin 2 of IC10, where you should see a distorted square wave having a frequency approximately equal to 1 MHz. Adjust the 4-40-pF trimmer capacitor until this frequency is equal to 1 MHz.
5. Measure the pulse width of the

See Software.

Dick is a programmer. Dick is bored. Harried. Dick struggles with trace chores. Debugging routines. Nonexistent documentation. Hidden bugs. So Dick is four months behind schedule. And customers are upset when bugs slip through. They yell and make Dick upset. They make Dick's boss upset. Nobody is very happy.



See Software Run.

Jane is a happy programmer. She uses ANIMATOR.[™] It's a VISUAL PROGRAMMING[™] aid for MICRO FOCUS[™] LEVEL II COBOL.[™] It runs on a micro. It makes child's play of test and debugging tasks.

With ANIMATOR Jane sees a picture of the program explaining itself. In real time. In COBOL source code. ANIMATOR tracks the program's exact execution path. Including subroutine branches. Jane can have the program run fast. Or slow. Or stop. With one key. This makes it easy to spot problems. Insert fixes. Set breakpoints. Instantly.

Jane's programs are best sellers. They're delivered on time. With no hidden bugs. Jane's boss likes this about Jane. Because he doesn't like customers to yell at him.



Run, Software, Run.

This software vendor just went public. Because he doubled productivity. Eliminated bugs. Cut costs. Produced terrific applications. Beat the competition to market. And customers don't yell at him anymore. All thanks to ANIMATOR.



See ANIMATOR now.

Let ANIMATOR help you do better work. And speed your applications to market. Write for more information. Or call (415) 856-4161. Right now.

MICRO FOCUS

2465 E. Bayshore Rd., Suite 400, Palo Alto, CA 94303

© 1984 Micro Focus Inc. All Rights Reserved.
LEVEL II COBOL, ANIMATOR, VISUAL PROGRAMMING, MICRO FOCUS and the MICRO FOCUS Logo are trademarks of Micro Focus Ltd.

2465 East Bayshore Rd., Suite 400, Palo Alto, CA 94303
I'd like more information

Name _____ Title _____
Company _____ Phone _____
Address _____
City _____ State _____ Zip _____

IRQ output at the 2N3904 transistor. It should be approximately equal to 0.1 ms. If there is no output pulse at this point, work your way back toward pin 2 of IC10 until you find the square wave again. Once you find the square wave, you can be pretty sure that you have made a wiring error somewhere between that point and the $\overline{\text{IRQ}}$ line.

- The frequency of the $\overline{\text{IRQ}}$ pulse train should change as you open and close the various switches on S1. If it does not, you should check the wiring at this point in the circuit.
- Initialize a new disk using the Hello routine shown in listing 1. Connect the $\overline{\text{IRQ}}$ line to pin 30 on the hobby/prototype board and turn the computer on. If it does not function normally, you probably have made an error in entering Hello.

Next, wire the logic circuitry shown in figure 4 and perform the following measurements:

- Execute the following BASIC statements; you should see the Start Conversion pulse (pin 5 of IC16) periodically go from 0 to +5 V.

```
100 POKE -16143,0
110 FOR I=0 TO 100:NEXT I
```

```
120 POKE -16143,1
130 FOR I=0 TO 100:NEXT I
140 GOTO 100
```

- Execute the following BASIC statements; you should see the Data Strobe pulse for Input 1 (pin 9 of IC13) periodically go from 0 to +5 V.

```
100 X=PEEK(-16143)
110 FOR I=0 TO 100:NEXT I
120 GOTO 100
```

- Execute the following BASIC statements; you should see the Data Strobe pulse for Input 2 (pin 6 of IC13) periodically go from 0 to +5 V.

```
100 X=PEEK(-16142)
110 FOR I=0 TO 100:NEXT I
120 GOTO 100
```

- Execute the following BASIC statements; you should see the Data Strobe pulse for Input 3 (pin 10 of IC13) periodically go from 0 to +5 V.

```
100 X=PEEK(-16141)
110 FOR I=0 TO 100:NEXT I
120 GOTO 100
```

If you have made it this far, congratulations. The next phase is the most difficult to test, so be especially careful when you wire it up. For now,

you should wire up the AD7570 associated with Input 1. Keep the leads between IC2 and IC5 short to minimize the tendency for the circuit to oscillate. Once you have finished building the circuit, perform the following tests to make sure it is working correctly:

- The voltage at pin 2 of IC2 should be equal to -5 V.
- Execute the following BASIC statements; you should see the BUSY line periodically go from 0 to +5 V.

```
100 POKE -16143,0
110 POKE -16143,1
120 POKE -16143,0
130 FOR I=0 TO 100:NEXT I
140 GOTO 100
```

If your circuit passed all these tests, there is a high probability that it is wired correctly. You will now need to test your hardware with the software routines I'll provide next month in part 2. ■

Acknowledgment

This project was supported by the Human Capability Corporation of Southfield, Michigan.

Richard C. Hallgren is an associate professor in the Department of Biomechanics, Michigan State University, East Lansing, MI 48824. He works on applications of microprocessor-based systems to scientific research.

LIMIT

Makes your
Wordstar™
directories
look like this.



ANYONE who has used this popular word-processing package knows that finding a file from the screen can be frustrating. Unfortunately, the screen shows every file on the disk. **LIMIT** allows you to select the group of files to be shown. \$39*

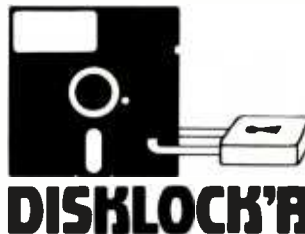

Keep unauthorized users from running programs or viewing private data files. Simple to use — just two commands. \$59*

THESE AND OTHER FINE
PROGRAMS AVAILABLE FROM:

COMPUTER PUBLISHING COMPANY

1945 N. Fine #101 Fresno, CA 93727
(209) 453-0777

AVAILABLE FOR CP/M, MS-DOS, CPM/86
CPM & CPM/86 are trademarks of Digital Research, Wordstar is a trademark of
MicroPro Int'l, Disklock'r is a trademark of Computer Publishing

STABILITY

MULTI-TASKING

—

—

ELEGANCE

—

PROVEN

COMPATIBILITY

—

HARDWARE INDEPENDENCE
COMPATIBILITY

EVOLUTIONARY

PRODUCTIVITY

FLEXIBILITY

LANGUAGES
COMPATIBILITY
TRAINING

COMPATIBILITY
PORTABILITY
ELEGANCE
MULTI-USER
STANDARD
HARDWARE INDEPENDENCE
PRODUCTIVITY

MATURE
PROVEN
RELIABLE

EASY TO LEARN
EASY TO USE

EDUCATION
BUSINESS

EXPANDABILITY
MAINTENANCE
DOCUMENTATION
EVOLUTIONARY

DOCUMENTATION

EASY TO LEARN
EASY TO USE

PRODUCTIVITY
FLEXIBILITY
FAMILIARITY

BUSINESS
EDUCATION
INSTRUMENTAL

PRODUCTIVITY
BEST SERVICE
TRAINING
BUSINESS
MATURE
APPLICATIONS
FAMILIARITY
EASY TO LEARN

MULTI-TASKING
SOUND INVESTMENT
EVOLUTIONARY

SUPPORT

MULTI-TASKING
SOUND INVESTMENT

MATURE

ELEGANCE
PORTABILITY
RELIABILITY
COMPATIBILITY

POWERFUL

COMPATIBILITY
 RELIABLE MULT
 SOFTWARE STAI
 DOCUMENTATIO
 EASY TO USE HA
 DEVELOPMENT I
 COMPATIBILITY
 RELIABLE MULT
 SOFTWARE STAI
 DOCUMENTATIO
 EASY TO USE HA
 DEVELOPMENT I
 COMPATIBILITY
 RELIABLE MULT
 SOFTWARE STAI
 DOCUMENTATIO
 EASY TO USE HA
 DEVELOPMENT I
 COMPATIBILITY
 MULTI-USER PORTAB
 RELIABLE MULTI-TASKING SOUND IN
 'SOFTWARE STANDARD EVOLUTIONAR
 'OCUMENTATION MAINTENANCE S
 'Y TO USE HARDWARE INDEPEN
 'OPMENT EXPANDABILITY
 'RIBILITY MULTI-USER

ELEGANCE P
 TMENT COMM
 'PRODUCTIVITY FL
 RT SERVICE POW
 TRAINING LANGU
 BY BUSINESS INTE
 TY ELEGANCE POPUL
 TMENT COMMUNICA
 'PRODUCTIVITY FLEXIBL
 RT SERVICE POWERFU
 TRAINING LANGUAGES SOFT
 BY BUSINESS APPLICATIONS
 TY ELEGANCE POPULAR PROV
 TMENT COMMUNICATIONS A
 'PRODUCTIVITY FLEXIBILITY FA
 RT SERVICE POWERFUL EASY
 TRAINING LANGUAGES SOFT
 BY BUSINESS I INTERNATIONAL
 TY ELEGANCE P ULAR PROV
 TMENT COMMUNICATIONS A
 'PRODUCTIVITY 'BILITY FA
 RT SERVICE PI UL EASY
 TRAINING LA ES SOFT
 BY BUSINESS D TIONA
 TY ELEGANCE P PROV

UNIX SYSTEM V. FROM AT&T. FROM

Marketability. Serviceability. Portability. UNIX System V has the ability to open a lot of new business doors. That's why it has emerged as an industry standard.

And that's why you should invest in UNIX System V.

potential of the expanding multi-user and multi-tasking business computer market.

The profits of standardization

For software houses, the portability of UNIX System V programs means that they can be sold to many more users.

For hardware manufacturers, UNIX System V programs are a sure bet for a profitable future.

every time they buy a new computer, they'll be more receptive to the new hardware technology you offer for sale.

It's not hard to sell programmers on UNIX System V. A large pool of programmers is already familiar with its advanced programming capabilities, high-level "C" language, and modular design. You'll enjoy increased programmer productivity. And a high return on investment.

Small wonder that so many companies are jumping on the bandwagon—with hardware and software products based on UNIX System V from AT&T.

Service that goes on and on

AT&T is backing up its commitment to UNIX System V with a program of

N MATU
 P LICATI
 ILIARI
 TO LEAR
 VARE RE
 EDUCAT
 N MATU
 P LICATI
 ILIARI
 TO LEAR
 VARE MI
 TAINTE
 N MATU
 P LICATI
 ILIARI
 TO LEAR
 VARE SO
 EDUCAT
 N MATU
 P LICATI
 ILIARI
 TO LEAR
 VARE IN
 EDUCAT
 N MATU

COMPATIBILITY
RELIABLE MULT
SOFTWARE STAI
DOCUMENTATIO
EASY TO USE HA
DEVELOPMENT
COMPATIBILITY
RELIABLE MULT
SOFTWARE STAI
DOCUMENTATIO
EASY TO USE HA
DEVELOPMENT
COMPATIBILITY
RELIABLE MULT
SOFTWARE STAI
DOCUMENTATIO
EASY TO USE HA
DEVELOPMENT
COMPATIBILITY
RELIABLE MULT
SOFTWARE STAI
DOCUMENTATIO
EASY TO USE HA
DEVELOPMENT
COMPATIBILITY



SYSTEM V

NOW ON, CONSIDER IT STANDARD.

training, support and documentation that is second to none. Including a problem-reporting system. Newsletters. A hotline. And periodic updates. Best of all, the source of this service is AT&T, whose own Bell Laboratories developed the UNIX Operating System over ten years ago. That gives you (and your customers) access to the scientists and technicians who created the UNIX System V in the first place.

"Is it based on UNIX System V?"
 You're going to be hearing a lot about AT&T's UNIX System V. Especially from companies in the market for business

computers. Or software to run on those computers. They're going to be asking a lot of questions. And the first one will be, "Is it based on UNIX System V?" From now on, the future belongs to those who have the right answer. To get all the answers about UNIX System V, just fill out the coupon. We'll send you our brochure, "Why Good Business Decisions are Based on UNIX System V," as well as full product and service information.

UNIX System V. From AT&T. From now on, consider it standard.
 ©1984 AT&T Technologies, Inc.

Mail to: AT&T, P.O. Box 967, BY0400AA
 Madison Square Station, New York, NY 10159

Name _____
 Title _____
 Company _____
 Address _____
 City _____ State _____ Zip _____
 Phone _____

My business category (check one):
 OEM/VAR Software House
 MIS/DP Mgt. General Business Mgt.

Other _____
 UNIX System Licensee Yes No Don't know





Who's sold more printers
to American business?

Epson®

Actually, we've not only sold more printers to American business, we've sold more printers to America.

Which brings up some very important reasons why Epson is the printer for *your* business.

Standard equipment.

Virtually every microcomputer made is Epson-compatible. Which means manufacturers make their computers to work with our printers, because Epson printers are not only the world leaders, they're the world standard.

The reason why.

We sell more printers, because we make better printers. Our features are consistently one step ahead of the competition. Our quality and value have never been equalled. And our reliability rates are second to none.

Another reason.

Epson printers are stocked by more computer stores in more

places than any other brand. Which means if you *ever* have a problem — and you probably won't — we'll be there.

Your next printer.

It can be very confusing buying a printer nowadays. But it needn't be. If you want the features, the reliability, the quality, the value, just remember one thing.

Epson.

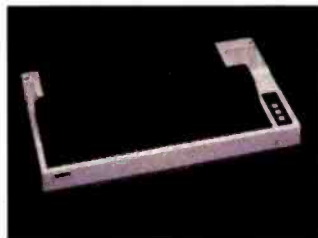

*Number one.
And built like it.*

EPSON

EPSON AMERICA, INC.

3415 Kashiwa Street
Torrance, California 90505

The Epson FX-100™ can print spreadsheets in correspondence-quality type at 160 characters per second. To see it and the entire line of Epson high-performance printers, call (800) 421-5426 for the dealer in your area. In California, call (213) 539-9140.

Epson is a registered trademark and FX-100 is a trademark of Epson America, Inc.

BY 4/84

Reviewer's Notebook

Rich Malloy

BYTE Senior Technical Editor

The Panasonic Sr. Partner

As everyone knows, the success of the IBM PC has set off an avalanche of PC clones, not only in the U.S., but also in the Far East. A prototype of one of these arrived here recently from Japan. And judging by this prototype, I am tempted to say that this one looks like the best of all. This new transportable is called the Sr. Partner (I assume that they mean *Senior Partner*, not *Señor Partner*) and it has some incredible capabilities at a very reasonable price.

The Sr. Partner is a little smaller than the standard sewing-machine-type transportable computer such as the Compaq. It features a 9-inch green-phosphor display, two half-height 5¼-inch drives (320K bytes each), a good supply of memory (256K bytes), and a thermal printer. And then there's the software: Wordstar, Visicalc, PFS:File, PFS:Report, PFS:Graph, GW-BASIC, and MS-DOS version 2.0. This all costs \$2495.

As if that is not enough, the Sr. Partner is also one of the most compatible PC clones I've seen. Even PC-TALK, the popular low-priced BASIC communications program runs on it. It seems to rank right up there with the Compaq. Also, the Sr. Partner's graphics adapter actually seems to be better than the IBM PC's. It doesn't flicker during scrolling, and objects that are meant to be colored on a color display come out as true grays on the monochrome monitor, not as hatched areas.

Not everything is perfect, however. Although the display does not flicker during scrolling, the scrolling does seem to be a little slower on this display. Also, the fan on this machine sounds like a small vacuum cleaner.

I'm not sure exactly how Panasonic will be selling this machine. The Japanese seem to have trouble marketing their computers in the U.S. But if you see one of these at your local

computer store, I suggest taking a good look at it.

The ACT Apricot

With the arrival of the Macintosh and the HP 150, the new small 3½-inch disks are getting very popular. Yet another machine to use these disks is the Apricot, new from the ACT Corporation, which sells the Victor 9000 (né Sirius) in Europe. The Apricot features a 9-inch display, two 3½-inch disk drives, and a keyboard that has a small 2-line liquid-crystal display. It is also a *semitransportable*, which means it doesn't look like a sewing machine (like all the other transportables), but it's small and you can take it home for the night without too much difficulty. The computer sells for \$3100 and comes with a modest selection of software.

Apricot's designers have taken advantage of some of the capabilities of MS-DOS version 2.0 to produce an elaborate menu-based operating system. This system is interesting, but I'm a bit too jaded to appreciate it. Perhaps I've spent too much time on CP/M.

The really interesting thing about the Apricot is the LCD on its keyboard. Sometimes it functions as a clock/calendar and at other times it is used to label the six function keys on the keyboard. And, if you press the Calc button on the keyboard, the LCD becomes a regular calculator. This extra display is a nice idea that other manufacturers should study.

The Smart Cable

An interesting product arrived here from IQ Technologies in Bellevue, Washington, called the Smart Cable (SC817). This enhanced connecting cable promises to connect almost any computer's serial port to almost any serial peripheral for \$90. All you have to do is make sure the transmission rates, word lengths, and stop bits match up on both machines.

Such a product would be ideal for a place like BYTE, where we are always trying to link up a new computer with a new printer. Unfortunately, the Smart Cable is not quite as smart as I would have hoped; it is not a simple "connect it and forget it" device. You have to flip a few switches on the cable connector until transmission is successful. And it doesn't work with every computer and every printer. For example, we had trouble connecting a NEC APC computer with a NEC Spinwriter. But it is better than resorting to the breakout box and trying to match the proper signal lines. And it is quicker than trying to get some overworked distributor to send the right code.

This Month

The most newsworthy review in this issue is on Coleco's Adam (see page 206). Our reviewer claims that the machine that sounded too good to be true, is.

The Rainbow 100 from DEC also finally gets a chance to be reviewed (see page 170). Note, however, that our reviewer never did get a copy of MS-DOS or a CP/M-86 format program to work with in time for the review. Such products do exist, and they work fairly well. DEC does seem to produce good products, but they take quite a bit of time.

As for software, we have a review of the Peachtext 5000 package for the several leading MS-DOS machines (see page 186). Also, on page 224 we review Micro-Logic, a simulation program for logic circuits.

And last, but by no means least, we have an immense survey of 24 statistical packages for various microcomputers (see page 234). This survey is so comprehensive that you might need one of these packages just to compare them all. ■

Rich Malloy is BYTE's product-review editor.

The Rainbow 100

*It runs CP/M-80, CP/M-86, and MS-DOS,
but only on Rainbow-format disks*

David B. Suits

Rochester Institute of Technology

The Rainbow 100 microcomputer was Digital Equipment Corporation's first stab at the microcomputer market. When introduced last year, only a handful of programs were available for it. Times have changed, though, and the Rainbow is worth looking at again.

The Rainbow, shown in photo 1, has two microprocessors instead of the usual one: an 8-bit Z80A and a 16-bit 8088. It has a large keyboard, an excellent display (with a color-graphics option), serial ports for a printer and modem, and a 400K-byte dual-disk drive. It comes with CP/M-86/80, which can run either 8- or 16-bit CP/M programs. MS-DOS is available as an option.

The Display

The standard Rainbow comes with a 12-inch (diagonal) black-and-white monitor that is compatible with the DEC

VT102 terminal. It is packaged in a tapered plastic case that is small enough and light enough (about 14 pounds) to be moved easily on your desk. The monitor has an adjustable rear leg so that you can tilt it back to the viewing angle you prefer. Brightness and contrast controls are at the rear of the monitor, which is not a particularly accessible location. But since they will probably not be used often, their placement should not be a problem.

Each character on the display is formed from an 8- by 9-pixel array (which includes 2 pixels for descenders) inside a 10 by 10 matrix. The characters may be displayed normally, in reverse video, highlighted, blinking, and underlined. Double-width and double-height characters are also available, but only on a line-by-line basis. Photo 2 shows how Rainbow characters look without enhancements.



Photo 1: The Rainbow 100 computer.



Photo 2: A sample display on the Rainbow 100.



Photo 3: *The Rainbow's 105-key keyboard. Label strips (along the top of the keyboard) may be changed. Note the division of keys into four groups: the standard typewriter keys, a set of editing keys (including cursor control), a numeric keypad, and, along the top, a row of special-function keys.*

Normally the screen displays 24 lines of 80 characters each, but it may also display 24 lines of 132 characters each. Actually, the display resolutions are 24 by 83 and 24 by 137, but the extra columns are not used. Some of the Rainbow's application programs—including RED (for Rainbow editor) and the Select-86 word processor—will allow you full use of the 132-column display.

The screen is automatically blanked after 30 minutes of inactivity, presumably to prevent burning of the tube's phosphor coating. Pressing any key restores the screen with no loss of data. A setup key lets you control tab settings, scroll setting by pixel or by character, modem, and printer settings (number of bits, parity options, and so on), blinking block or blinking underline cursor, automatic key-repeat (on or off), key-click volume, and other system parameters. Scrolling by pixel rows means that the screen scrolls very smoothly instead of jumping up by character rows. It is not until you see a smooth scrolling screen that you realize how bothersome a character-row scroll can be. Setup also allows you to specify an 80- or 132-column screen, but you may not change the screen width during the running of a program (such as a word processor) without losing the display data.

The display uses ASCII (American National Standard Code for Information Interchange) characters plus foreign-language characters. A clever programmer can also gain access to what DEC calls "high-speed video," which allows a set of 32 graphics characters to be displayed. There are no dot graphics with Rainbow in its minimum configuration, but an expansion-board option provides dot-addressable graphics with a resolution of 800 pixels horizontally by 240 vertically. With an optional color monitor (and, after all, what is a rainbow without

color?), you can display 16 colors in low-resolution mode (400 by 240 pixels) or 4 colors in high-resolution mode (800 by 240 pixels). With a monochrome monitor, the different colors are displayed as various gray levels. The system I had for review, unfortunately, did not have the graphics option installed, and a local dealer had only a short demo program with monochrome graphics. But what I did see was impressive both for its resolution and its speed.

The Keyboard

The 105-key keyboard, shown in photo 3, is connected to the monitor case with a thin, coiled cord and a telephone-style modular plug. It communicates with the system unit via a 4800-bps (bits per second) asynchronous serial port. The keyboard has six editing keys: Find, Insert, Remove, Delete, Previous Screen, and Next Screen. These are used a great deal in many of the Rainbow application programs. Below the editing keys are four cursor keys arranged with the left arrow on the left, the right arrow on the right, and so forth. To the right of these is a numeric keypad along with period, hyphen, comma, and Enter keys. For some reason, the plus sign, asterisk, and virgule keys are not included with the numeric keypad. Instead, along the top of the pad there are four keys labeled PF1 through PF4. Presumably they are programmable, but I haven't come across their use in any application program so far.

Along the top of the keyboard are 20 special-function keys, arranged in five groups. Among those keys is a Help key, which provides a paragraph or two of on-line instructions for various commands that the program uses. This is one of several reasons why the Rainbow

At a Glance

Name

Rainbow 100

Manufacturer

Digital Equipment Corporation
Personal Computer Marketing
2 Mount Royal Ave.
POB 1008
Marlborough, MA 01752

Summary

A solid, capable machine with superior documentation. Novice users will feel quite comfortable

Dimensions

System unit: 19 by 6.5 by 14.3 inches;
Monitor: 13.75 by 11.5 by 12.25 inches;
Keyboard: 21 by 2 by 6.57 inches

Weight

System unit: 30 lbs (13.6 kg);
Monitor: 14 lbs (6.4 kg);
Keyboard: 4.5 lbs (2 kg)

Power Requirements

115VAC, 230VAC (switch selectable), 47-63Hz, 218 watts

Processors

4.012-MHz Zilog Z80A 8-bit and 4.815-MHz Intel 8088
16-bit microprocessors

Memory

24K bytes ROM, 64K bytes RAM (expandable to 256K)

Standard Configuration

System unit (with integrated 800K disk drive, RS-232/423 printer and modem ports, 64K RAM, and space for 3 expansion boards), monochrome monitor, 105-key keyboard

Video Display

12-inch diagonal monochrome CRT, memory mapped, RS-170 composite, 80 or 132 columns by 24 rows with boldface, underline, blink, double height, and reverse video. Resolution is 800 by 240 pixels. ROM character set includes standard ASCII and foreign-language characters

Keyboard

Detached with 105 keys, including 4 cursor control keys, a numeric keypad, 6 editing keys, and 24 function keys

Options

64K or 192K RAM board, color/graphics board, second RX50 dual-disk drive, 10-megabyte hard disk, color monitor, additional communications port with high-speed path for hard disk, system unit floor stand, motorized column stand for monitor, workstation desk, system stand with castors

Software

| | |
|-------------------------------|-------|
| MS-DOS | \$200 |
| Select-86 word processor | \$395 |
| Multiplan spreadsheet | \$275 |
| MBASIC-86 | \$250 |
| MWC-86 C compiler | \$500 |
| Phonelink CP/M Communications | \$300 |

Prices

| | |
|--|--------|
| System unit (with one RX50 dual-disk drive) | \$2675 |
| 12-inch monochrome monitor | \$325 |
| Keyboard | \$245 |
| Extra 64K bytes RAM | \$495 |
| Extra 192K bytes RAM | \$650 |
| Second RX50 dual-disk drive | \$995 |
| Color/Graphics (not including color monitor) | \$695 |
| Color monitor | \$1325 |
| Extended Capabilities option | \$500 |
| 10-megabyte hard disk and controller | \$1495 |
| Hardware manual | \$50 |
| Peripheral cable (10 feet) | \$25 |
| LA50 printer | \$695 |
| LA100 printer | \$2690 |
| LQPO2 printer | \$2800 |
| System unit floor stand | \$79 |
| Motorized column assembly for monitor | \$149 |
| Workstation desk (with motorized column) | \$649 |
| Worktable and desk | \$549 |
| System stand with castors | \$299 |

can be comfortable for beginners to use. The Do key, another of the special-function keys, is used constantly, but not consistently, in various programs I've run on the Rainbow. The meaning of the key is more ambiguous than the word "do" would suggest. For example, sometimes the key is used as a "do it" key. In the Select-86 word processor, however, it sometimes means "do it" and sometimes "abort" and sometimes "exit from mode." With the Select-86 spelling checker, the Do key means "accept."

Above the Help and Do keys are four small LEDs (light-emitting diodes) labeled Hold Screen, Lock, Compose, and Wait. These keys come on when their corresponding keys are pressed. Compose, however, is not supported by CP/M-86/80.

Most of the keys have an auto-repeat feature; that is, they will repeat if held down for more than about one-half second.

The keyboard has a fairly solid feel. If you're comfort-

able with a typewriter's keyboard, you should feel at home with the Rainbow's. For my tastes, though, the Rainbow's keyboard is a bit too stiff and springy. I found that prolonged typing on it was somewhat tiring.

Actually, the Rainbow's keyboard is a little confusing. For instance, the grave accent key is located where you usually expect to see the Escape key. DEC also placed an extra key between the Z and the Shift keys, just as IBM did. It is easy to hit that extra key by accident. The Caps Lock key is another nuisance; I don't like the ease with which the key is activated. I am constantly just barely hitting it as my little finger goes for the Shift key.

The System Unit

The system unit contains the microprocessors, 64K bytes of RAM (random-access read/write memory), and 24K bytes of ROM (read-only memory) that contains diagnostic routines, the bootstrap loader, and a dumb terminal program. The system unit also houses a dual

Fast and restless.

The new Delta-15 printer kicks out AnyCalc, easy as 1,2,3!

In a 9 to 5 world full of changing spreadsheet data, you need a business printer that moves fast. A printer that constantly fires out printed information. A printer called Delta-15.

Delta has the ability to print multi-copy spreadsheets at an intense 160 cps. Its throughput never rests. In fact, it never even wavers in speed. That means that Delta constantly fits the most work into every single second.

Delta comes in a 10" or 15½" carriage size. It offers you the flexibility of standard 8K parallel and serial interface. And has the ability to underline, accept macro instruction, and print characters that range from full graphics to everyday printing to scientific notations.

Plus, as always, you get our unique 180 day warranty (90 days on print head).

So for everyone who needs their spreadsheet data "yesterday," this is as close as you can come! The new fast and restless Delta-15 business printer from Star.

starTM
MICRONICS · INC

THE POWER BEHIND THE PRINTED WORD.

Computer Peripherals Division

P.O. Box 612186, Dallas/Ft. Worth Airport, TX 75261 (214) 456-0052



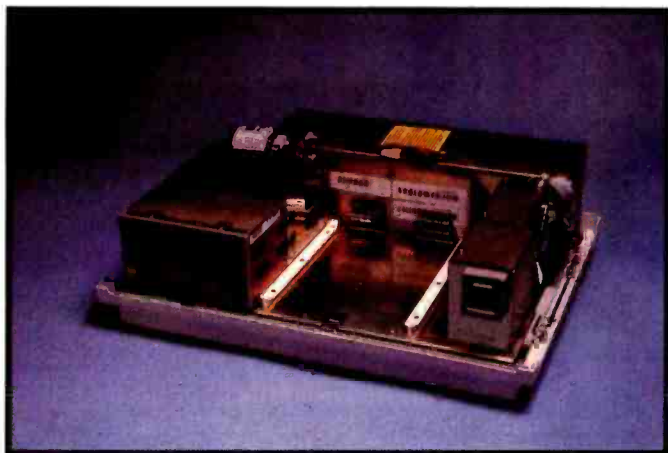

Photo 4: A look under the Rainbow's cover. The power supply is along the rear edge. The RX50 drive is on the right. The empty spot in the middle will accept another RX50 drive or a 5¼-inch 10-megabyte hard-disk drive.

5¼-inch, single-sided, quad-density disk drive, I/O (input/output) interfaces, and a power supply. Photo 4 shows the insides of the system unit.

The Z80A processor handles all the disk I/O. The 8088 handles all the other system functions and is available for running CP/M-86 programs. Both microprocessors have 2K bytes of RAM for their own use and 62K bytes of shared RAM. If they try to access the shared RAM at the same time, or during a refresh, wait states will occur, but each has access to its private 2K-byte RAM without wait states. Memory in the Rainbow 100 may be expanded to 256K bytes, but the additional RAM can be accessed only by the 8088.

Both the printer and the modem ports are controlled by a NEC 7201 multiprotocol serial controller that supports many variations of asynchronous, byte-synchronous, and bit-synchronous protocols. The 7201 has two independent receiver/transmitter channels. The printer uses one channel, configured as RS-232C/423 from 75K to 96K bps. The other channel is an RS-232C/423 modem port that supports communications from 50 bps to 19.2K bps.

The system unit can be placed horizontally on your desk or vertically with the optional stand. A lever on each side of the system unit lets you remove the cover. Underneath is an assemblage of sheet metal boxes, with only some short sections of a few cables exposed. You can push down a little spring latch under the front of the disk-drive unit and then pull it out; it comes out easily on slides. To the left of the disk drive is another slide arrangement for the optional second disk drive or for the optional hard-disk drive. The power-supply cabinet stretches across the entire rear of the unit. Where, though, is all the digital circuitry? If you turn the unit around, unscrew four large plastic screws, and unplug two cable assemblies, the Rainbow's motherboard can be slid out like a secret drawer from underneath the power supply. The motherboard, shown in photo 5, is a 10½-inch by 14-inch printed-circuit board that is sup-

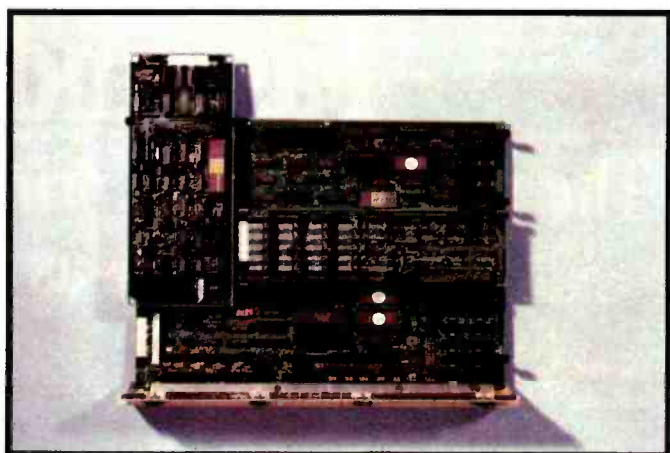

Photo 5: The Rainbow's motherboard. The rear of the board is on the bottom. The disk controller is the vertical board on the left. The 3- by 10-inch board that runs horizontally across the middle is the optional RAM expansion board.

ported in place principally by guides along the left and right sides. Taken out of the guides, the board is fragile—barely able to support itself. In fact, it has a plastic support beam attached to it underneath, but I would not want to trust this little beam to hold the entire weight.

The motherboard has a series of 1-inch plastic posts sticking up. It is to these posts that the disk-drive controller and optional boards are attached. It is a very clever arrangement, although it does not give you an awful lot of space. With the disk controller and a memory-expansion board in place, there is room for only two more boards (each measuring about 3 by 10 inches).

The rear of the motherboard is attached to a vertical metal plate that forms part of the rear of the system unit. The video, printer, and modem cable connectors are attached to this plate by means of two thumbscrews. Also in the rear of the system unit is a row of LEDs that serve as error indicators, in case the monitor cannot be used to display error messages.

The Rainbow's RX50 disk drive can handle two 5¼-inch quad-density, single-sided, soft-sectored disks. Each disk holds about 400K bytes, which gives you an on-line storage of 800K. The drive has two read/write heads but only one spindle and stepper motor for both heads. As a consequence, both heads always move together. This slows disk operation somewhat. Suppose, for example, that you want to read data on an inner track of disk A and write it to an outer track on disk B. The disk heads must travel together back and forth between the extremities, which takes more time than if the heads could travel independently. After a few seconds of inactivity, the drive motors are automatically turned off to reduce wear on the disks.

Because there is a single motor for two read/write heads, the upper drive wants its disk inserted label side up but the lower drive needs its disk mounted label side down, and this creates a little confusion at first. Even later on you have to be attentive to the differences. This is especially the case when moving a disk from one drive

**Is the Penpad™ 320
the greatest graphics
tablet in the world?**

**Or, is it the greatest
keyboard and mouse?**

Or, is it a lot more?

Penpad 320 can do what no graphics tablet in the world can do; it can read your writing and enter it into your PC as if you had used a keyboard. It can also turn freehand charts and graphs into their precise geometric counterparts or it can display your graphics exactly as drawn. Touch the command box to change colors. Touch the drawing and it's instantly painted. Print labels or descriptions where you want. You control the size and color, upper or lower case.

Making presentation graphics or slides with a Penpad is easier and faster than any other means available.

The pen is the cursor. It's also a mouse, a paintbrush, a touch command tool, and of course, a pen. Even managers find that editing text is a lot faster with a Penpad than with a keyboard. And, anyone using software like Lotus 1-2-3™ will be surprised at how easy it is to set up and fill out spreadsheets, "mouse" through them, and correct mistakes or write in whole columns of numbers in a fraction of the time it would take with a keyboard and a mouse. Touch a command box labeled in plain English to invoke functions or complex combinations of keystrokes.

No productivity improvement tool, with the exception of the personal computer itself, comes even close to offering you the power or ease of a Penpad. Most people find it hard to believe that Penpad can do all this until they've tried it.

Ask your IBM PC or COMPAQ dealer to order the Penpad for you.

Pencept, Inc., 39 Green Street, Waltham, MA 02154. Telephone: 617/893-6390.

Authorized Dealerships available.

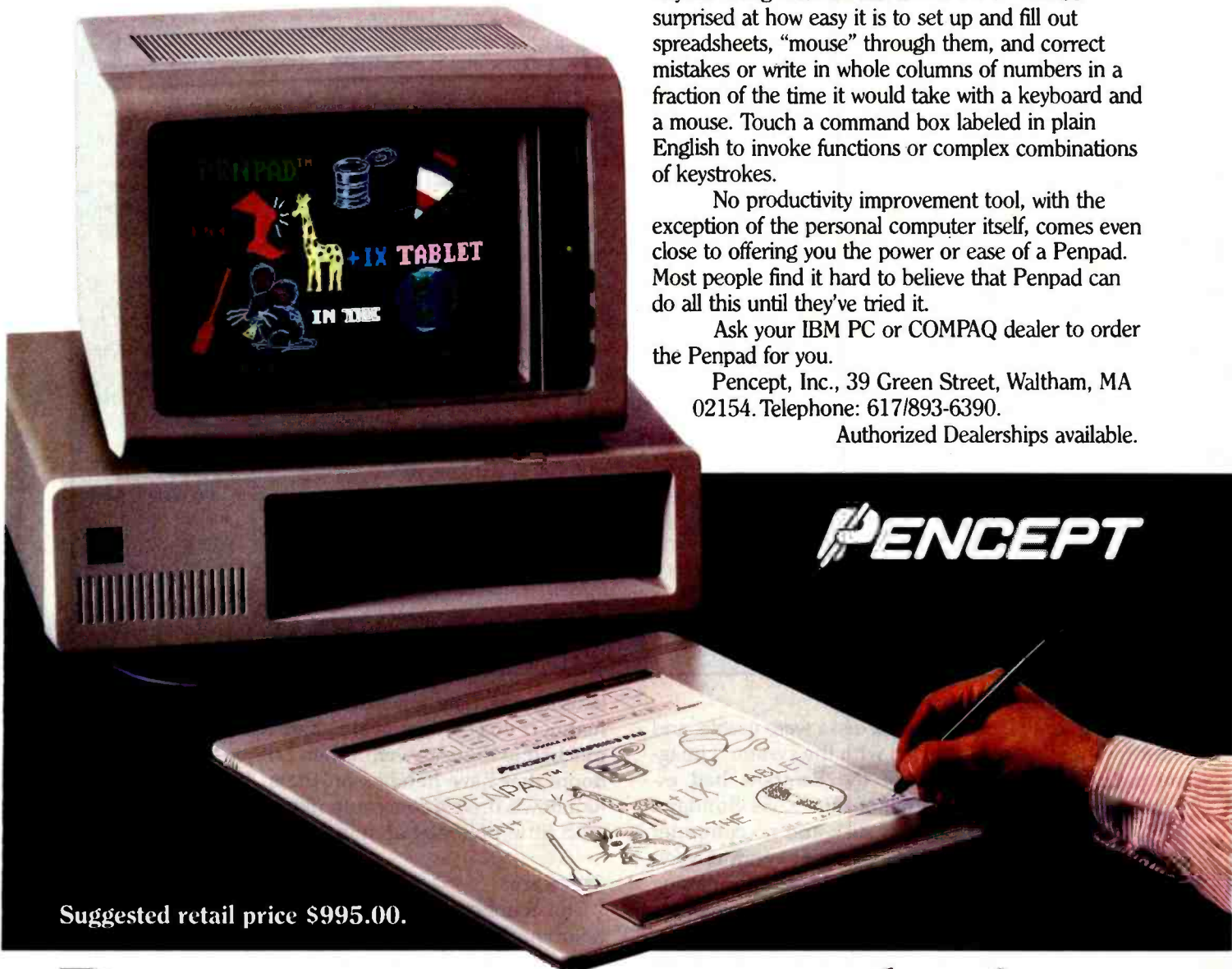

PENCEPT

Suggested retail price \$995.00.

Draw your own conclusions.

Select-86 Word Processor for the Rainbow

Select-86, by Select Information Systems, is a solid and capable system that works well with the Rainbow. You can request it to recognize the Rainbow's 132-column screen, for example. It is a text editor, formatter, and printer program. With it you can merge documents with mailing lists or spreadsheets with text files.

From Select-86's main menu you may create a new file, edit an existing file, delete a file, display a file (without editing), look at a disk directory, rename a file, print a file (in the "background," if you wish, while you are editing another file), and invoke the spelling checker.

Boldface, underline, superscripts, and subscripts are supported by Select-86 (and Digital's LASO printer will handle all of those commands). You may format the document with headers, footers, and page numbers. You may specify left justification (i.e., flush left, ragged right), centering, and left-right justification. Flush right, ragged left—a very uncommon format—is not supported.

Select-86 comes with Superspell, a spelling-checker program. At first I thought this was not very useful because a dictionary is an awful lot faster than a computer-based spelling checker. But even a good speller can mistype a word or two. Superspell can help by proofreading your document for you. I thought it might be fun to see if Superspell recognized the word "Superspell." It didn't. "DEC" didn't pass, either. Nor, predictably, did "Wordstar" or the names of some other word processors. But it did recognize both "Rainbow" and "Select-86." Superspell's dictionary comes with just under 10,000 words, which is not an awful lot, but you can add words to it whenever you wish. Initially, you will have to add quite a few words to help it out, because it will not recognize some special words that you may use frequently (such as proper names) or variations of common words (such as "typing").

Some of the ordinary text-editing functions are a bit cumbersome to use. For example, to insert text, you must go into the "insert" mode. In insert mode, deleting something previously entered is possible only by using the backspace key. But suppose you spot a typo a few lines above where the cursor is. Then you must exit the insert mode by pressing the Do key, move to the offending spot using the arrow keys, press E for erase, move the cursor past the bad character, and press Do again. But wouldn't it be much easier

to erase the mistake without leaving the insert mode? In fact, the answer is yes, and I hear that version 2.4 of Select-86 corrects this problem, but I couldn't verify it.

There are a few features that I think a good word processor ought to have, but which Select-86 does not. For instance, although tabs are supported, there is no easy way to specify that "the following words should be moved over flush with the right margin." If you want it done, you have to do it manually. There is also no way to avoid "orphans"—a single line that begins a new paragraph at the bottom of a page—unless you do it manually. That is, you have to step through the formatted document, find each page break, and, if there is an orphan, enter a command that will force an early page break. Doing so may create an orphan on the next page, so you'll have to check there, and so on. A command such as "make sure there are at least n lines left on this page before continuing" is an easy command to install, and I wish Select-86 had it. I also wish there was a command to reserve a number of contiguous lines so that a drawing, photo, etc., of a specified size could be inserted into the final document. Once again, if you want to make sure that the lines you skip for such a space do not cross a page boundary, you'll have to step through the document and see for yourself.

Select-86 also does not have footnoting and indexing, but perhaps you could not expect to have such features without a substantial rise in price.

For first-time users, there is a Teach program that teaches you all about Select-86's commands and capabilities. It takes an hour or so to go through the program, but you can selectively step through or come back and review parts at some later time. Not only does it tell you what the various commands and their options do, but it invites you to try your hand at some of them, and then it tells you whether you've been successful. There may be a few bugs in the program (or else it is not quite idiot-proof) because part way through one session the disk suddenly became write-protected and the program crashed. In addition, one section told me that I did not correctly do the exercise it gave me, when in fact I had done it correctly. My only other criticism of the Teach program is that when it congratulates me for doing something correctly it printed little messages that became just a bit too flippant. At times I felt as if I were being treated like a child.

to another—it must be flipped over.

Originally, only DEC-formatted disks were usable, and the formatter was not included with the system. I imagine many early purchasers of the Rainbow had experiences such as a recent one of mine: one Sunday I badly needed another Rainbow disk and no computer stores were open. Luckily, independent vendors soon met the need and developed and marketed a formatting program. Now, however, DEC includes a formatter on the operating-system disk.

To open the door on the upper drive, the instructions tell you to push on the upper part of the door with your finger. The door comes out and up like a single-piece garage door. Unfortunately, this almost assures that your finger will be caught between the door and the disk housing. There is nothing painful about it, but it sure

is annoying. The lower drive door opens in a similar manner, except downward, and my poor finger gets pinched in there as well. When I think of all the garage doors that have handles on them, I wonder why the Rainbow's drive doors could not have been constructed with little pull tabs or some similar device.

Software

The Rainbow 100 comes with CP/M-86/80. CP/M's notorious line editor, ED, is included on the CP/M-86/80 disk, but it's hard to imagine that you'd want to use it when RED is provided, too. RED is a screen-oriented text editor that seems to have about the same command power as ED, but few of the drawbacks. Since it is a screen editor, you see what you're doing right on the screen; that is, you move the cursor around the screen,

Compute and print client tax returns in minutes

on your microcomputer with **MICRO-TAX**

Time is money. You know that. You know that your clients know that. Think about it. You're a professional. You're a tax professional. Please, give the rest of your clients the same service you give your complete client base.

FEDERAL AND STATE PACKAGES TO MEET EVERY NEED. MICRO-TAX offers 14 Federal tax packages and 25 state packages (only available with the Level II Program), so you can select the programs that best meet your needs.

- Level I — Federal Individual Package, for individuals preparing their own taxes.
 - Level II — Federal Professional Individual Package, for accountants, registered agents, tax attorneys, and other tax professionals.
 - Level III — Federal Partnership/Corporate Package, for those who prepare Federal Partnership, Corporate, and Subchapter S returns.
 - Level IV — Overseas Tax Package, addresses the unique tax situations of United States Expatriates.
- Levels II, III, and IV have a depreciation module and automatically compute underpayment penalties and minimum tax. In addition, Levels II and III automatically compute self-employment taxes, and Level II computes income averaging.

FLEXIBLE DATA ENTRY. With MICRO-TAX* you can organize data entry in a sequence similar to that of manual tax preparation, or you can choose another sequence. The menu driven system makes data entry simple.

MULTIPLE PRINTING OPTIONS. You can input client tax information at the time of interview and produce forms immediately, or enter data during the day and batch print returns at night. MICRO-TAX* prints your returns on IRS forms, IRS approved substitute forms, or with transparent overlays.

TAXNET* — TELETXT SUPPORT NETWORK. MICRO-TAX* customers can now have access to an electronic mailbox and instantaneous memobard through the TAXNET*

network support network. With TAXNET,* you can send information, ask questions, get answers and updates—directly through your computer and a modem.

TAX ORGANIZER. Now MICRO-TAX* offers a Tax Organizer. You get both the software and the forms. At each year, you can send your clients an organizer with the prior year's client data printed on it.

HARDWARE COMPATIBILITY. MICRO-TAX* is compatible with your IBM PC/XT, DEC Rainbow,* Radio Shack,* or any other personal computer with CP/M-80,* PC DOS* or MS DOS* — from Apple* to Zenith.*

So, take the tedium out of tax preparation — save time and money — Call Micro-Tax* for complete details, or call your local dealer.

| FULL FEDERAL MICRO-TAX* PERSONAL COMPUTER SYSTEMS | 1983 FEDERAL FORMS AND SCHEDULES INCLUDED | | | | | | | | | | | | | | | | | | | | | | | | | PRINTS | | | | | | | | |
|---|---|-------|--------|------|------|-------|------|---|---|----|---|-----|------|------|------|------|------|------|------|------|------|------|------|------|------|--------|-------|------------------|-----------|----------------|----------------------------|---|---|---|
| | 1040 | 1040A | 1040ES | 1041 | 1042 | 1120S | 2041 | C | E | SE | W | 706 | 706A | 706B | 706C | 706D | 706E | 706F | 706G | 706H | 706I | 706J | 706K | 706L | 706M | 706N | BATCH | Substitute Forms | IRS Forms | Transparencies | Continuous Reprinted Forms | | | |
| Level I, Individual \$195 | • | • | • | • | • | • | • | • | • | • | • | • | • | • | • | • | • | • | • | • | • | • | • | • | • | • | • | • | • | • | • | • | • | |
| Level II, Professional Individual \$1000 | • | • | • | • | • | • | • | • | • | • | • | • | • | • | • | • | • | • | • | • | • | • | • | • | • | • | • | • | • | • | • | • | • | |
| Level III, Partnership/Corporate \$1000 | • | • | • | • | • | • | • | • | • | • | • | • | • | • | • | • | • | • | • | • | • | • | • | • | • | • | • | • | • | • | • | • | • | • |
| Level IV, Overseas \$2000 | • | • | • | • | • | • | • | • | • | • | • | • | • | • | • | • | • | • | • | • | • | • | • | • | • | • | • | • | • | • | • | • | • | • |

* All forms and schedules subject to final IRS changes for 1983 tax year.
 • 25 integrated state returns available • Orders taken for yearly update packages
 • Transparencies: Levels I, \$150; Levels II, III, IV, \$250 each.



*CP/M—trademark of Digital Research, Inc.; DEC Rainbow—trademark of Digital Equipment Corp.; MICRO-TAX and TAXNET—trademarks of Microcomputer Taxsystems, Inc.; MS DOS—trademark of Microsoft Corp.; PC DOS, IBM PC, and IBM XT—trademarks of IBM; Apple—trademark of Apple Computers; Zenith—trademark of Heath Company and Zenith Radio Corp.; Radio Shack—trademark of Tandy Corp.

MICRO-TAX* MICROCOMPUTER TAXSYSTEMS, INC.
 6203 Variel Avenue, Suite A Woodland Hills, CA 91367, Dept. 1B Phone (213) 704-7800
 (Area code changes to (818), effective January 1984)

Circle 255 on inquiry card.

MBASIC for the Rainbow

Microsoft's MBASIC-86 (V5.22) BASIC interpreter is available for the Rainbow for \$250. If you have ever programmed with a version of Microsoft BASIC, you'll feel at home with MBASIC-86. I was curious to know the speed of MBASIC-86 on the Rainbow, so I turned to Phil Lemmons' review of the Victor 9000 in the November 1982 BYTE, page 216, which lists a set of seven benchmark programs written in BASIC. They are shown in listing 1. Note, however, that the original prime number benchmark program did not define integer variables as I have done in line 0 of listing 1e. Using real variables, MBASIC-86 gave me an OUT OF MEMORY error when I tried to dimension the 7001 element array, and so I had to use integer variables to conserve memory. Table 1 compares the benchmark programs on the Rainbow 100, Victor 9000, and IBM PC systems. Overall, they seem to be fairly evenly matched.

I was disappointed with the implementation of this BASIC on the Rainbow. Many of the keys on the Rainbow do not have their expected function in MBASIC-86. The cursor keys, for example, do not move the cursor, and the backspace key acts as an old-style rub-out key; that is, it prints a back slash and then the character that is being "rubbed out," followed by another back slash. This is a confusing way to indicate a deletion.

| Benchmark | TIME (in seconds) | | |
|-------------------|--|---|--------|
| | Rainbow 100 MBASIC-86 V5.22 CP/M-86/80 | Victor 9000 BASIC-86 V5.21 MS-DOS 1.2 | IBM PC |
| Empty do-loop | 8.3 | 7.7 | 6.4 |
| Division | 22.6 | 21.8 | 23.8 |
| Subroutine jump | 17.5 | 16.9 | 12.4 |
| MID\$ (substring) | 25.6 | 24.6 | 23.0 |
| Prime number | 183.5 | 197.0 | 190.0 |
| Disk-write | 36.0 | 50.3 | 32.0 |
| Disk-read | 22.0 | 21.3 | 22.9 |

Table 1: The timing results of the seven benchmark tests in listing 1. The first five programs originally appeared in Gregg Williams' review of the IBM PC in the January 1982 BYTE; the sixth and seventh were added in Phil Lemmons' review of the Victor 9000 computer in the November 1982 BYTE.

Listing 1: BASIC benchmark programs used in table 1. Listing 1a times an empty do-loop. Listing 1b tests the speed of a division operation. Listing 1c tests a subroutine call and return. Listing 1d times BASIC's MID\$ function (i.e., substring extraction). Listing 1e is the Sieve of Eratosthenes algorithm for generating prime numbers. Listing 1f times the writing of a 64K-byte file to disk. Listing 1g is a disk-read program that reads the file generated in listing 1f.

(1a)

```
60 A=2.71828
80 B=3.14159
100 FOR I=1 TO 5000
320 NEXT I
```

(1b)

```
60 A=2.71828
80 B=3.14159
100 FOR I=1 TO 5000
120 C=A/B
320 NEXT I
```

(1c)

```
60 A=2.71828
80 B=3.14159
100 FOR I=1 TO 5000
120 GOSUB 1000
320 NEXT I
340 END
1000 RETURN
```

(1d)

```
80 A$="abcdefghijklm"
100 FOR I=1 TO 5000
120 B$=MID$(A$,6,6)
320 NEXT I
```

(1e)

```
0 DEFINT A-Z
1 SIZE=7000
2 DIM FLAGS(7001)
3 PRINT "only 1 iteration"
5 COUNT=0
6 FOR I=1 TO SIZE
7 FLAGS(I)=1
8 NEXT I
9 FOR I=0 TO SIZE
10 IF FLAGS(I)=0 THEN 18
11 PRIME=I+I+3
12 K=I+PRIME
13 IF K > SIZE THEN 17
14 FLAGS(K)=0
15 K=K+PRIME
16 GOTO 13
17 COUNT=COUNT+1
18 NEXT I
19 PRINT COUNT "primes"
```

(1f)

```
10 CLEAR 1000
40 A$="12345678123456781234567812345678"
60 B$=A$+A$+A$+A$
80 NR=500
100 OPEN "R",#1,"TEST"
120 FIELD #1,128 AS Z$
140 FOR I=1 TO NR
160 LSET Z$=B$
180 PUT #1,I
200 NEXT I
220 CLOSE #1
240 PRINT "DONE"
```

(1g)

```
10 CLEAR 1000
40 A$="12345678123456781234567812345678"
60 B$=A$+A$+A$+A$
80 NR=500
100 OPEN "R",#1,"TEST"
120 FIELD #1,128 AS Z$
140 FOR I=1 TO NR
160 LSET Z$=B$
180 PUT #1,I
200 NEXT I
220 CLOSE #1
240 PRINT "DONE"
```



UNIX, with change.

With Idris, developers get the functionality, compatibility and portability of UNIX. And pocket the Idris difference.

- **GREATER PORTABILITY.** Applications developed under Idris on any micro compiler can run on any other which supports Idris. These are PDP-11s (including PRO-350 and Micro-11), numerous Motorola 68Ks and the 8086/88 based IBM PC and DEC Rainbow.
Idris runs under MS/DOS as an application!
- **COMPLYING WITH THE UNIX USER GROUP STANDARDS.**
- **TWICE THE NUMBER OF USERS** as UNIX on comparable hardware, because Idris is optimized for microprocessors.
- **MORE DISK SPACE FOR FILES AND PROGRAMS.** Idris occupies less than 1.5 megabytes of disk.
- **MORE COST EFFECTIVE PER USER.** The \$550 end-user price is for as many users as the hardware will allow.
- **MORE TASKS RUN SIMULTANEOUSLY** because Idris requires less memory. Typically, 50 KB for the Kernel plus 50 KB for a compile. For example, you can overlap communication simultaneously with word processing and spreadsheet analysis and Fortran compilation.
- **EASY END-USER LICENSING** provided by use of Whitesmiths' authorization seal.



That's UNIX with change. To get more out of your computer, call or write to Whitesmiths, Ltd.

Whitesmiths, Ltd.

97 Lowell Road Concord, MA 01742
(617) 369-8499 Telex 951708 SOFTWARE CNCM

UNIX is a trademark of Bell Laboratories; DEC, PDP-11 and Rainbow are trademarks of Digital Equipment Corporation; IBM and IBM PC are trademarks of International Business Machines Corporation; MS-DOS is a trademark of Microsoft Corp.; Idris is a trademark of Whitesmiths, Ltd. Distributors: Australia, Fawnray Pty. Ltd., Hurstville, (612) 570-6100; Japan, Advanced Data Controls Corp., Chiyoda-ku, Tokyo (03) 263-0383; United Kingdom, Real Time Systems, Douglas, Isle of Man 0624833403; Sweden, Unisoft A.B., Goteborg, 031-13-56-32.

and when you insert text or delete text, you see the results automatically. For more sophisticated applications, such as printing with formatted output and integration of files with mailing lists, you'll need a word processor. But, except for these more sophisticated features, RED looks and feels exactly like the Select-86 word processor. Since the cost of Select-86 is \$595, having RED supplied on the CP/M-86/80 disk is a real boon. Curiously, the optional MS-DOS disk has only the EDLIN editor, which seems to be about like CP/M's ED.

Another good surprise is the Maint utility program. It is an all-purpose housekeeping program that has its own editor. It lets you delete files, rename files, reset file attributes, and display file contents without editing them.

There are dozens of programs available for the Rainbow, most of which are standard CP/M-80 programs. A rather extensive, annotated list is published by DEC in *The Rainbow Handbook*, a \$6.95 paperback that your local dealer probably carries. Among the programs are spreadsheets, word processors (see the text box about Select-86 on page 176), accounting packages, programming languages (see the text box about MBASIC on page 178), and databases.

Documentation

Rainbow's documentation is very slick: spiral-bound, typeset pages with copious illustrations. Each manual is written in a simple, clear manner with key bits of in-

formation repeated frequently so that a complete novice is guided through every step. Documentation for the CP/M operating system has long endured a rather nasty reputation for confusion and obscurity. The manuals with the Rainbow 100, however, indicate that a major change has taken place. The CP/M-86/80 documentation is well organized and has lots of examples. This is the sort of documentation other companies might do well to emulate.

Although the Rainbow's manuals are well written, I wonder if there are too many of them. Consider what you are faced with when you first unpack the system: a little flyer telling you what to do in case the computer interferes with your TV reception; a *Read Me First* booklet consisting of 42 pages listing the errors in the other manuals; a 63-page *Installation Guide*; a 75-page *Getting Started* guide; a 110-page *Owner's Manual*; and a 258-page *User's Guide*. In addition, each separate software package has its own set of two or three guides. I think there ought to be an index to the information in all these guides. But there is help in Rainbow's computer-based instruction course, which will take you by the hand and explain the system for you, after you've finally turned the machine on and inserted the disk. The program even draws pictures of the computer on the screen. After going through the course, there is little excuse for being baffled any longer.

A sophisticated user will notice the conspicuous absence of two rather important documents—the hard-

SIMPLY SUPERB!

OEM Manufacturers

Our Centronic Standard Parallel Interface printers are compatible with any personal computer. The quality software can be provided in accordance with buyer's Special Requirements.

Dealer/Distributor

We've created a printer that's simple to use, simple to maintain, and simple to buy.

your every need. No fancy gimmicks or exorbitant prices; just a simple to use plotter that gets the job done right.

With Ball Pen and paper available anywhere throughout the U.S., this model has been especially designed for the Apple II®: just plug it in, and it's ready to use. No software needed!... Simple!

And best of all is the simple price... Superb!

SALES REP. WANTED!

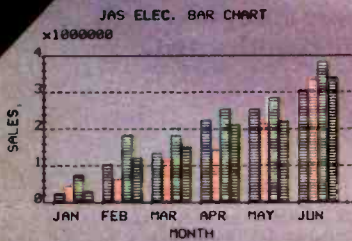

JAS Electronic Corporation

2nd FL., No. 86, Fu Hsing N. Rd., Taipei, Taiwan, R.O.C.

P.O. Box: 34-133, Taipei, Taiwan, R.O.C.

Telex: 13690 JASTPE Tel: (02) 7727251 (5 lines)

Circle 201 on Inquiry card.

PICK UP WHERE IBM[®] LEAVES OFF.

Portable or desktop, you're way ahead when you pick up a **CORONA PC.**[™] Because we give you everything you've ever wanted in an IBM¹-compatible PC and more. For a great deal less.

COMPATIBLE AND MORE.

Our systems run all software that conforms to IBM PC programming standards. And the most popular software does.

We deliver twice the memory, with room for eight times as much.

We deliver a fast-access 320K floppy drive, a communication port and an improved IBM PC keyboard with indicator lights.

Our systems include high-resolution monitors (12" desktop, 9" portable) for crisper, cleaner displays, and both have built-in high-resolution graphics (640 x 325).

You get a complete system, ready to go to work.



MORE VERSATILITY.

With all the necessary features built into the main unit, the four expansion slots can be used for your special needs. For example, color or our optional 10MB hard disk.



MORE SPEED.

Our RAM-disk software gives you temporary disk-type storage that works many times faster than disks.

PLUS SOFTWARE.

Our systems come with the operating system: MS-DOS.² A programming language:

GW BASIC.² A training course: PC Tutor.³ A professional word processor: MultiMate.⁴ Plus DOS utilities and demonstration programs. Or you can get the p-System⁵ from N.C.I. and write or run portable Pascal packages.

ALL FOR A GREAT DEAL LESS.

Even with all the extra features and performance, our systems still cost significantly less than the equivalent IBM PC.

Drop by your nearest **CORONA PC** dealer for a very convincing demonstration. Or contact us at 31324 Via Colinas, Westlake Village, CA 91361. (213) 991-1144 or (800) 621-6746 toll-free. Telex 658212 WSLK, in Europe 76066 CDS NL.

© Corona Data Systems 1983. 1. TM International Business Machines. 2. TM Microsoft. 3. TM Comprehensive Software Support. 4. TM Softword Systems. 5. TM University of California.



CORONA[™]
data systems, inc.

Here's just a taste of our great prices.

Apple 128K RAM card with VisiCalc™ Pre-Boot Software. Legend™ and Saturn™ compatible. 2 year warranty.....\$299.00

IBM 256K RAM fully populated with RS-232-C port. 2 year warranty.....\$349.00

IBM 512K RAM with RS-232-C port. 2 year warranty.....\$579.00

WE HAVE MACINTOSH SOFTWARE IN STOCK

DISKETTES

Verbatim S.S. D.Den.....\$24.50
Verbatim D.S. D.Den.....\$39.50
3M S.S. D.Den.....\$22.00
3M D.S. D.Den.....\$35.50

PRINTERS

Juki 6100 Letter Quality.....\$489.00
Epson RX-80 100cps Par.....\$ CALL
Epson FX-100 and MX-100.... \$ CALL
NEC 2050 Letter Quality.....\$985.00

MONITORS

Taxan Amber.....\$125.00
BMC Color Composite.....\$249.00

To order or for
information call
In Los Angeles:
(818) 706-0333

For all your computer
needs, come visit our
new California store.

**Alpha
Byte**
COMPUTER
PRODUCTS

31312 VIA COLINAS
WESTLAKE VILLAGE, CA 91362

Satisfaction Assurance — Your satisfaction is assured by our 30 day guarantee on all hardware products we sell. All manufacturers' warranties are honored by manufacturers. Dead-on-arrival software will be replaced free during the first 20 days, however, no refunds or exchanges on software. Proof of purchase required. All returns must be authorized in advance.

ware manual and the CP/M-86/80 BIOS (basic input/output system) listing. Except for the pin-outs for the serial modem port (but not for the printer port), the only description given of the insides of the Rainbow is a rather superficial gloss in the *Owner's Manual*. You can't find out such things as the processor's clock speeds unless you purchase a separate hardware manual for \$50. There is no good reason for the omission of the BIOS listing. Perhaps the thought was that only systems programmers and hackers will want such a listing, and they can purchase it separately. But local Rainbow dealers can sell the BIOS listing only as part of an extensive, three-volume documentation kit that costs a whopping \$315.

On the plus side, support for Rainbow users can be had in two ways. First, there is a DEC users group, DECUS (Digital Equipment Computer Users Society), that is probably one of the largest users groups in the world. It is a nonprofit organization supported by DEC and provides a library of programs, newsletters for special interest groups, and occasional national symposiums. Membership is free. Write to DECUS, One Iron Way, MR02-1/C11, Marlborough, MA 01752. Second, there are at least two independent, commercial magazines devoted to DEC computers: *The DEC Professional* (POB 362, Ambler, PA 19002-0362) and *Personal and Professional* (POB 114, Springhouse, PA, 19477).

The Rainbow 100 Plus

The new Rainbow microcomputer, the Rainbow 100 Plus, was introduced in 1983. It is essentially the Rainbow 100, upgraded in several ways, including a beefed-up power supply and an integrated 10-megabyte hard disk. The operating system is CP/M-86/80 V2.0, which, among other things, can read 48-tpi (tracks per inch) disks (Rainbow disks are normally 96 tpi), as well as IBM PC single-sided disks. (With MS-DOS V2.05 the Rainbow Plus will handle IBM XT disks.) [Editor's Note: I tried using IBM disks in the Rainbow. Sure enough, the Rainbow did read them. But don't try writing to them with the Rainbow, or you'll scramble the information on the disks. . . . R.K.] Standard memory is now 128K bytes of RAM, expandable to 896K. The necessary space for all that memory has been made available by employing 256K-bit chips. The Compose Character key, which was not supported on the original Rainbow, is implemented on the Rainbow Plus to generate over-strike characters.

Conclusion

On a scale of 1 to 10, I give the DEC Rainbow 100 a 6. For quality, I would lean toward DEC rather than toward the IBM PC. But for roughly equivalent systems, the IBM PC costs slightly less. Although the PC is perhaps more popular at the moment, the Rainbow seems to have a chance. ■

David B. Suits is assistant professor of philosophy at Rochester Institute of Technology. His review of the NEC APC appeared in the October 1983 issue of BYTE. He may be contacted at the College of Liberal Arts, Rochester Institute of Technology, POB 9887, Rochester, NY 14623.

trained mouse.

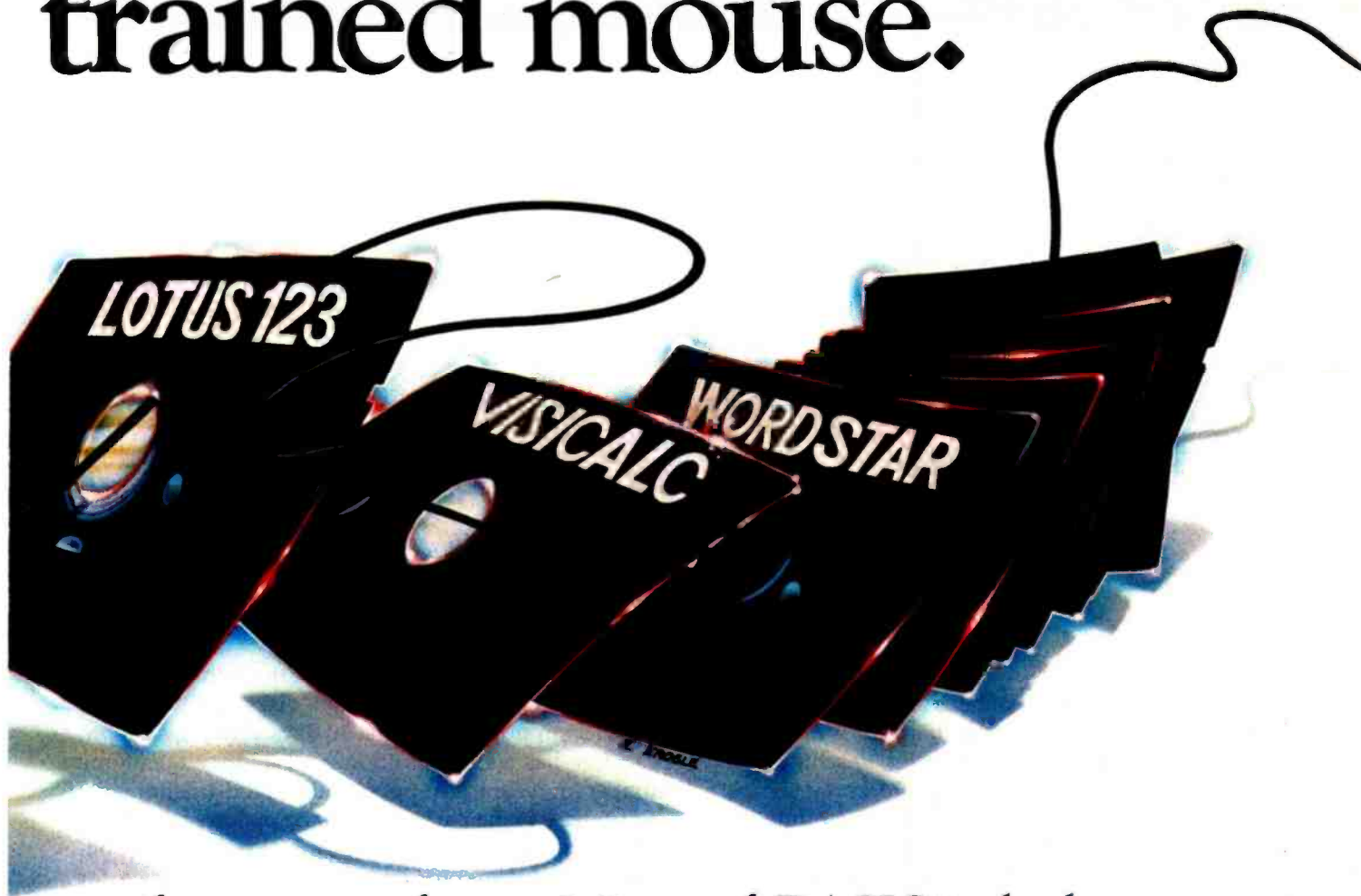

performance software. Microsoft BASIC is the language spoken by nine out of ten microcomputers worldwide.

MICROSOFT Our MS™-DOS operating system tells
The High Performance Software your IBM PC how to think.

So don't monkey around with any other mouse. Call 800-426-9400 (in Washington State call 206-828-8088) for the name of your nearest Microsoft dealer. Then go with Microsoft Mouse. The mouse that soars.

A close-up photograph of a hand holding a large, black, three-dimensional logo that reads 'MSOFT'. The letters are thick and blocky. The hand is positioned at the bottom right, with the thumb and index finger gripping the 'T'. The background is dark and out of focus.

Microsoft and Multiplan are registered trademarks and MS is a trademark of Microsoft Corporation.
Lotus 1-2-3 is a trademark of Lotus Development Corporation. VisiCalc
is a registered trademark of VisiCorp. WordStar is a registered trademark of MicroPro.
IBM is a registered trademark of International Business Machines Corporation.

Peachtext 5000

A collection of five business applications that are confederated—not integrated—into one package

Stevanne Ruth Lehrman
Analytic Resources

The Peachtext 5000 package should be the answer to a businessman's prayers. It contains all the basic applications that a business needs, and the price is an affordable \$395. Although an able performer, Peachtext 5000 has a few rough spots that you should know about.

I'll focus on Peachtext's capabilities one module at a time. One fact should be kept in mind: the individual modules began life as independent applications from diverse manufacturers. Thus, Peachtext 5000 is not truly an integrated package. Each module stands alone rather than as a section of a whole.

The Peachtext package consists of six single-sided floppy disks, two spiral-bound manuals (8½ by 5½ inches), a "quick start" card, and a box of 10 blank disks. Instead of issuing the "usual" license disclaiming all

responsibility for the functionality of the software, Peachtree promises to replace defective disks and offers free technical support for the first 30 days after registration. Peachtree has a support package: a toll-free telephone number for technical support and printed amendments and updates to the package (with the option of Peachtree performing the update for a nominal fee). Best of all, support customers are entitled to a reduced rate for future upgrades. The support option costs \$96 per year.

There are five program disks plus a disk labeled "configurator." Here lies the first trap for the unwary. During the configuration process, every disk, including the configurator, is altered. Unfortunately, the documentation gives you no warning of this.

Otherwise, copying and configuration are relatively straightforward. Copy the original programs and the DOS (disk operating system) onto formatted disks. The originals are single sided. If you have double-sided drives, you can combine programs onto single disks. Next, place the configurator disk in drive A, the word-processing disk in drive B, and type PCONFIG. The questions asked are simple: which microcomputer? which printer? etc. You can use one of nine letter-quality printers or a "draft printer." Presumably, the term refers to dot-matrix printers, though none are listed, not even the ubiquitous IBM/Epson MX-80. I suspect Peachtree assumes that all businesses use full-character printers.

Peachtext Word Processor

All the action in Peachtext 5000 begins with the shared main menu (see photo 1). Options are divided into three groups: document commands, disk commands, and special commands. Document commands cover editing, printing, copying, deleting, renaming files, displaying



Photo 1: The main menu of Peachtext 5000. All functions are called from this menu.



New Qantex 7020. It speaks their language.

If you buy any printer without considering the Qantex 7020, you could make a serious mistake. This multi-mode workhorse is compatible with nearly all of today's PCs and software. So no matter which programs or PCs you use now or in the future, the 7020 can handle them. Lotus 1-2-3, VisiCalc, Wordstar, dBASE II, BPS, Business Graphics, Perfect Writer, Apple, IBM, Epson, DEC — you name it.

As a high density graphics printer, the 7020 is fully dot addressable with resolution to 144 x 144 dots per inch and handles your most

complex applications. Quickly and quietly.

As a single pass NLO word processor (75cps), the 7020 gives you a choice of fonts along with proportional spacing, justification, auto underline, bold and more. Data processing is a breeze with bidirectional printing at 180 or 150 cps. User defined formats and 6 part forms capability are both standard.

It even provides built in variable bar code capability and an operator-initiated test mode. And with industrial quality construction and a 500-million-character printhead

life, the 7020 will be around for years of hard use.

The 7020 costs just \$1,495 and is backed by the most comprehensive support in the industry. Find out how compatible it can be with your business. Contact Qantex for details or a demo, 60 Plant Avenue, Hauppauge, NY 11788. Call toll-free 800-645-5292, in New York State 516-582-6060.

 **north atlantic**
Qantex

Get yourself a

This little critter comes with specially-designed software that flies through the maze of keystrokes on the most popular business programs faster than you can say "cheese."

Microsoft® Mouse puts the power to run Multiplan®, Lotus 1-2-3™, VisiCalc® and WordStar® in the palm of your hand. Click the left button on the mouse, a custom menu appears. In English, not hieroglyphics. Click the right button and execute your



command: move text or data, edit, format, print. All at blinding speed without touching the keyboard.

It also lets you create your own menus for editing and formatting existing application programs. So people can learn programs quicker and do more productive work as they learn.

The mightiest mouse.

Microsoft Mouse runs circles around other mice. It is the high performance mouse for the IBM® PC and PC XT. From the company known for high

At a Glance

Name
Peachtext 5000

Audience
Business executives

Type
"Personal productivity system" applications software containing Peachtext word processor, Random House Electronic Thesaurus, Spelling Proofreader, List Manager, and Peachcalc spreadsheet

Manufacturer
Peachtree Software Inc.
3445 Peachtree Rd., NE
Atlanta, GA 30326
(404) 239-2045

Format
5¼-inch floppy disk

Computer
IBM PC or PC XT, Compaq Portable Computer, Texas Instruments Professional Computer, Zenith Z-100

Documentation
Two volumes, spiral-bound
Lesson Plan, 207 pages; Reference Guide, 224 pages

Price
\$395

disk directories, and invoking Help screens. These document commands apply only to the word-processing functions.

The disk commands serve to swap disks and change the default drive. I advise ignoring these two because they can get you into trouble too easily. Your program disk must be in drive A, which leaves drive B for data files. Peachtext expects drive A to be the default drive. When I set B as the default, I got error messages when changing programs and at unexpected points in the middle of using a module. However, to retrieve a file or write a file to disk, you must name it B:myfile.doc. Otherwise, you write to the program disk.

The special commands link Peachtext with Spelling Proofreader, List Manager, Peachcalc, and telecommunications. You may be prompted to change program disks after selecting one of these—depending on how you configured your working copies. (This main menu is Peachtree's effort to integrate the modules.) Peachtext 5000 does not include the telecommunications package referred to in the menu; Peachtree sells that program separately.

If you do not specify an existing document or provide a name for a new one, Peachtext automatically assigns the name WORK.DOC to the document to be edited. The Edit Status screen shows the status of the whole writing/editing process, including available workspace (see photo 2). Peachtext 5000 addresses a maximum of 128K bytes of memory. The Edit Status screen shows a total of 54,351 characters available for text. This translates as 25 to 30 double-spaced pages. The size of a file is displayed as percentage of memory and number of charac-

ters; the memory remaining is also shown. Remember, however, that Peachtext is aimed at business letters and calculations, not novels or 200-page reports. From the Edit Status screen, line width, tab spacing, margins (top, bottom, left, right) and line spacing may be set.

Editing

To begin text entry and editing from the Edit Status screen, press <Enter>. Writing a new document is easy; just start typing as if using a typewriter and the text wraps automatically. You use <Enter> as a "hard return" at the end of a paragraph or whenever you wish to leave a blank line. At the bottom of the screen, the text automatically scrolls up one line. So most new text is entered at the very bottom of the screen. Editing and entering new text takes place on the same screen; there's no need to shift modes.

Moving around in an existing document is slow. The bottleneck begins with cursor control. (Or should I say *lack of cursor control*?) Using the arrow keys, you can move one character right or left or one line up or down. The Tab key moves the cursor to locations eight columns apart. The <Home> key moves the cursor to the beginning of the current line, then alternately between the top and the bottom of the screen. <Ctrl> T takes the cursor to the top of the text, <Ctrl> B to the bottom. Function keys F1 and F2 move you backward and forward one page; shifted F1 or F2 scrolls one line. It is impossible to move by word, sentence, or paragraph. Any location not on the left edge of the screen is difficult to reach. This slow and cautious movement may not handicap an executive who uses word processing infrequently; however, for someone constantly at the keyboard, more freedom of movement is mandatory.

Short pieces of additional text may be inserted into an existing document by moving the cursor to the spot, pressing the <Ins> key (character insert), and typing.



Photo 2: The Edit Status screen of the Peachtext word processor. The screen shows the filename, its status, the number of characters used, and the number of characters remaining.

The cursor does not change size or color to indicate that you are in Insert mode. Using another function key (e.g., a cursor or the <Enter> key) cancels Insert mode. Peachtext automatically reformats text as you write. For lengthy additions, the F8 key (full insert) clears space on the screen by moving subsequent text down. When finished adding text, press F8 again. Most function keys operate within this full-insert mode.

The key deletes a character at the cursor position. The Backspace key deletes a character to the left of the cursor but will not travel past the left margin of a line. F4 deletes the word to the right of the cursor. Pressing F9 twice deletes the line to the right of the cursor. Although this does offer some protection from accidental deletion, after you have deleted one line you need only press F9 once to continue the destruction. A buffer that temporarily saves deleted text would offer more protection.

Blocks of text to be moved, copied, or deleted must be identified by marking the beginning and end of the block of text with the F3 key. Then you use the <Esc> key to exit from the text to the Edit Status screen. At the backslash (\), you can type the commands to copy, delete, or extract the text. Unfortunately, you can no longer see what text you are manipulating or where it is going. You must have exactly two block markers in the text. More or fewer markers results in an error message. Confusion is possible: the mark left by the F3 key is identical to the formatting command mark for underlining.

As with all other deletions, text deleted as a block is text lost. Peachtext displays a "Deleting *n* characters" message (*n* equals the number of characters in the block) and asks for confirmation. I find it difficult to confirm destruction of sentences I cannot see.

The search and replace capabilities of this package are the standard varieties found in other word processors, but there's one difference: all its variations are invoked by one key. Where some word processors (e.g., The Final Word) have search, global replace, and query replace (i.e., Do you really want to do a substitution here?) capabilities, Peachtext uses multiple presses of the F6 key. You may specify that you want to repeat an operation a specific number of times. There is no query replace.

Pressing F6 produces a previously unseen message line at the bottom of the screen. You type in the word or words to search for, then press <Enter>. F5 repeats the search. To search and replace, you press F6, type in the string to be located, press F6, and type in the replacement. If you press F6 a third time, you can specify how many times you wish the action repeated. Just pressing <Enter> replaces only the first string found.

The Search function is case-sensitive, so the desired word must be typed in exactly as it appears in the text. If you use all lowercase letters, the Search won't find the word at the beginning of a sentence. If you capitalize the first letter, it will ignore the same word in lowercase. Without query replace, you must be careful how you specify a word. Otherwise, it may find the given letter

combination in the middle of a word: when replacing "the" with "this," the word "other" will be changed to "othisr."

Peachtext searches the text from the current cursor location to the end. It neither performs a backward search nor does it wrap from the end back to the beginning and come to rest at the original starting point. The task is further complicated by a lack of understandable messages. Substituting the prompts "Search for:", "Replace with:", and "How many times:" for that tiny colon wouldn't have been all that hard when the program was adapted to the IBM Personal Computer (PC).

If you like to page back and forth between locations in your text, Peachtext probably isn't for you. First, there's a shortage of road signs. There is no status line with page, line, or column counter to tell where you are currently working. Second, there is no easy way to leave a place marker in the text and find it again. Instead, you must type in a unique identifier, move to the beginning of the document (no backward searches, remember?), search for the desired information, move again to the top of the text, and search for your identifier.

Peachtext is right on target when it comes to merge capabilities. There are more ways to create customized letters than one review can describe. Mailing lists may be created within Peachtext with its Variables functions or with a separate module, the List Manager. Individual paragraphs can be labeled, either in one file or as individual files, and called in as desired. Once you get past the too-brief documentation, Peachtext outperforms Wordstar's Mailmerge.

Printing Documents

Text formatting and printing options are also very powerful: left, right, or center justified, margin changes in midtext, printing text to screen (instead of to a printer) for review, headers, footers, underlining, and more. Formatting is achieved by commands set from the Edit menu, embedded in the text, and entered at the keyboard when the Print Status screen is displayed. The Print Status screen reflects information Peachtext found at the beginning of a document prior to the first text character.

When faced with a trade-off between screen-orientation and formatting capabilities, Peachtree went for formatting. As a result, your printed document may not look like the text displayed on your video screen. Text can, however, be printed to the screen. In some cases, the results will still be approximate because monitors can't show proportional space nor display more columns than the screen holds.

One area affected by the lack of screen orientation is Peachtext's inability to scroll horizontally past 80 columns, although the formatter permits a maximum printing width of 132 characters. But in my experience this is not really a problem.

I especially like the ability to place nonprinting comments within text. By typing the * command at the beginning of any document, you can track the latest revi-

A few smart reasons to buy our smart modem:

Features

1200 and 300 baud, auto-dial, auto-answer
 Compatible with "AT" command set
 Can be used with CROSSTALK-XVI or Smartcom II software
 Regulated DC power pack for cool, reliable operation
 Eight indicator lights to display modem status
 Speaker to monitor call progress
 Attractive, compact aluminum case
 Two built-in phone connectors
 Compatible with The Source and Dow Jones News Retrieval
 Unattended remote test capability
 Phone cable included
 Availability

Ven-Tel 1200 PLUS

Hayes

| | |
|-----|-----------|
| Yes | Yes |
| Yes | Yes |
| Yes | Yes |
| Yes | No |
| Yes | Yes |
| Yes | Yes |
| Yes | Yes |
| Yes | No |
| Yes | Yes |
| Yes | No |
| Yes | Yes |
| Now | |

Price

\$499 **\$699**

The Ven-Tel 1200 PLUS offers high speed, reliable telecommunications for your personal computer or terminal. Whether you use information services or transfer data from computer to computer, the Ven-Tel 1200 PLUS is the best product around. Available at leading computer dealers and distributors nationwide.

Also from Ven-Tel: internal modems for the IBM and HP-150 Personal Computers with all of the features of the 1200 PLUS.

You choose. The Ven-Tel 1200 PLUS—the smartest choice in modems.

Ven-Tel Inc.

2342 Walsh Avenue
 Santa Clara, CA 95051
 (408) 727-5721

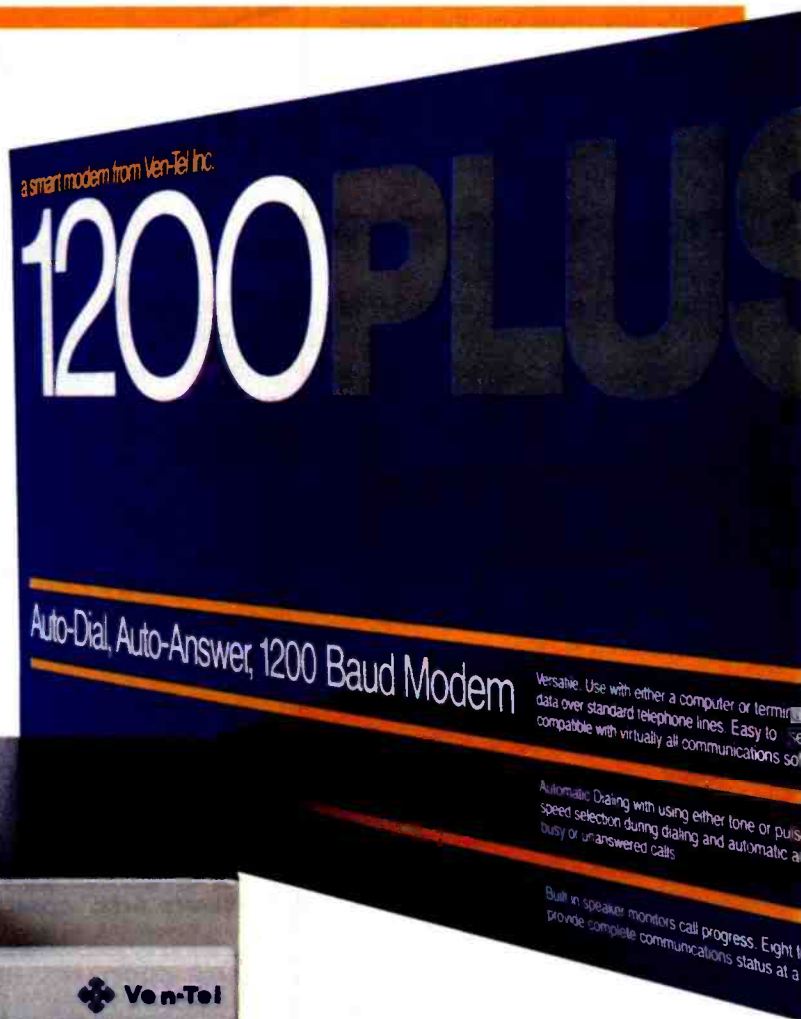

EQUATIONS PROCESSED NO PENCIL. NO PAPER. NO MANUAL LABOR.

The TK!Solver® program will take on your toughest problems—linear, quadratic, simultaneous equations, whatever. Then stand back. Because TK!Solver turns your personal computer into a simple, yet powerful, desktop equation processor.

Whether your problem is a simple formula or a model consisting of many equations, TK!Solver can help improve your productivity. Once the equations are written, enter the known values, press the ! key, and TK!Solver gives you the answer.

Engineers, scientists, architects, financial analysts and planners, educators, researchers, and other professionals who use equations and mathematical models can work more creatively with TK!Solver.

TK!SOLVER GIVES YOU: BACKSOLVING

If the programs you use now require you to rewrite the same equation to solve for different unknowns, TK!Solver can dramatically improve your productivity. Enter your problem once and then solve for the unknowns no matter where they are in your equation.

ITERATIVE SOLVING

If TK!Solver can't solve an equation directly, take an educated guess at the answer. Type the ! key and the TK!Solver program starts with your guess and performs repeated approximations to converge on the answer.

LIST SOLVING

Given a list of input values, TK!Solver automatically calculates the equation for every value in

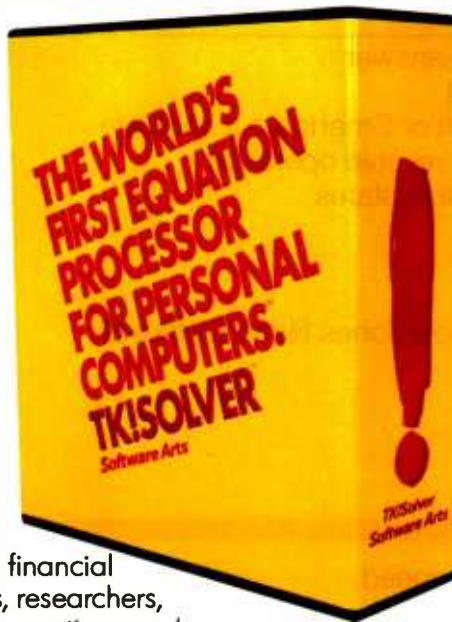

your list. For example, if you want to know how different interest rates will affect monthly loan payments, enter a list of interest rates and let TK!Solver calculate the payment amount for each value.

UNIT CONVERSIONS

Any type of unit conversion—Fahrenheit to Celsius, meters to feet, dollars to deutschmarks, newtons to dynes—can be made without altering your equations. Just define the numerical relationship between two units of measurement and the TK!Solver program automatically converts the variable value to the unit you specify.

TABLES AND PLOTS

Quickly generate tables and plots of your results on your screen or printer.

AVAILABLE NOW

You can run the TK!Solver program on the IBM® PC and XT and compatible machines, the Digital™ Professional™ 350, the Digital™ Rainbow™ 100, the Wang Professional Computer, Apple® IIe, and on the following personal computers using MS™-DOS: TI Professional Computer, GRiD Compass Computer,™ Canon AS-100, Eagle® 1600, Toshiba T300, and the Zenith Z-100.™

SEE IT TODAY

There's more. Lot's more. But you'll have to see it to believe it. And that's easy. Bring your own equations into your nearest computer retailer and ask to see the TK!Solver program in action. The world's first equation processor for personal computers.

TK!Solver®

By Software Arts,™ creators of VisiCalc®

27 Mica Lane, Wellesley, Massachusetts 02181 617-237-4000

TK, TK!, TK!Solver, the stylized ! and the slogan "THE WORLD'S FIRST EQUATION PROCESSOR FOR PERSONAL COMPUTERS" are trademarks or registered trademarks of Software Arts, Inc. Software Arts is a trademark of Software Arts, Inc. and Software Arts Products Corp. The TK!Solver program is a product of Software Arts, Inc., which is solely responsible for its contents. VisiCalc is a registered trademark of VisiCorp. Apple is a registered trademark of Apple Computer Inc. IBM is a registered trademark of International Business Machines Corporation. GRiD Compass Computer is a trademark of GRiD Systems Corporation. Z-100 is a trademark of Zenith Data Systems. Eagle is a registered trademark of Eagle Computer, Inc. Digital, Professional, and Rainbow are trademarks of Digital Equipment Corporation. WANG is a registered trademark of Wang Laboratories Inc. MS is a trademark of Microsoft Corporation.

Copyright © 1984 Software Arts, Inc. All rights reserved.

FORMAT COMMANDS:

```

BMa.... Set bottom margin at a lines
CENTER. Center entire text
CPi.... Set pitch at a per inch
CTR.... Center one line only
Ha.... Move by n horizontal increments
Ina.... Set indentation at a
JUST.... Justify text (blank insertion)
JUSTC... Justify by character spreading
Ka(-n). Kerning command (squeeze)
LEFT... Set left flush
LINEa... Move to line a
LINE-a. Move backwards to line a
LIT.... Set literal format
Lm.... Set left margin at a
LPi.... Set lines per inch at a
NL..... Force new line
Pi..... Set paragraph indentation
PI-m.... Negative paragraph indent
PLa.... Set page length at a lines
PROP ON/OFF. Set proportional printing
RF..... Right flush one line only
RIGHT... Set right flush
Rm.... Set right margin width
SPa.... Set spacing at a lines
SPH.... Set half-spacing
SPB.... Inactivate linefeed
TABa... Move to column a
TAB"n". Move to n, printing c
Tm.... Set top margin at a
Vn..... Move vertically by n
    
```

More (Y/N)? _

Photo 3: One of the Help screens available from the main menu.

sion, summarize content, or leave a note to the next person who uses the file. A second plus is being able to add information directly from the keyboard at print time, using variables and the Get command.

I use an IDS Prism 132 printer, capable of true proportional spacing, underlining, boldface type, superscript, subscript, and several acrobatic tricks like dot-addressable graphics. Although Peachtext offers many formatting and printing options, I could not get them to operate on my printer. I've used other word processors that didn't include the Prism on the list of compatible printers. Most of the time, I could send control codes directly to the printer and thus take advantage of all the program's formatting options. Peachtext overrode control codes I sent before entering the program and ignored special characters sent from the keyboard at printing time. [Editor's note: Peachtext contains the Out command that is designed to send control sequences to printers.... A.A.L.]

Saving Text

There are four ways to end an editing session and five ways to save a file to disk without exiting from Edit mode. All are invoked from the Editing Status screen. Typing End at the backslash saves your text. END=<Document> saves your text under a new name. The Quit command bails you out without saving the changes, and Quitx exits while saving temporary documents on disk.

To write memory to disk, you again start at the Editing Status screen. W saves all text in memory to disk; Wn saves n lines. WC saves all text from the beginning of the document to the cursor. WR is useful for long documents that do not fit into memory. When you first retrieve a document longer than 40 pages, only part of it is read from the disk. After editing this section, press <Esc> to return to the Edit Status screen. At the backslash, type W and press <Enter>. When the computer has stopped writing to disk, type R and <Enter>: the next section of the document is retrieved. WCR writes all text from the beginning to the cursor and then reads an equal number of lines from the disk into memory.

Speed up system construction and provide better performance with Vector's

S-100 & STD BUS MAINFRAMES

- Supplied with high performance Faraday shielded motherboards.
- Integral card racks with plastic guides.
- EMI filtered. Fan. Heavy duty power supply.
- Quality aluminum case with interchangeable slide out vinyl finished panels in various colors.



STD BUS
(IEEE P961)
VP200
Mainframe
\$750.00

S-100 BUS
(IEEE 696)
VP100
Mainframe
\$725.00

NEW S-100 FUNCTIONAL BOARDS

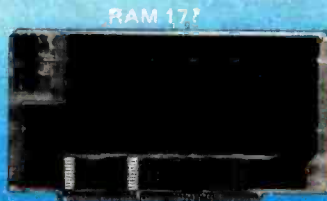

RAM 17?

- RAM 17 - 64K of low power static RAM for CPU speeds to 10 MHz. 8800GR17B. \$450.00.
- INTERFACER 1 - Two RS232 ports, 50-19200 Baud, USART's perform all basic I/O functions. 8800GFB .. \$295.00.

- INTERFACER 2 - Three parallel ports, one RS232 port, selectable rate interrupt timer. 8800GF2B. \$325.00.

* Trademarks of COMPUPRO

Vector Electronic Company

12480 G Street, Ave., P.O. Box 4336, Sylmar, CA 91342-0336;
(818) 366-9661

103

Introducing the 64K BYTE MODULE...

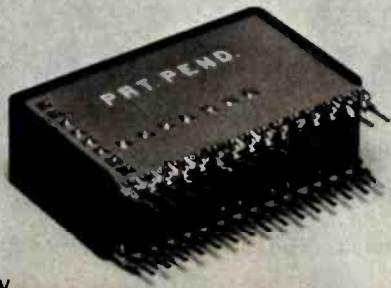

VK 64-1-8V

8 DYNAMIC RAM CHIPS IN 1 COMPACT UNIT.

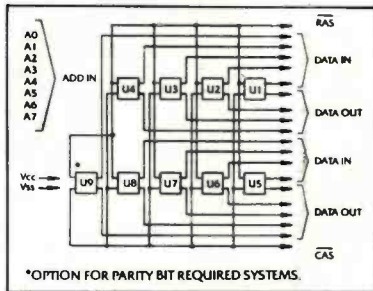

SCHEMATIC

Featuring

- 40% to 70% reduction in P.C. board area
- Possible reduction from 4 to 2-layer mother board
- Compactness gives shorter distances, lower distributed capacitance, higher speeds, less support components
- Higher speed, reliability due to lower chip temperatures
- Single +5V operation, expand in 64K byte increments
- 100% tested: each chip as well as the module is tested
- 200 nanosecond access time is standard; faster available
- 32-pin package
- Designed to be pin for pin compatible with upcoming 256K Byte Module, available soon from VANKELL INDUSTRIES.

NOW — Move up to the 64K Byte Module for maximum memory in the smallest amount of space!

The 64K Byte Module is available in two sizes (vertical and horizontal). Each size may be ordered with parity bit option. Application notes for the Zilog Z80 and the Intel 8088 microprocessors will be shipped with each order.

VERTICAL MODULES: 1.05" H x 1.7" L x .5" W

Model No. VK 64-1-8V \$195.00
Model No. VK 64-1-9V (with parity bit) \$209.00

HORIZONTAL MODULES: .45" H x 1.7" L x 1.15" W

Model No. VK 64-1-8H \$195.00
Model No. VK 64-1-9H (with parity bit) \$209.00
Also available ... a 64 x 1 x 4 module which is pin for pin compatible with the TI-4416 or an equivalent 16 x 1 x 4 chip.
Model No. VK 64-1-4 \$112.00

ORDER TOLL FREE: (800) 521-0060
California residents call: (800) 521-8165

Master charge, Visa, Bank Checks or Money Orders accepted. Mail orders accepted. California residents add 6.5% Sales Tax. All orders shipped UPS. Prepaid within continental U.S.

For product information call (818) 793-1140

VANKELL INDUSTRIES

100 N. Hill Ave. • Ste. 203 • Pasadena, Ca. 91106

Peachtext's six Help screens can be summoned from the main menu by typing a question mark followed by <Enter>. These screens cover menu functions, recognition characters, edit commands, print commands, variables, and data files (see photo 3 for the Print Help screen). From the Edit Status screen, additional help is offered: read, write, include, kill, print, end, quit, and others. Oddly enough, the use of the arrow and function keys is listed nowhere.

Spelling Proofreader

After working with Peachtext, the next logical step is to check your spelling. First, you save the document you were working on. Selecting SP from the main menu starts the Spelling Proofreader. Once at the menu, you can choose from the following options: Spell Check Document, Maintain Dictionary, Change Default Table, Get Help!, and End Spelling Proofreader.

The program is the fastest spelling checker I've used. It provides a running tally of the number of words checked, the percentage of unique words, the number of words it can't locate in its 20,000-word dictionary, and the percentage of unmatched words. Note that I've said

**You can use the Random House
Electronic Thesaurus while editing
your document.**

spelling checker, not editor. Once Spelling Proofreader is finished comparing words with its dictionary, your work begins. Words are presented alphabetically, one at a time, stripped of context. For each unmatched word, you can choose to add it to the dictionary, accept it as correct, or mark it for later correction. You can't correct it during the proofreading—you can only mark it as wrong.

Alternately, you can review all the words as a group and accept, correct, or add all the words to the dictionary with a single command. This process works well if you know everything is misspelled or that this group represents the latest technical jargon you want Spelling Proofreader to learn; otherwise, group review is worthless. In either case, you have to return to Peachtext to change misspelled words. That's a disadvantage; the better proofreading programs both check and correct. Some can even help find possible spellings and can recognize words corrected earlier in the run. The first time you write a word, you have to spell it properly. Every time after that, the program just wants a confirmation of the change to be made. That's handy when you spell the same word wrong 15 times in one article.

The Maintain Dictionary function enables you to review what words are in a particular section of the dictionary. You enter a letter or word at which to begin and a letter or word at which to end. Then, the words fly by on the screen too fast to be read. However, it does report the number of words that fall within the range.

You can't reach the top using just your woods.



Arnold Palmer

© 1982 Lanier Business Products, Inc.

To succeed in business, you can't let good ideas slip through your grasp. Or forget to write those quick, but important notes. When a thought strikes, you have to capture it immediately. Often, a pencil and pad just aren't up to the task. Now you can get rid of that handicap. With a Pocket Caddy™ Thought Processor from Lanier. The Pocket Caddy goes where you go. And can be operated with just a thumb and a finger.

So even in a car, where a pencil is useless, you can record all the ideas that will help you get ahead faster.

The choice? Scratch out a living. Or get the Pocket Caddy. And move ahead at the speed of sound.



I'd like more information on the Pocket Caddy.

Name _____

Title _____

Company _____ Phone _____

Business Address _____

City _____

County _____ State _____ Zip _____

Mail to Lanier Business Products, Inc.
1700 Chantilly Drive N.E., Atlanta, GA 30324

Ask your office manager about Thought Processors.
Or call (800) 241-1706. In Georgia, (404) 321-1244 collect.

LANIER
Mar. '84 Byte 1 76 G C4

MOVE AHEAD AT THE SPEED OF SOUND **LANIER THOUGHT PROCESSING™**

For a no obligation demonstration of the Pocket Caddy™, the Lanier Thought Processor™ that can help you reach the top faster, circle. 216

AD #484

Current Specials - In Stock Now



IBM-PC
\$2995

Two 320 drives, 128k RAM, color graphics/monochrome card, monochrome monitor

IBM-XT ... \$4549

Call for prices on IBM-Compatibles, Apple McIntosh, Software

PRINTERS

Tally Spint \$329
Okidata 92 Call
Okidata 93 parallel Call
IDS Prism 132 \$1209
Gemini 10X \$329
Epson FX80 Call
Epson FX100 Call

**MICROSOFT
WORD**
\$275

MODEMS

Hayes Smartmodem \$219
Hayes 300/1200 \$609
Hayes 1200B \$439
Anchor Mark VIII \$269
Anchor VI Internal, IBM \$145

Quad Board 64 k 6 function ... \$279

All other brands at similar savings.

GEMINI 15 100 cps 15" carriage .. **\$359** **EPSON** MX 100 ... **\$609**

DRIVES
Control Data or Tandon 320k/360k
\$229

AST
Six Pak Plus 64K, S,P,C
\$295

SANYO 555
Computer w/Wordstar, Spellstar, Infostar
CALL

HERCULES
GRAPHICS
Card for IBM PC
\$359

HERE'S WHAT OUR CUSTOMERS SAY ... "full service attention at mail order prices. Informed, helpful, responsive." *Wes Gilbert, DATA I/O*

OPENING SOON IN VANCOUVER, BC

ORDERS ONLY
1-800-531-3133
Information
206-641-7233

PACIFIC COMPUTERS

13240 Northup Wy #4 - Bellevue, WA 98005

Prices reflect 3% cash discount • Bankcards • Sorry no COD • FOB Bellevue
All items currently in stock.

When I requested a list of all words beginning with Q I was given 78 words.

You may add and delete words from the dictionary or combine two dictionaries into one. When you press M, Spelling Proofreader automatically alphabetizes new words and discards words marked for deletion. The Default tables tell Spelling Proofreader which dictionary to use for proofreading and the symbol to use in marking incorrect words.

Random House Electronic Thesaurus

The Random House Electronic Thesaurus has the ease-of-use capabilities that Spelling Proofreader should have. First, you can use it during the writing process: you don't have to exit from Peachtext. Second, changes are made immediately: you needn't go back to manually enter the desired word.

During editing, position the cursor on the first letter of the word for which you need a synonym. Press the F10 function key and, quick as a wink, a wealth of words appears on the lower part of the video screen. Although Thesaurus comes on a separate disk, there is enough room for both Peachtext and Thesaurus on a double-sided disk.

By pressing the right and left arrow keys, you can try alternatives until you have the word you want. Press <Enter> and the substitution is made. If you don't like the choices, pressing the <Esc> key takes you back to Edit mode.

To increase the chance of a successful word match, use the simplest form of a word and add -ed, -s, or -ing endings after using the thesaurus program. The keyword list is limited, though not quite so badly as the spelling checker's dictionary of words.

The Random House Electronic Thesaurus has more synonyms than keywords, and there is no cross-index. If removing endings doesn't work, you may be forced to think of a synonym yourself before you try the thesaurus program again.

List Manager

List Manager is designed to maintain mailing lists and other short files and to serve as a source of information for Peachtext. It is not a full-function database manager. Field names may be up to 14 characters long. Lists are restricted to 14 fields, but no field length is specified. The *Peachtext 5000 Reference Guide* does comment that item length should be as short as possible because this influences the number of records that will fit on a disk.

DF (Define File) is used to create a new file. After designating a name and title, you specify the name and length of the fields. Within the fields, the F1 and F2 keys are used to move the cursor from one field to the next. Changing field names or values and adding additional fields is easy during this phase. You may also set a default value for a field.

Each file is indexed by the fields you defined, and indices may be changed at a later date. You may select up to three sort fields. One field serves as the primary in-

COMPETITIVE EDGE

P.O. Box 556
Plymouth, MI 48170

Call
313-451-0665

Competitive Edge Integrated Systems

Lomas Components

286, 128K, STATIC, 38, 4K BAUD ... \$4095
THUNDER 186, 256K, 2-5" DRS ... 1995
THUNDER 186, 256K, 2-8" DRS ... 2695
8MHz 8086, 128K, LDP72, HAZ ... 3195

Compupro® Components

286, 128K, D-1A, IO4, 551 \$4695
8086, 128K, D-1A, IO4 3795
85/88, 64K, D-1A, IO4 3195
68K, 128K, D-1A, IO4 3595

All systems include operating system and 8" drives unless shown otherwise and all but 68K include Word Processor, Spell Checker & Merge. Single board computers in 4 slot cabinet rest in 15 slot.

| | | |
|---|--------------------|---------------------|
| THUNDER 186 256 W/CPP/M-86® ... 1195 | CPU 286 1146 | CPU 68K 459 |
| LIGHTNING 286 \$1116 - 8086 420 | CPU 8086 495 | CPU 85/88 327 |
| RAM 67 STATIC 725 - 128K DYN ... 396 | RAM 21 657 | RAM 22 1155 |
| 256K DRAM 636 - LDP 72 220 | DISK 1A 459 | DISK 3 525 |

Terminals, Printers, Software

Teletek Components

SYSTEM W/SYSTEMMASTER® 2-8" .2095
SYS W/SYSTEMMASTER 2-5" 1795
TWO USER SYSTEM 2-8" 3895
FOUR USER SYSTEM 2-8" 4695
FOUR USER 10MP HARD DISK 5595
SIX USER 40MP HD 20MB TAPE ... 8995
SYSTEMMASTER BOARD .585 - SBC 2 .995
HD/CTC HD CONTR .525 - SBC 1 .577

WYSE 50,38,4K,80/132 14" 550
QUME 102 GR ... 539 - 102 AMBER ... 549
VISUAL 55 750 - VISUAL 50 675
C.ITOH F10 1095 - F10 55 1395
C.ITOH 1550 675 - 8510SP 625
8" DSDD DISKETTES QTY 10 27
DRI CB80 325 - DRI C 8086 225
DRI CB86 375 - RMAC 150

All prices and specifications subject to change, CP/M®, CP/M-86 are registered trademarks of Digital Research. Compupro® is a Godbout Company. Systemmaster® is a registered trademark of Teletek Enterprises.

BIG TIME STATISTICS GO SMALL



Statpro™ brings the power of mainframe statistics to your personal computer.

Until now, serious statistical analysis meant mainframes, computer centers and a lot of extra work for you.

Enter Statpro, the most powerful statistical software system ever developed for personal computers.

It lets you do almost everything you do on a mainframe on your IBM® or Apple® personal computer. Including descriptive statistics, regression, ANOVA, factor and cluster analysis, to name just a few capabilities.

And Statpro's awesome power isn't limited to number crunching. You can plot all your results in four-color graphics, such as scatter, triangle and regression plots, dendrograms, histograms and pie charts.

What's more, Statpro has sophisticated database management capabilities which make entering, manipulating, transforming and editing data quick and easy.

Most important of all, you get this incredible power in one integrated, fully documented, easy-to-use package.

Statpro for personal computers. Another example of why small is beautiful.

Contact your local dealer. Or Wadsworth Professional Software, Inc., Statler Office Building, 20 Park Plaza, Boston, MA 02116.

800-322-2208
In Massachusetts call (617) 423-0420.



Wadsworth Professional Software

Statpro is a trademark of Wadsworth Professional Software, Inc. Apple is a registered trademark of Apple Computer, Inc. IBM is a registered trademark of International Business Machines, Corp.

dex, used by List Manager to organize the records (e.g., name or company). Zip code might be your secondary index on a mailing list. The final step in creating a List Manager file is specifying how many records you anticipate entering in this file. List Manager indicates how many records would fill the disk, which is an extremely useful piece of information. If the space is insufficient, press <Esc> to change the information you entered or substitute a new disk.

To add records to a file, select UF from the List Manager menu. UF is a cross between Search and Add. List Manager assumes you are correcting an existing record. In order to present you with a potential match, it asks how you wish to look up an entry and asks what information you seek. You may reject the entry, in which case another potential match is produced. If a matching entry is not found, List Manager offers you a new record page with the information you provided placed in the corresponding field. For example, suppose you have defined a file called Party. The file contains names, addresses, telephone numbers, and favorite foods. You decide to index by name, zip code, and food. Now you start adding friends to the file. The first few are quick—no matches. But what happens if you have 21 friends named Malloy? Entering each name becomes more arduous. The same routine is necessary to locate a record to be deleted. Select UF, find the record, and type D at the Accept prompt. Before erasing, you must verify that you truly wish to delete this record.

Information in a file may be sorted several ways to generate labels, lists, and reports. Wildcard searches, in which not all characters are specified, are possible. Relationships may be less than, equal to, or greater than a value given. AND and OR are operational bases of selection. There is one peculiarity: in order to sort numbers properly, you must use preceding zeros (i.e., 001, 002, etc.). If you don't, both 1 and 100 would be listed before 2.

Possibly the best reason to use List Manager is its ability to combine with Peachtext for individualized letters. If your main use of word processing is mass mailings, List Manager makes the Peachtext merge capabilities shine.

The Produce Report submenu enables you to specify print format, sorting keys, and where to print (screen, disk, or printer). A second function, DP (Define Print Format), is used to determine exactly how the output is printed—on labels or on envelopes. Both are necessary when merging a List Manager file with a Peachtext document for individualized letters.

Files may be redefined by using DF (Define File) followed by CF (Combine Files). This works well when adding or eliminating fields from a record, but if all you want to do is change a field name, the process seems needlessly laborious.

The program is simple, but the documentation is very confusing. I never found a clear explanation of the difference between PR and DP or precisely when each was

ALF COPY SERVICE

1315F Nelson Street

Denver, CO 80215

(303) 234-0871

FAST • RELIABLE • LOW COST

If you produce software, ALF's disk copying service is the quick, convenient answer to your duplication needs. Most orders are shipped in less than a week. Every disk we copy is verified bit by bit and guaranteed 100% flawless.

We can copy virtually any soft-sectored mini format. Standard formats: Apple II (including nibble-copy proof, double-boot, and fast load), Apple III, Atari, IBM PC, Kaypro, NEC PC8000, Osborne, TRS-80 I and III, Zenith Z-90 and Z-100, and more. Copy protection is available for most formats.

Our "no frills" pricing means you don't have to buy extras you don't need—set-up charges start at \$10, and copying charges are 30¢ to 40¢ per side. (See blank disk prices at right. Minimum: 50 copies.) Quantity discounts available for large orders.

Of course, we have the frills too: label application, 3-hole vinyl pages, printing of labels and sleeves, shrink packaging, heat sealing, and much more. We can put your product in a customized package—vinyl folder or IBM-style binder/slip case—for a low price in small or large quantities.

ALF is one of the oldest and most trusted names in the duplication business. ALF designs and manufactures copying machines that other copying services and software publishers around the world rely on every day. Our complete understanding of duplication technology assures you of the finest reproduction available.

We're eager to solve your duplication and packaging problems—whether you want one service or a total package. Give us a call today!

BLANK DISKS

ALF buys large quantities of disks for our disk copying service—and we can pass our savings on to you. If you're buying hundreds of disks, ALF is your ideal source for top quality disks at a reasonable price. We buy our disks in bulk packages, avoiding the expense of fancy printing and labeling.

The disks listed below are 5 1/4", single sided, double density (except as noted), unlabeled, with hub reinforcement ring. Other disks are available, call for details.

| | |
|-----------------------------------|----------------------|
| 3M | \$165 per 100 |
| MEMOREX | \$165 per 100 |
| NASHUA | \$160 per 100 |
| NASHUA (single density) | \$140 per 100 |
| VERBATIM | \$190 per 100 |

Without sleeves: add \$2.50 shipping per 100.

With tyvek sleeves: add \$7 plus \$2.50 shipping per 100.

Packed in boxes of 10 with tyvek sleeves: add \$15 plus \$3.00 shipping per 100.

Taxan monitors when precision counts

Dedicated to quality and precision, TAXAN offers a complete line of monitors including green and amber, ultra-high resolution monochrome, plus medium and high resolution RGB monitors.

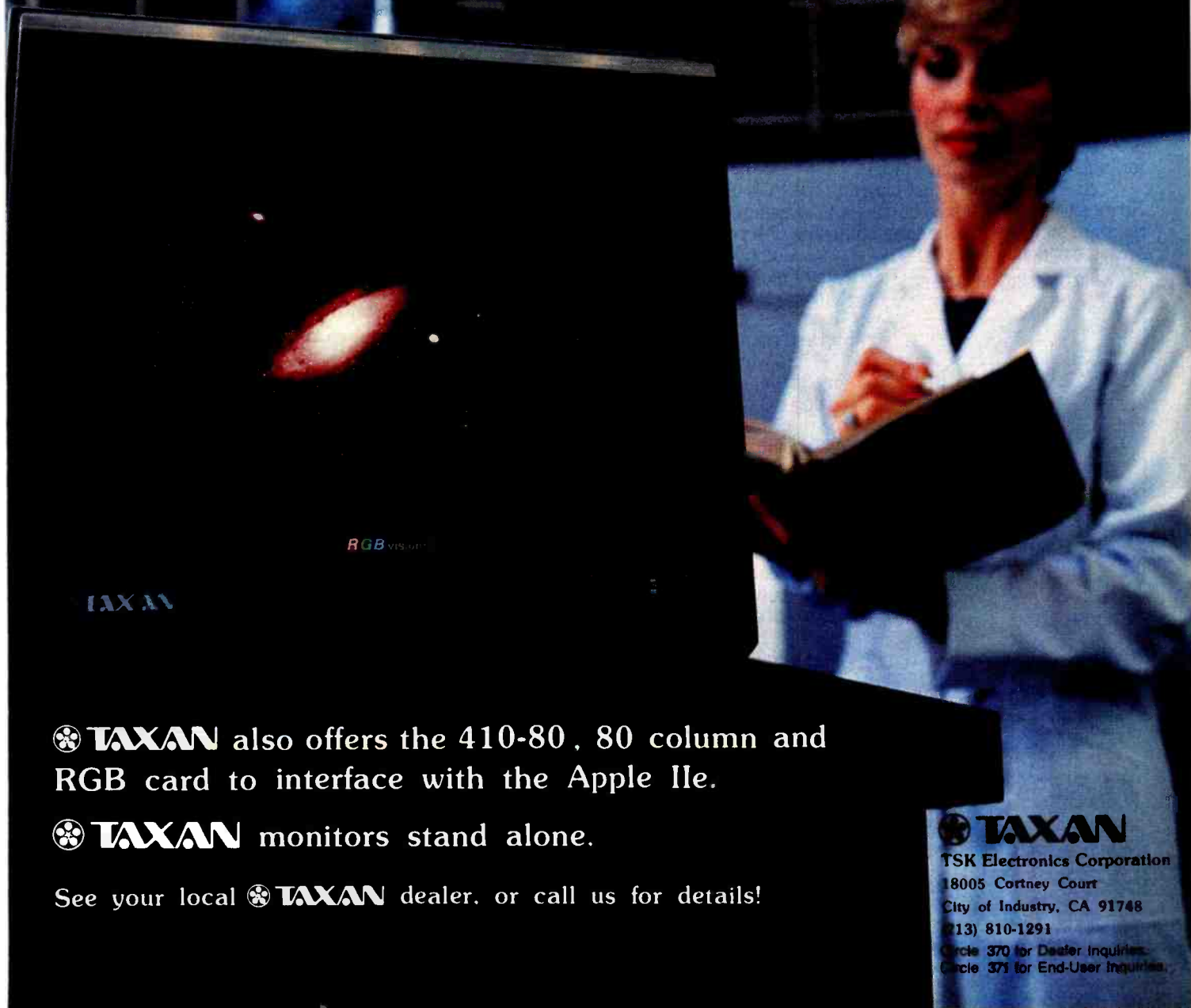

⊗ TAXAN also offers the 410-80, 80 column and RGB card to interface with the Apple IIe.

⊗ TAXAN monitors stand alone.

See your local ⊗ TAXAN dealer, or call us for details!

TAXAN

TSK Electronics Corporation
18005 Cortney Court
City of Industry, CA 91748
(213) 810-1291
Circle 370 for Dealer Inquiries
Circle 371 for End-User Inquiries

“There’s no magic to using your personal computer for data acquisition.”

Fred Molinari, President

There’s no trick to it.

Just take your choice of our new single board plug-ins and bring complete analog and digital I/O capabilities to your personal computer.

Whether you’re working in laboratory research or industrial process control, our single boards can give you measurement and control capabilities without having to spend big bucks.

And who knows that better than the leading supplier of low cost data acquisition boards, systems, and software?

Our boards include A/D with programmable gain, D/A, digital I/O, clock and direct memory access capabilities. With power and performance to match your PC, our analog interfaces provide 12 or 16-bit A/D resolution and direct connection for high or low level signal inputs.

And these boards just plug into the PC’s backplane. No messy external boxes or cables. User input connections are simple with our compatible line of screw terminal panels.

| DATA ACQUISITION FOR PC'S | | | | | |
|---------------------------|------------|------------|-------------|------------|------------------|
| | 12-BIT A/D | 12-BIT D/A | DIGITAL I/O | PROG CLOCK | SOFTWARE LIBRARY |
| IBM PC™ | X | X | X | X | X |
| APPLE II™ | X | | | X | |
| TI PROFESSIONAL™ | X | X | X | X | X |
| DEC RAINBOW™ | X | X | X | X | X |
| COMPAQ™ Portable | X | X | X | X | X |

Comprehensive user manuals with many programming examples get you up and running fast.

So why look any further? No other analog I/O systems can offer PC users such quality, power and performance for such a reasonable price.

After all, making data acquisition easy is what we’re all about.

And that’s no illusion.

Call
(617) 481-3700,
Ext. PC



Data Translation is the leading supplier of personal computer hardware and software for data acquisition and control.

DATA TRANSLATION

World Headquarters: Data Translation Inc., 100 Locke Dr., Marlboro, MA 01752 (617) 481-3700 Tlx 951-646.
European Headquarters: Data Translation, Ltd., 430 Bath Rd., Slough, Berkshire SL1 6BB England (06286) 3412 Tlx 949-652.
In Canada: (416) 625-1907.
IBM PC is a registered trademark of IBM. Apple II is a registered trademark of Apple Computer Corp. TI Professional is a registered trademark of Texas Instruments, Inc. DEC Rainbow is a registered trademark of Digital Equipment Corp. COMPAQ is a registered trademark of COMPAQ Computer Corp.

to be used. The List Manager Help function is equally terse. One- or two-sentence explanations are given for each item on the List Manager menu.

Peachcalc

You can reach Peachcalc from within Peachtext or directly on start-up. Your first time through, type a question mark before starting to work on the spreadsheet. The Help screen explains how to move the cursor and some basic text-entry information. This is only the first of many Help screens. Throughout the program, even while entering a complex command, you may type ? on the status line to get a list of options and results relevant to that operation.

The spreadsheet is 63 columns wide (A through BK) and 254 rows deep. Data is entered into the worksheet one cell at a time. Numerical information is limited to 16 significant digits plus a decimal point and an optional sign. Text is limited to 115 characters and must be preceded by a single or double quotation mark. Columns may be up to 126 characters wide. Formulas may not exceed 116 characters.

Movement from one cell to another is done with the arrow keys or, for larger jumps, by typing the equal sign (=) and a block address. The worksheet may be split to display two separate areas. These windows may be scrolled together or scrolled independently.

Worksheet information is given on three lines at the bottom of the screen. The first of these lines is the status line. It contains the current direction of cursor movement, the name of the active block, format, and contents of the block. Error messages appear on the far right of this line. Current block width, usable memory, and available options appear on the prompt line, located immediately below the status line. New information is typed on the entry line before being written to a particular block. The number at the beginning of the line changes to reflect the number of characters typed.

All commands are invoked by typing a slash and the first letter of the command on the entry line. Like Supercalc, on-line command prompts are single letters. The Format command (/F) is used to set options for the numeric display (decimal, dollars rounded to nearest cent, decimal fractions rounded up or down, etc.), text display, column width, and to protect data integrity. The Global command (/G) is a subset of Format and determines whether a particular command applies to a whole worksheet or to a subset only.

The amount of data in a cell is independent of the column width (i.e., if you have a 15-digit number on your entry line, Peachcalc displays as much of the number as it can and keeps the rest in memory). Given a column width of 10, only the first 10 digits appear on the worksheet. Hidden numbers are displayed on the edit line when the cursor rests on that cell. If the entry is a label, the excess characters overflow into the adjoining cell if that cell is otherwise unused. Information in a cell may be numerical or textual (such as a label). Either a formula or its results may be displayed. When you are edit-

At last, a letter-quality printer for tightwads.

And we don't mean a bargain-basement special, either.

Not by a long shot. The Abati LQ-20 is a top-quality printer, all the way. Offering quiet, bidirectional operation, an 18 characters per second printing speed, single sheet or optional continuous form tractor feed, and a full one-year warranty. All at a price even Ebenezer Scrooge would love.

And you'll love it, too.

Especially when you consider that the Abati LQ-20 is compatible with IBM, Apple, or any other microcomputer you might own.

Plus, it's incredibly easy to configure for word processors and spreadsheets, as well as most other software. And it's available in either serial or parallel formats.

At \$479*, it's easy to see why anyone looking for a great buy in letter-quality printers is looking at the Abati LQ-20. So should you. After all, you don't have to be a tightwad to buy the Abati LQ-20. Just act like one. Call 1-800-447-4700.

Abati

*Parallel model.

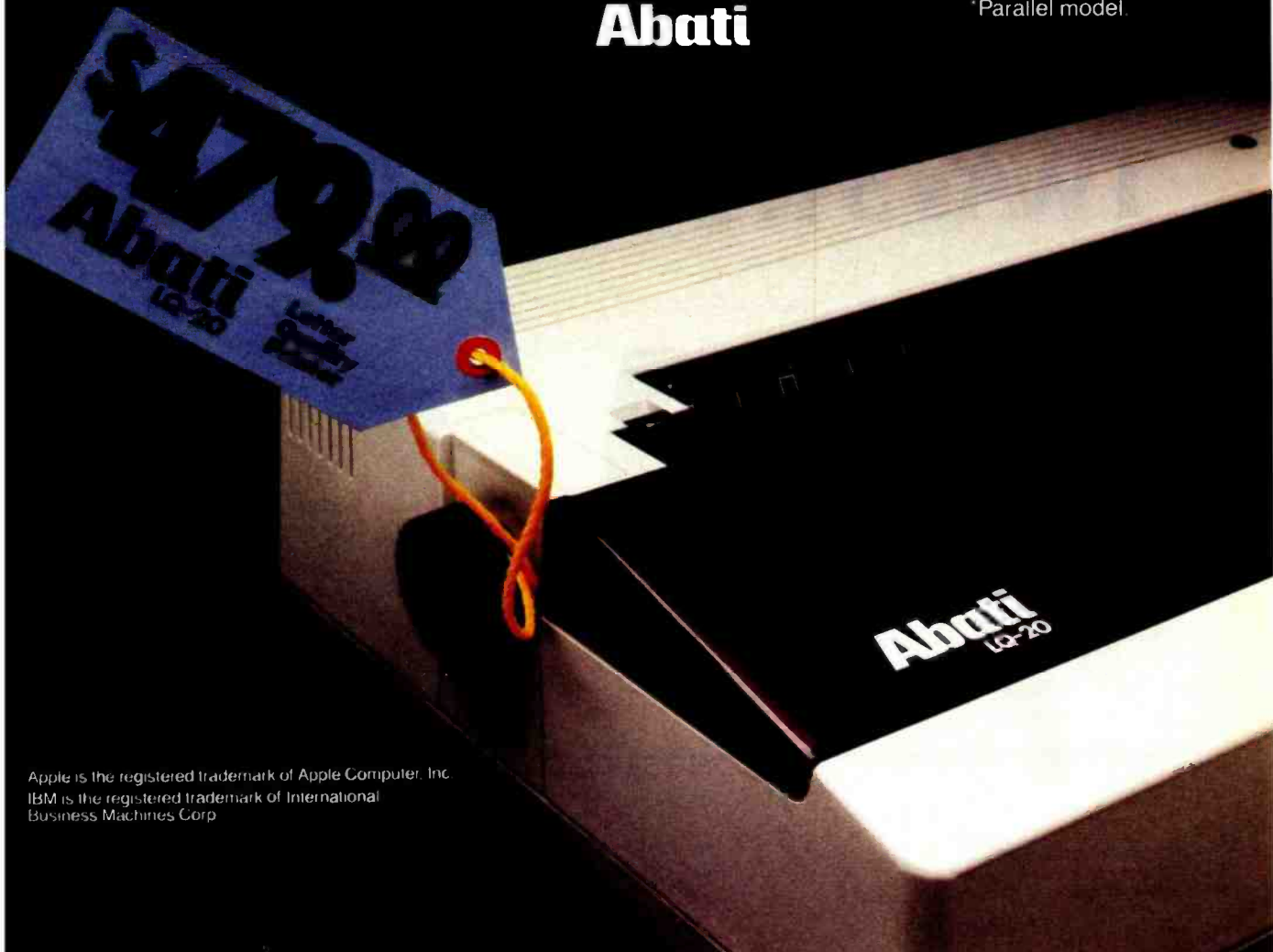

Apple is the registered trademark of Apple Computer, Inc.
IBM is the registered trademark of International
Business Machines Corp.

ing a box, the original formula appears on the status line.

Peachcalc has strong replication abilities. The Repeat command (/R) can be used to copy one block or many blocks, one time or many times. Starting a label with a single quote prints it across a whole row.

Worksheets may be saved to disk using the Save (/S) command. If you try to exit Peachcalc with your file unsaved, the program prompts for a yes or no decision because worksheet data is not saved automatically when you quit. The Zap (clear everything) command is also a possible hazard. Although Peachcalc requests a yes or no before responding to your /Z, the wrong choice can leave you with an empty worksheet and no way of recovery.

Peachtree offers a separate graphics program to produce pie charts and a few other graphs. Within Peachcalc, you can print rows of asterisks or other symbols for a Visicalc-style bar chart.

Documentation

I've saved the documentation until now in order to examine the user manuals as a unit. Documentation is crucial to any program. The better the documentation, the easier the program is to learn, and the lower a user's frustration.

Of the two manuals containing operating instructions, most novices will turn first to the *Lesson Plan*, which offers a rapid tour through each module. I particularly liked the word-processing lessons, in which a user is

asked to help Abe Lincoln rewrite the Gettysburg Address. It's cute, at least the first time through. The other lessons show no such humor.

The larger manual is the *Reference Guide*. It begins with installation instructions and an overview of Peachtext 5000. Each section discusses concepts and major functions of the program. The whole manual suffers badly from brevity. Thirty pages isn't enough to explain spreadsheets. The Visicalc manual is eight times as long.

Chapter 1 in the section on Peachtext is entitled "The Peachtext Menu." The authors hurry through their discussion of the main menu. Chapter 2 deals with creating and editing a document; topics are arranged semialphabetically, not logically. Chapter 3 covers "Recognition Characters." Printing and formatting are covered in Chapter 4. Chapter 5, dealing with variables, covers one of the most complex functions of Peachtext in very few pages.

Both Spelling Proofreader and List Manager discuss each menu option in turn. Although they suffer from a shortage of examples (which is true of the whole manual), the sections on Spelling Proofreader and List Manager are perhaps the most logically organized. The Thesaurus is slighted, with only a scant three pages of information.

Chapter 1 of the Peachcalc section is labeled "Concepts" and offers a combination of definitions and functions. Chapter 2 tours the worksheet: how to move, the status line, the prompt line. Chapter 3 covers the status,

TWA's 3 PAIR BEATS PAN AM



prompt, and entry lines. The / commands are described next. The final chapter lists formulas and functions recognized by Peachcalc.

The appendix of the main manual contains summaries of Peachtext and Peachcalc commands. A section on customizing and maintaining the programs follows. Though not mentioned in the table of contents, error messages are discussed at the end of each appendix.

The lack of indexes further decreases the manual's usefulness. Although the manual is divided into sections for each program, you can spend hours thumbing back and forth between the two books as you work your way through creating and printing a document.

Peachtext 5000 as a Single Package

Examined one at a time, the Peachtext 5000 modules belong in that crowd of programs that do the job adequately. They're not superstars, but neither are they real villains. You don't love a calculator or telephone, you just use it.

When you attempt to evaluate Peachtext 5000 as a whole, the picture changes for the worse. Peachtree labels the package a "personal productivity system." I'm not sure what they mean by that. I see it as a series of individual programs loosely tied together by a narrow ribbon—the common main menu. Given the diverse origins of the pieces, it's no surprise that the ribbon is not too tight.

Peachtext began life as Magic Wand, a program

popular long before the IBM PC appeared. Peachcalc is an alias of the original version of Supercalc; Supercalc, though newer than Magic Wand, is still of the same generation.

The three other modules are equally diverse. Peachtree acknowledges Random House as the source of its thesaurus package. There is no identification of the source of Spelling Proofreader. (Aspen Software sells a Random House spelling checker with dictionaries ranging from 20,000 to 50,000 words.) List Manager was written by Peachtree, as far as my sources know.

The weak point of Peachtext's integration is commands. In any program, consistency of function is crucial to good design. Peachtext 5000 is inconsistent in how commands are given and, more crucial, in what commands mean. There is no excuse for confusion over how, when, and where to enter commands and which commands to use. The first step in ending the mess is better documentation. The second step is to really adapt the pieces, not just stick a common menu up front. Instead, Peachtext includes some functions that are invoked by the dedicated function keys, others are called from a slash on a status/editing line within the workspace, and some require exiting the current work to a separate status screen with a backslash. I lost count of the number of times I tangled up the slash of Peachcalc with the backslash of Peachtext.

In Peachcalc, typing the slash command marker calls a prompt line to help you make your decisions. If you

's FULL HOUSE.



TWA'S INTERNATIONAL
BUSINESS CLASS HAS 6-SEATS ACROSS.
PAN AM'S HAS 8.



WHO'S YOUR MONEY ON?

For space and comfort across the Atlantic, the smart money's on TWA. Because TWA has 6-across seating. Pan Am and most others have eight. So on TWA, every seat is either an aisle seat or a window seat. That means there's never more than one person sitting next to you, so you'll have more room to work, and more room to relax.

And by the end of March you'll get comfortable 6-across seating on every widebody TWA flies overseas—our L-1011's as well as our 747's. That's because we're folding down the two middle seats and adding more legroom in our L-1011's. So now, they'll be more comfortable than ever.

TWA's Ambassador Class®—it's the odds-on favorite to Europe and the Middle East.

You're going to like us





We're looking for people who can see beyond the obvious.

If Christopher Columbus had been content to ship cargo around the Mediterranean, he would have missed the opportunity to discover the New World.

If LINKABIT engineers weren't thinking about what could be, instead of what is, we wouldn't be at the forefront of the telecommunications industry.

Thanks to a cadre of conceptual achievers, however, LINKABIT has continued to set the standard in diverse and complex projects such as MILSTAR terminals, video scrambling equipment, domestic satellite systems, modems, codecs, advanced processors and fault-tolerant systems.

Now, we're looking for more of the same kinds of thinkers to join our ranks in the following areas:

- Satellite Data Communications
- Satellite Network Technologies
- Information and Network Security
- Speech Coding and Compression
- Local Digital Switching Systems
- Modulation and Coding Techniques
- Synchronization Techniques
- Advanced Digital Signal Processing
- RF & Analog Design

The creative, free-thinking atmosphere at LINKABIT promotes excellence and is a reflection of our physical environment. San Diego, America's Finest City in location, climate, cultural and recreational facilities, offers you and your family an unsurpassed lifestyle. This invigorating setting, combined with the challenge, satisfaction, and reward of a career at LINKABIT, provides an unbeatable opportunity to fulfill your goals. Opportunities are also available in the Washington, D.C. area and Boston.

If you see your opportunity here, send your resume to: Dennis Vincent, M/A-COM LINKABIT, 3033 Science Park Road, San Diego, CA 92121.

You'll discover a world of obvious possibilities.

M/A-COM



M/A-COM LINKABIT, INC.

Equal Opportunity/
Affirmative Action Employer

get lost in the middle of a command, typing a question mark invokes a Help screen with all possible choices for that particular situation. At the Peachtext backslash, you may enter a single character followed by <Enter> or a combination of characters followed by <Enter>. The only way to know which command uses which pattern is to know the program well or to keep the reference guide open. There is no prompt line, and Help is a separate function not accessible once you have entered other information.

To further confuse the matter, List Manager and Spelling Proofreader do not use either form of command marker. Functions are called from the program menu only. And each module uses its own variations on function keys. It's hard to be productive when you are drowning in conflicting, inadequately documented commands.

As much as I dislike shuffling disks, I'm not downgrading Peachtext for using five program disks. Most users won't be trading modules that often. If you have ever used a compiler, you know you can spend all day swapping disks between phases of creating a program.

Final Words

Is Peachtext 5000 a winner or a loser? It's not a package I find congenial to use. You'll have to total up the final score yourself.

The merge and formatting capabilities of Peachtext are pluses, and they are definitely above average. Printing is very good if you have one of the printers listed; otherwise, it's only fair. Peachtext does an adequate job on draft printers. Block manipulation is average; cursor moves are poor.

In terms of ease of use and convenience, the Random House Electronic Thesaurus rates as very good. A larger vocabulary would raise that score to excellent. Although it's fast at matching words and multitalented at adding and subtracting words, Spelling Proofreader is a weak link in Peachtext 5000. The fatal flaw is its inability to correct words.

List Manager earns a good grade for its flexibility, especially the report-generation facility. Although I dislike the routine to add records, it is counterbalanced by List Manager's ability to supply information to Peachtext for customized letters.

Peachcalc is a solid package. It is not a 1-2-3 or a Supercalc 3, but judged on its own merits, the electronic spreadsheet is the best part of Peachtext 5000 and deserves a rating of excellent.

Documentation is the major flaw. Over half of the problems with Peachtext 5000 are caused by inadequate documentation. Even Peachtree's enlightened support policy doesn't compensate for the documentation. As I said earlier, bad documentation is a preventable crime. With an index, better organization, and a readable layout, the manuals would be infinitely more usable. ■

Stevanne Ruth Lehrman (15 Larkspur Rd., Newton, MA 02168) is the founder of and vice-president of product evaluation for Analytic Resources. Her specialty is competitive analysis of software and documentation.

Why buy an IBM XT when you can buy an IBM PC or compatible, our Pegasus XT Conversion Kit™ and save yourself almost \$1,600?

For \$1,295 you can buy our internal 10 megabyte hard disk system installed in an IBM PC or compatible of your choice.

Think about it. When you consider buying an IBM XT or XT look-alike, you're after large storage, the convenience of IBM compatible software, and the peace of mind associated with a quality product. But one thing you're not looking for is paying more than you have to.



The Savings

If you buy an IBM XT, it's going to cost you \$4,995 for the XT system unit. You'll get 10 megabytes of hard disk storage, one 320 Kbytes floppy disk drive, 8 slots, a \$120 asynchronous communication adaptor, 128K of RAM and the three IBM initials.

We recommend instead, that you buy the IBM PC for \$2,104. You'll get one 320 Kbyte floppy disk drive, 5 slots, 64K of RAM, the same three IBM initials, a space for your dealer to put the Pegasus XT Conversion Kit, and an extra \$2,891 to buy it with. But since the Pegasus XT Conversion Kit costs only \$1,295 installed, you'll have an extra \$1,596 — almost \$1,600 — left over. With many compatibles you'll have even more.

But if you already own an IBM PC and were thinking you'd just get the

XT expansion chassis, we have a surprise for you. If you add the \$1,295 cost of the Pegasus XT Conversion Kit to the \$2,104 price of an IBM PC, you can have a second computer — instead of a dumb box — for less than the price of the XT expansion chassis.

Hard Disk Quality

Now, before you start thinking that IBM's hard disk is better than ours, remember that IBM doesn't make their own hard disk for the IBM XT. They go into the marketplace, just like we do, and strike the best price they can. If you were to buy an IBM XT, your hard disk might come from one

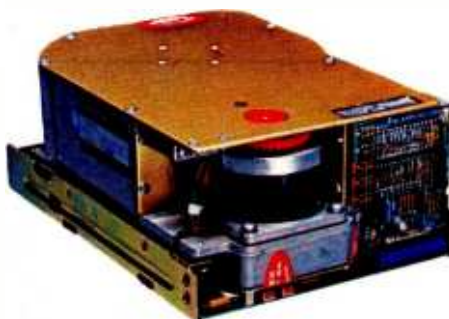

of four manufacturers. It's possible, in fact, that the IBM XT might have the same hard disk that you'd get in our Pegasus XT Conversion Kit.

The Role of the Controller

But the hard disk is not the whole story. It takes a controller card to get your files from the hard disk to your computer so you can use them.

The IBM XT has a good controller card. Unfortunately, it is not designed to take advantage of some of the ad-

vances in hard disk technology. Our controller card will work with our 10 megabyte hard disk all the way up to our 140 megabyte hard disk — and everything in between. With the IBM XT controller, you're limited to four manufacturers. The Pegasus controller board, on the other hand, configures to whatever hard disk you may want to install in the future. There is virtually no limit on hard disk size or number of manufacturers you can use.



Larger Disks

Pegasus offers an entire line of hard disks. You can expand your IBM PC far beyond the storage of the IBM XT. You can add our 23 megabyte hard disk for only \$1,995, or our 40 megabyte for only \$500 more. And if you really need storage, we offer a 65 and 140 megabyte hard disk that slides right into the same space that IBM and the compatible manufacturers put their 10 megabytes.

So, before you decide to spend more money than you have to, consider the Pegasus XT Conversion Kit. You'll get dealer support, the same 90 day warranty IBM gives, and have enough money left over to buy one of our larger hard disks. And isn't larger storage why you were looking at the hard disk in the first place? Contact your computer dealer today.

IBM is a registered trademark of International Business Machines, Inc. XT Conversion Kit is a trademark of Great Lakes Computer Peripherals, Inc.

GREAT LAKES
COMPUTER PERIPHERALS, INC.

2200 West Higgins Road, Suite 245
Hoffman Estates, Illinois 60195

In Illinois (312) 884-7272
800-323-6836

Dealer Inquiries Invited

What should you look for in personal

Before you go looking for personal computer software, you should know what personal computer software looks like.

(You're not alone if you don't already know that software programs come in a package.)

Programs are "pre-recorded" on cartridges, tapes or diskettes. And, although you can't tell by looking at these cartridges, tapes or diskettes, the programs on them can be very different.

What you put in is what you get out.

What happens when you play a high-quality tape on a high-quality recorder? Superior sound.

This analogy can also hold true with software. The better the program quality, the better the result — be it improved productivity or creativity.

IBM Personal Computer Software is both tested and approved by IBM. And these programs are designed to take advantage of an IBM personal computer's many advanced hardware features.

What the value is.

What are improved math skills worth? More efficient inventory control? Faster communications? What is accomplishment worth?

Any way you look at it, the value of personal computer software is the value of doing your best.

What compatibility means.

Many of the same software programs that run on the IBM Personal Computer you use at work will run on other IBM personal computers you use in other places. So you can, for example, continue in your family room what you started in the classroom or boardroom. (Or the other way around.)



computer software?



communications

Dial up information services with a single keystroke. Send or receive mail... stock and weather reports... charts or spreadsheets... automatically over standard phone lines.

What's available.

One software program can't satisfy everyone's computing needs. That's why IBM has such an extensive library of programs. You'll find a series for productivity, education, business, entertainment, lifestyle, programming or communications.

With IBM Personal Computer Software, you have a choice.

In word processing, for example, you may want a simple program for memo writing. You'll find that program in the IBM software library. If you want a sophisticated program for report writing, you'll find that in the library as well.

What's inside.

Sometimes learning a program is easy. Sometimes it's not. That's why inside every IBM software package are instructions that are clear and understandable.

What you can do right now.

There's more to look for in personal computer software than what you've read here. To find out more, look no further than your authorized IBM Personal Computer dealer. For one near you, call 800-447-4700. In Alaska or Hawaii, 800-447-0890.

IBM[®]

Personal Computer Software

Circle 190 on inquiry card.

The Coleco Adam

This inexpensive home computer has all the necessary peripherals, but using it is no Garden of Eden

Jules H. Gilder
Computer Consultant

In the past few months, you've probably heard a lot about the new Coleco Adam computer. With its built-in word processor, Applesoft-compatible BASIC, letter-quality daisy-wheel printer, 80K bytes of RAM (random-access read/write memory), ability to use all Colecovision game cartridges and accessories, and a price tag of less than \$750, it sounded too good to pass up. It is often said that if something sounds too good to be true, it probably is. The Coleco Adam is no exception to this rule.

There are two versions of the Adam computer. The machine used for this review is a stand-alone unit with a Colecovision game system built into it (see photo 1). The other version consists of an expansion module that plugs into an existing Colecovision game system and converts it to a computer. The one feature of the Adam that I have had no problems with is its ability to function as a video game. After producing hundreds of thousands of these game machines, Coleco has that process down pat. Would that it were so for the rest of the system.

The Adam comes in three parts. The main system console includes a Colecovision game unit, main processor and memory, digital data pack (cassette) drive, and expansion interfaces. The daisy-wheel printer includes the only power cord for the system, passing power to the main console using the same cable that sends printer information back. The keyboard is connected to the main console with a coiled telephone-type cord. Two Colecovision joysticks (one of which can be mounted to the keyboard using an adapter that comes with the system) and three digital data packs are also included. One tape contains SmartBASIC, one is a preformatted blank tape to store programs or word-processing files, and the third is a game, Buck Rogers Planet of Zoom (see photo 2).

Plugs and Slots

The Adam has several interfaces for communications and expansion. Power for the system comes from the printer, which uses a single cable to send power to and receive printer signals from the main console, making it difficult to tap into that signal to use a different printer. Next to the printer/power plug on the left side is a standard modular telephone plug marked "Adamnet"; the plug is to be used for an optional modem. Another telephone plug on the front of the console is used to connect the keyboard. On the right side of the system console are two standard nine-pin joystick connectors and a Colecovision expansion interface for attaching Coleco's add-on modules for its advanced games.

Under an easily removable top are three expansion slots, next to the connectors for the installed tape drive and for an optional second drive (see photo 3). Also on top is the Colecovision game-cartridge slot. On either side of that slot are two reset switches: one resets the machine as a computer, the other resets it as a game.

The Adam's peripherals are connected to the main console via a network called Adamnet; each peripheral contains its own 6801 microprocessor. The main system microprocessor is a Zilog Z80A. Four 6801s are used: one as the Adamnet controller and one each in the printer, the keyboard, and the tape drive. Although Coleco has touted the system's resultant multitasking capabilities, systems delivered to date support only the most rudimentary form of multitasking: while a user plays the Buck Rogers game, the tape drive loads the next video screen. The system cannot work on a separate task while the printer is printing, however.

Screen Memory

A personal computer stores its display screen in a sec-



Photo 1: *The Coleco Adam includes a tape drive, a printer, 64K bytes of RAM, a keyboard, a Colecovision game system, and two joysticks.*

tion of memory, which is used by a video processor (in this case, the Texas Instruments 9928) to generate a TV image. In most computers, this memory can be addressed by the main processor, and it can be changed using machine language or POKE statements to put the appropriate values into memory locations. In the Adam, however, the 16K-byte video memory is not addressable from the Z80A microprocessor. The 9928 has its own operating-system software to store video information, which can be used either by the Z80A or the 9928, but Coleco provides technical information on this only to licensed software developers.

Because this memory is not directly accessible by the system's main processor, PEEK or POKE commands cannot be used to locate screen information, and screens cannot be transferred using BLOAD or BSAVE commands. Thus, although Coleco's SmartBASIC is partly compatible with Applesoft, programs that use POKE or BLOAD to insert information directly into either the text or high-resolution screen won't run on the Adam. Because the screen memory in the Adam is not memory mapped as in the Apple, programmers will need more technical information to achieve faster high-resolution graphics action than is possible using BASIC. Coleco said a technical reference manual will be available by early summer.

High-Speed Tape System

One of the technical breakthroughs that can be seen in the Adam is its low-cost, high-speed digital tape system. Although most hobbyists snobbishly turn up their noses at the mere mention of tape storage, Coleco has

done an impressive job on the Adam's tape drive. To begin with, everything is automatic and transparent to the user. In fact, the tape commands are virtually identical to the disk commands used in Apple's DOS 3.3, with a few exceptions.

One change I dislike is the elimination of the powerful DOS 3.3 EXEC command, which enables ASCII (American National Standard Code for Information Interchange) files to be read in and appended to program files. Because programs are stored in ASCII format, the differences between the LOAD command and the EXEC command may have seemed to Coleco small enough to abandon the latter. The manual suggests no way to combine two ASCII program files, which is what the EXEC command was used for. Storing programs as ASCII files means they can be easily edited by the word processor, but it also means they require considerably more space on the tape and take longer to load than tokenized programs.

The Adam tape drive operates at two speeds: fast and faster. It reads and writes to the tape at a speed of 19,200 bits per second (bps), or 20 inches per second (ips), according to Coleco. In search mode, it scans the tape at 80 ips.

"Blank" tapes are preformatted with information that tells the tape drive where the head is currently located, much as information on a floppy disk tells the disk drive at which track and sector the head is located. A catalog stored on the tape indicates where each file is kept. The drive switches to its high-speed search mode to properly position the tape and uses its low-speed mode to read data from the tape.

At A Glance

Name

Coleco Adam

Manufacturer

Coleco Industries Inc.
999 Quaker Ln. South
West Hartford, CT 06110
(203) 725-6000 or (800) 842-1225

System Unit

Size: 18½ by 10½ by 4½ inches
Processor: Zilog Z80A
Memory: 80K bytes expandable to 144K bytes; 16K bytes of that memory is dedicated to the video display
Interfaces: Three expansion slots under a removable cover; one Colecovision expansion slot; one Colecovision game-cartridge slot; four-wire telephone-type jack for Adamnet; nine-pin connector for printer signals and power; two 9-pin joystick plugs; four-pin telephone-type jack for the keyboard
Mass storage: One 256K-byte digital data pack (cassette) drive; room for optional second drive (\$200)

Keyboard

Size: 15½ by 6½ by 2¼ inches
Features: 75 full-travel sculptured keys in standard typewriter layout, including six numbered programmable function keys, six word-processing command keys, and five cursor keys; a 12-key numeric keypad, accessible only from the word processor; auto-repeat on all keys

Printer

Size: 15½ by 14½ by 5½ inches
Features: 10-cps print speed; standard interchangeable daisy-wheel print element and ribbon

Display

Attaches to a standard color or black-and-white television; 256 by 192 display resolution (maximum); 36 characters by 24 lines in word-processor mode; 31 characters by 16 lines in SmartBASIC

Accessories

Two Colecovision joysticks with keypad; special holder to attach one joystick to the keyboard; all necessary cables and adapters; one blank preformatted digital data pack (cassette)

Software

Internal Smartwriter word processor; SmartBASIC (partly Applesoft compatible); Buck Rogers Planet of Zoom arcade game (tape)

Documentation

Four manuals, all 6 by 9 inches: Set-Up, 64 pages; Smartwriter, 101 pages; SmartBASIC, 225 pages; Buck Rogers, 10 pages. Also includes card for free one-year subscription to Adam Family Computing magazine.

Price

\$750

Peripherals

Scheduled for release this year: Adamlink 300/1200-bps modem, less than \$250; 5¼-inch disk drive, less than \$400; 64K-byte memory expansion, less than \$200; accessory kit, including three print wheels, a blank digital data pack, a multi-strike carbon ribbon, and a tape-head cleaner, all for about \$40; printer tractor-feed option, \$125

Audience

First-time computer buyers wanting a complete home computer system for less than \$1000

Although the Adam's tape drive is uncomfortably slow compared with floppy-disk drives, it operates much faster than any standard cassette-tape drive. The 20-ips speed is far faster than a normal cassette speed of about 1½ ips and even faster than the 15-ips speed used for professional recordings.

The tape used in the Adam system, although similar in appearance to ordinary cassette tape, differs significantly from it. Several modifications have been made to the plastic cassette shell so that it is not possible to use a standard audiocassette in the Adam computer or place an Adam digital data pack into an ordinary cassette recorder. Changes were also made to the tape media, according to Coleco.

When using the Adam data packs, you must take care to be sure they are properly seated in the drive. There is no built-in guiding mechanism to help do this.

Backups Are a Problem

The standard Adam comes with one tape drive and room for a second one. But even if you have two drives, it isn't any easier to make backups, because the operating system does not have a COPY or a BACKUP command.

This can be a serious problem, particularly because SmartBASIC resides on tape and Coleco provides only one copy of it. If humans and computers were perfect, one copy would be sufficient. Because neither is, the inevitable is bound to happen: an important program, or even SmartBASIC, could be lost.

Twice, the SmartBASIC file on my tape was somehow damaged. Coleco suggested that it may have been my fault and that the tape may have been damaged by the machine's magnetic field (see "Two Tales of Adam" on page 212). I think not, but in any case it took several phone calls and a week and a half to get a replacement. It's apparently a new version. The BASIC filename no longer appears in the catalog, but it loads properly.

When benchmark programs were run to see how long it would take to write and read a 64K-byte file to tape, three different data packs caused the Write program to terminate with an I/O (input/output) error (see "Benchmarking SmartBASIC," page 214). A fourth data pack permitted the 64K-byte file to be written to tape, but the file could not be read due to more I/O errors; this problem is most disturbing because there is no warning that the data written out to tape is unreadable.

[Editor's note: Coleco has said that a large number of tape problems have occurred because consumers leave tapes on an Adam peripheral or in the drive while turning the machine on or off. However, even tapes handled exactly as Coleco suggests rapidly lose capacity due to problems in allocating file space; deleting a file does not necessarily free up the tape space it used. Coleco has recommended using the BASIC INIT command to reformat a blank tape. The INIT command should not be used on the BASIC tape because it erases all the information on a tape, including the SmartBASIC software and all the program and text files. . . . M.W.]

Coleco has indicated that it plans to come out with a utility data pack containing both a Copy program and a program for initializing (or formatting) blank data packs. Blank data packs weren't available at the time of this review; Coleco said they should be on the market (at a price of less than \$8) by the time this article is published. The tapes are roughly the length of a C-60 cassette and store 255K bytes of data. Coleco said the Adam tape system can handle longer tapes to store a half-megabyte of data, but those tapes are not yet available.

A Complete System

Perhaps the Adam's strongest selling point is the fact that it is a complete system. The price even includes a letter-quality daisy-wheel printer. Computer snobs quickly will point out that the printer is slow, capable of printing only about 10 characters per second (cps), and they're correct: it is slow. But I don't consider speed an important issue with the Adam.

I'm not against fast printers—frankly, I prefer them—but for the newcomer to computing who's going to use the machine for programming and word-processing applications, a 10-cps daisy-wheel printer is a darn good compromise. It would have been nice if Coleco had used a standard printer interface on the computer so that those who want to could use higher-speed printers. The company has indicated that a serial printer interface may be available later.

The daisy wheel used in the Adam printer is a standard 96-character plastic wheel, and the ribbon is a standard Diablo Hytype I or Xerox 800. The printer is capable of both superscripting and subscripting (from the word-processor mode) but cannot print in boldface. I had a number of problems with three different printers; despite Coleco's best efforts, I still don't have one that works.

Coleco's literature indicates that the printer is bidirectional, but this is true only in the word-processor mode. In BASIC, the printer prints in one direction only.

Three cheers for Coleco's keyboard! The company's engineers, when designing this low-cost home computer, were smart enough to realize that the keyboard was not the place to save money. The keyboard on the Adam has 75 full-travel keys arranged in a standard typewriter configuration, including six special word-processing keys, six programmable function keys, and five cursor-control keys (see photo 4). The keyboard is attached to the main console via a coiled cable that has standard modular tele-



Photo 2: The Adam's 64K bytes of user memory and 16K bytes of video memory, plus the 255K-byte tape drive, enable use of more advanced entertainment software than Coleco's game system. Shown here is a scene from the Buck Rogers game that's included with the machine.

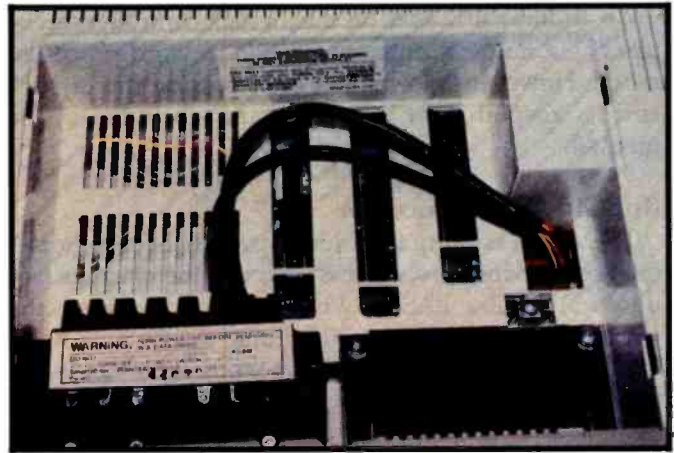

Photo 3: Three expansion slots reside under a removable top panel. Also visible is the digital data pack (cassette tape) drive and room for an optional second tape drive.



Photo 4: The Adam's detachable keyboard, perhaps the best-designed part of the system, has 75 full-travel keys.



Photo 5: *The Adam's word processor is built into the system's ROM chips. Although limited, the Smartwriter word processor should be adequate for home use.*

phone connectors on each end.

An additional 12 keys on the joystick controller can be used as a numeric entry pad while in word-processor mode. However, information on accessing the joystick and its keypad from BASIC was not included in the manual.

Built-In Word Processor

The Adam is more than just a personal computer. A full-fledged word processor is built into the machine (see photo 5). Unlike BASIC, which is stored on tape, the word-processing program is built into the system's ROM (read-only memory). The Adam's word processor is certainly suitable for home use, but it doesn't have all the capabilities demanded by a professional word-processing system.

The word processor is slow. It can keep up with even

the speediest typist, but access to text entered in different sections of a document is slow. If you want to move from one part of a long document to another, the cursor-control keys permit movement either one line at a time or several lines at a time by pressing the arrow keys and the Home key together. Even this "fast" movement through text is agonizingly slow for someone used to professional word processors.

Although the word processor has some advanced features, such as subscript and superscript characters, it lacks others, such as boldface print or form-letter processing. It does not have a "what you see is what you get" type of display, so you never really know what your text is going to look like until you print it out. The display uses 36 characters per line. On the bottom of the screen is a graphic representation of a typewriter roller; across the top and the left side are horizontal and vertical margin markers, which are helpful because they give you an idea of where you're typing on a printed page.

The word processor was still not fully debugged when the first machines were shipped. When I decided to change the margins for text already entered, the computer reformatted the text and all seemed well. However, when I continued to enter text, the computer would sometimes refuse to recognize carriage returns and would continue entering text on the same line. Coleco said this bug was fixed, as were others, in the current version of the machine.

[Editor's note: *The word processor occasionally repositions the cursor to the beginning of text after some text insertions, requiring movement to the inserted line using cursor keys or the SEARCH command before continuing. Coleco called this a "nondestructive" bug because it does not damage text, and said it plans to fix it at a later date. . . .M.W.]*

Another annoying feature of the word processor is that in order to implement many of the functions, several keystrokes must first be executed. For example, to delete text

a message to our subscribers

From time to time we make the BYTE subscriber list available to other companies who wish to send our subscribers material about their products. We take great care to screen these companies, choosing only those who are reputable, and whose products, services, or information we feel would be of interest to you. Direct mail is an efficient medium for presenting the latest personal computer goods and services to our subscribers.

Many BYTE subscribers appreciate this controlled use of our mailing list, and look forward to finding information of interest to them in the mail. Used are our subscribers' names and addresses only (no other information we may have is ever given).

While we believe the distribution of this information is of benefit to our subscribers, we firmly respect the wishes of any subscriber who does not want to receive such promotional literature. Should you wish to restrict the use of your name, simply send your request to the following address.

BYTE Publications Inc
Attn: Circulation Department
70 Main St
Peterborough NH
03458

Announcing
the sudden obsolescence
of the floppy disk.

NEW

HELIX PC BUBBLE DISK™

HALF-MEGABYTE MEMORY BOARD

The first bubble memory board for
IBM PC/XT and compatible computers.

- NON-VOLATILE: You don't lose data when there is no power.
 - Eight times faster than a floppy disk.
 - For fixed or portable use without need for back-up storage.
 - Impervious to dust, dirt, humidity, cold— as reliable in the North Sea, the Sahara, a Space Station, as in your office.
 - Mean time between failure (MTBF) more than 20 years.
 - Rugged enough to withstand vibration and shock up to 200Gs.
- For complete details, see us in L.A.
at Comdex/Winter '84, Booth #1526.
Or contact:



Helix Laboratories, Inc. Marketing Division—Suite 720
11601 Wilshire Blvd., Los Angeles, CA 90025
(213) 477-8221—outside California, 800-468-0004
Dealer Inquiries Welcome

© 1984, Helix Laboratories, Inc.

Two Tales of Adam

The first time I used the Adam, the SmartBASIC cassette wouldn't even load. Supposing the tape was defective, I took it to the dealer for replacement, only to learn that Coleco wouldn't provide such spares. After quite a few phone calls and two trips, I managed to return my computer and buy another from another dealer.

This time, SmartBASIC loaded quickly; after several days, however, the SmartBASIC file vanished from the tape. A call to Coleco's consumer hotline resulted in a technical honcho suggesting that I probably left the tape on top of the printer or a television, thus erasing it. He then complained that people have less respect for tapes than for floppy disks. However, I don't think I did subject the tape to harm. An added curiosity: when SmartBASIC was erased—and it happened again another time—no other files were affected.

In any case, I was without BASIC; it was several phone calls and a week and a half later before I received a new tape.

The printer worked fine for the first two weeks, and then the daisy wheel started spinning like crazy. After I reset the machine, the printer no longer operated properly, printing different characters than the ones I typed. Coleco experts had no explanation but agreed to replace the printer.

Another phone call and two weeks later, a replacement arrived. It didn't work. Another call led to another printer. This time, the printer came with a piece of paper in it that had obviously been used to test the printer before it was shipped. The test showed plainly that the tops of some of the letters were missing—they shipped it anyway. Maybe someday I'll get a complete, working system. —Jules Gilder

I spent two days running the Adam computer through simple tests and benchmarks without experiencing a single problem. It was only when I tried to do useful work that the Adam showed problems.

I typed a long BASIC program into the machine and tried to save it to tape. After whirring for a few minutes, the Adam reported a "No More Room" error—although I was trying to save a file about 6000 characters long when the directory said I had 220 blocks (about 220,000 characters) free.

I learned that I could save shorter files, however, and thus saved half of my program. Later, the length of files I could save grew shorter and shorter until I could no longer tolerate it. I decided to write a letter to Coleco explaining the problems, planning to send the tapes for replacement as the company suggested on its consumer hotline (after putting me on hold for 45 minutes).

The word processor, for some reason, dropped a line of my letter while it was being printed. I corrected the letter; the word processor dropped a different line of text. The third time I tried, the printer locked up and wouldn't print. I couldn't save the letter to tape since the tape drive was the problem.

My dealer agreed to replace the main console and tapes, taking parts from a machine that had been returned because of a defective printer. Everything was fine for another week, and then the "No More Room" error reappeared. I knew I only had about 40K bytes saved to tape, so I checked the directory. This time, the directory said there were only 16 blocks free (I was trying to save a 22K-byte file). The tape had lost almost all of its 255K-byte capacity!

The word processor in my second machine also exhibited problems, this time replacing characters in my text at random during printing. After waiting three weeks for a replacement, I received a refund from my dealer. —Mark Welch

[Editor's note: Coleco said that most of the aforementioned problems have been corrected in later versions of the Adam. However, "nondestructive" problems, such as repositioning the cursor after an insertion in the word processor, have not yet been corrected, Coleco noted. At press time, we were unable to test a newer machine. . . M.W.]

you must press the Delete key, move the cursor to the first character to be deleted, press the Hi-Lite function key, highlight the text to be deleted using the cursor keys, and finally press Final Delete.

SmartBASIC

SmartBASIC is not located in ROM but must be loaded from a digital data pack as described previously. Early purchasers of the Adam computer got one of several versions of SmartBASIC with bugs. BASIC wouldn't even load properly in the first machine I bought.

Other changes were made to SmartBASIC. To mimic Apple's DOS 3.3, one section of the tape is reserved for directory information. In early versions of the SmartBASIC tape, this information is stored at the beginning of the tape. Later versions have the data stored in the middle of the tape to cut down on the access time to any particular program. In early versions of SmartBASIC, the CHAIN command does not work.

If you're wondering which version of BASIC came with

your computer, you've got a problem: despite the many changes to the language, all versions are labeled 1.0.

Although Coleco boasts that its SmartBASIC is compatible with Applesoft, there are a number of differences in the languages. SmartBASIC was not written by Microsoft, as was Applesoft, and does not have the same internal construction as Microsoft BASIC. A positive result of this difference is that new ideas in interpreter design were included. For example, SmartBASIC checks syntax on entry. SmartBASIC is also more highly table-driven than Microsoft BASIC, increasing the operating speed. SmartBASIC may be the fastest 8-bit BASIC around.

Another advantage of SmartBASIC not being written by Microsoft is that it doesn't have the bugs associated with Microsoft BASIC. The author of this language made sure that all floating-point numbers are properly represented, with no round-off errors occurring as with IBM's Microsoft BASIC.

The SmartBASIC interpreter's unusual way of storing

Text continued on page 216

Circle 165 on inquiry card. →

dBASE II™ made Easier!

Now dBASE II is made easy with QUICKCODE by FOX & GELLER. QUICKCODE is a program generator, a computer program which writes computer programs.

QUICKCODE™

**VERSION FOR
IBM AVAILABLE**

**The dBASE II
Program Generator**



FAST AND SIMPLE

With QUICKCODE you can generate a customer database in 5 minutes. It's that fast. All you have to do is draw your data entry form on the screen. It's that simple!

NO PROGRAMMING REQUIRED

QUICKCODE writes concise programs to set up and maintain any type of database. And the wide range of programs cover everything from printing mailing labels and form letters, to programs that let you select records based on your own requirements. There are even four new data types that are not available with dBASE II alone.

YOU CONTROL

And since you work directly with your information at your own speed and your own style, you maintain complete control. Telling your computer what to do has never been so easy.

CALL US AT (201) 794-8883



FOX & GELLER

FOX & GELLER, Inc. 604 Market Street, Elmwood Park, N.J. 07407
FOX & GELLER, Ltd. Amsterdamsestraatweg 23, 1411 AW Naarderen, The Netherlands

Benchmarking SmartBASIC

At the time the Adam was introduced, Coleco claimed that its SmartBASIC was faster than Applesoft BASIC, with which it was to be compatible, and also that its digital data pack (cassette) drive would operate at "transfer rates comparable to floppy disks." As can be seen from BYTE's standard benchmark programs (see table 1), SmartBASIC is indeed faster than Applesoft at some operations, but a comparison of the mass-storage speeds shows that the Adam is much slower. A lack of compatibility is also apparent in running the benchmark programs.

The prime-number algorithm normally uses a 7000-element array (see listing 3), an acceptable value for the Apple and most computers with 64K bytes of RAM (random-access read/write memory). But the Adam, for reasons unknown, cannot dimension an array larger than 5112 elements. As a result, no direct comparison can be made for the prime-number benchmark. A version with

5000 elements shows the Adam to be much faster than the Apple, but the incompatibility should alert users to the possibility of other limitations in the Adam.

The Adam was also unable to run the standard Applesoft BASIC benchmarks to write and read a 64K-byte file (listing 2) because that program writes text data to a file as five hundred 128-character blocks. The Adam's SmartBASIC cannot accept a 128-character string as input (listing 2b, line 180), and thus it could not run the program using the file written by listing 2a. A new program, writing a 64K-byte file as one thousand 64-character lines, was used (listing 1). As the table shows, it takes the Adam about nine minutes to access the 64K-byte file, compared to Applesoft's three minutes. (Note that Applesoft is already slow compared to the 32-second run-time for the IBM Personal Computer.)

—Mark Welch

Listing 1: The 64K-byte file disk/tape Write and Read programs used to compare SmartBASIC and Applesoft (see table 1).

(1a)

```
5 nr = 1000
6 a$ = "1234567812345678"
7 b$ = a$ + a$ + a$ + a$
10 d$ = CHR$(4): REM Control-D
15 PRINT "opening file"
20 PRINT d$; "OPEN TEST"
30 PRINT d$; "WRITE TEST"
40 FOR i = 1 TO nr
42 PRINT b$
44 NEXT i
50 PRINT d$; "CLOSE HELLO"
55 PRINT " done"
59 END
```

(1b)

```
5 nr = 1000
10 d$ = CHR$(4): REM Control-D
15 PRINT "opening file"
20 PRINT d$; "OPEN TEST"
30 PRINT d$; "READ TEST"
40 FOR i = 1 TO nr
42 INPUT c$
44 NEXT i
50 PRINT d$; "CLOSE HELLO"
55 PRINT " done"
59 END
```

BYTE back issues for sale

| | 1976 | 1977 | 1978 | 1979 | 1980 | 1981 | 1982 | 1983 | 1984 |
|-------|------|--------|--------|--------|--------|--------|--------|--------|--------|
| Jan. | | | | \$2.75 | \$3.25 | \$3.25 | | \$3.70 | \$4.25 |
| Feb. | | | \$2.75 | \$2.75 | \$3.25 | \$3.25 | \$3.70 | \$3.70 | \$4.25 |
| March | | | \$2.75 | | \$3.25 | \$3.25 | \$3.70 | \$3.70 | \$4.25 |
| April | | | \$2.75 | \$2.75 | \$3.25 | \$3.25 | \$3.70 | \$3.70 | |
| May | | \$2.00 | \$2.75 | \$2.75 | \$3.25 | \$3.25 | \$3.70 | \$3.70 | |
| June | | \$2.00 | \$2.75 | \$2.75 | \$3.25 | \$3.25 | \$3.70 | \$3.70 | |

| | 1976 | 1977 | 1978 | 1979 | 1980 | 1981 | 1982 | 1983 | 1984 |
|-------|--------|--------|--------|--------|--------|--------|--------|--------|------|
| July | \$2.00 | \$2.00 | \$2.75 | \$2.75 | \$3.25 | | \$3.70 | \$4.25 | |
| Aug. | | \$2.00 | \$2.75 | \$2.75 | | \$3.25 | \$3.70 | \$4.25 | |
| Sept. | | \$2.75 | \$2.75 | \$2.75 | \$3.25 | | \$3.70 | \$4.25 | |
| Oct. | | | \$2.75 | \$2.75 | \$3.25 | \$3.25 | \$3.70 | \$4.25 | |
| Nov. | | | | \$3.25 | | \$3.25 | \$3.70 | \$4.25 | |
| Dec. | | \$2.75 | \$2.75 | \$3.25 | \$3.25 | \$3.25 | \$3.70 | \$4.25 | |

Circle and send requests with payments to: **BYTE Back Issues**
P.O. Box 328
Hancock, NH 03449

Listing 2: The 64K-byte file disk Write (2a) and Read (2b) programs normally used as benchmarks for the Apple II Plus. The Adam cannot accept the 128-character string during line 180 in listing 2b.

(2a)

```

5 D$ = "": REM CONTROL-D
40 A$ = "12345678123456781234567812345678"
60 B$ = A$ + A$ + A$ + A$
80 NR = 500
100 PRINT D$"OPEN TEST"
120 PRINT D$"WRITE TEST"
140 FOR I = 1 TO NR
180 PRINT B$
200 NEXT I
220 PRINT D$"CLOSE"
240 PRINT "DONE"

```

(2b)

```

5 D$ = "": REM CONTROL-D
80 NR = 500
100 PRINT D$"OPEN TEST"
120 PRINT D$"READ TEST"
140 FOR I = 1 TO NR
180 INPUT B$
200 NEXT I
220 PRINT D$"CLOSE"
240 PRINT "DONE"

```

Listing 3: The standard prime-number program used as a benchmark. To run on the Adam, lines 1 and 2 had to be changed to reflect a limit of 5112 elements to an array. For the benchmark listing, the values of 7000 and 7001 were replaced with 5000 and 5001.

```

1 SIZE = 7000
2 DIM FLAGS(7001)
3 PRINT "only 1 iteration"
5 COUNT = 0
6 FOR I = 1 TO SIZE
7   FLAGS(I) = 1
8 NEXT I
9 FOR I = 0 TO SIZE
10  IF FLAGS(I)=0 THEN 18
11  PRIME = I+I+3
12  K=I+PRIME
13  IF K>SIZE THEN 17
14  FLAGS(K)=0
15  K=K+PRIME
16  GOTO 13
17  COUNT = COUNT + 1
18 NEXT I
19 PRINT COUNT, " primes"

```

| Benchmark | Adam SmartBASIC | Applesoft BASIC |
|---------------------------------------|--------------------|--------------------|
| Empty FOR...NEXT loop | 55 | 6.66 |
| Division | 500 | 29.0 |
| Subroutine jump | 11.1 | 13.9 |
| MID\$(substring) | 20.7 | 32.3 |
| Prime number (7000 elements) | (error) | 190.0 |
| Prime number (5000 elements) | 78.0 | 170.0 |
| 64K-byte tape/disk write (listing 1a) | 564.0 | 200.0 |
| 64K-byte tape/disk read (listing 1b) | 527.0 | 214.0 |
| 64K-byte disk write (listing 2a) | (error) | 175.0 |
| 64K-byte disk read (listing 2b) | (error) | 217.0 |

Table 1: The timings of Adam SmartBASIC and Apple II Plus Applesoft BASIC using seven BASIC benchmark programs. The listings for the first five programs appear on page 54 of "A Closer Look at the IBM Personal Computer" (January 1982 BYTE, page 36). The disk/tape read and write programs are reproduced in listings 1 and 2. Adam was unable to dimension a 7000-element array and so a smaller (5000-element) array was tested on both the Adam and the Apple II Plus.

Check enclosed

Payments from foreign countries must be made in US funds payable at a US bank.

VISA

Master Card

Card # _____ Exp. _____

Signature _____

name _____

address _____

city _____

state _____ zip _____

Prices include postage in the US. Please add \$.50 per copy for Canada and Mexico; and \$2.00 per copy to foreign countries (surface delivery).

Please allow 4 weeks for domestic delivery and 8 weeks for foreign delivery.

Coleco's Third-Party Software License

Software developers seeking technical information are required to sign Coleco's Technology Licensing Agreement before Coleco will reveal the information needed to write anything more complex than a simple SmartBASIC program. But the agreement represents an exacting toll to software developers.

First, Coleco demands the right to inspect samples of any program before the developer distributes it. If Coleco isn't satisfied with the program's quality, the developer must change it as Coleco requests or lose the software license. If Coleco does terminate the license, the software developer must cease manufacturing all programs licensed under the agreement.

If a problem in quality control was the reason for terminating the agreement, the developer must send Coleco the remaining inventory. Otherwise, the developer must provide a list of the complete inventory and dispose of excess stock within 90 days. Coleco also demands the right to perform a physical inventory to verify the developer's claims. If the developer doesn't permit the inventory, Coleco claims the right to remove all remaining inventory by entering the storage location, without any liability for damage.

Coleco licensees must also mention the Adam in advertising and provide booth space for Adam products at trade shows.

Perhaps the most restrictive clause in the agreement is this one: "Licensee agrees that it will not, during the term hereof, make or cause to be made disparaging or critical references to the quality of Coleco's products and/or Coleco's business methods." In essence, developers cannot talk critically about Coleco's products or practices.

Text continued from page 212:

program lines in memory was less understandable to me. Program lines don't have the familiar Microsoft line structure (2 bytes point to the next line, 2 bytes for the line number, a tokenized line, and a 0 as a line terminator). In SmartBASIC, the line numbers and next-line pointers are stored in separate tables elsewhere in memory.

The SmartBASIC manual is a classic example of how not to produce a manual. Coleco has indicated it is painfully aware of the deficiencies and said a new manual is being prepared.

Microsoft BASIC stores lines in memory in numerical order, moving segments of the program up and down as lines are added and deleted. SmartBASIC stores lines as they are entered: if line 100 is entered first and line 10 second, they are stored in memory in that order. This doesn't cause problems when the program is listed because the next-line pointer table is properly maintained.

Incompatibilities extend beyond the internal structure of the language. Some tape-based commands are lacking, and other commands (such as FLASH, by which characters are made to flash between inverse and nor-

mal) are not provided on early versions of the machine. Most of the other Applesoft commands have been implemented, but early buyers of the Adam are not going to be able to use them because the proper documentation is not included. For example, shape tables and DRAW and XDRAW commands are mentioned several times in the current manual under definitions of other commands but are not themselves explained. Coleco said they are covered in the new manual.

Another annoying feature of SmartBASIC is that it requires spaces between keywords, as do later versions of Microsoft BASIC. Applesoft is very tolerant of this sort of thing and is smart enough to recognize most keywords without spaces.

Although most of the Applesoft commands are available in SmartBASIC, many Applesoft programs may not run as is because of hardware differences. For example, Applesoft uses four memory locations to control the borders of the active screen window so that only certain portions of it are scrolled or modified. SmartBASIC does not have this windowing capability. Also, some Applesoft programs read the keyboard directly by looking at a particular memory location to see what key has been pressed. Coleco's manuals do not include this information for the Adam, which uses different locations. And, as previously mentioned, Applesoft programs that directly access the Apple's memory-mapped display will not run on the Adam without major changes.

Another difference between the Apple II and the Adam relates to their display size. The Apple displays 40 characters per line. The Adam, however, has a 36-character display in the word-processing mode and a 31-character display in BASIC. The difference causes some display problems.

SmartBASIC's HGR routine has a bug in it: if you try to draw a box along the outer borders of the HGR screen (0,0 to 0,255 to 159,255 to 159,0 to 0,0), a triangle is drawn instead. If you switch to HGR2, the program works fine.

Coleco said it is planning to come out with an improved version of the language, fully integrated with the word processor to provide sophisticated editing capabilities (BASIC programs can now be edited with the word processor only by resetting the machine). Although it is also working on implementing other languages, including Logo, Coleco said it will always support BASIC.

How Not to Produce a Manual

The SmartBASIC manual is a classic example of how not to produce a manual. It appears as if it were rushed out the door with little thought given to its composition, completeness, or accuracy. I've been involved with personal computers ever since the KIM-1, so I've seen a lot of manuals, good and bad. The BASIC manual that comes with the Adam, however, is the worst I have ever seen. The book is full of typographical errors, programming errors, and misleading statements. In addition, it is incomplete: there are roughly 30 SmartBASIC commands that are not documented.

Blazing BASIC.

Who said BASIC had to be slow?

Microsoft® BASIC Compiler lets you create MS™-DOS programs that are so fast users will never know they were written in BASIC.

The compiler produces fast, efficient native code. The result? Three to ten times faster operation than the same interpreted program. Even faster for programs that make maximum use of integers.

But it's not only fast in execution, it's fast for development. It's **MICROSOFT** the one BASIC compiler designed to work best with our BASIC interpreter — the de facto industry standard. Together, they let you develop and debug your programs interactively using the interpreter, then compile for speed.

And like all Microsoft languages, the standard linking

interface makes it easy to combine assembly language subroutines.

Microsoft BASIC Compiler is just one reason Microsoft is your best source for high performance languages for 8088/86 based micros.

Call 800-426-9400 to order
the blazing BASIC compiler.
\$395*

In Washington State, call 206-828-8088. Ask for operator A4, who will rush you your order, send you more information, or give you the name of your nearest dealer to see Microsoft BASIC in action.



*Price exclusive of handling and Washington State sales tax.

Microsoft is a registered trademark and MS is a trademark of Microsoft Corporation.

The BASIC manual is typewritten, or printed on a computer printer (not the Adam's), which means that one typeface dominates throughout the book; boldface is used for emphasis. No illustrations or color are used; it's a very dull graphic presentation. (The other manuals included with the system do use graphics and photos.)

For now, Coleco's customer-service people suggest Adam owners buy an Applesoft BASIC manual.

The table of contents covers only the first 131 of the book's 222 pages and does this with only four brief entries. No mention is made of the reference section, where each command (except for the 30 undocumented ones) is explained. There is no index.

The situation is aggravated even further by the fact that there is no delineation in the manual between operating-system commands and BASIC commands. For example, the manual's authors combine the BASIC DEL command and the operating system's DELETE command into a single misleading definition: "The DEL or DELETE command may be used to erase a single line, a sequence of consecutive lines, an entire program or an entire data file." The manual gives an example of the DEL command by listing a four-line program whose line numbers are 10, 20, 30, and 40. Lines 20 through 40 are deleted, the

book says, by entering "DEL 15,40" —in this case, the DEL command is used to delete a range of lines that begins with a nonexistent line number. Although this works, there is no explanation of *how*. Novice users are left to figure out for themselves, if they can, how the DELETE command works and what it is used for.

An example of misinformation occurs on the next page of the manual: you are told that it is only possible to have one-, two-, or three-dimensional arrays; a quick test, however, shows that much larger multidimensional arrays are possible, probably up to 255, as is the case with most BASICs.

The manual includes two blue pages full of corrections to be marked by the buyer onto the appropriate pages, but not all the bugs are corrected. For example, the sample program listed with the HGR and HGR2 commands to draw a rectangle on the high-resolution screen was obviously not tested—a line was missing. (The missing line is: 35 H PLOT 100,10 TO 100,100.) Without this line, the program draws only three sides of a rectangle. The manual also states that the resolution increases from 256 by 160 picture elements (pixels) in HGR to 280 by 192 pixels with HGR2; actually, the resolution for HGR2 is 256 by 192 pixels.

Coleco has indicated that it is painfully aware of the deficiencies of the original BASIC manual and that a new one is being prepared. It should be out by the time this issue is published. In the meantime, Coleco's customer-

FREE SHIPPING
Order line: 800-354-7330

SANYO SUPER SYSTEMS

SYSTEM #1 \$1195
SANYO MBC-550
 • SANYO GREEN MONITOR
 • GEMINI 10 X • SOFTWARE •
 Sanyo MBC-550 Single Drive Computer • Sanyo CRT-36 Monitor • Star Micronics Gemini 10X • Cabling • WardStar • CalcStar • Easywriter • MS-DOS • Sanyo Basic •

SYSTEM #2 \$1525
SANYO MBC-555
 • SANYO GREEN MONITOR
 • GEMINI 10X • SOFTWARE •
 Sanyo MBC-555 Dual Drive Computer • Sanyo CRT-36 Monitor • Star Micronics Gemini 10X • Cabling • WordStar • CalcStar • SpellStar • InfoStar • Mail Merge • Easywriter • MS-DOS • Sanyo Basic •

| PRINTERS | |
|-------------------------|--------|
| C. ITOH | |
| Prowriter 8510 | \$335 |
| A 10-20 | \$505 |
| F-10 Serial or Parallel | \$940 |
| 8510SP (Prowriter SP) | \$565 |
| COMREX | |
| CR-2 | SAVE |
| DIABLO | |
| 620 RO | \$860 |
| 630 RO | \$1715 |
| S-11 | \$560 |
| P-11 | \$560 |
| EPSON | |
| RX-80 | SAVE |
| RX-80 F/T | SAVE |
| FX-80 | SAVE |
| FX-100 | SAVE |
| LQ1500 | SAVE |
| JUKI | |
| 6100 | \$480 |
| NEC | |
| 2010 | \$780 |
| 2050 | \$905 |
| 8023A | \$385 |
| 3510 | \$1370 |
| 3550 | \$1715 |

| OKIDATA | |
|-------------------------|--------|
| 82A | SAVE |
| 83A | SAVE |
| 84P | SAVE |
| 84S | SAVE |
| 92 | SAVE |
| 93 | SAVE |
| QUME | |
| 11/40 w/Interface | \$1370 |
| 11/55 w/Interface | \$1570 |
| Letter Pro 20P | \$609 |
| Letter Pro 20S | \$609 |
| SILVER REED | |
| EXP 500 | \$390 |
| EXP 550P | \$580 |
| EXP 550S | \$610 |
| EXP400 | \$329 |
| STAR MICRONICS | |
| Gemini 10X & 15X | SAVE |
| Delta 10 | SAVE |
| TALLY | |
| MT 160L w/tractors | SAVE |
| MT 180L w/tractors | SAVE |
| Spirit 80 | SAVE |
| TOSHIBA | |
| 1350 Serial or Parallel | \$1450 |
| TRANSTAR | |
| 130P | \$675 |
| 120P | \$450 |
| T315 | \$450 |

| TERMINALS TELEVIDEO | |
|------------------------|--------|
| 910 + | \$555 |
| 914 | \$540 |
| 924 | \$670 |
| 925 | \$705 |
| 950 | \$905 |
| 970 | \$980 |
| ZENITH | |
| Z-29 | \$649 |
| COMPUTERS SANYO | |
| MBC-550 System | \$1195 |
| MBC-555 System | \$1525 |
| TELEVIDEO | |
| 803 | \$1799 |
| ZENITH | |
| Z-100 Low Profile | \$2635 |
| Z-100 All-In-One | \$2815 |
| MODEMS HAYES | |
| 1200 | \$490 |
| 1200B | \$435 |
| 300 | \$205 |

| DISK DRIVES RANA | |
|------------------------|-------|
| Elite 1 | \$215 |
| Elite 2 | \$345 |
| Elite 3 | \$410 |
| 1000 w/DOS (for Atari) | \$305 |
| MONITORS BMC | |
| 12" Green | \$89 |
| 13" Color | \$210 |
| TAXAN | |
| 12" Amber | \$125 |
| ZENITH | |
| 12" Green | \$95 |
| 12" Amber | \$120 |

Prices reflect 3% to 5% cash discount. Product shipped in factory cartons with manufacturer's warranty. Free shipping is on UPS ground only. Prices & availability subject to change without notice. Send cashier's check or money order...all other checks will delay shipping two weeks.



SILICON SPECIALTIES
 2034 WEST SOUTHERN
 MESA, ARIZONA 85202
 602-969-0909

Raging C.

Concise structure and fast execution make C the ideal language for applications and system-level programming.

And compared with other MS-DOS C compilers, Microsoft® C consistently produces the fastest executable code.

It supports the full C language and includes an extensive library of subroutines that implement most UNIX™-compatible functions.

Small, medium, compact, and large memory models give you flexibility in selecting the addressing requirements of your software. Programs can be designed to make effective use of the available memory of your computer, up to one megabyte.

Microsoft C Compiler provides you with a complete development system including the compiler, run time library, linker and library manager, and full support of

MS-DOS 2.0 directory structure (pathnames) and I/O redirection.

How do programmers feel about Microsoft C?

“In the top category for its quick compile and execution time, small incremental code, best documentation, and consistent reliability.”**

—Ralph Phraner, *BYTE Magazine*

“Best for software development.”

—Bill Hunt, *PC Tech Journal*

“Produces good, tight-running programs.”

—Peter Norton, *Softalk*

Call 800-426-9400 to order the raging C. \$500*

In Washington State, call 206-828-8088. Ask for operator A4, who will rush you your order, send you more information, or give you the name of your nearest dealer to see Microsoft C in action.



*Price exclusive of handling and Washington State sales tax.
Microsoft is a registered trademark and MS is a trademark of Microsoft Corporation.
UNIX is a trademark of Bell Laboratories.

**Reprinted with permission. *BYTE Magazine*, August '83.

service people suggest that Adam owners buy an Apple-soft BASIC manual.

Replacements, Peripherals, and Accessories

Early purchasers of the Adam are stuck with what comes in the original package. Dealers have not been provided with spares or backups of any element of the package, and additional game tapes or even blank tapes were not available at the time of this review. But the manufacturer said it is planning on making a variety of accessories available. A 64K-byte RAM expansion kit will reportedly sell for less than \$200.

Coleco announced that it will offer a double-sided, double-density 5¼-inch disk drive, Personal CP/M, and an 80-column expansion board for less than \$400; the products are scheduled for release by June. Extra tape drives will be available soon for less than \$200 each. (Tape duplicators have said that Coleco's high-speed tape is not easy to duplicate, and at least one major software manufacturer has indicated that it's heard that Coleco is switching to disk drives. Time will tell.) Coleco has also announced a 300/1200-bps modem, priced less than \$250, that should be available by early summer.

Third-Party Software

With a very large potential customer base for the Adam, it's not surprising that many third-party software firms are interested in producing software for the machine. But unless Coleco changes its attitude toward third-party vendors, it may suffer the same problems that befell Texas Instruments when it tried to control all software produced for the TI 99/4A.

Al Kahn, Coleco's vice president, has indicated in no uncertain terms that the Adam's creator does not intend to make the same mistake that Texas Instruments did and will support all third-party vendors of software, including those that wish to market their products by themselves. But Coleco is not revealing much technical information about the Adam and will not tell software developers anything about the operating system or the locations of subroutine entry points unless the developers are licensed by Coleco. Some of that technical information will be in the technical reference manual, which should be available in June; until then, however, the information will be available only to licensed software developers.

This policy will do little to spur the much-needed software support that will make or break the Adam. It was many small software companies, not a few large firms, that made computers like the Apple successful by providing thousands of applications programs. If Coleco doesn't change its policy soon, small software developers are likely to choose a less reluctant manufacturer's machine. In addition, many larger software companies may choose not to support the Adam because of the license restrictions Coleco imposes before divulging proprietary information. (See the text box on page 216 for a closer look at the third-party license.)

Adam owners may discover that Coleco's reluctance

to reveal technical information is resulting in a limited number of software titles for their computers. However, a number of publishers, including Spinnaker, Infocom, Sierra On-Line, Broderbund, Human Engineered Software, and Activision, have announced software support for the Adam.

Reliability

The Adam computer's track record for reliability is terrible, if my experiences are an accurate indication. I have had four different systems in the space of two months and am waiting for my fifth. The printer is still not working. Other problems have centered around the operating system, the BASIC tape, and the tape drive. The only component that seems to be holding up well is the keyboard.

Coleco has claimed that reliability problems are low and within normal rates of occurrence. Considering that I've had four systems in two months and still haven't got one that's working satisfactorily, I find that hard to believe. [Editor's note: *At press time, Coleco said most word-processing and tape-drive defects had been corrected, and that a revised, more informative manual would solve most of the other problems that have led to returns. . . .M.W.*]

Conclusions

Although the Adam is a machine with a lot of potential, much of it has yet to be realized. The computer was apparently rushed into production before it was completely debugged and, as I've indicated, it has a terrible record of reliability. Many corrections are being made to its documentation, and the BASIC that comes with the computer is being enhanced. These corrections and enhancements, as well as what promises to be a broad range of peripherals and accessories, are scheduled to appear later this year.

Bearing all of this in mind, the best recommendation I can make is don't buy an Adam—yet. Wait until Coleco fixes all of the Adam's bugs and delivers on all of its promises. More than one company has entered the home computer market with great fanfare and plans for the future, only to drop out of the market and leave its early supporters stranded high and dry. Mattel is a good example of this. It promised a wide variety of peripherals and CP/M compatibility for its Aquarius computer, but now it is out of the home computer business; people who bought the Aquarius are stuck with a machine that has no support and no future.

I'm not saying this will happen with Coleco, but it could. Recent articles in the financial press hinted that Coleco is betting the whole company on the Adam and it's not yet clear that it's going to win that bet. ■

Jules H. Gilder (RD2, Box 475, Monticello, NY 12701) is a former editor of Personal Computing magazine and the Microcomputer Software Letter. He has just finished writing his eighth book, The Executive's Guide to Integrated Software.

Ferocious FORTRAN.

Microsoft® FORTRAN crunches numbers with a vengeance!

It combines fast and efficient native code compilation with built-in 8087 coprocessor support. The result? Mini and mainframe performance from your MS™ DOS micro.

Based on the '77 standard, Microsoft FORTRAN supports extensive statements and data types—including complex numbers and IEEE single and double-precision floating point accuracy.

Support for large arrays (greater than 64K bytes), separate module compilation, and overlays, allow you to create very large programs—up to one megabyte, with access to more than 65 thousand records in a file as large as four gigabytes.

How do programmers feel about Microsoft FORTRAN?

“The first FORTRAN compiler

that takes advantage of the full addressing capability of the 8088 and the power of the 8087.”

—Jack Wilschke, *Softalk*

“We decided to use the Microsoft FORTRAN Compiler for its INTEGER 4 capability and the flexibility of its 8087 implementation.”

—Charlie Huizena & Chip Barnaky, *PC World*

Call 800-426-9400 to order the ferocious FORTRAN. \$350*

In Washington State, call 206-828-8088. Ask for operator A4, who will rush you your order, send you more information, or give you the name of your nearest dealer to see Microsoft FORTRAN in action.



*Price exclusive of handling and Washington State sales tax.
Microsoft is a registered trademark and MS is a trademark of Microsoft Corporation.

HARDWARE for APPLE II+ /Ile

| | LIST PRICE | OUR PRICE | CALL |
|---|------------|-----------|------|
| APPLE IIe, 128K, 80 COLUMN | | | |
| APPLE IIe, STARTER SYSTEM BY APPLE (Sys. A) | | | |
| 64K and 80 column | | | |
| Disk II with controller | | | |
| Apple Monitor | | | CALL |

| | LIST PRICE | OUR PRICE | CALL |
|---|------------|-----------|------|
| APPLE IIe STARTER SYSTEM BY CONROY-LA POINTE (SYSTEM B) | | | |
| 128K and 80 column | | | |
| 1 Micro SSI Drive with controller | | | |
| Filer, Utility and Apple DOS 3.3 Diskette | | | |
| Zenith 12" Green Monitor | | | |
| RF Modulator (for color TV) | | | |
| Game Paddles | | | |
| Game w/color graphics and sound | | | |
| 50 Blank Generic Diskettes | | | CALL |

LIMITED WARRANTY: is 100% Parts & Labor for 90 days by us.

DISK DRIVES

| | | |
|---------------------------------------|--------|--------|
| AMDEK Amisk 1.3" Micro-Floppy, 143K | \$ 299 | \$ 249 |
| CENTRAL PT., Filer, Util. & Apple DOS | \$ 20 | \$ 15 |

| | LIST PRICE | OUR PRICE |
|---------------------------|------------|-----------|
| μ-SCI A2, 143K Disk Drive | \$ 479 | \$ 430 |
| A82, 143K to 328K Drive | \$ 569 | \$ 429 |
| A2 Controller Card | \$ 100 | \$ 79 |
| A40, 160K, Drive | \$ 449 | \$ 299 |
| A70, 286K, Drive | \$ 599 | \$ 299 |
| A10, A40 Controller | \$ 100 | \$ 79 |

| | LIST PRICE | OUR PRICE |
|------------------------------------|------------|-----------|
| 1/2 HIGH ALPS A40 Belt Drive, 163K | \$ 299 | \$ 199 |
| TEAC, T40, Direct Drive, 163K | \$ 349 | \$ 239 |
| TEC, T80, Double Sided, 326K | \$ 449 | \$ 299 |
| Controller Card by ComX | \$ 110 | \$ 59 |

| | LIST PRICE | OUR PRICE |
|------------------------------|------------|-----------|
| Rana Elite 1, 163K, 40 Track | \$ 379 | \$ 269 |
| Elite 2, 326K, 80 Track | \$ 649 | \$ 429 |
| Elite 3, 652K, 160 Track | \$ 849 | \$ 539 |
| Elite Controller | \$ 145 | \$ 89 |

RAM EXPANSION

| | | | |
|--|------|--------|--------|
| ALS, ADD Ram (I+) | 16K | \$ 100 | \$ 59 |
| ComX, 80 col. +64K RAM, for 1e, 1 yr. Wty. | | \$ 199 | \$ 99 |
| ComX, RAM Card, 1 Yr. Wty. (I+) | 16K | \$ 179 | \$ 39 |
| MicroSoft, RAM Card (I+) | 16K | \$ 100 | \$ 69 |
| Titan/Saturn RAM Card (I+) | 32K | \$ 249 | \$ 169 |
| RAM Card (I+) | 64K | \$ 425 | \$ 299 |
| RAM Card (I+) | 128K | \$ 599 | \$ 399 |

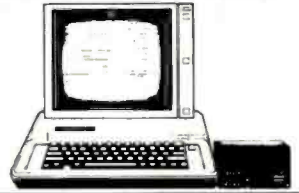

VIDEO CARDS

| | | |
|---|--------|--------|
| ALS, Smartem II (+ or e) | \$ 179 | \$ 139 |
| ComX, 80 col. +64K RAM (Ile) 1 yr. wty. | \$ 199 | \$ 99 |
| Videx, VideoTerm 80 col. (+ or e) | \$ 345 | \$ 229 |
| UltraTerm (+ or e) | \$ 379 | \$ 278 |
| Soft Video Switch (II+) | \$ 35 | \$ 25 |
| Enhance II (II+) | \$ 149 | \$ 99 |
| Function Menu (II+) | \$ 39 | \$ 29 |

MISCELLANEOUS

| | | |
|---|--------|--------|
| ALS, The CP/M Card V3.0 (+ or e) | \$ 399 | \$ 299 |
| Z-Card (+ or e) | \$ 169 | \$ 129 |
| AST, RF Modulator, to use TV | \$ 35 | \$ 25 |
| CCS, Serf Interface 7710A (Ser BAUD) | \$ 100 | \$ 75 |
| Chalkboard, Power Pad | \$ 110 | \$ 75 |
| Eastside, Wild Card (copier, II+ only) | \$ 140 | \$ 99 |
| Wild Card 2 (copier, + or e) | \$ 170 | \$ 139 |
| Wild Card Plus (copier, + or e) | \$ 90 | \$ 65 |
| Kensington, System Saver | \$ 298 | \$ 219 |
| Key Tronic, KB200 keyboard (I+) | \$ 125 | \$ 85 |
| Koala, Touch Tablet w/Micro Illustrator | \$ 65 | \$ 49 |
| Kraff, Joystick (Ap II/I+) | \$ 50 | \$ 39 |
| Paddie (Ap II/I+) | \$ 50 | \$ 39 |
| M&R, Sup R lan (+ or e) | \$ 345 | \$ 235 |
| MicroSoft, 280 Software (+ or e) | \$ 645 | \$ 445 |
| 280 Software Prem. Pack (I+) | \$ 695 | \$ 479 |
| 280 Software Prem. Pack (II+) | \$ 495 | \$ 339 |
| MicroTalk, Dumping 64, Buffer | \$ 349 | \$ 269 |
| Orange, Micro, Grappier Plus (+ or e) | \$ 175 | \$ 119 |
| 16K Buffer Board for Grappier Plus | \$ 175 | \$ 119 |
| Buffered Grappier Plus, 16K | \$ 245 | \$ 179 |
| Paymar, Lower Case Chip (II+) | \$ 50 | \$ 39 |
| PCPI, Appli-Card, 14 features, 6MHz | \$ 375 | \$ 275 |
| 128K RAM Ext. w/Appidisk, 6MHz | \$ 595 | \$ 479 |
| RH/Starburst, Super Fan II | \$ 75 | \$ 59 |
| TH/Starburst, Accelerator II | \$ 599 | \$ 449 |
| Transend/SSM, A/D, Serial/Para I/F | \$ 225 | \$ 169 |
| TG Products, Game Paddles (II+) | \$ 40 | \$ 29 |
| Joystick (II+) | \$ 60 | \$ 45 |
| Videx, PS10 I/F Card | \$ 229 | \$ 169 |
| WICO, Mouse, Complete | \$ 179 | \$ 119 |

SOFTWARE for APPLE II+ /Ile

BUSINESS

| | | | |
|--|-------------|--------|-------|
| Applied Soft Tech., VersaForm | \$ 389 | \$ 259 | |
| Artsci, Magic Window II | \$ 150 | \$ 99 | |
| Artsci, Magic Window (Mail & Words) | \$ 225 | \$ 149 | |
| Ashton-Tate, dBase II (Req CP/M 80) | \$ 700 | \$ 385 | |
| Friday (Requires CP/M 80) | \$ 295 | \$ 199 | |
| BPI Systems, GA, AR, AP, PR or NV, ea. | \$ 395 | \$ 269 | |
| Broderbund, Bank Street Writer | \$ 70 | \$ 47 | |
| Continental, GL, AR, AP or PR, each | \$ 250 | \$ 165 | |
| Home Accountant | \$ 75 | \$ 49 | |
| FCM | \$ 100 | \$ 69 | |
| Dow Jones, Market Analyzer | \$ 350 | \$ 275 | |
| Market Manager | \$ 300 | \$ 235 | |
| Market Microscope | \$ 700 | \$ 525 | |
| Fox & Geller, Quadeck (for dBase II) | \$ 295 | \$ 185 | |
| dGraph (for dBase II) | \$ 295 | \$ 185 | |
| dUtility (for dBase II) | \$ 99 | \$ 65 | |
| Hayden, Pe Writer (Specify 80 col. bd) | \$ 150 | \$ 99 | |
| Howard Sok, Real Estate Analyzer II | \$ 195 | \$ 129 | |
| Tax Prepare, 1984 | \$ 250 | \$ 165 | |
| LJK, Letter Perfect w/Mail Merge (I+) | \$ 150 | \$ 99 | |
| Micro Craft, Verdict or Billkeeper (CP/M) | \$ 955 | \$ 495 | |
| Micro Lab, Tax Manager | \$ 180 | \$ 119 | |
| Micro Pro, (all Req 280-CP/M Card) | | | |
| WordStar w/Applicard & CP/M SPECIAL | \$ 495 | \$ 325 | |
| WordStar** w/ Training Manual SPECIAL | \$ 495 | \$ 239 | |
| MailMerge** SPECIAL | \$ 250 | \$ 129 | |
| SpellStar** SPECIAL | \$ 250 | \$ 129 | |
| WordStar Professional, 4 Pak, SPECIAL | \$ 895 | \$ 429 | |
| MicroSoft, MultiPlan/CP/M Apple DOS | \$ 250 | \$ 169 | |
| Osborne/C.P. Soft., (Disk and Book) (Stat., Bus. & Mgmt) | \$ 100 | \$ 49 | |
| Some Common Basic Programs (75 ea.) | \$ 100 | \$ 49 | |
| Practical Basic Programs (40 ea.) | \$ 100 | \$ 49 | |
| Peachtree, Requires CP/M & Basic, 64K | | | |
| Series 40 GL & AR & AP, all 3 | \$ 395 | \$ 239 | |
| Perfect, Perfect Writer | \$ 349 | \$ 219 | |
| Perfect Writer/Speller 2 pak | \$ 399 | \$ 249 | |
| Perfect Writer or Perfect Calc. ea. | \$ 249 | \$ 149 | |
| Perfect Writer/Speller/ | | | |
| File (Calc 4) | \$ 969 | \$ 499 | |
| Pearson, Personal Print | \$ 295 | \$ 195 | |
| Quick, Word Lookup & Leshcheck (Ile) | \$ 189 | \$ 139 | |
| Quark, Word Lush, (Use w/Lugger) | \$ 149 | \$ 89 | |
| Sensible, Sen. Speller, 80col Bd. | \$ 125 | \$ 85 | |
| Bookends | \$ 125 | \$ 85 | |
| Sierra/On-Line, ScreenWriter Pro, 2 Pak | \$ 200 | \$ 135 | |
| ScreenWriter II | \$ 130 | \$ 89 | |
| The DictionaryNEW! | \$ 100 | \$ 69 | |
| Gen Manager II NEW! | \$ 230 | \$ 155 | |
| Homeward | \$ 50 | \$ 34 | |
| Siicon Valley, Word Handler | \$ 60 | \$ 39 | |
| List Handler | \$ 50 | \$ 35 | |
| Handler Pak (Word, List & Spell) | \$ 139 | \$ 89 | |
| Software Publishing, PFS, File | \$ 125 | \$ 84 | |
| (specify + or e) | PFS, Report | \$ 125 | \$ 84 |
| PFS, Graph | \$ 125 | \$ 84 | |

| | | |
|-----------------------------------|--------|--------|
| Stoneware, DB Master Version 4.0 | \$ 350 | \$ 229 |
| DB Utility I or II | \$ 129 | \$ 87 |
| Advanced DB Master | \$ 595 | \$ 495 |
| Flight Simulator II | \$ 50 | \$ 37 |
| System Plus, GL, A/P & A/R, 3 Pak | \$ 995 | \$ 555 |
| Veraplog, Logo | \$ 150 | \$ 99 |
| VisiCorp/Personal Software | | |
| Visicalc 3.3 | \$ 250 | \$ 169 |
| Visicalc Enhanced (Ile) | \$ 250 | \$ 179 |
| Visible or VisiDoc, each | \$ 250 | \$ 179 |

UTILITY & SYSTEM

| | | |
|---------------------------------------|--------|--------|
| Beagle, Apple Mechanic or DiskQuick | \$ 30 | \$ 22 |
| Double Take | \$ 35 | \$ 25 |
| TypeLabels Req. Ap. Mechanic | \$ 20 | \$ 15 |
| DOS5 Boss or Utility City, each | \$ 30 | \$ 22 |
| Tip Disk II | \$ 20 | \$ 15 |
| Pronto DOS5 | \$ 30 | \$ 20 |
| Alpha Plot | \$ 40 | \$ 27 |
| Central Point, Filer, DOS 3.3 & Util. | \$ 20 | \$ 15 |
| Copy II Plus (bit copier) | \$ 40 | \$ 30 |
| Einstein, Compiler - Applesoft BASIC | \$ 129 | \$ 85 |
| Epson, Graphics Dump | \$ 15 | \$ 9 |
| Hayes, Terminal Prog (SM or MM, ea.) | \$ 100 | \$ 55 |
| Insoak, GraFOR by Paul M. Lutz | \$ 75 | \$ 59 |
| Microsoft, A.L.D.S. | \$ 125 | \$ 85 |
| Fortran 80 | \$ 195 | \$ 135 |

COMPLETE MICROSOFT LINE IN STOCK

| | | |
|--|--------|-------|
| Omega, Locksmith (bit copier) Ver 5.0 | \$ 100 | \$ 75 |
| Penquo, Complete Graphics System II | \$ 70 | \$ 53 |
| Graphics Magician | \$ 60 | \$ 41 |
| Phoenix, Zoom Graf | \$ 40 | \$ 34 |
| Quality, Bag of Tricks | \$ 40 | \$ 29 |
| UniSoft, Essential Data Duplicator III | \$ 80 | \$ 49 |

HOME & EDUCATIONAL

| | | |
|--|--------|-------|
| Beagle Bros., Beagle Bag | \$ 30 | \$ 22 |
| Broderbund, Chopade | \$ 35 | \$ 26 |
| Archite Machine | \$ 60 | \$ 40 |
| Loote Runner | \$ 35 | \$ 25 |
| Apple Panic | \$ 30 | \$ 21 |
| BudgeCo., Probal Control. Set | \$ 40 | \$ 27 |
| Contend, Home Accountant | \$ 75 | \$ 49 |
| Dataseq, Artic or Zasson, each | \$ 40 | \$ 27 |
| Edu-Ware, (Large Inventory) | Call | |
| Hayden, Sargon II (Chess) | \$ 35 | \$ 29 |
| Sargon III (Chess) | \$ 50 | \$ 34 |
| Infocom, Zork I, II, III, or Starcross, each | \$ 40 | \$ 27 |
| Koala, Full line in stock, CALL | Call | |
| Learning Co., (Large Inventory) | Call | |
| Micro Lab, Miner 2049r | \$ 40 | \$ 27 |
| Monogram, Dollars and Cents | \$ 100 | \$ 69 |
| Scarborough/Lighting, MasterType | \$ 40 | \$ 27 |
| Silver/On-Line, Ultima II | \$ 60 | \$ 40 |
| Sil-Tech, Wizardry | \$ 50 | \$ 39 |
| Spinnaker, Kindercomp (others in stock) | \$ 30 | \$ 20 |

OVERSTOCK SPECIALS

| | LIST PRICE | OUR PRICE |
|--|------------|-----------|
| WHILE THEY LAST | | |
| CORVUS 6 Meg | \$2095 | \$1495 |
| 11 Meg | \$2750 | \$2185 |
| 20 Meg | \$3750 | \$2895 |
| IBM-PC Interface Manual, S/W&Cable Kit | \$ 300 | \$ 249 |
| IBM-PC Omni Transporter, 4 Pak SPECIAL | \$1850 | \$1395 |
| Apple Interface, Manual, S/W & Cable Kit | \$ 300 | \$ 249 |
| CCS, Serial Interface 7710A (Ser Baud) | \$ 150 | \$ 99 |
| ComX, 16K RAM Card, 1 Yr. Wty. for II+ | \$ 179 | \$ 39 |
| ComX, 80 col. +64K RAM, for 1e, 1 yr. Wty. | \$ 199 | \$ 99 |
| Silicon Valley, List Handler | \$ 50 | \$ 35 |
| Word Handler | \$ 60 | \$ 39 |
| Handler Pak (Word, List & Spell) | \$ 130 | \$ 89 |
| Videx, Videoterm, 80 column card for II+ | \$ 345 | \$ 229 |

MISCELLANEOUS

| | | |
|---|--------|-------|
| Electronic Protection, Lemon | \$ 80 | \$ 40 |
| Lime | \$ 90 | \$ 80 |
| Peach | \$ 98 | \$ 86 |
| Orange | \$ 140 | \$ 96 |
| Kensington, PC Saver** Lime, Card w/filer | \$ 50 | \$ 39 |
| NetworkX, Writeme, 4 col., w/filer surge | \$ 70 | \$ 49 |

NEC

| | | |
|---------------------------------|--------|--------|
| w/Printer, P2021A, 16K(64K) | \$ 799 | \$ 699 |
| Data Recorder, PC2821A | \$ 115 | \$ 99 |
| Printer, PC2221A, Thermal, 40 c | \$ 170 | \$ 145 |
| HP 11C, Calculator | \$ 120 | \$ 99 |
| HP 11C, Calculator | \$ 90 | \$ 75 |
| 41CX, Calculator NEW! | \$ 325 | \$ 275 |
| 41C, Calculator | \$ 195 | \$ 149 |
| 41CV, Calc. w/22K Mem | \$ 275 | \$ 219 |

for the ATARI

| | | |
|------------------------|--------|--------|
| RANA 1000 Drive 320K | \$ 449 | \$ 369 |
| KOALA, Pad w/Micro Ilk | \$ 100 | \$ 75 |

★ MEANS A BEST BUY

DISKETTES

| | LIST PRICE | OUR PRICE |
|--|------------|-----------|
| BROWN DISK | | |
| 10 ea., Pulse I, DS/DD, 48TPI | \$ 45 | \$ 32 |
| 10 ea., Pulse II, DS/DD, 96TPI | \$ 60 | \$ 45 |
| CCD, 100 ea SS/DD, 40T (Apple, IBM) | \$ 560 | \$ 179 |
| 100 ea SS/DD, 40T (Apple, IBM) | \$ 55 | \$ 19 |
| 10 ea DS/DD, 40T (IBM, H/P) | \$ 750 | \$ 296 |
| 10 ea DS/DD, 40T (IBM, H/P) | \$ 75 | \$ 35 |
| DYSAN, 10 ea SS/SD (Apple, etc.) | \$ 69 | \$ 39 |
| 10 ea DS/DD, 48TPI (H/P, etc.) | \$ 89 | \$ 49 |
| MAXELL, 10 each MD1, SS/DD | \$ 55 | \$ 29 |
| 10 each MD2, DS/DD | \$ 75 | \$ 39 |
| VERBATIM, 10 ea MD25-01, SS, SD | \$ 49 | \$ 25 |
| 10 ea MD34, DS DD | \$ 84 | \$ 45 |
| GENERIC™ DISKETTES—AS LOW AS \$1 | | |
| w/labels, no labels, top quality, 90 day limited warranty by us. | | |
| 10 ea SS/SD, 35 Track (Apple, Atari) | \$ 42 | \$ 17 |
| 100 ea SS, SD, 35 Track (Apple, Atari) | \$ 415 | \$ 130 |
| 1000 ea SS, SD, 35 Track, (Apple, Atari) | \$4150 | \$ 995 |
| 10 ea DS/DD, 48TPI (IBM, H/P) | \$ 63 | \$ 25 |
| 100 ea DS, DD, 48TPI (IBM, H/P) | \$ 626 | \$ 170 |
| 1000 ea DS, DD, 48TPI (IBM, H/P) | \$6260 | \$1400 |

NO HASSLE
MOVE-IN BACK
GUARANTEE
ON OVERSHEW

LOVE
YOUR
WORD!

GENERIC™ DISKETTES

Each at 1000 quantity.

SS SD \$1.00 Each

DS DD \$1.40 Each

1983 by COMX Corporation

Above money back guarantee by COMX Corporation, not us.

MODEMS AND ACCESSORIES

| | | |
|--------------------------------|--------|--------|
| ANCHOR, Signalman MK I (RS232) | \$ 99 | \$ 75 |
| Signalman Mark XII | \$ 399 | \$ 269 |
| HAYES, IBM-PC Smartmodem 1200B | \$ 595 | \$ 439 |
| IBM-PC Smartcom II Software | \$ 119 | \$ 89 |
| Stack Chronograph (RS-232) | \$ 249 | \$ 189 |
| Stack Smartmodem 300(RS-232) | \$ 289 | \$ 225 |
| Smartmodem 1200 (RS-232) | \$ 695 | \$ 525 |
| Microdemon 100 (S-100 bus) | \$ 399 | \$ 275 |
| Microdemon file w/Smartcom | \$ 329 | \$ 239 |
| IBM-PC to Modem Cable | \$ 39 | \$ 29 |
| NOVATION | | |

THE IBM-PC SUPPLY CENTER

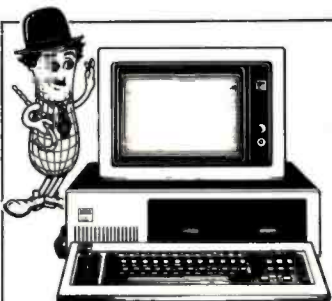

256K IBM-PC

Two 320K Disk Drives by CDC
90 Day Warranty By Us
Call for Details

| MEMORY CHIP KITS | LIST PRICE | OUR PRICE |
|--|------------|-----------|
| Add-on to your memory cards or mother board 200% tested. With 90 day warranty | | |
| 64K Kit, 200NS, 9 chips, 4164 | \$ 50 | \$ 45 |
| 16K Kit, 200NS, 9 chips, 4116 (for PC-1 motherboard) | \$ 50 | \$ 16 |
| AMDEK MAI 4-in-1 Multiple Board, Color Graphics, Mono, 128K | \$ 599 | \$ 519 |
| AST ComboPlus, 64K, S/P/C | \$ 395 | \$ 279 |
| ComboPlus, 256K S/P/C | \$ 695 | \$ 485 |
| MegaPlus II, 64K, 2S/P/C | \$ 495 | \$ 345 |
| MegaPlus II, 256K, 2S/P/C | \$ 795 | \$ 585 |
| 256K MegaPlus II Expander | \$ 395 | \$ 295 |
| SupPakPlus, 64K, S/P/C + S/W | \$ 395 | \$ 279 |
| SupPakPlus, 256K S/P/C + S/W | \$ 695 | \$ 485 |
| SupPakPlus, 384K S/P/C + S/W | \$ 895 | \$ 585 |
| For SupPak w/ Game Port, add | \$ 50 | \$ 45 |
| I/O Plus II, S/P/C | \$ 215 | \$ 150 |
| I/O Plus II, S/P/C/Prog | \$ 265 | \$ 185 |

| | | |
|--------------------------------------|--------|--------|
| CCS SuperVision, 132 col. mono board | \$ 850 | \$ 599 |
| Z Plus 64, 1st Z80B, 64K para port | \$ 875 | \$ 685 |

| | | |
|---|--------|--------|
| * ComX 256K RAM Card with Fastrak™ RAM disk emulator and spooler software | \$ 495 | \$ 325 |
|---|--------|--------|

| | | |
|---------------------------------|-------|-------|
| CURTIS PC Pedestal™ for Display | \$ 80 | \$ 85 |
| 3 to 9 foot keyboard cable | \$ 40 | \$ 30 |
| Vertical CPU "System Stand" | \$ 25 | \$ 19 |
| Monochrome Ext. Cable Pair | \$ 50 | \$ 35 |

| | | |
|---------------------------------|--------|--------|
| HERCULES Monochrome Board | \$ 499 | \$ 349 |
| Key Tronic KB1510, Std keyboard | \$ 269 | \$ 199 |

| | | |
|---|--------|--------|
| Koala Koala Pad™ w/PC Design Programmer's Guide | \$ 150 | \$ 109 |
| | \$ 15 | \$ 12 |

| | | |
|---|--------|--------|
| MAYNARD Multifunction (6) Card MFC | \$ 89 | \$ 79 |
| Memory Card no RAM card | \$ 230 | \$ 169 |
| Memory Card 256K card | \$ 499 | \$ 395 |
| SANDSTAR Modules for above cards in stock | Call | |

| MICROSOFT | LIST PRICE | OUR PRICE |
|-----------------|------------|-----------|
| RAMCard 256K | \$ 550 | \$ 385 |
| SystemCard 256K | \$ 625 | \$ 469 |
| SystemCard 64K | \$ 395 | \$ 295 |
| Mouse | \$ 195 | \$ 145 |

| | | |
|--------------------------------|---------|---------|
| MOUSE SYSTEMS, PC Mouse w/soft | \$ 295 | \$ 195 |
| ORCHID PCnet™ Starter Kit, LAN | \$ 1490 | \$ 1190 |
| PCnet™ Circuit Board Kit | \$ 295 | \$ 545 |

| | | |
|--|--------|--------|
| PLANTRONICS ColorPlus&Draltzman 16 color brd. w/Para | \$ 475 | \$ 375 |
|--|--------|--------|

| QUADRAM | LIST PRICE | OUR PRICE |
|---|------------|-----------|
| * Quadlink NEWEST VERSION | \$ 680 | \$ 485 |
| Quadboard no RAM, expand to 384K | \$ 595 | \$ 215 |
| Quadboard 64K, expand to 384K | \$ 395 | \$ 279 |
| * Quadboard, 384K | \$ 595 | \$ 395 |
| Quadboard II, no RAM, expand to 256K | Call | Call |
| Quadboard II, 64K, expand to 256K | \$ 395 | \$ 285 |
| Quadboard II, 256K, 6 function | \$ 595 | \$ 395 |
| Quad 512 + 64K plus serial port | \$ 325 | \$ 265 |
| Quad 512 + 256K plus serial port | \$ 550 | \$ 420 |
| Quad 512 + 512K plus serial port | \$ 895 | \$ 625 |
| Quadcolor I, board, 16 colors | \$ 295 | \$ 225 |
| Quadcolor II, board, use with Quadcolor I | \$ 275 | \$ 209 |
| Quadchrome, 12" RGB Monitor | \$ 795 | \$ 499 |
| Quadscreen, 17" 968 x 512 Monitor | \$ 1599 | \$ 1595 |
| Microfazer, w/CoPy, PP, 8K, MPB w/PS | \$ 189 | \$ 129 |
| Microfazer, w/CoPy, PP, 64K, MP64 w/PS | \$ 319 | \$ 219 |
| Microfazer, w/CoPy, PP, 128K, w/PS | \$ 465 | \$ 295 |
| Microfazer, Snap-on, 8K, PP, Epson w/PS | \$ 179 | \$ 145 |
| Microfazer, Snap-on, 64K, PP, Epson w/PS | \$ 319 | \$ 235 |
| All Microfazers are expandable (w/coPy to 512K)(Snap-on to 64K) | | |

| | | |
|---------------------------|--------|--------|
| Tecmar 1st MATE, 64K | \$ 389 | \$ 295 |
| 1st MATE, 256K | \$ 589 | \$ 439 |
| Captain, 64K, S/P/C/Prog | \$ 424 | \$ 324 |
| Captain, 384K, S/P/C/Prog | \$ 795 | \$ 585 |

| | | |
|--|--------|--------|
| Titan Accelerator PC (8086 + 128K RAM) | \$ 995 | \$ 750 |
|--|--------|--------|

| | | |
|-----------------------|--------|-------|
| TG PRODUCTS, Joystick | \$ 60 | \$ 40 |
| WICO, IBM-PC Mouse | \$ 100 | \$ 69 |



Prices and availability subject to change. Ca

\$55

★ 9 Each, 4164, 200 ns, MEMORY EXPANSION
90 Day Warranty by us

\$325 \$295 Two or more.

★ ComX 256K RAM BOARD
Fully Compatible 1 Year Limited Warranty by ComX
With Fastrak RAM Disk Emulator and Spooler Software
Works on DOS 1.1 or 2.0

★ MEANS A BEST BUY

for the IBM-PC or XT **DRIVES** AND ACCESSORIES

CONTROL DATA OR Tandon
320K 360K DS DD DISK DRIVES
With Detailed Installation Instructions
30 Day Warranty by Factory Authorized Distributor
Same as now installed by IBM **\$229** \$239 For One.
HALF \$199 HEIGHT

| AMDEK | LIST PRICE | OUR PRICE |
|---|------------|-----------|
| Amdisk W, 1/2 height, internal, 320K/360K | \$ 329 | \$ 249 |
| Amdisk III, Dual 3" Micro Floppy, 320K/360K | \$ 599 | \$ 529 |
| Cable, Amdisk III to IBM-PC interface | Call | |

| MAYNARD | LIST PRICE | OUR PRICE |
|--|------------|-----------|
| Floppy Drive Control Brd. up to 4 drives | \$ 215 | \$ 189 |
| Same with Parallel Port | \$ 300 | \$ 239 |

8" CP/M-80 SOFTWARE

| MUCH MORE IN STOCK | LIST PRICE | OUR PRICE |
|--|------------|-----------|
| ASHTON-TATE, dBase II | \$ 700 | \$ 385 |
| Friday | \$ 295 | \$ 249 |
| BLUE CHIP, Millionaire | \$ 70 | \$ 43 |
| DIGITAL RES., CBASIC | \$ 150 | \$ 99 |
| CBASIC Compiler (CB80) | \$ 500 | \$ 339 |
| Pascal/MT+ | \$ 350 | \$ 239 |
| CIS CBOL+ | \$ 850 | \$ 575 |
| PL/I | \$ 550 | \$ 375 |
| C Compiler | \$ 350 | \$ 250 |
| FOX & GELLER, Quick Code | \$ 295 | \$ 185 |
| dUnit | \$ 99 | \$ 62 |
| dGraph | \$ 295 | \$ 185 |
| INFOCOM, Starcross, Zork II or III, ea | \$ 60 | \$ 34 |
| Deadline or Planetfall, each | \$ 50 | \$ 40 |
| MICROCRAFT, Verdict or Billkeeper, ea | \$ 995 | \$ 495 |
| MICROPRO, Wordstar™ | \$ 495 | \$ 239 |
| MailMerge™ | \$ 250 | \$ 129 |
| WordStar Prof. 4Pak(Call) | \$ 895 | \$ 429 |
| MICROSOFT, Multiplan | \$ 275 | \$ 195 |
| CBOL-80 Compiler | \$ 750 | \$ 350 |

SOFTWARE for IBM-PC or XT

| BUSINESS | LIST PRICE | OUR PRICE |
|---|------------|-----------|
| ALPHA, Database Manager II | \$ 295 | \$ 195 |
| ASHTON-TATE, PC-DOS & 128K | \$ 700 | \$ 385 |
| dBase II User's Guide (Book) | \$ 30 | \$ 20 |
| Evening's DB Primer (Book) | \$ 15 | \$ 12 |
| The Financial Planner | \$ 700 | \$ 395 |
| Friday | \$ 295 | \$ 199 |
| APPLIED SOFT, TECH., Versafont | \$ 389 | \$ 285 |
| ASK MICRO, GL, AR, AP, INV or PR ea | \$ 495 | \$ 295 |
| BPI, GA, AR, AP or PR | \$ 595 | \$ 395 |
| * CONTINENTAL, Home Accountant | \$ 150 | \$ 89 |
| FCM (Filing, Cataloging, Mailing) | \$ 125 | \$ 89 |
| Property Management | \$ 450 | \$ 329 |
| DOW JONES, Market Analyzer | \$ 350 | \$ 279 |
| Market Manager | \$ 300 | \$ 239 |
| Market Microscope | \$ 700 | \$ 525 |
| * EINSTEIN, Writer NEW! | \$ 300 | \$ 199 |
| Memory Trainer NEW! | \$ 80 | \$ 55 |
| Speller NEW! | \$ 150 | \$ 95 |
| Mailer NEW! | \$ 80 | \$ 55 |
| Letter Scenes NEW! | \$ 300 | \$ 185 |
| FOX & GELLER, Quickcode (MSDOS) | \$ 295 | \$ 179 |
| dGraph (MSDOS) | \$ 295 | \$ 179 |
| dUnit (MSDOS or CP/M86, ea) | \$ 99 | \$ 59 |
| Grafox (Color Graphics Brd) | \$ 295 | \$ 185 |
| MAYDEN, IBM Pie Writer | \$ 200 | \$ 135 |
| Pie Speller | \$ 100 | \$ 69 |
| HOWARDSON, Real Estate Analyzer II | \$ 250 | \$ 189 |
| Tax Preparer, 1984-1983 | \$ 295 | \$ 220 |
| IUS, EasyWriter II(WP) | \$ 350 | \$ 259 |
| EasySpeller II | \$ 225 | \$ 148 |
| EasyFiler (a DBMS) | \$ 400 | \$ 299 |
| Business System: GL+AR+AP | \$ 1495 | \$ 995 |
| GL+AR+AP, PR, OE or INV, each | \$ 595 | \$ 395 |
| * INSOFIT, Data Design (easy to use DBMS) | \$ 225 | \$ 169 |
| LIFETREE, Volkswinner | \$ 285 | \$ 195 |
| * LOTUS, 1-2-3 | \$ 495 | \$ 329 |
| MICROCRAFT, Verdict or Billkeeper, ea | \$ 995 | \$ 495 |
| MICRO LAB, Tax Manager | \$ 250 | \$ 189 |
| MICROPRO, WordStar™ | \$ 495 | \$ 239 |
| MailMerge™ | \$ 250 | \$ 129 |
| WordStar Prof. 4Pak(Call) | \$ 895 | \$ 429 |
| * WordStar Professional, 4 Pak | \$ 995 | \$ 499 |
| StarIndex™ | \$ 195 | \$ 149 |
| InfoStar™ | \$ 495 | \$ 259 |
| ReportStar™ | \$ 350 | \$ 199 |
| StarBurst™ | \$ 195 | \$ 113 |
| * MICRORIM, R base, Games 4000 | \$ 495 | \$ 335 |

| BUSINESS | LIST PRICE | OUR PRICE |
|--|------------|-----------|
| MICROSOFT, Multiplan | \$ 250 | \$ 189 |
| Word | \$ 375 | \$ 259 |
| Word with Mouse | \$ 475 | \$ 325 |
| Financial Statement | \$ 100 | \$ 69 |
| Budget | \$ 150 | \$ 99 |
| * OSBORNE/COMX, (Book, B. business, Statistics & Math Programs on DS/OD Disks) | \$ 165 | \$ 110 |
| Some Common Basic Prog. (70 ea.) | \$ 100 | \$ 69 |
| Practical Basic Programs (40 each) | \$ 100 | \$ 69 |
| PBL, Personal Investor 1.1 | \$ 145 | \$ 99 |
| PEACHTREE, Peach Pak (GL, AR, AP) | \$ 395 | \$ 239 |
| Peach Tree 5000 | \$ 395 | \$ 239 |
| PEARLSOFT, Personal (DBMS & MIS) | \$ 295 | \$ 185 |
| * PERFECT, Perfect Writer™ | \$ 349 | \$ 219 |
| Writer & Speller, 2 Pk | \$ 399 | \$ 249 |
| Perfect Writer or Perfect Calc, each | \$ 249 | \$ 149 |
| Perfect Writer, Speller, Filer, Calc (4) | \$ 999 | \$ 499 |
| SOFTWARE ARTS, TK! Solver | \$ 299 | \$ 219 |
| SOFTWARE PUBLISHING, PFS-File | \$ 140 | \$ 94 |
| PFS:Report | \$ 125 | \$ 84 |
| PFS:Write NEW! | \$ 140 | \$ 95 |
| PFS:Graph NEW! | \$ 140 | \$ 95 |
| SORCUM, SuperCalc II | \$ 295 | \$ 195 |
| SuperCalc III | \$ 395 | \$ 285 |
| SSI/SATELLITE, WordPerfect | \$ 495 | \$ 375 |
| Personal WordPerfect | \$ 195 | \$ 149 |
| SOT/INFOTEK, The Creator | \$ 300 | \$ 195 |
| STONEWARE, Advanced D.B. Master | \$ 595 | \$ 395 |
| SYNAPSE, File Manager | \$ 100 | \$ 87 |
| SYNERGISTIC, Data Reporter | \$ 250 | \$ 169 |
| T/MAKER, T/Maker III | \$ 275 | \$ 169 |
| VISICORP, VisCalc 4 | \$ 250 | \$ 179 |
| VisFile or VisSchedule | \$ 300 | \$ 219 |
| Desktop Plan I | \$ 300 | \$ 219 |
| WordWith VisSpell (128K) | \$ 375 | \$ 269 |

UTILITY & SYSTEM

| | | |
|---|--------|-------|
| 1983 CL SOFTWARE AWARD: Copy II PC by Central Point Software is still the best software buy of 1983 and 1984. It will copy more copy protected software and faster than any other backup system. Unlike other copiers it makes an exact duplicate of your original and it does 100% verification of copy. Documentation is excellent! | | |
| * CENTRAL POINT, Copy II PC, Backup | \$ 40 | \$ 30 |
| * COMX, Fastrak™, RAM/Disk emulator and printer spooler program. Works on any PC/DOS version or RAMCard. Menu Driven | \$ 100 | \$ 59 |

| UTILITY & SYSTEM | LIST PRICE | OUR PRICE |
|---------------------------------------|------------|-----------|
| DIGITAL RESEARCH, Concurrent CP/M-86™ | \$ 350 | \$ 225 |
| CP/M-86™ | \$ 60 | \$ 40 |
| CBASIC 86™ | \$ 200 | \$ 135 |
| CBASIC Compiler (86 or MSDOS), each | \$ 600 | \$ 365 |
| Pascal/MT+ (CP/M-86) | \$ 400 | \$ 269 |
| PL/I (MSDOS) or CP/M-86, each | \$ 600 | \$ 399 |
| Access Mgr/MSDOS or CP/M-86, ea | \$ 750 | \$ 499 |
| Display Mgr/MSDOS or CP/M-86, ea | \$ 400 | \$ 178 |
| Speed Prog. Pkg (CP/M-86) | \$ 500 | \$ 339 |
| CIS CBOL-86 | \$ 850 | \$ 525 |
| DR LOGO-86 | \$ 100 | \$ 69 |
| HAYES, Smartfont II (Data Com.) | \$ 119 | \$ 89 |
| MICROCROM, Microterminal (Data Com.) | \$ 100 | \$ 65 |
| MICROSTUF, Crosstalk XVI (Data Com.) | \$ 195 | \$ 129 |
| MICROSOFT, MultiMath/Samp | \$ 300 | \$ 199 |
| Business BASIC Comp | \$ 600 | \$ 399 |
| Pascal Compiler | \$ 350 | \$ 250 |
| C Compiler | \$ 500 | \$ 339 |
| BASIC Compiler | \$ 395 | \$ 269 |
| FORTRAN Compiler | \$ 350 | \$ 250 |
| COBOL Compiler | \$ 750 | \$ 495 |
| BASIC Interpreter | \$ 350 | \$ 250 |
| NORTON, Utilities 2.0, 14 programs | \$ 80 | \$ 65 |
| ROSESOFT, Prokey | \$ 130 | \$ 89 |

HOME & EDUCATIONAL

| | | |
|---|--------|--------|
| EPYX/Auto. Siml., Temple of Apshai | \$ 40 | \$ 29 |
| Oil Barons | \$ 100 | \$ 75 |
| * ARMONK, Executive Suite | \$ 40 | \$ 27 |
| BLUE CHIP, Millionaire or Tycoon | \$ 60 | \$ 39 |
| BPI SYSTEMS, Personal Accounting | \$ 195 | \$ 139 |
| * BRODERBUND, Apple Panic (Color) | \$ 30 | \$ 19 |
| Lode Runner or Serpentine, each | \$ 35 | \$ 24 |
| COMPREHENSIVE, PC Tutor (1.1 or 2.0, ea.) | \$ 60 | \$ 40 |
| CONTINENTAL, Home Accountant+ | \$ 150 | \$ 89 |
| DATAMOST, Pkg Plan/Space Strike, ea | \$ 30 | \$ 22 |
| DAVIDSON, The Speed Reader II | \$ 75 | \$ 49 |
| INFOCOM, Deadline or Suspended, ea | \$ 50 | \$ 39 |
| Zork I or Zork II or Zork III, ea | \$ 40 | \$ 27 |
| * INSOFIT, Mystery, Wordstar or Quotara, ea | \$ 35 | \$ 29 |
| MICRO LAB, Mines 2049 | \$ 40 | \$ 29 |
| MICROSOFT, Flight Simulator | \$ 50 | \$ 33 |
| MONOGRAM, Dollars & Sense | \$ 165 | \$ 110 |
| PBL CORP., Personal Investor | \$ 145 | \$ 99 |
| SOFTWARE SYSTEMS Multimate | \$ 495 | \$ 295 |
| SPINNAK, Snapper Troops (1 or 2) | \$ 45 | \$ 35 |
| Story Machine or Face Maker | \$ 35 | \$ 24 |
| STRATEGIC, The Warp Factor | \$ 40 | \$ 30 |
| SUBLOGIC, Night Mission Printal | \$ 40 | \$ 27 |

OUR AD #B2

VISA

NO SALES TAX

NATIONAL TOLL FREE ORDER DESK (800) 547-1289

Order Desk Hours: 6AM to 6PM PST

Oregon TOLL FREE [800] 451-5151
Hot Line For Information On Your Order
Portland: 245-6200

[503] 245-1030

FREE GIFT

Use of our order forms qualifies you for a free gift with your order. Get on our mailing list now for order forms, and our new newsletter and sales specials announcement. Our customers are already on our list!

MAIL TO: P.O. Box 23068, Portland, OR 97223

NAME _____

ADDRESS _____

CITY _____ STATE _____ ZIP _____

COUPON

Micro-Logic

A simple way to design digital circuits with your Apple II or IBM PC

Richard Krajewski
 BYTE Technical Editor

Until now, microcomputers have been in a rut. They've been used for word processing, spreadsheets, and games, period. Sure, there have been occasional odd-ball uses, such as controlling your coffeepot, but there haven't been any new applications for which we could say, "Yep, the microcomputer is the only way to do that now." And that's a shame, because the microcomputer can be very versatile.

Now there is a new and limitlessly practical application for the microcomputer—the design of digital circuits. Minicomputers and mainframes have been designing digital circuits for a long time, but the application has only recently become widely available for the microcomputer. A digital-design program may be of limited interest to the average computerist, but for those thousands and thousands of engineers who are chained to paper, pencil, and template, a microcomputer-aided design system is too good to pass up.

Micro-Logic is a good example of a digital-design program for the microcomputer. The program lets you design and test hypothetical digital circuits on your Apple II or IBM Personal Computer. It has two parts: the designer module and the analyzer module.

The Designer Module

The designer module lets you draw the digital logic circuits. When you call the module from the main menu, you get another menu that lets you 1) erase old designs, 2) begin designing, 3) change or add digital component shapes, or 4) return to the main menu. The first choice erases files produced from the previous design session. The second choice lets you begin drawing a new circuit or change an old one. The third choice lets you change or add component shapes, but it does not let you define the function of the components; you do that with the analyzer module. Figure 1 shows the shapes that are provided with Micro-Logic.

Drawing a circuit with the designer module is easy. If you want an inverter, you just type A for add and INV for inverter. For an AND gate with three inputs, you type A for add and AND3 for the AND gate. (By the way, the gates have only one orientation—input from left, output on right.) To draw a line from one gate to another, you press C for connect and the proper combination of direction keys to bring the line from the output of one device to the input of another.

Quitting the designer module presents a problem. You can quit only by typing Q, which not only ends the designer module but saves the design you've been working on. You should also be able to quit without saving the design. If you've found that you don't need the circuit you've been working on, you have to either erase every line one at a time or save the file containing the design and then erase it. You can't erase a file while you are using the designer module, either. For that, you need to use the analyzer module. There's also no way to rename a circuit-design file; all designs must use the same name. The only way to keep things separate is to use a different data disk for each design.

Notice that the designer module doesn't really do any designing. You do that yourself. You must specify the Boolean expression of the circuit, minimize it yourself with the Karnaugh map, and then draw it on the computer screen. The big advantage of the designer module is that you can draw the circuit quickly and, more important, test it later with the analyzer module.

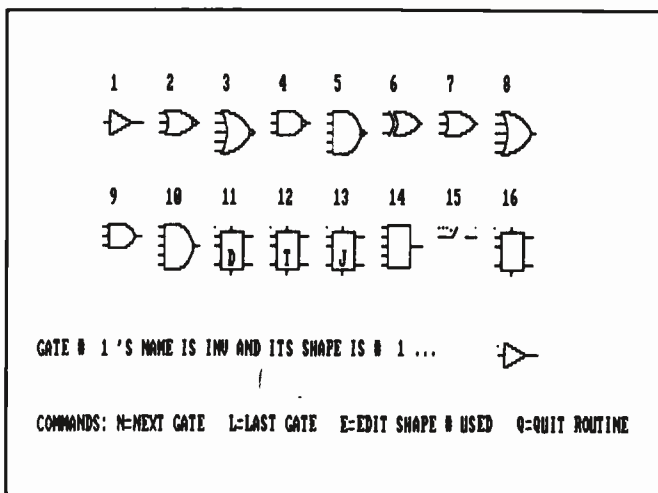

Figure 1: The logic component shapes available for use in Micro-Logic.

The Analyzer Module

This module is the more complicated of the two. When you call it from the main menu, you see a menu that lets you select 1) the network editor, 2) disk operations, 3) the simulation program, 4) utilities, 5) the test-pattern editor, 6) the gate library, 7) the clock library, or 8) the main menu.

The network editor lets you call up the "netlist" that is generated by the designer module for a circuit that you have designed, or it lets you create your own netlist without a corresponding circuit. A netlist is a list of circuit components and their interconnections (see figure 2). Micro-Logic uses a netlist rather than the circuit graphics for testing and simulation. Actually, you don't even need to draw a circuit—you can type in a netlist instead and get the same results. However, you will probably find it easier to use the designer module to generate the netlist, especially when you are designing a complex circuit.

The disk-operations option lets you save or retrieve a network, delete files, and view the disk directory. The simulation option shows the timing pattern at every node of the circuit that you have loaded into memory along with the clock pattern and input patterns that you have also loaded into memory. The utilities option lets you select 1) the nodes to be monitored in the timing simulation, 2) a fan-out report, 3) simulation files for comparison, or 4) macros to be mapped into gates. (A macro, to Micro-Logic, is a circuit that is treated as a single gate. To create a macro, you draw the circuit and "map" it onto one of the logic component shapes. This way, you can create integrated circuits.)

The test-pattern editor lets you create input data for simulation runs on your circuit. The gate and clock libraries contain the truth tables of the logic gates and the waveform patterns of the clock. You can change the truth tables as well as the clock waveform patterns.

A Typical Design Session

After you've made backup copies of the Spectrum Software disks and placed a copy of PC-DOS or Apple DOS on the program disk, you are ready to design a circuit. When you boot up, the first thing you see is the main menu. The menu lets you choose between the designer module and the analyzer module. It also gives

At a Glance

Name

Micro-Logic

Type

Logic design and simulation system

Manufacturer

Spectrum Software
690 West Fremont Ave.
Sunnyvale, CA 94087
Technical-support hot line: (408) 738-4387

Format

Three 5¼-inch disks

Language

Machine language

Computer

Apple II or IBM Personal Computer with 128K bytes of memory and two disk drives

Documentation

About 150 pages, 8½ by 11 inches, in a three-ring binder

Price

\$475

Audience

Electronics engineers, technicians, and electronics instructors

you the option of making a new data disk or ending the Micro-Logic program.

You choose the designer module to draw your circuit, which you have already specified by either Boolean equation or rough sketch. When the designer module begins, you just call for the logic gates that you need and make the proper connections between them. You're not limited to one screen, by the way, but to nine screens that are interconnected. When you're done, you press Q to save the design and return to the main menu. Figure 3 shows a circuit prepared with Micro-Logic.

You can now analyze your circuit by choosing the analyzer option. Once in the analyzer menu, you select the disk-operations option, which lets you load the network that you generated with the designer module into memory. Your design will require an input, so you can choose one from the test-pattern editor. Figure 4 shows

| NO. | NAME | LABEL | SIMFILE NETWORK | | | | | | | |
|-----|---------|-------|-----------------|---|---|---|---|---|---|---|
| | | | A | B | C | D | E | F | G | H |
| 1 | DATA 1 | DATA | 0 | 0 | 0 | 0 | 0 | 0 | | |
| 2 | PHASE 1 | CLOCK | 0 | 0 | 0 | 0 | 0 | 0 | | |
| 3 | INV | DBAR | 1 | 0 | 0 | 0 | 0 | 0 | | |
| 4 | AND3 | | 2 | 2 | 3 | 0 | 0 | 0 | | |
| 5 | NOR3 | QBAR | 0 | 4 | 7 | 0 | 0 | 0 | | |
| 6 | AND3 | | 2 | 2 | 1 | 0 | 0 | 0 | | |
| 7 | NOR3 | Q | 5 | 6 | 0 | 0 | 0 | 0 | | |

Figure 2: The netlist of the circuit in figure 3 as it appears on the screen. The items under the column labeled NAME are the logic devices, input data channel, and clock. The lettered columns show to which device the inputs of a device are connected. For instance, one of device 4's inputs is connected to device 2.

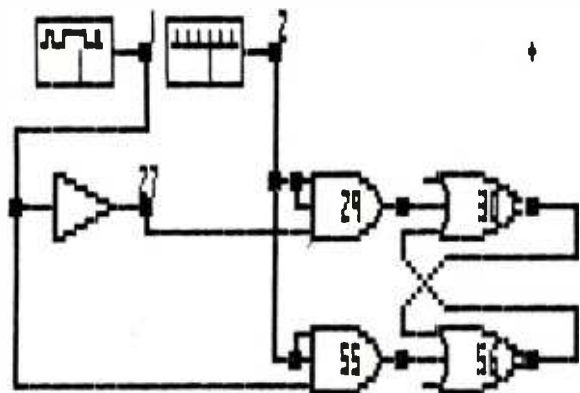

Figure 3: A digital logic circuit prepared with Micro-Logic. The names and labels of each of the devices are shown not on the diagram but on the netlist. The numbers shown are the grid numbers of the screen and have nothing to do with the function of the circuit.

(4a)

| | | SIMFILE | | | | | | | | | | | | | | | |
|---------|------|--------------------|------|------|------|-------|---------|--------|-----|------|----|----|----|----|----|----|----|
| | | Page 0 Clock Times | | | | | | | | | | | | | | | |
| | | 1 | 2 | 3 | 4 | 5 | 6 | 7 | 8 | 9 | 10 | 11 | 12 | 13 | 14 | 15 | 16 |
| DATA 1 | | 1 | 0 | 1 | 0 | 1 | 0 | 1 | 0 | 1 | 0 | 1 | 0 | 1 | 0 | 1 | 0 |
| DATA 2 | | 0 | 0 | 0 | 0 | 0 | 0 | 0 | 0 | 0 | 0 | 0 | 0 | 0 | 0 | 0 | 0 |
| DATA 3 | | 0 | 0 | 0 | 0 | 0 | 0 | 0 | 0 | 0 | 0 | 0 | 0 | 0 | 0 | 0 | 0 |
| DATA 4 | | 0 | 0 | 0 | 0 | 0 | 0 | 0 | 0 | 0 | 0 | 0 | 0 | 0 | 0 | 0 | 0 |
| DATA 5 | | 0 | 0 | 0 | 0 | 0 | 0 | 0 | 0 | 0 | 0 | 0 | 0 | 0 | 0 | 0 | 0 |
| DATA 6 | | 0 | 0 | 0 | 0 | 0 | 0 | 0 | 0 | 0 | 0 | 0 | 0 | 0 | 0 | 0 | 0 |
| DATA 7 | | 0 | 0 | 0 | 0 | 0 | 0 | 0 | 0 | 0 | 0 | 0 | 0 | 0 | 0 | 0 | 0 |
| DATA 8 | | 0 | 0 | 0 | 0 | 0 | 0 | 0 | 0 | 0 | 0 | 0 | 0 | 0 | 0 | 0 | 0 |
| DATA 9 | | 0 | 0 | 0 | 0 | 0 | 0 | 0 | 0 | 0 | 0 | 0 | 0 | 0 | 0 | 0 | 0 |
| DATA 10 | | 0 | 0 | 0 | 0 | 0 | 0 | 0 | 0 | 0 | 0 | 0 | 0 | 0 | 0 | 0 | 0 |
| DATA 11 | | 0 | 0 | 0 | 0 | 0 | 0 | 0 | 0 | 0 | 0 | 0 | 0 | 0 | 0 | 0 | 0 |
| DATA 12 | | 0 | 0 | 0 | 0 | 0 | 0 | 0 | 0 | 0 | 0 | 0 | 0 | 0 | 0 | 0 | 0 |
| DATA 13 | | 0 | 0 | 0 | 0 | 0 | 0 | 0 | 0 | 0 | 0 | 0 | 0 | 0 | 0 | 0 | 0 |
| DATA 14 | | 0 | 0 | 0 | 0 | 0 | 0 | 0 | 0 | 0 | 0 | 0 | 0 | 0 | 0 | 0 | 0 |
| DATA 15 | | 0 | 0 | 0 | 0 | 0 | 0 | 0 | 0 | 0 | 0 | 0 | 0 | 0 | 0 | 0 | 0 |
| DATA 16 | | 0 | 0 | 0 | 0 | 0 | 0 | 0 | 0 | 0 | 0 | 0 | 0 | 0 | 0 | 0 | 0 |
| DATA 17 | | 0 | 0 | 0 | 0 | 0 | 0 | 0 | 0 | 0 | 0 | 0 | 0 | 0 | 0 | 0 | 0 |
| DATA 18 | | 0 | 0 | 0 | 0 | 0 | 0 | 0 | 0 | 0 | 0 | 0 | 0 | 0 | 0 | 0 | 0 |
| UP | DOWN | RIGHT | LEFT | JUMP | EDIT | PRINT | *RANDOM | BINARY | SET | QUIT | | | | | | | |

(4b)

| | | CLOCK SUB-CYCLE TIME | | | | | | | | | | | | | | | | | | | |
|----|---------|---------------------------------------|---|---|---|---|---|---|---|---|---|---|---|---|---|---|---|---|---|---|---|
| | | 1 1 1 1 1 1 1 1 1 1 1 1 1 1 1 1 1 1 2 | | | | | | | | | | | | | | | | | | | |
| # | NAME | 1 | 2 | 3 | 4 | 5 | 6 | 7 | 8 | 9 | 0 | 1 | 2 | 3 | 4 | 5 | 6 | 7 | 8 | 9 | 0 |
| 1 | PHASE 0 | 1 | 1 | 1 | 1 | 1 | 1 | 1 | 1 | 1 | 1 | 1 | 1 | 1 | 1 | 1 | 1 | 1 | 1 | 1 | 1 |
| 2 | PHASE 1 | 0 | 0 | 0 | 0 | 1 | 1 | 1 | 0 | 0 | 0 | 0 | 0 | 0 | 0 | 0 | 0 | 0 | 0 | 0 | 0 |
| 3 | PHASE 2 | 0 | 0 | 0 | 0 | 0 | 0 | 0 | 0 | 0 | 0 | 0 | 0 | 0 | 0 | 0 | 0 | 0 | 0 | 0 | 0 |
| 4 | PHASE 3 | 0 | 0 | 0 | 0 | 0 | 0 | 0 | 0 | 0 | 0 | 0 | 0 | 0 | 0 | 0 | 0 | 0 | 0 | 0 | 0 |
| 5 | PHASE 4 | 0 | 0 | 0 | 0 | 0 | 0 | 0 | 0 | 0 | 0 | 0 | 0 | 0 | 0 | 0 | 0 | 0 | 0 | 0 | 0 |
| 6 | PHASE 5 | 0 | 0 | 0 | 0 | 0 | 0 | 0 | 0 | 0 | 0 | 0 | 0 | 0 | 0 | 0 | 0 | 0 | 0 | 0 | 0 |
| 7 | PHASE 6 | 0 | 0 | 0 | 0 | 0 | 0 | 0 | 0 | 0 | 0 | 0 | 0 | 0 | 0 | 0 | 0 | 0 | 0 | 0 | 0 |
| 8 | PHASE 7 | 0 | 0 | 0 | 0 | 0 | 0 | 0 | 0 | 0 | 0 | 0 | 0 | 0 | 0 | 0 | 0 | 0 | 0 | 0 | 0 |
| 9 | PHASE 8 | 0 | 0 | 0 | 0 | 0 | 0 | 0 | 0 | 0 | 0 | 0 | 0 | 0 | 0 | 0 | 0 | 0 | 0 | 0 | 0 |
| 10 | PHASE 9 | 0 | 0 | 0 | 0 | 0 | 0 | 0 | 0 | 0 | 0 | 0 | 0 | 0 | 0 | 0 | 0 | 0 | 0 | 0 | 0 |

COMMAND MENU: L=LEFT R=RIGHT E=EDIT P=PRINT Q=QUIT

Figure 4: The input patterns used for the circuit in figure 3. The DATA 1 bit pattern in 4a was used as the data input to the circuit. The PHASE 1 bit pattern in 4b was used as the clock for the circuit. Other data and clock patterns can be created with the Edit function.

THE FORTH SOURCE™

MVP-FORTH

Stable - Transportable - Public Domain - Tools

You need two primary features in a software development package... a stable operating system and the ability to move programs easily and quickly to a variety of computers. MVP-FORTH gives you both these features and many extras. This public domain product includes an editor, FORTH assembler, tools, utilities and the vocabulary for the best selling book "Starting FORTH". The Programmer's Kit provides a complete FORTH for a number of computers. Other MVP-FORTH products will simplify the development of your applications.

MVP Books - A Series

- Volume 1**, *All about FORTH* by Haydon. MVP-FORTH glossary with cross references to fig-FORTH, *Starting FORTH* and FORTH-79 Standard. 2nd Ed. \$25
- Volume 2**, *MVP-FORTH Assembly Source Code*. Includes CP/M®, IBM-PC®, and APPLE® listing for kernel \$20
- Volume 3**, *Floating Point Glossary* by Springer \$10
- Volume 4**, *Expert System* with source code by Park \$25
- Volume 5**, *File Management System* with Interrupt security by Moreton \$25

NEW
NEW
NEW

MVP-FORTH Software - A Transportable FORTH

- MVP-FORTH Programmer's Kit** including disk, documentation, Volumes 1 & 2 of MVP-FORTH Series (*All About FORTH*, 2nd Ed. & *Assembly Source Code*), and *Starting FORTH*. Specify CP/M, CP/M 86, CP/M+, APPLE, IBM PC, MS-DOS, Osborne, Kaypro, H89/Z89, Z100, TI-PC, MicroDecisions, Northstar, Compupro, Cromenco, DEC Rainbow, NEC 8201, TRS-80/100 \$150
- MVP-FORTH Cross Compiler** for CP/M Programmer's Kit. Generates headerless code for ROM or target CPU \$300
- MVP-FORTH Meta Compiler** for CP/M Programmer's kit. Use for applications on CP/M based computer. Includes public domain source \$150
- MVP-FORTH Fast Floating Point** Includes 9511 math chip on board with disks, documentation and enhanced virtual MVP-FORTH for Apple II, II+, and ILe. \$450
- MVP-FORTH Programming Aids** for CP/M, IBM or APPLE Programmer's Kit. Extremely useful tool for decompiling, callfinding, and translating. \$150
- MVP-FORTH PADS (Professional Application Development System)** for IBM, or APPLE. An integrated development system with complete documentation for PC, XT or PCjr and Apple II, II+ and ILe. Will run on most IBM and Apple look-alikes. \$500
- MVP-FORTH Floating Point & Matrix Math** for IBM or Apple \$85
- MVP-FORTH Graphics Extension** for IBM or Apple \$65
- MVP-FORTH MS-DOS file Interface** for IBM PC PADS \$80
- MVP-FORTH Expert System** for development of knowledge-based programs for Apple, IBM, or CP/M. \$100

NEW
NEW
NEW

FORTH COMPUTER

- Jupiter Ace** \$150
 - 16K RAM Pack \$50
 - 48K RAM Pack \$125

FORTH CROSS COMPILERS Allow extending, modifying and compiling for speed and memory savings, can also produce ROMable code. •Requires FORTH disk.

| | | | |
|--------------------------------|-------|---------------------------------------|-------|
| <input type="checkbox"/> CP/M | \$300 | <input type="checkbox"/> IBM• | \$300 |
| <input type="checkbox"/> 8086• | \$300 | <input type="checkbox"/> Z80• | \$300 |
| <input type="checkbox"/> 68000 | \$300 | <input type="checkbox"/> Apple II/II+ | \$300 |

Ordering Information: Check, Money Order (payable to MOUNTAIN VIEW PRESS, INC.), VISA, MasterCard, American Express. COD's \$5 extra. Minimum order \$15. No billing or unpaid PO's. California residents add sales tax. Shipping costs in US included in price. Foreign orders, pay in US funds on US bank, include for handling and shipping by Air: \$5 for each item under \$25, \$10 for each item between \$25 and \$99 and \$20 for each item over \$100. All prices and products subject to change or withdrawal without notice. Single system and/or single user license agreement required on some products.

FORTH DISKS

FORTH with editor, assembler, and manual.

- APPLE** by MM \$100
- APPLE** by Kuntze \$90
- ATARI®** valFORTH \$60
- CP/M®** by MM \$100
- HP-85** by Lange \$90
- HP-75** by Cassidy \$150
- IBM-PC®** by LM \$100
- NOVA** by CCI 8" DS/DD \$175
- Z80** by LM \$100
- 8086/88** by LM \$100
- 68000** by LM \$250
- VIC FORTH** by HES, VIC20 cartridge \$50
- C64** by HES Commodore 64 cartridge \$60
- Timex** by HW \$25

Enhanced FORTH with: F-Floating Point, G-Graphics, T-Tutorial, S-Stand Alone, M-Math Chip Support, MT-Multi-Tasking, X-Other Extras, 79-FORTH-79, 83-FORTH-83.

- APPLE** by MM, F, G, & 83 \$160
- ATARI** by PNS, F, G, & X. \$90
- CP/M** by MM, F & 83 \$160
- Apple, GraFORTH** by I \$75
- Multi-Tasking FORTH** by SL, CP/M, X & 79 \$395
- TRS-80/II or III** by MMS, F, X, & 79 \$130
- Timex** by FD, tape G, X, & 79 \$45
- Victor 9000** by DE, G, X \$150
- Extensions** for LM Specify IBM, Z80, or 8086
 - Software Floating Point \$100
 - 8087 Support (IBM-PC or 8086) \$100
 - 9511 Support (Z80 or 8086) \$100
 - Color Graphics (IBM-PC) \$100
 - Data Base Management \$200
- Requires LM FORTH disk.
- fig-FORTH Programming Aids** for decompiling, callfinding, and translating. CP/M, IBM-PC, Z80, or Apple \$150

FORTH MANUALS, GUIDES & DOCUMENTS

- ALL ABOUT FORTH** by Haydon. See above. \$25
- FORTH Encyclopedia** by Derick & Baker \$25
- The Complete FORTH** by Winfield \$16
- Understanding FORTH** by Reymann \$3
- FORTH Fundamentals**, Vol. I by McCabe \$16
- FORTH Fundamentals**, Vol. II by McCabe \$13
- FORTH Tools, Vol.1** by Anderson & Tracy \$20
- Beginning FORTH** by Chirlian \$17
- FORTH Encyclopedia Pocket Guide** \$7
- And So FORTH** by Huang. A college level text. \$25
- FORTH Programming** by Scanlon \$17
- FORTH on the ATARI** by E. Floegel \$8
- Starting FORTH** by Brodie. Best instructional manual available. (soft cover) \$18
- Starting FORTH** (hard cover) \$23
- 68000 fig-Forth** with assembler \$25
- Jupiter ACE Manual** by Vickers \$15
- 1980 FORML Proc.** \$25
- 1981 FORML Proc 2 Vol** \$40
- 1982 FORML Proc.** \$25
- 1981 Rochester FORTH Proc.** \$25
- 1982 Rochester FORTH Proc.** \$25
- 1983 Rochester FORTH Proc.** \$25
- A Bibliography of FORTH References, 1st. Ed.** \$15
- The Journal of FORTH Application & Research Vol. 1, No. 1** \$20
- Threaded Interpretive Languages** \$23
- META FORTH** by Cassidy \$30
- Systems Guide to fig-FORTH** \$25
- Invitation to FORTH** \$20
- PDP-11 User Man.** \$20
- FORTH-83 Standard** \$15
- FORTH-79 Standard** \$15
- FORTH-79 Standard Conversion** \$10
- Tiny Pascal fig-FORTH** \$10
- NOVA fig-FORTH** by CCI Source Listing \$25
- NOVA** by CCI User's Manual \$25
- Installation Manual for fig-FORTH,** \$15

NEW
NEW
NEW
NEW

Source Listings of fig-FORTH, for specific CPU's and computers. The Installation Manual is required for implementation. Each \$15

| | | | |
|--------------------------------|----------------------------------|-------------------------------|--|
| <input type="checkbox"/> 1802 | <input type="checkbox"/> 6502 | <input type="checkbox"/> 6800 | <input type="checkbox"/> AlphaMicro |
| <input type="checkbox"/> 8080 | <input type="checkbox"/> 8086/88 | <input type="checkbox"/> 9900 | <input type="checkbox"/> APPLE II |
| <input type="checkbox"/> PACE | <input type="checkbox"/> 6809 | <input type="checkbox"/> NOVA | <input type="checkbox"/> PDP-11/LSI-11 |
| <input type="checkbox"/> 68000 | <input type="checkbox"/> Eclipse | <input type="checkbox"/> VAX | <input type="checkbox"/> Z80 |

MOUNTAIN VIEW PRESS, INC.

PO BOX 4656

MOUNTAIN VIEW, CA 94040

(415) 961-4103

UNIX

and MS-DOS, and VMS too!

UniPress can meet your software needs, for a range of hardware, including VAX, MC68000, and IBM-PC.

UniPress, your UNIX source.

PACKAGING: VAX/VMS and UNIX, MC68000/UNIX on Sun, Masscomp, Apollo, Tandy 16, Apple Lisa, Sritek Board for IBM PC, Dual, Plexus, Callan, and Cyb. Perq and Perkin Elmer, too. Source code, as well as binary. Maintenance available. Inquire regarding other hardware.

UniPress Software

UNIX SOFTWARE

- Full UniPlus + UNIX for Apple LISA \$ 495
- EMACS—Multi-window text editor (Gosling version)395
- LEX—Powerful word processor500
- PHACT—Isam file manager250
- /RDB—Relational database tools250
- MENU SYSTEM—Menu generation495
- UniCalc—Powerful spreadsheet350
- MIMIX—CP/M emulator495
- Lattice C cross compiler—to 8086 and 68000 (includes linker, librarian, disassembler, etc.) 5000

Priced from

MS-DOS SOFTWARE

- Software tools—Unix-like facilities add power to MS-DOS: includes ed, grep, sort, diff, cat, etc.200
- PHACT—Isam file manager250
- C compiler—Full C language395
- Coherent—Unix-like operating system for IBM-PC XT500

VMS SOFTWARE

- EMACS—Multi-window text editor (Gosling version)2500

OEM and dealer inquiries invited. Quantity terms available.

Call or write for more information.

UniPress Software, Inc.

1164 Raritan Avenue, Highland Park, NJ 08904
201-985-8000 Toll Free: 800-222-0550 (outside NJ)
Telex: 709418

Mastercard and Visa

Overseas distribution available through
Lifeboat Associates — Japan

Unix is a trademark of Bell Laboratories.
VMS is a trademark of Digital Equipment Corp.
MS-DOS is a trademark of Microsoft.
UniCalc is a trademark of Lattice, Inc.

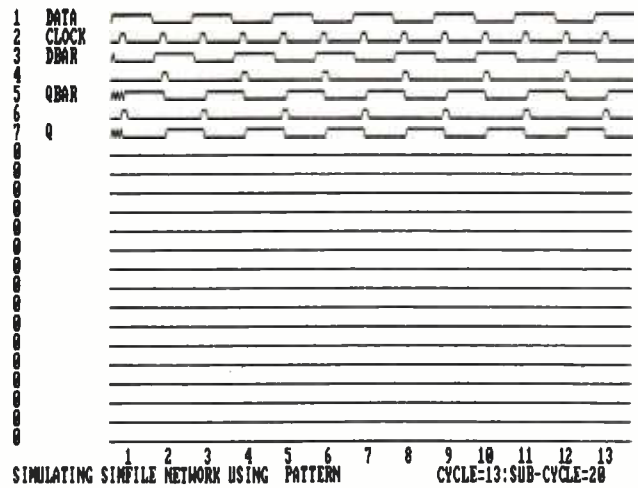

Figure 5: The timing simulation for the circuit in figure 3.

the pattern that I used in the simulation of the circuit in figure 3. When that's done, you can select a waveform for the clock signal.

Next, you have to decide how long the simulation will last and whether you want your design to be "compacted." You specify time in the simulation with clock cycles. For instance, you can run a simulation for 20 clock cycles. Compacting cleans up the netlist that the designer module created for your design. The designer module typically assigns two or three times more nodes than are needed at first because it assigns a node designation for every connection you make. Compacting discovers these faults. Unfortunately, it does nothing to make your design work better or with fewer parts; in other words, it does not minimize your circuit as you would with a Karnaugh map.

Figure 5 shows the timing simulation for our circuit. You can print out the simulation with the print-screen option if you are using an IBM PC. The beauty of this technique is that you can try several circuits without building a single one and obtain the timing information much more quickly than if you were to actually build the circuit and test the timing yourself.

If the simulation reveals a timing problem, you can obtain a fan-out report to see if you are connecting too many lines to the output of one device, which would cause an extra delay in that device. In fact, you can vary the delay of each device so that it matches the delay you would expect in the real world. You can also specify a variable delay that is a function of the fan-out of the device. Figure 6 shows the specifications for an AND gate that includes the delay.

Problems

Micro-Logic's biggest problem is its documentation. The manual is so difficult to read and so poorly organized that it is an outright obstacle to learning the system. For \$475, you might expect a professionally prepared manual; instead, the Micro-Logic manual is right off the author's typewriter, with those really w-i-d-e blocks of text so typical of amateur documentation. The

BHART-NEVADA (800) 845-5555

NATIONWIDE LEASING

To get our FREE monthly bargain flyer with specially priced items and unadvised specials, circle reader response card or drop us a note (sorry absolutely no telephone requests!)

SPECIAL!! FREE WITH ANY PURCHASE OVER \$100!

1 hour connect-time on **COMPUTER SPORTS WORLD** — The World's First All-Sports Information Electronic Newspaper — Recreational and Professional Use Updated hourly 24 hours a day!
(Also available w/o purchase: \$175 subscription fee and \$35/hour)

UNBELIEVABLE \$999

10 MB Hard Disk for IBM-PC

15 MB only \$249 higher!
includes case, power supply, controller
1/0 Card (plugs into your PC) & Driver for DDS 2 0 0 ONLY \$199
Highest Quality — Unconditional 90-day Warranty
Similar Savings on hard disks for APPLE, TANDY

SHARP PC-5000

Revolutionary Portable Computer 8088 MS-DOS bubble "Disk" optional built-in printer & modem.



\$CALL

BMC LIST \$2995
FINAL REDUCTION \$1,595

IBM-PC

\$2449

SAME DAY SHIPPING

2 thinline floppies (room for hard disk!)
keyboard \$125 color card \$229
Plantronics Color Plus \$379
factory cartons 90-day warranty

SAVE 50% & more

NEC PC-8800
List \$3618 Your Cost ONLY **\$1,699**
16-bit card, 128K, MS-DOS... \$499

SPECIAL! COLUMBIA 1600
\$3000 FREE Software
Nationwide Service by Bell & Howell.
NOW YOU CAN LEASE A COLUMBIA 1600 1 FOR ONLY \$83/MO

SANYO 550 \$839
1 dr color, MS-DOS W.S. CalcSt3
SANYO 552 dr color all software above plus MailMerge
SpellStar InfoStar BEST BUY 1085

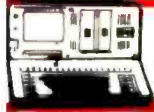

ZORBA Portable Computer
Sold last year for \$2495
Most sophisticated 8-bit CP/M portable
Ever Made!

SAVE \$995

60%

64K RAM, 2 drives d.s.d., 800 KB read/write IBM-PC, Xerox 820, KayPro, Osborne, DEC format!
(And with CO-POWER 88 you can even execute PC software!) Standard Interfaces: serial, parallel
IEEE-488! Software included: CP/M 2.2, CBasic, Wordstar, Mailmerge, Calcstar
New in factory carton, full factory warranty & nationwide service. **INTERNATIONAL ORDERS WELCOME!**
Shipped immediately air-freight Collect! **HURRY! QUANTITIES VERY LIMITED!**

CO POWER 88 by SWP 16-BIT POWER For Your KAYPRO
(or Osborne, Zorba, Xerox 8201 with 8088 CoProcessor Board. Use MS-DOS to read/write IBM-PC diskettes and execute PC Software! PLUS 256K RAMDISK speeds CP/M up to 10 times! 90-day warranty! IMMEDIATE AVAILABILITY!
SPECIAL INTRODUCTORY OFFER 256K CoProcessor Board **\$499**
FREE SHIPPING!

FOR APPLE II

| | | | |
|------------------------------------|-----|--|----|
| DISK CONTROLLER | 59 | EPROM WRITER CARD | 79 |
| Z-80 CARD | 66 | POWER SUPPLY, 5 amp | 69 |
| 80 COLUMN CARD | 79 | COOLING FAN & surge protector | 59 |
| 80 COL CARD w/softswitch & reverse | 109 | Highest quality, ceramic chips throughout! | |
| 16K RAM CARD | 65 | | |
| PRINTER CARD w/cable | 69 | | |

90 Day Unconditional Warranty!

For information on any of the products featured above, send self-addressed, stamped envelope (2 leaflets = 1 oz. postage)

NASHUA FLOPPY DISKETTES

First quality, individual envelopes, original factory boxes of 10. 5 1/4" diskettes have reinforced hubs.
LIFE TIME WARRANTY! Minimum Order 3 boxes.

| | |
|------------------|------|
| 5 1/4" s.s. s.d. | 1.49 |
| 5 1/4" s.s. d.d. | 1.84 |
| 5 1/4" d.s. d.d. | 2.15 |
| 8" s.d. s.d. | 1.84 |
| 8" d.s. d.d. | 2.69 |

SIGNALMAN XII

MODEM, 300-1200 BAUD.
Auto-dial, Auto-answer
List \$399 **ONLY \$274**

(All features of other smart modems)
PLUS: features you won't find in the competition: Dial-tone detect, Busy detect!

NEW: BROTHER Electronic Typewriters for Office and Home!

ROMAR-II Apple-compatible, ideal second computer 469

COMPUTERS

| | |
|--|---------|
| TAVA fully IBM compatible, 2 drives | 1699 |
| CORONA-PC LIST 2995 | 2299 |
| CORONA-PC portable | \$ CALL |
| EAGLE PC-XL Hard disk | 3395 |
| EAGLE SPIRIT-XL | 3995 |
| EAGLE 1620 | 3995 |
| EAGLE 1630 | 4995 |
| ZENITH Z-100, FREE Lotus 1-2-3 | |
| Hard disk optional | 2239 |
| NEC-APC 8" drives FREE SOFTWARE: CP/M 86, W.S., SpellStar, MailMerge, SuperCalc, JBASE II, Millionaire | |
| HD-2 monochrome | 2749 |
| HD-3 color | 3249 |
| SEQUA MS-DOS & CP/M-80 | \$ CALL |
| INTERTEC Superbrain Computer, Headstart | \$ CALL |
| MORROW MicroDecision MD 2 w/terminal | 1469 |
| MORROW MicroDecision MD II in stock | \$ CALL |
| TELEVIDEO Portable | \$ CALL |
| MOLECULAR | \$ CALL |

SOFTWARE SUPER SPECIAL CONDOR III

w/ReportWriter **\$299**

| | | |
|--|-----|---|
| ★ WORDSTAR PROPAK (W/S, SpellStar, MailMerge, StarIndex) | 479 | ★ |
| ★ FRIDAY | 189 | ★ |
| ★ BOTTOM LINE STRATEGIST | 288 | ★ |
| ★ PFS-FILE | 99 | ★ |
| ★ IUS G/L, A/R, A/P (per module) | 369 | ★ |

| | LIST | YOUR PRICE | | UTILITIES | |
|---------------------------------|------|------------|---|-----------|------|
| WORD PROCESSING | | | | | |
| Final Word (Uncom) | 300 | 228 | Disk Doctor (Supersoft) | 100 | 74 |
| Footnote (Dig Markt) | 125 | 85 | Fancy Font (SoftCraft) | 180 | 159 |
| PeachPak (Peachtree) | 500 | 330 | Smart Key II | 90 | 72 |
| Perfect Writer/Speller | 695 | 286 | Super Sort (MicroPro) | 250 | 164 |
| Punct. & Style (Oasis) | 125 | 90 | Supervyz (Epic) | 90 | 65 |
| Spellbinder (Lexisoft) | 495 | 264 | | | |
| The Word Plus (Oasis) | 150 | 105 | LANGUAGES | | |
| | | | Basic Compiler | 395 | 269 |
| TRAINING | 75 | 54 | Basic Interpreter 80 | 350 | 239 |
| SPREAD SHEET/FINANCIAL PLANNING | | | Cobol Compiler (MicroSoft) | 750 | 499 |
| MultiPlan (Microsoft) | 275 | 190 | Fortran 80 Compiler | 500 | 330 |
| ProfitPlan (Chang Labs) | 195 | 140 | Level II Cobol (D/R) | 1600 | 1150 |
| SuperCalc II (Sorcim) | 295 | 194 | Pascal MT/MT-86 | 500 | 420 |
| VisiCalc (VisiCorp) | 250 | 199 | PL/I (D/R) | 500 | 468 |
| SuperCalc III | | | RM/Cobol full dev sys. | 750 | 540 |
| | | | RECREATIONAL | | |
| DATA BASE MANAGEMENT | | | Zork | 49.95 | 33 |
| 1-2-3 (Lotus) | 499 | 349 | Deadline, Starcross | | |
| dBase-II (Ashton-Tate) | 700 | 390 | Planetfall, Witness, | | |
| dGRAPH (Fox & Geller) | 295 | 199 | SusPended | 59 | 39 |
| DUTIL (Fox & Geller) | 99 | 71 | (KAYPRO, OSBORNE, OO, MORROW, etc., add \$20) | | |
| InfoStar (MicroPro) | 495 | 327 | DATA COMMUNICATIONS | | |
| Notebook (Dig Markt) | 150 | 102 | Crosstalk (MicroSoft) | 195 | 139 |
| PFS FILE (Soft Pub.) | 140 | 101 | Move-It (Woolf) | 125 | 89 |
| PFS GRAPH (Soft Pub.) | 125 | 89 | Smarcom II (Hayes) | 119 | 80 |
| PFS REPORT (Soft Pub.) | 125 | 89 | APPLICATIONS SOFTWARE (Cyma, MBA, Star, | | |
| Q-PRO-4 (Quick n' Easy) | 395 | 285 | Peachtree Artificial Intelligence, etc.) | \$ CALL | |
| Quickcode (Fox & Geller) | 295 | 212 | | | |

PRINTERS

SPECIAL

PANASONIC KXP 1090 Dot-Matrix Printer
100 CPS, FULLY compatible (print & graphics)
w/EPSON MX-80

| | |
|---------------------------|---------|
| Mannesmann-Talley MT-160L | 599 |
| MT-180L NEW | 779 |
| GEMINI-10X List \$499 | 279 |
| Gemini Delta 10, 160 CPS | \$ CALL |
| Epson FX-80 | 549 |
| Epson RX-80 | \$ CALL |
| Okidata 92 | 439 |
| NEC 8023 | 339 |
| NEC 8025 | \$ CALL |

Daisy-Wheel Printers:

| | |
|-------------------------------|----------------|
| DAISYWRITER 2000 | 1095 |
| TRANSTAR 130, emulates Diablo | 679 |
| BROTHER HR-25 | 799 |
| DYNAX HR-15, best buy | 439 |
| DYNAX KEYBOARD | 189 |
| JUKI 6100 | \$ CALL |
| Silver-Reed EXP 550 | \$ CALL |
| Mannesmann-Tally Sprint | LIST \$399 299 |
| NEC SPINWRITER Zato | 869 |

TERMINALS MONITORS

| | | | |
|----------------------|---------|-------------------|-----|
| HAZELTINE Esprit I | 539 | DYNAX 12 Amber | 135 |
| HAZELTINE Esprit III | 719 | TAXAN RGB | 315 |
| QUME QV1-102 | 529 | TAXAN 460 hb res. | 499 |
| QUME QVT-108 | 729 | ZENITH RGB | 524 |
| WYSE 50 | \$ CALL | PRINCETON PGS | 485 |
| TELEVIDEO 914 | \$ CALL | NEC 1216 | 419 |

TOLL-FREE LINE BUSY? Hard as we try, the heavy demand sometimes results in all our toll-free lines being engaged. To place an order call (702) 451-1361; we will take your order promptly and Credit you double the cost of your call!!!

MODEMS

| | |
|----------------------------|-----|
| HAYES 1200 | 484 |
| HAYES 1200B w/ SmartCom II | 439 |
| HAYES MicroModem IIe | 239 |
| US ROBOTICS Password | 349 |

TELEX ORDERS: Hardware under \$1,000 and all Software. Please Telex re larger hardware items only if you are eligible for U.S. Export License! All export orders add 10% TELEX 472-0127 Attn: EMO

(6a)

INPUT STATES

```

PIN 1 0101010101010101010101010101010101010101010101010101010101010101
PIN 2 0011001100110011001100110011001100110011001100110011001100110011
PIN 3 0000111100001111000011110000111100001111000011110000111100001111
PIN 4 0000000011111111000000001111111100000000111111110000000011111111
PIN 5 0000000000000000111111111111110000000000000000111111111111111111
LAST..0000000000000000000000000000000011111111111111111111111111111111

```

NO. NAME

OUTPUT STATE TRUTH TABLE FOR ABOVE INPUT STATE

```

1 INV      1010101010101010101010101010101010101010101010101010101010101010
2 NOR3     1000000010000000100000001000000010000000100000001000000010000000
3 NOR5     1000000000000000000000000000000010000000000000000000000000000000
4 NAND3    111111011111110111111101111111011111110111111101111111011111110
5 NAND5    111111111111111111111111111101111111111111111111111111111110
6 EX-OR    01100110011001100110011001100110011001100110011001100110011001100110
7 OR3      011111101111110111111101111111011111110111111101111111011111111
8 OR5      0111111111111111111111111111011111111111111111111111111111111
9 AND3     0000000100000001000000010000000100000001000000010000000100000001
10 AND5    0000000000000000000000000000000010000000000000000000000000000001
11 DFF TTL 0101010101010101010101010101010101010101010101010101010101010101
12 TFF TTL 0101010101010101010101010101010101010101010101010101010101010101
COMMAND MENU: U=UP D=DOWN E=EDIT C=COPY P=PRINT Q=QUIT

```

(6b)

| NO. | NAME | DELAY | | DEFAULT CLOCKS | | OR PIN # | CLOCK SAMPLING METHOD FOR PINS | | | | | OUT | |
|-----|---------|-------|-----|----------------|-----|----------|--------------------------------|---|---|---|---|-----|---|
| | | FIX | VAR | IN | OUT | | 1 | 2 | 3 | 4 | 5 | | |
| 1 | INV | 1 | 1 | 0 | 0 | 0 | 0 | 0 | 0 | 0 | 0 | 0 | 0 |
| 2 | NOR3 | 1 | 1 | 0 | 0 | 0 | 0 | 0 | 0 | 0 | 0 | 0 | 0 |
| 3 | NOR5 | 1 | 1 | 0 | 0 | 0 | 0 | 0 | 0 | 0 | 0 | 0 | 0 |
| 4 | NAND3 | 1 | 1 | 0 | 0 | 0 | 0 | 0 | 0 | 0 | 0 | 0 | 0 |
| 5 | NAND5 | 1 | 1 | 0 | 0 | 0 | 0 | 0 | 0 | 0 | 0 | 0 | 0 |
| 6 | EX-OR | 1 | 1 | 0 | 0 | 0 | 0 | 0 | 0 | 0 | 0 | 0 | 0 |
| 7 | OR3 | 1 | 1 | 0 | 0 | 0 | 0 | 0 | 0 | 0 | 0 | 0 | 0 |
| 8 | OR5 | 1 | 1 | 0 | 0 | 0 | 0 | 0 | 0 | 0 | 0 | 0 | 0 |
| 9 | AND3 | 1 | 1 | 0 | 0 | 0 | 0 | 0 | 0 | 0 | 0 | 0 | 0 |
| 10 | AND5 | 1 | 1 | 0 | 0 | 0 | 0 | 0 | 0 | 0 | 0 | 0 | 0 |
| 11 | DFF TTL | 3 | 2 | 0 | 0 | 2 | 2 | 0 | 2 | 2 | 2 | 2 | 2 |
| 12 | TFF TTL | 1 | 1 | 0 | 0 | 2 | 2 | 0 | 2 | 2 | 2 | 2 | 2 |
| 13 | JK TTL | 1 | 1 | 0 | 0 | 2 | 2 | 0 | 2 | 0 | 0 | 0 | 2 |
| 14 | BLANK | 1 | 1 | 0 | 0 | 0 | 0 | 0 | 0 | 0 | 0 | 0 | 0 |
| 15 | TGATE | 1 | 1 | 0 | 0 | 0 | 0 | 0 | 0 | 0 | 0 | 0 | 0 |
| 16 | DFF MOS | 1 | 1 | 1 | 2 | 0 | 2 | 2 | 2 | 2 | 2 | 2 | 1 |
| 17 | TFF MOS | 1 | 1 | 1 | 2 | 0 | 2 | 2 | 2 | 2 | 2 | 2 | 1 |
| 18 | JK MOS | 1 | 1 | 1 | 2 | 0 | 2 | 2 | 2 | 2 | 2 | 2 | 1 |

COMMAND MENU: U=UP D=DOWN E=EDIT C=COPY P=PRINT Q=QUIT

Figure 6: The logic-gate specifications: the truth table (6a) and the characteristics table including the device delay (6b).

margins are so wide that I often couldn't find the beginning of the next line. Then there's the problem of the index: there isn't one, so forget about looking something up quickly. I realize that this is the problem you hear over and over again about software from small companies, but maybe we ought to complain over and over again until they get it right. I hope that the next edition of Micro-Logic will have a professionally written and typeset manual.

Another problem, albeit a very minor one, is that you

cannot create a complete schematic with Micro-Logic. That is, you cannot include power-supply connections, capacitor noise bypasses, and so forth. Micro-Logic is strictly concerned with the logic array and nothing else. The supporting circuitry is pretty standard and simple for an engineer to do, and wasteful for the computer to do, so I can see why the author of Micro-Logic left it out. Just don't present a Micro-Logic-generated diagram to your technician for construction unless he knows how to design support circuitry. You'll still have to use an elec-

...SORRY CHARLIE
FOR LEAVING
YOU OUT!



**FEATURES
INCLUDE:**

16 Bit CPU
With 128K RAM Memory
Expandable to 256K,
Two 320KB Slimline
Disk Drives,
Floppy Disk Controller,
Monochrome Monitor and
Adapter, Parallel and
Serial I/O's.

**BEST OF ALL!
TEN DAYS FREE TRIAL!
ALL YOU PAY IS
SHIPPING!**

**FOR MORE DETAILS
CALL OR WRITE
TO: TAVA CORPORATION
16861 Armstrong,
Irvine, California 92714
714/261-0200
Headquarters/Telex: 181667
Answer Back COMPDSHACK IRIN**

IBM® COMPATIBILITY AFFORDABLE PRICE TAVA PC

**THE SMART COMPUTER USER
WANTS REAL VALUE WITH
IBM COMPATIBILITY!**

Circle 353 on Inquiry card.

THE TAVA PC. The ultimate Personal Computer. It gives you IBM PC® Compatibility at a fraction of the cost. Choosing a personal computer is a difficult decision. But, when your decision is a TAVA PC, it's not hard at all! The TAVA PC runs under DOS 1.1, 2.0, CP/M86®, and p-System®. You can choose from a large library of all the most popular IBM PC software products such as dBaseII®, Lotus 1-2-3®, Visicalc® and thousands more.

CP/M86 is a registered trademark of Digital Research, Inc.
UCSDp is a registered trademark of Softech Microsystems

IBM PC is a registered trademark of IBM Corp.
Visicalc is a registered trademark of Visicorp

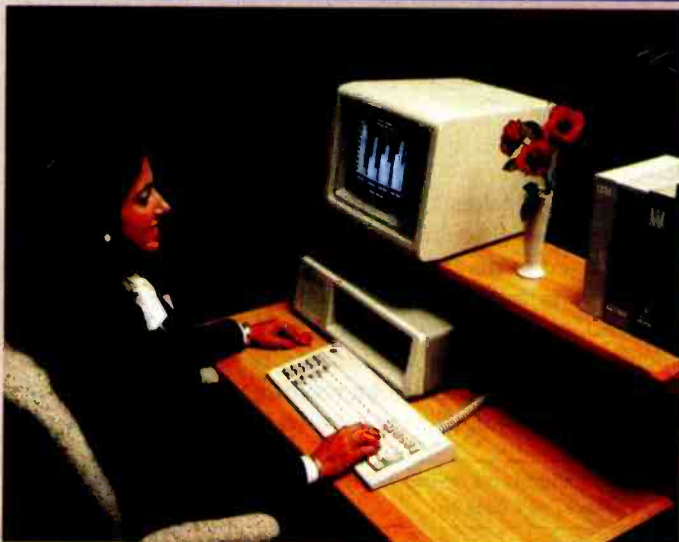

©TAVA CORPORATION 1983
trademark of ASHTON-TATE, Inc.

†California residents add 6% sales tax.

dBASE II is a registered
trademark of Ashton-Tate, Inc.
LOTUS 1-2-3 is a registered trademark of Lotus Development

COMPUTER SECURITY

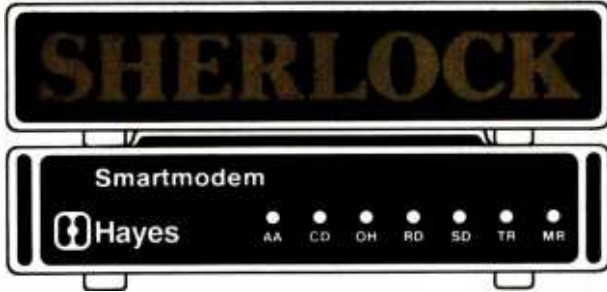

Provides simple, effective and inexpensive Computer Security through your Hayes® Smartmodem.®

See us at Booth no. 1543

COMDEX/Winter '84

It's Elementary!



C.H. SYSTEMS

8533 WEST SUNSET BLVD. • SUITE 106 • LOS ANGELES, CA 90069

PHONE (213) 854-3536

Hayes, and Smartmodem are registered trademarks of Hayes Microcomputer Products, Inc.



NOT ANOTHER BLACK BOX—

A Software Implementation within Your Product Hardware

If you manufacture a computer system or a computer based product, allow it to EMULATE/COMMUNICATE by installing one or more of Systems Strategies "C" Language based communication packages.

- 3270 SNA/SDLC Emulation
- 3270 BSC Emulation
- 2780/3780/HASP Emulation
- X.25 Levels 1, 2, 3 Communication

You can purchase these "C" Language packages with source code and license to distribute in your hardware product. Each package is available either "Port it Yourself" with instruction manual and training or ported to your hardware by Systems Strategies' communications staff.

**Systems Strategies/Advanced Technology Division
Specialists in Data Communications Software**



Systems Strategies Inc.
225 West 34th Street
New York, New York 10001
(212) 279-8400

tronics template to add the final details, and you'll still have to test the circuit layout for noise problems and unforeseen delay problems that the layout may cause. Speaking of layout, I may be asking for the world, but I wish Spectrum Software would make an add-on package that would create board layouts from information generated by Micro-Logic.

Finally, there are not enough help options in the menu. Could a single screen full of additional information take up too much room on a disk or take too much time to develop? Perhaps the author of Micro-Logic felt that "real engineers" don't use help options. I'm sure that's true—but only after they have learned the system. Please give us more help options next time, Spectrum.

Praises

If I were an engineer and I had the option of using Micro-Logic or my paper and pencil, would I use Micro-Logic? You're darned right I would. For an investment of \$475, I would get neater diagrams in less time and, more important, I would be able to run simulations on the designs. Compare \$475 to the price of a mainframe or a minicomputer design system, which could easily be in the \$100,000 range, and you know you have a bargain. I grant you that the larger systems have superior features, such as board-layout optimization, but in a business where a design may require thousands or millions of dollars, Micro-Logic is a cost-effective compromise between features and cost.

The simulation feature should pay for the program the first few times you use it, because it saves you the trouble of having to build a prototype to test the circuit's timing. A disadvantage of prototypes is that you may not be able to tell if the timing problem is in the layout, the component itself, or somewhere else. Because Micro-Logic concentrates on component delay, you can break the design up into more manageable components and troubleshoot more easily.

In addition to being valuable to practicing electronics engineers, Micro-Logic should be an asset to electronics engineering schools, because it will give students hands-on design experience without the fuss of dealing with a large electronics parts inventory. The program should also be a useful tool to the electronics engineering professor, who can use it to demonstrate the operation of digital circuits.

Conclusion

Micro-Logic takes a while to learn, but it is worth the effort. It is an efficient design system that does what it is supposed to do at a reasonable price. It should prove to be very popular with electronics engineers, engineering schools, and professors. If Spectrum Software would spruce up the manual, include more help features, and add a way to quit the design module without saving the design, Micro-Logic would be worth even more. ■

Richard Krajewski is a technical editor at BYTE. He can be reached at POB 372, Hancock, NH 03449.



GIVE YOUR CHILDREN A GREAT TEACHER FOR THEIR APPLE.

Bring Basic Math, Algebra, Physics, Computer Literacy, Computer Concepts and Foreign Languages to your Apple II Plus or IIe

PLATO® Educational Courseware is a great teacher because it's both serious and fun. This makes it a truly exciting home learning experience... one that your children will use again and again.

PLATO makes a real adventure of topics that children often find dull... like Algebra. Difficult concepts such as roots, polynomials and quadratic equations become almost fun and therefore easier to learn.

With PLATO courseware, children study by competing against themselves and by interacting

with stimulating graphics that keep them motivated. They see their progress, and experience the rewards of real achievement.

Widen your child's world
Select from a growing library



of courseware for Apple II Plus and Apple IIe microcomputers. Ask about lessons also available for the TI 99/4A and Atari 800.

Ask for PLATO courseware wherever quality computer products are sold.

Discover the excitement PLATO courseware can bring to learning... in your home.

For a free catalog describing all the PLATO courseware for microcomputers: call toll-free 800/233-3784. (In California, call 800/233-3785.) Or write Control Data Publishing Co., P.O. Box 261127, San Diego, CA 92126.

Warranty available free from Control Data Publishing Co., 4455 Eastgate Mall, San Diego, CA 92121.

PLATO
COMPUTER-BASED EDUCATION

GD
CONTROL DATA
PUBLISHING

Statistical Software for Microcomputers

A comparative analysis of 24 packages

James Carpenter, U.S. Government; Dennis Deloria, U.S. Government;
and David Morganstein, Westat Inc.

The expanding availability of low-cost computing equipment offers us the opportunity to perform complex statistical analyses without a mainframe computer. Unfortunately, few sources of information on the capabilities and limitations of the burgeoning list of statistical software are available.

Several years ago, Platt and Platt (see reference 5) compared the regression performance of four personal computer software packages. They proposed a number of characteristics for comparing different packages. More recently, Woodward and Elliott (see reference 9) sent questionnaires to software developers asking them about the characteristics of their packages. They made available a table on the information provided by 30 software developers. In the November 1983 *BYTE*, Lachenbruch presented the statistical accuracy of regression computations for four packages available for the Apple.

In this review, we first propose and define comparative features of importance in the selection of a statistical package for a personal computer. We then describe general characteristics of the hardware and operating-system requirements, documentation and ease of use, and the statistical options that you may expect to find.

We then compare the features of the 24 packages we examined. After this, we talk about statistical accuracy and compare results obtained using a common data set. The comparisons are based on previously tested and documented data sets used on larger computers for the purpose of assessing accuracy.

The packages fall into one of two categories. While many of the programs try to provide most of the computations needed for a wide range of statistical analyses, some of them have specific purposes. That is, they deal with a fairly small subset of statistical functions. These more specialized packages may, however, have features not found in other packages, or they may excel in their specialty. The Dynacomp program Parafit fits unknown parameters of nonlinear, user-supplied functions, an option few of the other packages have. Alternatively, STAN is an exceptional package for performing the analysis of linear models such as multiple regressions. While general-purpose packages provide answers to many

other questions, only SYSTAT is as comprehensive in the area of linear models as STAN.

The packages differ in another important way. Most of them are self-contained: you buy one program. Others, such as SpeedSTAT and HSD, come in a series: you buy only those modules or programs that perform the functions you need. For the latter type, we have tried to obtain all the programs in the series to make our assessment. However, since you can purchase them individually, we have listed their capabilities separately in the tables that follow.

As you can imagine, we experienced some difficulty in judging the packages on the basis of their documentation and a small amount of hands-on experience. We welcome your comments on our evaluation criteria and hope that our effort makes it easier for you to decide if you need a statistical package and to select the proper one. If you have had some experience with other packages, please share it with us as we have begun a clearinghouse for the collation and dissemination of information.

Individual Packages

You can't do a comparison of software without describing the package from a user's point of view. While our tables contain a great deal of useful comparative information, many of the programs have special points worth mentioning. Several of the packages described below do not appear in our tables due to their unique characteristics. We include a description since they may be of interest to some readers.

ABSTAT: This easy-to-use general statistics package handled all our errors in stride; intelligible error messages were displayed. We were never rudely kicked out of the program or prevented from recovering. Help was always available (just type "?") in the form of a clear statement of what you should do next. You could back out of commands if you changed your mind by typing "!".

Its good data-management and data-processing capabilities are easy to use except for one bothersome requirement: you must specify the total number of variables while creating a data set, and it must be large enough

to allow for additional variables you may need. If you exceed this number, you must create a larger, empty data set and transfer the old data. These operations are easy but should not be the responsibility of the user.

The statistics are of the type found in elementary textbooks. Unfortunately, the two-way ANOVA allows only one observation per cell. ANOVA and regression require different file organization—a fault the company says is high on its priority list for modification. It indicated to us that a new version should be out early in 1984.

AIDA: This is a general-purpose statistical package with a wide range of capabilities. One of its most novel features is a virtual-memory system that reads variables from the disk when they are not currently in memory. AIDA was one of the few programs that let you add your own routine (in BASIC) that can be called directly as an AIDA command. AIDA's greatest limitation is in its numeric range. Numbers are stored internally as 2-byte integers (i.e., have a range of only plus or minus 32,767). Another difficulty is the storage of each variable as an individual file with a filename that includes the number of cases in the file. You must specify the number of cases when initiating analysis with AIDA. This number is later used as part of the filename to access the data. If the number of cases given when starting the program does not match the filename, the file cannot be found. While a quick catalog of the disk reveals the number of cases allowing you to restart your analysis, this procedure is awkward. Another weak point of AIDA is that a separate utility program must be run to add cases to an existing variable.

A-Stat: This general-purpose package provides many of the most desirable statistical functions. It is modeled after P-Stat, the minicomputer package. It has easy-to-use case filtering to specify subsets of records for analysis. While it has no graphical capability, it includes an interface to the Appleplot graphics package. It is written in Applesoft BASIC, and the author has thoughtfully provided both source and compiled versions. The program has undergone improvements for many years; the most recent version, 83.1, includes menu selection to simplify use of its previous command-language-only operating style. Case processing is done one record at a time; cases are read from the disk using BASIC string-handling routines. While this access method permits substantial file sizes, it results in long process times, even when running the compiled version. The author suggests that the program can be run in a batch mode, leaving you free to do something else while the computations are completed.

Dynacomp: A series of four packages, the easy-to-use Dynacomp programs perform somewhat unique, though valuable, statistical functions. The Regression1 program fits a generalized version of a polynomial regression. A polynomial regression tries to estimate a dependent variable using an expression involving various powers of an independent variable. Regression1 extends this to powers of selected functions (e.g., logs, exponentials, etc.) of the independent variable. The second regression

Statistical Analysis Packages

ABSTAT
Anderson-Bell
POB 191
Canon City, CO 81212
(303) 275-1661

AIDA
Dr. David Lingwood
Action-Research Northwest
11442 Marine View Dr., SW
Seattle, WA 98146
(206) 241-1645

A-Stat 83.1
Gary Grandon
Rosen Grandon Associates
7807 Whittier St.
Tampa, FL 33617
(813) 985-4911

Dynacomp
Dynacomp Inc.
1427 Monroe Ave.
Rochester, NY 14618
(716) 442-8960

EDA (Exploratory Data Analysis)
Paul Velleman
Conduit
POB 388
Iowa City, IA 52244
(319) 353-5789

HSD Stats Plus, ANOVA II, and Regress II
Stephen Madigan
and Virginia Lawrence
Human Systems Dynamics
9249 Reseda Blvd.,
Suite 107
Northridge, CA 91324
(213) 993-8536

Introstat 2.2
Ideal Systems
POB 681
Fairfield, IA 52556
(515) 472-4507

Microstat
Jack Purdham
Ecosoft Inc.
5311 North Central
Indianapolis, IN 46220
(317) 283-8883

Micro-TSP
College Division
McGraw-Hill
Princeton Rd.
Hightstown, NJ 08520
(609) 426-5000

Number Cruncher
Jerry L. Hintze
865 East 400 North

Kaysville, UT 84037
(801) 546-0445

NWA Statpak
Northwest Analytical Inc.
1532 SW Morrison St.
Portland, OR 97205
(503) 224-7727

SAM
International Software
Box 160
Welwyn Garden City
Herts, England A18 6TQ

SpeedSTAT: Volume 1: Frequencies and Crosstabs; Volume 2: Regression and Correlation
Dennis LaRue
Softcorp International
229 Huber Village Blvd.
Westerville, OH 43081
(614) 267-3109
(800) 543-1350

SPS Version 3A.0 (Statistical Processing System)
Data Basic Inc.
102 South Main
Mount Pleasant, MI 48858
(517) 772-5055

STAN
David M. Allen
Statistical Consultants Inc.
Park Plaza Office Bldg.
462 East High St.
Lexington, KY 40508
(606) 252-3890

Statpac
Wallonick Associates
5624 Girard Ave. South
Minneapolis, MN 55419
(612) 866-9022

Statpro
Mark Imhof
and Steve Hewett
Wadsworth Electronic
Publishing Company
20 Providence
Boston, MA 02116
(617) 423-0420

SYSTAT
Systat Inc.
1127 Asbury Ave.
Evanston, IL 60202
(312) 864-5670

The Winchendon Group:
ELF and ARIMA
3907 Lakota Rd.
POB 10114
Alexandria, VA 22310
(703) 960-2587

program, Parafit, lets you enter your own one-variable function and then estimates the unknown coefficients of the function. The third program is a fairly standard multiple-regression program that permits transformations of the independent variable. It permits a direct computation using all the independent variables provided or a stepwise version (labeled iterative) that adds an independent variable at each step and calculates the improvement in fit provided. The fourth program performs an analysis of variance. It allows for several models with as many as five factors. Unfortunately, all but the one-way model must be balanced designs, that is, they must have the same number of observations in each cell.

One general comment about each program is that the documentation is brief. While each manual includes a worked-out example, the most extensive manual contains only 16 pages, much of which covers background theory. We had no problem getting the programs to perform their analyses.

EDA: Exploratory Data Analysis is an idea based on concepts described by Tukey in his 1977 book of the same name. The package is an extension of a series of programs in both BASIC and FORTRAN published in a 1981 paperback book by Velleman and Hoaglin. Almost none of the statistical procedures in our tables are provided by this package, so it is not listed there. True to Tukey's philosophy, however, many of those statistical procedures have nonparametric counterparts in EDA. They are counterparts in the sense that they attempt to determine many of the same characteristics of a data set, but they do so using methods that are based on fewer assumptions, are more resistant to extreme values, and do not calculate significance tests. Their purpose is to present the "lay of the land" in a data set, not to examine precise hypotheses, hence the name exploratory. The other packages reviewed here are not based on EDA although some produce EDA-type graphics.

The EDA package provides nine statistical routines, including stem-and-leaf displays, letter-value displays, box plots, condensed x - y plots, resistant line computations, smoothing computations, coded tables, median Polish tables, and rootgrams. In addition, it includes a few utility routines, such as data entry, editing, transformation, and file storage. The statistical concepts behind each routine are adequately described in the Velleman and Hoaglin book included with the disks. Operation of the program is described in a 13-page addendum. Although somewhat limited in scope, the package is easy to learn and can usefully perform the exploratory analyses for which it is intended, filling a unique niche among these packages.

HSD: A series of three programs, the HSD packages provide general descriptive statistics (Stats Plus), regression (HSD Regress II), and analysis of variance (ANOVA II) capabilities. We found Stats Plus difficult to use because of the confusion resulting from the use of two file types: random access and sequential. The user must remember that certain statistical and data-handling functions require a certain file type. For example, ANOVA

requires sequential files; cross tabulation requires random access; single data items cannot be deleted in sequential files; transformation errors are handled differently for each file type; data items are truncated during both keyboard input and transformations if the user-specified field width is exceeded for random-access files; and trailing blanks in search keys must be specified when searching random-access files.

In addition to the data-handling capabilities and high-resolution scatterplots of Stats Plus, Regress II features five regression procedures: simultaneous solution, forward solution, stepwise solution, backward solution, and polynomial regression. Regress II avoids the file-type confusion by using only random-access files for data. However, the user must still carefully plan the field widths of each variable entered or transformed.

ANOVA II shares the same data-handling capabilities of its sister packages while sticking with sequential files. The package features a mixed design capability—any combination of between-subjects and within-subjects factors up to a five-way ANOVA. Instead of using indicator variables to determine design cells, ANOVA II prompts for the data items in each cell. The user may either enter the data from the keyboard or specify a data file for each design cell.

Introstat 2.1: This package is targeted for people in the behavioral sciences, presumably because it makes special provision for case IDs. It is easy to use and does simple statistics. It has five different tests for significant differences among groups—we surmise that behavioral scientists want reassurance that their groups are really different!

This version uses only one disk drive. It is difficult to use with your data file on a disk other than the one that contains the programs since it does not indicate when to swap disks. Fortunately, the package is copyable and its code occupies less than half a disk (54K bytes), so plenty of room is available for several data sets of the size appropriate for this package (fewer than 3000 data items).

Although the entire data set is stored in RAM (random-access read/write memory) for fast manipulation, the data set must be read again each time a new option is selected from the main menu.

Microstat: This package was an enigma to us. On one hand it was a full-featured package with most of the desirable features one might wish for in a statistical package for professional use. On the other hand, we all had difficulty getting it to run without crashing at awkward times. Part of the difficulty was encountered in the installation procedure. Some of the installation parameters were not described in the manual (e.g., printer device number), and it crashed with the wrong number (0 worked). No error instructions or hints were given in the manual, and the cryptic screen comment was not helpful ("Out of bounds in line 1910"). Another part of the difficulty was the four levels of precision provided by the four BaZic interpreters included. A good feature of Microstat permits the user to make trade-offs between

Text continued on page 252

INDUSTRIAL GRADE IEEE-696/S-100 BOARDS

Dual Systems designs and manufactures a variety of IEEE-696/S-100 boards for 16-bit microprocessor systems running under UNIX and other operating systems. These boards bring high performance and three years of field-proven experience to your computing environment.

Each board is rigorously tested and burned-in for 168 grueling hours. If it can't bear the heat, it won't bear our name.

High Performance System Boards

Model WDC-SMD The WDC-SMD Hard Disk Controller* is specially designed for high throughput in large, heavily-loaded multi-user UNIX systems. All sectors on a track are transferred essentially within a single disk rotation regardless of where the head first settles or the order in which sectors are encountered.

The controller offers 16-bit throttled DMA data transfers and disk transfers up to 10 Mb/sec. Also features dual-ported, full-track, look ahead cache, and on-board microprocessor. Interfaces with one or two SMD drives. \$2195.

Model S104-DMA The most advanced, intelligent, 4-port serial I/O board available for the IEEE-696/S-100 bus, this module features 256 bytes of FIFO buffer for input characters and provides DMA transfers for output. A built-in 8085A processor greatly reduces system overhead. \$695.

*Patent Pending

Model DMEM Features 256K bytes of memory and either 8 or 16-bit data paths. 24-bit addressing, and parity checking on each byte. DMEM has no S-100 wait states. \$1395.

Model EPROM Capable of either 8 or 16-bit data transfers, this 32/64K EPROM offers the versatility of running with 68000, Z-8000, 8086, 16000, and other 16-bit processors. It accepts industry-standard 2732 and 2716 EPROMs. 64K RAMS may be mixed with 2716 EPROMs for use as a RAM/EPROM board. \$345.

Model CPU-68000M High-performance CPU board with 16-bit data path, 10 MHz CPU operation, and MC68451 MMU for multi-tasking applications. \$1195.

Model CPU-68000 Similar to 68000M, but features 8K bytes of on-board ROM with Motorola's MacsBug monitor instead of the Memory Management Unit. \$895.

Models M/BD-15 & 20 Back Planes These premium quality motherboards feature four-layer construction with two internal ground planes, and Schottky-diode termination. They provide high-speed operation with true transmission line characteristics and minimum noise. M/BD-15: \$495, M/BD-20: \$545.

Model CMEM This non-volatile CMOS memory board provides easy-to-use 8 or 16-bit data paths and 32K bytes of memory with dynamically movable write/protect window. On-board lithium battery holds data for 3-10 years with power off. \$725.

Data Acquisition and Control Boards

Model CLK-24C Clock-calendar features a LSI CMOS chip and on-board, long-life lithium battery. \$325.

Model AIM-12 A highly reliable A-to-D converter with 35msec. maximum conversion time, 12-bit resolution and accuracy, and 32 channels single-ended/16 channels differential. \$725.

Model AOM-12 This D-to-A converter offers I/O-mapped port address, 12-bit $\pm 1/2$ L.S.B. accuracy (0-70°C), and voltage outputs of 0 to 10 volts, ± 5 volts, and ± 10 volts. \$675.

Model VIC 4-20 Converts voltage outputs from AOM-12 into four separate 4-20MA current outputs. Module also provides overvoltage protection on all current output, plus transient protection per ISA standards. \$600.

For more information, call (415) 549-3854. Dual Systems Corp., 2530 San Pablo Avenue, Berkeley, CA 94702

THERE'S ONLY ONE
DUAL

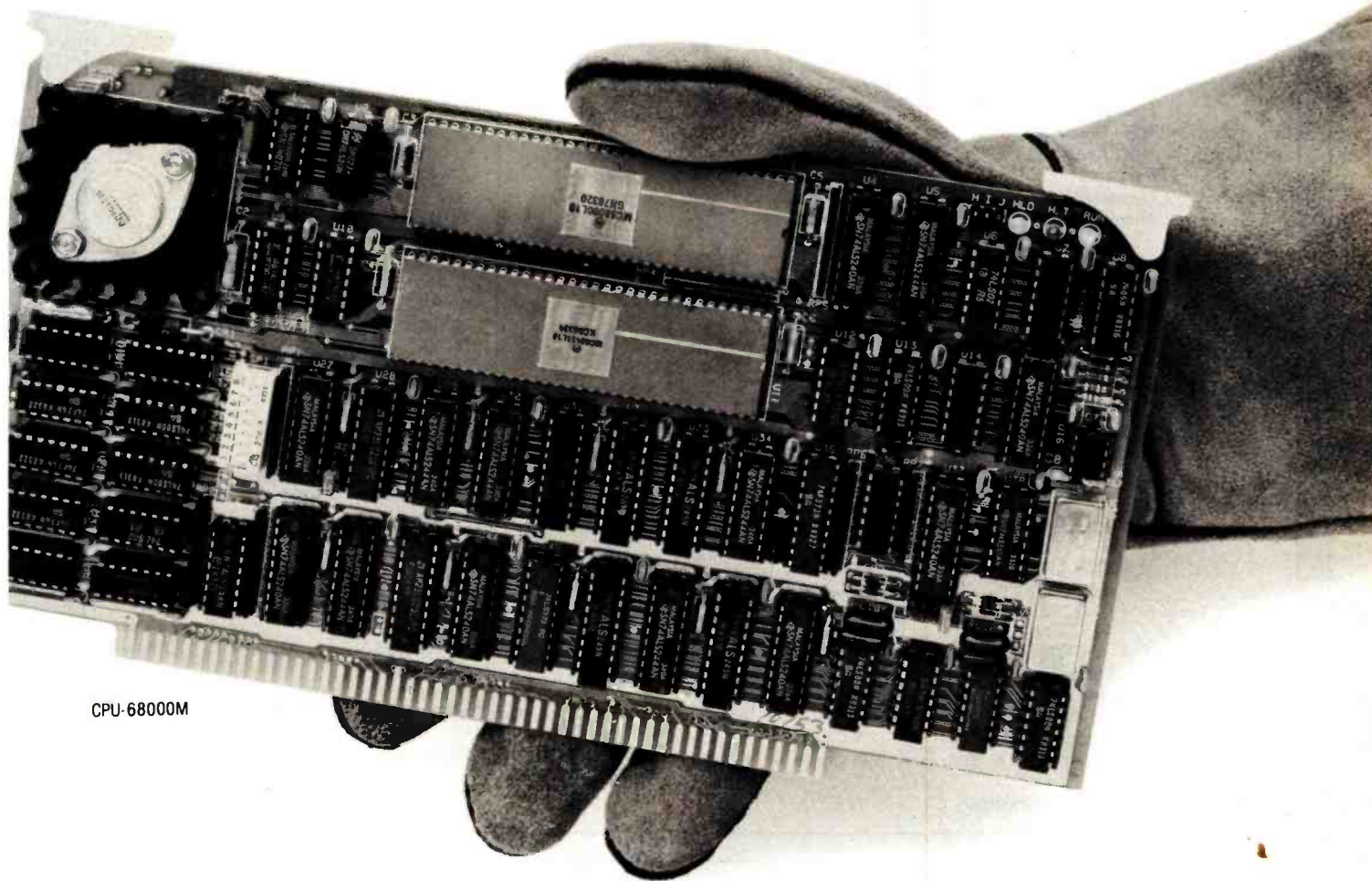

CPU-68000M

Interpreting the Tables

We found ourselves repeatedly dividing the packages into broad categories on the basis of their general characteristics, such as operating-system and hardware requirements, their limitations and documentation, their data-management features, and the range of statistical functions they perform. Tables 1-12 compare our assessment of these features for the software packages examined.

The first two tables provide general information. In particular, table 1 lists all available versions for various computers or operating systems. Tables 2-12 contain information specific to the version we tested. Our results often depend upon the particular version examined (e.g., the amount of data that can be processed). With a few exceptions, the packages were tested on an Apple II with 64K bytes of memory and two disk drives.

The following symbols are used throughout the tables: slash (/) means or; comma (,) means and; dash (—) means no, none, or not available; Y means yes; and question mark (?) means unknown.

General Characteristics

Table 1 covers program requirements.

Operating System: The packages examined operate on one of the following microcomputer operating systems: CP/M, UCSD

Pascal, PC-DOS, or Apple DOS. The systems are coded as follows: 8 = CP/M-80, 6 = CP/M-86, U = UCSD Pascal, P = PC-DOS, and A = Apple DOS.

RAM/Disk Drives: Stating disk-drive requirements is complicated by the range of storage capacity and format. The common disk sizes are 5¼ and 8 inches. However, the capacity of different configurations (single- vs. double-sided; single- vs. double-density) varies. Before selecting a package, be sure that your hardware can access the available disk formats provided by the distributor. If the program is distributed in a protected form, you may not be able to use peripherals such as hard disks or RAM disks. Be sure that the distributed format can be read on your system (e.g., buying a program that runs under the CP/M operating system does not guarantee that your particular hardware can read any of the distributed formats).

Additional Software Needed: The table indicates if additional software is needed to operate the package. For example, one package requires the BaZic language, a variant of BASIC. Many programs written in and supplied in BASIC require an interpreter. We have noted the following software requirements: A = Applesoft BASIC, P = UCSD Pascal p-code interpreter (for software supplied in UCSD compiled Pascal), Z = BaZic, and M = Microsoft BASIC (provided on disk with some, but not all, machines running CP/M or PC-DOS).

| | Operating Systems ¹ | RAM (K bytes), min ² | Disk Drives ² | Additional Software ^{3,2} | Price ⁴ |
|-------------------|--------------------------------|---------------------------------|--------------------------|------------------------------------|--------------------|
| ABSTAT | 8/6/P | 56/128/128 | 2 | — | \$395 |
| AIDA | A | 48 | 1 | A | \$235 |
| A-Stat | A/8/P | 48/56/64 | 1 | A | \$200 |
| Dynacomp Regr 1 | A | 48 | 1 | A | \$24 |
| Dynacomp Regr 2 | A | 48 | 1 | A | \$24 |
| Dynacomp Multilin | A | 48 | 1 | A | \$29 |
| Dynacomp ANOVA | A | 48 | 1 | A | \$44 |
| HSD Stats Plus | A | 48 | 1 | A | \$200 |
| HSD Regress II | A | 48 | 1 | A | \$150 |
| HSD ANOVA II | A | 48 | 1 | A | \$150 |
| Introstat | A/P/R | 48/64/48 | 1 | A/B/R | \$125 |
| Microstat | 8/P | 48/? | 2 | Z | \$325 |
| Micro-TSP | A/P | 48/64 | 1 | A/B | \$295 A |
| | | | | | \$395 I |
| Number Cruncher | 8/6/P | 56/?? | 1 | B | \$200 |
| NWA Statpak | 8/P/B | 48/?? | 2 | M/B | \$495 |
| SAM | A/8/6/P | 48/56/?? | 2 | A/M | \$395 |
| SpeedSTAT Vol. I | A | 48 | 2 | A | \$249 |
| SpeedSTAT Vol. II | A | 48 | 2 | A | \$299 |
| SPS | A/8/6/P | 48/64/64/64 | 1 | A/M/M/B | \$350 |
| STAN | UA/UI | 64/64 | 2 | U | \$300 G |
| | | | | | \$250 N |
| Statpro | UA/UI | 64/128 | 2 | — | \$2000 |
| SYSTAT | 8/P/X | 56/256/500 | 2 | — | \$495 |
| TWG ELF | A/8/6/P | 48/64/128/128 | 1/2/2/2 | A/—/—/— | \$200 A/E |
| | | | | | \$300 S |
| TWG ARIMA | A | 48 | 1 | A | \$300 A/E |
| | | | | | \$400 S |
| Wallonick Statpac | 8/P | 64/128 | 2 | — | \$399 |

1/ 8 = CP/M-80, 6 = CP/M-86, P = PC-DOS or MS-DOS, A = Apple DOS, B = B DOS, UA = Apple Pascal, UI = IBM Pascal, R = Atari DOS, X = Unix

2/ Listed in same order as the operating systems

3/ A = Applesoft BASIC, B = IBM BASIC, M = Microsoft BASIC, R = Atari BASIC, U = UCSD Pascal p-code, Z = BaZic

4/ A = Apple, I = IBM, G = with graphics, N = no graphics, E = 8-bit DOS, S = 16-bit DOS

Table 1: Program requirements.

Table 2 covers general program features.

Code Type/Extensibility: A valuable feature found in several packages is the capacity to extend the program with user-provided routines. This was normally possible only for programs such as A-Stat, which were provided on unprotected disks and came in source code (usually BASIC). In a few cases, such as AIDA, the program author described how the user could add routines or change the program computations or display. In other instances, by providing the source code for the program, the author makes it possible for the user to modify the program. The table contains entries to show whether source code was provided and whether methods for extending the package were provided and documented.

Copyability: The table notes if the package is copyable, allowing the purchaser to make backup copies. Unfortunately, some of the packages are distributed in a protected format that does not easily allow the creation of archival copies.

Separate Programs: The packages consisted either of a single program, perhaps containing subprograms automatically chained together, or of a series of individual programs. In the latter case, typified by NWA Statpak, the user must select and run the appropriate program for each purpose, returning each time to the operating-system level. A series of separate programs is, in our minds, less desirable since it is more confusing to the user, who must remember which program does what. Because it forces rereading of the data set as each new program is run, such a package can be time-consuming to operate.

Operation Style: The statistical packages operate either

through the use of menus or by a command language that is described in the table as Operation Style. A menu (coded M) provides an on-screen display of the options that can be selected at each step. A command language (coded C), such as that used by AIDA, displays only a program prompt on the screen while awaiting a syntactically correct reply from the user. We find the use of menus easier for the uninitiated; it certainly permits quicker initial use of the software. Once learned, however, a language allows the operator to select the desired options without having to answer a series of questions. A-Stat recently added a series of menus in addition to its command language.

A second aspect of ease of use is the presence of long sequences of prompts or questions (coded Q) from which the operator cannot escape, and which must be repeated each time a similar application is requested. This characteristic is usually associated with the menu style of operation. An improved method would allow for abbreviated entry by a more experienced user or for a method to escape from a program path entered by accident.

Batch Mode: The ability to use an external text file of commands to run the program, referred to as a batch operation on main-frame computers, is a useful option. While the advantages of a personal computer include interactive operation, the processing time for large data files may preclude a quick turnaround. A batch-mode option lets you submit a series of requests and leave the computer to process them.

Escape Option: Another aspect of ease of use is an escape sequence. This should be included in any system to allow escape

| | Code Type ¹ | Extensible | Copyable ² | Separate Programs | Operation Style ³ | Batch Mode | Escape Option | Help Function | Error Handling ⁴ |
|-------------------|------------------------|------------|-----------------------|-------------------|------------------------------|------------|---------------|---------------|-----------------------------|
| ABSTAT | O | — | Y | — | C,Q | Y | Y | Y | G |
| AIDA | S | Y | Y ¹ | — | C,Q | Y | — | Y | G |
| A-Stat | O,S | — | Y | — | M/C,Q | Y | Y | — | G |
| Dynacomp Regr 1 | S | Y | Y | — | Q | — | — | — | P |
| Dynacomp Regr 2 | S | Y | Y | — | Q | — | — | — | P |
| Dynacomp Multilin | S | Y | Y | — | Q | — | — | — | P |
| Dynacomp ANOVA | S | Y | Y | — | Q | — | — | — | P |
| HSD Stats Plus | ? | — | — | — | M,Q | — | Y | — | F |
| HSD Regress II | ? | — | — | — | M,Q | — | Y | — | F |
| HSD ANOVA II | ? | — | — | — | M,Q | — | Y | — | F |
| Introstat | S | — | Y | — | M,Q | — | — | — | F |
| Microstat | O | — | Y | — | M,Q | — | — | — | P |
| Micro-TSP | ? | — | Y ¹ | — | C,M,Q | Y | — | — | G |
| Number Cruncher | S* | — | Y | — | M | — | — | — | P |
| NWA Statpak | S | — | Y | Y | Q,C | — | — | — | F |
| SAM | S | — | — | — | M,Q | — | Y | Y | P |
| SpeedSTAT Vol. I | S | — | — | — | M,Q | — | Y | — | G |
| SpeedSTAT Vol. II | S | — | — | — | M,Q | — | Y | — | G |
| SPS | S | Y | Y | — | M,Q | — | Y | — | F |
| STAN | O | — | Y | Y | M,Q | Y | — | Y | P |
| Statpro | O | — | Y | — | M,Q | — | Y | Y | F |
| SYSTAT | O | — | Y | Y | C | Y | — | Y | G |
| TWG ELF | S/O | — | Y | — | M,Q | — | — | — | P |
| TWG ARIMA | S | — | Y | — | M,Q | — | — | — | P |
| Wallonick Statpac | O | — | Y | — | M | Y | — | — | F |

1/ S = Source, O = Object, B = Both, * = Protected BASIC, cannot list source code

2/ f = Programs are but boot disk is not copyable

3/ C = Commands, M = Menus, Q = Questions (listed in order of predominant use)

4/ G = Good (recoverable, explains, indicates source of error), F = Fair, P = Poor

Table 2: General program features.

| | Equipment We Used ¹ | Maximum Capacity ² | | | Case-Handling Method ³ | Missing-Data Methods ⁴ | Variable Types ⁵ | No. Significant Digits ⁶ |
|-------------------|--------------------------------|-------------------------------|--------------|-----------------------|-----------------------------------|-----------------------------------|-----------------------------|-------------------------------------|
| | | No. of Variables | No. of Cases | No. Data Items (000s) | | | | |
| ABSTAT | A,C,D | 64 | ? | 2 | M | C/P/O/ | R | 7 |
| AIDA | A | 254 | 4000 | 17 | V | C | R | 4.5 |
| A-Stat | A | 45 | ? | D | C | C/P | R | 9 |
| Dynacomp Regr 1 | A | 2 | ? | ? | M | — | R | 9 |
| Dynacomp Regr 2 | A | 2 | ? | ? | M | — | R | 9 |
| Dynacomp Multilin | A | ? | ? | ? | M | — | R | 9 |
| Dynacomp ANOVA | A | 2 | ? | ? | M | — | R | 9 |
| HSD Stats Plus | A | 20 | 600 | 12 | M | — | R | 9 |
| HSD Regress II | A | 20 | ? | 2 | M | — | R | 9 |
| HSD ANOVA II | A | 5 | ? | 1-10 (V) | M | — | R | 9 |
| Introstat | A | ? | ? | 4.8 | M | ? | R | 9 |
| Microstat | A,C,D | ? | D | D | C | C | R | 8/10/12/14 |
| Micro-TSP | A,I | 20/G | ? | 5 | M | — | R | 9 |
| Number Cruncher | I | 100 | D | D | C | C | R | 8 |
| NWA Statpak | A,I | V | V | V | M,C | C | R,I,C | 16 |
| SAM | A | ? | ? | ? | M | C | R,C | 9 |
| SpeedSTAT Vol. I | A | 128 | 2048 | 13 | M | P | I,R,C | 4.5 |
| SpeedSTAT Vol. II | A | 128 | 2048 | 13 | M | C | I,R,C | 4.5 |
| SPS | A | ? | ? | 4 | M | C | R | 9 |
| STAN | A | 31 | D | D | C | C | R,C | 7 |
| Statpro | A,I | 36/72 | 750/1200 | 27 | C | C/P | R | 7 |
| SYSTAT | K,I | 50/75 | D | D | C | C/P/O | R,C | 15 |
| TWG ELF | A | 250 | M | M | C | C/O | R | 9 |
| TWG ARIMA | A | ? | ? | 0.5 | M | — | R | 9 |
| Wallonick Statpac | I | 255 | 5000 | D | C | O | R | ? |

1/ All entries in this and the following tables were evaluated with respect to versions tested on this equipment. A = Apple II+ with 64K bytes of RAM, C = CP/M card, D = 80-column card, I = Compaq or IBM PC with 256K bytes, K = Kaypro II

2/ (Capacity may vary among package versions.) D = Limited by disk capacity, G = 58 variables allowed if graphics not used, M = Multidisk (unlimited capacity), V = Varies by program

3/ M = Memory, C = Read case by case, V = Virtual memory

4/ C = Casewise, P = Pairwise, O = Other

5/ R = Real, I = Integer, C = Character

6/ More significant digits may be available for other operating-system versions

7/ e, where range is $\pm 10^e$

8/ N, where N is the maximum number of categories allowed

9/ N = Numeric, C = Character, B = Both N and C, P = Position of variable in file record

Table 3: Limitations on the data.

from the current operation, should it be entered incorrectly.

Help Function: Several of the packages, such as ABSTAT, STAN, and SYSTAT, contain a help function to obtain a description of the options currently available.

Error Handling: In the best of all worlds, a user who encounters a problem will receive a detailed message showing how to exit from the current predicament and correct the problem. Unfortunately, the error handling in many of the packages is poor. The user is rarely given insight into the source of the problem and is occasionally thrown forcibly out of the program.

Table 3 covers limitations on the data.

Maximum Capacity: Although most packages operate on computers with as little as 48K bytes of memory, they have limitations on the number of cases, number of variables per case, or on the product of these (referred to as data items). In many instances, the limitation is due to a requirement that the entire data set fit in memory or on a single storage disk.

In other situations, the file size is limited by the dimension of arrays. This limitation can be overcome if source code for the pack-

age is provided. Some of the packages request the number of variables to be used and then indicate the number of cases that can be used. These programs dynamically dimension the storage.

The limitation may be on the total number of cases (rows of the data array) or variables (columns of the data array). Alternatively, it might be a limit on the total number of data items. The table identifies either the upper limits on number of cases, number of variables per case, or total number of data items, when these were specified. In some instances, when the limits were not stated, we were able to determine these limits by examining the source code.

Case-Handling Methods: The approach to data handling used by the program is described in one of three ways. On one extreme, coded M and exemplified by SpeedSTAT and ABSTAT, the entire data set must fit into memory. This limits the amount of data while maximizing the speed of processing. At the other extreme, coded C, programs such as A-Stat and STAN process the data set one record at a time. The entire data set must be read for each function. This approach maximizes the amount of data that can be handled but slows processing. A preferred method, coded V and

| Value Ranges Quantitative ⁷ | | | Variable Identifiers | |
|---|---------|--------------------------|-------------------------|---------------------------|
| Real | Integer | Qualitative ⁸ | Type ⁹ | Max. Length (if char.) |
| 17 | — | — | B | 8 |
| 4.5 | — | 100 | B | 10 |
| 37 | — | 20 | B | 255 |
| 37 | — | — | P | — |
| 37 | — | — | P | — |
| 37 | — | — | P | — |
| 37 | — | — | P | — |
| 37 | — | — | B | 6 |
| 37 | — | — | B | 6 |
| 37 | — | — | B | 6 |
| 37 | — | — | B | 10 |
| ? | — | — | B | 5 |
| 37 | — | — | C | 6 |
| 38 | — | — | N | — |
| 38 | 4.5 | ? | P | — |
| 37 | — | ? | B | 4 |
| 3.1 | 8 | 1296 | B | 16 |
| 3.1 | 8 | 1296 | B | 16 |
| 37 | — | — | C | 4 |
| 38 | — | 127 | C | 8 |
| 38 | — | — | B | 9 |
| 35 | — | 50 | B | 12 |
| 37 | — | — | C | 8 |
| 37 | — | — | C | 8 |
| 37 | — | ? | C | 40 |

used by AIDA, has the appearance of a virtual system. In this system, variables are called into memory as they are needed. If a variable not currently in memory is needed, it will be read into memory at that time.

Missing-Data Methods: Statistical packages typically handle missing data in one of two ways. One method is to exclude an entire case from the analysis if any variable is missing within the case. This method obviously eliminates a lot of cases. An alternative is to exclude only the missing variable value from statistical operations that require it. For example, regression analysis requires a sum of cross products. In pairwise deletion, a case with a missing value on one variable will be treated as follows: the missing variable cannot be used in the computation of cross products that contain it; however, all other variable cross products will be computed for the case. A description of the treatment of missing data is shown as C = casewise deletion, P = pairwise deletion, O = other, or "—" = none. Preparation for missing data varies by package. Often, a specific character or value is required to denote missing data.

Variable Types: Three data types were found: real, integer, and character. Few packages permit all three types as allowable input.

Maximum Decimals/Value Ranges: We describe the precision of usable data in two ways. For real and integer data, the table gives the absolute range of values as a power of 10 (e.g., $10 + \text{Er}$). It also shows the number of digits of precision used in computations when this was noted in the documentation. For qualitative data, the table indicates the number of unique levels permitted.

Variable Identifiers: The nature and length of user-supplied labels are shown. Typical options for identification are numeric only (e.g., VAR001), alpha only (e.g., AGE or INCOME), or a choice of either.

Table 4 covers documentation.

The user must depend heavily on the documentation provided with the package and on-screen displays to learn how to use the program and to resolve problems. The documentation is enhanced if it contains a tutorial including example applications. For packages that present menus and questions, sample runs should be included to indicate typical responses. For packages that are command oriented, an alphabetized reference section is helpful. Regardless of operating style, an index should be included.

Other items noted in the documentation comparisons are whether there is a reference card summarizing the available commands, a description of the technical formulas, and a list of technical references relevant to the statistical procedures. A list of formulas used in computations would clarify the procedures used by the program's author. NWA Statpak, SpeedSTAT, and Statpro had extensive documentation on the formulas used in their computations. We comment on these matters of documentation and offer our overall assessment of ease of use.

Data Management and Processing

In these tables, we describe how the packages manage and process data. First we discuss the entry, editing, storage, retrieval, and display of data. Then we talk about the packages' ability to process the data through subsetting, merging, sorting, and transforming.

Table 5 covers data management.

Keyboard Entry: Almost all statistical software packages permit the entry of raw data from the keyboard. However, some packages running under CP/M or UCSD Pascal require the data to be prepared in a machine-readable form with an operating-system editor or by output from another program. The table indicates whether the package permits you to enter the data from the keyboard.

Access Foreign Data: Another characteristic we examined was the capacity to read from or write to files that can be used or created by other programs. First, we note whether the package can access a standard operating-system file. This is typically an ASCII file with fixed column positions for variables or with a delimiter such as a comma or space between variables. To access the standard file, you may need to reformat it using a utility provided with the package or your own program designed according to information provided in the documentation.

One increasingly common format is that of the DIF (Data Interchange Format) file introduced by Software Arts Products Inc. (creators of Visicalc). DIF is a standard format that authors can use to make their data files compatible. Another valuable file for-

| | Number of Pages | Table of Contents | Index | Summary Card | Tutorial | Sample Runs | Formulas | No. Technical References | Easy to Use |
|-------------------|-----------------|-------------------|-------|--------------|----------|-------------|----------|--------------------------|-------------|
| ABSTAT | 94 | Y | Y | — | Y | Y | Y | 0 | Y |
| AIDA | 89 | Y | Y | Y | Y | Y | — | 15 | Y |
| A-Stat | 140 | Y | — | Y | Y | Y | — | 5 | Y |
| Dynacomp Regr 1 | 12 | — | — | — | — | Y | — | 0 | — |
| Dynacomp Regr 2 | 14 | — | — | — | — | Y | Y | 1 | — |
| Dynacomp Multilin | 16 | — | — | — | — | Y | Y | 1 | — |
| Dynacomp ANOVA | 15 | — | — | — | — | Y | — | 2 | — |
| HSD Stats Plus | 104 | Y | Y | — | Y | Y | — | 5 | Y |
| HSD Regress II | 82 | Y | Y | — | Y | Y | — | 7 | Y |
| HSD ANOVA II | 52 | Y | Y | — | Y | Y | — | — | Y |
| Introstat | 57 | Y | Y | — | Y | — | — | 1 | Y |
| Microstat | 99 | Y | — | — | — | Y | — | 1 | Y |
| Micro-TSP | 175 | Y | Y | — | Y | — | Y | 5 | Y |
| Number Cruncher | 78 | Y | — | — | Y | Y | — | 1 | Y |
| NWA Statpak | 250 | Y | Y | — | — | Y | Y | 2 | Y |
| SAM | 39 | Y | — | — | — | Y | — | 0 | Y |
| SpeedSTAT Vol. I | 174 | Y | Y | — | Y | — | Y | 7 | Y |
| SpeedSTAT Vol. II | 250 | Y | Y | — | Y | — | Y | 10 | Y |
| SPS | 115 | — | Y | — | — | — | — | 15 | — |
| STAN | 101 | Y | — | — | — | Y | — | 11 | Y |
| Statpro | 381 | Y | Y | Y | Y | — | Y | 14 | Y |
| SYSTAT | 239 | Y | Y | Y | Y | Y | — | 63 | Y |
| TWG ELF | 118 | Y | Y | — | Y | Y | — | 8 | — |
| TWG ARIMA | 73 | Y | Y | — | Y | — | — | 16 | — |
| Wallonick Statpac | 105 | Y | — | — | — | — | Y | 2 | Y |

Table 4: Documentation features.

| | Access Foreign Data | | | | | Edit | | | |
|-------------------|---------------------|-----------------------|-----------|----------------|---------------------------------|-----------------------|--------|-----|--------|
| | Keyboard Data Entry | Standard System Files | DIF Files | dBASE II Files | File Documentation ¹ | Single Data Structure | Change | Add | Delete |
| ABSTAT | Y | Y | — | Y | — | — | Y | Y | Y |
| AIDA | Y | Y | — | — | — | Y | Y | Y | — |
| A-Stat | Y | Y | Y | — | G | Y | Y | Y | — |
| Dynacomp Regr 1 | Y | Y | — | — | — | — | Y | Y | Y |
| Dynacomp Regr 2 | Y | Y | — | — | — | — | Y | Y | Y |
| Dynacomp Multilin | Y | Y | — | — | — | — | Y | Y | Y |
| Dynacomp ANOVA | Y | Y | — | — | — | — | Y | Y | — |
| HSD Stats Plus | Y | Y | — | — | I | — | Y | Y | — |
| HSD Regress II | Y | Y | — | — | I | Y | Y | Y | Y |
| HSD ANOVA II | Y | Y | — | — | G | — | Y | — | — |
| Introstat | Y | Y | — | — | G | Y | Y | Y | Y |
| Microstat | Y | — | — | — | G | Y | Y | Y | Y |
| Micro-TSP | Y | Y | Y | — | I | Y | Y | Y | Y |
| Number Cruncher | Y | — | — | — | I | Y | Y | Y | — |
| NWA Statpak | Y | Y | — | — | G | — | Y | Y | Y |
| SAM | Y | Y | — | — | I | Y | Y | Y | Y |
| SpeedSTAT Vol. I | Y | — | Y | — | — | Y | Y | Y | — |
| SpeedSTAT Vol. II | Y | — | Y | — | — | Y | Y | Y | Y |
| SPS | Y | Y | Y | — | G | Y | Y | Y | Y |
| STAN | — | Y | — | — | G | Y | — | — | — |
| Statpro | Y | Y | — | — | — | Y | Y | Y | Y |
| SYSTAT | Y | Y | — | — | I | Y | Y | Y | Y |
| TWG ELF | Y | Y | Y | — | G | Y | Y | Y | — |
| TWG ARIMA | Y | Y | Y | — | G | Y | Y | Y | — |
| Wallonick Statpac | Y | Y | — | — | G | Y | Y | Y | Y |

1/ G = Good, I = Incomplete

2/ F = Flexible, I = Inflexible

3/ Y = Package provides the means to turn printer on and off, A = To print a run session, user must direct all output to a text file by a command given at beginning of the session of each module and then list the text file

Table 5: Data management.

mat is that used by the dBASE II database package that operates under CP/M, CP/M-86, and PC-DOS. The table notes if either of these formats is supported. Table 5 also indicates if a standard operating-system ASCII file can be generated and read by the program.

File Documentation: Most packages use their own file format for storage of data. If standard system files cannot be read or written, it is important that the internal file format be documented. Without this, you will be limited to keyboard entry of data and will not be able to use your data with any other program. Table 5 indicates if adequate documentation is provided to permit access to internal files.

Single Data Structure: An important data-management feature that is related to ease of use is the nature of the data structure employed. Most programs use a single data structure in which the cases are rows of the file (records) and the variables are columns. Some packages, however, turn this definition around for some of the analytical options, defining a column as a sample or group. For example, both the HSD ANOVA II and Statpro ANOVA options use two different formats, depending on the type of analysis being conducted. This varying of a file definition is potentially confusing, and we believe that it should be avoided.

Edit: After initial entry, you may have to add new records, edit existing records, or delete unneeded records. These functions may be accomplished within the package or you may be required to do this yourself. None of the editing operations provided are full-screen

activities. The usual method is to specify the record number and then the variable name that is to be changed. The current entry might then be displayed and the new entry requested.

We point out that an edit function may not be considered necessary, especially if the required operating system provides an editor. Of course, the use of an external editor can result in some inconvenience. Discovery of data errors will necessitate that you exit from the package, complete the required edit, and then return to the statistical package. This is not as handy as being able to make corrections from within the program.

Store Results on Disk: Another useful feature is the option either to print the output or to store it into a file that can later be used by a word processor.

Print: An obviously important feature of a statistical package is the ability to obtain a hard copy of the results. Flexibility in printed output is described in the table. As a minimum, you will want to display the data or a subset of it. The table indicates whether this printout has a rigid format (I = inflexible) or can be controlled (F = flexible). The ability to get hard copy of the session, including the numerical results and possibly the prompts and responses, is noted.

Table 6 covers data processing.

Selecting Cases: You may want to perform an analysis on a subset of your data or conduct simultaneous analyses on several subsets or strata. Most packages allow a degree of filtering of the file to analyze subsets. The table summarizes the presence of this feature; it notes if you can subset by case numbers or by variable ranges. Subsetting by variable range is usually done with logical statements regarding one or more variables. The table provides the following categories: S = single range, A = Boolean AND permitted, B = Boolean AND and OR permitted between ranges of variables, and V = a list of specific values may be requested. The A and B codes indicate that two or more logical statements can be specified either for a single variable or for two or more variables.

Join Files: You may need to expand an existing file with additional data representing new cases or new variables on old cases. The presence of either join operation is noted.

Sort: Sorting of a file may be desired or may be a requirement to correctly perform certain analysis options. In at least one package, the data must be sorted to obtain ranks. The table notes the presence of a sort operation.

Transform: Frequently, transformations of data are required. Transformations might include simple univariate functions such as logical operations, adding a constant, or taking logs. Alternatively, the transformation might involve computations such as addition or multiplication, which use more than one variable. We note whether the usual arithmetic operations (+, -, *, /) are permitted and whether other math functions can be used to create new variables from existing ones. We also check for the capability of generating random variables for use in simulations. The computation of some probability density function, cumulative density function, and inverse CDF is noted. While it may be possible to compute these using functions provided for transforming data, we indicate in the table if a specific, single-step transform is provided.

Method: The method of specifying the transformation varies. Some packages require a command with supplied parameters (denoted C), others use a menu to select the transformation (denoted M), and still others require a BASIC or Pascal-like formula to be supplied (denoted F).

Conditional Transform: This option lets you limit the transformation to only those cases that meet specific conditions, such

| Store Analytic Reports | Print | | |
|------------------------|-----------------------------|--------------------------|---------|
| | Formatted Data ² | Run Session ³ | Results |
| Y | I | Y | Y |
| — | I | Y | Y |
| Y | F | Y | — |
| — | — | — | — |
| — | — | — | — |
| — | — | — | — |
| — | I | — | Y |
| — | F | — | Y |
| — | I | — | Y |
| — | F | Y | Y |
| — | F | — | Y |
| Y | I | Y | Y |
| Y | F | — | Y |
| Y | F | Y | Y |
| Y | I | Y | Y |
| Y | I | — | Y |
| Y | I | — | Y |
| Y | F | A | Y |
| Y | I | — | Y |
| Y | F | Y | Y |
| — | I | — | Y |
| — | I | — | Y |
| — | I | Y | Y |

| | Selecting Cases | | Join Files | | Sort ² | | | Transform | | | |
|-------------------|-----------------------------|--------------------------------|------------|---------------|-------------------|----------------|-----------------------------|-------------|--------------------|-------------------|-------------|
| | By Case Number ¹ | By Variable Range ¹ | Casewise | Variable-wise | Max. No. Vars | Asc/Descending | Variable Types ³ | Random Vars | Prob. Dens. Funct. | Cum. Dens. Funct. | Inverse CDF |
| ABSTAT | A | A | Y | Y | M | A | N | Y | — | — | — |
| AIDA | S | S | Y | Y | 1 | A | N | Y | — | — | — |
| A-Stat | S | S | Y | Y | M | A | C | Y | — | — | — |
| Dynacomp Regr 1 | — | — | — | — | — | — | — | — | — | — | — |
| Dynacomp Regr 2 | — | — | — | — | — | — | — | — | — | — | — |
| Dynacomp Multilin | — | — | — | — | — | — | — | — | — | — | — |
| Dynacomp ANOVA | — | — | — | — | — | — | — | — | — | — | — |
| HSD Stats Plus | — | A | Y | Y | — | — | — | — | — | — | — |
| HSD Regress II | — | A | Y | Y | — | — | — | — | — | — | — |
| HSD ANOVA II | — | — | Y | Y | — | — | — | — | — | — | — |
| Introstat | S | — | Y | Y | 2 | A | N | Y | — | — | — |
| Microstat | S | — | Y | Y | M | A/D | N | Y | Y | Y | — |
| Micro-TSP | S | — | Y | Y | — | — | — | — | — | — | — |
| Number Cruncher | — | — | — | Y | 1 | A | N | Y | — | — | — |
| NWA Statpak | A | A | Y | Y | 1 | A/D | N/C | Y | Y | Y | — |
| SAM | — | S | Y | Y | — | — | — | — | — | — | — |
| SpeedSTAT Vol. I | S | — | — | — | — | — | — | — | — | — | — |
| SpeedSTAT Vol. II | S | S | — | — | — | — | — | — | — | — | — |
| SPS | S | S | Y | Y | 1 | A | R | Y | — | — | — |
| STAN | — | — | — | — | M | A | N/C | Y | — | — | — |
| Statpro | S | A | Y | — | 1 | A | N | Y | — | — | — |
| SYSTAT | B | B | Y | Y | 1 | A/D | N | Y | — | — | — |
| TWG ELF | — | B | — | — | — | — | — | Y | — | — | — |
| TWG ARIMA | — | B | — | — | — | — | — | Y | — | — | — |
| Wallonick Statpac | — | B | Y | Y | 1 | A/D | N | — | — | — | — |

1/ In one step: V = Value list, S = Single range, A = Boolean AND of ranges, B = Boolean AND and OR ("Case Number" is a variable with values assigned sequentially by the package. Thus, "time period" may serve as a case number.)

2/ M = Four or more

3/ N = Numeric, C = Character

4/ C = Command and parameters, M = Menu, F = Formula statements, Q = Questions

Table 6: Data processing.

| | Means | | | Moments | | Coefficients | | |
|-------------------|------------|----------|-----------|----------|----------------|--------------|----------|-----------|
| | Arithmetic | Harmonic | Geometric | Variance | Std. Deviation | Skewness | Kurtosis | Variation |
| ABSTAT | Y | — | — | Y | Y | Y | Y | Y |
| AIDA | Y | — | — | Y | Y | — | — | — |
| A-Stat | Y | — | — | Y | Y | — | — | — |
| Dynacomp Regr 1 | — | — | — | — | — | — | — | — |
| Dynacomp Regr 2 | — | — | — | — | — | — | — | — |
| Dynacomp Multilin | — | — | — | — | — | — | — | — |
| Dynacomp ANOVA | — | — | — | — | — | — | — | — |
| HSD Stats Plus | Y | — | — | — | Y | — | — | — |
| HSD Regress II | Y | — | — | Y | Y | — | — | — |
| HSD ANOVA II | Y | — | — | — | Y | — | — | — |
| Introstat | Y | — | — | Y | Y | — | — | — |
| Microstat | Y | — | — | Y | Y | Y | Y | Y |
| Micro-TSP | Y | — | — | Y | Y | — | — | — |
| Number Cruncher | Y | — | — | Y | Y | Y | Y | — |
| NWA Statpak | Y | Y | Y | Y | Y | Y | Y | Y |
| SAM | Y | — | — | Y | Y | Y | Y | — |
| SpeedSTAT Vol. I | Y | — | — | Y | Y | Y | Y | — |
| SpeedSTAT Vol. II | Y | — | — | Y | Y | Y | Y | — |
| SPS | Y | — | — | Y | Y | Y | Y | Y |
| STAN | Y | — | — | — | Y | — | — | — |
| Statpro | Y | Y | Y | Y | Y | Y | Y | Y |
| SYSTAT | Y | — | — | — | Y | Y | Y | — |
| TWG ELF | Y | — | — | Y | Y | Y | Y | — |
| TWG ARIMA | — | — | — | — | — | — | — | — |
| Wallonick Statpac | Y | — | — | Y | Y | Y | Y | — |

Table 7: Summary statistics.

Transform

| | | Other Math Functions | Lag() (capability) | Method ⁴ | Conditional Transf. ¹ |
|---|-------|----------------------|---------------------|---------------------|----------------------------------|
| + | - * / | | | | |
| Y | | Y | Y | F | A |
| Y | | Y | Y | C/F | B |
| Y | | Y | — | C | S |
| — | | Y | — | M/F | — |
| — | | Y | — | — | — |
| — | | Y | — | M/F | — |
| — | | — | — | — | — |
| Y | | Y | — | M | — |
| Y | | Y | — | M | — |
| Y | | Y | — | M | — |
| Y | | Y | — | F | — |
| Y | | Y | Y | F | — |
| Y | | Y | Y | F | — |
| Y | | Y | Y | M | S |
| Y | | Y | Y | Q,M | A |
| Y | | Y | Y | F | — |
| — | | — | — | — | — |
| Y | | Y | Y | M | — |
| Y | | Y | — | M | — |
| Y | | Y | Y | F | — |
| Y | | Y | Y | M/F | A |
| Y | | Y | Y | F | B |
| Y | | Y | Y | F | B |
| Y | | Y | Y | F | B |
| Y | | Y | — | C/F | B |

as falling within a range of case numbers or having a specified range of values for some variable. If a case does not meet the conditions, it is generally given a missing value for the transformed variable. However, in at least one case, ELF, it is given the value of the previous case.

Statistical Functions

We classified the statistical functions performed by the packages into one of several categories: summary statistics, graphics, non-parametrics, linear models, and time series. Several packages recognize the need to permit case weighting for survey data based on probability samples or for heteroscedastic models. Below, we describe each category and note when case weighting is permitted.

Table 7 covers summary statistics.

In the computation of descriptive statistics, we view separately the analysis of qualitative data and quantitative data. A distinction between the two would be useful to prevent irrelevant actions such as the computation of means on nominal data; however, few of the programs examined maintained such a distinction. We note what summary statistics the packages develop. Among these are means, standard deviations and other moments of the distribution, percentiles, and order statistics (order statistics identify the smallest to largest of the sample values). In some cases, ranks can be obtained, but only through a multistep operation involving sorting. Several packages (such as A-Stat) require precomputation and storage of statistics, such as means and correlations for input into linear-model options.

Use of Weights: When analyzing survey data, it is frequently necessary to use a weighting variable to correctly reflect the importance of each case. We note if the package allows for the specification of a weight variable. (The same computation can be done via a transformation involving multiplying all the variables in the analysis by the weight variable. However, this involves a lot of extra work and the creation of numerous transformed variables.) The availability of a direct weight option is a real virtue when it is needed.

Table 8 covers graphics.

Since most personal computers have graphics capabilities, we expected to find fairly sophisticated graphical applications within statistical packages. Unfortunately, this is the exception rather than the rule. Many graphical displays, especially histograms, are of a simple low-resolution text form. With two exceptions, the data-display features fall into two areas: histograms and bivariate plots. The Statpro graphics package (Apple version) provides many other graphical displays, including pie charts, triangular scatterplots, and normality plots to check analysis assumptions. SYSTAT's Graphics module options include normal probability plots, contour plots, and stem-and-leaf displays.

Graphics displays for the various packages vary widely in their general form. We use the following codes to describe this: T denotes text character displays, L indicates a low-resolution (i.e., block) display, and H denotes the use of high-resolution pixel graphics. The table indicates whether a color display is provided and whether you can supply titles and labels. (Some packages label the graphs automatically, using the variable names.)

The table notes if automatic formation of groups for histograms is provided or if the user may optionally define them. When scatterplots are requested, we note whether the user may select the scaling and centering parameters or if it can be done automatically by the program. Clearly, the most general approach for both

Order Statistics

| Percentiles | Order Statistics | | | Use of Weights |
|-------------|------------------|---------------|-------------|----------------|
| | Ranks | Trimmed Means | Min. & Max. | |
| — | Y | — | Y | — |
| — | Y | — | Y | Y |
| — | — | — | Y | — |
| — | — | — | — | — |
| — | — | — | — | — |
| — | — | — | — | — |
| Y | Y | — | Y | — |
| — | Y | — | — | — |
| — | Y | — | — | — |
| — | — | — | Y | — |
| — | Y | — | Y | — |
| — | Y | — | Y | — |
| — | — | — | Y | — |
| — | — | — | Y | — |
| — | Y | — | Y | — |
| — | Y | — | Y | — |
| — | Y | Y | Y | Y |
| — | — | — | Y | Y |
| — | — | — | — | — |
| — | — | — | Y | — |

| | Mode ¹ | Color | Titles | Labels | 1-Var. Histogram | Histogram Grouping ² | 3-D Histograms | X-Y Scatter- plot | Scatter- plot Scaling ² | 3-D Scatter- plot |
|-------------------|-------------------|-------|--------|--------|---------------------|------------------------------------|-------------------|-------------------------|--|-------------------------|
| ABSTAT | T | — | — | — | Y | B | — | Y | B | — |
| AIDA | H | — | — | — | Y | M | — | Y | A | — |
| A-Stat | — | — | — | — | — | — | — | — | — | — |
| Dynacomp Regr 1 | T | — | — | — | — | — | — | Y | A | — |
| Dynacomp Regr 2 | T | — | — | — | — | — | — | Y | A | — |
| Dynacomp Multilin | T | — | — | — | — | — | — | Y | A | — |
| Dynacomp ANOVA | — | — | — | — | — | — | — | — | — | — |
| HSD Stats Plus | H | — | Y | Y | Y | M | — | Y | A | — |
| HSD Regress II | H | Y | Y | Y | — | — | — | Y | A | — |
| HSD ANOVA II | H | — | Y | Y | — | — | — | — | — | — |
| Introstat | H | — | — | Y | — | — | — | Y | B | — |
| Microstat | T | — | Y | Y | Y | M | — | Y | B | — |
| Micro-TSP | H | — | — | — | — | — | — | Y | A | — |
| Number Cruncher | T | — | Y | Y | Y | B | — | Y | B | — |
| NWA Statpak | T | — | Y | — | Y | B | — | Y | B | — |
| SAM | T | — | — | — | Y | B | — | Y | A | — |
| SpeedSTAT Vol. I | — | — | — | — | — | — | — | — | — | — |
| SpeedSTAT Vol. II | — | — | — | — | — | — | — | — | — | — |
| SPS | H | — | — | — | Y | M | — | Y | A | — |
| STAN | H | — | Y | — | — | — | — | Y | A | — |
| Statpro | H | Y | Y | Y | Y | B | — | Y | B | — |
| SYSTAT | T | — | Y | Y | Y | B | — | Y | B | — |
| TWG ELF | H,T | Y | — | Y | Y | A | — | Y | A | — |
| TWG ARIMA | T | — | — | — | — | — | — | Y | A | — |
| Wallonick Statpac | T | — | Y | Y | Y | M | — | Y | A | — |

1/ T = Text, L = Low-Res, H = Hi-Res

2/ A = Automatic, M = Manual, B = Both, — = None

3/ P = Print, F = File, — = No, G = Lo-res graphics can be printed, hi-res can be saved to a file

Table 8: Graphics.

| | Friedman Two-Way ANOVA | Kendall's Tau | Kolmogorov- Smirnov | Kruskal- Wallis H | Mann- Whitney U | Spearman Rank-Order Cor. | Wilcoxon Signed Rank | Wald- Wolfowitz Runs |
|-------------------|------------------------------|------------------|------------------------|----------------------|--------------------|--------------------------------|----------------------------|----------------------------|
| ABSTAT | — | — | — | — | Y | Y | — | — |
| AIDA | — | — | — | Y | — | Y | — | — |
| A-Stat | — | Y | — | — | — | — | — | — |
| Dynacomp Regr 1 | — | — | — | — | — | — | — | — |
| Dynacomp Regr 2 | — | — | — | — | — | — | — | — |
| Dynacomp Multilin | — | — | — | — | — | — | — | — |
| Dynacomp ANOVA | — | — | — | — | — | — | — | — |
| HSD Stats Plus | — | — | — | — | — | — | — | — |
| HSD Regress II | — | — | — | — | — | — | — | — |
| HSD ANOVA II | — | — | — | — | — | — | — | — |
| Introstat | — | — | — | — | Y | — | Y | — |
| Microstat | Y | — | Y | Y | — | Y | Y | Y |
| Micro-TSP | — | — | — | — | — | — | — | — |
| Number Cruncher | Y | Y | — | Y | Y | Y | Y | Y |
| NWA Statpak | Y | Y | Y | Y | Y | Y | Y | — |
| SAM | — | — | — | — | — | — | — | — |
| SpeedSTAT Vol. I | — | Y | — | — | — | Y | — | — |
| SpeedSTAT Vol. II | — | Y | — | — | — | Y | — | — |
| SPS | — | — | — | — | — | Y | — | — |
| STAN | — | — | — | — | — | — | — | — |
| Statpro | — | — | Y | Y | Y | Y | Y | Y |
| SYSTAT | — | — | — | — | — | Y | — | — |
| TWG ELF | — | — | — | — | — | — | — | — |
| TWG ARIMA | — | — | — | — | — | — | — | — |
| Wallonick Statpac | — | — | — | — | — | — | — | — |

1/ M = Depends on amount of free memory (RAM) (approx. 1000 cells), D = Depends on printer (80-col. printer: 10 x arbitrary; 132-col.: 19 x arbitrary)

2/ R = Row, C = Column, E = Cell

Table 9: Nonparametrics and tables

| Box & Whiskers | Pie Chart | Save Graphics ³ |
|----------------|-----------|----------------------------|
| — | — | PF |
| — | — | F |
| — | — | — |
| — | — | — |
| — | — | — |
| — | — | — |
| — | — | F |
| — | — | F |
| — | — | F |
| — | — | — |
| — | — | P |
| — | — | F |
| — | — | — |
| — | — | PF |
| — | — | — |
| — | — | — |
| — | — | — |
| — | — | — |
| — | — | F |
| Y | Y | PF |
| Y | — | PF |
| — | — | G |
| — | — | P |
| — | — | P |

types of display is the possibility of manual override of an otherwise automatic operation.

The table also indicates if other graphics displays, such as three-dimensional bivariate histograms, pie charts, or Box & Whiskers diagrams, are featured. (A Box & Whiskers diagram is a special form of histogram that identifies various percentiles. Its appearance is that of a box containing the median and denoting the second and third quartiles of the distribution surrounded by whiskers locating other percentiles.)

Finally, we note whether the package allows graphical displays to be printed directly or saved to a file. Typically, high-resolution graphics can only be saved to a file so the user is responsible for the printer interface.

Table 9 covers nonparametrics and tabulation capabilities.

Nonparametric statistics assume no underlying mathematical model to the data. They also do not make assumptions about the distribution of errors where parametric approaches usually require that data have a normal or Gaussian distribution. As the table shows, few packages provide these statistics.

A description of the ability of the program to produce crosstabs of quantitative data is shown. We have included an entry indicating the computation of associated statistics, such as a test of the independence of rows and columns.

The table also shows which of several types of Chi-square tests can be performed. These include the usual test of independence of marginals, the goodness of fit, and other hypotheses of probability models, such as conditional independence or log-linear model parameters. Also noted is the ability to accept frequency counts as an alternative to creating and recreating the table from the raw data items for each analysis.

| Kendall's Coef. of Conc. | Tables | | | Chi-Square Tests | | | Data Entry | | Calculate Percents ² |
|--------------------------|-------------------|---------------------------------|---------------------|------------------|-------------------|------------|-------------|-------|---------------------------------|
| | No. of Dimensions | Max. No. of Levels ¹ | Indep. of Marginals | Goodness of Fit | Log-Linear Models | Data Items | Frequencies | | |
| — | 2 | D | Y | Y | — | Y | Y | R,C,E | |
| — | 2 | 100 x 100 | Y | — | — | Y | — | R,C | |
| Y | 2 | 15 x 15 | Y | — | — | Y | — | R,C,E | |
| — | — | — | — | — | — | — | — | — | |
| — | — | — | — | — | — | — | — | — | |
| — | — | — | — | — | — | — | — | — | |
| — | 5 | 9 x 9 | Y | — | — | Y | Y | R,C,E | |
| — | — | — | — | — | — | — | — | — | |
| — | — | — | — | — | — | — | — | — | |
| — | 2 | 10 x 10 | Y | — | — | Y | — | — | |
| Y | 2 | 5 x 20 | Y | Y | — | Y | Y | E | |
| — | — | — | — | — | — | — | — | — | |
| — | 2 | ? | Y | — | — | Y | Y | R,C,E | |
| — | 2 | 10 x 500 | Y | Y | — | Y | Y | R,C,E | |
| — | 2 | ? | Y | — | — | — | — | R,C,E | |
| — | 2 | 128 x 2048 | Y | — | — | Y | — | R,C,E | |
| — | 2 | — | — | — | — | — | — | — | |
| Y | 2 | 10 x 10 | Y | — | — | Y | — | R,C | |
| — | — | — | — | — | — | — | — | — | |
| — | 2 | 12 x 9 | Y | Y | — | Y | Y | R,C,E | |
| — | 50 | 50 x 50 | Y | Y | Y | Y | Y | R,C,E | |
| — | 3 | M | Y | — | — | Y | Y | R,C,E | |
| — | — | — | — | — | — | — | — | — | |
| — | 2 | 50 x 50 | Y | — | — | Y | — | R,C,E | |

| | Regression | | | | T-Tests | | ANOVA | | | |
|-------------------|------------|-----------------------|------------|----------|---------|--------|-------|-----------|---------------------------------|----------------|
| | Simple | Multiple ¹ | Polynomial | Stepwise | Paired | Groups | N-way | Contrasts | Unequal Cell Sizes ² | Random Effects |
| ABSTAT | Y | Y | — | — | Y | Y | 2 | — | — | — |
| AIDA | Y | Y | — | — | Y | Y | 1 | — | — | — |
| A-Stat | Y | Y | — | — | Y | Y | 2 | — | Y | — |
| Dynacomp Regr 1 | Y | — | Y | — | — | — | — | — | — | — |
| Dynacomp Regr 2 | — | — | — | — | — | — | — | — | — | — |
| Dynacomp Multilin | Y | Y | — | Y | — | — | — | — | — | — |
| Dynacomp ANOVA | — | — | — | — | — | — | 5 | — | — | — |
| HSD Stats Plus | Y | — | — | — | Y | Y | 2 | — | Y | — |
| HSD Regress II | Y | Y | Y | Y | — | — | — | — | — | — |
| HSD ANOVA II | — | — | — | — | — | — | 5 | Y | Y | — |
| Introstat | Y | — | — | — | Y | Y | 2 | — | — | — |
| Microstat | Y | Y | — | Y | Y | Y | 2 | — | — | — |
| Micro-TSP | Y | Y | — | — | — | — | — | — | — | — |
| Number Cruncher | Y | Y | — | Y | Y | Y | 4 | Y | Y | Y |
| NWA Statpak | Y | Y | Y | Y | Y | Y | 3 | — | — | Y |
| SAM | Y | Y | — | Y | Y | Y | 10 | — | — | — |
| SpeedSTAT Vol. I | — | — | — | — | — | — | — | — | — | — |
| SpeedSTAT Vol. II | Y | Y | Y | Y | — | — | — | — | — | — |
| SPS | Y | Y | — | — | — | Y | 1 | Y | — | — |
| STAN | Y | Y | — | — | — | — | — | Y | — | — |
| Statpro | Y | Y | Y | Y | Y | Y | 3 | — | Y | Y |
| SYSTAT | Y | Y | Y | Y | Y | Y | 30 | Y | Y | Y |
| TWG ELF | Y | Y | — | Y | Y | Y | 2 | — | — | Y |
| TWG ARIMA | — | — | — | — | — | — | — | — | — | — |
| Wallonick Statpac | Y | Y | — | — | Y | Y | 2 | Y | — | — |

1/ More than two independent variables
 2/ For higher than one-way ANOVA

Table 10: Linear models.

| | Equipment Used ³ | Longley's Data | Longley's Data |
|---------------------|-----------------------------|----------------------|------------------|
| | | (all 6 indep. vars.) | (3 indep. vars.) |
| ABSTAT | A,C | 2.9 | 5.2 |
| AIDA | A | 2.0* | 3.2* |
| A-Stat | A | 3.2 | 5.0 |
| Dynacomp Multilin | A | 2.6 | 5.9 |
| HSD Regress II | A | Refused | 7.5 |
| Microstat | A,C | 5.2 | Not Run |
| Micro-TSP | A | 5.7 | 6.6 |
| Number Cruncher | I | 6.8 | 6.6 |
| NWA Statpak | A,C | 3.7 | 6.5 |
| SAM | A | 4.3 | 8.0 |
| SpeedSTAT Vol. II | A | Refused | 3.6* |
| SPS | A | 1.8 | 4.9 |
| STAN | A | Refused | 7.6 |
| Statpro | I | 5.2 | 8.3 |
| SYSTAT | I | 9.0 | 9.0 |
| TWG ELF | A | 3.1 | 8.7 |
| Wallonick Statpac | I | 5.6 | 9.0 |
| WRYALG ² | B | Not Available | 3.3 |

1/ All coefficients were rounded to 9 decimal digits before averaging
 2/ WRYALG stands for the "worst routine you are likely to get" (see reference 1)
 3/ A = Apple II Plus, C = CP/M card, I = IBM PC, B = mainframe computer, single precision, * denotes that input is restricted to 4.5 digits. We therefore had to manually adjust the regression coefficients by the appropriate power of 10.

Table 11: Average accuracy of regression coefficients (maximum accuracy is 9 digits¹).

| Uses Weighted Data | Discriminant Anal. | Factor Anal. | Gen. Lin. Models | Save Residuals | Diagnostics | | | | | |
|--------------------------|-----------------------|-----------------|------------------------|-------------------|----------------|--------------------|---------------------------|--------------|-------------------|---|
| | | | | | Cor. Matrix | Var-Cov. Matrix | Inverse of Var-Cov. | Partial R | Durbin- Watson | |
| — | — | — | — | Y | Y | — | — | — | — | Y |
| Y | — | — | — | Y | Y | — | — | — | — | — |
| Y | — | Y | — | Y | Y | — | — | — | — | Y |
| — | — | — | — | — | — | — | — | — | — | — |
| — | — | — | — | — | — | — | — | — | — | — |
| — | — | — | — | — | — | — | — | — | — | — |
| — | — | — | — | — | Y | — | — | — | — | — |
| — | — | — | — | — | Y | — | — | Y | Y | Y |
| — | — | — | — | — | Y | — | — | — | — | — |
| — | — | — | — | Y | Y | Y | — | Y | Y | Y |
| — | — | — | — | Y | Y | — | — | — | — | Y |
| Y | — | Y | — | Y | Y | — | — | — | — | Y |
| — | — | — | — | Y | Y | Y | — | — | — | Y |
| — | Y | Y | — | Y | Y | — | — | — | — | — |
| — | — | — | — | — | — | — | — | — | — | — |
| — | — | Y | Y | Y | Y | Y | — | Y | Y | Y |
| Y | — | — | Y | Y | — | — | — | — | — | Y |
| — | Y | Y | Y | Y | Y | Y | — | — | — | — |
| — | Y | Y | — | — | Y | — | — | — | — | Y |
| — | — | — | — | — | — | — | — | — | — | — |
| — | — | — | — | Y | Y | — | Y | Y | — | Y |

The table also indicates the kinds of percentages that can be calculated: row, column, or cell.

Table 10 covers linear models.

Although regression analysis, discriminant analysis, and ANOVA are all variations of the General Linear Model, they are often treated as separate operations within a statistical package. Most programs examined provide distinct routines to perform these analyses.

Simple and Multiple: A common use for a statistical package is the computation of simple or multiple regression coefficients and estimates of their significance. Most packages provide this capability. Programs performing these computations usually include the r-square (percent of variance explained) value as part of the results.

Polynomial: The table notes if a separate polynomial-regression option is available. Polynomial regression includes various powers, such as squares and cubes, of a single predictor variable. While transformations of the data may be possible to obtain the same result, a number of programs provide this analysis directly.

Stepwise: When examining a large set of potential predictor variables, the ability to step through them in an ordered way can be instructive. Stepwise regression lets you examine the incremental effects of the various predictors and determine how much added predictive power comes from including them.

ANOVA: The table indicates the level of complexity provided for ANOVA problems. It notes if higher than one-way analyses are permitted. If so, the capability for using unbalanced designs

is described. Another feature identified is the ability to analyze repeated measure designs. Other useful options would be the display of estimated means, multiple range tests, and the specification of tests of contrasts. We have noted only the presence of tests of contrasts.

General Linear Model: Only a few programs, one example being STAN, permit the automatic generation of dummy variables from quantitative data. These variables can be used to conduct ANOVA or discriminant analyses (this feature is indicated in the table as the General Linear Model, GLM). If the GLM, ANOVA, or discriminant-analysis options are not present, the user must create the required dummy variables either by transformation, if available, or by direct entry of the design matrix.

Discriminant Analysis: This linear model is used to predict which of several groups a case belongs in based on a number of independent variables. It is a variation of multiple regression where the dependent variable is qualitative rather than quantitative.

Factor Analysis: This technique seeks the underlying variables that cause variation in the observed cases. Although a host of methods for defining factors are available, we have noted only if at least one option is provided.

The area in which the packages differ greatly is in the additional support needed to conduct a thorough analysis. Merely computing the desired model coefficients and their significance is not enough.

Save Residuals: One desirable option for most models is the storage of residual values, the differences between the observed and

| | Two-Stage OLSQ | Serial (Auto) Cor. | Cochrane- Orcutt | ARIMA | Moving Averages* | Fourier Analysis |
|-------------------|-------------------|--------------------------|---------------------|-------|---------------------|---------------------|
| ABSTAT | — | — | — | — | — | — |
| AIDA | — | — | — | — | — | — |
| A-Stat | — | — | — | — | — | — |
| Dynacomp Regr 1 | — | — | — | — | — | — |
| Dynacomp Regr 2 | — | — | — | — | — | — |
| Dynacomp Multilin | — | — | — | — | — | — |
| Dynacomp ANOVA | — | — | — | — | — | — |
| HSD Stats Plus | — | — | — | — | — | — |
| HSD Regress II | — | — | — | — | Y | — |
| HSD ANOVA II | — | — | — | — | — | — |
| Introstat | — | — | — | — | — | — |
| Microstat | — | — | — | — | Y | — |
| Micro-TSP | Y | Y | Y | — | — | — |
| Number Cruncher | — | — | — | — | — | — |
| NWA Statpak | — | Y | — | — | Y | Y |
| SAM | — | — | — | — | — | — |
| SpeedSTAT Vol. I | — | — | — | — | — | — |
| SpeedSTAT Vol. II | — | — | — | — | — | — |
| SPS | — | — | — | — | — | — |
| STAN | — | Y | — | — | — | — |
| Statpro | Y | Y | — | — | Y | — |
| SYSTAT | — | Y | — | — | — | — |
| TWG ELF | — | — | — | — | — | — |
| TWG ARIMA | — | Y | — | Y | Y | — |
| Wallonick Statpac | — | — | — | — | — | — |

* Complete functional routines. For capability to produce moving averages using lag with other transformations, see table 6.

Table 12: Time series.

predicted values. If the residuals are saved as a new variable, they can be plotted and examined using the graphics routines.

Diagnostics: Other important support options for linear models include an analysis of residuals for the presence of autocorrelation (such as the computation of the Durbin-Watson *d* statistic) or with bivariate plotting. Yet other useful features include the computation of correlation or covariance matrices, crucial to the stability of the computed effects.

Table 11 covers statistical accuracy.

In a broad sense, statistical accuracy means getting the correct answer to your problem. We have limited our examination to the results obtained for one type of problem, multiple regression, since most packages have this capability. Further, this is a commonly desired analysis.

Computation errors for a given set of data and specified model typically arise from one of three sources: the algorithm used (a feature of the program), the precision (limited by hardware and system software), and the condition of the data matrix. For multiple regressions, the computed coefficients are particularly affected by these errors while the predicted values and estimates of multiple correlation are comparatively unaffected (see references 1 and 3).

Algorithm and precision errors are likely to creep in during the process of calculating and inverting the sum of cross products matrix required to compute a regression. Many procedures exist for doing this, and many have notably poor precision since they

involve taking differences of large quantities (see reference 8).

Several measures have been proposed to reflect the condition of the data. By this we mean the extent to which small changes in the data will produce large changes in the solution (see reference 4). As a test of performance, we calculated regression coefficients for a "troublesome" data set and compared them with the "best" result. The data consisted of 16 observations on seven national economic variables used for this type of comparison (see reference 3). The data is highly colinear and has a high perturbation index; that is, small changes will result in large differences in the estimated regression coefficients. Since the relative performance of the packages could change under another set of ill-conditioned data, we conducted a second test using a subset of the variables that was relatively well conditioned.

We compared the output of the packages for the ill-conditioned problem with the "best result known to us," obtained by Longley on a desk calculator. His results agree with the DORTHO (double-precision ORTHO) routine used by Beaton (see reference 6). We used the same method for the better-conditioned problem, as well. We must note that, for the ill-conditioned data, the "best" result differs substantially from the "correct" solution (see reference 1).

To measure the number of digits of agreement with the "best" result, we used a slight modification of a formula used by Wampler (see reference 7). For a calculated value, *b*, and a "true" value, *t*, the number of digits of agreement is

| | Documentation | Data Management | Data Processing | Summary Statistics | Graphics | Nonparametrics & Tables | Linear Models | Time Series |
|-------------------|---------------|-----------------|-----------------|--------------------|----------|-------------------------|---------------|-------------|
| ABSTAT | G | G | G | G | F | G | G | — |
| AIDA | G | G | G | G | G | G | F | — |
| A-Stat | F | G | G | G | — | G | G | — |
| Dynacomp Regr 1 | F | F | — | — | F | — | F | — |
| Dynacomp Regr 2 | F | F | — | — | F | — | — | — |
| Dynacomp Multiin | F | F | — | — | F | — | F | — |
| Dynacomp ANOVA | F | F | — | — | — | — | F | — |
| HSD Stats Plus | G | F | F | F | G | G | F | — |
| HSD Regress II | G | F | F | F | F | — | F | F |
| HSD ANOVA II | G | — | F | — | — | — | F | — |
| Introstat | G | G | G | F | F | G | F | — |
| Microstat | G | G | G | G | F | G | G | F |
| Micro-TSP | G | G | F | F | F | — | F | G |
| Number Cruncher | F | F | F | G | F | G | G | — |
| NWA Statpak | G | G | G | G | F | G | G | G |
| SAM | F | G | F | G | F | F | G | — |
| SpeedSTAT Vol. I | G | F | — | G | — | G | — | — |
| SpeedSTAT Vol. II | G | F | F | G | — | F | F | — |
| SPS | F | G | F | G | G | G | G | — |
| STAN | G | F | F | F | F | — | G | F |
| Statpro | G | F | G | G | G | G | G | F |
| SYSTAT | G | G | G | G | F | G | G | F |
| TWG ELF | G | G | F | G | G | F | G | — |
| TWG ARIMA | G | G | F | — | F | — | — | G |
| Wallonick Statpac | F | G | G | G | F | F | F | — |

G = Good
 F = Fair
 — = None or Negligible

Table 13: Ratings of main features.

$$\begin{aligned}
 & - \log(|b-t|/m) \text{ if } m < > 0 \text{ and } b < > t \\
 \text{or } & - \log(|b-t|) \text{ if } m=0 \text{ and } b < > t \\
 \text{or } & d \text{ if } b=t
 \end{aligned}$$

where m is the minimum of the absolute values of b and t , and d is the digits of precision used by the statistical package. The table shows the value averaged over all coefficients in each data set for each package. As a comparison, we show this value for the "worst routine you are likely to get."

Table 12 covers time series.

Several packages provide for the analysis of serially correlated data. The possibilities are through two-stage ordinary least squares, computation of autocorrelation coefficients, Fourier power spectra analysis, moving averages, or ARIMA models.

Table 13 is a summary.

We have tried to summarize the various tables into one overview. This table contains a single rating (G = good, F = fair, and "—" = negligible) for each of the general categories examined. We produced this table by adding entries from the earlier tables.

Documentation: To get a good rating here, a package had to have a table of contents, an index, and either a tutorial or sample runs. A fair rating was given if it had only an index or a table of contents and either a tutorial or sample runs.

Data Management: A good rating was given if the package could perform all the following: allow two or more edit functions

(entry, edit, add, or delete), make a hard copy of an entire session, and access foreign data files. A fair rating was given if the package could do two or three of these.

Data Processing: To obtain a good rating, a package had to permit case selection, join and sort files, and perform transformations. A fair rating was given for two or three of these.

Summary Statistics: We gave a rating of good if the package could compute means and standard deviations, one other coefficient shown in the table, and order statistics. A fair rating was given for doing two or three of the four.

Graphics: This was a more difficult area to summarize. We settled on a good rating for the production of histograms and high-resolution scatterplots or for exceptional capabilities in the production of scatterplots. A fair was given for packages with only one of the two displays.

Nonparametrics: To obtain a good rating, the package had to produce tables and perform at least one nonparametric test. A fair rating was given for only one of these.

Linear Models: We rated a package good if it included both multiple regression and analysis of variance options (both might be accomplished through the use of the General Linear Model) and at least one diagnostic statistic. A fair rating was given for performing only one of the analyses.

Time Series: A good rating was given to packages with two or more of the displayed options. A fair was given for one option.

EXPOTEK

1-800-528-8960

Guaranteed Low Prices

IBM CALL SAVES

AST, Hercules, Maynard, Persyst, Quadram.

Ram Memory 4164-150 \$59/9 per set

TERMINALS

| | |
|------------------|-------|
| Adds | |
| A-1 Green | \$485 |
| A-2 Green | 490 |
| Viewpoint 60 | 619 |
| Hazeltine | |
| Esprit I | 485 |
| Esprit II | 540 |
| Esprit III | 735 |
| Qume | |
| QVT 102 Green | 535 |
| QVT 102 Amber | 550 |
| QVT 103 Green | 840 |
| QVT 103 Amber | 850 |
| Televideo | |
| 910 + | 549 |
| 925 | 699 |
| 950 | 899 |
| 970 | 975 |
| Wyse | |
| Wyse 100 | 680 |
| Wyse 300 | 1020 |
| Visual | |
| Visual 50 Green | 599 |
| Visual 55 Green | 720 |
| Zenith | |
| Z-29 | 635 |

MODEMS

| | |
|----------------------|-----|
| Hayes | |
| Smart 300 | 199 |
| Smart 1200 | 485 |
| U.S. Robotics | |
| Password | 375 |

PRINTERS

| | |
|--|----------------|
| C. Itoh | |
| Pro-writer I (8510A) Par. | 339 |
| Pro-writer (8510A) Serial | 439 |
| 1550 Parallel | 529 |
| 1550 BCD SERIAL | 589 |
| F-10 40CPS | 949 |
| F-10 55CPS | 1269 |
| Comrex Call - Save \$ | |
| Daisywriter | |
| Daisywriter 2000 | 999 |
| Daisywriter Cable | 40 |
| Datasouth | |
| DS120 | 595 |
| DS180 | 1155 |
| DS220 | 1590 |
| Diablo | |
| 620 (25CPS/Serial) | 875 |
| 630 (40CPS/Multi-IF) | 1710 |
| Epson All models Call - Save \$ | |
| IDS p series color Call - Save \$ | |
| Juki | |
| 6100-18 | 469 |
| Okidata | |
| All models | Call - Save \$ |
| Mannesman-Tally | |
| 160L | 589 |
| 180L | 829 |
| NEC | |
| 3550 (For IBM PC) | 1589 |
| 3510 | 1365 |
| 7710 | 1890 |
| Qume | |
| 1140 W/IBM Interface | 1359 |
| 1155 W/IBM Interface | 1489 |
| Star Micronics | |
| Gemini 10X | CALL |
| Gemini 15X | CALL |
| Gemini 15 | 370 |
| Silver Reed | |
| EXP 550P | 575 |
| Toshiba | |
| P-1350 | 1499 |
| Transtar | |
| 120 P | 499 |
| 315 Color Printer | 499 |
| Sheet Feeders & Tractors CALL | |

COMPUTERS

| | |
|--------------------------|------|
| Altos | |
| 580-10 | 3550 |
| 586-10 | 6598 |
| 586-14 | 7680 |
| 8600-12 | 8399 |
| Columbia Call | |
| Eagle Call | |
| Franklin Call | |
| Pied Piper Call | |
| NEC Portable Call | |
| Northstar | |
| Advantage | 2160 |
| Advantage w/5MB | 3345 |
| Advantage w/15MB | 4315 |
| Televideo Systems | |
| 802 H | 4210 |
| 803 | 1815 |
| 1603 | 2150 |
| 806/20 | 4775 |
| 800 A (user station) | 999 |
| Teleport | Call |
| Zenith Call | |

MONITORS

| | |
|------------------|-----|
| Amdek | |
| Video 300 GREEN | 129 |
| Video 300 AMBER | 145 |
| Color I Plus | 275 |
| Color II Plus | 425 |
| BMC | |
| 12" Green | 89 |
| 12" Color | 219 |
| NEC | |
| JB 1201 | 155 |
| JB 1260 | 115 |
| Taxan | |
| 12" Amber | 125 |
| Zenith | |
| 12" Green Screen | 95 |
| 12" Amber Screen | 120 |

DISK DRIVES

| | |
|---|----------------|
| Tandon | |
| 5 1/4" TM 100-1 SS/DD 160K | 150 |
| 5 1/4" TM 100-2ADS/DD 320K | 225 |
| TM101 4/96 TPI Quad Den) | 339 |
| Indus (for Atari) Call - Save \$ | |
| Pertec | |
| 5 1/4" FD200-5 (160 K SS/DD 40TR) | 139 |
| 5 1/4" FD250-5 (320 K DS/DD 40TR) | 195 |
| Micro-Sci | |
| A-2 (35TR) | 225 |
| A-40 (40TR) | 269 |
| Rana | |
| 1000 (for Atari) | Call - Save \$ |
| Elite I | 249 |
| Elite II | 399 |
| Elite III | 509 |

CUSTOMER SERVICE (602) 861-1141 TWX 910 950-1194
10439 N. CAVE CREEK RD. #111 PHOENIX AZ 85020

Text continued from page 236:

execution speed and precision by choosing the appropriate interpreter, but the drawback is that all related parameters and data files must be matched to the chosen interpreter or the program crashes. For example, a data file created by the 14-digit-precision interpreter cannot be read by the 8-digit one. An additional section in the manual is badly needed to help users interpret commonly encountered error messages and to suggest remedies. Without doubt, long-term experience with Microstat would permit users to avoid these errors.

Ecosoft is planning to release a new version of Microstat written in the C language about the time this review is published. The compiled version should greatly improve the speed of execution.

Micro-TSP: This package provides regression-based tools for modeling and forecasting time series. The tools are four varieties of multiple linear regression (one dependent variable): ordinary least squares (OLSQ), first-order autoregressive correction of OLSQ (the Cochrane-Orcut method), and two-stage least squares with and without the autoregressive correction. Each technique is executed by a command that produces a table of the coefficients with their standard errors and t-statistics and some summary statistics, such as the adjusted R-squared, standard error of the regression, and the Durbin-Watson statistic. Micro-TSP remembers the coefficients from the most recent regression and uses them in the command that automatically generates forecasts over a user-specified period. The only other statistical command provides summary statistics, including a covariance matrix, for a group of series.

Several time series can be plotted simultaneously versus time by typing the command PLOT followed by a list of series names. PLOT(N) produces normalized plots of time series (subtract mean and divide by standard deviation of the series). A plot of the residuals from the most recent regression can be obtained by PLOT(R). Scatterplots of one series versus another can be obtained from the GRAPH command. PLOT and GRAPH produce high-resolution graphics on the Apple but require a color/graphics monitor adapter for the IBM PC.

Micro-TSP is easy to use and well suited for handling time series of up to several hundred observations each. We have several minor criticisms that could be corrected in future versions. The requirement that the user describe the time dimension of data in a file before the file can be loaded is unforgivable, especially since there is no way to obtain the information from within the package, although it is stored at the beginning of the file itself. Next, although the workfile feature provides a quick way to save all time series currently in RAM under one filename (a handy method for interrupting your work), Micro-TSP has two sets of file-handling commands: one for the time series in the workfile and one for the series on disks. Why not have just one set of commands with a consistent single-letter parameter to reference the disk?

The manual has a good introduction on how to use two of the four regression types in three chapters featuring case studies of actual problems and real data. The

A TIMELY ANNOUNCEMENT FOR ProDOS™ USERS:

Congratulations! You not only have a powerful new operating system in Apple's* ProDOS, you can now get an incredibly versatile Clock/Calendar card to use with it. PROCLOCK™.

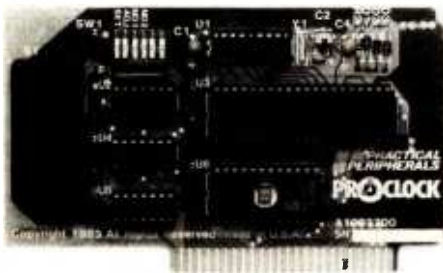

PROCLOCK is the first Clock/Calendar designed for ProDOS-based systems as well as other Apples running DOS 3.3, CP/M**, Pascal, Applesoft*, and BASIC.

What's more, PROCLOCK fully emulates Superclock II, Thunderclock Plus and Apple Clock*. So programs written for these products can be used without any modification.

Of course, PROCLOCK will time- and date-code files. And consider how much money you could save by timing your modem to transmit when the phone rates are cheapest. You can even use PROCLOCK as part of an automatic appliance control system.

Plus, PROCLOCK's powerful interrupt capabilities are invaluable to programmers working with time-sensitive routines and multi-tasking. It can generate interrupts at intervals of 1 millisecond, 1 second, 1

minute, 1 hour, or any combination of those. And all interrupts are software-controlled and handled through PROCLOCK's on-board PIA.

Speaking of software, you also get a diskette full of sample programs, utilities and applications like our Time-Clock II job/time logging program.

PROCLOCK even includes one feature we don't expect anyone to take advantage of—a 10-year lithium battery that keeps the clock running even if your computer is left off for long periods of time.

But just try to keep away from your Apple long enough to put that to the test! With PROCLOCK, you'll have a whole new world of applications to explore. And plenty of time to explore it. Because PROCLOCK is a reliable, well-built piece of hardware. So well-built, it's backed by a five-year warranty.

Ask your dealer about PROCLOCK. It's perfect timing for ProDOS users!

Another practical product from Practical Peripherals—makers of MICROBUFFER™, PRINTERFACE™, GRAPHICARD™, and SERIALL™.

**PRACTICAL
PERIPHERALS**

31245 La Baya Drive, Westlake Village, CA 91362
(818) 991-8200 • TWX 910-336-5431

*ProDOS, Apple, Applesoft and Apple Clock are registered trademarks of Apple Computers, Inc. **CP/M is a registered trademark of Digital Research, Inc.

ATTENTION LA36 USERS

The DS120 Terminal Controller makes your LA36 perform like a DECwriter® III.

The Datasouth DS120 gives your DECwriter® II the high speed printing and versatile performance features of the DECwriter® III at only a fraction of the cost. The DS120 is a plug compatible replacement for your LA36 logic board which can be installed in minutes. Standard features include:

- 165 cps bidirectional printing
- Horizontal & Vertical Tabs
- Page Length Selection
- 110-4800 baud operation
- 1000 character print buffer
- X-on, X-off protocol
- Self Test
- RS232 interface
- 20 mA Current Loop interface
- Top of Form
- Adjustable Margins
- Double wide characters
- Parity selection
- Optional APL character set

Over 9,000 DS120 units are now being used by customers ranging from the Fortune 500 to personal computing enthusiasts. In numerous installations, entire networks of terminals have been upgraded to take advantage of today's higher speed data communications services. LSI microprocessor electronics and strict quality control ensure dependable performance for years to come. When service is required, we will respond promptly and effectively. Best of all, we can deliver immediately through our nationwide network of distributors. Just give us a call for all the details.

datasouth
computer corporation

P.O. Box 240947 • Charlotte, North Carolina 28224
704 / 523-8500

Monitor Mover Gives You Back Your Desk



Monitor Mover frees up valuable work space while keeping your CRT close at hand. It adjusts in four ways to each individual user. To free up even more space put your system on the side of your desk with the System Sidekick.

Monitor Mover \$129.95
System Sidekick \$79.95

Lintek 
Computer Accessories

Dealer inquiries
welcome.

P.O. Box 8056, Grand Rapids, MI 49508 (616) 241-4040

other two types are described briefly but not illustrated.

Number Cruncher: This unpretentious program performs many tasks simply and well. It would probably not be ranked first in any single area, but it provides the common procedures one might want in each area. The main menu offers three choices plus exit. To begin, it is always necessary to either create or open a data file. You then choose from an array of 31 transformations on the second menu or proceed directly to the third menu of 13 different statistical procedures. Once a file is opened, it stays open through all the procedures until a new file is opened, and a status comment stays at the top of the screen naming the open file. Entering data to a file is easy, but adding variables to a full file is more laborious, necessitating the creation of a new file and the merging of both files, naming all variables again in the process. "Naming" the variables really means re-assigning the variable numbers since the program does not accept character names.

A broad array of useful transformations is available, and new variables can easily be created, provided space for them was allocated when the data file was opened. When opened, all variables for all cases are initialized to 0, which lets most statistical procedures process the file without interference, even with "empty" variables allocated for future use. However, some statistical procedures get confused about zeros. One such case is the crosstab program, which leaves valid zeros off without accounting for them. Unlike many of the other procedures, the crosstab fails to document which variable numbers were used, so that the operator must religiously write down the appropriate numbers or be hopelessly confused two days later.

The regression results using the Longley data were among the most accurate of any program tested. Some procedures were simple enough to let a first-time computer user work independently after an hour of instruction. Though simple, certain aspects of the program are tedious, such as having to specify all 29 variables in our test data set over and over in the different procedures. For the most part, Number Cruncher was a pleasure to use and devoid of unpleasant surprises.

NWA Statpak: The wide range of procedures in NWA Statpak is attested to by the 78 separate programs provided. The mostly clear and comprehensive manual walks the user through each program with sample runs and organizes them in groups for easy reference. The very strength of such variety is also the package's major weakness, since each program must be run independently of the others. To perform a simple crosstab requires running several programs, each time entering the name of the file to open, the respective columns representing each variable (variable names are not supported), and all additional parameters requested by each program. The payoff, however, is ample. In return for this work, you can perform nearly any data manipulation or statistical task you might commonly encounter along with more than a few uncommon tasks.

The unorthodox approach used by NWA Statpak pro-

Tek's best-selling 60 MHz scopes: Now 25 ways better for not a penny more!

Now Tek has improved its 2213/2215 scopes with brighter displays. Greater accuracy. And more sensitive triggering. At no increase in price.

The 60 MHz 2213 and dual time base 2215 have been the most popular scopes in Tektronix history. Now, Tek introduces an "A" Series update with more than 25 specification and feature enhancements—things you have asked for such as single sweep—all included at no added cost.

A brighter display and new vertical amplifier design provides sharp, crisp traces.

That makes the 2213A/2215A a prime candidate for tasks like TV troubleshooting and testing, where fast sweeps are typical.

New features include 10 MHz bandwidth limit switch, separate A/B dual intensity controls (2215A only), and power-on light: additions customers have suggested for

giving these scopes the final measure of convenience. Triggering, sweep accuracy, CMRR and many more major specifications are better than ever. Check the performance chart: not bad for scopes already considered the leaders in their class!

The price: still \$1200* for the 2213A, \$1450* for the 2215A. Or, step up to the 100 MHz 2235 for just \$1650*! You can order, obtain literature, or get expert technical advice, through Tek's National Marketing Center. Direct orders include operator manuals, two 10X probes,

15-day return policy, world-wide service back-up and comprehensive 3-year warranty.

Talk to our technical experts.

Call toll-free:
1-800-426-2200
Ext. 155.

In Oregon call collect:
(503) 627-9000 Ext. 155.



1-800-426-2200



| Specification enhancement | 2213/2215 "A" Series | 2213/2215 |
|-----------------------------|--|---|
| CRT brightness | 14 kv accel. potential | 10 kv accel. potential |
| Vertical accuracy | 3%, 0° to 50°C | 3%, +20° to 30°C |
| Chop rate | 500 kHz | 250 kHz |
| input capacitance | 20 pF | 30 pF |
| CMRR | 10 to 1 at 25 MHz | 10 to 1 at 10 MHz |
| Channel isolation | 100:1 at 25 MHz | Not specified |
| A Trigger sensitivity (int) | 0.3 div at 5 MHz | 0.4 div at 2 MHz |
| TV triggering | 1.0 div compos. sync | 2.0 div compos. sync |
| Sweep accuracy (in 10X) | 4%, 15° to 35°C | 5%, 20° to 30°C |
| Delay jitter | 20,000 to 1 (2215A) 10,000 to 1 (2213A) | 10,000 to 1 (2215) 5,000 to 1 (2213) |
| Holdoff Range | 10:1 | 4:1 |

*Price F.O.B. Beaverton, OR.
All scopes are UL Listed and CSA approved. 3-year warranty includes CRT and applies to 2000 family oscilloscopes purchased after 1/1/83

vides some unique benefits. For example, many of the stand-alone data-manipulation programs can be used as general utilities. And, since the BASIC source code is provided, it is possible to modify all the programs for unique applications. The programming is exemplary in its clarity. Like many of the packages using interpreted BASIC, many procedures are notably slow. In professional applications, where speed of execution is an important factor, the programs can be compiled using either the Microsoft or IBM Compiler, as appropriate. Some modifications are required, but the clear programming makes necessary alterations straightforward, and the improvement in speed is considerable. All things considered, this serious, comprehensive package merits consideration by any CP/M user doing a wide variety of statistical analyses who wishes a large library of well-documented statistical programs in BASIC source code.

SAM: Developed in the United Kingdom, SAM performs a wide range of statistical functions. We found SAM to be one of the weaker packages. The manual is a brief 40 pages. About half of it consists of example printouts, leaving a text portion of about 20 pages. While the manual's cover suggests that SAM can be useful for survey analysis, SAM does not allow specification of a weight variable for analyzing probability samples. The SAM manual cover also indicates time series capability. However, the only related function we found was the ability to lag or lead data through a conversion (i.e., transformation) function. Obviously, the user could employ the correlation features to compute autocorrelation coefficients, but this is a multistep operation, not a menu option. On the plus side, SAM is easy to use and is one of the few packages providing a stepwise regression option.

SpeedSTAT: This series of individual programs will, when completed, provide a complete set of statistical functions. Currently, only two programs, Frequencies and Regression, are available. The Analysis of Variance and Time Series programs will appear shortly, and we have received a test version of the ANOVA package. The programs are very easy to use. The philosophy behind the packages appears to be that statistics can be used by most businesses to assess the "whys" behind their operation. The programs do not look or "feel" like typical statistical programs in that little, if any, statistical jargon is used and little statistical knowledge is required to obtain results. The accompanying manuals are quite complete, clearly documenting both the formulas used and the limitations of the data. We should point out that, like AIDA, SpeedSTAT stores data as 2-byte integers. Thus, even though you can specify a format for a field, the number of digits of precision is quite limited.

SPS: The version we worked with was developed for use at a university. As such, it was a bit rough when compared with commercial products. However, it is particularly strong in the area of experimental design, being one of the few programs featuring the General Linear Model. SPS provides many useful regression diagnostics not computed by many other packages. Among these

are Press residuals and Mallows Cp. We recently received several new versions, including an improved version (4.2) for the Apple and another version for the IBM PC. The manuals for these are much more complete than those for the earlier versions.

STAN: This package provides complete support for linear models (regression, analysis of variance, etc.). It does not purport to be a general-purpose statistical program. With it, a knowledgeable user can analyze virtually any linear model likely to be encountered. STAN prepares dummy variables from qualitative ones, thus expanding its power beyond the limit on the number of variables found in table 5. That is, when performing an ANOVA, one qualitative variable with six levels requires five dummy variables in the analysis. Unlike the other packages, the table 5 entry for STAN refers to the number of variables, counting a qualitative variable as one, not one less than the number of its levels. Other packages may permit the user to create the five dummy variables and perform the analysis, but all five count against their limitations on number of variables. STAN computes the P-values (probabilities) of the test statistic. Most other packages require the user to look up the value in a suitable table.

Statpac: This program differs from most in that it is batch-oriented. While this initially seemed like an anachronism, in practice it proved to be quite useful. Before any runs could be carried out, it was necessary to first prepare a "codebook" file (giving variable names, value names, type of data, and so on), a "data" file (containing raw data), and an "analysis control" file (containing all the statistical commands and parameters for a run). While this slowed things up initially, it provided several advantages. For instance, you can correct any errors in the command syntax, variable names, or other entries without reentering everything else. Also, if you want to run parallel analyses on different variables, or slightly modified runs, it is simple to change one or two lines and rerun the entire procedure.

Other characteristics that set this package apart are value labeling, variable-recoding procedures, and a routine to handle multiple variable-responses. Value labeling lets you code values such as 1 = male and 2 = female, so that all tabular output will automatically include these labels for the appropriate rows or columns. Variable-recoding procedures include absolute recode, recode-if, select-if, compute, and compute-if. The multiple variable-response capability permits easy analysis of questionnaire items in which the respondent can give multiple answers.

Statpro: This is one of the most extensive and the most expensive of the packages we examined. Statpro runs under Softech Microsystems' UCSD p-System and performs many functions. (As a result of the extensive disk-storage requirements, the Apple version is delivered on sixteen 5¼-inch disks, most of which are double-sided.) The software comes in three subsystems, each with its own manual: one for database functions, one for statistics, and one for graphics. Among the programs we

One of Japan's leaders would like to go to work for you.



Fujitsu, Japan's largest computer company, sends you their best. The new Micro 16s personal business computer. A combination of thoughtful planning, innovative thinking and quality craftsmanship. Just what you'd expect from a Japanese company that's been making computers for three decades.

The Micro 16s is a complete computer system. The options of other computers are our standards. For example, its price includes the CP/M-86[®] operating system, SuperCalc^{2™} electronic spreadsheet, WordStar[®] word processing, a high resolution color graphics monitor, and two microprocessors, the Z80[®]A 8-bit and 8086 16-bit.

The Micro 16s will run any of the more than 3,000 CP/M[®] software programs on the market today. Optional operating systems for the Micro 16s include MS[™]-DOS and the

multi-tasking Concurrent CP/M-86.[™]

The Micro 16s also comes with a detachable keyboard, dual built-in 5¼" floppy disk drives, 128 kilobytes of internal memory expandable to over one megabyte, and expansion slots for future growth.

The unique and flexible design of the Micro 16s makes it easy to add advanced microprocessors of tomorrow, hard disks, mainframe communications or local area networking when the time is right.

Put a Japanese leader to work for you. Fujitsu's Micro 16s. For more information or the name of your nearest dealer call toll free 1-800-MICRO 16. Or write Fujitsu Microelectronics, Inc., Professional Microsystems Division, 3320 Scott Blvd., Santa Clara, CA 95051.



Fujitsu's Micro 16s.™

Computer problems? DON'T BLAME THE SOFTWARE!

Isolators prevent:

- CPU/printer/disk interaction
- Lightning or spike damage
- AC power line disturbances
- RFI-EMI interference



Pat. # 4,259,705

Commercial Grade Isolators

- ISO-1 3 Isolated Sockets \$ 81.95
- ISO-2 2 Isolated Socket Banks, 6 Sockets \$ 81.95

Industrial Grade Isolators

- ISO-3 3 Double Isolated Sockets \$122.95
- ISO-11 2 Double Isolated Banks, 6 Sockets \$122.95

Laboratory Grade Isolators

- ISO-17 4 Quad Isolated Sockets \$213.95
- ISO-18 2 Quad Isolated Banks, 6 Sockets \$180.95

- Circuit Breaker, any model (Add-CB) Add \$ 11.00
- Remote Switch, any model (Add-RS) Add \$ 20.00

ESP Electronic Specialists, Inc.
171 S. Main St., Box 389, Natick, Mass. 01760 (617) 656-1532

Toll Free Order Desk 1-800-225-4876
MasterCard, VISA, American Express

examined that run on an Apple, Statpro is far and away the most comprehensive package, computing more statistics and performing more analyses. Its graphics package is very thorough, containing options that include pie charts, triangular scatterplots, and normality curves for testing statistical assumptions. (The graphics package was not available in the prerelease IBM PC version we reviewed.)

While we have not tested Statpro in a hard-disk configuration, the user may want to operate it with such hardware. When using a floppy-disk system, the user is constantly requested to swap disks. Sometimes the user is requested to put a particular disk in one drive, yet for other purposes this same disk is to be put in the second drive. To use the complete system, eight separate work disks must be formatted using a utility provided with Statpro. The user will notice that Statpro has menus that duplicate entries from previous menus; that is, the same option may have to be requested twice from two consecutive menus to obtain the desired analysis.

SYSTAT: Although we have only recently begun working with this package, we find it to be one of the most powerful, with many mainframe characteristics. The version we reviewed ran on an IBM PC and required 256K bytes of RAM, although the CP/M version will run with only 64K bytes. It is command driven and uses a deceptively simple set of commands in view of the powerful procedures it provides. The manual presents examples of runs using all the commands in order to avoid the confusion that often results when generic commands are presented.

The real surprise came when we discovered the range, sophistication, and speed of SYSTAT's procedures. In addition to all the commonly used univariate statistics, SYSTAT was the only package to provide a multivariate general linear-hypothesis module, which includes multivariate analysis of variance, profile analysis of repeated measures, principal components analysis, and canonical correlation. It also provides modules for factor analysis with rotation and scoring and multidimensional scaling. The Tables module was the only one in our review to permit four-way and larger contingency tables, with analysis of log-linear models. The Graphics module offers a variety of options, including normal probability plots, contour plotting, stem-and-leaf diagrams, and detrended residual plots. However, graphical displays are formed by text characters, unlike the high-resolution color graphics of Statpro. Complex transformations of data are possible using an internal BASIC language that, like the rest of the package, was written in compiled FORTRAN. Other modules planned for release in the near future include cluster analysis of variables or cases, pen plotter graph routines, robust estimation routines, and time series analyses.

Another nice surprise was the speed with which the programs executed their calculations. When the output from the analysis of the Longley data was sent to the screen, the results were nearly instantaneous. Upon exiting each module, all RUN commands are printed auto-

THE PURCHASING AGENT

We can buy any microcomputer product for you from our 292 participating wholesalers. Here are the net prices on a few of the 7,000 products we can buy for you, acting as your purchasing agent.

| | | | | | |
|------------------------|-------|--------------------------|-------|------------------------|-------|
| COMPUTERS | | COMPUTERS | | MONITORS | |
| Altos 580-10 | 4,199 | Northstar Advantage | 2,107 | Amdak RGB II | 450 |
| 586-20 w/o Term. | 6,018 | w/Dual Floppies | 3,249 | NEC 1203 | 536 |
| 386-40 | 9,027 | w/8 meg | 4,315 | 1410 RGB | 780 |
| Compupro Godbout* | 4,065 | w/15 meg | 4,315 | Princeton RGB w/cable | 485 |
| Sys 816A RAM 17" | 4,179 | Onyx C5002A, 256K, 14M | 3,022 | All others | CALL |
| Sys 816A RAM 21" | 6,459 | Sage II, w/2,640K | 3,470 | PLOTTERS | |
| Sys 816AH* | 6,459 | IV, w/12 meg | 5,830 | Houston Instr., DMP 41 | 2,321 |
| Sys 816C* | 6,462 | IV, w/18 meg | 6,273 | Strobe M 100 | 461 |
| Sys 816CH* | 8,856 | IV, w/40 meg | 7,965 | All others | CALL |
| Sys 816D* | 9,887 | Sanyo 555, w/2-160K | 1,100 | PRINTERS | |
| Sys 816E* | 6,462 | Talavideo TS 803 | 2,027 | Anadex 9625B, par. | 1,190 |
| Sys 816Z* | 3,722 | TPC 2, port. | CALL | C. Itoh A 10-20 | 534 |
| *Completely Assembled | | Zanith ZF-100 21 | 2,157 | F-10, 40 cps. | 1,000 |
| M-Drive-H | 1,100 | ZF-110-22 | 2,585 | Diablo 630 API | 1,815 |
| RAM 21, 128K, 14 Mhz | 758 | ZW-120-32 | 3,945 | NEC 7710 | 1,900 |
| RAM 22, 256K | 1,292 | All others | CALL | Okidata | CALL |
| Pragmatic 20 meg. | 2,990 | HARD DISKS | | All others | CALL |
| Pragmatic 40 meg. | 4,686 | Talgrass 20 meg. w/tape | 3,097 | TERMINALS | |
| Columbia Sys., 2.320K | 2,779 | All others | CALL | Televideo 925 | 715 |
| Sys., 12 meg. | 4,119 | IBM PERIPHERALS | | WYSE WY-50 | 539 |
| Sys., portable | 2,320 | Keytronics 5150 Keyboard | 189 | All others | CALL |
| Eagle 1630 | 4,699 | MODEMS | | TAX SOFTWARE | |
| Molecular SM 8 10 meg. | 4,848 | Hayes 1200 | 499 | Microtax | CALL |
| Morrow Micro D, MD 3 | 1,585 | US Robotics Password | 349 | | |
| NEC APC-H03 | 2,999 | | | | |
| APC-H12 Col. Graph. | 618 | | | | |
| APC-H26, 10 meg. | 2,172 | | | | |

CALL US FOR THE NET PRICE ON ANY OF THE 7,000 OTHER PRODUCTS WE CAN BUY FOR YOU AS YOUR PURCHASING AGENT.

Since 1980

B-84-4



THE PURCHASING AGENT, INC.
574 Weddell Drive, Suite 5
Sunnyvale, CA 94089
(408) 744-0646

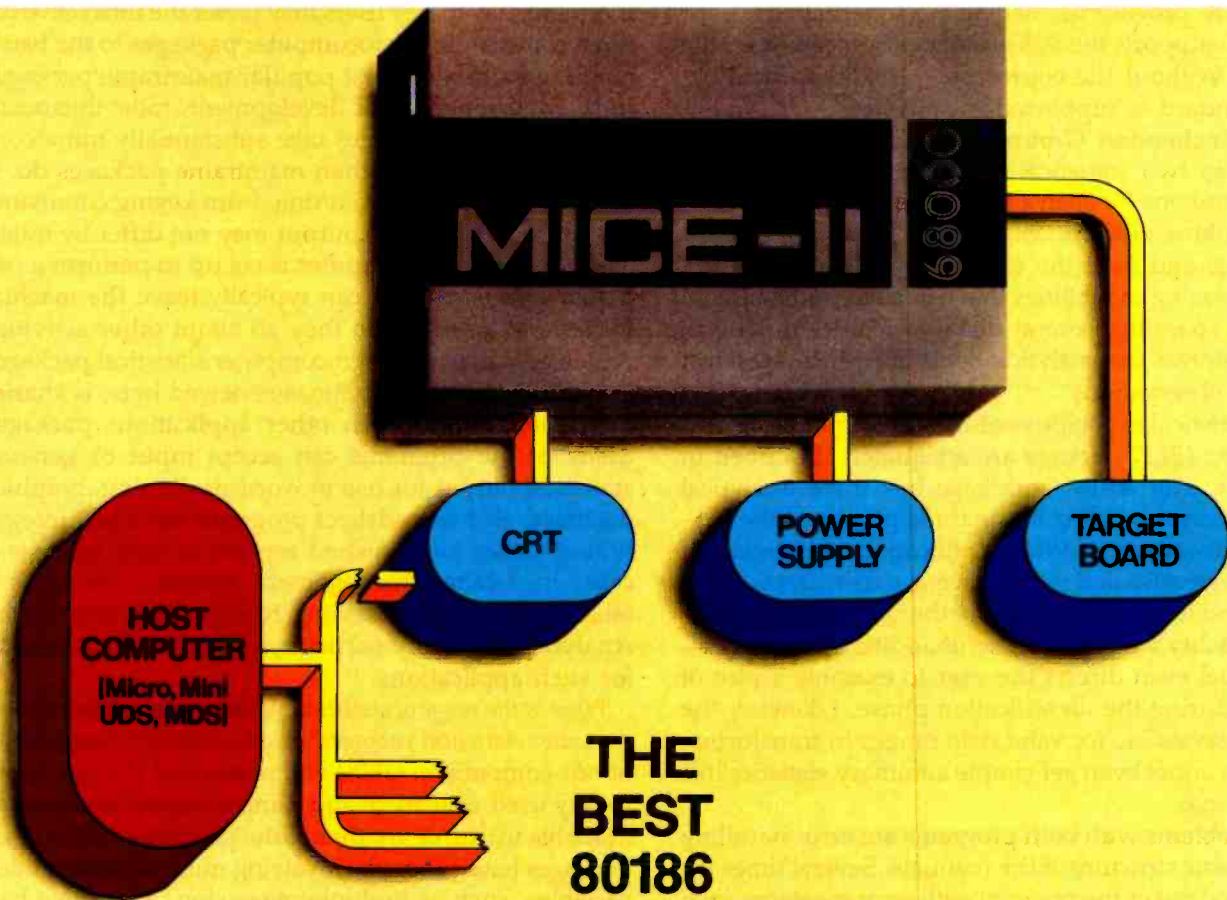

THE BEST 80186 DEVELOPMENT/ DEBUGGING

**TOOL
YOU
CAN
BUY
FOR
\$4,200**

It's powerful, portable, configurable. Use it to turn your mini/micro computer into a cost-effective full-scale universal development system.

Use it to expand your full-scale development system into a multi-workstation system.

Use it with MULTIMICE to debug hardware/software in a multi-processor environment.

Use it to evaluate different micro-processors at a minimum change-over cost.

It's easy to use. MICE I/O drivers are available for Apple II, IBM-PC, PDP-11, VAX, MDS, iPDS, TI Professional and all CP/M systems. And symbolic debugging is available for some models.

MICROTEK INTERNATIONAL, INC.
2-1, Science Road 1
Hsinchu Science-based Industrial Park
Hsinchu, Taiwan, 300, R.O.C.

It gives you all these features. Real-time emulation with no wait state • Retain full memory and I/O space • Resident assembler/disassembler • Real-time forward/backward trace up to 2048 cycles • Instruction step, cycle step through program • Two hardware breakpoints • Interchangeable personality module • Up to 128K emulation memory.

It supports all these microprocessors. 8048 • 8085 • 8086/88 (MAX) • 8086/88 (MIN) • 80186/80188 • 6809/6809E • 68000 • 68008 • 68010 • 6502 • 65SCXX Series • 65SC1XX Series • Z80R • NSC 800.

And it's programmer supported. GP-256 micro based, system/gang EPROM programmer for JEDEC pinouts. MICE I/O driver or master loading.

MICROTEK LAB, INC.
17221 South Western Ave.
Gardena, CA 90247
(213) 538-5369



matically to provide permanent documentation.

SYSTAT supports the 8087 numeric coprocessor for the IBM PC. Without the coprocessor, the 80-bit floating-point standard is supported in software.

The Winchendon Group: The Winchendon Group (TWG) has two statistical packages: one for general statistics and one for analyzing time series by the ARIMA or Box-Jenkins method. The two packages are data-set compatible and have the same data-management and data-processing capabilities that can build and maintain data sets spanning several disks—a feature unique to TWG. However, the analytical limits of ARIMA are fewer than 500 observations.

The statistical capabilities of the Econometrics Linear Forecasting (ELF) package are adequately described in the tables. The ARIMA package has three analytical modules corresponding to the three phases of the Box-Jenkins procedure: model identification, estimation of the autoregressive and moving average coefficients of the model, and forecasting values of the time series. A plotting capability would be a useful addition to ARIMA—the manual even directs the user to examine a plot of the data during the identification phase. Likewise, the user is responsible for valid data ranges in transformations but cannot even get simple summary statistics like min and max.

Two problems with both programs are error handling and the basic structure of the manuals. Several times we were kicked out of the program with error messages such as BREAK IN LINE 2560, END OF DATA. After patiently following the example in the identification phase of ARIMA, we were rewarded with the message LOG OF NEGATIVE NUMBER. The structure of the manual does not correspond with the menus, and the menus are not even shown in the manual. This makes it hard to find what you need.

General Guidance

How practical are available microcomputer statistical packages for use in a research or business environment? Experienced mainframe statistical-package users tend to be especially suspicious of a microcomputer's capabilities. Yet, consider the wide range of features present in many of the packages shown in our comparison charts. The best of the packages are eminently practical for serious, professional applications. Many others look as though they would amply fill less demanding applications, sometimes at far less cost (although cost is an unreliable indicator of quality). Our tests show that the best of the packages equal or exceed the accuracy of many packages running on mainframes.

For both small data sets (e.g., fewer than 100 cases and 30 variables) and moderate ones (e.g., fewer than 2000 cases and 250 variables), it is not only possible to perform analyses on a microcomputer rather than a mainframe, it may even be the more desirable alternative. For example, in a professional research environment, the cost savings from using a microcomputer may pay for both the hardware and software in a relatively short time. Fur-

thermore, day-to-day users may prefer the interactive features common in microcomputer packages to the batch-mode operation of most popular mainframe packages. In their current state of development, most microcomputer statistical packages take substantially more computer time to execute than mainframe packages do. In practice, the total elapsed time from keying commands until receiving printed output may not differ by much. Also, once a microcomputer is set up to perform a particular analysis, users can typically leave the machine for several hours while they go about other activities.

One advantage of microcomputer statistical packages, frequently exploited by those reviewed here, is sharing input and output with other applications packages. Many of the programs can accept input or generate statistical output for use in word-processing, graphics, database, and spreadsheet programs for direct integration of tables into finished reports or easy analysis of cases in database-management systems. The rows in table 5 relating to Accessing Foreign Data and Storing Analytic Results are particularly important to consider for such applications.

What is the range of statistical procedures available in microcomputer statistical packages? Even a cursory examination of our comparison tables will reveal that the most commonly used univariate and nonparametric analyses are available in one or another of the programs. Most of the packages have programs involving multiple independent variables, such as multiple regression, and a few have even more complex programs, such as factor analysis, multiple discriminant analysis, and canonical correlation. In short, the most commonly used statistical procedures are now available. The issue for a prospective buyer is whether needed procedures can all be obtained in one package, and whether that package will handle the number of cases in the user's data set on the user's microcomputer with a style of operation compatible with the user's preferences. We believe, based on our own experience, that most buyers will need to purchase more than one package to get all the features they require. A combination of packages should be able to share a data set in a common format.

How many cases and variables will they process? Some packages are limited to small data sets; others process multidisk data sets. Unfortunately, few of the manuals provided much detail about the number of cases and variables that could be handled on particular microcomputers having different available RAM. Nor did we have the time and resources to test the limits for any of them. Thus, while we are convinced that very large data sets can be processed by some of the packages, although perhaps awkwardly, we strongly advise prospective buyers who need this capability to consult with the developer or dealer first, as well as to arrange a trial period if possible.

How fast do they perform calculations? In a word, slowly. Many packages were written using interpreted languages, primarily BASIC. For small test data sets of 20 cases, the calculations seemed quite fast. But when the



Introducing the Freedom 200. No other VDT gives you more, for less.

For only \$745, the Freedom 200 gives you more user-relevant functions and optimized ergonomic features than any other standard VDT.

You get 106 keys, clustered for maximum user efficiency.

Plus 10 user-programmable non-volatile function keys (256 bytes worth) for a host of applications.

Plus 11 cursor control keys, including tab by word for easy editing.

Plus flexible non-volatile set-up modes, full page or status line, to easily configure your terminal exactly the way you want it.

Plus user-definable smooth scrolling regions, with selectable scroll rates.

Plus split-screen capability.

Plus 128 ASCII characters, with 86 extended graphic characters for forms creation.

Plus non-embedded attributes (visual and data entry).

Plus double-high/double-wide characters.

Plus programmable answerback message for enhanced security.

Plus programmable time out, to prolong the life of your screen.

Plus easy serviceability, and space for add-on boards.

Plus two-page standard memory in emulation modes and one-page memory in native mode, with additional memory optional.

Plus 8 foreign character sets.

Plus TeleVideo 950 and Lear Siegler ADM 31 emulation.

Plus more.

To find out more, contact your local Liberty dealer or distributor.

Or call Liberty direct.

(415) 543-7000.

No other VDT gives you more, for less.

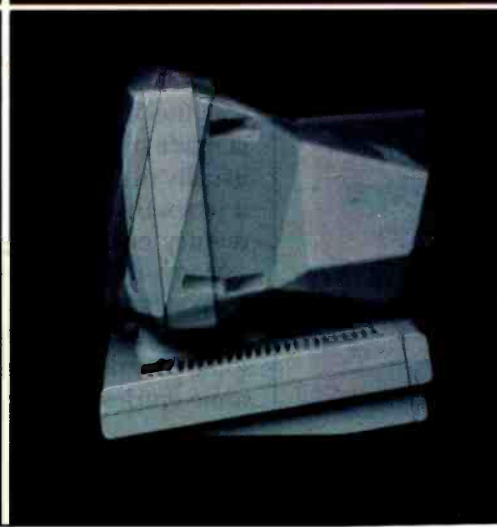
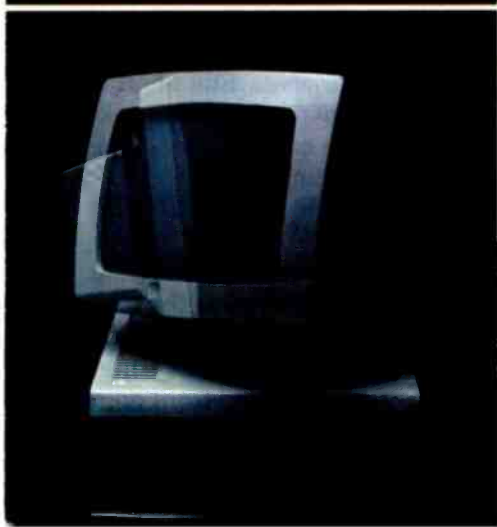
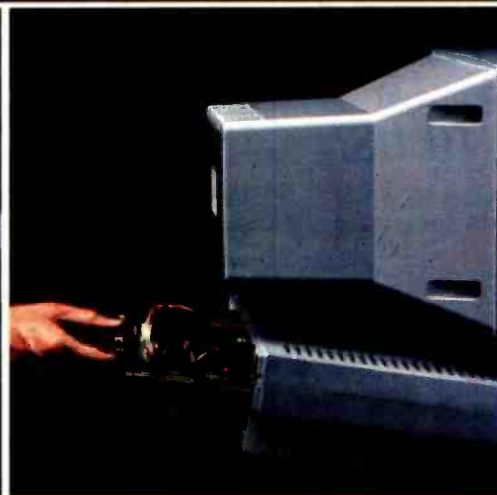

See us at COMDEX Atlanta
Booth 3432 West Hall.

 **LIBERTY**

© Liberty Electronics 1984.

Circle 220 on inquiry card.

JUKI 6100

LETTER QUALITY PRINTER

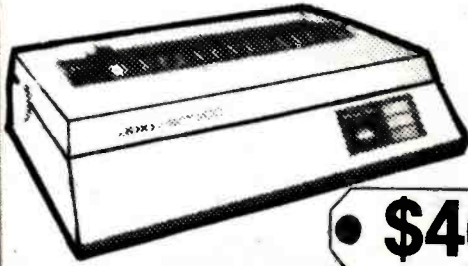

• **\$469.**

- 18 cps
- Word processing and graphic functions
- Proportional spacing control
- Uses IBM Selectric ribbons
- Compatible with Kaypro, IBM, Apple, Osborne, and others.



Free shipping in U.S.



COMPUTERS and more

2420 University Ave., To Order
San Diego, Ca. 92104 (619) 291-1442

number increased to 100, 500, or more, the time needed for processing increased substantially. Some of the faster packages held all the cases in memory at once, but this seriously limited the number of cases that could be processed. Others were bound by incessant read-write operations on the disks and with the attendant hardware inefficiencies. A select few appeared substantially faster than others, but since we did not make any direct speed comparisons, we cannot provide objective information.

However, some packages facilitated the batch mode of operation by permitting simulated batch processing, so the microcomputer could be left running overnight. Anyone who has experienced the frustrations of working on a badly overloaded timesharing mainframe might even find that the total elapsed time from input to output is less for microcomputers.

We suggest that you suspend your prejudices about speed until you can actually give some of the packages a fair trial. Also, the time is soon coming when packages that are fast by any standard will become available. A select few of those reviewed here appear to have already surpassed some of the traditional speed barriers for microcomputer statistical applications.

How easy are they to use? Many of them can be easily learned by persons who have never used a computer to analyze data before. However, nearly every package assumes that the user has a basic familiarity with the statistics involved. Several of them were exemplary in the simplicity of their structure from the user's point of view. These were as easy to learn and as foolproof as any complex statistical-analysis package is likely to be. Almost all of them were easier to use than most of the common mainframe packages, but typically they provided far fewer procedures so that there was less to learn.

On the negative side, though, there were many problems. All packages had traits that annoyed us as we used them. No doubt we could adjust, given more time, but we were puzzled by the frequent inconsistencies and lapses in some of the otherwise well-thought-through programs. One of the most irritating aspects of many programs was the need to enter the same information about the number of cases, number of variables, filenames, system parameters, and so on over and over again as one proceeded through a series of related operations. Another annoyance was having to always move lockstep through a series of menus time and time again, usually from the very beginning each time, when doing parallel operations on different variables. Still another was the lack of an escape mechanism when a mistake is made or a filename forgotten at a crucial time. It was usually necessary to restart the program or, worse, reboot it when this happened. Sometimes this necessitated the reentry of our data set as well.

Many of the programs use the same key for different purposes at different times, without prompting the user about the change. As noted in our comparison table, some programs required the use of the Return key after some entries but not others. Packages varied from poor

DECADES OF SERVICE

FROM THE NATION'S LARGEST NEC DEALER

Where Do You Turn To Solve Your Computer Puzzle?



TURN TO US!

We'll show you the easiest way to put the pieces together.

Matched. Compatible. Proven—
Use Someone Else's Engineering to Supplement Yours.

Our professional applications specialists are happy to assist you in configuring business and scientific computer systems from the thousands of hardware and software products we regularly handle.

Our specialties include:

- CAD/CAM Graphics
- Multi-user Databases
- Foreign Language Processing
- Communications

Our GSA Contracts:



Washington Computer Services

97 Spring Street (212) 226-2121
N.Y., N.Y. 10012

an affiliate of
WASHINGTON
ELECTRIC COMPANY
SINCE 1912

HOURS: 9 AM - 5 PM / Monday-Friday TELEEX: 12-5606 CABLE: WASHCOMP NYK

PLEASE! Do not confuse us with mail order dealers. We are a full service distributor serving the data processing & installation needs of business and industry from micros to mainframes. System houses, educational institutions & governmental agencies given special consideration. Dealer and international inquiries welcome.

Every option you'll ever need.

You're looking at ULTRAFRAME™, a powerful 8/16 bit multiprocessor you can configure to handle any application.

It's the one system that can tackle your toughest jobs today with the capacity to grow up to 32 users or tasks — within the same chassis.

Get 5" & 8" Winchester drives from 10-120MB (formatted). Also, 14" models from 145MB to 1,160MB. And backup systems appropriate to any system you design.

The super micro that almost configures itself.

Our version of TurboDOS™ is extremely easy to integrate thanks to the IBS TURBO-INTEGRATOR™ — a menu-driven utility that will help you

get the right system configuration into your customers hands in record time.

Save yourself hours of valuable time with the TURBO-INTEGRATOR, the fastest way to configure for peripherals and design multiuser system

security. Generate user-friendly shells with the IBS MenuMaster-T™

The industry's longest warranty.

We've built the ULTRAFRAME to last — and backed it with a full three year warranty. Plus, we give a level of old-fashioned factory support you won't get from anyone else. And on-site maintenance is available nationwide through 45 service centers.

FRONT



BACK



ULTRAFRAME™



INDEPENDENT BUSINESS SYSTEMS

Call collect (415) 443-3131 TWX: 910-386-6003 IBSNET
5915 Graham Court, Livermore, CA 94550

A feast for OEM's and system integrators.

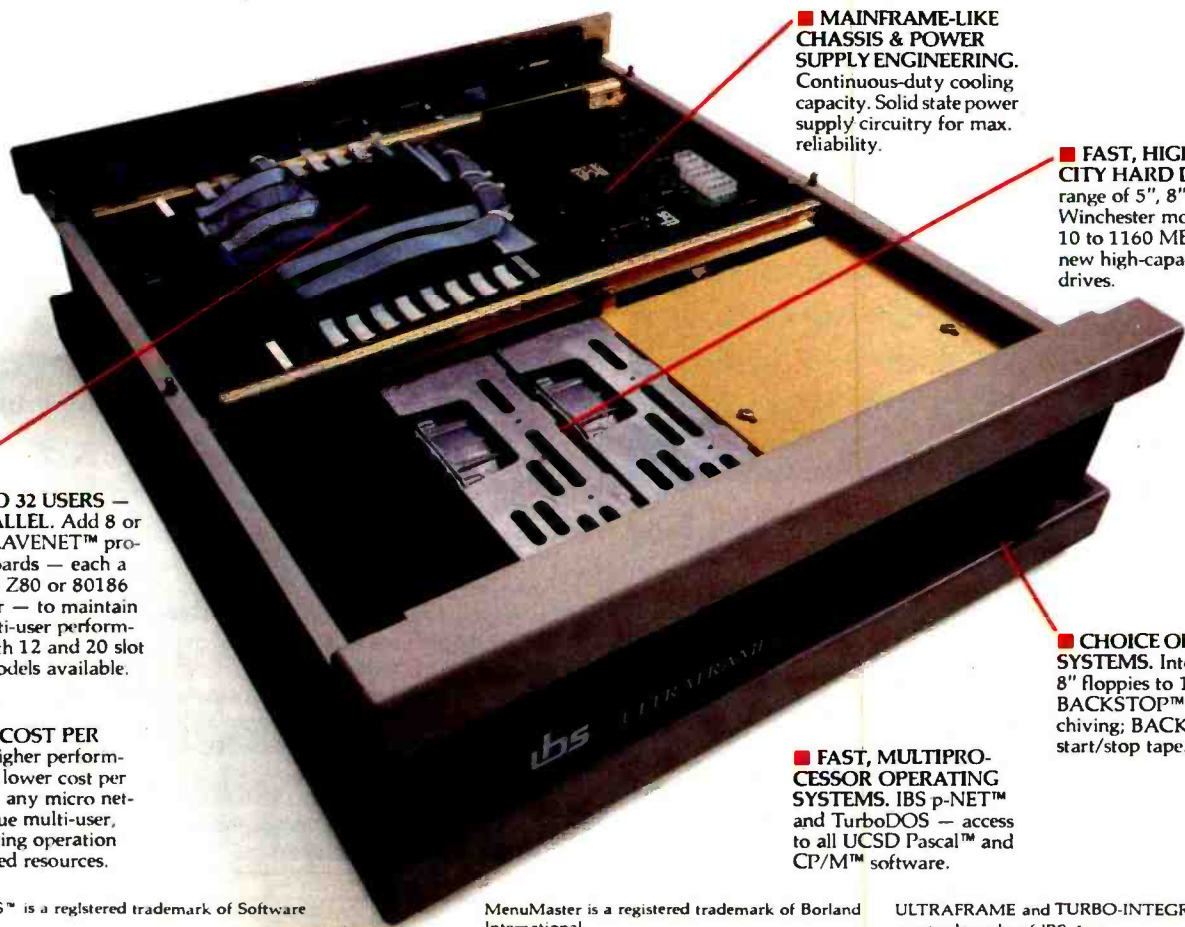

■ **UP TO 32 USERS — IN PARALLEL.** Add 8 or 16 bit SLAVENET™ processor boards — each a complete Z80 or 80186 computer — to maintain fast, multi-user performance. Both 12 and 20 slot S-100 models available.

■ **LOW COST PER USER.** Higher performance and lower cost per user than any micro network. True multi-user, multitasking operation plus shared resources.

■ **MAINFRAME-LIKE CHASSIS & POWER SUPPLY ENGINEERING.** Continuous-duty cooling capacity. Solid state power supply circuitry for max. reliability.

■ **FAST, HIGH CAPACITY HARD DISKS.** Full range of 5", 8" and 14" Winchester models from 10 to 1160 MB, including new high-capacity 5" drives.

■ **CHOICE OF BACKUP SYSTEMS.** Integral 5" or 8" floppies to 1.2 MB. BACKSTOP™ video archiving; BACKSTOP II™ start/stop tape.

■ **FAST, MULTIPROCESSOR OPERATING SYSTEMS.** IBS p-NET™ and TurboDOS — access to all UCSD Pascal™ and CP/M™ software.

TurboDOS™ is a registered trademark of Software 2000.

MenuMaster is a registered trademark of Borland International.

ULTRAFRAME and TURBO-INTEGRATOR are trademarks of IBS, Inc.

Does your Apple leave you hungry?



We've got speed, performance and 3,000 new applications to satisfy that appetite.

Introducing the Digital Research CP/M Gold Card.™ The pick of the hardware crop for your Apple® Computer

Just plug it into any slot in your Apple II, II+ or IIe, and you get a new generation machine that runs CP/M Plus™ and all those programs it could never handle before.

Impressive, but not surprising. After all, who better than the creators of CP/M® to perfect it for your Apple?

And if you thought your Apple was a bit slow, chew on this.

We combined CP/M Plus, the Z80B microprocessor and optional Disk Cache to push your Apple to perform up to three times faster than any of the competition.

With the speed to handle programs like dBase II™ in half the time. And we've included CBASIC® so you can write customized programs.



It even boosts your monitor's CP/M output to full 80 column video. And those are just the basics.

For serious programmers we also included a macro-assembler and symbolic debugger. Explaining it all in two complete manuals.

It all comes down to this. Soon

there will be two kinds of Apple users. Those with the CP/M Gold Card. And those who are still hungry for one.

 **DIGITAL
RESEARCH**[®]

We make computers work.SM

The products and corporate logos referred to herein may be trademarks or registered trademarks of the companies indicated. The Digital Research logo and products are either trademarks or registered trademarks of Digital Research Inc. © 1984 Digital Research Inc. All rights reserved.

Circle 123 on inquiry card.

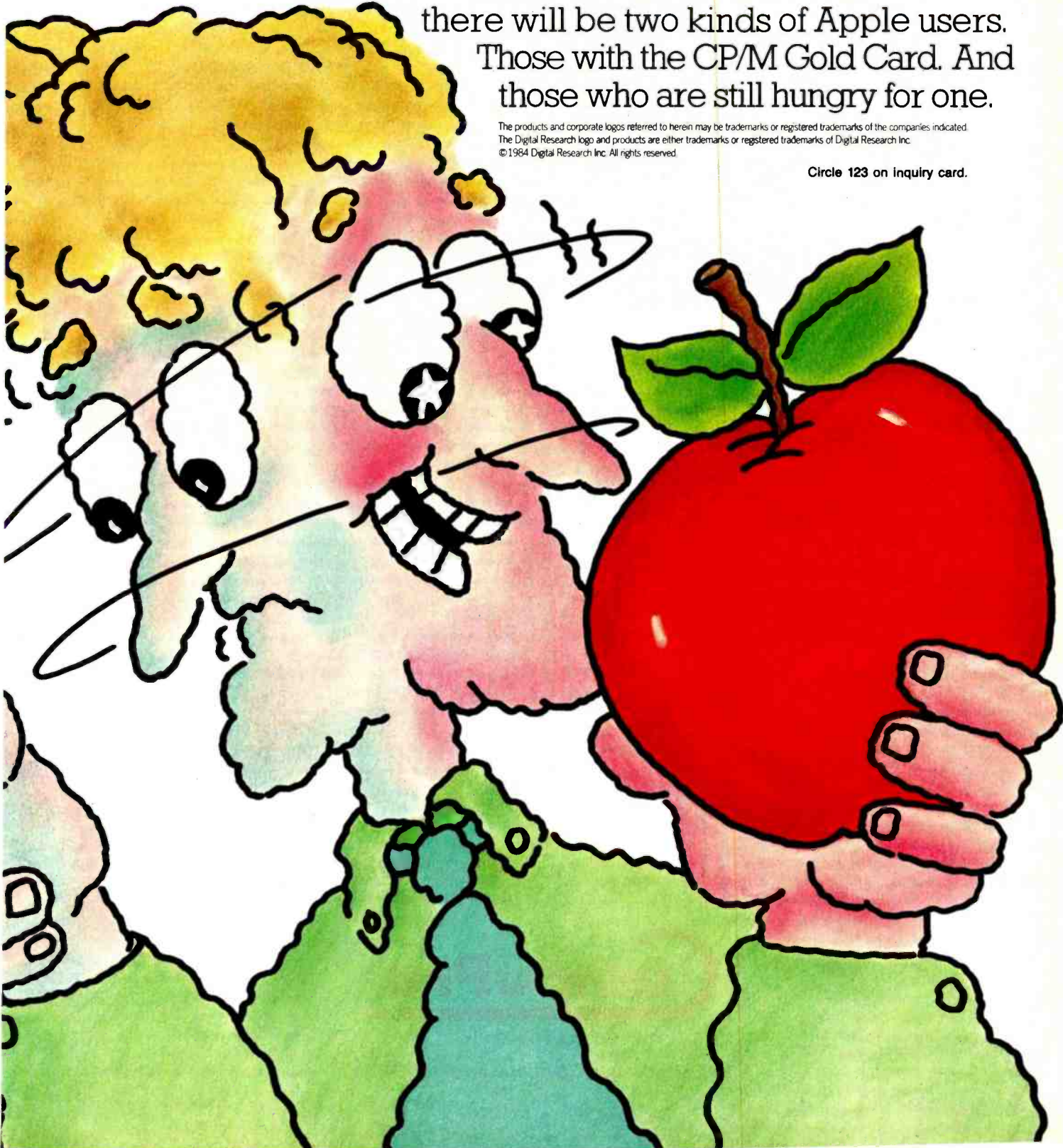

SEVEN ACES



CPUs nimble and swift — a card sharp's delight.

When CompuPro introduced the first CPU board with both 8- and 16-bit capabilities, it was like handing a royal flush to systems integrators. How could we top that?

You gave us the answer. "Make a CPU that will access 16 megabytes at a swipe," you urged. So we designed CPU 68K. "Make one for people who need top speed and 16-bit power," you pleaded.

CompuPro responded with CPU 286, the board with two brains: one to bundle bytes and the other to scan the conveyor belt ahead and fetch the necessary tools.

So, by giving you flexibility without sacrificing performance, quality or reliability, CompuPro has dealt all players a winning hand: Seven Aces.

They're worth betting on.

CPU 8085/88

Is CompuPro's pioneering dual processor, running the vast library of both 8-bit and 16-bit programs at clock speeds up to 8 MHz. *Maximum* software access. \$495, \$595 CSC.

CPU 86/87

uses Intel's widely favored 8086 chip, so you get the broadest range of time-tested 16-bit software. Includes sockets for the 8087 math co-processor and 80130 firmware chip. \$800 10 MHz, \$850 CSC 10 MHz. With 8087 chip, \$1050 5 MHz, \$1150 CSC 5 MHz.

CPU 68K

lets you rummage around in 16 Mbytes of memory at a time — not just the usual 64 Kbytes. Access huge databases, invert mammoth matrices, or turn titanic tables topsy-turvy. Includes socket for memory management unit. \$695 8 MHz, \$775 10 MHz, \$850 CSC 10 MHz.

CPU Z

brings the Z80 chip's sophisticated instruction set to bear on the whole range of 8-bit software at clock speeds of 6 MHz. Ideal for multi-user installations, with 24-bit addressing that handles up to 16 Mbytes of memory. \$325, \$425 CSC.

CPU 286

is CompuPro's most far-sighted processor. It handles all 8086/8088 software, but many times faster with the help of a unique look-ahead capability. A memory management unit is *built-in*. \$1585 8 MHz, \$1750 CSC 10 MHz.

CPU 16032

features true 32-bit internal architecture that makes your micro byte off bigger words, like a mini. Ideal for Unix and other large operating systems. Includes sockets for floating point unit and memory management unit. Handles clock speeds up to 10 MHz. \$695, \$845 CSC. MMU available.

SPU-Z

lets multiple users share expensive resources such as disk drives, printers and modems — not to mention data. Let our slave processor give individual attention where it's needed, freeing the more expensive CPU for bus management. \$695, \$795 CSC.

For your business, industrial and scientific computing solutions, call (415) 786-0909, ext. 206 today for the location of the Full Service CompuPro System Center nearest you.

CompuPro products are backed by a one-year limited warranty — two years for boards qualified under the Certified System Component high-reliability program.

CompuPro®

A GODBOUT COMPANY

Prices and specifications subject to change without notice.

© 1983 CompuPro

3506 Breakwater Court, Hayward, CA 94545

For dealer locations, see page 435.

This Month's Features

A new computer and an old language highlight BYTE's features in this issue. Any odd or peculiar articles, advertisements, or announcements can only be ascribed to that north-country, mid-winter affliction known as cabin fever—the theoretical cause of the wackiness common at April's arrival.

The new computer is the brainchild of a group of former Atari and Intel engineers headed by Roger Badertscher. The company and the computer are called Mindset. As Senior Technical Editor Gregg Williams explains, Mindset hopes to bring arcade-quality graphics to medium-priced personal computers.

The old language is BASIC, that standby of microcomputers that helped popularize the machines. Our examination of the current state of BASIC focuses on several new versions of the language that purport to improve on the evolved industry standard, Microsoft BASIC. The newer BASICs permit structured programming and use the increased power of the latest microprocessors. As you'll discover, windows mean a lot in this brave new world of BASIC, too. Our report looks at True BASIC, BetterBASIC, Macintosh BASIC, Professional BASIC, and BASIC-09. Will these new BASICs attract a following? Predictions not included.

You've no doubt been wondering what the Russians are up to. Ruth Heuertz reports on Soviet microprocessor technology in a feature beginning on page 351. Readers in the Commodore camp may find the VIC-20 Terminal Emulator program by John Russo of substantial interest (a VT100 for less than \$100?).

Mark L. Siegel delineates the proposed ANSI standard for video terminals, exploring what may be a way to make screen control consistent among differing terminal brands.

Not more than one or two of us have been wondering what Jim McQuaid might be up to these days, but we all find out as he reveals details on a new home appliance, Smart Blankie. (Yes, there was a full moon the night this article was written.)

Next month, look for features on using cache memory to maximize the performance of hard-disk drives, batch processing with MS-DOS 2.0, and a look inside the ROM of the TRS-80 Model 100 portable computer.

—G. Michael Vose, Senior Technical Editor, Features

270 **The Mindset Personal Computer**
Gregg Williams

298 **Is BASIC Getting Better?**
G. Michael Vose

300 **True BASIC**
Brig Elliott

302 **BetterBASIC**
G. Michael Vose

318 **Macintosh BASIC**
Scot Kamins

334 **Professional BASIC**
Donald P. George

344 **BASIC-09**
Brian Capouch

351 **Soviet Microprocessors and Microcomputers**
Ruth Heuertz

365 **Toward Standardized Video Terminals: ANSI X3.64 Device Control**
Mark L. Siegel

379 **A VIC-20/Commodore 64 Terminal Emulator**
John P. Russo

422 **Smart Blankie**
Jim McQuaid

The Mindset Personal Computer

Gregg Williams
BYTE Senior Technical Editor

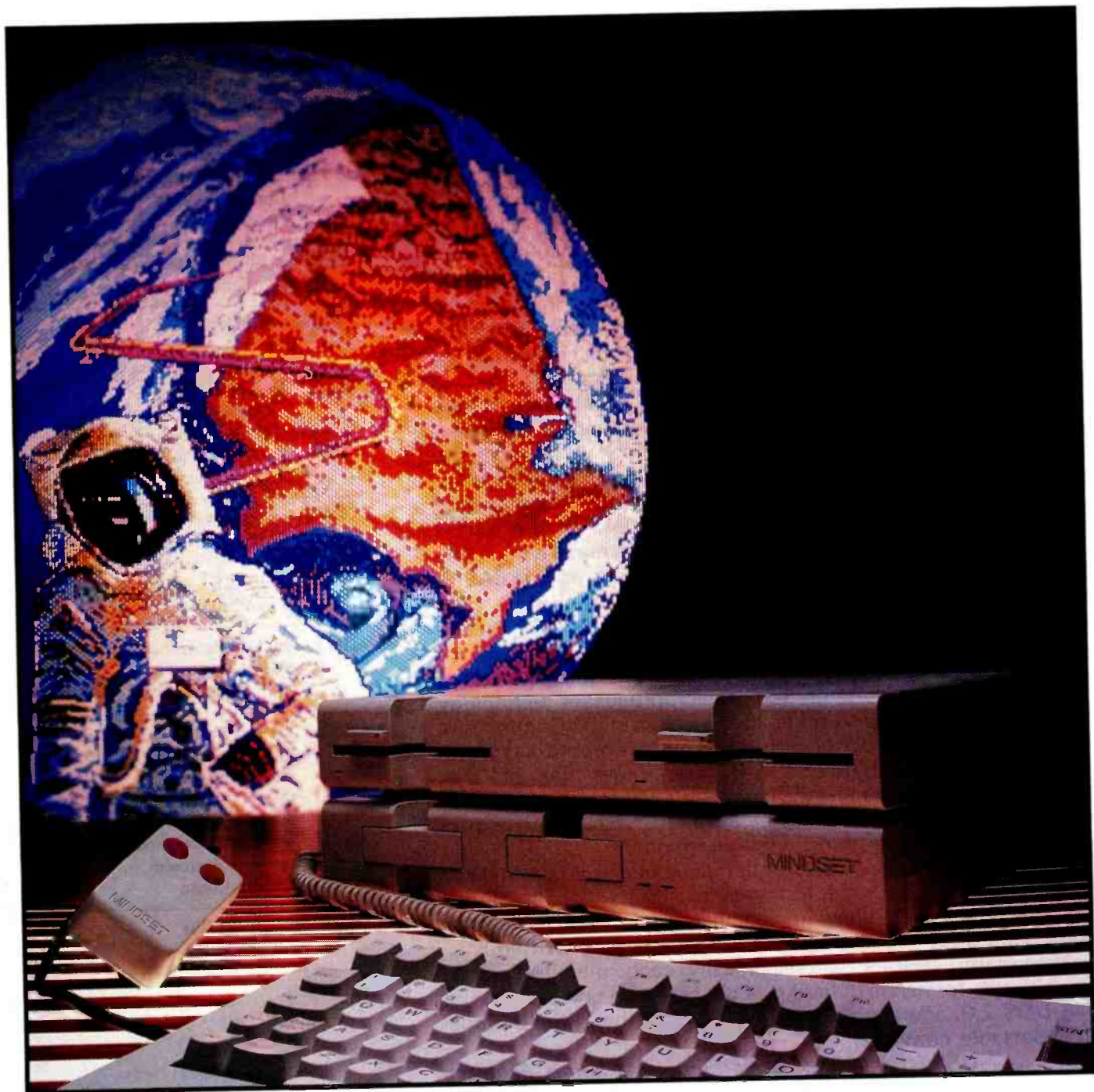

Custom VLSI chips bring \$50,000 technology to a \$2000 IBM PC-compatible computer

The Mindset Personal Computer (see photo 1) is a promising graphics-oriented computer that breaks new ground. It uses the Intel 80186 16/16-bit microprocessor (16-bit internal and external data bus) and two custom processor chips to create glitchless graphics at sufficient speed to make smooth animation possible. Taking its inspiration from graphics-oriented minicomputers costing more than \$50,000, Mindset uses this state-of-the-art microcomputer technology to bring its price down to about \$1200, with a full-blown two-disk system costing about \$2600—and it also throws in a good amount of IBM PC compatibility at no extra cost. Mindset is slated to be available sometime during the second quarter of 1984.

Configurations and Prices

The Mindset can be configured in three different ways. The top two configurations include some IBM compatibility (allowing the machine to run the IBM PC versions of most major application programs without change). All three configurations include hardware that gives you very fast graphics and animation, even in BASIC.

Its simplest configuration includes the System Unit, which is a stand-alone cartridge-based personal computer. It includes an Intel 80186 microprocessor running at 6 MHz, 32K bytes of system ROM (read-only memory), 32K bytes of user RAM (random-access read/write memory), 32K bytes of screen memory (called a *frame buffer* by Mindset and many computer-graphics users), a detached 84-key keyboard with cable and two



Photo 1: The Mindset Personal Computer. In the background are the System (bottom) and Expansion (top) units. In the foreground are the detachable keyboard, an optional two-button mouse, and the supplied GW BASIC programming language in cartridge form.

connectors for a mouse and/or Atari-style joystick, two cartridge slots, three I/O (input/output) module slots (for add-on hardware equivalent to Apple or IBM peripheral cards), a Mindset GW BASIC cartridge, and video outputs for a television, a composite color monitor, and an RGB (red-green-blue) monitor. At the time of this writing, Mindset estimates this computer's retail price will be about \$1200.

The next step up includes the addition of the Expansion Unit, which fits on top of the System Unit and adds 96K bytes more RAM (for a total of 128K bytes of user RAM), one 360K-byte 5¼-inch (IBM PC-compatible) floppy-disk drive, and three I/O module slots. This unit brings the total computer price to around \$2000 and gives you a disk-based computer with some IBM PC compatibility; it runs Microsoft's MS-DOS 2.0, available for about \$60 extra.

The top-of-the-line configuration includes all the above plus a second disk drive and an additional 128K bytes of memory, both of which are added to the Expansion Unit. This gives you a two-disk, 256K-byte sys-

tem that runs some IBM PC software for about \$2600.

Design Philosophy

The inspiration for the Mindset computer came from two markets: the CAD/CAM computer and terminal market (machines costing \$50,000 to \$100,000) and the IBM PC market. (CAD and CAM refer to *computer-aided design* and *manufacturing*, respectively.) Mindset's vision was to make a computer with most of the graphics power of a CAD/CAM system for a consumer-computer price. Its approach was to adapt CAD/CAM technology to a smaller and less expensive computer by using custom VLSI (very-large-scale integration) chips to perform complicated graphics quickly and cheaply.

By working with a custom chip manufacturer, VLSI Technology Inc. of San Jose, California, and drawing on the expertise of employees who came from companies like Zilog, Intel, and Atari, the Mindset design team created two custom VLSI chips, one for pixel-oriented graphics and one for handling the video display, and designed a computer around them and the Intel 80186 microprocessor (an enhanced chip that runs a superset of the 8086 instruction set

Using the Mindset, Saul Bernstein "painted" this view of an astronaut putting the world on line to represent this month's theme of real-world interfacing. (Photo by Michael Decastro.)

(2a)

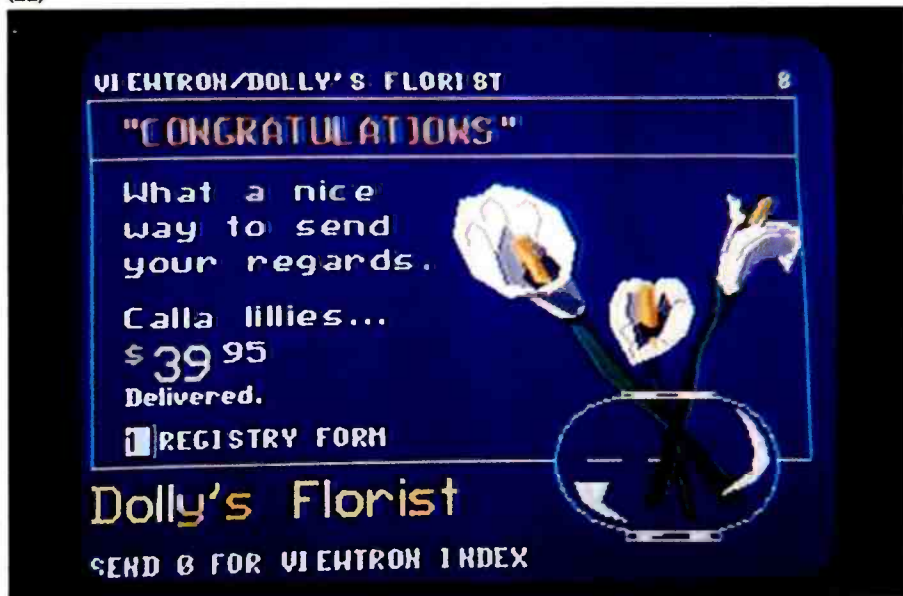

(2b)

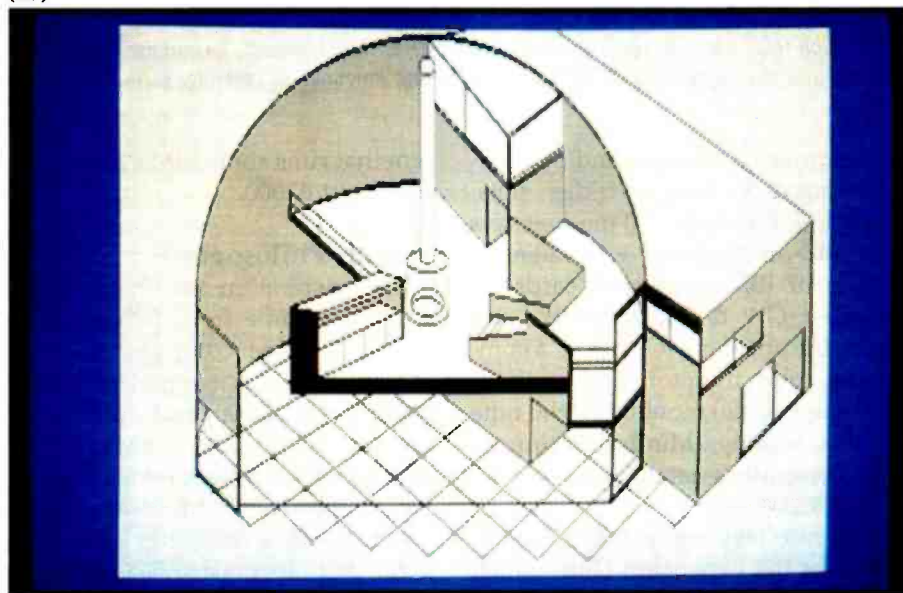

(2c)

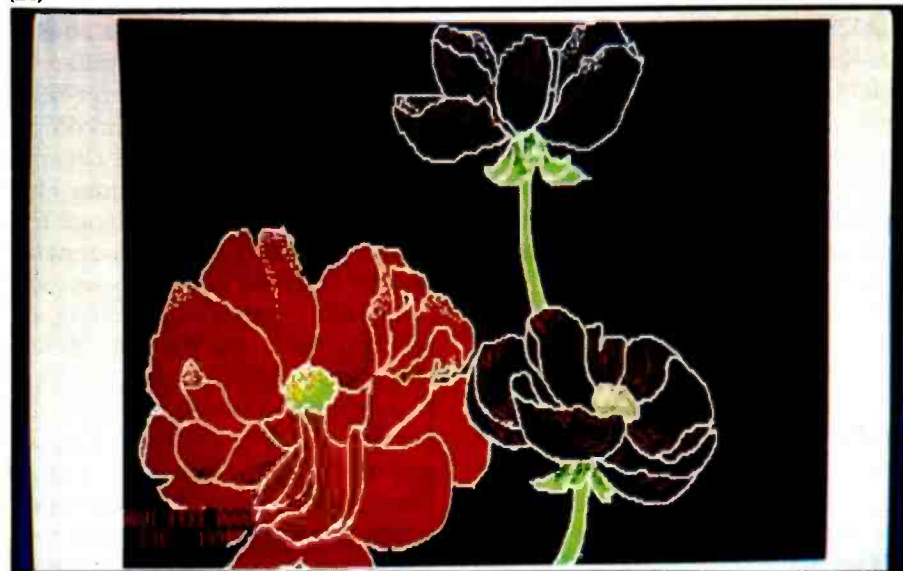

and replaces about 20 chips in a comparable 8086-based design). Intel designed its 8086 family of microprocessors to be able to use a family of yet-to-be-designed coprocessor chips that, in effect, extend the instruction set of the Intel 80186 (Intel's 8087 floating-point arithmetic chip is the best-known coprocessor chip). The custom graphics chip in the Mindset computer is actually a coprocessor chip, the first to be designed outside Intel.

The resolution of Mindset graphics is not appreciably more than that of an IBM PC, but Mindset made that decision to allow itself to offer a low-cost computer: higher-resolution graphics would have forced the user to buy an RGB color monitor costing anywhere from \$1400 to \$4000. Still, the Mindset shares the following characteristics with its more expensive CAD/CAM counterparts: bit-mapped graphics; color indirection (the ability to choose from 512 possible colors the 16 that can be in use at one time); custom hardware to perform pixel-aligned graphics operations quickly, regardless of byte and word boundaries; and custom software that delivers a set of useful graphics-oriented subroutines. Photos 2a through 2c show representative Mindset graphics.

Mindset added limited IBM PC compatibility to give it a considerable base of ready-to-run software. The company would have liked to have had 100 percent software compatibility, but this conflicted with some of its other goals. The Mindset computer is BIOS-entry-point- and graphics-screen-compatible with the IBM PC; this means that if a program uses the Microsoft MS-DOS BIOS (basic input/output system) calls and manipulates the graphics screen directly (as all programs should, but many don't), the Mindset can run the same disk without modification. Mindset tested many popular IBM PC packages and, if they didn't work,

Photo 2: *Graphics on the Mindset. Photo 2a is an image created by PLP (presentation-level protocol) graphics commands. Photos 2b and 2c are done in the 640-by-200-pixel, 4-color mode.*

SYSTEM UNIT

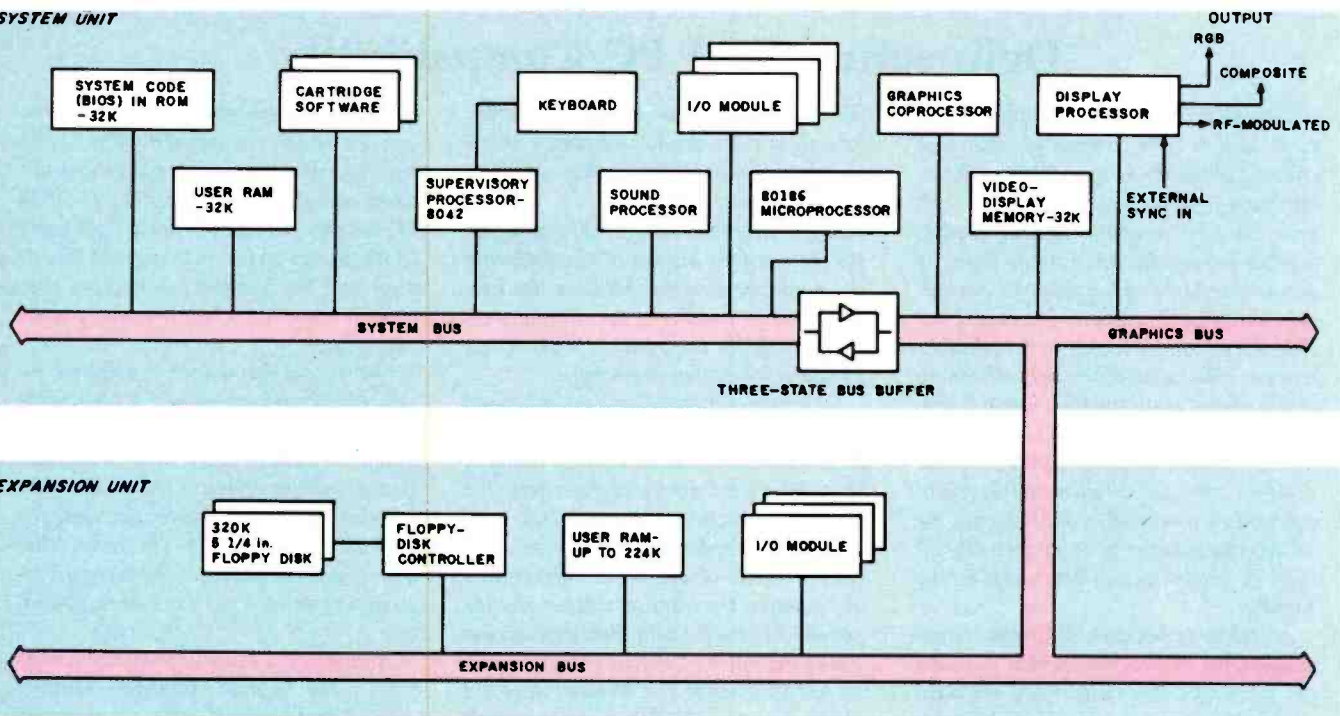

Figure 1: Block diagram of the Mindset personal computer.

tying up the 80186 and all the system components on the other side of the bus.

The Intel 80186 has a full 16-bit-wide data bus to complement its internal 16-bit architecture. Because it is not restricted by an 8-bit data bus (like the 8088 in the IBM PC), and because it runs at a higher clock rate

(6 MHz instead of the PC's 4.77 MHz), the Mindset should run faster than the IBM PC. (For details on the effect of bus width on microprocessor performance, see my "Benchmarking the Intel 8086 and 8088," July 1983 BYTE, page 147.) A spokesperson at Mindset said that the company chose the 6-MHz 80186 over the 8-MHz ver-

sion to ensure a "sufficient quantity" of the part for manufacturing the computer.

System Code in ROM

One significant feature of the Mindset is its use of system code in ROM (this is similar to the IBM PC); in this way, the computer can work as a stand-alone unit (without disk) or, if disks are present, software on the disk can "hook" the ROM software into itself and make it a disk-based system. The ROM software contains start-up instructions—what to do when the computer is first turned on. It also includes the computer's BIOS, a set of routines that let the programmer do character- and block-oriented input and output (and other elementary functions) without having to know the physical addresses or characteristics of the hardware being used. (The routines, when referred to by number, are called *interrupt vectors*.) For example, BIOS routine 16 decimal (called by the software-interrupt instruction INT 10, where "10" is the decimal number 16 in hexadecimal) controls 16 functions relating to the video display—setting the display type, reading the cursor position, putting a character to the display, and others.

| Interrupt Vector (Hexadecimal) | IBM PC Description | Mindset Description | Comments |
|--------------------------------|----------------------|---------------------|---|
| 2 | Nonmaskable | Reserved | Vector 2 is a hardware interrupt that is implemented differently on the 8088 and 80186; Mindset uses this vector for a proprietary purpose but knows of no conflict when trying to use IBM software |
| 10 | Video | Video I/O | There is full compatibility except in video modes not supported by the Mindset computer |
| 15 | Cassette | Dummy IRET | The Mindset places an IRET (return from interrupt) here because it does not support cassette I/O |
| 16 | Keyboard | Keyboard I/O | There is full compatibility except where the Mindset keyboard differs from the IBM PC keyboard |
| 18 | Cassette BASIC | Dummy IRET | The Mindset does not need this vector because its BASIC is not in ROM |
| 1D | Video Initialization | Reserved | The IBM vector returns information specific to its hardware; the Mindset ignores this vector |

Table 1: Deviations of Mindset interrupt vectors 0 through 1F hexadecimal from their IBM PC counterparts. The closer to identical these two are, the greater the degree of IBM PC compatibility; the differences here are very small.

Delineating IBM PC Compatibility

Mindset did not set out to create a computer that is IBM compatible; rather, it created a computer using radically different hardware from the IBM PC that can run many IBM PC programs. The distinction is small but significant. For one thing, it means that Mindset has made no attempt to be hardware compatible: you cannot use IBM PC expansion boards in the Mindset because it has no hardware slots. The irony of this compatibility situation is that if software designers programmed the way they were supposed to—using operating-system routines instead of direct manipulation of the hardware—and IBM had designed the PC to make it easier to do so, virtually all IBM PC programs would run as is on the Mindset.

According to Mindset, "Mindset is compatible with PC programs which run with the color card and which use standard ROM OS calls and/or MS-DOS 2.0 functions, or with PC-DOS 1.1 programs which map into PC-DOS 2.0." In addition, the Mindset works with programs that address video-display memory directly and make use of the 6845 video-display-controller status registers. (Because the Mindset does not use the 6845 for video display, it does not respond to most manipulations of it; however, so many

IBM PC programs use it to find out when to write to video-display memory without causing visual glitches that Mindset emulates these registers.) In general, though, programs should call operating-system routines instead of manipulating the hardware directly (Mindset has provided a large number of operating-system routines in its computer to make direct hardware access unnecessary).

Differences between the characteristics of the IBM PC and the Mindset account for some inherent incompatibilities. Many of these have been discussed elsewhere: the "Keyboard" section of the main text, table 1 (operating-system-call differences), and table 8 (video-display-mode differences). For example, the Mindset will not run the popular Microsoft Flight Simulator because it uses the 160- by 100-pixel graphics mode, an IBM PC mode the Mindset does not allow. Also, the Mindset does not include BASIC in ROM or support the IBM-style light pen or joystick.

When using the IBM PC with a graphics-interface card in text mode, you can display characters with any combination of 16 foreground colors and 8 background colors and optional blinking. The Mindset supports blinking characters but only two color modes: black on white and white

on black. By changing the color palette, you can display characters in other colors, but you will be limited to only those two colors on the display. In addition, the IBM PC has memory space for up to eight pages of 40-column text or four pages of 80-column text; the Mindset has reserved only enough memory for half that many alternate pages.

Finally, another source of software incompatibility occurs because of a hardware incompatibility between the 8088 and the 80186. According to Mindset, the vector that is used for keyboard I/O on the 8088 is dedicated in the 80186 to refreshing the system's dynamic RAM. This means that a program that reassigns the keyboard interrupt vector will not work on the Mindset.

Although the Mindset promises to work with many IBM PC packages, Mindset owners will be faced with an annoying uncertainty every time they see a piece of IBM PC software. In some cases, Mindset will have tested the software and determined its compatibility, but it can't keep up with the explosion of software we have today. The user's best bet is to deal with a software vendor that will let him or her try it before buying.

modified the computer so that they would. Many word processors (Peachtext, Wordstar, Superwriter), spreadsheets (1-2-3, Multiplan, Supercalc 3, Visicalc), databases (dBASE II, Condor), and other programs work as is.

The Mindset computer is incompatible with the IBM PC in that the former does not have a cassette interface; however, the operating system was designed to interact with cartridges as sequential-file devices. The Mindset computer also does not support a monochrome graphics display, light pen, IBM-style resistive joysticks, and some color graphics modes. For a more detailed look at this issue, see the text box "Delineating IBM PC Compatibility."

Open Software/Closed Hardware

Mindset recognizes the important role of third-party product developers

in the success of a new computer, but it has taken a curious approach in its company policy toward them. It is actively promoting the development of third-party software (more on this

Mindset Is promoting the development of third-party software while discouraging third-party hardware vendors.

later) but is rigidly guarding all details about the hardware itself, thus discouraging third-party hardware vendors and forsaking the increased popularity that comes from the availability of a large amount of hardware for the system. Mindset gives two reasons for its closed-hardware policy: first, to allow future versions of the hardware to include changes

without making them incompatible with existing software; and second, to protect its design from imitation by competitors. Mindset's policy, for better or worse, limits the depth of technical information that follows.

Machine Architecture

Figure 1 shows a block diagram of the Mindset personal computer. The diagram shows the contents of both the System and Expansion units. The system, graphics, and expansion buses have a 16-bit data bus and a 20-bit address bus. The system and graphics buses are joined by a *three-state bus buffer* that can either isolate or connect the bus lines on either side of it. In some cases, the system isolates the two buses so that the graphics coprocessor and display processor can perform a lengthy function (e.g., clearing the screen or refreshing the video display) without

| Interrupt Vector (Hexadecimal) | Value in AH Register (Hexadecimal) | Function |
|---|------------------------------------|---|
| Video Support | | |
| EE | 01 | Writes a character string to the screen along with string's attributes |
| EE | 02 | Selects TV or monitor as display device and reloads color palette |
| EE | 05 | Sets the cursor shape for character modes |
| EE | 06 | Supports synchronization with external video devices |
| EE | 07 | Specifies scan line that generates a display interrupt |
| EF | 0E | Returns frame-buffer address and sizes |
| Graphics Initialization | | |
| EF | 00 (01) | Sets (gets) screen-mode information |
| EF | 02 (03) | Sets (gets) transparent and combination modes |
| EF | 04 (05) | Sets (gets) address of destination buffer |
| EF | 06 (07) | Sets (gets) write mask |
| EF | 0A (0B) | Sets (gets) color-palette data |
| EF | 0F (10) | Sets (gets) address of user-defined display interrupt routine |
| EF | 12 (13) | Sets (gets) collision mask |
| EF | 14 (15) | Sets (gets) clipping rectangle |
| EF | 16 (17) | Sets (gets) the collision and clipping enable/disable flags and the address of the associated interrupt routine |
| EF | 1F (20) | Sets (gets) pointer to user-specified font |
| EF | 22 (23) | Sets (gets) the parameter-block mode value, which determines whether certain parameter lists are contiguous areas or linked lists |
| Graphics Primitive Operations | | |
| EF | 08 | Basic bitblt operation: moves one rectangular area of graphics to another |
| EF | 09 | Fills a rectangular region with a 16-bit pattern |
| EF | 0C | Draws a series of points of the same color |
| EF | 0D | Draws a series of lines of the same color |
| EF | 19 | Draws a filled convex polygon |
| EF | 1A | Draws a series of filled ellipses, circles, and pie sections |
| EF | 1B | Draws a series of hollow ellipses, arcs, and circles |
| EF | 21 | Displays character strings at any location with a user-specified font |
| Miscellaneous Graphics | | |
| EF | 11 | In a double-buffered graphics mode, switches display to alternate buffer |
| EF | 18 | Waits until the graphics coprocessor finishes current task, then returns collision and clipping results of the last 16 tasks |
| EF | 1C (1D) | Saves (restores) the current state of the graphics coprocessor chip |
| EF | 24 | Poles the current status of the graphics coprocessor chip |
| Miscellaneous Nongraphics Commands | | |
| EE | 08 (09) | Sets (gets) the mode for (from) the real-time clock |
| EE | 0C (0D) | Sets (gets) the time for (from) the real-time clock |
| EE | 0E (0F) | Sets (gets) the date for (from) the real-time clock |
| EE | 15 | Formats a RAM cartridge to accept information and support a directory |
| EE | 18 (19) | Reads (writes) blocks of data from (to) a RAM cartridge |
| EE | 1F | Reads status of both joystick ports |
| EE | 21 | Turns off the power to the system |
| EE | 24 (25) | Sets the sound mode (registers) |
| EE | 26 | Transfers sound data directly to the system D/A (digital-to-analog) converter |
| EE | 28 (29) | Writes (reads) a character to (from) the RS-232C output (input) buffer |
| EE | 2C (2D) | Sets up the RS-232C input (output) buffer |

Table 2: Important BIOS routines supplied by the Mindset ROM operating system.

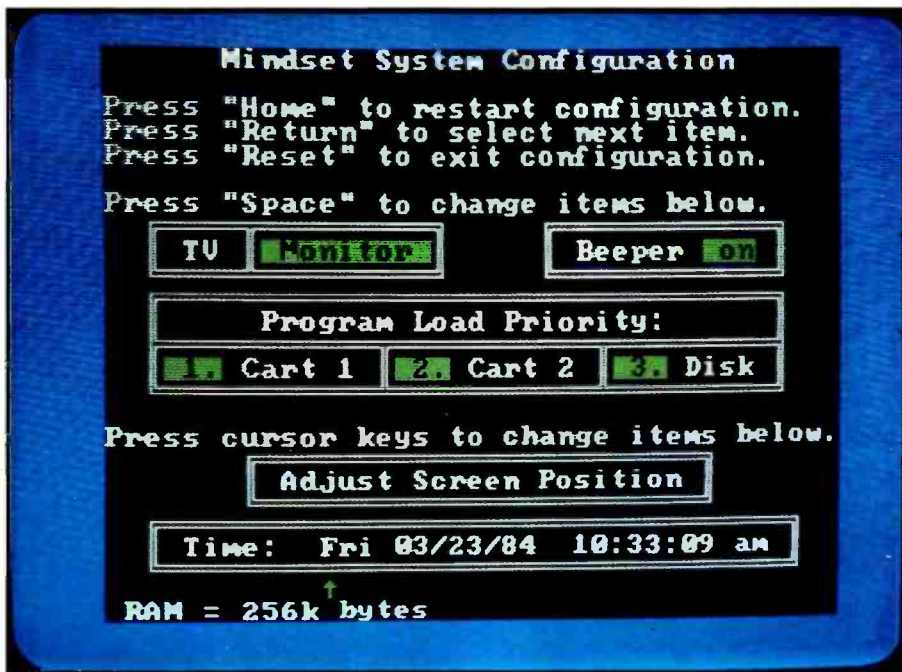

Photo 3: The System Configuration screen appears at the beginning of a session when you hit the Sys Config key. This screen shows how much memory you have (see lower left corner) and allows you to change certain system parameters.



Photo 4: Although this Mindset keyboard is quite similar to the IBM PC keyboard, Mindset has made several improvements. Note, among other things, the more conventional layout of the function keys F1 through F10 and the improved position of the Shift keys.

The Mindset BIOS routines are a superset of the IBM PC's, thus contributing to IBM compatibility. Interrupt vectors 0 through 1F hexadecimal are essentially the same as on the IBM PC (see table 1 for a list of differences). In addition, Mindset uses interrupt vector EE hexadecimal for 57 system-specific functions (distinguished by the value of the AH register when the interrupt is executed) and vector EF for 39 graphics-related functions (table 2 lists some of the more important EE and EF vectors).

By creating an interrupt structure that includes all the basic interactions needed between a program and the system hardware, Mindset is strongly encouraging programmers to create code that will work on the computer even if Mindset changes the control addresses and even the implementation of some functions in hardware.

The system-specific BIOS routines include a set of RS-232C-related routines that allow data transfers to occur, interrupt-driven, as a background process. You can set up both

input and output data buffers. Once you start an I/O operation, the system can send the data in the output buffer or receive external data into the input buffer automatically while the foreground program goes on to other tasks.

Many of the extended graphics BIOS routines will take a list of arguments, and one call to that routine will perform a given operation up to 65,535 times. For example, one BIOS call can draw 20,000 line segments of the same color, but you need to make two BIOS calls to draw two line segments, each in a different color.

Starting the Computer

If you want to use cartridge software in the Mindset, you insert the program in one or both of the cartridge slots and turn a dial on the left face of the computer to clamp the cartridge contacts in an internal zero-insertion socket. You can insert cartridges in either slot; the operating system can find the proper software to run, even if both cartridge slots are occupied.

The on/off switch is located on the back of the keyboard; however, it does not directly control the power. The supervisory processor (an 8042) remains active as long as the computer is plugged into a wall socket. It constantly "listens" for keypresses from the keyboard; the on/off switch is simply a keypress(es) that the 8042 uses to "wake up" the rest of the system.

The computer checks three sources for the code it will execute on startup—the disk and the left and right cartridge slots. You can set the order of checking as well as other items such as time, date, and screen-image position (relative to the edges of the display area) by hitting the Sys Config key just after starting the system; this key causes the *System Configuration screen* to be displayed (see photo 3). The values chosen by modifying this screen remain in effect as long as the computer is plugged into an electrical outlet.

Keyboard

Photo 4 shows the Mindset keyboard. Mindset had the courage to

FIRST ANNOUNCEMENT OF A BREAKTHROUGH IN VIDEOTEX TECHNOLOGY.

NOW WORLD SYSTEM VIDEOTEX CAN BE IMPLEMENTED ON A MICRO FOR A MICROSCOPIC PRICE!

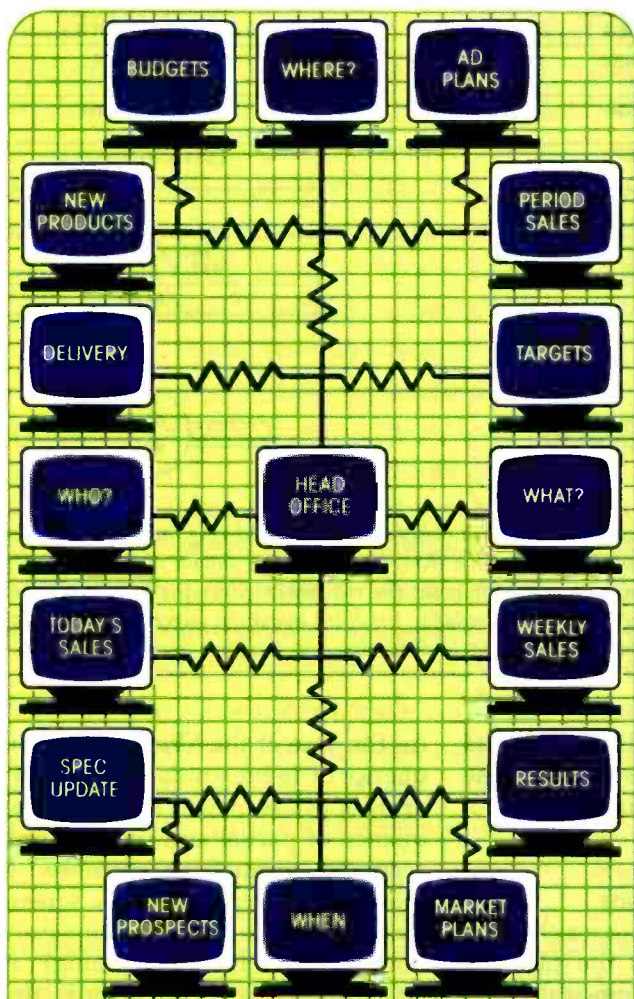

16 PORT PRIVATE
VIDEOTEX SYSTEM

for less than **\$625** per port

Metrotel, creators of the now world famous Videotex Editing Package, announce a major breakthrough. After years of development in the British market, Metrotel have created a Videotex Host Package which can be implemented on most CP/M, S100, Z80 based microcomputers and the BBC Micro.

A NEW BOON FOR BUSINESS!

The opportunities for business are endless – Head offices can keep in constant touch with their field sales force, remote branch offices or their more important customers.

Two way information can be provided quickly, efficiently and confidentially. Metrotel PVS features full local and remote editing. Mailbox and response frames, together with a two tier password and account number security system. Metrotel PVS can help business to become more responsive to today's demanding information requirements for a minimal cost.

SEE HOW LITTLE IT COSTS!

Until now the cost of implementing a private Videotex system has been prohibitive for most small/medium size businesses. In today's cost conscious business environment only a system which recognises financial accountability can ever succeed. Metrotel PVS has been predicted as: – "an affordable system which will undoubtedly advance business efficiency." All that is required to implement

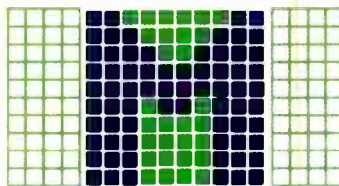

METROTEL

Distributor Enquiries to –
METROTEL VIEWDATA
SYSTEMS LTD., 6 HIGH STREET,
RUISLIP, MIDDLESEX HA4 7AP,
ENGLAND. Tel: +44 8956 77071.

your own Private Videotex system for up to 100 users is Metrotel PVS software, a Metrotel Modem Multiplexer and 16 Auto answer Modems supporting inexpensive Videotex terminals. Typical costs, less than \$10,000, which means a private Videotex system is within reach of every business.

EASY TO USE SOFTWARE

Metrotel software is written to a high professional standard to conform to the Videotex philosophy of a simple user interface. Metrotel PVS software is menu driven, self explanatory and designed for the end user. This feature, coupled with a high standard of documentation and after sales support, ensures that the user spends all his time in the active pursuit of his own business, rather than grappling with the software.

Send coupon for full details of Metrotel PVS.

To: Metrotel Viewdata Systems,
c/o World System Videotex,
20th Floor, 341 Madison Ave.,
New York NY10017

Please send me full details of the exciting Metrotel PVS system.

Name _____

Company _____

Address _____

Telephone _____

SEE US AT THE 'WORLD SYSTEM' STAND – VIDEOTEX '84 – CHICAGO APRIL 16-18

CP/M is a registered trade mark of Digital Research.

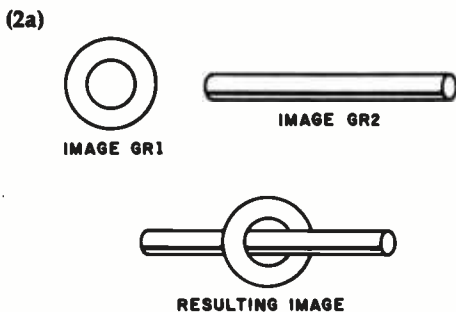

(2b)

| GENERAL BLT COPY PARAMETER BLOCK | |
|--|--|
| SOURCE RASTER ADDRESS | |
| SOURCE RASTER WIDTH | |
| X LOCATION IN SOURCE Y LOCATION IN SOURCE | |
| X LOCATION IN DESTINATION Y LOCATION IN DESTINATION | |
| X-SIZE } OF BLOCK Y-SIZE } TO TRANSFER | |
| SOURCE MASK | |

(2c)
OPERATION

| PARAMETER BLOCK FOR FIRST TRANSFER | |
|---------------------------------------|--|
| ADDRESS OF GR1 RASTER | |
| RASTER WIDTH OF GR1 | |
| (GR1 X-SIZE)/2 0 | |
| X-DEST + (GR1 X-SIZE)/2 0 | |
| GR1 X-SIZE/2 GR1 Y-SIZE | |
| FFFFH | |

| PARAMETER BLOCK FOR TRANSFER 2 | |
|-----------------------------------|--|
| ADDRESS OF GR2 RASTER | |
| RASTER WIDTH OF GR2 | |
| GR2 X-SIZE 0 | |
| 0 Y-DEST + (GR1 Y-SIZE)/3 | |
| GR2 X-SIZE GR2 Y-SIZE | |
| FFFFH | |

| PARAMETER BLOCK FOR TRANSFER 3 | |
|-----------------------------------|--|
| ADDRESS OF GR1 | |
| RASTER WIDTH OF GR1 | |
| (GR1 X-SIZE)/2 0 | |
| 0 0 | |
| (GR1 X-SIZE)/2 GR1 Y-SIZE | |
| FFFFH | |

RESULT

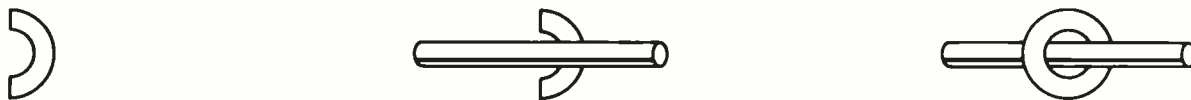

Figure 2: Mindset graphics at work. Using the Mindset block-graphics commands, you can easily create a rod-and-ring image from its two component images (see figure 2a). Figure 2b gives the format for the parameter block of the three block transfers shown in figure 2c. The first operation in figure 2c draws the right half of the ring. The second operation superimposes the rod image. Since the transfer is done in transparent mode, the space surrounding the rod image does not replace the ring. Similarly, the third operation superimposes the left half of the ring over the rod. Some computers would have to do considerable calculations to draw these overlapping images correctly.

break with the seemingly sacred (but annoying) IBM PC keyboard layout. Although I used the keyboard for only a few minutes, it looks like most of the changes are improvements. Note that the keypad does not double as a numeric keypad; because of this, the keyboard has no Num Lock key. The Start and Pause keys are new, returning extended key codes 133 and 134, respectively. The new Reset key resets the machine, replacing the Ctrl-Alt-Del combination on the IBM PC; it also returns the same key code (83 decimal). Also note the changed positions of the following keys: the 10 function keys, Alt, Caps Lock, the left Shift key, Backspace, the reverse slash key, Ins, Del, Pg Up, Pg Dn, Brk (Break), Scr Lk (scroll lock), Home, End, and the four cursor keys. I particularly like the placement of the

cursor keys in the modified diamond configuration, which is said to be the best cursor-key layout in terms of ergonomics.

Graphics Coprocessor

The graphics coprocessor chip is a VLSI chip that takes the place of about 300 MSI (medium-scale integration) chips. Its main function is *bitblt operations*, movement of bit-aligned block transfers within the video-display memory. The Mindset, like most other microcomputers, works on *bit-mapped graphics*, graphics in which the screen is composed of a rectangular array of dots and the dot array is stored in memory as a linear stream of bits, with one or more bits corresponding to one dot. Though the video display is organized as an array of bits, it is stored

(in the case of the Mindset) as a sequence of 16-bit words. An arbitrary array of pixels may be stored as a sequence of partial and whole words scattered throughout memory. To move such an image on the screen, most computers must do complicated (and therefore time-consuming) calculations to locate the words that comprise the image and, when necessary, move only the bits that correspond to part of the image. The Mindset graphics coprocessor does this function in hardware rather than tie up the microprocessor, which would otherwise do it more slowly in software. In addition, the graphics coprocessor can draw arbitrary straight lines as a built-in function. Figure 2 shows how bitblt operations can simplify the drawing of a composite three-dimensional image.

How to make your Apple run 3½ times faster.



Just plug in the Accelerator IIe™ and watch your Apple® II, II Plus or IIe take off.

Imagine running VisiCalc®, DB Master®, Applesoft, Apple Fortran or Pascal without long delays. With the Titan Accelerator IIe, your Apple II, II Plus or IIe runs these programs a true 3½ times faster. The Accelerator IIe also runs your Franklin, Basis and other Apple II compatibles 3½ times faster. This faster computer response time means less waiting for you and an increase in your productivity.

This Titan exclusive has its own fast 6502 processor, 64K of high-speed memory, and built-in fast language card. It is transparent to your software and is hardware compatible with most standard peripherals. And you can turn it off from the keyboard to run your Apple at regular speed.

Find out how to run faster and increase your productivity without breathing hard. For information on the Accelerator IIe and other Titan products, see your computer dealer or contact:



 **Titan**
TECHNOLOGIES, INC.

310 West Ann Street, Ann Arbor, MI 48104
Telephone (313) 662-8542

Apple is a registered trademark of Apple Computer Inc.
VisiCalc is a registered trademark of VisiCorp.

DB Master is a registered trademark of Stoneware, Inc.
Accelerator IIe is a trademark of Titan Technologies, Inc.

Sales and Marketing by The MARKETING RESOURCE GROUP, Fountain Valley, CA.

| Combination Mode Number | Data Placed in Destination Area |
|-------------------------|--|
| 0 | source |
| 1 | AND of source and destination |
| 2 | OR of source and destination |
| 3 | XOR (exclusive OR) of source and destination |
| 4 | NOT (inverse) of source |
| 5 | AND of destination and inverted source |
| 6 | OR of destination and inverted source |
| 7 | XOR of destination and inverted source |

Table 3: Block-graphics transfer modes. The graphics coprocessor can transfer a block of graphics in eight different ways, each one substituting a different image for the destination area.

A block-transfer operation has several options, two of which are its *transparent* and *combination* modes. Suppose that an irregularly shaped object is drawn within a rectangle of black and that this rectangle is moved to a new location. If the transparent mode is off, the image will carry its rectangle of black around with it. If transparent is on, only nonzero (non-black) pixels are transferred, and the object appears to be on top of whatever image was at the destination. This gives what I call "virtual sprites"—multicolored shapes that can be placed anywhere quickly but without the size, color, and position limitations associated with sprite-

creating hardware. This simple replacement of destination pixels by source pixels is only one of eight possible combination modes. The source pixel (or its inverse) can either replace the destination pixel or be combined with it using a logical AND, OR, or XOR (exclusive OR) operation; table 3 lists these combinations and their mode numbers.

The graphics coprocessor does its operations from an internal set of microcode. Because it uses internal microcode instead of external machine code, it is very fast. Although this approach is slightly slower than another chip design that hard-wires its functions through its structure, it

leaves Mindset with an interesting future option: by creating a chip with a different set of microcode, it can easily create a new graphics coprocessor chip with new capabilities.

Display Processor

The other custom VLSI chip Mindset created for its computer controls the translation of the video-display memory to some visible image on the monitor or television and other related functions. It specifies what graphics mode is in effect and how the color palette interprets each logical color (pattern stored in memory) as a physical color (shade of color as displayed on the monitor or television). As stated earlier, the Mindset can display up to 16 colors at a time, but, ironically, an RGB monitor does not give you the widest selection of colors. If you use an RGB monitor, you are limited to the 16 colors that can be produced from all 16 combinations of the red, green, blue, and intensity on/off inputs to the monitor. If, however, you are using a composite monitor or television, each of the 16 color palette definitions is defined by a 9-bit number, 3 bits each for the red, green, and blue intensities; this gives a total of 512 possible colors from which to choose.

The display processor maintains the synchronization and timing signals of the video signal, draws the colored border around the active portion of the display, and lets you shift the video image slightly to get the best view of the active display area. It also oversees the refreshing of the video display (every 1/60 second for noninterlaced modes, every 1/30 second for interlaced) and the dynamic RAM used to store the video display.

The display processor must take active control of the bus to read the video-display memory. To minimize the amount of time it does this, the designers included a 16-word buffer that the chip quickly fills, then more slowly empties while creating the actual video display.

Supervisory Processor

The supervisory processor is an Intel 8042 microprocessor that is active as long as the computer is plugged

At a Glance

Name
Mindset Personal Computer

Manufacturer
Mindset Corporation
617 North Mary
Sunnyvale, CA 94086
(408) 737-8555

Dimensions
System Unit—16 by 12.2 by 2.8 inches
Keyboard—16 by 7 by 1.5 inches
Expansion Unit—16 by 12.2 by 2.5 inches

Weight
System Unit—6 pounds
Keyboard—3 pounds
Expansion Unit—7.5 pounds with one disk drive, 11 with two disk drives

Standard Configuration
System Unit plus Expansion Unit—128K bytes of user memory, 32K bytes of screen memory, 64K bytes of system ROM, one 320K-byte 5¼-inch disk drive, keyboard, GW BASIC cartridge; see text for other configurations

Processor
6-MHz Intel 80186 microprocessor (16-bit architecture, 16-bit data bus)

Keyboard
Detached 84-key keyboard with 6-foot coiled cable; has two sockets for optional mouse and/or Atari-style joystick

Hardware Options
Second disk drive, mouse pointing device, 128K bytes of extra memory

Software Options
Mindset MS-DOS 2.0, about \$60

Prices
One-disk system (described above), about \$2000; two-disk system with 256K bytes of memory, about \$2600; cartridge-only system, about \$1200 (prices approximate at time of writing)

Both letter-quality and draft hard copy

Fastest document throughput in its class

Both friction and tractor paper feed

Industry standard serial and parallel interfaces.

Better, more versatile operator controls

TI reliability

Compatibility with third-party and proprietary software

Better, more durable easy-access font modules

Introducing the TI 855 microprinter. No other printer says better so many ways.

Feature for feature, no other microprinter can match the versatility, compatibility, reliability and productivity of the OMNI 800* Model 855 microprinter. Here's why.

Two Printers In One. With the TI 855 you get the speed of dot matrix draft copy. Plus the precise clarity of the most advanced matrix technology for letter-quality print. It's two printers in one — at one low price.

A Great Family Name. Texas Instruments is known for providing the world with the industry standard for printers — the TI 810. TI builds the same reliability into every 800 series microprinter. Both the 855 and the data processing Model 850 are part of the expanding TI line of high-performance, low-cost microprinters.

Hardware Compatible. The TI 855 microprinter is compatible with all major PC hardware. And it provides both serial RS232C subset and "Centronics-type" parallel as standard interfaces.

Software Compatible. The TI 855 uses industry standard escape sequences for compatibility with virtually all third-party software. And for those with proprietary software needs, a model is available with ANSI standard escape sequences.

Tough Font Modules For Quick Character Change. Three font modules can be inserted into the front of the printer at one time, and are accessed individually. Each contains both draft- and letter-quality character sets. They're easier to use, more reliable and more durable than traditional metal or plastic daisy wheels.

More Productivity Than Any Other Microprinter. The 855 offers both friction and tractor paper feed, to handle all types of word and data processing applications. A quick-change snap-in cartridge ribbon. Raster and mosaic graphics. And intelligent printing which maximizes document throughput — regardless of format.

Get the printer that makes for better information systems. For more information visit your nearest TI authorized dealer or write Texas Instruments Incorporated, P.O. Box 402430, Dept. DPF-082BY, Dallas, TX 75240. Or call toll-free: 1-800-527-3500.



TEXAS INSTRUMENTS

Creating useful products and services for you.

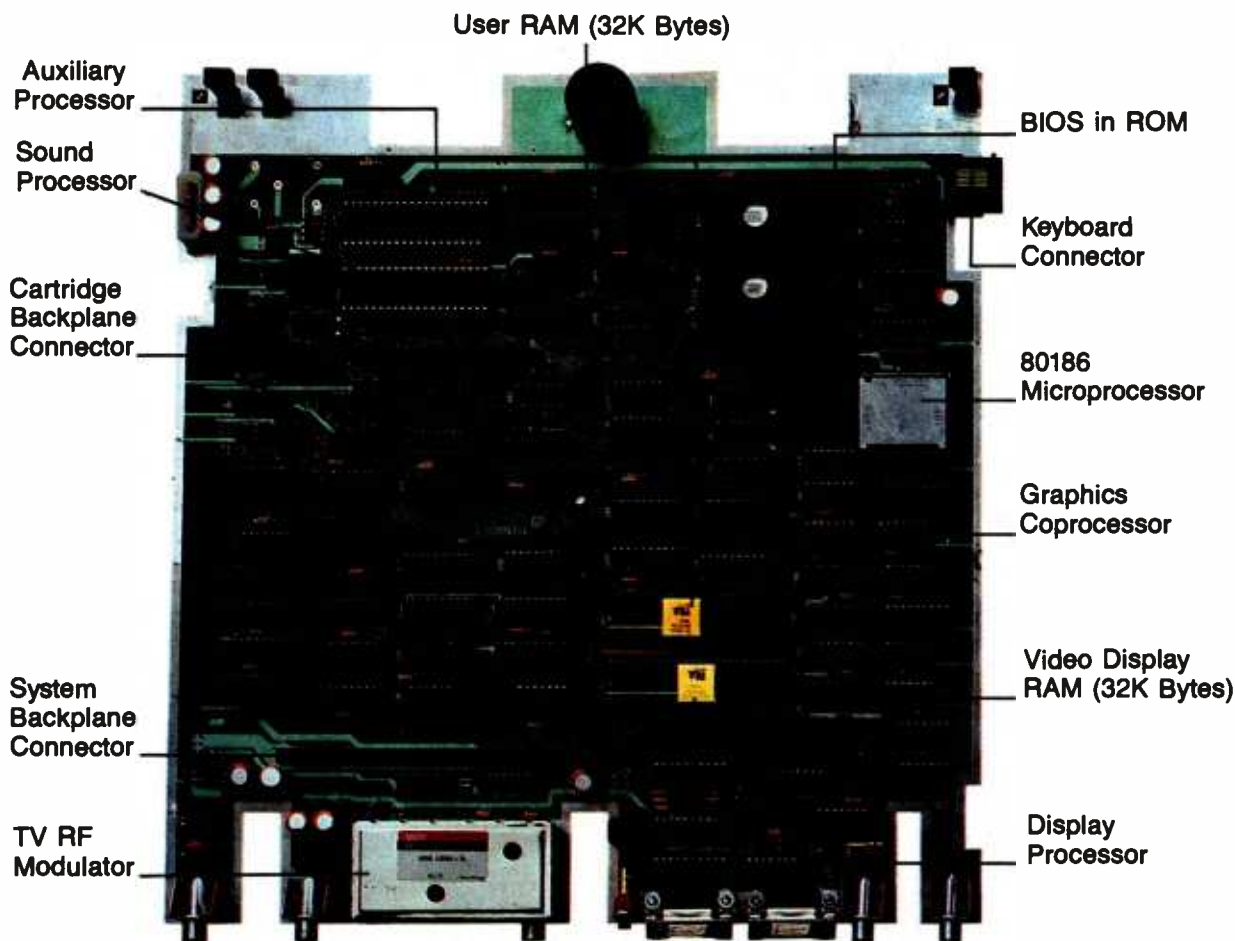

Photo 5: *The Mindset motherboard, which is a completely functional 80186-based computer.*

into an electrical outlet. It implements the Mindset clock/calendar (which is independent from the real-time clock provided for IBM PC compatibility). In addition, it receives and decodes keypresses from the keyboard and monitors "wake-up lines" from the keyboard and all I/O modules (see the section on I/O modules below). The supervisory processor, as well as other major components, can be seen in photo 5.

Cartridges

Mindset has designed three types of cartridges that can be placed into the two slots on the front of the System Unit: a cartridge can contain ROM (for programs or data), RAM (for data or extra memory) with battery backup, or a combination of both. Each cartridge has room for

four 28-pin ICs; compatible ROM or RAM chips can be put in each slot, as long as the total amount of each is a multiple of 4K bytes. The cartridge mates to the System Unit via a 44-pin connector that includes 16 data lines and 15 address lines (see table 4).

The ROM cartridges can hold up to 64K bytes (using 128-kilobit ROMs or EPROMs) or 128K bytes (using 256-kilobit ROMs); later, 128K-byte EPROM (erasable programmable read-only memory) cartridges will be feasible when the cost of 256-kilobit EPROMs goes down. A ROM cartridge can store either data or, more likely, a program to be executed.

The RAM cartridges can hold up to 8K bytes of memory (up to 32K bytes when higher-capacity dynamic-RAM chips become cheaper). The memory

can be used to store data (in sequential-file format) or programs. An internal battery (which is recharging whenever the cartridge is in the computer—a nice touch) keeps the contents of the memory active even when the cartridge is outside the computer; see photo 6. Most Mindset owners will find several uses for such a cartridge. It will also be important to people who buy the diskless \$1200 unit, where it will replace the cassette recorder and tape as the mass-storage medium.

The RAM/ROM cartridge will have half as much of each kind of memory, 4K bytes of RAM, 32K bytes of ROM (or, later, 16K RAM, 64K ROM), and the cartridge will include battery backup for the RAM.

The first four words of every cartridge give information about its con-

X-NET™ Local Area Network Broadens The Horizons Of All IBM PC's.*



X-NET: The affordable LAN that runs MBSI Accounting Software, Database, Electronic Mail and over 1,000 multi-user application packages.

Here are some of the reasons your company needs X-NET Local Area Network:

- 1. READY ACCESS TO ALL INFORMATION.** With X-NET, any computer can get information from any other computer on the network. This means more than one operator can be entering orders, invoicing, changing inventory . . . all at the same time! But where security is needed, you can keep any file private while still within the network.
- 2. YOU CAN START SMALL . . .** Even if you have as few as two PC's, you'll have a system that is easily expandable and will grow with your company.
- 3. . .OR GET BIGGER.** X-NET grows as you grow, networks up to 255 PC's, and best of all, expansion is so simple, you can do it yourself.
- 4. MBSI ACCOUNTING SOFTWARE.** X-NET's software includes Accounts Receivable, General Ledger, Accounts Payable, Order Entry, Inventory Control and Payroll. You can still use your Spread Sheet and Word Processing software, but now much more effectively because your computer power is tied together.
- 5. MULTI-USER DATABASE PACKAGE.** Now even non-programmers can create network databases (with access security) in minutes.
- 6. COBOL PROGRAMS.** Over a thousand multi-user application programs designed for large computers now run on PC's networked with X-NET.

7. ELECTRONIC MAIL. X-MAIL gives you instant, infallible, confidential mail delivery in-house, and works 24 hours a day and has total recall!

8. AFFORDABILITY. X-NET offers more value for less money to any company doing computing on any level. And the software is priced comparably to what others are charging for no-growth single-user software.

9. NO COSTLY CENTRAL FILE SERVER. X-NET eliminates the need of having an expensive computer to act as a Central File Server, something other networks require.

10. SHARE YOUR PERIPHERALS. No longer does each of your computers need its own set of peripherals. Any computer on X-NET is linked to your printers, plotters, disk-drives, etc. A huge money-saver!

*X-NET also operates on IBM PC compatibles.

Call your local dealer or XCOMP today.



XCOMP, Inc.
3554 Ruffin Road South
San Diego, CA 92123-2502
619-573-0077
TELEX: 182786

IBM is a registered trademark of International Business Machines Corporation. MBSI is a registered trademark and division of RealWorld Corp. X-NET is a trademark of XCOMP, INC.

© 1984 XCOMP, INC.

| Pin | Name | Function |
|--|---------------|------------------------|
| 1-2,42 | GND | Ground |
| 3,7,5,4,6,8,9,10,17, 15,13,11,14,16,18,20 | bD0-bD15 | Data bits 0-15 |
| 19,21,23,25,27,29,31, 32,30,28,24,12,33,38,37 | bA1-bA15 | Address bits 1-15 |
| 22 | -bSEL1 | Select 1 |
| 25 | -bSEL2 | Select 2 |
| 26 | -bRD | Read |
| 34 | -bWR | Write |
| 36 | not connected | |
| 39-40 | +5 V | +5 volts |
| 41 | -bCPRSNT | Cartridge present |
| 43-44 | TRCKLCHG | +5-volt trickle charge |

Table 4: Signals from the Mindset cartridge connector.



Photo 6: The Mindset RAM cartridge with battery backup. NVRAM stands for "nonvolatile RAM."

figuration. The first word is a cartridge identification number (used to confirm that the cartridge is meant for the Mindset computer). The second word tells whether the cartridge is structured as a sequential file, whether the memory needs to be given a wait state, and whether the cartridge is a master or slave cartridge. The third word tells how much RAM and ROM the cartridge contains. The fourth word is reserved for future use.

I/O Modules

I/O modules are Mindset's answer to the peripheral slots and cards used

in Apple and IBM PC computers—like peripheral cards, they let you add extra capabilities to your computer via add-on hardware, but they are easier to handle and install. The System and Expansion units can each hold three I/O modules, the slots for which are in the rear of the machine (see photo 7a).

The I/O modules connect to either unit through a 36-pin connector that includes eight data lines (all data transfer is done a byte at a time), five address lines, and various control lines (see table 5). One such line is a "wake-up" line. This is a signal that an outside device, through the I/O

module, can give to a Mindset computer that has been turned off. When the computer receives this signal, it turns itself on and begins executing a preset program. The I/O module interface also includes eight lines that constitute a device identification number. Because of this information, I/O modules do not need to be plugged into a certain I/O slot.

At the time this was written, Mindset was planning to announce the following I/O modules: a second-voice sound module (see below), an RS-232C interface, a Centronics-style parallel interface, a presentation-level-protocol (PLP) graphics receiver cartridge (for receiving videotex drawings), and both 300- and 1200-bps (bits per second) direct-connect modems. Both modems take two slots each and handle the HDLC protocol needed to do videotex. Photo 7b shows an opened RS-232C interface module.

Sound Processor

The Mindset sound processor is a simple but effective microprocessor-driven device that operates in four modes and can currently give up to six musical voices. In addition, a second sound processor can be added as an I/O module to create a stereo music synthesizer. Three of the modes give you three, four, and six musical voices, with more control on the modes that generate fewer voices. The fourth mode allows the 80186 to directly control the circuit's D/A (digital-to-analog) converters; this gives maximal control but, of course, ties up the 80186.

GW BASIC and MS-DOS 2.0

The only piece of software included with the Main Unit is a 70K-byte cartridge containing GW BASIC, an extended version of the graphics-oriented GW BASIC from Microsoft. In addition to the graphics commands supported by GW BASIC (which is itself a superset of the MBASIC supplied in most microcomputers), Mindset worked with Microsoft to include additional commands that exploit some of the computer's special graphics capabilities. All graphics commands are written to

The Micro-world's Most Powerful Editor is also the Easiest to Use.

Easy to Use

VEDIT is an exceptionally easy to use, flexible and powerful full-screen editor. Now you can perform word processing quickly and easily, yet have command of editing tools created for the most sophisticated programmer.

VEDIT helps you concentrate on creativity instead of devoting your attention to operating the program.

VEDIT is also forgiving - it allows you to make mistakes or experiment. If you don't like what you've just typed, 'undo' it with a single keystroke.

Need Help? Just press the help key, a summary of commands and your keyboard layout will be displayed. Even include your own help messages.



Powerful

VEDIT - the micro industry's most respected full screen editor - has evolved into a powerful programming language, with the flexibility, performance & features of SPF, TECO and other mainframe editors. The power of its command macro language is virtually limitless. Sophisticated search/replace with pattern matching of multiple strings in multiple files may be executed automatically. You can create a custom macro program to do virtually anything. Translate source code. Format printed output. Convert WordStar files to VEDIT. With a one line command you can selectively strip comments from programs. And macros may be loaded, saved and reused at a later time.

VEDIT is a 'virtual editor' with unlimited and automatic file handling capability - there is no limit to the size of files you can edit. Plus you can change disks at any time.



Other helpful features include a directory display, single key search and selective replace, line and column display, word wrap, adjustable margins, paragraph formatting & print functions, plus the unique ability to completely determine your own keyboard layout.

Acclaimed

VEDIT is highly acclaimed in every major computing journal. Reviewers say VEDIT is 'nothing short of outstanding', and 'the most flexible programming editor I've ever seen'. In InfoWorld's 1983 Report Card of word processing software, VEDIT scored highest of all CP/M-MSDOS word processors/editors reviewed.

VEDIT's Newest Features

- Horizontal Scrolling (Edit Spread Sheets)
- Single Key Search & Selective Replace
- Pattern Matching ● On-Line Help
- Numerical Capability

Expect a lot from VEDIT. While easy to use, VEDIT is specifically designed for complex text manipulations. VEDIT has 10 text registers for extensive 'cut & paste' on multiple files, plus special features for programming in Pascal, PL/1, C, Assembler and other languages.

- True Full Screen Editing
- Automatic Disk Buffering
- Compact (Only 16K) & Fast
- 'Undo' Key to Restore Line
- Automatic Indent/Undent
- Repeat Function Key
- Text Move and Copy
- Load, Save Buffers on Disk
- Powerful Command Macros
- Directory Display

- Insert Another Disk File
- Unlimited File Handling
- Recovery from Full Disk
- Change Disks While Editing
- Word Wrap
- Format Paragraph
- Printing
- 200 Page Indexed Manual
- Startup Command File
- Customizable Keyboard Layout



VEDIT runs on practically every computer, CRT terminal, and memory mapped display made. To order, please specify your computer make, operating system (CP/M, CP/M-86, Concurrent CP/M-86, MSDOS, etc.), and disk format.

VEDIT - Disk and Manual
 8080, Z80 or IBM PC. \$150
 CP/M-86 or MSDOS \$195
 Manual Only. \$18

CP/M is a registered trademark of Digital Research Inc. MSDOS is a trademark of Microsoft. IBM is a trademark of International Business Machines. WordStar is a trademark of MicroPro.

CompuView

PRODUCTS, INC.

Circle 96 on inquiry card.

1955 Pauline Blvd., Ann Arbor, Michigan 48103 (313) 996-1299 Telex - 701821
 Orders: P.O. Box 1349, Ann Arbor, Michigan 48106

(7a)

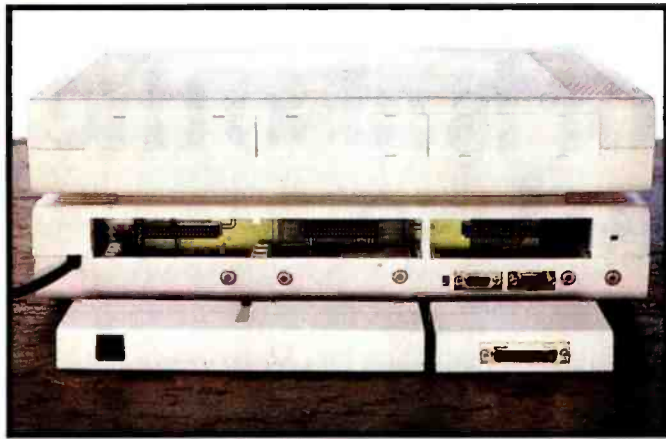

(7b)

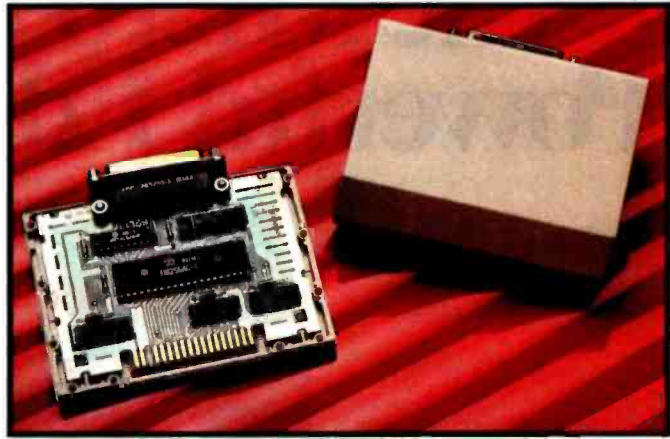

Photo 7: Photo 7a shows the rear panels of the System Unit (bottom) and Expansion Unit (top). Each unit contains connections for three I/O modules. At the bottom left of photo 7a is a modem module (which takes two module slots). The connectors on the bottom rear of the System Unit are, from left to right, audio out, composite video out, RF-modulated video out, channel 3/channel 4 switch, RGB video out, external sync in, auxiliary serial in, and auxiliary serial out. At the bottom right of photo 7a is the RS-232C module; photo 7b shows the same module disassembled.

make best use of the graphics functions available as BIOS calls.

Mindset GW BASIC handles rectangular images and animation as follows. A rectangular image, which I call a *view*, must first be drawn on screen; it can then be saved in a numeric array and, from there, manipulated. You can then create an *object* (which is identified by a number) as a series of one or more views. Then, with one or more GW BASIC statements, you can give the object a starting and ending location on the screen, and you can tell it how fast to move and how often to change from one view to the next. GW BASIC then keeps the image in motion *without supervision by the GW BASIC program* and automatically moves it until it reaches its destination, collides with an object, or moves outside a given rectangular boundary (you can cause a subroutine to execute at this time). In addition, objects can have their motion stopped or resumed or they can be deactivated (frozen in place and made invisible) or activated. See table 6 for a list of Mindset's graphics extensions to GW BASIC.

Mindset MS-DOS 2.0, an implementation of Microsoft's MS-DOS 2.0 tailored to make optimal use of the Mindset hardware and ROM operating system, is, like IBM's DOS, optional and does not come when you buy the Expansion Unit. It comes with an IBM-style book of documentation and will sell for about \$60.

Third-Party Software

The Mindset computer will run dozens of IBM PC programs as is (see the text box "Delineating IBM PC Compatibility" on page 273 for details of incompatibility). Although its internal hardware is very different from that of the IBM PC, the design team iterated the hardware design until a selected group of popular IBM PC products worked on it. I was given a list of 41 products that had been guaranteed to run correctly on the Mindset; among them are Adventure, Word, and Multiplan (Microsoft); Condor Series 20-1 Database; dBASE II and Friday (Ashton-Tate); Deadline, Starcross, Witness, and Zork I-III (Infocom); Lotus 1-2-3; Peachtext 5000 (Peachtree Software); PFS:File, Graph, Report, and Write (Software Publishing Company); PIE Writer (Hayden Software); Spellstar, Wordstar, and Wordstar 3.3 (Micropro); Supercalc 2 and 3 (Sorcim); Visicalc and Visicalc IV (Visicorp). The list is probably longer by now, and Mindset added that "most IBM PC programs" will also run as is on the Mindset computer.

In addition, Mindset has been working closely with software companies to get enhanced products for its computer; at the time that this was written, Mindset said that approximately 25 companies were working on business, educational, personal productivity, and entertainment programs. Parker Brothers, Odesta, and Synapse are working on

games, and Datasoft, Time Arts, and IMSI are working on graphics packages.

The Video Display

Graphics capabilities are at the heart of the Mindset computer, so we will look at them in more detail. As you can see from the memory map in table 7, the video-display memory starts at address B8000 hexadecimal, just as it does in the IBM PC. Whereas the IBM PC maintains 16K bytes of memory for color graphics, the Mindset computer reserves 32K bytes. With Mindset graphics modes that take 16K bytes of memory or less (see table 8), the computer can set up two areas for the video display and, at any given moment, display one of them; this is called *double buffering*. Double-buffered modes let you create glitch-free video graphics: the program alternates between showing the two buffers, always drawing the new image on the buffer not visible.

You will need a special monitor with a high-persistence phosphor to use the two interlaced graphics modes, modes 5 and 6. All the other modes are *noninterlaced*—that is, the entire video image is redrawn every 1/60 second. In the two interlaced modes, the image is drawn in two 1/60-second passes—the first draws all the even scan lines, and the second fills in all the odd scan lines. This means that each scan line is redrawn every 1/30 second. The human eye can detect 30-Hz flickering but not 60

VectorScan 512

Color and Monochrome Graphic Controller Provides High Resolution Graphics on any computer with a RS-232 serial port.

Features Include:

- High Resolution 512 x 480 Pixels x 16 Colors/Intensities.
- Color Lookup Table for each of the possible 16 pixel levels.
- Allows overlay of four independent text and graphic images.
- Non-Interlaced mode allows 8 overlays of text and graphics.
- Rack Mount option (19 inch) is only 1¾ inches in height.
- Parallel input option allows high speed image data transfer.
- Internal Character Generator for Horizontal and Vertical axes.
- Simple ASCII command structure allows system independence.
- Internal Line, Arc, Circle, Point, Programmable Shape and more.
- Extra RS-232 connector allows "Loopthrough" operation.
- Internal microprocessor with 8K firmware and 128K video RAM.
- Internal printer port for hardcopy on low cost matrix printers.
- Firmware expandable to 16K, Programmable Shape Table to 3K.
- RGB output is IBM-PC compatible allowing low cost monitors.
- Monochrome output is RS-170 composite video and sync.
- Includes firmware for IDS Color PRISM printers.
- Allows 128K video RAM to be used as a 128K printer spooler.

Applications:

CAD/CAM, Medical, Business, Slide Generation, Industrial Process Control, Laboratory Data Display, Mapping, Meteorological Studies, Graphic Artwork, Typesetting, CRT Strip Chart Recorders, Printed Circuit Artwork, Educational Graphics, Mathematical Modeling, Engineering, Bulletin Boards.

Computers:

IBM-PC, Apple, Epson, Morrow, North Star, Cromemco S-100, Radio Shack, Heath, DEC, and most others.

Operating Systems:

CPM-80, CPM-86, PC-DOS, MS-DOS, UNIX, OASIS, RT-11

Languages:

BASIC, PASCAL, FORTRAN, PL/I, FORTH, ASSEMBLY

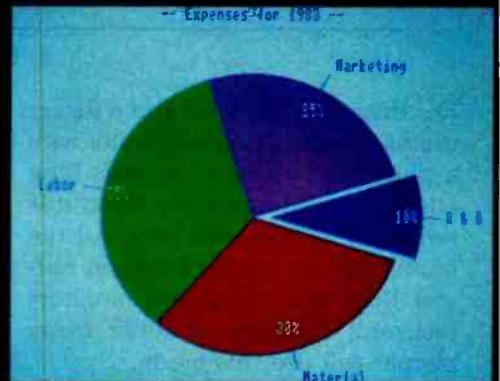
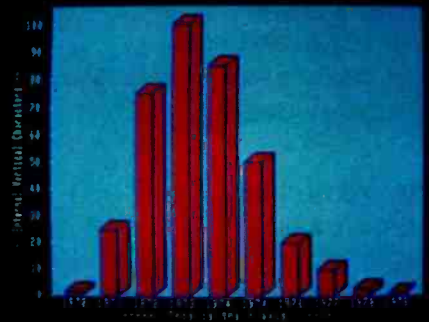
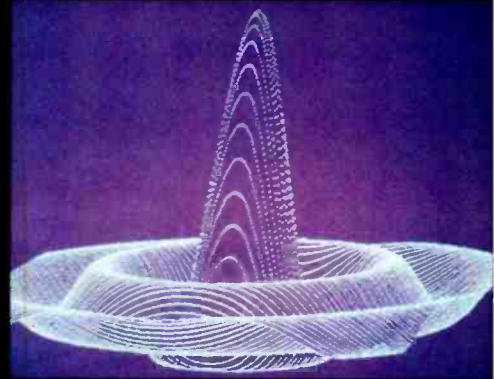

PRICES

| | |
|-----------------------------------|----------|
| VectorScan 512 with 128K RAM | \$975.00 |
| 12 Inch color monitor | CALL |
| Rack Mount Option | \$175.00 |
| Parallel Input Option | \$150.00 |
| Printer Cable | \$ 45.00 |
| Monochrome Monitor with P-39 tube | \$235.00 |
| VectorScan 512 | |
| Programmers Manual | \$ 3.00 |

Dealer and OEM discounts available.



| Pin | Name | Function | Pin | Name | Function |
|-------|----------|-------------------------|-------|-----------|--------------------------|
| 1-2 | GND | Ground | 25 | RESET | Reset |
| 3-4 | + 5 V | + 5 volts | 26 | CLK0 | Clock 0 |
| 5 | + 12 V | + 12 volts | 27 | CLK1 | Clock 1 |
| 6 | - 12 V | - 12 volts | 28 | MODRDY | Module ready |
| 7 | TRCKLCHG | + 5-volt trickle charge | 29 | MODIRQ | Module interrupt request |
| 8 | LRESET | Long reset | 30 | -MODID | Module ID enable |
| 9-16 | D0-D7 | Data bit 0-7 | 31 | -WAKE-UP | Wake-up |
| 17-21 | A1-A5 | Address bit 1-5 | 32 | AUDIO IN | Audio in |
| 22 | -RD | Read | 33 | AUDIO OUT | Audio out |
| 23 | -WR | Write | 34 | SYSCLK | System clock |
| 24 | -MODSELX | Module select x | 35-36 | GND | Ground |

Table 5: Signals from the Mindset I/O module connector.

| BASIC statement | Function |
|-----------------------------------|--|
| DIM OBJECT BALL1(15,20) | Defines BALL as a numeric array large enough to hold a 15- by 20-pixel view |
| DEF OBJECT 3 AS BALL1,BALL2,BALL3 | Defines a numbered object as a series of one or more views |
| OBJECT 3,1 = 10,2 = 50 | Positions object 3 at screen location (10,50); this statement can set any or all of 10 parameters: beginning, ending, and offset X and Y locations, how long each view will be displayed, object transparency, the number of the current view, and the speed of movement |
| SPD = OBJECT(3,10) | Returns the current speed (parameter 10) of object 3 |
| ACTIVATE 2,3,5 | Restores animation of objects 2, 3, and 5 |
| DEACTIVATE 3,4 | Freezes objects 3 and 4 and makes them invisible |
| START 1 | Restores motion to object 1 |
| STOP 1 | Stops all motion in object 1 but leaves it visible |
| COL2 = COLLISION(2) | Determines if object 2 has collided with anything |
| COL23 = COLLISION(2,3) | Determines if objects 2 and 3 have collided with each other |
| ON COLLISION 2,3 GOSUB 20000 | Performs the subroutine at line 20000 if objects 2 and 3 have collided |
| COLLISION ON/OFF/STOP | Resumes, ends, or suspends reporting of object collisions in general |
| CL2 = CLIP(2) | Determines if computer tries to draw object 2 outside the clipping rectangle |
| ON CLIP 2 GOSUB 20000 | Performs the subroutine at line 20000 if computer tries to draw object 2 outside the clipping rectangle |
| CLIP ON/OFF/STOP | Resumes, ends, or suspends reporting of object clipping in general |
| AR23 = ARRIVAL(2) | Determines if object 2 has arrived at its destination |
| ON ARRIVAL 2 GOSUB 20000 | Performs the subroutine at line 20000 if object 2 has arrived at its destination |
| ARRIVAL ON/OFF/STOP | Resumes, ends, or suspends reporting of object arrivals in general |

Table 6: Animation extensions to Mindset GW BASIC.

Hz; therefore, modes 5 and 6 flicker unless you use a special monitor with a phosphor whose glow lasts long enough to still be visible when it is refreshed 1/30 second later. All the mode 5 and 6 images I saw on normal RGB and composite monitors flickered; therefore, I doubt many people will use this mode.

When the system is in a graphics mode, you can make it generate an interrupt at the end of any scan line.

The system defaults to generating this interrupt at the beginning of *vertical blanking*, the time between the drawing of the last line of active video and the first active-video line of the next frame. The vertical-blanking interval lasts about 4 milliseconds (ms) and is used by the system to update the video-display memory while it is not being used for display (to prevent visual glitches from appearing on the screen). The interrupt thus generated

is called the *VBLANK* interrupt. You can modify, replace, or add to the system *VBLANK* interrupt routine, thus allowing you to modify the video display (and do other things) on the fly—that is, while the display is being drawn. (The Atari home computers also use scan-line and *VBLANK* interrupts heavily.)

Also, as you can see from figure 1, the Mindset computer allows several video input and output options. The

AIM HIGH



Before you work anywhere, take a look at the tools we work with.

NASA's space shuttle. For Air Force officers working as electrical or aerospace engineers, the challenge is just beginning. In fact, from laboratories to lasers to launch pads, we have exciting projects and management opportunities very few employers can offer.

For example, we are developing experiments that will be an important part of the space shuttle's cargo in the years to come. Experienced Air Force engineers will work as shuttle mission planners and as astronaut flight controllers.

If you have an electrical or aerospace engineering degree, or soon will have, we may have a challenging future for you as an Air Force officer. It's a future that demands the vision and commitment of people like you. And it's vital to our country.

For more information about Air Force engineering opportunities, mail the card. Or call toll-free 1-800-423-USAF (in California 1-800-232-USAF). Better yet, send your resume to HRS/RSAANE, Randolph AFB, TX 78150. There's no obligation.

AIR FORCE
A great place for engineers.

| Memory Location (Hexadecimal) | Length in Kilobytes | Function |
|-------------------------------|---------------------|--|
| 0-07FFF | 32 | 32K bytes of on-board RAM |
| 08000-3FFFF | 224 | 224K-byte slot for expansion RAM |
| 40000-7FFFF | 256 | Reserved |
| 80000-8FFFF | 64 | Cartridge slot 1, first half |
| 90000-9FFFF | 64 | Cartridge slot 1, second half |
| A0000-B7FFF | 96 | Reserved |
| B8000-BFFFF | 32 | 32,000 bytes of video-display memory followed by 768 bytes reserved by Mindset for unspecified use |
| C0000-CFFFF | 64 | Cartridge slot 2, first half |
| D0000-DFFFF | 64 | Cartridge slot 2, second half |
| E0000-F7FFF | 96 | Reserved |
| F8000-FFFFF | 32 | 32K bytes for ROM-based operating system |

Table 7: The Mindset memory map.

| Screen Resolution (Pixels) | Number of Colors | Double-Buffering? | Mindset Mode Number | IBM PC Mode Name |
|----------------------------|------------------|-------------------|---------------------|-------------------|
| 160 by 100 | 16 | no | NA | low-resolution |
| 300 by 200 | 2 | yes | 0 | NA |
| 300 by 200 | 4 | yes | 1 | medium-resolution |
| 320 by 200 | 16 | no | 2 | NA |
| 640 by 200 | 2 | yes | 3 | high-resolution |
| 640 by 200 | 4 | no | 4 | NA |
| 320 by 400 (interlaced) | 4 | no | 5 | NA |
| 640 by 400 (interlaced) | 2 | no | 6 | NA |

Table 8: A comparison of IBM PC and Mindset graphics modes. Modes are noninterlaced unless otherwise marked. NA means "not available" for a given computer.

computer has separate output jacks for composite, RGB, and RF-modulated video; these are outputs to a composite monitor, an RGB monitor, and an ordinary television set, respectively. In addition, the Mindset allows the video signal to be driven by an external video synchronization signal. If some colors in the color palette are defined as being keyed to external video, the computer video output can be combined with an external video signal; this allows the external image (from, say, a video camera or laser disk) to replace the area of the display where the keyed color would have appeared.

Bitblt Operations

Bitblts are, as I said before, bit-aligned block transfers—that is, oper-

ations that work on rectangular areas of video-display memory. Also mentioned were the transparent and combination modes that affect bitblt operations. They can also be affected by several other modifiers: the write mask, the collision mask, the clipping rectangle, and the user-defined collision/clip/task-done interrupt routine.

The *write mask* is a 16-bit mask that is consulted whenever a word in the destination area is about to be altered; only bits in the destination word corresponding to bits that are 1 in the write mask can be altered. A write mask of FF hexadecimal allows the bitblt operation to proceed normally (all bits are 1s), while a write mask of 0 forces the computer to make no changes to the destination

area. Other write-mask values can be used to limit or modify the bitblt operation taking place.

The *collision mask* is an n -bit mask (where n is the number of bits needed to represent a pixel in the current graphics mode) that defines what a collision is when a bitblt operation is performed. A collision is said to occur when the logical AND of the destination pattern and the write mask matches the value of the collision mask. (This situation is further modified by a "don't-care" mask that signals a collision when only certain specified bits match.) As noted below, a collision can cause the computer to execute a user-defined interrupt routine.

You can optionally define a *clipping rectangle* with a single BIOS call. Once a clipping rectangle is defined, no bitblt operation can change any area outside that rectangle; *clipping* is said to occur when the graphics coprocessor detects an attempted change outside the clipping rectangle. The clipping rectangle can be used for many things, from the creation of window-based software to protecting nonvideo-display memory from graphics commands.

You can establish which events will cause an interrupt (collision, clipping, the completion of an operation by the graphics coprocessor, or any combination) and specify the address of the interrupt routine. Although one routine must service as many as three conditions, the AH register holds a value that tells the interrupt routine which single condition caused the current interrupt. The interrupt-on-task-done is useful when you remember that the graphics coprocessor can work independently of the 80186. You might use such an interrupt routine to service a queue of graphics tasks, the first of which would be given to the graphics coprocessor as soon as the latter indicates it is free.

Finally, one bitblt operation deals with placing text within a destination buffer. Unlike many computers, the Mindset computer is always in graphics mode, and normally each character would have to draw alphanumeric characters a bit at a time.

Fortunately, the BIOS includes a routine that writes a string to the destination buffer given the string, the character font to be used, and the location and orientation (left, right, up, down) of the string. If you do not use the default font built into the computer, you can define your own—your font can be proportional or fixed-width and can be any number of pixels wide and high. The ability to use any number of character fonts of any size is a very nice feature.

Documentation

The Mindset System Unit will come with the *GW BASIC Reference Manual and Operation Guide for the Mindset Personal Computer*, both in the 3-ring-binder-and-slipcover size and format made popular by IBM PC documentation. The Expansion Unit, Mindset MS-DOS 2.0, and other Mindset products will come with documentation sections to be added to the *Operation Guide*. In addition, Mindset will be offering its Programmer's Reference Library for software developers at a price of about \$70. This will include an 8086 macro assembler on disk, a *Programmer's Reference Guide* (to explain DOS), and a *Technical User's Guide* (to explain the Mindset system). This is a particularly good buy (the macro assembler, if it's any good, is worth double that price) and shows Mindset's commitment to encouraging third-party software.

Distribution, Dealer Training, and Warranty

A spokesperson from Mindset said that it was putting together a network of dealers consisting of "full-service computer retailers," including "major chains" of computer stores. The dealers would also be authorized repair centers. Dealers would receive both in-person and videotape training to sell the Mindset; the spokesperson offered no details on these subjects. The computer's warranty will be for 90 days, including all parts and labor.

Caveats

This product preview was conducted after three days at Mindset

Animation and the Mindset

by the Mindset Design Team

We all know that movies and cartoons are a series of still pictures flashing by to give the illusion of motion. Children still play with the little books that they can "page flip" to produce a few seconds of animated movement. Those little books give a quick idea of the problem of the animator, whether doing cartoons or computer graphics. An hour of action takes 43,200 pictures at an animation rate of 12 frames a second, the minimum acceptable rate. If each image takes 32,000 bytes, we need storage for 1,382,400,000 bytes. Just as a cartoonist would not draw 43,200 images, neither would a computer animator keep more than a gigabyte of images on line. The Mindset contains special hardware that eases the job of animation in real time; these features both simplify and speed up the process. In many ways, it is a fast and enhanced form of cel animation.

Cel animation is a classic technique using sheets of transparent celluloid (called cels) with only part of the image drawn on each cel. As an example, take a simple scene of a dog running past a house. First, the background cel with the house is drawn. Next, a cel with the dog's body is placed over the first cel. Finally, the tail and legs are laid down with the final cel, and the composite cel is photographed. The top two cels are removed, the body laid down again but moved a little over, the new positions of the legs and tail are added, the composite cel is photographed, and so on. Cel animation is detailed and exacting work with a practical limit of about seven cel layers.

The Mindset graphics coprocessor offers all the techniques of cel animation and more. It is a special 16-bit microprocessor with the complexity of an 8086 but optimized to move and manipulate images. Each image is stored as a raster (or pixel array) of whatever size (up to 64K bytes) appropriate for that image. When moving the house, for example, onto the display, you tell the graphics coprocessor the size of the house image (which is, say, 40 by 87 pixels) and the destination area (which is, say, 320 by 200) and which pixel in the destination to move to.

An obvious advantage of the cel is that it overlays only what is painted on it. It is transparent where it is not painted. The

Mindset graphics coprocessor can be told to regard all zero pixels as transparent so that they will not affect the destination raster. If the house is surrounded by zero pixels, it will overlay the scene, just as in cel animation. The Mindset, of course, does not care how many cels overlay a scene. Beyond this, the graphics coprocessor permits all logical bit operations. Also, you can specify the logical NOT of either raster. This leads to many special operations, including bit planes, fade-in and dissolve of images, striping, color changes, etc. Clipping bounds can be specified so that an image can be easily made to disappear through a doorway and a Times Square sign effect is trivial.

A computer display is rewritten every 1/60 second. Changing part of the image will cause flicker if it occurs during the video display. The Mindset provides an interrupt to synchronize writing of the image with the display. There still comes a time when there is more to write than time allows. The Mindset has modes for double buffering of images so that page flipping can be used. At the slowest rate that produces acceptable animation, this gives almost five frames to change the image in the buffer not being shown and then to "flip" the pointer just before the fifth frame.

Power and function are obvious traits of the Mindset, but neither of them are any use if the machine isn't fast. The Mindset architecture has been designed with speed in mind. The graphics coprocessor and the display processor are on a separate graphics bus and have priority access to the video-display memory (the frame buffer). The graphics coprocessor and the 80186 work in parallel as long as the 80186 is not addressing the frame buffer while the graphics coprocessor is trying to run, or as long as the graphics coprocessor is not addressing main memory while the 80186 is. In effect, a lot of the display can be built by the graphics coprocessor while the 80186 is doing other useful things.

The Mindset achieves its animation speed and function through parallel processing and special processors optimized to move and manipulate pixels. Conceptually, it is the next logical step in cel animation and creativity tools.

SOFTWARE GALORE

CP/M-APPLE-IBM-PC-EPSON
Discounts up to 52% on
Software and Hardware

ULTIMATE SELECTION
LARGE INVENTORY
LIGHTNING FAST SERVICE
ROCK BOTTOM PRICES

SOFTWARE GALORE WILL
BUY YOU A SIX MONTH
SUBSCRIPTION TO BYTE.
(LIMITED OFFER)

| | LIST | OUR PRICE |
|--------------------------------|--------|-----------|
| dBase II/D Util/QuickCode | \$1120 | \$ 599 |
| WordStar/dBase II | 1195 | 615 |
| NEW! — SuperCalc III/dBase II | 995 | 599 |
| EasyWriter II/Mail II/Spell II | 650 | 219 |
| IUS-GL/AR/AP | 1785 | 1249 |
| MultiTool-Word w/Mouse | 475 | 339 |
| WordStar Pro Pack/Lotus 1-2-3 | 1190 | 695 |

SOFTWARE

| | |
|---------------------------|-----|
| dBase II | 379 |
| Friday! | 179 |
| Home Acct. Plus | 99 |
| Dow Jones Market Analyzer | 285 |
| Lotus 1-2-3 | 329 |
| WordStar | 239 |
| WordStar ProPack | 389 |
| MultiPlan | 165 |
| Champion GL/AP/AR each | 319 |
| SoftWord MultiMate | 319 |
| Keyboard Template | 15 |
| SuperCalc III | 249 |
| Micro RIM RBase 4000 | 379 |
| PFS:File | 89 |

HARDWARE

| | |
|--------------------------------|------|
| CORONA PC | 2450 |
| Taxan Monitors | 139 |
| NEC APC Mono/Drive | 2198 |
| Hayes-Smartmodem 1200B | 399 |
| Hayes-Smartmodem 1200 | 489 |
| Hayes-Smartmodem 300 | 239 |
| Rana 1000 Drives-Atari | 329 |
| Dynamic Ram (Set 9) | 55 |
| MicroSoft System Card 256K-IBM | 435 |
| Elgar 401 | 596 |
| Corvus 10MB | 2335 |
| Microtek RV611C | 79 |
| Videx Videoterm W/SS | 219 |
| Dumpling GX | 89 |
| Cool&Time Apple Fan | 70 |
| EPS Keyboards-Apple | 269 |

PRINTERS

EPSON * BROTHER * C. ITOM
OKIDATA * STAR * NEC

| | |
|---------------------|------|
| Oki 93 | 725 |
| Juki Letter Quality | 489 |
| NEC 3550 | 1895 |
| Epson FX-100 | 699 |
| Epson FX-80 | 529 |

ACCESSORIES

| | |
|-------------------------------|------|
| Verbatim-Single & Double Side | CALL |
| Flip n'Files | CALL |
| Ribbons | CALL |
| Cables | CALL |

(800) 423-6326

REFERENCES: Dun & Bradstreet.

Security Pacific Bank, Marina Del Rey FDIC, Rockwell Int. *We are a Membership Buying Service. Calif. (213) 827-1851

SOFTWARE GALORE: 4079 Glencoe Ave., Marina Del Rey, CA 90292 — Terms: M/O OK, M/C or VISA add 2%. American Express add 4%. NO C.O.D.'s. \$1.50 Handling and \$5.00 Freight except hardware. Prices subject to change without notice. California residents add 6 1/2% sales tax.

Glossary

bitblt: short for "bit block transfer." The steps required to move an array of pixels from one area in computer memory to another area.

color palette: an array in memory that contains the digital representations of the colors to be displayed on the screen.

frame buffer: the area of memory that contains all the pixels to be displayed on the screen. The frame-buffer size in bytes is determined by the equation

$$\frac{\# \text{ of bits/pixel}}{8} \times \text{pixels per scan line} \times \# \text{ of scan lines}$$

Also referred to as "video-display memory."

object: exists within a raster as a rectangular array of pixels.

pixel: short for "picture element." The smallest element of the display area. Each pixel is represented by a number of bits in memory.

raster: a word-aligned rectangular array of pixels (n words in width by m scan lines in height).

raster op: the operation used to modify pixel values during a bitblt.

scan line: one horizontal display line of pixels on a screen.

v-blank: the amount of time required for the cathode-ray display to retrace from the end of the last scan line in one frame to the start of the first scan line in the next frame (approximately 16 ms).

(less than two months before the product announcement), subsequent telephone calls to its technical people, and study of several technical documents. When I was at Mindset, I saw two breadboarded prototypes (using discrete ICs instead of the custom chips) and one preproduction unit (with custom chips and printed-circuit boards). I did not see GW BASIC. Although I saw several impressive demonstration programs, I saw no commercially available software meant to use Mindset graphics, either from Mindset or third-party vendors. The only documentation I saw was an internal document that will probably be part of the Programmer's Development Library; the document was clear and well organized. My only hands-on experience with the computer was less than an hour with a rudimentary in-house drawing program called Ida.

Commentary

If Apple had put this product out (and done it as well as it did the Macintosh), this computer would have become the next Apple II and dominated the under-\$5000 market. However, a new company like Mindset does not have the industry and consumer recognition of Apple and

IBM, and, for reasons that have nothing to do with product quality, Mindset's computer may not achieve as large a share of the market as it would have as part of an established company and product line.

This product looks solid, and the company has made more right decisions than most new companies. I like the design (enough IBM PC compatibility to be useful plus superior hardware), the custom chips (which demonstrate a significant jump in the performance/price ratio, even more than the Apple Macintosh), and the early and enthusiastic support of third-party software vendors.

My reservations come from the things I didn't see less than two months before the product announcement (documentation, finished software, GW BASIC, and marketing details), the closed-hardware architecture, and the lack of follow-through in developing the potential of the product. The last two points need further elaboration.

By choosing a closed-hardware architecture over an open one (i.e., by deciding to keep hardware details secret), Mindset has forced software developers to create software that will be compatible with future versions of the Mindset hardware. This lets

Mindset make small revisions to its product's hardware and software without having to worry about compatibility problems with existing software and hardware; it also allows the company to create more powerful computers in the future that can be upward compatible with existing Mindset-based software.

On the negative side, the closed-hardware policy prevents the establishment of a large volume of third-party hardware, such as that developed for the Apple II and IBM PC families (a factor that has contributed significantly to their continued success), and forces users to depend on Mindset as the sole vendor of I/O modules. (The one exception to this is that software developers will be told enough to create software cartridges.) In the past, a closed-hardware policy has not prevented companies from reverse-engineering the hardware to make new products, and it has ultimately had a significant negative effect on the popularity of the machine in question. I don't see

any reason why this case should be any different.

By saying that Mindset has not followed through on its product, I am only expressing my opinion that it should do something that it has decided not to (perhaps for no worse reason than lack of resources, a very real limitation). I was far more impressed upon first seeing the Apple Macintosh, even though it and the Mindset are equally important in terms of hardware. This leads me to believe that microcomputers are most effective when they are conceived and implemented with a single unifying vision. Apple did this; Mindset did not. Its vision of creating a powerful, graphics-oriented computer for around \$2000 comes through very strongly. However, by not dealing with the issue of what jobs this computer can uniquely do and creating the appropriate software, the company has caused its computer to stand out less than it deserves to. The unity of Apple's vision (embodied primarily in the

Macintosh's strong software design) ultimately makes its computer more interesting than the Mindset. As it stands, the Mindset is just another computer with more power but no new applications it can be used for; with the right software, it could easily eclipse anything now on the market.

Conclusions

The Mindset sets a new record in the price/performance ratio of a microcomputer, bringing most of the speed and function of a \$50,000 graphics minicomputer to a machine almost 1/20 the cost. If the computer is delivered as described and has a sufficiently high level of IBM compatibility, it promises to be an extremely attractive alternative to the IBM PC that, while paying tribute to a PC-driven market, breaks the hammerlock that PC-compatibility-mania has placed on technical innovation in the microcomputer marketplace. ■

Gregg Williams is a senior technical editor at BYTE.

COMPUTERIZED DATA ACQUISITION AND CONTROL—\$490

NO PROGRAMMING NECESSARY

ANALOG CONNECTION II

(For Apple)

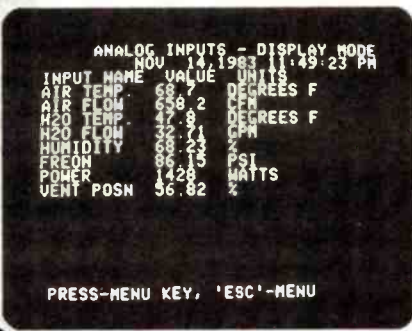

```

NOV 14 1983 11:49:23 PM
ANALOG INPUTS - DISPLAY MODE
INPUT NAME VALUE UNITS
AIR TEMP 68.7 DEGREES F
H2O TEMP 47.8 DEGREES F
H2O FLOW 32.7 CFM
HUMIDITY 68.23 %RH
FREQON 86.15 PSI
POWER 1428 WATTS
VENT POSN 56.82 %

PRESS-MENU KEY, 'ESC'-MENU

NOV 14 1983 12:10:00 PM
PRESENT ANALOG
AIR TEMP 68.7 DEGREES F
H2O TEMP 47.8 DEGREES F
H2O FLOW 32.7 CFM
HUMIDITY 68.23 %RH
FREQON 86.15 PSI
POWER 1428 WATTS
VENT POSN 56.82 %

DIGITAL I/O
FAN ON
DUMP ON
CONFIRM 'R' OFF
VENT MOTN OFF
H2O LEVEL OFF
LIMIT SW OFF
SPARE OFF
SPARE OFF
    
```

- **ANALOG INPUTS**
thermocouples
pressure sensors
strain gauges
flow meters
current loops
voltages
currents
potentiometers
- **DIGITAL (CONTROL) OUTPUTS**
relays
solid state relays
annunciators
lamps
LEDs
- **DIGITAL INPUTS**
switches
level sensors
TTL, CMOS

laboratory-process control-engineering-heating
ventilating, and air conditioning-solar energy-chemistry

Setup data logging, process monitoring, process control, in simple menus! Don't spend 100s of hours programming.

The Apple becomes a control panel from which you can monitor ovens, control tests, log data, sound alarms, or control processes. Monitor and control temperature, pressure, flow, strain, or any other parameter. All you do is connect the sensors. Specify the input ranges and engineering units (such as degrees, volts, PSI) in easy to use menus.

Low cost, but high performance: high accuracy, high noise rejection, protected inputs, ten input ranges, 8 to 48 inputs, 8 to 48 digital I/O's. Automatic compensation for 10 different thermocouple types.

Starts at \$490 including the data acquisition and control software. For Apple II, II+, or IIE computer.



"Real world interfacing is no longer a mystery to me"

Inspector Free Soul
send to:



Strawberry Tree Computers
949 Cascade Dr.
Sunnyvale, Ca. 94087
or Call (408) 736-3083

89.6% chose ScratchPad Plus over Multiplan, Visicalc IV and Supercalc 2.

In a comparison survey, including both computer users and non-computer users, ScratchPad Plus was the spreadsheet of choice.

ScratchPad Plus
89.6%

The group was asked to rate the four spreadsheets on a variety of features, including:

| | |
|---------------------------|-------------------------|
| screen display | virtual memory |
| data entry | quick command summaries |
| cursor movement | long strings |
| multiple window splitting | cell locations |
| | and many other features |

89.6% chose ScratchPad Plus.

Why was ScratchPad Plus chosen by such a wide margin? In some cases it was found ScratchPad Plus' single hand entry was easier to use. Or they preferred the implementation of unlimited window splitting. Or they thought virtual memory, a unique ScratchPad Plus feature, was important to them.

But don't take our word for it. Try the ScratchPad Plus comparison for yourself. Go to your nearest dealer and get some hands-on experience. We want you to see for yourself why so many people prefer ScratchPad Plus.

Retail Price: \$195.00

For a complete copy of our survey results, write SuperSoft, Survey Results, P.O. Box 1628, Champaign, IL 61820.

Available for the IBM Personal Computer, NCR Decision Mate V, Texas Instruments Professional Computer, Rainbow 100, Wang Professional Computer, and other popular microcomputers using the MS DOS, CP/M-86, or CP/M-80 operating systems.

SuperSoft
FIRST IN SOFTWARE TECHNOLOGY

P.O. Box 1628 Champaign, IL 61820 (217) 359-2112 Telex 270365

All Others
10.4%

Decision Mate V is a registered trademark of NCR Corporation
Texas Instruments Professional Computer is a registered trademark of Texas Instruments, Inc.

IBM Personal Computer is a registered trademark of International Business Machines, Inc.

Rainbow 100 is a registered trademark of Digital Equipment Corporation
Wang Professional Computer is a registered trademark of Wang Laboratories, Inc.

MS DOS and Multiplan are registered trademarks of Microsoft Corporation

Visicalc IV is a registered trademark of VisiCorp.

Supercalc 2 is a registered trademark of Sorcim Corp.

Japanese Distributor:

ASR Corporation International, TBL Building, 7th Floor, 1-19-9 Toranomon, Minato-Ku, Tokyo 105, Japan.
Tel. (03)-5025550, Telex: 222-5650 ASRTYO J.

European Distributor:

SuperSoft International Ltd., 51 The Pantiles, Tunbridge Wells, Kent, England TN2 5TE.
Tel. 0892-45433. Telex: 95441 Micro-G.

DAX PLUS.

The data base manager that understands you.

Data base management used to be the source of endless frustrations. Secretaries, executives, and even programmers were forever having trouble understanding the data base and getting it to do what they wanted. Doing something new could take ages.

No longer. DAX PLUS has uncomplicated data base management on microcomputers.

The heart of DAX PLUS is its unique Inquiry Processor which understands commands written in your language, English. It's a snap to produce reports, add data, change file structure, or whatever you want. Spontaneous reports with endless variations can be produced almost instantaneously. It's like having "what if" available in your data base. An example inquiry might be:

sort staff by surname with salary greater than 5000 dollars show surname break-on age & total salary showing the heading

"SAMPLE REPORT --DATED : \$ Page: #"



From idea to report in two minutes, fifteen seconds.

The report produced by DAX PLUS was formatted automatically and includes the heading shown above, the current date and the page number at the top of each page. Using DAX PLUS, this report could be produced by a beginner in less than three minutes. Producing a similar report using most other popular data base managers would be a major undertaking.

Listed below are some features of DAX PLUS which are not found in dBASE II,* another data base manager for microcomputers:

| FEATURE | DAX PLUS | dBASE II |
|---|----------|----------|
| English language inquiry processor | YES | NO |
| User may easily design the layout of data input forms | YES | NO |
| A time data type allows calculations to be performed on hours and minutes—this is invaluable to time cost applications. | YES | NO |
| Automatic report generator eliminates the need to manually format each report | YES | NO |
| Full data entry validations includes case conversion, range checking, and pattern matching | YES | NO |
| Extensive on-line help is available | YES | NO |
| Menu or English language command driven | YES | NO |
| User may define new command vocabulary | YES | NO |
| Simple mail-merge facilities | YES | NO |
| Simple file structure allows easy access to data | YES | NO |
| Calculations may be included in an English inquiry | YES | NO |

RBP

To further simplify things for the end user, DAX PLUS has a special feature called RBP which allows a series of inquiries to be processed together. This means complicated applications can be easily operated by an inexperienced user with a few simple commands.

DAX PLUS also contains a file conversion utility which converts your old dBASE II files to DAX PLUS files fast.

Simplify your data management work with DAX PLUS, the data manager that understands your language, is dramatically faster and is simpler to use. See your local computer dealer or write SuperSoft, P.O. Box 1628, Champaign, IL 61820.

DAX PLUS: \$549.00
DAX PLUS with VoiceDrive: \$649.00
Available for MS DOS, PC DOS, and CP/M

SuperSoft®

FIRST IN SOFTWARE TECHNOLOGY P.O. Box 1628 Champaign, IL 61820 (217) 359-2112 Telex 270365

*dBASE II is a registered trademark of Ashton-Tate

SuperSoft Language Library

For PC DOS®, MS DOS,
CP/M-86®, and others

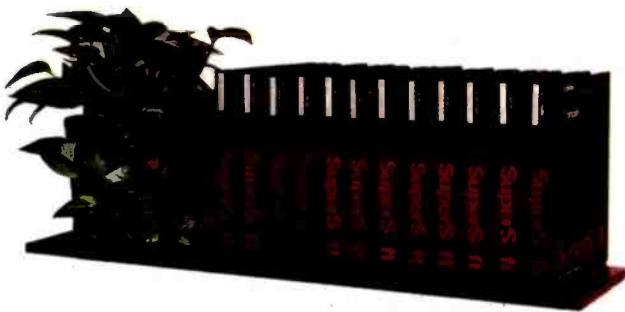

A programmer's most important software tool is the language compiler or interpreter he uses. He has to depend on it to work and work well.

At SuperSoft, we believe it. That's why we offer three fine compilers: SuperSoft FORTRAN, SuperSoft BASIC, and SuperSoft C, that answer the programmer's need for rock solid, dependable performance on 16 bit systems.



BASIC COMPILER

Compatible with Microsoft BASIC

The SuperSoft BASIC compiler, available under CP/M-86 and MS DOS, is compatible with Microsoft* BASIC and follows the ANSI standard.

Greater accuracy with BCD math routines

If you have used other languages without BCD math, you know how disconcerting decimal round off errors can be. For example:

| With IBM PC* BASIC | With SuperSoft BASIC with BCD math |
|-----------------------|--|
| 10 A = .99 | 10 A = .99 |
| 20 PRINT A | 20 PRINT A |
| 30 END | 30 END |
| Output: .9899999 | Output: .99 |

As you can see, SuperSoft BASIC with BCD provides greater assurance in applications where accuracy is critical.

SuperSoft's BASIC is a true native code compiler, not an intermediate code interpreter. It is a superset of standard BASIC, supporting numerous extensions to the language. Important features include:

- Four variable types: Integer, String, and Single and Double Precision Floating Point (13 digit)
- Full PRINT USING for formatted output
- Long variable names
- Error trapping
- Matrices with up to 32 dimensions
- Boolean operators OR, AND, NOT, XOR, EQV, IMP
- Supports random and sequential disk files with a complete set of file manipulation statements
- IEEE floating point available soon as an option
- No run time license fee

Requires: 128K memory

BASIC compiler: \$300.00

For CP/M-86®, MS DOS, and PC DOS

*SuperSoft BASIC is compatible with Microsoft BASIC interpreter and IBM PC BASIC. Due to version differences and inherent differences in compilers and interpreters some minor variations may be found. Machine dependent commands may not be supported. The vast majority of programs will run with no changes.

FORTRAN

C Compiler

SuperSoft FORTRAN is the answer to the growing need for a high quality FORTRAN compiler running under CP/M-86 and IBM PC DOS. It has major advantages over other FORTRAN compilers for the 8086. For example, consider the benchmark program used to test the IBM FORTRAN in *InfoWorld*, p. 44, Oct. 25, 1982. (While the differential listed will not be the same for all benchmark programs, we feel it is a good indication of the quality of our compiler.) Results are as follows:

| | |
|--------------------------|--------------|
| IBM FORTRAN: | 38.0 Seconds |
| SuperSoft FORTRAN | 2.8 Seconds |

In its first release SuperSoft FORTRAN offers the following outstanding features:

1. Full ANSI 66 standard FORTRAN with important extensions
2. Standard data types, double precision, varying string length, complex numbers
3. Free format input and free format string output
4. Compact object code and run time support
5. Special functions include string functions, dynamic allocation, time/date, and video access
6. Debug support: subscript checking, good runtime messages
7. Full IEEE floating point
8. Full 8087 support available as option (\$50.00).
9. Ratfor preprocessor available as option (\$100.00).

Program developers:

SuperSoft's family of FORTRAN compilers means you can write your programs once and they will run under CP/M-80, CP/M-86, and MS DOS. This lets you get your applications running fast no matter what the environment.

SuperSoft FORTRAN: available NOW and working great!

Requires: 128K with CP/M-86 or MS DOS,
32K with CP/M-80
FORTRAN: \$425.00 (in each environment)
8087 Support: \$ 50.00
Ratfor: \$100.00

For CP/M-86®, MS DOS, IBM PC DOS®, and CP/M-80®

In conjunction with SuperSoft, SuperSoft FORTRAN was developed by Small Systems Services, Urbana, IL, a leader in FORTRAN development.

Japanese Distributor:
ASR Corporation International, TBL Building, 7th Floor,
1-19-9 Toranomon, Minato-Ku, Tokyo 105, Japan
Tel: (03)-5025550, Telex: 222-5650 ASRTYO J

European Distributor:
SuperSoft International Ltd., 51 The Pantiles,
Tunbridge Wells, Kent, England TN2 5TE
Tel: 0892-45433 Telex: 95441 Micro-G

In 1982 SuperSoft helped C programmers around the world move their applications from 8 to 16 bit operating systems with the first C compiler under CP/M-86®, PC DOS, and MS DOS.

Today there are several C compilers on the market, and you can look at them all. But if you want a C that's fully portable, syntactically compatible with UNIX version 7 C, rigorously tested, fast in both compilation and execution, packed with more library functions than any other, and produces a very highly optimized assembly code... then you'll find only one. The SuperSoft C compiler.

Professional Quality

SuperSoft started working on C over three years ago, and the work has never stopped. While others were struggling to put in features, SuperSoft was refining and polishing... adding the quality professionals depend on.

Thoroughly Tested

SuperSoft C has been tested with hundred of commercial application programs. And all this testing has paid off... with a compiler that's highly reliable in every phase of operation.

Portable

SuperSoft C is now available in most operating system environments. Since we don't sell operating systems, we can support them all. And as new operating systems become popular, SuperSoft C will be there.

Packed with Library Functions

SuperSoft now has the most complete set of library functions available. All provided with source code.

Thorough User Manual

The new user manual is extensive—jammed with thorough explanations to help you every step of the way. And our technical hotline can help answer any additional questions.

SuperSoft C: \$350.00

SuperSoft

FIRST IN SOFTWARE TECHNOLOGY

P.O. Box 1628 Champaign, IL 61820
(217) 359-2112 Telex 270365

Microsoft is a trademark of Microsoft Corporation
IBM PC is a trademark of International Business Machines Corporation
CP/M and CP/M-86 are registered trademarks of Digital Research
UNIX is a trademark of Bell Laboratories

Is BASIC Getting Better?

The language that made early microcomputers accessible is maturing to match the sophistication of a new generation of hardware

G. Michael Vose
BYTE Senior Technical Editor

BASIC is as comfortable as an old pair of jeans to those renegades who learned programming on microcomputers. On many early microcomputers, BASIC was more than a language—it was also the operating system of the machine, the interface between the electronics inside the beast and the gawk-eyed neophyte at the keyboard.

Learning to program in BASIC was thrilling. The first time you printed out your name 100 times with the help of a FOR...NEXT loop you experienced a rush comparable to serving an ace on the tennis court or hitting a 280-yard tee shot. Figuring out a sorting algorithm was akin to getting an A on an algebra final or getting a kiss from your first sweetheart.

In the last eight years, microcomputers have grown up, matured from 1K- and 2K-byte user memory, cassette-based novelties into 256K-byte, 16-bit microprocessor-based powerhouses. The language of microcomputers has evolved, too, through Pascal and FORTH, to C and Modula-2. BASIC hasn't stood still in the intervening years—the text box "A

OUTPUT

BASIC is
as comfortable as
an old pair of jeans
to those renegades who learned
about programming on microcom-
puters.

IS BASIC GETTING BETTER?
by G. Michael Vose

Source Code

```
list 170-  
170 PRINT:PRINT:PRINT  
180 PRINT " BASIC is"  
190 PRINT " as comfortable as"  
200 PRINT " an old pair of jeans"  
210 PRINT " to those renegades who learn  
220 PRINT " about programming on microco  
230 PRINT " puters."  
240 SELECT 4
```

BASIC-09

Professional BASIC

Macintosh BASIC

Better BASIC

True BASIC

Brief History of Microsoft Basic" chronicles the evolution of Microsoft BASIC (MBASIC), the de facto industry standard for BASIC since its creation in 1974.

But is it fair to ask in 1984, a watershed year in the history of the information age, is BASIC getting any better? Has the language kept up with the needs of the programmers who use it? Has it kept pace with the Wizard of Oz machines it runs on?

The following pages will describe several significant new developments on the BASIC frontier. BYTE presents a look at five recent versions of BASIC that purport to improve on the Microsoft standard. These examinations are not reviews—three of the products have not been released as of this writing—nor do they compare the BASICs in question to one another. Instead, we offer descriptions of these new BASICs with an eye toward answering the question headlined above—is BASIC getting better?

These products collectively show several important trends for BASIC, including: a move away from interpreters to compilers; an emphasis on built-in program-development tools; and, in the newest products, a multiple-window environment for creating programs, offering the ability to view source code and its output simultaneously.

Interestingly, the new BASICs recognize the need for an interactive environment for BASIC (that's part of

what makes BASIC attractive as a tool for learning to program computers) and they avoid traditional compilers. A new class of compiler, the incremental compiler, has found favor among BASIC's recent innovators. This compiler permits the simulation of interactivity, provides another level of error checking, and would, by itself, be a significant improvement to BASIC.

But the new BASICs provide even more: user-defined procedures and functions, called by name; named subroutines; unlimited variable and label names; alternate screens for looking at source code, providing variable cross-reference tables, and examining output; and support of large user memory, math-coprocessors, and sophisticated graphics.

The first of the BASICs we'll look at is BetterBASIC, a product from a Massachusetts-based start-up firm called Summit Software Technology. Next, Scot Kamins examines the new Macintosh BASIC, a language developed to take advantage of the powerful new Apple computer (see "The Apple Macintosh Computer," by Gregg Williams, February 1984, page 30). Then, Don George investigates Professional BASIC from Morgan Computing Company Inc., of Dallas, Texas. On page 344, Brian Capouch explores the BASIC-09 language that runs on MC6809 microprocessor-based machines using the OS-9 operating system.

The recent announcement of a new version of BASIC by a company founded by BASIC's original authors, John Kemeny and Thomas Kurtz, prompts the text box "True BASIC" on page 300. Little concrete information was available about this product at the time of this report, and the claims of the text box's author, Brig Elliott (vice-president of True BASIC Inc.), could not be verified. But this announcement warrants attention because of the reputation of the principals involved in the effort.

The evolution of a standard for the BASIC language is mired in the complicated bureaucratic process required by the American National Standards Institute (ANSI). While a standard has been proposed, there is a lesson to be learned from the innovation that has been taking place in the absence of a standard: new products try to emulate what the market has determined to be a standard. In the case of BASIC, that standard is the Microsoft version. The following pages will show that you can improve on a standard while not getting too far away from it. ■

G. Michael Vose is features editor for BYTE. He can be reached at POB 372, Hancock, NH 03449.

A Brief History of Microsoft BASIC

Microsoft BASIC (MBASIC) is an industry standard for BASIC languages simply because it was the first—and for many years the only—version of BASIC available for microcomputers. MBASIC introduced a new generation of programmers to the esoteric art of writing instructions for computers.

The first microcomputer BASIC interpreter was written in 1974 by Paul Allen and Bill Gates on a PDP-8 minicomputer for an Intel 8080 microprocessor emulator. This project was an outgrowth of college work in computer science and freelance programming activity, and it explored the feasibility of producing a language product for the then new devices being marketed by Micro Instrumentation and Telemetry Systems (MITS). These machines were called microcomputers, the first of which was named the Altair 8800. This early BASIC interpreter required 4K bytes of RAM (random-access read/write memory) and was crude by today's standards.

MITS licensed the Gates/Allen BASIC for the Altair in late 1975, and Microsoft was born. By the end of 1976, over 10,000 Altairs had been sold with either the 4K-byte or the 8K-byte MBASIC. The fledgling company's work on an expanded version of the language using 8K bytes of RAM was spurred by a new machine under development by the office-machine company, Commodore Ltd. The Commodore PET debuted in mid-1976 with a licensed version of the 8K-byte MBASIC. Commodore's license was long-term and permitted alterations to the code supplied by Microsoft. Commodore has since modified this early version of 8K-byte MBASIC to produce its own versions of PET, VIC-20, and C-64 BASIC rather than going back to Microsoft for upgrades.

This early version of 8K-byte MBASIC is commonly referred to as version 2.0, the 4K-byte version is 1.0. In early 1978, Microsoft sold a license to Tandy Corporation for the TRS-80 Model I. This machine initially used a BASIC written in house, called Level I BASIC, a limited product that soon gave way to Level II, or MBASIC version 2.0. At the same time, the company

licensed version 2.0 to another recent entry into the computer business, a West Coast-based garage operation dubbed Apple Computer Inc.

By early 1979, a new version of the language was under development. Version 3.0 of MBASIC provided extended functions for program development (TRACE, AUTO, etc.) plus graphics and sound commands. These enhancements were made to comply with the requests of potential new licensees who wanted software that showed off the newest hardware capabilities.

Microsoft claims an installed base of two million; Digital Research claims a like amount for CP/M.

On the heels of version 3.0 came a version of MBASIC that supported floppy-disk drives. Known in house as version 4.0, the rest of the world called it Disk BASIC and its popularity spread quickly.

Late 1980 brought IBM and Microsoft together, an event that catapulted Microsoft into a leadership position in the microcomputer-software industry. Working with Seattle Computer, Microsoft created version 5.0, or GW (Gee Whiz) BASIC. Version 5.0, finally released in late 1981, was designed to take advantage of 16-bit processor environments and added many enhancements for sophisticated color graphics, windows and ports, music, softkeys, and other features.

Microsoft claims an installed base of 2 million machines licensed to run the various versions of its BASIC interpreter. This claim is conservative at best. Digital Research, Microsoft's major competitor in operating systems and language products, claims a like number of CP/M installations. It is likely that there are a substantial number of machines running MBASIC that don't use CP/M but that there are a much lower number for the reverse case.

True BASIC

Brig Elliott
True BASIC Inc.

Twenty years after inventing the BASIC language, Professors John G. Kemeny and Thomas E. Kurtz have teamed up again to develop a powerful and portable version of the new ANSI American National Standard BASIC. (For information on the proposed standard for the BASIC language, see "On the Way to Standard BASIC" by Thomas Kurtz, June 1982 BYTE, page 182, and "The Proposed ANSI BASIC Standard," by Ronald Anderson, February 1983 BYTE, page 194.)

Kemeny and Kurtz have started True BASIC Inc., and the company's first major product is a new version of the BASIC computer language called, appropriately, True BASIC. True BASIC's design goals are portability, power, ease of use, and speed.

The initial version of True BASIC will run on the IBM PC and PCjr, but its implementors will produce versions for other major microcomputers during the coming year. They estimate a three-month conversion process for each new machine.

The True BASIC system consists of a modern version of BASIC with good control structures, graphics, and file handling; an integrated screen editor; and helpful utility programs such as formatters and variable cross-reference generators.

The True BASIC Language

The True BASIC language is based on the proposed ANSI American National Standard, which has been in preparation since 1974. Tom Kurtz, a founder of True BASIC Inc., was chairman of the ANSI committee defining BASIC during this time. True BASIC has slimmed down the language from the proposed standard by removing clutter and features few programmers use but it has kept and enhanced the powerful core of the language.

In a nutshell, the True BASIC language has all the convenience of older BASICs, but has added many features to let programmers build large, complicated programs. These features include modern control structures, machine-independent raster graphics, separately compiled functions and procedures, error trapping, several types of files, double-precision floating-

point numbers, and built-in matrix manipulation.

Many of these capabilities have never before been available on microcomputers. But microcomputers have grown enough so that True BASIC can offer features seldom found even on mainframes.

A particular point of pride for the True BASIC team is that the language will handle enormous amounts of memory. Most microcomputer languages currently available have difficulty accessing more than 64K or 128K bytes of memory. Because memory sizes can grow into the megabytes, this is too restrictive. True BASIC allows objects (strings, arrays, etc.) to be very large—the only practical limit is the amount of memory in a given machine. In fact, True BASIC is targeted for machines with at least 128K bytes of memory, though a stripped-down version for 64K bytes may be available.

Truly Portable Programs

Programs written in True BASIC will be truly portable. The True BASIC language is implemented as a portable compiler with run-time routines; only a small section of the code needs to be rewritten to bring the language up on a new machine. Programs written in True BASIC, therefore, will be able to run without change on any of the microcomputers for which compilers exist.

True BASIC Inc.'s president, Christian Walker, points out that graphics have long been the scourge of transportable programs. "There used to be no way you could get a BASIC program to draw pictures on both the Apple and the IBM PC," he comments. But programs written in True BASIC don't access the screen in terms of pixels or screen images—they plot their results in terms of "problem coordinates" that automatically translate to work on any machine that supports the True BASIC system.

True BASIC is implemented by a compiler that compiles code for an interpreter. Proprietary compilation techniques make the code run much faster than existing interpreter versions of BASIC. True BASIC programs will execute as fast as, or faster, than programs written in some compiled BASICs.

Dazzling Graphics

One major strength of the early versions of BASIC was how easy they made it to print numbers. The complicated format statements used by FORTRAN were all eliminated. True BASIC makes it just as

easy to get graphic output—points, lines, polygons, graphs, and so forth.

Gone are the days of tediously counting pixels on the screen and doing complicated arithmetic to figure out where to put lines. All plotting in True BASIC is done in terms of "problem coordinates"; if you want to plot millions of tons of potatoes versus years, you do all your plotting in terms of these coordinates. True BASIC automatically maps these coordinates to the screen, telling True BASIC where to position the output graphics and what size to make them.

Complicated graphics operations such as point plotting, axes, polygon drawing and shading, and textual labels are all built into True BASIC and can be managed by single statements. Programmers can use all the colors available on a given computer with assurance that True BASIC will make reasonable approximations when these programs are ported to other kinds of machines.

Perhaps most exciting, True BASIC lets you define "pictures" or graphic sub-routines. When a picture is drawn, its output can be moved, rotated, shrunk, or expanded—thus a "house" picture could repeatedly call a "window" picture to draw several windows. Each time the picture of the window could be moved to a new location, and perhaps it could be shrunk or expanded.

The True BASIC Environment

True BASIC provides more than just a language system. Also included are an integrated "smart" screen editor and debugger. The screen editor has a knowledge of BASIC syntax so that you can easily mark and manipulate statements, loops, and functions. In many ways, this editor resembles a word processor geared toward the BASIC language.

Along with the standard BASIC system commands such as NEW and OLD, etc., are the PRINT, PLOT, LET, CALL, SET, and ASK commands. These let you inspect and/or change the values of variables, call functions, and draw pictures—all in "immediate mode."

Novice users may wish to type their programs with line numbers, as in older BASICs. But more experienced users will probably prefer the screen editor, especially in its "split-screen" mode, where the program text and the output of the running program may be displayed simultaneously.

True BASIC

Not Just for Education

Kemeny and Kurtz have designed True BASIC primarily for the high school and college educational markets. As Kemeny points out, both publishers and authors have been hurt seriously by the multitude of incompatible BASICs running on different machines. Authors could not hope to have their programs work on more than one or two different microcomputers.

Various publishers have been contacted about True BASIC, and have shown great interest in such a portable language. Authors, too, have been enthusiastic. "Look," says Kemeny, "They are just dying for a way to get their programs out to the students."

But Kurtz mentions that commercial software houses have also shown interest in the product. "Any time a good version comes out, it's useful to programmers." [Editor's Note: Very little concrete information was available about True BASIC at the time of this writing. True BASIC Inc. reports that it expects to have the IBM PC version of the language ready for testing and evaluation by hardware vendors by June 1, 1984, with a release to the general public slated for October 1, 1984. All of the claims made for True BASIC in this product description could not be verified. We include this material because True BASIC is backed by two of the most respected individuals in the BASIC language community, John Kemeny and Thomas Kurtz.]

Brig Elliott is vice-president of product development at True BASIC Inc. (39 South Main St., Hanover, NH 03755). He comes to the company after 10 years as a systems programmer and manager.

BetterBASIC

Combining the best of BASIC and Pascal provides a more powerful language that doesn't lose its friendliness

G. Michael Vose

BYTE Senior Technical Editor

BetterBASIC is a product of Summit Software Technology Inc. (40 Grove St., Wellesley, MA 02181). It is a version of BASIC designed to run initially on the IBM PC and PCjr computers and their compatibles. The language will be available for other MS-DOS machines within a year.

BetterBASIC is incrementally compiled, provides separate user-defined procedures and functions, and is extensible through the use of modules. Modules can be created by programmers from within the language. Special-function modules for graphics, windows, and future capabilities will be available from the company in coming months.

BetterBASIC's design emphasizes the benefits of structured programming by offering strict data typing, readability enhancements, and a variety of control structures, particularly procedures and functions. Procedures and functions are scoped so that variables within them are local; they can be made accessible to outside structures with programmer intervention.

The Modular Structure of BetterBASIC

One of the unique features of BetterBASIC is its modularity. BetterBASIC consists of a number of different modules that you can configure to produce a version of BetterBASIC with exactly the capabilities of a particular hardware configuration

and/or application. Furthermore, you can create your own new language statements and "package" these new statements into modules that can be made a permanent part of BetterBASIC.

In its most basic form, BetterBASIC consists of two separate modules that must always be present on the program disk:

B.COM — This is the primary executing portion of BetterBASIC, loaded into memory by the command "B." Once loaded, this program begins executing and will load B.DEF, the second portion of BetterBASIC, into memory.

B.DEF — This file contains the actual language definitions for BetterBASIC and will always be loaded immediately after B.COM. Both B.COM and B.DEF must be contained as files on the program disk.

Together, B.COM and B.DEF produce a limited but complete plain-vanilla version of BetterBASIC that executes in the standard MS-DOS operating-system environment. Because BetterBASIC is an extensible language, this form of BetterBASIC can now be used to extend the language through the creation of BetterBASIC modules.

A BetterBASIC module is a separately compiled, relocatable software unit containing BetterBASIC procedures and/or functions, as well as any static data shared by the procedures/

functions contained in the module. Once a module has been loaded into memory, those procedures and functions that have been declared public will be available as extensions to the vanilla version of BetterBASIC.

The BetterBASIC Programming System comprises these basic modules plus a number of sophisticated language-extension modules that together result in the BetterBASIC programming environment.

The BetterBASIC Configuration File

The loading/creation of a custom version of BetterBASIC is controlled by an optional configuration file, B.CNF, that contains the names of modules to be used in a programming session, as well as other information controlling the various operating modes of BetterBASIC. If B.CNF does not exist on the program disk, the plain-vanilla version of BetterBASIC results.

If B.CNF exists, it will be a simple ASCII file containing load-time information in the form of one or more lines of text. Each line of text generally specifies either the name of a module to be loaded or a BetterBASIC language parameter to be set (see Specifying BetterBASIC Parameters).

Specifying Modules

To specify that a particular module be included in the loaded version of BetterBASIC, simply add a line, as



follows, to B.CNF:

```
MODULE=filename
```

More than one module may be specified in a single line, as follows:

```
MODULE=filename1+filename2  
+...+filenameN
```

Specifying BetterBASIC Parameters

B.CNF may also contain directives to set several BetterBASIC parameters to specified values, as follows:

STACK=hexnum — This directive allows you to specify the size of BetterBASIC's internal stack. This stack holds dynamic (recursive) variables. A larger stack allows more local dynamic variables. The default size is currently hexadecimal 2800. If the number given is less than hexadecimal 2800, the default size is used.

PREC=num — Allows you to specify the real math precision. The number must be in the range of 6 to 24 decimal.

AUTODEF=ON/OFF — Sets BetterBASIC's Autodef mode to on or off. The default is on.

INTERRUPT=ON/OFF — Sets BetterBASIC's Interrupt mode to on or off. The default is off.

USERMEM=hexnum — Reserves a given number of paragraphs for user memory, i.e., memory that will not be allocated to BetterBASIC and can be requested by an assembly-lan-

guage procedure in a user module.

STATUS=ON/OFF — Enables/disables the status-line display at the bottom of the console display.

Available Modules

The full BetterBASIC system includes the following modules:

B.EXT — This module provides a number of useful procedures and functions in addition to the standard built-in procedures and functions provided by B.COM and B.DEF, such as RND, RANDOMIZE, HEX\$, and others.

FILEIO.DOS — Provides a flexible interface to the MS-DOS disk-file system. It allows BetterBASIC to interact with both sequential and random record disk files. For sequential disk-file access, the FILEIO procedures offer Microsoft BASIC-compatible syntax, while for record-oriented I/O, BetterBASIC's record variables provide a higher-level syntax.

CONSOLE.IBM# — Provides access to the IBM PC's special-function keys, and implements a screen editor that allows flexible editing of a BetterBASIC program. This module also provides compile-time and run-time support of the IBM PC's function keys (F1-F10).

GRAPHICS.IBM — Supports the IBM PC's color-graphics adapter and provides high-level graphics statements, such as CIRCLE, PAINT,

DRAW, etc. Photos 1 and 2 demonstrate the language's graphic output.

WINDOWS.IBM — Allows the IBM PC's display screen (monochrome or color) to be divided into separate, independent display windows. Each window can display data independently in scrolling or nonscrolling modes. Data can be read from and written to any window. While the BetterBASIC windows will generally be nonoverlapping, provision has been made for "pop-up" windows that can temporarily overlay other windows. Photos 3 through 5 show sample BetterBASIC windows.

HELP — Provides on-line help functions using a pop-up window to display help information about a particular topic. Being a module, this allows the help feature to be removed once a user becomes proficient in BetterBASIC.

Industry Standards

BetterBASIC is syntax compatible with Microsoft GW (Gee Whiz) BASIC and IBM PC BASIC. Many of the Microsoft BASIC (MBASIC) keywords are duplicated within the language. In all, BetterBASIC has 140 keywords.

BetterBASIC implements approximately 80 percent of the keywords in the BASIC standard proposed by

Hit Any Character to Continue

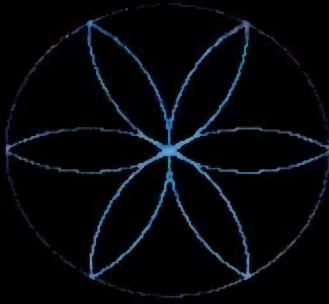

Photo 1: A sample of BetterBASIC graphic output.

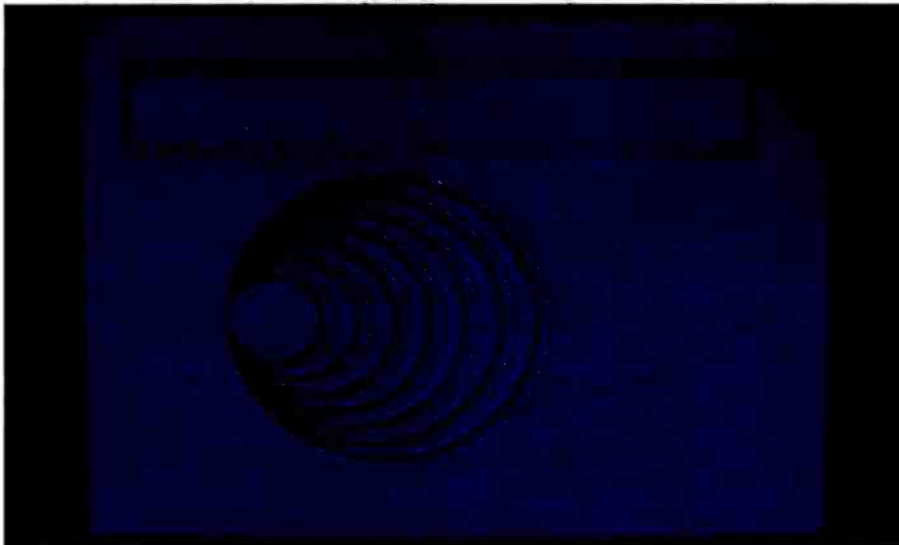

Photo 2: A BetterBASIC graphic drawn using the CIRCLE command.

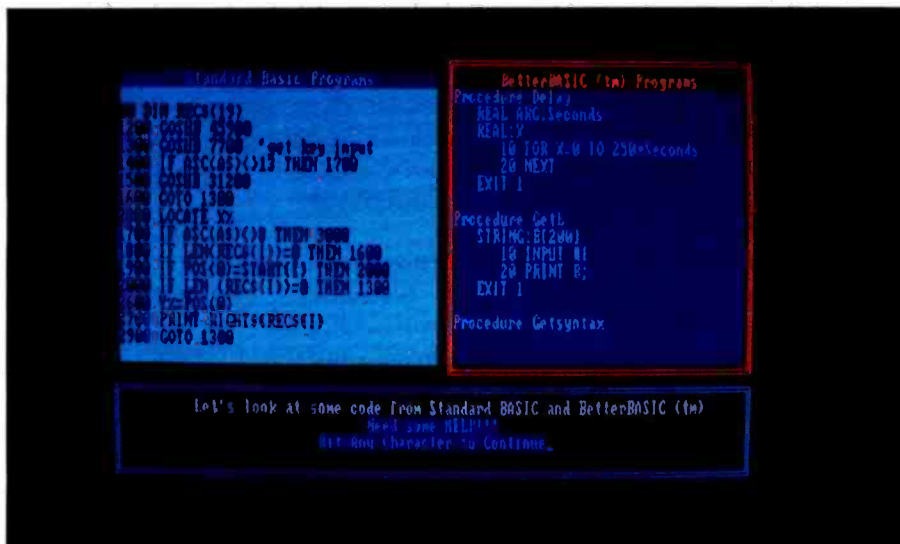

Photo 3: Windows, with standard BASIC on the left and BetterBASIC source code on the right.

ANSI (American National Standards Institute). Its math conventions are the same as the proposed standard's, but its graphics keywords, added by a separate module, differ from the standard's, closely emulating the MBASIC graphic keywords.

The language differs from both standards in the following significant ways:

- It encourages strict data typing.
- It provides global and local variables.
- It provides procedures and functions.
- It offers the Pascal-like record-variable data structure.
- It provides the module for adding extensions to the language.

Compiled—Not Interpreted

The ultimate programming language must be easy to learn, easy to use, and easy to transport from computer to computer. These qualities inspired the authors of BetterBASIC to create a language that is compiled to offer speed and efficiency but that retains the interactive nature of interpreted languages like standard BASIC.

Incremental compiling provides both the speed *and* the interaction of BetterBASIC. Each line of source code compiles as it is entered into the computer's memory. As each line is entered, existing program fragments can be run and tested.

This is in contrast to traditional compilation techniques where the entire source-code program is compiled, run, and tested only *after* it is written.

Incremental compilation is fast but its primary advantage may be its error-handling capability. As source-code lines are entered, the compiler finds and reports syntax errors—often pointing out the exact error, like a missing parenthesis—allowing the correction of errors on the spot. Therefore, when a complete program is in memory, it is guaranteed to be syntactically error free.

Standard compilers report errors only during the compilation of the entire source-code program. This makes the correction of syntax and

lexical errors time-consuming and tedious, as the source code must be changed and the entire program re-compiled.

The code generated by the BetterBASIC compiler is not microprocessor machine code. Instead, the compiler generates pseudo-code (p-code) for the virtual machine, a software construct that interprets p-code for the IBM PC's microprocessor.

This virtual-machine architecture of BetterBASIC makes the language easily transportable among Intel 8086-based, and eventually Motorola MC68000-based, machines.

Readability

Because one of generic BASIC's strengths is its readable, English-like command structure, BetterBASIC strives to make the language even friendlier with a variety of enhancements.

First, the language permits variable names of unlimited length. Because all characters in a name are significant, names like TEMPERATURE1 and TEMPERATURE2 are possible. Several words can be strung together using the underscore character, as in NET_PROFIT_QUARTER.

These descriptive variable names are a blessing when you decide to make changes to the program. Making a modification in line 400 of your program will be easier if you're looking for the variable NET_PROFIT instead of X or NP.

A second enhancement to program readability is the indentation of code within loops. A BetterBASIC loop looks like this:

```
10 For I = 1 to 10
20 Print I
30 Count = I
40 Next
```

BetterBASIC indents multiple nested-code structures an additional two spaces. For example:

```
10 For I = 1 to 10
20 Print I;
30   For J = 1 to 4
40   Print J
50 Next
60 Next
```



Photo 4: Another set of windows; note the available data types listed in the right window.

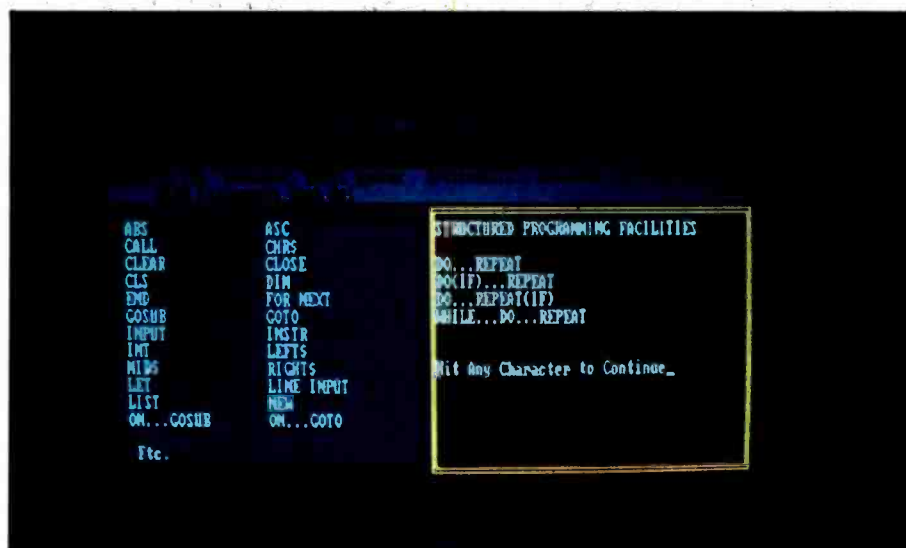

Photo 5: A partial list of control structures (right window.)

There can be no confusion when reading this code that one FOR...NEXT loop executes *within* the other.

BetterBASIC's most significant contribution to readability, however, is its procedures/functions capability. Discussed in detail later, procedures and functions can replace subroutines, providing a way to write routines with meaningful names that are used in a program just like language keywords.

In addition to long variable names, named procedures and functions, and indentation of code within loops, BetterBASIC provides:

- a way to list all existing procedures and functions with their nesting

status and argument types displayed

- a function to display current system status—parameters such as the current precision of floating-point math, and the status of switches such as automatic declaration of variables (see Variable Declaration)
- a function to query the type of variables
- another to determine the number of dimensions in an array

All of these features simplify the maintenance of your program environment and make BetterBASIC programs easier to understand.

Text Manipulators

Text-variable (also called string-



THANKS TO COMPU SERVE'S CB SIMULATOR,

“DIGITAL FOX” ACCESSED “DATA HARI” AND PROCEEDED TO AN “ALTARED” STATE.

The CB Simulator, where CompuServe Subscribers can Access Friends and Influence People on 72 Different Channels.

Just pick your handle and get on line. From math to matrimony, there's always someone out there who speaks your language. Friends from all over the U.S. and Canada are at it 24 hours a day. Talking tech or just having fun. And if you've got a secret, just use the CB Scrambler.

That'll fool the “lurkers,” those CB “see it alls” who get their kicks by watching. Or you can always use the private talk mode for guaranteed one-to-one conversation.

The CB Simulator is just one of CompuServe's many electronic communications options that include a National Bulletin Board, Professional Forums and Electronic Mail. Plus, there's a world of on-line information and entertainment all for the price of a local phone call plus connect time.

You can access CompuServe with almost any computer and modem, terminal or communicating word processor.

To receive your illustrated guide to the CompuServe Information Service and learn how to subscribe, call or contact:

CompuServe

Consumer Information Service, P.O. Box 20212
5000 Arlington Centre Blvd., Columbus, OH 43220

800-848-8199
In Ohio call 614-457-0802

An H&R Block Company

variable or character-variable) manipulation in BetterBASIC is enhanced by a variety of functions unavailable in previous versions of BASIC. These functions include the traditional INSTR, LEFT\$, RIGHT\$, and MID\$ operators and add new operators to convert between uppercase and lowercase, to insert and delete characters from strings, and to append text to a string.

The text operators in BetterBASIC not only perform standard string-search functions but also double as assignment statements. This permits operations such as

200 RIGHT\$(Name\$,6) = "Client"

Strings in BetterBASIC default to 16 characters but can be declared to any length up to 32,767 characters. The practical limit to string length is much lower, of course, but this limit is the only kind that BetterBASIC is subject to.

Variable Declaration

As highlighted earlier, BetterBASIC variables are easy to track because they use descriptive names. Of equal importance is the capability to type all variables—to specify a variable as an integer, string, or other type (see the A Closer Look at Data Types section that comes next).

Strict data typing gives you the flexibility to use the kind of variable types that will guarantee that your programs are as fast, and use as little memory, as possible. This facility also aids program maintenance. BetterBASIC lists all variables by type at the beginning of the source-code listing of all program structures.

There are two kinds of variable declaration in BetterBASIC: explicit declaration, a "structured-programming" technique useful primarily to aid maintenance and debugging; and first-use declaration, sometimes called automatic declaration.

Standard BASICs use both techniques, but BetterBASIC has a switch that lets you turn off the automatic declaration of variables, forcing you to use explicit declarations. In this way, BetterBASIC can help you acquire better programming technique.

A Closer Look at Data Types

BetterBASIC offers seven data types—integer plus a subset, byte, real-number, string or character, record, a pseudo-data type called a pointer, and arrays of all the other types.

A byte data type and an integer data type are both whole numbers. Bytes are in the range 0 to 255, while the range for integers is -32,767 to +32,767. Bytes require a single byte for storage in memory while integers consume up to 2 bytes.

Real numbers in BetterBASIC have a range of 9.99×10^{-255} to 9.99×10^{253} . Real numbers require up to 16 bytes for storage in memory, depending on the chosen precision for floating-point math operations.

String data types store the ASCII (American National Standard Code for Information Interchange) representation of the intended data and require 1 byte of storage for each character plus 2 bytes for overhead.

A record data type is a complex variable comprised of fields that can be any of the other BetterBASIC data types (see Record Variables).

A pointer is a pseudo-data type used to "point" to another data structure. Changing the value of a pointer changes the value of the variable it points to. Pointers are useful in linking record variable fields.

Arrays of all data types constitute another data type. BetterBASIC even supports arrays of arrays.

Arrays and record variables are structures that are built using the BetterBASIC command (*type* ARRAY) (RECORD) STRUC. This command lets you build and name shapes, or templates, of complex data structures without consuming any memory. You can then declare a structure of a given shape when you need it for data manipulation.

There are declaration statements for each data type in BetterBASIC. For example, the declaration

INTEGER Counter, Flag, Number
STRING Password
REAL Net_Profit, Gross_Profit

creates three integer variables named Counter, Flag, and Number; a text

Multi-function RS-232 Transfer Switches

MFJ-1240
\$79.95
Choice of 8 models



Multi-function RS-232 transfer switches let you switch your computer among printers, modems, terminals, any RS-232 peripherals; monitor data/line failure, protect data lines from surges, and use as null modem for less cost than a switch alone.

Switches 10 lines (2, 3, 4, 5, 6, 8, 11, 15, 17, 20). LED data/line indicators monitor lines 2, 3, 4, 5, 6, 8, 20. Metal oxide varistors protect data lines 2, 3 from voltage spikes and surges. Push button reverses transmit-receive lines (2, 3). PC board eliminates wiring, crosstalk, line interference. Connects any one input to any one output.

| Model | Price | In | Out | Model | Price | In | Out |
|----------|----------|----|-----|----------|----------|----|-----|
| MFJ-1240 | \$79.95 | 1 | 2 | MFJ-1244 | \$139.95 | 3 | 3 |
| MFJ-1241 | \$89.95 | 2 | 2 | MFJ-1245 | \$109.95 | 3 | 5 |
| MFJ-1242 | \$119.95 | 2 | 3 | MFJ-1246 | \$199.95 | 5 | 5 |
| MFJ-1243 | \$119.95 | 1 | 4 | MFJ-1247 | \$99.95 | 1 | 2 |

Switches 20 lines

AC Power Centers

MFJ-1108
\$99.95

MFJ-1108, \$99.95. Add convenience, prevent data loss, head bounce, equipment damage. Relay latches power off during power transients. Multi-filters isolate equipment, eliminate interaction, noise, hash. MOVs suppress spikes, surges. 3 isolated, switched socketpairs. One unswitched for clock, etc. Lighted power, reset switch. Pop-out fuse. 3 wire, 6 ft. cord. 15A, 125V, 1875 watts. Aluminum case. Black. 18x2 3/4x2 in. MFJ-1107, \$79.95. Like 1108 less relay. 8 sockets, 2 unswitched. MFJ-1109, \$129.95. Like 1107 but intelligent. Switch on device plugged into control socket and everything else turns on. Others available.



Acoustic/Direct Coupled Modem



Use with any phone anywhere MFJ-1233 \$129.95

MFJ-1233 Acoustic/Direct Coupled 300 baud modem. Versatile. Use with virtually any phone, anywhere. Use battery or 110 VAC. Direct connect mode: Plug between handset and base. Use with single or multi-line phones. Acoustic coupled mode: Use with phones without modular plugs. Quality muffs give good acoustic coupling, isolates external noise for reliable data transfer. Originate/answer. Self test. Carrier detect, ON LEDs. RS-232, TTL compatible. Reliable single chip modem. Crystal controlled. Aluminum cabinet. 9x1 1/2x4 in. Other models available.

Order from MFJ and try it. If not delighted, return within 30 days for refund (less shipping).

One year unconditional guarantee.
Order yours today. Call toll free 800-647-1800. Charge VISA, MC. Or mail check, money order. Add \$4.00 each for shipping and handling.

CALL TOLL FREE 800-647-1800
Call 601-323-5869 in MS, outside continental USA.

MFJ ENTERPRISES INCORPORATED
921 Louisville Road, Starkville, MS 39759

SAVE BIG ON COMPUTER PRODUCTS

MODEMS
HAYES

| | |
|-----------------------------------|-----|
| Smartmodem 300 | 209 |
| Smartmodem 1200 | 489 |
| Smartmodem 1200B | 425 |
| Micromodem II E | 240 |
| Smartcom II Software (for IBM PC) | 99 |

NOVATION

| | |
|----------------------------------|-----|
| J. Cat 300B direct | 99 |
| 103 SmartCat 300B Smart | 159 |
| 103/212 Smart 300/1200 B | 379 |
| AppleCat II 300 baud for Apple | 200 |
| 212 AppleCat 300/1200B for Apple | 390 |
| Access 1-2-3 1200B for IBM | 379 |

MONITORS
GORILLA

| | |
|-----------|-------|
| 12" Green | 88.00 |
| 12" Amber | 94.00 |

TAXAN

| | |
|-----------------------|-----|
| 12" KG-12N (green) | 120 |
| 12" KG-12N-UY (amber) | 125 |
| RGB vision III | 499 |

AMDEK

| | |
|---------------------------|-----|
| V300G 12" green | 130 |
| V300A 12" amber | 145 |
| V310A 12" amber (for IBM) | 160 |
| Color I + 13" composite | 280 |
| Color II 13" RGB | 425 |
| Color IV 13" RGB analog | 740 |

QUADRAM
MICROFAZER

| | |
|------------------|-----|
| QRMP-B Par/Par | 135 |
| QRMSB-B Ser/Par | 145 |
| QRMMSS-B Ser/Ser | 145 |
| QRMPS-B Par/Ser | 145 |

QUADBOARD (for IBM PC)

| | |
|------------|-----|
| QR5064 64K | 270 |
| QR4064 64K | 270 |

QUADLINK

| | |
|--------------------------------------|-----|
| QR 3000 for IBM | 475 |
| QR 3010 for Compaq | 475 |
| QR 3020 for Columbia | 475 |
| QR B201 Quadcolor-1 | 200 |
| QR B202 Quadcolor-2 (upgrade kit) | 200 |
| e Ram 80 — 80 col card for Apple IIe | 115 |

DISKETTES
10 — 5 1/4" Floppy Diskettes (packed with a storage box)

| SS/SD | SS/OD | DS/DO |
|-------------|---------|-------|
| Wabash \$19 | \$22.50 | \$30 |
| Maxell NA | 27.00 | 39 |
| Dysan NA | 27.00 | 39 |
| Maxell NA | 36.00 | 42 |

PRINTERS

Tremendous Discounts

GEMINI
DELTA
EPSON
COMREX
DIABLO • TTX
MANNESMANN TALLY
Most Models IN STOCK
CALL FOR PRICES

HEWLETT-PACKARD CALCULATORS

| | | | |
|---------|-----|---------|-----|
| HP-11C | 70 | HP-15C | 90 |
| HP-12C | 90 | HP-16C | 90 |
| HP-41C | 145 | HP-41CX | 245 |
| HP-41CV | 200 | HP-97 | 560 |

all software & accessories too

PORTABLE COMPUTERS

| | | | |
|--------|-----|-------|-----|
| HP 71B | 399 | HP-75 | 719 |
|--------|-----|-------|-----|

CABLES — INTERFACES
accessories for Computer Printers

| | |
|---|-----|
| GRAPPLER PLUS | 130 |
| 16K BUFFERED GRAPPLER | 165 |
| Apple Dumping | 70 |
| Caroco G | 70 |
| 10 ft. Par. Cable for IBM | 32 |
| 10 ft. 36x36 Parallel | 32 |
| 10 ft. 25x25 RS-232 | 25 |
| Y Cable (for TI-99/4A) | 25 |
| 6 ft. TI-99/4A parallel cable | 25 |
| 13x16 printer stand for 80 col printers | 15 |
| 16x22 printer stand (heavy duty) for wide carriage printers | 40 |

RIBBONS, PAPER

| | |
|------------------------------|----|
| Paper — 1000 Sheet Pack | |
| 9 1/2 x 11 white, 20 lb | 12 |
| 9 1/2 x 11 green bar, 20 lb | 12 |
| 9 1/2 x 11 trim edge, 20 lb | 15 |
| 14 1/2 x 11 green bar, 20 lb | 19 |

Ribbon Cartridges

| | |
|------------------------|------|
| for Epson 80 col | 4 |
| for Epson 132 col | 7 |
| for Mann. Tally 160 | 11 |
| for Mann. Tally 180 | 14 |
| for M.T. Sprint 80 | 7.50 |
| for Panasonic 1090 | 6.50 |
| for Diablo HiType II | 5 |
| for C. Itch Starwriter | 5 |

Thin spool ribbons

| | |
|---|--|
| for Gemini 10/10X, 15/15X, Okidata 80, 82, 83 | |
| 6 for 15.00 or 12 for 24.00 | |

CALL TOLL FREE 800-621-1269 EXCEPT Illinois, Alaska, Hawaii

Corp. Accts. Invited. Min. Ord. \$15.00. Mastercard or Visa by mail or phone. Mail Cashier's Check, Mon. Ord., Pers. Check (2 wks. to cl.) Add \$4.00 1st item (AK, HI, P.R., Canada add \$10.00 first item) \$1.00 ea. add'l ship. & handl. Shipments to IL address add 7% tax. Prices sub. to change. WRITE for catalog. RETURN POLICY: Defective Only: Most products replaced within 30 days of purchase with identical merchandise only. Computer and large peripherals replaced only when defective on arrival (within 3 work days of purchase). Other problems covered by mfr. warranty. ALL ELEK-TEK MERCHANDISE IS BRAND NEW, FIRST QUALITY AND COMPLETE.

ELEK-TEK, inc.

6557 N. Lincoln Ave., Chicago, IL 60645
(312) 631-7800 (312) 677-7560

variable called Password; and two real variables called Net_Profit and Gross_Profit.

These variables will always appear in a table at the top of any listing made of the source code of the program structure in which these variables appear.

BetterBASIC variables are local to the program structure in which they are created. You can declare an integer variable called Counter in your main program, and it will be unknown inside any procedures or functions you write. In fact, you can subsequently declare a variable called Counter within a procedure, and that variable will be different from the main program variable Counter and unknown to the main program. In this way, BetterBASIC provides unparalleled data integrity.

Record Variables

Of all its data types, BetterBASIC's record variable is the most flexible. Similar to Pascal's record variable, this data type is an amalgam of separate fields, each of which can be any other data type—even arrays or other record variables. A record variable is thus similar to an array except that the elements can be of any type or size. The elements of a record are addressed using the notation

recordname.fieldname

For example, to extract the entry in a record variable named Payfile1 for the information for a Name field storing the value Jones, you would write

PRINT PAYFILE1.NAME

and would receive the following display:

JONES

The record, Payfile2, would contain another name (presumably with a variety of facts associated with the name).

Pointers

Pointers are pseudo-variables in BetterBASIC. Their primary purpose is to permit the linking of record vari-

Organize direct mail sales... and more!

List Wize™

The "wise" choice in List Information Management.

DEC Rainbow 100 & 100+ IBM PC

LIST WIZE lets you keep the information you need most in a highly organized system for handy and efficient access to names, addresses, telephone numbers, appointments, clients, business prospects... and more!

Large data capacity. User-designed files and fields. Flexible file-availability. Complete sorting

control. Alphabetical and numerical listings. Fast and easy printing. Full printer options. File merge capability. Versatile filing uses. Mathematical calculations.

The one program "custom-designed" for YOUR business needs!

ORBYTE™ SOFTWARE

Box 948, Waterbury, CT 06720 203-621-9361

Professional Software for the Software Professional

DMA products operate on
the full range of
Z80, 8086, 8088 processors,
including the IBM-PC

Here's what you can do!

Application Creation

FORMULA II™

The Application Creator

The first and only Application Creator—a do-it-yourself concept for office automation. FORMULA II lets you define your files, forms, menus, and reports—FORMULA II then creates your program. FORMULA II includes a Database manager with an English Query language and a Form/Report Creator with word processing features.

Communications

ASCOM™

ASCOM™ is the most versatile asynchronous communication package for microcomputers on the market. It features interactive, menu-driven, and batch operations; supports auto-answer and auto-dial modems; includes most popular protocols; provides network simulation; and many other options. Xerox Corporation, NCR, Monroe Systems for Business, and the big 8 accounting firms use ASCOM™.

SYNC/COM™—A bisynchronous communication package that will be configurable for a variety of systems and includes a flexible interface to the operating system. 2780/3780/3270 protocols available on microcomputers with appropriate hardware.

TERMCOM™—A configurable terminal emulator allowing any personal computer to emulate most conversational and selected block mode terminals with asynchronous communications. Available December 1983.

Utilities

EM80/86™

This software emulator lets you use eight bit software on sixteen bit microcomputers without hardware modifications.

The 8086 O.S. Converter™

CP to MS—Permits execution of Digital Research's CP/M-86 programs under Microsoft's MSDOS (or PC DOS).

MS to CP—Permits execution of MSDOS programs under CP/M-86.

UT-86™

This package of user-friendly utilities for the IBM Personal Computer and similar systems includes copying, directory sorting, patching, and a general purpose file print utility.

Coming Soon

DMA."C"™—A "C" language compiler which will generate either Z80 or 8086 assembly language code. Due to a unique optimization routine which is based upon a functional "P-code" model, the efficiency of DMA."C" will far exceed that of existing compilers.

DMA DMA DMA

WE SPEAK YOUR LANGUAGE WE SPEAK YOUR LANGUAGE WE SPEAK YOUR LANGUAGE

DYNAMIC MICROPROCESSOR ASSOCIATES, INC.

545 FIFTH AVENUE, NY, NY 10017

Dealer Inquiries only • (212) 687-7115

able fields. To establish a pointer, it must be SET—that is, it must be assigned to a variable to point to that variable.

An example will clarify this process. Assume the existence of a record variable, Payfile1, with a field, Name, containing the data, Jones. The assignment operation

```
SET P = PAYFILE1.NAME
```

will establish P as a pointer, pointing at the variable, Payfile1.Name. A subsequent

```
PRINT P
```

yields

```
Jones
```

Similarly, the following steps alter the contents of Payfile1.Name:

```
P = "Smith"
PRINT PAYFILE1.NAME
```

```
Smith
```

As you can see, changing the pointer also changes the data stored in the variable pointed to.

Typically, pointers are used within record variables to link one record to another. This is done by simply declaring a field of the record to be a pointer.

The ability to write stand-alone procedures and functions that allow modular programming is one of BetterBASIC's principal features.

Here is how a BetterBASIC record variable is declared:

```
Record STRUCT:PAYROLL
(String:Name,Street,City,State
Real:Zip,Gross Pay,Deduct
Ptr:Link)
```

This syntax builds a template for the creation of record variables with eight

fields. To declare actual variables, you now enter

```
PAYROLL: PAYFILE1,PAYFILE2,
PAYFILE3
```

to create three variables with the structure, Payroll, having the names Payfile1, Payfile2, and Payfile3. We can link these three record variables together by setting their pointers. This operation is shown below:

```
SET PAYFILE1.LINK = PAYFILE2
SET PAYFILE2.LINK = PAYFILE3
SET PAYFILE3.LINK = PAYFILE1
```

Stand-alone Constructs

The ability to write stand-alone procedures and functions is one of BetterBASIC's principal features. These constructs allow truly modular programming. They can be virtually unlimited in length, are unknown at all levels except the one in which they were created, and can have their own local variables, arguments, DATA lists, and local error-handling routines.

GTEK INC. (601) 467-8048

EPROM PROGRAMMER

DEVELOPMENT HARDWARE/SOFTWARE

HIGH PERFORMANCE/ COST RATIO

Compatible w/all Rs 232 serial interface port * Auto select baud rate * With or without handshaking * Bidirectional Xon/Xoff and CTS/DTR supported * Read pin compatible ROMS * No personality modules * Intel, Motorola, MCS86, Hex formats * Split facility for 16 bit data paths * Read, program, formatted list commands * Interrupt driven, program and verify real time while sending data * Program single byte, block, or whole EPROM * Intelligent diagnostics discern bad and erasable EPROM * Verify erasure and compare commands * Busy light * Complete w/Textool zero insertion force socket and integral 120 VAC power (240 VAC/50Hz available)

DR Utility Package allows communication with 7128, 7228, and 7956 programmers from the CP/M command line. Source Code is provided. PGX utility package allows the same thing, but will also allow you to specify a range of addresses to send to the programmer. Verify, set the Eprom type.

MODEL 7316 PAL PROGRAMMER
Programs all series 20 PALS. Software included for compiling PAL source codes.

Software Available for CPM,¹ ISIS,²

TRSDOS,³ MSDOS.⁴

1. TM of Digital Research Corp.
2. TM of Intel Corp.
3. TM of Tandy Corp.
4. TM of Microsoft.

Post Office Box 289
Waveland, Mississippi 39576
(601)-467-8048

Avocet Cross Assemblers are available to handle 8748, 8751, Z8, 6502, 680X, etc. Available for CP/M and MSDOS computers. Order by processor type and specify kind of computer.

Model DE-4 U/V Products hold 8, 28 pin parts. High quality professional construction.

5879 stand alone
MODEL 7956



MODEL 7956 GANG PROGRAMMER
Intelligent algorithm. Stand alone. copies eight EPROMS at a time. With RS-232 option \$1099.

\$549
MODEL 7316

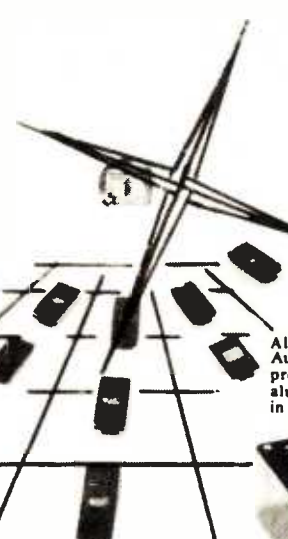

Model 7128-L1,L2,L2A \$239.00
Model 7128-24 \$329.00
DR8 or DR5 \$ 30.00
DR8PGX or DR5PGX .. \$ 75.00
Cross Assemblers \$200.00
XASM (for MSDOS) .. \$250.00
U/V Eraser DE-4 \$ 78.00
RS232 Cables \$ 30.00
8751 adapter \$174.00
8755 adapter \$135.00
48 Family adapter \$ 98.00

\$549
MODEL 7228

MODEL 7228 EPROM PROGRAMMER
All features of Model 7128 plus Auto Select Baud super fast adaptive programming algorithms. low profile aluminum enclosure. Programs 2764 in one minute!

\$429
MODEL 7128



MODEL 7128 EPROM PROGRAMMER
Programs and Reads:

\$1195
MODEL 7324

MODEL 7324 PAL PROGRAMMER
Programs all series 20 & 24 PALS. Operates stand alone or via RS232.

| NMOS | NMOS | CMOS | EEPROM | MPU'S |
|-------|-------|-------|--------|-------|
| 2508 | 2758 | 27C16 | 5213 | 8748 |
| 2516 | 2716 | 27C32 | 5213H | 8748H |
| 2532 | 2732 | C6716 | X2816 | 8749H |
| 2564 | 2732A | 27C54 | 48016 | 8741 |
| 68766 | 2764 | | 12816A | 8742H |
| 68764 | 27128 | | | 8741H |
| 8755 | 27256 | | | 8751 |
| 5133 | | | | |

HIGH PERFORMANCE

LONG DISTANCE RACER

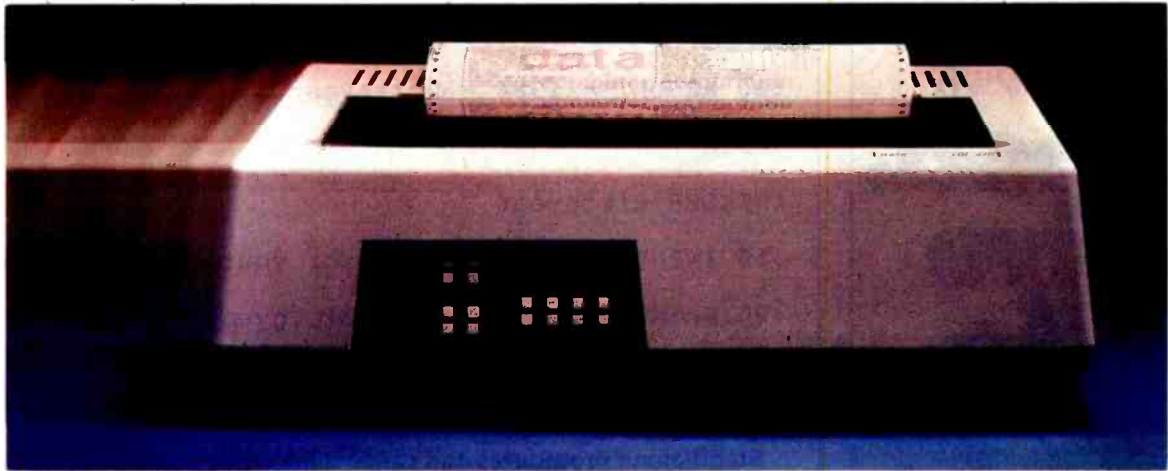

You can't win a race when you're not on the road. That's why you need a printer that does more than run fast. You need one that runs *long*. You need a Datasouth.

MORE CHARACTER

The printhead on a Datasouth printer is rated to live through 500 million characters. Even in the most demanding applications, this means years of service without an overhaul.

HEAVY DUTY CYCLE

For a Datasouth printer, "100% duty cycle" is something of an understatement. So far, over 35,000 Datasouth printers have hit the hard copy road, and so few have pulled into the garage for repairs, it's hard to say how close to forever any of them will last.

MORE THAN THE HUM OF ITS PARTS

There's less to go wrong with a Datasouth printer. With sophisticated microprocessor control and unusually

efficient design, Datasouth printers have few moving parts. They also don't need add-on "personality boards" to accommodate different computers.

TAKE YOUR CHOICE

Datasouth reliability comes in two high performance models. The DS180 is a legendary workhorse that delivers crisp data quality printing at 180 CPS. The new multimode DS220 cruises at 220 CPS for high speed data printing and at 40 CPS for letter-quality word processing. Both models print precision dot-addressable graphics.

If you have a high performance printing need, Datasouth has a high performance printer to fill it.

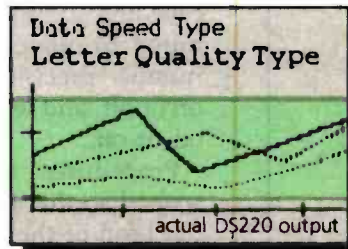

DRIVE ONE TO WORK

Test drive a Datasouth printer at your nearest showroom today. Then put it to work. With a Datasouth racing beside you, there's no way to lose.

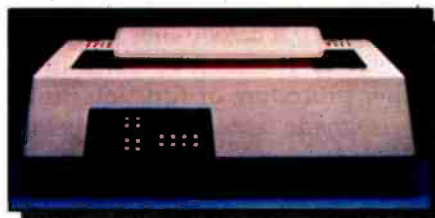

datasouth

H I G H P E R F O R M A N C E M A T R I X P R I N T E R S

Find Datasouth Printers At
Participating **ComputerLand** Stores
And Other Fine Dealers.

AVAILABLE NATIONWIDE
THROUGH OUR NETWORK OF
SALES AND SERVICE DISTRIBUTORS
CALL TOLL FREE:
1-800-222-4528

Datasouth Computer Corporation
Box 240947 · Charlotte, NC 28224
704/523-8500 · Telex 6843018 DASOU UW

Circle 119 on inquiry card.

**Give
Blood.
Give
Life.**

Company blood drives are a vital part of our nation's blood supply. So please have your firm start planning for a blood drive, today. And you can help save many lives tomorrow.

American
Red Cross



We'll Help. Will You?

 A Public Service of This Magazine
& The Advertising Council

Listing 1: The function, *Age*, followed by a program to call it with the argument, *Birthyear*, and print the result. Note that *Birthyear* is a separate variable in the main program and the function.

```
.INTEGER FUNCTION Age
```

```
Integer Function: Age
```

```
234567 Bytes Left
```

```
:10 INTEGER ARG Birthyear
```

```
:20 RESULT = 1984 - Birthyear
```

```
:main
```

```
INTEGER Birthyear
```

```
.10 INPUT "Enter the year of your birth: ";Birthyear
```

```
.20 PRINT "You are ";Age(Birthyear);" years old."
```

Stand-alone procedures and functions are made possible by a division of the computer's memory resources into segmented work spaces. Initially, there is only a single BetterBASIC work space, the main program work space denoted by the prompt ". ". But each time a procedure or function is declared, a new work space is created. A procedure/function work space is denoted by the prompt ": ". The on-screen status line also indicates the current work space, in addition to other items such as real-number precision, auto-declaration on or off, and whether interrupts are on or off.

Procedures and functions are scoped so that they can be called at the level of their creation. If a procedure is declared at the main program level, it can be called from that level only. It cannot be called by another procedure or function (unless it is made external, see below). Similarly, a procedure created from within a procedure can be called by that procedure only—it cannot be called from the main program or from any other procedure outside the one that created it.

Procedures

Procedures are declared by entering the keyword, **PROCEDURE**, fol-

lowed by a name. The name can be a simple word or a complex label containing several words linked by an underline character (), as in **SWAP_NUMBER_ROUTINE**. On entry of the statement and name, the screen displays

```
.PROCEDURE CLS  
Procedure:CLS  
256712 Bytes Left  
:
```

To write the code for the procedure, the programmer proceeds as in the main work space, using line numbers and any and all BetterBASIC keywords. Because line numbers and variables are local to the procedure, you can use the same line numbers and variable names used elsewhere without conflict (although possibly not without confusion with variable names). For example, to complete a clear-the-screen procedure, you could enter

```
:10 PRINT CHR$(12)
```

```
REM ASCII character 12 is the IBM  
PC clear-screen character
```

```
:20 PRINT "OK"
```

```
REM just a fancy prompt
```

:main

The keyword MAIN prompts an exit from the procedure work space back to the main work space. At this point, the procedure is called by entering its name:

.CLS

or by using the name in a program line:

.100 CLS

This invokes the procedure and clears the screen, printing an "Ok" at the top.

The scope of procedures and functions can be altered with the keyword EXTERNAL. The scope of variables can also be changed using this keyword. EXTERNAL can make a variable or an entire procedure or function visible to other program levels.

Functions

Functions are created and called in the same way as procedures. In this way, they are substantially different from the functions in standard BASIC. They can be as long and complex as you care to make them. Functions are subject to the same scope rules as procedures.

Functions require at least one argument (it may be a dummy argument) and return a result. Listing 1 is an example function to compute a person's age—it requires the year of birth as an argument.

A RESULT statement forces an exit from the function with the returned value as the result. A function may have multiple RESULT statements but will exit on initial execution of one.

Arguments

Functions require at least one argument but either functions or procedures can receive arguments of any data type, including arrays and records. In the latter case, a special argument class, the ANY ARG, is used to permit the passage of an unknown data type (required because record variables can contain mixed data types). ANY argument declara-



Podunk or Pebble Beach?

Golf at a world famous course is just one of the many rewards of investment success. Improve your chances for that success with Dow Jones News/Retrieval®.

Even if you're just starting out in the market, Dow Jones News/Retrieval can help compress hours of research into instantaneous, well-organized, well-timed reports and analyses you can use to pinpoint trends and opportunities and improve your chances for investment success.

Dow Jones News/Retrieval gives you more time to assess more of what you need to know: company and industry activity, economic and

earnings forecasts, Securities and Exchange Commission reports, and electronic stock quotes that are continuously monitored for accuracy by our staff.

The wide variety of high-quality data bases accessible on most personal computers include Dow Jones Current and Historical Quotes, as well as exclusive access to *The Wall Street Journal*, *Barron's* and the Dow Jones News Service.

As smart investors everywhere have discovered, there's only one Dow Jones. . .and only one Dow Jones News/Retrieval. Invest a few moments right now and discover the difference it can make for you.

DOW JONES
NEWS/RETRIEVAL®

Copyright © 1984. Dow Jones and Company, Inc. All Rights Reserved.
Dow Jones News/Retrieval® is a registered trademark of Dow Jones and Company, Inc.

FOR FULL DETAILS, CALL 800-345-8500, EXT. 144

Alaska, Hawaii and foreign, call 1-215-789-7008, Ext. 144

tions can be used at any time in a procedure or function, but specific data-type declarations are preferable and constitute good programming practice.

Error Handling

Procedures and functions can include error-handling routines to handle the typical errors to which the construct might be vulnerable. If no error routine is included, the scoping rules of the language call the error-handling routines at the program level that called the procedure or function. If no routines exist at this level, all the way back to the main program level, BetterBASIC then issues a system error message and halts execution as in standard BASIC.

Extending the Language

BetterBASIC's most significant feature is its use of modules. A module can be created by any BetterBASIC programmer and linked to the existing language system at configuration (see The BetterBASIC Configuration File on page 302). A module is usual-

ly desirable as a permanent addition to the language. They are not limited to code written in BetterBASIC. Modules can also contain assembly-language code. In this way, it becomes simple to adapt the language to specific hardware or even to make application programs part of the language.

It is the module that makes the language extensible. For example, to make the earlier example procedure CLS part of BetterBASIC, it can be made into a module with the command

`.MAKE MODULE`

Execution of this command eliminates the procedure's source code and retains the virtual-machine object code. The module is assigned a module number that is displayed on the screen. At this point, CLS becomes a new keyword in the language, callable at any level.

Conclusion

BetterBASIC is a substantial im-

provement to previous versions of the language, but a major concern is whether there is a need for yet another version of BASIC. All BASIC designers hope their version will become standard, and a standard language would seem to allow no room for competitors. It could be that the public perception of Microsoft BASIC as a standard may make it impossible for other versions of BASIC, regardless of worth, to gain a toehold in the marketplace.

The problem, then, for purveyors of upgraded language products becomes one of educating the potential market about the advantages of their products. A modicum of luck may be required, as well. The history of successful microcomputer software to date has shown that the surest way to the top is often on the coattails of a significant new piece of hardware. ■

G. Michael Vose is features editor of BYTE (POB 372, Hancock, NH 03449).

Quality you expect, at a price you don't.

BECK DOUBLE DENSITY DISKETTES

SINGLE SIDED **\$2.19** ea. / **\$2.79** ea. DOUBLE SIDED

Our message to you is simple. If you like the quality of Dysan, Verbatim, 3M, et al, you'll like the quality of Beck soft sector

Why does Beck cost less?

Our philosophy is: Excellent quality and reliability, at a cost that beats the jackets off other diskettes. We can do it because we (1) put our money into the product, not mega-marketing schemes and fancy packaging; and (2) sell our money-saving 25-diskette pack to you direct via a toll free order line, so you get fast, door-to-door service efficiently.

When you buy Beck, you've got the best. Beck Quality. Beck Reliability. And, of course, Beck Price.

1D, soft sector 5 1/4" diskette \$2.19 each
2D, soft sector 5 1/4" diskette \$2.79 each
For IBM, Apple, TRS and 97% of popular microcomputers.



5 1/4" flexible diskettes. The only major difference is cost. We're less expensive. In fact, a lot less expensive.

What about quality and reliability?

At Beck, our success as a diskette manufacturer depends upon our ability to provide you with a fully reliable, quality diskette - every time. For that reason we take no shortcuts. You get the best because we are committed to excellence. Every diskette is manufactured to very strict quality standards. We test and retest 21 times throughout the manufacturing process to insure compliance with no less than 42 rigid specifications. We make sure you get the very best - a 100% certified, 100% error free diskette.

Our satisfaction money-back guarantee and full 7 year warranty are proof of our commitment to excellence and confidence in our product.

Order Now Toll Free

1-800-BECKMFG

Door to Door in 48 hrs.
(In New Hampshire call 924-3821)

Corporate Accounts Welcome

Order Toll Free 1-800-232-5634. Available in 25 pack only, plus freight. Complete with hub reinforcing rings, Tyvek envelopes, color coded user labels, and nonmetallic write protect tabs. All Beck Diskettes meet or exceed ANSI specifications.

ORDER DESK ONLY
(800) 292-3360
 TOLL FREE OUTSIDE CALIF.

(800) 272-3360
 TOLL FREE IN CALIFORNIA

"WHY PAY MORE"
COMPARE THESE PRICES
MC-P APPLICATIONS
Brings Software & Hardware
At Unbeatable Prices

SOFTWARE

| | LIST | OUR |
|--|-------|-------|
| APPLIED SOFTWARE TECHNOLOGY | | |
| VersaForm | \$389 | \$269 |
| ASHTON TATE | | |
| Financial Planner | 700 | 452 |
| Friday | 295 | 199 |
| BPI ACCOUNTING SYSTEMS | | |
| GL/AP/AR (Each) | 395 | 285 |
| CONTINENTAL | | |
| Property Management | 495 | 327 |
| FOX & GELER Quick Code | 295 | 174 |
| FUNK SOFTWARE Sideways | 60 | 45 |
| HOWARD SOFT | | |
| Real Estate Analyzer II Apple | 199 | 135 |
| Tax Preparer Apple | 199 | 135 |
| Apple | 199 | 175 |
| IBM | 250 | 199 |
| HUMAN SOFT DB Plus | | 89 |
| LATTICE C Compiler | 500 | 325 |
| LIFETREE Volkswriter Deluxe | | 179 |
| METASOFT Benchmark | 499 | 295 |
| MICROSTUFF Crosstalk | 195 | 129 |
| MICROPRO Spell Star | 250 | 162 |
| Word Star w/Applicard | 495 | 349 |
| Mail Merge | 250 | 162 |
| Super Sort | 250 | 149 |
| Calc Star | 145 | 86 |
| Info Star | 495 | 320 |
| Word Star Pro | 695 | 395 |
| MICRORIM | | |
| R Base 4000 | 495 | 339 |
| MICROSOFT | | |
| Flight Simulator (IBM) | 50 | 35 |
| Flight Simulator (Apple) Sublogic | | 29 |
| Multitool Word W/Mouse | 475 | 339 |
| Multitool Financial | 100 | 69 |
| Multitool Budget | 150 | 99 |
| Pascal Compiler | 350 | 245 |
| C Compiler | 500 | 345 |
| PBL CORPORATION | | |
| Personal Investor | 145 | 98 |
| PETER NORTON | | |
| Peter Norton Utility | 80 | 57 |
| PEACHTREE | | |
| Peach Pack (AR, AP, GL) | 595 | 249 |
| Peach Text 5000 | 395 | 245 |
| ROSESOFT Prokey | 75 | 57 |
| SOFTWARE ARTS T.K Solver | 299 | 219 |
| SOFTWARE DIMENSIONS | | |
| Accounting Plus | | |
| GL, AR, AP, PR, INV - Each | 495 | 295 |
| SOFTWARE PRODUCTS INTERNATIONAL | | |
| Open Access | 575 | 415 |
| SATELLITE SOFTWARE | | |
| Word Perfect | 495 | 325 |
| SOFTWARE PUBLISHING | | |
| Pfs: File | | |
| Apple | 125 | 85 |
| IBM | 140 | 95 |
| Pfs: Report | 125 | 85 |
| SOFTWORD SYSTEM | | |
| Multimate | 495 | 299 |
| SORCIM SuperCalc II | 295 | 185 |
| SuperCalc III | 395 | 275 |
| SYNPSE File Manager | 150 | 97 |
| WOLF Move-It | 199 | 125 |
| VISICORP | | |
| Visicalc IV | 250 | 175 |
| Visifile (Apple) | 250 | 187 |
| Visifile (IBM) | 300 | 195 |
| VisiSchedule | 300 | 195 |
| VisiWord w/free VisiSpell | 375 | 285 |
| Visitrend/Plot | 300 | 195 |

NO PHONE ORDERS FOR LOTUS 1-2-3

LOTUS 1-2-3
\$316⁰⁰

LOTUS + VOLKSWRITER
\$475⁰⁰

DUTIL + QUICK CODE
\$215⁰⁰

WORD STAR
\$275⁰⁰

DBASE II
\$379⁰⁰

EDIX/WORDIX
\$129⁰⁰

MULTIPLAN
\$168⁰⁰

HOME ACCOUNTANT
\$ 52⁰⁰

BANK STREET WRITER
\$ 49⁰⁰

TANDON TM1000-2
\$225⁰⁰

OKIDATA 92
\$459⁰⁰

AMDEK COLOR II
 HI RES RGB
\$435⁰⁰

AST MEGA PLUS 64K
\$275⁰⁰

NOVATION J-CAT
\$105⁰⁰

EPSON FX 100
\$735⁰⁰

HERCULES GRAPHICS CD.
\$359⁰⁰

KOALA TOUCH PAD
\$ 95⁰⁰

HARDWARE

| | LIST | OUR |
|---|-------|-------|
| HAYES MICROCOMPUTER PRODUCTS | | |
| Hayes 300 Baud | \$289 | \$199 |
| Smart Modem 1200B | 599 | 429 |
| Smart Modem 1200 | 699 | 495 |
| ADVANCED LOGIC SYSTEM (Apple II) | | |
| Z-Card | 169 | 115 |
| Printer Mate (Parallel) | 99 | 55 |
| CP/M Card (W/ CP/M 3.0) | 399 | 315 |
| MICROSOFT | | |
| 64K Ram Card (IBM) | 350 | 249 |
| MPC PERIPHERALS (Apple) | | |
| Parallel Interface Card (w/Cable) | 90 | 68 |
| MOUSE SYSTEMS | | |
| PC Mouse w/Software | 295 | 219 |
| NOVATION | | |
| Apple - Cat II | 389 | 275 |
| 212 Auto Cat | 695 | 595 |
| Smart-Cat 103/121 | 595 | 445 |
| Smart-Cat 103 | 249 | 187 |
| PEGASUS | | |
| Hard Disk 10 mgb | | 1399 |
| PERSONAL COMPUTER PRODUCTS | | |
| Applicard 6 Mhz | 375 | 280 |
| KRAFT & TG Joystick | | |
| IBM | 70 | 49 |
| Apple | 65 | 45 |
| TALL GRASS Hard Disk 10 mgb | 3495 | 2995 |
| VERBATIM DISC | | |
| S/S D/D 10 Pk | 49 | 24 |
| D/S D/D 10 Pk | 71 | 38 |
| AMDEK MAI BOARD | | |
| | 599 | 495 |
| ELECTRONICS PROTECTION DEVICES | | |
| Orange | 140 | 99 |
| Peach | 98 | 69 |
| QUADRAM | | |
| Quadboard II 64K | 395 | 285 |
| Quadcolor I | 295 | 219 |
| Quadlink | 680 | 525 |
| MEMORY CHIP SET | | |
| (64K/9 chips) | 95 | 55 |
| PRINTERS | | |
| NEC 7730 RO Parallel | 2595 | 2295 |
| Daisey Writer 2000 | 1395 | 1185 |
| Qume 1140 | 1685 | 1525 |
| MONITORS | | |
| Amdek 12" 310A | 230 | 175 |
| Quadchrome 17" | 695 | 525 |
| Princeton RGB Hi Res | 795 | 495 |

CALL FOR SOFTWARE & HARDWARE PRICES NOT LISTED HERE

USED PCs & APPLES BOUGHT & SOLD

"International Dealer Enquiries Welcomed"

Circle 239 on inquiry card.

MC-P APPLICATIONS, INC.
 111 W. St. John St., Suite 307
 San Jose, CA 95113 Phone (408) 293-3360
 Telex: 294207 MCPA UR
 HOURS: 8 a.m. to 5:30 p.m. — Mon. - Sat.
 Call for prices in AUSTRALIA
 at 02-929-8468

TERMS: All prices subject to change. Cashier's check/MO/Bank Transfer. Allow time for company or personal checks to clear. Prices reflect cash prepaid discount. VISA/MASTER CARD/COD/PO's 3%. California residents add sales tax. **SHIPPING:** \$4 per item for UPS surface (\$8 for Blue Label) Monitors \$20. Printers \$25. within continental USA.

VOICE SYNTHESIZER FOR APPLE AND COMMODORE

NEW!



• Over 250 word vocabulary - affixes allow the formation of more than 500 words • Built-in amplifier, speaker, volume control, and audio jack • Recreates a clear, natural male voice • Plug-in user ready with documentation and sample software • Case size: 7 1/4" L x 3 1/4" W x 1-3/8" H

APPLICATIONS: • Security Warning • Telecommunication • Teaching • Handicap Aid • Instrumentation • Games

The JE520 VOICE SYNTHESIZER will plug right into your computer and allow you to enhance almost any application. Utilizing National Semiconductor's DIGITALKER™ Speech Processor IC (with four custom memory chips), the JE520 compresses natural speech into digital memory, including the original inflections and emphases. The result is an extremely clear, natural vocalization.

| Part No. | Description | Price |
|----------|----------------------------|----------|
| JE520CM | For Commodore 64 & VIC-20 | \$114.95 |
| JE520AP | For Apple II, II+, and IIe | \$149.95 |



JE66A EPROM PROGRAMMER 8K to 64K EPROMS - 24 & 28 Pin Packages

Completely Self-Contained - Requires No Additional Systems for Operation
• Programs and validates EPROMs • Checks for properly erased EPROMs • Erases EPROMs or EPROMs • RS232C Computer interface for editing and program loading • Loads data into RAM by keyboard • Changes data in RAM by keyboard • Loads RAM from an EPROM • Compares EPROMs for content differences • Copies EPROMs • Power input: 115VAC, 60Hz, less than 10W power consumption • Enclosure: Color-coordinated, light tan panels with molded and pieces in mocha brown • Size: 13 1/4" L x 8 1/4" D x 3 1/4" H • Weight: 5 1/4 lbs.

The JE66A EPROM Programmer erases and programs various 8-Bit Word EPROMs from 8K to 64K-Bit memory capacity. Data can be entered into the JE66A's internal 8K x 8-Bit RAM in three ways: (1) from a ROM or EPROM (2) from an external computer via the optional JE665 RS232C BUS, (3) from its own keyboard. The JE66A's RAM may be accessed for emulation purposes from the panel's test socket to an external microprocessor. In programming and emulation, the JE66A allows for emulation, change and validation of program content. The JE66A's RAMs can be programmed quickly to all "1"s (or any value), allowing unique addresses in the EPROM to be programmed later without necessity of "10" erasing. The JE66A displays DATA and ADDRESS in convenient hexadecimal (alphanumeric) format. A "DISPLAY EPROM DATA" button changes the DATA readout from RAM used to EPROM word and is displayed in both hexadecimal and binary code. The front panel features a convenient operating guide. The JE66A Programmer includes one JM16A Jumper Module (see listed below).

JE66A-A EPROM Programmer... \$995.00

JE665 - RS232C INTERFACE OPTION - The RS232C interface option implements computer access to the JE66A's RAM. This allows the computer to manipulate, store and transfer EPROM data to and from the JE66A. A sample program using IBMPC for MS-DOS for CP/M computers. Documentation is provided to adapt the software to other computers with an RS232C port. 9600 Baud, 8-bit word, odd parity and 2 stop bits.

JE664-ARS EPROM Prog. w/ JE665 Option... \$1195.00

EPROM JUMPER MODULES - The JE66A's JUMPER MODULE (Personality Module) is a plug-in module that pre-sets the JE66A for the proper programming pulses to the EPROM and configures the EPROM socket connectors for that particular EPROM.

| JUMPER MODULE | EPROM | PRICE |
|---------------|--------------------|---------|
| JM08A | 2708 | \$14.95 |
| JM16A | 2716, 1M62514 (70) | \$19.95 |
| JM16B | 1M62714 (5-10) | \$14.95 |
| JM22A | 1M62532 | \$14.95 |
| JM28B | 2732 | \$14.95 |
| JM32C | 2732A | \$14.95 |
| JM44A | MC48754, MC48754A | \$14.95 |
| JM48A | 2784 | \$14.95 |
| JM48C | 1M62550A | \$14.95 |

4-Digit Fluorescent Alarm Clock Kit

NEW!



• Bright 4-digit 0.5" high display • 10 minute snooze alarm • AM/PM indicator • Automatic display dimmer
The JE750 Clock Kit is a versatile 12-hour digital clock with 24-hour alarm. The clock has a bright 0.5" high blue-green fluorescent display. The display will automatically dim with changing light conditions. The 24-hour alarm allows the user to disable the alarm and immediately re-enable the alarm to activate 24 hours later. The kit includes all documentation, components, case and wall transformer. Size: 6 1/4" L x 3 1/4" W x 1 1/4" D.
JE750 Alarm Clock Kit... \$29.95



Misumi 54-Key Unenclosed Matrix All-Purpose Keyboard
• SPST keyswitches • 20 pin ribbon cable connection • Low profile keys • Features: cursor controls, control, caps (lock), function, enter and shift keys • Color (keycap): grey • Weight: 1 lb.
KB54... \$14.95

71-Key ASCII Cherry Keyboard
• 7 bit parallel ASCII with strobe • 11 key numeric keypad • SPST mechanical keyswitches • 15-30 card-edge connector • Features: escape, control, cursor controls, plus ten additional function keys • Color white • Weight: 2 lbs. • Spec. included
KB1801... \$29.95

106-Key 8-Bit Serial ASCII Keyboard
• Numeric and cursor keypad • 10 user definable keys • 7 LED function displays • Security lock • N-key rollover • Uses Intel 8048/8748 • Color: white w/black panel • Documentation included • Weight: 6 1/2 lbs.
KB139... \$59.95

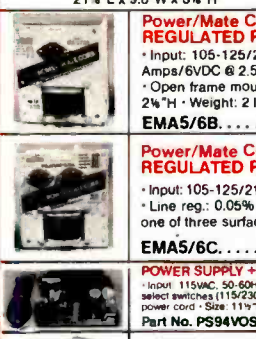

Power/Mate Corporation REGULATED POWER SUPPLY +5VDC @ 3 Amp / +6VDC @ 2.5 Amp
• Input: 105-125/210-250VAC at 47-63 Hz • Output: 5VDC @ 3.0 Amps/6VDC @ 2.5 Amps • Line regulation: 0.05% • Load reg.: 0.1% • Open frame mounts on any of 3 surfaces • Size: 4 1/4" L x 4" W x 2 1/4" H • Weight: 2 lbs.
EMAS/6B... \$29.95

Power/Mate Corporation REGULATED POWER SUPPLY +5VDC @ 6 Amp / +6VDC @ 5 Amp
• Input: 105-125/210-250VAC at 47-63 Hz • Output: 5V @ 6A/6V @ 5A • Line reg.: 0.05% • Load reg.: 0.1% • Open frame mounts on any one of three surfaces • Size: 5 1/4" L x 4 1/4" W x 2 1/4" H • Wt: 4 lbs.
EMAS/6C... \$39.95

POWER SUPPLY +5VDC @ 7.6 AMP 12VDC @ 1.5 AMP SWITCHING
Input: 115VAC, 50-60Hz at 3 amp/230VAC, 50Hz at 1.6 amp • Fan volt./power supply select switches (115/230VAC) • Output: 5VDC @ 7.6 amp, 12VDC @ 1.5 amp • 8 foot back power cord • Size: 11 1/2" L x 13 1/2" D x 3 1/4" H • Weight: 6 lbs.
Part No. PS94VDS... \$39.95



POWER SUPPLY 4-Channel Switching
Microprocessor, mini-computer, terminal, medical equipment and process control applications. Input: 90-130VAC 47-60Hz, Output: +5VDC @ 5A, -5VDC @ 1A, +12VDC @ 1A, -12VDC @ 1A. Line reg.: ± 0.2%, Ripple: 30mV p-p, Load reg.: ± 1%, Overcurrent protection. Ad. 5V main output: ± 10%, 8-3/16" L x 1-7/8" D x 4-1/8" H, Wt. 1 1/2 lbs.
Part No. FCS-604A... \$69.95 each



Switching Power Supply for APPLE II, II+ & IIe™
• Can drive four floppy disk drives and up to eight expansion cards • Short circuit and overload protection • Fits inside Apple computer • Fully regulated +5V @ 5A, +12V @ 3A, -5V @ 5A, -12V @ 5A • Direct plug-in power cord included • Size: 9 1/4" L x 3 1/4" W x 2 1/4" H • Weight: 2 lbs.
KHP4007... \$79.95

DISKETTES AND ACCESSORIES

5 1/4" and 8" Diskettes

ULTRA MAGNETICS - 5 1/4" DISKETTES

| Part No. | Description | Base | Price |
|----------|--|------|---------|
| UM81401 | 5 1/4" 5SD0 Soft Sector with Hub Ring and Envelope | 10 | \$24.95 |
| UM82000 | 5 1/4" 5SD0 Soft Sector with Hub Ring (Bulk) | 100 | 189.95 |
| UM82401 | 5 1/4" 5D50 Soft Sector with Hub Ring and Envelope | 10 | \$2.95 |
| UM82140 | 5 1/4" 5D50 Soft Sector with Hub Ring (Bulk) | 100 | 239.95 |
| UM81101 | 5 1/4" 5SD0 Soft Sector with Envelope (80TP) | 10 | 34.95 |
| UM80214 | 5 1/4" 5SD0 Soft Sector 16TB (Bulk) | 100 | 756.95 |
| UM82101 | 5 1/4" 5D50 Soft Sector with Envelope (80TP) | 10 | 41.95 |
| UM82017 | 5 1/4" 5D50 Soft Sector (Bulk) | 100 | 399.95 |

SK (ESKE) - 5 1/4" DISKETTES

| | | | |
|-------|--|-----|--------|
| SK10 | 5 1/4" 5SD0 Soft Sector with Hub Ring and Envelope | 10 | 39.95 |
| SK15B | 5 1/4" 5SD0 Soft Sector with Hub Ring (Bulk) | 100 | 199.95 |
| SK20 | 5 1/4" 5D50 Soft Sector with Hub Ring and Envelope | 10 | 26.95 |
| SK20B | 5 1/4" 5D50 Soft Sector with Hub Ring (Bulk) | 100 | 199.95 |

ULTRA MAGNETICS - 8" DISKETTES

| | | | |
|---------|---|-----|--------|
| UM81276 | 8" 5SD0 IBM Compatible (128 3/4" 28 Sectors) and Envelope | 10 | 34.95 |
| UM80025 | 8" 5SD0 IBM Compatible (128 3/4" 28 Sectors) Bulk | 100 | 239.95 |
| UM82726 | 8" 5D50 Soft Sector (unformatted) with Envelope | 10 | 69.95 |
| UM80040 | 8" 5D50 Soft Sector (unformatted) Bulk | 100 | 208.95 |

All diskettes listed above are boxed. All have Hub Rings with the exception of the Quad Density and the 8" SK's.

DISKETTE ACCESSORIES

Disk Minder
• Attractive, functional disk storage system • 50 (8") or 75 (5 1/4") disk storage capacity • Easy lifting and retrieving • Protects disk from dust contamination • Molded from durable smoked plastic with front carrying handle • Size: 7 1/4" x 6 1/4" x 9 1/4" D • Weight: 2 lbs.
Part No. Description Price
DM75 Stores 75 (5 1/4") Diskettes \$19.95 each
DM50 Stores 50 (8") Diskettes \$29.95 each

Mini-Pak
• Stores 10 (5 1/4") diskettes • Protects disk from dust contamination • Durable smoked plastic • Size: 6 1/4" x 5 1/4" x 1 1/4" D
Part No. Description Price
MP10 Stores 10 (5 1/4") Diskettes \$2.95 each

Diskette Envelopes
Sleeves for Bulk-Purchased Diskettes
• Tear proof • Lint-free • Non-static protectant • View: front Part No. Description Price
MP201 10 White 5 1/4" Envelopes 10 for \$ 1.49
MP201-100 100 White 5 1/4" Envelopes 100 for \$19.95
MP201 10 White 8" Envelopes 10 for \$ 1.95
MP201-100 100 White 8" Envelopes 100 for \$17.95

Vinyl Pages
For 3-Ring Binders
Protects disks from dirt, scratches, dust, spills, and other contaminants. Reduces the risk of getting dirt on your disk drive head. Size: 6 1/4" x 11"
Part No. Description Price
PC001 2 Pocket 5 1/4" Vinyl Page 10 for \$7.95
PC002 4 Pocket 5 1/4" Vinyl Page 10 for \$9.95
PC014 1 Pocket 8" Vinyl Page 10 for \$7.95
PC014-2 2 Pocket 8" Vinyl Page 10 for \$9.95

Mail Pak™
• Holds up to 3 diskettes • Ideal for mailing and retail packaging • Duct proof and durable • Treatment makes disks easy identification
Part No. Description Price
MP05 Holds 3 ea. 5 1/4" Diskettes \$2.49 each
MP08 Holds 3 ea. 8" Diskettes \$3.95 each

\$10.00 Minimum Order - U.S. Funds Only
California Residents Add 8 1/2% Sales Tax
Shipping Add 5% plus \$1.50 Insurance
Send S.A.S.E. for Monthly Sales Flyer!

Spec Sheets - 30c each
Send \$1.00 Postage for your
FREE 1984 JAMECO CATALOG
Prices Subject to Change

Mail Order Electronics Worldwide

Jameco ELECTRONICS

1355 SHOREWAY ROAD, BELMONT, CA 94002
4/84 PHONE ORDERS WELCOME - (415) 592-8097 Telex: 176043

MasterCard VISA

8" FLOPPY DISK DRIVE

- Single-Sided
- 77 Tracks
- 400/800K Bytes Capacity
- Industry Standard

The FDD100-8 8" Floppy Disk Drive (Industry Standard) features single or double density. Recording mode: FM signal, MFM double density. Transfer rate: 250K bit/sec, single density; 500K bit/sec, double density. The FDD100-8 is designed to work with the single-sided soft sector IBM Diskette I, II or disk cartridge. Power: 115VAC @ 50-60Hz, ± 24VDC @ 1.7 amps max. • 5VDC @ 1.2 amps max. Unit as pictured above does not include case, power supply or cables. Size: 8.55" W x 14" L x 4.5" H. Weighs 12 lbs. Incl. 96 pg. manual.

FDD100-8... \$169.95 ea.

5 1/4" APPLE™ Direct Plug-In Compatible Disk Drive

- Uses Shugart SA330 mechanics • 143K formatted storage • 33 tracks - compatible with Apple controller • Complete with connector card • Size: 8 1/4" L x 5-9/16" W • Weight: 4 1/2 lbs. Part No. ADD-514 \$195.95

5 1/4" TEAC DISK DRIVE
Single-Sided Half-Height 5 1/4" Drive

- Single or double density • 48 TPI • 40 tracks • 6 ms track to track • 5W power consumption • Brushless DC direct-drive motor • 1600Bytes formatted storage • One year warranty parts and labor

Double your work space with the TEAC 5 1/4" FLOPPY DISK DRIVE. Because the TEAC FDD5A Drive is half the height of conventional drives, you can fit up to four TEAC drives in the same space as two conventional drives. Or, have room for two floppy disk drives and a hard disk drive. Includes operating manual. Requires +5VDC @ 55A and +12VDC @ 3A. Size: 5 1/4" x 1 1/4" x 8 1/2" Wt: 3 lbs.
FD55A... \$249.95

5 1/4" SHUGART DISK DRIVE
Double-Sided Half-Height 5 1/4" Drive

- Single or double density • 48 TPI • 40 tracks • 400Bytes formatted storage • 6 ms track to track • Brushless DC direct-drive motor • One year warranty parts and labor

Backed by the industry's largest and most experienced engineering sales and service organization, the SA455 is the smart solution for a wide range of desktop applications. Includes operating manual. Requires +5VDC @ 7A and +12VDC @ 7.5A. Size: 5.88" x 1.63" x 8 1/2" Wt. 3.3 lbs.
SA455... \$259.95

5 1/4" PANASONIC DISK DRIVE
Double-Sided Half-Height 5 1/4" Drive
Shugart SA455 Equivalent

- Single or double density • 48 TPI • 40 tracks • 6 ms track to track • 327KBytes formatted storage • One year warranty parts and labor

The JAS51 is perfect for word processors, personal and portable computers, small business computers and terminal add-ons. Includes operating manual. Requires +5VDC @ 9A and +12VDC @ 1A. Size: 5.88" x 1.63" x 8 1/2" Wt. 3.3 lbs.
JAS51-2... \$239.95

DISK DRIVE CABLE CUSTOM

We stock a wide variety of signal cables and 3 power cable kits to meet your disk drive requirements. We also customize cable assemblies for many other applications. Call for a price quote.

IBM MEMORY EXPANSION KIT COMPAQ COMPATIBILITY

SAVE HUNDREDS OF \$\$\$ BY UPGRADING MEMORY BOARDS YOURSELF!

Most of the popular memory boards allow you to add an additional 64K, 128K, 192K, or 256K. The IBM64K Kit will populate these boards in 64K bite increments. The kit is simple to install - just insert the nine 64K RAM chips in the provided sockets and set the two groups of switches. Directions are included.

IBM64K (Nine 200ns 64K RAMs) ... \$49.95

EXPAND YOUR MEMORY

TRS-80 to 16K, 32K, or 48K

****Model 1 =** From 4K to 16K Requires (1) One Kit
Model 3 = From 4K to 48K Requires (3) Three Kits
Color = From 4K to 16K Requires (1) One Kit

****Model 1 equipped with Expansion Board to 48K Two Kits Required - One Kit Required for each 16K of Expansion -**

TRS-16K3 *200ns for Color & Model III... \$12.95
TRS-16K4 *250ns for Model I... \$10.95

TRS-80 Color 32K or 64K Conversion Kit

Easy to install kits come complete with 8 ea. 4164-2 (200ns) 64K dynamic RAMs and conversion documentation. Converts TRS-80 color computer with 8, E, T, F and HC circuit boards to 32K. Also converts TRS-80 color computer to 64K. Flex DCS OS-9 required to utilize full 64K RAM on all computers.
TRS-64K2... \$44.95

UV-EPROM Eraser

8 Chips - 51 Minutes

1 Chip - 37 Minutes

Erase 2708, 2716, 2732, 2764, 2816, 2832, 2856. Erase up to 8 chips within 81 minutes (1 chip in 37 minutes). Maintains constant exposure distance of one inch. Special conductive foam liner eliminates static build-up. Built-in safety lock to prevent UV exposure. Compact - only 9.00" x 3.70" x 2.80". Complete with holding tray for 8 chips.

DE-4 UV-EPROM Eraser... \$79.95
UVS-11EL Replacement Bulb... \$16.95

Macintosh BASIC

A semicompiled language with tools designed to simplify the writing of code

Scot Kamins

Technology Translated Inc.

Since so many things about Apple's new Macintosh computer are different from other computers, it should come as no surprise that Donn Denman's Macintosh BASIC is also different. Briefly stated, Macintosh BASIC is a semicompiled, multitasking, structured language system (without line numbers), complete with a full-screen text editor and a highly sophisticated debugger, that takes advantage of many of the Macintosh's unique features. This article describes what is unique about the language.

Macintosh BASIC is semicompiled. When you type in a new program line, the line is immediately passed to a part of the system called the B-

code generator. This generator compiles the program line and updates the program data structures. The system checks the syntax of the line as the line is compiled and provides immediate feedback as to the line's general lexical correctness. Later, when the program is executed, the compiler makes another quick pass through the program (about 2 seconds for a 50K-byte program) to check the integrity of its control structures. Assuming there are no final compilation errors, program execution continues. The compact B-code is then interpreted, making for a very fast BASIC.

Macintosh BASIC is quite large (48K bytes), and it can grow. It is

segmented; about 32K bytes live in memory at any time, leaving about 50K bytes for program and variable table space. (Actually, because of the CALL command, programs can be virtually any length.) If a program needs a part of BASIC that isn't in RAM (random-access read/write memory), such as formatted output, the editor, the debugger, or some other large code segment, it loads in from the disk.

Macintosh BASIC lets you execute any number of programs simultaneously and develop one or more additional programs at the same time (see figure 1). Each time a line of code is interpreted, the system checks for other events that might need attention and handles them accordingly. Each program is granted a fixed amount of execution time in 1/60-second increments or any interval set by the programmer. When a program's time slice is up, the system moves to the next program for interpretation.

No line numbers are required in Macintosh BASIC. You get around the program by branching to sections of code identified by *labels*. You can use numbers, but labels tend to be a lot more meaningful and make tracing program flow much easier.

Environment

In most BASICs, the entire display area is ordinarily occupied by the program listing or by the output. In Macintosh BASIC, the display area, called the *desktop*, is typically oc-

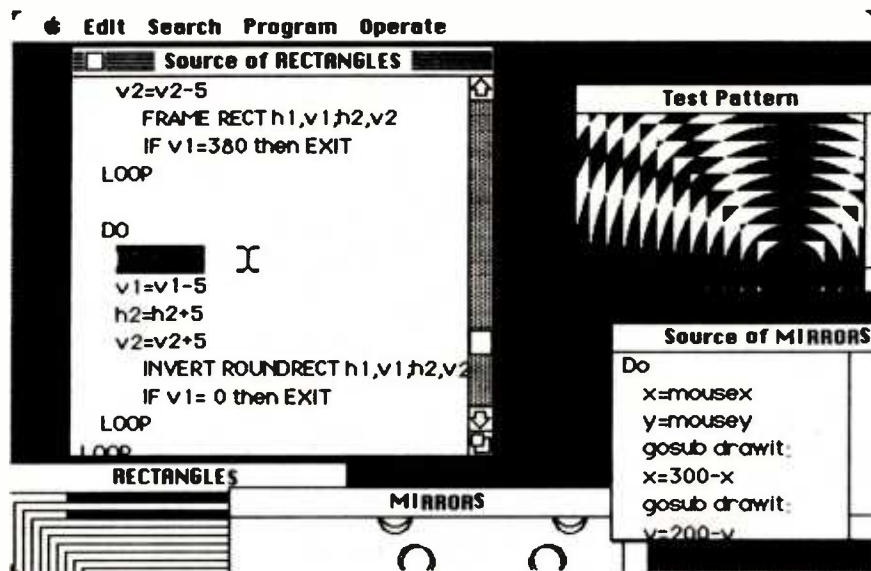

Figure 1: Multitasking in Macintosh BASIC.



cupied by a variety of graphics and text material. Most material appears in *windows*, sections of the desktop that can grow, shrink, or move at the discretion of the programmer. Figure 2a shows the BASIC desktop with three copies of the same program in windows of different sizes. Listing 1 shows what the whole program looks like; you can't see all of it because all of it won't fit in the viewing area of the Listing window. Figure 2b shows what running the program produces. Note that none of these windows shows an entire program; there are more lines in the program than will fit in any of the visible areas. To see the rest of the program listing, you press the mouse button with the pointer on the down arrow in the *scroll bar* (located at the right of the window), revealing the rest of the code.

When a Macintosh BASIC program is executed, the Listing window is overlaid by an Output window that displays any text or graphics produced by the executing program. Both the Listing window and the Output window can be (and often are) displayed at the same time, making program development and debugging easier than in traditional environments.

Macintosh BASIC's tools and command words (verbs that affect programs as a whole, like RUN, LOAD, and SAVE) appear in menus whose titles are listed in the *menu bar* running across the top of the desktop. To

choose a menu item, use the mouse to move the pointer to the menu you want, press and hold the mouse button, and drag the pointer down to the specific tool or command you want.

The Macintosh BASIC interactive programming environment makes writing code a lot easier than do most other BASICs because of the huge variety of tools. The tools include those available to every Macintosh application (specifically, the *desk accessories*, the screen-oriented editor, and the Clipboard) and a set of special development and debugging aids designed for the language, including flexible search and replace capabilities, several printing options, and a very sophisticated debugger.

Desk Accessories

Among the desk accessories, accessible from the desktop menu, programmers will find the Calculator, the Note Pad, and the Clock most useful (see figure 3). The Calculator is a simple four-function calculator useful for doing quick operations; you can use the system editor to transfer calculation results into your program code. The Note Pad lets you write memos to yourself about special sections of code that need attention, or anything else you need to remember but don't want to scribble on a piece of paper that will quickly get lost. The Clock is extremely useful, either to time program execu-

tion or to remind a hacker when to eat lunch. You can have all these tools (and any others, for that matter) operating while you develop and run programs.

Using the mouse and the screen-oriented editor, you can cut, copy, paste, or entirely remove all or part of a program. In combination with the Clipboard, the system-wide text and graphics buffer, you can quickly and easily move whole blocks of code from one section of a program to another section of the same program or to a different program (see figure 4). Additionally, you can move material into (or out of) the BASIC programming environment from any other Macintosh application including a spreadsheet, a word processor, or the Mac Paint graphics application.

Also on the Menu

The other menus provide access to tools specific to Macintosh BASIC. Among the tools seldom seen in other systems are Search and Replace, in the Search menu; Debug, in the Program menu; and Directory, in the Operate menu.

The search tools help you to locate and/or change any group of characters, either once or repeatedly, matching or ignoring the case of the alpha-

(2a)

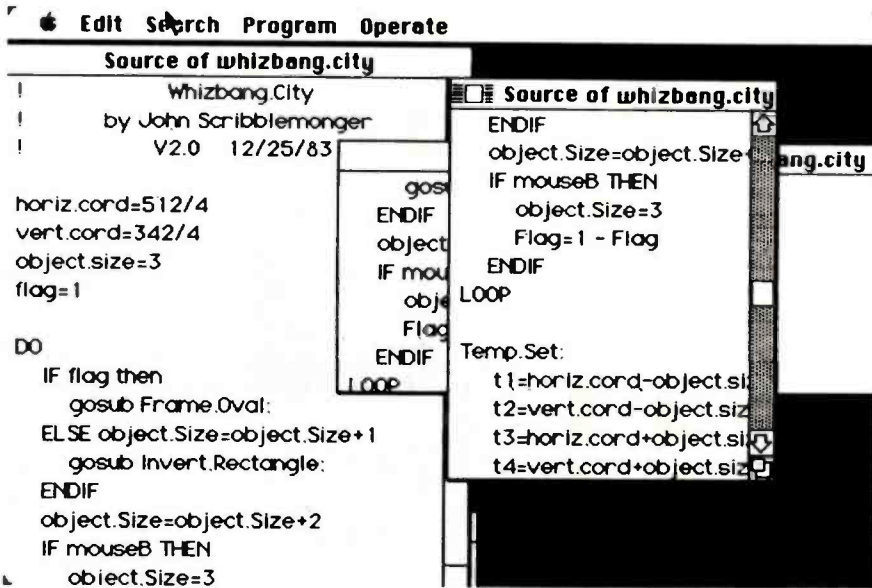

(2b)

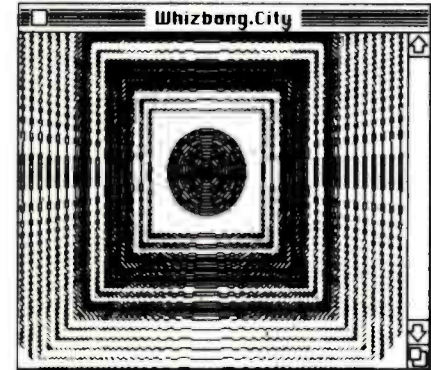

Figure 2: Three "views" of the same program in windows of different sizes (2a). None of these windows shows an entire listing (see listing 1 below). Figure 2b shows the Output window for the program Whizbang.city (listing 1).

betic characters. These search tools can be extremely useful for changing a nondescriptive variable to one that makes more sense—say, changing all occurrences of the variable E7 to EMPLOYEE.7—or to replace improper spellings in variable names, labels, or prompting phrases.

Listing 1: The Whizbang.city program.

```

Whizbang.City
by John Scribblemonger
V2.0 12/25/83

horiz.cord=512/4
vert.cord=342/4
object.size=3
flag=1

DO
  IF flag then
    gosub Frame.Oval:
  ELSE object.Size=object.Size+1
    gosub Invert.Rectangle:
  ENDIF
  object.Size=object.Size+2
  IF mouseB THEN
    object.Size=3
    Flag=1 - Flag
  ENDIF
LOOP

Temp.Set:
t1=horiz.cord-object.size
t2=vert.cord-object.size
t3=horiz.cord+object.size
t4=vert.cord+object.size

Return

Frame.Oval:
Gosub Temp.Set:
Frame Oval t1,t2; t3,t4
Return

Invert.Rectangle:
Gosub Temp.Set:
Invert Rect t1,t2; t3,t4
Return

```

The Program menu (see figure 5) lists the command verbs, or menu selections, programmers tend to use most during code development, including certain commands not available or meaningful in other BASIC systems. Most notable here are the two Save commands, the Update command, and the Debug command.

Selecting Save Source sends an ASCII (American National Standard Code for Information Interchange) text copy of the program to the disk, just as it appears in the Listing window. Save Object stores only the program's B-code—that is, the code in its compiled form. You can retrieve, edit, and execute a program saved as text, but a program saved as code can be

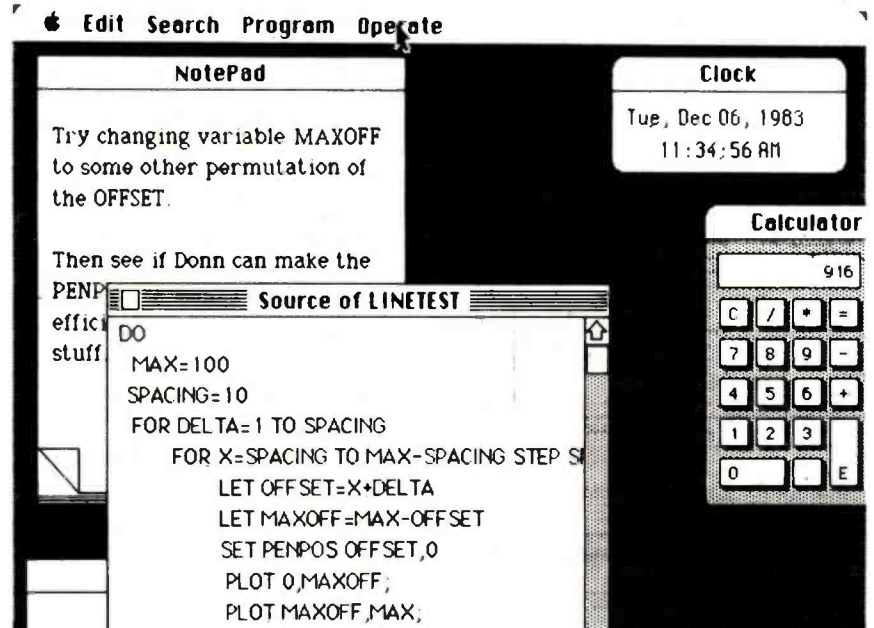

Figure 3: Macintosh desk accessories run concurrently with program development. The Note Pad (in the background) has eight pages and holds 256 bytes per page.

executed only. Code files are safe from tampering; once they go to disk, they cannot be viewed or changed. Thus, profit-minded programmers can protect their code from the prying eyes of unscrupulous code pilferers. Update lets you modify running programs. You can change a program line in the Listing window, select Update from the Program menu, and watch the immediate effects of the change in the Output window.

Choosing Debug turns on the debugging environment. When this command is in effect, the normal Listing window is replaced by the one in figure 6. The finger symbol moves up and down the listing, pointing to the line of code currently being executed. Simultaneously, the system displays a dynamic variable and breakpoint table showing the current values of all non-array variables; all of these values can be changed while the code being debugged is executing (updating is automatic).

You can set and clear breakpoints for any or all variables. The program can break whenever a particular variable is referenced or changed or is equal to, less than, or greater than some value or other variable. When the program hits a breakpoint, execution halts and it waits for the programmer to determine what happens next. By using the mouse to press a button displayed on the desktop beneath the Listing window, you can make execution resume at full speed until the next breakpoint, full speed through the next control block (a DO/LOOP, FOR/NEXT, SELECT CASE, subroutine, etc.), or go immediately into a single-step mode. In single-step mode, only one line of code is executed; the programmer tells BASIC to execute each subsequent line of code by pressing the space bar.

Additionally, there's an alphabetical list of all the labels in the program. This feature makes it easy for you to see why you got that "undefined label" error when your program is trying to branch to CALL.YOUR.MOTHER: instead of to CALL.YOUR.MOM:.

| Function | Description |
|----------|--|
| BTN | tells which interactive button has been pushed |
| DIAL | tells which interactive dial has been activated |
| FORMAT\$ | Macintosh BASIC equivalent of PRINT USING |
| KBD | gives the ASCII code of the most recent key pressed |
| MENU | tells when an interactive menu is chosen |
| MOUSEB | yields the state of the mouse button |
| MOUSEX | returns the horizontal position of the mouse pointer |
| MOUSEY | returns the vertical position of the mouse pointer |
| TYP | tells the data type of the next item in the input stream (numeric, string, or picture) |

Table 1: Macintosh BASIC numeric data types.

| Storage Form | Symbol | Accuracy | Range |
|-------------------------|--------|----------|----------|
| Double-precision real | none | 15 | 1E+-1022 |
| Single-precision real | | 7 | 1E+-126 |
| Extended-precision real | \ | 18+ | 1E+-4000 |
| Short integer | % | 4+ | +/-32767 |
| Long integer | # | 18+ | +/-9E18 |
| Boolean | - | 1 | 0 or 1 |

Table 2: Some Macintosh BASIC functions not available in most other BASICs. "Interactive" refers to graphics objects (menus, buttons, dials) that appear on the screen and can be manipulated with the mouse.

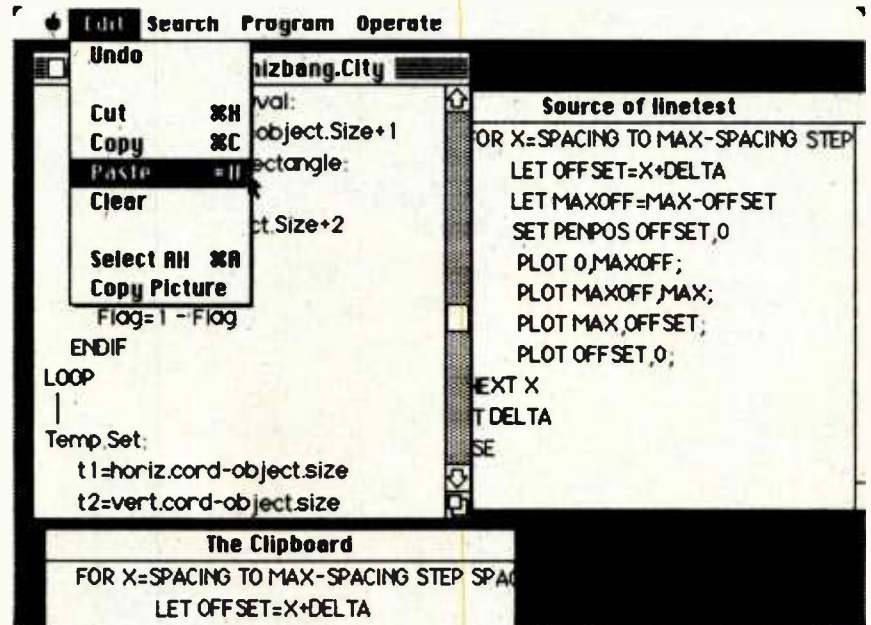

Figure 4: Material in the Clipboard, just copied from the Linetest program on the right, is about to be pasted into a second program. The source lines in Linetest remain undisturbed.

Verex

Whatever program you're interested in, it will always have a happy ending with Verbatim, the world's best-selling name in flexible disks.

In fact, one out of every four disks sold is made by Verbatim. And for good reasons. They're certified 100% error-free. And each is backed by a warranty for your peace of mind: Verex,[™] for 1 year; Datalife,^{*} for 5 years; Optima Series,^{*} for 17 years.

For your nearest Verbatim dealer, call toll-free 800-538-1793. In California or outside the U.S., call collect (408) 737-7771.

Because with Verbatim all the data you record always comes back verbatim.

Optima

Datalife

Verbatim.

Nothing's better than a Verbatim response.

Circle 380 on inquiry card.

Enjoy programs without interruptions.



The Operate menu holds commands you might typically use to test programs. RUN is the usual BASIC command to execute a program (something in this language has to be usual). In Macintosh BASIC, Halt and Continue are useful for checking the program's Output window and variable table from time to time. The Directory selection produces a menu of all BASIC programs on the disk; drag the pointer to one of the program names and BASIC loads the program for you. The Quit command is your way out of BASIC, returning you to the main Macintosh system (called the Finder).

With Macintosh BASIC, you can obtain four kinds of hard-copy printouts: everything on the screen, everything in the Listing window including material you can't see, all text and graphics in the Output window, and material sent to the printer by the running program itself. The listings in this article were all printed directly from the Macintosh.

The Language

Variable names in Macintosh BASIC can be of any length, and all characters in the name are significant. The first character must be alphabetic; the rest can be nearly anything you can type from the keyboard, which includes the entire ASCII code set plus nonroman and other special characters. The only exceptions are arithmetic symbols and other delimiters (comma, semicolon, colon, and space).

Macintosh BASIC supports array

variables for all eight data types and subtypes discussed later. Arrays can have any number of dimensions, and each dimension can have 32,767 elements. All arrays must be dimensioned before use. When you DIM an array, you can specify ranges for element numbers. Thus, you can say DIM YEAR%(1900 TO 1986) to specify an 87-element integer (the % denotes integer) array whose first number is 1900 and whose last number is 1986. You can also stipulate ranges for separate dimensions, as in DIM NAMES\$(10 TO 75, 165 TO 300).

There are three main data types in the language: strings, pictures, and numerics. Strings are pretty standard; they are enclosed in quotes, either single or double, and their variable names end in the usual BASIC symbol, \$.

You create a picture data type by either creating a shape or a whole picture in a graphics application (like Mac Paint) and transferring it to BASIC through the Clipboard or by drawing a shape in BASIC using various graphics commands. You can then assign the shape to a picture variable; the variable name ends in the symbol @.

The numeric data type is further divided into six subtypes: Booleans, two types of integers, and three types of reals. Table 1 shows the storage form, symbol, range, and digits of accuracy for each subtype.

In addition to the five standard arithmetic operators (+, -, *, /, ^), Macintosh BASIC includes DIV for integer division and MOD for

modulo, defined as the arithmetic remainder of integer division. The relational operators (<, =, >, <>, ><) and logical operators (AND, OR, and NOT) are standard; the string concatenation symbol is &.

Macintosh BASIC has the usual range of arithmetic, trigonometric, and string functions, including DEF FN (user-defined functions) for both numbers and strings. Table 2 describes many of the functions that don't appear in most other BASICs or are unique to Macintosh BASIC in some major way. The term "interactive," appearing in several of the descriptions, refers to graphics objects (entire menus, buttons, dials) you can make appear on the screen and can manipulate with the mouse.

Control Structures

Most flow of control statements in Macintosh BASIC take the form of control structures. The language has a GOTO statement, but you never have to use it. In fact, the only place the GOTO statement appears in the language manual as part of a code example is in the section describing GOTO itself.

Besides the familiar FOR/NEXT structure and the DO/EXIT/LOOP structure, in which all statements between the keywords DO and LOOP are repeated infinitely (EXIT lets you escape the loop), this BASIC includes some variations on new structures proposed in the 1982 ANSI (American National Standards Institute) BASIC proposal. A multiline IF/THEN/ELSE/ENDIF lets you execute

DOUBLE PRECISION • FORTRAN • INDEXED ARRAYS • CHARACTER VARIABLES • UNLIMITED CASES • VARIABLE RECORD LENGTHS • MISSING DATA • RELATIONAL DATABASE • REPORT GENERATION • NUMERICAL AND CHARACTER MULTIPLE KEY SORT/MERGE • IF... THEN... ELSE • FOR... NEXT • GOTO • INTERACTIVE/BATCH • ASCII/BINARY FILES • SCATTERPLOTS • HISTOGRAMS • CONTOUR PLOTS • MULTI-FUNCTION PLOTS • BOX PLOTS • STEM-AND-LEAF DIAGRAMS • PROBABILITY PLOTS • BASIC STATISTICS • BREAKDOWNS • MULTI-WAY TABLES • LOG-LINEAR MODELS • PAIRWISE/LISTWISE CORRELATIONS • MULTIPLE REGRESSION • POLYNOMIAL REGRESSION • STEPWISE REGRESSION • WEIGHTED LEAST SQUARES • MULTIVARIATE REGRESSION • LEAST SQUARES ANOVA • ANOCOVA • REPEATED MEASURES • MANOVA • GENERAL LINEAR MODEL • PRINCIPAL COMPONENTS • MULTIDIMENSIONAL SCALING • CLUSTER ANALYSIS

SYSTAT™

MS-DOS,™ PC-DOS,™ CP/M,™ UNIX™
1127 ASBURY AVENUE EVANSTON, IL 60202

(312) 864-5670



The Operate menu holds commands you might typically use to test programs. RUN is the usual BASIC command to execute a program (something in this language has to be usual). In Macintosh BASIC, Halt and Continue are useful for checking the program's Output window and variable table from time to time. The Directory selection produces a menu of all BASIC programs on the disk; drag the pointer to one of the program names and BASIC loads the program for you. The Quit command is your way out of BASIC, returning you to the main Macintosh system (called the Finder).

With Macintosh BASIC, you can obtain four kinds of hard-copy printouts: everything on the screen, everything in the Listing window including material you can't see, all text and graphics in the Output window, and material sent to the printer by the running program itself. The listings in this article were all printed directly from the Macintosh.

The Language

Variable names in Macintosh BASIC can be of any length, and all characters in the name are significant. The first character must be alphabetic; the rest can be nearly anything you can type from the keyboard, which includes the entire ASCII code set plus nonroman and other special characters. The only exceptions are arithmetic symbols and other delimiters (comma, semicolon, colon, and space).

Macintosh BASIC supports array

variables for all eight data types and subtypes discussed later. Arrays can have any number of dimensions, and each dimension can have 32,767 elements. All arrays must be dimensioned before use. When you DIM an array, you can specify ranges for element numbers. Thus, you can say DIM YEAR%(1900 TO 1986) to specify an 87-element integer (the % denotes integer) array whose first number is 1900 and whose last number is 1986. You can also stipulate ranges for separate dimensions, as in DIM NAME\$(10 TO 75, 165 TO 300).

There are three main data types in the language: strings, pictures, and numerics. Strings are pretty standard; they are enclosed in quotes, either single or double, and their variable names end in the usual BASIC symbol, \$.

You create a picture data type by either creating a shape or a whole picture in a graphics application (like Mac Paint) and transferring it to BASIC through the Clipboard or by drawing a shape in BASIC using various graphics commands. You can then assign the shape to a picture variable; the variable name ends in the symbol @.

The numeric data type is further divided into six subtypes: Booleans, two types of integers, and three types of reals. Table 1 shows the storage form, symbol, range, and digits of accuracy for each subtype.

In addition to the five standard arithmetic operators (+, -, *, /, ^), Macintosh BASIC includes DIV for integer division and MOD for

modulo, defined as the arithmetic remainder of integer division. The relational operators (<, =, >, <>, ><) and logical operators (AND, OR, and NOT) are standard; the string concatenation symbol is &.

Macintosh BASIC has the usual range of arithmetic, trigonometric, and string functions, including DEF FN (user-defined functions) for both numbers and strings. Table 2 describes many of the functions that don't appear in most other BASICs or are unique to Macintosh BASIC in some major way. The term "interactive," appearing in several of the descriptions, refers to graphics objects (entire menus, buttons, dials) you can make appear on the screen and can manipulate with the mouse.

Control Structures

Most flow of control statements in Macintosh BASIC take the form of control structures. The language has a GOTO statement, but you never have to use it. In fact, the only place the GOTO statement appears in the language manual as part of a code example is in the section describing GOTO itself.

Besides the familiar FOR/NEXT structure and the DO/EXIT/LOOP structure, in which all statements between the keywords DO and LOOP are repeated infinitely (EXIT lets you escape the loop), this BASIC includes some variations on new structures proposed in the 1982 ANSI (American National Standards Institute) BASIC proposal. A multiline IF/THEN/ELSE/ENDIF lets you execute

DOUBLE PRECISION • FORTRAN • INDEXED ARRAYS • CHARACTER VARIABLES • UNLIMITED CASES • VARIABLE RECORD LENGTHS • MISSING DATA • RELATIONAL DATABASE • REPORT GENERATION • NUMERICAL AND CHARACTER MULTIPLE KEY SORT/MERGE • IF... THEN... ELSE • FOR... NEXT • GOTO • INTERACTIVE/BATCH • ASCII/BINARY FILES • SCATTERPLOTS • HISTOGRAMS • CONTOUR PLOTS • MULTI-FUNCTION PLOTS • BOX PLOTS • STEM-AND-LEAF DIAGRAMS • PROBABILITY PLOTS • BASIC STATISTICS • BREAKDOWNS • MULTI-WAY TABLES • LOG-LINEAR MODELS • PAIRWISE/LISTWISE CORRELATIONS • MULTIPLE REGRESSION • POLYNOMIAL REGRESSION • STEPWISE REGRESSION • WEIGHTED LEAST SQUARES • MULTIVARIATE REGRESSION • LEAST SQUARES ANOVA • ANOCOVA • REPEATED MEASURES • MANOVA • GENERAL LINEAR MODEL • PRINCIPAL COMPONENTS • MULTIDIMENSIONAL SCALING • CLUSTER ANALYSIS

SYSTAT™

MS-DOS,™ PC-DOS,™ CP/M,™ UNIX™
1127 ASBURY AVENUE EVANSTON, IL 60202

(312) 864-5670

TAKE THE CATALOG

CHALLENGE

- For Savings
- For Selection
- For Service

Other companies waste time and overhead producing expensive catalogs. Computers and More doesn't. Putting the latest products and best prices in our customers' hands, not catalogs, is our goal. We challenge any catalog company to match our pricing, selection and service. Take the catalog challenge and save! • New Product or Price.

COMPUTERS

| Desk Top | Portable |
|-------------------------------|--------------------------------|
| IBM P/C 2-320K 2195 | Columbia VP 2349 |
| IBM XT ON SALE! 1989 | Corona 1-320K 1989 |
| Columbia 1600-1 2289 | Panasonic Sr. Partner. 1995 |
| Columbia 1600-4 3494 | Kaypro II CALL |
| Corona 2-320K 2389 | Kaypro 4 1669 |
| Eagle 1620 3995 | Teletote 1289 |
| Eagle PC XL 3395 | Teletote TPC-2 1759 |
| NEC All Models 3495 | Eagle Spirit XL 3495 |
| Epson QX-10 ON SALE! 1995 | The Computer by Sharp NEW! 639 |
| Dec Rainbow 100 CALL | NEC 8201A 639 |
| Leading Edge P/C 2199 | Compaq 1 drive CALL |
| Televideo 803 or 1605 H. CALL | Apple Compatible CALL |
| Franklin DMS CALL | Epson HX-20 CALL |
| Apple Computers CALL | Zorba 9 in. 1776 |

PRINTERS

| Letter Quality | Dot Matrix |
|------------------------|----------------------------|
| NEC 3550 (IBM) 1695 | C. Itoh 8510 339 |
| Cannon Ink Jet 634 | C Itoh 1550 645 |
| Juki 6100 489 | Epson FX-80 CALL |
| Silver-Reed 550 599 | Epson RX-80 CALL |
| Silver-Reed 770 CALL | OKI 82A 319 |
| Transtar 130 699 | OKI 83A 589 |
| Transtar 140 1089 | OKI 80 319 |
| NEC 2010 859 | OKI 92A 449 |
| NEC 2015 859 | OKI 93 739 |
| NEC 2050 (IBM) CALL | Rnemam 80 Col. 349 |
| F-10 Starwriter 1099 | Gemini Delta 10 549 |
| F-10 Printmaster 1349 | Gemini Radux 10 or 15 CALL |
| PowerType by Star CALL | Gemini 10X 259 |
| HR-1 589 | Toshiba P-1350 SALE |
| HR-15 ON SALE! 589 | NEC 8025 699 |
| Diablo 630 CALL | IDS Prism 132 1165 |
| Daisywriter 48K 1089 | Mann-Tally 160L 619 |
| DTC 380-2 1049 | Mann-Tally 180L 849 |
| Brother HR-25 769 | Transtar 315 CALL |

ACCESSORIES

| IBM | Apple |
|-----------------------------------|--------------------------------|
| Supervision by CCS 679 | Rana 8088 CPU CALL |
| Paradise Multi display 419 | Dual Interface (Par & Ser) 159 |
| Graphics Card by Hercules 367 | 80 Col/64K for tie 116 |
| STB Video Board 349 | PKASO Card 127 |
| Baby Blue by Microlog 459 | Par. Interface 59 |
| AST Six Pak 289 | Koala Touch Tablet 84 |
| AST PC Net 1279 | Wildcat Computer SALE! |
| Smartmdm 1200 B/w/soft 429 | Premium SII Cd II 349 |
| Password Modem 339 | Sup R Mod 49 |
| Tandon TM 100-2 219 | Disk Drive 199 |
| CDC Disk Drive DS/DD 227 | Drive Controller 59 |
| Disk Controller by Maynard 157 | Disk Emulator 294K 519 |
| HaH High 320K 199 | Ulratem 289 |
| Quaddisk 6 meg. Fixed 1589 | MicroModem II 269 |
| Keytronic New 5150 198 | Smart Modem 1200 329 |
| Kraft Joystick 34 | D-Cal 149 |
| USI Color/Graphics 1/2 & Para 359 | Kraft Joystick 29 |
| Corvus+Pegasus+Corona 469 | Davong 5 Meg 1359 |
| Quadram Quadlink 469 | Microbuffer II 209 |
| Quadram New Quad Bro 64K 298 | 80 Col cd 99 |
| Tecmar 1st Mate 259 | BUF Grappler+ CALL |
| Tecmar Graphics Master 559 | Wizard 16K 53 |
| Orchid Technologies CALL | Keytronic KB200 217 |

MONITORS

| Color | Monochrome |
|------------------------|------------------|
| Princeton MX-12 \$469 | Taxan Amber 129 |
| Princeton SR-12 649 | Taxan Green 129 |
| New Max-12 199 | Zenith 122 A 125 |
| NEC JC-1203 (IBM) 519 | Zenith 123 G 97 |
| Taxan RGB-3 449 | Amdek 310 A 169 |
| Quadram Quadchrome 497 | Amdek 300 159 |
| Zenith - New CALL | New Max-12 199 |

SOFTWARE

| IBM | Apple |
|-------------------------|-----------------------|
| R Base CALL | Tax Preparer 147 |
| Millionaire 39 | Home Accountant 49 |
| Wizardry 39 | Great Plains CALL |
| Wordstar 239 | Peachtree CALL |
| Easywriter II 259 | PFS Solutions CALL |
| Volkswriter 119 | PFS File 84 |
| Visicalc (256K) 179 | PFS Report 84 |
| Multiplan 189 | PFS Graph 84 |
| Lotus 1-2-3 319 | d Base II 397 |
| PFS Graph 89 | Visilite 169 |
| PFS File 89 | Versaform 264 |
| PFS Report 83 | T.I.M. CALL |
| PRS Solutions CALL | List Handler 59 |
| d Base II 384 | Wordstar 249 |
| CDEX - Any Program 49 | Bank Street Writer 47 |
| Tax Preparer 169 | Screenwriter II CALL |
| OZ by F & G CALL | Magic Window 97 |
| Intostar 259 | Magic Call 97 |
| Personal Pearl 199 | Zork I 27 |
| Home Acct Plus 112 | Zaxxon 27 |
| Peachtree CALL | Chopifier 26 |
| Properly Management 329 | Frogger 24 |
| Digital Research SALE! | Wizardry 39 |
| DESO NEW! | Jumpman 29 |
| Select 299 | |

Terminals

| |
|------------------------|
| Wyse 300 1019 |
| Wyse 200 1019 |
| Adds - All Models CALL |
| T.V. 910+ 569 |
| T.V. 925 C 749 |
| T.V. 950 C 969 |
| Oume 102 A 549 |
| Oume 102 G 549 |
| Oume 108 A 679 |
| Zenith CALL |

Plotters

| |
|-------------------------|
| Mann-Tally Pxy 3 689 |
| Sweet-P 528 |
| Six-Shooter CALL |
| Amdex X-Y 569 |
| Amdex 6 Pen Auto 995 |
| Quadjet by Quadram CALL |
| C. Itoh CX (Par) 549 |
| C. Itoh CS (Ser) 549 |
| Strobe 8 Pen 799 |
| Houston Ins HI-Pad 759 |

COMPUTERS

1 Year Warranty Available

TO ORDER: Phone orders invited using Visa, MasterCard, or bank wire transfers. Visa, MC, service charge of 2%. Mail orders may send charge card number (include expiration date), cashiers check, money order, or personal check (allow 10 business days for personal or company checks to clear). Please add 3% (\$5.00 minimum) for UPS shipping, handling, and insurance. All equipment is in factory cartons with manufacturer warranty. Opened products not returnable. Restocking fees for returned merchandise. Equipment subject to price change and availability. Retail prices differ from mail order prices. Call residents add 6% State Tax. Company and school P.O.'s accepted on approval. IBM & Apple are registered trademarks. International inquiries welcomed. Telex 697120. Datamat Attn Dept 322



and More

The Catalog Changers!

3620 - 30th Street
SAN DIEGO, CA 92104
TO ORDER
(619) 291-1442

Listing 2: A multiple-line IF control block.

```

Source of IF...THEN/ELSE/ENDIF
IF DAY.TEMP > HOT THEN
    CLOTHES$ = SWIM.STUFF$
    GOSUB BEACH:
ELSE CLOTHES$ = WALK.STUFF$
    GOSUB CITY:
ENDIF
    
```

as many statements as you want if a condition is either true or false (see listing 2). An extremely flexible SELECT CASE/ENDCASE construct takes the place of the restrictive ON...GOSUB statement. It enables the program to transfer execution to sets of statements based on the value of some expression. There can be multiple statements for each case or range of cases (see listing 3). The language has several interrupt control structures, all of which are based on a structure bounded by the keywords WHEN and ENDWHEN; these interrupts let you determine which code is executed if any one of a number of events occurs anytime during program execution. You can plan interrupts to occur whenever a key is pressed, when the mouse is moved or its button pushed, when an error occurs, or at other times (see listing 4).

Subroutines are handled in the usual way (except that the language uses GOSUB labels); additionally there's a CALL statement that enables entire programs to act as subroutines. CALL lets you pass parameters back and forth with the summoned program; when the called program ends, control returns to the statement following CALL in the source program.

Graphics

Macintosh BASIC provides commands for both static and animated graphics on a bit-mapped 512- by 342-point screen. You can plot points with the PLOT command (controlling the size of the pixels with PENSIZE) or create shapes with the keywords RECT (for rectangle), ROUNDRECT (a rectangle with rounded corners), or OVAL. Shapes can be outlined

ALDOS • COLUMBIA • CORONA • EPSON • EAGLE • DEC RAINBOW • SYSCOM • COMPAG • GEMINI • JUKI • EAGLE

IBM • APPLE • FRANKLIN • OSBORNE • KAYPRO •

• TRANSTAR • QUADRAM • DAVONG • CORVUS •

Listing 3: A SELECT CASE construct using strings (3a) and a SELECT CASE construct using numerics (3b).

(3a) **Source of SELECT CASE/ENDCASE (STRINGS)**

```

SELECT CASE PARTY$
  CASE "REPUBLICAN"
    CALL REPUBLICAN.PRIMARY.BALLOT
  CASE "COMMUNIST"
    CALL MILITIA
  CASE "DEMOCRAT", "TORY", INDEPENDENT$
    GOSUB FURTHER.CHOICE:
    CALL GENERAL.PARTY.BALLOT
  CASE LEFT$(PARTY$, 3) = "SEP"
    CALL SEPARITIST.PRIMARY.BALLOT
  CASE ELSE
    CALL GENERAL.PRIMARY.BALLOT
ENDSELECT

```

(3b) **Source of SELECT CASE/ENDCASE (NUMBERS & RANGES)**

```

SELECT CASE AGE
  CASE 2, 4, 5
    GOSUB PRESCHOOL:
  CASE 6 TO 12
    GOSUB GRAMMAR.SCHOOL:
  CASE 15, 18 TO 35, VAL (OLD$)
    CALL CHECK.DEMOGRAPHICS
  CASE >70
    GOSUB MIGHT.BE.RETIRED:
ENDSELECT

```

(FRAME), filled in (PAINT) with a preestablished shade or pattern (SET PATTERN), complemented from the last appearance (INVERT), or erased altogether (ERASE). The various shapes can then be combined into a single picture and stored in a picture variable (RECORD PICTURE) and recalled (DRAW PICTURE). For animated sequences, you can ROTATE, SCALE, and ANIMATE a picture, moving it across the display. All graphics appear within the Output window, so your Listing and Debugging windows can coexist with a running graphics program.

Disk File Structures

Disk file structures have many options. I will cover only the major highlights; many of the available statements and options are not examined here.

There are three types of file organization: sequential (serial access for text data), stream (serial access for binary data), and relative (random access, usually for text data). Length of a record in a relative file must be set in advance, but it can be any length

Listing 4: The interrupt construct for errors and keypress.

Source of WHEN / ENDWHEN

```

WHEN ERR
  CALL ERROR.CHECK
  GOSUB SECOND.CHANCE:
ENDWHEN

WHEN KBD
  PRINT "WHICH MENU DO YOU NEED?"
  GOSUB MENU.CHOICE:
  CALL MENU$
ENDWHEN

```

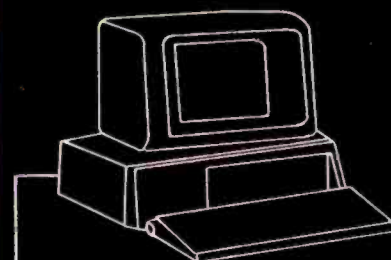

IBM-PC/XT or PC compatible
IEEE-488 INTERFACE BOARD



- Implements the entire IEEE-488 standard – transfer commands and data, perform serial and parallel polling.
- A resident firmware interpreter simplifies programming and accepts any ASCII string or code including Tektronix Standard Codes and Formats and IEEE-488 command mnemonics. Interpreter routines support BASIC, PASCAL, C and other languages.
- Supports the PrtSc (print screen) key, and all BASIC print statements for IEEE-488 printers and devices.
- Small size – see BYTE 11/83, p. 314
- Accepts a standard IEEE-488 cable.
- Uses only 16 bytes of RAM and no I/O ports.
- A 116 page Reference Manual provides a tutorial and programming examples for digitizing, interactive bus control, bus diagnostics, and many other applications.
- \$395 complete. There are no extra software or cabling charges.

cec

CAPITAL EQUIPMENT CORP.

10 Evergreen Avenue
Burlington, MA. 01803
(617) 273-1818

IBM is a trademark of International Business Machines Corp.

DIAMOND DELIVERS!

dBase II \$ call
Infostar \$259
Multipan \$159
Multitool Word \$249
Multitool Word w/Mouse \$249
Wordstar/Mailmerge/Spellstar/Star Index \$319
Wordstar Pro Pak/Lotus 123/dBase II \$379
dBase II/Quickcode \$579

Multimate \$309
Volkswriter Dlx \$179
Supercalc 3 \$239
Wordstar \$245

| | LIST | SALE | | LIST | SALE |
|----------------------|--------|-------|------------------------|-------|-------|
| Alpha Software* | \$250 | \$139 | Micropro* | \$250 | \$135 |
| APPLE-IBM CONNECTION | \$295 | \$169 | MAILMERGE | \$250 | \$135 |
| DATA BASE MANAGER II | \$295 | \$199 | SPELLSTAR | \$645 | \$339 |
| Ashton-Tate* | | \$359 | WORDSTAR/MAILMERGE | \$695 | \$309 |
| FRIDAY | \$650 | \$ 99 | PLANSTAR | \$595 | \$299 |
| Condor* | \$150 | \$125 | INFOSTAR/STARBURST | \$195 | \$ 99 |
| CONDOR 3 | \$195 | \$269 | STARBURST | \$200 | \$ 99 |
| Continental* | | \$ 99 | SUPERSTORT II | \$195 | \$139 |
| HOME ACCOUNTANT | \$400 | \$ 99 | MICROSOFT* | \$100 | \$ 69 |
| ULTRAFILE | \$150 | \$145 | MOUSE | \$150 | \$ 99 |
| Digital Research* | \$200 | \$109 | MULTITOOl BUDGET | \$350 | \$239 |
| PASCAL MT+ 86 | \$150 | \$ 44 | MULTITOOl COMPILER | \$350 | \$239 |
| CONCURRENT CP/M 86 | \$ 60 | \$269 | PASCAL COMPILER | \$500 | \$349 |
| C BASIC 86 | \$ 400 | \$349 | FORTRAN | | \$239 |
| PERSONAL BASIC | \$500 | \$ 79 | C COMPILER | \$395 | \$239 |
| CP/M 86 | \$ 95 | Scall | PEACHTREE* | | \$329 |
| ACCESS MGR | | \$265 | PEACHTEXT 5000 | \$495 | \$239 |
| DISPLAY MGR | \$350 | \$219 | Professional Software* | | \$ 85 |
| DR LOGO | \$300 | \$119 | WORD PLUS W/BOSS | \$125 | \$ 95 |
| PC DOS LANGUAGES | \$195 | \$109 | Software Publishing* | \$140 | \$ 95 |
| Dow Jones* | | \$189 | PFS: REPORT | \$140 | \$ 95 |
| MARKET ANALYZER | \$295 | \$ 59 | PFS: FILE | \$140 | \$ 95 |
| MARKET MANAGER | \$295 | \$199 | PFS: GRAPH | \$140 | \$ 95 |
| Financier* | \$ 99 | \$119 | PFS: WRITE | \$295 | \$159 |
| PERSONAL SERIES II | \$150 | \$109 | Sorcim* | \$295 | \$159 |
| TAX SERIES | | \$ 59 | SUPERCALC 2 | \$375 | \$269 |
| Fox & Geller* | | \$ 59 | SUPERWRITER | \$250 | \$169 |
| QUICKCODE | | \$199 | Visicorp* | \$300 | \$199 |
| GRAPH | \$250 | \$119 | VISICALC IV | \$300 | \$205 |
| QUICKCODE | | \$199 | VISIFILE | \$300 | \$205 |
| QUICKCODE | | \$199 | VISITREND/PLOT | \$395 | \$269 |
| QUICKCODE | | \$199 | VISISCHEDULE | \$395 | Scall |
| QUICKCODE | | \$199 | AST Research* | | \$499 |
| QUICKCODE | | \$199 | 6 PAK PLUS 64K | \$699 | \$429 |
| QUICKCODE | | \$199 | ALL OTHER AST PRODUCTS | \$599 | \$429 |
| QUICKCODE | | \$199 | Hayes* | | \$489 |
| QUICKCODE | | \$199 | SMARTMODEM 1200 | \$680 | \$219 |
| QUICKCODE | | \$199 | SMARTMODEM 1200B | \$295 | \$269 |
| QUICKCODE | | \$199 | Quadrant* | \$395 | \$425 |
| QUICKCODE | | \$199 | QUADLINK | \$595 | \$269 |
| QUICKCODE | | \$199 | QUADCOLOR | \$395 | \$269 |
| QUICKCODE | | \$199 | 64K EXPANDABLE BOARD | \$499 | \$355 |
| QUICKCODE | | \$199 | 256K | | |
| QUICKCODE | | \$199 | QUADBOARD EXP. TO 384K | | |
| QUICKCODE | | \$199 | Hercules* | | |
| QUICKCODE | | \$199 | GRAPHICS CARD | | |

At Diamond Software we offer the best selling business application software for your IBM PC, CP/M or Apple Computer at the lowest possible prices. And we maintain a complete technical department to assist you before, during and after your system purchase. Not only that, we offer same day shipment on most items and we accept Visa, Mastercard and also American Express. We'll even pay the shipping charges if you send us a money order, cashiers, company or personal check. Purchase orders are gladly accepted from qualified organizations and we welcome dealer inquiries. Call Diamond today, you'll be glad you did.

TO ORDER CALL TOLL-FREE 1-800-227-0545
Diamond Software Supply 484 Lake Park Ave., Suite 123 • Oakland, CA 94610
 For price quotes, information, or in California call 1-415-893-7676. We credit your order for the call. Technical Department (415) 893-7678. International Telex 338139 (attn. 149)

Support, Service and Price.

Shipping/Handling UPS surface \$3.00 plus an additional \$3.00 per item for UPS Blue. C.O.D. orders add \$4.00. For personal check allow 2 weeks for delivery.

you choose; there is no limit (beyond memory) to the number of records in a file.

The keyword RECTYPE determines how data is stored: display files are standard ASCII and can be shown in a window or be printed; internal files are binary and are for storage only. You can designate any file, no matter what type, to be an input file (a file which can only be read), an output file (to which data is sent but not retrieved), or OUTIN (accessible for both input and output). You can later change a file's access designation.

You create a file, and later make it accessible for use, with the OPEN statement. OPEN sets the channel number (1 through 99) that links the file to the system and the name of the file associated with the channel:

OPEN #3: NAME "Macmumble"

The preceding statement opens a file named Macmumble and assigns it to channel #3. Since no further parameters are given, the file uses the default parameters, which makes it a sequential display file enabling OUTIN access. The following statement opens a relative file with a record length of 250 characters for the storage of ASCII text data.

OPEN #54: NAME "Foobar", ACCESS OUTPUT, ORGANIZATION RELATIVE, RECSIZE 250

The OPEN statement is intelligent: after you've opened a file, you don't have to restate the organization, record size, or RECTYPE each time you use it. Assuming you've issued the CLOSE statement for the file "Foobar" described above, you can later access it again by just saying OPEN #54: NAME "Foobar". Up to 10 channels can be open at the same time.

All devices (like the serial port, the printer, windows on the desktop) can be accessed in the same manner as files. Device names are specified in the same way as any filename except that the first character in the name is a period.

MOST ACCOUNTING SOFTWARE TURNS WORK STATIONS INTO BATTLE STATIONS.

When you have Champion Accounting Software, your personnel can leave the combat zone. Because Champion™ gives you the performance you need, without a fight.

Champion is written in dBASE II™ on one convenient disk. And its features make conventional accounting software obsolete.

PERFORMANCE YOU CAN SEE.

Other software dealers will tell you what they think their product will do. Only Champion dealers will show you how the software performs:

- Help function provides users with clear, concise, on-line answers to questions about Champion.

- Unparalleled recovery program automatically puts the user's books back in balance in the event of a crash.
- Realtime updating. All files are simultaneously updated when data is entered.

PRaised BY EXPERTS.

"It performs extremely well... If you are looking for a good, competitively priced, fully integrated accounting package... take a close look at this one."

Amanda Hixson
INTERWORD, 9/83

"... users will find this to be a very comprehensive software package with several attractive features that make it superior to its competition."

Carl Heinz, CPA
INTERFACE AGE 8/83

For more about Champion performance, see the Champion dealer nearest you. And get the accounting software system that lets you work in peace.

Champion is a registered trademark of Champion Software Corporation. dBASE II is a registered trademark of Ashton-Tate.

Champion Software Corporation
Formerly:
Data Base Research Corporation
66 South Van Gordon, Suite 155
Lakewood, CO 80228. (303) 987-2588

CHAMPION

BUSINESS ACCOUNTING SOFTWARE

Circle 497 for Dealer Inquiries.
Circle 498 for End-User Inquiries.



NOW AVAILABLE FOR IBM P.C.

CALL (303) 987-2588 FOR A FREE DEMONSTRATION

ERG/68000 MINI-SYSTEMS

- Full IEEE 696/S100 Compatibility

HARDWARE OPTIONS

- 8MHz, 10 MHz, or 12 MHz 68000/68010 CPU
- 68451 Memory Management
- Hardware Floating Point
- Multiple Port Intelligent I/O
- 64K/128K Static RAM (70 nsec)
- 256K/512K/1MB Dynamic RAM (150 nsec)
- Graphics-Digital Graphics CAT-1600
- DMA Disk Interface
- SMD Disk Interface
- 1/4" or 1/2" Tape Backup
- 5 1/4" or 8" Floppy Disk Drives
- 5MB-474MB Hard Disk Drives
- 7/10/20 Slot Back Plane
- 20 or 30A Power Supply
- Desk Top or Rack Mount Encl.

SOFTWARE OPTIONS

- 68KFORTH¹ Systems Language
- CP/M-68K² O/S with C, 68K-BASIC¹, 68KFORTH¹, FORTRAN 77, EM80 Emulator, Whitesmiths³ C, PASCAL
- IDRIS² O/S with C, PASCAL, FORTRAN 77, 68K-BASIC¹, CIS COBOL⁴, INFORMIX⁵ Relational DBMS
- UNIX⁶ SYS V O/S with C, PASCAL, FORTRAN 77, BASIC, RM COBOL⁷, ADA⁸, INFORMIX⁵, Relational DBMS
- VED 68K Screen Editor
- Motorola's MACSBUG and FFP Package

Trademark ¹ERG, ²Digital Research, ³Whitesmiths, ⁴Micro Focus, ⁵RDS, Inc., ⁶Bell Labs, ⁷Ryan McFarland, ⁸U.S. DoD

30 Day Delivery - OEM Discounts



since 1974

Empirical Research Group, Inc.
P.O. Box 1176
Milton, WA 98354
(206) 872-7665

Listing 5: Five programs used for benchmark tests (5a). Listing 5b is the Sieve benchmark program using Print Quick from the Program menu.

(5a)

```
Source of gosubs
print time$; ' at start'
for x=1 to 5000
  gosub foo:
next x
print time$; ' when done'
end

foo: return
```

```
Source of loops
! Loops
Print "Start at ";time$
FOR I=1 TO 5000
NEXT I
PRINT "Done at ";time$
```

```
Source of divs
print time$; ' at start'
for x=1 to 5000
  y=x div 3
next x
print time$; ' when done'
```

```
Source of divides
print time$; ' at start'
for x=1 to 5000
  y=x/3
next x
print time$; ' when done'
```

```
Source of mid$
print time$; ' at start'
b$='Apple Computer Inc'
for x=1 to 5000
  a$=mid$(b$,6,7)
next x
print time$; ' when done'
print a$
end
```

(5b)

```
! Sieve
s%=8190
dim flags%(s%+1)
print "start ";time$
count%=0
for i%=0 to s%
  flags%(i%)=1
next i%
for i%=0 to s%
  if flags%(i%)=0 then goto 250
  prime%=i%+i%+3
  k%=i%+prime%
  goto 200
200 if k%>s% then goto 240
  flags%(k%)=0
  k%=k%+prime%
  goto 200
240 count%=count%+1
250 next i%
print 'done ' ;time$
print count% ; ' primes'
```

| Test | Time (seconds) |
|----------------------------------|----------------|
| Empty GOSUBs | 3.0 |
| Empty FOR/NEXT loop | 1.5 |
| Midstring search | 9.0 |
| Real divide (by 3) | 18.0 |
| Integer divide (by 3) | 3.0 |
| Eratosthenes Sieve (1899 primes) | 31.5 |

Table 3: Benchmark results.

OPEN #1: NAME ".PRINTER"
OPEN #35: NAME ".SERIAL",
ACCESS INPUT
OPEN #17: NAME ".WINDOW:
FOOBAR"

The first of the three lines above assigns channel 1 to the printer. Because printers by their nature are write-only devices, you don't need to specify the file as access output. The second line provides the serial port channel #35; its access mode is specified because serial ports are two-way. The third line addresses the Output window created by the program FOOBAR. This enables some other file either to add to the Output window or to read the window's contents.

To send and retrieve data, use the keywords PRINT and INPUT for ASCII text (display files) and WRITE and READ for binary data (internal files). Potential overwriting or "out of data" problems are handled with the

“They promised me service like I’ve never seen. I never saw it.”

Stop the shock...with Exxon office automation.

Today, more and more companies are shocked over the time it takes to service their office automation equipment.

Shockproof your office automation

With Exxon office automation, “service shock” is a thing of the past. Because we provide service for every product we sell — quickly and efficiently.

If you ever need to call the Exxon toll-free service number, a service operator will immediately determine if your problem is opera-

tional or equipment oriented. If it's operational, a service specialist will duplicate your steps on live equipment to determine the best solution. If your trouble is with the equipment itself, a service call will be arranged instantly.

Ready where you are

The Exxon service organization covers virtually every county in America. And that means it's faster and easier for us to repair your equipment right in your office.

Computerized service system

From the time you purchase your equipment from an Exxon sales branch, our computerized service management system will maintain a complete service record of all your office equipment. So even before our field engineer arrives, we can begin to diagnose your problem.

For more information

Call 800-327-6666, or write Exxon Office Systems, P.O. Box 10184, Stamford, CT 06904-2184. We'll be happy to tell you about our basic maintenance agreement and customer service system.

Service to Exxon products is provided through the Exxon Office Systems Customer Service Organization, independent sales agents, and Western Union Telegraph Company Field Service Division.



EXXON OFFICE SYSTEMS

The future...without the shock.

key phrases IF THERE and IF MISSING.

```
PRINT #7, RECORD 53, IF THERE
THEN GOSUB DONTWRITE.
OVER:: A$
```

The preceding statement sends a field of text data (A\$) to record 53 of the relative file on channel #7. If that record already exists, then program control branches to the subroutine called DONTWRITE.OVER:. The first colon after the subroutine name is required by label syntax, the second by file syntax.

The following example retrieves two fields of binary data from an internal file hooked to channel 67 and stores them in real variable NUMBER and string variable NAMES\$; if there's no data there, control branches to a program named PROTECTIT.

```
READ #67, IF MISSING THEN
CALL PROTECTIT: NUMBER,
NAMES$
```

The Macintosh provides some fairly sophisticated sound stuff, and BASIC takes advantage of it. You can control the volume, pitch, timbre, and amplitude of each of four individual tones. You can also play any note over a four-octave range. (You can play over a greater range, but really low notes sound too soft and really high ones sound too shrill for my ears.)

Set-options are system parameters that you can control. You can ASK or SET the current value of any set-option. There are set-options for nearly all parts of the language, but the most important ones have to do with graphics, windows, and text. Graphics options include the height and width of the penstroke and the pattern the penstroke produces. Window options control how much of a program's output is displayed on the desktop in pixels, how large the entire graphics area is, and what logical boundaries to associate with physical ones. Text set-options include the current position of the insertion point (the mouse's footprint), margins within which text is to appear, and the number of characters between tab stops.

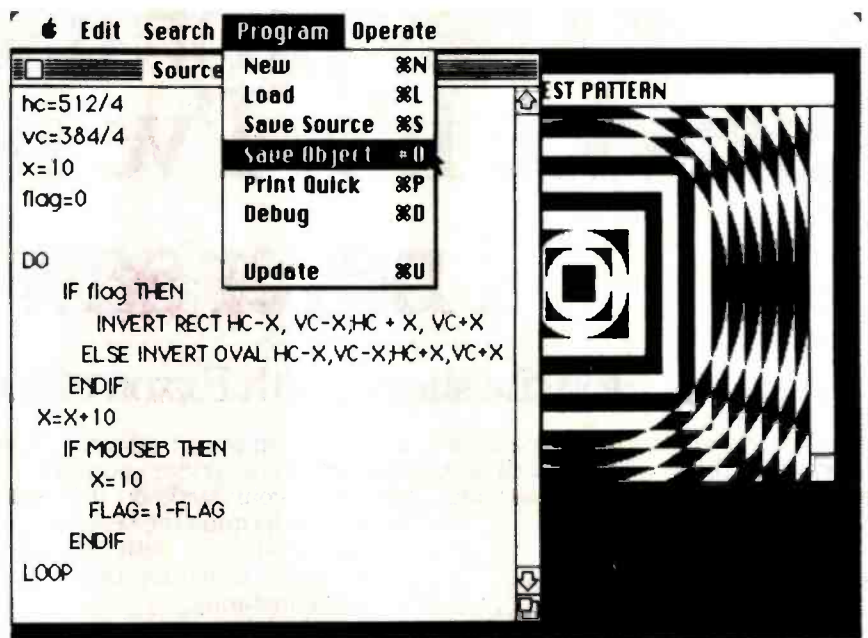

Figure 5: A program menu with Save Object selected by the mouse. This command is used to save a binary version of a program.

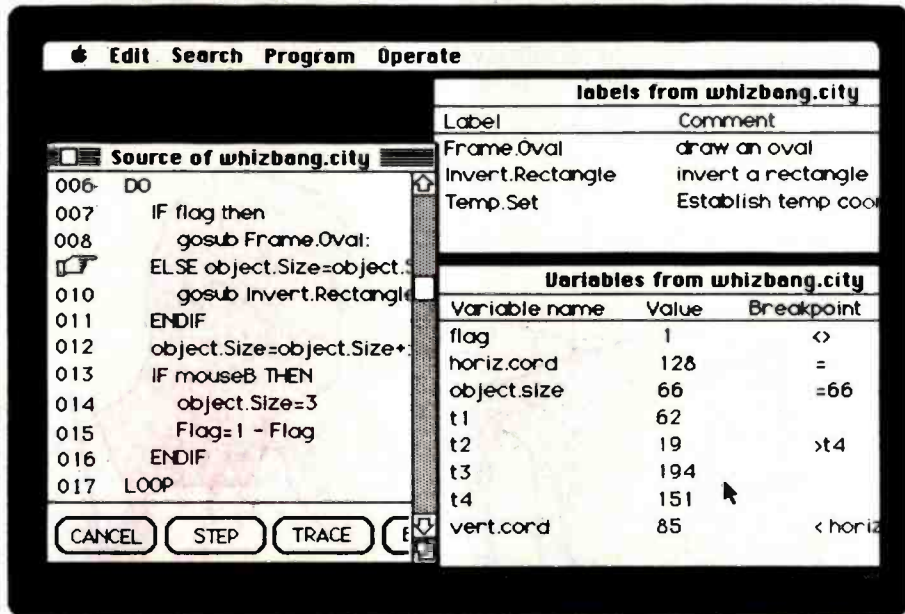

Figure 6: The Macintosh BASIC Dynamic Debugger. The windows have been "shrunk" so that the major parts of all three would show. The Debugger adds line numbers for easy reference.

Table 3 shows the results of some standard benchmark tests I ran on my Macintosh; the programs are shown in listing 5. I used the Macintosh's internal clock to do the timing; the smallest increment it reports is in full seconds. I ran each test five times; all but the Sieve were run for 5000 iterations. The results of two similar trials were sometimes different because the timing started in midsecond. ■

Macintosh BASIC will be available in the summer of 1984 at a price of \$99. The language will be known officially as Macintosh BASIC. This would seem to preclude its use on other Apple computers. Microsoft BASIC also is available for the Macintosh; the price is \$150.

Scot Kamins is senior writer for Technology Translated Inc. (1047 Sutter St., San Francisco, CA 94109), a technical writing firm.

We're "Customer Friendly"

We're Sun Software. We're new and we're ready to start treating you like a valued customer—not just a voice on the telephone.

And we're convenient, too. Just call our toll-free number to order any one of over 2000 titles and more than 90 formats. Plus we guarantee that our prices are absolutely the lowest you'll find anywhere.

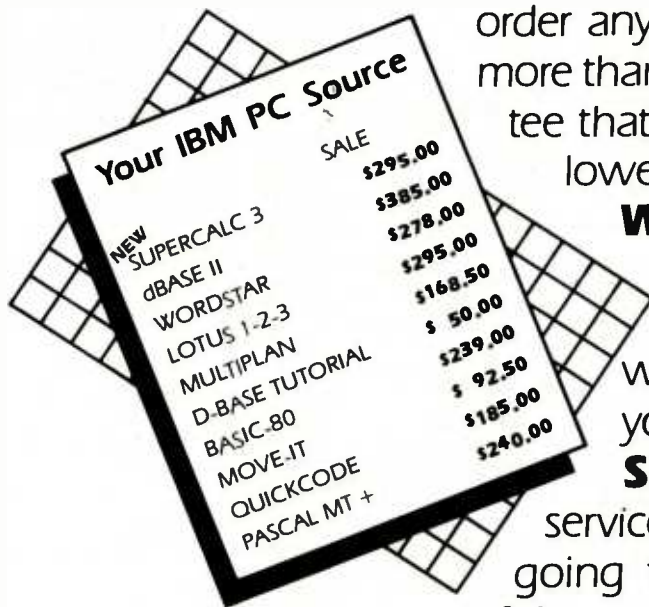

We'll take your order and get it to you in 5 days or less—virtually anywhere in the world. And if you're in the U.S., you'll never pay for shipping.

So call us to access the most in service, the best in selection. We're going to make "customer-friendly" state-of-the-art.

Call 1-800-222-7393

(In California call: 1-800-722-6284)

TELEX: 215604 PCS UR ATTN: Sunmicro

By modem: (213) 458-9209

Sun Software

1344 Fourth Street.

Santa Monica, CA 90401

TERMS: Shipping by UPS Surface, US Mail. Call for UPS Blue or next day delivery. C.O.D., Check, Master Card and Visa accepted. California residents add 6% tax. Los Angeles County residents add 6.5% tax.



**SUN
SOFTWARE™**

A division of Sunmicro Electronics, Inc.

©1983 Sunmicro Electronics, Inc.

COMPUTER MAIL ORDER

NEC PRINTERS
 NEC 2050 \$999.00
 NEC 3550 \$1679.00

PERCOM/TANOON DRIVES
 5 1/4" 320K Floppy \$229.00
 5 Meg Hard w/Controller CALL
 10 Meg Hard w/Controller CALL
 15 Meg Hard w/Controller CALL
 20 Meg Hard w/Controller CALL

AMOEK
 310A Amber Monitor \$169.00
 DXY 100 Plotter \$599.00
 Color II \$399.00

AST RESEARCH
 Six Pak Plus...from \$279.00
 Combo Plus II...from \$279.00
 Mega Plus...from \$309.00
 I/O Plus...from \$139.00

QUADRAM
 Quadlink \$479.00
 Quadboard...as low as \$289.00
 Quad 512 Plus...as low as \$249.00
 Quadcolor...as low as \$219.00
 Chronograph \$89.00
 Parallel Interface Board \$89.00
 64K RAM Chips Kit \$59.00

MICROPRO
 WordStar/MailMerge \$349.00
 InfoStar \$299.00
 SpellStar \$159.00
 CalcStar \$99.00

MICROSTUF
 Crosstalk \$105.00

MICROSOFT
 Multiplan \$159.00

ASHTON TATE
 dBASE II \$389.00
 Friday! \$185.00

IUB
 EasyWriter II \$249.00
 EasySpeller \$119.00
 EasyFiler \$229.00

CONTINENTAL SOFTWARE
 1st Class Mail/Form Letter...\$79.00
 The Home Acct. Plus \$88.00

IBM



VIBICORP IBMAPPLE

| | | |
|---------------------|--------|--------|
| VisiCalc | 159.00 | 159.00 |
| VisiCalc 4 | 159.00 | 269.00 |
| VisiCalc-Advanced | 249.00 | 269.00 |
| VisiWord/Spell | 199.00 | 199.00 |
| VisiLink | 169.00 | 169.00 |
| VisiFile | 199.00 | 169.00 |
| VisiSchedule | 199.00 | 199.00 |
| Visidex | 159.00 | 159.00 |
| VisiPlot | 135.00 | 135.00 |
| VisiTerm | 75.00 | 75.00 |
| Desktop Plan | 199.00 | 169.00 |
| Bus. Forecast Model | 75.00 | 75.00 |
| Stretch Calc | 75.00 | 75.00 |
| VisiTutor Calc | 59.00 | 59.00 |
| VisiTutor-Advanced | 75.00 | 75.00 |
| VisiTutor Word | 59.00 | 59.00 |
| Vision Calc | 249.00 | 249.00 |
| Vision Graph | 129.00 | 129.00 |
| Vision Mouse | 159.00 | 159.00 |
| Vision Host | 319.00 | 319.00 |

pfs

| | | |
|----------------------|-------|-------|
| Write: | 79.00 | 89.00 |
| Graph: | 79.00 | 89.00 |
| Report: | 79.00 | 79.00 |
| File: | 79.00 | 89.00 |
| Solutions! as low as | 16.00 | 16.00 |

*Call On Titles

LOTUS

1-2-3 \$329.00

PROFESSIONAL SOFTWARE

PC Plus/The Boss \$349.00

SYNAPSE

File Manager \$89.00

MBC-550 PC ... CALL

MBC-555 PC ... CALL
 MBC 1100 \$1499.00
 FDD 3200-320K Drive \$389.00
 MBC 1150 \$1899.00
 MBC 1200 \$1849.00
 FDD 6400-640K Drive \$489.00
 MBC 1250 \$2099.00
 PR 5500 Printer \$599.00

APPLE/FRANKLIN DISK DRIVES MICRO-BCI

A2 \$219.00
 A40 \$299.00
 A70 \$319.00
 C2 Controller \$79.00
 C47 Controller \$89.00

RANA

Elite 1 \$279.00
 Elite 2 \$389.00
 Elite 3 \$569.00

APPLE IIe STARTER PACK
 64K Apple IIe. Disk Drive & Controller.
 80 Column Card, Monitor II & DOS 3.3
COMPLETE CALL

TERMINALS

914 \$569.00
 924 \$689.00
 925 \$739.00
 950 \$929.00
 970 \$1039.00

COMPUTERS

Teleport Portable CALL
 800A \$1099.00
 802 \$2699.00
 803 \$1949.00
 802H \$4695.00
 806/20 \$4999.00
 816/40 \$9199.00
 1602 \$3399.00
 1603 CALL

MONITORS AMOEK

300 Green \$149.00
 300 Amber \$159.00
 310 Amber \$169.00
 Color 1 \$279.00
 Color 1 Plus \$299.00
 Color 2 \$399.00
 Color 2 Plus \$419.00
 Color 3 \$349.00
 Color 4 \$699.00

BMC

12" Green \$88.99
 12" Green HI-RES \$119.99
 9191-13" Color \$249.99

GORILLA

12" Green \$88.99
 12" Amber \$95.99

NEC

JB 1260 Green \$109.00
 JB 1201 Green \$149.99
 JB 1205 Amber \$159.99
 JC 1215 Color \$299.99
 JC 1216 RGB \$429.00
 JC 1460 Color RGB \$359.00

PRINCETON GRAPHICS

HX-12 RGB \$519.00

SAKATA

100 \$269.00

TAXAN

210 Color RGB \$299.00
 400 Med-Res RGB \$319.00
 415 Hi-Res RGB \$439.00
 420 Hi-Res RGB (IBM) \$489.00
 100 12" Green \$125.00
 105 12" Amber \$135.00

UBI

Pl 1, 9" Green \$99.99
 Pl 2, 12" Green \$119.99
 Pl 3, 12" Amber \$149.99
 Pl 4, 9" Amber \$139.99
 1400 Color \$269.99

QUADRAM

Quadchrome 8400 \$579.00

ZENITH

ZVM 122 Amber \$109.00
 ZVM 123 Green \$89.99
 ZVM 135 Color/RGB \$469.99

SANYO



FRANKLIN



ACE 1000 Color Computer CALL
 ACE Family Pack System CALL
 ACE PRO PLUS System CALL
 ACE 1200 Office Mgmt. System CALL
 NOT IIE EXPENSIVE

TeleVideo

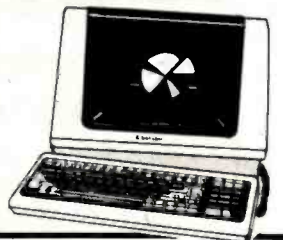

MODEMS ANCHOR

Mark I (RS-232) \$79.00
 Mark II (Atari) \$79.00
 Mark III (TI-99) \$109.00
 Mark IV (CBM/PET) \$125.00
 Mark V (Osborne) \$95.00
 Mark VI (IBM-PC) \$169.00
 Mark VII (Auto Ans/Auto Dial) \$119.00
 Mark XII (1200 Baud) \$299.00
 TRS-80 Color Computer \$99.00
 9 Volt Power Supply \$9.00

HAYES

Smartmodem 300 \$219.00
 Smartmodem 1200 \$509.00
 Smartmodem 1200B \$459.00
 Micromodem II \$265.00
 Micromodem II Plus \$299.00
 Micromodem IIE \$269.00
 Micromodem 100 \$299.00
 Smart Com II \$89.00
 Chronograph \$199.00

NOVATION

J-Cat \$99.99
 SmartCat 103 \$179.00
 SmartCat 103/212 \$399.00
 AutoCat \$219.00
 212 AutoCat \$549.00
 Apple Cat II \$249.00
 212 Apple Cat \$569.00
 Apple Cat 212 Upgrade \$309.00
 Cat \$139.99
 D-Cat \$149.00
 PC-Cat \$399.00

ZENITH

ZT-1 \$309.00
 ZT-10 \$339.00
 ZT-11 \$369.00

APPLE INTERFACE CARDS & BUFFERS

Choose from PKASO, Orange Micro, MPC, MicroMax, Tymac, Quadram & Practical Peripherals CALL

= WEST = = CANADA = = EAST =

800-648-3311 800-268-4559 800-233-8950

In NV call (702) 588-5654 Dept. 0401
 Order Status Number 588-5654
 P.O. Box 6689 Stateline NV 89449

In Toronto call (416) 828-0866 Dept. 0401
 Order Status Number 828-0866
 2505 Dunwin Drive Unit 1B
 Mississauga Ontario Canada L5L1T1

In PA call (717) 327-9575 Dept. 0401
 Order Status Number 327-9575
 Customer Service Number 327-1450
 477 E Third St. Williamsport PA 17701

No risk, no deposit on C.O.D. orders. Pre-paid orders receive free shipping within the UPS Continental United States with no waiting period for certified checks or money orders. Add 3% (minimum \$5.00) shipping and handling on all C.O.D. and credit card orders. Larger shipments may require additional charges. NV and PA residents add sales tax. All items subject to availability and price change. We stock manufacturer's and third party software for most all computers on the market. Call today for our new catalog.

COMPUTER MAIL ORDER



Koala
Technologies Corporation

KOALA PADS

| | |
|-------------------|---------|
| Atari (Disk)..... | \$75.00 |
| Atari (ROM)..... | \$82.00 |
| C-64 (DISK)..... | \$75.00 |
| C-64 (ROM)..... | \$82.00 |
| IBM..... | \$99.00 |
| AP/Franklin..... | \$85.00 |



**HOME
COMPUTERS**

Commodore

CBM 8023... \$599

| | |
|---------------------------|-----------|
| MSD SD1 Disk Drive..... | \$349.00 |
| MSD SD2 Disk Drive..... | \$599.00 |
| CBM 4032..... | \$599.00 |
| CBM 8096..... | \$869.00 |
| CBM 9000..... | \$999.00 |
| B128-80..... | \$769.00 |
| CBM 64K Memory Board..... | \$269.00 |
| 8032 to 9000 Upgrade..... | \$269.00 |
| 2031LP Disk Drive..... | \$299.00 |
| 8050 Disk Drive..... | \$949.00 |
| 8250 Disk Drive..... | \$1199.00 |
| 4023 Printer..... | \$379.00 |
| 8023 Printer..... | \$569.00 |
| 6400 Printer..... | \$1399.00 |
| Z-RAM..... | \$499.00 |
| Silicon Office..... | \$699.00 |
| The Manager..... | \$199.00 |
| Soft ROM..... | \$125.00 |
| VisiCalc..... | \$159.00 |

**PROFESSIONAL
SOFTWARE**

| | |
|---------------------------------|----------|
| Word Pro 2 Plus..... | \$159.00 |
| Word Pro 3 Plus..... | \$189.00 |
| Word Pro 4 Plus/5 Plus.....each | \$279.00 |
| InfoPro..... | \$179.00 |
| Administrator..... | \$399.00 |
| Power..... | \$79.00 |

We stock a full inventory of software for Commodore, such as: Artworx, Broderbund, Commercial Data, Creative Software, Epyx, HES, MicroSpec, Nufekop, Romox, Sirius, Synapse, Thorn EMI, Tronix, UMI, Victory, Spinnaker, Rainbow & Timeworks!

**ATARI SOFT
Games for IBM, Apple, C64 & VIC 20**

| | IBM/Apple | C64/VIC 20 |
|-------------|-----------|------------|
| Pac Man | 29.99 | 37.99 |
| Centipede | 29.99 | 37.99 |
| Dig Dug | 29.99 | 37.99 |
| Donkey Kong | 29.99 | 37.99 |
| Defender | 29.99 | 37.99 |
| Robotron | 29.99 | 37.99 |
| Star Gate | 29.99 | 37.99 |

CMO'S PORTABLE CORNER

HP 71B
\$499.99

PC-8201
\$599

41 CV..... \$129.99

41 CX..... \$199.99

| | |
|-------------------------------|----------|
| HP 10C..... | \$51.99 |
| HP 11C..... | \$69.99 |
| HP 12C..... | \$88.99 |
| HP 15C..... | \$88.99 |
| HP 16C..... | \$88.99 |
| HP 75C..... | \$749.99 |
| HPIL Module..... | \$98.99 |
| HPIL Cass. or Printer..... | \$359.99 |
| Card Reader..... | \$143.99 |
| Extended Function Module..... | \$63.99 |
| Time Module..... | \$63.99 |

NEC

| | |
|---------------------------------|----------|
| PC-8221A Thermal Printer..... | \$149.00 |
| PC-8281A Data Recorder..... | \$99.00 |
| PC-8201-06 8K RAM Chips..... | \$105.00 |
| PC-8206A 32K RAM Cartridge..... | \$329.00 |



PC-1500A... \$165.99

PC-1250A... \$88.99

| | |
|------------------------------------|----------|
| CE 125 Printer/Cassette..... | \$128.99 |
| CE-150 Color Printer/Cassette..... | \$171.99 |
| CE-155 8K RAM..... | \$93.99 |
| CE 161 16K RAM..... | \$134.99 |
| CE 500 ROM Library..... | \$29.99 |

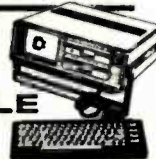

**SX-64
PORTABLE
\$839.00**

VIC 20 CALL

CBM 64 \$199

| | |
|----------------------------------|----------|
| C1541 Disk Drive..... | \$249.00 |
| C1530 Datasette..... | \$69.00 |
| C1520 Color Printer/Plotter..... | \$129.00 |
| M-801 Dot Matrix Printer..... | \$219.00 |
| C1526 Dot Matrix/Serial..... | \$299.00 |
| C1702 Color Monitor..... | \$249.00 |
| C1311 Joystick..... | \$4.99 |
| C1312 Paddies..... | \$11.99 |
| C1600 VIC Modem..... | \$59.00 |
| C1650 Auto Modem..... | \$89.00 |
| Logo 64..... | \$49.00 |
| Pilot 64..... | \$39.00 |
| Simon's Basic..... | \$19.00 |
| Word Pro 64 Plus..... | \$59.00 |
| Parallel Printer Interface..... | \$49.00 |
| Calc Result 64..... | \$129.00 |
| Codewriter 64..... | \$75.00 |
| Quick Brown Fox..... | \$49.00 |
| Word Pro 64 Plus..... | \$59.00 |
| MCS 801 Color Printer..... | \$499.00 |
| DPS 1101 Daisy Printer..... | \$459.00 |
| Magic Voice Speech Module..... | \$54.00 |
| Desk Organizer Lock..... | \$49.00 |

**600XL
\$99**

With Purchase of
1010 Program Recorder,
E.T. Phone Home &
C1311 Joysticks
**TOTAL SYSTEM
PRICE \$259**

| | |
|--------------------------------|----------|
| 1010 Recorder..... | \$74.00 |
| 1020 Color Printer..... | \$249.00 |
| 1025 Dot Matrix Printer..... | \$339.00 |
| 1027 Letter Quality..... | \$309.00 |
| 1030 Direct Connect Modem..... | \$119.00 |
| 1050 Disk Drive..... | \$339.00 |
| CX30 Paddle..... | \$12.00 |
| CX40 Joystick..... each | \$8.00 |
| CX77 Touch Tablet..... | \$64.00 |
| CX80 Trak Ball..... | \$48.00 |
| CX85 Keypad..... | \$105.00 |
| 488 Communicator II..... | \$229.00 |
| 4003 Assorted Education..... | \$47.00 |
| 4011 Star Raiders..... | \$33.00 |
| 4012 Missile Command..... | \$29.00 |
| 4013 Asteroids..... | \$29.00 |
| 5049 VisiCalc..... | \$159.00 |
| 7097 Logo..... | \$79.00 |
| 7101 Entertainer..... | \$69.00 |
| 7102 Arcade Champ..... | \$75.00 |
| 8026 Dig Dug..... | \$33.00 |
| 8030 E.T. Phone Home..... | \$33.00 |
| 8031 Donkey Kong..... | \$39.00 |
| 8033 Robotron..... | \$35.00 |
| 8034 Pole Position..... | \$39.00 |
| 8036 Atari Writer..... | \$79.00 |
| 8040 Donkey Kong, Jr..... | \$39.00 |
| 8043 Ms. PacMan..... | \$39.00 |
| 8044 Joust..... | \$39.00 |

**DISKETTES
MAXELL**

| | |
|----------------------|---------|
| 5 1/4" MD-1..... | \$29.00 |
| 5 1/4" MD-2..... | \$39.00 |
| 8" FD-1 (SS/DD)..... | \$39.00 |
| 8" FD-2 (DS/DD)..... | \$49.00 |

VERBATIM

| | |
|-------------------|---------|
| 5 1/4" SS/DD..... | \$26.99 |
| 5 1/4" DS/DD..... | \$36.99 |

ELEPHANT

| | |
|-------------------|---------|
| 5 1/4" SS/SD..... | \$18.49 |
| 5 1/4" SS/DD..... | \$22.99 |
| 5 1/4" DS/DD..... | \$28.99 |

HEAD

| | |
|-------------------------------|---------|
| 5 1/4" Disk Head Cleaner..... | \$14.99 |
|-------------------------------|---------|

**DISK HOLDERS
INNOVATIVE CONCEPTS**

| | |
|------------------------------------|---------|
| Flip-n-File 10..... | \$3.99 |
| Flip-n-File 50..... | \$17.99 |
| Flip-n-File(400/800ROM)Holder..... | \$17.99 |

LJK ENTERPRISES

| | |
|---------------------------------------|---------|
| Atari Letter Perfect-Disk(40/80)..... | \$79.99 |
| Atari Letter Perfect-ROM(40 col)..... | \$79.99 |
| Atari Letter Perfect-ROM(80 col)..... | \$79.99 |
| Atari Data Perfect-ROM(80 col)..... | \$79.99 |
| Atari Spell Perfect-DISK..... | \$59.99 |
| Atari Utility/MailMergé..... | \$21.00 |
| Apple Letter Perfect..... | \$99.00 |
| Apple Data Perfect..... | \$75.00 |
| Apple LJK Utility..... | \$21.00 |
| Apple Lower Case Generator..... | \$19.00 |



600XL..... \$189
800XL..... \$299
1200XL CALL
1400XL CALL



| | |
|-----------------|----------|
| AT 88-S1..... | \$369.00 |
| AT 88-A1..... | \$259.00 |
| AT 88-S1PD..... | \$449.00 |
| AT 88-DDA..... | \$119.00 |
| RFD 40-S1..... | \$449.00 |
| RFD 40-A1..... | \$269.00 |
| RFD 40-S2..... | \$699.00 |
| RFD 44-S1..... | \$539.00 |
| RFD 44-S2..... | \$869.00 |

TEXAS INSTRUMENTS

| | |
|---------------|----------|
| TX 99-S1..... | \$279.00 |
|---------------|----------|

RANA

| | |
|-----------|----------|
| 1000..... | \$329.00 |
|-----------|----------|

TRAK

| | |
|------------|----------|
| AT-D2..... | \$389.00 |
|------------|----------|

INDUS

| | |
|---------------|----------|
| GT-Drive..... | \$379.00 |
|---------------|----------|

MEMORY BOARDS

| | |
|----------------------------|----------|
| Axlon 32K..... | \$59.00 |
| Axlon 48K..... | \$99.00 |
| Axlon 128K..... | \$299.00 |
| Intec 32K..... | \$59.00 |
| Intec 48K..... | \$85.00 |
| Intec 64K..... | \$99.00 |
| Intec Real Time Clock..... | \$29.00 |

ALIEN VOICE BOX

| | |
|------------|----------|
| Atari..... | \$119.00 |
| Apple..... | \$149.00 |

**CONTROLLERS &
JOYSTICKS
WICO**

| | |
|--------------------------|---------|
| Joystick..... | \$21.99 |
| 3-way Joystick..... | \$22.99 |
| Famous Red Ball..... | \$23.99 |
| Power Grip..... | \$21.99 |
| BOSS Joystick..... | \$17.99 |
| ATARI VIC Trak Ball..... | \$34.99 |
| Apple Trak Ball..... | \$54.99 |
| Apple Adapter..... | \$15.99 |
| Apple Analog..... | \$37.99 |

KRAFT

| | |
|--------------------------|---------|
| Joystick..... | \$41.99 |
| Atari Single Fire..... | \$12.99 |
| Atari Switch Hitter..... | \$15.99 |
| Apple Paddies..... | \$34.99 |
| IBM Paddies..... | \$34.99 |
| IBM Joystick..... | \$46.99 |

AMIGA

| | |
|------------------|---------|
| 3100 Single..... | \$13.99 |
| 3101 Pair..... | \$19.99 |
| Joyboard..... | \$37.99 |

TG

| | |
|----------------------|---------|
| Atari Trak Ball..... | \$47.99 |
| Apple Joystick..... | \$47.99 |
| Apple Trak Ball..... | \$47.99 |

= WEST = = CANADA = = EAST =
800.648.3311 800.268.4559 800.233.8950

In NV call 17021588 5654 Dept 0401
Order Status Number 588 5654
P O Box 6689 StateLine NV 89449

In Toronto call 4161828-0866 Dept 0401
Order Status Number 828 0866
2505 Dunwin Drive Unit 1B
Mississauga Ontario Canada L5L1T1

In PA call 7171327 9575 Dept 0401
Order Status Number 327 9576
Customer Service Number 327 1450
477 E Third St Williamsport PA 17701

CANADIAN ORDERS All prices are subject to shipping, tax and currency fluctuations. Call for exact pricing in Canada
INTERNATIONAL ORDERS All shipments outside the Continental United States must pre-pay by certified check only. Include 3 (minimum \$5.00) shipping and handling
EDUCATIONAL DISCOUNTS Additional discounts are available to qualified Educational Institutions
APO & FPO Add 3 (minimum \$5.00) shipping and handling

Circle 88 on inquiry card.

Professional BASIC

Providing support for the 8087 coprocessor, and an array of debugging aids, this programming system makes BASIC a serious 16-bit tool

Donald P. George

Transamerica Occidental Life

Professional BASIC is a new version of the familiar BASIC language and was released initially for the IBM Personal Computer (PC) and PC compatibles. In terms of the language's features, Professional BASIC can be viewed as an extension of PC BASIC. By default, the product is also an extension of GW BASIC, the advanced version of the language Microsoft markets to the remainder of the world.

Morgan Computing Company, the publisher of Professional BASIC, has developed a product that extends the language in several unusual directions. The result is a program with outstanding, if not unique, educational qualities. Professional BASIC has the potential to favorably affect the process of learning the BASIC language and learning programming in general. Additionally, these same facilities serve as a nearly ideal environment for the debugging of non-trivial program code.

Morgan's product supports, in an unprecedented way, the visualization of program execution. It is not always true that a picture is worth a thousand words, but in learning to program, the adage is not only valid but conservative. Professional BASIC provides the pictures (in this case, windows) in ways that make understanding of the programming process, and the debugging of that process when it goes awry, clearer and much less confusing.

My intent in this article is to brief-

ly explain the capabilities of Professional BASIC and throw in a few comments, positive and negative, along the way.

IBM PC BASIC Extended

Dr. Neil Bennett, the author of Professional BASIC, designed the language as a logical superset of PC BASIC. Almost all of the features included in IBM's (or Microsoft's) offering are included in this product. Most programs (Morgan says 95 percent plus) written in PC BASIC should run under Professional BASIC without change. The reverse is also true. However, Professional BASIC programs running under PC or GW BASIC would forgo many powerful and useful coding extensions.

Professional BASIC's extensions can be classified into several areas:

- improved program environment support
- new immediate commands
- visualization and debugging screens

The Improved Program Environment

Morgan has added much to the traditional BASIC environment. The language can use all of the memory available in your machine. For the IBM PC, this can amount to 640K bytes (if expansion boards are used). Compared with the 64K-byte limit almost universal for the language,

this expanded memory is a welcome improvement.

Professional BASIC can use the Intel 8087 arithmetic coprocessor. This device is specifically designed for floating-point math operations, and its use speeds up program execution for those programs heavily involved with mathematical computations.

The product provides the ability to reference labels as well as statement numbers for all branching operators. For example, the following code is perfectly valid Professional BASIC syntax:

```
100 PROGRAM.MAINLINE.  
    ROUTINE;  
200 GOSUB INT.PGM.FOR.EXEC  
300 GOSUB LOAD.REFERENCE.  
    TABLE  
400 GOTO STANDARD.EXIT.  
    ROUTINE
```

Note the long variable and subroutine names. In Professional BASIC, data names and labels have no practical length limit. The language supports names up to 320 characters long.

Professional BASIC is incrementally compiled; most implementations of BASIC are interpreted. Briefly, the difference is that, with an interpreter, each instruction of a program is converted into the equivalent machine instructions each time the BASIC instruction is executed. If you loop through a section of BASIC code 100 times, *each* one of those BASIC in-

Professional BASIC

structions is converted into machine code and executed 100 times.

The Professional BASIC incremental compiler passes the entire BASIC program through a line-by-line conversion process that produces an intermediate-level language. Morgan refers to this intermediate-level code as "microcode" or "pseudo code," but it more accurately resembles the p-code produced by many Pascal systems. This conversion process has some immediate advantages and one disadvantage. The advantages are increased speed of program execution (three to four times faster than PC BASIC) and checking of syntax and control errors as each line of source is entered so that syntax errors never halt program execution once it begins.

The disadvantage is the time it takes the compiler to make its second pass, just prior to program execution. My experience with the product is that this time frame is short enough not to be of concern: it's literally a few seconds for most programs.

Beep Beep

Another unusual feature of this product is a function called *dynamic syntax checking*. Professional BASIC constantly checks each character as you enter program code, and the system beeps when an invalid combination is entered. The system beeps again if the next keystroke is invalid. At the second unacceptable keystroke, the system dynamically gen-

erates a list of all the characters that are valid at this point in the syntax of the statement you are entering. (See figure 1 for an example of this display.)

An old computer adage says that the best way to correct an error is to not allow it in the first place. Morgan has built this fundamental design concept into the language.

New Commands at Command Level

Professional BASIC has several useful commands that can be entered when the program is in command level. The user can set breakpoints in a BASIC program by simply entering a line number or label name. When control passes to that statement, execution automatically suspends.

Another useful feature is the FIND command. If you enter a command like FIND TOTAL.CNT, Professional BASIC lists every line in the program that references TOTAL.CNT. To get a list of only those lines that assign TOTAL.CNT a value, use the Professional BASIC command FIND TOTAL.CNT=.

The FINETRACE facility, another unusual and useful feature, is available in both command and execution modes. If you have a complicated mathematical expression and need to see just how the expression is being evaluated, FINETRACE displays each intermediate value as the program

goes from initial function to the final numeric result. (See figure 2 for an example.)

Windows: The Big Difference

The normal way to begin a program with the Professional BASIC system is to enter the RUN command. Now you can perform your first bit of magic. Just press L and you are in List Trace mode. The display clears and a screen full of your program code appears. A reverse video shades the instruction currently being executed. This bar dances around like crazy as it briefly highlights each executing instruction. Suddenly, loops are not an abstract concept anymore; they are a discernible pattern on the screen (see figure 3).

To stop all this kinetic motion, press the space bar and the tableau freezes. Every additional press of the

```
10 TOTAL = FIELD1 F
TRY {AEIMOXaeimox^*/{+==:' .}
```

Figure 1: The system emits a beep when an invalid keystroke is entered. The second consecutive invalid character forces a display like the one above. In this example, the F is invalid in the assignment statement.

space bar advances the program one instruction. Hold down the space bar and the action moves along at a steady pace. Press the Enter key and full-speed execution resumes.

To see what is taking place on the normal display screen, press P. Instantly, the screen is blanked and then replaced with the normal video display your program presents. Press L and you are back in List Trace mode again.

Pressing T activates the Chronological Trace window. This trace displays each line of the program as it is being executed and the values of any variables in that line of code. Just to make things more interesting, this trace can be run backward. Actually, the program doesn't run backward—previous trace values (which were saved) are simply displayed in reverse order—but the effect is the same. (See the right side of figure 5 for an example.)

The Array window lets the numeric keys serve as special scrolling keys.

But what about all the other variables in my program? you might be wondering; can I see them all as well? The answer, with Professional BASIC, is yes. By entering V, you can display the Variable window. This display shows every nonarray variable name in the program along with its data type and current value. The values change as the program executes, but a press of the space bar freezes the action.

As is the case with all the windows supported by Professional BASIC, the arrows and paging keys can be used to position the display for lengthy lists that won't fit on one video screen. (See figure 4 for an example of a Variable screen.)

The values of all array variables can be viewed with the Array window (A). This particular window lets the numeric keys serve as special scrolling keys that can scroll up to 10,000 lines with a single keystroke.

Professional BASIC provides windows to monitor WHILE and FOR/NEXT control structures, to display the nesting of GOSUBs, and to show

```
10 DEFINT A-Z
20 N = 0
30 ALPHA = 648
40 BETA = N * ALPHA / (N*4 - ALPHA*7)
50 N = N+ 1
60 ALPHA = ALPHA - 2
70 GOTO 40
RUN
```

```
In the line with the sequence number 40,
Integer Divide Error, 36288 / 0
Press Return for a slow motion replay
BETA=N*ALPHA/(N*4-ALPHA*7)
BETA=N*ALPHA/(252*4-ALPHA*7)
BETA=N*ALPHA/(1008-ALPHA*7)
BETA=N*ALPHA/(1008-144*7)
BETA=N*ALPHA/(1008-1008)
BETA=N*ALPHA/(0)
BETA=252*ALPHA/0
BETA=252*144/0
BETA=36288/0
Integer Divide Error, 36288 / 0
```

Figure 2: Professional BASIC traps certain processing errors such as division by 0. For this kind of error, the FINETRACE facility automatically engages to help resolve the problem.

```
50          1 070          x s          1 step f 0 g 0 1 1 v 0
10 'SIMPLE EXAMPLE LOOP PGM
20 'AUTHOR == DP GEORGE
30 '12/17/83
40 LOOP.CNT = 1
   MONTH   = 12
   YEAR    = 1983
50 LOOP.POINT;
60 IF LOOP.CNT = 20 THEN
   GOTO TERMINATION.ROUTINE
70 PRINT "LINE NUMBER";LOOP.CNT;
80 DAY = LOOP.CNT
90 DATE.FACTOR = DAY/365+MONTH/12+YEAR
100 PRINT DATE.FACTOR
110 LOOP.CNT = LOOP.CNT + 1
120 GOTO LOOP.POINT
130 TERMINATION.ROUTINE;
140 CLS
150 PRINT "PROGRAM TERMINATING"
160 END
```

Figure 3: An example of a List Trace window for a small representative program. The first line on the display is a status line that shows the current instruction number, the speed of execution (Morgan calls this a speedometer), the number of active FOR/NEXT and GOSUB statements, and several other data items. The current instruction is shown highlighted.

```
160          1 000          x s          1 step f 0 g 0 1 1 v 0
   sng DATE.FACTOR          1984.052
   sng DAY          19
   sng LOOP.CNT          20
   sng MONTH          12
   sng YEAR          1983
   int 2.LOCAL.COMBINED.SAVE.AREA.AND.CHECK.SW          99
6 / 6
```

Figure 4: An example of the Variable window display. The code sng stands for a single precision variable, and int stands for an integer variable.

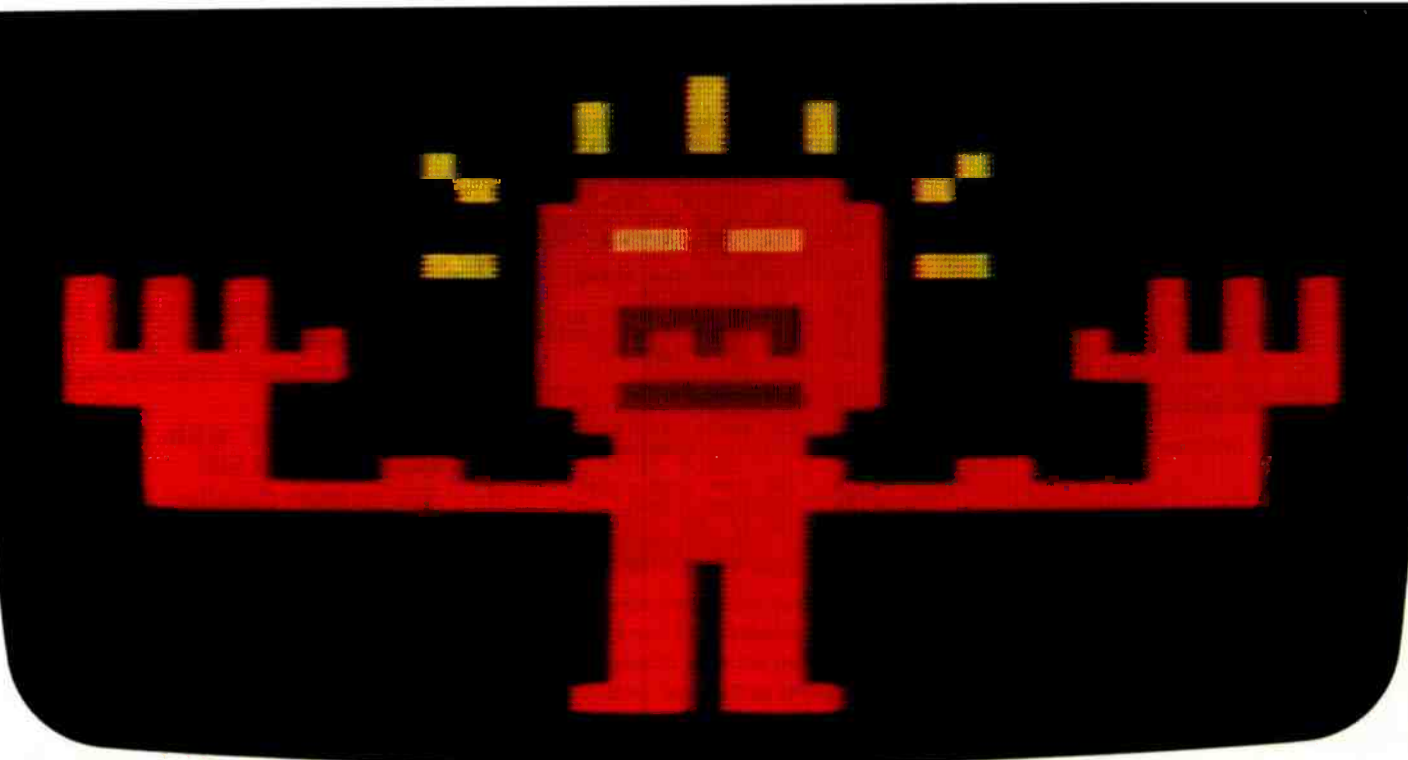

WOULD YOU SHELL OUT \$1000 TO MATCH WITS WITH THIS?

SUSPENDED™, The WITNESS™, PLANETFALL™, ENCHANTER™, and INFIDEL™—

Meet your match. Meet Infocom games: perhaps the best reason in software for owning a personal computer.

In fact, people have been known to purchase computers and disk drives solely for the purpose of playing our games. And they haven't been disappointed. Because Infocom's prose stimulates your imagination to a degree nothing else in software approaches. Instead of putting funny little creatures on your screen, we put you inside our stories. And we confront you with startlingly realistic environments alive with situations, personalities, and logical puzzles the like of which you won't find elsewhere. The secret? We've found the way to plug our prose right into your imagination, and catapult you into a whole new dimension.

If you think such an extraordinary experience is worth having, you're not alone. Everything we've ever written—ZORK® I, II, and III, DEADLINE™, STARCROSS™,

has become an instant best-seller. For the simple reason that Infocom offers you something as rare and valuable as anything in software—real entertainment.

At last, you can fritter away your evenings playing a computer game without feeling like you're frittering away your computer investment.

Step up to Infocom. All words. No pictures. The secret reaches of your mind are beckoning. A whole new dimension is in there waiting for you.

(For more information on Infocom games contact: Infocom, Inc., P.O. Box 855, Garden City, NY 11530.)

INFOCOM™

The next dimension.

For you: Apple II, Atari, Commodore 64, CP/M 8, DEC Rainbow, DEC RT-11, IBM, MS-DOS 2.0, NEC APC, NEC PC-8000, Osborne, TI Professional, TI 99/4A, TRS-80 Model I, TRS-80 Model III.



```

130          162 000          x s . lt step f 0 g 0 1 1 vP0
10 'SIMPLE EXAMPLE LOOP PGM          145 70 PRINT "LINE NUMBER";
20 'AUTHOR == DP GEORGE          146 80 DAY = LOOP.CNT
30 '12/17/83
40 LOOP.CNT = 1          147 90 DATE.FACTOR = DAY/36
   MONTH = 12
   YEAR = 1983          148 100 PRINT DATE.FACTOR
50 LOOP.POINT;          149 110 LOOP.CNT=LOOP.CNT = 1
60 IF LOOP.CNT = 20 THEN
   GOTO TERMINATION.ROUTINE          150 120 GOTO LOOP.POINT
70 PRINT "LINE NUMBER";LOOP.CNT;          151 50 LOOP.POINT;
80 DAY = LOOP.CNT          152 60 IF LOOP.CNT = 20 TH
90 DATE.FACTOR = DAY/365+MONTH/12+YEAR          153 70 PRINT "LINE NUMBER";
100 PRINT DATE.FACTOR          154 80 DAY = LOOP.CNT
110 LOOP.CNT = LOOP.CNT = 1
120 GOTO LOOP.POINT          155 90 DATE.FACTOR = DAY/36
130 TERMINATION.ROUTINE;          156 DATE.F 1984.052
140 CLS          157 100 PRINT DATE.FACTOR
150 PRINT "PROGRAM TERMINATING"          110 LOOP.CNT=LOOP.CNT = 1
160 END          158 LOOP.C 20
          158 120 GOTO LOOP.POINT
          159 50 LOOP.POINT;
          160 60 IF LOOP.CNT = 20 TH
          161 GOTO TERMINATION.ROU
          162 130 TERMINATION.ROUTINE;

```

Figure 5: An example of a split-screen display. The left side of the display contains a List Trace window, and the right shows a Chronological Trace window. The current instruction is highlighted in both windows. The numbers 145-162 on the right correspond to the number of instructions executed so far in the program; they serve as a unique "serial number" for each line of the trace.

the text of the microcode as it is being executed. With all this valuable information in separate windows, you will often need to be in two or more places at once.

All software has its limits. Profes-

sional BASIC supports simultaneously two windows only (split virtually down the center of the display screen). Considering the amount of data to be displayed and the constraint of an 80-character line, two

windows on the screen at once is a practical limit. To split the screen, you press S. By default the second display brought up is the Variable window. You can change it to any other display by entering the code for the next desired window. Figure 5 shows a split-screen display with a List Trace window and a Chronological Trace window displayed simultaneously.

Learning BASIC with Professional BASIC

The facilities described previously should tempt the experienced programmer. The value of the various windows in debugging is fairly obvious. The inevitable result will be the production of code that, if not error-free, contains fewer errors than would otherwise have been the case. And the code will be produced much more quickly, with a great deal less aggravation and frustration.

The role of Professional BASIC in the learning environment is equally (if not more) valuable. The appreciation felt by the experienced user for the inner workings of such BASIC

WAIT NOT, WANT NOT!

If you've been waiting for a disk emulator that can increase your system's throughput by as much as 50 times, the wait is over. **QUASI-DISK** is here!

QUASI-DISK is a high capacity, I/O mapped RAM board which acts like an additional disk drive on any S-100 system.

Here's what makes **QUASI-DISK** a better buy than the others:

- Fully S-100/696 compatible.
- **QUASI-DISK** offers 2 modes of expansion:
 - a) Chip capacity may be doubled with the addition of an add-on module.
 - b) Storage capacity may be increased to 4 Megabytes by replacing 64K RAMs with 256K devices.
- DMA compatible with transfer rates to 2 Megabytes/second.
- On board powerfail logic write protects disk during power failures.
- Optional battery back-up provides 2 hours of powerfail protection.
- External wall mount power supply allows system power to be switched off while data is retained indefinitely.
- Six layer printed circuit board improves performance and reliability.



GUARANTEE

Unique design guarantees that **QUASI-DISK** will perform as advertised, in standard as well as non-standard S-100 systems. **OR YOUR MONEY BACK**

Manufactured by:

Electra™ **logics**

— Incorporated —

- Requires only 6 I/O addresses to access entire board.
- Supports extended I/O addressing when enabled.
- On board 22 bit address generator may be programmed for auto increment or decrement if desired.
- Any sector size may be implemented.

- Onboard LED's indicate "drive active" and "powerfail status".
- Price includes installation software on 8" SS/SD diskette with all source code supplied.
- Sample CP/M* Bios routines are included for integration into any CP/M* system.
- **QUASI-DISK** is covered by a 1 year warranty and an extended warranty option is also available.

QUASI-DISK (512K)—\$895.00
Expansion Module
(additional 512K)—\$695.00
Back-up Battery (Including
wall mounting supply)—
\$195.00

*CP/M is a registered trademark of Digital Research.

TIME SAVED IS MONEY
WELL SPENT

Dot Matrix

| ANADEX | |
|--------------|-----------|
| 9500B | \$1119.88 |
| 9501B | \$1119.88 |
| 9620B | \$1209.88 |
| 9625B | \$1309.88 |
| WP-6000 | \$2359.88 |
| WP-6500 | \$2599.88 |
| WP-6000/6500 | |
| Tractor | \$139.88 |

| C. ITOH | |
|------------------------|----------|
| Prowriter | \$379.88 |
| w/RS-232 | \$499.88 |
| Prowriter 2 | \$609.88 |
| w/RS-232 | \$679.88 |
| Prowriter BPI (IBM-PC) | \$479.88 |
| Prowriter SP (80 col.) | \$519.88 |
| w/RS-232 | \$539.88 |

| EPSON | |
|--------------|-------|
| RX/FX Series | SCALL |

| IDS/DATAPRODUCTS | |
|------------------|-----------|
| P-480 | \$439.88 |
| Prism 132 | \$1489.88 |
| w/4-color | \$1699.88 |

INFORUNNER



| | |
|---------|----------|
| Riteman | \$339.88 |
|---------|----------|

| MEMOTECH | |
|----------|----------|
| DMX-80 | \$339.88 |

MANNESMANN TALLY



| | |
|-----------|----------|
| MT-160 L | \$629.88 |
| MT-180 L | \$879.88 |
| MT-Spirit | \$329.88 |

| QUADRAM | |
|---------|-------|
| QuadJet | SCALL |

STAR MICRONICS

| | |
|------------|----------|
| Gemini 10X | \$299.88 |
| Gemini 15X | \$429.88 |
| Delta 10 | \$499.88 |
| Delta 15 | \$589.88 |
| Radix 10 | \$629.88 |
| Radix 15 | \$679.88 |

| TOSHIBA | |
|----------------|-----------|
| P-1350 | \$1739.88 |
| P-1350 Tractor | \$169.88 |

Letter Quality

C. ITOH



| | |
|-----------------------------------|-----------|
| A-10 Starwriter | \$599.88 |
| F-10 Starwriter | \$1119.88 |
| F-10 Printmaster | \$1489.88 |
| Tractor Feed | \$219.88 |
| Single Bin Sheet Feeder (A10/F10) | \$599.88 |

DIABLO

| | |
|----------------|-----------|
| 620 (RS-232C) | \$939.88 |
| 620 Tractor | \$189.88 |
| 630 (Parallel) | \$2019.88 |
| 630 (RS-232C) | \$2019.88 |
| 630 (PC) | \$2019.88 |

OKIDATA

Microline Family

The Okidata *Microline* family offers IBM-PC users a wide range of features for almost any application. All *Microline* printers are made with the same rugged materials and care. No matter which printer you select, you've chosen one of the best printers made.

The *Microline 92* (160 cps) is ideal for word processing. It features 10, 12 & 17 cpi, a correspondence font, double-width, emphasis/boldface, sub/super scripts, underlining, pin/friction feed (tractor is optional on the 92) & dot-addressable graphics (120 x 144 dpi). The 93 is the 136 column version. Parallel interfaces are standard; the RS-232C interface is optional.

The *Microline 84* (132 col) is the Step 2 version, featuring 200 cps at 10, 12, & 17 cpi (w/double-width), all with a correspondence mode & dot addressable graphics. Parallel or RS-232C interfaces available.

A new PROM called PC Plug-n-Play turns a 92, 93 or an 84 into an IBM-PC compatible printer, with full capabilities. You will sacrifice a few features (like 12 cpi) but the PROMs are worth it if total compatibility is your goal.

The *Microline 84* (120 cps) is a data cruncher. Features 10 & 16 cpi (5/8 double-width). Dot-addressable graphics are optional. The 83A is the 136 column version.

The Okidata *Microline* Series.....SCALL 800-343-0726 FOR PRICES

| | |
|--------------------|-----------|
| 630 ECS (PC) | \$2359.88 |
| 630 Tractor | \$209.88 |
| 620/630 Sheet Feed | \$599.88 |

| NEC | |
|-----------------------------------|-----------|
| 2010/2030 | \$899.88 |
| 2050 | \$1039.88 |
| 3510 | \$1549.88 |
| 3530 | \$1699.88 |
| 3550 | \$1859.88 |
| 2000/3500 Tractor | \$239.88 |
| 2000/3500 Single-bin Sheet Feeder | \$479.88 |
| 7710/7730 | \$2199.88 |
| 7700 Tractor | \$379.88 |
| 7700 Sheet Feed | \$599.88 |

| QUME | |
|-------------------|-----------|
| Sprint 11/40 | \$1559.88 |
| Sprint 11/55 | \$1769.88 |
| Tractor Feed | \$219.88 |
| Sheet Feed | \$599.88 |
| LetterPro (20cps) | \$709.88 |

SILVER REED



| | |
|--------------------|-----------|
| EXP-770 (Parallel) | \$999.88 |
| EXP-550 (RS-232C) | \$1079.88 |
| EXP-550 (Parallel) | \$609.88 |
| EXP-550 Tractor | \$129.88 |
| EXP-500 (Parallel) | \$449.88 |
| EXP-500 Tractor | \$119.88 |

SMITH-CORONA



| | |
|-----------|----------|
| Messenger | \$589.88 |
|-----------|----------|

STAR MICRONICS

| | |
|-----------|----------|
| PowerType | \$359.88 |
|-----------|----------|

Accessories

| Printer Stands | |
|-------------------|---------|
| 10" Printer Stand | \$39.88 |
| 15" Printer Stand | \$49.88 |

| Microfazer | |
|-----------------|----------|
| 8K P/P | \$129.88 |
| 64K P/P | \$169.88 |
| 128K P/P | \$239.88 |
| 256K P/P | \$549.88 |
| 512K P/P | \$769.88 |
| Male-male cable | \$29.88 |

| Cables | |
|--|---------|
| Printer cables for the IBM-PC, IBM-PC/IDS, Compaq, Columbia MPC & VP, Eagle-PC/Splitr, Centronics, and many others, as well as 9-wire modem cables. All cables | \$29.88 |

Printer Switches

| | |
|--|----------|
| 2-way & 4-way switches for 36-pin Centronics or 25-pin RS-232C. All connectors are female, & cables are extra. | |
| Video Switch Box | \$109.88 |
| 4-Way Switch Box | SCALL |

Monitors

| AMDEK | |
|------------------|----------|
| 300G (12" green) | \$149.88 |
| 300A (12" amber) | \$159.88 |
| 310A (12" amber) | \$199.88 |

| NEC | |
|-------------------|----------|
| 1205M (12" amber) | \$169.88 |
| 1201M (12" green) | \$169.88 |

| PRINCETON GRAPHICS | |
|--------------------|----------|
| PGS HX-12 | \$509.88 |
| PGS Max-12 | \$199.88 |

| QUADRAM | |
|------------|----------|
| QuadChrome | \$519.88 |

ROLAND

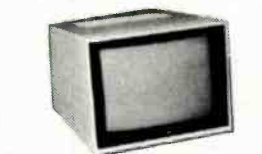

| | |
|---|----------|
| DG-121 Composite (12" green or amber) | \$159.88 |
| DG-122 TTL-type Monochrome (12" green or amber) | \$179.88 |

Modems

| HAYES | |
|---------------------|----------|
| Smartmodems | |
| MicroModem IIe | \$259.88 |
| 300 baud | \$239.88 |
| 300/1200 baud | \$559.88 |
| 1200B w/SmartCom II | \$489.88 |

| NOVATION | |
|----------------|----------|
| AppleCat Modem | \$309.88 |

| SmartCat Modems | |
|-----------------|----------|
| 300 baud | \$189.88 |
| 1200 baud | \$439.88 |

| Access 1-2-3 | |
|---|----------|
| IBM-PC internal board modem w/Crosstalk | \$449.88 |

US ROBOTICS



| Password | |
|-----------|----------|
| 1200 baud | \$369.88 |
| 300 baud | \$159.88 |

| PC Modem | |
|---------------|----------|
| Standard | SCALL |
| PC Modem 64K | \$579.88 |
| PC Modem 256K | \$779.88 |
| Teipac | \$69.88 |

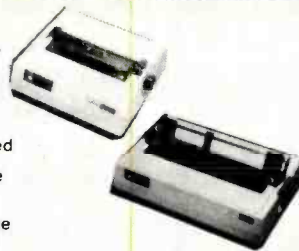

Peripherals

| ALS (Apple) | |
|--|----------|
| 'S-232C Card | \$119.88 |
| Smarterm II (80 Column Video Card) | \$149.88 |
| Z-Card (Z-80 card w/CP/M 2.2 & utilities) | \$149.88 |
| ALS CP/M 3.0 Card (Includes CP/M Plus 3.0, CBASIC, GSX-80 for CP/M Graphics) | \$329.88 |

| ALLOY (IBM-PC) | |
|-----------------|-------|
| 52 MB Disk/Tape | SCALL |
| PC Tape Backup | SCALL |

| AMT (Apple) | |
|----------------|----------|
| AMT MicroDrive | \$219.88 |

| AST RESEARCH (IBM-PC) | |
|-----------------------|----------|
| 64K MegaPlus | \$309.88 |
| 256K MegaPlus | \$509.88 |
| Parallel Port | \$329.88 |
| Optional RS-232C Port | \$49.88 |
| Game Port | \$49.88 |
| 256K MegaPak | \$329.88 |
| 64K Sixpak | \$289.88 |
| 256K SixPak | \$469.88 |
| 384K SixPak | \$659.88 |
| Game Port | \$49.88 |

| HERCULES (IBM-PC) | |
|-------------------|----------|
| Graphics Master | \$379.88 |

| MA SYSTEMS (IBM-PC) | |
|---------------------|----------|
| ColorPlus | \$439.88 |
| I/O Processor | \$349.88 |

| MICROSOFT (Apple/IBM-PC) | |
|--------------------------|----------|
| Mouse (IBM PC) | \$149.88 |
| SoftCard System | \$559.88 |
| Z80/Videx Combo | \$519.88 |
| Z80 Softcard | \$279.88 |
| 16K RAMcard | \$89.88 |

| MOUSE SYSTEMS (IBM-PC) | |
|------------------------|----------|
| PC Mouse | \$239.88 |

| PARADISE/USI (IBM-PC) | |
|-----------------------|----------|
| MultiDisplay | \$479.88 |

QUADRAM (IBM-PC)

| | |
|--|----------|
| Quadboards | SCALL |
| Quad 512+ (64K) | \$239.88 |
| Quad 512+ (256K) | SCALL |
| Quad 512+ (512K) | SCALL |
| 12MB QuadDisk | SCALL |
| 20MB QuadDisk | SCALL |
| Quad Memory(64K) | \$209.88 |
| Quad Memory(128K) | \$279.88 |
| Quad Memory(192K) | \$339.88 |
| QuadColor-1 | \$219.88 |
| QuadColor-2 | SCALL |
| Quad I/O | SCALL |
| Parallel Card, RS-232C Card or Clock/Calendar Card | \$79.88 |
| QuadLink | \$499.88 |
| Quad eRAM (Apple) | \$119.88 |

QCS (IBM-PC)

| External Hard Disks | |
|---------------------|-----------|
| 12MB | \$2099.88 |
| 20MB | \$2339.88 |
| 26MB | \$2509.88 |

RANA SYSTEMS

| | |
|------------|----------|
| Elite-1 | \$259.88 |
| Elite-2 | \$489.88 |
| Elite-3 | \$639.88 |
| Controller | \$99.88 |

TANDON (IBM-PC)

| | |
|----------|----------|
| TM 100-2 | \$229.88 |
|----------|----------|

TBL PRODUCTS (Apple)

| | |
|------------------------|---------|
| Cooling Fan | \$59.88 |
| Printer Card & Cable | \$59.88 |
| Apple Drive Controller | \$59.88 |

TITAN

| Apple II+/IIIe | |
|---------------------------|-----------|
| Accelerator II | \$499.88 |
| 32K Memory Board | \$169.88 |
| 64K Memory Board | \$279.88 |
| 128K Memory Board | \$399.88 |
| IBM-PC/XT | |
| Cygnus I/O (Par.) | \$149.88 |
| Cygnus I/O (RS-232) | \$169.88 |
| Multifunction Board w/64K | \$559.88 |
| w/576K | \$1069.88 |

VIDEX

| | |
|----------------------|----------|
| VideoTerm w/switch | \$239.88 |
| VideoTerm w/o switch | \$209.88 |
| UltraTerm | \$289.88 |
| Enhancer II | \$109.88 |

Information/Orders:

(603) 881-9855

Prices/Orders Only:

(800) 343-0726

- No Hidden Charges:**
- You get FREE shipping on all orders within the 48 states.
 - Most orders delivered within 10 days or less. UPS 2nd Day and Overnight available for most areas (costs extra).
 - Easy payment terms: We accept all major credit cards, certified checks, money orders, company checks or personal checks (allow 21 days for personal checks).
 - We never charge extra for credit cards.
 - Credit cards are not charged until order is shipped.
 - We accept CODs up to \$1000 (add \$10 handling fee per order) payable with certified check or money order.
 - We have a \$50 minimum order.
 - Company Purchase Orders are accepted on a limited basis & upon approval only. Sorry, no APO or foreign orders accepted.

All our equipment is shipped with full manufacturer's warranty. We are an authorized dealer for all products we sell to insure full warranty support, & we're authorized for warranty work on a number of printers. We also offer extended warranty plans for many printers. We prepared this ad in March, & prices do change, so call to verify them.

Our Computer Showroom is now open in Amherst, New Hampshire, five miles west of Nashua (one hour from Boston).



THE BOTTOM LINE

Send \$1.00 & our computer type for our new computer catalog.

HIGH TECHNOLOGY AT AFFORDABLE PRICES

THE BOTTOM LINE

MILFORD, NH 03055-0423 □ TELEPHONE (603) 881-9855

Graphics for Zenith Terminals



Graphics-Plus transforms Z19 into super terminal

The GRAPHICS-PLUS enhancement board installs easily into your Zenith Z19 terminal to give you powerful graphics capability as well as expanded user features. For a small investment, your Z19 now rivals the horsepower of very expensive terminals.

You get Tektronix 4010 compatibility to run industry standard graphics software. In the text mode, you get DEC VT100 compatible 80 and 132 column formats and 24/49 line

displays. Plus seven pages of off-screen scrolling memory. A "plain English" Set-up mode. Sixteen programmable function keys. And many more convenience features.

Printer Port Option

To capture your graphs and text on hardcopy, you will also want our printer interface board for popular dot matrix printers. Specify if you need serial or parallel compatibility.

* Ask about GRAPHICS-PLUS for the Z-29

Northwest Digital Systems

P.O. Box 15288
Seattle, WA 98115
(206) 524-0014

| | | |
|---|--------|----------|
| <input type="checkbox"/> Enter my Order | | |
| <input type="checkbox"/> Send literature only | | Quantity |
| <input type="checkbox"/> GRAPHICS PLUS (GP-19) board | \$ 849 | |
| <input type="checkbox"/> Z19 Terminal with GP-19 installed | 1495 | |
| <input type="checkbox"/> Printer I/O board | 195 | |
| <input type="checkbox"/> Serial I/O <input type="checkbox"/> Parallel I/O | | Total \$ |
| Name _____ | | |
| Company _____ | | |
| Address _____ | | |
| City _____ State _____ Zip _____ | | |
| Telephone _____ | | |

constructs as FOR/NEXT, WHILE/WEND, GOSUB, etc., is not shared by the novice programmer. Professional BASIC provides a unique environment in which these strange objects come alive and their obscure antics become visual and obvious to the eye of the inexperienced user. This version of BASIC sets new standards for usability and "user friendliness."

Summary

Much more could be said about Professional BASIC. I would like to mention briefly a few more features.

- If you enter part of a data name or label and the @ character, Professional BASIC will complete the name.
- If you enter your code with multiple statements on a line and without "white space," the product will reformat the code (including indenting) automatically.
- Professional BASIC can produce a report in which each instruction that has not been executed in the testing process is underlined.
- Professional BASIC can produce a histogram report showing the relative frequency of execution of each instruction in the run.

As innovative and fully featured as this product is, there are some features that are missing (you just can't please some people). My list includes true subroutines, local variables, ALT-key macros, and an optional separate compiler. The language now requires a minimum of 256K bytes to run. My wish list would increase the memory requirements another notch or two, which may be why those features are not currently supported. ■

Professional BASIC is available from Morgan Computing Company, 10400 North Central Expressway, Suite 210, Dallas, TX 75231. The product costs \$345.

Donald P. George (4643 Castleview Dr., Covina, CA 91724) is a project manager for training at Trans-america Occidental Life. He holds a B.A. in quantitative methods from Cal State Fullerton. He is the author of a book on BASIC programming scheduled to be published this spring.

The only way to make costly anti-static mats 100% effective.



Anti-static mats offer some protection. But the anti-static protection ends where the mat ends.

Someone walking past a terminal can generate enough static energy to zap your computer—creating anything from a glitch to a serious memory loss.

In dealing with real life situations, mat protection doesn't go far enough because the mat doesn't go far enough. So unless *everyone* is standing barefoot on the mat, you're asking for static problems.

Staticide® protection goes everywhere—static-proofs every square inch of your EDP or office environment.

One application of Staticide to floors, work stations and equipment keeps the entire area static-free for up to six months.

And now you can wipe out static on CRT screens, copiers and key-

boards with new Staticide® Wipes™. This convenient towelette cleans while eliminating static—without harming or damaging sensitive electronic components.

The Staticide System. 100% protection for just a small percent of what a mat will cost.

Best of all, people can behave like normal. No tiptoeing. No mat crowding. No kidding.

Staticide and Staticide Wipes. The only practical 100% solution.



ACL products available worldwide.

Staticide

by ACL Incorporated

We take static from our customers.



1960 E. Devon Avenue
Elk Grove Village, IL 60007
(312) 981-9212, TELEX: 4330251

Call or write for free literature.

Circle 12 on inquiry card.

The only way to make costly anti-static mats 100% effective.



Anti-static mats offer some protection. But the anti-static protection ends where the mat ends.

Someone walking past a terminal can generate enough static energy to zap your computer—creating anything from a glitch to a serious memory loss.

In dealing with real life situations, mat protection doesn't go far enough because the mat doesn't go far enough. So unless *everyone* is standing barefoot on the mat, you're asking for static problems.

Staticide® protection goes everywhere—static-proofs every square inch of your EDP or office environment.

One application of Staticide to floors, work stations and equipment keeps the entire area static-free for up to six months.

And now you can wipe out static on CRT screens, copiers and key-

boards with new Staticide® Wipes™. This convenient towelette cleans while eliminating static—without harming or damaging sensitive electronic components.

The Staticide System. 100% protection for just a small percent of what a mat will cost.

Best of all, people can behave like normal. No tiptoeing. No mat crowding. No kidding.

Staticide and Staticide Wipes. The only practical 100% solution.



ACL products available worldwide.

Staticide

by ACL Incorporated

We take static from our customers.

 1960 E. Devon Avenue
Elk Grove Village, IL 60007
(312) 981-9212, TELEX: 4330251

Call or write for free literature.
Circle 12 on inquiry card.

BASIC-09

A structured, incrementally compiled BASIC for Motorola MC6809-based microcomputers

Brian Capouch

St. Joseph's College

The BASIC-09 programming language, developed by the Microware Corporation in conjunction with Motorola, is a high-level program development system for the Motorola MC6809 microprocessor. It possesses syntactic features that have more in common with Pascal or C than with BASIC but maintains standard BASIC source code compatibility. The language runs under the OS9 operating system (OS), a modular, Unix-like OS designed to take advantage of the architectural features of the MC6809.

Interpretive Compilation

BASIC-09 is organized as a multi-pass compiler/interpreter. Each line of BASIC-09 source code is compiled incrementally into an intermediate code (called i-code by way of analogy to Pascal p-code). Lines of code can be entered either from the keyboard, via a built-in text editor, or from a mass-storage file. The compiler detects a large number of syntax errors and immediately reports them. This eliminates the annoying problem, presented by most compilers, of having to repeatedly resubmit programs to the compiler for detection of trivial spelling and punctuation errors. After a complete source code program has been entered, a second pass of the compiler checks the source code for context-dependent errors such as loop closures, line-number references, and type clashes. The twice-compiled i-code is then interpreted by an execution pass. A

unique feature of the BASIC-09 run-time interpreter is an integral debugger, entered automatically whenever an error is detected. The debugger lets the user print and change the values of variables, trace, and single-step through a program. Breakpoints can be entered into the source code at compile time to let the user suspend execution of a running program and enter the debugger. Program execution may be resumed from the debugger after the breakpoints or after a nonfatal error.

The Workspace Concept

The BASIC-09 programming environment is organized into a *workspace*, a memory segment into which procedures load. BASIC-09, like Pascal and other high-level languages, uses named procedures that can call one another and pass parameters both by reference and by value. The workspace contains all procedures germane to a particular project. A statistics report indicates the amount of memory required by each procedure, both for its program code and for its data. Procedures can be loaded into and saved from the workspace into mass storage, either individually or in groups. The entire workspace may also be saved or retrieved as a unit.

Once a given program (defined to be one or more procedures) has been debugged and tested, the user may invoke a fourth pass of the compiler, a process known as *packing*. This pass

of the compiler accomplishes several tasks. First, it removes all variable names and line-number references in order to compact the code and make it inaccessible for editing. It also makes the procedure available to other users via the OS9 memory module mechanism. A typical BASIC-09 environment includes several packed BASIC-09 modules available to every user of the system; all users can perform commonly required tasks such as terminal cursor addressing and file handling. When the BASIC-09 run-time system detects a procedure invocation, it first checks to see if the procedure is currently located in a user's workspace. If not, it checks memory to see if the procedure is a packed module currently in use by another user. If so, both users may share its program memory, with the only overhead required by the second user being that needed for local variable storage. If the procedure is not in memory, a search of the mass-storage directory checks for a packed procedure of the required name. If found, it automatically loads into system memory.

The OS9 Interface

Although the BASIC-09 programming system is powerful, it acquires additional power from its interface with the host OS9 operating system. OS9, functionally very similar to Unix, is a multiuser, multitasking OS with a highly modular organization. Several of its features are of interest

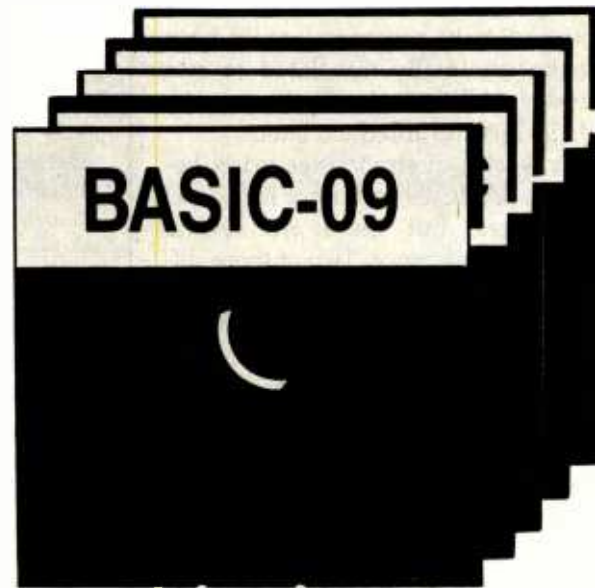

to the BASIC-09 programmer. First, BASIC-09 has a clearly defined interface to the OS, letting the user easily mix BASIC-09 code with assembly-language routines, as well as routines written in other high-level languages, such as Pascal, COBOL, and C. Because parameters are passed in a standard method using the MC6809 stack, users may easily write assembly-language routines to gain speed and efficiency.

Other OS9 system functions are available to BASIC-09 programs. Two particularly powerful functions are concurrent processing and pipelines. Any BASIC-09 procedure may at any time begin a new process as a *background*, or concurrent, process. This means that the new process will run simultaneously with the currently executing program. An example of the use of concurrent processing would be the listing of an output file to a printer. This listing can be done so the program that invoked the listing continues uninterrupted while the listing goes on in the background. A feature of this sort greatly enhances the user efficiency of BASIC-09 programs. Additionally, OS9 lets the user create program pipelines (see the text box on page 346) wherein the standard output from one program becomes the standard input of another. This makes it possible for useful modules to be mixed and matched to create special-purpose processors from simple building blocks. Packed BASIC-09 programs

are fully pipeline compatible, meaning they may be used to implement pipelines (as in the examples given in the text box). Pipelines can also be created to pipe the output of standard system utility programs (such as directory listings) directly into the BASIC-09 I/O (input/output) system. This eliminates having to use temporary files and their associated overhead. BASIC-09 programs can also send their output down pipelines for processing by system utility programs or other BASIC-09 programs.

Named Procedures and Long Variable Names

BASIC-09 procedures and variables use similar naming conventions that are superior to almost every other language extant. Names are significant to 128 characters and follow the conventions in vogue for other high-level languages. Although case is not significant in BASIC-09 identifiers, it is recommended that lowercase characters be used where practical because BASIC-09 automatically capitalizes keywords. Since there is a case distinction between variables and keywords, it is easy to scan procedures for variables. Also, procedure calls can use string variables instead of constants to enable the passing of procedure names as parameters.

BASIC-09 has a full complement of control structures, similar to those

found in other structured languages: WHILE-DO, REPEAT-UNTIL, FOR-NEXT, and LOOP-FOREVER are all implemented, as well as a multiline IF-THEN-ELSE statement. Additionally, a conditional EXITIF statement is available for all loops to provide a painless, structured way of exiting. Of the other high-level languages I am familiar with, only C has a superior means of leaving a loop without leaving behind a mess.

BASIC-09 recognizes five atomic data types: integer, byte, real, string, and Boolean. Strings may be from 1 to 255 characters in length. Variables may be declared to be of any of these types, or may be declared by default, using the same conventions as in standard BASIC. Users may also define their own complex types with the BASIC-09 TYPE statement, similar to the record-type structure in Pascal. Elements of a user-defined type may be any atomic data type or another user-defined type. Thus, it is possible to declare arbitrarily complex data structures that are nonrectangular and fitted to the nature of the data at hand. In addition to this "recursive" definition of data structures, BASIC-09 procedures may be called recursively as well.

Despite the structured capabilities of BASIC-09, it is also completely

source-code compatible with almost all "standard" implementations of BASIC. Of course, as is commonly found, I/O statements are seldom compatible from one BASIC to another; BASIC programs would have to be minimally translated to run under BASIC-09. I will discuss the BASIC-09 I/O interface later.

A wealth of similarities exists between BASIC-09 and other high-level languages, but there are several points of difference. Two of these differences can be considered limitations of the current implementation of BASIC-09. First, there are no pointer data types as in other structured languages, which makes coding algorithms based on pointers impossible. Also, there is no means of declaring global variables. Consequently, data that must be known to all procedures in a program must be explicitly passed as parameters from procedure to procedure. The severity of this limitation is vehemently argued amongst BASIC-09 programmers; the issue is discussed more fully under Decoupling.

BASIC-09 programs communicate to the outside world through OS9 data paths, and as such they closely resemble the conventions used by Unix. File I/O, which can be directed to any file or device in the system, uses the byte-stream convention: all files look to BASIC-09 like a stream of bytes, and all devices look like files. Thus it is possible to debug programs by shunting file I/O to a terminal or printer by changing only a pathname inside the program. Normally file I/O is done in binary format, although the READ and WRITE commands do file I/O in ASCII (American National Standard Code for Information Interchange). When an internal-format GET or PUT is done, only the number of bytes specified by the data structure in question is retrieved. Files may consist of intermingled data of varying types and yet can still be accessed randomly. A SEEK command makes it possible to position a file pointer to any byte within a file. The sleek, optimized I/O system available under BASIC-09 is a major convenience of the language.

Pipelines and Filters

A Unix-inspired concept, pipelines let the standard output of one program become the standard input of another program. If a program reads all its input from the standard input path and writes all its output to the standard output path, then it is called a filter. This is because the programs transform, or filter, the data passing through them. Filters may be hooked together to form pipelines in the OS9 operating system.

In the pipeline shown in the figure below, the OS9 input redirection operator < is used to connect a data file to the first program in the pipeline, called EatBlanks (see listing 1). This program reduces consecutive runs of blanks to a single blank. The output of EatBlanks is then piped

(using the pipeline operator !) into the standard input path of the filter program Lowerize (see listing 2), which changes all uppercase letters to lowercase using a logical OR function. Then, in certain conditions where a linefeed needs to be added to each carriage return, the filter program LF (see listing 3) is added to the series. This replaces every instance of the carriage-return character with a carriage return/linefeed pair. A properly filtered output then displays on the user's terminal. It could also be redirected to a mass-storage file or a device using the operator >. Note that packed BASIC-09 procedures are invoked by users in exactly the same way as system utility programs.

(This is contents of input file, named "testfile":)

```

This      is a test      of the ABILITY
of
my little program
to      eat Blanks AND change UpPeR CaSe      to
lower.

```

(OS9 command line to set up a pipeline:)

```
OS9:EatBlanks <testfile ! Lowerize ! LF
```

(This is output to user's terminal:)

```

this is a test of the ability
of my little program
to eat blanks and change upper case to
lower.

```

An example of the pipeline capability of the OS9 operating system. The text between the dotted lines is the command line that funnels the text above through the three filter programs (listings 1, 2, and 3) to produce the text at the bottom.

Decoupling

As mentioned earlier, global variables cannot be used in BASIC-09.

This has led to an ongoing debate in the BASIC-09 community regarding the severity of this limitation in the

Listing 1: The filter program, EatBlanks. In all three listings, the numbers at the left represent the number of bytes of memory taken up by each line. BASIC-09 indents and capitalizes keywords automatically.

```

0000 (* Filter program to eat consecutive runs of blanks from
0039 (* standard input
004B
004C (* We must catch end-of-file, which causes an error
007F ON ERROR GOTO 100
0085
0086 DIM InPath,OutPath:BYTE
0091 DIM Blank,Char,LastChar:STRING[1]
00A5
00A6 Blank=CHR$(32)
00AE InPath=0
00B5 OutPath=1
00BC (* Set LastChar to dummy value for first pass of loop
00F1 LastChar=CHR$(SFF)
00FA
00FB WHILE NOT(EOF(#InPath)) DO
0106 GET #InPath,Char
0110 IF Char=Blank AND LastChar=Blank THEN
0125 (* Do nothing
0132 ELSE
0136 PUT #OutPath,Char
0140 ENDIF
0142 LastChar=Char
014A ENDWHILE
014E
014F 100 (* We do no extra error checking here
0177 END

```

Listing 2: The filter program, Lowerize.

```

0000 (* Filter to transform all uppercase letters to lower
0035
0036 (* EOF on input stream causes error, trap it
0062 ON ERROR GOTO 100
0068
0069 DIM InPath,OutPath:BYTE
0074 DIM Char:STRING[1]
0080 InPath=0
0087 OutPath=1
008E
008F WHILE NOT(EOF(#InPath)) DO
009A GET #InPath,Char
00A4 IF Char>="A" AND Char<="Z" THEN
00B9 Char=CHR$(LOR(ASC(Char),$20))
00C7 ENDIF
00C9 PUT #OutPath,Char
00D3 ENDWHILE
00D7
00D8 100 (* We do not check for errors here
00FD END

```

Listing 3: The filter program, LF.

```

0000 (* Procedure to convert CR to CR/LF pair
0028 (* For use with processors that do not automatically follow CR w/LF
006B
006C (* Error vector upon detection of EOF
0091 ON ERROR GOTO 100
0097
0098 DIM Char:STRING[1]
00A4 DIM CR:STRING[1]
00B0 DIM LineFeed:STRING[1]
00BC DIM InPath,OutPath:BYTE
00C7
00C8 CR=CHR$(SOD)
00D1 LineFeed=CHR$(SOA)
00DA InPath=0
00E1 OutPath=1
00E8
00E9 WHILE NOT(EOF(#InPath)) DO
00F4 GET #InPath,Char
00FE IF Char=CR THEN
010B PUT #OutPath,Char
0115 PUT #OutPath,LineFeed
011F ELSE
0123 PUT #OutPath,Char
012D ENDIF
012F ENDWHILE
0133
0134 100 (* No error detection here, either
0159 END

```

language. It is undeniable that it presents obstacles when translating code from other structured languages.

However, another school of thought applauds the total decoupling of modules that this convention re-

quires. Many program bugs are introduced by procedures "knowing about" or being allowed to change variables where they shouldn't. Under BASIC-09 this can certainly happen, but it can never happen by chance. All data that passes back and forth between procedures must do so explicitly. According to this approach, the total decoupling enforced by BASIC-09 is actually a boon instead of a bane. Time alone will resolve this argument.

BASIC-09 and its parent OS9 operating system are available on a wide range of MC6809 configurations. Recently, the potential market for the system has been expanded at both ends. Radio Shack has begun to distribute OS9 and BASIC-09 for its low-cost TRS-80 Color Computer. This opens up a mass market and greatly expands the potential exposure that BASIC-09 will enjoy. At the other end of the spectrum, the GMX-III system from GIMIX Inc. (1337 West 37 Place, Chicago, IL 60609, (312) 927-5510) is a high-end system that features intelligent I/O processing, hardware memory protection, and up to 140 megabytes of hard-disk storage. Installations running this system support 12 to 16 users at 19,200 bits per second, making the system highly competitive with many minicomputers. The programmer efficiency offered by BASIC-09 is an invaluable component of these systems and promises an increasing number of users in days to come. ■

Brian Capouch (RR1 Box 270, Monon, IN 47959) teaches computer science at St. Joseph's College in Rensselaer, Indiana, and operates a computer consultant's firm, Oikos Systems. Capouch holds a B.A. in Spanish from Indiana University and raises cows and chickens on his farm.

Designed by Robert Doggett, Larry Crane, Ken Kaplan, and Terry Ritter, BASIC-09 was first released in the spring of 1980. The language is available in a single version from Microware Systems Corporation, 5835 Grand Avenue, Des Moines, Iowa 50304, (515) 279-8844. The price is \$195.00. BASIC-09's installed base is estimated at 10,000 units. Recent licensees include Tandy Corporation, Fujitsu, and Dragon Data.



**CRAFTSMEN OF THE NEW TECHNOLOGY.
BEST PRICES WITH QUALITY SUPPORT* ON SOFTWARE AND HARDWARE.**

ORYX SYSTEMS

QUALITY DISCOUNTS

APPLE/ FRANKLIN

| | |
|-----------------------------|--------|
| ASHTON-TATE | |
| d-Base II | Call |
| ASPEN/WANG SOFTWARE | |
| Grommatik | \$ 60 |
| Proofreader | 42 |
| BEAGLE BROS. | |
| Apple Mechanic | \$ 22 |
| DOS Boss | 17 |
| Utility City | 22 |
| BRODERBUND | |
| Bank Street Writer ... | \$ 45 |
| General Ledger w/AP .. | 305 |
| Payroll | 275 |
| CDEX | |
| Visicalc Training | \$ 45 |
| CENTRAL POINT | |
| Copy II + | \$ 34 |
| CONTINENTAL SOFTWARE | |
| Home Accountant | \$ 49 |
| DOW JONES | |
| Market Analyzer | \$ 245 |
| Market Manager | 219 |
| Microscope | 525 |

LOGO CORNER

| | |
|------------------|-------|
| Krell Logo | \$ 75 |
| Terrapin | Call |

| | |
|---------------------|------|
| LINK SYSTEMS | |
| Datafax | Call |
| Datalink | 79 |

d-BASE II CORNER

| | |
|-------------------------|--------|
| Ashton-Tate | |
| d-Base II | Call |
| Bottom Line | |
| Strategist | 259 |
| FPL | 410 |
| Friday | 179 |
| Human Soft | |
| d-Base Plus | \$ 90 |
| Fox & Geller | |
| Quick Cad | \$ 175 |
| D Uhl | 58 |
| Sensible | |
| D-Programmer | Call |
| Software Banc | |
| d-Base II | |
| User's Guide: | |
| w/ d-Base II | \$ 15 |
| w/o d-Base II | 20 |
| Anderson-Bell | |
| Abstat | Call |
| Tylog Systems | |
| d-Base Window ... | \$ 159 |
| d-Base Door | Call |
| All above available | |
| PC-DOS | |

| | |
|------------------------|---------|
| MICROPRO | |
| Wordstar (Special | |
| w/ CP/M Card, | |
| 70 col. & 64K) | \$ Call |
| Infostar (Includes | |
| CP/M, 70 col., 64K) .. | Call |
| Pro Pak | |
| (WS/MM/SS/Index) .. | 399 |

| | |
|-----------------------|--------|
| MICROSOFT | |
| Cobol-80 | \$ 499 |
| Fortran-80 | 145 |
| TASC Compiler | 119 |
| A.L.D.S. | 79 |
| Multiplan (DOS) | 165 |

| | |
|-----------------|-------|
| OMEGA | |
| Locksmith | \$ 79 |

| | |
|-------------------------|--------|
| PEACHTREE (CP/M) | |
| Peachpak 40 G/L + | |
| A/R + A/P (Special) .. | \$ 215 |
| All Other | |
| Peachtree Products .. | Call |

| | |
|--|-------|
| PENGUIN SOFTWARE | |
| Complete Graphics .. | \$ 50 |
| Graphics Magician ... | 39 |
| Complete Graphics/ Apple Tablet | 86 |

| | |
|-----------------------|------|
| SIERRA ON-LINE | |
| Homeward | Call |

| | |
|----------------------|--------|
| SOFTCH | |
| Basic Compilers' | |
| Runtime | \$ 169 |
| Softach | 94 |
| UCSD P-system Set .. | 469 |

| | |
|----------------------------|-------|
| SOFTWARE PUBLISHING | |
| PFS: File | \$ 79 |
| PFS: Graph | 79 |
| PFS: Report | 79 |

| | |
|-------------------|-------|
| SUPERSOFT | |
| Basic Tutor | \$ 79 |
| Fortran | 299 |

| | |
|---------------------|--------|
| SYSTEMS PLUS | |
| Landlord | \$ 375 |

| | |
|-------------------------|--------|
| VISICORP | |
| Visicalc (II or IIE) .. | \$ 165 |
| Visischedule | 195 |

CP/M SOFTWARE

| | |
|-------------------|--------|
| COMPUVIEW | |
| *V-Edit 8080 Z80, | |
| IBM/PC | \$ 130 |
| *V-Edit CP/M 86, | |
| MS DOS | 160 |

| | |
|-------------------------|---------|
| DIGITAL RESEARCH | |
| *Pascal MT + W/SPP .. | \$ 389 |
| DR Assembler & Tools .. | 149 |
| CP/M 2.2 | 125 |
| C Basic 2 | 95 |
| PL/1-80 | 375 |
| C Basic Compiler | |
| (CB-80) | 299 |
| Access or Display Mgr. | 299 |
| C Language/compiler .. | 260 |
| Concurrent CP/M 2.0 .. | Call |
| All 8" - 86 Version | |
| of Above | \$ Call |

| | |
|-----------------------------|-------|
| INFOCOM | |
| *Deadline | \$ 49 |
| *Starcross | 39 |
| *Suspended | 39 |
| *Zork, I, II, III (each) .. | 39 |

| | |
|--------------------|---------|
| LEXISOFT | |
| *Spellbinder | \$ Call |

| | |
|----------------------------|--------|
| MARK OF THE UNICORN | |
| *Final Word | \$ 199 |

| | |
|---------------------|---------|
| MICROPRO | |
| *WordStar | \$ Call |
| *InfoStar | Call |
| *Pro-Pack | |
| (WS/MM/SS Index) .. | Call |
| All others | Call |



Peachtree Software

PEACHTREE CORNER

| | |
|--|--------------------|
| ▶ PeachPak 4 (GL, AP, AR) | \$ 215 |
| ▶ Series 8 | |
| (GL, AP, AR, Sales Inv., Inventory Control, Job Cost, Client Post. & Acct.) | each module \$ 389 |

| | |
|----------------------|--------|
| MICROSOFT | |
| Basic 80 | \$ 239 |
| Basic Compiler | 249 |
| Fortran 80 | 330 |
| Cobol 80 | 449 |
| Macro 80 | 130 |
| MuMath/MuSimp | 179 |
| MuLisp/MuStar | 155 |
| *Multiplan | 165 |

| | |
|-------------------------|--------|
| ORGANIC SOFTWARE | |
| *Datebook | \$ 229 |
| *Milestone | 229 |

| | |
|----------------------------|--------|
| PICKLES & TROUT | |
| CP/M for TRS | \$ 180 |

| | |
|-------------------------|--------|
| PRO/TEM SOFTWARE | |
| *Footnote | \$ 105 |

| | |
|------------------------|-------|
| REVASCO | |
| Z80 Disassembler | \$ 85 |

| | |
|-------------------|---------|
| SPI | |
| Open Access | \$ Call |

| | |
|-------------------------|--------|
| SORCIM | |
| *Supercalc III | \$ 249 |
| Superwriter | |
| (w/Speller & Mailer) .. | \$ 169 |

| | |
|-----------------|--------|
| SELECT | |
| Select Word | |
| Processor | \$ 329 |

| | |
|------------------------------|-----|
| STAR SOFTWARE SYSTEMS | |
| *Legal Time, Billing | 787 |
| *Property Mgmt. | 787 |

STAR SOFTWARE SYSTEMS ACCOUNTING PARTNER

Easy to use menu-driven programs for the beginner that can be linked with a sophisticated system as needed.

Your "Partner" includes: general ledger, accounts receivable, accounts payable and payroll. Also included for a nominal fee is an "800" number for access to the Star Question Center Back-Up Support Unit.

ORYX PRICE

| | |
|------------------|--------|
| MICROSTUF | |
| *Crosstalk | \$ 109 |

| | |
|-----------------------------|--------|
| NORTHWEST ANALYTICAL | |
| *Statpak | \$ 365 |

| | |
|--------------------------|--------|
| OASIS | |
| The Word Plus | \$ 103 |
| Punctuation and Style .. | 90 |

| | |
|-------------------------|-------|
| SUPERSOFT | |
| *Diagnostic II | \$ 89 |
| Disk Doctor | 74 |
| *Fortran 4 | 299 |
| Basic-8086 | 225 |
| C Cross Assembler | 400 |
| *ScratchPod | 187 |

| | |
|--------------------------|-----|
| T MAKER III | 215 |
|--------------------------|-----|

FORMATS AVAILABLE

All prices below are for 8" standard. Other formats are available. Some formats subject to "Download" fee and require minimum 2 weeks for delivery. Please inquire.

IBM/PC

Please see CP/M listing. All products with an * in front are also made for PC/DOS and are priced the same unless otherwise specified.

| | |
|-------------------------|--------|
| ALPHA SOFTWARE | |
| Data Base Mgr. II | \$ 179 |
| Mailing List | 72 |
| Executive Pkg. | 105 |
| Type Faces | 79 |
| Question | 35 |
| Apple-IBM Connection .. | 189 |

| | |
|-----------------|------|
| AUTODESK | |
| Autocad | Call |

| | |
|---------------------------|------|
| BULLISH INVESTMENT | |
| Net Worth | Call |

| | |
|----------------------|-------|
| CENTRAL POINT | |
| Copy II PC | \$ 34 |

| | |
|-----------------------|-------|
| CONTINENTAL | |
| Home Accountant | \$ 89 |

| | |
|------------------------|-------|
| CTak | |
| PC Calculator | \$ 29 |
| Prog. PC Calculator .. | 49 |
| Prog. PC Calculator | |
| w/ Fin. Mod. | 55 |

| | |
|-------------------------|------|
| DIGITAL RESEARCH | |
| Concurrent CP/M 86 .. | Call |
| CP/M-86 | 39 |
| Cobol 86 | 499 |

| | |
|------------------------|------|
| Pascal MT + 86 | |
| CP/M 86 w/SPP | 375 |
| SPP 86 | 130 |
| C Basic 86 | 135 |
| Pascal MT+ (PC/DOS) .. | 385 |
| DR Logo | Call |

| | |
|-----------------------|--------|
| DOW JONES | |
| Market Analyzer | \$ 245 |
| Market Manager | 219 |

| | |
|-----------------|------|
| ECO-SOFT | |
| Micrstat | Call |

| | |
|--------------------|--------|
| FINANCIER | |
| Tax Series | 105 |
| Financier II | \$ 119 |

| | |
|-----------------|--------|
| FYI | |
| Superfile | \$ 139 |
| FYI 3000 | 287 |

| | |
|-------------------------|--------|
| GRAPHIC SOFTWARE | |
| Super Chartman II | \$ 299 |
| Super Chartman IV ... | 199 |

| | |
|------------------------|--------|
| LIFETREE | |
| Volkswriter Deluxe ... | \$ 179 |

| | |
|-----------------|---------|
| MICROMIM | |
| R-base | \$ Call |

| | |
|----------------------|------|
| PEACHTREE | |
| See CP/M listing. | |
| PeachText 5000 | Call |

| | |
|--------------------------|--------|
| PEARLSOFT | |
| Pearl Acct'g 2 (16 bit) | |
| (GL, AP, AR, P, INV.) .. | \$ 650 |
| Personal Pearl | 236 |

| | |
|-------------------------|--------|
| SUPERSTOFF | |
| C Compiler - 8086 | \$ 350 |
| Star Edit | 180 |
| Disk Edit | 75 |
| Basic Compiler | 225 |
| 8087 Support | 40 |
| SYSTEMS PLUS | |
| Landlord (prop mgmt) \$ | 375 |
| Runtime Basic | |
| (req'd for above) | 45 |
| ... and many more! | |

| | |
|---------------------------|-----|
| Videx Display | |
| Enhancer II | 109 |
| Videx Func. Strip | 59 |
| Videx Videoterm | |
| VT-600 | 235 |
| Videx Ultraterm | 259 |
| Wesper 16K Ram Card | 69 |

| | |
|------------------------------|---------|
| TECMAR Products | \$ Call |
| XEDEX/MICROLOG | |
| Baby Blue | \$ Call |
| Baby Blue II | \$ Call |
| TALL TREE | |
| 512K JRAM Mem Bd | \$ 699 |

IBM/PC BOARDS

| | |
|--|---------|
| AST RESEARCH | |
| ComboPlus 64K (CI/Cal, Ser & Par, I/F, 256K capacity) | \$ 279 |
| MegaPlus 64K, (CI/Cal, Ser Port, 512K capacity w/Megapak) | \$ 269 |
| Extra parts available for Megaplus and I/O Plus II (Game, P/S) | \$ 40 |
| Megapak 256K upgrade for Megaplus | \$ Call |
| I/O Plus II CI/Cal and Ser Port | 115 |
| LNW Products | \$ Call |

| | |
|--|--------|
| MAYNARD ELECTRONICS | |
| Floppy Drive Cntrlr | \$ 160 |
| Floppy Drive Cntrlr w/ Par Port | 209 |
| w/ Ser Port | 219 |

DISPLAY CARDS CORNER

| | |
|--|---------|
| Hercules Graphics Board | \$ 359 |
| Orchid Monochrome Graphics Adapter | \$ Call |
| Plantronics Colorplus | \$ Call |
| USI Display Card (color/monochrome) | \$ Call |
| Amdex MAI Card | \$ Call |
| Tecmar Graphic Master | \$ Call |

| | |
|---|--------|
| QUADRAM | |
| Quadboard 64K, (Clk/Cal, Ser & Par Ports, Software) | \$ 279 |

| | |
|---------------------------------|-----|
| Microtazer Stack Printer | |
| Buffer (exp. to 512K) | |
| ▶ Parallel/Parallel 8K | 132 |
| ▶ Parallel/Parallel 64K | 188 |
| ▶ Serial/Parallel 8K | 170 |
| ▶ Serial/Serial 8K | 170 |

| | |
|--|---------|
| Quadlink 64K Mem (allows Apple SW to run an IBM/PC) | \$ Call |
|--|---------|

MONITORS

| | |
|--|---------|
| Amdex 300A Am | \$ 149 |
| Amdex Color II + | 435 |
| NEC JB1201 - 12" Gr | 169 |
| NEC JB1260 - 12" Gr | 119 |
| NEC JC1216 RGB | 435 |
| PGS HX12 RGB Clr | \$ Call |
| Panasonic CT160 10" comp. | \$ Call |
| Sanyo 8112 12" HR Gr | \$ Call |

| | |
|-------------------|---------|
| SONY | |
| Profeel 12" | \$ Call |
| Profeel 19" | \$ Call |
| Profeel 25" | \$ Call |

| | |
|----------------------------|------|
| Taxan | |
| KG12N-UY 12" HR Am \$ | 139 |
| KG12N 12" HR Gr | 132 |
| RGB Vision-1 12" LR Clr \$ | Call |
| RGB Vision-3 12" HR Clr \$ | 459 |
| US1 1200A 12" HR Am \$ | 159 |

MODEMS

| | |
|--------------------------------|--------|
| Hayes 300 | \$ 205 |
| Hayes 1200 | 495 |
| Hayes 1200B (Int) | 449 |
| Hayes Chronograph | 189 |

| | |
|--|---------|
| Novation | |
| Apple-Cat II | \$ 259 |
| PC Cat w/ Crosstalk (also known as Access 1-2-3 1200B) | \$ Call |
| 212 Smart Cat | \$ 489 |

| | |
|--------------------------|---------|
| US Robotics | |
| Auto-Dial 300/1200 | \$ 459 |
| Auto-Link 300/1200 | 410 |
| Password | \$ Call |

DISK DRIVES

| | |
|---------------------------------|---------|
| CDC 1800 | 249 |
| Corona | |
| 5 MB Hard w/cntrlr | 1,395 |
| 10 MB Hard w/cntrlr | 1,795 |
| Corvus | \$ Call |
| Davong 10/15/20 MB | \$ Call |
| Tandon TM-100-2 | 239 |

| | |
|------------------------------|--------|
| HALF HIGHS | |
| Matsushita | \$ 249 |
| Panasonic | 205 |
| Shugart | 229 |
| Super 5 (Apple) | 229 |
| Teac w/brackets | 259 |

PRINTERS

| | |
|----------------------------------|----------|
| Anodex | \$ Call |
| C. Itoh | |
| Starwriter | \$ 1,049 |
| Prowriter 8510P | \$ Call |
| Prowriter 1550P | \$ 599 |
| Epson FX-80 | 575 |
| GE/Genicom Printers | \$ Call |
| IDS/Data Products | |
| Prism 80 w/4 options | 1,399 |
| Prism 132 w/4 options | 1,547 |
| Microprism | 479 |

| | |
|------------------------------|---------|
| Mannesman Tally | |
| MT180L | Call |
| MT160L | 585 |
| Spirit | \$ Call |
| NEC 3550 | \$ Call |
| NEC 8023A | 389 |
| NEC 2031 | \$ Call |
| Okidata | |
| Microline 82A | \$ Call |
| Microline 83A | \$ Call |
| Microline 92 | \$ Call |
| Quadram Quadjet | \$ Call |

| | |
|----------------------------|---------|
| Siemens | |
| Ink Jet Printers | \$ Call |
| Silver-Reed | |
| Daisy Wheel | \$ Call |
| Star Micronics | |
| Gemini 10X | 299 |
| Gemini 15X | \$ Call |
| Teletex T1014 | \$ Call |
| Transtar | |
| T-130 P&S | 665 |
| T-315 P - Dot Matrix | 489 |
| T-120 P&S | 475 |

... and much more.

DISKETTES

| | |
|--------------------------------|-------|
| 3M 5" DS, DD, Box | \$ 40 |
|--------------------------------|-------|

| | |
|--|----|
| Maxell 5" DS, DD, MD2, Box | 40 |
| Verbatim 5" DS, DD, Box | 35 |
| Ultra Magnetics 5" DS, DD, Bonus Box (12 Diskettes) | 35 |
| (3 Boxes Minimum) | |

PLOTTERS

| | |
|---|---------|
| Enter P100 Sweet P | |
| Apple/Franklin, IBM/PC | \$ Call |
| Strobe M100 Plotter w/ I/F Apple/Franklin | 499 |
| Strobe M100 Plotter (RS 232) | 499 |
| Panasonic | |
| Digital Plotter | \$ Call |

MISC.

| | |
|---------------------------------|---------|
| Alpha-Delta "MACC" | |
| Surge Protector | \$ 69 |
| Chalkboard | \$ Call |
| Curtis PC Products | \$ Call |
| Keytronic | |
| Keyboard 5150 | \$ Call |
| WP KB5151 | \$ Call |
| WP KB5151 Dvorak | \$ Call |
| Koala Technologies | |
| Graphic Tablet | \$ 95 |

| | |
|--------------------|-------|
| PROMETHEUS | |
| Applesurance | \$ 99 |
| Pra Modem | 449 |
| Versocard | 159 |

| | |
|----------------------------|---------|
| Seattle Computer | |
| 8087 Package | \$ 299 |
| Street Electronics | |
| Echo Speech Synth IBM \$ | 179 |
| Echo II Speech Synth | 129 |
| Echo Word | \$ Call |
| Symtec | |
| Light Pen IBM/PC | 140 |
| Light Pen Apple/FRK | 200 |

| | |
|--------------------------|----|
| TG | |
| Joystick IBM/PC | 49 |
| Joystick Apple/FRK | 46 |

| | |
|------------------------|---------|
| Wico | |
| Analog Joystick | 59 |
| Apple Adapter | 18 |
| IBM/PC I/F Card | \$ Call |
| Versa Computing | |
| VersaWriter | \$ 235 |

Please:

- ▶ Wisconsin residents add 5% for sales tax.
- ▶ Add \$3.50 for shipping per software and light items. For multiple and other items, call.
- ▶ Foreign — add 15% handling & shipping for prepayment. (Int'l money order.)
- ▶ Prices are subject to change without notice.
- ▶ All items subject to availability.

Store prices are strictly retail.

We Welcome:

- ▶ COD (Add \$2.00 per shipment. Cash or certified check required.)
- ▶ Visa, MasterCharge & American Express. (Add 4%.)
- ▶ Checks. (Allow 1-2 weeks for clearing.)

Working Hours:
Monday-Friday 8:30-5:30
Saturday 10:00-2:00
Central Time

ORYX SYSTEMS, INC.

CRAFTSMEN OF THE NEW TECHNOLOGY

425 First Street • P.O. Box 1961
Wausau, Wisconsin 54401

*For technical assistance, order status and in Wisconsin:
715-848-1374

Int'l Telex: 260181
ORYX SYS WAU

ORDER TOLL FREE OUTSIDE WISCONSIN 1-800-826-1589



IBM PC & XT

IBM PC & XT COMPUTERS
Call for price & availability

MONITOR SALE

RGB COLOR



Princeton HX-12, 12" RGB color, high resolution 690 dot, 16 colors, single cabinet as IBM monitor... \$479

Quadrachrome, 12" RGB color, 690-dot high resolution, 16 colors... \$569
Amdek RGB Color II Plus, 640-dot high resolution, 16 colors... \$459
Zenith ZVM135, 12" RGB color, with green switch, speaker & more... Call

GREEN SCREEN

Dynax GM-120, 12" green, high resolution 600-dot, 20 MHz. This is our best seller (as shown)... \$129
Roland DG MB-122G, 12" green, 18 MHz, hi-resolution 720x350 dots, fully compatible with IBM monochrome display card... \$CALL
USI P1-3, 12" green, 1000-dot high resolution, 20 MHz... \$156
Taxan KG-12N, 12" green, 800-dot hi resolution... \$149
Gorilla 12" green monitor... \$99

AMBER SCREEN

Dynax AM-121, 12" amber, 600-dot hi resolution, 20 MHz... \$149
Taxan KAT-12N, 12" amber, 800-dot hi resolution... \$150
USI P1-3, 12" amber, 1000-dot hi resolution, 20 MHz... \$165
Amdek 310A, 12" amber, 900-dot hi resolution, designed to run on IBM monochrome display card... \$179



IBM compatible
5 1/4" DISK DRIVES

Tandon TM-100K1 Single-sided, double density, 160K formatted... \$189
Tandon TM-100-2 Double-sided, double density, 320K formatted... \$225
Tandon TM-100-4 Double-sided, quad density... \$335
Control Data, double-sided, double density, 320K formatted... \$235



IBM compatible
Half Height Disk Drives

Teac 55B half height, double-sided, double density, 320K formatted, direct drive design... \$225
Qume half height drive, double-sided, double density, 320K... \$229
Panasonic half height drive, double-sided, double density, 320K... \$189

DAVONG Systems, Inc.

Hard Disks: 10, 15, 21, 32 MB... \$CALL
Tape Backup systems... \$CALL
Networking Systems... \$CALL

Tech 5 Selector Switches

Now you can direct your computer output to a different printer or data device by a flip of a switch.
Centronic A-B - All 36 pins switched, Gold plated connectors, Plastic case \$140
RS-232 A-B - All 25 pins switched, Gold plated connectors... \$CALL
Plastic case... \$115
Metal case... \$125

TEAGLE COMPUTER

PC Plus II - 128K, 2-320K drives, green monitor... \$CALL
SPIRIT Portable - 128K, 2-320K drives... \$CALL
SPIRIT Portable - 128K, 1-360K drive, 10MB harddisk... \$CALL
PC-XL - 128K, 1-360K drive, 10MB harddisk, IBM-XT compatible... \$CALL

CALL FOR BEST PRICES!

IBM PC & XT COMPUTERS

Call for price & availability

AST Multi-Function Cards for IBM PC and XT

(Each card now comes w/ SuperDrive & SuperSpool)
Memory installed on card

| | | | | | | |
|-------------------------------------|-------|-------|-------|-------|-------|-------|
| none | 64K | 128K | 192K | 256K | 320K | 384K |
| with parallel, serial ports & clock | \$227 | \$267 | \$317 | \$367 | \$417 | \$467 |
| above plus game port | \$262 | \$302 | \$352 | \$402 | \$452 | \$502 |

SixPak Plus Cards

Amount of memory installed on board - None 64K 128K 192K 256K
w/serial port No. 1 & clock... \$226 \$266 \$316 \$366 \$416
w/ether parallel or serial port No. 2... \$274 \$314 \$364 \$414 \$464
w/both parallel & serial port No. 2... \$309 \$349 \$399 \$449 \$499
MegaPak - expands a fully populated MegaPlus card(256K) to 512K \$299
Optional Game Port... add \$50

MegaPlus II Cards

I/O Plus II Cards

Standard card w/one serial port (S1) and clock/calendar... \$129
Additional Parallel (P), Game (G), or Serial 2 (S2) port... add \$35 ea.

JRAM BOARD by Tall Tree Systems

The JRAM board provides usable memory above the 640K boundary with its unique software controlled hardware package. Add 4 JRAM boards and increase the memory capacity to 2 MB. 512K JRAM board w/softwa... \$699

Add Multi-Tasking to your IBM-PC now!

TASC MASTER software with AddRam Elite or AddRam Plus Ultimate Multi-Function Boards

- TASCMASTER software converts PC-DOS to concurrent PC-DOS to run up to 9 programs concurrently in background mode. The user can move freely between different programs without terminating any of them.
- User expandable memory from 64K to 512K on a single board.
- Real time clock/calendar with NiCd battery that recharges itself.
- RamSpool works with both parallel & serial printers and can operate both types simultaneously. RamSpool is hard disk supported under DOS 2.0.
- RamDisk creates up to two electronic disk drives in RAM, utilizing up to 320K ea.

AddRam Elite (parallel & serial ports) AddRam Plus (Two serial ports)
Memory installed - 64K 128K 192K 256K 320K 384K 448K 512K
\$399 \$450 \$519 \$579 \$639 \$699 \$759 \$819

QUADRAM QUADBOARD - Multi-Function board for IBM-PC

Full parity checking & memory selective addressing w/Spool & QDrives software.

Amount of memory installed on card - none 64K 128K 192K 256K
with parallel, serial ports, clock/calendar... \$235 \$275 \$325 \$375 \$425

STB RIO PLUS Multi-function memory expansion card for IBM-PC/XT. 64K-384K parity checked memory. Complete with parallel port, RS-232C serial port, game port, clock/calendar, print buffer/disk emulator software.

memory installed - 64K 128K 192K 256K 320K 384K
\$289 \$339 \$389 \$439 \$489 \$539

HERCULES GRAPHICS CARDS

Creates hi-resolution graphics on the IBM monochrome. \$CALL
Amdek MAI Board - for both monochrome & color monitor plus 96K user memory expansion \$499
Universal Research Color Card - for both color and monochrome displays, w/parallel port... \$399
Vista Disk Master - Disk controller card for both 5 1/4" & 8" drives, IBM-PC/XT compatible... \$CALL

Special Purpose Cards

PLANTRONIC ColorPlus - Offers more colors in hi resolution plus parallel port \$CALL
TECMAR GRAPHIC MASTER - Multi-function graphics board for both RGB color or monochrome displays and can do graphics on both... \$CALL
STB Color Graphics Board - The newest entry from STB. Operates RGB color or monochrome monitor. It can also do graphics on the monochrome display... \$CALL

Hayes Smart Modem

300 - \$209
1200 - \$485
1200B - \$429

DYNAMIC RAM CHIPS

4116 (16K) 200 mt... \$150 ea. 9/812
1164 (64K) 200 mt... \$5.95 ea. 9/550
4164 (64K) 150 mt... \$6.95 ea. 9/860

THE POWER DIRECTORS

P2 - A unique control center and surge protector w/5 lighted and a master rocker switches for your computer & accessories. It also filters out EMI & RFI interferences... \$125
P12 - Similar to P2 but w/6 switches, a master switch & digital clock... \$189

ROLAND DXY R300 Plotter

8-open intelligent X-Y Plotter. Hi-speed 180mm/sec. IBM-PC compatible. 11" x 17" paper size. Horizontal or vertical operation. Dual speed switch. Parallel and serial interfaces... \$CALL

ELECTRIC COPY HOLDERS

AcctoType 1 - 14" max. paper width. Has magnifying bar & built-in light. Foot pedal electrically scrolls copy up & down. Built-in isolation filter prevents electrical interference with computer. A must for WP... \$179
AcctoType II - Above but 17" x 11" \$199

TELETEX TTX-1014

NEW! 12 CPS daisywheel printer w/ built-in tractor adjustable 2%-14% w/parallel & serial interfaces. Wordstar compatible. Programmable pitch & line spacing. Compact size... \$499

TELETEX TTX-3000

Smart Terminal
Built-in text edit & graphic capability, graphics processing & design for updating to stand-alone computer, word processing & telecomm system. 80x25 line swivel screen, 10 function keys & numeric keypad... \$549
Complete w/1014 printer... \$949

GENESIS Cutsheet Feeder

Single bin feeder, mechanically driven for high reliability - no electronics, no motor. Easy installation. Available for Diablo 620/630, C. Itoh F-10, Brother HR-1, Silver Reel 550 (specify)... \$475

BROTHER HR-25

New! 23 CPS daisywheel printer w/ 2 color printing, 3K buffer, Proportional spacing, etc. Parallel... \$CALL
Tractor for HR-25... \$119
Cut Sheet Feeder for HR-25... \$199

BROTHER HR-1A

16 CPS daisy wheel printer, bi-directional, uses standard typewriter ribbons, 16% max. paper width... Super special \$549

DYNAX DX-15

New! Letter quality daisywheel printer with 2-color printing. Logic seeking, bi-directional, proportional spacing, graphic & bold printing, direct printing, super/sub script, auto double strike & underline, 3 K buffer, Parallel... \$CALL
Tractor... \$199
Cut sheet feeder... \$119
Keyboard... \$179

SILVER REED EXP-550

16 CPS daisywheel printer, bi-directional printing, proportional and incremental spacing. Parallel... \$649

DAISYWRITER 2000

The intelligent letter-quality printer w/48K built-in buffer memory, 17 CPS, bi-directional, auto margin justification, universal interfaces \$1,059

FUJITSU SF 530

A super daisywheel with a max. speed of 80 cps (64 cps by Shannon text in 10 cps), two servomotors, a servo controlled position sensor and an ultra fast hammer assure speed and accuracy. It uses either the unique 127 character print wheel or the standard 96-character wheel, 110 or 220 VAC operation, par./serial... \$CALL

TOSHIBA P1350

Super dot-matrix printer w/24-pin buffer, 19 CPS, 19 pin, 360 dpi, 100 CPS letter-quality (parallel) \$CALL

JUKI 6100

18 CPS daisywheel, 13" platen, 2K buffer, 3-pitch, (parallel)... \$599
Tractor for 6100... \$120

TRANSTAR 130P

Letter quality daisywheel printer. 16 CPS, bi-directional, proportional spacing, super/sub script, underline, bold face. Parallel/serial... \$CALL

OKIDATA

ML-80, 80 CPS, 80 col. Parallel... \$269
ML-82A, 120 CPS, 80 col. pin & friction feed, parallel & serial... \$359
ML-83A, 120 CPS, 136 col. tractor & friction feed, parallel/serial... \$595
ML-84P, 200 CPS, 136 col. friction & tractor feed, (parallel)... \$980
ML-84S, above but serial... \$1,059
ML-82P, 160 CPS, 80 col. friction & tractor feed, (parallel)... \$499
ML-92S, above but serial... \$599
ML-93P, 160 CPS, 136 col. tractor & friction feed, (parallel)... \$699
ML-93S, above but serial... \$739
2410P, 350 CPS, 136 col. friction & tractor, 2-color, (parallel)... \$2,295

NEC

3550 Spinwriter, 350 wpm, 203 col., auto proportional space, justification, bi-directional, parallel... \$CALL
2050 Spinwriter, similar to above but 200 words per minute... \$CALL
CutSheet Feeder for 3550... \$CALL
7730 Spinwriter, 85 CPS, IBM compatible... \$CALL

IDS PRISM

IDS Microprism 480 printer... \$479
IDS Prism 80, 200 cps, 80 col. graphic, tractor/friction feed, sheet feeder, parallel... \$1,159
IDS Prism 80C, above + 4 color... \$1,259
IDS Prism 132, similar to Prism 80 but 132 columns, parallel... \$1,395
IDS Prism 132C, above + 4 color... \$1,495

All merchandise is brand new & guaranteed. All prices reflect 3% cash discount for full payment by cash, cashier's check/money order. Personal or company checks requires 2-3 weeks to clear. Visa, Mastercard & PO's accepted from qualified customers. COD's accepted with 20% paid deposit plus \$3 COD fee. No COD's to Canada or FPO/APO. Shipping/insurance/handling charges: 3% of total order value by UPS Surface, 5% by UPS Air & Parcel Post (Min. \$3). Calif. residents add sales tax. No sales tax on out-of-state orders. Prices & availability subject to change without notice.

EASTERN ENTERPRISES, INC.

Mass Merchandising Since 1969
2937 S. VAIL AVE., LOS ANGELES, CALIF. 90040
(Hours: Monday-Friday 8:30am-4:30pm Pacific Time)

TOLL-FREE (800)392-7081
(ORDERS ONLY)
Calif., Alaska, Hawaii & all info Call (213) 725-3080

Circle 141 on inquiry card.

Soviet Microprocessors and Microcomputers

A review of Soviet literature indicates that most microcomputers in the U.S.S.R. are based on older American microprocessors

Ruth Heuertz

United Telephone Company

An examination of the state of the Soviet microprocessor industry reveals some startling, and some heartening, evidence about how the free exchange of information within our society affects our political and military position in the world community. It also reveals that copying another's innovation may not be a straightforward process.

The Soviet computer industry is moving ahead due largely to Yankee ingenuity. American integrated circuit (IC) processing equipment is used to some extent to produce Soviet microprocessors and support chips that often are direct imitations of American designs. The K580IK80 microprocessor is acknowledged by the Soviets as being an analog of the Intel 8080. The Elektronika-60 is extremely similar to the DEC (Digital Equipment Corporation) LSI-11/2. And the K589 bit-slice microprocessor series appears to be copied from the Intel 3000 series of chips. But despite their reliance on American innovation, the Soviets seem intent on developing their own microelectronics industry to produce the devices they need, rather than obtaining all those devices from the West.

According to current literature, Soviet microprocessors based on all the major logic technologies have been developed. However, all but one of

these microprocessors are made of multiple chips. Soviet production techniques seem to be less sophisticated than, not as reliable as, and a few years behind their American counterparts.

I based my research of the Soviet development of microprocessors through 1982 primarily on Soviet literature available in the United States and literature from the U.S. government. A 1982 internal report for the U.S. electronics industry stated that the estimated yearly value of U.S. production of IC microprocessors and microcomputers is over \$1 billion. The report states that in 1980, U.S. IC manufacturers produced 71.6 percent of the world's integrated circuits. The rest were produced in Japan (16.1 percent), Europe (5.9 percent), and the Soviet bloc and the rest of the world (6.3 percent).

Soviet Technology

There is some controversy about how the Soviets obtain the equipment and many of the innovations necessary for their advancement in computer technology, even though their strength in the theory of computation is well recognized. The U.S. Senate's Permanent Subcommittee on Investigations conducted hearings in 1982 on the transfer of high technology to the U.S.S.R. from the United States. During the hearings,

several specialists testified on the state of the art of Soviet microelectronics and on the means by which the Soviets achieved it.

William Casey, director of the Central Intelligence Agency (CIA), reported to the subcommittee that

The KGB has developed a large, independent, specialized organization which does nothing but work on getting access to Western science and technology. They have been recruiting about 100 young scientists and engineers a year for the last 15 years. They roam the world looking for technology to pick up. Back in Moscow there are 400 to 500 assessing what they might need and where they might get it—doing their targeting and then assessing what they get. It's a very sophisticated and far-flung operation.

The United States enacted an embargo to keep high-technology equipment from being exported to the Soviet bloc. The U.S. Export Administration Act of 1979 was intended to prevent the Soviet Union from using such equipment militarily.

The Soviets are said to have set up dummy corporations in the West for the purpose of purchasing sophisticated microelectronics manufacturing equipment. A 1981 CIA report, "Soviet Acquisition of Western Technology," told the subcommittee that Western microelectronics equipment acquisitions had permitted the

Soviets to "systematically build a modern microelectronics industry."

Dr. Lara H. Baker Jr., at the Los Alamos Laboratory of the Department of Energy, gave evidence before the subcommittee that the Continental Technology Corporation, based in West Germany and southern California, sent more than \$10 million in American-made high-technology equipment to the Soviet Union from 1977 to 1980. Much of this equipment was intended for use in the manufacture and testing of semiconductors. Baker said the Soviets had "purchased clandestinely all the hardware they need for equipping a good integrated-circuit production plant. They showed no interest in purchasing production equipment that was not state of the art." Some of the equipment bought by the Soviets included saws for cutting silicon crystals, equipment for making masks for IC production, plotters to draw the circuits, etc. If these purchases were compiled, according to Baker, they'd include at least one complete IC processing plant.

The previously mentioned CIA report to the subcommittee stated that in 1982 the U.S.S.R. was considered to be at the stage of implementing its large-scale integration (LSI) technology to high-volume production. The U.S.S.R. had also sought Western aid in building two or three polysilicon plants that would more than double previous Soviet capability.

Production is normally done in the Soviet Union at specific enterprises, and research and development is done at others. But because of the restricted use of microcircuits (restricted perhaps to the military sector and not available in the civilian sector) and their rapidly changing nomenclature, microcircuits are developed and produced by computer equipment development enterprises. The Ministry of Instruments, Automated Equipment, and Control Systems (MINPRIBOR) coordinates the development and production of specialized LSI chips and microprocessors in the Soviet Union.

Printed-circuit boards are reportedly made, using domestic Soviet

equipment, by the Electromechanical Plant Production Association in Leningrad. The boards are produced in two sizes, 1.5 by 110 by 124 millimeters and 1.5 by 140 by 235 millimeters. These are said to be as "good as the best world models." Perhaps the Soviets consider printed-circuit boards produced by Texas Instruments (TI) as some of the best: in early 1983, it was found that boards used in some Soviet ocean buoys are pin-for-pin compatible with those produced by TI. According to the previously cited specialists, these copies may have been developed using American equipment.

A coordinated production of microcomputer-related equipment is in progress in Council for Mutual Economic Assistance (CEMA) countries, led by the U.S.S.R. In 1982, production of SM 1420 and SM 1800 (based on an 8080-like processor) microcomputers was reportedly under way. At the thirty-fifth meeting of CEMA in 1981, a program was organized for the extensive development of microprocessor equipment during the 1982-1990 period. A total of 52 pilot microprocessor complexes and microprocessor-based devices are to be developed, and 29 complexes are to be produced before 1990.

The Soviet computer industry has been dependent on Western technology, using American equipment to produce copies of American computer chips. But the Soviets seem determined (at least in print) to reduce their reliance on American computer technology.

A Soviet Single-Chip Microprocessor

The K580IK80 is often described in Soviet and American literature as the Soviet analog of the Intel 8080 microprocessor. (Note the similarity in the numeric designations.) The K580IK80 is the only known single-chip Soviet microprocessor; the majority of Soviet microprocessors are made of multiple chips. Nine of the 10 known Soviet chip series are designed for the construction of multichip microprocessors.

The K580IK80 is a single-chip NMOS (negative-channel metal-

oxide semiconductor) microprocessor that handles 8 bits of information at a time on a bidirectional data bus and can address up to 64K bytes of memory with its 16-bit address bus. It has one arithmetic and six general-purpose registers, 78 instructions, and eight priority interrupts. The instruction cycle time is 2 microseconds. The operating temperature range for the K580IK80 microprocessor is -10 to 70 degrees centigrade. The chip comes in a 48-pin package.

In comparing the Intel 8080 with these specifications for the K580IK80, the similarities are remarkable. The only differences are a slightly smaller temperature range for the Intel 8080 (0 to 70 degrees centigrade) and the packaging (the 8080 has 40 pins). The Soviet microprocessor is packaged in a hermetic 48-pin flatpack of white ceramic, sealed with a gold-tin lid. Such packaging is primarily used in the U.S. for high-reliability military devices; it is more expensive to produce than the black plastic case normally used for civilian purposes. According to L. W. Gallup, who analyzed the K580IK80 for Control Data Corporation, the 1980 Soviet construction processes for the K580IK80 were comparable to those used by American companies in 1977, judging by the line definitions of the metallization. Gallup reported, "This confirms my earlier estimates that their technology is about three years behind us."

As with the 8080, the Intel 8224 clock generator and driver was obtained by the Soviets and imitations of it produced. Several K580 chips perform functions similar to those of Intel chips. Table 1 is a comparative chart of chips with corresponding functions. Perhaps several of the K580 chips are direct copies of Intel chips. The similarity of names certainly reflects that.

The K580IK80 microprocessor is intended for controller and microcomputer applications, such as in the Soviet SM family of small electronic computers. Some microcomputers based on the 8-bit microprocessor are the Kristall-60 and the Elektronika-K1-10. Another machine probably using the K580IK80 is the SM 2138



Your Career Is Our Business- Catch Our Magazine

Grab the brass ring through COMPUTER CAREERS

COMPUTER CAREERS magazine, published by the editors of Graduating Engineer, will be issued in the fall. This McGraw-Hill publication, focusing on career development, will be edited for computer specialists working in leading edge areas such as computer graphics, communications and robotics, as well as mainstream design and application of computer technology.

You are only eligible to receive a free subscription if you have graduated with a computer engineering/science major or are actively involved in the design of or application of computer science technology in your job function and your graduation date is between 1977-1984.

To receive this free subscription to COMPUTER CAREERS, fill in one of the attached postcards. We must have your home address only. If both cards are missing, send your request to: Violet Frey, Circulation Manager, COMPUTER CAREERS, Graduating Engineer, McGraw-Hill Publications Company, 1221 Avenue of the Americas, New York, N.Y. 10020.

COMPUTER CAREERS editorial content will focus on interests and concerns of the computer science/engineering specialist. Articles will sift through the maze of computer-related jobs to show you what and where the opportunities are... tell you how to weigh them now and in the future... offer expert advice that will help you move successfully ahead in your career... identify areas where you can build your personal attributes to enrich your career. In addition, the reader has available a Resume Forwarding Service in each issue.

Circle 174 on inquiry card.

COMPUTER CAREERS



K580 Series

- K580IK80 microprocessor
- K580IK24 clock driver
- K580IK51 serial peripheral interface
- K580IK53 interval timer
- K580IK55 parallel peripheral interface
- K580IK57 DMA chip
- K580IK59 interrupt processor

Intel 8080 Series

- 8080 microprocessor
- 8224 clock generator and driver
- 8251A programmable communication interface
- 8253 programmable interval timer
- 8255 programmable peripheral interface
- 8257 DMA controller
- 8259 interrupt controller

Table 1: The Soviet K580 series of integrated circuit chips and Intel chips with corresponding functions.

single-board computer (SBC), which uses an Intel 8080-based microprocessor. The SBC is used in the SM 50/40-1 microcomputer system and the MVS microcomputer development system. The MIKAM-2 controller has an SBC with a "functionally complete Intel 8080 microprocessor," probably meaning a K580IK80. V7 control microcomputers have the RMS/80 operating system, which is functionally similar to Intel's RMX/80 system and so might also use the K580IK80 microprocessor.

Elements of the SM 2138 module include a system bus driver, a 2K-byte static random-access read/write memory (RAM) block, a 4K-byte erasable programmable read-only memory (EPROM) block, a serial interface, a

parallel interface for one input/output (I/O) peripheral or for two input or output peripherals, a programmable timer, and an interrupt controller.

The SM 1800 is a microcomputer whose characteristics sound as if an 8080-like chip is part of its processor board. It has an NMOS 8-bit microprocessor whose instruction cycle time ranges from 2.0 to 8.5 microseconds depending on the instruction executed. Maximum addressable memory is 64K bytes. The processor board has less RAM and read-only memory (ROM) on board than the SM 2138 in the SM 50/40-1 had. This board has 1K bytes of RAM and 2K bytes of ROM.

Soviet sources do not state specifically that the K580IK80 is used in

the SM 50/40-1 and SM 1800 microcomputers. The SM 50/40-1 uses an "Intel 8080-based" microprocessor, which I presume to be the K580IK80. The characteristics of the SM 1800's central processing unit seem similar enough to those of the SM 50/40-1 to infer that the same microprocessor, namely the K580IK80, is used.

The Dzerzhinsk Experimental Design Office of the Khimavtomatika Scientific Production Association was developing analytical devices and systems using the K580IK80 microprocessor in 1982. Production of the SM 1800 was being organized in 1981 and was to have begun in 1982 through Soviet cooperation with other CEMA countries.

Statements about production figures for a particular Soviet device are rare in Soviet literature. In 1982, only 36 SM 50/40-1 microcomputer systems and 20 MVS systems were to be produced. These were to be punched-tape versions rather than disk versions. It was projected that 300 total systems would be produced in 1983 and 400 systems in 1984. That prediction was the only one in the Soviet sources I studied.

The Elektronika S5 Microcomputer Family

The S5 microcomputer line belongs to the larger Soviet Elektronika family. The microprocessors for this series seem to generally be con-

*IBM PC Compatible



E - PROMS - CALL! Lowest Prices Anywhere

- *4164-150P \$520
- *4164-200/250 505/469
- 4116-200 149
- *4164-120 549
- 6116-P3 499

Disk Drives: (F.D.B. Tampa)

- *TM-100-2 \$ 22424
- 4 29983
- *TM- 55-2 22386
- *10 mb Win 1,38547

(MS/DOS 2.0/IBM plug in & go)

Add \$2.95 shipping to all orders, 2.6% for credit card orders
 OEM • Quantity discounts available • P.O.s on approval • C.O.D. OK • Credit cards • FL residents add 5% tax • All new, no surplus, no seconds
 (Prices subject to change.)

4920 Cypress St., Tampa, FL 33607
 In FL, and for info., call 813-875-0299
FOR ORDERS ONLY, 800-237-8910



8 AM-8 PM EST

Circle 286 on inquiry card.

MAKE YOUR COMPUTER TALK

Best buy in speech synthesis!!

Plug in PROTALKER by Speech, Ltd. & your computer could be talking today. PROTALKER uses superior technology to provide high fidelity reproduction of any speaker's voice & intonation. Record & play messages in any language. PROTALKER comes with ready-to-use software for: easy preparation of speech files; playing messages from BASIC; and source assembly language drivers. You choose the best storage/quality trade-off with switch selectable digitizing rates of 2, 3, or 4 KB/sec. Use PROTALKER to insert voice instructions in all your programs. Manual comes with easy to follow programming examples. PROTALKER provides the best quality speech synthesis available for your micro.

Free software for ordering now!! PROTALKER & manual \$325. Manual only \$20. Specify S-100 or IBM PC board; CPM, CPM-86 or MS-DOS; 8" IBM SS-SD or 5 1/4" IBM PC disk format. M/C & VISA. Include your card number & expiration date. CA residents add 6.5% sales tax.

SPEECH, LTD.

3790 El Camino Real, Suite 213
 Palo Alto, CA 94306 415-858-2795

Circle 235 on inquiry card.

NEW LOW PRICES

MEDIA CONVERSION

We Put Your Data Where YOU Want It!

Your data can be copied from and/or to any of the following: 1/2" mag tape, 8" Diskette, 5 1/4" Diskette.

- 1/2 Inch Magnetic Reel Tape: 800 / 1600 B.P.I. ASCII / EBCDIC
- 8 Inch Diskette: CP/M, IBM 3740, DEC RT-11
- 5 1/4 Inch Diskette: Apple II — DOS, CP/M, Pascal IBM PC/XT — MS-DOS, CP/M

PLUS

Virtually ALL Soft-sectored Formats
PROFESSIONAL DATA SERVICES

385 Woodley Road
 Santa Barbara, CA

805/969-6993 9:00-5:30 PST

NEW FORMATS AVAILABLE

Circle 64 on inquiry card.

MicroAge[®]

**"BECAUSE WE COULDN'T
AFFORD MISTAKES!"**

"They guided us over the rough parts when we needed it"

"During September of 1982, we started our MicroAge Computer Store in Tulsa, Oklahoma with 3 people. Today we have 21 people working for us and two stores. By following MicroAge's advice and marketing strategy when we started in business, we were able to reach Tulsa's business computer buyers in a much shorter time than we could have on our own."

"Both of us had technical backgrounds in computers but lacked the marketing experience necessary to reach our goals. We used MicroAge's experience and leadership to guide us through the rough spots and boost our sales and marketing potential."

"MicroAge . . . they helped us build a sales organization to reach the Oklahoma businessman."

John E. Mosier

John Mosier
MicroAge Franchisee

George B. McLawhon

George McLawhon
MicroAge Franchisee

To build your own professional computer sales organization with MicroAge write to:

MicroAge[®]
COMPUTER STORES
"The Solution Store"[®]

1457 West Alameda • Tempe, Arizona 85282

(602) 968-3168



MicroAge franchisees John Mosier and George McLawhon shown with IBM products.

Circle 244 on inquiry card.

| | S5-01 | S5-02 | S5-11 | S5-12 | S5-21 |
|--|-------------------|-------------------|--------------------|------------------|------------------|
| minimum number of boards | 3 | 3 | 1 | 1 | 1 |
| word length (bits) | 16 | 16 | 16 | 16 | 16 |
| number of instructions | 31 | 31 | 31 | 31 | 31 |
| speed (thousand operations per second) | 10 | 10 | 10 | 10 | 150-200 |
| chip series | K536 | K536 | K536 | K536 | K586 |
| logic technology | PMOS | PMOS | PMOS | PMOS | NMOS |
| year introduced | 1975 | n.a. | 1976 | n.a. | n.a. |
| RAM in words | 3K | 4K | 128K | 128K | 256K |
| ROM in words | 2K | 2K | 1K | 2K | 2K |
| memory expansion (words) | to 28K bytes | to 32K* | to 32K | to 32K | to 32K |
| power consumption | 90 W | 100 W | 10 W | 30 W | 20 W |
| power requirement (+ V) | n.a. | n.a. | 1.5, 5, 24 | 1.5, 5, 24 | 5, 12 |
| dimensions (millimeters) | 420 by 380 by 225 | 460 by 412 by 243 | 267 by 270 by 28.5 | 284 by 298 by 30 | 309 by 252 by 29 |
| weight (in approximate kilograms) | n.a. | 23 kg | 1.2 kg | 1.5 kg | 1.2 kg |
| operating temperature (centigrade) | - 10 to +50 | - 10 to +50 | - 10 to +50 | - 10 to +50 | - 10 to +50 |

* It is not clear if the Soviet literature is referring to words or bytes of memory.

Table 2: A comparison of Elektronika S5 microcomputers.

structured using multiple chips. One of the U.S.S.R. state prizes for science and technology was awarded to an unnamed group for their "creation and widespread introduction" of the Elektronika family.

The S5 microcomputers use the same instruction set and have 16-bit words and memory-mapped I/O channels. Data can be processed by the word or by the 8-bit byte. Four S5 models are constructed using the K536 series chips and one uses the K586 series chips. The K536 chip series is used in these S5 microcomputers: the S5-01, the S5-02, the S5-11, and the S5-12. The chips are built using PMOS (positive-channel metal-oxide semiconductor) logic technology. The Elektronika S5-01 was introduced in 1975 and the Elektronika S5-11 in 1976. The S5-02 is an update of the S5-01, as is the S5-12 of the S5-11.

The K586 NMOS chip series is used in the Elektronika S5-21 microcomputer, which was first mentioned in Soviet literature in 1980. The K586IK1 is a 16-bit chip in the K586

series of chips. In one article, it is said to be a single-chip microprocessor, but an earlier reference maintains that the K586IK1 is a 16-bit arithmetic-logic unit (ALU) chip requiring a control chip and other chips to make a 16-bit microprogrammable microprocessor.

Table 2 has been formed by choosing information from various sources in an effort to provide an overall representation of the Elektronika S5 family. These sources have at times been at odds; the information that seems most consistent to the S5 series as a whole has been included.

The S5-11 was to be used in arms and in automobile construction. (Such a reference to Soviet military usage is extremely rare among the Soviet sources.) Since the K536 chips are said to be available in ceramic-metal packages, and the S5-01, S5-02, S5-11, and S5-12 microcomputers are all built using this chip series, perhaps the S5-01, S5-02, and S5-12 have also been used in weapons. Applications for the S5 microcomputers were under development at the

Volga-Vyatsk Regional Center for Debugging and Application of Microcomputers of the Family Elektronika S5.

An LSI-11/2 Look-Alike

The Elektronika-60 microcomputer system is one of the systems mentioned frequently in Soviet literature. It uses four 48-pin chips from the K581 NMOS chip series to make up the microprocessor. These chips are the K581IK1 (ALU) section, the K581IK2 control device, and the K581RU1 and K581RU2 microprogrammable memory. The microcomputer has 4K by 16-bit on-board RAM made up of chips that each store up to 512 words of 12-bit length. The K581 chip series was under production in 1980 and 1981.

The Elektronika-60's ALU handles 16-bit words, but the K581IK1 ALU chip is not cascadable. It has a speed (instruction cycle time) of 400 nanoseconds. There are eight 16-bit general-purpose registers and 26 microcode registers. The maximum address range is 32K by 16 bits. The mi-

When it comes to software development, the difference between a Sage IV computer and other micros is like day and night.

With the Sage Computer it'll take you fewer days and nights to finish your program.

Speed is the reason. Speed resulting from the fast MC68000 microprocessor, fast architecture, fast operating systems, and blinding transfer rates.

The fact is, even we are surprised by the amount of software that's developed on Sage Computers.

So if you're a programmer, maybe you should spend some time learning how much time you could save using a Sage IV.

The Hottest Languages And Operating Systems.

Programs in nearly all of the important languages can be written on the Sage computer.

Included in the price is the **p-SYSTEM** operating system which supports **Pascal, BASIC, and FORTRAN.**

Other operating systems are optional. For **UNIX** fans there's **IDRIS**, which runs up to twice as fast (even without a Sage computer). **IDRIS** conforms to *lusr* /Group Standards Committee

standards and programs written under it are highly portable to other micros.

CP/M advocates please note that Digital Research has developed **CP/M-68K** for Sage hardware, providing a truly complete software development environment. Versions of **Pascal, BASIC, C-BASIC, C,** and **FORTRAN 77,** as well as a very fast **APL,** may be used under this operating system.

The Sage IV is also blindingly fast when

If you found your language here, you just found your computer. The 16-bit, 2-million operation/sec Sage IV micro with up to one MByte RAM and 18-MByte internal hard disk.

For more information and the name of your nearest SAGE dealer, call us today. And be sure to ask about our new software catalog describing over 200 application programs for Sage computers.

Sage Computer Corporate Office,
4905 Energy Way, Reno, Nevada
89502. Phone (702) 322-6868
TWX: 910-395-6073/SAGE RNO

Eastern United States
Sage Computer
15 New England
Executive Park
Suite 120, Burlington, MA
01803 (617) 229-6868



running **hyperFORTH** with its extended programmer and user interfaces.

Besides **IDRIS**, other **Multi-User** operating systems that run on the Sage Computer are **PDOS, MBOS, and MIRAGE.**

A lot of excitement has been brewing in the Pascal World over Niklaus Wirth's new **MODULA 2**—and it's available for Sage computers. So is **ADA**, for the record.

© 1983 Sage Computer Technology all rights reserved Sage & Sage IV are trademarks of Sage Computer Technology

SAGE
COMPUTER



| | DEC LSI-11/2 | Elektronika-60 |
|--|----------------|-------------------|
| technology | NMOS | NMOS |
| number of microprocessor chips | 4 | 4 |
| word size (bits) | 16 | 16 |
| on-board RAM | 8K by 8 bits | 4K by 16 bits |
| number of instructions | over 70 | 64 or 78 |
| number of general-purpose registers | 8 | 8 |
| number of microcode registers | 26 | 26 |
| cycle time (nanoseconds) | 350 | approximately 400 |
| instruction execution times (microseconds) | 3.5 to 7.7 | 4.0 to 7.5 |
| number of addressing modes | 12 | 11 |
| maximum address range | 32K by 16 bits | 32K by 16 bits |

Table 3: A comparison of the Elektronika-60 microcomputer with the DEC LSI-11/2.

croprocessor module for the Elektronika-60 comes on a 280- by 240-millimeter board.

The Elektronika-60 was developed by the Ministry of the Electronics Industry (MINELEKTRONPROM) and by the Ministry of the Radio Industry (MINRADIOPROM). The Electronic Instrument-Making Association in Leningrad develops and produces LSI circuits and microprocessors that are used in several models of the Elektronika family. Products of the Association are distinguished by their high quality, and the number of products receiving the Soviet State Mark of Quality is increasing. This is apparently in opposition to typical Soviet production systems, which tend to stress quantity rather than quality. The microprocessor of the Elektronika-60 is provided by "the Leningraders" to a plant in Yerevan where controllers for the production of machining tools are made. This information suggests that the Elektronika-60's microprocessor is produced in Leningrad by the Association.

The Elektronika-60 reportedly uses an instruction set similar to that of the DEC LSI-11/2 microcomputer. The LSI-11/2 was a refined version of the LSI-11 introduced in 1975. This single-board computer was the first American microcomputer using 16-bit architecture, which at that time was ap-

pearing only in minicomputers. It had 8K bytes of resident RAM and its board size was 10 by 8.5 inches. The LSI-11/2 appearing in 1977 had its board size reduced to 5.2 by 8.9 inches but kept the same microprocessor features.

Further specifications of the LSI-11/2, according to DEC, are as follows. The LSI-11/2 microprocessor consists of four NMOS 40-pin packages: the data chip, the control chip, and two microcode ROM chips. Maximum address range is 32K by 16 bits or 64K by 8 bits. The LSI-11/2 microprocessor module contains eight 16-bit general-purpose registers. Cycle time is 350 nanoseconds.

Table 3 lists some shared characteristics of the Elektronika-60 and the DEC LSI-11/2.

Much of the information about the Elektronika-60 reads as though it came from a DEC manual about the LSI-11/2. And because of the similarities, I think that the Elektronika-60 is an imitation of the LSI-11/2. However, this speculation could be confirmed only through observation of an actual system.

The K589 Bit-Slice Series

The K589 chip series is used to build high-speed microprocessors and microcomputers using the bit-slice method to cascade ALU slices

together for the required word length. The chips are of Schottky bipolar technology and use the pipelining principle in a K589 microprocessor complex.

The K589 ALU slice is the K589IK02 chip, which comes in a 28-pin package. Each slice has a 2-bit capacity. The chip has one accumulator and 11 general-purpose registers. Its speed is 70 nanoseconds, and the single power supply is +5 V. The K589IK02 has an operating temperature range of -10 to +70 degrees centigrade. The microprogram control chip is the K589IK01, also built using Schottky bipolar technology. Its speed is 60 nanoseconds. It comes in a 40-pin package.

The K589 line is strikingly similar to the Intel 3000 series. The 3001 microprogram control unit and the 3002 central processing element are built using Schottky bipolar technology. The 2-bit 3002 has one accumulator and 11 general-purpose registers. It has a minimum cycle time of 70 nanoseconds. The 28-pin chip requires +5 V.

The 3001 microprogram control unit can control 512 words of microprogram ROM. A pipelined configuration of these can be formed for 2048 microinstruction addressability. The minimum cycle time is 60 nanoseconds. The 3001 also comes as a 40-pin chip. (Table 4 lists chips of the K589 and Intel 3000 series with corresponding functions.)

Soviet microcomputer development has steadily become more technologically sophisticated. Beginning in 1975, PMOS technology was evident in the development of the Elektronika S5-01 microcomputer, which uses the K536 chip series. The Elektronika-60 microcomputer using series K581 chips, various microcomputers using K580 chips, and the Elektronika S5-21 using series K586 chips were of NMOS technology. The Elektronika-60 was said to be in use by 1979, the Elektronika S5-21 by 1980. In 1980, the K580 chip series was under production. I was unable to find definite development dates for these three series. Of the CMOS microcomputers, the Elektronika NTs-80-01 using the K588 chip series

Four Reasons Why The Dysan Difference is Worth Paying For

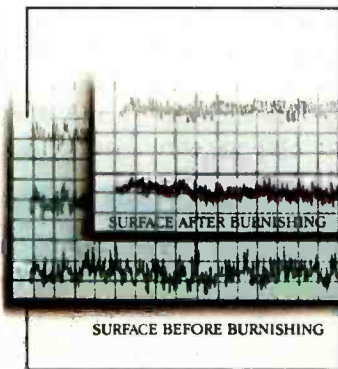

1. 100% Surface Tested

Only Dysan provides fully usable diskette surfaces that are truly 100% error-free across the entire face of the diskette. An exclusive on-and-between the track testing procedure guarantees error-free performance regardless of temperature and humidity distortions or slight head misalignments.

2. Advanced Burnishing Techniques

Dysan's advanced polishing methods create a smoother, more uniform diskette surface. This results in better signal quality on each track, less wear on drive heads and reliable access to data after millions of head passes.

3. DY¹⁰™ Lubricant

Dysan's proprietary DY¹⁰ lubricant complements the advanced burnishing process. Both maximize error-free performance while minimizing headwear. Optimal signal presence is maintained between the head and diskette surface during millions of write/read interfaces.

DY¹⁰ is a trademark of Dysan Corporation

4. Auto-Load Certification

Dysan's unique quality control methods reflect technological leadership in designing, producing and testing precision magnetic media. Each diskette is unerringly certified by Dysan-built, automated and microprocessor controlled certifiers. Your system and data base will benefit from Dysan's diskette reliability and unsurpassed quality.

Select from a complete line of premium 8" and 5 1/4" diskettes, in single or double densities, certified on one or both sides.

Circle 140 on inquiry card.



Corporate Headquarters:
5201 Patrick Henry Drive
Santa Clara, CA 95050
(800) 551-9000

K589 Series

K589IK01 microprogram control chip
K589IK02 central processing element
K589IK03 fast carry unit
K589IR12 buffer register
K589IK14 priority interrupt chip
K589AP16 bus driver
K589AP26 bus driver with inversion

Intel 3000 Series

3001 microprogram control unit
3002 central processing element
3003 look-ahead carry generator
3212 multimode latch buffer
3214 priority interrupt unit
3216 noninverting bidirectional bus driver
3226 inverting bidirectional bus driver

Table 4: *The K589 bit-slice series of chips and the equivalent Intel 3000 series of chips.*

reportedly was developed in 1979. The K589 series of Schottky bipolar technology and the K584 series of integrated injection logic (I²L) technology seem to have been developed in the 1979-80 period.

Soviet microcomputer specialists use terminology differently from Americans. For example, the K580, K582, and K586 series are said to be single-chip microprocessors; the Elektronika NTs-80 microcomputers

are referred to as having single-chip *microcomputers*. The term *microcomputer* is confused with *microprocessor*. Only the K580IK80 chip of the the K580 series is a single-chip microprocessor in the sense in which Americans use the term. The K580IK80 has the control unit and ALU on the same chip. But these other series—K582, K586, and K588 used in the Elektronika NTs-80 microcomputers—all have at least one con-

trol chip along with an ALU chip. In the West, these would be considered multiple-chip microprocessors.

Only one of the 10 known Soviet chip series includes a single-chip microprocessor—the K580IK80 of the K580 series chips. The overwhelming emphasis on multiple-chip microprocessors and microcomputers in the U.S.S.R. is surprising in comparison with an American emphasis on single-chip microprocessors. The Soviet multichip emphasis began with the Elektronika S5-01 bit-slice microcomputer. Soviet multichip microprocessors of NMOS, CMOS, I²L, and Schottky bipolar technologies have since been developed and produced. A disadvantage of the multichip method is that more space must be made available for the chips on the circuit boards. An advantage is that the needed density per chip is much lower, requiring less sophisticated production equipment. Additionally, less reliable production techniques can be used since the rejection of one chip does not mean the loss of the entire microprocessor, as it would in

AN ORDINARY DISK
CAN TAKE YOUR
BUSINESS AND
ZARNOUC BO
NOR ZINBE DAG.

producing single-chip microprocessors.

A compilation of some characteristics of known Soviet chip complexes is provided in tables 5 and 6.

Summary

How far is Soviet microcomputer technology behind American technology? L. W. Gallup at Control Data had direct access to the K580IK80 chip; comparing it to the Intel 8080, he concluded that Soviet chip construction technique was about three years behind American technique.

My research has relied on Soviet literature about their technology. Using this material, it is not easy to tell how advanced Soviet hardware is. In this kind of research, you must consider consistency in reports about particular devices to determine device characteristics. I have assumed that published reports about hardware lag behind actual developments; a truly up-to-date report on the Soviet state of the art cannot be attained through this approach. In considering how wide the gap be-

| Chip Series | Technology | Bit Groups | Single Chip | Multichip | Bit Slice |
|-------------|------------------|------------|-------------|-----------|-----------|
| K536 | PMOS | 8 | | • | • |
| K580 | NMOS | 8 | • | | |
| K581 | NMOS | 16 | | • | |
| K582 | I ² L | 4 | | • | |
| K583 | I ² L | 8 | | • | • |
| K584 | I ² L | 4 | | • | • |
| K586 | NMOS | 16 | | • | |
| K587 | CMOS | 4 | | • | • |
| K588 | CMOS | 16 | | • | |
| K589 | Schottky bipolar | 2 | | • | • |

Table 5: A comparison of the different Soviet microprocessor series.

tween Soviet and American development is, it is interesting to note the appearance times of the Intel 3000 series and the corresponding Soviet K589 series. The 3000 series was introduced in the U.S. in late 1974. A specific introduction date for the K589 series is unknown; however,

the earliest examples of its usage appeared in 1980 Soviet literature. If we assume that the K589 series was introduced in late 1979 or early 1980, that would indicate a five- to six-year lag in development time.

It is apparent that some Soviet equipment is copied from American

Let the gibberish stop here.

The TDK No-Risk Disk.™

Because no matter how many times you play it, the TDK No-Risk Disk won't scramble your thoughts or play games with your words.

Not once. Not ever.

Our lifetime replacement warranty guarantees that.

And our almost 50 years of experience in developing superior magnetic recording products support that.

That incidentally is more than you can say for any other disk.

Bringing us to our point.

Don't play games with an ordinary disk.

When you can play for keeps with an extraordinary disk.



TDK offers a complete line of the most popular disks in 5¼- and 8-inch formats.

TDK. THE NO-RISK DISK.™

Want to hook IBM?

Terminals. Personal Computers. ASCII devices. Hook them all into the IBM world with the new AVATAR™ PA1000 Protocol Converter.

The PA1000 provides low-cost IBM 3278/2 terminal emulation and coaxial connection to an IBM 3274/3276 cluster controller. Then, a single keystroke switches you back into the asynchronous world through an auxiliary RS-232-C port to access other computer systems, public information services or copy a screen to a printer.

Our microprocessor-based unit provides user-selectable rates up to 9600 baud, terminal keyboard configura-

tions, screen management and local or remote print functions. And, you can hook the PA1000 to a modem for remote dial-in access.

Simple, economical access to the world of IBM, just when you thought there was no answer. At \$995, getting hooked has never been so affordable. For more information on our AVATAR PA1000 Protocol Converter, contact

Avatar Technologies Inc.
99 South Street
Hopkinton, MA 01748

Or call us at
(617) 435-6872.

AVATAR™

Making IBM smarter since 1983.

IBM is a registered trademark of International Business Machines Corp.

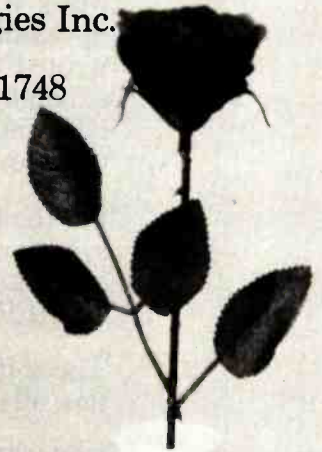

COHERENT™ IS SUPERIOR TO UNIX* AND IT'S AVAILABLE TODAY ON THE IBM PC.

Mark Williams Company hasn't just taken a mini-computer operating system, like UNIX, and ported it to the PC. We wrote COHERENT ourselves. We were able to bring UNIX capability to the PC with the PC in mind, making it the most efficient personal computer work station available at an unbelievable price.

For the first time you get a multi-user, multitasking operating system on your IBM PC. Because COHERENT is UNIX-compatible, UNIX software will run on the PC under COHERENT.

The software system includes a C-compiler and over 100 utilities, all for \$500. Similar environments cost thousands more.

COHERENT on the IBM PC requires a hard disk and 256K memory. It's available on the IBM XT, and Tecmar, Davong and Corvus hard disks.

Available now. For additional information, call or write,

Mark Williams Company
1430 West Wrightwood, Chicago, Illinois 60614
312/472-6659



Toward Standardized Video Terminals

ANSI X3.64 Device Control

A set of codes that promises to alleviate incompatibility

Mark L. Siegel
Televideo Systems Inc.

The video screen and the keyboard are the means by which most of us communicate with our computers, and they probably will remain the most efficient vehicles of human/computer interaction for years to come. A video-display terminal is a neat package containing both screen and keyboard, and even though many of today's personal computers contain integral keyboard and video-display circuits, discrete terminals are still the user workstation of choice in most large and many small computer systems. And most of the terminal operation principles involved apply also to the computers that integrate the functions.

Although conceptually and physically convenient, video-display terminals have suffered from software incompatibility. But a direct attack on this problem has been mounted by the development of a standardized method of controlling a terminal's functions. In this article I will describe the weapon of attack: the ANSI X3.64 standard.

Why a Standard is Needed

What happens when you sit down at a video-display terminal and hit

the Return key? The cursor on the screen responds by moving to the left edge of the screen (and sometimes also down one line). You get the impression that the key directly controls the cursor's movement. But it doesn't. The depression of the key is sensed by the terminal's keyboard-control circuitry, which generates a unique binary code. The terminal's display-control hardware receives this code, interprets it, and recognizes it as a Return character; the hardware then moves the cursor's position accordingly. Or it can be even more complex: the key depression can be transmitted to a remote computer, where a program is running that analyzes the Return-key code and transmits back some different code to modify the screen contents in a way appropriate to some particular application.

The interface between a terminal and a computer must take account of compatibility on both the electrical level and the code (or logic) level. For specifying alphanumeric and other printable or displayable characters, all peripheral devices found in personal computer systems use the set of codes known as ASCII, the American

National Standard Code for Information Interchange, shown in table 1. (ASCII's formal name is ANSI X3.4-1977; the abbreviation is pronounced "ass-key.") Some departures from the ASCII standard occasionally do occur in the character set, in some seldom-used characters, but differences typically emerge in how each manufacturer defines the codes for control functions.

Designers of terminals (and other peripheral devices) must choose a set of codes to indicate not only which alphanumeric characters are to be displayed or printed, but also to initiate various control functions: to move cursors, change colors, or scroll the display. Most video terminals use similar hardware to control the display. What may be different are the binary codes that have been chosen to represent the particular functions. Thus, even if one terminal's circuitry is almost identical to another's, if the control codes are different, the two terminals cannot be used with the same software.

ASCII was developed with the activities common to simple printers and teletypewriter terminals in mind. However, the variety of computer pe-

| b_7 _____ b_6 _____ b_5 _____ | | | | | | 0 | 0 | 0 | 0 | 1 | 0 | 1 | 1 | 1 |
|---|------------|------------|------------|------------|----------------|-----|-----|----|---|---|---|---|-----|---|
| Bits | b_4 ↓ | b_3 ↓ | b_2 ↓ | b_1 ↓ | Column Row↓ | 0 | 1 | 2 | 3 | 4 | 5 | 6 | 7 | |
| | 0 | 0 | 0 | 0 | 0 | NUL | DLE | SP | 0 | @ | P | | p | |
| | 0 | 0 | 0 | 1 | 1 | SOH | DC1 | ! | 1 | A | Q | a | q | |
| | 0 | 0 | 1 | 0 | 2 | STX | DC2 | " | 2 | B | R | b | r | |
| | 0 | 0 | 1 | 1 | 3 | ETX | DC3 | # | 3 | C | S | c | s | |
| | 0 | 1 | 0 | 0 | 4 | EOT | DC4 | \$ | 4 | D | T | d | t | |
| | 0 | 1 | 0 | 1 | 5 | ENQ | NAK | % | 5 | E | U | e | u | |
| | 0 | 1 | 1 | 0 | 6 | ACK | SYN | & | 6 | F | V | f | v | |
| | 0 | 1 | 1 | 1 | 7 | BEL | ETB | ' | 7 | G | W | g | w | |
| | 1 | 0 | 0 | 0 | 8 | BS | CAN | (| 8 | H | X | h | x | |
| | 1 | 0 | 0 | 1 | 9 | HT | EM |) | 9 | I | Y | i | y | |
| | 1 | 0 | 1 | 0 | 10 | LF | SUB | * | : | J | Z | j | z | |
| | 1 | 0 | 1 | 1 | 11 | VT | ESC | + | ; | K | [| k | { | |
| | 1 | 1 | 0 | 0 | 12 | FF | FS | , | < | L | \ | l | | |
| | 1 | 1 | 0 | 1 | 13 | CR | GS | - | = | M |] | m | } | |
| | 1 | 1 | 1 | 0 | 14 | SO | RS | . | > | N | ^ | n | ~ | |
| | 1 | 1 | 1 | 1 | 15 | SI | US | / | ? | O | _ | o | DEL | |

Table 1: The American National Standard Code for Information Interchange (ASCII). This table is arranged to allow the character positions to be specified in column/row character notation, where the column number is the decimal equivalent of bits b_7 through b_5 in a 7-bit environment (or bits a_8 through a_5 in an 8-bit environment), and the row number is the decimal equivalent of bits b_4 through b_1 or bits a_4 through a_1 , with b_7 (or a_8) the most significant bit in the character. Bit combinations are represented by the notation "column m , row n " or alternatively as " m/n ", where m and n are the decimal column and row numbers, respectively. For instance, the capital letter A is the character in position 4/1.

ipherals has grown considerably, and the number of different functions has also grown. The 32 control characters specified by the X3.4 ASCII standard became inadequate some years ago for providing peripheral control for the growing crop of new peripherals and their functions.

Many applications today demand sophisticated editing capability in video terminals, which therefore must have versatile screen-control functions. Users wish to be able to quickly move the active position (and its cursor) to any point on the display screen. Also, they need the flexibility for inserting and deleting single characters, strings of characters, or entire lines. These control functions go well beyond the scope of the ASCII standard.

When no control-function standard existed, designers of peripherals

created their own control sequences using whatever combinations of ASCII control characters seemed handy. It was not uncommon, especially in devices with many functions, for designers to exhaust the existing set of control codes. They had to resort to using longer combinations or sequences of control characters. Because there were no common guidelines for creating these sequences, no two manufacturers used the same ones for the same purposes.

As a result, a programmer developing application software for a computer system always had to find out the specific codes used by the particular peripheral devices attached to the computer in order to write the device-driver portions of the software. This part of the program was therefore device-specific and would

work properly with only that particular device or another that happened to employ the same control codes.

Application programs written to be used from a video terminal had to contain code to match that particular terminal's control sequences—often rendering the application programs useless on a system with a different terminal.

For vendors that design and manufacture all the components of their computer systems, use of proprietary terminal-control character sequences posed few problems. But vendors that assembled systems by purchasing processors, terminals, and peripherals from different manufacturers regarded the proliferation of control protocols as a plague, as did a group of manufacturers that sold terminals to those vendors. Expecting

THE ULTIMATE MULTI-PROCESSOR BUILDING BLOCKS

SBC 300
single board computer

VFW-III
floppy/Winchester disk controller

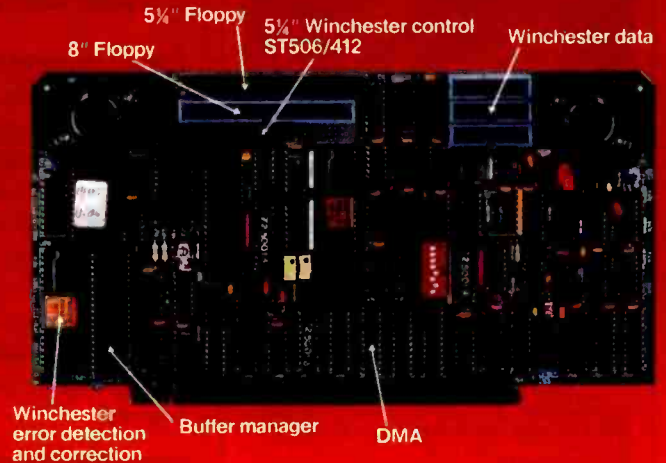
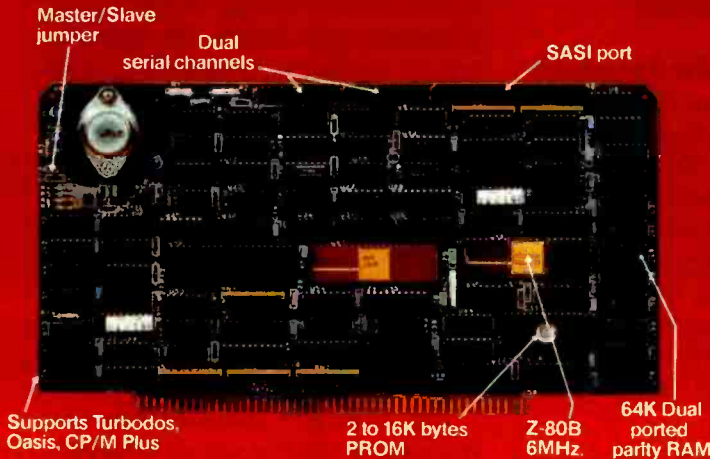

AND HERE'S WHY!

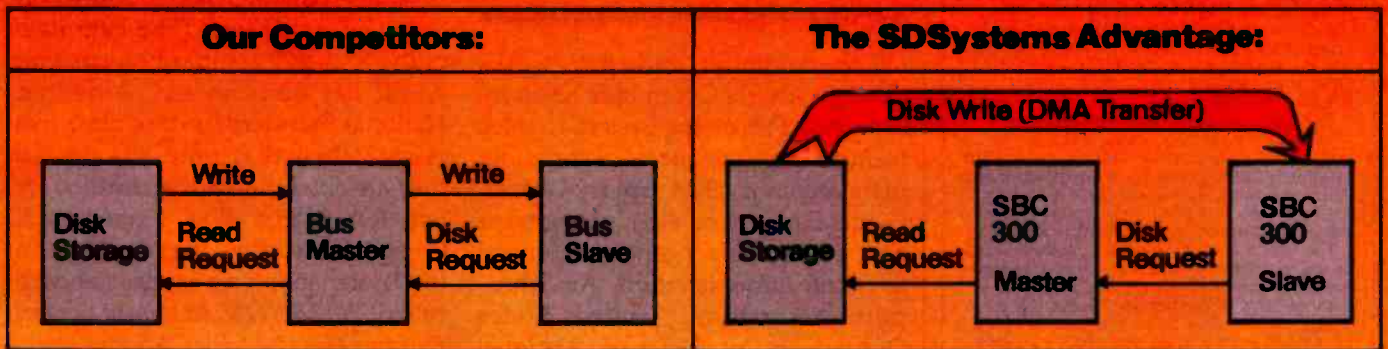

The SBC 300 offers you 64K bytes of dual ported parity RAM. Dual porting allows DMA transfers from disk storage *directly* to an individual slave processor. This maximizes multi-processor system performance.

Performing the DMA transfers is the VFW-III peripheral controller. It is quite possibly the only S-100 disk controller you'll ever want to buy. With the VFW-III you'll have simultaneous control of up to three 5 1/4" Winchester drives and up to four 5 1/4" and 8" floppy drives.

Together they are the ultimate multi-processor building blocks. Systems integrators appreciate our strict adherence to the IEEE-696 specification and our complete line of high quality S-100 bus products. Evaluation hardware is available for qualified OEM's. Call, write, or circle the number below to receive technical information on these and other fine SDSystems products.

Z80 product Zilog Corp. Turbos is a trademark of Software 2000, Inc. Oasis is a trademark of Phase One Inc. CP/M Plus is a trademark of Digital Research, Inc.

We make C easy...



and work!

Eco-C compiler...we've got it all.

Whether you're a seasoned professional or just getting started in C, the Ecosoft C compiler has everything you'll ever need.

COMPLETENESS:

Our Eco-C compiler is a complete implementation of C and supports all operators and data types (including long, float and double).

EFFICIENCY:

The compiler generates extremely efficient Z80 code using Zilog's mnemonics. On the benchmarks tested, typically we finished either first or second using substantially less generated code.

PORTABILITY:

The Eco-C library contains over 100 functions that are UNIX V7 compatible, and includes a complete transcendental package. Programs developed with the Eco-C compiler can be moved to virtually any system with little or no change.

EASE OF USE:

The Eco-C compiler includes Microsoft's MACRO 80 assembler, linker, library manager and supporting documentation. The assembler (M80) generates industry-standard REL file output. The linker (L80) is fast and uses only the functions you request in the program. Program development is a snap.

The user's manual is clear, concise and full of useful information. For those of you just getting started with C, we also include a copy of the C Programming Guide (Que). This B. Dalton Best Seller has been adopted by a number of leading universities around the country and is included with each compiler. The book is designed to help you learn C from the ground up. We ought to know...we wrote the book.

We've made the compiler easy to work with for the professional and beginner alike. Most error messages, for example, tell you in English (not just a number) the line number and character position of the error, what was expected and a page reference to the Guide to consult for help if you need it.

PRICE:

We saved the best for last; we've cut the price by \$100.00. Now you can buy the Eco-C compiler for only \$250.00 (MACRO 80 and the book alone are worth \$218.00!). Shop around and we think you agree that the Eco-C compiler is the best value available.

The Eco-C compiler requires a Z80 CPU, CP/M, 54K of free memory and about 240K of disk space (one or two drives). An IBM-PC version will be available in the first quarter of 84. To order your Eco-C compiler, call or write.



Ecosoft Inc.
P.O. Box 68602
Indianapolis, IN 46268
(317) 255-6476



TRADEMARKS:
Eco-C (Ecosoft), MACRO 80 (Microsoft), CP/M (Digital Research)

to benefit greatly from the existence of a standard set of control sequences, these independent peripheral-device manufacturers became conspicuously interested during the late 1960s and early 1970s in the attempt by ANSI, the American National Standards Institute, to develop an American National Standard for device-control character sequences to be used together with the printing-character ASCII standard.

Development of the Standard

One surprise about American National Standards is that their use is largely voluntary. ANSI cannot of itself force any manufacturer to produce products conforming to them, but ANSI standards carry considerable weight because of ANSI's fair and methodical committee process and the organization's reputation for representing nearly all interested parties.

A key part of X3.64 is the control-sequence introducer.

The computer industry works through ANSI's Committee X3 on Information Processing Systems, which includes representatives of computer manufacturers (IBM, Sperry Univac, Digital Equipment, etc.), user groups and government agencies (General Services Administration, Air Transport Association, United States Department of Defense, National Bureau of Standards), and trade and professional associations (Institute of Electrical and Electronics Engineers, Association for Computing Machinery, etc.). All American National Standards pertaining to computers pass through committee X3. The standards bear numbers showing their committee origin, their sequence of adoption, and the year they were approved—like X3.64-1979. (For more detailed information, see reference 4.)

The X3 committee assigned the work of developing the device-control extensions to ASCII to the X3L2 Technical Subcommittee on

Codes and Character Sets. The X3L2 committee was directed to devise a standard that could meet the foreseeable needs for input/output control of one entire class of peripheral devices, the ones that create images in two dimensions by character-oriented means. This class includes video-display terminals, character and line printers, and microfilm output printers. The standard was intended to be useful in a wide variety of applications, including on-line form filling by templates, typesetting, and word processing.

After the technical subcommittee finished its methodical process in 1977, and after the higher-level ANSI committees had voted approval in 1979, ANSI published the document called ANSI X3.64-1979: *Additional Controls for Use with the American National Standard Code for Information Interchange*.

The X3.64-1979 standard was formulated in compliance with the procedures for extending ASCII set forth in a standard called ANSI X3.41-1974: *Code-Extension Techniques for Use with the 7-Bit Coded Character Set of American National Standard Code for Information Interchange*. (The later date of the X3.4-1977 standard means that ASCII has been revised. American National Standards expire after five years; when that time has passed they are either revised, reaffirmed, or left for dead.) The International Organization for Standardization (ISO) later adopted a similar standard called ISO DP6429: *Additional Control Functions for Use with Character-Imaging Devices*—essentially a superset of X3.64-1979.

What the Standard Does

The X3.64-1979 standard was not intended to define the exact electronic features or characteristics of any particular peripheral device. In fact, the technical subcommittee did not anticipate that any single device would incorporate all of the controls defined by the standard.

What the standard does is specify control sequences for a great number of control functions, almost all that you would find in commercial computer equipment. The X3.64 docu-

Enjoy a world of learning and leisure with the Sakata Model SC-100 Color CRT Monitor

Model SC-100 accepts a composite video signal; has a modern streamlined design; includes an audio speaker and an earphone jack for privacy of operation and is compatible with fine popular personal computers.

Your SAKATA monitor will enhance your picture comparable to the most expensive computers available.

Improve your education and increase your fun with SAKATA CRT DISPLAY MONITORS . . . "We Promise Performance" . . .

Also available: Model SC-200 13" RGB high

resolution COLOR CRT MONITOR. Model SC-300 13" RGB super high resolution COLOR CRT MONITOR. Model SG-1000 12" monochrome high resolution CRT MONITOR (green). Model SA-1000 12" monochrome high resolution CRT MONITOR (amber).

SAKATA CRT MONITORS are available wherever personal computers are sold or write for technical and illustrated literature and prices.

SAKATA U.S.A. CORPORATION
651 Bonnie Lane, Elk Grove Village,
Illinois 60007 / (312) 593-3211
800-323-6647 (outside Illinois)

Circle 320 on Inquiry card.

Sakata

"Serving industry worldwide since 1896"



Illustrated:
Model SC-100 13" CRT
COMPOSITE COLOR
DISPLAY MONITOR

I/O PROCESSOR™

Takes Your IBM PC™ A Step Beyond By Adding a New Dimension of Productivity and Convenience

I/O PROCESSOR increases your productivity by increasing your PC's capabilities. And I/O PROCESSOR offers you the convenience no other expansion board can.

I/O PROCESSOR is a multifunction board offering 2 parallel ports, 1 serial port, a 64K printer buffer and a chronograph. The key to I/O PROCESSOR's unique abilities is its on-board Z-80 computer.

INCREASED PRODUCTIVITY

I/O PROCESSOR's 64K buffer eliminates wasted hours of waiting for your printer to finish printing before you can use your computer. The buffer frees the computer for your use while the printer continues printing. You save time and increase productivity.

You can even use the buffer for TWO printers. Simply initiate printing instructions and I/O PROCESSOR's computer does the rest.

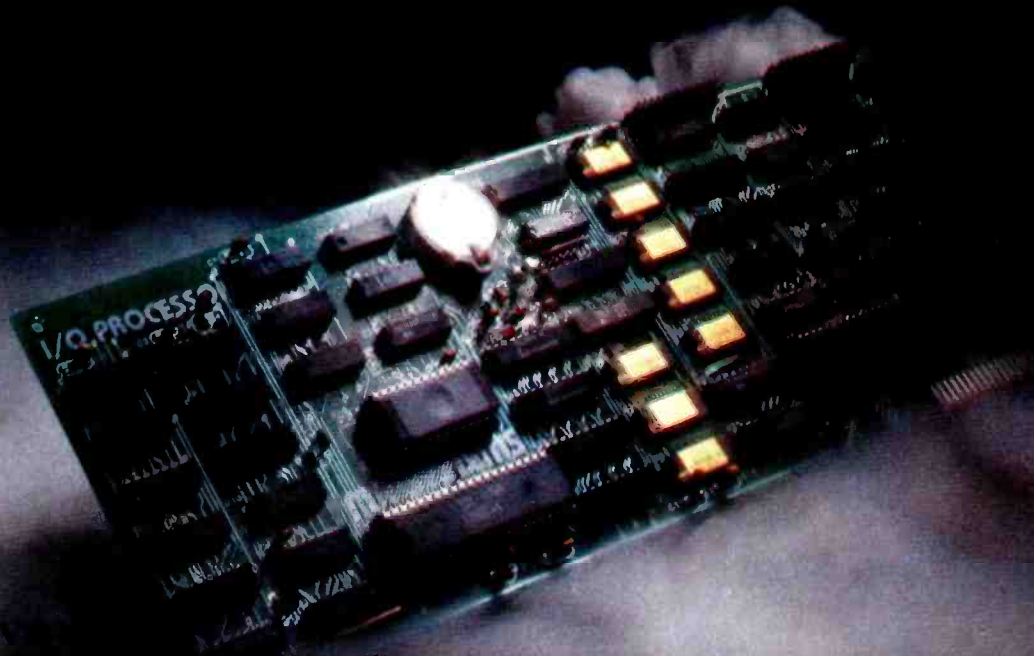

ADDED CONVENIENCE

With other printer buffers, you must tediously enter programs or load disks to activate the printer buffer. Not only is this time-consuming, but it also ties up your PC's processor.

I/O PROCESSOR offers you the convenience. The on-board computer handles the complete operation of the buffer, so you can use all of your PC software — it's fully compatible. No special programs or disks.

I/O PROCESSOR doesn't tie up your PC's processor. It works independently, using the on-board Z-80 computer to increase printing speed and provide full software compatibility.

I/O PROCESSOR is backed with years of reliable performance and is backed with an excellent warranty.

I/O PROCESSOR will help you compute more productively and conveniently. That's why it's the most advanced I/O board available now at your local computer dealer.

I/O PROCESSOR is available now at your local computer dealer.

FOR YOUR SYSTEM

ment describes 97 possible functions; the ones of interest to users of video terminals include changing the cursor and active position, editing lines, and scrolling.

All of the characters that appear in ANSI X3.64 control sequences are ASCII characters. These are used as an alphabet for building a set of control "words" that describe control functions.

One key part of X3.64 is the *control-sequence introducer* or CSI—a sequence of characters that unmistakably identifies the characters that follow as parts of a command to invoke one of the control functions of the video terminal (or other device). The regular CSI in X3.64 for the 7-bit ASCII character set consists simply of two ASCII characters: the Escape control character (decimal 27) and the left-bracket ("[" character. (There are also an as yet seldom-used 8-bit CSI and corresponding sequences.) In addition, some of the X3.64 functions are introduced by a single Escape character.

The characters that follow the CSI prefix in an X3.64 sequence specify the function that is to occur and supply numeric parameters that are needed by many functions. The characters following the CSI are either *intermediate* or *final*. In most cases any intermediate characters after the CSI supply the parameters, while the final character specifies the functions to occur, but sometimes intermediate characters assist in specifying the function. There is no limit to the number of intermediate characters. It is possible to build compound control sequences: a single CSI prefix can be followed by a string of parameters and function-specifying characters, with the codes for each function, separated by semicolons, used as delimiters.

Only printable characters are used in X3.64 sequences following the CSI; among other things, this allows the system to use the X-on and X-off (Control-S and Control-Q) nonprinting characters to start and stop the flow of data between the host computer and the terminal with no chance that the nonprinting characters will be mistaken by the terminal for function commands.

The major control functions available in X3.64 are listed in table 2. Each function is identified by both a name and a short mnemonic; the table is in alphabetical order by mnemonic.

The functions are affected by various modes that can be set (turned on) and reset (turned off) by means of the Select Mode and Reset Mode functions. A list of modes and the parameters to change them is given in table 3. The Select Mode and Reset Mode functions can also be used with reserved-private parameters in a specific video-terminal design to control modes and functions that exist only in that particular terminal.

A Function Example

Of all the command functions, the cursor controls are perhaps the most familiar, and of these the most versatile is the Cursor Position (CUP) sequence, which allows the cursor to be placed at any arbitrary position on the display screen. The format of the CUP, from table 2, is

Esc [Pn ; Pn H

The sequence begins with the ASCII Escape character (here abbreviated to "Esc") followed by the left bracket. These two together form the 7-bit control-sequence introducer. After the CSI comes a parameter, denoted here by Pn. In an actual command, this variable would be replaced by one or more ASCII characters for numeric digits, positions 3/0 through 3/9 in table 1. The first parameter is terminated by a semicolon, which leads to the second parameter—again, one or more ASCII characters representing digits. The "H" at the end of the command both terminates the second numeric parameter and specifies that the command is the CUP.

For instance, consider the sequence

Esc [17 ; 45 H

This sequence instructs the terminal to move the active position (and the cursor that indicates it) to the seventeenth line from the top of the screen and to the forty-fifth col-

SPECTACULAR OFFERS

wabash

6 YEAR WARRANTY

| | | | |
|-------|--------|-------------------------------|-------|
| M11 | 5 1/4" | SINGLE SIDE SINGLE DENSITY | 1.49* |
| M13 | 5 1/4" | SINGLE SIDE DOUBLE DENSITY | 1.89* |
| M14 | 5 1/4" | DOUBLE SIDE DOUBLE DENSITY | 2.39* |
| M16 | 5 1/4" | DOUBLE SIDE QUAD DENSITY | 3.49* |
| F111 | 8" | SINGLE SIDE SINGLE DENSITY | 1.89* |
| F1312 | 8" | SINGLE SIDE DOUBLE DENSITY | 2.59* |
| F144 | 8" | DOUBLE SIDE DOUBLE DENSITY | 2.99* |

maxell

LIFETIME WARRANTY

| | | | |
|---------|--------|-------------------------------|-------|
| MD1 | 5 1/4" | SINGLE SIDE SINGLE DENSITY | 2.09* |
| FD1-128 | 8" | SINGLE SIDE DOUBLE DENSITY | 3.49* |

BASF

2 YEAR WARRANTY

| | | | |
|-------|--------|-------|-------|
| 54968 | 5 1/4" | ss,dd | 1.79* |
| 53428 | 8" | ss,dd | 1.89* |

BASF

LIFETIME WARRANTY

| | | | |
|-------|--------|-------|-------|
| 54974 | 5 1/4" | ss,dd | 2.09* |
| 54998 | 8" | ss,dd | 2.29* |

TDK

LIFETIME WARRANTY

| | | | |
|------|--------|-------|-------|
| 2501 | 5 1/4" | ss,dd | 2.19* |
| 2801 | 8" | ss,dd | 3.59* |

Memorex

1 YEAR WARRANTY

| | | | |
|------|--------|-------|-------|
| 3481 | 5 1/4" | ss,dd | 1.99* |
| 3062 | 8" | ss,dd | 2.09* |

3M

LIFETIME WARRANTY

| | | | |
|--------|--------|-------|-------|
| 7440-0 | 5 1/4" | ss,dd | 1.99* |
| 740-0 | 8" | ss,dd | 2.30* |

FUJI

LIFETIME WARRANTY

| | | | |
|------|--------|-------|-------|
| MD1D | 5 1/4" | ss,dd | 2.14* |
| FD1S | 8" | ss,dd | 3.09* |

WE ALSO STOCK AT FANTASTIC LOW PRICES

OPUS

Dysan

ULTRA

Floppies, Tapes, Data Cartridges, Data Cassettes, and Disk Packs

*QUANTITY 100. SMALLER QUANTITIES ADD 5%

| | |
|---|--|
| DISK DRIVE HEAD CLEANING KITS 5 1/4" 15.95 | C-10 CASSETTES Get 8 cassettes, and Cassette/8 Library Album 8.00 |
|---|--|

| | |
|--|---|
| SNAP-IT POWER CENTER Turn one outlet into six! Power Surge Control RFI Filtration 15 Amp Circuit Breaker 59.95 | LIBRARY CASES 8" Kas-sette/10 2.99 5 1/4" Mini Kas-sette/10 2.49 |
|--|---|

BOOK VALUES

FULL SELECTION, DISCOUNT PRICES

on hundreds of titles published by ALFRED, HAYDEN, DILITHIUM, SAMS, TAB, MCGRAW HILL and many others.

SOFTWARE

AT FANTASTIC PRICES SAVE UP TO 50%

on thousands of software packages for all systems, including Business, Language, Engineering, Games, Graphics, Utility, and many more.

* Write purchase orders accepted from government agencies and well rated firms for net 30 day billing. * International orders accepted with a 15.00 surcharge for handling, plus shipping charges. * C.O.D. requires a 10% deposit. * We accept Visa, MasterCard, Money Orders, and Certified checks. * Checks require bank clearance. * All shipments F.O.B. San Diego. * Minimum shipping and handling 2.00, minimum order 10.00. * California residents add 6% sales tax. Prices and terms subject to change without notice. * All sales subject to availability, acceptance, and verification. * All sales are final. * Satisfaction guaranteed or full refund.

We also offer printer ribbons, printwheels, type elements, equipment covers, power consoles, paper supplies, storage and filing equipment, furniture and many other accessories for word and data processing systems. Write for our free catalog

Digits Only
800-854-1555

Information
619-268-3537

Modern Printing (America)
619-268-4488

Exclusive Monthly Specials

ABC
DATA PRODUCTS

ITT TELEX 4952217
8868 CLAIREMONT MESA BLVD.
SAN DIEGO, CALIFORNIA 92123

GET ORGANIZED

With Our New Line Of Quality Products



PR#1
pictured

PR#1 16 x 13 x 4 **\$29.95**

PR#2 24 x 13 x 4 **\$39.95**

Both made of 1/4 inch smoked acrylic, featuring a bottom feed slot and non-skid feet.

**Sturdy
Bronze
Acrylic
Copy
Holder**



\$19.95

**Office
Quality
Gas Operated
Ergonomic
Computer
Chair**



Available in
blue
red
camel
brown
lt grey
charcoal

Retails for \$179.95

**MIDAMERICA Priced At
only \$99.95**

add \$45.95 for arms

**MIDAMERICA
WHOLESALE, INC.
COMPUTER ACCESSORIES**

8135 215th St. 
Lakeville, MN 55044

MN residents add 6% sales tax. Dealer inquiries invited.

Add \$2.50 shipping for each item. **CALL FOR COMPETITIVE DISKETTE PRICES.**

TO PLACE ORDERS CALL ANYTIME

1-800-328-2977

MN residents **612-469-4666**

| Mnemonic | Name | Sequence | Default Value | Type or Mode |
|----------|----------------------------|-----------------------------|---------------|--------------|
| APC | Application Prog Command | Esc Fe | | Delimiter |
| CBT | Cursor Backward Tab | Esc [Pn Z | 1 | EdF |
| CCH | Cancel Prev Character | Esc T | | |
| CHA | Cursor Horizontal Absolute | Esc [Pn G | 1 | EdF |
| CHT | Cursor Horizontal Tab | Esc [Pn I | 1 | EdF |
| CNL | Cursor Next Line | Esc [Pn E | 1 | EdF |
| CPL | Cursor Preceding Line | Esc [Pn F | 1 | EdF |
| CPR | Cursor Position Report | Esc [Pn ; Pn R | 1, 1 | |
| CSI | Control Sequence Intro | Esc | | Introducer |
| CTC | Cursor Tab Control | Esc [Ps W | 0 | EdF |
| CUB | Cursor Backward | Esc [Pn D | 1 | EdF |
| CUD | Cursor Down | Esc [Pn B | 1 | EdF |
| CUF | Cursor Forward | Esc [Pn C | 1 | EdF |
| CUP | Cursor Position | Esc [Pn ; Pn H | 1, 1 | EdF |
| CUU | Cursor Up | Esc [Pn Y | 1 | EdF |
| CVT | Cursor Vertical Tab | Esc [Pn Y | | EdF |
| DA | Device Attributes | Esc [Pn c | 0 | |
| DAQ | Define Area Qualification | Esc [Ps o | 0 | |
| DCH | Delete Character | Esc [Pn P | 1 | EdF |
| DCS | Device Control String | Esc P | | Delimiter |
| DL | Delete Line | Esc [Pn M | 1 | EdF |
| DMI | Disable Manual Input | Esc \ | | Fs |
| DSR | Device Status Report | Esc [Ps n | 0 | |
| EA | Erase in Area | Esc [Ps O | 0 | EdF |
| ECH | Erase Character | Esc [Pn X | 1 | EdF |
| ED | Erase in Display | Esc [Ps J | 0 | EdF |
| EF | Erase in Field | Esc [Ps N | 0 | EdF |
| EL | Erase in Line | Esc [Ps K | 0 | EdF |
| EMI | Enable Manual Input | Esc b | | Fs |
| EPA | End of Protected Area | Esc W | | |
| ESA | End of Selected Area | Esc G | | |
| FNT | Font Selection | Esc [Pn ; Pn Space D | 0, 0 | FE |
| GSM | Graphic Size Modify | Esc [Pn ; Pn Space B | 100, 100 | FE |
| GSS | Graphic Size Selection | Esc [Pn Space C | none | FE |
| HPA | Horz Position Absolute | Esc [Pn ' | 1 | FE |
| HPR | Horz Position Relative | Esc [Pn a | 1 | FE |
| HTJ | Horz Tab w/Justification | Esc l | | FE |
| HTS | Horizontal Tab Set | Esc H | | FE |
| HVP | Horz & Vertical Position | Esc [Pn ; Pn f | 1, 1 | FE |
| ICH | Insert Character | Esc [Pn @ | 1 | EdF |
| IL | Insert Line | Esc [Pn L | 1 | EdF |
| IND | Index | Esc D | | FE |
| INT | Interrupt | Esc a | | Fs |
| JFY | Justify | Esc [Ps ; ... ; Ps Space F | 0 | FE |
| MC | Media Copy | Esc [Ps i | 0 | |
| MW | Message Waiting | Esc U | | |
| NEL | Next Line | Esc E | | FE |
| NP | Next Page | Esc [Pn U | 1 | EdF |
| OSC | Operating System Command | Esc] | | Delimiter |
| PLD | Partial Line Down | Esc K | | FE |
| PLU | Partial Line Up | Esc L | | FE |
| PM | Privacy Message | Esc ~ | | Delimiter |
| PP | Preceding Page | Esc [Pn V | 1 | EdF |
| PU1 | Private Use 1 | Esc Q | | |
| PU2 | Private Use 2 | Esc R | | |
| QUAD | Typographic Quadding | Esc [Ps Space H | 0 | FE |
| REP | Repeat Char or Control | Esc [Pn b | 1 | |
| RI | Reverse Index | Esc M | | FE |
| RIS | Reset to Initial State | Esc c | | Fs |
| RM | Reset Mode | Esc [Ps l | none | |
| SD | Scroll Down | Esc [Pn T | 1 | EdF |
| SEM | Select Edit Extent Mode | Esc [Ps Q | 0 | |
| SGR | Select Graphic Rendition | Esc [Ps m | 0 | FE |
| SL | Scroll Left | Esc [Pn Space @ | 1 | EdF |
| SM | Select Mode | Esc [Ps h | none | |
| SPA | Start of Protected Area | Esc V | | |
| SPI | Spacing Increment | Esc [Pn ; Pn Space G | none | FE |
| SR | Scroll Right | Esc [Pn Space A | 1 | EdF |
| SS2 | Single Shift 2 (G2 set) | Esc N | | Introducer |
| SS3 | Single Shift 3 (G3 set) | Esc O | | Introducer |

Table 2: The 7-bit device-control codes in American National Standard X3.64-1979. A given peripheral device may not respond to all codes, but most ANSI-compatible video terminals work with a subset of the most popular functions.

Table 2 continued on page 373

Table 2 continued:

| | | | | |
|-----|--------------------------|------------------|------|-----------|
| SSA | Start of Selected Area | Esc F | | |
| ST | String Terminator | Esc \ | | Delimiter |
| STS | Set Transmit State | Esc S | | |
| SU | Scroll Up | Esc [Pn S | 1 | EdF |
| TBC | Tab Clear | Esc [Ps g | 0 | FE |
| TSS | Thin Space Specification | Esc [Pn Space E | none | FE |
| VPA | Vert Position Absolute | Esc [Pn d | 1 | FE |
| VPR | Vert Position Relative | Esc [Pn e | 1 | FE |
| VTS | Vertical Tabulation Set | Esc J | | FE |

Abbreviations:

- EdF editor function
- FE format effector
- Gs is a graphic character appearing in strings (Gs from 2/0 to 7/14)
- Ce is a control represented as a single bit combination in the C1 set of controls in an 8-bit character set
- Fe is a Final character of a 2-character Escape sequence that has an equivalent representation in an 8-bit environment as a Ce (Fe from 4/0 to 5/15)
- Fs is a Final character of a 2-character Escape sequence that is standardized internationally with identical representation in 7-bit and 8-bit environments and is independent of the currently designated C0 and C1 control sets (Fs from 6/0 to 7/14)
- Pn is a numeric parameter in a control sequence, a string of zero or more characters from 3/0 to 3/9
- Ps is a variable number of selective parameters in a control sequence with each selective parameter separated from the other by the code 3/11 (which usually represents a semicolon); Ps from 3/0 to 3/9 and 3/11

| Parameter Character | Mode Mnemonic | Mode Function |
|---------------------|---------------|---|
| 3/0 | | an error condition |
| 3/1 | GATM | guarded-area transfer mode |
| 3/2 | KAM | keyboard action mode |
| 3/3 | CRM | control representation mode |
| 3/4 | IRM | insertion/replacement mode |
| 3/5 | SRTM | status-reporting transfer mode |
| 3/6 | ERM | erasure mode |
| 3/7 | VEM | vertical editing mode |
| 3/8 | | reserved for future standardization |
| 3/9 | | reserved for future standardization |
| 3/10 | | reserved separator for parameters |
| 3/11 | | standard separator for parameters |
| 3/12 | | reserved for private (experimental) use |
| 3/13 | | reserved for private (experimental) use |
| 3/14 | | reserved for private (experimental) use |
| 3/15 | | reserved for private (experimental) use |
| 3/1 3/0 | HEM | horizontal editing mode |
| 3/1 3/1 | PUM | positioning unit mode |
| 3/1 3/2 | SRM | send/receive mode |
| 3/1 3/3 | FEAM | format effector action mode |
| 3/1 3/4 | FETM | format effector transfer mode |
| 3/1 3/5 | MATM | multiple area transfer mode |
| 3/1 3/6 | TTM | transfer termination mode |
| 3/1 3/7 | SATM | selected area transfer mode |
| 3/1 3/8 | TSM | tabulation stop mode |
| 3/1 3/9 | EBM | editing boundary mode |
| 3/1 3/10 | | reserved separator for parameters |
| 3/1 3/11 | | standard separator for parameters |
| 3/1 3/12 | | error condition—unspecified recovery |
| 3/1 3/13 | | error condition—unspecified recovery |
| 3/1 3/14 | | error condition—unspecified recovery |
| 3/1 3/15 | | error condition—unspecified recovery |
| 3/2 3/0 | LNM | line-feed/new-line mode (not in ISO DP6429) |
| 3/2 3/1 | | |
| . | | |
| . | | reserved for future standardization |
| 3/9 3/9 | | |
| 3/12 3/0 | | |
| . | | |
| . | | reserved for private (experimental) use |
| 3/15 3/15 | | |

Table 3: ANSI X3.64 mode-changing parameters used with the Select Mode and Reset Mode functions. ASCII characters are specified by column/row notation (see table 1).

DeSmet C

The fastest 8088 C Compiler available

FULL DEVELOPMENT PACKAGE

- C Compiler
- Assembler
- Linker and Librarian
- Full-Screen Editor
- Newsletter for bugs/updates

SYMBOLIC DEBUGGER

- Monitor and change variables by name using C expressions
- Multi-Screen support for debugging PC graphics and interactive systems
- Optionally display C source during execution
- Breakpoint by Function and Line #

COMPLETE IMPLEMENTATION

- Both 1.0 and 2.0 DOS support
- Everything in K&R (incl. STDIO)
- Intel assembler mnemonics
- Both 8087 and Software Floating Point

OUTSTANDING PERFORMANCE

Sieve Benchmark

| | |
|---------|---------------|
| COMPILE | 4 Sec. RAM — |
| | 22 Sec. FDISK |
| LINK | 6 Sec. RAM — |
| | 34 Sec. FDISK |
| RUN | 12 Sec. |
| SIZE | 8192 bytes |

DeSmet C
Development Package **\$159**

To Order Specify:

Machine _____

OS MS-DOS CP/M-86

Disk 8" 5 1/4 SS 5 1/4 DS

CW A R E
CORPORATION

P.O. BOX 710097
San Jose, CA 95171-0097
(408) 736-6905

California residents add sales tax. Shipping: U.S. no charge, Canada add \$5, elsewhere add \$15. Checks must be on a US Bank and in US Dollars.

—MODEMS—

*Signalman MARK XII **\$249.95**
1200/300 Baud Auto Dial/Ans
Hayes™ Compatible

*VOSKMODEM 300 Baud **\$59.95**
Limited Offer/FREE Source Memb.

*The Computer Phone Book **\$9.95**

*The Complete Handbook of
Personal Computer Comm. **\$12.95**

—COMPUTER—

Sanyo MBC-550 \$845

Order: (800) 235-6646 OP 555
Calif. (800) 235-6647 OP 555

VISA/MC ACOM Electronics
Add 3% Dept. 120
Shipping 4151 Middlefield Rd.
Add 2% Palo Alto, CA 94303

Circle 13 on inquiry card.

COMPUTER SUPPLIES DISKETTES

5 1/4
S/S S/D
MIN. ORDER 50

\$160

RIBBONS

OKIDATA
MICROLINE 84
EPSON
MX100
MIN. ORDER 6

\$377

\$784

LABELS • CONTINUOUS FORMS

PeachText 5000 REG 395⁰⁰ 235⁰⁰
complete line of

EDUWARE SOFTWARE
plus other major brands

•Terms: Visa, M.C. or C.O.D.
•Dealer Inquiries Invited

**COMPU-MEDIA
SOFTWARE, INC.**

159 Main St. S.I.N.Y. 10307
CALL TOLL FREE 1-800-248-2418
in N.Y. State 212-967-1700



Circle 393 on inquiry card.

VT 102



**PC102™ SOFTWARE
TURNS YOUR PC INTO A
VT100/102/52 TERMINAL**

Requires: IBM type PC, 64K, 1 drive, 25x80 display,
async adpt, and IBM DOS or QNX.

PRICED FROM \$89.

Optional: Local Printer & File Transfer
Optional: 132-Column Support

For more information call or write:

gms GENERAL
MICRO SYSTEMS

7525 MITCHELL RD. SUITE 101. MPLS MN 55344
(612) 937-9194

IBM is a registered trademark of International Business Machines.
PC100, GMS are trademarks of General Micro Systems.

Circle 478 on inquiry card.

umn across from the left. The numbers consist of the ASCII characters for one, seven, four, and five—all parameters in X3.64 are assumed to be in decimal radix. There are spaces shown here between the elements of the sequence for clarity, but no spaces should actually appear in a real command except where explicitly required. If no parameters are supplied, the command is executed with both parameters defaulting to 1, and the cursor goes to the home position.

Flexibility and Expansion

Functions similar to CUP exist to move the cursor to any position along a given line or down a column. Other functions can move the cursor relative to the position it has when the command is received. Editing functions include sequences to control the insertion or deletion of individual characters, strings of characters, or complete lines of text. More advanced functions allow the display screen to be divided into special-purpose fields that can be highlighted, protected against change, or even rendered invisible.

Other functions exist to specify operations that you'll hardly ever find in a video-display terminal. That should be no real surprise, because no one ever intended that all peripheral devices should implement every part of the X3.64 standard. But the functions are there for use by flatbed plotters, typesetting equipment, and whatever else gets invented.

The X3L2 committee left room for future expansion by reserving certain codes. Conscientious designers of terminals and software will take steps to ensure future compatibility: spelling out exactly which codes are used, avoiding the reserved codes, and not assigning nonstandard functions to control sequences used in the standard. Avoiding conflict shouldn't be too hard: using only one intermediate character in control sequences, over 1000 private function codes can be constructed.

The development and increasing use of the X3.64 device-control standard promises to allow near-complete compatibility between different makes of video terminals. The con-

trol sequences for all of the most common functions will be the same in any two video terminals that conform to the standard, even if the two terminals were designed years and continents apart. A programmer writing application software can use a set of ANSI X3.64 control sequences and remain confident that the software will work properly with any terminal that meets the standard. And users will have greater range than ever before in choosing a video terminal that can work with their systems.

There's not room here to cover all the details of all the functions in this article. To use the standard, you'll need a copy of the X3.64-1979 document, which you can order from ANSI, 1430 Broadway, New York, NY 10018 for \$17 plus \$4 for postage. Take time to study it; and use table 2 in this article as a quick reference. ■

References

1. ANSI X3.4-1977: *American National Standard Code for Information Interchange*. New York: American National Standards Institute (ANSI), 1977.
2. ANSI X3.41-1974: *Code-Extension Techniques for Use with the 7-Bit Coded Character Set of American National Standard Code for Information Interchange*. New York: ANSI, 1974.
3. ANSI X3.64-1979: *Additional Controls for Use with the American National Standard Code for Information Interchange*. New York: ANSI, 1979.
4. Card, Chuck, R. Donald Prigge, Josephine L. Walkowicz, and Marjorie F. Hill. "The World of Standards." *BYTE*, February 1983, page 130.
5. Fleming, Jim and William Frezza. "NAPLPS: A New Standard for Text and Graphics." Part 1, *BYTE*, February 1983, page 203. Part 2, *BYTE*, March 1983, page 152. Part 3, *BYTE*, April 1983, page 190. Part 4, *BYTE*, May 1983, page 272.
6. Langhorst, Fred and Thomas B. Clarkson III. "Realizing Graphics Standards for Microcomputers." *BYTE*, February 1983, page 256.
7. Shuford, Richard S. "Standards: The Love/Hate Relationship." *BYTE*, February 1983, page 6.
8. "Using Extended Screens and Keyboard Control." In *IBM Personal Computer Computer-Language Series: Disk Operating System (version 2.00)*. Boca Raton, FL: IBM Corporation, 1983.

Mark Siegel is executive vice-president and general manager of the terminals division of Televideo Systems Inc. He can be reached at Televideo Systems, 1170 Morse Ave., Sunnyvale, CA 94086.

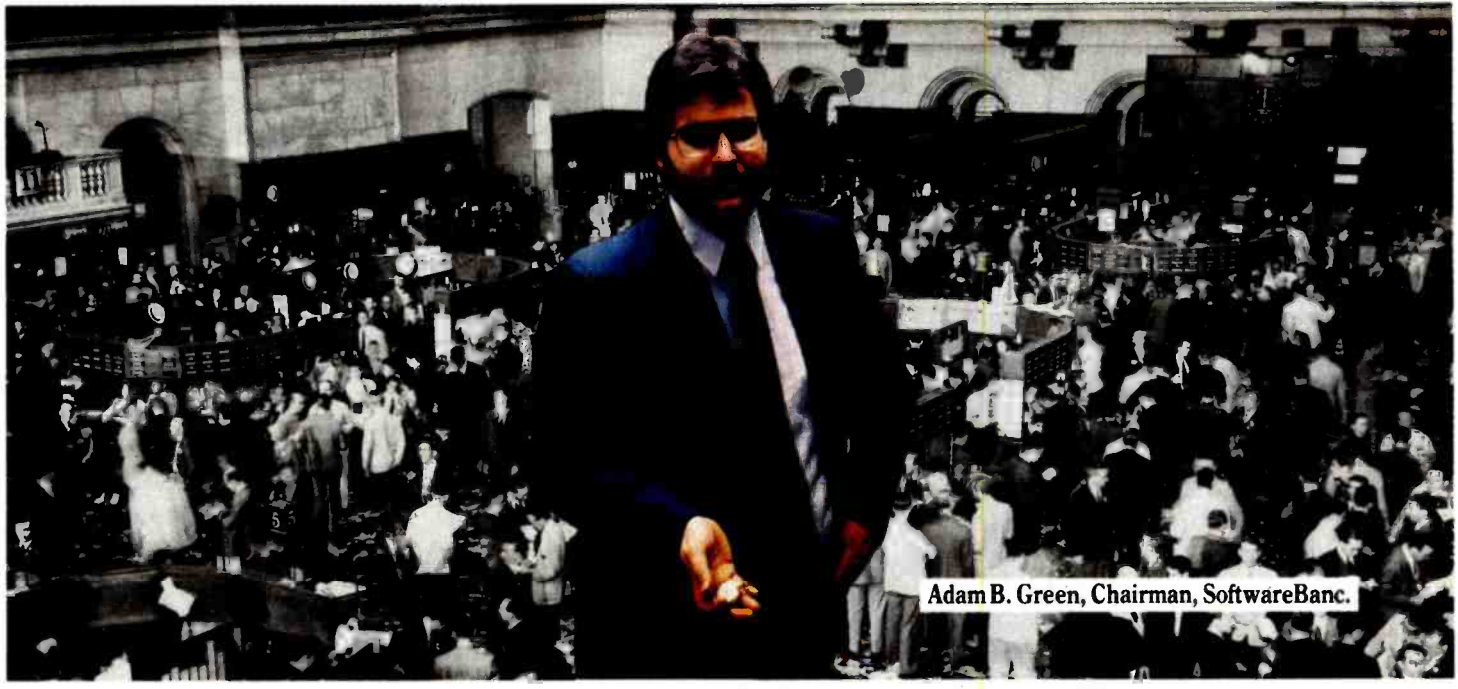

Adam B. Green, Chairman, SoftwareBanc.

TIME IS MONEY

Do you want to spend your time as intelligently as you spend your money? The decision may be yours, but your concerns are ours. We know you don't want to spend more time learning business software than you do using it. So we provide the productivity tools you can bank on to INVEST IN YOURSELF, time and time again.

It's no wonder over 50% of our business comes from repeat customers and referrals. For quality seminars, videotapes, books and software, you can count on SoftwareBanc for a guaranteed return on your investment.

\$ SEMINARS

As a full service organization, we provide fine professional training. Adam B. Green, well known dBASE II educator, uses a custom video presentation to highlight these invaluable lectures. \$200/day

dBASE II Fundamentals
dBASE II Programming
Advanced dBASE II Techniques

Problem Solving with 1-2-3
Exploring UNIX

Atlanta
May 14-18

*Boston/Waltham
June 18-21

Toronto
July 9-13

New York
August 13-17

Costa Mesa/Orange County
September 17-21

* In cooperation with Bentley College, Waltham, MA

\$ VIDEOTAPES

Learn the basics of dBASE II in three hours with this professionally produced training package. We give you everything you need to reproduce Adam B. Green's popular dBASE II seminar in your own home or office. You receive everything but the lunch!

| | |
|-------------------------------------|----------|
| dBASE II Demo | \$ 25.00 |
| dBASE II Fundamentals (VHS or BETA) | \$295.00 |
| dBASE II Fundamentals (U-MATIC) | \$395.00 |

\$ BOOKS

Built on years of practical experience in testing, supporting and teaching dBASE II, we take pride in offering you our accumulated knowledge. Interest adds up with new tips and techniques never before published!

| | |
|--------------------------------|---------|
| dBASE II User's Guide | \$29.00 |
| Advanced dBASE II User's Guide | \$29.00 |
| Report Writing in dBASE II | \$15.95 |
| 101 Questions in dBASE II | Soon |

\$ SOFTWARE

As an authorized dealer of every product we sell, you are assured of expert technical support, knowledgeable salespeople and fast, dependable service with a smile!

| | |
|--|-------|
| dBASE II with free dBASE II User's Guide | \$439 |
| WordStar | \$269 |
| 1-2-3 with free 123 Trans | \$399 |

(Available at SoftwareBanc Seminars)

Take stock in SoftwareBanc! Call or write for the free catalogs which include our complete product line, seminar curriculum and unique services.

At SoftwareBanc, a wise investor is our best customer.

To order, call (800) 451-2502 or (617) 641-1241 in Mass. Hours are 9 a.m. - 8 p.m. EST Monday - Friday and 9 a.m. - 5 p.m. EST on Saturday.

Payment may be made by: MC/VISA, MO, check or COD. Terms available to qualified customers. MA residents add 5% sales tax. Add \$5 for S&H. Prices subject to change without notice. Dealer inquiries invited. Ask about our Discount Savings Plan.

dBASE II is a registered trademark of Ashton-Tate
1-2-3 is a registered trademark of Lotus Development Corp.
WordStar is a registered trademark of MicroPro
UNIX is a registered trademark of Bell Laboratories



SoftwareBanc

661 Massachusetts Avenue, Arlington, MA 02174

(800)-451-2502

(617) 641-1241 in MA

Circle 333 on inquiry card.

BYTE April 1984 375

THE *first* **BYTE**

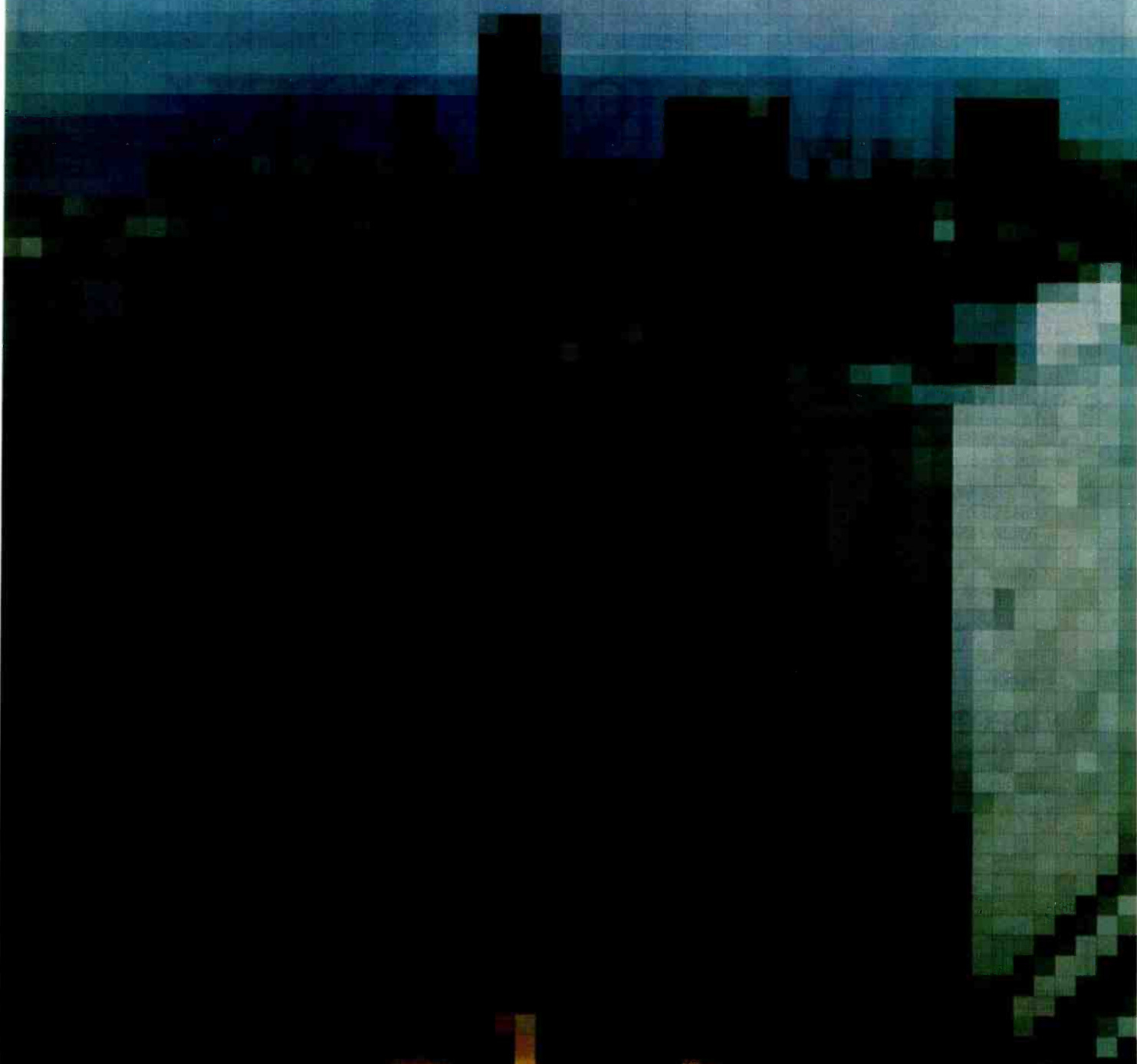

COMPUTER SHOW

Chicago
McCormick Place
May 10-12, 1984

Welcome to the new computer shows designed specifically for BYTE subscribers. . .the *BYTE Computer Shows*. The first will be in Chicago's McCormick Place on May 10-12, but you don't have to travel cross-country to get there—others will be held this year in San Francisco, Boston and Los Angeles.

The BYTE Shows will be "selling" shows—where you can buy, not just look. BYTE subscribers will enjoy special reduced admission prices to all BYTE shows, and conference seminars. Those seminars will be targeted to the interests of BYTE subscribers, and led by such BYTE favorites as

Jerry Pournelle.

The BYTE Shows will be professionally produced by The Interface Group—the same pros who bring you the Comdex Shows. Their show know-how, combined with BYTE's editorial expertise, will make the BYTE Shows ideal information centers and shopping marts for BYTE subscribers.

More details on BYTE subscriber benefits will be coming to you by mail. But plan now to be in Chicago May 10-12, or at the BYTE Show nearest you!

BYTE 

People are going for Friday!™ like there's no tomorrow.

Friday! is the new electronic file handling system that has become an instant best-seller because it's so revolutionary.

Within two weeks, it broke into the Top 20 on the sales chart of Softsel, one of the country's leading computer software distributors.

And it's now well on its way to the top.

The Friday! phenomenon is simple.

Friday! uses simple menus and talks to you in plain English, so almost anybody can use it.

It's great for sales and commissions, clients and portfolios, mailing lists and labels, invoices, inventories, paychecks, reports and more. And it works with other microcomputer software like 1-2-3™ and dBASE II® (our own advanced database management system).

It comes with a complete, step-by-step tutorial, but you can set up an "electronic file" without even looking at the manual, then use it at the touch of a few keys.

Friday! finds any filed information in seconds. Computes totals, subtotals, commissions, etc. Prints form letters and mailing labels. Gives you quick reports from all or part of a file with a few key-strokes. Or if you need a special report for



your bank or board of directors, just "paint" the format on your screen, then have Friday! do all the work.

And while Friday! does more than file handling systems selling for as much as \$495, it's yours for just \$295 (suggested retail price)!

For more information, contact Ashton-Tate, 10150 West Jefferson Boulevard, Culver City, CA 90230. (800) 437-4329 ext. 202. In Colorado, (303) 799-4900. In the U.K., call (0908) 568866.

Or for the name of your nearest dealer, just call 1-800-4-FRIDAY, ext. 202.

ASHTON · TATE

©Ashton-Tate 1983. Friday! is a trademark and dBASE II is a registered trademark of Ashton-Tate. 1-2-3 is a trademark of Lotus Development Corp.

A VIC-20/Commodore 64 Terminal Emulator

This versatile program puts you in touch with mainframes

John P. Russo
Indiana University

I purchased a VIC-20 because I was interested in using it as a terminal (via a modem) with a Prime 550. The terminal program that came with the modem had a number of serious defects. It had no cursor, uppercase characters only, and backspacing wasn't displayed on my screen. After a few weeks of frustration, I began to modify the program and, eventually, I completely scrapped it and started over. The result is the program in listing 1. It has a combination of features not available, to my knowledge, on other terminal programs. These include:

1. compatibility with expanded and unexpanded VIC-20s as well as the Commodore 64
2. one keystroke log-in
3. uppercase-only key
4. time since log-in available with one keystroke
5. choice of blinking or steady cursor
6. capability for local text files on disk or cassette to be sent to mainframe
7. automatic repeat on all keys

Because the program is written in BASIC, it can be easily modified. Yet, in practical terms, it runs as fast as machine-language programs, be-

cause it keeps up with the 300-bps (bits per second) transmission rate used by many modems. I had to work a bit to make the program efficient enough to achieve this speed, so you should be careful if you change lines 600-653.

Because no one types at a speed of 30 characters per second, the only real challenge for the program is in keeping up with long transmissions from the mainframe. Early versions of the program were not successful in this regard and the 500-byte receiving buffer occasionally overflowed. However, after I introduced a number of refinements, the program easily handled transmissions of any length. The only place where the speed of BASIC limits the program significantly is in sending files. The culprit here is the GET statement, which is slow in retrieving information from either tape or disk.

How the Program Works

The basic structure of the program is simple. After opening a communications channel, initializing, and printing the function-key menu, the program awaits user input. If a function key is pressed (see Function

Keys), the routine performs the indicated operation and returns to await input. If that input is a character then the character is dispatched. Let's assume that the program is running and you type an "a." Immediately, the code for this character is sent over the phone lines to the mainframe. In the full-duplex mode, the mainframe echoes back the received character and it is printed on your screen so that you can see that all is well. The program then continues to look for incoming characters, but if none arrives, it turns its attention once again to the keyboard and the cycle starts again.

There is a slight complication to the send-receive operation, however. Commodore uses different character codes than do mainframes, most of which use ASCII (American National Standard Code for Information Interchange) codes. Thus, the program must perform conversions before sending characters or printing received characters. The arrays S\$ (sending array) and R\$ (receiving array) accomplish this task quickly and efficiently.

For example, suppose that a lowercase "a" (ASCII 97) is typed and is

Listing 1: The terminal-emulator program for VIC-20 and Commodore 64 computers.

```

10 REM *****
15 REM *
20 REM *      TERMINAL EMULATOR FOR VIC-20 AND COMMODORE 64      *
25 REM *
30 REM *      AUTHOR:  JOHN  RUSSO
35 REM *
50 REM *      DATE:    JANUARY,1983
60 REM *
70 REM *****
75 REM
80 REM
85 REM *****
90 REM * OPEN 7 BIT FULL DUPLEX RS232 CHANNEL AND DIMENSION ARRAYS *
95 REM *****
100 REM
110 LET BAUD$ = CHR$(38)
115 LET DUPLEX$ = CHR$(160)
120 OPEN 5,2,3, BAUD$ + DUPLEX$
130 DIM R$(127), S$(255)
140 REM *****
150 REM *      INITIALIZE VARIABLES AND DEFINE CONSTANTS      *
160 REM *****
170 LET QUOTE$ = CHR$(34)
175 LET BACKSPACE$ = CHR$(157)
180 LET ERASE$ = " " + BACKSPACE$
190 LET DARK$ = CHR$(162) + BACKSPACE$
200 LET CURSR$ = DARK$
205 LET TIME$ = "000000"
210 LET CAP% = 32
220 LET LGIN$ = "YOUR LOGIN MESSAGE"
225 FOR K = 32 TO 64
230 LET S$(K) = CHR$(K)
235 LET R$(K) = CHR$(K)
240 NEXT
245 FOR K = 65 TO 90
250 LET S$(K) = CHR$(K + CAP%)
255 LET R$(K) = CHR$(K+128)
260 LET S$(K+128) = CHR$(K)
265 LET R$(K+32) = CHR$(K)
270 NEXT
275 FOR K = 91 TO 95
280 LET S$(K) = CHR$(K)
285 LET R$(K) = CHR$(K)
290 NEXT
310 S$(13) = CHR$(13) : R$(13) = CHR$(13) : S$(148) = CHR$(13)
315 S$(20) = CHR$(8) : R$(8) = CHR$(20) : S$(160) = CHR$(32)
320 S$(171) = CHR$(17) : S$(174) = CHR$(19) : S$(175) = CHR$(16)
330 S$(188) = CHR$(3) : S$(179) = CHR$(125) : R$(125) = CHR$(179)
340 R$(92) = CHR$(94) : R$(95) = CHR$(164)
345 PRINT CHR$(14)
350 REM *****
360 REM *      PRINT HELP MENU
365 REM *****
370 PRINT CHR$(147)
380 PRINT "USE FUNCTION KEYS"
390 PRINT " AS FOLLOWS"
400 PRINT: PRINT
410 PRINT "F1: PRINT THIS MENU "
420 PRINT
430 PRINT "F2: SEND TEXT FILE "
440 PRINT
450 PRINT "F3: TIME SINCE LOGIN "
460 PRINT
470 PRINT "F4: KEY REPEAT ON-OFF "
480 PRINT
490 PRINT "F5: SEND LOGIN MESSAGE "
500 PRINT
510 PRINT "F6: CURSOR (NO)BLINK "
520 PRINT
530 PRINT "F7: CAPS ON-OFF "
540 PRINT
550 PRINT "F8: CHANGE SCREEN "
560 PRINT
570 PRINT "USE COMMODORE KEY AS CONTROL KEY"
575 REM *****
580 REM *      RECEIVING AND SENDING LOOPS
590 REM *****
600 PRINT CURSR$;
605 IF BLINKOFF THEN 625
610 LET COUNT% = COUNT% + 1
615 IF COUNT% = 10 THEN LET CURSR$ = DARK$
620 IF COUNT% = 20 THEN LET CURSR$ = ERASE$ : LET COUNT% = 0
625 GET CH$ : IF CH$ = " " THEN 650
630 LET CCODE% = ASC(CH$)
635 IF CCODE% > 132 AND CCODE% < 141 THEN 655
640 PRINT#5, S$(CCODE%);

```

sent to the mainframe without modification. In reality, the Commodore code ("a"=65) for this character would be sent. The mainframe would interpret the sent character using standard ASCII codes, under which ASCII 65="A." Thus, if no conversion is done, a lowercase character is perceived as an uppercase character. It follows that to send a lowercase "a," we must send a character whose code equals 97. Thus, we define S\$(65) = CHR\$(97). The sending array is defined so that when we type a given character, that character is actually sent to the mainframe. Conversely, the receiving array is designed so that when the mainframe sends a character, that character is correctly echoed on our microcomputer screen. (Table 1 is a comparison of the two sets of codes.)

The program itself includes few remarks, so detailed line-by-line comments are given in table 2.

Function Keys

The program is written so that the function keys serve the following special purposes:

- F1 display this function-key list
- F2 send text file to mainframe
- F3 print time since log-in
- F4 key repeat on-off
- F5 send log-in message
- F6 cursor (no) blink
- F7 caps on-off
- F8 change screen

If you have worked on terminals before, this list will be almost self-explanatory. Function key F1 prints the preceding list as a Help menu, in case you forget what the keys do. Using F2 is a bit more complicated and is explained in some detail under Sending Files.

On the mainframe I customarily use, there is a 60-minute time limit on the dial-up ports, so it is convenient to have easy access to the time since log-in. Because the VIC and 64 have built-in clocks, it was a simple matter to add this feature, which is accessed through the use of key F3. In this version of the program, the elapsed-time indicator ignores hours and resets to zero at 60 minutes. If

Listing 1 continued on page 382

VISA
 MASTERCHARGE
 AMERICAN EXPRESS



4221 Winfield Scott Plaza · Scottsdale, Az 85251

FREE SHIPPING
 ON BANK WIRE
 TRANSFERS!!

FOR TECHNICAL INFORMATION & AZ ORDERS:

FOR PRICE QUOTES & ORDERING:

602-949-8218

1-800-328-8905

Use Your CREDIT CARD!

| | | | |
|--|--|---|--|
| <p>FRANKLIN HAYES NOVATION ALTOS ZENITH TELEVIDEO SANYO USI TRANSTAR MICOM DATASOUTH</p> |  <p>Mannesmann Tally</p> <ul style="list-style-type: none"> • Standard — 7 x 9 160 CPS • NLO — 40 x 18 40 CPS • 2K Buffer and Tractor Standard <p>160 L 80 col. Call Best Seller 180 L 132 col. Call Best Seller SPIRIT Call Best Seller</p> | <p>TAXAN DIABLO NEC EPSON U.S. ROBOTICS PRINTEK DAISYWRITER JUKI STAR AMDEK EAGLE</p> | <p>NOW IN STOCK!!!</p> <p>Pick Up Columbia's Portable VP Computer</p>  <p>And Get A Real Handle On IBM-PC Compatibility</p> |
|  <p>IDS</p> <ul style="list-style-type: none"> • Proportional Spacing • 8 Character Styles • 200 CPS BI Directional • Color Optional • Sheet Feed • Graphics • 3.4K Buffer <p>Prism 80 Prism 132 and Micro Prism S Call</p> | <p>OKIDATA OSBORNE GTC ADDS DEC C ITOH SILVER-REED MANY OTHERS</p> | <p>NEW XL SPIRIT</p>  <p>EAGLE</p> <p>OUR PC FLYS</p> <p>IBM Compatible Simply a better PC. All models available for immediate delivery Call Lowest S</p> | <p>MS-DOS with Color Graphics, 16-Bit Personal Computer 256KB RAM Expandability</p>  <p>SANYO</p> |



AN INNOVATIVE AND RELIABLE MODEM:



INTRODUCING . . . "U.S. ROBOTICS"

| | | | | | | | | | |
|-----------|----------------|---------------|-------|----------------|----------------|-----------------|---------------|----------------|------------|
| PASS-WORD | AUTO DIAL 212A | IBM* PC MODEM | S-100 | AUTO LINK 212A | AUTO LINK 1200 | MICRO LINK 1200 | AUTO LINK 300 | MICRO LINK 300 | PHONE LINK |
|-----------|----------------|---------------|-------|----------------|----------------|-----------------|---------------|----------------|------------|

2% Shipping Tax for pre-paid, 3% Shipping Tax for C.O.D.'s paid by cashier's checks or money orders.

**GIVE YOUR COMPUTER
THE ABILITY TO
INTERACT WITH
THE REAL WORLD**



**MONITOR AND CONTROL
TEMPERATURES**

**MANAGE INDUSTRIAL
PROCESSES**

**MEASURE ENERGY
CONSUMPTION**

**CONTROL LAMPS AND
APPLIANCES**

**PROVIDE SECURITY
PROTECTION**

**PERFORM SCIENTIFIC DATA
COLLECTION**



**The ADC-1 serves as a real world
interface for any computer or
modem with a RS-232 serial port.**

This sophisticated yet easy-to-operate
data acquisition and control system
includes:

- 16 Analog to Digital Inputs - 12 bits provide 0.1mV resolution over ± 0.4V.
- 4 Digital Inputs for security and rotary encoder sensors.
- 6 Switched Outputs for relays and low voltage device control.
- AC Line Carrier Transmitter - controls 32 BSR X-10 type remote modules.
- Owner's Manual with detailed programming examples.

Sensors available from Remote Measurement Systems include: light, temperature, humidity, wind, sound, soil moisture, ultrasonic ranging, energy consumption and security.

**The ADC-1 - an exceptional
purchase at \$369.**

**REMOTE MEASUREMENT
SYSTEMS, INC.**

P.O. Box 15544 • Seattle, Washington 98115
Tel. 206-525-3369

Send for complete specifications
Telephone, Visa and Mastercard
orders welcome.

Listing 1 continued:

```

650 GET#5,ECHO$: IF ECHO$ = "" THEN 600
651 PRINT ERASE$; R$(ASC(ECHO$));
652 IF ECHO$ = QUOTE$ THEN POKE 212,0
653 GOTO 650
655 ON CCODE% - 132 GOTO 370, 675, 700, 750, 800, 900, 950, 980
660 REM *****
665 REM * PRINT TIME SINCE LOGIN *
670 REM *****
675 PRINT
680 PRINT MID$(TIME$,3,2); " MINUTES SINCE LOGIN"
685 GOTO 600
695 REM *****
700 REM * SEND LOGIN MESSAGE *
704 REM *****
710 GET#5, CH$
715 LET TIME$ = "000000"
720 FOR K = 1 TO LEN(LGIN$)
725 PRINT#5, S$(ASC(MID$(LGIN$,K,1)));
730 NEXT
735 PRINT#5, CHR$(13)
740 GOTO 650
745 REM *****
750 REM * CAPS ON-OFF *
755 REM *****
760 LET CAP% = 32 - CAP%
765 FOR K = 65 TO 90
770 LET S$(K) = CHR$(K + CAP%)
775 NEXT
780 GOTO 600
795 REM *****
800 REM * SEND FILE *
805 REM *****
815 INPUT "NAME OF FILE"; NAME$
820 OPEN 1,1,0,NAME$
825 GET#1, CH$ : GET#1, CH$
830 GET#1, CH$ : IF CH$ = "" THEN 830
835 LET CCODE% = ASC(CH$)
840 IF CCODE% = 10 THEN CLOSE 1:GOTO 600
845 PRINT#5, S$(CCODE%);
850 FOR K = 1 TO 20:NEXT
855 GET#5,ECHO$: IF ECHO$ = "" THEN 870
860 PRINT R$(ASC(ECHO$));
865 IF ECHO$ = QUOTE$ THEN POKE 212,0
870 FOR K = 1 TO 20:NEXT
875 GOTO 830
885 REM *****
900 REM * KEY REPEAT ON-OFF *
905 REM *****
915 LET REPEAT% = 128 - REPEAT%
920 POKE 650,REPEAT%
925 GOTO 600
945 REM *****
950 REM * CURSOR BLINK ON-OFF *
955 REM *****
960 LET BLINKOFF = 1 - BLINKOFF
965 LET CURS~$ = DARK$
970 GOTO 600
975 REM *****
980 REM * CHANGE SCREEN COLOR *
985 REM *****
990 POKE 36879,8 : REM FOR 64, POKE 53281,8
995 PRINT CHR$(5)
1000 GOTO 370
    
```

you want to accommodate longer periods, then modify line 680 to include hours.

When the program first runs, only the spacebar and the backspace (Inst-Del) keys repeat automatically if held down. If you depress function key F4, all keys will repeat. Using this key again will return the program to the original mode.

Function key F5 is convenient when logging in. To use it, you'll first have to modify line 220 of the program, so that LGIN\$ contains the appropriate log-in message. After this change has been made, hitting key F5

after receiving the carrier signal should log you in.

A standard feature of many terminals is a choice of either steady or blinking cursor. If you wish to have a steady cursor, it is only necessary to use key F6. Hitting the key for a second time returns you to a blinking cursor. Incidentally, when running the program, you will notice that I have used a cursor character that changes when the terminal program is running.

When you depress the Caps Lock key on your Commodore, it will affect not only letters but numerals and

COMPARE

The Benchmarks: Lomas Data Products vs. Compupro*

A benchmark comparison was made of the Lomas Data Products board set (LIGHTNING ONE, HAZITALL, LDP72 and RAM67) and a comparable COMPUPRO board set (CPU86/87 10MHz, INTERFACER-4, DISK1 and RAM21). Both CPUs were setup to run without waitstates during memory cycles. Both systems used double sided disk drives with 3 ms.

step rates and used double density diskettes with 1024 byte sectors. The test consisted of assembling the source code for the example BIOS (BIOS.A86), distributed with standard CP/M-86**. The results should be self explanatory. LOMAS DATA PRODUCTS offers superior performance.

| | LIGHTNING ONE™ 10 MHZ | COMPUPRO CPU86/87 10 MHZ | LIGHTNING 286™ 6 MHZ |
|--|--------------------------|-----------------------------|-------------------------|
| ASSEMBLY TIME (SEC.) | 47 | 55 | 41 |
| RATIO TO 10 MHZ LIGHTNING ONE | 1.00 | 1.17 | .88 |
| BOARD SET COST LIST PRICE AS TESTED | \$2545.00 | \$3040.00 | \$3290.00 |
| COST PERFORMANCE RATIO | \$2545.00 | \$3556.80 | \$2895.20 |
| | 1.00 | 1.40 | 1.14 |

Other LDP Advantages

There are many additional reasons for choosing LDP as your supplier for S100 16 bit products. We don't choose the operating system you can run on our board sets, we let you make the choice. We support CP/M-86, CCP/M-86**, MP/M-86* and MS-DOS***. MS-DOS is by far the most widely distributed 16 bit operating system and more application and support is offered to run using MS-DOS than the other competing operating systems. Our 1 year guarantee on our boards offers the customer the protection he deserves.



LDP offers the following advanced boards for the S100 bus:

■ LIGHTNING 286

The fastest processor on the S100 bus contains many advanced features. Based on the Intel 82086 processor this board maintains software compatibility with earlier 8088 and 8086 products.

■ LIGHTNING ONE

Our 8086/8088 based processor board may be operated at speeds up to 10 MHz, and will accept optional 8087 and 8089 co-processors.

■ THUNDER 186

The first and only complete 16 bit processor on a single board. This processor board uses Intel's advanced 80186 microprocessor to provide a high de-

gree of integration and allow a complete computer to be built on a single S100 bus board.

■ MEMORY BOARDS

We offer both DYNAMIC and STATIC RAM for the S100 bus. Our STATIC RAM will run with our 80286 CPU without waitstates.

■ HAZITALL System Support Board

The HAZITALL provides complete I/O support for our systems including two serial ports, two parallel ports, battery protected clock calendar and a host interface for a WD100X hard disk controller.

■ LDP72 FDC

The LDP72 floppy disk controller is an advanced disk controller allowing intermixed 5" and 8" floppy drives. The digital data separator insures long adjustment free operation.

■ SYSTEMS

LDP offers a full range of ready to plug in systems for your convenience. Our S100-PC is an ideal choice for the user wishing to purchase a compact, high-performance personal computer.

LDP

LOMAS DATA PRODUCTS, INC. □ 66
Hopkinton Road, Westboro, MA 01581
□ Tel: (617) 366-6434 □ Telex: 4996272

* COMPUPRO is a trademark of GODBOUT ELECTRONICS

*** MS-DOS is a trademark of Microsoft

** CP/M-86, CCP/M-86 and MP/M-86 are trademarks of Digital Research

| Character | ASCII | Commodore | Character | ASCII | Commodore | Character | ASCII | Commodore |
|-----------|-------|-----------|-----------|-------|-----------|-----------|-------|-----------|
| | 32 | 32 | A | 65 | 193 | a | 97 | 65 |
| ! | 33 | 33 | B | 66 | 194 | b | 98 | 66 |
| " | 34 | 34 | C | 67 | 195 | c | 99 | 67 |
| # | 35 | 35 | D | 68 | 196 | d | 100 | 68 |
| \$ | 36 | 36 | E | 69 | 197 | e | 101 | 69 |
| % | 37 | 37 | F | 70 | 198 | f | 102 | 70 |
| & | 38 | 38 | G | 71 | 199 | g | 103 | 71 |
| ' | 39 | 39 | H | 72 | 200 | h | 104 | 72 |
| (| 40 | 40 | I | 73 | 201 | i | 105 | 73 |
|) | 41 | 41 | J | 74 | 202 | j | 106 | 74 |
| * | 42 | 42 | K | 75 | 203 | k | 107 | 75 |
| + | 43 | 43 | L | 76 | 204 | l | 108 | 76 |
| , | 44 | 44 | M | 77 | 205 | m | 109 | 77 |
| - | 45 | 45 | N | 78 | 206 | n | 110 | 78 |
| . | 46 | 46 | O | 79 | 207 | o | 111 | 79 |
| / | 47 | 47 | P | 80 | 208 | p | 112 | 80 |
| 0 | 48 | 48 | Q | 81 | 209 | q | 113 | 81 |
| 1 | 49 | 49 | R | 82 | 210 | r | 114 | 82 |
| 2 | 50 | 50 | S | 83 | 211 | s | 115 | 83 |
| 3 | 51 | 51 | T | 84 | 212 | t | 116 | 84 |
| 4 | 52 | 52 | U | 85 | 213 | u | 117 | 85 |
| 5 | 53 | 53 | V | 86 | 214 | v | 118 | 86 |
| 6 | 54 | 54 | W | 87 | 215 | w | 119 | 87 |
| 7 | 55 | 55 | X | 88 | 216 | x | 120 | 88 |
| 8 | 56 | 56 | Y | 89 | 217 | y | 121 | 89 |
| 9 | 57 | 57 | Z | 90 | 218 | z | 122 | 90 |
| : | 58 | 58 | [| 91 | 91 | { | 123 | — |
| ; | 59 | 59 | \ | 92 | 92 | | 124 | — |
| < | 60 | 60 |] | 93 | 93 | } | 125 | — |
| = | 61 | 61 | ^ | 94 | 94 | ~ | 126 | — |
| > | 62 | 62 | _ | 95 | 95 | | | |
| ? | 63 | 63 | | 96 | 96 | | | |
| @ | 64 | 64 | | | | | | |

Table 1: A comparison of ASCII and Commodore character codes.

special characters as well. This creates a problem when you wish to type programs in uppercase letters. When running the program, depressing function key F7 causes a shift to uppercase-only mode, and all letters will be sent as uppercase characters. However, numerals and special characters are not affected. To regain the ability to send lowercase characters, merely hit key F7 again.

As set up in the program, key F8 changes the screen to white characters on a black background, but you can modify the numbers in the POKE statement to get any color combination that is available.

Control keys are standard on a terminal, and on most computers serve the following purposes:

- Control-C: end of text
- Control-S: temporarily suspend transmission from mainframe
- Control-Q: resume transmission
- Control-P: Break key

The Commodore key functions as a control key and must be held down while being used.

If the English pound sign is sent, it will be interpreted as a backslash. The left arrow key sends an underscore and actually prints as an underscore on your screen. By changing the sending and receiving arrays, any ASCII character may be sent, but the characters echoed on your screen are limited to the standard set of Commodore characters. For more on this, see *Modifying the Program*.

Sending Files

Let's assume that you have a text file named "TEXT" stored on tape and you wish to send a copy to the mainframe. The exact procedure for sending files will vary slightly from computer to computer, but you should be able to adapt the basic method given here. The description that follows is for persons with cassette recorders. If you have a disk drive, you should be able to modify

the procedure without too much difficulty. After logging in and starting a new file in your mainframe's editor, get into the input mode of the editor and then hit key F2. Your microcomputer will ask for the filename and then ask you to push the Play button on the cassette drive. As soon as the file is found, transmission will begin. After the file has been sent, it can be inspected or modified with the help of your large computer's editor.

If you want to send copies of the BASIC program, you'll first have to convert the program into a text file. To do this, first load the program into your Commodore. Then type

```
OPEN 1,1,2,"FILENAME":CMD 1:
LIST
```

This command opens a channel to the recorder, sends (via CMD 1) output to the recorder instead of the screen, and then lists the program currently held in memory. The cassette drive will stop and start a num-

Text continued on page 388

Gifford has a lock on multiuser CP/M[®] 8-16.

It's 11:00 P.M. Do you know where your files are?

It's great when multiple local and off site users can run any 8- or 16-bit CP/M or MP/M™ program. It's even better when they can share expensive resources like printers, hard disks, and tape drives. Best of all is when they can share your most precious resource— data. Gifford has been delivering systems with all these features for over two years.

But sometimes data is sensitive. How do you keep people from taking more than their fair share?

Gifford adds a new dimension to CP/M security.

With our new security features, you can control what resources and data are shared.

Gifford's proprietary security enhancements include user login with encrypted passwords, control over access rights of modem users, secure electronic mail, and the ability to restrict users to specified terminals, programs, and directory areas. Plus, an audit log utility that keeps a permanent record of system activity. And you also get all the standard security features of Digital Research's MP/M-86™.

You select the level of security needed to get the best balance between file sharing and file safety.

Unleash productivity with Gifford's Virtual Terminals.

With our Virtual Terminals, each terminal on your system can monitor up to four different programs running concurrently. And at the touch of a key you can switch screens instantly from one program to another.

You could look up an address in dBASE II™, jump over to SuperCalc™ to make some projections, then switch instantly to WordStar® to use this information to update a letter. If you forget what's on a screen, just touch a key to refresh your memory. You won't need to go through the distracting process of loading and unloading programs.

And since your Virtual Terminal can run any 8- or 16-bit CP/M or MP/M program, you can choose the best programs for your job from the biggest software library in the world. It's easier than 1, 2, 3!

The Gifford Security Blanket: Total Solutions.

Gifford delivers solutions. This means professional pre-sale consultation, expert system integration with 200 hour system burn-in, complete training, and full after sale support.

For example, our three user CompuPro® based system with a 21-megabyte hard disk costs just \$9,990, and can be easily expanded for \$500 per

user. This includes MP/M 8-16, SuperCalc, and dBASE II.

Other Gifford solutions include systems with hard disks that range from 5 to 300 megabytes, 4 and 9 track tape backup, printers, plotters, and modems. Single- and multiuser 8086, 68000, and Z-80 based systems are available for immediate delivery, with 80286 and 16032 systems on the way.

Two year warranty protection.

In the unlikely event that you encounter a hardware related problem, we'll replace any defective S-100 part within 24 hours FREE for two full years. But chances are, it can be solved on the Gifford service hotline or diagnosed via modem. All at no cost to you.

Lock in on Gifford Security today.

If total support, training, on site service, obsolescence-proof upgradeable S-100 bus architecture, and complete system security sound appealing, cut the coupon or give us a call. We'll send you a free brochure that tells the whole story. Once you get it you'll see why Gifford has a lock on multiuser CP/M 8-16.

Gifford Computer Systems is a Full Service CompuPro® Systems Center.



The powerful Gifford System 321 shown with optional GCS-80 Virtual Terminals.

GIFFORD
COMPUTER SYSTEMS
2446 Verna Court, San Leandro, CA 94577
(415) 895-0798 A division of G&G Engineering
I'D LIKE THE WHOLE STORY.
Please send me your brochure.

Name _____ Title _____
Organization _____ M/S _____
Address _____
City _____ State _____ Zip _____
Phone _____
 Please have a representative call me. **BY-S**

GIFFORD COMPUTER SYSTEMS □ San Leandro, CA (415) 895-0798 □ Los Angeles, CA (213) 477-3921 □ Houston, TX (713) 680-1944
Amherst, NY (716) 833-4758 □ Telex: 704521

AS GOOD AS WHOLESALE PRICES

64K DRAMS

(200 NS)

\$4.99 ea.

(Quantity Price
150 NS Also
available)

DISK DRIVE FOR IBM PC \$179 ea.
(10 Units and Up)



Complete TAVA PC System includes FDC, Two DS/IDD Disk Drives, 128K Memory, Monitor & Monitor Adapter
\$2395

IBM PC XT Compatible System
IBM PC with 128K of Memory, FDC, One DS/DD Disk Drive, Monitor, Monitor Adapter, DOS 2.0, 10MB Hard Disk Sub System includes Cables, Controller, Software
\$3995

10 MB Hard Disk Sub System for TAVA PC or IBM PC includes 10 MB Winchester Formatted, Controller Card, Software and Cables.

Internal \$1295
External \$1495

Color Graphics Card \$199
(In Quantity)

Apple IIe \$Low Price

**Monitors, Printers, Cables
and Software also available.**

ANI

17752 Sky Park Circle, Suite 210,
Irvine, CA 92714

714/261-6226 (6227)

| Line | Comments |
|---------|---|
| 110 | Set data-transmission rate to 300. |
| 115 | Set duplex to full, disable parity check, set bits to 7. |
| 120 | Open RS-232C channel as specified in lines 110 and 115. |
| 130 | Dimension sending (S\$) and receiving (R\$) arrays. |
| 170-200 | Define some of the constants used in the program. BACKSPACE\$, ERASE\$, DARK\$, and CURSOR\$ are used to control the cursor. |
| 210 | CAP% is used in conjunction with typing caps only. |
| 220 | This line should contain your actual log-in message. |
| 225-340 | Define sending and receiving arrays so that sent Commodore characters are converted to ASCII and vice versa. See table 1. |
| 345 | Enable lowercase character typing. |
| 370 | Clear the screen. |
| 380-570 | Print the function-key menu. |
| 600 | Print the cursor, CHR\$(162). |
| 605 | If cursor blink is turned off, skip next three lines. |
| 610-620 | Controls blinking cursor display. |
| 625 | Get character from keyboard. If none typed, go to line 650 to look for character from mainframe. |
| 630 | Compute Commodore character code, CCODE%. |
| 635 | If character code is between 132 and 141, then a function key has been depressed; go to line 655 for further instructions. |
| 640 | Send typed character to mainframe. |
| 650 | Look for echo character returned from mainframe in full-duplex mode. If none received, then go back to look for character from keyboard. |
| 651 | Erase cursor and print character received from mainframe. |
| 652 | If a double quotation-mark character is received, then reset quote mode with proper POKE. |
| 655 | Determine which function key has been depressed and go to appropriate part of program for action. |
| 680-685 | Print time since log-in using built-in clock variable TIMES\$. Then return to main loop. |
| 705-740 | Send log-in message to mainframe. |
| 705 | Send carriage-return character to let mainframe know you are on line. |
| 715 | Set clock back to zero. |
| 720-730 | Using MID\$ function and S\$ array, send log-in message, one character at a time. |
| 735 | Send carriage-return character. |
| 760-780 | Caps only enable-disable. |
| 760 | CAP% will be changed from 0 to 32 or vice versa. |
| 765-775 | Change part of sending array corresponding to lowercase characters. |
| 800-875 | Send text file to mainframe. |
| 815 | Ask for filename. |
| 820 | Open cassette for reading. To read from disk, change this to OPEN 1,8,1,NAME\$. |
| 825 | The first two characters in the text file are return characters and will be read and ignored. |
| 830 | This is the start of a loop. GET a character from the text file. If none is found, try again. |
| 835 | Compute the Commodore code of the character. |
| 840 | If the end-of-file character is found, then close the file and return to the main program. |
| 845 | Send proper character to the mainframe. |
| 850 | This is a delay loop. For some reason, the program wouldn't work right without this. The machine kept getting confused about which characters in the tape buffer had been read. |
| 855 | Look for echo from the mainframe. |
| 860 | Print the echo on the screen. |
| 865 | Reset the quote mode if a double quote received. |
| 870 | Delay loop—see explanation of line 850. |
| 875 | End of loop. |
| 915 | REPEAT% will change from 0 to 128 or vice versa. |
| 920 | POKE 128 will enable key repeat and POKE 0 will disable it. |
| 960 | BLINKOFF will change from 1 to 0 or vice versa. |
| 965 | This line makes sure the cursor is visible when blink is turned off. |
| 990 | Change screen to black. |
| 995 | Change characters to white. |

Table 2: Comments for listing 1.

PRO-MODEM 1200



It's about time.

Time for your computer to make the telephone connection — with an intelligent, full 212A 300/1200 baud modem — with a real time clock/calendar — and with the capability to expand into a complete telecommunications system. It's time for PRO-MODEM 1200. Much more than just a phone modem.

When you're on-line, time is money. PRO-MODEM telecommunications systems help you save. By monitoring the duration and cost of your phone calls. And by sending and receiving messages, unattended, at preset times when the rates are lower. . . with or without your computer. Compare the \$495 PRO-MODEM 1200 with any other modem on the market. For example, you'd have to buy both the Hayes Smartmodem 1200 plus their Chronograph for about \$950 to get a modem with time base.

PRO-MODEM 1200 is easy to use. A convenient "Help" command displays the Menu of operating command choices for quick reference whenever there's a question about what to do next. Extensive internal and remote self-diagnostics assure that the system is operating properly. Some of the other standard features include Auto Answer, Touch Tone and Pulse Dialing, and Programmable Intelli-

PRO-MODEM does more. It lets you build a full telecommunications system with features like Auto Dialer, Incoming and Outgoing Message Buffering, Business/Personal Phone Directory, Program-able Operating Instructions, a 12-Character Alpha-Numeric Time and Message Display, and versatile PRO-COM Software. PRO-MODEM commands are Hayes compatible so you can use most existing telecommunications software without modification. There's much more to the PRO-MODEM story. See your local dealer for complete details. He'll show you how to save time. And money. Prometheus Products, Inc., 45277 Fremont Blvd., Fremont CA 94538, (415) 490-2370

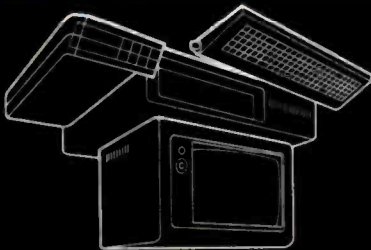

PROMETHEUS

Personal Computer Values

• IBM-PC BOARDS •

| | |
|--------------------------------------|-------|
| Amdek MAI Graphics Board..... | \$499 |
| AST Research Six Pak Plus 64k..... | 299 |
| AST Research Mega Plus II 256k..... | 599 |
| AST Research Extender Card..... | 55 |
| CCS 132 Column Super Vision Board .. | 680 |
| Hercules Graphics Card..... | 369 |
| Microsoft 256k RAM Board..... | 445 |
| Microsoft 64k System Board..... | 275 |
| Microsoft 256k System Board..... | 429 |
| Plantronics Color Plus..... | Call |
| Quad Ram Quadlink..... | Call |
| Quad Ram Quadboard..... | 285 |
| Tecmar 1st MATE Board..... | 295 |
| Tecmar Graphics Master..... | 589 |

Color Graphics Special

PC-Peacock color graphics board + 4-Point Graphics CAD Software

BOTH FOR \$449.95

• DOT MATRIX PRINTERS •

| Okidata | | Epson | |
|-----------------------|-------|-----------------------|-------|
| ML-80..... | Call | RX-80..... | Call |
| ML-82A..... | Call | RX-80F/T..... | Call |
| ML-83A..... | Call | MX-100..... | Call |
| ML-84 Par..... | Call | FX-80..... | Call |
| ML-92 Par..... | Call | FX-100..... | Call |
| ML-93 Par..... | Call | Star Micronics | |
| NEW! Riteman | | Gemini 10X..... | \$299 |
| Inforunner..... | \$319 | Gemini 15X..... | 499 |
| NEW! Panasonic | | Delta 10..... | 549 |
| KX-P1090..... | \$339 | Radix 10..... | 719 |

• DAISYWHEEL PRINTERS •

| NEC | | Diablo | |
|--------------------|-------|------------------|--------|
| 2010 (Ser)..... | \$879 | 620..... | \$998 |
| 2030 (Par)..... | 879 | 630 R-155..... | 1899 |
| 2050 (IBM-PC)..... | 999 | 630 ECS/IBM..... | 2195 |
| 3510 (Ser)..... | 1499 | Qume | |
| 3550 (IBM-PC)..... | 1899 | 11/40..... | \$1399 |
| 7710 (Ser)..... | 2159 | 11/55..... | 1599 |

• MONITORS •

| Amdek | | Zenith | |
|----------------------|-------|-------------------|-------|
| 300G 12" Gr..... | \$139 | 123 12" Gr..... | \$118 |
| 300A 12" Amb..... | 159 | 122 12" Amb..... | 145 |
| 310A 12" Amb..... | 169 | 131 Med. Res..... | |
| Color I..... | 299 | RGB..... | 319 |
| Color II +..... | 449 | 135 High Res..... | |
| Color III..... | 385 | RGB..... | 549 |
| BMC 12AU 12" Gr..... | 385 | | |

• DISC DRIVES •

| | |
|---|--------|
| Tandon 100-2 DSDD 5.25"..... | \$249 |
| Tandon 848-2 8" DSDD..... | Call |
| Mitsubishi 8" DSDD..... | Call |
| Mitsubishi 5.25 1/2 height DSDD..... | 175 |
| Tallgrass Technologies | |
| 6MB Hardfile Disk for IBM-PC..... | \$1895 |
| 20MB Hardfile Disk for IBM-PC..... | 2795 |
| 70MB Hardfile Disk and Tape Backup..... | Call |

• DISKETTES •

| IBM | | Maxell | |
|------------------|---------|---------------------|---------|
| 5 1/4" SSDD..... | \$29.95 | 5 1/4" MD1..... | \$23.95 |
| 5 1/4" DSDD..... | \$36.95 | 5 1/4" MD2..... | \$33.95 |
| 8" DSDD..... | \$47.95 | 8" SSDD..... | \$36.95 |
| 3M/Scotch | | Best Buy | |
| 5 1/4" SSDD..... | \$20.95 | 5 1/4" DSDD 48TPI | |
| 5 1/4" DSDD..... | \$27.95 | Brand of our choice | |
| 8" SSDD..... | \$23.95 | | \$16.95 |

All prices, F.O.B. shipping point, subject to change. All offers subject to withdrawal without notice. Advertised prices reflect a 2% cash discount (order prepaid prior to shipment). C.O.D. credit card orders, 2% higher.

MiniMicroMart

Box 2991B Syracuse, N.Y. 13220

315-422-4467

WRITE FOR OUR FREE 100 PAGE CATALOG!

Text continued from page 384:

ber of times. (Programs stored as text files take up about twice as much tape as they do when stored as program files.) When the drive finally stops for the last time, some information will still be in the tape buffer. To get it out and to properly close the file, type

PRINT#1: CLOSE 1

The cassette will turn one final time and the program will be on tape, but as a text file, not as a program file. I recommend that you store any such text file at the beginning of a cassette, so that rewinding the tape is easy.

Modifying the Program

The program in listing 1 was written with two primary goals: efficiency and readability. Conserving memory space was a secondary consideration. If you have an unexpanded VIC, you'll have to "crunch" the program a bit. Take out all of the remark statements, use shorter variable names, leave out spaces, and, if necessary, take out the Help menu. With these changes you should be able to run the program.

To make the program usable with as many machines as possible, I had to make a few compromises. In particular, the limited memory of the VIC was kept in mind, and the 22-column VIC format was also a factor. One specific way in which this affected the program was in format of the Help menu. If you have a Commodore 64 you can spruce the menu up a bit.

If you want to add features to the program that are accessed through the function keys, you will have to give something up, of course. The (no) blink cursor option is an obvious candidate because it's a decision that most people want to make only once. If you opt for a (permanent) steady cursor, I recommend that you delete lines 605-620, which will improve program efficiency somewhat.

By using table 1, you can send ASCII characters not on the Commodore keyboard. Suppose, for example, that you wish to send the vertical-bar character, which has ASCII code 124. First, choose an "unused"

key, preferably one with mnemonic value. In this case, a logical choice would be a Shift "-", which actually resembles the vertical-bar character. If you add the following line to your program, you will be able to send this character, and the echo you get back will be somewhat helpful.

325 S\$(221) = CHR\$(124) : R\$(124)
= CHR\$(221)

The net effect of this line is that when you send a Shift "-", a vertical-bar character will be received by your mainframe, and when the mainframe echoes this character, a reasonable facsimile will be printed on your video display.

One program capability that you might want to add is the ability to communicate in half-duplex mode. This is relatively easy. First, change the value of the variable DUPLEX\$ (line 115) to equal CHR\$(176). Then, add the following line to the program:

626 PRINT CH\$;

This line ensures that when a key is typed, it will appear on your screen. (Recall that in half-duplex, no echo is sent back from the mainframe.)

The data-transmission rate and the number of bits in the codes sent can be adjusted with the variable BAUD\$. This variable appears in line 110 and is defined there as BAUD\$ = CHR\$(32 + 6). The 32 sets the number of bits in characters transmitted at 7. To change this to 8 bits, use a 0 instead. The 6 sets the data-transmission rate at 300. Using a 1, 2, 3, 4, 5, or 7 will change this to 50, 75, 110, 134.5, 150, or 600, respectively. More helpful information can be found in your VIC or Commodore 64 reference manual, and I'm sure there are a number of ways you could tailor this program for your own purposes. ■

John P. Russo (16817 Cleveland Rd., Granger, IN 46530) is an associate professor of mathematics and computer science at Indiana University at South Bend, IN. While not using a Sage II or VIC-20, he enjoys woodworking, gardening, and playing handball.

THE SMALL BUSINESS MAINFRAME

MuSYS NET/work 8816

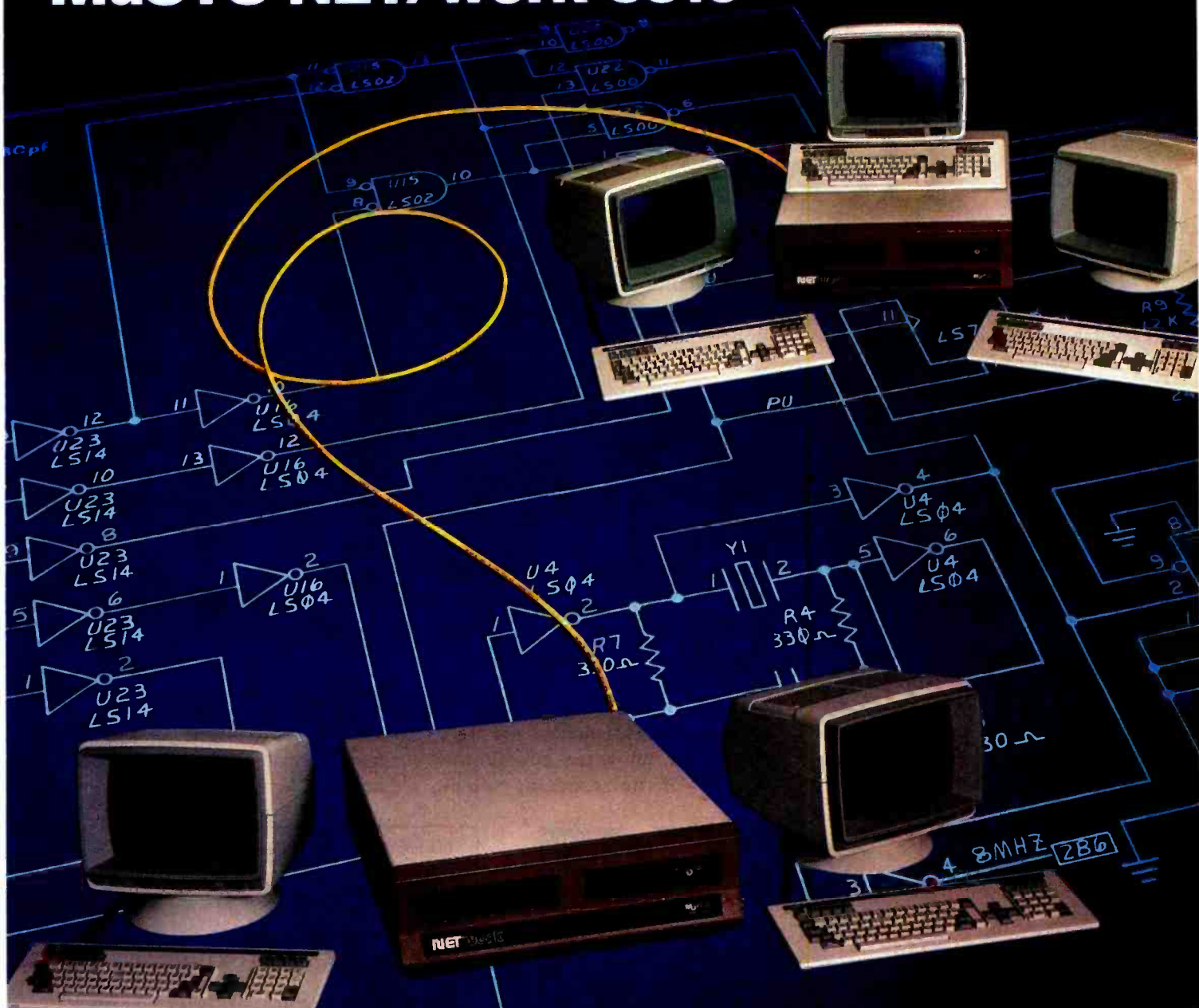

Large Multi-user Capability

The NET/work 8816 is an 8/16 bit Multi-user, Multi-processor small business computer system that affords **"Mainframe Power at a Micro Price"**. The major features of the system are:

- Expandable from 2 to 8 users, with **18 to 242 formatted Megabytes** of reliable high speed storage. Each user has their own computer with a minimum of 128K RAM and access to a common database of information.
- **Runs over 3,000 CP/M and MP/M software packages.** The NET/work 8816 operates under an enhanced version of the TurboDOS operating system, providing each user with **one of the industry's largest TPAs** (minimum 63 KB).
- You won't outgrow this system! **Room for growth** without costly changes. Networking via ETHERNET links up to 16

systems to accommodate 256 users with 3.8 GIGABYTES of high-speed online disk storage.

- **Easy to install**, boots from the hard disk with a Menu-driven System Configuration Program, **and even easier to use.**
- Plus, Cartridge or 9 Track Tape Back Up Subsystems are available.

Call toll free 1-800-852-5362 for literature (sent in 24 hours), inside California (714) 662-7387. Or write MuSYS Corporation, 1752-B Langley, Irvine, California 92714. TWX 910-595-1967. Cable MUSYSIRIN.

DEALER and OEM INQUIRIES WELCOME

NET/work is a trademark of MuSYS Corporation. TurboDOS is a trademark of Software 2000, Inc. CP/M is a trademark of Digital Research, Inc. Ethernet is a trademark of Xerox Corporation.

MUSYS
CORP.
specialists in multi-user business systems

Help the Old Programmers' Home



For over 7 months, the Old Programmers' Home of Paulsborough, New Hampshire, has been providing the utmost in care for those programmers who are no longer able to practice their arcane craft. Located in the scenic New England countryside, the Home tries to create a calm, tranquil shelter for those members of this esteemed profession who are too old or too burnt out or have to pay too much alimony.

The Old Programmers' Home provides each of its residents with a warm bed, good hearty fast food, and an unlimited supply of cola and fan-fold paper. Residents are even provided with access to a

small quantity of semi-operational teletypewriter terminals and card-punch machines. On special occasions, field trips are made to the Social Security office, the Museum of Computer History, and the Armonk Landfill.

Affiliated with the Famous Programmers' School, the Home attempts to set a new standard of care for these forgotten programmers. Doctors and other staff members are completely fluent in hexadecimal, octal and even binary notation. All room numbers and temperature and blood-pressure measurements are recorded in all three notations. Age is of no concern; some

residents, in fact, are over 35 years old.

Please give as much as you can to the Home so that these former hackers can live in the comfortable surroundings they know and love. All contributions are completely non-deductible. Unfortunately, because of restrictions in the Home's accounting programs, all contributions must be equal to or greater than \$32,768 and must be evenly divisible by 2. No stamps, please.

(Bar-code versions of this advertisement are available for \$163.84 from specially selected computer stores.)



Because physical fitness is so important for good health, the Old Programmers' Home is especially proud of its spacious exercise room. Here residents perform calisthenics and aerobic exercises or even play volley ball.

(do not cut on dotted line)

**The Old Programmers' Home
Dept. APRFOL
8008 Bootstrap Road
Paulsborough, NH 03458-0463**

I would like to contribute \$32,768 or more (evenly divisible by 2) to help the staff of the Old Programmers' Home. I understand that my contribution is completely non-deductible in all federal, state and local jurisdictions.

- I enclose a lot of unmarked bills
 Please charge my Swiss bank account

Name (optional) _____
Address _____

Favorite soft drink _____

Call 1-800-555-1212 for information

A nominally non-profit organization in association with the Famous Programmers' School, Inc.

You Don't Have To Be A Magician To Select The Right System

Advanced Digital makes system selection easy. No tricks, No Illusions... just an expanding line of Single and Multi-user, Multi-processing S-100 based computer systems that exceed the most demanding customer requirements.

For 1 To 8 Users, It's Super Star...

Tired of fighting the limitations of floppies and streamer tapes? SUPER STAR is the **FIRST** S-100 based system to use the 5 MByte Fixed/5MByte Removable cartridge Winchester disk drive as standard. SUPER STAR offers such outstanding features as a six-slot motherboard, low power consumption, and S-100 Bus. IEEE 696 compatibility. Easily expandable to eight users with TurboDOS* and Advanced Digital's Master/Slave boards. SUPER STAR is the best Cost/Performance Act on the stage today.

New 8/16-Bit Super System II Gives You Up to 20 Users...

For those large installations, its Advanced Digital's new SUPER SYSTEM II. Its many features appear right before your eyes like magic. Features such as a 12-slot motherboard, a choice of 20 MByte Winchester disk drive (standard) to 140 MByte of on-line capacity, high-speed, high-reliability 5 MByte Removable Cartridge for back-up at speeds approaching 1.5 MBytes/min., and a one year, 100% parts/labor warranty. SUPER SYSTEM II - A hard act to follow.

All Advanced Digital Systems are compatible with CP/M* 2.2, CP/M 3.0. Concurrent CP/M and TurboDOS. When equipped with Advanced Digital's new SUPER 186 16-Bit Single Board Computer, you magically change from 8-Bits to 16-Bits. You can even perform simultaneous multi-tasking operations of both 8-Bit and 16-Bit programs.

Advanced Digital computers may perform like magic, but there's no rabbit in the hat... only high-quality, extremely reliable components designed and manufactured to assure user satisfaction. Don't be dazzled by cheap tricks and illusions, see your Advanced Digital dealer and take the mystery out of system selection.



 **ADVANCED
DIGITAL
CORPORATION**

Leading The Microcomputer Technology

*CP/M is a trademark of Digital Research
*TurboDOS is a trademark of Software 2000

Advanced Digital

5432 Production Drive, Huntington Beach, CA 92649
Tel. (714) 891-4004 • Telex 183210 ADVANCED HTBH

In Europe:

Advanced Digital U.K. Ltd.

27 Princess St., Hanover Square
London W1R8NQ • United Kingdom
409-0011 • 409-3359 Telex 265840 FINEST

A Keyboard Input Routine for IBM PC BASIC

Customize BASIC's INPUT statement for your application

Randy D. Peck
Pacific Micro Software Engineering

One of the more prominent shortcomings of BASIC, particularly for entry-intensive applications, is its lack of a formatted INPUT statement. When an INPUT statement is executed, the computer simply displays a prompt and waits for you to begin typing. You can type anything and everything—special characters, control codes, or the first three chapters of *War and Peace*. The BASIC INPUT statement offers no control over maximum field length or acceptable character set, and it does not differentiate between numeric and string variables until after the entry has been made.

It would be handy, in a number of applications, to have an INPUT statement that would accept only as many characters as it was programmed to accept—an INPUT that defined its input field with inverse blanks and could easily be adapted to accept only certain subsets of characters, such as integers, uppercase alphanumerics, or any other type. And it would be nice if the prompt were displayed in high-intensity characters, returning to normal intensity only after the input had been accepted.

The keyboard input described here has all these features and more. You need only change a few lines of your own BASIC programs to use it.

Operation

This subroutine (see listing 1) is meant to be used as a substitute for the BASIC INPUT statement and should be called with a GOSUB at the line where the INPUT statement would normally occur. Listing 2 illustrates a sample call.

The variables PROMPT\$, ROW%, COL%, and FLDLEN% must be set in the program from which this subroutine is called. PROMPT\$ is the text that should be displayed as the prompt. ROW% and COL% are in-

teger variables representing the row and column of the display where the line will begin. The integer variable FLDLEN% should be set to the maximum number of characters allowed in the input field.

In setting these parameters, there are a couple of things to keep in mind. First, the input field begins at the print position immediately following the prompt; so, if you want spaces to appear between the prompt and the input, those spaces should be included as the last characters in the PROMPT\$ string. Second, the routine requires that prompt and input be confined to a single line, so don't include any carriage returns in the PROMPT\$ string. Also, if the number of characters in the prompt text and input field exceed the number of spaces remaining on the line (after the starting column position), the routine returns an error message and accepts no input.

In the subroutine itself, the first section of code does initialization. Some internal variables are set, and the prompt and a blank input field are displayed at the requested location on the screen. After that, the routine reads characters from the keyboard one at a time, checking whether they belong to a defined character set (the definition of such a set is discussed under Filters). Characters are displayed only if they are members of that set—invalid characters are ignored just as if the key had not been pressed.

Other checks prevent the user from entering too many characters or from trying to backspace out of the input field. Occurrence of either condition is signaled by a beep from the terminal (no displayed message). Note that once the input field is full, there are still two characters that can legally be entered: the backspace and the carriage return. Any other characters entered at this point will be ignored.

Text continued on page 396

GET YOUR MESSAGE THROUGH.

EVEN WHEN YOUR MODEM SENDS IT BY WAY OF THE OKEFENOCKE SWAMP.

When you send data by telephone through nasty environments like this, it can run into problems tougher than just alligators. Problems like impulse noise. Chatter from the switchgear. Static from the atmosphere or bad weather. Distortion due to crosstalk or just plain white noise.

To get your message through, your IBM PC or XT needs the advanced performance features of the PC: IntelliModem.™ It's got the best receive sensitivity available today—actually down below -50 dBm. So now you can achieve a high level of data transmission integrity. Even with bad connections.

Get patented modem technology.

The PC: IntelliModem is elegantly simple. Its patented design does it all on a single microprocessor chip, with just one crystal. Other modems take

two, four or more μ Ps (and even more oscillators), and still accomplish less.

How do we do this? By creating architectural innovations in firmware, and by pushing the chip to its limit, close to 12 MHz. Since it uses fewer parts, the PC: IntelliModem's no-compromise design offers higher reliability, a more compact form factor, and lower costs.



This design elegance leads naturally to more elegant performance. Take line status detection, for example. The PC: IntelliModem's adaptive, decision-directed logic monitors line status more closely than other modems. Even at weak or degraded signal levels. So it can make connections with less chance of error, by detecting signals for dial tone, remote ringback, busy and voice—some of which other modems ignore.

Plan ahead with integrated voice and data.

For opening up a whole new world of integrated voice and data applications, there's nothing like the PC: IntelliModem. Literally. Its easy-to-use software package—PC: IntelliCom™—lets you switch repeatedly between talking or listening and sending or receiving data. All at

Make sure your modem has all these PC: IntelliModem features

Integrated Voice/Data

- Switch between voice and data communications
 - Programmable telephone handset jack
- #### Status Reporting
- Line status detection (dial tone, busy, remote ringback, voice answer, modem answer, incoming call)

- Audio monitor
 - Programmable status LED
- #### PC: IntelliCom™ Software Included
- 99-name on-line telephone directory
 - Auto-dial, auto-repeat dial, auto-answer
 - Link to another number if busy
 - File transfer
 - Data capture to diskette
 - Programmable auto log-on sequences

Compatible with Crosstalk™ and PC-Talk III™

Pulse and Tone Dialing
Receive Sensitivity: -50 dBm
Speeds: 110, 300, 1200 baud

the touch of a single function key. That means now both you and your computer can talk on the same line. Without having to hang up, re-dial or plug and unplug a lot of cables.

So if you're designing microcomputer datacomm products—or just looking for a PC/XT modem for yourself, check out the PC: IntelliModem at your local dealer. You'll get the message. And so will they. Or contact: Bizcomp, 532 Weddell Drive, Sunnyvale, CA 94089; 408/745-1616.

Bizcomp: A history of innovation.

| | |
|------|---|
| 1980 | Invented first command-driven modem |
| 1981 | Introduced proprietary line-status monitoring |
| 1983 | Designed first single- μ P 212A-compatible modem |
| 1983 | Introduced first integrated voice/data modem for IBM PC |
| 1983 | Granted patent on command-driven modem |

BIZCOMP®
We've got people talking.

Listing 1: *Intended to be substituted for the BASIC INPUT statement, this subroutine displays your prompt in high-intensity characters. Immediately following the prompt is an input field defined by inverse blanks. It can be tailored to accept any type of input or subset of characters.*

```

1000 '*****
1010 '*
1020 '*           A KEYBOARD INPUT ROUTINE FOR IBM PC BASIC
1030 '*           by Randy D. Peck
1040 '*
1050 '* This subroutine is intended to be used as a substitute for the
1060 '* IBM PC BASIC 'INPUT' statement. It prints the prompt in high-
1070 '* intensity, displays the input field in inverse, and accepts only
1080 '* the set of characters and number of characters defined by the
1090 '* programmer.
1100 '*
1110 '* The following four variables must be set upon entry to the routine:
1120 '* PROMPT$ = String constant used to prompt for desired input
1130 '* ROWX = Integer constant used as row for the prompt and input
1140 '* COLX = Integer constant used as column the prompt will begin in
1150 '* FLDLENX = Integer constant defining maximum length of input field
1160 '*
1170 '* VARTXT$ = String variable returned from the routine
1180 '*
1190 '*****
1200 REM -----
1210 REM           INITIALIZE THE DISPLAY AREA
1220 REM -----
1230 VARTXT$="" 'Initialize input buffer to null
1240 IF (COLX+LEN(PROMPT$)+FLDLENX) > 79 THEN PRINT "INPUT LINE TOO LONG.":RETURN
1250 FSTPOSX=COLX+LEN(PROMPT$) 'First column of input text
1260 ENDPOSX=COLX+LEN(PROMPT$)+FLDLENX 'One after last column of input text
1270 COLOR 15,0 'Set character display to high-intensity mode
1280 LOCATE ROWX,COLX 'Move cursor to desired coordinates
1290 PRINT PROMPT$; 'Print the prompt in high-intensity
1300 COLOR 0,7 'Set character display to inverse mode (black on white)
1310 PRINT " "; 'Print inverse cursor at first input field position
1320 FOR IX=2 TO FLDLENX
1330 PRINT " "; 'Inverse blanks define rest of input field
1340 NEXT IX
1350 LOCATE ROWX,FSTPOSX 'Move cursor back to first column of input field
1360 REM -----
1370 REM           BEGINNING OF MAIN LOOP
1380 REM -----
1390 CHAR$="" 'Clear buffer used to hold current character
1400 WHILE CHAR$="" 'Wait until a key has been pressed
1410 CHAR$=INKEY$ 'And assign it to the variable CHAR$
1420 WEND
1430 IF (POS(0)=ENDPOSX) AND (CHAR$(<)CHR$(13)) AND (CHAR$(<)CHR$(8)) THEN BEEP:
GOTO 1370 'Check for field overflow
1440 REM -----
1450 REM           THIS SECTION EXECUTES IF CHAR$ IS A BACKSPACE
1460 REM -----
1470 IF (CHAR$(<)CHR$(8)) THEN 1560 'If not a backspace then skip this section
1480 IF (POS(0)=FSTPOSX) THEN BEEP:GOTO 1370 'Can't backspace from here
1490 VARTXT$=LEFT$(VARTXT$,LEN(VARTXT$)-1) 'Remove backspaced character
1500 'The next three lines serve to backspace the cursor by one column:
1510 LOCATE ROWX,POS(0)-1
1520 IF (POS(0)=ENDPOSX-1) THEN PRINT " ";LOCATE ROWX,POS(0)-2
1530 IF (POS(0)=ENDPOSX-1) THEN PRINT " ";LOCATE ROWX,POS(0)-1
1540 GOTO 1370 'Go back for another character
1550 REM -----
1560 REM THIS SECTION EXECUTES FOR ALL OTHER CHARACTERS EXCEPT CARRIAGE RETURN
1570 REM -----
1580 IF CHAR$=CHR$(13) THEN 1650 'If carriage return, then finish up
1590 REM IF ANY 'FILTERS' ARE USED, THEY SHOULD BE INSERTED HERE.
1600 VARTXT$=VARTXT$+CHAR$ 'Else add current character to input text buffer
1610 PRINT CHAR$; 'And echo it to the display
1620 IF (POS(0)=ENDPOSX) THEN PRINT " ";LOCATE CSRLIN,POS(0)-1
'If field not full, print a cursor character in the next field position
1630 GOTO 1370 'Go back for another character
1640 REM -----
1650 REM           THIS SECTION EXECUTES WHEN THE CARRIAGE RETURN GETS PRESSED
1660 REM -----
1670 IF (POS(0)=ENDPOSX) THEN PRINT " "; 'Erase cursor character
1680 COLOR 7,0 'Set character display back to normal mode
1690 LOCATE ROWX,COLX 'Move cursor to first position of PROMPT$
1700 PRINT PROMPT$ 'And restore the prompt to normal intensity
1710 'Use this line to convert VARTXT$ to the appropriate type
1720 RETURN 'VARTXT$ now holds the new data in string form

```

THE BUFFER DID IT.

Who Stole The 1500 Letters From The Computer?

Let's just say you've got to send a letter to 1500 different people. Would you like to spend 22.5 hours* or 60 seconds of computer time?

With a garden-variety buffer, the computer has to mix, merge and send 1500 addresses and 1500 letters to the buffer. Trouble is, most buffers only store about 32 letters. So after 32 letters, the computer's down until the printer's done. Altogether, you're talking 22.5 hours.

In the case of our new (not to mention amazing) ShuffleBuffer, computer time is 60 seconds flat. Just give

ShuffleBuffer one form letter and your address list, and it takes care of the mixing, the merging, and the printing. But that's not all ShuffleBuffer's stolen from the computer. Oh, no.

Who Changed and Rearranged The Facts?

Again, ShuffleBuffer's the culprit. You want to move paragraph #1 down where #3 is? Want to add a chart or picture? No problem. No mystery, either. Any buffer can give you FIFO, basic first-in, first-out printing. And some

buffers offer By-Pass; the ability to interrupt long jobs for short ones. But only ShuffleBuffer has what we call Random Access Printing — the brains to move stored information around on its way to the printer. Something only a computer could do before. Comes in especially handy if you do lots of printing. Or lengthy manuscripts. Or voluminous green and white spread sheets. And by the way, ShuffleBuffer does store up to 128K of information and gives you a By-Pass mode, too.

And Who Spilled The Beans 239 Times?

Most buffers can't tell the printer to duplicate. If they can, they only offer a start/stop switch, which means you're the one who has to count to 239. Turn your back on your buffer, and your printer might shoot out a room full of copies. ShuffleBuffer, however, *does* control quantity. Tell it the amount, and it counts the copies. By itself.

So, What's The Catch?

There isn't any. Sleuth around. You won't find another buffer that's as slick a character as this one.

You also won't find one that's friendly with any parallel or serial computer/printer combination. This is the world's only universal buffer.

With a brain.

Who Wants You To Catch A ShuffleBuffer In Action?

You guessed it. We do. Just go to your local computer dealer and ask him to show you a ShuffleBuffer at work. Or, you can call us at (215) 667-1713, and we'll clue you in on all the facts directly.

* Based on an average 4000 character letter & 128K buffer.

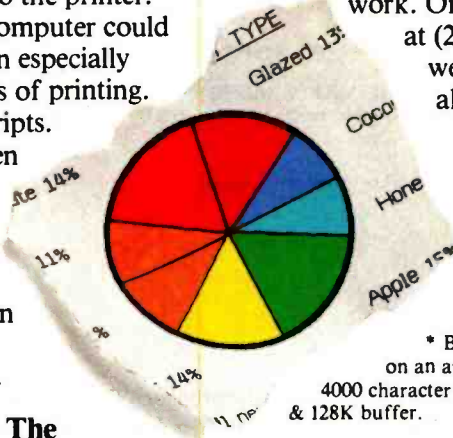
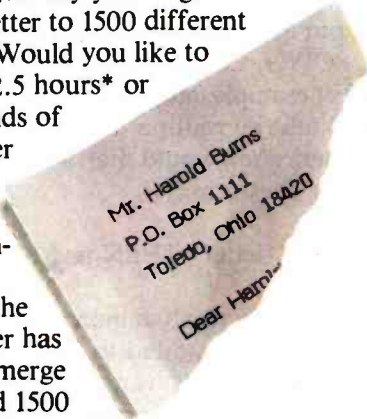

Now, keep th
my doughboy
Love,
Gladys

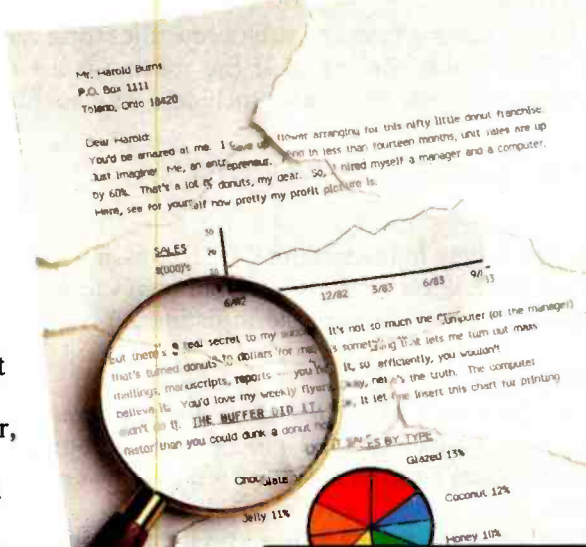

ShuffleBuffer
The Buffer with a Brain

IS Interactive Structures Inc.
146 Montgomery Avenue
Bala Cynwyd, PA 19004

Listing 2: This sample program segment shows how you might use the routine (two variations) to input a name and a social security number. Just set the text of the prompt, the location on the screen where you want the prompt to appear, and the length of the input field. Then, execute a GOSUB and set the results to your own variable name.

```

100 '
110 '
120 '
130 COL%=1
140 REM GET NAME
150 PROMPT$="Enter your name: "
160 ROW%=5
170 FLDLEN%=15
180 GOSUB 1000 'Character input
190 NAME$=VARTXT$
200 REM GET SOCIAL SECURITY NUMBER
210 PROMPT$="Enter your social security number: "
220 ROW%=7
230 FLDLEN%=9
240 GOSUB 2000 'Whole number input
250 SSNUM=VARTXT$
260 '
270 '
280 '

```

Text continued from page 392:

When the carriage return is finally pressed, the routine changes the prompt to normal intensity and executes a RETURN.

After returning from the subroutine, the string variable VARTXT\$ holds the input. If the routine is set up to receive numbers, be sure to include a line such as:

```
1710 VARTXT = VAL(VARTXT$)
```

Immediately following the GOSUB, assign VARTXT\$ (or VARTXT, if it is a number) to your own variable name. (Again, refer to the example in listing 2.)

Filters

To restrict the set of characters that may be entered during input, I have included a line in the subroutine (line 1590) that can be used to "filter" out the unwanted characters.

Because I did not include a specific filter in listing 1, the routine will accept any character the keyboard can deliver. To include a filter, either replace line 1590 with one of the following, or write your own to fit special requirements.

For positive whole numbers, use:

```
1590 IF (CHAR$ < "0" OR CHAR$ > "9") THEN
      GOTO 1370
```

For real numbers, use:

```
1590 IF (CHAR$ < "0" OR CHAR$ > "9")
      AND (CHAR$ < > "-" ) AND (CHAR$ < > "." )
      THEN GOTO 1370
```

For uppercase alphanumerics and spaces, use:

```
1590 IF (CHAR$ < "0" OR CHAR$ > "9")
      AND (CHAR$ < "A" OR CHAR$ > "Z")
      AND (CHAR$ < > " ") THEN GOTO 1370
```

Although this description implies that you should use a separate subroutine for each type of input you need to accept, it would be possible to use one subroutine for several types of input by coding for a fifth parameter (besides PROMPT\$, ROW%, COL%, and FLDLEN%) to express input type. For example, an "input type" parameter value of "A" might tell the routine that you wanted to input an alphanumeric. You would then add a filter line for each type, using the form:

IF parameter value = "letter" THEN text of filter

This would save memory if you had more than one type of input and could easily be added to the subroutine. I didn't write the routine this way because logical-strength, control-coupled modules (those that use a function-code argument to control program logic) are less than desirable from a design standpoint.

It's Not Perfect

The program falls short of being an ideal keyboard input routine. Its most serious limitation is its lack of control over the order in which characters must be entered.

For example, when you are entering numbers, the computer doesn't know that a minus sign can only appear in front of digits, or that the number of decimal points is limited to one. So when a real number is expected, the subroutine will accept input such as: 54.-2--96.-. In this case, the value returned in VARTXT would be 54.

A Suggestion

To take full advantage of this subroutine, reuse it. Keep a copy of the routine on a disk, and the next time you write a program that needs keyboard input, merge it with this subroutine. You won't need to debug it—you did that the first time you used it.

Incidentally, I follow this practice with other routines. I keep dozens of subroutines for utilitarian purposes on separate disks.

Conclusion

I have presented a subroutine intended to replace BASIC's INPUT statement. By setting a few parameters and executing a GOSUB, your programs can become more user-friendly, more attractive, and ultimately more reliable than they were. ■

Randy D. Peck (6000 Bay Shore Walk, Long Beach, CA 90803) holds a bachelor's degree in computer science and recently founded a company that writes custom software for small- to medium-sized businesses. He uses an IBM PC XT.

WATCH THE BIG GUYS

When you are going to expand a thousand IBM PC's you want to get it right. Fact is, if you are going to expand one PC you want to get it right. That's why world leaders in computers, energy, manufacturing, research and education as well as tens of thousands of individual computer owners have picked Qubie' for their PC or XT expansion products.

THE PEOPLES CHOICE

You can't gather an impressive list of customers without great products. You just have to be impressed with **MegaPlus II™**, **SixPakPlus™**, and the **Qubie' PC212A/1200**

modem card. **MegaPlus II™** is the most flexible expansion product available for the PC. It's companion, the **SixPakPlus™**, has quickly become the number one selling multifunction board for IBM PC's. The Qubie' modem card utilizes four digital microprocessors to provide flawless performance at 300 or 1200 baud. It even comes with **PC-TALK III™** software, the program PC WORLD magazine called, "The benchmark that other PC communications packages are measured against". All this for under \$300. No wonder the Fortune 500 is impressed!

THE RIGHT PRICE

Our prices don't just look good, they are. No extra charges for shipping, testing, insurance, credit cards, or COD fees. If you are in a hurry, 2 day air service is available for just \$5 extra. We also offer a Qubie' exclusive, our **PREFERRED CUSTOMER PLAN**. For \$50 we will extend your warranty a second year, perform warranty repairs within 24 hours, and return your board by UPS blue label air service.

DON'T FORGET SERVICE

We will be there when you need us. Knowledgeable people to answer your questions before and after you buy. Warranty repairs are performed within 48 hours or we replace your board. All products are guaranteed for one year on parts and labor. If not completely satisfied within 30 days of purchase, return your board for a complete refund including the postage. Join our list of impressive customers. You'll be glad you did.

TO ORDER BY PHONE:

In CA (805) 987-9741
Outside CA (800) 821-4479

TO ORDER BY MAIL:

Send a complete description of products, and your daytime phone number. Include check or credit card with expiration date. (Personal checks take 14 days to clear). California residents add 6% sales tax.

CORPORATIONS & INSTITUTIONS

Call for details on terms and delivery before mailing your purchase order. If your organization needs large quantities we have the prices and quick delivery you need.



AST SixPakPlus™ / \$229 includes:
Clock/calendar with battery back-up
Asynchronous communications port, (RS232C serial, COM1 or 2)
Memory sockets for up to 384k
Parallel Printer Port (LPT1 or 2)
SuperDrive & SuperSpooler software
One year Parts & Labor warranty

Options:
64k memory \$55
Game Option \$35

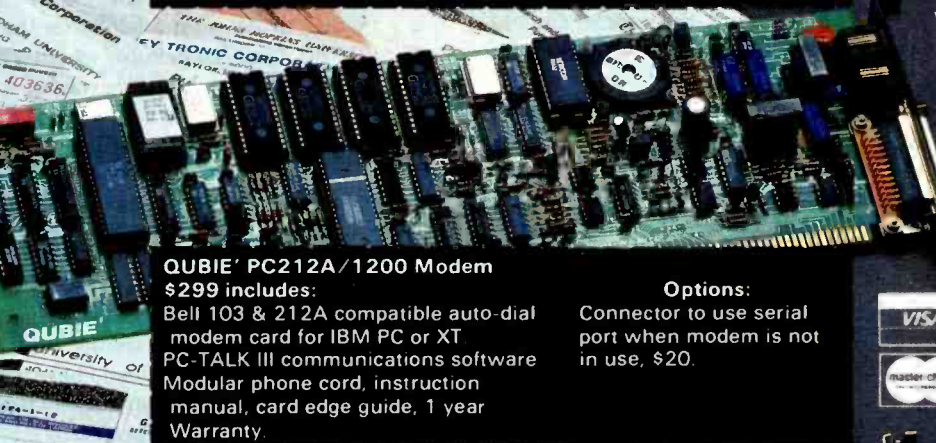

QUBIE' PC212A/1200 Modem
\$299 includes:
Bell 103 & 212A compatible auto-dial modem card for IBM PC or XT
PC-TALK III communications software
Modular phone cord, instruction manual, card edge guide, 1 year Warranty.

Options:
Connector to use serial port when modem is not in use, \$20.



AST MegaPlus II™ / \$229 includes:
Clock/calendar with battery back-up
Asynchronous communications port, (RS232C serial, COM1 or 2)
Memory sockets for up to 256k
SuperDrive & SuperSpooler software
One year Parts & Labor warranty

Options:
64k memory \$55
2nd async port \$35
Printer port \$35
GamePak \$40
MegaPak 256k \$299
MegaPak 128k \$199

4809 Calle Alto, Camarillo, CA 93010
Tempo House, 15 Falcon Road, London SW11, United Kingdom

CPM / 80 MACRO ASSEMBLERS

We've been selling these industrial-quality assemblers to the development system market since 1978. They are now available for the CP/M market.

FEATURES:

- Fully relocatable
- Separate code, data, stack, memory segments
- Linker included
- Generates appropriate HEX formatted object files
- Macro capability
- Conditional assembly
- Cross reference
- Supports manufacturer's mnemonics
- Expanded list of directives
- 1 year free update

Assemblers now available include:

| Chip | Price | Chip | Price |
|------------|-------|-----------|-------|
| 1802/1805 | \$495 | NSC800 | \$495 |
| 8051 | 495 | F8,3870 | 495 |
| 6500/01/02 | 495 | Z8 | 495 |
| 6800/01/02 | 495 | Z80 | 395 |
| 6805 | 495 | 9900/9995 | 595 |
| 6809 | 495 | Z8000 | 695 |
| 8085 | 495 | 68000 | 695 |

Take advantage of leading-edge technology. Get your own Realms assembler today. Use your MasterCard, Visa or American Express, and order by phone: (408) 729-3011

**Relational Memory Systems, Inc.
1650-B Berryessa Road,
San Jose, CA 95133**

All software shipped on a 5 1/4" single density floppy disk. A signed object Code License Agreement required prior to shipping. Prices subject to change without notice.

realms[®]

BYTE's User to User

Conducted by Jerry Pournelle

Needed: Spare Parts

Dear Jerry,

I read with considerable interest your description of your problems with one of the Tandon companies in "Buddy, Can You Spare a Door Latch?" (December 1983, page 59) because it raised familiar issues that have bothered me for some time. At present, there seems to be a serious limitation in the ability to get replacement parts for computer hardware, with the exception of integrated circuits. It appears to me that a significant subindustry could be developed that simply sells spare parts for currently available equipment.

This problem is not limited to Tandon. Last summer I worked for a small software company that needed to replace a stepping motor for its C. Itoh Prowriter printer. (The same printer is sold as the Apple Dot Matrix printer and, with a software revision, as the Apple Imagewriter. Though it is less popular than the Epson, it is more durable.) We were unable to find the motor anywhere and eventually had to take the printer to our dealer.

When you take something to your dealer, he doesn't generally replace a defective part, either. He replaces some subassembly. This is also the case in most mainframe repairs. It tends to be very costly, although in some cases it can save money, since subassembly prices are based on the average cost of repairing them. A subassembly such as a PC board that was completely destroyed by lightning would thus cost less to replace by this method than by locating and replacing all the defective parts.

Curiously, Appendix III of the Tandon OEM Operating and Service Manual gives a "recommended spare parts list"; where do they expect the end user to get those parts? The only clue is the note: "All components are standard commercial parts purchased to original equipment manufacturer's (OEM) specifications." That isn't telling much. The service manual, incidentally, is sold by Priority One; however, either they don't carry the parts or they aren't listed in the catalog. Your solution of buying a whole new spare drive seems kind of costly to me.

I was interested in particular by your experiences with Tandon. As a reader of

Electronics magazine, I regularly see Tandon's large, impressive, multipage, heavy-paper advertisements. But it's true that the ads are aimed at engineers in large companies; your experience suggests that Tandon doesn't seem to feel end users are that important. That is unfortunate, since they are the authorities on their equipment, not the OEM or the dealer. Tandon is a well-known company in the electronics industry because it produces disk drives at a cost far below what others claim is the minimum feasible cost, and they are generally better drives. It is currently working on reducing the price of hard-disk drives and has announced a \$500 hard-disk drive, with plans to reduce the cost even further. But the treatment you received from Tandon (which I must conclude I would also receive if I called the company) suggests that there is some need there for education in matters of public relations. It is not really an unreasonable request to expect to be able to get replacement parts. I wrote to Tandon several months ago regarding the use of its disk drives on models other than the IBM PC. I needed to know whether or not a given head-stepping rate was acceptable or whether it would damage the drives. I have received no reply.

As an independent software developer, your comments help me to understand the user's perspective on software; I always try to read all the User's Columns for that reason, and yours is by far the best. But I am always looking for new and better ways of doing things, and I will continue to watch Modula; I have a group of colleagues who are presently trying it out on a commercial project.

J. Eric Roskos
Nashville, TN 37212

The micro industry isn't going to be mature until there are multiple sources of spare parts at reasonable prices. That certainly hasn't happened yet.

Since my announcement in the December User's Column, Workman and Associates has had a positive flood of orders for Tandon Drive spare-parts kits. Alas, Tandon thinks four to six weeks is a reasonable delivery time for Workman's order; as I write this, Barry Workman still can't get door latches and the other parts. Tandon has a high minimum order, so no individual user can buy from the company either. We hope that by the time this is in

PGS introduces the no-compromise monitor to meet your no-compromise needs.

High resolution

Once you've invested in a first-rate computer, you don't want to compromise with a second-rate monitor. That's why PGS introduced the first no-compromise monitor, the Princeton HX-12. It set the price/performance standard for high resolution RGB color monitors.

Super resolution

Now we're introducing the first no-compromise monitor in the super resolution class. It's our new SR-12, an RGB monitor that meets the most demanding expectations at a price that will surprise you.

Monochrome

And, for price/performance in a monochrome monitor, we're introducing the MAX-12: our new amber monitor that's as easy on the eyes as it is on your budget.

The monitor to meet your needs

All three PGS monitors are engineered for no-compromise performance to provide you with a cleaner, sharper image than any other monitor in the same price class. The HX-12 and the SR-12 both feature uncompromising color convergence for crisp whites without color bleed. The MAX-12 offers impressive clarity in a monochrome monitor with easy-on-the-eyes amber phosphor.

And all three monitors come with a non-glare screen and a shielded cable that plugs directly into the IBM PC or XT.

The HX-12 has the highest resolution (690x240) and the finest dot pitch (.31 mm) in its class. And yet its suggested retail price is comparable to many medium resolution monitors. The HX-12 brings no-compromise color to the PC and now, with the PGS RGB-80 board, to the Apple IIe as well. **Suggested retail price: \$695.**

The new SR-12, in conjunction with the PGS high performance color graphics card, also features a .31 mm dot pitch supporting 690 horizontal resolution. However, by increasing the horizontal scan rate to 27.5 KHz, the SR-12 can support 400 vertical resolution in non-interlaced mode. This results in a very high quality, flickerless image with the ability to generate graphics and text that is truly of monochrome quality. **Suggested retail price: \$799.**

The new MAX-12 offers you easy-on-the-eyes amber with 720x350 resolution at a suggested retail price (\$249) that is actually lower than the leading green-on-black competitor. And the MAX-12 runs off the IBM PC monochrome card—no special card is required.

Clarity of the Max 12 is enhanced by dynamic focusing circuitry which ensures sharpness not only in the center but also in the edges and corners. **Suggested retail price: \$249.**

Whatever your needs, from word processing to super resolution graphics, there's now a no-compromise PGS monitor that sets the standard. Ask your dealer for a demonstration and let your eyes decide. Or call for more information and the name of your nearest dealer.

You can look to PGS for the image your eyes deserve.



NEW: adapter available for PCjr.



800-221-1490

PGS Princeton Graphic Systems
An Intelligent Systems Company

1101-I State Road
Princeton, New Jersey 08540
609 683-1660 TLX 6857009 PGS Prin

Circle 300 on inquiry card.

Now available at Computerland, Entré and local independent computer dealers. Nationwide service provided by Bell and Howell Service Company and MAI Sorbus Service Co.

Travel insurance for computers

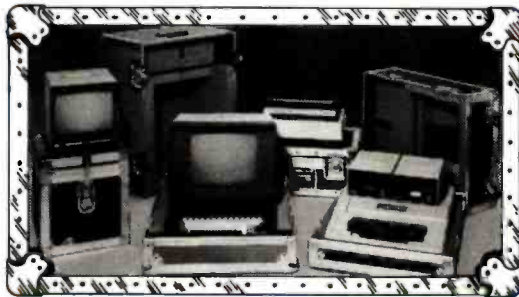

Remarkable lightweight ATS Computer Cases protect from bumps, knocks and falls

Now, transport microcomputers, drives, printers, etc. easily and with peace-of-mind. Rugged ATS Computer Cases, with specially designed, high-density, full foam interiors insulate and protect your equipment from jolts and shocks... even drops of several feet... whether being carried across town or shipped across country. Hundreds of stock cases available for individual computer brands, peripherals and related equipment.

For information, simply write or call (617) 653-6724 today.

Exceeds A.T.A. Requirements

ATS Cases

ATS Cases, Inc., 25 Washington Avenue
Natick, MA 01760 (617) 653-6724

5-Year Warranty

BYTE's User to User

print, Workman will be able to ship spare-parts kits on the day the order is received.

I'm not entirely certain that Tandon's attitude about spare parts is reasonable, but there doesn't seem to be much we can do about it. I agree the company makes adequate equipment at good prices, but I pity anyone who has to deal with it directly. . . . Jerry

On Strange Equipment

Dear Jerry,

This letter is coming to you via an obsolete and nearly useless monster called a Sci-Pro 100A. I managed to get the use of this machine because the company I work for was going to be selling them (nobody bought any). However, there is no documentation for the operating system, called Sci-DOS, nor for its resident software, called Sci-Tran. The machine comes with a full program for a restaurant-management system and has lots of disks for that, but that is almost all it will do, aside from being a poor-grade TV-typewriter/printer. It doesn't even have cursor-control functions (or at least I haven't been able to find them). It will transmit a full screen (16 by 80) to the printer, but then it feeds a form at the end.

I'm writing to you in the hope that perhaps you might know (or know who would know) where I might get hold of the documentation for this beast. The manufacturers have gone out of business but were once to be found at: Sci-Pro Inc., 8505 East Orchard Rd. #106, Englewood, CO 80111.

Rumor has it that the Sci-Tran is an enhanced FORTRAN. You couldn't prove it by me. What little literature there is for the machine says it sold for about \$20,000 retail, including a fairly nice 130-column printer. The microprocessor is supposed to be a custom 16-bit device, and it is a 3-chip system apparently built by Data General (at least the marking on the chips that I take to be the microprocessor lead me to that conclusion).

Gregory L. Shepherd
Salem, OR 97303

Alas, I know nothing of the machine. Perhaps one of the readers can help?

I'm far too dependent on microcomputers to take chances with obsolete equipment, and I can't really recommend it as a worthwhile practice. Years ago, MacLean and I used to play with older machines for fun, but I haven't time enough even for that now.

Order your personalized computer paper...NOW!

Printed with your name, business, club, anything. Paper is white, 20# bond. Choice of 5 ink colors. Fits all printers using 9 1/2 x 11 continuous paper (8 1/2 x 11 when detached). Limited offer of low prices, and special offer.

Satisfaction Guaranteed—
full refund if not satisfied by returning unused paper.

We pay shipping and handling for orders over \$45.00

Orders for different personalized names may be combined for free shipping to one address.

Special Offer
Order now and we'll send free samples of other computer paper specialties with your order.

Name _____
Street _____
City _____ State _____ Zip _____

Personalize as follows: Leave space between words.
(For more than one order use separate sheet for 30 character personalization)

Check ink color: Red Blue Gray Brown Canary

500 sheets at \$19.95 \$ _____
1000 sheets at \$34.95 \$ _____
2000 sheets at \$49.95 \$ _____
Shipping, handling \$ 4.00
(if under \$45.00)
Total order \$ _____

Enclose check or money order. No COD's. Texas residents add 5 1/2% sales tax. VISA and MasterCard accepted. Send number, signature, and expiration date. Allow three weeks for delivery.
Mail order to: **Personalized Computer Paper/Dept. B**
P.O. Box 20539/San Antonio, Texas 78220/
512-227-0585

IF YOUR DATA'S WORTH REMEMBERING, IT'S WORTH PROTECTING.

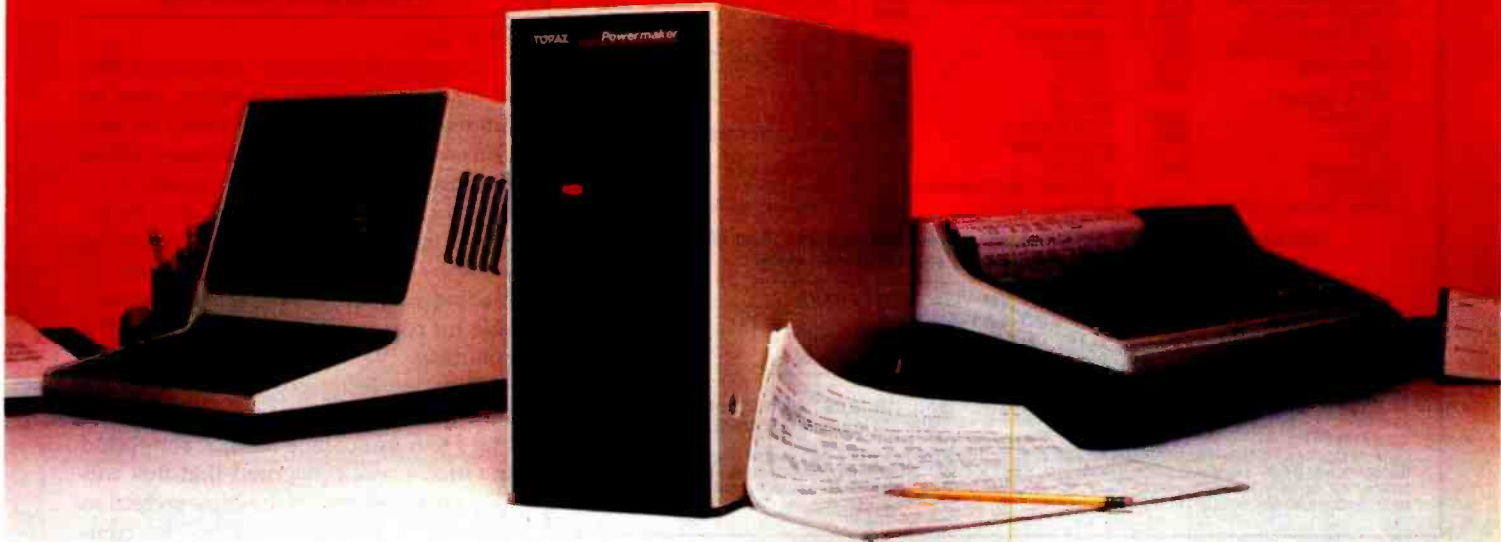

POWERMAKER[®] MICRO UPS

A split-second blackout or a sudden voltage sag can shut down your small business computer, completely wiping out critical data. Inventories, payrolls, receivables — whatever is in the memory may be lost instantly.

Although this type of data is just as important to a small business as it is to a large corporation, blackout protection has always been far too costly for small business applications. But now there is the Powermaker Micro UPS, an inexpensive standby power source specifically designed for small business computers.

This new rechargeable power system provides up to 35 minutes of steady sine-wave power, enabling even the most sensitive small computers to ride through blackouts and voltage sags completely unaffected.

Why sine-wave power? Because square-wave power impairs the performance of many printers, viewing screens and timing circuits. A Powermaker Micro UPS produces a sine wave that exactly matches the waveshape of

commercial power, ensuring compatibility with any computer system.

In addition to providing highly reliable blackout and brownout protection, a Powermaker system also protects against electrical noise, one of the major causes of computer errors and component malfunction. A Powermaker UPS is portable, completely automatic, maintenance free and plugs into any standard 120V outlet.

No matter how small your computer, your

data is worth remembering. Protect it with an affordable Powermaker Micro UPS.

For complete information about the new Powermaker Micro UPS from Topaz, please fill out this coupon or call us.

**TOPAZ; 9192 TOPAZ WAY
SAN DIEGO, CA 92123-1165
PHONE: (619) 279-0831
TWX: (910) 335-1526**

- Please send me complete information about Powermaker[®] Micro UPS.
 Please have a representative call me.

Name _____

Title _____

Company _____

Address _____

City _____ State _____

Zip _____ Phone _____

TOPAZ[®]
SQUARE D COMPANY

Circle 365 on Inquiry card.

SAVE

DISCOUNT SOFTWARE

Ad #51

SOFTWARE FOR CP/M®, IBM®, APPLE®

| | | |
|--|--|--|
| ASHTON-TATE dBASE II \$449 Friday! \$265 DIGITAL RESEARCH DR Assembler & Tools \$179 CP/M 2.2 Intel MDS \$135 TRS 80 Model II (P&T) \$219 Pascal MT+ (Compiler) \$315 SPP Package \$175 CBasic \$119 FOX & GELLER Quickcode \$265 DGraph \$265 D-Utill. \$ 75 Quickscreen \$135 IANSYST lankey (Typing Tutor) \$ 59 | MICROPRO Wordstar \$289 Mailmerge \$179 WordStar/MailMerge \$450 WordStar Professional \$549 Option Pack \$265 MICROSOFT MultiPlan \$225 Fortran \$399 Macro 80 \$159 Basic 80 \$275 Word & Mouse \$399 MICROSTUFF Crosstalk \$149 OSBORNE (McGRAW/HILL) Enhanced Osborne \$299 | SORCIM SuperCalc II \$265 SuperCalc III \$355 STAR Accounting Partner \$349 VISICORP Visicalc \$219 Visiplot/Trend \$259 Visi On CALL WOOLF Move-It! \$ 99 OTHER GOODIES Prokey \$119 Adv DB Master \$535 Smart Key II \$ 81 Punctuation & Style \$112 |
|--|--|--|

We carry many more software packages and formats than listed, so give us a call if you don't see what you need.

ORDER TOLL FREE VIA VISA/MASTERCARD
 1-800-421-4003
 CALIF: 1-800-252-4092
 These are order taking lines only — M-F, 8AM-5PM PST

FOR: • Customer Service • Information
 • Technical Support
 (213) 837-5141 — M-F, 8AM-5PM PST

Outside Continental U.S.—add \$10 plus Air Parcel Post. Add \$3.50 postage & handling per each item. California residents add 6½% sales tax. Allow 2 weeks on checks. C.O.D. \$3.00 extra. Prices subject to change without notice. All items subject to availability. * Mfr. trademark. Blue Label \$3.00 additional per item. CP/M is a registered trademark of DIGITAL RESEARCH, INC.

MAIL ORDERS 6520 SELMA AVE.
WELCOMED: LOS ANGELES, CA 90028

BYTE's User to User

My advice would be to get something a bit more standard. I've seen the Osborne 1 for sale for as little as \$595, complete with documentation. Add to that a Xerox Americare service policy and you've still paid very little for a machine that wouldn't have quite so many irritating quirks.... Jerry

Protection Schemes

Dear Jerry,

Emerging Technology Consultants Inc. of Boulder, Colorado, seems to have an interesting twist to copy-protect its new Offix software. While the company allows the loadable module to be copied, it requires that the distribution disk be inserted into a drive to begin program execution—possibly for the purpose of reading a cipher key. I find this unacceptable for reasons I stated in a letter to the company.

Emerging Technology also makes firm statements in the product instructions that DOS extensions are not supported in Offix. I was concerned that this was also a consequence of the copy-protection scheme. A telephone call to the company's office brought me the answer that no, this was only to free the company of responsibility for improperly designed extensions. I'm not sure that answers the question. However, I did not try the package, so I don't know if it would work with my AST disk-emulation software.

I use Emerging Technology's very excellent Wordix (text formatter) and Spellix (spelling checker) products, which are not copy-protected. However, I have returned Offix because in no place did the announcements indicate that it had imposed such restrictions. I'd appreciate your comments.

Mark Bigelow
 Concord, CA 94518

The Offix package looks interesting from the advertisements (I don't think we've used any of Emerging Technology's software), but I certainly would never become dependent on anything that required an uncopyable original-distribution disk. There are just too many things that can happen to a disk.

The ad reads, in big, bold letters, "Execution of Offix without an original distribution disk in drive A or B may damage your computer." That would be more than enough to keep those programs out of my machines. Suppose the company made a mistake in its machine-damaging software?

It's surprising that Emerging Technology

FEEL LIKE A KID IN A CANDY STORE?

Now rent or buy all the software you want



SoftRent[™], the computer professionals, have the answer. We let you rent before you buy!

With so many choices on the market, finding the software that's right for your needs can be time consuming. And expensive.

So now, call for our FREE catalog, and choose from over 1200 of the most popular recreational, educational and business software packages to try before you buy.

All packages are original manufacturers' software complete with manual.

Act today! Order your software from the experts at SoftRent[™]. Call for your FREE brochure and ask about even greater savings through our exclusive membership club.



341 S. Cedros Avenue
 Solana Beach, CA 92075
 8:30 a.m. - 6:00 p.m. M-F 8:30 a.m. - 12 noon Sat



619 481-0559 San Diego
 800 221-1031 California
 800 221-4568 All Others

THE ONE AND ONLY

CRAMBO

You've got a problem. Go to your favorite computer store. Ask to see their Combo Cards. Then ask about their RAM Cards. See the problem? Just too many to pick from. Now, ask to see the CRAMBO™. No problem. There's only one. Ours. Except you don't know what a CRAMBO is. You've probably guessed it's a Combo Card piggy backed to a RAM Card. So it only takes up one slot in your IBM/PC. That's right. But here are the details.

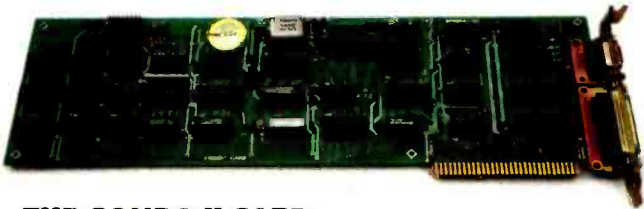

THE COMBO II CARD:

For **\$189** you'll get a Clock Calendar, Async Communications, Parallel Printer and a Game Adapter.

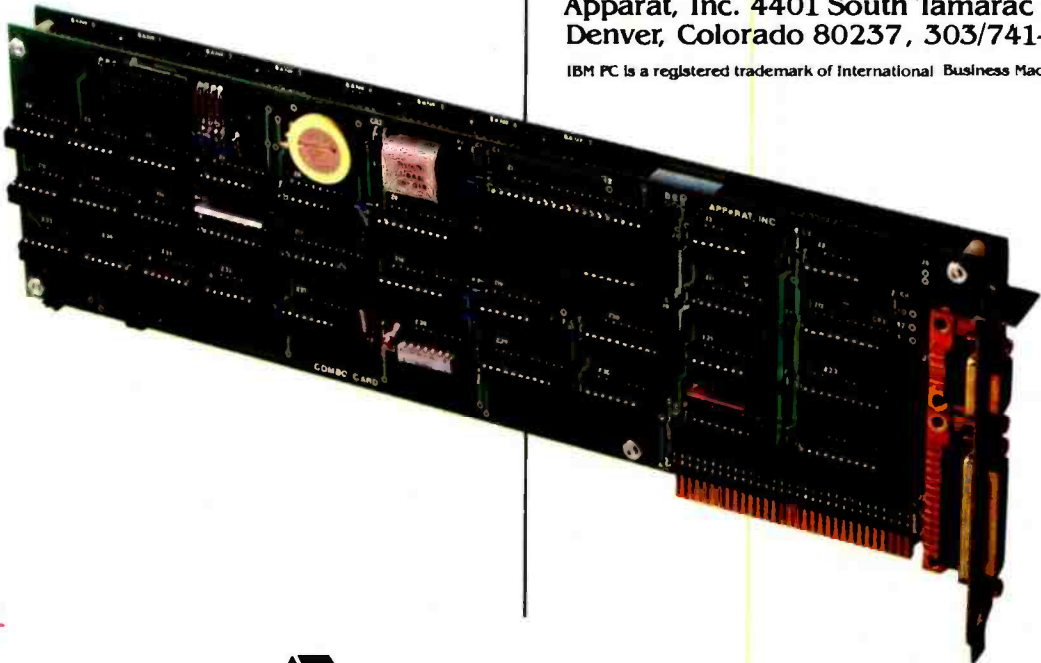

THE 512K RAM CARD:

It too, is only **\$189** with 64K of RAM installed. And when you need more RAM, 64K increments are available for \$64 each. And, SDRIVE, the electronic disk emulator, is available at no cost with the RAM Card.



You can buy either of our boards separately for use in the XT or PC expansion chassis. But only our boards can be piggy backed to give you the one and only CRAMBO. And for only **\$359**.

Go check out the CRAMBO at the same store carrying all those Combo Cards and RAM Cards. If they don't have the CRAMBO have them call us. **800/525-7674**. Or write: Apparat, Inc. 4401 South Tamarac Parkway, Denver, Colorado 80237, 303/741-1778.

IBM PC is a registered trademark of International Business Machine Corp.

 **Apparat, Inc.**

Circle 33 on inquiry card.



Seven years ago, when Datapoint introduced the world's first local area network, ARC® (Attached Resource Computer), we sparked a revolution in business communications. Datapoint is the undisputed leader with more than 5,000 ARC® LANs installed and operating.

SUPPORT ANALYSTS

Your team will be the key in support of office applications such as WP, mail and multiplan. You will review specifications and documentation for support of these applications.

OPERATING SYSTEMS PROGRAMMERS

You will design and implement current as well as future operating systems and utilities - knowledge of Assembly, Pascal and "C".

OFFICE AUTOMATION PROGRAMMERS

You will be a part of a team developing the office future - stressing reliability and user friendliness. Programming experience using high level "C" and similar languages is desired.

SOFTWARE QUALITY ANALYSTS

These high visibility positions involve systems test, analysis, planning, development, and software performance analysis and testing.

#1 TEAM IN NETWORKING

1-800-531-5770

1-800-292-5106

(In Texas)

DATAPPOINT offers excellent salaries and one of the best relocation packages in the industry. Activate your career by calling and mailing your resume to: Technical Recruiter, Datapoint Corporation, 9725 Datapoint Dr., MS G-05-102, San Antonio, TX 78284. We are an equal opportunity employer m/f/h. (refer to ad 102)



BYTE's User to User

does this; its program cost of \$99 invites customers to play fair, and I expect most would without the copy protection. In any event, I am not moved to trust the company's ability not to damage my machine, given that the company boasts that it can do it.

Copy protection is futile anyway: any scheme you can devise can be defeated by a good systems hacker. Pirates aren't foiled by copy-protection schemes, but legitimate users often are... Jerry

File-Check Function

Dear Jerry,

In BYTE's User to User (December 1983, page 499), in response to Alan Beagley's letter, you ask "I wonder how many other programs there are that allow illegal filenames?" Using dBASE II (2.4) and the MODIFY command, I created a file called TAB:SET.COMD that other dBASE command files could access, but it could not be accessed from Wordstar or CP/M because both "saw" TAB: as the drive. This was only a minor problem since dBASE could RENAME the file.

Ronny Richardson
Chamblee, GA 30341

It's really not hard to write a filename check function and, once that's done, to incorporate it into every new program. I wonder why more programmers don't do it?

Thanks... Jerry

More Power To You

Dear Jerry,

I am a hard-core programmer and love to program in assembly language. (I know it's weird, but even assembly language is easier when you enforce your own structure and comment it to death.) I say all of this to ask you if you have heard about any plans by AT&T to bring its 3B20D processor down to a single chip. It's a board-level product now. I think that AT&T has a great opportunity to produce a universal microprocessor since this device may store its microprograms in RAM (64K). Currently this is a 32-bit machine and thus expensive. There should be only a few problems making it into a 16/32 processor like the 68000.

I first saw information on the 3B20D in *The Bell System Technical Journal*, vol. 62, no. 1, January 1983. Pages 181 to 205 provide an overview of the whole system and a look at the processor. What we're talking about here (and what AT&T is talking

about) is flexibility that microcomputer users have only dreamed of. Can you imagine running 68000, 16032, 8080-series, 6800-series, and even some IBM mainframe software on this machine? I think the Lisa software would be great on this machine if its primitives were implemented in microcode.

I can imagine all of this; I can also appreciate the complexity of the task. But I can also imagine AT&T competing with IBM by providing complete PC compatibility. AT&T can also provide service and reliability that IBM customers have come to expect. I would appreciate any information on the subject.

Leonard Timmons
Atlanta, GA 30342

Sounds interesting!

We all expect AT&T to come strongly into the micro market; it should provide an effective counterweight to IBM.

Of course IBM and AT&T are pretty big spheres; even jammed closely together that leaves a lot of room for smaller fish in the interstices! What with the 16032 coming, and the falling prices of memory, it's clear that we'll have some really powerful machines to work with; it's important, though, that we don't let the micro community get split into dozens of incompatible little fiefdoms... Jerry

Scientists: FORTRAN vs. Modula-2

Dear Jerry,

Though your answer to Mark Finger's letter (BYTE's User to User, December 1983, page 499) may have been appropriate for most users, physics and astronomy students simply have to learn FORTRAN. So much exists in FORTRAN that it seems unlikely that scientists will change to Pascal, Modula-2, or whatever. We need FORTRAN on microcomputers so that students can work up programs and eventually transfer them to other computers or else be able to write similar FORTRAN programs or patches on mainframes.

It often seems that scientists have been forgotten by the makers of modern small computers; we are undoubtedly too small a market.

Jay M. Pasachoff
Hopkins Observatory
Williams College
Williamstown, MA 01267

There is FORTRAN for microcomputers,

INTERFACE IT.....PUT IT IN PRINT

JUKI[®] MODEL 6100

THE
LETTER QUALITY
DAISYWHEEL
PRINTER HAS PC
COMPATIBILITY

\$599



If word processing has become increasingly important in considering the growth of your personal computer system, then your choice in selecting a printer should be a major decision, not a major investment. If PERFORMANCE, COMPATIBILITY and PRICE are significant factors in determining your decision, then the Juki Model 6100 Letter Quality, Daisywheel Printer will benefit you. Here's why...

PERFORMANCE

Engineered for precision performance, the Juki Model 6100 has been field tested and proven for accuracy, reliability and versatility. It prints bi-directionally at 18 cps, has proportional spacing, 10/12/15 pitch and performs the latest word processing functions including superscript, subscript, bold/shadow printing, double strike, underlining and graphics. It houses over 40 built-in control commands, has a buffer memory expandable to 8k, and operates on a linear induction motor ensuring accurate positioning. Also, the Juki Printer is lightweight and conventional in design, has a low noise level and is available with a Tractor Feed.

COMPATIBILITY

Interface it... the Juki Letter Quality, Daisywheel Printer is compatible with all major personal computers and is equipped with Centronics Parallel interface as standard equipment and is available with the RS-232C Serial connection as well. It conveniently uses IBM Selectric[™] ribbons and 100 character Royal/Adler[™] daisywheels with a variety of type styles to choose from.

COST BENEFIT

With all the advanced features of a higher priced unit combined with convenience and dependability, the low cost of the Juki Model 6100 adds up to one thing... hard copy at a soft price.

At \$599.00 the Juki Model 6100 Letter Quality, Daisywheel Printer will complement your personal computer system with a minimum investment.

Contact your local Juki Distributor for further details.



JUKI INDUSTRIES OF AMERICA, INC.

AGORA DATA PRODUCTS
7304-L South Alton Way
Englewood, CO 80112
303/779-8444
Serving: MT, WY, CO, UT, NM

BUTLER ASSOCIATES, INC.
82A Worcester Street
Newton, MA 02451
617/864-5270
Serving: ME, NH, VT, CT, RI, MA

COMPUTER SERVICES
INTERNATIONAL CORP.
550 Sylvan Avenue
Englewood Cliffs, NJ 07632
201/569-6306
Serving: METRO NY, E. PENN.

GENTRY ASSOCIATES, INC.
7885 Cypress Drive
Orlando, FL 32809
305/896-7460
Serving: AL, GA, FL, NC, SC, MS, LA, AR, VA

INFORMATION SYSTEMS, INC.
2420 E. Galton Street, Unit E
Arlington Heights, IL 60005
312/278-5400
Serving: WI, IL, MN, IA, MO, KS, IN, OH

INTERNATIONAL BUSINESS
SYSTEMS CENTER
7823 Little River Turnpike
Annandale, VA 22003
703/750-3885
Serving: MD, DE, DC, VA

OSBORN COMPUTED
TECHNOLOGIES, INC.
8808 Old Columbia Road
E. Syracuse, NY 13057
315/437-6888
Serving: UP STATE NY

SIGMA DISTRIBUTING
2110 110th Ave. N.E.
Bellevue, WA 98005
206/454-8387
Serving: WA, OR, ID, AR

SOUTHERN MICRO
DISTRIBUTORS
8708 Royal Lane
Irving, TX 75063
214/258-8808
Serving: TX, OK, AR, CA

STAR-TRONIC
DISTRIBUTOR CO.
23676 Freeway Park Drive
Farmington Hills, MI 48024
313/477-7500
Serving: MI, IN, OH, KY, W. VA, WV

TECHNOLOGY MARKETING CORP.
2300 Valley View Lane
Suite 100
Dallas, TX 75234
214/243-7984
Serving: TX, OK, AR, LA

VITER
830-G Boardwalk Avenue
San Marcos, CA 92069
619/744-8305
Serving: So CA

WESTERN MICRO
TECHNOLOGY
10040 Burbank Road
Cupertino, CA 95014
408/725-1880
Serving: N. CA, NV/AZ

NATIONAL HEADQUARTERS
JUKI INDUSTRIES OF AMERICA, INC.
CA DIVISION
290 Market Street
San Jose, CA 95102
415/281-8800

WEST COAST
JUKI INDUSTRIES OF AMERICA, INC.
CALIFORNIA DIVISION
2553 Lamita Boulevard
Torrance, CA 90505
310/325-3083

TBS

IBM® COMPATIBLE

\$649

In large dealer or OEM quantities

MAXIMUM IBM® COMPATIBILITY

K-1000



CARDS N DRIVES
for OEM



K-2000

STANDARD FEATURES:

- Multi-Layered Board (made in U.S.A., 1 year warranty)
- 8088 Processor
- 64K RAM
- Expandable to 256K
- Power Supply
- Cooling Fan
- Metal Casing
- Detachable Keyboard
- Two RS-232 Serial Ports
- One Parallel Printer Port

PC-2000 BIOS is designed to give maximum compatibility with IBM approved software, under MS DOS 1.1, 2.0, CP/M-86, and Qunix, such as Lotus 123, Flight Simulation, and VisiCalc.

CALL NOW FOR EVALUATION UNIT

TBS

CORP.

714-630-6361

630-6362

990-4662

TELEX: 753197

2732 E. MIRALOMA AVE. • ANAHEIM, CA. 92806

IBM is a trademark of IBM Corporation. Qunix is a trademark of Quantum Software. MS DOS is a trademark of Microsoft Corporation. CPM is Digital Research's trademark.

"Let us be ready to take the field whenever danger calls." JOHN HANCOCK

Training and readiness are vital for today's minute men too. So is support from you, their employers. Write: Employer Support of the Guard and Reserve, Arlington, VA 22209. Protect their future while they protect yours.

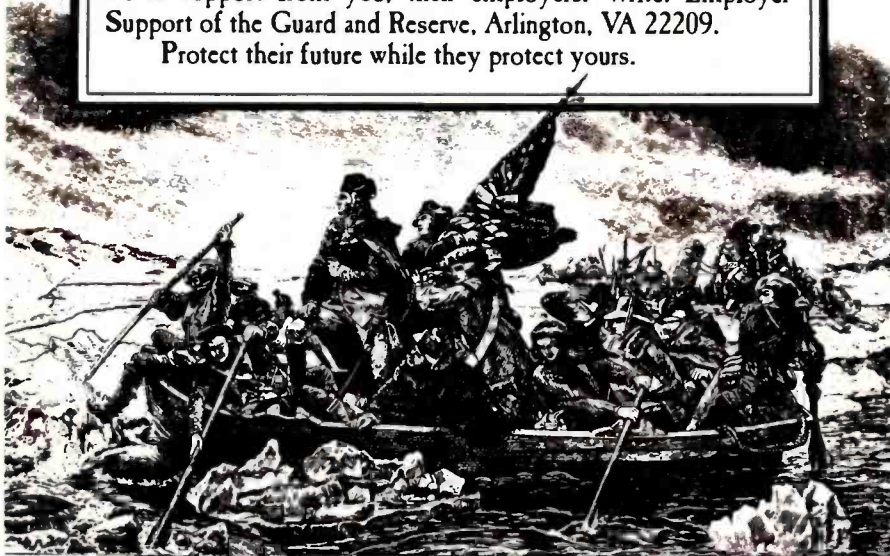

EMPLOYER SUPPORT OF THE GUARD & RESERVE



A Public Service of This Publication

BYTE's User to User

and slowly but surely it's being improved. Indeed, some versions of FORTRAN for the IBM PC and other 8086 machines have library routines for using the power of the 8087 math chip, which gives you more of what you want to use FORTRAN for.

I remain unrepentant: I believe that any program you can write in FORTRAN is better written in Modula-2, unless you simply want quick and dirty answers to specific problems and have no intention of ever running the program again. In those cases, BASIC works quite well, as does APL... Jerry

An Expressive Exclamation

Dear Jerry,

First of all, I've been hearing rumors about a new single-chip 300/1200 bit-per-second (bps) modem that's supposed to be coming on the market around the first of the year. It's supposed to sell for something like \$50, possibly less. Do you have any information on it? We've seen major price breakthroughs on disk drives, printers, and computers. Meanwhile, modems are still expensive, especially the 1200-bps units. Is the time ripe for some action in the marketplace with this product?

Secondly, in BYTE's User to User for December, you may have set an Olympic record by using the word "alas" at least nine times. There may be more; I lost count. Do you know of a good microcomputer version of *Roget's Thesaurus*? I'll help buy it for you since, except for that one minor fault, your column is both readable and useful.

Lewis M. Phelps
San Francisco, CA 94118

Unfortunately, I know of no 300/1200 bps modem at anything like that price. I wish I did.

Ouch... Jerry

Hacking Redefined

Dear Jerry,

Perhaps there is no universal agreement on what is meant by the word "hacker," but most dictionaries of the English language are quite colorful in their definition of the word "hack."

Moreover, while there may be times when what one wants is a literary hack, are you proud of your potboilers? Although language is dynamic and extensible, it should not be traumatized by con-

VISUAL 1050 Personal Computer System

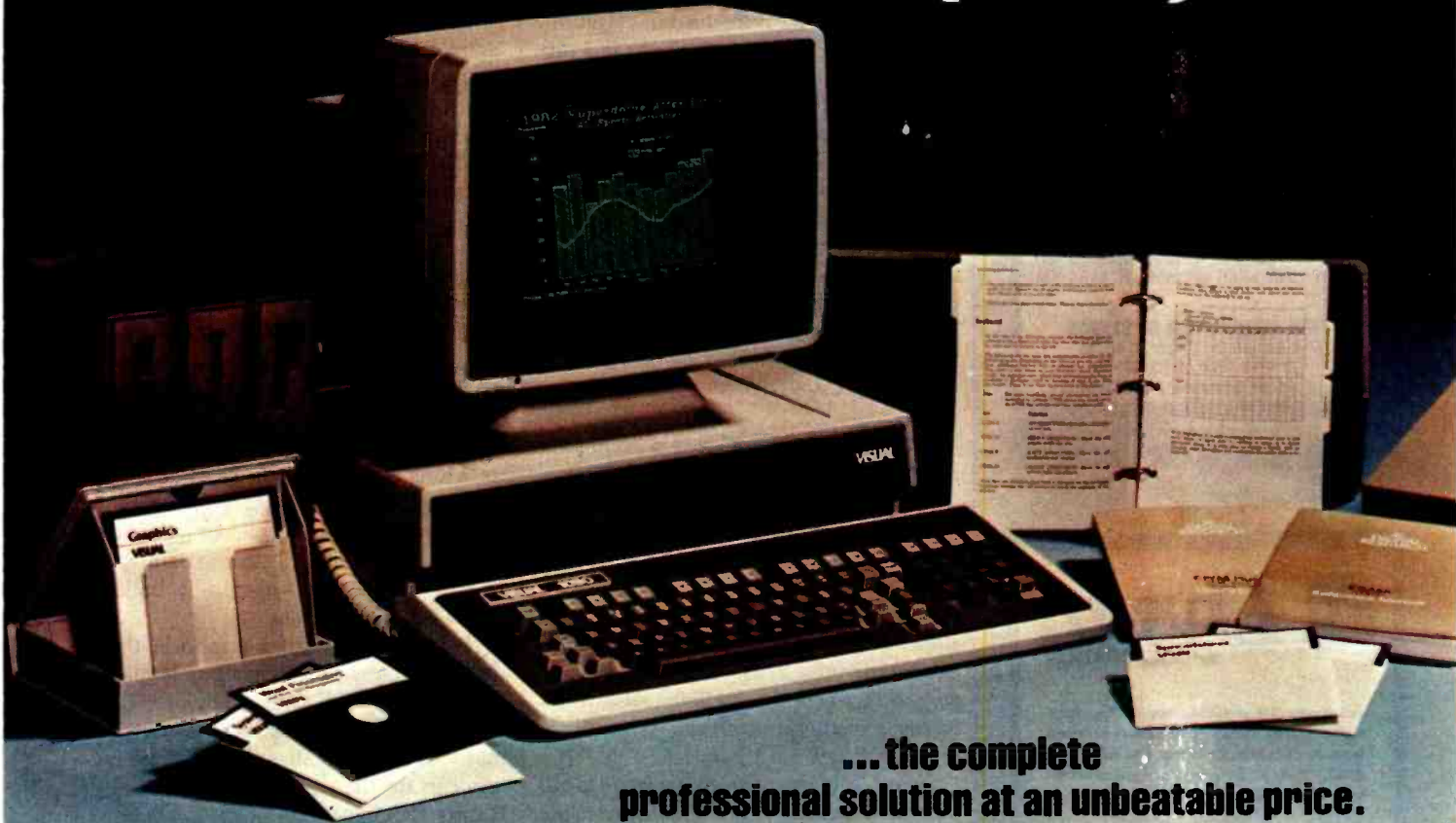

... the complete professional solution at an unbeatable price.

Complete Solution The VISUAL 1050 is an advanced personal computer system designed especially for managers and professionals. It comes complete with top-rated software and high-performance hardware... all fully configured for easy set-up and simple operation. The VISUAL 1050 costs much less than other full-feature personal computers and comes with everything you need to tackle important professional jobs, right out of the box.

Words, Numbers and Graphics The VISUAL 1050 solves more professional problems than any other computer in its class. Whether you work with words, numbers, or graphics, the VISUAL 1050 speaks your language. You get *WordStar*,[™] *MailMerge*,[™] *Multiplan*[™] and Digital Research's *DR Graph*[™]... leading software packages for word processing, spreadsheet and graphics. And all have been specially adapted to share data and perform as an integrated software family.

Communications, BASIC and More... You get *Terminal Emulation* software which turns your VISUAL 1050 into a powerful ASCII terminal for dial-up access to remote computer resources. And you get *CBASIC*[®] for custom programming applications. *CP/M Plus*,[®] a new and improved release of CP/M, allows your VISUAL 1050 to support hundreds of popular third-party packages.

Unbeatable Value \$2,695 is the total retail price for the VISUAL 1050. You get the best and most popular software packages, ready to run on hardware which offers the features and quality you should demand. Two high capacity disc drives. 128K memory standard. Fast, bit-mapped graphics. Full size green screen.

Circle 384 on inquiry card.

| | VISUAL 1050 | IBM™ PC | Apple™ IIe | DEC Rainbow™ |
|--------------------------------------|----------------|------------------------|------------------------|------------------------|
| Base System Price ¹ | \$2,695 | \$2,750 | \$2,390 | \$3,495 |
| Serial Port (RS232) | STANDARD | \$119 | \$195 | 2 STANDARD |
| Parallel Port | STANDARD | \$119 | \$180 | STANDARD |
| Bit-Mapped Graphics | STANDARD | \$240 | STANDARD | \$845 |
| Word Processing Software | STANDARD | \$200-\$500 | \$200-\$500 | \$200-\$500 |
| Spreadsheet Software | STANDARD | \$200-\$300 | \$200-\$300 | \$200-\$300 |
| Business Graphics Software | STANDARD | \$200-\$400 | \$200-\$400 | \$200-\$400 |
| Communications Software | STANDARD | \$100-\$200 | \$100-\$200 | STANDARD |
| COMPLETE SOLUTION PRICE | \$2,695 | \$3,928-\$4,628 | \$3,465-\$4,165 | \$4,940-\$5,540 |
| Dual Drive Capacity | 800 KB | 640 KB | 280 KB | 800 KB |
| Graphics Resolution | 640 x 300 | 640 x 200 | 280 x 192 | 800 x 240 |
| Keys on Keyboard | 93 | 83 | 63 | 105 |
| Standard Memory | 128K | 64K | 64K | 64K |
| Optional Winchester | YES | YES | YES | YES |
| Tilt and Swivel Display | YES | NO | NO | NO |

1—Includes CPU, Standard Memory, Keyboard, Display, Two Disc Drives, and Operating System.
Based on manufacturers' information available February, 1984. VISUAL 1050 includes 128K User Memory Standard.

Standard printer and communication ports. Rugged 93-key keyboard with special *WordStar* engravings. You can't buy a more complete hardware and software solution at anywhere near the price.

VISUAL See for yourself[®]

Visual Technology Incorporated
540 Main Street, Tewksbury, MA 01876
Telephone (617) 851-5000. Telex 951-539

®Registered trademark of Visual Technology Incorporated

1984 3M SPECIAL



We're bringing in the New Year with specials on quality 3M information processing products. Including:

- DISKETTES • MAG TAPE
- DATA CARTRIDGES

PLUS! Specials on many other products in our full-range discount catalog of computer supplies. Call, write, or utilize reader service to obtain your FREE catalog of 1984 3M Specials.

LYBEN COMPUTER SYSTEMS

1250-E Rankin Dr., Troy, MI 48063
Phone: (313) 589-3440

Simply #1 in Service & Reliability

3M Authorized Distributor
Information Processing Products

Circle 231 on Inquiry card.



Dysan

CORPORATION

Solve your disc problems, buy 100% surface tested Dysan diskettes. All orders shipped from stock, within 24 hours. Call toll FREE (800) 235-4137 for prices and information. Visa and Master Card accepted.

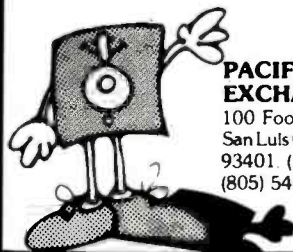

PACIFIC EXCHANGES

100 Foothill Blvd.
San Luis Obispo, CA
93401 (In Cal. call
(805) 543-1037.)

Circle 282 on Inquiry card.

SMAL/80

| SMAL/80 | Assembler |
|--------------|------------|
| HL=M(PTR); | LHLD PTR |
| DE=9; | LXI D,9 |
| HL=HL+DE; | DAD D |
| IF A=L EQUAL | CMP L |
| THEN | JNZ L1 |
| A=A-14 | SUI 14 |
| ELSE | JMP L2 |
| A=L; | L1:MOV A,L |
| M(BC)=A; | L2:STAX B |

New! Z-80 version (runs on 8080's): \$175. 8080 version only: \$150. Macroprocessor only: \$75. Available on CP/M disks. Add \$4 for shipping. Complete tutorial text: "Structured Microprocessor Programming" (Publ; Yourdon Press) \$20 plus \$2 shipping. Send for your free button and literature or try the Ultimate Demo: SMAL/80 is Guaranteed!

Chromod Associates,

1030 Park Ave., Hoboken, N. J. 07030
Telephone: (201) 653-7615

Circle 62 on Inquiry card.

BYTE's User to User

tradition. Whenever the words Apple, Hero, Rainbow, Winchester, Volition, Reality, and Prometheus appear in a distinguished publication (i.e., *Random House Dictionary of the English Language*) in their usurped sense, I will deal with them as they are defined. Until there is universal agreement on a complimentary definition of "hack," I will continue to construe it in its derogatory sense.

Thank you for your very informative BYTE columns, and for the ones that are amusing as well.

Ron Dotson
Glendale, CA 91208

The origin of "hacker" as applied to computer people is obscure. I'm told that it comes from an older expression that implies something worked crudely, as in making furniture with an ax.

However, at MIT and a number of other institutions it is a mark of pride to be a "hacker," since it implies that one knows how to get inside the operating system and, in general, do fancy things with the machines. Also, it has become a pretty standard verb, as in "hacking your BIOS."

Since a lot of programmers are proud to call themselves hackers, your determination to use the word in the old way could result in communicating something not intended... Jerry

Eight Bits are OK

Dear Jerry,

Analyzing microcomputer systems, I found that there is a huge class of 8-bit applications and algorithms: word processing, compilers, interpreters, in fact everything that has to analyze, manipulate, or generate text characters. It is not surprising to find that 8-bit microprocessors are the most effective for these tasks. For example, Wordstar for CP/M requires only half the memory of the IBM PC version.

If you use the memory that you saved using an 8-bit microprocessor instead of a 16-bit one as a silicon disk, you actually get more throughput for the same money with an 8-bit system.

Some might argue that the 16-bit machines can address more memory. For most home applications, however, I regard this as a burden and not a feature. Because programs suddenly have to work with 24-bit addresses, they become more complex, bulkier, and sometimes slower.

If a 16-bit machine is really faster than an 8-bit one, so what? Who cares waiting

10 milliseconds more or less for an editor command? And what's so great about a 16-bit compiler that saves you 20 seconds processor time if the disk input/output took 5 minutes?

When it comes to number crunching, the 16-bit machines are of course superior to their 8-bit brothers. But 32-bit machines would be even more powerful. And how about 64 bits or...? There are almost no applications where a 16-bit microprocessor would be more efficient than a 32-bit machine. So why use a 16-bit if you can have 32 bits or more? As a result, 16-bit machines will soon be just a memory of an evolutionary step in computer history.

The 8-bit machines, however, will stay for a long time to come. I see a future for them in the home and personal computer market where most applications are text oriented: videotex, electronic mail, electronic banking, and electronic bulletin boards, to name a few.

There is a computer euphoria these days and many people just buy the latest and newest stuff, not analyzing their needs. Once the euphoria has settled, many users will realize that an 8-bit system can do their job cheaper.

Hanns Proenen
Cologne, West Germany

I, too, believe the 8-bit machines will be with us for quite a while. However, 16-bit systems do have considerable advantages for graphics; if you're doing spreadsheets and such, the faster number crunching becomes significant; and good on-line help and self-documentation takes lots of memory.

Also, consider the question of languages. The 16-bit machines are, or can be, a great deal faster for higher-level-language programmers to work with. Some of the better languages, such as Modula-2, don't exist on 8-bit machines; thus, some of the newest and best software will be awhile getting down to them.

... Jerry ■

Jerry Pournelle is a former aerospace engineer and current science-fiction writer who loves to play with computers.

Jerry Pournelle welcomes readers' comments and opinions. Send a self-addressed envelope to Jerry Pournelle, c/o BYTE Publications, POB 372, Hancock, NH 03449. Please put your address on the letter as well as on the envelope. Due to the high volume of letters, Jerry cannot guarantee a personal reply.

NOW AVAILABLE ON THE IBM XT.



Powerbase for the powerhouse

At last: a completely new relational data base management system that fully utilizes and enhances the power of the best micro on the market today. And makes it available to those whose expertise is business, not computers.

We call it POWERBASE.™ Software clever enough to meet your information needs, easy enough to be mastered in half an hour. No fancy programming. No unnecessary computer jargon. You simply paint your screens and define the information you need. PowerBase does the rest. Pleasurably.

POWERBASE and DATAZOOM are trademarks of G.M.S. Systems, Inc.

PowerBase introduces DATAZOOM™ and the exclusive Zoom Key which, at the touch of your fingertip, explodes data to deeper and deeper levels of revealing detail. Other features include ultra-fast b-tree access, multiple files, powerful editing and table look-up functions, flexible report writer, the ability to search, sort, and scan other files... and many more.

Master data without having to master computers. The power of the micro is now *fully* yours with PowerBase, the new breed of software that makes data management basically simple.

Circle 173 on Inquiry card.

power-base™
with datazoom™



Call or write for
our free informative
brochure.

gms systems inc.

12 W. 37th Street N.Y., N.Y. 10018

(212) 947-3590

Dealer inquiries invited.

Conducted by Steve Clarcia

Whither IMSAI?

Dear Steve,

I'm looking for information on an IMSAI computer system and where I might be able to purchase one. Thanks for your help.

Danté Mahoney
Mt. Laurel, NJ

The IMSAI computer system was one of the first S-100 bus systems manufactured. It had a front panel from which bootstrap programs could be loaded and which presented the status of the system to the operator. The old IMSAI system is no longer manufactured, but many of these systems exist and are sometimes resold by individuals. Advertisements for IMSAI equipment can be found in buyer guides such as Computer Shopper under the heading S-100 Equipment. Subscriptions can be obtained from Computer Shopper, POB F, 407 South Washington Ave., Titusville, FL 32796.

A new improved IMSAI 8080 has been introduced by the Fischer-Freitas Corporation. A catalog of the new IMSAI product line can be obtained from IMSAI Computer Division, Fischer-Freitas Corp., 910 81st Ave., Bldg. 14, Oakland, CA 94621. . . . Steve

VIC-20/Apple Disk Drives

Dear Steve,

I have an odd combination for you! Do you know if there is any way that I can make my VIC-20 compatible with Apple III disk drives? I don't believe there is any product on the market that will connect these two. Could you provide me with the information to build the necessary circuitry or to get in touch with someone who could

help? If possible, I would like to do this for less than \$100. Thanks for your time.

Lee Brewer
Greenville, SC

Short of building a disk-drive controller and interfacing it to your VIC-20, there is no easy way to achieve compatibility with Apple III disk drives. The disk drives designed for the VIC-20 are called intelligent drives because they contain their own 6502 microprocessors. Some of the computer overhead that is expended in initializing a disk and reading and writing files is handled by the drive circuitry. The Apple III uses a different type of disk-drive controller, and much of the drive operation is software controlled.

A suitable controller could be built, but the price would depend on your supply of components. It could easily cost \$100 or more. You would then have to write your own disk operating system to run this drive, and it would be incompatible with any disk programs commercially available for your VIC-20.

There is always a reluctance to buy an accessory that costs more than the base unit, as is the case with the VIC-20 and its disk drive, but, in this instance, it is the wiser choice. . . . Steve

Mail-Order Service Training

Dear Steve,

Is there a course in computer servicing that you can recommend? I live out in the backwoods and would like to learn more about doing my own servicing, preferably via a correspondence course. Any help you could provide would be appreciated.

Terence Buie
Porthill, ID

Several correspondence courses are available that deal

with computer servicing. You can obtain free catalogs for these courses by writing to

NRI Schools
McGraw-Hill Continuing
Education Center
3939 Wisconsin Ave.
Washington, DC 20016

National Technical Schools
4000 South Figueroa St.
Los Angeles, CA 90037. . .
Steve

MC68000 and the p-System

Dear Steve,

I'm working on an implementation of the adaptable p-System from Softech using my own Z80-based hardware, and I'd like to get it running with the MC68000. Maybe you can help me. Do you know of any manufacturers that supply microcomputers or boards that use the VME bus? Do any of these manufacturers offer the p-System as an option? Do you know if there are any implementations of the p-System in a multiuser environment (as a task under Unix) or using local networks?

Lipkunsky Nahum
Tel Aviv, Israel

Signetics Corporation manufactures four board-level modules for the VME bus and a VME bus card cage. The boards include an MC68000 processor with optional memory-management unit (MMU), a 256K-byte memory board, a disk controller, and a system controller board. The processor board can be used in multiuser, multitasking systems and can respond to any of the seven priority interrupts from the VME bus. For more information, write to Signetics Corporation, 811 East Arques Ave., Sunnyvale, CA 94086.

Empirical Research Group Inc. is developing products for the VME bus using 68000 and 16032 processors. It may have information on a p-System for the VME bus. You can obtain information on ERG products from Empirical Research Group Inc., POB 1176, Milton, WA 98354.

You should also be able to obtain more information on the newest versions of the p-System from Softech Microsystems, 16885 West Bernardo Dr., San Diego, CA 92127. . . . Steve

Building and Troubleshooting

Dear Steve,

First, I want to tell you how much I enjoy your projects; then I'd like to ask your advice on a couple of my projects. I'm trying to add an infrared (IR) sensor to my robot. The transmitter is simply a 555 pulse generator driving an IR LED; the receiver is a phototransistor/741 op amp/567 tone decoder combination. I can't seem to make the system work. How can I verify that the IR beam is being received?

My second project involves communications. I have a chart of frequencies that are assigned to numbers for signaling specific units. I'd like to be able to enter a given number via a simple contact-closure keypad, decode this through a keyboard decoder, and have the output drive seven-segment displays that indicate the frequency assigned to that number. Any suggestions?

Also, can you recommend some necessary test equipment and perhaps a good book on using test equipment and doing troubleshooting?

Ray Poli
Flint, MI

Introducing the Most Powerful Business Software Ever!

TRS-80™ (Model I, II, III, or 16) • APPLE™ • IBM™ • OSBORNE™ • CP/M™ • XEROX™

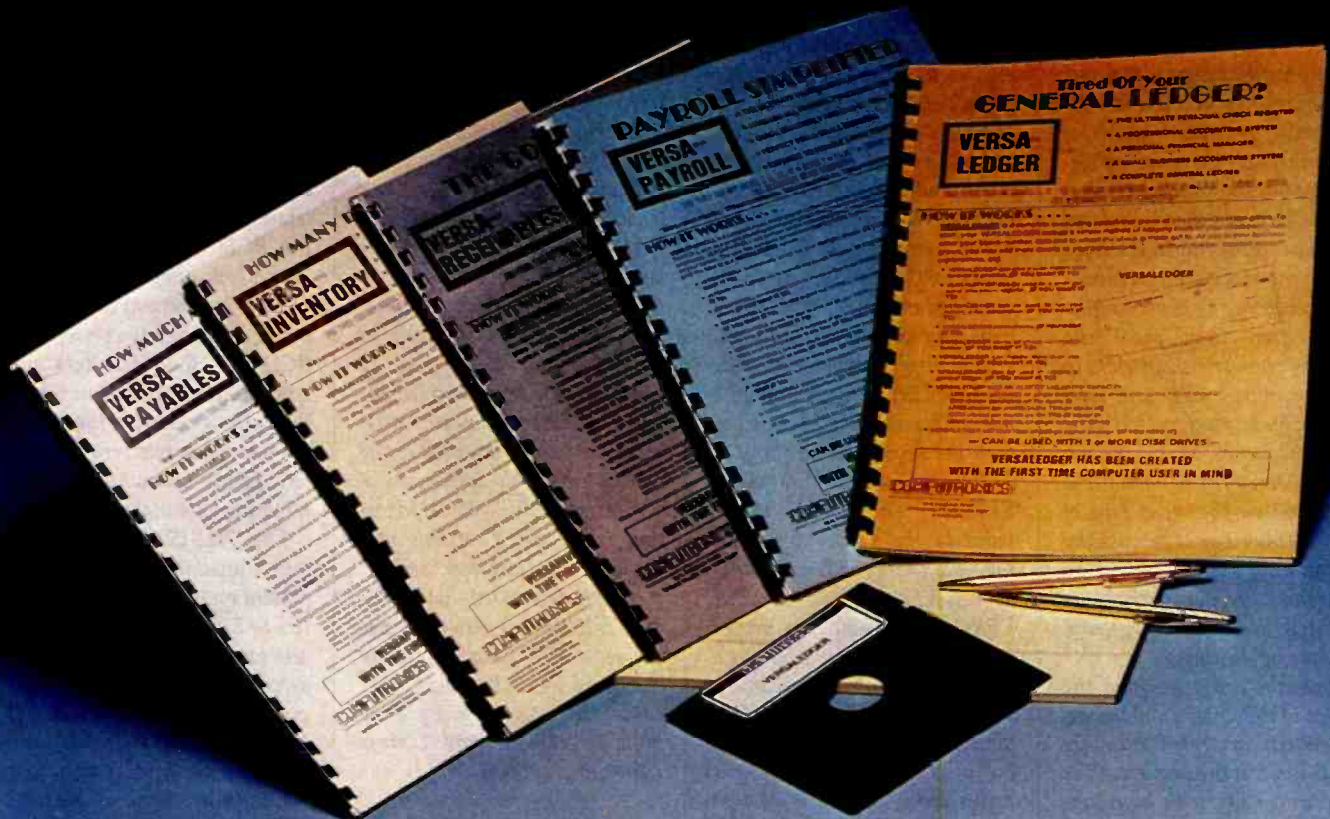

The VERSABUSINESS™ Series

Each VERSABUSINESS module can be purchased and used independently, or can be linked in any combination to form a complete, coordinated business system.

VERSARECEIVABLES™ \$99.95
 VERSARECEIVABLES™ is a complete menu-driven accounts receivable, invoicing, and monthly statement-generating system. It keeps track of all information related to who owes you or your company money, and can provide automatic billing for past due accounts. VERSARECEIVABLES™ prints all necessary statements, invoices, and summary reports and can be linked with VERSALEDGER II™ and VERSAINVENTORY™.

VERSAPAYABLES™ \$99.95
 VERSAPAYABLES™ is designed to keep track of current and aged payables, keeping you in touch with all information regarding how much money your company owes, and to whom. VERSAPAYABLES™ maintains a complete record on each vendor, prints checks, check registers, vouchers, transaction reports, aged payables reports, vendor reports, and more. With VERSAPAYABLES™, you can even let your computer automatically select which vouchers are to be paid.

VERSAPAYROLL™ \$99.95
 VERSAPAYROLL™ is a powerful and sophisticated, but easy to use payroll system that keeps track of all government-required payroll information. Complete employee records are maintained, and all necessary payroll calculations are performed automatically, with totals displayed on screen for operator approval. A payroll can be run totally, automatically, or the operator can intervene to prevent a check from being printed, or to alter information on it. If desired, totals may be posted to the VERSALEDGER II™ system.

VERSAINVENTORY™ \$99.95
 VERSAINVENTORY™ is a complete inventory control system that gives you instant access to data on any item. VERSAINVENTORY™ keeps track of all information related to what items are in stock, out of stock, on backorder, etc., stores sales and pricing data, alerts you when an item falls below a preset reorder point, and allows you to enter and print invoices directly or to link with the VERSARECEIVABLES™ system. VERSAINVENTORY™ prints all needed inventory listings, reports of items below reorder point, inventory value reports, period and year-to-date sales reports, price lists, inventory checklists, etc.

VERSALEDGER II™ \$149.95
 VERSALEDGER II™ is a complete accounting system that grows as your business grows. VERSALEDGER II™ can be used as a simple personal checkbook register, expanded to a small business bookkeeping system or developed into a large corporate general ledger system without any additional software.

- VERSALEDGER II™ gives you almost unlimited storage capacity (300 to 10,000 entries per month, depending on the system),
- stores all check and general ledger information forever,
- prints tractor-feed checks,
- handles multiple checkbooks and general ledgers,
- prints 17 customized accounting reports including check registers, balance sheets, income statements, transaction reports, account listings, etc.

VERSALEDGER II™ comes with a professionally-written 160 page manual designed for first-time users. The VERSALEDGER II™ manual will help you become quickly familiar with VERSALEDGER II™, using complete sample data files supplied on diskette and more than 50 pages of sample printouts.

SATISFACTION GUARANTEED!

Every VERSABUSINESS™ module is guaranteed to outperform all other competitive systems, and at a fraction of their cost. If you are not satisfied with any VERSABUSINESS™ module, you may return it within 30 days for a refund. Manuals for any VERSABUSINESS™ module may be purchased for \$25 each, credited toward a later purchase of that module.

To Order: **Write or call Toll-free (800) 431-2818**
 (N.Y.S. residents call 914-425-1535)

- * add \$3 for shipping in UPS areas
- * add \$5 to CANADA or MEXICO
- * add \$4 for C.O.D. or non-UPS areas
- * add proper postage elsewhere

DEALER INQUIRIES WELCOME

All prices and specifications subject to change / Delivery subject to availability.

COMPUTRONICS

50 N. PASCACK ROAD, SPRING VALLEY, N.Y. 10977

* TRS-80 is a trademark of the Radio Shack Division of Tandy Corp. • *APPLE is a trademark of Apple Corp. • *IBM is a trademark of IBM Corp. • *OSBORNE is a trademark of Osborne Corp. • *CP/M is a trademark of Digital Research. • *XEROX is a trademark of Xerox Corp.

The circuits you described for your IR transmitter and receiver sound like they should do the job if they were working properly. Troubleshooting circuits of this type is not difficult if you have an oscilloscope available. The classical approach is to start looking for the proper waveforms at their sources (in this case, the 555 pulse generator) and continue through the stages of circuitry until the waveform is lost. The problem can then be isolated to a few components in the stage where the waveform was lost.

If everything looks good in the transmitter, then place the receiver phototransistor close to the transmitter LED and start looking for a waveform with the same frequency as in the receiver. Don't try to measure a waveform on the input pins of the 741 (pins 2 or 3) because the operation of the 741 will try to force these two pins to the same potential (usually virtual ground in most applications).

Problems can arise from the design of the circuits and the environment in which they are used. First, if the device is to be used in a room with high ambient light, you may want to use a PIN diode in the receiver in place of the phototransistor to reduce the effect of ambient light. Second, recheck the calculations for the center frequency of the 567 tone decoder to make sure it matches the frequency of the waveform at the 555. Third, if no signal is detected at the phototransistor, you may need to get a higher-powered LED or place several LEDs in series to obtain a larger IR signal.

An excellent article on this subject appeared in the November 1983 Computers & Electronics (see *The Electronics Scientist* column by Forrest M. Mims, page 90).

To do an effective job troubleshooting digital circuits, you should have a volt-ohm meter (VOM), an oscilloscope, and a digital-logic probe. Depending on the circuit being analyzed, some or all of this equipment may be needed. Several books on

troubleshooting are available. One is *Troubleshooting Microprocessors & Digital Logic* by Robert L. Goodman. It can be obtained from Electronics Book Club, Blue Ridge Summit, PA 17214.

Your question about displaying frequencies using a single contact-closure keypad will require the construction or purchase of a small, dedicated computer with a seven-segment readout. For example, a small pocket computer like the Radio Shack PC-4 could be programmed in BASIC to display a frequency on its one-line liquid-crystal display. If you construct your own dedicated computer, a microprocessor could be used to scan the keyboard and jump to a software routine stored in EPROM. The routine would point to the proper frequency (depending on the key that was depressed) already stored in the EPROM and send the proper seven-segment code, 1 byte at a time, to a multiplexed seven-segment display. The multiplexed display can be controlled by a UDN-2981A segment driver and a 75492 or 74145 digit driver. The construction of a small 8085-based computer of this type was described in the September 1980 Microcomputing (see "Build Your Own 8085A-Based Micro," page 62)... Steve

512K for the S-100

Dear Steve,

Is there a source for a 512K-byte dynamic RAM card with bit parity for the S-100 bus? If not, what would be the best way to go about building one for use with my Z-100? Thank you for your help.
Marshall F. Peterson
Covina, CA

The largest dynamic RAM boards that I have seen on the commercial market for the S-100 bus are 256K bytes. These boards are available through several advertisers in BYTE, such as

Priority One Electronics, Jade Computer Products, and California Digital. These boards are presently using 4164 dynamic RAM chips, but with the 256K-bit chips waiting in the wings it won't be long before these boards take another step upward in size. If you are looking for an M-Drive, you can get one with 512K bytes of memory that is IEEE-696 compatible from Priority One.

Constructing a dynamic RAM board with 512K bytes can be tricky because many times these large memory chips do not lend themselves very well to wire-wrapping techniques. It can, however, be accomplished, and an excellent two-part article on the subject appeared in the March and April 1982 issues of BYTE (see "Build This Memory," parts 1 and 2). In this case, the author, Cameron Spitzer, used 4116 devices to build a 64K-byte S-100 board but discusses the use of 4164 devices to expand the board to 256K bytes. These same principles could be used to build a 512K-byte board if care is exercised... Steve

Data Conversion/Transmission

Dear Steve,

Some time ago I acquired an instrument that reads colors in the visible-light spectrum and displays them in terms of red, blue, and green by providing a 3-digit readout for each color. In addition to the 9 digits that represent the colors, a 6-digit counter keeps track of the number of measurements taken, providing a total display of 15 digits. Each digit is driven separately by a 7447 driver/decoder and latched with a 7475 latch. The instrument works fine in every respect, but there is no interfacing provision for any type of external computer or printer. I've been able to extract the BCD (binary-coded decimal) output for each digit, and now I need an in-

terface, either parallel or RS-232C. I would appreciate your advice.

Robert Cvetkovic
Lorain, OH

Extracting data from one device and sending it to another is always a challenging project, and usually there are several ways to attack the problem. With the information you provided about the instrument, the problem seems to be in multiplexing the BCD data from the 7475 latches onto a common 4-bit bus. Once this is accomplished, it is a simple matter to convert the BCD data to ASCII data and transmit the information serially with a UART (universal asynchronous receiver/transmitter). Figure 1 shows one method for doing this that might work.

The 74LS150 data selectors will transmit the information present on one of the input lines (E1 to E15) to the output of the selector (W). The line selected is determined by the binary value present at the A, B, C, and D inputs. Because 4 bits are to be selected for each BCD digit, four 74LS150s are used. A 74LS163 4-bit binary counter is used to determine which digit will be selected. The outputs of the four data selectors now form the BCD value of the selected digit. This value could now be transmitted by the UART as BCD data, but one more chip will convert the data to binary information. This is accomplished with the 74LS184 BCD-to-binary converter, and the binary output now forms the lower 4 bits of the byte to be transmitted. The upper 4 bits of the transmitted byte are hard-wired at the UART to convert the data to ASCII representation.

Once the display is latched, a pulse applied to the TBRL (transmit buffer register load) input of the UART will latch the ASCII code for the first digit into the UART transmit buffer. The UART will now transmit the first byte through the serial output line (TRO) and send a pulse from the TBRE (transmit

Text continued on page 417

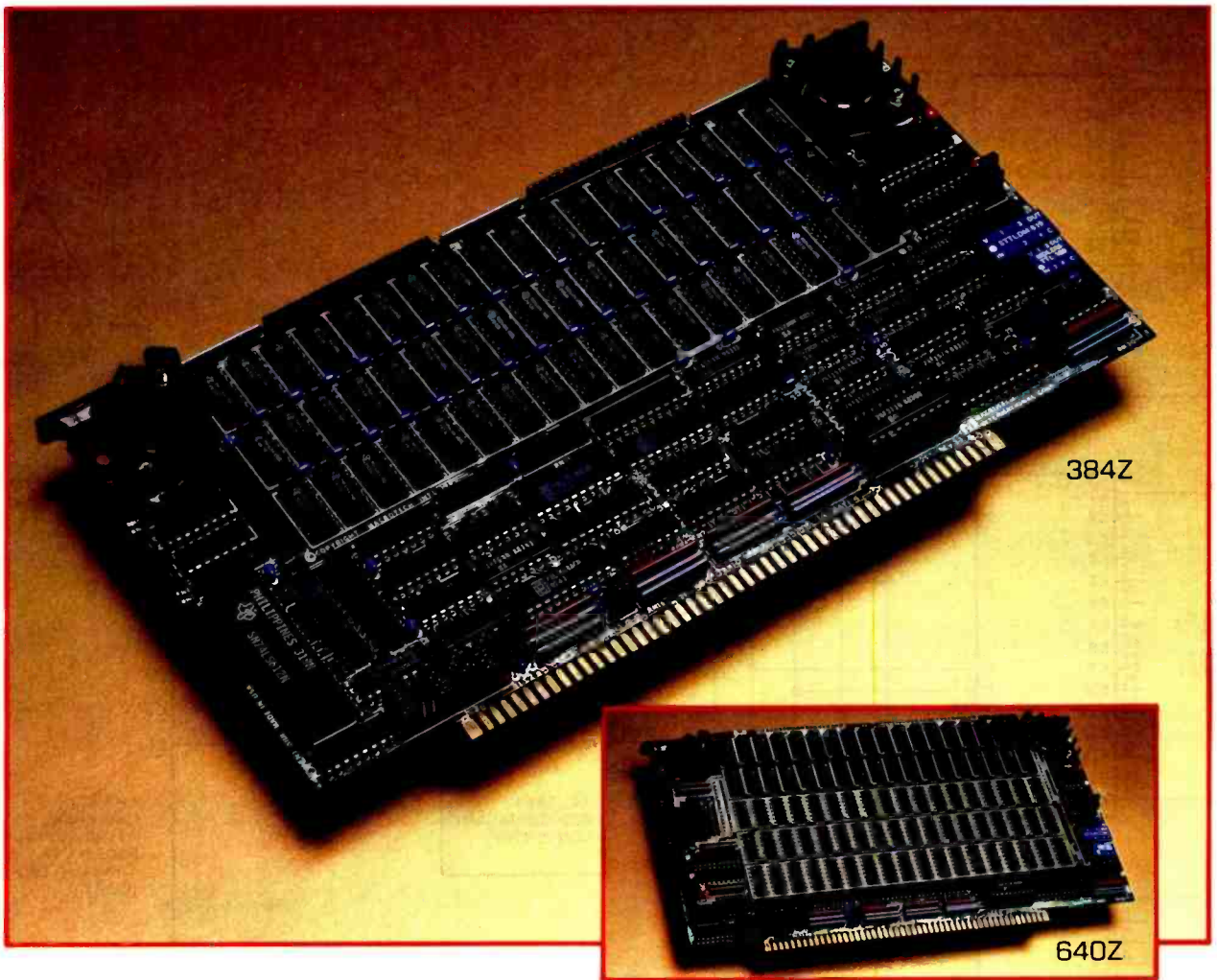

SUPERCHARGE YOUR Z-100 SYSTEM

Macrotech announces three new memory products for Zenith Z-100 computers. Designed specifically for Z-100 systems, our Z-Series can increase your main memory up to a full megabyte with the use of only one expansion slot.

- Includes unique, lightning-fast "Macrocache"™ pseudo-disk operating software enabling dynamic memory allocation between full cache mode and "virtual disk" mode.
- Runs under Z-DOS* or CP/M 86.
- Full byte parity (standard on all Macrotech S-100 dynamic memory products).
- Comprehensive technical manual included.
- Full one year warranty.

PRICES:

| | |
|---------------------------------------|------------|
| 384Z—Adds 384K high speed dynamic RAM | \$1,375.00 |
| 640Z—Adds 640K high speed dynamic RAM | \$1,975.00 |
| 896Z—Adds 896K high speed dynamic RAM | \$2,250.00 |

Macrotech also offers ADIT, the only full-featured intelligent I/O expansion module for S-100. Utilizing full DMA, the ADIT provides up to 16 full duplex RS 232/RS 422 channels from one expansion slot.

For more information about the Z-Series of Z-100 memory products, or the ADIT intelligent I/O board, contact your local Zenith dealer or Macrotech International Corp.

* Z-DOS is a registered trademark of Zenith Data Systems.
CP/M is a registered trademark of Digital Research.



MACROTECH INTERNATIONAL CORP.

9551 Irondale Ave., Chatsworth, CA 91311, (818) 700-1501

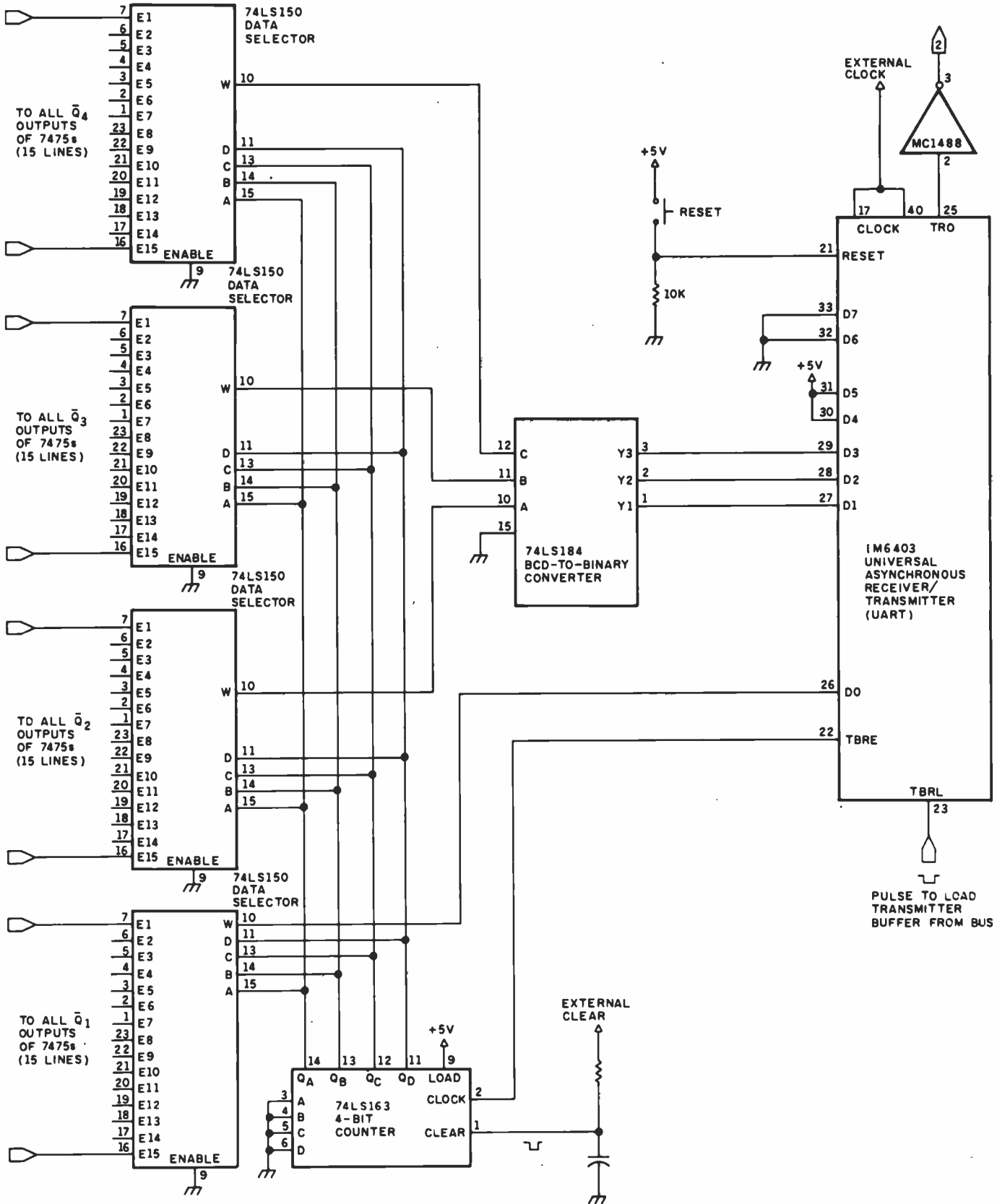

Figure 1: A method to convert BCD data to ASCII data.

1000 FLOPPY DISKS

VS. THE BANK.™



Savings you can take to the bank: 200 MB only \$2,195. CORVUS is proud to introduce the BANK.

It's the most dramatic breakthrough in low cost, high capacity mass memory systems since CORVUS introduced the Winchester disk for microcomputers in 1979.

The BANK's removable tape cartridges hold up to 200 megabytes of information. That's equal to 1000 double density floppies or 10 times the capacity of the largest hard

disks commonly available for microcomputers. You can use the BANK to complement a Winchester disk. It has 19 times the capacity.

And the BANK's cartridges are removable for unlimited capacity and storage.

On-line archival back-up you can bank on. You can use the BANK as a

random access archival device.

If your Winchester disk fails, you can restore selected volumes without having to restore the entire

contents of the hard disk.

The BANK is the perfect solution to your back-up storage problems as a shared storage device on OMNINET™—the leading Local Area Network for microcomputers.

Call CORVUS for the name of the dealer nearest you. We're sure you'll smile... all the way to the bank.

For more information contact: CORVUS SYSTEMS, 2100 Corvus Drive, San Jose, CA 95124, 1-800-4-CORVUS.

CORVUS

THE NETWORKING COMPANY.

The BANK connects to various brands of computers using OMNINET Local Area Network TRANSPORTER™ interface cards. The BANK is currently available for the CORVUS CONCEPT™ and the IBM PC™. CORVUS, THE NETWORKING COMPANY, the BANK, OMNINET, CORVUS CONCEPT and TRANSPORTER are trademarks of CORVUS SYSTEMS, INC. IBM and IBM PC are trademarks of International Business Machines.

Reserve the world in seconds.



Holidex II[®], the industry's first bi-modal reservation system, ensures that your room is waiting at over 1700 hotels in more than 50 countries. For reservations just call 800-HOLIDAY.

*A better
place to be*SM



COMPUTER WAREHOUSE

CALL TOLL FREE **1-800-528-1054**

SANYO* EPSON SYSTEMS

DUAL DRIVE SYSTEM \$1495

SANYO MBC-555 • SANYO CRT-36
HI-RES GREEN MONITOR
EPSON RX-80 WordStar • CalcStar

• Mailmerge • InfoStar • Spell Star
• Easywriter • MS-DOS • Sanyo Basic
Above with Sanyo CRT-70
Color Monitor **\$1939**

SINGLE DRIVE SYSTEM \$1175

SANYO MBC-550 • SANYO
CRT-36 HI-RES GREEN
MONITOR • EPSON RX-80

WordStar • CalcStar • Easywriter
• MS-DOS • Sanyo Basic
Above with Sanyo CRT-70
Color Monitor **\$1629**

PRINTERS

Blue Chip
M120/10 W/Commodore Interface **\$279**
M120/15 W/Commodore Interface **\$349**

C-Itoh
A10-20 **\$499**
F-10 Parallel or Serial **\$935**
55 CPS Serial or Parallel **\$1319**
8510 Parallel (Prowriter) **\$329**
8510SP (Prowriter SP) **\$899**

Computer International
Daisywriter 2000 w/48K **\$999**

Cornrex
CR-2 **\$449**

Datasouth
DS180 **\$1185**

Diablo
820 **\$850**
830 AP1 **\$1899**
830 ECS/IBM **\$2075**
S-11 **\$589**
P-11 **\$559**

Epson
All Printer Models **Call**

Inforunner
Riteman **\$329**

IDS
Microprim 480 **\$385**
Priam 132 **\$1310**
Priam 132 Color **\$1500**

Juki
6100 **Call**

NEC
PC-8023A **\$385**
PC-8025 **\$669**
3510 **\$1365**
3550 **\$1710**
7710 **\$1900**
2010 **\$785**
2015 **\$785**
2060 **\$910**

Okidata
82A **Call**
83A **Call**
84P **Call**
84S **Call**
92 **Call**
93 **Call**
2350P **Call**
2410P **Call**

Olivetti
PRAXIS 41 (w/interface) **\$539**
2300 INK JET **\$319**

Panasonic
1090 **\$299**

Qume
11/40 w/interface **\$1369**
11/55 w/interface **\$1869**
Letter Pro 20P **\$609**
Letter Pro 20S **\$609**

Silver Reed
EXP400 **\$325**
EXP550P **\$879**
EXP550S **\$610**
EXP500 **\$389**

Star Micronics
Gemini-10X **Call**
Gemini-15X **Call**
Delta 10 **Call**
Delta 15 **Call**
Radix **Call**

Tally
MT 180L w/Tractors **Call**
MT 180L w/Tractors **Call**
Spirit 80 **Call**

Toshiba
P1350 Serial or Parallel **\$1445**

Transtar
120P **\$449**
120S **\$489**
130P **\$669**
130S **\$709**
140S **\$1179**
T315 **\$449**

VIDEO TERMINALS

ADDS
A-2 Green **\$490**
Viewpoint 80 **\$619**

Altos
Smart II **Call**

Hazeltine
Esprit I **\$485**
Esprit II **\$540**
Esprit III **\$735**

Qume
QVT 102 Green **\$535**
QVT 102 Amber **\$550**
QVT 103 Green **\$540**
QVT 103 Amber **\$550**
QVT 108 Green **\$680**
QVT 108 Amber **\$699**

Televideo
910+ **\$639**
914 **\$639**
924 **\$669**
925 **\$689**
950 **\$889**
970 **\$969**

Wyse
Wyse 50 **\$489**
Wyse 100 **\$680**
Wyse 300 **\$1020**

Visual
Visual 50 Green **\$619**
Visual 55 Green **\$709**

Zenith
Z-29 **\$644**

MODEMS

Hayes
Smartmodem **\$199**
Smartmodem 1200 **\$485**
Smartmodem 1200B **\$430**
Micromodem IIe **\$235**

US Robotics
212A Autodial **\$420**
Password 1200 **\$310**
IBM PC Modem **\$320**

MONITORS

Amdek
Video 300 **\$130**
Video 300A **\$145**
310A **\$150**
Color I **\$270**
Color I Plus **\$275**

BMC
12" Green **\$85**
13" Color **\$210**

Princeton Graphic
HX-12 **\$499**

Taxan
12" Amber **\$125**

Zenith
12" Green Screen **\$95**
12" Amber Screen **\$95**

DISK DRIVES

Rana
Elite 1 **\$215**
Elite 2 **\$345**
Elite 3 **\$410**
Controller (w/Drive only) **\$ 65**
1000 w/DOS (for Atari) **\$305**

DISKETTES

Maxell
MD-1 (Qty. 100) **\$230**

Scotch
744-0 (Qty. 100) **\$200**

Elephant
S/S S/D (Qty. 100) **\$155**

QUADRAM

Quadlink **\$449**
Quadboard 64K **\$249**
Quadboard 256K **\$389**
Quadboard II 64K **\$249**
Quadboard II 256K **\$389**
Microfazer (ME16) 16K **\$129**
Microfazer (ME32) 32K **\$149**
Microfazer (MSS16) 16K **\$149**
Microfazer (MSS32) 32K **\$179**

COMPUTERS

Altos
All models **Call**

Columbia **Call**

Corona **Call**

Eagle

PC-E **\$1775**
PC-1 **\$2645**
PC-2 **\$3075**
PC-XL **\$3955**
1620 **\$3955**
1630 **\$5625**
1640 **\$7225**

NEC
PC-8201A CPU **\$ 589**
PC-8206A 32K Ram **\$ 289**
PC-8221A Thermal Printer **\$ 129**
PC-8281A Recorder **\$ 89**
PC-8201A-90 Battery Pack **\$ 15**

Northstar
Advantage **\$2160**
Advantage w/5MB **\$3345**
Advantage w/15MB **\$4315**

Sanyo
MBC-550 System **\$1175**
MBC-555 System **\$1495**

Televideo Systems
802 H **\$4210**
803 **\$1795**
1803 **\$2150**
806/20 **\$4775**
800 A (user station) **\$999**
Teleport **Call**

Zenith
Z-100 Low Profile **\$2625**
Z-100 All-In-One **\$2800**
Z-150 Single Drive **\$1949**
Z-150 Dual Drive **\$2349**
Z-150 10 Megabyte **\$3449**
Z-160 Single Drive **\$2099**
Z-160 Dual Drive **\$2399**

Order Line: 1-800-528-1054

Order Processing & Other Information: 602-954-6109



2222 E. Indian School Rd.
Phoenix, Arizona 85016

Store Hours: Tue-Fri 10-5:30 Saturday 9-1
Order Line Hours: Mon-Fri 8:30-5:30 Saturday 9-1



Prices reflect 3% to 5% cash discount. Product shipped in factory cartons with manufacturer's warranty. Please add \$8.00 per order for shipping. Prices & availability subject to change without notice. Send cashier's check or money order...all other checks will delay shipping two weeks.

affected by the brightness of the screen display.

Several articles have been written on interfacing light pens that may be helpful:

Pytlik, William F. "PET Pen." Microcomputing, July 1980, page 84.

Holder, Wayne. "Constructing a Light Pen." 80 Microcomputing, April 1980, page 38.

Mims, Forrest M. "Experimenting with a Light Pen." Popular Electronics, December 1980, page 80.

Lilja, David J. "Build a Simple Light Pen for the Apple II." BYTE, June 1983, page 395. . . . Steve

Disk-Format Compatibility

Dear Steve,

I am looking for a portable computer that can read, format, and write a variety of CP/M disk formats, but so far I have not found one that can read Apple CP/M disks. Do you know of any software that can be used on a Z80 computer to accomplish this task? Why isn't at least one widely used disk format standard for 5 1/4-inch disks? Thanks for your help. I look forward to reading Ask BYTE and your Circuit Cellar articles every month.

Bob Midden
Baltimore, MD

Compatibility among disk formats for 5 1/4-inch disks is virtually nonexistent. Even if the format for two disks appears to be the same, it is not likely that they can be read by different machines. The only real method of obtaining disk compatibility among different systems is to use an 8-inch single-sided single-density disk drive that uses the IBM 3740 format. This format allows disks written under CP/M to be read by other systems using CP/M.

Committees are being set up to address this problem in the future, but knowing standards

committees, it may be years before an accepted 5 1/4-inch standard is adopted.

However, all is not yet lost. Several software houses are beginning to write software that reconfigures the software drivers of several CP/M computers so that they can read disks formatted on other 5 1/4-inch CP/M systems. For example, Port-A-Soft is selling software that allows Morrow computers to read and write Kaypro, Osborne, and DEC VT-180 disks. It also sells software that allows Kaypro to read and write Osborne, Superbrain, NEC PC, Xerox, TRS-80, Morrow, Heath, Zenith, IBM PC, TI, and DEC VT-180 disks.

Port-A-Soft also offers a disk reformatting service that reformats Apple disks into other formats and converts many other disk formats into Apple-readable form. For more information on this subject, contact Port-A-Soft, 423 East 800 N, Orem, UT 84057. . . . Steve

In the "Affordable Tape Backup" letter in the February 1984 Ask BYTE, page 442, the price for the Pegasus 25-megabyte tape backup system was inadvertently listed as \$695. The actual price is \$895. We apologize for the error and any inconvenience that it may have caused. ■

In Ask BYTE, Steve Garcia answers questions on any area of microcomputing. The most representative questions received each month will be answered and published. Do you have a nagging problem? Send your inquiry to:
Ask BYTE
c/o Steve Garcia
POB 582
Glastonbury, CT
06033

Due to the high volume of inquiries, personal replies cannot be given. All letters and photographs become the property of Steve Garcia and cannot be returned. Be sure to include Ask BYTE in the address

64K S100 STATIC RAM

\$199⁰⁰
KIT

NEW!

LOW POWER!
RAM OR EPROM!

BLANK PC BOARD
WITH DOCUMENTATION
\$55

SUPPORT ICs + CAPS
\$17.50

FULL SOCKET SET
\$14.50

FULLY SUPPORTS THE
NEW IEEE 696 S100
STANDARD
(AS PROPOSED)
FOR 56K KIT \$185

ASSEMBLED AND
TESTED ADD \$50



FEATURES:

- Uses new 2K x 8 (TMM 2016 or HM 6116) RAMs.
- Fully supports IEEE 696 24 BIT Extended Addressing.
- 64K draws only approximately 500 MA.
- 200 NS RAMs are standard. (TOSHIBA makes TMM 2016s as fast as 100 NS. FOR YOUR HIGH SPEED APPLICATIONS.)
- SUPPORTS PHANTOM (BOTH LOWER 32K AND ENTIRE BOARD).
- 2716 EPROMs may be installed in any of top 48K.
- Any of the top 8K (E000 H AND ABOVE) may be disabled to provide windows to eliminate any possible conflicts with your system monitor, disk controller, etc.
- Perfect for small systems since BOTH RAM and EPROM may co-exist on the same board.
- BOARD may be partially populated as 56K.

256K S-100 SOLID STATE DISK SIMULATOR!

WE CALL THIS BOARD THE "LIGHT-SPEED-100" BECAUSE IT OFFERS AN ASTOUNDING INCREASE IN YOUR COMPUTER'S PERFORMANCE WHEN COMPARED TO A MECHANICAL FLOPPY DISK DRIVE.

FEATURES:

- 256K on board, using + 5V 64K DRAMS.
- Uses new Intel 8203-1 LSI Memory Controller.
- Requires only 4 Dip Switch Selectable I/O Ports.
- Runs on 8080 or Z80 S100 machines.
- Up to 8 LS-100 boards can be run together for 2 Meg. of On-Line Solid State Disk Storage.
- Provisions for Battery back-up.
- Software to mate the LS-100 to your CP/M* 2.2 DOS is supplied.
- The LS-100 provides an increase in speed of up to 7 to 10 times on Disk Intensive Software.
- Compare our price! You could pay up to 3 times as much for similar boards.



BLANK PCB
(WITH CP/M* 2.2
PATCHES AND INSTALL
PROGRAM ON DISKETTE)

\$6995

\$39900

#LS-100 (FULL 256K KIT)

ALL SALES SUBJECT TO THE TERMS OF OUR 90 DAY LIMITED WARRANTY. FREE COPY UPON REQUEST.

THE NEW ZRT-80 CRT TERMINAL BOARD!

A LOW COST Z-80 BASED SINGLE BOARD THAT ONLY NEEDS AN ASCII KEYBOARD, POWER SUPPLY, AND VIDEO MONITOR TO MAKE A COMPLETE CRT TERMINAL. USE AS A COMPUTER CONSOLE, OR WITH A MODEM FOR USE WITH ANY OF THE PHONE-LINE COMPUTER SERVICES.

FEATURES:

- Uses a Z80A and 6845 CRT Controller for powerful video capabilities.
- RS232 at 16 BAUD Rates from 75 to 19,200.
- 24 x 80 standard format (60 Hz).
- Optional formats from 24 x 80 (50 Hz) to 64 lines x 96 characters (80 Hz).
- Higher density formats require up to 3 additional 2K x 8 6116 RAMS.
- Uses N.S. INS 8250 BAUD Rate Gen. and USART combo IC.
- 3 Terminal Emulation Modes which are Dip Switch selectable. These include the LSI-ADM3A, the Heath H-19, and the Beehive.
- Composite or Split Video.
- Any polarity of video or sync.
- Inverse Video Capability.
- Small Size: 6.5 x 9 inches.
- Upper & lower case with descenders.
- 7 x 9 Character Matrix.
- Requires Par. ASCII keyboard.

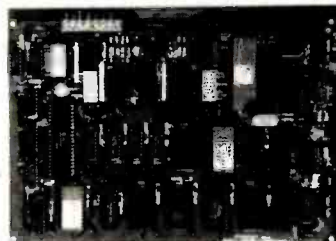

BLANK PCB WITH 2716
CHAR. ROM, 2732 MON. ROM

\$5995

SOURCE DISKETTE - ADD \$10
SET OF 2 CRYSTALS - ADD \$7.50

WITH 8 IN.
SOURCE DISK!
(CP/M COMPATIBLE)

\$12995

ZRT-80 (COMPLETE KIT,
2K VIDEO RAM)

Digital Research Computers

P. O. BOX 461565 • GARLAND, TEXAS 75046 • (214) 271-3538

TERMS: Add \$3.00 postage. We pay balance. Orders under \$15 add 75¢ handling. No C.O.D. We accept Visa and MasterCard. Texas Res. add 5% Tax. Foreign orders (except Canada) add 20% P & H. Orders over \$50 add 85¢ for insurance.

NEVADA COBOL



NEVADA COBOL For business • A favorite with business programmers everywhere, because it's so easy to learn and use • Very compact; compile and execute up to 2500 statements in 32K RAM, 4000 in 48K, etc. • Based on ANSI-74 with some level 2 features • Dynamic loading of up to 5 active called programs at any one time and chaining to new main programs • Hexidecimal non-numeric literals to 120 characters; numeric literals to 18 digit precision • Choice of 16-bit binary, packed decimal, or display • Picture characters and record description elements • COPY statement • Random Access and Sequential files, both fixed and variable length • VALUE OF FILE-ID IS data name • Paragraph and section names; compound conditionals • Interactive ACCEPT/DISPLAY • Easily understood diagnostic error messages • Includes diskette and 165-page manual • \$39.95.

NEVADA FORTRAN

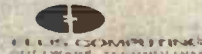

NEVADA FORTRAN For engineering and science • Both a subset and superset to ANSI-66 standards with some 1977 level features • Load and execute individual assembly language programs, or Intermix assembly and FORTRAN statements • COPY statement, IF..THEN...ELSE constructs, CHAINING with Blank and Named COMMON, TRACE debugging • Numbers stored as Binary Coded Decimals to preserve accuracy • Hexidecimal constants and variable length strings • Arrays up to 7 dimensions • Logical-True or -False • Random Access and Sequential files • Error trapping with full control over all errors; more than 150 error messages—in English—in a user-changeable file • Requires 48K RAM • Includes diskette and 214-page manual • \$39.95.

COBOL APPLICATION PACKAGES BOOK 1



NEVADA COBOL APPLICATIONS Book 1 • Contains four application programs with complete COBOL Source Code • Superior documentation that saves even professional programmers precious time • 73-page manual • \$9.95.

NEVADA PILOT



NEVADA PILOT For dialog • Perfect for industrial and office training, drill and testing, virtually all programmed instruction, word puzzle games, and data entry facilitated by prompts • Has an integrated full-screen text editor and an interface for latest peripheral options such as VTRs, voice response units, etc. • Simple format and vocabulary enable beginners to quickly develop dialog programs • Perfect companion language for BASIC, COBOL, and FORTRAN application packages • This advanced version written by the language's creator, Prof. John Starkweather, meets or exceeds all PILOT-73 standards • Includes diskette and 131-page manual • \$39.95.

NEVADA BASIC

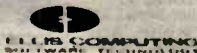

NEVADA BASIC For business, education, engineering, science • Easy-to-learn and easy-to-use, this straightforward language lets beginners quickly write useful programs, while offering the experienced user professional features; it's simply a better BASIC • Single- or multi-line functions defined by user • Full matrix functions • Built-in, full-screen text editor—Prof. Starkweather's design • Key-stroke editing functions available during input of programs and data • Access to program and data files on disk; Random Access and Sequential files • User control over format of numeric output • Character- and time-controlled INPUT statement • Immediate execution mode for statements • BCD Math, 8 or 12 digit precision—no round-off errors; trigonometric and logarithmic functions; arithmetic, logical, and relational operators • IF-THEN-ELSE statements • Error trapping and recovery • Includes diskette and 220-page manual • \$39.95.

NEVADA EDIT



NEVADA EDIT For program writing • It may pay off better than any software purchase you've made • An elegantly simple and easy-to-use character-oriented full-screen video display text editor designed specifically to create BASIC, COBOL, and FORTRAN programs • Has single-key commands, scrolling, block moves, search and replace; cursor can be moved freely about the entire screen • Completely customizable tab stops, default file type, keyboard control key layout, and CRT by menu selection; can be configured to nearly every terminal • Very compact; requires only 12K disk space • Includes diskette and 59-page manual • \$39.95.

“How can you sell first-class software for just \$39.95?”

Our customers invariably ask: “...As powerful and professional as Nevada Software is, how can you possibly sell it for just \$39.95?...” Here’s how we do it, why Nevada is a genuine old-fashioned bargain.

How we save costs— and pass the savings on to you.

Start with development costs. We either write our own packages or license them from top professionals; that saves the overhead of a big development group.

Next, our packages are functional instead of fancy. We don’t concentrate on fancy notebooks; we concentrate on content. You get a better product, with savings on materials, assembly, warehousing. For extra savings, we buy by the truckload.

Then there’s advertising. You’ll find Nevada ads only in professional journals: not cheap—but much less expensive than business magazines or TV.

Finally, we sell direct, which saves another 30-50%.

After all the savings, at \$39.95 we still have a fair profit. And you have a fair price.

Compare Nevada.

Check Nevada’s features (opposite page). Compare them with any similar software packages—even those costing five to twenty times more. You’ll be amazed. Nevada is high-level, professional software created by top-notch designers, refined by experience. Here’s what the media says:

- (Nevada FORTRAN) “I heartily recommend it, especially at 1/12 the Microsoft* price.” MICROSYSTEMS, November 1983.
- “If you want to learn or teach someone FORTRAN, this is the package to buy.” ACCESS, March/April 1983.

- (Nevada EDIT) “A well-thought-out product with excellent documentation and an astoundingly low price.” MICROCOMPUTING, May 1983.

And the list goes on. Nice words; also nice is our proof of customer satisfaction—reorders.

Nevada—for the long haul.

In an industry where new companies often fade before they shine, Nevada is an old-timer; we’ve been around since 1977, the beginning of the micro business.

The key to our longevity is satisfied customers—customers pleased with top products for bottom prices. That’s why so many universities specify Nevada for their courses and use our documentation for texts; it’s why more than 40,000 professionals, educators, students, engineers, scientists, and businesspeople—worldwide—have made Nevada #1.

See for yourself—with no risk.

Satisfaction is guaranteed—or your money back. That’s right; you must be completely satisfied with every Nevada Software purchase, or return the package within 30 days—in good condition with the sealed diskette unopened—and we’ll gladly refund your money. There is no risk.

How can we sell powerful, professional software for just \$39.95?—now you know. Why not use the coupon, or call, to order your Nevada bargains?—today.

CP/M is a registered trademark of Digital Research, Inc. Microsoft is a registered trademark of Microsoft Corp. TRS-80 is a registered trademark of Tandy Corp. Apple II is a trademark of Apple Computer, Inc. Osborne is a registered trademark of Osborne Computer Corp. Xerox 820 is a trademark of Xerox Corp. Kaypro is a trademark of Non-linear Sys. Heath Zenith is a trademark of Heath Corp. IBM is a trademark of International Business Machines Corp. Nevada BASIC, Nevada COBOL, Nevada FORTRAN, Nevada PILOT, Nevada EDIT, and Ellis Computing are trademarks of Ellis Computing, Inc. © 1983 Ellis Computing, Inc.

NEVADA SOFTWARE FOR CP/M \$39.95



Send to
ELLIS COMPUTING, INC.
3917 Noriega Street
San Francisco, CA 94122 Phone 415/753-0186

SINCE 1977

Please send me: **Software Packages**
 BASIC COBOL FORTRAN PILOT EDIT

Disk Format:

- 8" SSSD (Standard CP/M IBM 3740)
- 5 1/4" Diskette for:
 - Access
 - Apple CP/M (Must have softcard)
 - DEC VT 180
 - Epson QX-10
 - Heath Hard Sector (Z-89)
 - Heath Soft Sector (Z-90)
 - IBM-PC (Baby blue or big blue card)
 - Kaypro Double Density
 - Micropolis Mod II (Vector Graphic)
 - NEC PC 8001
 - Northstar Double Density
 - Northstar Single Density
 - Osborne Single Density
 - Sanyo
 - Superbrain DD, DOS 3.X (512 byte sec)
 - Televideo
 - TRS-80 Model I (Relocated to 4200 hex)
 - TRS-80 Model 1/Base O Mapper
 - Xerox 820 Single Density

Send my order for _____ packages @ \$39.95 each Total _____

COBOL Application package @ \$9.95 each Total _____

California residents add 6.12% Sales Tax. Sales Tax _____

Outside North America, add \$6 per package for shipping. Shipping _____
(Postage paid within North America) Checks must be in U.S. dollars and drawn on a U.S. bank

Check enclosed Mastercard VISA TOTAL _____

Card # _____ Exp. Date _____

Signature _____

Ship to: Name _____

Street _____

City/State/Zip _____

The CP/M operating system, an 8080, 8085, or Z-80 microprocessor, and 32K RAM are required. Note: Double Density drives can read Single Density diskettes

Smart Blankie

A sophisticated diurnal environmental control system

Jim McQuaid
Analog Devices

Seven years ago, Bernie Schwarz was installing and servicing garage door openers for Sears in Cupertino, California. Today he is on the verge of bringing computer technology closer than ever before to the heart of American life. His start-up company, Sleep Smart Inc., is about to introduce the first microprocessor-based electric blanket.

This intelligent electric blanket employs advanced technology for what seems a simple purpose. The Smart Blankie senses environmental conditions and adjusts temperatures according to EEPROM (electrically erasable programmable read-only memory)-based look-up tables that can be tailored to individual preferences.

The Smart Blankie System

Like the Lisa, the Smart Blankie never truly powers off; it simply switches to a low-power state after the night is concluded. The microprocessor is a CMOS (complementary metal-oxide semiconductor) Intel 80186 for low power consumption. The 80186 cuts down on the number of support chips required. There are 32K bytes of dynamic RAM (random-access read/write memory), 82K bytes of bubble memory, and one 16K-bit EEPROM.

The flexible circuit board is long and thin so that it can fit comfortably at the foot of the bed (see figure 1). Sleep Smart chief engineer and chronic insomniac Boris Switsrick scoured Silicon Valley for a company that would make this totally nonstandard board. The company he found had previously been silk-screening plastic bottles for a large liquid-drain-

**The processor
maintains a rolling
flip-flop for historical
trending and personal
warmth correction.**

opener company, so Boris concluded that they had the expertise in working with flexible supports.

A long ribbon cable/cord runs under the bottom sheet, carrying a pressure/temperature sensor, based on a flat-pack version of the AD590 sensor. This sensor/package combination was only available in MIL-STD versions but later testing showed that some sleepers generated combined pressure/temperature ranges that bordered on the specifications of the MIL-STD anyway.

Two additional sensor cables run through the blanket. The longi-

tudinal sensor cable monitors temperature just under the blanket and, by integrating acceleration with a strain gage in the transverse sensor cable, measures the breathing rate or activity level of the sleeper(s). The final temperature sensor is in the manual control unit, usually placed on a nightstand or the floor; this reads the room temperature.

Sensor readings are digitized on alternate clock ticks and stored in 12-bit A/D (analog-to-digital) converter format in a series of latched storage locations. Alternate processor cycles clock data onto the local processor bus where it is ticketed for speeding if exceeding 55 mph. The processor maintains a rolling flip-flop for historical trending and personal-warmth correction. This information is written into bubble memory and summarized by a midmorning executive routine that runs once a day, after the switch to low power.

Operation

The sensor-intensive aspect of the blanket is what gives it the ability to respond to sleeping conditions. In typical use, the sleeper does not even have to turn the blanket on. The blanket immediately produces a temperature, based on the body weight, skin temperature, and room temper-

ature, that soothes the sleeper and produces a feeling of well-being. Several minutes later, after the sleeper's breathing rate and activity level have begun to stabilize, the temperature begins to ramp down to a comfortable sleeping range but compensates for changes in room temperature. When the sleeper gets up for a period longer than twenty minutes the blanket powers down, thus saving power.

The head of Smart Blankie's software and user interface group, Thackeray ("The Hacker") Jones explains the real potential. "The factory default behavior of the system can be tailored by the user to almost any kind of requirement. We have gone out of our way to provide a user-friendly blanket." The familiar control unit on the nightstand provides complete control of the blanket's functions, including, of course, a manual override of the temperature. The blanket also has a "learning" mode with accelerated clock time so that a sleeper can "train" the blanket to respond by clock time throughout the night or perform any number of library algorithms of ramping and controlling temperatures.

Accessories

At the time of product introduction there will be several accessories available. Initially, the manual control provides learning-mode control, manual override, and LED (light-emitting diode) time display. Sensing that the user interface might be critical to the success of the product, engineer Jones pushed for a voice output module as the first priority. Drawing on the system resources of the real-time clock and extensive nonvolatile memory, the voice output system enhances the soothing atmosphere with dulcet whispers (volume adjustable) for "Good Night" and appropriate levels of volume for wake-up calls.

High on the list of enhancements to be announced after first product shipments is a local-area network. The blanket, with its system intelligence, could control lights, thermostats, toasters, coffee pots, radios, and so on. Hacker Jones says that the networking protocol will be simple but

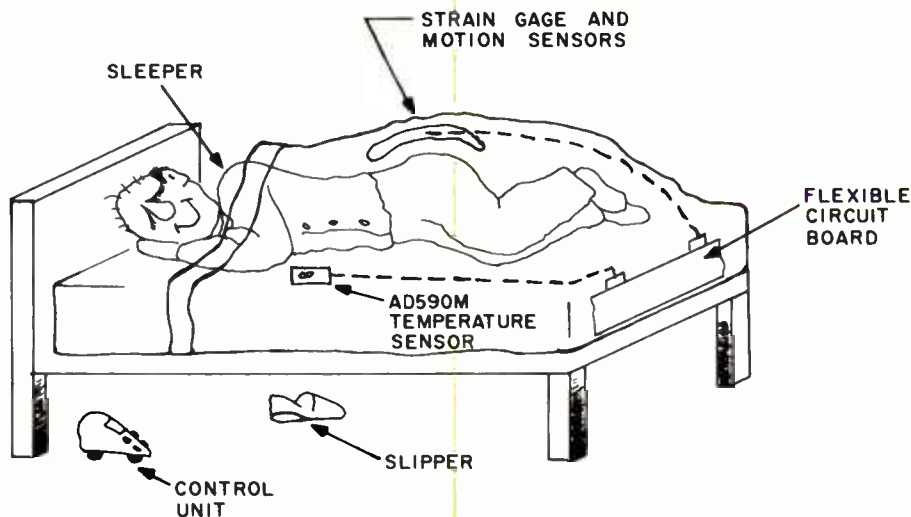

Figure 1: The Smart Blankie operational environment.

the system design allows for growth. "No standard has yet emerged in HANs (home-area networks), although General Electric has talked about one." Noting that simple schemes like the BSR-X10 controllers have the widest market acceptance, Jones says that the company will support any standards that emerge.

A baby blanket, Smart Blankie jr., also is planned. The baby blanket will use the networking system to signal a parent if a rising blanket temperature and low activity levels suggest that the blanket has been kicked off.

First Impressions

I tested the Smart Blankie at Sleep Smart's modest Silicon Valley headquarters, in their Shut-Eye suite of test chambers. It was a nippy evening last February when I, forgoing the comfort of flannel PJs, slipped between the sheets, wrapped only by the Smart Blankie.

Of course production models are still unavailable, so this blanket had a few extra touches thrown in. I had just pulled up the covers and fluffed the pillow when the manual control said soothingly, "Good Night, Jim. Sleep smart!"

Of course, some bugs and reliability problems were evident. A chill overcame me around midnight as the result of a system crash. A faint whisper from the voice output droned

"diurnal diurnal diurnal" again and again. My blanket was quickly rebooted and brought back on line, but Hacker Jones admitted that one elusive bug showed up in one test when both the sleeper and the date rolled over at the same time.

The Future

The blanket will sell for \$149.88. While this is more than the cost of standard blankets, Schwarz feels that the market can sustain it. "We are where Betamax was seven years ago," he states. "Because we are first, we can push the learning/manufacturing curve toward complete dominance of this emerging market." He admits, however, that initial shipments of king-sized blankets will be pint-sized. Later the blanket will be downsized and the shipment rate upsized. Accessories are expected to play an important part in the success of Sleep Smart Inc. for the next 18 months.

At \$149.88, Smart Blankie is not cheap. Sleep Smart may face strong competition from Westinghouse, General Electric, Hamilton-Beach, and IBM. But Bernie Schwarz says, "We have made our bed and we intend to lie in it." ■

Jim McQuaid is a senior software technical writer for Analog Devices, Measurement and Control Division (Rte. 1 Industrial Park, POB 280, Norwood, MA 02062).

Special April Book Review

You'd Better Love Your BLANK Computer: The Generic Computer Book

Howard Blabbe
Blabbe Books
Hardscrabble, NH: 198n,
128 pages, \$19.95.

Reviewed by
Duncan Mackenzie

This book represents the latest innovation by an author/publisher who has a psychotic fixation on being the first to put out a machine-specific book for a newly announced computer. A combination of electronic and printing technology have made this unique book possible. And because it's the first publication of its type (although probably not the last), this review must treat the production process more than the content.

Suppose you've just heard of the announcement of the Burndazzle Mach-19 Personal Computer—the hot new computer that the *Wall Street*

Journal says will shake civilization. One hour after the Burndazzle press conference, you can go to a participating book dealer and ask to purchase a copy of *You'd Better Love Your BURNDAZZLE MACH-19 Computer*. When you ask to purchase the book, the bookstore clerk begins assembling it from the unique *You'd Better Love Your BLANK Computer* kit.

First, the clerk enters a secret code on the hidden keypad of the Blabbe Flash Printer, after which the printer's autodialing modem calls Blabbe Central. Through this high-speed link the text of Chapter 1, which contains the complete specifications of the Burndazzle Mach-19 as announced at the press conference, is downloaded and printed in the finest dot matrix on recycled newsprint.

The clerk goes to the secret Blabbe Books Customization Cache, a strongbox that can be opened only after two clerks simultaneously turn keys in key switches 8 feet apart. The Cuss Cache, as it's

known in the trade, contains sets of press-on stickers that have been preprinted with the names of all computers reported to be in development by Blabbe Books' exclusive espionage corps. The clerk selects a set of Burndazzle Mach-19 stickers, carefully ignoring the similar Mach-10 and Warp-6 stickers, and inserts the stickers into the blank spaces strategically left in the generic *You'd Better Love Your BLANK Computer* main text and, of course, on the cover and title page (hence the BLANK in the generic title).

The main text, in chapters 2 through 12, covers the usual boring topics that are now required by a NATO treaty to be part of all personal-computer books: why floppy disks are better than cassette tapes (slightly inappropriate for the Burndazzle, since it uses only charge-coupled bubbles for storage, but nice to know anyway), how to write a short program in Microsoft BASIC, and how to log onto Compuserve.

Once the stickers have

been stuck in, Chapter 1 tacked on to the rest of the book, and the whole thing pasted into its sealed, dust-proof jacket, you've got your complete copy of *You'd Better Love Your BURNDAZZLE MACH-19 Computer*.

The genius of Howard Blabbe was to realize that a single main text could be so easily and economically customized for each new computer on the market, using the new high technologies of on-site demand printing and gummed stickers, and that the computer-illiterate public will buy virtually any book, even one containing so little real information, as long as the name of a specific computer appears in the title.

The patented Blabbe system ensures that the freshest, most up-to-date specifications of the newest computers on the market will appear in Chapter 1 of all *You'd Better Love Your BLANK Computer* books. Just don't count on learning anything from the book that you couldn't learn from reading the press release.

Special April Letters

A Technical Solution to a Legal Problem

Your readers may be interested in a hardware modification that may help them deal with those impossible software agreements. I refer, of course, to the "warranties" that make you assume all responsibilities and give up all your rights, and to which you are supposed to have agreed the moment you break open the software's cellophane wrapper.

By enhancing the modulation circuitry in a disk drive's head driver, using three BHDs (black-hole diodes; see April 1981 BYTE, page 363), I can now read a disk while it is still in its wrapper. Because I don't open the package, I don't have to agree to the manufacturer's terms!

Of course I can't write on such disks (yet), but I never use my originals for anything anyway, except to make two backups from which I work.

Naturally, the disk drive's clutch mechanism cannot work normally with a disk that is still in its sleeve and cellophane wrapper and (usually) stiffened with a hunk of cardboard. Therefore, either the whole package or the head on its arm must spin. I have tried both methods and each works.

The first method is the more costly. I had to first saw my Apple Disk II in half to give the still-packaged disk room to rotate, then mount extensions on the clutch to engage gently enough not to tear the cellophane.

The second method is easier, if you

have the parts. I had an old Sears record player, so I mounted the floppy-disk head and arm on that, then positioned the software package to be stationary as the hardware spun—just the opposite of the usual method, but, as the theory of relativity would predict, it doesn't matter whether the disk spins inside the disk drive or the disk drive spins outside the disk.

Speaking of relativity, the black-hole diodes are necessary to draw excess charge off the cellophane. As anyone who has struggled with plastic wrap knows, static buildup can be monstrous. When a charged sheet of cellophane begins to rotate at the speeds I'm talking about, it becomes a planar current, with all that entails. I actually had to use *three* BHDs!

I had originally planned to use just two

BHDs because I needed three sinks. (BHDs have two inputs each.) But I overloaded the one that I had hooked the charge wipers to, and the circuitry rapidly burned out as static buildup welded everything together. So don't take chances; use the extra charge sink.

(By the way, I followed all precautions about isolation of the BHDs. I placed each at least an inch from the rest of the circuitry, on a separate piece of perf board. Then I surrounded them with metal boxing to prevent accidental brushing against the diodes. This also helps shield against their gamma radiation and reduces the noise from the air that the black holes suck up.)

Now I'm the envy of my friends because of my stacks of unopened software that I use regularly. But little do they realize that the real payoff is in the rest I get, sleeping more easily knowing that I'm not violating the software agreements that used to make me feel so guilty.

T. Chmee Algol
Bakery Consulting
Belmont, MA 02178

April BYTE's Bits

You Heard It Here First

After reviewing U.S. census figures and the sales figures for the microcomputer industry, a disturbing trend has become apparent. Sales projections indicate that approximately 5 million personal computers will be purchased in 1984 as compared to an expected birth rate of 3.8 million children. The conclusions are obvious; computers are more popular than children.

Extending the projections produces figures that show the sales of microcomputers continuing to rise while the birth rate will remain at the present level or even decline for some years into the future. "Long-range demographic trends are somewhat disturbing because of the present trend towards home computers and away from children," said Researcher Debra Hurd in an article in *Videoprint* newsletter. Ms. Hurd also noted,

"Children are essential if the home computer market is to have any future at all after about the year 2040."

MacAzines

O. D. Dreggs of Clone Publishing, Coopertoni, California, announced that Clone will be publishing the first eight of its new family of magazines aimed at Macintosh owners. "Rather than wait for other publishers' magazines to appear, Clone decided to compete against itself," said Dreggs. The eight magazines include *MacBuff* for nudist users, *Mac'n'Stein* for Macintosh-owning pub owners, *MacTruk* for 18-wheeler enthusiasts, *Listen, Mac* for assertion-training graduates, *MacAdamia* for Hawaiian computer nuts, *MacDonald* for farmers, *MacRug* for toupee-wearing users, and *MacRag*, which is specifically aimed at fledgling publishers.

SATISFY YOUR DRIVES!

70 MAIN/FRAMES & DISK ENCLOSURES FROM \$100



800D2F
 5" Floppy Main/Frame
 (10 cards) **\$392**

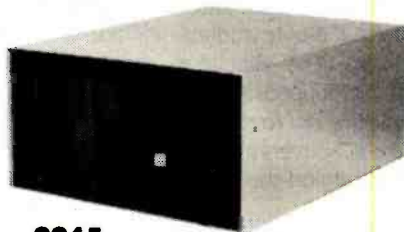

2215
 5" Floppy Winchester
 Main/Frame (7 cards) **\$380**

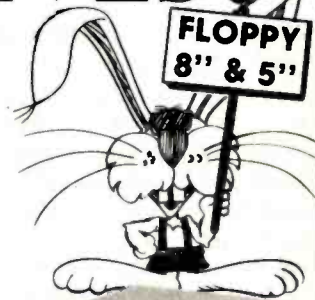

2905
 5" Disk Enclosure **\$100**

32 Page
 Free Fakt
 Pakt Catalog

Write or call for our brochure which includes our application note: "Making micros, better than any ol' box computer"

INTEGRAND

8620 Roosevelt Ave./Visalia, CA 93291
 209/651-1203

We accept BankAmericard/Visa and MasterCard

MISCELLANEOUS



Megamaus from Vacucorp

Designed specifically to settle the burning question of the microcomputer age—Just how many buttons should a mouse have?—Megamaus includes a full ASCII keyboard. Megamaus is the first mouse-like peripheral that allows users to continue to type while moving the cursor. A companion product, Electrodent, includes only an octal-based keypad.

A product of Vacucorp, specialists in antiquated methodology, Megamaus uses a proprietary forced-air process

instead of complicated electronics. Each time a key is pressed, an ASCII-compatible string of air bursts flows down the hollow Megamaus tail to the computer. "A special decoder board mounts in the computer and converts the pulses of air into those weird electronic signals," says marketing director Brucey Helmholes. Information on the Megamaus and related products can be obtained from Vacucorp, 70 Main St., Potterborough, NH 03458.

Looking for Mr. Dos

MRI {Marginal Research Inc.} of San Obscuro, California, unveiled MR-DOS, a single-user nontasking operating system package for personal computers. Tyler Sperry, founder and chief software engineer of MRI, says MR-DOS is aimed at the user "who thinks that the Unix environment is a room near the entrance to the harem and that Xenix is the Marx brother that no one can ever remember."

Instead of the traditional "A>" prompt, MR-DOS responds with the message "Well?" and the sound of impatient foot-tapping. The Help function suggests that the user read the 1466-page manual (provided at substantial extra cost).

Memory-management techniques are said to be state of

the art. The booter sits on top of the CCP, which places the BDOS somewhere under the BIOS, in the middle of the TPA, but not in ROM. Headerless code in the stack registers supports overlapping segmentation in standard 256-byte addressable chunks. The allocation tables are bit-mapped to the interrupt vectors, not to mention calls to the I/O drivers from the duck blind behind the printer ports.

MR-DOS is sold in two configurations, a lower-priced edition for the novice user called Fast Eddie and a high-end edition known as Big Al. Fast Eddie provides the purchaser with both a version number and a complete sign-on message; Big Al features Marginal's System Programmer's Application Module, or S.P.A.M., a

collection of utilities and infinite regresses. Purchasers of MR-DOS receive a personalized case history of their particular version and a certificate of adoption suitable for framing.

New Languages

Computechsoft Inc. of San Luis Abysmo, Kansas, has announced two new programming languages, ORTHFAY and LIMP. ORTHFAY is an enhancement of FORTH that employs both RPN (reverse Polish notation) and PLS (Pig Latin syntax); it can be used to produce code so elegant that it becomes meaningless immediately, rather than after the weeks or months required by common FORTH variants. An interpretive language, it usually requires several attempts (and pricked fingertips) to get ORTHFAY threaded. Once loaded, however, the kernel is capable of intricate weaving and fairly decent fried chicken.

LIMP, Computechsoft's Lisp IMPLementation, is a boon for researchers interested in lower-level higher-density artificial intelligence. Experts observe that LIMP is a much truer simulation of the human learning process than most AI languages, requiring repeated prompting and constant repetition of simple subroutines. Use of the word "Eratosthenes"—even in a remark—has been known to provoke fatal crashes.

A Real EDITER Program

The EDITER Program from Nadir Engineering takes a text file and rewrites it, beefing up weak areas, reorganizing where necessary, and clearing ambiguities and areas of fuzzy thinking. EDITER allows menu selection of several modes of writing—Chaucerian, Victor-

ian, Bureaucratese, ancient Greek, terse engineering, terse vernacular, Pidgin English, or three choices of dialect, two ethnic and one generic. (Brooklynese, Urdu, and turgid are to be released soon.)

For more information, contact D. McLanahan, Chief Engineer in Charge, Nadir Engineering, POB 17, Marlow, NH 03456.



Real Hacker's Shirt

Bitwear Garments of Hack 'n' Sack, Montana, has announced the availability of its Real Hacker's Shirt. This wear-only shirt is designed to put the nouveau-chic 3½-inch floppy-disk users in their places. Just because they can carry their so-called floppy disks in their shirt pockets is no reason to be glum. Thanks to Bitwear, you can flaunt your real-hacker 8-inch floppies.

This 100 percent mercerized yak-hair pullover is available in white with red, green, blue, or gold marsupial-like pouches. The handsome floppy-disk pouch is lined with an anti-static fabric and with lead foil so you can wear it during medical and dental X-rays and through airport security systems without fear of damaging your latest edition of DDT-patched code. A hard-disk version of the Real Hacker's Shirt is under development. For more information, contact Bitwear Garments, Eastern Division, The Guernsey Building, Peterbowwow, NH 03458.

We Offer You More!

That's right. If you compare the benefits of ordering from National Computer to all our competitors, you'll see why more smart shoppers buy from us everyday. We save you money even before you order with our toll-free 800 line, and then if you find a lower advertised price we'll try to meet it. Since we stock what we advertise you can rest assured your order will be shipped promptly. In addition, if for any reason you are not satisfied with any hardware you purchase from National Computer you may return it for exactly what you want or a full refund. Check us out! We've been in business for over 4 years, and one glance at our catalog will demonstrate the commitment we have to direct marketing and to our fine customers.

HOURS:
MONDAY-FRIDAY
7:30 AM-6:00 PM P.S.T.
SATURDAY
9:00 AM-3:00 PM



VIDEO MONITORS

| | |
|------------------------------|--------|
| AMDEX 300 12" Hi-res green | 145.00 |
| AMDEX 300A 12" Amber | 158.95 |
| AMDEX Color I Plus 13" Color | 329.95 |
| AMDEX Color II Hi-res RGB | 438.95 |
| AMDEX 3100 Green | 179.95 |
| AMDEX 310A Amber | 179.95 |
| COMREX 5600 12" hi-res amber | 169.95 |
| NEC 1201M 12" Hi-res green | 159.95 |
| Princeton PGS HX-12 | 499.95 |
| TAXAN Vision 112" md-res RGB | 329.95 |
| TAXAN 12" hi-res amber | 149.95 |
| ZENITH 12" hi-res green | 110.95 |



KAYPRO
The anytime-anywhere computer. Includes CPM, CBASIC, a spreadsheet and wordprocessing software. PLEASE CALL FOR MORE DETAILS.



PRINCETON PGS HX-12

IDEAL FOR IBM PC!
High Resolution 12" RGB color monitor.
•80 character x 25 lines
•890H x 240V dot resolution
•16 colors, high & low intensity
•Includes IBM PC cable
•Very affordable

CALL

We carry the Quadram Quadchrome for only \$529.95



QUADLINK by Quadram

Only \$499.95

Now you can run Apple software on your IBM PC. Advance technology from the IBM PC peripheral leader, Quadram has made it possible. Quadlink allows using all IBM enhancements while running Apple software, including all peripherals. Now you can enjoy the best of both software worlds including hi-res games, special packages not available on the IBM PC. Applize your IBM today!

POPULAR SOFTWARE

| | |
|------------------------------|--------|
| WordStar by MicroPro | 299.95 |
| Random House Thesaurus | 129.95 |
| MailMerge by MicroPro | 169.95 |
| SuperSort by MicroPro | 169.95 |
| SpellStar by MicroPro | 169.95 |
| dBase II/MS-DOS or CP/M86 | 429.95 |
| LOTUS 1-2-3 Call for Details | 399.95 |
| Peachtree GRAFAP 4 pak. | 299.95 |
| SuperCalc by Sorcim | 139.95 |
| Crosstalk by LifeTime | 139.95 |
| Microsoft MultiPlan | 179.95 |
| Microsoft Flight Simulator | 39.95 |
| VisiCalc | 169.95 |
| VisitFile | 219.95 |
| VisitTrend/Plot | 219.95 |
| VisitSchedule | 219.95 |
| VisitWord (req. 128K) | 299.95 |



EAGLE COMPUTER

EAGLE PC-2 IBM Compatible

Includes 128K, two DS/DD 320K drives, color card, keyboard, monitor, two serial ports, one parallel port, Eagle Writer, Eagle Calc, MS-DOS and CP/M 86. Other Eagle configurations available.
Call for pricing

—APPLE COMPATIBLE— Wildcat Mobile Computer

64K Ram, one or two drives, one serial, one parallel port, RGB output, detachable keyboard. Call for more information

NEW! TAXAN 420 MONITOR

12" hi res RGB CALL



MODEMS

| | |
|--|-----|
| ANCHOR MARK III—Now Available 300/1200 BAUD, DC Hayes Compatible | 299 |
| TRAVES Smartmodem 300 | 219 |
| HAYES Smartmodem 1200 | 409 |

COMPATIBLE MODEMS FOR IBM PC

| | |
|----------------------------|-----|
| HAYES Smartmodem 1200B | 449 |
| Cactus Technology | 299 |
| Novation JCAL 300 | 115 |
| Rixon PC212A (IBM PC) CALL | 349 |
| PC Modem Plus | 349 |



IBM Personal Computer

Includes 64K, 2 DS/DD 320K drives, keyboard, color video card and MS-DOS. PLEASE CALL FOR SYSTEM PRICES.



PC MOUSE

For use with IBM, Ratliff Shack, Apple, etc. System includes Mouse Systems M1 optical mouse w/pad & RS-232 interface

Only \$249.95

MICROSOFT MOUSE AVAILABLE PLEASE CALL FOR PRICE



BIG BLUE Z—80 CARD

Z-80 with 64K, parallel & serial I/O hard disk interface & clock
BYAD DS1 7 80 ram with software 579.95



KOALA TOUCH TABLET

A new dimension in computer control with the touch of a finger. Special price 109.95



MISCELLANEOUS

| | |
|------------------------------------|--------|
| SYMTEC Light Pen | 139.95 |
| KHAI 1 Joystick | 58.95 |
| KHAI 1 Padlock | 49.95 |
| Micro-control Systems Space Tablet | 479.95 |



SWEET-P PLOTTER

Simple to operate plotter which easily interfaces to the PC, using a centronics parallel port. Complete with software, set of pens, paper and operators manual. List Price \$295.00. Special Offer



EPSON FX-80 EPSON RX-80

Call for Special Price
EPSON FX 100
STAR GEMINI 10X & 15X
CITOH PROWRITERS I & II
NEC 8023A
TOSHIBA P 1250
IUS PRISM 132 W/COLOR
Please Call for BEST PRICE and Availability



OKIDATA ML92

180 cps, 10" carriage, 80 columns
Only \$469.95

| | |
|---------------------------|--------|
| Tractor for ML 92 | 58.95 |
| OKIDATA 93 | 759.95 |
| OKIDATA 82A with tractor | 389.95 |
| OKIDATA 83A | 595.95 |
| OKIDATA 84A par w/tractor | 969.95 |



TRANSTAR 315 COLOR PRINTER

Prints 4 colors plus more than 30 shades, all in a single pass of the printing head. And it's built by Seiko

Only \$549.95



LETTER QUALITY PRINTERS

| | |
|---------------------------------|---------|
| CITIHOF 10 Starwriter 40 cps | 1149.95 |
| CITIHOF F 10 Printmaster 55 cps | 1649.95 |
| Daisywriter 40 cps w/48K buffer | 1079 |
| NEC 3510 33 cps RS 232 serial | CALL |
| NEC 3530 33 cps parallel | CALL |
| JUKI 6100 18 cps | CALL |
| BROTHER DYNAX HR 1 and HR 1B | CALL |
| FRANSTAR 120 & 130 | CALL |
| QUME SPRINT II PLUS | CALL |



NEC 3550 Sprinwriter for IBM PC

Only \$1889.95



QUADRAM QUADBOARD

256K only \$399.95

64K 209.95 128K 349.95 192K 639.95

512 QUADBOARD

64K 209.95 256K 349.95 512K 639.95

Coming soon! New direct connect modem.



AST MEGAPLUS

| | |
|--------------------------------------|--------|
| 64K with serial & clock | 339.95 |
| 128K 399.95 192K 449.95 256K 499.95 | |
| 67K with parallel & serial | 379.95 |
| 128K 439.95 192K 499.95 256K 549.95 | |
| MegaPak option (256K) for 512K total | 329.95 |

COMBOPLUS

64K with serial, parallel & clock 339.95

128K 399.95 192K 459.95 256K 499.95

I/O PLUS

Serial, parallel, clock and game adapter port 225.00



Apparat, Inc. COMBOCARD II

Serial port, parallel port, clock and game port all on one card

Only \$169.95

RS 232 cable for combo card 29.00



PLANTRONICS

Feedback Electronics

FREDERICK COLORPLUS

HI-RES COLOR GRAPHICS CARD

Includes draftsman utility software

PLEASE CALL FOR BEST PRICE



DISK DRIVES FOR IBM PC

| | |
|----------------------------|--------|
| Tandon TM 100-2 DS/DD | 249.95 |
| Tandon 5 1/4" Half-Heights | CALL |
| Davong 5 mb | CALL |
| Davong 10 mb | FOR |
| Davong 15 mb | PRICES |



COLUMBIA MPC

IBM PC Compatible System

Includes 128K, two DS/DD 320K drives, 2 RS-232 serial ports, centronics parallel printer ports, 8-IBM compatible expansion card slots, video monochrome/color graphics card, and IBM type keyboard. Included with system is MS-DOS, CP/M 86, BASICA (w/color graphics), asynchronous communications support, macro assembler) Perfect Writer, Perfect Speller, Perfect Calc, Perfect Filer, Columbia Tutor, diagnostics and NOT Lite Support. Please call for price. Available with Winchester Disk.



COLUMBIA VP PORTABLE

Featuring IBM-PC and COMPAQ compatibility teamed with the most comprehensive software package in the industry to deliver all the functions you need. Includes 128K RAM, expandable to 256K, 2.5" half-high floppy disk drives with 320K DS/DD 5 1/4" green screen, 80x25 characters. Full IBM compatible keyboard. The unit only weighs 12 lbs.

PLEASE CALL FOR MORE DETAILS



inexpensive IBM PC Compatible

The new SANVO MPC 550 is a 16 bit IBM PC work-alike that will run all software currently available IBM PC software. Features include:

- 8086 CPU + 128K RAM memory + 180K Floppy disk storage + Color graphics centronics printer port + Sanyo BASIC + Diagnostics + Utilities + Speaker + Joystick port + MS-DOS + Word Processing and Spread Sheet Software all included.

All for less than \$1000

Call for more information and prices on other configurations.

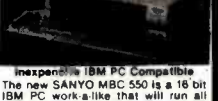

MICROBUFFERS by Quadram

PRINT BUFFERS

Please call for prices on the configuration of your choice.

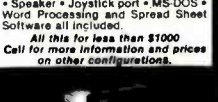

PROTECT YOUR COMPUTER

| | |
|----------------------------------|--------|
| Lemon, 8 out, surge prot. | 49.95 |
| Lime, w/power switch | 79.95 |
| 8" x 8" cord | 79.95 |
| Orange, w/EMI-RFI filter | 115.00 |
| Plum, 3 out, EMI-RFI AC filter | 44.50 |
| IBM PC Saver, In-Line Power cord | CALL |

Diskettes

| | |
|---|-------|
| 3M Scotch 5 1/4" DS/DD | 35.95 |
| Box of 10 Verbatim Diskette 5 1/4" DS/DD | 38.95 |
| Box of 10 Disk Drive Head Cleaning Kit for 5 1/4" | 27.95 |

It's Here! National Computers Winter 1983 collection of State-of-the-art computer merchandise is available now.



You'll find dozens of products, including computers, printers, video monitors, modems and accessories for IBM PC, APPLE IIe and many other computer systems, all at the great price you expect from us. It includes dozens of illustrations and informative descriptions. And best of all, it's free!

TOLL-FREE ORDERING 800-854-6654

NATIONAL COMPUTER PRODUCTS

8338 Center Drive, La Mesa, CA 92041-3791 Calif. Alaska, &

Information on products, and order inquiries call (619) 460-6502 Hawaii call (619) 698-8088

DEALERS, WE BUY EXCESS STOCK, PLEASE CALL OR WRITE

controlled by HP minicomputers, desktop computers, and calculators, . . . can be operated by a number of other 16-bit controllers to provide complete automatic-test and process-control functions." The multiprogrammer is defined as a device that uses internal microprocessor-based control circuits to operate up to 15 plug-in input/output cards. Cards are purchased from the manufacturer to accomplish various tasks. The author describes the characteristics of a D/A (digital-to-analog) voltage converter, resistance output, D/A current converter, voltage regulator, low-level A/D (analog-to-digital), programmable timer, frequency reference, pulse counter, stepping-motor control, digital output, relay output, digital input, isolated digital input, event sense, process

interrupt, and breadboard cards.

The remainder of the fourth chapter is devoted to applications of the multiprocessor in various production-testing operations and the programming fundamentals necessary for instrument control. Careful attention is used to describe the characteristics that might affect overall performance such as noise immunity, system protection, isolation, and troubleshooting techniques.

The final chapter of the book is devoted to programming techniques in order to "perform the various control and instrumentation functions." The author uses block diagrams extensively to illustrate various points of description. Topics include output modes (system enable and timing, data transfer, computer-data input, hand-

shake, and timing) and input modes (dedicated input, timing, and interrupt/search). The final sections of this chapter describe how the various plug-in cards are programmed. In my opinion, the author has covered a tremendous amount of material in a relatively small amount of space. My only desire would be for more examples.

As a Whole

Thus, the first three chapters interface well with the concluding chapters that deal with multiprogrammer devices. They establish the input and output methods, while the last chapters explain how you can collect and analyze the data with the use of commercial devices.

If this book were to be compared with a cookbook, it would be described as one that discusses the ingredients

in a recipe without giving the actual proportions. Now this has both its good and bad points. First, I believe the author accomplished his task—the book is a crash course in microcomputer-based instrumentation geared to the levels of individuals from various backgrounds. Second, the book was not intended to be a source of various interface circuits but rather a source of techniques. (Perhaps like the steps in baking a fruit pie without going into detail on the type of fruit filling). And so, this is a highly valuable book on the techniques of interfacing, leaving the actual implementation to the reader. ■

William H. Murray (RD 3, Box 363, Montrose, PA 18801) is a professor of computer science at Broome Community College in Binghamton, NY 13902.

Modula-2. Simply Better.

More and more software developers are finding a new language simply better than C or Pascal. They're finding Modula-2, by Niklaus Wirth, the creator of Pascal. For professional programmers, it's simply a better language.

Modula-2. Simple like Pascal (if you know Pascal, you can be writing Modula programs in hours) but with much more power and flexibility. Power to handle any professional application, so there's no need for extensions.

Modula-2. Better than C because it gives you strong typing and superior separate compilation facilities. That means you write cleaner programs, faster.

Only LOGITECH's Modula-2/86 system translates directly into high-speed native code for PC-DOS™, MS-DOS™ and CP/M-86™.

No other system speeds your Modula programs along faster than our native code compiler. And our high-level, symbolic debugger ensures your programs arrive in flawless running condition.

Multi-level overlays, 8087 support, ROMable code, and a full library of standard modules make Modula-2/86 the perfect system for every professional application.

We also offer the only VAX/VMS™ resident and cross compiler for the 8086.

For VAX mainframes to PCs, look to LOGITECH's Modula-2 software development systems. For professional programmers, it's simply a better choice.

 LOGITECH

805 Veterans Blvd., Redwood City, CA 94063
415-326-3885
LOGITECH SA (In Europe)
CH-1143 Apples, Switzerland

See us at
COMDEX™
Atlanta-Booth 4658

PC-DOS is a TM of IBM. MS-DOS is a TM of Microsoft. CP/M-86 is a TM of Digital Research. VAX/VMS is a TM of Digital Equipment Corp. 0384



NEW PRODUCTS

Before Johann Sebastian Bach developed a new method of tuning, you had to change instruments practically every time you wanted to change keys. Very difficult.

Before Avocet introduced its family of cross-assemblers, developing micro-processor software was much the same. You needed a separate development system for practically every type of processor. Very difficult and very expensive.

But with Avocet's cross-assemblers, a single computer can develop software for virtually any microprocessor! Does that put us in a league with Bach? You decide.

The Well-Tempered Cross-Assembler

Development Tools That Work

Avocet cross-assemblers are fast, reliable and user-proven in over 3 years of actual use. Ask NASA, IBM, XEROX or the hundreds of other organizations that use them. Every time you see a new microprocessor-based product, there's a good chance it was developed with Avocet cross-assemblers.

Avocet cross-assemblers are easy to use. They run on any computer with CP/M* and process assembly language for the most popular microprocessor families.

5 1/4" disk formats available at no extra cost include Osborne, Xerox, H-P, IBM PC, Kaypro, North Star, Zenith, Televideo, Otrona, DEC.

Turn Your Computer Into A Complete Development System

Of course, there's more. Avocet has the tools you need from start to finish to enter, assemble and test your software and finally cast it in EPROM:

Text Editor VEDIT -- full-screen text editor by CompuView. Makes source code entry a snap. Full-screen text editing, plus TECO-like macro facility for repetitive tasks. Pre-configured for over 40 terminals and personal computers as well as in user-configurable form.

CP/M-80 version \$150
 CP/M-86 or MDOS version \$195
 (when ordered with any Avocet product)

EPROM Programmer -- Model 7128 EPROM Programmer by GTek programs most EPROMS without the need for personality modules. Self-contained power supply ... accepts ASCII commands and data from any computer through RS 232 serial interface. Cross-assembler hex object files can be down-loaded directly. Commands include verify and read, as well as partial programming.

PROM types supported: 2508, 2758, 2516, 2716, 2532, 2732, 2732A, 27C32, MCM8766, 2564, 2764, 27C64, 27128, 8748, 8741, 8749, 8742, 8751, 8755, plus Seeq and Xicor EEPROMS.

| Avocet Cross-assembler | Target Microprocessor | CP/M-80 Version | •CP/M-86 IBM PC, MSDOS** Versions• |
|------------------------------|-----------------------|-----------------|------------------------------------|
| •XASMZ80 | Z-80 | \$200.00 each | \$250.00 each |
| •XASM85 | 8085 | | |
| XASM05 | 6805 | | |
| XASM09 | 6809 | | |
| XASM18 | 1802 | | |
| XASM48 | 8048/8041 | | |
| XASM51 | 8051 | | |
| XASM65 | 6502 | | |
| XASM68 | 6800/01 | | |
| XASMZ8 | Z8 | | |
| XASMF8 | F8/3870 | | |
| XASM400 | COP400 | | |
| XASM75 | NEC 7500 | | |
| Coming soon: XASM68K...68000 | | \$500.00 | |

(Upgrade kits will be available for new PROM types as they are introduced.)

Programmer \$429
 Options include:
 • Software Driver Package --
 • enhanced features, no installation required.
 • CP/M-80 Version \$ 75
 • IBM PC Version \$ 95
 RS 232 Cable \$ 30
 8748 family socket adaptor ... \$ 98
 8751 family socket adaptor ... \$174
 • 8755 family socket adaptor ... \$135

- **G7228 Programmer by GTek** -- baud to 2400 ... superfast, adaptive programming algorithms ... programs 2764 in one minute.
- Programmer \$549
- Ask us about Gang and PAL programmers.
- **HEXTRAN Universal HEX File Converter** -- Converts to and from Intel, Motorola, MOS Technology, Mostek, RCA, Fairchild, Tektronix, Texas Instruments and Binary formats.
- Converter, each version \$250

Call Us

If you're thinking about development systems, call us for some straight talk. If we don't have what you need, we'll help you find out who does. If you like, we'll even talk about Bach.

CALL TOLL FREE 1-800-448-8500
 (In the U.S. except Alaska and Hawaii)

VISA and Mastercard accepted. All popular disc formats now available -- please specify. Prices do not include shipping and handling -- call for exact quotes. OEM INQUIRIES INVITED:

*Trademark of Digital Research **Trademark of Microsoft



AVOCET SYSTEMS INC.
 DEPT. 484-B
 804 SOUTH STATE STREET
 DOVER, DELAWARE 19901
 302-734-0151 TELEX 467210

Microcomputer Interfacing

Harold S. Stone
Addison-Wesley
Publishing Co. Inc.
Reading, MA
1982, 383 pages
hardcover, \$32.95

Reviewed by
Stephen Locke

I know what you're thinking—another book on micro-computer interfacing. Indeed, the proliferation of computer book titles has never been greater in the publishing business than now. So many people are searching for knowledge on this complicated subject that it seems some publishers and writers are producing books that are a waste of the reader's time. *Microcomputer Interfacing* by Harold S. Stone is not one of those.

This is a text book and, as such, is intended for both undergraduate and professional readers. The undergraduates should be majoring in computer engineering or enrolled in a computer-

science program that exposes them to logic design, assembly-language programming, and a high-level language. This prior knowledge is recommended before reading this book. However, I found the only background knowledge I needed was about the meaning of the logic-gate symbols and flip-flops. I saw no need for a high-level language background. But it would help you to be very familiar with transistors, microprocessors, and assembly language in order to get the most value from reading this book. A mathematics background is assumed in the mention of LaPlace transforms in a section on phase-locked loops. (Phase-locked loops are used in magnetic disk-read circuits to quickly lock onto the frequency of the clock data that is imbedded in the data-signal read from the disk. This effectively rejects noise.) You may have to skip this section if your math skills are not up to par.

An Overview

Many of the chapters cover a discussion of basic princi-

ples, methods and detailed examples of applying these principles, suggested laboratory experiments, and nonlaboratory problems. As the author points out, the basic principles of microprocessor technology are important enough to continue into the future. However, detailed examples given in this text use technology and integrated circuits (ICs) available at the time this book was written and may soon be obsolete.

Following the book's index is a numerical index of the 98 IC devices referred to in the text. The book's main index is expanded to include a definition of terms used. This index/glossary is especially useful in a field that contains so many acronyms and new terms. Also, the bibliography contains numerous references for those who may wish to seek further information.

As a whole, this book is written for future designers rather than service people or hobbyists. But I've found that if you know how a microprocessor system works and was designed, you can do a bet-

ter job of repairing, modifying, and designing attachments. A lot of practical information is supplied about techniques for connecting computers to peripherals and communication devices and also about the method for programming the computer to control external devices.

Specifics

The author includes a much-needed chapter on shielding, grounding, and transmission-line techniques. When the length of a TTL (transistor-transistor logic) line becomes more than about 18 inches, the line should be considered as a transmission line and treated as such to prevent glitches. Glitches are due to the signal's bouncing off the end of the line and being reflected back to the source, and can be analyzed by transmission-line design techniques.

A list of ICs used for receivers and transmitters for communication lines (to remote terminals) is offered with recommendations. The author stresses common-mode rejection as the most important parameter, due to

wabash®

When it comes to
Flexible Disks, nobody
does it better than
Wabash.

MasterCard. Visa Accepted.
Call Free: (800) 235-4137

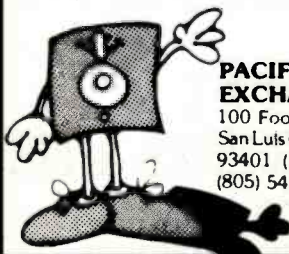

PACIFIC EXCHANGES
100 Foothill Blvd.
San Luis Obispo, CA
93401 (In Cal call
(805) 543-1037)

IBM PC, APPLE, etc. . .

SHARING AND SWITCHING PROBLEMS?
GILTRONIX HAS THE SOLUTION!

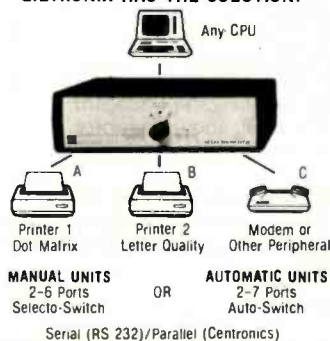

LOW COST ADD-ONS FROM THE MAIN
MANUFACTURER

Giltronix

3780 Fabian Way, Palo Alto, CA 94303
(415) 493-1300

COMPUTER RUNS MOTORS



- ROBOTS
- PROCESS CONTROL
- CONVEYORS
- ONE PORT RUNS UP TO FOUR MOTORS

Use your computer with the CDFR controller to command speed and direction of two independent motors from a single output port. For robot drive motors or any two functions requiring proportional bipolar control of 15Vdc up to 12 Amps each. Normally the controller installs between the computer, a 12Vdc battery, and two DC PM motors mounted right and left on a robot. Simple software commands set speed and direction latches in the CDFR thus freeing your computer for other tasks. Two CDFR's control four motors with a single port. The CDFR speed control uses CMOS, optoisolators & relayless PWM power circuitry. One year limited warranty. Buy now with parallel interface for \$225.00, or serial for \$315.00. Other robotics components available. MC, VISA, MO, or check.

VANTEC

15445 VENTURA BLVD., SUITE 10-281
SHERMAN OAKS, CA 91413
(213) 993-1073

SPECIALS ON INTEGRATED CIRCUITS

6502 @ 4.90 6520 @ 4.00 6522 @ 5.00 4116 @ 1.85
2532 @ 5.90 2716 @ 4.45 6116 @ 6.45 4164 @ 6.90

Anchor Automation Signalman MODEMS

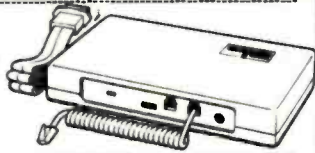

FREE SOURCE MEMBERSHIP WITH SIGNALMAN
All Signalman Modems are Direct Connect, and provide the best price-performance values. Dealer and OEM inquiries invited

| | |
|--------------------------------|------------|
| Veloxmodem with computer cable | 68 |
| Mark VII Auto Dial/Auto Answer | 99 |
| Mark XII Smart Model 1200/300 | 279 |
| DC HAYES Smartmodem | 219 |
| DC Hayes Smartmodem 1200/300 | 519 |



| | |
|---|------------|
| PROM QUEEN for C64 or VIC | 130 |
| Apple Emulator for Commodore 64 | Call |
| STAT Statistics Package for C64 | 95 |
| Solid Oak 2 Level Stand for C64 or VIC | 29 |
| C64/VIC Switch (networking) | 129 |
| BACKUP V1.0 tape copier for C64 or VIC | 20 |
| CARDBOARD/6 Motherboard - VIC | 64 |
| CARDBOARD/5 Motherboard - C64 | 56 |
| CARD PRINT G Printer Int. with Graphics | 72 |
| CARD PRINT B Printer Interface—C64/VIC | 48 |
| CARDBOARD/3s Motherboard - VIC | 22 |
| CARDCO C64/VIC Calculator Keypad | 32 |
| CARDRAM/16 RAM Expansion - VIC | 49 |
| Complete CARDCO Line in stock | |
| CIE and VIE IEEE Interfaces in stock | |
| MSD SuperDrive for C64 or IEEE | 365 |
| MAE Assembler for C64 | 50 |
| Koala Pad Touch Tablet—C64 or VIC | 75 |
| CBC 4/12 Analog to Digital 4 chan/12 bit | 179 |
| MULTIPLAN for C64 | 79 |
| Dust Cover for C64 or VIC | 6 |
| Grand Master Chess for C64 | 24 |
| COMAL Language for C64 | 14 |

with sprites, color graphics, sound, turtle graphics.
BusCard II from Batteries Included 159
ULTRA BASIC - 64 with Turtle Graphics 37
Super Disk Utility - C64 - includes backup 19
MicroChess - C64 - 8 levels of play 17
HES MODEM with software for C64 45
Commodore 64 Programmers Reference Guide 16
WordPro 3+/64 with Spelling 85
VIController (also C64) - BSR Controller 50
COM VOICE Synthesizer for C64 or VIC 139
VIC products in stock - call for extra discounts.
Victory Software for VIC and C64 in stock.

APPLE—FRANKLIN ITEMS

| | |
|---|------------|
| FRANKLIN—complete line in stock | |
| QUENTIN Drives for Apple/Franklin | 189 |
| Swapper Stopper | 26 |
| automatic switch between paddles and joystick | |
| KRAFT Apple Joystick | 40 |
| Kraft Apple Paddle Pair | 30 |
| Koala Pad Touch Tablet-Apple/Franklin | 90 |
| SPINNAKER Software in stock | |
| Broderbund Software in stock | |
| 16K RAM Card for Apple | 59 |
| Multiplan—Microsoft | 185 |
| Solid Oak 2 Level Stand for Apple | 29 |
| Serial Card for Apple | 89 |
| MPC RAM/80 column card for Ite (AP/TEXT) | 139 |
| Z80 Softcard and CP/M (Microsoft) | 235 |
| RANA Elite I with Controller | 389 |
| Parallel Printer Interface/Cable | 69 |
| Microtek and MPC Interfaces in stock | |
| Grappler + Interface | 135 |
| DC Hayes Micromodem II, Ite with Smartcom | 245 |
| PFS: File or PFS: Report or PFS: Graph | 95 |
| Videx 80 Column Card | 209 |
| Apple Blue Book | 19 |

Commodore

See us for Personal, Business, and Educational requirements. Educational Discounts available.

PETSCAN I \$245 base price

Allows you to connect up to 30 CBM/PET Computers to shared disk drives and printers. Completely transparent to the user. Perfect for schools or multiple word processing configurations. Base configuration supports 2 computers. Additional computer hookups \$100 each.

COMPACT/STCP \$115

Intelligent Terminal Package for PET, CBM, C64
Includes ACIA Hardware / STCP Software

SCREENMAKER 80 Column Adapter for C64 139

Provide big screen capability for business applications.

Copy-Writer Word Processor for C64 49

Full-featured package with 800 lines of text in memory. Includes double column printing, graphic capability, full printer support.

Special Screenmaker/Copy-Writer Combo 179

| | | |
|---|----|------------------------|
| VICTORY Software for VIC and C64 | | |
| Metamorphosis | 16 | Creator's Revenge |
| Labyrinth of Creator | 16 | Galactic Conquest |
| Kongo Kong | 16 | Annihilator |
| Chomper Man | 16 | Grave Robbers |
| Bounty Hunter | 16 | Adventure Pack I or II |

PAPER CLIP Word Processor - CBM/C64 60

ORACLE Data Base from Batteries Included 89

| | |
|---|-----------|
| SPINNAKER Software C64, Apple, IBM, Atari | |
| Computer's First Book of PET/CBM | 11 |
| POWER ROM Utilities for PET/CBM | 78 |
| WordPro 4+ - 8032, disk, printer | 285 |
| VISICALC for PET, ATARI, or Apple | 189 |
| Computer's First Book of 64 Sound & Graphics | 11 |
| SM-KIT enhanced PET/CBM ROM Utilities | 40 |
| PET Spacemaker II ROM Switch | 36 |
| Computer's First Book of Games | 11 |
| Dust Cover for PET, CBM, 4040, or 8050 | 8 |
| CmC Interfaces (ADA1800, ADA1450, SADI in stock) | |
| Computer's Reference Guide to 64 Graphics | 11 |
| Computer's Machine Language for Beginners | 11 |
| HES Software and Hardware in stock | |
| UMI products in stock | |

FlexFile for PET/CBM/C64 \$59

DataBase, Report Writer with calculations, Mailing Lists. Easy to use, and can be modified.

FORTH for PET/C64 full FIG model - Cargile/Riley 50
includes all FORTH 79 Standard extensions, structured 6502 assembler with nested decision macros, standard 16x64 screens, ability to read/write BASIC sequential files, sample programs, introductory + reference manual.

Metacompiler for FORTH for independent object code 30

Floating Point for FORTH 20

KMMM PASCAL IV for PET/CBM/C64 99

Virtually full Jensen-Wirth implementation is now suitable for advanced placement courses.

EARL for PET/CBM Disk-based ASSEMBLER 65

SuperGraphics - BASIC Language Extensions 45

Fast graphics, sound, turtle graphics routines for PET/CBM.

RAM/ROM for PET/CBM 4K \$75 8K \$90

COMAL Language for C64, CBM, PET 14

CBM Public Domain Software - C64 27 disks 75

STAT for PET/CBM/C64 and Apple 95

Comprehensive Statistical Analysis Routines

Includes complete file handling capabilities, summary statistics, confidence intervals, hypothesis tests, exponential mean tests, multiple and power series regression, analysis of variance, histograms, and non-parametric tests.

PageMate 60 Command Word Processor 20

Full-featured package for all Commodore computers. Full screen editing, and supports disk, tape, and all printers.

DISK SPECIALS



| | | | |
|----------------------|----------|----------|-----------|
| Scotch (3M) 5" ss/dd | 10/ 2.10 | 50/ 1.90 | 100/ 1.86 |
| Scotch (3M) 5" ds/dd | 10/ 2.65 | 50/ 2.45 | 100/ 2.40 |
| Scotch (3M) 8" ss/dd | 10/ 2.20 | 50/ 2.00 | 100/ 1.98 |
| Scotch (3M) 8" ds/dd | 10/ 2.80 | 50/ 2.50 | 100/ 2.47 |

We stock VERBATIM DISKS

Write for Dealer and OEM prices.

| | | | |
|-------------------|----------|----------|-----------|
| Sentinal 5" ss/dd | 10/ 1.80 | 50/ 1.75 | 100/ 1.65 |
| Sentinal 5" ds/dd | 10/ 2.40 | 50/ 2.35 | 100/ 2.25 |

We stock Dysan disks

| | | | |
|-----------------|----------|----------|-----------|
| Wabash 5" ss/dd | 10/ 1.50 | 50/ 1.45 | 100/ 1.40 |
| Wabash 5" ss/dd | 10/ 1.80 | 50/ 1.75 | 100/ 1.65 |
| Wabash 5" ds/dd | 10/ 2.50 | 50/ 2.45 | 100/ 2.35 |

We stock MAXELL DISKS

Write for dealer and OEM prices.

| | | |
|--|------------|----------------------|
| Disk Storage Pages | 10 for \$4 | Hub Rings 50 for \$6 |
| Disk Library Cases | 8"—3.00 | 5"—2.25 |
| Head Disk Cleaning Kits | 12 | |
| AMARAY Disk Storage Systems in stock | | |
| Innovative Concepts FLIP 'N' FILES in stock. | | |

CASSETTE TAPES—AGFA PE-611 PREMIUM

| | | | |
|------|---------|---------|----------|
| C-10 | 10/ .61 | 50/ .58 | 100/ .50 |
| C-30 | 10/ .85 | 50/ .82 | 100/ .70 |



data systems

| | | | |
|---------------------------------------|-----|----------|-------------|
| ZVM-122A | 99 | ZVM-123G | 89 |
| ZVM-131 | 300 | ZVM-135 | 490 |
| Z100 16-bit/8-bit System | | | CALL |
| Z29 Terminal (DEC and ADM compatible) | | | 680 |

Z-150 IBM PC COMPATIBLE CALL

Z-160 PORTABLE PC CALL

We stock entire Zenith line.

USI Video Monitors - Green or AMBER 20 MHz hi-res Dealer and OEM inquiries invited

WRITE FOR IBM PC COMPATIBLE PRICES

| | |
|---|------------|
| Multiplan—IBM or Apple | 185 |
| Quadboard for IBM available | |
| KOALA PAD Touch Tablets—Apple, Atari, IBM, CBM | |
| Peachtext 5000 Software Package | 209 |
| PFS Software for IBM and Apple in stock | |
| SPINNAKER Software C64/VIC, Apple, IBM, Atari | |
| VOTRAX Personal Speech System | 269 |
| BMC 9191 Color Monitor | 229 |
| BMC 12A 12" Green Monitor | 79 |
| Oynax (Brother) DX-15 Daisy Wheel Printer | 469 |
| Brother HR-25 Daisy Wheel Printer (25 cps) | 769 |
| Itoh Prowriter Parallel Printer | 379 |
| Panasonic 1090 Printer with Correspondence Mode | 279 |
| Gemini 10X | 289 |
| EPSON, Okidata, Star Micronics printers in stock | |
| USI CompuMOD 4 R F Modulator | 29 |
| We Stock AMDEK Monitors | |
| A P Products | 15% OFF |
| COMPUTER COVERS IN STOCK | |
| BROOKS 6 Outlet Surge Suppressor/Noise Filter | 54 |
| Surge Suppressor-6 outlet | 29 |
| Electrohome 1302-2 13" Hi-res RGB Monitor | 335 |
| Panasonic 12" Monitor (20 MHz) with audio | 135 |
| Syneretek SYM-1 Microcomputer | 189 |

Hewlett Packard



Write or call for prices.

DATASHIELD BACKUP POWER SOURCE \$265

Battery back up Uninterruptible Power Supply with surge and noise filtering. The answer to your power problems.

ATARI - WE STOCK ENTIRE LINE SPINNAKER and Broderbund Software in stock.

215-822-7727

252 Bethlehem Pike
Colmar, PA 18915

A B Computers

WRITE FOR CATALOG. Add \$1.50 per order for United Parcel

We pay balance of UPS surface shipping charges on all prepaid orders (add extra for mail, APO/FPO, air). Prices include cash discount.

Regular prices slightly higher. Prices subject to change.

Plus Video Tapes

Harold S. Stone, the author of *Microcomputer Interfacing* and a professor at the University of Massachusetts at Amherst, has authored an accompanying set of 12 videocassettes called *Microprocessor Interfacing* that supplement this text book, turning the combination into a veritable course in engineering. The tapes are produced and distributed by the Association of Media-based Continuing Education for Engineers (AMCEE), as well as distributed by

Addison-Wesley. Each one runs about 40 minutes and is divided into theory and lab experiments. This is useful because you don't have to set up the experiment yourself, much time is saved, and experiments shown on videotape work every time. The complete course is \$3600; a 12-week rental is \$1080; a preview package is \$115 and includes a study guide published by AMCEE; and transparencies for classroom use are \$15.95. Contact AMCEE, 225 North Ave. NW, Atlanta, GA 30332.

high AC and/or DC voltages across local and remote electrical grounds.

One section includes a case history of a computer that was connected to a terminal located in another building. Because the system burned out when lightning struck nearby, recommendations are given for an improved design.

I appreciated reading the history of minicomputer bus systems and protocol schemes. For background information is a discussion of

the DEC PDP-8 and PDP-11 bus protocol and IBM's bi-sync communication design. Although many would consider these systems obsolete, there are enough of them in use today so that the information can be quite useful.

But the range of this book provides something for people representing a variety of interests. The first chapter covers the various structures of microcomputers including input/output interfacing techniques. Methods for safe connections with transmis-

sion lines, bus connections, and memory systems are covered in the next few chapters. Serial and parallel interfacing techniques, magnetic recording, design, and development of software precede the convenient glossary mentioned earlier.

On the Other Hand

I believe the section on the IEEE-488 interface standard could be improved by a more detailed description. Although nine pages were devoted to this interface, I would have appreciated an example of a complicated system with assembly programs given. Also, the interface can be used in a simple way by not using all control lines, but this was not pointed out in the book.

I also found there was no discussion of a Universal Asynchronous Receiver/Transmitter (UART). This popular IC deserves a little space, although I admit, if you can understand the chapters on serial and parallel communication, you would not have any trouble using a UART with the assistance of a manufacturer's data sheet. But you would

have to know such a device existed.

Some confusion exists in the book between DMA (direct memory access) and cycle-steal operations. It is my understanding that during DMA the processor must relinquish control of certain lines and buses to the I/O device. These are the address bus, data bus, and some control lines. A peripheral device can gain control of both buses and these control lines through the use of tri-state drivers. Cycle-steal operations are similar except that the address lines from the processor are not disconnected and the processor generates addresses for the I/O device. I would have liked this minor confusion cleared up.

Because the writing style is clear and compact, I can recommend the purchase of this book to anyone with an engineering background and the desire to understand a sometimes complicated subject. ■

Stephen Locke is a consulting engineer residing at 817 Belair Dr., Darien, IL 60559.



ZENTH/Heath Users

Double Your 5 1/4" disk storage capacity without adding a drive.

Get twice as much from your H88 or H89 microcomputer. Our FDC-880H floppy disk controller, in conjunction with your 5 1/4" drives, for example, expands memory capacity from 256 bytes to 512 bytes per sector.

And it handles single and double-sided, single and double-density, 8" and 5 1/4" drives — simultaneously.



C. D. R. Systems Inc.
Controlled Data Recording Systems Inc.
7210 Clairmont Mesa Blvd., San Diego, CA 92111
(619) 560-1272

Circle 59 on inquiry card.



APPLEWARE, INC.

The Apple Users Group Software Library

For the first time enjoy your Apple to its fullest capacity, using specially packed disks with over 60 outstanding programs each. [not available from any other source]

Each packed disk includes an extensive variety of interesting, useful and entertaining programs indispensable to all computerists! Mixed category packed disks include:

BUSINESS • EDUCATIONAL • DATA BASE • GAMES • UTILITIES • SCIENCE • MUSIC • GRAPHICS • FINANCE

Library Disks I, II and III are mixed categories. Single category disks are: **GAMES • UTILITIES • GRAPHICS • INTEGER • SCIENCE • TECH • MUSIC & AUDIO**

Individual disks available at \$59.95 each.

Order direct from this ad and Save up to \$150. Buy Library Disks I, II and III and get a special bonus disk FREE. Over 260 programs for \$179.95 = \$4. shipping. But for the Best Value, receive any 9 disks featuring over 600 of our best programs for only 65¢ each for a package price of \$389. Certified Postage plus handling each!

*** Band one-time membership fee of \$15. (no fee charged to institutions) for 1000 + program catalog and gain access to a library of over 10,000 programs at a special 15% discount [Foreign memberships \$28. U.S.]**

For Orders Only Call now
TOLL FREE: 1-800-327-8664
Florida: 1-305-987-8665

Or Write:
Appleware, Inc.
8400 Hayes Street
Hollywood, Fla. 33024

Program Disks compatible with Apple II • II • IIe, III Emul., Franklin Ace and IBM Quid



Circle 35 on inquiry card.

The Statistician

CPM IBM-PC TRS-DOS XENIX

- Multiple Regression Stepwise Ridge All Subsets Backward Elimination
- Time Series Analysis
- Descriptive Statistics
- Transformations
- Survey Research
- Nonparametrics
- XY Plots
- ANOVA
- Random Samples
- Data Base
- Search & sort
- Hypothesis tests

Please call **TOLL FREE 1-800-334-0854 (Ext. 814)**



for more information or write:
Quant Systems
Box 628
Charleston, SC 29402
VISA/M/C Accepted

Circle 306 on inquiry card.

CompuPro...

for Performance, Quality and Reliability

Anyone can sell you a box full of hardware. But is it too much computer? Too little? Will it run the appropriate software? What about service? If you need the right answers before and after the sale, call your nearest **Full Service CompuPro System Center**. For product information, see pgs. 71 & 268.

ALABAMA

Birmingham
Cost Plus Computers
(205) 879-5976

ARIZONA

Scottsdale
S-100
(800) 528-3138

CALIFORNIA

Bakersfield
Creative Computing Serv.
(805) 835-1118

Berkeley
American Computers
& Engineers
(415) 849-0177

Track Computer Center
(415) 845-6366

Burlingame
Mentzer Computer
Systems
(415) 340-9363

Canyon Country
Creative Computing Serv.
(805) 251-9877

Chatsworth
Priority One Electronics
(213) 709-6789

Hayward
Best Computers Hayward
(415) 886-4732

Irvine
Priority One Electronics
(714) 660-1411

Los Angeles
American Computers
& Engineers
(213) 477-6751
Gifford Computer
Systems
(213) 477-3921

Mountain View
ACC
(415) 969-4969

Oakland
Track Computer Center
(415) 444-8725

Pacific Palisades
System Interface
Consultants
(213) 454-2100

Pasadena
Omni Unlimited
(213) 795-6664

Petaluma
Advanced Information
Management
(707) 763-7283

Pleasanton
Best Computers
Stoneridge
(415) 463-2233

Sacramento
Logic Systems
(916) 922-3377

San Leandro
Gifford Computer
Systems
(415) 895-0798

San Rafael
Computer House
(415) 453-0865

Santa Barbara
Data Bank
(805) 962-8489

Santa Maria
Data Bank
(805) 922-1333

Santa Rosa
Matrix Computers
(707) 542-0571

Sunnyvale
Pragmatic Designs Inc.
(408) 736-8670

COLORADO

Lakewood
Rocky Mountain
Microsystems
(303) 232-4545

FLORIDA

Brandon/Tampa
Micro Computer
Technology
(813) 685-7659

Orlando
Data/Office
(305) 629-6776

Satellite Beach
Binary Magic, Inc.
(305) 777-7080

HAWAII

Kahului Maui
Capacity Plus
Computers
(808) 871-7984

ILLINOIS

Athens
Computers Plus
(217) 636-8491

La Grange Park
Small Business
Systems, Inc.
(312) 579-3311

Skokie
Lillipute Computer
Mart, Inc.
(312) 674-1383

INDIANA

Terre Haute
General Software, Inc.
(812) 234-9421

KANSAS

Ellinwood
Genesys Systems, Inc.
(316) 564-3636

MARYLAND

Bethesda
JR Systems
(301) 657-3598

MASSACHUSETTS

Boston
New England
Electronic Exch.
(617) 491-3000

Chestnut Hill
Key Micro Systems
(617) 738-7306

MISSISSIPPI

Pascagoula
Automated Accountants
(601) 769-2937

NEW YORK

Amherst
Gifford Computer
Systems
(716) 833-4758

Deer Park
Datapro Systems, Inc.
(516) 595-1311

New York
Park Plaza Computer
Center, Inc.
(212) 759-5820

**Park Plaza Computer
Center, Inc.**
(212) 505-8200

**Park Plaza Computer
Center, Inc.**
(212) 344-5151

**Park Plaza Computer
Center, Inc.**
(212) 595-5353

Staten Island
John D. Owens Assoc.
(212) 448-6283

NORTH CAROLINA

Greensboro
General Semantics
Computers
(919) 378-1500

OREGON

Portland
Microwest Computer
Products
(503) 238-6274

PENNSYLVANIA

Philadelphia
Information Network
Systems
(215) 364-8220

RHODE ISLAND

Coventry
Key Micro Systems
(401) 828-7270

TEXAS

Austin
CPA Systems, Inc.
(512) 458-9281

Informa, Inc.
(512) 459-4216

Omegax Systems
(512) 476-6069

Dallas
Dator Systems
(214) 521-0915

Ft. Worth
Dataworth Computer
Systems
(817) 877-4041

Houston

**Gifford Computer
Systems**
(713) 680-1944

Informa, Inc.
(713) 861-7612

Seguin
CPA Systems, Inc.
(512) 379-0660

VIRGINIA

Woodbridge
Office Networks Corp.
(703) 690-3312

WASHINGTON

Bellevue
North Ridge
Computer Systems
(206) 453-0596

Seattle
American Computers &
Engineers
(206) 583-0130

WISCONSIN

Greenfield
Byte Shop
of Milwaukee
(414) 281-7004

Madison
Beam International
(608) 255-2325

AUSTRALIA

Bankstown
Automation Statham
Pty., Ltd.
(02) 709-4144

CANADA

Coquitlam, B. C.
CSC System Center Ltd.
(604) 941-0622

Vancouver, B. C.
Dynacomp Business
Computers Ltd.
(604) 872-7737

THE PHILIPPINES

Quezon City
Corona International Inc.
78-34-71

UNITED KINGDOM

Swansea
Comcen Technology Ltd.
(0792) 796000

CompuPro®

A GODBOUT COMPANY

3506 Breakwater Court, Hayward, CA 94545

Pro Bono Publico

The Public Domain Users Group provides free public-domain software to anyone for only the cost involved of formatting the disk to run on one of 17 possible computers. The library receives new disks frequently and currently houses 200 programs. Membership is \$10 a year. For information, contact Public Domain Users Group, POB 1442, Orange Park, FL 32067-1442.

Morrow Users Convene in DC

The Morrow User Group of Washington, DC, meets at 7:30 p.m. on the second Tuesday of the month in the Washington metropolitan area. Users of the Morrow Designs Micro Decision line who become members can benefit from a discussion of problems, distribution of public-domain software, instructional courses, a monthly newsletter, and group-purchase discounts. A computerized bulletin-board service is planned. Annual dues are \$25. For details, contact the Morrow User Group of Washington, DC, POB 832, Arlington, VA 22216, (301) 277-3760.

Tips on Investments

The Microcomputer Investors Association (MCIA), a professional, nonprofit association, is part of an information network that uses microcomputers to make and manage investments. A journal, *The Microcomputer Investor*, which is produced twice a year, contains articles and programs. For an information packet, send \$5 to Dr. Jack Williams, MCIA, 902 Anderson Dr., Fredericksburg, VA 22405.

Curious About Robots?

The Colorado Parents of Robots, a robot users group in the early stages of development, meets at 7:30 p.m. on the third Thursday of each month in Denver, Colorado. There are no dues. All interested persons are encouraged to contact P. J. Scardino for details at the Colorado Parents of Robots, 12351 West 64th St., Arvada, CO 80004, (303) 421-6361.

Computer Club in South Africa

The Cape Computer Club in Cape Town, South Africa, meets on the first Thursday of each month at the Athenaeum in Newlands and welcomes new members, user group information, and newsletters from groups around the world. Directed toward the hobbyist, the club supports at least seven special-interest groups for various computers. The *Cape Computer Club Print Out* or *C3P0* is produced each month and is free to members. It contains a fleamarket, letters, and articles. The club sponsors classes prior to meetings, maintains a library, and provides purchase discounts. The annual subscription is R15; R8 for students and country members. For further information, contact the Cape Computer Club, POB 6251, Roggebaai 8012, South Africa.

Yavapai County CP/M Users Unite

The Yavapai County CP/M Users Group serves users of Osborne, Kaypro, IMSAI, and Commodore 64 computers. The club meets monthly in Prescott, Ari-

zona, and maintains a disk library of public-domain programs. For details, contact Julie Woodman, POB 68, Kirkland, AZ 86332.

A Clearinghouse for 9000 Fellow Users

The Inter-Galactic Victor/Sirius Users Group of Scottsdale, Arizona, produces *Problem Solvers Unanimous (PSU)*, a newsletter that is designed to educate subscribers both in the U.S. and abroad who use or sell the Victor 9000. *PSU* keeps track of a dozen Victor users groups and almost ten Victor publications. All Victor users are invited to participate. Members receive software discounts. A 12-month subscription is \$36. For details, contact Joe and Ann Reid, *PSU Newsletter*, POB 3244, Scottsdale, AZ 85257, (602) 946-5948.

PC Active in the Rockies

The PC Users Group of Colorado, formerly called the Denver Users Group, meets at 7 p.m. on the last Thursday of every month in the Capital Federal Savings Building in Boulder. A subscription to the newsletter, *Pcock*, is included in the \$12 annual membership fee. For further details, contact Howard Weissman, PC Users Group of Colorado, POB 944, Boulder, CO 80306, (303) 443-5528 evenings.

CP/Morrow in Sacramento

The CP/Morrow Computer Group meets on the first Thursday of each month in Sacramento, California. It welcomes correspondence with other CP/M-oriented

groups. A \$12 annual membership includes a subscription to the monthly newsletter. For further information, contact the CP/Morrow Computer Group, POB 654, Carmichael, CA 95608.

Apple Users Meet in Ontario

The Apple Users Group, affiliated with Microcomputer Users International, serves Apple users in Michigan and the Sault Ste. Marie area of Canada. Production of a monthly newsletter is planned. For meeting times and locations, contact Bert Williams, 47 Tuckett St., Sault Ste. Marie, Ontario P6A 4G8, Canada, (705) 254-1459.

Bowling Green Hosts Computerists

The Bowling Green Commodore Users Group serves users of the Commodore 64 in the vicinity of Bowling Green, Kentucky. The club welcomes any new members from the surrounding areas. For further details, contact Alex Fitzpatrick, Creekside Apt. #6, Route 11, Bowling Green, KY 42101, (502) 781-9098.

Ecumenical Computer Exchange Formed

A computer-exchange association has been formed to aid member churches in the acquisition of computers and word-processing equipment at the lowest possible costs. Churches of all denominations are welcome to participate in this endeavor sponsored by the Unitarian Universalist Churches of central Ohio. For information, send a self-addressed, stamped envelope to the

★ THIS MONTH'S SPECIAL ★

| | | | |
|------------------------------|-------|-------------------------|-------|
| BRODERBUND AE (II) | \$24 | CONCURRENT CP/M 86(PC) | \$219 |
| DATASOFT ZAXXON (II) | \$25 | AMDEK | |
| MICROLAB MINER2049 ER (II) | \$28 | MAI GRAPHICS BOARD (PC) | \$499 |
| MICROPRO INFOSTAR (II) | \$249 | QUADRAM QUADLINK (PC) | \$479 |
| PERFECT SOFTWARE (II/PC) | CALL | LPS II LIGHT PEN (II) | \$259 |
| DIGITAL RESEARCH CP/M 86(PC) | \$39 | | |

★ SYSTEMS ★

| COLUMBIA MPC | NEC | | |
|--------------|------|----------------------|--------|
| 1600-1 | CALL | 8201A Portable (16K) | 669.00 |
| 1600-4 | CALL | 8K Ram Chip | 99.00 |
| 1600-VP/G | CALL | 32K Ram Cartridge | 349.00 |
| 1600-VP/A | CALL | Cassette Recorder | 99.00 |
| | | Thermal Printer | 149.00 |

| | |
|--|-------------------------------------|
| APPLE SOFTWARE | |
| ALPHA SOFTWARE | QUALITY Bag of Tricks 27 |
| Apple-IBM Connection 199 | SCARBOROUGH MasterType (Ile) 29 |
| AST VersaForm 255 | Picturewriter 29 |
| Obase 139 | Snowpaw 29 |
| ML/CJ/IE @ 33 | SENSIBLE Speller IV 83 |
| ARTSCI Magic Window II 99 | SIERRA ON-LINE 85 |
| Magic Mailer 49 | Screenwriter II 69 |
| Magic Words 49 | Dictionary 135 |
| Magic Calc 99 | Screenwriter Pro. 69 |
| Magic Memory 79 | General Manager 155 |
| Magic Pack (Window/Mailer/Words) 149 | Frogger 25 |
| ASHTON-TATE dBase II 385 | Ultima II 39 |
| Bottomline Strategist 279 | Homeward 39 |
| Financial Planner 419 | SILICON VALLEY 39 |
| Friday 199 | Word Handler 39 |
| BEAGLE BROTHERS 29 | List Handler 36 |
| Alpha plot 29 | Speller Handler 49 |
| Dos Boss 22 | SIRIUS Type Attack 28 |
| GPLE 39 | Pascal Graphics Editor 75 |
| BLUE CHIP Millionaire 385 | SOFTWARE ARTS (Ile Only) 29 |
| BPI GL/AP/AR/INV/PR @ 269 | TK Solver 89 |
| BRODERBUND Choptiler 40 | Financial Management 89 |
| Arcade Machine 40 | Intro. to Science 89 |
| Lode Runner 25 | Mechanical Engineering 89 |
| Bank SL Writer 47 | SOFTWARE PUBLISHING 26 |
| Bank SL Speller 305 | (Specify Ile+ or Iie) 84 |
| GL/AP 275 | pfs #e 79 |
| AR/PR 30 | pfs:Write (Ile Only) 84 |
| CENTRAL POINT Copy II- 15 | SORDIM Supercalc II 199 |
| File 160 | SOUTHWESTERN DATA 99 |
| CONTINENTAL GL/AP/AR/PR @ 49 | ASCII II Exp. Pro. up to 30% off |
| Home Accountant 49 | SPINNAKER 145 |
| FCM 69 | STONEWARE O.B. Master 229 |
| CBS SOFTWARE Full Line CALL | D.B. Master Ver. 4 229 |
| DATAMOST Full Line CALL | SUBLOG 35 |
| DATASOFT Full Line CALL | Flight Simulator 27 |
| DESIGNWARE Full Line CALL | Flight Simulator II 35 |
| DOW JONES Connector 45 | TERRAPIN Logo 99 |
| Market Analyzer 275 | WIDE 24 |
| Market Microscope 525 | Ultra Appewriter Preboot 56 |
| Market Manager 235 | Ultra Visicalc Preboot 24 |
| Investment Evaluator 129 | VISICORP Visicalc (II-) 169 |
| EDOUFIN Full Line CALL | Visicalc (Ile) 169 |
| EINSTEIN Memory Trainer 69 | Visicalc Advanced (Ile) 269 |
| The Einstein Compiler 99 | Other Products CALL |
| EPYX Full Line CALL | APPLE HARDWARE 29 |
| FDX & GELLER Quick Code 185 | ALS Smarter II 139 |
| dGraph 185 | CP/M Card 299 |
| dUtil 65 | Z-Card II 129 |
| Quick Screen 119 | AXLON Ramdisk 128K 749 |
| HAYDEN Pie Writer 99 | Ramdisk 320K 749 |
| Sargon III 34 | CHALKBOARD Power Pad 99 |
| Zork I/II/III @ 27 | CENTRAL POINT Wildcard 2 319 |
| INSOFT GrafOrth 56 | DANA Cooling Fan 319 |
| KENSINGTON Format II 119 | EPS Keyboard 29 |
| LEARNING COMPANY CALL | Prom @ 279 |
| LINK SYSTEMS 159 | GIBSON LABS Light Pen 29 |
| Datalax (40 Col.) 159 | HAYES PRODUCTS 36 |
| Datalax (80 Col.) 199 | Mach II Joystick (II-) 36 |
| LIVING VIDEOTEK 119 | Mach III Joystick (Ile) 42 |
| ThinkTank (II or Iie) 99 | Mach III Joystick (Ile) 49 |
| LJK Letter Perfect 79 | INDOS SYSTEMS 319 |
| Data Perfect 79 | 143K Drive w/control 269 |
| Edit 6502 79 | 143K Drive w/o control 65 |
| LOTUS Executive 149 | KENSINGTON System Saver 85 |
| Briefing System 79 | KOALA Graphic Tablet 49 |
| MEGANAUS Megawriter 79 | KRAFT Joystick 29 |
| Aspapel 79 | Paddles 39 |
| MICROLAB Datafactory 215 | MICRO SGI A2 Drive 79 |
| MICROPRO Full Line CALL | A2 Controller 79 |
| MICROSOFT Multiplan 169 | A40 Drive 299 |
| Budget System 109 | A40 Drive 299 |
| Financial Statement 69 | A4070 Controller 69 |
| Other Products CALL | MICROSOFT Ram Card 79 |
| MONOGRAM 69 | Sotcard 230 |
| Dollars & Sense 73 | Sotcard Plus 455 |
| MUSE Superext W/D 72 | Sotcard Premium 490 |
| Superext Pro. (Ile) 72 | Premium Sotcard Ile 389 |
| Castle Wolfenstein 22 | MICROTEK 169 |
| PEACHTREE CALL | Dumping-16 189 |
| PEARLSOFT 195 | Dumping-32 189 |
| Personal Pearl 49 | Dumping-64 219 |
| PENGIN 49 | Dumping-GX 159 |
| Complete Graphics System 49 | RV-611C Parallel Card 89 |
| Graphics/Magician 39 | SV-622 Serial Card 119 |
| Special Effects 29 | 80 Col/64K Card (Ile) 429 |
| PERFECT SOFTWARE CALL | O-Disk 128K 399 |
| PHOENIX Zoom Grafix 34 | Visipak 429 |
| | ORANGE MICRO 179 |
| | Buffer Grappier*16K 179 |

| | |
|---|---|
| PRACTICAL PERIPHERALS 29 | IBM SOFTWARE 29 |
| Microbuffer II- 16K 29 | ALPHA Data Base Manager II 195 |
| Microbuffer II- 64K 29 | AST Versaform 255 |
| [Specify par. or ser.] 29 | Templates PO/INV@ 38 |
| Other products 83 | ML/CJ/IE@ 33 |
| TENCAL Cool + Time 75 | ASHTON-TATE dBase II 385 |
| PD Paddles (II- or Iie) 29 | Bottomline Strategist 279 |
| Joystick (II-) 45 | Financial Planner 395 |
| Select A Port 45 | Friday I 198 |
| Track Ball (II- or Iie) 49 | ASK MICRO 295 |
| Joystick (Ile) 49 | GL/AP/AR/INV/PR/PO/SD @ 295 |
| TITAN Accelerator II 169 | BLUE CHIP Millionaire 385 |
| Ram Card 32K (II-) 399 | BPI GL/AP/AR/PR @ 395 |
| Ram Card 128K (II-) 169 | BRODERBUND Bank Street Writer 47 |
| TRANSEND/SSM AIO-2 99 | BRUCE & JAMES Word-Vision 39 |
| Par./Graphics Card 125 | BUSINESS SOLUTIONS Jack 2 399 |
| ASID Ser. Card 279 | CAXTON Cardbox 199 |
| VIDEX Ultraterm CALL | CBS Full Line CALL |
| Other Products 198 | CENTRAL POINT Copy II PC 30 |
| IBM SOFTWARE 29 | CHANG LABS Starter Kit 599 |
| ALPHA Data Base Manager II 195 | (Memo Pad/Graph Panel/File Plan) |
| AST Versaform 255 | COMPREHENSIVE 39 |
| Templates PO/INV@ 38 | PC Tutor 1.1 or 2.0 79 |
| ML/CJ/IE@ 33 | CONTINENTAL FCM 79 |
| ASHTON-TATE dBase II 385 | Home Accountant + 89 |
| Bottomline Strategist 279 | Property Management 329 |
| Financial Planner 395 | DATAMOST Write On 89 |
| Friday I 198 | R.E. Investment 49 |
| ASK MICRO 295 | DAVIDSON Speed Reader II 49 |
| GL/AP/AR/INV/PR/PO/SD @ 295 | DESIGNWARE Spellocopter 29 |
| BLUE CHIP Millionaire 385 | DIGITAL RESEARCH Full Line CALL |
| BPI GL/AP/AR/PR @ 395 | DOW JONES Connector 45 |
| BRODERBUND Bank Street Writer 47 | Market Analyzer 275 |
| BRUCE & JAMES Word-Vision 39 | Market Manager 235 |
| BUSINESS SOLUTIONS Jack 2 399 | Market Microscope 525 |
| CAXTON Cardbox 199 | Investment Evaluator 129 |
| CBS Full Line CALL | EINSTEIN Writer 95 |
| CENTRAL POINT Copy II PC 30 | Speller 55 |
| CHANG LABS Starter Kit 599 | Mailer 55 |
| (Memo Pad/Graph Panel/File Plan) | Amdisk V 5' DS/DD 499 |
| COMPREHENSIVE 39 | ART Six Pak Plus 64k-c/s/p 296 |
| PC Tutor 1.1 or 2.0 79 | Six Pak Plus 256k-c/s/p 495 |
| CONTINENTAL FCM 79 | Six Pak Plus 384k-c/s/p 595 |
| Home Accountant + 89 | Other Products 159 |
| Property Management 329 | CCS Super Vision Board 159 |
| DATAMOST Write On 89 | Super Vision Graphics 195 |
| R.E. Investment 49 | CHALKBOARD Power Pad 179 |
| DAVIDSON Speed Reader II 49 | COMPUTER ACCESSORIES 159 |
| DESIGNWARE Spellocopter 29 | P12 Power Director 179 |
| DIGITAL RESEARCH Full Line CALL | ENTER Sweet P Plotter 599 |
| DOW JONES Connector 45 | BPS Business Graphics 299 |
| Market Analyzer 275 | HAYES PRODUCTS 36 |
| Market Manager 235 | Mach II Joystick 39 |
| Market Microscope 525 | Mach III Joystick 39 |
| Investment Evaluator 129 | HERCULES Graphics Card 349 |
| EINSTEIN Writer 95 | KOALA Graphic Tablet 109 |
| Speller 55 | KRAFT Joystick 39 |
| Mailer 55 | N & R Sup'r Extender 499 |
| Amdisk V 5' DS/DD 499 | MICROSOFT Mouse 145 |
| ART Six Pak Plus 64k-c/s/p 296 | Ramcard 64k 249 |
| Six Pak Plus 256k-c/s/p 495 | Ramcard 256k 385 |
| Six Pak Plus 384k-c/s/p 595 | Systemcard 64k 275 |
| Other Products 159 | Systemcard 256k 435 |
| CCS Super Vision Board 159 | PERCOM DATA 279 |
| Super Vision Graphics 195 | S/S 2nd Drive 359 |
| CHALKBOARD Power Pad 179 | D/S 2nd Drive 359 |
| COMPUTER ACCESSORIES 159 | PERSYST Col/Gr Card 239 |
| P12 Power Director 179 | Monochrome Board 239 |
| ENTER Sweet P Plotter 599 | Multiunction Board 64k 349 |
| BPS Business Graphics 299 | QUADRAM Quadlink 485 |
| HAYES PRODUCTS 36 | Quadboard 64k 279 |
| Mach II Joystick 39 | Quadboard II 64k 285 |
| Mach III Joystick 39 | Quad 512 + 64k 265 |
| HERCULES Graphics Card 349 | Quad 512 + 256k 420 |
| KOALA Graphic Tablet 109 | |
| KRAFT Joystick 39 | |
| N & R Sup'r Extender 499 | |
| MICROSOFT Mouse 145 | |
| Ramcard 64k 249 | |
| Ramcard 256k 385 | |
| Systemcard 64k 275 | |
| Systemcard 256k 435 | |
| PERCOM DATA 279 | |
| S/S 2nd Drive 359 | |
| D/S 2nd Drive 359 | |
| PERSYST Col/Gr Card 239 | |
| Monochrome Board 239 | |
| Multiunction Board 64k 349 | |
| QUADRAM Quadlink 485 | |
| Quadboard 64k 279 | |
| Quadboard II 64k 285 | |
| Quad 512 + 64k 265 | |
| Quad 512 + 256k 420 | |

| | |
|---|--------------------------------------|
| MEGANAUS Megawriter 79 | Quad 512 + 512k 675 |
| Megaspell 79 | QuadColor II 225 |
| MICROLAB Data Factory 215 | QuadColor II 209 |
| Minor 2049 29 | RADIOSHOCK Drive 299 |
| TX Manager 399 | STB Graphix Plus 399 |
| MICRONIM R base 4000 329 | TECMAR 1st Mate 64k 296 |
| MICROSOFT Multiplan 169 | 70 Joystick w/Toggle 49 |
| Budget System 109 | Paddles 39 |
| Financial Statement 69 | Track Ball 49 |
| Word 275 | WESPER MICRO 249 |
| Word W/Mouse 35 | Memory Card 64k 69 |
| Flight Simulator 169 | WIDC Mouse 69 |
| Other Products 399 | Analog Joystick CALL |
| MONOGRAM Dollars & Sense 109 | Track Ball 59 |
| MUSE Superext Pro 73 | IBM Interface Card 99 |
| Punctuation & Style 119 | MODEMS & SOFTWARE 99 |
| PEACHTREE Peachtext 5000 235 | ANCHOR Mark I (RS-232) 75 |
| Peachpack (GL/AR/AP) 545 | Mark II (Atari) 79 |
| GL/AP/AR/PR/INV/SI @ 119 | Mark V (Osborne) 99 |
| BUSINESS Graphics 195 | Mark VI (PC) 199 |
| PEARLSOFT Personal Pearl 195 | Mark VII (RS-232) 119 |
| PETER SOFTWARE CALL | Mark XII (PC) 269 |
| PETER NORTON Utilities 59 | Volks Modem (RS-232) 59 |
| SATELLITE / SSI Word Perfect 319 | HAYES 239 |
| SOFTWARE ARTS TK Solver 269 | Microterminal Ile w/sc I 239 |
| SOFTWARE PUBLISHING 225 | Smartcom I (Ile/Iie) 89 |
| PFS File 94 | Smartmodem 1200 B w/sc II 439 |
| PFS Report 84 | Smartcom II (PC/DEC) 99 |
| PFS Graph 94 | Smartmodem 1200 (RS-232) 499 |
| PFS Write 94 | Smartmodem 300 RS-232 225 |
| SOFTWARE TECH Multisolver 325 | Chronograph (RS-232) 189 |
| SOFTWARE Multimite 299 | Microterminal 100 (S-100) 319 |
| SORDIM Supercalc 149 | MICROCOM 59 |
| Supercalc II 195 | Microterminal (I) 59 |
| Supercalc III 265 | Microterminal (PC) 65 |
| Super Spelguard 149 | NOVATION Apple Cat II 269 |
| SPINNAKER Full Line CALL | 212 Apple Cat II 559 |
| STONEWARE O.B. Master Adv. 395 | 212 Apple Cat II Upgrade 319 |
| STRATEGIC SOFTWARE 195 | Access 123 w/Crosstalk (PC) 419 |
| Bottomline V/Lotus 123 195 | CAT (RS-232) 159 |
| Bottomline V/Multiplan 195 | O-CAT (RS-232) 102 |
| Bottomline V/Supercalc 195 | J-CART (RS-232) 199 |
| Bottomline V/Visicalc 400 | SMARTCAT 103 (RS-232) 199 |
| SUBLOG Pinball 29 | SMARTCAT 103/212 (RS-232) 569 |
| SUPERSOFT Personal DB 90 | 212 AUTO CAT (RS-232) 849 |
| VISICORP Stretchcalc 179 | Executive Infone 999 |
| Visicalc IV w/C-dex 79 | PROMTECHUS 395 |
| Visidow 269 | Promodem 1200 395 |
| Other Products CALL | TRANSEND/SSM 69 |
| YARDI SYSTEMS 295 | Transend I (II) 69 |
| Property Management 295 | Modem card w/Source (II) 259 |

| | |
|---------------------------------------|----------------------------------|
| IBM HARDWARE 519 | MONITORS 135 |
| AMDEK MAI board 499 | AMDEK Video 300 Green 149 |
| Amdisk III 3' Dual Drive 499 | Video 300A Amber 149 |
| Amdisk V 5' DS/DD 499 | Other Products CALL |
| ART Six Pak Plus 64k-c/s/p 296 | NEC JB 1201 Green 159 |
| Six Pak Plus 256k-c/s/p 495 | JC1215 Color 299 |
| Six Pak Plus 384k-c/s/p 595 | Other products CALL |
| Other Products 159 | PSS HX-12 499 |
| CCS Super Vision Board 159 | QUADRAM CALL |
| Super Vision Graphics 195 | TAXAN 12' Green HI 145 |
| CHALKBOARD Power Pad 179 | 12' Amber HI 149 |
| COMPUTER ACCESSORIES 159 | 210 Color LO 299 |
| P12 Power Director 179 | RGB Vision 1 LO 319 |
| ENTER Sweet P Plotter 599 | RGB Vision 3 HI 499 |
| BPS Business Graphics 299 | 420 12' RGB HI (PC) 599 |
| HAYES PRODUCTS 36 | KX-121 12' Green (PC) 169 |
| Mach II Joystick 39 | KX-122 12' Amber (PC) 179 |
| Mach III Joystick 39 | Tilt/Swivel Base w/clock 49 |
| HERCULES Graphics Card 349 | PRINTERS 49 |
| KOALA Graphic Tablet 109 | EPSON FX 80/100 CALL |
| KRAFT Joystick 39 | OKIDATA Full Line CALL |
| N & R Sup'r Extender 499 | BROTHER HR-15P 549 |
| MICROSOFT Mouse 145 | DRESSLHAUS 49 |
| Ramcard 64k 249 | Fingerprint (Spec. Printer) |
| Ramcard 256k 385 | |
| Systemcard 64k 275 | DISKETTES 32 |
| Systemcard 256k 435 | DYSAN 5 1/4" SS/SD 37 |
| PERCOM DATA 279 | 5 1/4" SS/DD 43 |
| S/S 2nd Drive 359 | Plastic 800d 150 |
| D/S 2nd Drive 359 | 3M, IBM, MAXELL CALL |
| PERSYST Col/Gr Card 239 | TK, VERBATIM, BULK CALL |
| Monochrome Board 239 | |
| Multiunction Board 64k 349 | |
| QUADRAM Quadlink 485 | |
| Quadboard 64k 279 | |
| Quadboard II 64k 285 | |
| Quad 512 + 64k 265 | |
| Quad 512 + 256k 420 | |

TERMS: Add 3% for shipping & handling (UPS Ground). Blue Label & Next Day Air can be arranged. Add 6% tax for California residents. Add 2% for Visa/MC purchases. Allow 2 weeks for personal and company checks to clear. All sales final. Defective hardware must be returned within 10 days of receiving date and accompanied by RMA# for exchange only. \$2.00 charge for C.O.D.'s, Cashier's Check only. Prices subject to change without notice. Apple is the Registered Trademark of Apple Computer, Inc., IBM is the Registered Trademark of International Business Machines, Corp.

NATIONAL : 800-821-4381
CALIFORNIA : 800-421-3245



★ **FREE GIFT WITH ORDER** ★



INFORMATION: 805-683-1779
805-683-3006
ORDER HOURS: M-F 8-6 PST
SAT 10-5 PST
STORE HOURS: M-F 9-6 PST
SAT 10-5 PST

Address: 5788 Dawson St., Goleta, CA 93117.

Peripheral Networking Now



Buy ASCII Intelligent Port Expanders

- Eliminate Manual Switching by Remote Control
- Improve Productivity and Reliability
- Share Printers, Modems or Plotters
- Expand Computers or Terminals
- Use Matrix Switching for Multiple Transmission or Security
- Supports Polling and Queing

INSTANT COMPATIBILITY with new computer devices and MAJOR OEM PRODUCTS:

Altos — Burroughs — Data General — DEC
H.P. — IBM — NCR — Northstar — Victor
and other key manufacturers.

Call 213-793-8979 to EXPAND YOUR SYSTEMS TODAY.



Advanced Systems Concepts Inc.
435 N. Lake Ave., Dept. B4
Pasadena, CA 91101
800-824-7080 Telex: 701 215

SUPPLIES FORMS & STATIONERY

for Apple, IBM PC, TRS-80 & other Desk-Top Computers

- Continuous checks, statements, or Invoices ... 500 for \$49.95 or less.
- Compatible with 350 software publishers.
- Diskettes, printer ribbons, Micro-perf™ letterheads, labels, work station aids.
- High quality, low prices, small quantities.
- Money-Back Guarantee.
- Next day shipment of supplies ordered by TOLL FREE phone.
- Send today for your FREE CATALOG

Call today for your FREE CATALOG

Phone TOLL FREE 1 + 800-325-1117

(MA, 1 + 800-448-4688).

G7A 84.3



A Division of
New England
Business
Service, Inc.

CODE 11009

Nebs Computer Forms

12 South Street, Townsend, Massachusetts 01469

Clubs and Newsletters

Unitarian Universalist Computer Exchange, c/o D. P. Lantz, 1373 Howell Dr., Newark, OH 43055.

Cottage Industry Revisited

Cottage Computing, a monthly publication from Home Business News, contains articles and items of interest for anyone planning to make his or her computer pay for itself. Educational and household-computing articles are included with news of events, business ideas, bulletin-board listings, and reviews of hardware, software, and books. Advertisement rates are available upon request. Issues are \$1 each or \$12 for one year. For details, contact *Cottage Computing*, Home Business News, 12221 Beaver Pike, Jackson, OH 45640.

New Age Homebrew

The Homebrew Robots of San Francisco, California, is a forum where robot builders and experimenters can exchange ideas, experience, skills, and equipment. For details, contact Bob Platt, Homebrew Robots of San Francisco, Heald College, Technical Division, 150 4th St., San Francisco, CA 94103.

Epson Users Cooperate

The Epson QX-10 Users Group of Lemont, Pennsylvania, produces a newsletter, offers a cooperative plan for member discounts, and distributes public-domain programs. Advertisements are free for members. Annual dues are \$20, a family membership is \$25, and student memberships are \$15. For details, contact Epson QX-10 Users Group, Box 1076, Lemont, PA 16851.

Notes from a Bug

To promote information interchange and an understanding of the IBM Personal Computer and compatible computers, the CDP Baltimore Users Group (BUG) meets regularly and welcomes all interested parties. Users of Columbia Data Products (CDP) MPC and VP are welcome. A newsletter, the *Bugletter*, is produced. For details, contact the CDP Baltimore Users Group, POB 223, Owings Mills, MD 21117.

Trading Post for Computers or Disks

Trade-a-comp/Trade-a-disk is a monthly newsletter for those wanting to buy, sell, or trade new and used computer hardware and software. The readership includes first-time home-computer or business users and employers seeking specialists and vice versa. An ad must contain a minimum of 20 words; each word costs \$0.15 per issue. A subscription is \$18 for one year or \$10 for six months. For information, contact *Trade-a-comp/Trade-a-disk*, POB 671, Bethel Park, PA 15102.

Ample Apple Groups in Schools

The Apple Computer Clubs, an organization designed to bring together elementary and secondary school students who want to share their experiences in computing, expects to assist over 10,000 schools in starting Apple Computer Clubs. The club issues a kit of materials that contains information about how to start a club, maintains a library of resources for club members, produces publications, posters, manuals, a bimonthly newsletter, and other supplementary materials. For fur-

NO SURCHARGE FOR MASTER CARD AND VISA

PREPAID PRICES INCLUDE SHIPPING AND INSURANCE, UPS Ground Continental USA only.

MONITORS

| | |
|-----------------------------------|-----|
| Amdek | |
| 300A | 143 |
| 300C | 133 |
| 310A | 175 |
| Dynax | |
| 12" Green | 127 |
| 12" Amber | 138 |
| Taxan | |
| RGB III | 446 |
| RGB 420 | 534 |
| PGS | |
| PGS HX12 | 485 |
| MAX 12 | 196 |
| Sony | |
| KX-1211HG-Profeel, the best | 725 |
| USI | |
| Pi 2 12" Green | 125 |
| Pi 3 12" Amber | 142 |
| Sanyo | |
| 8112 Hi/Res | 195 |
| NEC | |
| JB 1201 | 162 |
| JB 1205A | 172 |
| JC 1410 | 817 |

MODEMS

| | |
|-------------------------------------|-----|
| Hayes | |
| 300 | 207 |
| 1200 | 493 |
| 1200B | 432 |
| Micromodem IIe W/T | 242 |
| US Robotics | |
| Password | 340 |
| Autodial 212A | 460 |
| Novation | |
| Access 1,2,3 | 473 |
| Apple Cat II | 277 |
| Prometheus Products | |
| Promodem 1200 | 385 |
| Options Processor | 78 |
| Memory \$30 per 16K up to 64K | 64K |
| Alphanumeric Display | 78 |
| Procom Software-Apple, IBM | 78 |
| Rixon | |
| PC212A | 415 |
| P212A | 415 |

IBM ACCESSORIES

| | |
|--------------------------------|------|
| Ast Research | |
| 6-Pack 64K | 269 |
| Combo Plus 64K | 269 |
| Mega Plus | 269 |
| 64 K Ram Set | 55 |
| Micro Graphics | |
| RGB, Monochrome, Printer | 398 |
| Plantronics | |
| Color Plus | 375 |
| Hercules Computer | |
| Hercules Graphics Card | 370 |
| Amdek | |
| MAI | 477 |
| Koala | |
| Koala Graphic Tablet | Call |

PRINTERS

| | |
|--|------|
| C. Itoh | |
| Prowriter 8510P 120 cps | 353 |
| Prowriter 8510SP 180 cps | 495 |
| Prowriter 8510SPC 180 cps color | 589 |
| Prowriter 1550P 120 cps | 581 |
| Prowriter 1550SP 180 cps | Call |
| Prowriter 1550SPC 180 cps color | Call |
| New CX4800 plotter | 610 |
| New A10 25 cps Daisy Wheel | 549 |
| Starwriter F10 40 cps Daisy Wheel | 997 |
| Printmaster F10 55 cps Daisy Wheel | 1323 |
| We Know How to Make Your Prowriter IBM Compatible | |
| Okidata | |
| 92p | 433 |
| 93p | 705 |
| IBM Printer Rom | 45 |
| 2350 | 2000 |
| 2410 | 2380 |
| Star Micronics | |
| Gemini 10X 120 cps | 285 |
| Gemini 15X 120 cps | 423 |
| Delta 10 160 cps | 448 |
| Delta 15 160 cps | 633 |
| NEC | |
| 3550 40 cps | 1767 |
| 7710 55 cps | 1963 |
| Brother | |
| HRI 16 cps | 569 |
| HR25 23 cps | 765 |
| Dynax | |
| DX15 14 cps | 453 |
| Keyboard | 149 |
| IDS | |
| Prism 132 color | 1535 |
| Prism 80 color | 1419 |
| Transtar | |
| 315 color | 450 |
| Silver Reed | |
| 550 | 595 |
| 500 | 431 |
| Juki | |
| 6100 18 cps | 487 |
| Teletex | |
| 1014 12 cps | 455 |
| Mansman Tally | |
| Spirit 80 cps | 315 |
| 160 160 cps | 641 |

DISK DRIVES

| | |
|------------------------------------|-----|
| For IBM | |
| Tandon TM100-2 | 238 |
| Teac 55B 1/2 Height | 210 |
| Panasonic/Shugart 1/2 Height | 205 |
| CDC | 215 |
| For Apple | |
| Super 5 1/2 Height | 203 |
| Quentin Ap 100-Y | 242 |
| Quentin Ap 105-Y 1/2 Height | 213 |
| Quentin Controller | 48 |
| Rana 1 | 255 |
| Rana 1 with Controller | 325 |

HAVE IT YOUR WAY

18 Slot Chassis
125 Watt Power
and
IBM Compatible CPU



IMP SYSTEM — \$1,300

The S-100 Concept for IBM Compatible Systems

You want a computer. You like the flexibility and options of the IBM PC. EXCEPT there are some things that you want your way. YOU:

- Don't like the funny keyboard.
- Want 1/2 height drives so you can add a hard disk later.
- Want a powerful supply that is adequate for disk expansion.
- Want more than three additional slots.
- Want a faster or different CPU.
- Want higher resolution graphics.
- Want Dvorak or other keyboard layout.

| | List | Our |
|--|------|------|
| TIME SPECTRUM | 395 | Call |
| APSTEK | 369 | Call |
| CRAMBO | 359 | Call |
| BIG BLUE | 600 | Call |
| EASIBOARD + 15 functions | 350 | |
| Maynard Sandstar | 230 | |
| PC GT 80186 8MHz | 580 | Call |
| Scion | 1595 | |
| Halo-Intlgnt High Res Graphics | 150 | |
| PROTIUM | 1195 | |
| Keytronics Keyboard QWERTY | 169 | |
| Keytronics Keyboard DVORAK | 169 | |
| Keytronics Keyboard 5151 | 255 | |
| Lotus 1-2-3 users, you need this keyboard. | | |

COMPUTERS

| | |
|-------------------------|------|
| Franklin OMS 1200 | 1709 |
| Columbia 1600-1 | 2750 |
| TAVA PC | 1900 |
| Eagle I | 1650 |
| Eagle II | 2050 |
| Eagle III | 2270 |
| Eagle IV | 3500 |
| Eagle PC-2 | 2730 |
| Eagle 1620 | 3400 |
| Eagle 1630 | 5270 |
| Eagle 1640 | 6400 |

TERMINALS

| | |
|------------------|-----|
| Televideo | |
| 914 | 563 |
| 925 | 717 |
| 950 | 914 |
| Wyse | |
| 50 | 569 |
| Teletex | |
| 3000 | 494 |

SOFTWARE

| | |
|----------------------------------|-----|
| Ashton Tate | |
| dBase II | 389 |
| Friday | 184 |
| Software Arts | |
| TK Solver | 215 |
| Solver Pac | 88 |
| Seasoned Systems | |
| Sure Stroke Dvorak Tutor | 48 |
| Sorcim | |
| Super Calc III | 287 |
| Micro Pro | |
| Wordstar | 258 |
| Mail Merge | 131 |
| Spellstar | 131 |
| Pro Pack | 475 |
| MBSI | |
| Realworld GI | 533 |
| Realworld AR | 533 |
| ATI | |
| For Most Software Programs | 69 |
| Hayes | |
| Smart Com | 72 |
| Micro Stuff | |
| Crosstalk | 134 |
| Micro Rim | |
| RBase | 372 |
| S-100 | |
| Sierra Data Sciences | |
| SBC-100 Master | 750 |
| SBC-100S Slave | 650 |
| CPM | 110 |
| Turbo Dos Multi-user | 630 |

California Residents add 6.5% State Sales Tax

Shipping extra for outside USA, FPO and APO

Please include an address reachable by UPS, no P.O. boxes, and your phone number where you can be reached during the day.

(213) 344-4455

Circle 211 on inquiry card.

ORDERING TERMS

Prepaid: Money Orders, Cashier's Checks, Certified Checks, Bank Wire Transfers, Master Card, Visa, AMEX (add 3% for AMEX) and Personal Checks (allow 15 banking days for all personal checks). Please include Valid Driver's License # and Major Credit Card for Identification.

Knowledge Systems Inc.
19707 Ventura Blvd.
Woodland Hills, CA 91364

ther information, contact The Apple Computer Clubs, POB 948, Lowell, MA 01853, (617) 459-7181.

For Teachers and Students of Math

The Oklahoma Educational Computer Users Program (OECUP) invites teachers of computer-related mathematics and mathematically gifted students to classes and conferences sponsored by the University of Oklahoma. OECUP membership is open to schools and educators in Oklahoma as well as from neighboring states. Free disks of public-domain software for the TRS-80 and Apple computers are distributed to members. The group also announces grants, contest opportunities, magazines, and invitations to participate in computer-related events. The University of Oklahoma's 50-microcomputer laboratory is open for use by secondary school teachers and students. The first-year membership is \$35, which includes a year's subscription to the journal of the International Council for Computers in Education, *The Computing Teacher*. Thereafter the membership is \$25 annually. For further information, contact Dr. Richard V. Andree, Mathematics Department, 601 Elm St., University of Oklahoma, Norman, OK 73019.

Down In the Valley

The Delaware Valley DEC PC Users Group meets quarterly at Digital headquarters in Blue Bell, Pennsylvania. It produces a newsletter that is distributed one month before the meetings. Annual dues are \$10. For further details, contact Tom Deahl, 815 Carpenter Lane, Philadelphia, PA 19119, (215) 848-4545.

New Horizons for Timex/Sinclair

T-S Horizons, affiliated with the Portsmouth, Ohio, Area Timex/Sinclair User Group, contains programming articles, hardware modifications, business- and home-finance modifications, and numerical or statistical analyses for the Timex/Sinclair 1000, 1500, and 2068. For further details, contact Rick Duncan, *T-S Horizons*, 2002 Summit St., Portsmouth, OH 45662, (614) 354-2563.

PCs and the Law

The Lawyer's PC is a twice-monthly newsletter for lawyers who use the IBM PC or compatible brands in their practices. It offers guidelines on applying computers to the law office. Another publication in the same genre is produced for users of TRS-80s,

The Lawyer's Microcomputer (see December 1982, page 505). An annual subscription for either publication is \$58 in the U.S., \$70 in Canada and Mexico, and \$94 overseas. For details, contact R.P.W. Publishing Corp., POB 1046, Lexington, SC 29072, (803) 359-9941.

Keep Up with PACE

The Pittsburgh Atari Computer Enthusiasts (PACE) meet at 7 p.m. on the second Thursday of every month in the Marriott Green Tree in Pittsburgh, Pennsylvania. The monthly newsletter, *Keeping PACE*, contains software reviews, news updates, and a

list of the programs maintained in the disk library. Annual membership is \$20, which includes the newsletter. For information, contact W. H. Cleis, PACE, 60 Clover Dr. Apt. 30, Pittsburgh, PA 15236.

Talk with Victor

Users, sellers, potential owners, and distributors of the Victor 9000 and related products are welcome to receive the monthly newsletter of the Victor Group, *Victor Talk*. The \$30 annual membership fee can be sent to *Victor Talk*, 1850 Union St. #498, San Francisco, CA 94123. ■

If you would like BYTE readers to know about your club or newsletter send the details accompanied by no more than one newsletter to Clubs and Newsletters, BYTE Publications, POB 372, Hancock, NH 03449. Overseas groups are encouraged to participate. Please allow at least three months for your announcement to appear.

BYTE's Bugs

Missing Bracket Mars Program

A missing bracket in David Clark's source code of Lmodem.c results in a "While Missing" error statement. (See "Lmodem: A Small Remote-Communication Program," November 1983, page 410.)

Between the end of the listing on page 418 and its resumption on page 420, a closing curly bracket should be added. The bracket is required to close the compound statement that started with the conditional statement

if (firstchar == SOH). ■

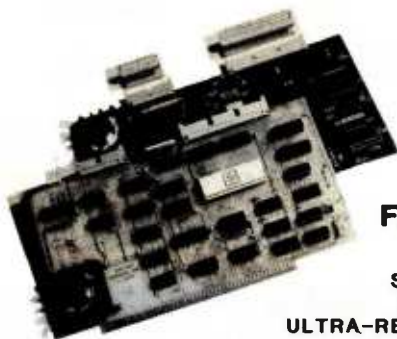

ULTRA-RES™ GRAPHICS

IEEE-696 S-100

- 1 X 512 X 512 \$495
- 3 X 512 X 512 \$1250
- 1 X 1024 X 1024 \$995

IBM-PC

- 1 X 512 X 512 \$495
- 1 X 1024 X 1024 \$995
- CONSOLE EMULATOR \$50
- PLOT 10 \$150

FEATURES

Starting Prices

Software drivers, Hardware zoom, Programmable Display Resolution, Windowing, Multi-Controller Capability, NEC UPD7220 Graphic Controller

ULTRA-RES Trademark CSD Inc.
IBM-PC Trademark IBM

C.S.D. Incorporated
P.O. BOX 253 Sudbury, MA 01776
(617) 443-2750

COMPLETE YOUR CP/M LIBRARY

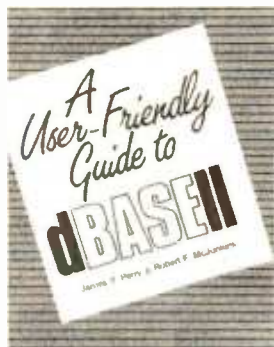

A USER FRIENDLY GUIDE TO dBASE II™

James T. Perry/Robert F. McJunkins

The first easy-to-understand yet rigorous treatment of dBASE II in book form will prove valuable to those who want to get into data base management from the ground floor.

Providing numerous examples and figures to make learning easy, Perry and McJunkins present an overview of the terminologies, conventions and capabilities of dBASE II, plus the steps needed to install it in your system.

You'll learn the dBASE II operational commands, methods of altering the contents of your data base and then you'll move on to advanced operations like SORTing, COPYing and MODIFYing data. You can even create your own dBASE II commands.

ISBN: 0-8359-8119-3



THE COMPLEAT APPLE® CP/M®

Steven Frankel

Now that a growing number of Apples are out-fitted for CP/M operation, users can take advantage of the more sophisticated spread sheet, word processing and other business oriented software on the market. To learn effective operation of the Apple with CP/M, read this book!
ISBN: 0-8359-0800-3

THE COMPLEAT KAYPRO®: KAYPRO II, KAYPRO IV, KAYPRO 10

Steven Frankel

The beginning Kaypro user gets a thorough understanding of this CP/M based computer system and learns to use its BASIC and utility programs not only for word processing but for the whole gamut of available business software packages. Over 45 programs on the market are reviewed. Another 34 programs are available on disk (see THE COMPLEAT KAYPRO for details).
ISBN: 0-8359-0802

For more information:

RESTON COMPUTER GROUP

Reston Publishing Company, Inc.

A Prentice-Hall Company

11480 Sunset Hills Road

Reston, Virginia 22090

(800) 336-0338



A PROGRAMMER'S NOTEBOOK:

Utilities for CP/M-80®

David E. Cortesi

A programming craftsman guides you through the total development of 12 functional programs for the CP/M-80 operating system.

Cortesi clearly spells out what needs each program answers and how it functions. He then develops the logic specifications and codes the entire program (in 8080 Assembly Language).

You'll pick up more than 50 useful subroutines designed for engineering and business applications without investing in costly software enhancements and you'll sharpen your systemic programming skills by following a professional at work.

ISBN: 0-8359-5641-5

CP/M® for the KAYPRO® with and introduction to dBASE II™

James T. Perry/Robert F. McJunkins

Introduces newcomers to the CP/M system and shows seasoned users the advanced capabilities of Kaypro computers.

Managing data becomes less intimidating as you become familiar with the commands and utilities available. You'll find examples of actual CP/M sessions, know what to expect when commands are executed and you'll stop off at convenient points to try your hand at the keyboard. Careful! Error situations are even built in so that you will learn how to avoid mistakes.

If you own or are considering the purchase of dBASE II (the widely-used data base management system), Perry and McJunkins also give you a complete overview of dBASE II and the commands and routines you need to use it effectively.

ISBN: 0-8359-1100-4



Books Received

Advanced Microprocessors, Amar Gupta and Hoo-min Toong, eds. New York: John Wiley and Sons, 1983; 368 pages, 22.3 by 28.8 cm, hardcover, ISBN 0-471-88176-7, \$41.50.

The Amazing Race, William H. Davidson. New York: John Wiley & Sons, 1984; 288 pages, 15.8 by 23 cm, hardcover, ISBN 0-471-88711-0; \$17.95.

Animation, Games, and Sound for the IBM PC, Tony Fabbri. Englewood Cliffs, NJ: Prentice-Hall, 1983; 208 pages, 17.5 by 23.5 cm, softcover, ISBN 0-13-037689-2, \$16.95.

Apple II BASIC, David C. Goodfellow. Blue Ridge Summit, PA: Tab Books, 1983; 240 pages, 19.8 by 23.3 cm, softcover, ISBN 0-8306-1513-X, \$13.50.

The Apple II Circuit Description, Winston D. Gayler. Indianapolis, IN: Howard W. Sams & Co., 1983; 264 pages, 21.3 by 28 cm, spiral-bound, ISBN 0-672-21959-X, \$22.95.

Applesoft Language, 2nd ed. Brian D. Blackwood and George H. Blackwood. Indianapolis, IN: Howard W. Sams & Co., 1983; 280 pages, 15.3 by 23 cm, spiral-bound, ISBN 0-672-22073-3, \$13.95.

The Art of Problem Posing, Stephen I. Brown and Marion I. Walter. Philadelphia, PA: The Franklin Institute Press, 1983; 160 pages, 15 by 22.8 cm, softcover, ISBN 0-89168-052-7, \$11.95.

Artificial Intelligence, A. M. Andrew. Philadelphia, PA: Heyden & Son Inc., 1983; 216 pages, 16 by 24.3 cm, hardcover, ISBN 0-85626-165-3, \$33.

Better BASIC for the Apple, J. N. P. Hume and R. C. Holt. Reston, VA: Reston Publishing Co., 1983; 304 pages, 17.3 by 23.3 cm, softcover, ISBN 0-8359-0466-0 \$14.95.

BASIC Fun, Susan Drake Lipscomb and Margaret Ann

Zuanich. New York: Avon Books, 1982; 176 pages, 13 by 19 cm, softcover, ISBN 0-380-80606-1, \$2.25.

BASIC by Design, Andrew Kitchen. Englewood Cliffs, NJ: Prentice-Hall, 1983; 512 pages, 17.5 by 23.3 cm, softcover, ISBN 0-13-060269-8, \$18.95.

BASIC for Microcomputers, Roger W. Haigh and Loren E. Radford. New York: Van Nostrand Reinhold, 1983; 350 pages, 19.5 by 24.5 cm, hardcover, ISBN 0-442-27843-8, \$22.45.

Basics of Timex/Sinclair 1000, ZX81 BASIC, Allen H. Wolach. Reston, VA: Reston Publishing Co., 1983; 208 pages, 15.5 by 23.5 cm, hardcover, ISBN 0-8359-0425-0, \$16.95.

The Big Trak Book, Tom Rowley and Ron Leckrone. Reston, VA: Reston Publishing Co., 1984; 128 pages, 21 by 28 cm, softcover, ISBN 0-8359-0478-4, \$12.95.

Bits, Bytes & Buzzwords, Mark Garetz. New York: New American Library, 1983; 160 pages, 10.5 by 17.8 cm, softcover, ISBN 0-451-12841-9, \$2.95.

Building Controls into Structured Systems, Alan E. Brill. New York: Yourdon Press, 1983; 168 pages, 15.3 by 22.8 cm, softcover, ISBN 0-917072-27-8, \$29.

CP/M Primer, 2nd ed. Stephen Murtha and Mitchell Waite. Indianapolis, IN: Howard W. Sams & Co., 1983; 156 pages, 18.5 by 23 cm, softcover, ISBN 0-672-22170-5, \$16.95.

Common Algorithms in Pascal with Programs for Reading, David V. Moffat. Englewood Cliffs, NJ: Prentice-Hall, 1984; 238 pages, 17.3 by 23.3 cm, softcover, ISBN 0-13-152637-5, \$8.95.

Computability, George J. Tourlakis. Reston, VA: Reston Publishing Co., 1984; 576 pages, 18 by 24.3 cm, hard-

cover, ISBN 0-8359-0876-4, \$27.95.

Computer Aided Design, Raphael Kaplinsky. New York: Macmillan Publishing Co., 1982; 144 pages, 16 by 23.5 cm, hardcover, ISBN 0-02-949520-2, \$22.95.

Computers for Everybody, Jerry Willis and Merl Miller. New York: New American Library, 1983; 272 pages, 10.5 by 17.8 cm, softcover, ISBN 0-451-12840-0, \$3.50.

Computer Literacy: The Basic Concepts and Language, John V. Lombardi. Bloomington, IN: Indiana University Press, 1983; 128 pages, 15.5 by 23.3 cm, softcover, ISBN 0-253-21075-5, \$5.95.

The Computer Tutor: Atari Home Computer Edition, Gary W. Orwig and William S. Hodges. Boston, MA: Little, Brown & Co., 1983; 368 pages, 21.5 by 28 cm, softcover, ISBN 0-316-66502-9, \$15.95.

Designing Structured Programs, David Higgins. Englewood Cliffs, NJ: Prentice-Hall, 1983; 256 pages, 17.5 by 23.5 cm, softcover, ISBN 0-13-201418-1, \$14.95.

Dictionary of Computing, Valerie Illingworth, Edward L. Glaser, and I. C. Pyle, eds. New York: Oxford University Press, 1983; 408 pages, 16 by 24.3 cm, hardcover, ISBN 0-19-853905-3, \$24.95.

The DIF File, Donald H. Beil. Reston, VA: Reston Publishing Co., 1983; 254 pages, 17.5 by 23.5 cm, softcover, ISBN 0-8359-1305-8, \$15.95.

Discrete Mathematics for Computer Scientists, Joe L. Mott, Abraham Kandel, and Theodore P. Baker. Reston, VA: Reston Publishing Co., 1983; 576 pages, 18.3 by 24.3 cm, hardcover, ISBN 0-8359-1372-4, \$27.95.

Discrete Mathematics: A Computational Approach Using BASIC, Marvin Marcus. Rockville, MD: Computer Science Press, 1983; 352

pages, 14.3 by 22.8 cm, spiral-bound, ISBN 0-914894-38-2, \$19.95.

Does Your Small Business Need A Computer?, Martha Eischen. Blue Ridge Summit, PA: TAB Books, 1982; 168 pages, 13 by 21 cm, softcover, ISBN 0-8306-0624-6, \$10.95.

8080/8085 Assembly Language Subroutines, Lance A. Leventhal and Winthrop Saville. Berkeley, CA: Osborne/McGraw-Hill, 1983; 496 pages, 18.5 by 23.5 cm, softcover, ISBN 0-931988-58-6, \$15.95.

Elementary Fortran with Scientific & Business Applications, Frank C. Lin. Reston, VA: Reston Publishing Co., 1983; 350 pages, 15.3 by 23 cm, softcover, ISBN 0-8359-1696-0, \$15.95.

Encyclopedia of Computer Science and Engineering, 2nd ed. Anthony Ralston, ed. New York: Van Nostrand Reinhold, 1983; 1700 pages, 20 by 24.3 cm, hardcover, ISBN 0-442-24496-7, \$87.50.

The Executive's Guide to the IBM Personal Computer, Alan J. Parker. Reston, VA: Reston Publishing Co., 1983; 304 pages, 21 by 25.5 cm, hardcover, ISBN 0-8359-1809-2, \$49.95. Includes two floppy disks.

Experiments with Integrated Circuits, Richard J. Higgins. Englewood Cliffs, NJ: Prentice-Hall, 1983; 240 pages, 21 by 28 cm, softcover, ISBN 0-13-295527-X, \$14.95.

Fundamentals of Programming Languages, 2nd ed. Ellis Horowitz. Rockville, MD: Computer Science Press, 1984; 464 pages, 15.8 by 23.8 cm, hardcover, ISBN 9-88175-004-2, \$26.95.

FORTAN 77, V. A. Dyck, J. D. Lawson, and J. A. Smith. Reston, VA: Reston Publishing Co., 1984; 720 pages, 18.5 by 24.3 cm, hardcover, ISBN 0-8359-3163-3, \$23.95.

Foundations of Software

COMPUShACK

PRICES AND AVAILABILITY SUBJECT TO CHANGE WITHOUT NOTICE
ALL RETURNED MERCHANDISE SUBJECT TO A 20% RESTOCKING FEE.

ADD 10% FOR NET TERMS

PRICES GOOD IN U.S. ONLY.

PRICES REFLECTED IN THIS

SECTION ARE LOWER THAN FRANCHISE STORES.

WE TEST EVERY COMPUTER SYSTEM BEFORE WE SHIP IT!



**PERSONAL
COMPUTER**

**Special
of the
Month!**

IBM PC® COMPLETE LINE

IBM PC

64K, Two 320KB Disk Drives, Floppy Disk Controller, Video Card and High Res Monitor **\$2599.00**

HARD DISK SYSTEM FOR IBM PC

256K IBM PC® 360KB Disk Drive, FDC, 10MB Hard Disk W/Controller, Cabinet Controller & Software, Video Card and Monitor **\$3999.00**

Hard Disk Sub-System for IBM PC By TAVA CORP. \$1275.00

LOTUS 1-2-3 SOFTWARE \$399



FLOPPY DISK DRIVES For IBM PC

ADD-ON DRIVE FOR PC Jr.® .. CALL

TANDON

TM-100-2 DS/DD **CALL**

SLIMLINE 320KB

BY TAVA CORP. \$199

PRINTERS

OKIDATA

82A **\$429.00**
83A **\$669.00**
84AP parallel **\$999.00**
84AS serial **\$1099.00**
92A **\$525.00**
93A **\$899.00**

Daisywriter Daisywheel

Printer **\$1099.00**

**NEC
SPINWRITER**

NEC



7710-1 **\$2095** 3510 **\$1495**
7715-1 **\$2295** 3515 **\$1495**
7730-1 **\$2095** 3530 **\$1695**
7720-1 **\$2695** 3550 **\$1995**
7725-1 **\$2695** PC8023A **\$ 595**

**COMPANY SHOWROOM
WALNUT CREEK, CA
(415) 945-8011**

SPECIAL OF THE MONTH!



Desk Top IBM PC® Compatible Computer, 128K RAM, Two 320KB Disk Drives, Floppy Disk Controller, Video Adapter and Monitor, One Parallel Port, Two Serial Ports. System runs DOS 1.1, 2.0, and CP/M86® **CALL FOR PRICE**

Suggested List \$2395.00

Low Price High Quality TAVA Personal Computer Uses The Industry Standard Operating Systems: CP/M86® MS DOS® UCSD p-system® One year warranty on all parts. Runs most of the Software for IBM PC, eg. Lotus 1-2-3® dBaseII® Words Star® Multiplan® PFS® and Thousands more



AST RESEARCH

IO Plus-Parallel & Serial Port, Clock Calendar W/Bat. back-up, Superdrive, Superspool **\$199.00**

Combo Plus—256K, Parallel & Serial Port, Clock Calendar W/Bat. back-up, Superdrive, Superspool **\$450.00**

Mega Plus—512K, Parallel & Serial Port, Clock Calendar W/Bat. back-up **\$999.00**

QUADRAM

Quad Board - 256K, Parallel Port, Serial I/O Clock Calendar with battery backup **\$450.00**

512K Ram with Serial I/O **\$799.00**

CONOGRAPHIC

Color Card **\$995.00**

HERCULES GRAPHICS CARD

This card gives you 720x350 graphics **\$499.00**

BIG BLUE \$479.00

MAYNARD SANDSTAR SERIES

Multifunction Card **\$95.00**

Floppy Disk Controller **\$225.00**

Memory Card **\$189.00**

HAYES MICROCOMPUTER PRODUCTS

Micromodem 300 baud **\$299.95**

Smartmodem 1200 baud **\$529.95**

**BROTHER, TAVA, NEC, TANDON,
SHUGART, TOSHIBA, AND OTHER
MFR. PRODUCTS AVAILABLE!!**

MONITORS

AMDEK

300A **\$199.00** I **\$349.00**
300G **\$169.00** II **\$699.00**
310A **\$199.00** III **\$399.00**
IV **\$1199.00**

PRINCETON GRAPHICS SYSTEMS

High Res. Color **\$499**



APPLE IIe

Computer System Controller, Two Disk Drives, Monitor **\$1699**

ROMAR II Apple compatible Computer W/Z-Card Controller, Two Disk Drives and a Monitor for **\$1195.00**

COMPUShACK

HIGH TECHNOLOGY • LOW PRICES

Circle 81 on inquiry card.

CALL FOR STORE LOCATION

**THE UNIQUE FRANCHISING
CONCEPT WITH THE
FOLLOWING FEATURES:**

**PRIVATE LABEL PRODUCTS
WITH NO ROYALTIES,
DISCOUNT PRICES, FULL
SERVICE & SUPPORT,
COURTESY AND MORE.**

**COMPANY SHOWROOM
TUSTIN, CA
(714) 730-7227**

(714) 261-1000

FRANCHISE INQUIRIES WELCOME

16861 ARMSTRONG, IRVINE, CA 92714

HEADQUARTERS/TELEX: 181667-ANSWER BACK: COMPSHACK IRN

*IBM PC is a registered trademark of IBM Corp
*dBASE II is a registered trademark of Ashton-Tate, Inc
*LOTUS 1-2-3 is a registered trademark of Lotus Development
*Wordstar, Spellstar, Mailmerge are registered trademarks of Micropro International
*Visicalc is a registered trademark of VisiCorp

PRODUCTS AND PRICES NOT AVAILABLE
AT ALL STORES

Multiplan is a registered trademark of Microsoft Corp
PFS is a registered trademark of Software Publishing Co.
CP/M86 is a registered trademark of Digital Research, Inc.
MS-DOS is a registered trademark of Microsoft Corp
UCSDp is a registered trademark of Softech Microsystems

ALL FLOPPIES REPAIRED QUICKLY AT LOW COST

Design, J. F. Leathrum. Reston, VA: Reston Publishing Co., 1983; 202 pages, 15.5 by 23.5 cm, hardcover, ISBN 0-8359-2094-1, \$24.95.

Genesis II, Creation and Recreation with Computers, Dale Peterson. Reston, VA: Reston Publishing Co., 1983; 224 pages, 21.5 by 27.8 cm, softcover, ISBN 0-8359-2433-5, \$15.95.

Getting Started with 8080, 8085, Z80, and 6800 Microprocessor Systems, James W. Coffron. Englewood Cliffs, NJ: Prentice-Hall, 1984; 352 pages, 17.8 by 23.5 cm, softcover, ISBN 0-13-354663-2, \$14.95.

A Guide for Selecting Computers and Software for Small Businesses, Paul G. Enockson. Reston, VA: Reston Publishing Co., 1983; 128 pages, 24 by 18 cm, hardcover, ISBN 0-8359-2642-7, \$19.95.

Handbook of Microcomputer-Based Instrumentation and Controls, John D. Lenk. Englewood Cliffs, NJ: Prentice-Hall, 1984; 320 pages, 15.5 by 23.7 cm, hardcover, ISBN 0-13-380519-0, \$24.95.

How to Maintain and Service Your Small Computer, John G. Stephenson and Bob Cahill. Indianapolis, IN: Howard W. Sams & Co., 1983; 210 pages, 21.3 by 28 cm, softcover, ISBN 0-672-22016-4, \$17.95.

How to Program Your IBM PC, Advanced BASIC Programming, Carl Shipman. Tucson, AZ: HP Books, 1983; 272 pages, 21.3 by 28 cm, 3-ring binder, ISBN 0-89586-264-6, \$14.95.

How to Select and Buy a Personal Computer, Ursula Connor. Old Greenwich, CT: Devin-Adair Publishers, 1983; 200 pages, 15 by 23 cm, softcover, ISBN 0-8159-5717-3, \$9.95.

How To Use The IBM Personal Computer, Steven Manus. Sherman Oaks, CA: Alfred Publishing Co., 1983; 64 pages, 10.8 by 28 cm, softcover, ISBN 0-88284-234-X, \$2.95.

IBM PC Conversion Handbook of BASIC, J. Mel Harris and Michael J. Scofield. Englewood Cliffs, NJ: Prentice-Hall, 1983; 176 pages, 14.5 by 23 cm, softcover, ISBN 0-13-448481-9, \$12.95.

The IBM PC Connection, Neil L. Shapiro. New York: Micro Text/McGraw-Hill, 1983; 208 pages, 15.3 by 23.8 cm, softcover, ISBN 0-07-056419-1, \$16.95.

IBM PC Expansion & Software Guide, 2nd ed. Que Corp. Indianapolis, IN: Que Corp., 1983; 584 pages, 21 by 28 cm, softcover, ISBN 0-88022-027-9, \$16.95.

Intelligent Systems, The Unprecedented Opportunity, J. E. Hayes and D. Michie, eds. New York: John Wiley & Sons, 1983; 224 pages, 15.5 by 23.7 cm, hardcover, ISBN 0-470-27501-4, \$39.95.

Interactive Computer-Based Systems, Stephen J. Andriole. Princeton, NJ: Petrocelli Books, 1983; 152 pages, 16.3 by 24 cm, hardcover, ISBN 0-89433-191-4, \$16.95.

Interfacing to the IBM Personal Computer, Lewis C. Eggebrecht. Indianapolis, IN: Howard W. Sams & Co., 1983; 248 pages, 20.3 by 23.5 cm, softcover, ISBN 0-672-22027-X, \$15.95.

An Introduction to Programming the ORIC-1, R. A. and J. W. Penfold. London, England: Bernard Babani Ltd., 1983; 112 pages, 11 by 17.8 cm, softcover, ISBN 0-85934-104-6, £1.95.

Introduction to the Theory of Automata, Zamir Bavel. Reston, VA: Reston Publishing Co., 1983; 672 pages, 18.5 by 24.3 cm, hardcover, ISBN 0-8359-3271-5, \$27.95.

An Introduction to Visicalc Spreadsheets for the TRS-80 Model II and Model 16, Harry Anbarlian. New York: McGraw-Hill, 1983; 368 pages, 15.5 by 23.5 cm, spiral-bound, ISBN 0-07-001596-1, \$49.95.

Includes 8-inch floppy disk.
An Introduction to Vu-Calc

Spreadsheets for the Timex/Sinclair 1000 and the Sinclair ZX-81, Harry Anbarlian. New York: McGraw-Hill, 1983; 258 pages, 15.8 by 23.5 cm, spiral-bound, ISBN 0-07-001699-2, \$22.95.

Invitation to FORTRAN for the TRS-80, Lawrence L. McNitt. New York: Petrocelli Books, 1983; 248 pages, 15.3 by 23.3 cm, softcover, ISBN 0-89433-210-4, \$15.

Kensei, Steven Schlosstein. New York: Congdon & Weed Inc., 1983; 350 pages, 16 by 24.5 cm, hardcover, ISBN 0-86553-089-0, \$15.95.

Learning and Teaching with Computers, Tim O'Shea and John Self. Englewood Cliffs, NJ: Prentice-Hall, 1983; 320 pages, 14.5 by 23.5 cm, softcover, ISBN 0-13-527762-0, \$12.95.

Learning and Teaching Programming Using The TRS-80 Model III, Nancy Lee Olsen. Indianapolis, IN: Howard W. Sams & Co., 1983; 128 pages, 21.5 by 28 cm, spiral-bound, ISBN 0-672-22072-5, \$10.95.

Megabucks From Your Microcomputer, Timothy Orr Knight. Indianapolis, IN: Howard W. Sams & Co., 1983; 72 pages, 21.3 by 27.8 cm, softcover, ISBN 0-672-22083-0, \$3.95.

Microcomputer Programming with Microsoft BASIC, Robert G. Crawford and David T. Barnard. Reston VA: Reston Publishing Co., 1984; 432 pages, 17.5 by 23.5 cm, softcover, ISBN 0-8359-4356-9, \$15.95.

The NSC800 Microprocessor Cookbook, Roger C. Alford. Blue Ridge Summit, PA: Tab Books, 1983; 280 pages, 13 by 21 cm, softcover, ISBN 0-8306-1502-4, \$12.95.

1984 Computer Desk Diary, Gil Roeder and Jason A. Shulman. New York: Workman Publishing, 1983; 196 pages, 20.3 by 10 cm, spiral-bound, ISBN 0-89480-586-X, \$8.95.

100 Ready-To-Run Programs & Subroutines for the IBM PC,

Jeff Bretz and John Clark Craig. Blue Ridge Summit, PA: Tab Books, 1983; 320 pages, 19.8 by 23.3 cm, softcover, ISBN 0-8306-1540-7, \$16.50.

A Parent's Guide to Personal Computers & Software, the editors of *Consumer Guide* with Danny Goodman. New York: Simon & Schuster, 1983; 64 pages, 21 by 27.5 cm, spiral-bound, ISBN 0-671-49173-3, \$6.95.

Pascal Programming: A Beginner's Guide to Computers and Programming, Chris Hawksley. Cambridge, England: Cambridge University Press, 1983; 218 pages, 15.5 by 23.5 cm, hardcover, ISBN 0-521-25302-0, \$24.95.

The Personal Computer Glossary, George Ledin Jr. Sherman Oaks, CA: Alfred Publishing Co., 1983; 64 pages, 10.8 by 28 cm, softcover, ISBN 0-88284-233-1, \$2.95.

Personal Pascal, David E. Cortesi and George W. Cherry. Reston, VA: Reston Publishing Co., 1984; 432 pages, 17.5 by 23.5 cm, softcover, ISBN 0-8359-5522-2, \$16.95.

Pocket Guide to CP/M, Thomas A. Dwyer and Margot Critchfield. Reading, MA: Addison-Wesley, 1983; 100 pages, 10 by 15.8 cm, spiral-bound, ISBN 0-201-10363-X, \$7.25.

Pocket Guide to Wordstar, Bryn Bove and Cheryl Rhodes. Reading, MA: Addison-Wesley, 1983; 75 pages, 10 by 15.8 cm, spiral-bound, ISBN 0-201-07754-X, \$7.25.

The Power Of: 1-2-3, Robert E. Williams. Portland, OR: Management Information Source Inc., 1983; 184 pages, 20.8 by 26.8 cm, softcover, ISBN 0-13-687525-4, \$14.95.

The Power Of: VisiCalc, vol. 1 and 2, Robert E. Williams, Bruce J. Taylor, and Brian L. King. Portland, OR: Management Information Source Inc., 1982; 192 pages, 21 by 27.3 cm, softcover, ISBN 0-13-687418-5, \$14.95.

**"What took
five man-months of
development with dBASEII,
was accomplished
in two weeks
with DATAEASE."**

**Bob Scavullo, President
Noesis Computing Company**

DATAEASE — The totally integrated information management system that delivers ease-of-use without compromising power. Join the corporate clients that are turning to DATAEASE to get their information filed, sorted, analyzed and reported.

- AT&T
- Chemical Bank
- Exxon
- General Electric
- IBM
- Proctor & Gamble
- Prudential Life
- Touche Ross
- Tufts (School of Medicine)
- United Technologies

DATAEASE™

If you can read,
you can build a powerful application.

800-243-5123



Software Solutions, Inc. • 305 Bic Drive, Milford, CT 06460
203-877-9268 • Telex: 703972

Books Received

Proven Techniques for Troubleshooting the Microprocessor and Home Computer Systems, James W. Coffron. Englewood Cliffs, NJ: Prentice-Hall, 1984; 256 pages, 17.5 by 23.5 cm, softcover, ISBN 0-13-731738-7, \$14.95.

Relational Information Systems, T. H. Merrett. Reston, VA: Reston Publishing Co., 1984; 528 pages, 18 by 24.5 cm, hardcover, ISBN 0-8359-6642-9, \$24.95.

Robotics and Automated Manufacturing, Richard C. Dorf. Reston, VA: Reston Publishing Co., 1983; 208 pages, 15.8 by 23.5 cm, hardcover, ISBN 0-8359-6686-0, \$24.95.

Science and Engineering Programs for the IBM PC, Cass Lewart. Englewood Cliffs, NJ: Prentice-Hall, 1983; 144 pages, 14.5 by 23 cm, softcover, ISBN 0-13-794917-0, \$12.95.

Sprites, A Turtle, and TI LOGO, Jim Conlan and Don Inman. Reston, VA: Reston Publishing Co., 1984; 240 pages, 15.3 by 23 cm, softcover, ISBN 0-8359-7036-1, \$14.95.

Structured Digital Design Including MSI/LSI Components and Microprocessors, Raymond

M. Kline. Englewood Cliffs, NJ: Prentice-Hall, 1983; 464 pages, 18.5 by 24.3 cm, hardcover, ISBN 0-13-854554-5, \$33.95.

The Theory of Relational Databases, David Maier. Rockville, MD: Computer Science Press, 1983; 656 pages, 16 by 23.5 cm, hardcover, ISBN 0-914894-42-0, \$31.95.

Things To Do With Your Commodore 64 Computer, Jerry Willis, Merl Miller, and Deborah Willis. New American Library, 1983; 192 pages, 10.5 by 17.8 cm, ISBN 0-451-12843-5, \$3.95.

Things To Do With Your Commodore VIC 20, Jerry Willis, Merl Miller, and Deborah Willis. New York: New American Library, 1983; 192 pages, 10.5 by 17.8 cm, softcover, ISBN 0-451-12844-3, \$3.95.

Things To Do With Your TI-99/4A Computer, Jerry Willis, Merl Miller, and D. Lamont Johnson. New York: New American Library, 1983; 192 pages, 10.5 by 17.8 cm, softcover, ISBN 0-451-12842-7, \$3.95.

Things To Do With Your TRS-80 Model 4 Computer, Jerry Willis, Merl Miller, and Cleborne D. Maddux. New

York: New American Library, 1983; 224 pages, 10.5 by 17.8 cm, softcover, ISBN 0-451-12845-1, \$3.95.

Timex/Sinclair Interfacing, James M. Downey and Don Rindsberg. Englewood Cliffs, NJ: Prentice-Hall, 1983; 160 pages, 15.3 by 22.8 cm, softcover, ISBN 0-13-921742-8, \$10.95.

Transducers Theory & Applications, John A. Allocca and Allen Stuart. Reston, VA: Reston Publishing Co., 1984; 511 pages, 18 by 24 cm, hardcover, ISBN 0-8359-7796-X, \$22.95.

A User-Friendly Guide to CP/M, James T. Perry and Robert F. McJunkins. Reston, VA: Reston Publishing Co., 1983; 240 pages, 14.8 by 23.8 cm, softcover, ISBN 0-8359-8117-7, \$14.95.

VisiCalc Programming: No Experience Necessary, Shaffer & Shaffer Applied Research & Development Inc. Boston, MA: Little, Brown & Co., 1983; 258 pages, 19 by 23 cm, spiral-bound, ISBN 0-316-78235-1, \$59.95. Includes floppy disk.

Winchester Disks in Microcomputers, Jonah McLeod. Oxford, England: Elsevier International Bulletins, 1983;

194 pages, 21 by 29.7 cm, softcover, ISBN 0-946395-07-1, \$95.

Word Processing for Small Businesses, Steven F. Jong. Indianapolis, IN: Howard W. Sams & Co., 1983; 194 pages, 13.8 by 21.3 cm, softcover, ISBN 0-672-21929-8, \$11.95.

Wordstar with Style, Roger B. White Jr. Reston, VA: Reston Publishing Co., 1983; 208 pages, 14.8 by 22.8 cm, spiral-bound, ISBN 0-8359-8793-0, \$14.95.

The ZX81/TS1000 Home Computer Book, David C. Foyt. Berkeley, CA: Osborne/McGraw-Hill, 1983; 320 pages, 18.8 by 23.3 cm, softcover, ISBN 0-88134-106-1, \$11.95. ■

This is a list of books received at BYTE Publications during this past month. Although the list is not meant to be exhaustive, its purpose is to acquaint BYTE readers with recently published titles in computer science and related fields. We regret that we cannot review or comment on all the books we receive; instead, this list is meant to be a monthly acknowledgment of these books and the publishers who sent them.

IT'S SIMPLE. . .CALL AND SAVE MONEY!

Since 1978

1-800-841-0860

GA. & INFO
912-377-7120

**DIRECT MARKETING
COMPUTERS AND
EQUIPMENT
TO SAVE YOU MONEY!**

FREE UPON REQUEST

•DISCOUNT PRICE LIST AND INFORMATION KIT
•COPY OF MFR'S WARRANTY
PRICES AND PRODUCTS ARE SUBJECT TO CHANGE
WITHOUT NOTICE.

**TRS-80
COMPUTERS**

EPSON

star
MICROPRICE.COM

IBM PC Compatibles
Call For Your Choice

Columbia PC **Tandy Model 2000**

Other Products

\$CALL



**Micro Management
Systems, Inc.**

2803 Thomasville Road East
Cairo, Georgia 31728

TELEMARKET DEPT. 1

Are salaries for computer professionals going up?

Find out in our new, free Salary Survey.

No doubt during 1983, you knew that many organizations took a hard line on awarding liberal salary increases.

Yet, on the other hand, did you know that salaries for *some* computer professionals *soared* right on through the uncertain business outlook?

Our 1984 Computer Salary Survey and Career Planning Guide will explain why many computer professionals are able to advance their careers more successfully than others:

- How some professionals—performing the same work and having a similar amount of experience—are earning significantly more than their peers.
- Why some professionals now earn as much as 25% more than they did last year.
- What emerging skills are most in demand and which positions command high salaries now and in the future.
- How size of firm and computer

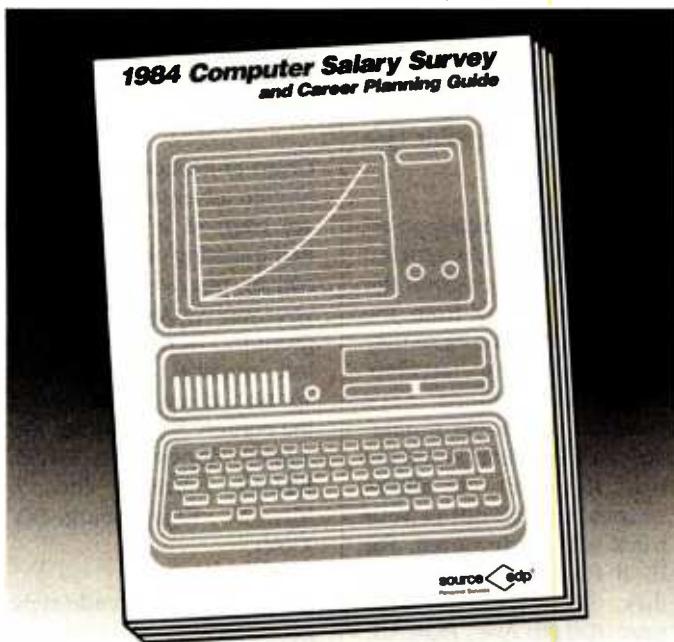

installation greatly affects compensation levels.

The new Survey is based on contacts with more than 44,000 computer professionals and 35,000 organizations. Not only are salary averages for fifty-eight positions reviewed (including ten new ones which we never before covered), but high and low compensation ranges are also covered.

Included are positions in programming, software, systems design, data base/data communications, Edp auditing, operations, computer sales, marketing, marketing support and management.

You owe it to yourself—especially if most of your career lies ahead—to call or write for your free copy today.

source edp
Personnel Services

The world's largest recruiting firm devoted exclusively to the computer profession.

Call Source™ today for your free copy

Is your salary still frozen?

Call the Source Edp office nearest you for a free copy of our new 32-page report. We'll mail a copy to you in strict confidence, without obligation.

If unable to call, write:

**Source Edp
Department B2
P.O. Box 7100
Mountain View, CA 94039**

When writing, please include your title.

United States:

| | |
|---------------------------|--------------|
| Alabama | |
| Birmingham | 205/322-8745 |
| Arizona | |
| Phoenix | 602/279-1010 |
| Tucson | 602/792-0375 |
| California | |
| Northern | |
| Mountain View | 415/969-4910 |
| Sacramento | 916/446-3470 |
| San Francisco | 415/434-2410 |
| Walnut Creek | 415/945-1910 |
| Southern | |
| Fullerton | 714/738-1313 |
| Irvine | 714/833-1730 |
| Los Angeles/ Downtown | 213/688-0041 |
| Los Angeles/ South Bay | 213/540-7500 |
| Los Angeles/West | 213/203-8111 |
| San Diego | 619/231-1900 |
| San Fernando Valley | 818/781-4800 |
| Colorado | |
| Denver | 303/773-3700 |

Connecticut

| | |
|-----------|--------------|
| Danbury | 203/797-0590 |
| Hartford | 203/522-6590 |
| New Haven | 203/787-4595 |
| Stamford | 203/967-4888 |
| Stratford | 203/375-7240 |

District of Columbia

| | |
|-----------------|--------------|
| Washington D.C. | 202/293-9255 |
|-----------------|--------------|

Florida

| | |
|-----------------|--------------|
| Fort Lauderdale | 305/491-0145 |
| Jacksonville | 904/356-1820 |
| Miami | 305/624-3536 |

Georgia

| | |
|----------|--------------|
| Atlanta | |
| Downtown | 404/588-9350 |
| North | 404/953-0200 |

Illinois

| | |
|-----------------|--------------|
| Chicago/E. Loop | 312/861-0770 |
| Chicago/W. Loop | 312/346-1280 |
| Oak Brook | 312/986-0422 |
| Rolling Meadows | 312/392-0244 |

Indiana

| | |
|--------------|--------------|
| Fort Wayne | 219/432-7333 |
| Indianapolis | 317/631-2900 |

Iowa

| | |
|------------|--------------|
| Des Moines | 515/243-0191 |
|------------|--------------|

Kansas

| | |
|---------------|--------------|
| Overland Park | 913/888-8885 |
| Wichita | 316/688-1621 |

Kentucky

| | |
|------------|--------------|
| Louisville | 502/581-9900 |
|------------|--------------|

Louisiana

| | |
|-------------|--------------|
| Baton Rouge | 504/924-7183 |
| New Orleans | 504/561-6000 |

Maryland

| | |
|-----------|--------------|
| Baltimore | 301/727-4050 |
| Greenbelt | 301/441-8700 |
| Towson | 301/321-7044 |

Massachusetts

| | |
|------------|--------------|
| Boston | 617/482-7613 |
| Burlington | 617/273-5160 |
| Wellesley | 617/237-3120 |

Michigan

| | |
|--------------|--------------|
| Detroit | 313/259-7607 |
| Grand Rapids | 616/459-6539 |

Lansing

| | |
|------------|--------------|
| Southfield | 313/352-6520 |
| Troy | 313/362-0070 |

Minnesota

| | |
|------------------|--------------|
| Minneapolis | |
| West Downtown | 612/544-3600 |
| St. Paul | 612/332-6460 |
| | 612/227-6100 |

Missouri

| | |
|-------------|--------------|
| Kansas City | 816/474-3393 |
| St. Louis | 314/862-3800 |

Nebraska

| | |
|-------|--------------|
| Omaha | 402/346-0709 |
|-------|--------------|

New Hampshire

| | |
|--------|--------------|
| Nashua | 603/880-4047 |
|--------|--------------|

New Jersey

| | |
|-------------|--------------|
| Cherry Hill | 609/482-2600 |
| Edison | 201/494-2800 |
| Morristown | 201/267-3222 |
| Paramus | 201/845-3900 |
| Princeton | 609/452-7277 |
| Somerset | 201/469-9444 |
| Somerville | 201/526-9658 |

New Mexico

| | |
|-------------|--------------|
| Albuquerque | 505/247-4270 |
|-------------|--------------|

New York

| | |
|---------------|--------------|
| Albany | 518/482-2035 |
| Buffalo | 716/835-9630 |
| New York City | |
| Grand Central | 212/557-8611 |
| Penn Station | 212/736-7445 |
| Wall Street | 212/962-8000 |
| Rochester | 716/263-2670 |
| Syosset, L.I. | 516/364-0900 |
| Syracuse | 315/422-2411 |
| White Plains | 914/683-9300 |

North Carolina

| | |
|---------------|--------------|
| Charlotte | 704/552-6577 |
| Greensboro | 919/379-1155 |
| Raleigh | 919/847-7605 |
| Winston-Salem | 919/724-0630 |

Ohio

| | |
|------------|--------------|
| Akron | 216/535-1150 |
| Cincinnati | 513/769-5080 |
| Cleveland | 216/771-2070 |
| Columbus | 614/224-0660 |
| Dayton | 513/461-4660 |
| Toledo | 419/242-2601 |

Oklahoma

| | |
|---------------|--------------|
| Oklahoma City | 405/722-7410 |
| Tulsa | 918/599-7700 |

Oregon

| | |
|----------|--------------|
| Portland | 503/223-6160 |
|----------|--------------|

Pennsylvania

| | |
|-----------------|--------------|
| King of Prussia | 215/265-7250 |
| Philadelphia | 215/665-1717 |
| Pittsburgh | 412/261-6540 |

Rhode Island

| | |
|------------|--------------|
| Providence | 401/751-0065 |
|------------|--------------|

South Carolina

| | |
|------------|--------------|
| Columbia | 803/256-7446 |
| Greenville | 803/271-7044 |

Tennessee

| | |
|-----------|--------------|
| Nashville | 615/256-0825 |
|-----------|--------------|

Texas

| | |
|------------------|--------------|
| Austin | 512/479-0720 |
| Dallas | |
| Central North | 214/954-1100 |
| Fort Worth | 214/387-1600 |
| Houston | 817/338-9300 |

Texas

| | |
|-------------------------------|--------------|
| Downtown Galleria/Post Oak | 713/751-0100 |
| San Antonio | 713/439-0550 |
| | 512/342-9898 |

Utah

| | |
|----------------|--------------|
| Salt Lake City | 801/966-3900 |
|----------------|--------------|

Virginia

| | |
|--------|--------------|
| McLean | 703/790-5610 |
|--------|--------------|

Washington

| | |
|---------|--------------|
| Seattle | 206/454-6400 |
| Spokane | 509/838-7877 |

Wisconsin

| | |
|-----------|--------------|
| Green Bay | 414/432-1184 |
| Madison | 608/251-0104 |
| Milwaukee | 414/277-0345 |

Canada:

| | |
|----------------|--------------|
| Ontario | |
| Toronto | |
| Don Mills | 416/425-5730 |
| Downtown | 416/865-1125 |
| Mississauga | 416/848-3344 |

Apple

Ardy, an arcade-type game. Help Ardy the Aardvark search for food in an anthill without tying his tongue in knots. Beware of worms, stinging ants, and spiders that are attacking him. For every 10,000 points gained in one of eight increasingly difficult levels, Ardy wins another life. For the II Plus; floppy disk, \$29.95. Datamost Inc., 8943 Fullbright Ave., Chatsworth, CA 91311-2750.

Baffles, an educational, interactive game that uses deductive reasoning and problem-solving skills. High school to college-level students in science and math learn systematic, economic procedures for formulating, testing, and confirming hypotheses consistent with observations made while playing this game. For II, IIe, and II Plus; floppy disk, \$50. Conduit, POB 388, Iowa City, IA 52244.

BASIC*, an extension of Applesoft BASIC for engineers, scientists, and students. This program enhances BASIC with features that include high-resolution graphic commands for bit and area graphics, built-in programmable character sets for printing alphanumeric characters, and insertion and deletion of characters. It also has commands for screen viewing/switching and painting the screen to any given color. For II, II Plus, and IIe; floppy disk, \$60. Softesmythe Software, 1000 West MacArthur #49, Santa Ana, CA 92707.

Biznes, a business-firm simulation program. Students can learn economic reasoning and theory in business by entering basic decisions

about capital, labor, and price. Receive reports on what the business will produce, sell, and the profit, if any. Lessons include the law of diminishing returns, the equimarginal principle, elasticity, and marginal revenue. For II, II Plus, and IIe; floppy disk, \$65. Conduit (see address above).

Bouncing Kamungas, an arcade-type game. As a melon farmer, you must skewer the Kamungas falling from the sky on your pitchfork so they don't ruin your melon crop. When the melons have ripened, rush them to market, avoiding Peronies on the road. If you hit one, all the melons that fall out of your truck will be devoured. For II, II Plus, and IIe; floppy disk, \$19.95. Penguin Software, 830 4th Ave., POB 311, Geneva, IL 60134.

Cavern Creatures, an arcade-type maze game. Many people before you have failed to find the underground city. The caverns that are full of awful creatures stand in your way of success. And you must avoid the deadly wall surfaces. For II and II Plus; floppy disk, \$29.95. Datamost Inc. (see address above).

Conquering Worlds, a strategic arcade-type game. The galaxy is on red alert and all civilizations are ready for war. As commander, you must capture planets, especially the pseudolife-robot successors of a once mighty but now extinct race. For the II Plus; floppy disk, \$29.95. Datamost Inc. (see address above).

The Coveted Mirror, a medieval adventure game. The kingdom of Starbury is governed by an iron-fisted ruler, Voar the Vermin. He owns four of the five pieces

of a magical mirror, once used to protect Starbury by the wizard, Munjistan. Find the last piece to break the power of Voar and save the kingdom. For II, II Plus, and IIe; floppy disk, \$19.95. Penguin Software (see address above).

Crypt of Medea, a high-resolution adventure game. You are trapped in a crypt. By manipulating objects to solve logical puzzles, you make your way through the underground. Horrors await you, but musical tunes interspersed at key points lighten the burden. For II, II Plus, IIe, and III; floppy disk, \$34.95. Sir-Tech Software Inc., 6 Main St., Ogdensburg, NY 13669.

Defender, an arcade-type game. Aliens are attacking your planet and you must use your best spaceship, *Defender*, to destroy them with smart bombs. Rescue the kidnapped humanoids before they are turned into killer mutants. With every fifth wave, ten humanoids are replaced. For II, II Plus, and IIe; floppy disk, \$34.95. Atari Inc., POB 61657, Sunnyvale, CA 94086.

Eagles, an air-combat simulation. As a World War I pilot, battle with legendary pilots and aircraft, or assemble your own plane or squadron. As you fly in dogfights, you note altitude changes, flying techniques, ground location, and a situational overview. For II, II Plus, IIe, and III; floppy disk, \$34.95. Strategic Simulations Inc., Building A-200, 883 Stierlin Rd., Mountain View, CA 94043-1983.

The Eating Machine, a nutritional-analysis program. You learn healthful diet management and meal planning,

while the program calculates what and how many nutrients, vitamins, and calories you consume. For II Plus and IIe; floppy disk, \$49.95. Muse Software, 347 North Charles St., Baltimore, MD 21201.

Fortress, a medieval strategy game for one or two players. Occupy and fortify your territory, then take over the surrounding countryside. The computer is an opponent that learns your strategy and uses it against you. For II Plus and IIe; floppy disk, \$34.95. Strategic Simulations Inc. (see address above).

Four-Letter Words, four educational word games. Test high school or college-level students' knowledge of four-letter words using different combinations of letters. A dictionary of more than 3000 four-letter words includes plurals. You can use this program in the game mode or the inquiry mode. For II, II Plus, and IIe; floppy disks, \$55. Conduit (see address above).

The Function Game, a mathematical educational program for seventh graders and above. Students explore the association between graphs of functions and their mathematical equations. Graphics, hints, scoring, and immediate performance feedback intensify home study. For II Plus and IIe; floppy disk, \$39.95. Muse Software (see address above).

Infidel, the first in a series of interactive-prose adventure games. Stranded in the Egyptian desert with only a map, a cube with ancient markings, and an incomplete hieroglyphics dictionary, you must find the buried entrance to the last pyramid and seize priceless treasures that have been mysteriously

THE FILE CONNECTION

8" DISKETTE SYSTEM FOR THE IBM PC



Our "FILE CONNECTION" programs provide 8" diskette file exchange between the IBM PC and most Micro-Mini-Main Frame computer systems.

Our "WORD CONNECTION" programs provide 8" diskette text document exchange between the IBM PC and many word processing systems.

Contact us for information about the hundreds of 5 1/4" and 8" diskette formats and systems which we currently support.

FLAGSTAFF ENGINEERING / 2820 West Darleen / Flagstaff, AZ 86001
Telephone 602-774-5188 / Telex 705609 FLAG-ENG-UD

From Computer Plus to YOU...

PLUS after PLUS after PLUS



Model 100 8K 8479
Model 100 24K 8435



Color Computer II 16K 8436
w/16K Ext. Basic 8465
w/64K Ext. Basic 8210



Model IV 16K 8449
Model IV 64K
2 Disk & RS232 81699



DMP120 8395
DMP200 8520



Color Computer Disk Drive
Drive 0 8329 Drive 1 8235



DWP210 8429

BIG SAVINGS ON A FULL COMPLEMENT OF RADIO SHACK COMPUTER PRODUCTS

| COMPUTERS | PRINTERS | | |
|-------------------------|------------------------|------|-------------------------|
| Model 4 Portable | Silver Reed DP500 D.W. | 425 | Model III 4 Drive 2 |
| 64K 2 Drives | Silver Reed DP650 D.W. | 575 | Model III 8 Drive 3 |
| Pocket Computer 2 | Silky Wheel II | 1195 | Primary Hard Disk M12 |
| Pocket Computer 3 | DWP410 | 1450 | Primary Hard Disk M11 |
| Pocket Computer 4 | CGF115 | 150 | BTC. |
| Model 2000 2 Drive | CGF220 Iris Jet | 545 | CCR-81 Recorder |
| Model 2000 WinHard Disk | DMP110 | 300 | Cassette Tapes (10 Pt) |
| Model 12 64K 1 Drive | DMP420 | 735 | 16K Ram Chips |
| Model 12 64K 2 Drive | DMP600 | 1415 | 64K Ram Chips |
| Model 168 1Dr 256K | DMP210 | 1080 | Model 4 64K Upgrade Kit |
| Model 168 2Dr 256K | Gemini 10X | 300 | M100 Bar Code Reader |
| MODEMS | Gemini 15X | 405 | 64K Printer Buffer |
| Hayes Smartmodem II | Prowriter | 399 | Printer Stand |
| Hayes Smartmodem 1200 | Olivardia | CALL | Printer Cables |
| Novation Smartmod 1200 | Epson | CALL | Printer Ribbons |
| Novation J-Cat | DISK DRIVES | | Printer Paper |
| AC-3 | Model III 4 Drive 0 | 515 | |
| DC Modem 1 | Model III 4 Drive 1 | 195 | |

CALL TOLL FREE
1-800-343-8124

- LOWEST POSSIBLE PRICES
- BEST POSSIBLE WARRANTY
- KNOWLEDGEABLE SALES STAFF
- TIMELY DELIVERY
- SHOPPING CONVENIENCE

computer plus

P.O. Box 1094
480 King Street
Littleton, MA 01460 SINCE 1973
IN MASSACHUSETTS CALL (617) 486-3193

T85-80 is a registered trademark of Tandy Corp

Software Received

hidden for ages. For the II; floppy disk, \$49.95. Infocom, 55 Wheeler St., Cambridge, MA 02138.

Mark & Recapture, an educational biology program. Students learn three techniques for estimating field populations of highly mobile animals: the Lincoln-Peterson, Schnabel, and Schumacher-Eschmeyer models. A sample is removed and marked from a simulated population. When returned, counts provide ratios showing dispersal. Students must be able to perform simple calculations and algebraic manipulations. For II, II Plus, and IIe; floppy disk, \$50. Conduit (see address above).

Mathdisk One, an educational program for use by high school and college-level students. The 43 programs let students invent and test random-number generators, input numbers that control graphics, and discover new prime-number-generating formulas. Includes workbook. For II Plus and IIe; floppy disk, \$29.90. University of Evansville Press, Box 329B, Evansville, IN 47702.

Predation, an educational program for college-level ecology classes. Students study predator-prey interaction, explore theories, and solve equations. Two programs include Introduction to Predator-Prey Dynamics and Advanced Predation Models. Documentation includes user's notes and study questions for analysis techniques. For II, II Plus, and IIe; floppy disk, \$50. Conduit (see address above).

Question and Answer, a teaching tool that aids in the presentation of test questions. A few types of questions are used: true and false, multiple choice, and fill in the blanks. The true and false

option is the only one that does not allow a second try or give hints. For II Plus and IIe; floppy disk, \$49.95. Bob Stalder, 3508 Furey Ave., Madison, WI 53714.

Speak Up!, a voice-synthesizer program that contains a text-to-speech algorithm for words and numbers. In order to convert words to speech, you must intentionally misspell words to meet their phonetic pronunciation. For II, II Plus, IIe, and III; floppy disk, \$39.95. Classical Computing Inc., POB 3318, Chapel Hill, NC 27515.

Star Destroyer, an interstellar-war game. As the captain of the Star Destroyer *Beowulf*, you must defend the Federation fleet from attacking aliens by vaporizing their starships. Two-voice music accompanies you in your venture. Requires a joystick. For II Plus and IIe; floppy disk, \$39.95. Harvest Time Software Co., POB 1527, Jacksonville, TX 75766.

Super Bunny, a graphic adventure game. Rabbitville is being attacked by wolves and snakes. Try to lead Reggie Rabbit to the magic carrots that turn him into Super Bunny. With five lives and other super qualities, he moves through various levels, pouncing on animals. Comic book included. For II and II Plus; floppy disk, \$29.95. Datamost Inc. (see address above).

SX-48, a cross-assembler package that allows MCS-48 software development. The editor lets you create MCS-48 assembler source programs, and an assembler that assembles 8048 source programs and generates a program listing and the object code. For II Plus and IIe; floppy disk, \$60. Allen Systems, 2151 Fairfax Rd., Columbus, OH 43221.

Announcing 4 New Collector Edition

BYTE COVERS

The 4 Byte covers shown below are the newest additions to the Collector Edition Byte Cover series. Each full color print is 11" x 14", including a 1 1/2" border, and is part of an edition strictly limited to 1000 prints. Each print is a faithful reproduction of the original Byte magazine, printed on museum quality acid free paper, and is personally inspected, signed and numbered by the artist, Robert Tinney. A Certificate of Authenticity accompanies each print.

Collector Edition Prints are carefully packaged flat to avoid bending, and are shipped first class within one week of receipt of order. The price of each print is \$25. All 4 prints are available as a set (Set 21-24) for only \$99. Other Collector Edition Byte Covers are also available from Robert Tinney Graphics. For a color brochure, or to order one or more of the prints shown, please check the appropriate box in the coupon below.

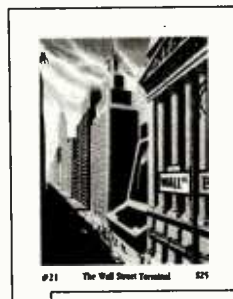

#21 The Wall Street Terminal \$25



#22 "Opening Files..." \$25



#23 The Ducks \$25

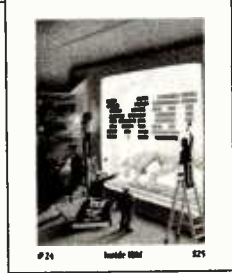

#24 Inside IBM \$25

Please send me the following Print (S), or Set (S):

QTY: _____ TITLE & PRINTY NO. _____

AMOUNT: \$ _____

Card No. _____

Exp. Date _____

SEND MY PRINTS (OR BROCHURE) TO:

Name: _____

Address: _____

City: _____

State: _____

ZIP: _____

Send this coupon to: **Robert Tinney Graphics**, 1864 N. Pamela Drive, Baton Rouge, LA 70815

FOR VISAS OR MASTERCARD ORDERS, or for more information, CALL 1-504-272-7266 (Days or Evenings)

Please send me your color brochure.

I have enclosed check or money order.

Yes MasterCard

Buy Hardware/Software at Wholesale, And Save On Software Rentals, As A NETWORK™ Member Only!

Save hundreds of dollars when you buy DIRECT from America's Number 1 Computer Buying Service at just 8% above DEALER WHOLESALE PRICES, plus shipping.

Members receive The Personal Computer NETWORK's Giant Catalog featuring thousands of products and the lowest prices on the widest selection of computer software and hardware in the nation!

RENT BEFORE YOU BUY—Members are eligible to join The NETWORK's Business and Game Software Rental Libraries for a much smaller fee than other software rental services. And The NETWORK's rental charges are far less—just 20%-25% of the Member WHOLESALE PRICE!

Join The NETWORK today for as low as \$8 for one year (or \$15 for two years) and receive all these exclusive, money-saving benefits:

- 1. REAL BUYING CLOUT**—Buy at just 8% above DEALER WHOLESALE PRICES, plus shipping. (On credit card orders there is a 3% service charge.)
- 2. CONVENIENT SHOP-AT-HOME CATALOG**
- 3. KNOWLEDGEABLE SERVICE CONSULTANTS**
- 4. FULLY INSURED FAST HOME DELIVERY**
- 5. OPTIONAL BUSINESS SOFTWARE RENTAL LIBRARY**—Members join for just \$30 per year in addition to the basic membership fee. Rent business software at just 20%-25% of The NETWORK's low prices for a 7-day period (plus a 3-day grace period for return shipping). 100% of your rental fee applies towards purchase.
- 6. OPTIONAL GAME SOFTWARE RENTAL LIBRARY**—Members join for just \$10 per year in addition to the basic membership fee. All the same conditions apply as for benefit five.
- 7. SPECIAL SAVINGS BULLETINS**—Save even more on limited-quantity merchandise!
- 8. DISCOUNT COMPUTER BOOK LIBRARY**—Save up to 50%!
- 9. MEMBERSHIP SATISFACTION GUARANTEE**—If you are not satisfied, notify us within 30 days to receive a 100% money-back refund.
- 10. PRODUCT SATISFACTION GUARANTEE**—If you are not satisfied with any hardware, return it within 15 days for a 100% money-back refund.

Low prices, fast home delivery and two software rental libraries are only the beginning! The NETWORK is your source for everything from memory chips to mainframes—and it's all just 8% above wholesale, plus shipping.

HARDWARE

Monitors (color and monochrome)
Printers
Complete Systems
Disk Drives (full/half height, add-on/add-in)
Multi-Function Boards
Graphics Boards
Modems
Local Area Networks
Memory Chips (all speeds available)
S-100 Components

SOFTWARE (rent or buy!)

Business Recreational Compilers Word Processors Utilities
Scientific Data Bases Educational Graphics CP/M-MS/DOS

SUPPLIES & ACCESSORIES

Blank Diskettes (all formats)
Paper Stock
Ribbons
Print Wheels
Cables
And More!

Choose hardware and software from hundreds of manufacturers, including:

- Altos
- Amdek
- Apparat
- AST
- Ashton-Tate
- Atari
- CDC
- Coleco
- Columbia
- Commodore
- Corona
- Cromemco
- DEC
- Digital Research
- Eagle
- Epson
- Franklin
- Hayes
- IBM
- IUS
- Lotus
- MicroPro
- Microsoft
- Morrow
- Motorola
- NEC
- Northstar
- Okidata
- Peach Tree
- Princeton
- Quadram
- Sanyo
- Sierra On-Line
- Software Publishing
- Softword
- Tandon
- Tecmar
- Texas Instruments
- Toshiba
- Visicorp
- Zenith

SYSTEMS SPECIAL

| | Retail | Wholesale |
|--|------------|-------------|
| NEC 8201 Notebook 16K RAM, 32K ROM, Text Editor, Communications, Basic, 8-line 40-Char. Display | \$799 | \$599* |
| Televideo Teleport Portable, 9" screen, 64K Z80-A, 2 386K Drives, WP, Calc., Graphics | \$1,999 | \$1,535* |
| TAVA PC 100% IBM PC Compatible; 2 DS-320K Disk Drives, 128K Memory (256K sockets), Keyboard, Amdek 300 Monitor, Color Card, And More! LOCAL SERVICE | \$2,395 | \$1,650* |
| 64K DRAM Memory Chips | \$11 ea. | \$5.10 ea.* |
| Brand Name Floppy Disks (DS/DD) Sold in boxes of 10. | \$5.20 ea. | \$2.25 ea.* |

*NETWORK Members pay just 8% over the wholesale price, plus shipping.



CALL TOLL FREE
1-800-621-S-A-V-E
In Illinois call (312) 372-4488

Your Membership Validation Number: **B414**
You can validate your membership number and, if you wish, place your first money-saving order over the phone by using your VISA, MASTERCARD or AMERICAN EXPRESS. Our knowledgeable service consultants are on duty Mon-Fri 8 AM to 7 PM. Sat 9 AM to 5 PM CST.

Call now...Join the NETWORK
and start saving today!

PERSONAL COMPUTER NETWORK
320 West Ohio
Chicago, Illinois 60610

All items subject to availability, prices subject to change without notice.
Copyright 1984, PC NETWORK INC.

THE NETWORK • MEMBERSHIP APPLICATION

YES! Please enroll me as a member of The NETWORK™ and rush my catalog featuring thousands of computer hardware and software products, all at just 8% above DEALER WHOLESALE PRICES. I will also receive all the other exclusive, money-saving services available to Members. I am under no obligation to buy anything. My complete satisfaction is guaranteed.

Please check (✓) all boxes that apply:

- Basic Membership**
- One-year membership for \$8
 - Two-year membership for \$15 (SAVE \$1)
 - Business Software Rental Library for \$30 add'l. per year—members only
 - Games Software Rental Library for \$10 add'l. per year—members only

Special V.I.P. Membership 414

Includes advance notification of special limited-quantity merchandise.

- One-year membership for \$15
- Two-year membership for \$25 (SAVE \$5)
- BOTH Business and Game Software Rental Libraries for \$35 add'l. per year—Extended 10-day rental to V.I.P. members only

- Bill my credit card: VISA MasterCard American Express Exp. Date _____ mo. year

Account Number: _____

Name _____

Address _____ Apt. No. _____

City _____ State _____ ZIP _____

Telephone (_____) _____

My computer(s) is: IBM PC Apple II TRS-80

Atari Commodore Other _____

Signature _____ (Signature required to validate membership)

TeloSchool, an administrative program for elementary schools. Keep track of almost 50 data items on each student, most of which you design. Eliminate repetitive typing by using standardized and customized reports and mailing labels. It also prints rosters and student profiles and tracks health problems, test scores, and participation in **extracurricular** activities. For II Plus and II; floppy disk, \$549. Telos Software Products, 3420 Ocean Park Blvd., Santa Monica, CA 90405.

Three Mile Island, a nuclear power plant management simulation. You manage a reactor with the touch of a few keys controlling valves, pumps, filters, and turbines. Stay within the budget, repair equipment, update your schedule, and prevent radiation leaks, interruption of electricity production, and the ultimate meltdown. For II Plus and II; floppy disk, \$39.95. Muse Software (see address above).

Tournament Golf, a golf-simulation program. Play golf from amateur to professional levels on two 18-hole courses. Graphics include fairways, greens, traps, and on-screen scoring. You practice on a driving range and putting green. But use strategy to avoid wind factors, woods, roughs, and water hazards. Up to four players can choose from 14 clubs displayed on the screen. For II, II Plus, and II; floppy disk, \$30. The Avalon Hill Game Co., 4517 Harford Rd., Baltimore, MD 21214.

Work Force II, a business program for home or office. Features include checkbook balancing, a printing calculator, loan amortization, savings rates, wage analysis, and a correctable typewriter. Menu provides for updating

data, change options, rerun programs, and printing of hard copies. For II, II Plus, and II; floppy disk, \$29.95. Core Concepts, POB 24157, Tempe, AZ 85282.

Atari

Cohen's Towers, an arcade-type game. You have been hired by your uncle to deliver the mail in his corporation. Avoid the boss's dog and the Corporate Spy who steals mail. Kiss the secretary for points and rise through the levels with as few demerits as you can. Requires a joystick. For the 400/800; floppy disk, \$29.95. Datamost Inc., 8943 Fullbright Ave., Chatsworth, CA 91311-2750.

Eagles, an air-combat simulation (see description under Apple). For 400/800 and 1200; floppy disk, \$34.95. Strategic Simulations Inc., Building A-200, 883 Stierlin Rd., Mountain View, CA 94043-1983.

Easy, a machine-language programming teaching tool using BASIC-like statements. This program, for use with AMAC or MAC/65 macroassemblers, can be used by both beginner and advanced programmers. Features include interaction with hardware by providing operations such as player-missile graphics, input/output, and scrolling. For 400/800 and 1200; floppy disk, \$39.95. Superware, 2028 Kingshouse Rd., Silver Spring, MD 20904.

Fortress, a medieval strategy game (see description under Apple). For 400/800 and 1200; floppy disk, \$34.95. Strategic Simulations Inc. (see address above).

Mr. Robot and His Robot Factory, an arcade-type

game. As Mr. Robot, you must collect all the power pills on one level before you can move on to one of the next 22 levels. Beware of obstacles such as moving treadmills, alien fire, energizers, and trampolines. Although you're given five lives, you get more if you can touch a life token. For the 400/800; floppy disk, \$34.95. Datamost Inc. (see address above).

Panzer Jagd, two tactical-combat games. You are a World War II commander of almost 20 German tanks with limited fuel supply that must cross a terrain full of randomly generated ambush points. In Panzerun, you command 25 armored and infantry units in battle under similar conditions. For 400/800 and 1200; floppy disk, \$30. The Avalon Hill Game Co., 4517 Harford Rd., Baltimore, MD 21214.

Smooth Writer, a word-processing package. Four programs provide extensive editing, the abilities to break up files too large for processing, format and print short or long text, and a horizontal scrolling feature that lets you access and select documentation before printing. For 400/800 and 1200; floppy disk, \$79. Digital Deli, 3258 Forest Gale Dr., Forest Grove, OR 97116.

The Tail of Beta Lyrae, a high-resolution graphics game. Aliens have taken over your mining settlements. You must destroy their installations by traveling over a variety of terrains including mountains, natural and man-made caverns, and cities. For 400/800; floppy disk, \$34.95. Datamost Inc. (see address above).

Ultima I, an adventure game. You have over 30,000 game days to travel through

a mystical world consisting of monsters, oceans, grasslands, forests, mountains, towns, castles, landmarks, dungeons, and outer space. In the process, you must eliminate the evil Mondain who rules the world. For 400/800 and 1200; floppy disk, \$39.95. Sierra On-Line Inc., Sierra On-Line Building, Coarsegold, CA 93614.

CP/M

ADS (Asset Depreciation System), a utility package for CP/M 2.2 operating systems designed to fulfill the requirement of tracking the cost of asset acquisition and subsequent depreciation, including straight line, declining balance, sum of the year's digits, and double-declining balance. It also prints reports and stores the entire depreciation schedule for any given schedule. Floppy disks, \$64.95. Interactive Data Systems, 1409 B St., POB 2352, Marysville, CA 95901.

Dataplotter, a plotting package that prints publication-quality line graphs and scatterplots on dot-matrix printers. Features include a variety of symbols to represent points on graphs, an interactive program, and three utility programs that manipulate data files. Does not require a graphics terminal or programming experience. Floppy disk, \$50. Lark Software, 7 Cedars Rd., Caldwell, NJ 07006.

Index, a utility package for CP/M 2.2 operating systems designed to index documents and document packages, briefs, reference material, and letters used in daily business transactions. This package is also capable of indexing a document either in keyword or key-phrase order

An Anadex Printer. Next to your Computer, the best friend your Business may ever have.

Perhaps the highest-quality matrix printer ever built, and certainly one of the quietest, the Anadex Silent/Scribe® printer family offers user-friendly operation, high-speed performance, and the flexibility to fit your computer and business applications.

For Word Processing, Silent/Scribe gives you high-speed drafts and crisp letter quality with a variety of fonts, formats and type faces.

Doing Spread Sheets? You can print 16 characters-per-inch to put the whole year on easy-to-file 8½-inch wide paper... or go up to 13½-inch widths if you wish.

If you're using the latest integrated software to combine word processing, calculations, and graphics, no problem. Silent/Scribe handles text, math symbols (including super and sub-scripts), complex graphics, mid-line font changes and underlining.

And with all this, Silent/Scribe's simplified programming and built-in memory is almost like getting a second computer free.

Silent/Scribe. Working alongside your computer, you'll find it easy to use, easy to live with, and ready to support you when needed... but then, what are friends for?

Call (800) 4 ANADEX
In California (800) 792-9992

 **Anadex**
© Copyright 1984. Anadex, Inc.

MADE IN
USA
FOR THE WORLD

The more
you know printers,
the more you'll
like Anadex.

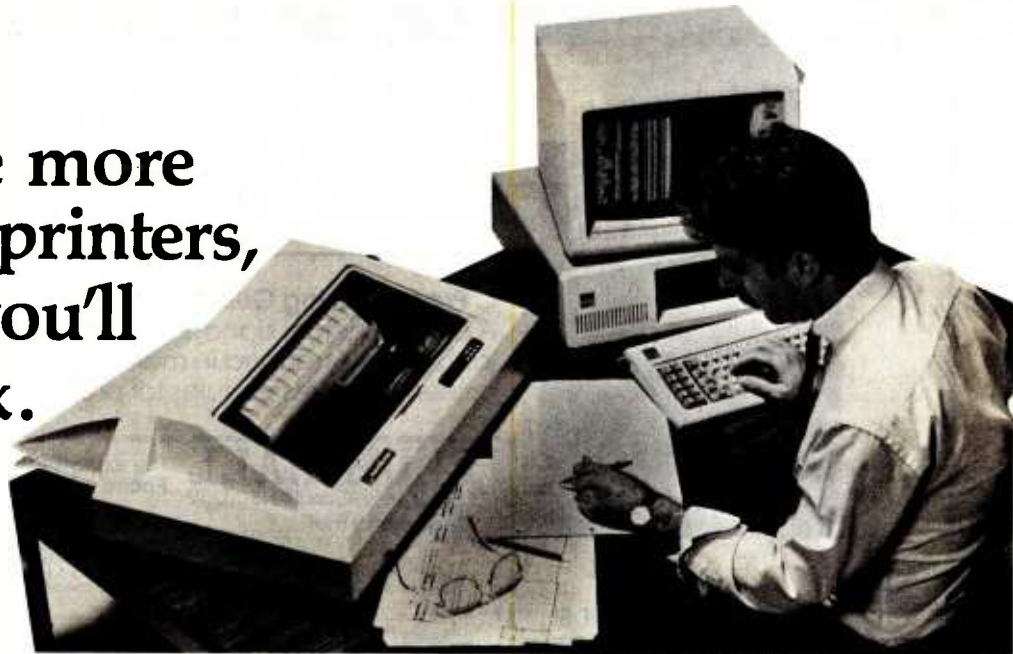

ANADEX, INC. • 1001 Flynn Road • Camarillo, California 93010 • Telephone: (805) 987-9660 • TWX 910-494-2761
U.S. Sales Offices: Irvine, California (714) 261-6140 • Schiller Park, Illinois (312) 671-1717 • Wakefield, Massachusetts (617) 245-9160
Hauppauge, New York, Phone: (516) 435-0222 • Atlanta, Georgia, Phone (404) 255-8006 • Austin, Texas, Phone: (512) 327-5250
ANADEX, LTD. • Weaver House, Station Road • Hook, Basingstoke, Hants RG27 8JY, England • Tel: Hook (025672) 3401 • Telex: 856762 ANADEX G
ANADEX GmbH • Behringstrasse 5 • 8752 Mainaschaff • W. Germany • Tel: 011-49-08021-7225 • Telex: 4188347

Software Received

and in ascending or descending order. Floppy disk, \$34.95. Interactive Data Systems (see address above).

UNREL, a disassembler package for relocatable files using CP/M 2.2 operating systems. You can decipher and modify relocatable files and handle files that have one or more program modules and can be preceded by an index as in IRL library files or in .REL files. Floppy disk, \$45. John E. Calkins, 535 Barley Sheaf Rd., Coatesville, PA 19320.

Utility, a business-analysis package for CP/M 2.2 operating systems. Use it to reference the 150 financial, depreciation, and inventory-control formulas and functions and also for structured basic programming. The functions include source code in structured format that can be in-

tegrated into any number of user-defined programs. Floppy disks, \$64.95. Interactive Data Systems (see address above).

Commodore

Bridge 64, a Bridge card-game simulation for novice and advanced players. Begin by learning the fundamentals of Bridge from the program. The computer will then take on the role of the challenger, with thousands of deals and bids available in high-resolution graphics. For the 64; cartridge, \$39.95. Handic Software Inc., Suite 7, 5090 Central Highway, Pennsauken, NJ 08110.

Calc Result, a spreadsheet program for business calculations or simulations. Fea-

tures include three-dimensional split-screen capability, full-color for additional monitoring, bar-chart format, and protection of formulas. For the 64; cartridge and floppy disk, \$79.95; advanced version on cartridge only, \$194.95. Handic Software Inc. (see address above).

Crossfire, an arcade-type game. The aliens have landed, the city has been evacuated, and your regiment has retreated. Your only hope of survival is to destroy the aliens with your laser before they destroy you. Played on a grid screen, the object is not to get caught in the crossfire. For the 64; cassette, \$29.95. Sierra On-Line Inc., Sierra On-Line Building, Coarsegold, CA 93614.

Diary 64, a database program that lets you keep track of phone numbers, addresses,

appointments, birthdays, or any items that need to be remembered. For use both in business and at home, features include printout for address labels or a variety of other lists from the file. For the 64; cartridge, \$29.95. Handic Software Inc. (see address above).

Forth 64, an operating system with a programming language for business applications and process-control environments. Features include a text editor, virtual memory, an interactive structured program environment, and functions in any numeric base. For the 64; cartridge, \$39.95. Handic Software Inc. (see address above).

Graf 65, a high-resolution graphics package. Turn statistical information into graphical formats. A special routine for computing the integral of

C LANGUAGE PROGRAMMING

From Plum Hall...the experts in C training

• C
Programming
Guidelines
Thomas Plum

• Learning to
Program in
C

Thomas Plum

FREE C LANGUAGE POCKET GUIDE!

A handy C language programming pocket guide is yours *free* when you order either (or both) of the manuals above. A full 14 pages of valuable C language information!

Learning to Program in C 372 pp., 7½" x 10". Price \$25.00

A practical, step-by-step guide for everyone acquainted with computers who wants to master this powerful "implementer's language". Inside, you will learn how to write portable programs for the full spectrum of processors, micro, mini and mainframe.

C Programming Guidelines 140 pp., 7½" x 10". Price \$25.00

A compilation of standards for consistent style and usage of C language. Arranged in manual page format for easy reference, it presents time-tested rules for program readability and portability.

PLUM HALL

1 Spruce Av, Cardiff NJ 08232

The experts in C and UNIX™ training.
Phone orders: 609-927-3770

Please send me: _____ information on C and UNIX Training Seminars
_____ copies of Learning to Program in C @ \$25.00/copy
_____ copies of C Programming Guidelines @ \$25.00/copy
NJ residents add 6% sales tax. Overseas, contact Prentice-Hall International.

NAME _____

COMPANY _____

ADDRESS _____

CITY/STATE/ZIP _____

Check American Express Master Card Visa

CARD # _____ EXP. DATE _____ / _____ Signature _____

UNIX is a trademark of AT&T Bell Laboratories

BY4

ANNOUNCING THE INSIDE STORY ON DATA SPEC™ CABLES.

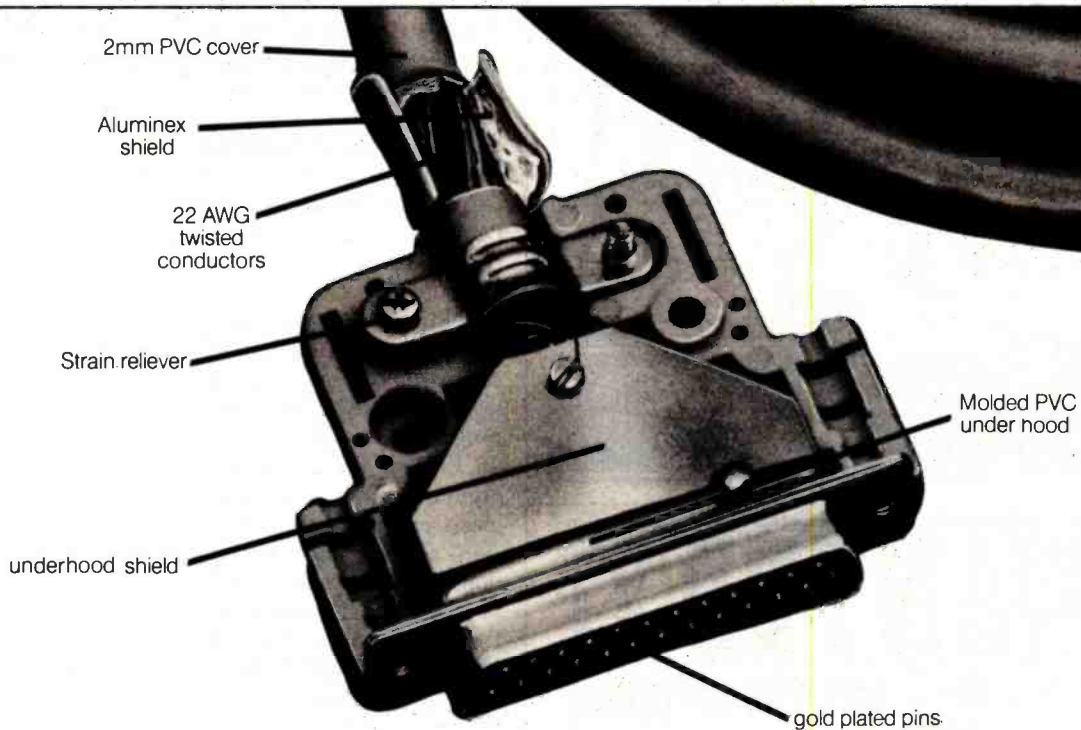

Take a look at the picture above. The shielding under the RS232 connector hood of DATA SPEC™ cables is different from anything you've seen before. No flimsy foil. Or painted hood. Instead, DATA SPEC™ gives you an extra heavy gauge shield under the normal hood which ensures that the cables exceeds the FCC requirements on emission standards.

And, if you look further inside, under the shield, you'll see the advent of PDT™* Technology. DATA SPEC™ cables are the first to employ this technique outside of aerospace applications. PDT Technology ensures that you will never have to solder a broken joint or even open the hood.

However, the biggest news is actually the littlest part of the story. The price.

You can find out about it at your dealer who carries DATA SPEC™ products. Modern manufacturing techniques have made DATA SPEC™ cables priced lower than lesser quality shielded cables.

DATA SPEC™ cables. There's more to it than meets the eye.

*PDT (Poly-vinyl doping technique) involves the injection of poly-vinyl under the shield to fuse the conductors and pins together, thus ensuring reliability under the most adverse conditions. PDT is a registered trademark of Advanced Tool Technology Inc.

DATA SPEC™

THE FAMILY OF HIGH INTEGRITY COMPUTER SUPPORT PRODUCTS.

18215 Parthenia Street, Northridge, 91326 CA (213) 701-5848

Circle 113 for Dealer inquiries.
Circle 114 for End-User inquiries.

The Software Toolworks presents: THE COMPUTER CHEF™ SERIES

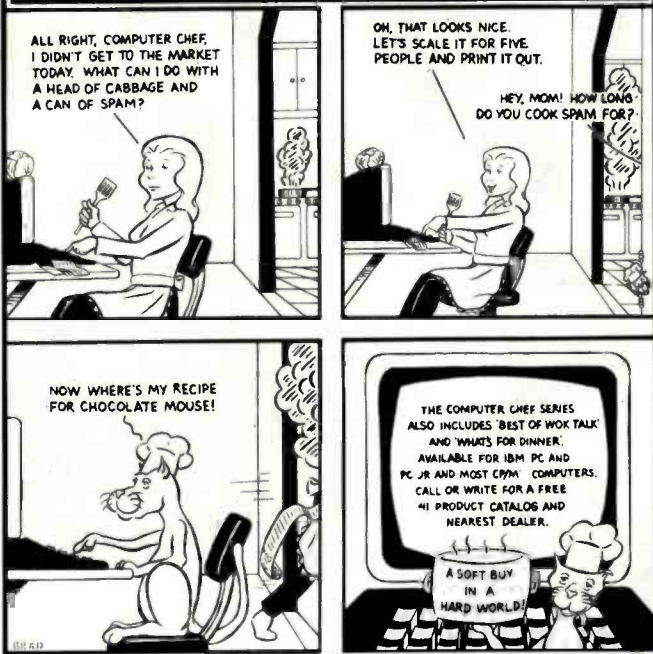

The Computer Chef Series includes Computer Chef and Best of Wok Talk, \$29.95 each, and What's for Dinner, \$19.95. The programs store, scale and help choose from over 300 available recipes or from those you've entered. The Computer Chef Series from your local retailer or The Software Toolworks, 15233 Ventura Blvd., Suite 1118, Sherman Oaks, CA 91403 (818) 986-4885.

©P. M. S. A registered trademark of Digital Research.

Software Received

a function with a range you select. Functions can be defined and plotted within an x-axis range. For the 64; cartridge, \$29.95. Handic Software Inc. (see address above).

Linear Programming System, a mathematical program. You can solve linear-programming problems with up to 50 variables and 35 constraints. Constraints can be less than, greater than, or equal to. All input is stored in a buffer, so you can change data in a revised problem. For the 64; cassette, \$9.99. Computer Heroes, 1961 Dunn Rd., East Liverpool, OH 43920.

SAT English I, a test-preparation program. Useful for improving scores on the College Entrance Exams, this program lets you brush up on English skills including grammar, antonyms, analogies, reading comprehension, and sentence completion. The instruction mode is as helpful as the test mode. For the 64; floppy disk, \$30. Micro Lab Inc., 2699 Skokie Valley Rd., Highland Park, IL 60035.

SAT Math I, a test-preparation program. To improve math scores on the College Entrance Exams, test and instruction modes provide how and why answers to your correct and incorrect responses. A few of the areas you'll strengthen include geometry, probabilities, square roots, ratios, and graphs. For the 64; floppy disk, \$30. Micro Lab Inc. (see address above).

Stat 64, a statistical utility package. To simplify work with statistics and graphic displays, this program adds 19 commands to BASIC that include horizontal and vertical bar charts, statistical commands for calculations of

mean value, standard deviation, and variance. For the 64; cartridge, \$29.95. Handic Software Inc. (see address above).

Super Text, a display-oriented word-processing package. This system for school work, home record keeping, or business uses lets you write documents and easily change or update them without retyping the entire piece. Other features include printing, storing, and reviewing; 80-column display without additional hardware; and on-screen formatting. For the 64; floppy disk, \$99. Muse Software, 347 North Charles St., Baltimore, MD 21201.

When I'm 64, a music-synthesizer system. In addition to the 15 preprogrammed songs, you can write your own songs, record them on disk, and play the computer keyboard like a synthesizer. Included in the program is an animated face that lets you see the lyrics of the songs. For the 64; floppy disk, \$29.95. The Alien Group, 27 West 23rd St., New York, NY 10010.

IBM Personal Computer

Blast, a telecommunications program. You can transfer binary or text files to or from any other computer. Features include terminal-emulation facilities for accessing host computers; text-file uploading and downloading; and support for auto-dial/auto-answer modems. Floppy disk, \$250. Communications Research Group Inc., 8939 Jefferson Highway, Baton Rouge, LA 70809.

Coherent, a program-development system written in C. This multiuser, multitasking

WANTED

"Buyers," & "We'll pay the shippin'"

• CALL FREE (800) 654.4058 •

"Call For Reduced Prices At Various Quantities"

| | | |
|---|---|---|
| <p>Verbatim.</p> <p>5 1/4" sin-side dbt-den. 2 40</p> <p>5 1/4" dbl-side dbt-den. 3 45</p> <p>5 1/4" sin-side quad 3 20</p> <p>5 1/4" dbl-side quad 4 40</p> <p>8" sin-side sin-den. 2 75</p> <p>8" sin-side dbt-den. 3 05</p> <p>8" dbt-side dbt-den. 3 40</p> <p>Head Cleaning Kits.... 5 20</p> <p>Refills. 9 55</p> | <p>Dysan CORPORATION</p> <p>5 1/4" sin-side dbt-den. 3 20</p> <p>5 1/4" dbl-side dbt-den. 4 20</p> <p>5 1/4" sin-side quad 4 45</p> <p>5 1/4" dbl-side quad 4 95</p> <p>8" sin-side sin-den. 3 45</p> <p>8" sin-side dbt-den. 4 45</p> <p>8" dbt-side dbt-den. 4 95</p> <p style="text-align: center;">We Stock "Bulk-Packed" Diskettes</p> | <p>3M Scotch</p> <p>5 1/4" sin-side dbt-den. 2 20</p> <p>5 1/4" dbl-side dbt-den. 3 20</p> <p>8" sin-side sin-den. 2 35</p> <p>8" sin-side dbt-den. 2 95</p> <p>8" dbt-side dbt-den. 3 90</p> <hr/> <p style="text-align: center;">Disk Minder - Smoked Plastic - Holds 75 Disks 16 75 ea</p> <p style="text-align: center;">Dealer Inquiries Welcomed</p> |
|---|---|---|

Prices per ea.
10 per box

the **Diskette Connection™**

P.O. Box 1674
Berthony, OK 73008

VISA

* (Continental U.S. only. Add 3% on orders under 40%)

WE'RE
MAKING
NEWS!

DIRECT SOFTWARE DISCOUNT DIGEST

- CPM®
- IBM®
- APPLE®

TO ORDER CALL (415) 459-1282 • TOLL FREE (800) 533-3012 CA (800) 533-3011 USA

Direct Software™ Discount Prices Save \$\$ and Make Sense to Smart Buyers Who Know What They Want!!

DIRECT SOFTWARE • MAKES PRIME PRODUCTS SO AFFORDABLE THAT THOSE IN THE KNOW WILL FIND IT UNWISE TO RESIST. OUR PRODUCTS ARE BACKED BY SUPPORT AND SERVICE. WITH SAME-DAY SHIPMENT ON MOST ORDERS. COMPARE OUR PRICES AND SAVE.

| | List | Sale |
|-----------------------|------|------|
| ALPHA SOFTWARE | | |
| Apple-IBM Connection | 250 | 169 |
| Data Base Manager II | 295 | 249 |
| Typeface | 125 | 79 |

| | List | Sale |
|------------------------|------|------|
| ANDERSON — BELL | | |
| ABSTAT | 395 | 319 |

| | List | Sale |
|--------------------|------|------|
| ASHTON-TATE | | |
| dBASE II | 700 | 389 |
| Friday | 295 | 199 |

| | List | Sale |
|-----------------------|------|------|
| ASPEN SOFTWARE | | |
| Grammatik | 75 | 56 |
| Proof Reader | 50 | 38 |

| | List | Sale |
|--------------------|------|------|
| A.T.I. | | |
| Training WordStar | 75 | 60 |
| Training dBASE II | 75 | 60 |
| Training Multiplan | 75 | 60 |

| | List | Sale |
|------------------------|------|------|
| BRUCE and JAMES | | |
| Wordvision | 80 | 69 |

| | List | Sale |
|-----------------|------|------|
| CDEX | | |
| MYB-Lotus 1-2-3 | 70 | 60 |
| MYB Visicalc | 70 | 60 |

| | List | Sale |
|--------------------------|------|------|
| DIGITAL MARKETING | | |
| Milestone | 295 | 249 |
| Datebook II | 295 | 249 |
| Footnote | 129 | 109 |
| Bibliography | 125 | 109 |
| Notebook | 150 | 119 |
| MICROLINK II | 89 | 79 |

| | List | Sale |
|---------------------|------|------|
| ACCOUNTING | | |
| REAL WORLD | | |
| Accounts Payable | 650 | 399 |
| Accounts Receivable | 650 | 399 |
| Payroll | 650 | 399 |
| General Ledger | 650 | 399 |
| RM Cobol | | 149 |

| | List | Sale |
|---------------------|------|------|
| I.U.S. | | |
| General Ledger | 595 | 359 |
| Accounts Receivable | 595 | 359 |
| Accounts Payable | 595 | 359 |

| | List | Sale |
|---------------------|------|------|
| PEACHTREE | | |
| General Ledger | 750 | 425 |
| Accounts Receivable | 750 | 425 |
| Accounts Payable | 750 | 425 |

| | List | Sale |
|-------------------------|------|------|
| DIGITAL RESEARCH | | |
| Concurrent CP/M 86 | 350 | 249 |
| CB 80 Compiler | 500 | 369 |
| CBASIC (CP/M 80) | 150 | 94 |
| SID (CP/M 80) | 100 | 75 |

| | List | Sale |
|-------------------------|------|------|
| FOX & GELLER | | |
| Quickcode | 295 | 175 |
| dGraph | 295 | 175 |
| dUtil | 99 | 58 |

| | List | Sale |
|---------------|------|------|
| CONDOR | | |
| Condor 3 | 650 | 319 |

| | List | Sale |
|-------------------------------|------|------|
| GAMMA PRODUCTION, INC. | | |
| Taxwizard 83 (IBM) | 60 | 50 |
| Taxwizard 83 (CP/M) | 50 | 40 |

| | List | Sale |
|------------------|------|------|
| HUMANSOFT | | |
| DBPlus | 125 | 89 |

| | List | Sale |
|--|------|------|
| IUS | | |
| Easy Filer | 400 | 229 |
| Easy Planner | 250 | 179 |
| Easy System II (writer, mailer, speller) | 395 | 239 |

| | List | Sale |
|-----------------|------|------|
| LEXISOFT | | |
| Spellbinder | 495 | 249 |

| | List | Sale |
|--------------------|------|------|
| LIFETREE | | |
| Volkswriter | 195 | 125 |
| Volkswriter Deluxe | 245 | 199 |

| | List | Sale |
|--------------|------|------|
| LOTUS | | |
| 1-2-3 | 495 | 315 |

| | List | Sale |
|--------------|------|------|
| MDBM | | |
| Knowledgeman | 500 | 329 |

| | List | Sale |
|-------------------------|------|------|
| SPECIALS | | |
| DBASE II + Quickcode | 995 | 525 |
| DBASE II + dUtil | 799 | 429 |
| DBASE II + DGraph | 999 | 539 |
| DBASE II + ABSTAT | 1095 | 717 |
| DBASE II + DBASE Window | 949 | 558 |
| DBASE II + WordStar | 1195 | 629 |

WORDSTAR \$248 | dBase II \$389
SuperCalc 3 \$239 | LOTUS \$315
RBASE: 4000 \$345

| | List | Sale |
|--------------------------|------|------|
| METASOFT | | |
| Benchmark Word Processor | 350 | 279 |
| Benchmark Mail List | 250 | 139 |

| | List | Sale |
|----------------------|------|------|
| MICROPRO | | |
| WordStar | 495 | 248 |
| WordStar / MailMerge | 645 | 347 |
| WordStar / SpellStar | 645 | 347 |
| Professional Pak | 845 | 395 |
| InfoStar | 495 | 258 |
| InfoStar - CP/M Card | 695 | 329 |
| WordStar - CP/M Card | 695 | 349 |
| MailMerge | 250 | 129 |
| SpellStar | 250 | 128 |
| CalcStar | 145 | 88 |
| WordStar / Option | 295 | 219 |

| | List | Sale |
|-----------------|------|------|
| MICRORIM | | |
| R Base 4000 | 495 | 345 |

| | List | Sale |
|-------------------|------|------|
| MICROSOFT | | |
| Multiplan | 250 | 169 |
| BASIC Interpreter | 350 | 249 |
| Flight Simulator | 50 | 38 |
| Word/Mouse | 475 | 319 |

| | List | Sale |
|-------------------|------|------|
| MICROSTUFF | | |
| Crosstalk | 195 | 109 |

| | List | Sale |
|---------------------|------|------|
| OASIS | | |
| The Word Plus | 150 | 105 |
| Punctuation & Style | 150 | 99 |

| | List | Sale |
|---------------------------|------|------|
| PEACHTREE SOFTWARE | | |
| Peachpak 4 | 395 | 275 |
| Peachtex 5000 | 395 | 219 |

| | List | Sale |
|--------------------------|------|------|
| PERFECT SOFTWARE | | |
| Perfect Writer | 489 | 249 |
| Perfect Speller | 289 | 159 |
| Perfect Filer | 589 | 249 |
| Perfect Writer / Speller | 695 | 359 |

| | List | Sale |
|---------------------|------|------|
| PETER NORTON | | |
| Norton Utilities | 80 | 58 |

| | List | Sale |
|-----------------------------------|------|------|
| SELECT Information Systems | | |
| Select Word Processor | 295 | 199 |
| SelectWrite | 99 | 79 |

| | List | Sale |
|-------------------------|------|------|
| SOFTWARE SYSTEMS | | |
| Multimate | 495 | 329 |

| | List | Sale |
|---------------|------|------|
| SORCIM | | |
| SuperCalc 1 | 195 | 129 |
| SuperCalc 2 | 295 | 169 |
| SuperCalc 3 | 395 | 239 |

| | List | Sale |
|--------------|------|------|
| SSI | | |
| Word Perfect | 495 | 315 |

| | List | Sale |
|--------------|------|------|
| TYLOG | | |
| dBase Window | 249 | 179 |
| dBase Door | 149 | 109 |

| | List | Sale |
|---------------------------|------|------|
| VISICORP | | |
| VisiOn Graph | 250 | 199 |
| Visicalc IV | 250 | 159 |
| Visicalc Advanced (Apple) | 400 | 249 |

| | List | Sale |
|---------------------|------|------|
| WOLF SYSTEMS | | |
| Move it (IBM) | 150 | 98 |
| Move it (CPM) | 125 | 89 |

CALL FOR PRODUCTS NOT LISTED!

- Purchase orders accepted
 - Prompt UPS service
 - Dealer and institutional discounts
 - Quantity discounts available
 - Call for charges and return policy; Prices may change; No Refunds
- ALL SALES FINAL**

Call today for our free catalog
TO ORDER CALL
(415) 459-1282

TOLL FREE

(800) 533-3012 CA
(800) 533-3011 USA

850 College Ave., Suite #3
Kentfield, CA 94904

In Less Than 3 Minutes

Your IBM Model 50, 60, 65, 75, or 85
Electronic Typewriter
can be an RS232C PRINTER or TERMINAL



CALIFORNIA MICRO COMPUTER Models 5060 and 5061 can be installed easily and require NO modifications to the typewriter.

For additional information contact:

CALIFORNIA MICRO COMPUTER
17791 Jamestown Lane Huntington Beach, CA
92647 (714) 848-3947

NEW!!

SPECIAL INTRODUCTORY OFFER

COPY COVER

DUST COVER & COPY HOLDER - PATENT PENDING -

CUSTOM FIT FOR
IBM PC XT
JR

COLUMBIA • APPLE
RADIO SHACK COCO
COMMODORE 64 • VIC 20
DEC RAINBOW • KAYPRO
TI99 • OTHER MODELS

\$39.95



COPY HOLDER DIRECTLY
IN FRONT OF OPERATOR
FOR GREATER TYPING
SPEED, ACCURACY, AND COMFORT

- Holds documents and copy up to 11 x 14 1/4".
- Easily the most attractive cover on the market today.
- Protects keyboard from dust and dirt. Static-free.
- Clips on and off in seconds.
- Made of sturdy clear Lucite™
- Quantity discounts available.



COPY COVER
6351 LK. WORTH RD.
LK. WORTH, FL 33463
SUITE #111

Ordering Information: Check, Money Order (payable to Copy Cover) Visa, MasterCard. No COD. Add \$3 shipping per order. Florida residents add 5% tax. State make and model of computer. Credit card orders state card # and exp. date.

Software Received

system is compatible with Unix and provides powerful general-purpose tools for constructing and maintaining programs, as well as solving particular application problems. Floppy disk, \$500. Mark Williams Company, 1430 West Wrightwood Ave., Chicago, IL 60614.

Colography, a color-graphics editor. You can create color-graphics images for business and sales presentations on screen. Programmers can write color-graphics programs. Features include the ability to duplicate, flip, move, paint, rotate, and scale the geometric patterns you create. Floppy disk, \$99.95. Cactus Software Inc., POB 880, Peoria, AZ 85345.

Customizer, a utility program that helps you customize your Wordstar version 3.24 program by adjusting preset values or defaults to your specific editing parameters. These patches include adjustment of justified margins, top and bottom margins, single-spacing, page numbers, and more. You can always change them back to the original defaults. Floppy disk, \$59.95. Computer Handholding, 1800 Market St. #91, San Francisco, CA 94102.

Disk Mechanic, a utility tool kit. You can analyze, preserve, repair, modify, and back up disks. The program can measure the rotation speed of any floppy-disk drive and control critical timing parameters such as drive-stepping rate and head-load time. Damaged portions of a disk can be read and copied. It also issues terse or detailed diagnostic reports. Floppy disk, \$73. MLI Microsystems, POB 825, Framingham, MA 01701.

EpsLst, a listing program for printers. Designed for both

business and home purposes, this program lets you compact printed information such as address files, source codes, telephone lists, and text for documentation into 12 columns across the page to include as many as 840 items. Saves lots of paper. Floppy disk, \$18. On Disk Software, POB 382, Lincoln, MA 01773.

Health Risk Assessment, a statistical-analysis package. This program plots any individual's future life expectancy by amassing vital statistics such as personal habits, past and family medical histories, occupation, and other factors. Suggestions are then given for improving longevity through modification of personal health habits. Floppy disk, \$59.50. Medmicro, POB 9615, Madison, WI 53715.

Innovative Mailing System, a mailing program for use both in business and at home. Features include adding and deleting names to and from files, changing existing records, and printing in alphabetical, mail-key, and numerical order. You can combine names and addresses with text to process form letters. Floppy disk, \$36.75. Hi-Tech Services, POB 370, Dunkirk, MD 20754.

Matrix Master, a BASIC ROM extension package. You can call the standard matrix operations from BASIC sub-routines. Features include abilities to add, subtract, multiply, transpose, inverse, identify, perform scalar arithmetic operations, and set matrix to a constant. Two load files are available and chained through an executive. Floppy disk, \$34.95. PAB Software Inc., POB 15397, Ft. Wayne, IN 46885.

Next Step, an applications-generator package. This business package lets you design

Would you buy an
electronic daisy wheel printer
that prints at a bi-directional
36 cps, has a standard 2K buffer
(expandable to 48K), subscript,
superscript, bold typing, carrier
feed in units of 1/120 inch,
forward/reverse paper feed in
units of 1/48 inch, emulates the
Diablo 630*, and *only* costs \$1295
?

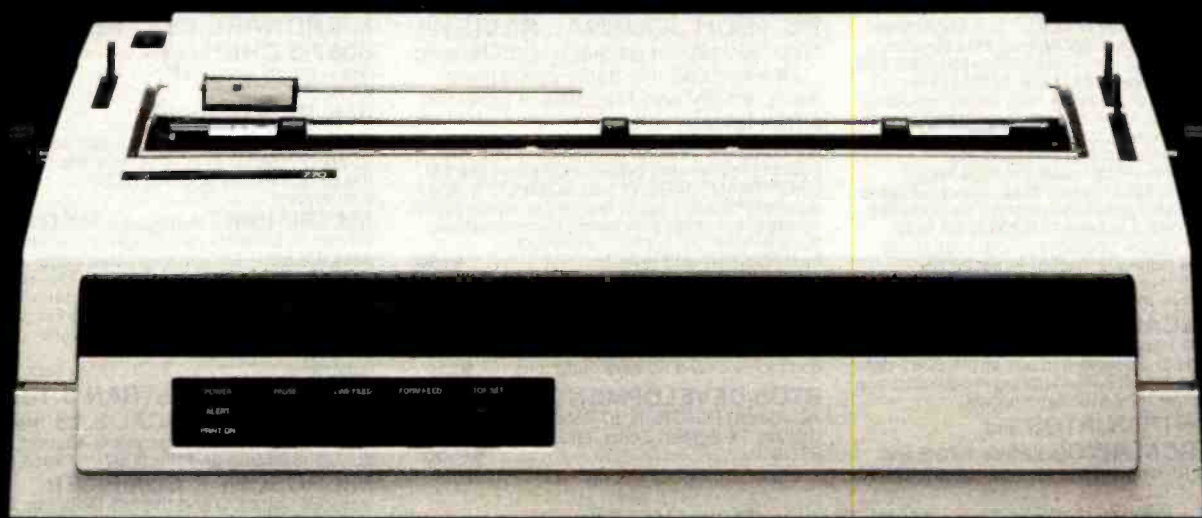

Then go buy a Silver-Reed EXP 770.

 **SILVER REED**

Silver-Reed America, Inc., 19600 S. Vermont Ave., Torrance, CA 90502 (213) 516-7008 (800) 421-4191 Inside Calif. (800) 252-7760

*Diablo is a trademark of XEROX Corp.

Circle 328 on inquiry card.

a custom package to your own specifications in a four-part process without knowing how to program. You create the database, enter information into the application, and create and run reports. Floppy disk, \$345. Execuware, 7415 Pineville-Matthews Rd., Suite 300, Box 10, Intercontinental Plaza, Charlotte, NC 28211.

Pac-Man, an arcade game. Fashioned after the video game, you try to consume as many dots as possible while avoiding goblins. Munch an energy dot and you can eat everything in sight, including the goblins. Win extra bonus points by eating the flashing dots. Floppy disk, \$34.95. Atari Inc., 1265 Borregas Ave., POB 427, Sunnyvale, CA 94086.

Personal Cobol, a utility package consisting of pro-

grams that provide powerful and easy-to-use facilities for creating, testing, and running sophisticated business programs written in full ANSI '74 Level II COBOL. Floppy disks, \$399. Micro Focus, Suite 400, 2465 East Bayshore Rd., Palo Alto, CA 94303.

Prolock, a copy-protection system. You can copy-protect individual files or an entire disk. The program marks files and only an operator who has the Prolock disk can use the marked software. The protection is invisible to the user. Bit or nibble copiers are rendered ineffective. Floppy disk, \$9.95. Vault Corp., Suite 500, 2649 Townsgate Rd., Westlake, CA 91361.

Rattenmund, a logical adventure game in which you use complete sentences in plain English to try to escape from

the city. Solve the puzzles, recognize opportunity, and avoid the elements while you struggle with vicious rats, poisonous snakes, a lecherous doctor, and a neurotic but heroic cat. Floppy disk, \$39.95. Wallace Associates, 934 Hunter Rd., Wilmette, IL 60091.

Robotron: 2084, an arcade-type game. It is the year 2084, and a robot revolt is going on. You are the only one that can defend humanity by resisting their mutant reprogramming. Beware of the grunts, brains, tanks, sheroids, electrodes, and especially the Hulk, who is immune to your laser. Floppy disk, \$34.95. Atari Inc. (see address above).

Salestaxfile, a business-indexing program that maintains sales-tax information and includes a 235-location

sales-tax file. Features include a comprehensive file maintenance to add, change, and delete locations; file printouts and displays in a variety of formats; and backup and recovery. Floppy disk, \$125. RJL Systems, 106 New Haven Ave., Milford, CT 06460.

Screen Saver, a collection of preventive-maintenance and protection programs. For use in protecting your screen from phosphor burnout, one program will turn your screen off automatically after a period of inactivity. It operates independently of application programs and operating systems. Other programs include a disk timer, memory test, disk-drive and disk tester, and a drive-cleaning utility. Floppy disk, \$19.95. Logical Systems Corp., Route 1, Box 253, St. Michael, MN 55376.

IBM PC 8087 SUPPORT FROM MicroWare

87FORTRAN/RTOS™ is a MicroWare adaptation of the Intel Fortran-86 compiler, a full ANSI-77 subset with 8087 extensions and overlays. It generates in line 8087 code allowing use of all 8087 data types, including 80 bit reals and 64 bit integers. The complete subset I/O is supported including Internal and External Files and List Directed I/O. 87FORTRAN/RTOS uses the Intel large memory model, allowing data/code structures which utilize the full megabyte. The compiler provides direct access to 8088 ports and supports logical operations on 8 and 16 bit operands normally treated in assembly language. It is ideal for large applications which are number intensive or control hardware.

87PASCAL/RTOS™ is Intel's ISO-Standard Pascal with 8087-8088 exceptions. These make it possible to use all the 8087 data types directly, while generating modules in one of the three Intel Memory Models.

87FORTRAN/RTOS and **87PASCAL/RTOS** include RTOS and support for one year. each \$1350

RTOS — Real Time Multi-Tasking/Multi-User Executive

RTOS is a MicroWare configured version of iRMX-86, Intel's legendary operating system. It includes the Intel Assembler, ASM-86, which supports the 8086, 8087, 8088 and 80186. All modules produced by the compilers or ASM-86 are linked, loaded and managed with LINK-86, LOC-86, LIB-86 and OH-86. These utilities support relocatable or absolute code, generate Intel Hexcode (when needed), and allow overlays. RTOS/ASM-86/LINK-86/LOC-86/LIB-86/OH-86 \$600

iRMX-86, LINK-86, ASM-86, LOC-86, OH-86, LIB-86, Pascal-86, Fortran-86 and PL/M-86 are trademarks of Intel Corp. IBM PC is a trademark of IBM Corp.

PC TECH JOURNAL REVIEW: "The MicroWare package is preferable ... it executes the basic operations more rapidly and MicroWare provides a free update service."

87BASIC™ includes patches to the IBM Basic Compiler and both runtime libraries for USER TRANSPARENT and COMPLETE 8087 support. Provides super fast performance for all numeric operations including trigonometrics, transcendental, addition, subtraction, multiplication, and division. \$150

87MACRO™ - our complete 8087 software development package. It contains a "Pre-processor," source code for a set of 8087 macros, and a complete object library of commonly called numeric functions. \$150

RTOS DEVELOPMENT PACKAGE includes 87FORTRAN, 87PASCAL, PL/M-86, Utilities, TX Screen Editor, and RTOS. \$2500

MICROWARE BEST SELLERS!

- 8087-3 CHIP** in stock with 180 day warranty and 8088 exchange **\$175**
- 64K RAM Upgrade** **\$64**
- FASTPAK™+8087** includes one runtime library (87BASIC or 87MACRO), the 8087 chip, the 87/88GUIDE, and installation instructions **\$325**
- MATRIXPAK™** manages a **MEGABYTE!** Written in assembly language, our runtime package accurately manipulates large matrices at very fast speeds. Includes matrix inversion and the solution of simultaneous linear equations. Callable from MS Fortran 3.13, MS Pascal 3.13, and MicroWare 87MACRO, 87BASIC, and RTOS compilers each **\$150**
- MICROSOFT FORTRAN 3.13**
- MICROSOFT PASCAL 3.13** These new IEEE compatible compilers support both double precision and the 8087 each **\$259**
- MICROSOFT C COMPILER** includes Lattice C and the MS Librarian. **\$350**
- Float 87 for MS C **\$125**
- Multitool Word **269**
- Microsoft Business Basic Compiler **495**
- SuperSoft Fortran **340**
- SSS 8087 Support **50**
- SuperSoft Voice Drive **895**
- TRACE86 Utility **125**
- Computer Innovations C86 **345**
- STSC APL★PLUS/PC **545**
- 64K QUADRAM **349**
- SANDSTAR 64K Card **275**
- Sandstar WS2 Hard Disk System **1355**
- HALO Graphics **125**
- Graphmatic **95**
- Energraphics **225**
- Anderson-Bell Abstat **345**
- Draft-Aide **595**

MicroWare

P.O. Box 79
Kingston, MA
02364
(617) 746-7341

You Can Talk To Us!

Have we got an ear-full for you.

Votrax voice synthesizers let your computer talk to you in a world of sound.

Now your ears are as important as your eyes when working with your computer. With a **Votrax** voice synthesizer your computer talks, and it talks to you in a world of sound you never thought possible.

Votrax was one of the first pioneers in the field. The **Votrax SC-01A** speech chip is state of the art, the one many other manufacturers use in their own equipment.

What it means to you is unparalleled speech capability. **Votrax** voice synthesizers pronounce words by using their basic building blocks rather than utilizing a vocabulary of a few hundred words. It assures you of an unlimited vocabulary. And an unlimited range of sounds: from jet planes to an advanced musical range.

Best of all, **Votrax** speech synthesizers are "smart," requiring no computer memory for operation. Your computing capacity stays free for other tasks. Small in size yet surprisingly economical, **Votrax** voice synthesizers are sophisticated pieces of equipment that hook-up in seconds.

Mix speech or sound, program sound frequencies or amplitude levels, or compose your own music with either the **Votrax Type 'N Talk™** or **Personal Speech System**.

Ideal for business, school, handicapped use or the home, **Votrax** voice synthesizers put a world of sound in your computer.

See your local computer retailer or call toll free for more product, warranty or ordering information: 1-800-521-1350 (in Michigan call 313-588-0341). Dealer inquiries welcome.

10 OPEN 1,2,0, CHR \$(6)
20 INPUT A\$
30 PRINT #1, A\$
40 GOTO 20



10 OPEN 1,2,0, CHR\$(6)
20 INPUT A\$
30 PRINT #1, A\$
40 GOTO 20

Votrax[®], INC.

1394 Rankin • Troy, Michigan • 48063-4074

Circle 240 on Inquiry card.

Scrollmate, a screen-display utility. The program creates a buffer in memory that can hold up to 14 screens on line. The screens or lines can be scrolled up or down with DOS commands or your own programs. Screens can be called to provide a window on display memory or printed. Floppy disk, \$69.95. Inner Loop Software, Suite 120, 5456 McConnell Ave., Los Angeles, CA 90066.

Softmaker II, a Microsoft BASIC program-generator package. This program lets you write BASIC database programs without previous programming experience. The modular, compact programs are easily modifiable and save program memory by using as little disk space as possible. Floppy disk, \$89.95. Rio Grande Software, 705 North Calhoun, POB 77, West Liberty, IA 52776.

Star Fleet I, a space-battle strategy game. You are an officer of Star Fleet. Work your way up to Admiral by defeating the Krellan and Zaldrion invaders. As your abilities improve, you automatically receive more challenging missions and are awarded decorations for outstanding performances. Floppy disk, \$49.95. Cygnus, POB 57825, Webster, TX 77598.

Tax Relief II, a business-tax preparation package. This program helps you calculate taxes using 24 schedules and forms and automatically selects the most advantageous method. Features include tax calculations, carry-overs, data-entry editing, reviewing, printing returns, batch printing, and updates. Floppy disk, \$299. Micro Vision, 145 Wicks Rd., Com-mack, NY 11725.

Ultima II, a fantasy role-playing game. In this sequel, you avoid the revenge of Minax,

the enchantress of evil. In so doing, create your own characters with varying amounts of such attributes as strength, agility, stamina, charisma, wisdom, and intelligence. Cast spells, explore dungeons, seize ships, and meet Lord British. Floppy disks, \$59.95. Sierra On-Line Inc., Sierra On-Line Building, Coarsegold, CA 93614.

Ultrafile, a database-management package for home and business uses. With little or no computer experience, you can retrieve, calculate, display, report, and make many kinds of graphs using the three programs for filing, reporting, and graphics. Floppy disks, \$195. Continental Software, 11223 South Hindry Ave., Los Angeles, CA 90045.

Wordvision, a word-processing program. You can create, revise, store, format, and print text for a variety of needs. Features include instant response, separate control panels, an indexed guide, and customized key labels or slip-on keytops for quick reference. Floppy disk, \$79.95. Bruce & James Program Publishers Inc., The Wharfside Building, Suite 357, 680 Beach St., San Francisco, CA 94109.

Word Wiggle, an educational word game. This program pits you against the computer in a race against time to see who can find the most words in a four-by-four grid of letters. Eleven skill levels and a 30,000-word dictionary develop vocabulary skills. Floppy disk, \$29.95. The Software Toolworks, Suite 1118, 15233 Ventura Blvd., Sherman Oaks, CA 91403.

Other Computers

Armer Balloon, an arcade-

type game. The year is 3249 and aliens are attacking you again. Earlier you eluded their fire, but now the defense shield barriers are broken by their armor dirigibles resembling balloons. Destroy the balloons before they destroy you. For the Toshiba T-100; floppy disk, \$34.95. J.W. Computers, 2655 West Guadalupe Rd. #7, Mesa, AZ 85202.

Decision Maker, an evaluation program for making informed decisions. For business and home uses, this program uses analytical procedures while you state the problem, list the alternatives, and weigh the options. You get an optimum solution based on your input. For the TRS-80 Color Computer; cassette, \$24.95. Armadillo International Software, POB 7661, Austin, TX 78712.

Firefly.Com, a puzzle game. Collect as many fireflies as you can and place them in the jar. With their flickering light, solve clues at the bottom of the jar to guess the quote. Capture all 20 fireflies and the quote appears. For the Heath/Zenith H-/Z-89; floppy disk, \$20. Friendli-ware, POB 21206, Lansing, MI 48909.

Shamus, an arcade-type game. As Shamus, you must reach the core of the Shadow's lair and destroy him. Explore four floors, each with 32 rooms, destroying guards along the way to defend your life. For the Texas Instruments TI 99/4A; ROM cartridge, \$44.95. Atari Inc., 1265 Borregas Ave., POB 427, Sunnyvale, CA 94086. ■

This is a list of software packages that have been received by BYTE Publications during the past month. The list is correct to the best of our knowledge, but it is not meant to be a full description of the product or the forms in which the product is available. In particular, some packages may be sold for several machines or in both cassette and floppy-disk format; the product listed here is the version received by BYTE Publications.

This is an all inclusive list that makes no comment on the quality or usefulness of the software listed. We regret that we cannot review every software package we receive. Instead, this list is meant to be a monthly acknowledgment of these packages and the companies that sent them. All software received is considered to be on loan to BYTE and is returned to the manufacturer after a set period of time. Companies sending software packages should be sure to include the list price of the packages and (where appropriate) the alternate forms in which they are available.

BYTE's Bits

Master's in Computer Education Program

A program leading to a Master's degree in computer education and training has been announced by Trinity College. This 33-credit program has three areas of emphasis: technical competency, planning for computer use in learning environ-

ments, and designing computer-based curricula and learning materials.

For more information, contact Deborah Blank, Education Department, Trinity College, Michigan & Franklin Ave. NE, Washington, DC 20017, (202) 269-2374. ■

Let your PC pick a printer.

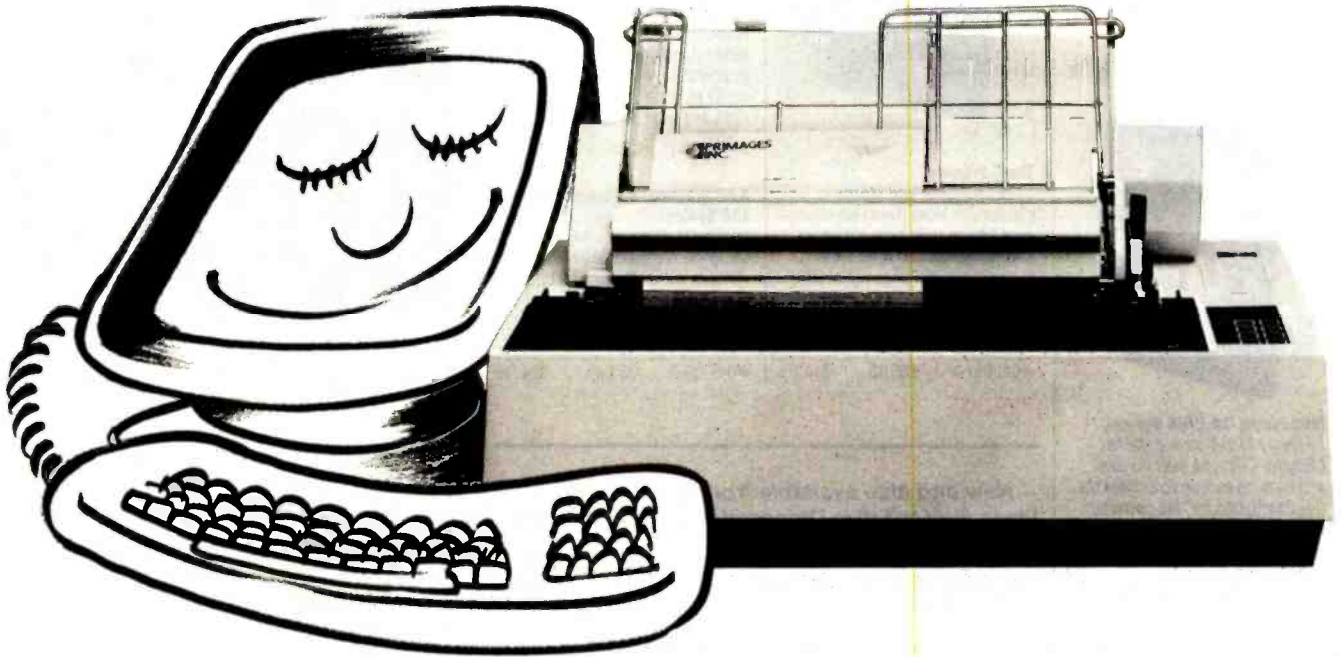

Primage I

When you bought your IBM Personal Computer, you meant business. And if you let your PC choose the best business printer to provide letter quality printing at high production speeds, its first choice would be Primage I.

That's because when all the facts are entered, the Primage I with PAGEMATE I* sheet feeder, gives you more for your money than any other daisy system—45 cps, heavy duty, letter quality printing, with automatic sheet feeder, for hundreds of dollars less than its closest competitor.

The lower cost and higher performance are all made possible by a totally new control technology that allows simple, inherently more reliable stepping motors to run at much higher speeds. The design eliminates lots of parts that you find in other serial printers. Parts you don't

have to pay for and, just as important, parts you don't have to maintain. Primage I features simplified controls, easy paper feeding and a wide choice of fonts. It also comes with a unique 100-spoke daisy wheel that provides switch selectable multiple languages, and an easy access, easy set-up interface that connects in seconds to IBM PCs, PC compatible micros and other popular personal computers.

When you compare Primage I with top quality daisy printers and sheet feeders that cost up to 50% more, we're confident you'll make the same choice your computer would. So come into your computer dealer today for a first hand demonstration. Or contact us for detailed product literature. Primages Inc., 620 Johnson Ave., Bohemia, NY 11716 (516) 567-8200.

*PAGEMATE is a trademark of Primages, Inc.

 **PRIMAGES
INC.**



**Ciarcia's Circuit Collar—
Volume IV**

by **Steve Ciarcia**. A new slew of buildable electronic projects from this famous workshop. Includes an interactive video disc controller, the Microvox text-to-speech synthesizer, an IBM compatible computer, and more!

#010966-4 256 pp. \$18.95



Introducing the UNIX System
by **Henry McGilton and Rachel Morgan**. Gets you over hurdles and hazards as it unscrambles the documentation for this powerful new tool and leads you to a perfect understanding of how best to use its remarkable features.

#045001-3 576 pp. \$18.95

Guide to the IBM Personal Computer
by **Walter Sikonowiz**. Goes beyond the manuals to help you exploit the full power of your IBM PC. Features DOS 2.0 and BASIC 2.0, and includes details on the new system architecture and expansion capabilities.

#057484-7 352 pp. \$19.95

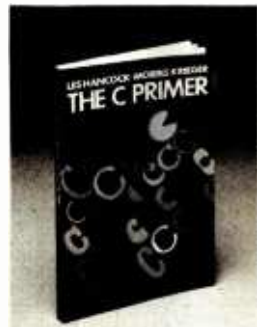

The C Primer
by **Les Hancock and Morris Kreiger**. Provides hands-on experience that enables both old hands and "C" novices to write better programs in the language of UNIX. "Clear and succinct... a book that really works." — *Personal Computing*

#025981-x 256 pp. \$14.95

**Other new titles
from McGraw-Hill**

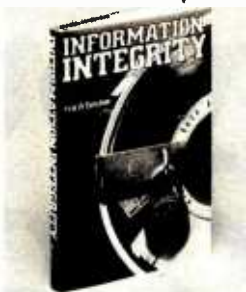

Information Integrity: A Structure for its Definition and Management
by **Hal B. Becker**. How vulnerable is your electronically stored business information to accidental loss or alteration, or deliberate fraud or theft? Here's how to recognize risks and head off dangers.

#004191-1 256 pp. \$26.95

A Programmer's View of the Intel 432 System
by **Elliott I. Organick**. All about using the revolutionary new advance in computer architecture — the iAPX 432 "mainframe on a micro" chip — for all those programming in Ada or Pascal.

#047719-1 352 pp. \$24.95

— **New and also available from McGraw-Hill —
these authoritative Datapro/McGraw-Hill guides**

| | | | |
|-----------------|-----------|---------|---------|
| APPLE SOFTWARE | #015403-1 | 256 pp. | \$19.95 |
| IBM PC SOFTWARE | #015424-4 | 256 pp. | \$19.95 |
| CP/M SOFTWARE | #015404-X | 256 pp. | \$19.95 |

**Latest in the ever-popular, ever-helpful
WEBSTER BUYER'S GUIDE series...**



Software Buyer's Guide
Selecting microcomputer software could be your Waterloo without these facts about today's 50 top-selling programs for spreadsheets, word processors, data base managers, communications packages, and integrated packages.

#068967-9 352 pp. \$19.95

Terminals and Printers Buyer's Guide
You've chosen your computer — now simplify the search for other hardware options. Here's what you should know to find the right price/performance trade-off among 150 major products to upgrade your system.

#068968-7 320 pp. \$19.95

Microcomputer Buyer's Guide, 3rd Ed.
To help you make sense of 500 available products — hardware, software, peripherals — here are full, in-depth details. The machines covered even include the latest — the Coleco Adam, the IBM PCjr, and the Macintosh from Apple.

#068963-6 384 pp. \$19.95

Office Automation & Word Processing Buyer's Guide
Direct comparisons of features and potentials, to help you choose the right system for every size business or special need — from electronic typewriters to communications networks.

#068962-8 320 pp. \$19.95

Available wherever computer books and products are sold.

For dealer info, call E. Crawford (212) 512-3601.
Other customers, call (609) 426-5254 (VISA & M/C accepted).

BYTE BOOKS

**...for hands-on help
when the chips are down**

Using your micro for business? For pleasure? In your profession? Whatever your computer connection, get hands-on help from the most trusted name in the field — **BYTE BOOKS**.

BYTE BOOKS are designed to make the most of your computer power. How? By giving you guidance from dedicated, expert authors — with names you recognize. By providing practical, usable information written for people, not machines. By offering problem-solving techniques, not dry theory. And all in handy, high-quality formats... at prices you can afford.



BYTE BOOKS
User-friendly microcomputer information

1221 Ave. of the Americas, Suite 26-1, New York, NY 10020

April 1984

April

Continuing Engineering Education Courses, Washington, DC, Orlando, FL, and San Diego, CA. More than 300 courses for practicing computer and information-processing professionals are offered by George Washington University. A few of the titles include "Mathematical Software for Scientific and Engineering Applications," "An Applications-oriented Approach to Artificial Intelligence," and "Minicomputers, Microcomputers/Processors for Nonelectrical Engineers." Fees range from \$625 to \$875. Contact Continuing Engineering Education, School of Engineering and Applied Science, George Washington University, Washington, DC 20052, (800) 424-9773; in the District of Columbia, (202) 676-8522.

April

Courses in C Language and Unix, various sites throughout the U.S. Three five-day courses are offered: "C Programming Workshop," "Advanced C Topics Seminar," and "Unix Workshop." For complete details, contact Joan Hall, Plum Hall Inc., 1 Spruce Ave., Cardiff, NJ 08232, (609) 927-3770.

April-June

Productivity '84, various sites throughout the U.S. This series of two-day programs serves as a showcase of Hewlett-Packard products. Seminars are available, and more than 25 products are to be demonstrated, including the HP 150 personal computer and laser printers. Admission is free. For more information, contact Hewlett-

Packard, Public Relations Department, 3000 Hanover St., Palo Alto, CA 94304, (800) 554-4466.

April-June

Seminars from the Continuing Education Institute, various sites throughout the U.S. Among the seminars offered are "Correlation and Spectral Analysis for Engineering and Scientific Applications," "Database Machines: An Overview," and "Peripheral Array Processors." For complete information, contact Continuing Education Institute, Oliver's Carriage House, 5410 Leaf Treader Way, Columbia, MD 21044, (301) 596-0111; in California, (213) 824-9545.

April-June

Seminars from Datapro Research Corporation, various sites throughout the U.S. Subject areas include data communications, microcomputers, and information systems. In-house presentations of technical programs can be arranged. For a 40-page catalog of seminars, contact Datapro Research Corp., 1805 Underwood Blvd., Delran, NJ 08075, (800) 257-9406; in New Jersey, (609) 764-0100.

April-June

Understanding Microprocessor-based Equipment and Troubleshooting, various sites throughout the U.S. This comprehensive four-day seminar provides a background in microprocessor fundamentals and troubleshooting techniques for technicians and engineers. Equipment familiarization and hands-on experimentation are emphasized. On-site presentations can be arranged. For information, contact the Registrar, Micro Systems Institute, Garnett, KS 66032, (913) 898-6152.

April-July

Reliability and Maintainability Engineering Institutes and Short Courses, various sites throughout the U.S. A few of the programs to be offered are "Reliability Engineering, Testing, and Maintainability Engineering" and "Mechanical Reliability and Probabilistic Design for Reliability—The Stress/Strength Interference Approach to Designing a Desired Reliability into Components and Equipment." For a complete schedule, contact Dr. Dimitri Kececioglu, College of Engineering, Aerospace and Mechanical Engineering Department, University of Arizona, Tucson, AZ 85721, (602) 621-2495.

April-August

Compuworkshops Computer Seminars for Educators, various locations throughout California. Among the seminars offered are "Authoring Tools and Word Processing for Educators," "BASIC Programming for Educators," "Designing Educational Courseware," "Computer Literacy for Educators," and "How to Set up a Computer-based Education Program in Your School or District." The fee is \$50 per course. For details, contact Compukids of Seal Beach, Rossmoor Shopping Center, 12385 Seal Beach Blvd., Seal Beach, CA 90740, (213) 430-7226; West Los Angeles, (213) 473-8002; Tarzana, (213) 343-4008; Rancho Bernardo/San Diego, (619) 451-1742.

April-August

Conferences and Expositions from the Society of Manufacturing Engineers, various sites throughout the U.S. and around the world. More than 25 conferences and expositions are scheduled. For a calendar, contact the Public Re-

lations Department, Society of Manufacturing Engineers, One SME Dr., POB 930, Dearborn, MI 48121, (313) 271-0777.

April-September

Computer Competence Seminars, Boston University Metropolitan College, Boston, MA. This series of hands-on presentations is tailored for managers who know little or nothing about computers and for those who wish to sharpen current skills. Some of the seminars on the docket are "The Complete Beginners Guide to Personal Computers," "PCs for Improving Financial Analysis and Decision Support," and "Personal Computers for Sales and Marketing Professionals." Fees range from \$225 to \$595. In-house programs can be organized. For details, contact Joan Merrick, University Seminar Center, Suite 415, 850 Boylston St., Chestnut Hill, MA 02167, (617) 738-5020.

April-October

Tutorial Short Courses from Hellman Associates, various sites throughout the U.S. Among the courses offered are "VLSI Design," "Digital Control," and "Error Correction." Fees are generally \$895. For a descriptive brochure, contact Hellman Associates Inc., Suite 300, 299 California Ave., Palo Alto, CA 94306, (415) 328-4091.

April 10-11

Business Expo & Conference '84, Convention Center, San Jose, CA. A few of the more than 30 workshops, seminars, and panel discussions that have been scheduled include presentations entitled "Handling Training Crisis in Office Automation Explosion," "How to Select Small Business Computers," and

"Managing Your Small Business." Complete details are available from Expo '84 Management, Carlidge & Associates Inc., Suite 205, 4030 Moorpark Ave., San Jose, CA 95117, (408) 554-6644.

April 11-12

Global Teleconferencing Symposium, Hilton Hotel, Washington, DC. This program is designed to provide teleconferencing information to top-level decision makers from government agencies and private industries. Issues include federal-telecommunications policy trends, human factors in the teleconferencing process, and training systems users. An exposition of products and services will run concurrently. For information, contact National Trade Productions Inc., 9418 Annapolis Rd., Lanham, MD 20706, (800) 638-8510; in Maryland, (301) 459-8383.

April 12-14

Carolina Computer Show, Civic Center, Charlotte, NC. Manufacturers, distributors, and retailers will display hardware, software, accessories, and services. Address inquiries to L & J Associates Inc., POB 53729, Fayetteville, NC 28305, (919) 323-4713.

April 12-14

Computers and Writing—Research and Applications, University of Minnesota, Minneapolis. Papers and panel discussions will focus on local-area networks and empirical studies of writer's behavior. Demonstrations of hardware and software are planned. For further information, contact the Program in Composition and Communication, University of Minnesota, 209 Lind Hall, 207 Church St. SE, Minneapolis, MN 55455, (612) 373-2541.

April 12-15

Computer and Communication Expo, Convention Hall Exposition Complex, Asbury Park, NJ. Contact Tom Gasque, Computer and Communication Expo, CereX Marketing, Convention Hall, Asbury Park, NJ 07712.

April 12-15

The Third Annual St. Louis Computer Showcase Expo, A. J. Cervantes Convention Center, St. Louis, MO. More than 100 national and local vendors will exhibit computers, word-processing equipment, associated peripherals, software, and services. Elementary and advanced seminars will be available. Admission is \$7.50. For details, contact The Interface Group Inc., 300 First Ave., Needham, MA 02194, (800) 325-3330; in Massachusetts, (617) 449-6600.

April 13-14

The Fourteenth Annual Virginia Computer User's Conference—VCUC-14, Sheraton Hotel, Blacksburg, VA. This conference is sponsored by the Virginia Tech Student Chapter of the Association for Computing Machinery and the computer science department of Virginia Tech. Topics include modeling and simulation, STARS and Japanese fifth-generation computers, and microcomputers. For information, contact Suzanne Nagy or Roger Goff, VCUC-14, 562 McBryde Hall, Virginia Tech, Blacksburg, VA 24061.

April 13-15

The International Personal Robotics Congress and Exposition 1984—IPRC '84, Convention Center, Albuquerque, NM. International corporations and high-technology executives can view

Our specialty: 68000, 6809 CPU, graphic, database, communication, export

Come visit us in our New York City Showroom. *IBM COMPATIBLE

| PRINTER | |
|---------------------|--|
| MICRO-PRISM | 110 cps, 84 x 84, graphic... 415 |
| EPSON | RS-232/parallel, pin & friction FX-80, FX-100, LQ1500 |
| BANANA | 50 cps... 205 |
| OKIDATA | Full Line... CALL |
| PRISM 132 | 200 cps, 132 col... 1,100 |
| TOSHIBA | 160 cps max 24-wire head... excellent letter quality... 1,550 |
| GEMINI | Delta 10... 525 |
| PANASONIC | CP1090 80 cps... 350 |
| DIABLO | P38 400 cps, 132 col... 1,795 |
| M.T. | Spirit 80 cps... 350 |
| *Letter Quality* | |
| NEC | 2050 20 cps for IBM... 965 |
| | 3550 35 cps for IBM... 1,725 |
| | 7710 55 cps for serial... 2,150 |
| DYNAX | HR25 23 cps parallel... 799 |
| | DX15 13 cps... 475 |
| COMREX | Comwriter II... 499 |
| C.I.TOH | F-10 40 cps Excellent... 1,075 |
| | A-10 18 cps... 570 |
| DIABLO | 630 API w/interface... 1,785 |
| QUME | 11+ 40 cps... 1,350 |
| | 50 cps... 1,550 |
| STAR | Letter Type 18 cps... 399 |
| TRANSTAR | 315 graphic... 479 |
| MODEMS | |
| HAYES | Smartmodem 300/1200 bps 499 |
| | Micromodem II w/software... 270 |
| NOVATION | Smartmodem 300/1200 bps 415 |
| | Access 1-2-3 w/crosstalk... 430 |
| LEXICON | 300 bps acoustic coupler... 125 |
| USR | Password 1200/300... 339 |
| DCA | IRMA Board for IBM PC-IBM3270 |
| KEYBOARD WITH MODEM | |
| Zenith ZT-1, ZT-11 | CALL |

| COMPUTER | |
|-------------|---|
| COLUMBIA | * 128K RAM, two floppies, monitor keyboard, softwares |
| CORONA | * 128K RAM, two drives, 640 x 325 graphic, monitor, MSDOS, PC TUTOR MultiMate word processing, BASIC |
| EAGLE | * PC2, PC+, SPIRITXL 128K RAM |
| EPSON | 256K RAM, monitor, |
| QX-10 | * keyboard, two floppies printer, CP/M, Valdocs IBM compatible option |
| NEW LEADING | * 128K RAM, two drives software |
| EDGE | |
| SANYO | * MBC 550, 555 |
| TELEVIDEO | * 1605 128K RAM |
| ZENITH | * Dual drives, Color |
| NEW | 128K RAM, graphic |
| CROMEMCO | * C-10 64K RAM, monitor, Z-80 CPU keyboard, software |
| DEC | 64K RAM, Z-80 & 8088 CPU, |
| RAINBOW | monitor, CP/M |
| NEC | Color APC 128K RAM |
| APC | Dual 8" drives |

| POWERFUL 68000 CPU | |
|---|---|
| Cromemco | 512K RAM 68000 & 4120 |
| CS1D5 | Z80 & two floppies |
| DUAL | 68000 CPU, 80MB SMD hard disk intelligent I/O, UNIX, Database |
| WICAT | 1 to 12 users, 68000 CPU, 256K to 4.5MB RAM, 10MB to 474MB hard disk, graphic |
| ALTOS, NORTHSTAR, OSM SWTPC, VAX, CORVUS | |

| PLOTTER/DIGITIZER | |
|--------------------|---------------------------|
| HOUSTON INSTRUMENT | DMP 29... CALL |
| | DMP 40... 795 |
| | DMP 41, DMP 42... CALL |
| | HIPAD digitizer... 725 |
| AMDEK | AmPlot II 6 pens... 1,095 |
| COMREX | CR1810... 545 |
| MT PLOTTER | PIXY-3 3 pens... 650 |

| TERMINAL/MONITOR | |
|----------------------------------|---------------------------------|
| ZENITH | Z-29 smart terminal. BEST PRICE |
| ZVM 135 | *RGB color/green monitor... 475 |
| ZVM 123 | *green monitor... 119 |
| | 124 22 MHZ, for IBM... CALL |
| Amber Monitor: Panasonic, Comrex | |
| HAZELTINE | Esprit II... 560 |
| | Esprit III... 625 |
| WYSE | 50 14" 80/132... 585 |
| VISUAL | 55... 725 |
| | VT-100/VT-102 compatible... 895 |
| QUME | 103 132 col... 890 |
| | Graphic terminals... CALL |

| PORTABLE ON-THE-GO | |
|--|--|
| Columbia, Corona, Eagle Televideo, Zenith, NEC PC 8021, Toshiba T-100 | |

Prices subject to change. American Express, Visa/Mastercard add 3%. F.O.B. point of shipment. 20% restocking fee for returned merchandise. Personal checks take 3 weeks to clear. COD on certified check only. N.Y. residents add sales tax. Manufacturers' warranty only. International customers, please confirm price before order. Accept P.O. from Fortune 500, schools and gov't.

Computer Channel **TELEX: 429418**
 21-55 44th Road
 Long Island City, NY 11101
 For information CALL (212) 937-6363
 To order CALL 1-800-331-3343

Computer Channel

The Rixon PC212A... The Perfect Modem For Your IBM® PC ...Only \$499

The Rixon® PC212A offers you the only 300/1200 BPS full duplex card modem with auto dial and auto answer that plugs directly into any of the IBM PC®* card slots. Because the Rixon PC212A was designed specifically for the IBM PC, it is loaded with user benefits.

The PC212A eliminates the need for an asynchronous communications adapter card and external modem cable, this alone saves you approximately \$190. The PC212A provides an extra 25 pin EIA RS232 interface connector, a telephone jack for alternate voice operation, and a telephone line jack for connection to the dial network.

Without question, the PC212A is the most user friendly, most reliable, and best performing modem for your IBM PC. An internal microprocessor allows total control, operation, and optioning of the PC212A from the keyboard.

A user friendly HELP list of all interactive commands is stored in modem memory for instant screen display. Just a few of the internal features are auto/manual dialing from the keyboard, auto dial the next number if the first number is busy and instant redial once or until answered. In the event of power disruption a battery back-up protects all memory in the PC212A. In addition, the PC212A is compatible with all of the communication programs written for the Hayes Smartmodem™** such as CROSSTALK.™† Also available

for use with the PC212A is the Rixon PC COM I,™* a communications software program (Diskette) and instruction manual to enhance the capabilities of the PC212A and the IBM PC. PC COM I operates with or replaces the need for the IBM Asynchronous Communications Support Program. The program is very user friendly and provides single key stroke control of auto log on to multiple database services (such as The Source^{SM&}), as well as log to printer, log to file transfer and flow control (automatic inband or manual control). PC COM I is only \$49.00 if purchased at the same time as the PC212A. The PC212A comes with a 2 year warranty. For more information contact your nearest computer store or Rixon direct at 800-368-2773 and ask for Jon Wilson at Ext. 472.

PC212A\$499.
PC212A WITH
ASYNCH PORT\$539.

BANGAMO WESTON
Schlumberger

RIXON INC.

2120 Industrial Pky., Silver Spring, Md. 20904
301-622-2121 TWX 710-825-0071 TLX 89-8347

The Rixon PC212A Card Modem

Another Modem Good Enough To Be Called RIXON

Circle 314 on inquiry card.

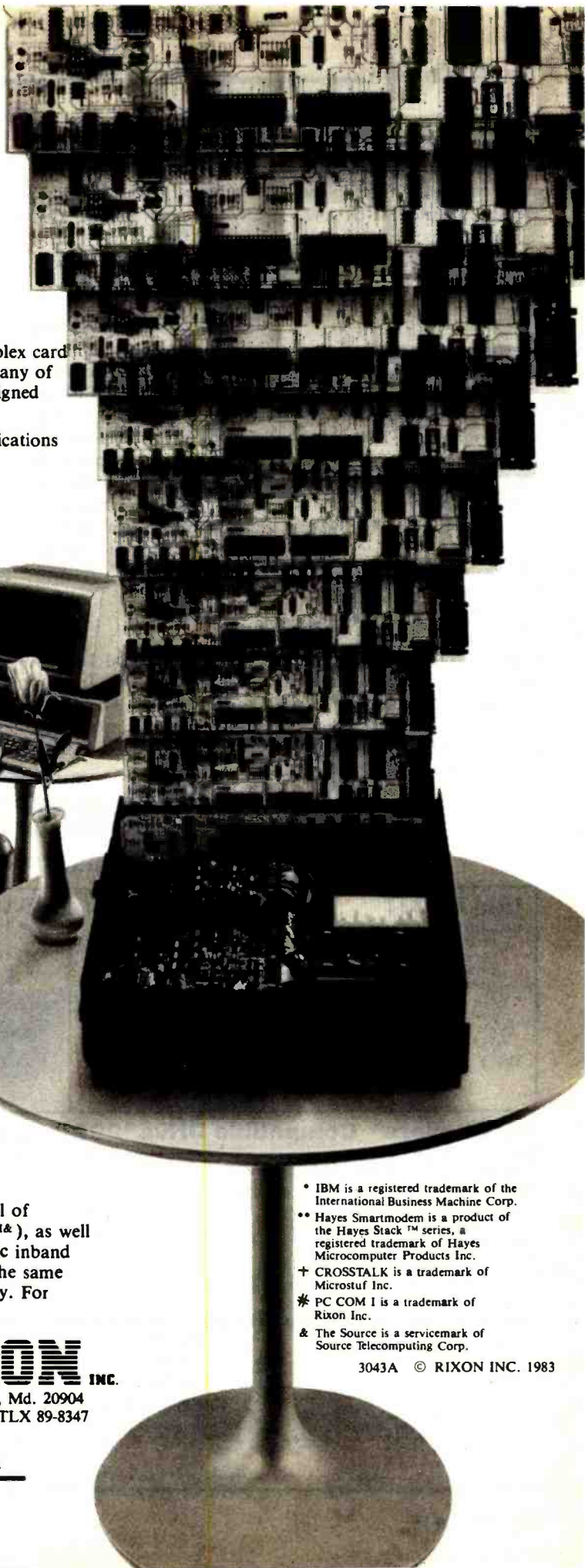

- * IBM is a registered trademark of the International Business Machine Corp.
- ** Hayes Smartmodem is a product of the Hayes Stack™ series, a registered trademark of Hayes Microcomputer Products Inc.
- † CROSSTALK is a trademark of Microstuf Inc.
- * PC COM I is a trademark of Rixon Inc.
- & The Source is a servicemark of Source Telecomputing Corp.

3043A © RIXON INC. 1983

the latest in robots designed to serve personal needs. Isaac Asimov will be the keynote speaker. For complete details, contact IPRC '84, 1547 South Owens St. #46, Lakewood, CO 80226, (303) 278-0662.

April 13-15
Interstellar Personal Computer Show, Interstate Fairgrounds, Spokane, WA. For details, contact Heymac Promotions, East 3607 33rd, Spokane, WA 99203, (509) 534-3661 (mornings) or (509) 327-4842 (afternoons).

April 13-15
Microcomputers and Basic Skills in College, Instructional Resource Center, City University of New York, NY. Papers will explore the use of microcomputers in post-secondary school basic-skills instruction, including English as a second language, read-

ing, writing, and speech. Address inquiries to Geoffrey Akst, Conference Chair, Instructional Resource Center, City University of New York, 535 East 80th St., New York, NY 10021, (212) 794-5425.

April 14
Third Semi-annual Meeting of the Massachusetts Association of Computer-using Educators, Simmons College, Boston, MA. This meeting will feature demonstrations on the uses of computers in the classroom. Contact Dr. Leonard Huber, Hampshire Educational Collaborative, Center School, 36 Hadley St., South Hadley, MA 01075, (413) 534-4563.

April 14-15
The Ninth Annual Trenton Computer Festival, Trenton State College, NJ. More than 100 commercial exhibitors and five acres of flea-market

tables will be featured at this annual spring event. Contact Marilyn Hughes, Trenton State College, Trenton, NJ 08625, (609) 771-2487.

April 15
Maryland Computer Meet, Armory, Silver Spring, MD. The opportunity to buy, sell, or trade hardware and software is combined with computer demonstrations. For details, contact Capitol Computer Group, 308 Main St., POB 5210, Laurel, MD 20707, (301) 498-0121.

April 16-18
Softside of Software, Loew's L'Enfant Plaza Hotel, Washington, DC. Examining the many facets of writing user-friendly software and documentation, this seminar focuses on documentation techniques, standards, software engineering tools, and designing on-line helps. User

and customer training are also addressed. The cost for all three days is \$595. For registration details, contact Cross Information Co., Suite B, 934 Pearl Mall, Boulder, CO 80302-5181, (303) 499-8888.

April 16-18
Videotex '84, Chicago, IL. The focus of this international conference and exhibition is commercial applications and activities of videotex. For details, contact Sally Summers, London Online Inc., Suite 1190, 2 Penn Plaza, New York, NY 10121, (212) 279-8890.

April 17-18
The Second Annual Broadband Local Networks Forum, Hyatt Regency Crystal City, Washington, DC. This forum brings together manufacturers and users of broadband local networks to ex-

DANA'S COMPUTER DISCOUNT

★ Highest Quality - Lowest Prices ★

| | | | | |
|--|--|--|---|--|
| <p>IBM PC KIT INCLUDES:</p> <ul style="list-style-type: none"> • DELUXE CASE • POWER SUPPLY W/FAN • DETACHABLE LOW PROFILE KEYBOARD • MOTHER BOARD FULLY SOCKETED • ALL COMPONENTS INCLUDED • FULL DOCUMENTATIONS • 128 K RAM • 5 EXPANSION SLOTS <p>ONLY \$995⁰⁰ ASSEMBLE IN 1 HOUR</p> |  <p>HALF HEIGHT Apple II & E Compatible Slim line - 40 trac w/patch Single sided 183 K capacity \$194⁰⁰</p> | <p>FULL HEIGHT Apple II & E Compatible 35 Trac Single sided 143 K capacity \$169⁰⁰</p>  | <p>TEAC FD55B The Highest Quality! Slim line - 40 trac capability Double sided, double density Compatible \$189⁰⁰</p>  | <p>LMS JOYSTICK Apple II & E Compatible Heavy duty case. \$29⁰⁰</p>  |
|--|--|--|---|--|

| | | | | | | | |
|--|--|-------------------------|-------|------------------------|------|-------|-------------------------|
| <p>Commodore® Compatible Drive \$299⁰⁰</p> | <p>RAM CHIPS</p> <table border="0"> <tr> <td>4184</td> <td>150NS</td> <td>\$5.95 ea. Limit 64 Pc</td> </tr> <tr> <td>4184</td> <td>200NS</td> <td>\$5.50 ea. per customer</td> </tr> </table> | 4184 | 150NS | \$5.95 ea. Limit 64 Pc | 4184 | 200NS | \$5.50 ea. per customer |
| 4184 | 150NS | \$5.95 ea. Limit 64 Pc | | | | | |
| 4184 | 200NS | \$5.50 ea. per customer | | | | | |

| | | | | | | | | | | | | | | | | | | | | | | | | | |
|--|--|-------------------------|----------|---------------------------|-------|---------------------------|-------|-----------------------|--------|---------------------------------|--------|---------------------------------|--------|---------------------|--------|-------------------------|------|--------------------------|------|--|-------|------------------------|-------|---|--|
| <p>Dana's Discount Computer Buyers Club ★ ★ ★ ★</p> <ul style="list-style-type: none"> • \$12.00 ANNUAL MEMBERSHIP (REFUNDABLE) • \$10.00 CREDIT TOWARD FIRST PURCHASE. • SPECIAL ADDED DISCOUNTS. • MONTHLY SPECIALS FOR MEMBERS ONLY. • SPECIAL MEMBERSHIP ACCOUNT AND I.D. CARD. • PERSONAL CHECKS ACCEPTABLE FROM CLUB MEMBERS. | <table border="0"> <tr> <td>TRAC FD55F (DSOD-96TPi)</td> <td>\$239.95</td> </tr> <tr> <td>12" Amber Monitor Low Res</td> <td>89.95</td> </tr> <tr> <td>12" Green Monitor Low Res</td> <td>89.95</td> </tr> <tr> <td>13" BMC Color Monitor</td> <td>249.95</td> </tr> <tr> <td>12" Atrona Amber Monitor Hi Res</td> <td>109.95</td> </tr> <tr> <td>12" Atrona Green Monitor Hi Res</td> <td>109.95</td> </tr> <tr> <td>80 Col. BMC Printer</td> <td>249.95</td> </tr> <tr> <td>3 1/4" Apple Compatible</td> <td>CALL</td> </tr> <tr> <td>3 1/4" IBM PC Compatible</td> <td>CALL</td> </tr> <tr> <td>5 1/4" (SSDD) Floppy Discs (Box of 10)</td> <td>16.95</td> </tr> <tr> <td>Cooling Fans for Apple</td> <td>44.95</td> </tr> </table> | TRAC FD55F (DSOD-96TPi) | \$239.95 | 12" Amber Monitor Low Res | 89.95 | 12" Green Monitor Low Res | 89.95 | 13" BMC Color Monitor | 249.95 | 12" Atrona Amber Monitor Hi Res | 109.95 | 12" Atrona Green Monitor Hi Res | 109.95 | 80 Col. BMC Printer | 249.95 | 3 1/4" Apple Compatible | CALL | 3 1/4" IBM PC Compatible | CALL | 5 1/4" (SSDD) Floppy Discs (Box of 10) | 16.95 | Cooling Fans for Apple | 44.95 | <p>APPLE II & E Disc Drive Controller Card Printer Interface Card Epson Compatible</p>  <p>\$44⁰⁰</p> | <p>APPLE COMPATIBLE COMPUTER ONLY:</p> <p>64 K Upper Lower 247 Functions on Keyboard Numeric Keypad H.D. Case \$499⁰⁰</p> |
| TRAC FD55F (DSOD-96TPi) | \$239.95 | | | | | | | | | | | | | | | | | | | | | | | | |
| 12" Amber Monitor Low Res | 89.95 | | | | | | | | | | | | | | | | | | | | | | | | |
| 12" Green Monitor Low Res | 89.95 | | | | | | | | | | | | | | | | | | | | | | | | |
| 13" BMC Color Monitor | 249.95 | | | | | | | | | | | | | | | | | | | | | | | | |
| 12" Atrona Amber Monitor Hi Res | 109.95 | | | | | | | | | | | | | | | | | | | | | | | | |
| 12" Atrona Green Monitor Hi Res | 109.95 | | | | | | | | | | | | | | | | | | | | | | | | |
| 80 Col. BMC Printer | 249.95 | | | | | | | | | | | | | | | | | | | | | | | | |
| 3 1/4" Apple Compatible | CALL | | | | | | | | | | | | | | | | | | | | | | | | |
| 3 1/4" IBM PC Compatible | CALL | | | | | | | | | | | | | | | | | | | | | | | | |
| 5 1/4" (SSDD) Floppy Discs (Box of 10) | 16.95 | | | | | | | | | | | | | | | | | | | | | | | | |
| Cooling Fans for Apple | 44.95 | | | | | | | | | | | | | | | | | | | | | | | | |

| | | | | | | | | | | |
|---|---------|--------|------|------|------|------|------|------|--|--|
| <p>IC's Available & More</p> <table border="0"> <tr> <td>74LS323</td> <td>\$2.25</td> </tr> <tr> <td>8116</td> <td>4.90</td> </tr> <tr> <td>2114</td> <td>1.49</td> </tr> <tr> <td>8502</td> <td>4.95</td> </tr> </table> <p>ORDER DESK 8:00 A.M. TO 5:00 P.M. PST MON. THRU FRI. Orders normally shipped within 48 hours.</p> | 74LS323 | \$2.25 | 8116 | 4.90 | 2114 | 1.49 | 8502 | 4.95 | <p>Join Our Club And Save! Orders: 1-800-262-DANA</p> <p>International orders accepted with a \$5.00 surcharge for handling, plus shipping charges • We accept Visa, MasterCard, Money Orders, and Certified checks • Checks require bank clearance • California residents add 6% sales tax • All subject to availability, acceptance, and verification • All sales are final • Satisfaction guaranteed or full refund.</p> | <p>Dana's Computer Discount P.O. Box 15485, Santa Ana, California In California: (714) 953-9105</p> <p>Product shipped in factory cartons with manufacturer's warranty. Prices & availability subject to change without notice.</p> |
| 74LS323 | \$2.25 | | | | | | | | | |
| 8116 | 4.90 | | | | | | | | | |
| 2114 | 1.49 | | | | | | | | | |
| 8502 | 4.95 | | | | | | | | | |

*Eagle, IBM, Apple, Apple IIE, and Commodore are all registered trade marks of Eagle, IBM, Apple and Commodore corporations.

Event Queue

signed for small-business executives. For details, contact Science Park '84, Five Science Park, New Haven, CT 06511, (203) 436-3089.

April 27

How to Document a Computer System, Holiday Inn-Central, Tampa, FL. This seminar presents a series of procedures that covers the system-development process, including project initiation, study, design, programming, implementation, and maintenance. The fee is \$155. Contact Technical Communications Associates, Suite 210, 1250 Oakmead Parkway, Sunnyvale, CA 94086, (800) 227-3800, ext. 977; in California, (408) 737-2665.

April 30

How to Document a Computer System, Sheraton-Emory Inn, Atlanta, GA. For details, see April 27.

April 30-May 2

Printed Circuit Fabrication, Sheraton Harbor Island West Hotel, San Diego, CA. The theme for this technical seminar, sponsored by PMS Industries, is "Building in Quality." It is designed as a problem-solving forum for the manufacturers of printed-circuit boards. Addresses by industry leaders and discussions on process-technology are on the agenda. The cost for the three-day session is \$350. Further information is available from Laura Harrel, PMS Industries, 625 Sims Industrial, Alpharetta, GA 30201, (404) 475-1818.

May 1984

May-July

Courses from Integrated Computer Systems, various sites throughout the U.S. Among the courses to be pre-

sented are "Designing with 16-bit Micros," "Programming in C: A Hands-on Workshop," and "Hands-on Unix Workshop." The fee for each course is \$895. Enrollment details are available from Ruth Dordick, Integrated Computer Systems, 6305 Arizona Place, POB 45405, Los Angeles, CA 90045, (213) 417-8888.

May 1-3

Electronic Production Efficiency Exposition, National Exhibition Centre, Birmingham, England. This exhibition brings together various organizations involved in producing hardware and software for automated factories. Technical sessions will cover such issues as computer-aided design and manufacturing, integration, test diagnosis and repair strategies, and electronic-manufacturing assembly techniques. Contact Network Events

Ltd., Printers Mews, Market Hill, Buckingham, MK18 1JX, UK; tel: (0280) 815226; Telex: 83111.

May 2-3

Networking Personal Computers, Halloran House, New York, NY. For details, contact Ginny Kania, Frost & Sullivan, 106 Fulton St., New York, NY 10038, (212) 233-1080.

May 3-6

Personal Computer Userfest/Chicago, O'Hare Exposition Center, Rosemont, IL. Apple, IBM, and compatible computers, software, and accessories will be featured. Information is available from Northeast Expositions, 822 Boylston St., Chestnut Hill, MA 02167, (617) 739-2000.

May 5

The Sixth Annual Computer Conference for Educators, Lesley College, Cambridge,

HARD COPY MADE EASY.

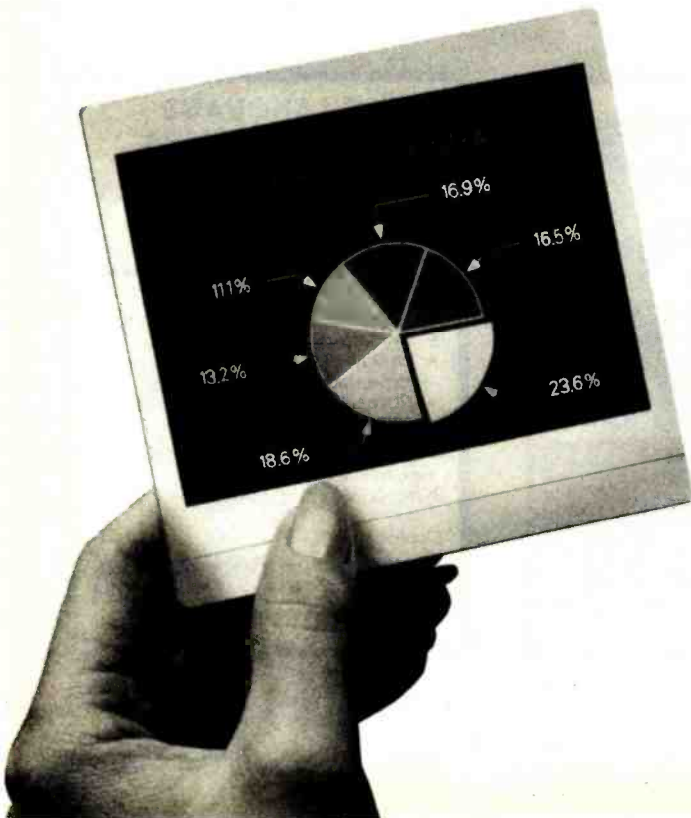

Picture CRT information in full color with the new **KODAK INSTAGRAPHIC™** CRT Imaging Outfit. JUST **\$190** LIST PRICE*

This new Kodak imaging outfit makes recording CRT graphic displays as easy as taking a photograph! Just hold the Instagraphic camera and cone over a 12- or 13-inch-diagonal CRT screen, and press the button. That's it!

Get a full-color photographic record—an instant print or a conventional print or slide†—without darkening the room. Without ambient light or parallax concerns. Without focusing. Without tying up your terminal, color printer, or plotter. All for an incredibly low \$190!

*Subject to change without notice. Dealer prices may vary.



MA. Panel discussions, more than 20 presentations, and sessions that include hands-on workshops on software in science, social science, language arts, and math will be offered. Additional information is available from Susan Friel or Nancy Roberts, Lesley College, 29 Everett St., Cambridge, MA 02238, (617) 868-9600.

May 6-9
Comunicaciones Expo '84, Curtis Hixon Hall, Tampa, FL. For details, contact Mitch Hall Associates, POB 860, Westwood, MA 02090, (617) 329-8090.

May 6-11
International Communications Association, Las Vegas, NV. This is the thirty-seventh annual conference and exposition. For details, contact ICA Headquarters, Suite 828, LB-89, 12750 Merit Dr.,

Dallas, TX 75251, (214) 233-3889.

May 7-9
EDP Audit, Controls, and Security Symposium, Woodfield Hyatt House, Woodfield, IL. This symposium offers seminars, workshops, and exhibits relating to the state of the art in electronic-data-processing (EDP) auditing. Address inquiries to EDP Audit Associates Inc., POB 255, Chicago Ridge, IL 60415, (312) 364-4624.

May 7-11
Fiber and Integrated Optics, Ottawa, Ontario, Canada. This short course explores such fiber-optic components as single- and multimode fiber cabling, photo detectors, receiver and repeater technology, and optical fiber sensors. The fee is \$875. For details, contact Continuing Engineering Education, George

Washington University, Washington, DC 20052, (800) 424-9773; in the District of Columbia, (202) 676-6106.

May 7-11
Tutorials for Professional Development, Marriott O'Hare, Chicago, IL. Two tracks, "Software Engineering" and "Networks and Communications," compose this program sponsored by the IEEE Computer Society and the Association for Computing Machinery. For a copy of the program, contact Tutorials for Professional Development, POB 639, Silver Spring, MD 20901, (301) 589-8142.

May 9-11
Session 84, Calgary, Alberta, Canada. The theme of this annual national conference of the Canadian Information Processing Society is "1984: Images of Fear, Images of

Hope." Parallel seminars, panel discussions, technical papers, and exhibits of hardware, software, and services will assist in the exchange of views between users and suppliers. Conference information can be obtained from Ms. Marilyn Harris, Suite 722, Suncor Tower, 500 4th Ave. SW, Calgary, Alberta T2P 2V6, Canada, (403) 261-5903.

May 10-12
BYTE Computer Show, McCormick Place, Chicago, IL. Seminars, product displays, and conference sessions are some of the highlights of this show sponsored by BYTE and *Popular Computing* magazines. For complete details, contact The Interface Group Inc., 300 First Ave., Needham, MA 02194, (800) 325-3330; in Massachusetts, (617) 449-6600.

Outfit includes camera, film, cone, more!

Get everything you need to record charts, graphics, formulas, etc, from your CRT in full color...for reports, documentation, or presentations. Complete outfit includes: Kodak Instagraphic camera with +3 close-up glass lens; two packages of new Kodak Instagraphic color print film with excellent resolving power (the camera and film can normally deliver *more* detail than a 2,000-line CRT can produce); a Kodak Instagraphic CRT cone (the interface between camera and CRT) designed to fit against the frame around the tube or against the cabinet; instruction manual; filter, carrying strap, foam strips, bumpers, spacers, and brackets for adapting your 35 mm single-lens-reflex camera to the cone. The Instagraphic camera and cone are covered by a Full Three-Year Warranty!

Ask for a demonstration. (You'll find your dealer listed in the Yellow Pages under Audiovisual Equipment & Supplies, Photographic Equipment & Supplies, or X-ray Products.) Or request more information. Check the coupon at right or call toll free for a free instant print of CRT data, plus a list of dealers who carry this exciting new product.

†If you want conventional prints and slides, use a 35 mm camera (not supplied in the outfit) equipped with a 35 mm lens capable of focusing at 11½ inches (290 mm), or you may be able to use a +1, +2, or a +3-diopter close-up lens with your present lens.



Motion Picture and Audiovisual Markets Division
 Eastman Kodak Company, Rochester, NY 14650



© Eastman Kodak Company, 1984
 Circle 142 on inquiry card.

IF YOU NEED CONVINCING, PHONE

1-800-445-6325, EXT. 207.

OR FILL OUT AND MAIL THIS COUPON.

Motion Picture and Audiovisual Markets Division
 Eastman Kodak Company, Dept. 412L, Rochester, NY 14650

**YES I WANT TO MAKE
HARD COPY EASY.
SHOW ME YOUR CAPABILITY.**

- Send me an instant print of a CRT display and more information. A5062
- Have a representative contact me. A5061

Name _____

Title _____ Company _____

Address _____

City _____ State _____

Zip _____ Phone _____

16 BIT PERSONAL COMPUTER

IBM — COMPATIBLE



- MULTI-FUNCTION 128 RAM on board can be expanded to 256 K.
- Color display card for R.G.B. Color, B/W monitor.
- Includes two double-side, double-density disk drivers 500K byte each.
- It can run LOTUS 1.2.3, MULTIPLAN, WORDSTAR, VISICALC, D. BASE II, MS-DOS 1.1, 2.0, CP/M-86. . . etc.

8 BIT PERSONAL COMPUTER

- 64K RAM, 6502 & Z-80 DUAL CPU
- We can supply more than 20 kinds of inter-face cards.

KUN YING ENTERPRISE CO., LTD.

Rm. 503, No. 41, Chung Hsiao W. Rd., Sec. 1, Taipei, Taiwan, R.O.C.
Telex: 27291 SANWU SUNNY
Tel: (02) 381-3682, 331-8779

When switching or lightning
cause voltage surges—
**is your
computer
safe?**



Perma Power®
Surge Suppressors
provide the
transient protection
computers need

- Protects components; prevents data errors
- Eliminates both line-to-line and line-to-ground surges
- Automatic failure shutdown prevents unprotected operation
- Extended Life models have RF and EMI filters and a three-year warranty



Now at your
computer store.

**PERMA POWER®
Electronics Inc.**

5615 West Howard Avenue • Chicago, Illinois 60648 • (312)647-9414

Event Queue

May 11

Writing Efficient Programs, Mathematics and Science Building, Room W-117, Montclair State College, Upper Montclair, NJ. Dr. Jon Bentley from Bell Laboratories will speak on writing machine-independent code. He will present a general set of rules for using this tool and show how those rules can speed up a program. A subtheme will address the problem of converting programming tricks into engineering techniques. For information, contact Gideon Nettler, Department of Mathematics and Computer Science, Montclair State College, Upper Montclair, NJ 07043, (201) 893-4294.

May 12-14

Softwest '84, Regency Hotel and Conference Center, Denver, CO. This conference and exhibition features seminars, lectures, and panel discussions on software, equipment, and peripherals for Apple and IBM computers. For information, contact Colorado Conference Group, Suite C, 3312 Cripple Creek, Boulder, CO 80303, (303) 499-1034.

May 13-17

Computer Graphics '84, Convention Center, Anaheim, CA. Panel discussions on specific standards, technical sessions exploring the application of standards in a working environment, and tutorials explaining standards will be complemented by an exposition. For details, contact the National Computer Graphics Association, Department ZF, Suite 601, 8401 Arlington Blvd., Fairfax, VA 22031, (703) 698-9600.

May 14-16

Annual Conference of ADCIS, Ohio State University, Columbus. This annual conference is sponsored by the Association for the Development of Computer-based In-

structional Systems (ADCIS). Papers and demonstrations of hardware, software, and courseware will emphasize portability. For details, contact ADCIS International Headquarters, 409 Miller Hall, Western Washington University, Bellingham, WA 98225, (206) 676-2860.

May 15-17

Criminal Justice Systems Conference, Virginia Commonwealth University, Richmond, VA. Presentations and panel discussions on recent developments in criminal justice applications of computer technology are planned. Additional sessions will address the uses of microcomputers in law enforcement. The fee is \$20. Information is available from Ben Wood, Department of Criminal Justice Services, 805 East Broad St., Richmond, VA 23219, (804) 786-4000.

May 15-17

Electro/84 and Mini/Micro Northeast/84, Boston, MA. Conference sessions will address a broad range of topics, including artificial intelligence, communications and networks, distributed systems, microprocessor technology, and robotics. For details, contact the producer of this program, Electronic Conventions Inc., 8110 Airport Blvd., Los Angeles, CA 90045, (213) 772-2965.

May 15-17

Micro City '84, Exhibition Complex, Bristol, England. More than 100 companies will exhibit computers, business systems, and communications equipment. For complete details, contact Tomorrow's World Exhibitions Ltd., 9 Park Place, Clifton, Bristol BS8 1JP, UK; tel: (0272) 292156/7.

May 16-18

Teaching Math with Microcomputers, Marriott Hotel,

WHOLESALE

SPECIALS

Diskettes

| 8 1/2" Soft Sector | | 10 | 50 | 100 |
|--------------------|-------|-------|----------|----------|
| Maxell MD1 | SS/DD | 23.00 | 22.00/10 | 21.00/10 |
| Maxell MD2 | DS/DD | 43.00 | 42.00/10 | 41.00/10 |
| Verbatim | SS/DD | 22.00 | 20.00/10 | 18.00/10 |
| Verbatim | DS/DD | 29.00 | 27.00/10 | 25.00/10 |
| Plan Label | SS/DD | 16.00 | 17.00/10 | 16.00/10 |
| Plan Label | DS/DD | 21.00 | 20.00/10 | 19.00/10 |
| TDK | SS/DD | 23.00 | 22.00/10 | 21.00/10 |
| TDK | DS/DD | 36.00 | 35.00/10 | 34.00/10 |

Printers

| | |
|---|--------|
| BMC BX-80 (80CPS PAR) | 269.00 |
| Inforunner RiteMan (120CPS PAR) | 299.00 |
| (BX-80 and RiteMan are Epson Compatible) Epson is a trademark of Epson Corp. | |

Sakata Monitors

| | |
|------------------------------|--------|
| SG-1000 (12" High Res Green) | 99.00 |
| SC-100 (13" Color w/speaker) | 289.00 |
| Shipping & Handling | CALL |

Order Toll Free 1-(800) 821-5339
or Call 1-(801) 298-0872
or Rush Check or Money Order To:
C. R. E. Wholesale Products
P. O. Box 361 North Salt Lake, Ut. 84054

Circle 105 on inquiry card.

WHOLESALE

RIBBONS

High Quality! Low Prices! Guaranteed!
Shipped Direct From Stock!

| Ribbon Type | 3 | 6 | 12 |
|----------------------------|----------|----------|----------|
| C. Itoh Prowriters | 5.00 ea. | 5.00 ea. | 4.00 ea. |
| Data South DS180 | 8.00 ea. | 6.00 ea. | 5.00 ea. |
| Dec La 30/36/40 | 3.00 ea. | 3.00 ea. | 3.00 ea. |
| Dec La 120/180 | 5.00 ea. | 5.00 ea. | 4.00 ea. |
| Diablo Hyltype II MS/Nylon | 4.00 ea. | 4.00 ea. | 3.00 ea. |
| Epson/IBM FX/RX/MX-40 | 5.00 ea. | 5.00 ea. | 4.00 ea. |
| Epson/IBM FX/RX/MX-100 | 7.00 ea. | 6.00 ea. | 5.00 ea. |
| Gemini 10/10X/15/15X | 2.00 ea. | 2.00 ea. | 2.00 ea. |
| NEC 3500 Multi-Strike | 6.00 ea. | 6.00 ea. | 5.00 ea. |
| NEC 5500/7700 MS/Nylon | 5.00 ea. | 4.00 ea. | 3.00 ea. |
| Okidata 80/82/83/82/83 | 2.00 ea. | 2.00 ea. | 2.00 ea. |
| Qume Sprint 3 & 5 MS/Nylon | 3.00 ea. | 3.00 ea. | 3.00 ea. |
| Texas Instruments 820 | 5.00 ea. | 5.00 ea. | 4.00 ea. |
| Texas Instruments 810 | 3.00 ea. | 3.00 ea. | 3.00 ea. |
| Triplet | 6.00 ea. | 6.00 ea. | 5.00 ea. |
| Ship + Hand in Cont USA | 3.00 | Free | Free |

Order Toll Free 1-(800) 821-5339
or Call 1-(801) 298-0872
or Rush Check or Money Order To:
C. R. E. Wholesale Products
P. O. Box 361 North Salt Lake, Ut. 84054

Circle 106 on inquiry card.

WHOLESALE

MODEMS

PASSWORD
and
IBM P.C. CARD

300/1200 Baud by U.S. Robotics

As Low As **325.00**

| | List | Qty 1 | Qty 2 | Qty 5+ |
|------------|-------------|------------|------------|------------|
| Password | 449.00 ea. | 349.00 ea. | 344.00 ea. | 325.00 ea. |
| P.C. Card | 449.00 ea. | 349.00 ea. | 344.00 ea. | 325.00 ea. |
| w/64K Ram | 699.00 ea. | 559.00 ea. | 554.00 ea. | 499.00 ea. |
| w/256K Ram | 1149.00 ea. | 925.00 ea. | 915.00 ea. | 825.00 ea. |

FEATURES

- 300/1200 Baud
- 2 Year Warranty
- Auto Dial
- Auto Answer
- Direct Connect
- Phone Cable Included
- Software Available

Free Shipping and Handling in Continental U.S.
Shipped Direct From Stock!

Order Toll Free 1-(800) 821-5339
or Call 1-(801) 298-0872
or Rush Check or Money Order To:
C. R. E. Wholesale Products
P. O. Box 361 North Salt Lake, Ut. 84054

Circle 107 on inquiry card.



E-Z-READER™
BAR CODE READER BY PERCON

\$475.00
LIST

- Reads dot-matrix and printed bar code labels
- Durable Hewlett Packard digital wand with replaceable tip
- Reads 3 of 9 or Interleaved 2 of 5
- RS-232-C. ASCII communications

PC
PERCON
2190 W. 11th St.
Eugene, OR 97402
503/344-1189

Circle 289 on inquiry card.

DVORAK

The Alternative Keyboard



Dvorak Standard Keyboard
for your H19orZ19 terminal
Simple modification kit \$35.00

Please specify numeric key layout:

DVORAK or STANDARD
7531902468 or 1234567890

* PA. Residents please add 6% sales tax

Drias ENTERPRISES
Attn: Kevin Dowling
PO Box CMU-145
Pittsburgh, PA 15213

Circle 135 on inquiry card.

MAKE BUCKS WITH YOUR BYTES

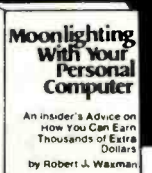

Full time, part time, or in your spare time, this book tells you how to earn thousands of extra dollars with your PC.

Available at bookstores, or send \$7.95 plus \$1.00 postage and handling to: World Almanac Publications, 200 Park Ave., Dept. BY, New York, N.Y. 10166.

Name _____
Address _____
City _____ State _____ Zip _____
Please allow 4 to 6 weeks for delivery.

Circle 392 on inquiry card.

Super Savings Apple Compatible Equipment

- 1/2 High Drives \$175.00
- Controller Card 44.00
- Heavy Duty Joy Stick 24.95
- Cooling Fan 38.00
- 80 Column Card 119.95
- Monitor - Amber 119.00
- Taxan 210 Color 299.00
- 16K Ram Card 39.95
- Ram Chips 16K 2.00 ea.
- Monitor Stand 12.95

THE LAST ENTRY

414 N. STATE COLLEGE BLVD.
#C182 - ANAHEIM, CA 92806

714-978-9833

Circle 394 on inquiry card.

Wire-Wrap® & Multiwire® Software

Whip your designs into shape with WIREMASTER



Never do another design by hand! Your computer and Wiremaster will quickly and accurately convert your schematic into wire lists, net maps, parts lists, checklists, and plots (optional) to give you total control. Handles ECL and twisted pair wiring. Versions available for NC machines.

Runs on IBM-PC, VAX, CP/M, MSDOS and Unix Computers.

No-risk demo disk available. Call or write for details.

AFTERTHOUGHT ENGINEERING
7266 Courtney Dr., San Diego, CA 92111
(619) 279-2868

Circle 21 on inquiry card.

dy lan Dysan CORPORATION

SPECIAL DISKETTE OFFER

The Dysan quality difference is yours to try with advanced production techniques that assure every diskette to be 100% error-free.

PLUS! If you call, write, or utilize reader service in response to this ad—we'll send you our full-range catalog of computer supplies with Special Offers good for further savings on Dysan diskettes and many other quality products.

LYBEN COMPUTER SYSTEMS
1250-E Rankin Dr., Troy, MI 48063
Phone: (313) 589-3440

Simply #1 in Service & Reliability

DISCOVER THE DYSAN DIFFERENCE

Circle 230 on inquiry card.

And then there were none.

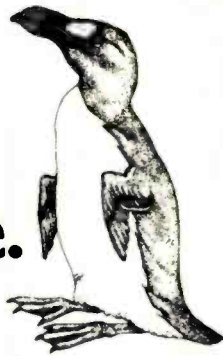

The list of already extinct animals grows . . . the great auk, the Texas gray wolf, the Badlands bighorn, the sea mink, the passenger pigeon . . .

What happens if civilization continues to slowly choke out wildlife species by species?

Man cannot live on a planet unfit for animals.

Join an organization that's doing something about preserving our endangered species. Get involved. Write the National Wildlife Federation, Department 105, 1412 16th Street, NW, Washington, DC 20036.



It's not too late.

Event Queue

Miami, FL. This program, sponsored by the National Council of Teachers of Mathematics (NCTM), is designed to inform elementary, intermediate, and secondary school mathematics teachers how to effectively use the microcomputer as a classroom tool. For further information, contact NCTM, 1906 Association Dr., Reston, VA 22091, (703) 620-9840.

May 19

The Seventh Annual Show & Tell Microcomputer Conference, University of Oklahoma Mathematics and Physical Science Complex, Norman, OK. Computer hobbyists are invited to speak briefly, demonstrate an example of their presentation, and answer questions. For details, send a self-addressed, stamped envelope to Show & Tell, Dr. Richard Andree, University of Oklahoma, Mathematics Department, 601 Elm St., Norman, OK 73019.

May 20-23

The Fourth Annual Conference of the Association of Human Resource Systems Professionals, Hyatt Regency, Fort Worth, TX. Roundtable discussions will address topics related to the theme for this conference, "People, Data, and Systems . . . Putting It All Together." This includes cross-disciplinary concerns and the practical requirements of successful human-resource information-system development as well as networking, vendor evaluation, and time management. For complete details, contact HRSP Inc., 3051 Adeline St., Berkeley, CA 94703, (415) 548-1364.

May 20-23

The Thirteenth Mid-Year Meeting of the American Society for Information Science, Indiana University, Bloomington. The theme for

this meeting is "The Micro Revolution: Implications for the Information Age." Joseph Weizenbaum, author of *Computer Power and Human Reason* and a professor of computer science at Massachusetts Institute of Technology, will speak. For more information, contact Stephen Harter, School of Library and Information Science, Indiana University, Bloomington, IN 47405, (812) 335-5113.

May 20-25

The Fourth Jerusalem Conference on Information Technology—JCIT, Jerusalem, Israel. Papers, panel discussions, workshops, and exhibits will emphasize software engineering and manufacturing related to the theme of this international event, the "Next Decade in Information Technology." Until April 30, the registration fee is \$200. After that date, the fee is \$225. Isratech '84, the national exhibition of high technology, runs concurrently with JCIT. For information on Isratech '84, contact the Government of Israel Trade Center, 350 Fifth Ave., New York, NY 10118, (212) 560-0660. For details on JCIT, contact the Fourth Jerusalem Conference on Information Technology, POB 29313, 61292 Tel Aviv, Israel; tel: (03) 258-535.

May 21-23

AAMSI Congress 1984—The Third Spring Joint National Congress, Hilton Hotel, San Francisco, CA. Invited and contributed papers, special sessions, tutorials, reviews, panel discussions, and demonstrations will focus on the applications of computers and information technology and systems to all fields of medicine. Program sponsors include a dozen professional organizations that have joined the American Association for Medical Systems and Informatics (AAMSI) in pro-



RS 232 TO CURRENT LOOP CONVERTER

- DC TO 9600 BAUD
- 20ma/60ma OPERATION
- TELETYPE COMPATIBLE
- FULL/HALF DUPLEX
- MODEL 64—HOST POWERED—\$80
- MODEL 65—SELF POWERED—\$100
- FULLY PROGRAMMABLE

Remark

Division of
TELEBYTE

Telebyte Technology, Inc.
148 New York Avenue
Halesite, NY 11743
(516) 423-3232

ducing this three-day program. For particulars, contact AAMSI, Suite 402, 4405 East-West Highway, Bethesda, MD 20814, (301) 657-4142.

May 22-25

COMDEX Spring, Georgia World Congress Center, Atlanta. For details, contact the Interface Group, 300 First Ave., Needham, MA 02194, (800) 325-3330; in Massachusetts, (617) 449-6600.

May 22-26

Micro Expo '84, Palais des Congrès, Paris, France. Manufacturers and vendors of hardware, software, peripherals, and accessories for the microcomputer market will attend this conference and exposition. For details, contact Sybex France, Centre Paris Daumesnil, 4 Place Felix Eboué, 75583 Paris Cedex 12, France. In the U.S., contact International Show Coordinator, Sybex Inc., 2344 Sixth St., Berkeley, CA 94710, (415) 848-8233.

May 22-26

Oficomp Korea 84—The International Korean Office and Information Management Exhibition and Conference, Korea Exhibition Center, Seoul, South Korea. Exhibits will include demonstrations of computers, communications equipment, and business machines. Contact Clapp & Poliak International, POB 70007, Washington, DC 20088, (301) 657-3090.

May 23-24

Automach-Australia '84, Royal Hall of Industries Showground, Sydney. This trade show serves to update Australian manufacturing industries on automated, integrated factory systems incorporating numerically controlled machinery, CAD/CAM, and robotics. For details, contact Mr. Greco, Howard Rotavator Pty., POB 82, Parramatta 2150, New

South Wales, Australia; tel: 630-1231; Telex: AA21328. In the U.S., contact SME World Headquarters, One SME Dr., POB 930, Dearborn, MI 48121, (313) 271-1500.

May 23-24

The 1984 Trends and Applications Conference, National Bureau of Standards, Gaithersburg, MD. Presentations will address current systems and applications as well as research into advanced concepts relating to the theme, "Making Database Work." Information can be obtained from Trends and Applications 84, POB 639, Silver Spring, MD 20901, (301) 921-3491.

May 23-25

The Eighth Conference on Computer Applications in Radiology, Stouffer's Riverfront Towers, St. Louis, MO. Patient information systems, personal computers and computers for the private office, teleradiology, computer-assisted instruction, and artificial intelligence are a few of the topics to be covered. Exhibits are included. The fee is \$350. For details, contact American College of Radiology, 20 North Wacker Dr., Chicago, IL 60606, (800) 227-5463; in Illinois, (312) 236-4963.

May 23-25

The Third Annual European Semiconductor Industry Conference, Hotel Kempinski, Berlin, West Germany. International industry leaders will discuss issues facing the semiconductor industry. Contact Barbara Chupp, Dataquest Inc., 1290 Ridder Park Dr., San Jose, CA 95131, (408) 971-9000.

May 26-27

The Third Annual Toronto PET User's Group (TPUG) Conference, Constellation Hotel, Toronto, Ontario, Canada. This program con-

Imagine what you can do with 4 more serial ports...



Now imagine doing it for \$279.

For Port Expansion...

Increase your I/O capabilities by interfacing your RS-232C peripheral devices to your computer with a BayTech Serial Port Expander. All BayTech Multiport Controllers - like the Model 524 - allow the user to mix and match peripheral devices of different configurations without the need to reconfigure the host device. BayTech's port expanders allow port selection through software control. Port configuration of the peripheral device ports may be changed by the user with the 524's menu-driven software.

Model 524/\$279

For Multiplexing/Demultiplexing...

BayTech's Model 524E, with its four buffered peripheral ports, allows four lines of data to be multiplexed and sent sequentially over a single communication line, then automatically demultiplexed by another 524E with distribution to the corresponding peripheral ports. 524E's configured back-to-back allow economical utilization of telephone communications.

Model 524E/\$319.



For Time-Sharing...

The Model 524DQ allows one to four users to share a computer through a single port. Users requesting access when the host port is busy will be given a position in a queue with the 524DQ providing appropriate messages, i.e., 'YOU ARE #1 IN THE QUEUE', 'YOU ARE #2 IN THE QUEUE', etc. Users will be automatically advanced in the queue with the 524DQ updating status messages. The 524DQ allows the most economical multi-user productivity from a single-port computer.

Model 524DQ/\$319

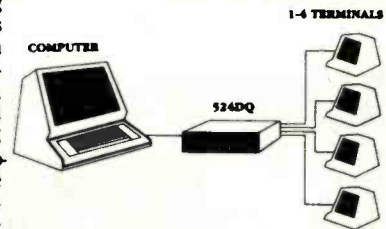

For Networking...

The Model 524F is BayTech's most versatile serial port expander. With its host port and four peripheral ports capable of any-port-to-any-port interconnection, applications are virtually unlimited. Because of its features, the 524F allows the user to create a local network providing simultaneous communication for four RS-232C devices.

Model 524F/\$329

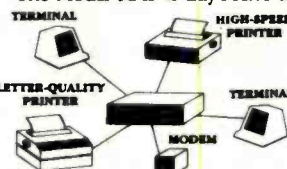

Other Models Available

BayTech continually develops new serial port expanders as the computer industry discovers new applications. Call us about our other models.

...need 8 ports... just \$499!

If you've found a BayTech Multiport above that handles your specific application, but you need even more expansion, choose an 8-port model from BayTech's new 528 Series. You get the same outstanding features but with 8 peripheral ports. And you get them at comparably modest prices.



To place your order or discuss your expansion problems.

1-800-523-2702



HIGHWAY 803, P.O. BOX 387
BAY ST. LOUIS, MS 39520
(601) 467-8231

sists of formal speeches, product exhibits, and a trader's corner for used computer equipment. For information, contact Chris Bennett, TPUG Business Office, 1912A Avenue Rd., Toronto, Ontario M5M 4A1, Canada, (416) 782-9252.

May 29-31

Gulf Coast Computer and Office Show, New Orleans, LA. Speakers, technical sessions, and product displays will highlight this exhibition. For full details, contact Gulf Coast Computer and Office Show, 119 Avant Garde Circle, Kenner, LA 70062, (504) 467-9949.

June 1984

June 4-5

Electronic Motion Control Association Seminar, Chicago, IL. This educational

program combines tutorial sessions with technical paper presentations. Devices and systems will be displayed. For details, contact the Electronic Motion Control Association, Suite 1200, 230 North Michigan Ave., Chicago, IL 60601, (312) 372-9800.

June 4-7

Electronics in Oil and Gas/U.S., Convention Center, Dallas, TX. This exhibition will focus on electronics technology as it applies to processing, production, supervision, data control, communications, testing, instrumentation, exploration, and safety associated with the petroleum and gas industry. The conference program, held concurrently with the World Oil and Gas Show and Conference, will cover telemetry, sensing, computers, simulation, and automation. Complete particulars are available

from Martin C. Dwyer International, 1350 East Touhy Ave., Des Plaines, IL 60018, (312) 299-9311.

June 6-9

The 1984 Rochester FORTH Applications Conference, University of Rochester, NY. An international conference now in its fourth year, this convocation is appropriate for both experienced users and newcomers to the FORTH language. Invited speakers will discuss real-time systems and FORTH applications and techniques. Contact Diane Ranocchia, Institute for Applied FORTH Research Inc., 70 Elmwood Ave., Rochester, NY 14611, (716) 235-0168.

June 6-8

ACM SIGCOMM '84 Symposium on Communications Architectures and Protocols, Montreal, Quebec, Canada.

Address inquiries to Rebecca Hutchings, Honeywell/FSD, 7900 Westpark Dr., McLean, VA 22102, (703) 827-3982.

June 11-15

Managing the Audit Computer-based Bank Systems, Chicago, IL. A course providing a comprehensive audit approach for evaluating and testing controls in computer-based bank systems. Information is available from Darlene Flooding, Bank Administration Institute, 60 Gould Center, Rolling Meadows, IL 60008, (312) 228-6200.

June 12-14

Info/Software, McCormick Place, Chicago, IL. An exposition and conference devoted exclusively to demonstrations of applications and systems software. Mainframe, minicomputer, and microcomputer software will



SAVE MORE THAN EVER ON...

3M Scotch® DISKETTES

AND OTHER COMPUTER NEEDS!



| | | | | | | | | | | | | | | | | | | |
|---|--|----------------|-------------------------|--------------|-------------------------|------------------|-------------------------|------------------|-------------------------|------------------|-------------------------|---|-----------------|----------------|-------------|----------------|--|-----------------|
| <p>3M Scotch® Diskettes</p> <p>are boxed in 10's with labels, envelopes and reinforced hubs on 5 1/4" diskettes.</p> <p>\$185 ea. 5 1/4" SSDD (744) Qty. 20</p> <p>\$235 ea. 5 1/4" DSDD (745) Qty. 20</p> <p>5 1/4" SSQD-96TPI (746) \$2.60 ea. 5 1/4" DSQD-96TPI (747) \$3.25 ea. 8" SSSD (740) \$2.05 ea. 8" SSDD (741) \$2.50 ea. 8" DSDD (743) \$3.10 ea.</p> | <p>DISK CADDIES</p> <p>...the original flip-up disk holder for 10 diskettes. Beige or grey only.</p> <p>5 1/4" \$165 ea. + .20 Shpng. 8" \$229 ea. + .20 Shpng.</p> <p>RIBBONS! at bargain prices.</p> <table style="width: 100%; border: none;"> <tr> <td>EPSON MX-70/80</td> <td>\$3.58 ea. + .25 Shpng.</td> </tr> <tr> <td>EPSON MX-100</td> <td>\$6.99 ea. + .25 Shpng.</td> </tr> <tr> <td>Okidata Micro 84</td> <td>\$3.66 ea. + .25 Shpng.</td> </tr> <tr> <td>Diablo 630 Mylar</td> <td>\$2.60 ea. + .25 Shpng.</td> </tr> <tr> <td>Diablo 630 Nylon</td> <td>\$2.93 ea. + .25 Shpng.</td> </tr> </table> | EPSON MX-70/80 | \$3.58 ea. + .25 Shpng. | EPSON MX-100 | \$6.99 ea. + .25 Shpng. | Okidata Micro 84 | \$3.66 ea. + .25 Shpng. | Diablo 630 Mylar | \$2.60 ea. + .25 Shpng. | Diablo 630 Nylon | \$2.93 ea. + .25 Shpng. | <p>DISKETTE 70 STORAGE</p> <p>The best buy we've seen! Dust-free storage for 70 5 1/4" diskettes with six dividers.</p> <p>\$1495 + \$3.00 Shpng.</p> <p>FLIP 'N FILE</p> <p>Redesigned for better appearance and greater ease of use. FLIP 'N FILE 25 holds 25 5 1/4" diskettes; FLIP 'N FILE 50 holds 50 5 1/4" diskettes.</p> <table style="width: 100%; border: none;"> <tr> <td>FLIP 'N FILE 50</td> <td>Retail \$39.95</td> </tr> <tr> <td>...DW Price</td> <td>\$26.95</td> </tr> <tr> <td></td> <td>+ \$5.00 Shpng.</td> </tr> </table>  | FLIP 'N FILE 50 | Retail \$39.95 | ...DW Price | \$26.95 | | + \$5.00 Shpng. |
| EPSON MX-70/80 | \$3.58 ea. + .25 Shpng. | | | | | | | | | | | | | | | | | |
| EPSON MX-100 | \$6.99 ea. + .25 Shpng. | | | | | | | | | | | | | | | | | |
| Okidata Micro 84 | \$3.66 ea. + .25 Shpng. | | | | | | | | | | | | | | | | | |
| Diablo 630 Mylar | \$2.60 ea. + .25 Shpng. | | | | | | | | | | | | | | | | | |
| Diablo 630 Nylon | \$2.93 ea. + .25 Shpng. | | | | | | | | | | | | | | | | | |
| FLIP 'N FILE 50 | Retail \$39.95 | | | | | | | | | | | | | | | | | |
| ...DW Price | \$26.95 | | | | | | | | | | | | | | | | | |
| | + \$5.00 Shpng. | | | | | | | | | | | | | | | | | |
| <p>WE WILL BEAT ANY NATIONALLY ADVERTISED PRICE!</p> <p>Nationwide: 1-800-621-6827 Illinois: 1-312-944-2788 Hours: 9 AM-5 PM Central Time Minimum Order: \$35.00</p> | | | | | | | | | | | | | | | | | | |

DISK WORLD!

SUITE 4806
30 EAST HURON STREET
CHICAGO, ILLINOIS 60611

Authorized Distributor
Information Processing Products 



SAVE MORE THAN EVER ON 3M Scotch® DISKETTES

LIFETIME WARRANTY!

\$185 ea. 5 1/4" SSDD (744) **\$235** ea. 5 1/4" DSDD (745) →

City, 20 QTY. 20
 5 1/4" SSDD—96TPI (745) \$2.60 ea.
 5 1/4" DSDD—96TPI (747) \$3.25 ea.
 8" SSDD (740) \$2.05 ea.
 8" SSDD (741) \$2.50 ea.
 8" DSDD (743) \$3.10 ea.

Shipping: 5 1/4" DISKETTES—Add \$3.00 per 100 or fraction thereof. 8" DISKETTES—Add \$4.00 per 100 or fraction thereof. OTHER ITEMS: Shipping charges as shown in addition to diskette shipping charges. Payment: VISA or MasterCard. COD orders only, add \$3.00. Taxes: Illinois customers, please add 8%.

Hours: 9 AM-5 PM Central Time For fast service call

Nationwide: 1-800-621-6827 In Illinois: 312-944-2788

DISK WORLD!

Suite 4806 • 30 East Huron Street • Chicago, Illinois 60611

Authorized Distributor Information Processing Products **3M**

Circle 127 on Inquiry card.



GREAT DISKETTES Super low prices SYNCOM

The low priced, high quality diskette with a LIFETIME WARRANTY. Packed in polybags of 10 with Tyvek envelopes, labels and reinforced hubs.

One of the best buys we've seen. **LIFETIME WARRANTY!**
\$139 ea. 5 1/4" SSDD **\$185** ea. 5 1/4" DSDD
 QTY. 20 QTY. 20

OTHER GREAT VALUES:

DISKETTE 70—Holds 70 5 1/4" diskettes in dust free safely \$14.95 ea. + \$3.00 Shpg.

DISK CADDIES—Flip up style holds 10 5 1/4" diskettes \$1.65 ea. + 20 Shpg.

Shipping: 5 1/4" DISKETTES—Add \$3.00 per 100 or fraction thereof. OTHER ITEMS: Shipping charges as shown in addition to diskette shipping charges. Payment: VISA or MC. COD orders only, add \$3.00. Taxes: Illinois customers, please add 8%.

Nationwide: 1-800-621-6827 In Illinois: 1-312-944-2788

Minimum Order: \$35.00 **WE WILL BEAT ANY NATIONALLY ADVERTISED PRICE!**

DISK WORLD!

Suite 4806 • 30 East Huron Street • Chicago, Illinois 60611

SYNCOM

Circle 128 on Inquiry card.

CLASSIC MEMORY CORP Flexible Diskettes

Life Time Warranty - 100% Certified
 33% Stronger Jacket... Longer Life
 High Density Oxide... Better Performance
 FREE CASE... Protective Storage
 Low Cost... More Diskettes For Your Money

| | |
|---|--|
| 5 1/4" SINGLE SIDE SINGLE DENSITY 48 TPI W/HUB RING Packed 10 per Soft Pack \$1.60 each | BULK SSSD 100/Case White Envelope W/HUB RING \$1.40 each |
| 5 1/4" SINGLE SIDE DOUBLE DENSITY 48 TPI W/HUB RING Packed 10 per Soft Pack \$1.89 each | BULK SSDD 100/Case White Envelope W/HUB RING \$1.70 each |
| 5 1/4" DOUBLE SIDE DOUBLE DENSITY 48 TPI W/HUB RING Packed 10 per Soft Pack \$2.47 each | BULK DSSD 100/Case White Envelope W/HUB RING \$2.25 each |

DELIVERED PRICES
 Free shipping in continental USA. Call for quantity discounts. We accept money orders, certified checks, VISA and MasterCard Personal checks accepted, but take two weeks to clear bank N.D. add 4%.

Software Services™
 1326 - 25th St. S., Suite H Fargo, ND 58103
1-800-634-2248

Circle 335 on Inquiry card.

→ All **LOWAS DATA PRODUCTS** ←
 16-BIT, 8-100 Bus: Systems & Boards

• • • **FIREBALL DISCOUNTS** • • •
 25% off List Price (UPS extra) for Cashier's Check or Money Order
 You save **MONEY** = We save **TIME**
 See → **LOWAS** ← ad in **BYTE** or request complete specifications

LIGHTNING SPEED
 80286-CPU & 80287-NDP: \$1458.75
THUNDERING PERFORMANCE
 80186 & I/O & 256K-DRAM & 5.25"/8" disk controller & CCP/M-86: \$1196.26

Configured for **SanTec-S700** printer:
 TeleVideo-GA970C VDT: \$1121.75
 Spellbinder-5.30 W/P: \$371.26

HIERATIC COMPUTER SYSTEMS
 BOX 133; MEDFORD, MA 02155
 (617) 391-8659

Circle 183 on inquiry card.

HARD DISK DRIVE SURPLUS SALE!

\$350 ea. *

* Say you're a **BYTE** reader to get this special price — normally \$380!

High reliability 8" Shugart SA 1002 5.33 Mbyte drives for \$350. ea., unused in their original factory packed cartons. 1000's of pleased customers. Also available: new Western Digital controller card (\$350.); interfaces for IBM, Apple, S-100, STD, Heath/Zenith, SS-50, SS-30. Shipping for drive, \$12. Call before they're gone —

LIQUIDATORS, 803-877-9828, or send check or money order to 105 S. Main St., Greer, S.C. 29651.

Circle 177 on Inquiry card.

MICRO COMPUTER ACCESSORIES GREAT PRICES!!!

For Business & Home Computer Users
 OPUS DISKETTES SS/DD \$20.00/Box of 10 7 year guarantee

We also carry **SENTINEL 3M**, or **MEMOREX** Diskettes
 Flip 'N' File 15 — \$ 8.00 Library Case - holds 15 Diskets
 Flip 'N' File 50 — \$31.00 Desk Top Storage - 50 Diskets

Send check or money order now to receive these low prices. Add \$2.00 for shipping and handling. California residents add 6% sales tax.

Call, Write or Telex for additional information.
 Modem Line - 714/892-4049 5-10 PM Daily, PST 365 days per year
 Voice Line - 714/898-7324 8 AM to 4:30 PM, PST 213/430-0167 Monday thru Friday
 Telex No. - 706846 HAMMERIND, UD 24 hrs a day

HAMMER INDUSTRIES
 5482 Oceanus Drive, Suite B P.O. Box 2419 Huntington Beach, California 92647

FREE CATALOG AVAILABLE

Circle 177 on Inquiry card.

QUASI-DISK, an S-100 RAM-Disk \$895. with .5 Mbyte of 64K DRAM

QUASI-DISK is an S-100 bus memory card with 64 sockets for Dynamic RAM. The capacity is .5 Mbyte using 64K D-RAMs or 2.0 Mbytes with 256K D-RAMs. Combinations of 64K and 256K D-RAMs may be used. QUASI-DISK is supplied with CP/M 80 software, including source code on an 8" diskette to allow the board to emulate a disk drive. This is a high quality six layer printed circuit board. Documentation includes professional schematics, however, two PAL ICs are undocumented.

Because RAM can be accessed approximately 1,000-fold faster than either a floppy diskette or a hard disk you will enjoy overall response times perhaps 35x faster than your current disk drive. Programming becomes more of a pleasure because your time is more productive.

OPTION: 64 socket piggy back expansion board. Supplied with 5 Mbyte of 64K D-RAMs or \$684. Capacity is expandable to 2.0 Mbyte using 256K RAMs.

OPTION: A battery back-up board.

MICROPROCESSORS UNLIMITED
 Beggs, Oklahoma
 (918) 267-4961

Circle 259 on Inquiry card.

ICs PROMPT DELIVERY!!! SAME DAY SHIPPING (USUALLY)

| DYNAMIC RAM | | |
|-------------|--------|---------|
| 256K | 200 ns | \$69.00 |
| 64K | 200 ns | 5.87 |
| 64K | 150 ns | 5.99 |
| 64K | 120 ns | 7.50 |
| 16K | 200 ns | 1.56 |
| EPROM | | |
| 27128 | 300 ns | \$22.50 |
| 2764 | 250 ns | 8.75 |
| 2732 | 450 ns | 5.30 |
| 2716 | 450 ns | 3.60 |
| 2532 | 450 ns | 4.75 |
| STATIC RAM | | |
| 6264P-15 | 150 ns | \$39.00 |
| 6264LP-15 | 150 ns | 41.00 |
| 6116P-3 | 150 ns | 5.75 |

MasterCard VISA or UPS CASH COD
Factory New, Prime Parts **µPco**
 MICROPROCESSORS UNLIMITED
 24,000 South Peoria Ave. (918) 267-4961
 BEGGS, OK. 74421
 Prices shown above are for Feb. 18, 1984
 Please call for current & volume prices. Prices subject to change. Please expect higher prices on some parts due to world wide shortages. Shipping and insurance extra. Cash discount prices shown. Small orders received by 5 PM CST can usually be delivered to you by the next morning via Federal Express Standard Air — \$5.99

Circle 260 on Inquiry card.

SELL your PROGRAMS and/or your EXPERTISE

For free information send stamped self addressed envelope to:

DYNAMIC BUSINESS PROGRAMMING,
 P.O. Box 34791,
 Los Angeles, CA, 90034

Circle 138 on Inquiry card.

be featured. Further information is available from Clapp & Poliak, 708 Third Ave., New York, NY 10017, (212) 661-8410.

June 13-15

Clinical Laboratory Computers Symposium 1984, Towsley Center, University of Michigan Medical School, Ann Arbor. Contact the Office of Continuing Medical Education, Towsley Center Box 057, University of Michigan Medical School, Ann Arbor, MI 48109, (313) 763-1400.

June 13-15

The Sixth Annual National Educational Computing Conference—NECC '84, University of Dayton, OH. Papers, workshops, and exhibits are designed to promote a higher quality of classroom instruction in educational computing. Com-

plete details on NECC '84 are available from Lawrence A. Jehn, Computer Science Department, University of Dayton, Dayton, OH 45469, (513) 229-3831.

June 13-15

PC-World Exposition, McCormick Place West, Chicago, IL. Further information can be obtained from Mitch Hall Associates, POB 860, Westwood, MA 02090, (617) 329-8090.

June 14-17

International Computer Show, Cologne, West Germany. Seminars, workshops, and hardware and software exhibits will highlight this international event focusing on informing users on buying-decision criteria, how to scrutinize software, and how to solve user's needs such as customer service, advice, and spare parts. Contact Messe-

und Ausstellungs-Ges.m.b.H Köln, Messeplatz, Postfach 210760, D-5000 Cologne 21, West Germany; tel: (0221) 821-1; Telex: 8873 426 a mua d.

June 16

Writing for the Computer Industry, Plymouth State College, Plymouth, NH. Topics to be addressed include how to write computer-related text for an international audience, electronic documentation, training and linguistic style, and how to integrate text and graphics. Contact Dr. Sally Boland, 5 Reed House, Plymouth State College, Plymouth, NH 03264, (603) 536-1550.

June 18-21

People, Computers, and FORTH Programming, Humboldt State University, Arcata, CA. This is a hands-on, introductory course for individuals wanting enough knowledge and experience with FORTH to write applications programs. In order to gain an understanding of some of FORTH's internal workings, experience using a computer language is advised. The fee is \$125 or \$175 with three quarter hours academic credit. Register with Claire Duffey, Office of Continuing Education, Humboldt State University, Arcata, CA 95521, or call (707) 826-3731.

June 18-22

Office Information System Software, Massachusetts Institute of Technology, Cambridge, MA. This course provides a systematic treatment of the concepts behind the design of multifunction office workstations, including technologies, human factors, software, and applications generators. Further information is available from the Director of the Summer Session, E19-356, MIT, Cambridge, MA 02139.

June 19-21

Computerized Office Equipment Expo, O'Hare Exposition Center, Rosemont, IL. For complete details, contact the show manager, Cahners Exposition Group, Cahners Plaza, 1350 East Touhy Ave., POB 5060, Des Plaines, IL 60018, (312) 299-9311.

June 20

How to Document a Computer System, Sheraton Commander Hotel, Cambridge, MA. For details, see April 27.

June 26-29

Using FORTH Effectively, Humboldt State University, Arcata, CA. This is a hands-on advanced course on the generation and internal operations of a FORTH system. A minimum of six months using FORTH and a knowledge of assembly language and operating-system principles are prerequisites. The fee is \$150 or \$200 with three quarter hours academic credit. Registration information is available from Claire Duffey, Office of Continuing Education, Humboldt State College, Arcata, CA 95521, (707) 826-3731. ■

Extended Processing S100 Boards

POWER I/O



High performance S100/IEEE-696 smart slave computer with 64K RAM, 3 serial ports, 1 centronic port, comprehensive 4K operating system in EPROM and 1 timer. Host access is through a high speed parallel I/O port. Accepts 256K RAMS when available. Optional ADD-ON board doubles I/O and RAM. Standard software and hardware supports 6 serial ports, 2 parallel ports and 512K of RAM. Entire board is software programmable including all I/O buffer sizes.

POWER I/O w/64K and 3S+P: \$375.00
64K RAM ADD-ON board: \$175.00
3S+P ADD-ON board: \$195.00
64K and 3S+P ADD-ON board: \$295.00

BURNER I/O II



Multifunction S100/IEEE-696 board. Complete EPROM programmer handles 5 volt EPROMS: 2508, 2758, 2516, 2716, 2532, 2732, 2732A, 2564, 2764, 27128, 27256. Fully I/O mapped. EPROM selected totally with software. No switches or program modules. Menu driven software supplied in 4K EPROM. 2 independent serial ports with baud rate to 19,200. 1 centronic type parallel port. Memory management for address lines A16-A23.

Option A: Full board \$355.00
Option B: Programmer \$220.00
Option C: I/O (2S+P) \$220.00
Option D: Programmer+I/O \$330.00
Option E: Memory management \$110.00
Memory management for B or C: \$ 25.00

All E.P. boards are built with quality components and are fully assembled and tested. Full documentation including schematics and source code listings.

ep Extended Processing 3861 Woodcreek Lane,
San Jose, Ca, 95117 (408) 249-8248

In order to gain optimal coverage of your organization's computer conferences, seminars, workshops, courses, etc., notice should reach our office at least three months in advance of the date of the event. Entries should be sent to: Event Queue, BYTE Publications, POB 372, Hancock, NH 03449. Each month we publish the current contents of the queue for the month of the cover date and the two following calendar months. Thus a given event may appear as many as three times in this section if it is sent to us far enough in advance.

REAL-WORLD INTERFACING

Interface Connects with RS-232C Ports

The Starbuck 8232 is a data-acquisition and control interface that connects with any computer through an RS-232C port. It comes with eight digital inputs, eight digital outputs, and eight 0- to 5-volt analog inputs with 8-bit accuracy. The 8232's built-in Motorola 6802 microprocessor provides 2K bytes of ROM and 2K bytes of RAM. Internal software permits buffered high-speed analog data acquisition at rates in excess of 7000 points per second and buffered data logging with storage for 2000 data points. Other programs may be downloaded to RAM.

All inputs are protected against overvoltage, and the outputs are optoisolated. Analog inputs are internally damped to reduce noise pickup. The 8232 can share an RS-232C line, and it lets you store analog data for later transmission. Communications are in ASCII. The 8232 can be battery-powered for remote-site applications.

The 8232 with operator manual costs \$540. For complete specifications, contact Starbuck Data Co., POB 24, Newton Lower Falls, MA 02162, (617) 237-7695.

Circle 604 on inquiry card.

Altext Transfers Data Between Computers

Altext Systems I and II transfer data between different makes of personal computers, word processors, and typesetting equipment. Stored data is said to be transferred in exactly the same format as the original. These stand-alone microcomputers can read and write

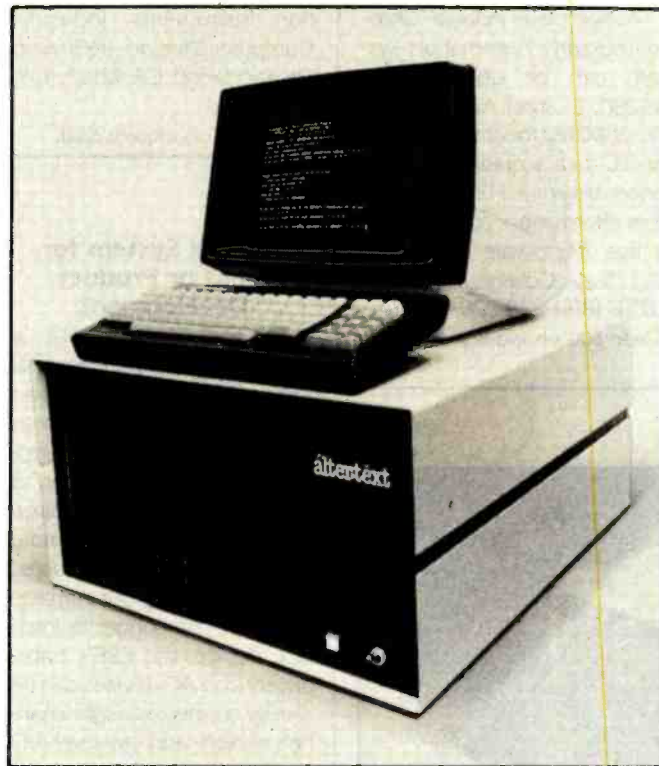

both 5¼- and 8-inch floppy disks. The System I reads floppy disks and transfers files on line to a front-end system. It can retrieve information via telephone lines and write it to a disk. System II is suitable for those interested in disk-to-disk capabilities.

The standard Altext System comes with 64K bytes of RAM, double-sided double-density 5¼- and 8-inch floppy-disk drives, keyboard, RS-232C serial port, printer port, video terminal, power supply, and communications cable. The detachable display monitor has an 80-character by 24-line format and a tilt-and-swivel base. Asynchronous communications protocols are standard. The data transfer rate ranges from 300 to 19,600 bps.

Bisynchronous communications, which emulate IBM 2770, 2780, 3780, and 3741 protocols, are offered as an option. A paper-tape interface and a printer equipped with both parallel and serial inter-

face capabilities are also available. The System I comes with 5¼- and 8-inch floppy-disk drives. The System II has four drives, two of each format. Base prices are \$12,000 and \$20,000, respectively. For more information, contact Altext Inc., 210 Lincoln St., Boston, MA 02111, (617) 426-0009.

Circle 607 on inquiry card.

Home Control System Doesn't Tie Up Computer

Cyberlynx's Smarthome I is a hardware and software combination that allows an Apple or an IBM Personal Computer to monitor a security system and control electrical appliances without tying up the computer. Smarthome I is made up of a controller unit, wireless security sensors, a hand-held remote controller, power-line appliance controllers, and software. Electrical appliances can be pro-

grammed to respond to emergency situations, and Smarthome can be set to alert you to equipment malfunctions. Programming is done by using a joystick or mouse to move objects or icons around the video screen. A draw program lets you customize this system to your house. The controller unit features multitasking firmware that leaves your computer free to run other programs.

Smarthome I is offered in a start-up kit, which provides the necessary equipment to set up and operate a basic home-security system. Prices begin at less than \$600. For full particulars, contact Cyberlynx, 4828 Sterling Dr., Boulder, CO 80301, (303) 444-7733.

Circle 608 on inquiry card.

Chromatography Automation System for Apples

The Adalab Chromatography Automation package for Apple II/IIe computers features menu-driven software, a data-acquisition/control card, and a chromatography interface module. The Chromatograph software supports up to four channels of simultaneous data acquisition and control for GCs (gas chromatographs), HPLCs (high-performance liquid chromatographs), and similar systems. It uses proprietary data-compression algorithms, which are said to permit more raw data storage than other systems. Chromatograph lets you calculate, review, edit, and store baseline information. Other attributes of the software include integration routines that determine retention time, height, width at half height, and symmetry. Data is stored in memory or on disk.

The Chromadapt Chromatography Interface Module amplifies detector signals and

provides binary gradient control of HPLC pumps using Chromatograph software. Chromadapt is equipped with eight digital inputs and eight digital outputs that can sense switch conditions, control valves, and so forth. In addition, its variable-scale D/A output permits playback of GC or HPLC data from computer memory to any analog strip-chart recorder or integrator.

A complete Adalab Chromatography Automation System can be obtained for \$4280. Existing Apple IIs can be retrofitted for gradient HPLC or GC data acquisition. Retrofit prices begin at \$1295. For further information, contact Interactive Microware Inc., POB 771, State College, PA 16801-0771, (814) 238-8294.

Circle 600 on inquiry card.

tion Instruments, Industrial Computer Division, 8601 Aero Dr., San Diego, CA 92123, (619) 279-5726.

Circle 606 on inquiry card.

Control System for OEM or Product Development

The R8E Microcontroller, a stand-alone computer control system, is suitable for use as an OEM dedicated controller or as an industrial product-development system. It can be used as a security-system monitor, EPROM programmer, remote data logger, or print spooler. Configured as a programmable controller, data logger, or interface device, the R8E's transducers and AC devices can be directly connected. Eight channels of high- and low-level A/D inputs are standard, as are three parallel ports (two of which are Centronics-compatible), one RS-232C serial port with switch-selectable data rates, and solid-state power relays. The R8E uses the Zilog Z8671 chip, which is designed for control applications with both 8- and 16-bit capabilities.

The R8E can hold up to 16K bytes of user memory, expandable to 78K bytes. Memory can be RAM, ROM, or EPROM; 2K bytes of battery-backed RAM are supported. Programming is done through a resident BASIC interpreter.

An EPROM programmer system, a rough-service two-axis interface board, an 80-column by 25-line terminal, and a cassette recorder are optional. The R8E can be ordered in starter kit or full-development system packages. The starter system includes the controller, 2K-byte BASIC interpreter, AC power supply, interface cable, 4K-byte CMOS RAM, and machine manual. It lists for \$449. The development system is made up of a 2K-byte

battery-backed RAM, 12K-byte Q-static RAM, batteries, speaker, zero-insertion force socket for slot 0, 2-amp AC power supply, interface cable, and manual. It costs \$569. Options begin at \$7.95. Contact H. H. S. Microcontrollers, 5876 Old State Rd., Edinboro, PA 16412, (814) 734-4338.

Circle 605 on inquiry card.

Data Acquisition and Control

The Analog Connection II from Strawberry Tree Computers is designed for laboratory and industrial applications including data logging, process monitoring, and process control. It will measure temperature, pressure, flow, and other analog inputs from voltage or current sources. Designed for use with Apple computers, the Analog Connection can switch heaters, fans, and pumps on and off at preset levels or from digital inputs. You can log data or display maximum, minimum, average, or difference of inputs. Alarm limits can be set for any input device, and input ranges and engineering units can be specified through menus. A menu that offers 10 different thermocouple types provides flexibility when measuring temperature. Linearization and cold-junction compensation are accounted for automatically.

Overall system accuracy is 0.04 percent. High noise rejection is 110 decibels, common mode, and 72 decibels, normal mode. Ten input ranges, which span from 25 millivolts to 10 volts and 2.5 to 50 milliamperes full scale, accept data from most sensors. The basic configuration of the Analog Connection consists of a single plug-in card with eight analog inputs and eight digital I/O lines. Data-acquisition software is provided. The Analog Con-

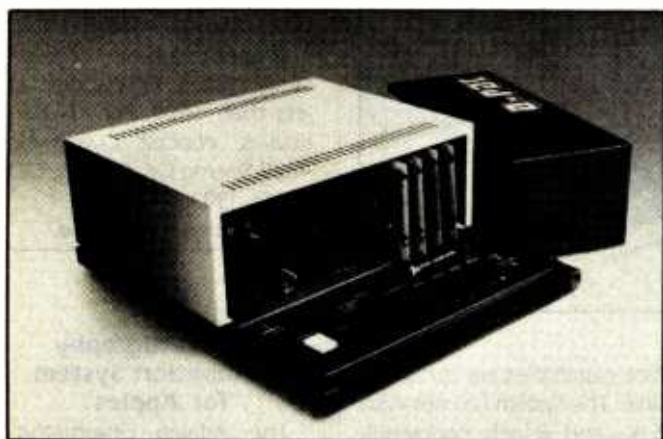

Industrial Micro Has Built-In A/D Interface

Action Instruments' A-Pac BC3 computer is designed for industrial data acquisition and control. It combines a built-in analog and digital I/O interface with a personal computer and a programmable logic controller. Salient features include 10 plug-in expansion slots, EPROM memory, battery-backed RAM, and clock/calendar.

A key element of the BC3 is a proprietary industrial software package known as ABLE (Action BASIC Language Enhancement). ABLE offers a wide set of control-oriented instructions. It lets one application program access another and allows parameters to interact between programs. Data logging, alarm and control annunciators, multiloop PID control, batch control, and distributed-processing applica-

tions programs are available. All the programs are said to minimize user programming.

Optional plug-in modules provide up to 256 inputs, including director sensors, thermocouples, strain-gauge and pressure transducers, analog voltages, and currents and digital logic levels. Outputs will control motors, industrial robots, solenoids, physical actuators, and solid-state relays. Action Instruments asserts that the BC3's on-board nonvolatile memory eliminates the need for peripheral memory devices.

An A-Pac BC3 start-up kit for basic applications costs \$5999 and includes a CRT, keyboard, I/O interface, and cables. Quantity and OEM discounts are available. The single-unit price for the BC3 is \$3500. For more information, contact Ac-

Value Ranges
Quantitative⁷Variable
Identifiers

| Real | Integer | Qualitative ⁸ | Type ⁹ | Max. Length (if char.) |
|------|---------|--------------------------|-------------------|---------------------------|
| 17 | — | — | B | 8 |
| 4.5 | — | 100 | B | 10 |
| 37 | — | 20 | B | 255 |
| 37 | — | — | P | — |
| 37 | — | — | P | — |
| 37 | — | — | P | — |
| 37 | — | — | P | — |
| 37 | — | — | B | 6 |
| 37 | — | — | B | 6 |
| 37 | — | — | B | 6 |
| 37 | — | — | B | 10 |
| ? | — | — | B | 5 |
| 37 | — | — | C | 6 |
| 38 | — | — | N | — |
| 38 | 4.5 | ? | P | — |
| 37 | — | ? | B | 4 |
| 3.1 | 8 | 1296 | B | 16 |
| 3.1 | 8 | 1296 | B | 16 |
| 37 | — | — | C | 4 |
| 38 | — | 127 | C | 8 |
| 38 | — | — | B | 9 |
| 35 | — | 50 | B | 12 |
| 37 | — | — | C | 8 |
| 37 | — | — | C | 8 |
| 37 | — | ? | C | 40 |

used by AIDA, has the appearance of a virtual system. In this system, variables are called into memory as they are needed. If a variable not currently in memory is needed, it will be read into memory at that time.

Missing-Data Methods: Statistical packages typically handle missing data in one of two ways. One method is to exclude an entire case from the analysis if any variable is missing within the case. This method obviously eliminates a lot of cases. An alternative is to exclude only the missing variable value from statistical operations that require it. For example, regression analysis requires a sum of cross products. In pairwise deletion, a case with a missing value on one variable will be treated as follows: the missing variable cannot be used in the computation of cross products that contain it; however, all other variable cross products will be computed for the case. A description of the treatment of missing data is shown as C = casewise deletion, P = pairwise deletion, O = other, or "—" = none. Preparation for missing data varies by package. Often, a specific character or value is required to denote missing data.

Variable Types: Three data types were found: real, integer, and character. Few packages permit all three types as allowable input.

Maximum Decimals/Value Ranges: We describe the precision of usable data in two ways. For real and integer data, the table gives the absolute range of values as a power of 10 (e.g., $10 + En$). It also shows the number of digits of precision used in computations when this was noted in the documentation. For qualitative data, the table indicates the number of unique levels permitted.

Variable Identifiers: The nature and length of user-supplied labels are shown. Typical options for identification are numeric only (e.g., VAR001), alpha only (e.g., AGE or INCOME), or a choice of either.

Table 4 covers documentation.

The user must depend heavily on the documentation provided with the package and on-screen displays to learn how to use the program and to resolve problems. The documentation is enhanced if it contains a tutorial including example applications. For packages that present menus and questions, sample runs should be included to indicate typical responses. For packages that are command oriented, an alphabetized reference section is helpful. Regardless of operating style, an index should be included.

Other items noted in the documentation comparisons are whether there is a reference card summarizing the available commands, a description of the technical formulas, and a list of technical references relevant to the statistical procedures. A list of formulas used in computations would clarify the procedures used by the program's author. NWA Statpak, SpeedSTAT, and Statpro had extensive documentation on the formulas used in their computations. We comment on these matters of documentation and offer our overall assessment of ease of use.

Data Management and Processing

In these tables, we describe how the packages manage and process data. First we discuss the entry, editing, storage, retrieval, and display of data. Then we talk about the packages' ability to process the data through subsetting, merging, sorting, and transforming.

Table 5 covers data management.

Keyboard Entry: Almost all statistical software packages permit the entry of raw data from the keyboard. However, some packages running under CP/M or UCSD Pascal require the data to be prepared in a machine-readable form with an operating-system editor or by output from another program. The table indicates whether the package permits you to enter the data from the keyboard.

Access Foreign Data: Another characteristic we examined was the capacity to read from or write to files that can be used or created by other programs. First, we note whether the package can access a standard operating-system file. This is typically an ASCII file with fixed column positions for variables or with a delimiter such as a comma or space between variables. To access the standard file, you may need to reformat it using a utility provided with the package or your own program designed according to information provided in the documentation.

One increasingly common format is that of the DIF (Data Interchange Format) file introduced by Software Arts Products Inc. (creators of Visicalc). DIF is a standard format that authors can use to make their data files compatible. Another valuable file for-

| | Number of Pages | Table of Contents | Index | Summary Card | Tutorial | Sample Runs | Formulas | No. Technical References | Easy to Use |
|-------------------|-----------------|-------------------|-------|--------------|----------|-------------|----------|--------------------------|-------------|
| ABSTAT | 94 | Y | Y | — | Y | Y | Y | 0 | Y |
| AIDA | 89 | Y | Y | Y | Y | Y | — | 15 | Y |
| A-Stat | 140 | Y | — | Y | Y | Y | — | 5 | Y |
| Dynacomp Regr 1 | 12 | — | — | — | — | Y | — | 0 | — |
| Dynacomp Regr 2 | 14 | — | — | — | — | Y | Y | 1 | — |
| Dynacomp Multilin | 16 | — | — | — | — | Y | Y | 1 | — |
| Dynacomp ANOVA | 15 | — | — | — | — | Y | — | 2 | — |
| HSD Stats Plus | 104 | Y | Y | — | Y | Y | — | 5 | Y |
| HSD Regress II | 82 | Y | Y | — | Y | Y | — | 7 | Y |
| HSD ANOVA II | 52 | Y | Y | — | Y | Y | — | — | Y |
| Introstat | 57 | Y | Y | — | Y | — | — | 1 | Y |
| Microstat | 99 | Y | — | — | — | Y | Y | 1 | Y |
| Micro-TSP | 175 | Y | Y | — | Y | — | Y | 5 | Y |
| Number Cruncher | 78 | Y | — | — | Y | Y | — | 1 | Y |
| NWA Statpak | 250 | Y | Y | — | — | Y | Y | 2 | Y |
| SAM | 39 | Y | — | — | — | Y | — | 0 | Y |
| SpeedSTAT Vol. I | 174 | Y | Y | — | Y | — | Y | 7 | Y |
| SpeedSTAT Vol. II | 250 | Y | Y | — | Y | — | Y | 10 | Y |
| SPS | 115 | — | Y | — | — | — | — | 15 | — |
| STAN | 101 | Y | — | — | Y | Y | — | 11 | Y |
| Statpro | 381 | Y | Y | Y | Y | — | Y | 14 | Y |
| SYSTAT | 239 | Y | Y | Y | Y | Y | — | 63 | Y |
| TWG ELF | 118 | Y | Y | — | Y | Y | — | 8 | — |
| TWG ARIMA | 73 | Y | Y | — | Y | — | — | 16 | — |
| Wallonick Statpac | 105 | Y | — | — | — | — | Y | 2 | Y |

Table 4: Documentation features.

| | Keyboard Data Entry | Access Foreign Data | | | File Documentation ¹ | Single Data Structure | Edit | | |
|-------------------|---------------------|-----------------------|-----------|----------------|---------------------------------|-----------------------|--------|-----|--------|
| | | Standard System Files | DIF Files | dBASE II Files | | | Change | Add | Delete |
| ABSTAT | Y | Y | — | Y | — | — | Y | Y | Y |
| AIDA | Y | Y | — | — | I | Y | Y | Y | — |
| A-Stat | Y | Y | Y | — | G | Y | Y | Y | — |
| Dynacomp Regr 1 | Y | Y | — | — | — | — | Y | Y | Y |
| Dynacomp Regr 2 | Y | Y | — | — | — | — | Y | Y | Y |
| Dynacomp Multilin | Y | Y | — | — | — | — | Y | Y | Y |
| Dynacomp ANOVA | Y | Y | — | — | — | — | Y | Y | — |
| HSD Stats Plus | Y | Y | — | — | I | — | Y | Y | — |
| HSD Regress II | Y | Y | — | — | I | Y | Y | Y | Y |
| HSD ANOVA II | Y | Y | — | — | G | — | Y | — | — |
| Introstat | Y | Y | — | — | G | Y | Y | Y | Y |
| Microstat | Y | — | — | — | G | Y | Y | Y | Y |
| Micro-TSP | Y | Y | Y | — | I | Y | Y | Y | Y |
| Number Cruncher | Y | — | — | — | I | Y | Y | Y | — |
| NWA Statpak | Y | Y | — | — | G | — | Y | Y | Y |
| SAM | Y | Y | — | — | I | Y | Y | Y | Y |
| SpeedSTAT Vol. I | Y | — | Y | — | — | Y | Y | Y | — |
| SpeedSTAT Vol. II | Y | — | Y | — | — | Y | Y | Y | Y |
| SPS | Y | Y | Y | — | G | Y | Y | Y | Y |
| STAN | — | Y | — | — | G | Y | — | — | — |
| Statpro | Y | Y | — | — | — | — | Y | Y | Y |
| SYSTAT | Y | Y | — | — | I | Y | Y | Y | Y |
| TWG ELF | Y | Y | Y | — | G | Y | Y | Y | — |
| TWG ARIMA | Y | Y | Y | — | G | Y | Y | Y | — |
| Wallonick Statpac | Y | Y | — | — | G | Y | Y | Y | Y |

1/ G = Good, I = Incomplete

2/ F = Flexible, I = Inflexible

3/ Y = Package provides the means to turn printer on and off, A = To print a run session, user must direct all output to a text file by a command given at beginning of the session of each module and then list the text file

Table 5: Data management.

mat is that used by the dBASE II database package that operates under CP/M, CP/M-86, and PC-DOS. The table notes if either of these formats is supported. Table 5 also indicates if a standard operating-system ASCII file can be generated and read by the program.

File Documentation: Most packages use their own file format for storage of data. If standard system files cannot be read or written, it is important that the internal file format be documented. Without this, you will be limited to keyboard entry of data and will not be able to use your data with any other program. Table 5 indicates if adequate documentation is provided to permit access to internal files.

Single Data Structure: An important data-management feature that is related to ease of use is the nature of the data structure employed. Most programs use a single data structure in which the cases are rows of the file (records) and the variables are columns. Some packages, however, turn this definition around for some of the analytical options, defining a column as a sample or group. For example, both the HSD ANOVA II and Statpro ANOVA options use two different formats, depending on the type of analysis being conducted. This varying of a file definition is potentially confusing, and we believe that it should be avoided.

Edit: After initial entry, you may have to add new records, edit existing records, or delete unneeded records. These functions may be accomplished within the package or you may be required to do this yourself. None of the editing operations provided are full-screen

activities. The usual method is to specify the record number and then the variable name that is to be changed. The current entry might then be displayed and the new entry requested.

We point out that an edit function may not be considered necessary, especially if the required operating system provides an editor. Of course, the use of an external editor can result in some inconvenience. Discovery of data errors will necessitate that you exit from the package, complete the required edit, and then return to the statistical package. This is not as handy as being able to make corrections from within the program.

Store Results on Disk: Another useful feature is the option either to print the output or to store it into a file that can later be used by a word processor.

Print: An obviously important feature of a statistical package is the ability to obtain a hard copy of the results. Flexibility in printed output is described in the table. As a minimum, you will want to display the data or a subset of it. The table indicates whether this printout has a rigid format (I = inflexible) or can be controlled (F = flexible). The ability to get hard copy of the session, including the numerical results and possibly the prompts and responses, is noted.

Table 6 covers data processing.

Selecting Cases: You may want to perform an analysis on a subset of your data or conduct simultaneous analyses on several subsets or strata. Most packages allow a degree of filtering of the file to analyze subsets. The table summarizes the presence of this feature; it notes if you can subset by case numbers or by variable ranges. Subsetting by variable range is usually done with logical statements regarding one or more variables. The table provides the following categories: S = single range, A = Boolean AND permitted, B = Boolean AND and OR permitted between ranges of variables, and V = a list of specific values may be requested. The A and B codes indicate that two or more logical statements can be specified either for a single variable or for two or more variables.

Join Files: You may need to expand an existing file with additional data representing new cases or new variables on old cases. The presence of either join operation is noted.

Sort: Sorting of a file may be desired or may be a requirement to correctly perform certain analysis options. In at least one package, the data must be sorted to obtain ranks. The table notes the presence of a sort operation.

Transform: Frequently, transformations of data are required. Transformations might include simple univariate functions such as logical operations, adding a constant, or taking logs. Alternatively, the transformation might involve computations such as addition or multiplication, which use more than one variable. We note whether the usual arithmetic operations (+, -, *, /) are permitted and whether other math functions can be used to create new variables from existing ones. We also check for the capability of generating random variables for use in simulations. The computation of some probability density function, cumulative density function, and inverse CDF is noted. While it may be possible to compute these using functions provided for transforming data, we indicate in the table if a specific, single-step transform is provided.

Method: The method of specifying the transformation varies. Some packages require a command with supplied parameters (denoted C), others use a menu to select the transformation (denoted M), and still others require a BASIC or Pascal-like formula to be supplied (denoted F).

Conditional Transform: This option lets you limit the transformation to only those cases that meet specific conditions, such

| Store Analytic Reports | Print | | |
|------------------------|-----------------------------|--------------------------|---------|
| | Formatted Data ² | Run Session ³ | Results |
| Y | I | Y | Y |
| — | I | Y | Y |
| Y | F | Y | — |
| — | — | — | — |
| — | — | — | — |
| — | — | — | — |
| — | I | — | Y |
| — | F | — | Y |
| — | I | — | Y |
| — | F | Y | Y |
| — | F | — | Y |
| Y | I | Y | Y |
| Y | F | — | Y |
| Y | F | Y | Y |
| Y | I | Y | Y |
| Y | I | — | Y |
| Y | I | — | Y |
| Y | F | A | Y |
| Y | I | — | Y |
| Y | F | Y | Y |
| — | I | — | Y |
| — | I | — | Y |
| — | I | Y | Y |

| | Selecting Cases | | Join Files | | Sort ² | | | Transform | | | |
|-------------------|-----------------------------|--------------------------------|------------|---------------|-------------------|----------------|-----------------------------|-------------|--------------------|-------------------|-------------|
| | By Case Number ¹ | By Variable Range ¹ | Casewise | Variable-wise | Max. No. Vars | Asc/Descending | Variable Types ³ | Random Vars | Prob. Dens. Funct. | Cum. Dens. Funct. | Inverse CDF |
| ABSTAT | A | A | Y | Y | M | A | N | Y | — | — | — |
| AIDA | S | S | Y | Y | 1 | A | N | Y | — | — | — |
| A-Stat | S | S | Y | Y | M | A | C | Y | — | — | — |
| Dynacomp Regr 1 | — | — | — | — | — | — | — | — | — | — | — |
| Dynacomp Regr 2 | — | — | — | — | — | — | — | — | — | — | — |
| Dynacomp Multilin | — | — | — | — | — | — | — | — | — | — | — |
| Dynacomp ANOVA | — | — | — | — | — | — | — | — | — | — | — |
| HSD Stats Plus | — | A | Y | Y | — | — | — | — | — | — | — |
| HSD Regress II | — | A | Y | Y | — | — | — | — | — | — | — |
| HSD ANOVA II | — | — | Y | Y | — | — | — | — | — | — | — |
| Introstat | S | — | Y | Y | 2 | A | N | Y | — | — | — |
| Microstat | S | — | Y | Y | M | A/D | N | Y | Y | Y | — |
| Micro-TSP | S | — | Y | Y | — | — | — | — | — | — | — |
| Number Cruncher | — | — | — | Y | 1 | A | N | Y | — | — | — |
| NWA Statpak | A | A | Y | Y | 1 | A/D | N/C | Y | Y | Y | — |
| SAM | — | S | Y | Y | — | — | — | — | — | — | — |
| SpeedSTAT Vol. I | S | — | — | — | — | — | — | — | — | — | — |
| SpeedSTAT Vol. II | S | S | — | — | — | — | — | — | — | — | — |
| SPS | S | S | Y | Y | 1 | A | R | Y | — | — | — |
| STAN | — | — | — | — | M | A | N/C | Y | — | — | — |
| Statpro | S | A | Y | — | 1 | A | N | Y | — | — | — |
| SYSTAT | B | B | Y | Y | 1 | A/D | N | Y | — | — | — |
| TWG ELF | — | B | — | — | — | — | — | Y | — | — | — |
| TWG ARIMA | — | B | — | — | — | — | — | Y | — | — | — |
| Wallonick Statpac | — | B | Y | Y | 1 | A/D | N | — | — | — | — |

1/ In one step: V = Value list, S = Single range, A = Boolean AND of ranges, B = Boolean AND and OR ("Case Number" is a variable with values assigned sequentially by the package. Thus, "time period" may serve as a case number.)

2/ M = Four or more

3/ N = Numeric, C = Character

4/ C = Command and parameters, M = Menu, F = Formula statements, Q = Questions

Table 6: Data processing.

| | Means | | | Moments | | Coefficients | | |
|-------------------|------------|----------|-----------|----------|----------------|--------------|----------|-----------|
| | Arithmetic | Harmonic | Geometric | Variance | Std. Deviation | Skewness | Kurtosis | Variation |
| ABSTAT | Y | — | — | Y | Y | Y | Y | Y |
| AIDA | Y | — | — | Y | Y | — | — | — |
| A-Stat | Y | — | — | Y | Y | — | — | — |
| Dynacomp Regr 1 | — | — | — | — | — | — | — | — |
| Dynacomp Regr 2 | — | — | — | — | — | — | — | — |
| Dynacomp Multilin | — | — | — | — | — | — | — | — |
| Dynacomp ANOVA | — | — | — | — | — | — | — | — |
| HSD Stats Plus | Y | — | — | — | Y | — | — | — |
| HSD Regress II | Y | — | — | Y | Y | — | — | — |
| HSD ANOVA II | Y | — | — | — | Y | — | — | — |
| Introstat | Y | — | — | Y | Y | — | — | — |
| Microstat | Y | — | — | Y | Y | Y | Y | Y |
| Micro-TSP | Y | — | — | Y | Y | — | — | — |
| Number Cruncher | Y | — | — | Y | Y | Y | Y | — |
| NWA Statpak | Y | Y | Y | Y | Y | Y | Y | Y |
| SAM | Y | — | — | Y | Y | Y | Y | — |
| SpeedSTAT Vol. I | Y | — | — | Y | Y | Y | Y | — |
| SpeedSTAT Vol. II | Y | — | — | Y | Y | Y | Y | — |
| SPS | Y | — | — | Y | Y | Y | Y | Y |
| STAN | Y | — | — | — | Y | — | — | — |
| Statpro | Y | Y | Y | Y | Y | Y | Y | Y |
| SYSTAT | Y | — | — | — | Y | Y | Y | — |
| TWG ELF | Y | — | — | Y | Y | Y | Y | — |
| TWG ARIMA | — | — | — | — | — | — | — | — |
| Wallonick Statpac | Y | — | — | Y | Y | Y | Y | — |

Table 7: Summary statistics.

Transform

| | | Other Math Functions | Lag() (capability) | Method ⁴ | Conditional Transf. ¹ |
|---|------|----------------------|---------------------|---------------------|----------------------------------|
| + | - */ | | | | |
| Y | Y | Y | Y | F | A |
| Y | Y | Y | Y | C/F | B |
| Y | Y | Y | — | C | S |
| — | Y | Y | — | M/F | — |
| — | Y | Y | — | — | — |
| — | Y | — | — | M/F | — |
| — | — | — | — | — | — |
| Y | Y | Y | — | M | — |
| Y | Y | Y | — | M | — |
| Y | Y | Y | — | M | — |
| Y | Y | Y | — | F | — |
| Y | Y | Y | Y | M | — |
| Y | Y | Y | Y | F | — |
| Y | Y | Y | Y | F | — |
| Y | Y | Y | Y | M | S |
| Y | Y | Y | Y | Q,M | A |
| Y | Y | Y | Y | F | — |
| — | — | — | — | — | — |
| Y | Y | Y | Y | M | — |
| Y | Y | Y | — | M | — |
| Y | Y | Y | Y | F | — |
| Y | Y | Y | Y | M/F | A |
| Y | Y | Y | Y | F | B |
| Y | Y | Y | Y | F | B |
| Y | Y | Y | Y | F | B |
| Y | Y | Y | — | C/F | B |

as falling within a range of case numbers or having a specified range of values for some variable. If a case does not meet the conditions, it is generally given a missing value for the transformed variable. However, in at least one case, ELF, it is given the value of the previous case.

Statistical Functions

We classified the statistical functions performed by the packages into one of several categories: summary statistics, graphics, non-parametrics, linear models, and time series. Several packages recognize the need to permit case weighting for survey data based on probability samples or for heteroscedastic models. Below, we describe each category and note when case weighting is permitted.

Table 7 covers summary statistics.

In the computation of descriptive statistics, we view separately the analysis of qualitative data and quantitative data. A distinction between the two would be useful to prevent irrelevant actions such as the computation of means on nominal data; however, few of the programs examined maintained such a distinction. We note what summary statistics the packages develop. Among these are means, standard deviations and other moments of the distribution, percentiles, and order statistics (order statistics identify the smallest to largest of the sample values). In some cases, ranks can be obtained, but only through a multistep operation involving sorting. Several packages (such as A-Stat) require precomputation and storage of statistics, such as means and correlations for input into linear-model options.

Use of Weights: When analyzing survey data, it is frequently necessary to use a weighting variable to correctly reflect the importance of each case. We note if the package allows for the specification of a weight variable. (The same computation can be done via a transformation involving multiplying all the variables in the analysis by the weight variable. However, this involves a lot of extra work and the creation of numerous transformed variables.) The availability of a direct weight option is a real virtue when it is needed.

Table 8 covers graphics.

Since most personal computers have graphics capabilities, we expected to find fairly sophisticated graphical applications within statistical packages. Unfortunately, this is the exception rather than the rule. Many graphical displays, especially histograms, are of a simple low-resolution text form. With two exceptions, the data-display features fall into two areas: histograms and bivariate plots. The Statpro graphics package (Apple version) provides many other graphical displays, including pie charts, triangular scatterplots, and normality plots to check analysis assumptions. SYSTAT's Graphics module options include normal probability plots, contour plots, and stem-and-leaf displays.

Graphics displays for the various packages vary widely in their general form. We use the following codes to describe this: T denotes text character displays, L indicates a low-resolution (i.e., block) display, and H denotes the use of high-resolution pixel graphics. The table indicates whether a color display is provided and whether you can supply titles and labels. (Some packages label the graphs automatically, using the variable names.)

The table notes if automatic formation of groups for histograms is provided or if the user may optionally define them. When scatterplots are requested, we note whether the user may select the scaling and centering parameters or if it can be done automatically by the program. Clearly, the most general approach for both

Order Statistics

| Percentiles | Ranks | Trimmed Means | Min. & Max. | Use of Weights |
|-------------|-------|---------------|-------------|----------------|
| — | Y | — | Y | — |
| — | Y | — | Y | Y |
| — | — | — | Y | Y |
| — | — | — | — | — |
| — | — | — | — | — |
| — | — | — | — | — |
| Y | Y | — | Y | — |
| — | Y | — | — | — |
| — | Y | — | — | — |
| — | — | — | Y | — |
| — | — | — | Y | — |
| — | Y | — | Y | — |
| — | — | — | Y | — |
| — | — | — | Y | — |
| — | Y | — | Y | — |
| — | — | — | Y | — |
| — | Y | — | Y | — |
| — | — | Y | Y | Y |
| — | — | — | Y | Y |
| — | — | — | — | — |
| — | — | — | Y | — |

| | Mode ¹ | Color | Titles | Labels | 1-Var. Histogram | Histogram Grouping ² | 3-D Histograms | X-Y Scatter- plot | Scatter- plot Scaling ² | 3-D Scatter- plot |
|-------------------|-------------------|-------|--------|--------|---------------------|------------------------------------|-------------------|-------------------------|--|-------------------------|
| ABSTAT | T | — | — | — | Y | B | — | Y | B | — |
| AIDA | H | — | — | — | Y | M | — | Y | A | — |
| A-Stat | — | — | — | — | — | — | — | — | — | — |
| Dynacomp Regr 1 | T | — | — | — | — | — | — | Y | A | — |
| Dynacomp Regr 2 | T | — | — | — | — | — | — | Y | A | — |
| Dynacomp Multilin | T | — | — | — | — | — | — | Y | A | — |
| Dynacomp ANOVA | — | — | — | — | — | — | — | — | — | — |
| HSD Stats Plus | H | — | Y | Y | Y | M | — | Y | A | — |
| HSD Regress II | H | Y | Y | Y | — | — | — | Y | A | — |
| HSD ANOVA II | H | — | Y | Y | — | — | — | — | — | — |
| Introstat | H | — | — | Y | — | — | — | Y | B | — |
| Microstat | T | — | Y | Y | Y | M | — | Y | B | — |
| Micro-TSP | H | — | — | — | — | — | — | Y | A | — |
| Number Cruncher | T | — | Y | Y | Y | B | — | Y | B | — |
| NWA Statpak | T | — | Y | — | Y | B | — | Y | B | — |
| SAM | T | — | — | — | Y | B | — | Y | A | — |
| SpeedSTAT Vol. I | — | — | — | — | — | — | — | — | — | — |
| SpeedSTAT Vol. II | — | — | — | — | — | — | — | — | — | — |
| SPS | H | — | — | — | Y | M | — | Y | A | — |
| STAN | H | — | Y | — | — | — | — | Y | A | — |
| Statpro | H | Y | Y | Y | Y | B | — | Y | B | — |
| SYSTAT | T | — | Y | Y | Y | B | — | Y | B | — |
| TWG ELF | H,T | Y | — | Y | Y | A | — | Y | A | — |
| TWG ARIMA | T | — | — | — | — | — | — | Y | A | — |
| Wallonick Statpac | T | — | Y | Y | Y | M | — | Y | A | — |

1/ T = Text, L = Low-Res, H = Hi-Res

2/ A = Automatic, M = Manual, B = Both, — = None

3/ P = Print, F = File, — = No, G = Lo-res graphics can be printed, hi-res can be saved to a file

Table 8: Graphics.

| | Friedman Two-Way ANOVA | Kendall's Tau | Kolmogorov- Smirnov | Kruskal- Wallis H | Mann- Whitney U | Spearman Rank-Order Cor. | Wilcoxon Signed Rank | Wald- Wolfowitz Runs |
|-------------------|------------------------------|------------------|------------------------|----------------------|--------------------|--------------------------------|----------------------------|----------------------------|
| ABSTAT | — | — | — | — | Y | Y | — | — |
| AIDA | — | — | — | Y | — | Y | — | — |
| A-Stat | — | Y | — | — | — | — | — | — |
| Dynacomp Regr 1 | — | — | — | — | — | — | — | — |
| Dynacomp Regr 2 | — | — | — | — | — | — | — | — |
| Dynacomp Multilin | — | — | — | — | — | — | — | — |
| Dynacomp ANOVA | — | — | — | — | — | — | — | — |
| HSD Stats Plus | — | — | — | — | — | — | — | — |
| HSD Regress II | — | — | — | — | — | — | — | — |
| HSD ANOVA II | — | — | — | — | — | — | — | — |
| Introstat | — | — | — | — | Y | — | Y | — |
| Microstat | Y | — | Y | Y | — | Y | Y | Y |
| Micro-TSP | — | — | — | — | — | — | — | — |
| Number Cruncher | Y | Y | — | Y | Y | Y | Y | Y |
| NWA Statpak | Y | Y | Y | Y | Y | Y | Y | — |
| SAM | — | — | — | — | — | — | — | — |
| SpeedSTAT Vol. I | — | Y | — | — | — | Y | — | — |
| SpeedSTAT Vol. II | — | Y | — | — | — | Y | — | — |
| SPS | — | — | — | — | — | Y | — | — |
| STAN | — | — | — | — | — | — | — | — |
| Statpro | — | — | Y | Y | Y | Y | Y | Y |
| SYSTAT | — | — | — | — | — | Y | — | — |
| TWG ELF | — | — | — | — | — | — | — | — |
| TWG ARIMA | — | — | — | — | — | — | — | — |
| Wallonick Statpac | — | — | — | — | — | — | — | — |

1/ M = Depends on amount of free memory (RAM) (approx. 1000 cells), D = Depends on printer (80-col. printer: 10 x arbitrary; 132-col.: 19 x arbitrary)

2/ R = Row, C = Column, E = Cell

Table 9: Nonparametrics and tables

| Box & Whiskers | Pie Chart | Save Graphics ³ |
|----------------|-----------|----------------------------|
| — | — | PF |
| — | — | F |
| — | — | — |
| — | — | — |
| — | — | — |
| — | — | — |
| — | — | F |
| — | — | F |
| — | — | F |
| — | — | — |
| — | — | P |
| — | — | F |
| — | — | — |
| — | — | PF |
| — | — | — |
| — | — | — |
| — | — | — |
| — | — | — |
| — | — | F |
| Y | Y | PF |
| Y | — | PF |
| — | — | G |
| — | — | P |
| — | — | P |

types of display is the possibility of manual override of an otherwise automatic operation.

The table also indicates if other graphics displays, such as three-dimensional bivariate histograms, pie charts, or Box & Whiskers diagrams, are featured. (A Box & Whiskers diagram is a special form of histogram that identifies various percentiles. Its appearance is that of a box containing the median and denoting the second and third quartiles of the distribution surrounded by whiskers locating other percentiles.)

Finally, we note whether the package allows graphical displays to be printed directly or saved to a file. Typically, high-resolution graphics can only be saved to a file so the user is responsible for the printer interface.

Table 9 covers nonparametrics and tabulation capabilities.

Nonparametric statistics assume no underlying mathematical model to the data. They also do not make assumptions about the distribution of errors where parametric approaches usually require that data have a normal or Gaussian distribution. As the table shows, few packages provide these statistics.

A description of the ability of the program to produce crosstabs of quantitative data is shown. We have included an entry indicating the computation of associated statistics, such as a test of the independence of rows and columns.

The table also shows which of several types of Chi-square tests can be performed. These include the usual test of independence of marginals, the goodness of fit, and other hypotheses of probability models, such as conditional independence or log-linear model parameters. Also noted is the ability to accept frequency counts as an alternative to creating and recreating the table from the raw data items for each analysis.

| Kendall's Coef. of Conc. | Tables | | | Chi-Square Tests | | | Data Entry | | Calculate Percents ² |
|--------------------------|-------------------|---------------------------------|---------------------|------------------|-------------------|------------|-------------|-------|---------------------------------|
| | No. of Dimensions | Max. No. of Levels ¹ | Indep. of Marginals | Goodness of Fit | Log-Linear Models | Data Items | Frequencies | | |
| — | 2 | D | Y | Y | — | Y | Y | R,C,E | |
| — | 2 | 100 x 100 | Y | — | — | Y | — | R,C | |
| Y | 2 | 15 x 15 | Y | — | — | Y | — | R,C,E | |
| — | — | — | — | — | — | — | — | — | |
| — | — | — | — | — | — | — | — | — | |
| — | — | — | — | — | — | — | — | — | |
| — | 5 | 9 x 9 | Y | — | — | Y | Y | R,C,E | |
| — | — | — | — | — | — | — | — | — | |
| — | — | — | — | — | — | — | — | — | |
| — | 2 | 10 x 10 | Y | — | — | Y | — | — | |
| Y | 2 | 5 x 20 | Y | Y | — | Y | Y | E | |
| — | — | — | — | — | — | — | — | — | |
| — | 2 | ? | Y | — | — | Y | Y | R,C,E | |
| — | 2 | 10 x 500 | Y | Y | — | Y | Y | R,C,E | |
| — | 2 | ? | Y | — | — | — | — | R,C,E | |
| — | 2 | 128 x 2048 | Y | — | — | Y | — | R,C,E | |
| — | 2 | — | — | — | — | — | — | — | |
| Y | 2 | 10 x 10 | Y | — | — | Y | — | R,C | |
| — | — | — | — | — | — | — | — | — | |
| — | 2 | 12 x 9 | Y | Y | — | Y | Y | R,C,E | |
| — | 50 | 50 x 50 | Y | Y | Y | Y | Y | R,C,E | |
| — | 3 | M | Y | — | — | Y | Y | R,C,E | |
| — | — | — | — | — | — | — | — | — | |
| — | 2 | 50 x 50 | Y | — | — | Y | — | R,C,E | |

| | Regression | | | | T-Tests | | | ANOVA | | |
|-------------------|------------|-----------------------|------------|----------|---------|--------|-------|-----------|---------------------------------|----------------|
| | Simple | Multiple ¹ | Polynomial | Stepwise | Paired | Groups | N-way | Contrasts | Unequal Cell Sizes ² | Random Effects |
| ABSTAT | Y | Y | — | — | Y | Y | 2 | — | — | — |
| AIDA | Y | Y | — | — | Y | Y | 1 | — | — | — |
| A-Stat | Y | Y | — | — | Y | Y | 2 | — | Y | — |
| Dynacomp Regr 1 | Y | — | Y | — | — | — | — | — | — | — |
| Dynacomp Regr 2 | — | — | — | — | — | — | — | — | — | — |
| Dynacomp Multilin | Y | Y | — | Y | — | — | — | — | — | — |
| Dynacomp ANOVA | — | — | — | — | — | — | 5 | — | — | — |
| HSD Stats Plus | Y | — | — | — | Y | Y | 2 | — | Y | — |
| HSD Regress II | Y | Y | Y | Y | — | — | — | — | — | — |
| HSD ANOVA II | — | — | — | — | — | — | 5 | Y | Y | — |
| Introstat | Y | — | — | — | Y | Y | 2 | — | — | — |
| Microstat | Y | Y | — | Y | Y | Y | 2 | — | — | — |
| Micro-TSP | Y | Y | — | — | — | — | — | — | — | — |
| Number Cruncher | Y | Y | — | Y | Y | Y | 4 | Y | Y | Y |
| NWA Statpak | Y | Y | Y | Y | Y | Y | 3 | — | — | Y |
| SAM | Y | Y | — | Y | Y | Y | 10 | — | — | — |
| SpeedSTAT Vol. I | — | — | — | — | — | — | — | — | — | — |
| SpeedSTAT Vol. II | Y | Y | Y | Y | — | — | — | — | — | — |
| SPS | Y | Y | — | — | — | Y | 1 | Y | — | — |
| STAN | Y | Y | — | — | — | — | — | Y | — | — |
| Statpro | Y | Y | Y | Y | Y | Y | 3 | — | Y | Y |
| SYSTAT | Y | Y | Y | Y | Y | Y | 30 | Y | Y | Y |
| TWG ELF | Y | Y | — | Y | Y | Y | 2 | — | — | Y |
| TWG ARIMA | — | — | — | — | — | — | — | — | — | — |
| Wallonick Statpac | Y | Y | — | — | Y | Y | 2 | Y | — | — |

1/ More than two independent variables
2/ For higher than one-way ANOVA

Table 10: Linear models.

| | Equipment Used ³ | Longley's Data | Longley's Data |
|---------------------|-----------------------------|----------------------|------------------|
| | | (all 6 indep. vars.) | (3 indep. vars.) |
| ABSTAT | A,C | 2.9 | 5.2 |
| AIDA | A | 2.0* | 3.2* |
| A-Stat | A | 3.2 | 5.0 |
| Dynacomp Multilin | A | 2.6 | 5.9 |
| HSD Regress II | A | Refused | 7.5 |
| Microstat | A,C | 5.2 | Not Run |
| Micro-TSP | A | 5.7 | 6.6 |
| Number Cruncher | I | 6.8 | 6.6 |
| NWA Statpak | A,C | 3.7 | 6.5 |
| SAM | A | 4.3 | 8.0 |
| SpeedSTAT Vol. II | A | Refused | 3.6* |
| SPS | A | 1.8 | 4.9 |
| STAN | A | Refused | 7.6 |
| Statpro | I | 5.2 | 8.3 |
| SYSTAT | I | 9.0 | 9.0 |
| TWG ELF | A | 3.1 | 8.7 |
| Wallonick Statpac | I | 5.6 | 9.0 |
| WRYALG ² | B | Not Available | 3.3 |

1/ All coefficients were rounded to 9 decimal digits before averaging
2/ WRYALG stands for the "worst routine you are likely to get" (see reference 1)
3/ A = Apple II Plus, C = CP/M card, I = IBM PC, B = mainframe computer, single precision, * denotes that input is restricted to 4.5 digits. We therefore had to manually adjust the regression coefficients by the appropriate power of 10.

Table 11: Average accuracy of regression coefficients (maximum accuracy is 9 digits¹).

| Uses Weighted Data | Discriminant Anal. | Factor Anal. | Gen. Lin. Models | Save Residuals | Diagnostics | | | | |
|--------------------------|-----------------------|-----------------|------------------------|-------------------|----------------|--------------------|---------------------------|--------------|-------------------|
| | | | | | Cor. Matrix | Var-Cov. Matrix | Inverse of Var-Cov. | Partial R | Durbin- Watson |
| — | — | — | — | Y | Y | — | — | — | Y |
| Y | — | — | — | Y | Y | — | — | — | — |
| Y | — | Y | — | Y | Y | — | — | — | Y |
| — | — | — | — | — | — | — | — | — | — |
| — | — | — | — | — | — | — | — | — | — |
| — | — | — | — | — | — | — | — | — | — |
| — | — | — | — | — | — | — | — | — | — |
| — | — | — | — | Y | Y | — | Y | Y | Y |
| — | — | — | — | — | Y | — | — | — | — |
| — | — | — | — | Y | Y | — | — | Y | Y |
| — | — | — | — | Y | Y | Y | — | — | Y |
| — | — | — | — | Y | Y | Y | — | — | Y |
| Y | — | Y | — | Y | Y | — | — | — | Y |
| — | — | — | — | Y | Y | Y | — | — | Y |
| — | Y | Y | — | Y | Y | — | — | — | — |
| — | — | — | — | — | — | — | — | — | — |
| — | — | — | Y | Y | Y | — | — | Y | Y |
| — | Y | Y | Y | Y | Y | — | — | — | Y |
| — | Y | Y | Y | Y | Y | Y | — | — | Y |
| — | — | — | — | — | — | — | — | — | — |
| — | — | — | — | Y | Y | — | Y | Y | Y |

The table also indicates the kinds of percentages that can be calculated: row, column, or cell.

Table 10 covers linear models.

Although regression analysis, discriminant analysis, and ANOVA are all variations of the General Linear Model, they are often treated as separate operations within a statistical package. Most programs examined provide distinct routines to perform these analyses.

Simple and Multiple: A common use for a statistical package is the computation of simple or multiple regression coefficients and estimates of their significance. Most packages provide this capability. Programs performing these computations usually include the *r*-square (percent of variance explained) value as part of the results.

Polynomial: The table notes if a separate polynomial-regression option is available. Polynomial regression includes various powers, such as squares and cubes, of a single predictor variable. While transformations of the data may be possible to obtain the same result, a number of programs provide this analysis directly.

Stepwise: When examining a large set of potential predictor variables, the ability to step through them in an ordered way can be instructive. Stepwise regression lets you examine the incremental effects of the various predictors and determine how much added predictive power comes from including them.

ANOVA: The table indicates the level of complexity provided for ANOVA problems. It notes if higher than one-way analyses are permitted. If so, the capability for using unbalanced designs

is described. Another feature identified is the ability to analyze repeated measure designs. Other useful options would be the display of estimated means, multiple range tests, and the specification of tests of contrasts. We have noted only the presence of tests of contrasts.

General Linear Model: Only a few programs, one example being STAN, permit the automatic generation of dummy variables from quantitative data. These variables can be used to conduct ANOVA or discriminant analyses (this feature is indicated in the table as the General Linear Model, GLM). If the GLM, ANOVA, or discriminant-analysis options are not present, the user must create the required dummy variables either by transformation, if available, or by direct entry of the design matrix.

Discriminant Analysis: This linear model is used to predict which of several groups a case belongs in based on a number of independent variables. It is a variation of multiple regression where the dependent variable is qualitative rather than quantitative.

Factor Analysis: This technique seeks the underlying variables that cause variation in the observed cases. Although a host of methods for defining factors are available, we have noted only if at least one option is provided.

The area in which the packages differ greatly is in the additional support needed to conduct a thorough analysis. Merely computing the desired model coefficients and their significance is not enough.

Save Residuals: One desirable option for most models is the storage of residual values, the differences between the observed and

| | Two-Stage OLSQ | Serial (Auto) Cor. | Cochrane- Orcutt | ARIMA | Moving Averages* | Fourier Analysis |
|-------------------|-------------------|--------------------------|---------------------|-------|---------------------|---------------------|
| ABSTAT | — | — | — | — | — | — |
| AIDA | — | — | — | — | — | — |
| A-Stat | — | — | — | — | — | — |
| Dynacomp Regr 1 | — | — | — | — | — | — |
| Dynacomp Regr 2 | — | — | — | — | — | — |
| Dynacomp Multilin | — | — | — | — | — | — |
| Dynacomp ANOVA | — | — | — | — | — | — |
| HSD Stats Plus | — | — | — | — | — | — |
| HSD Regress II | — | — | — | — | Y | — |
| HSD ANOVA II | — | — | — | — | — | — |
| Introstat | — | — | — | — | — | — |
| Microstat | — | — | — | — | Y | — |
| Micro-TSP | Y | Y | Y | — | — | — |
| Number Cruncher | — | — | — | — | — | — |
| NWA Statpak | — | Y | — | — | Y | Y |
| SAM | — | — | — | — | — | — |
| SpeedSTAT Vol. I | — | — | — | — | — | — |
| SpeedSTAT Vol. II | — | — | — | — | — | — |
| SPS | — | — | — | — | — | — |
| STAN | — | Y | — | — | — | — |
| Statpro | Y | Y | — | — | Y | — |
| SYSTAT | — | Y | — | — | — | — |
| TWG ELF | — | — | — | — | — | — |
| TWG ARIMA | — | Y | — | Y | Y | — |
| Wallonick Statpac | — | — | — | — | — | — |

* Complete functional routines. For capability to produce moving averages using lag with other transformations, see table 6.

Table 12: Time series.

predicted values. If the residuals are saved as a new variable, they can be plotted and examined using the graphics routines.

Diagnostics: Other important support options for linear models include an analysis of residuals for the presence of autocorrelation (such as the computation of the Durbin-Watson *d* statistic) or with bivariate plotting. Yet other useful features include the computation of correlation or covariance matrices, crucial to the stability of the computed effects.

Table 11 covers statistical accuracy.

In a broad sense, statistical accuracy means getting the correct answer to your problem. We have limited our examination to the results obtained for one type of problem, multiple regression, since most packages have this capability. Further, this is a commonly desired analysis.

Computation errors for a given set of data and specified model typically arise from one of three sources: the algorithm used (a feature of the program), the precision (limited by hardware and system software), and the condition of the data matrix. For multiple regressions, the computed coefficients are particularly affected by these errors while the predicted values and estimates of multiple correlation are comparatively unaffected (see references 1 and 3).

Algorithm and precision errors are likely to creep in during the process of calculating and inverting the sum of cross products matrix required to compute a regression. Many procedures exist for doing this, and many have notably poor precision since they

involve taking differences of large quantities (see reference 8).

Several measures have been proposed to reflect the condition of the data. By this we mean the extent to which small changes in the data will produce large changes in the solution (see reference 4). As a test of performance, we calculated regression coefficients for a "troublesome" data set and compared them with the "best" result. The data consisted of 16 observations on seven national economic variables used for this type of comparison (see reference 3). The data is highly colinear and has a high perturbation index; that is, small changes will result in large differences in the estimated regression coefficients. Since the relative performance of the packages could change under another set of ill-conditioned data, we conducted a second test using a subset of the variables that was relatively well conditioned.

We compared the output of the packages for the ill-conditioned problem with the "best result known to us," obtained by Longley on a desk calculator. His results agree with the DORTHO (double-precision ORTHO) routine used by Beaton (see reference 6). We used the same method for the better-conditioned problem, as well. We must note that, for the ill-conditioned data, the "best" result differs substantially from the "correct" solution (see reference 1).

To measure the number of digits of agreement with the "best" result, we used a slight modification of a formula used by Wampler (see reference 7). For a calculated value, *b*, and a "true" value, *t*, the number of digits of agreement is

| | Documentation | Data Management | Data Processing | Summary Statistics | Graphics | Nonparametrics & Tables | Linear Models | Time Series |
|-------------------|---------------|-----------------|-----------------|--------------------|----------|-------------------------|---------------|-------------|
| ABSTAT | G | G | G | G | F | G | G | — |
| AIDA | G | G | G | G | G | G | F | — |
| A-Stat | F | G | G | G | — | G | G | — |
| Dynacomp Regr 1 | F | F | — | — | F | — | F | — |
| Dynacomp Regr 2 | F | F | — | — | F | — | — | — |
| Dynacomp Multilin | F | F | — | — | F | — | — | — |
| Dynacomp ANOVA | F | F | — | — | — | — | F | — |
| HSD Stats Plus | G | F | F | F | G | G | F | — |
| HSD Regress II | G | F | F | F | F | — | F | F |
| HSD ANOVA II | G | — | F | — | — | — | F | — |
| Introstat | G | G | G | F | F | G | F | — |
| Microstat | G | G | G | G | F | G | G | F |
| Micro-TSP | G | G | F | F | F | — | F | G |
| Number Cruncher | F | F | F | G | F | G | G | — |
| NWA Statpak | G | G | G | G | F | G | G | G |
| SAM | F | G | F | G | F | F | G | — |
| SpeedSTAT Vol. I | G | F | — | G | — | G | — | — |
| SpeedSTAT Vol. II | G | F | F | G | — | F | F | — |
| SPS | F | G | F | G | G | G | G | — |
| STAN | G | F | F | F | F | — | G | F |
| Statpro | G | F | G | G | G | G | G | F |
| SYSTAT | G | F | G | G | F | G | G | F |
| TWG ELF | G | G | F | G | G | F | G | — |
| TWG ARIMA | G | G | F | — | F | — | — | G |
| Wallonick Statpac | F | G | G | G | F | F | F | — |

G = Good
 F = Fair
 — = None or Negligible

Table 13: Ratings of main features.

$$\begin{aligned}
 & - \log(|b-t|/m) \text{ if } m < > 0 \text{ and } b < > t \\
 \text{or } & - \log(|b-t|) \text{ if } m=0 \text{ and } b < > t \\
 \text{or } & d \text{ if } b=t
 \end{aligned}$$

where m is the minimum of the absolute values of b and t , and d is the digits of precision used by the statistical package. The table shows the value averaged over all coefficients in each data set for each package. As a comparison, we show this value for the "worst routine you are likely to get."

Table 12 covers time series.

Several packages provide for the analysis of serially correlated data. The possibilities are through two-stage ordinary least squares, computation of autocorrelation coefficients, Fourier power spectra analysis, moving averages, or ARIMA models. Table 13 is a summary.

We have tried to summarize the various tables into one overview. This table contains a single rating (G = good, F = fair, and "—" = negligible) for each of the general categories examined. We produced this table by adding entries from the earlier tables.

Documentation: To get a good rating here, a package had to have a table of contents, an index, and either a tutorial or sample runs. A fair rating was given if it had only an index or a table of contents and either a tutorial or sample runs.

Data Management: A good rating was given if the package could perform all the following: allow two or more edit functions

(entry, edit, add, or delete), make a hard copy of an entire session, and access foreign data files. A fair rating was given if the package could do two or three of these.

Data Processing: To obtain a good rating, a package had to permit case selection, join and sort files, and perform transformations. A fair rating was given for two or three of these.

Summary Statistics: We gave a rating of good if the package could compute means and standard deviations, one other coefficient shown in the table, and order statistics. A fair rating was given for doing two or three of the four.

Graphics: This was a more difficult area to summarize. We settled on a good rating for the production of histograms and high-resolution scatterplots or for exceptional capabilities in the production of scatterplots. A fair was given for packages with only one of the two displays.

Nonparametrics: To obtain a good rating, the package had to produce tables and perform at least one nonparametric test. A fair rating was given for only one of these.

Linear Models: We rated a package good if it included both multiple regression and analysis of variance options (both might be accomplished through the use of the General Linear Model) and at least one diagnostic statistic. A fair rating was given for performing only one of the analyses.

Time Series: A good rating was given to packages with two or more of the displayed options. A fair was given for one option.

EXPOTEK

1-800-528-8960

Guaranteed Low Prices

IBM CALL SAVES

AST, Hercules, Maynard, Persyst, Quadram.

Ram Memory 4164-150 \$59/9 per set

TERMINALS

| | |
|-----------------------|-------|
| Adds | |
| A-1 Green | \$485 |
| A-2 Green | 490 |
| Viewpoint 60 | 619 |
| Hazeltine | |
| Esprit I | 485 |
| Esprit II | 540 |
| Esprit III | 735 |
| Qume | |
| QVT 102 Green | 535 |
| QVT 102 Amber | 550 |
| QVT 103 Green | 840 |
| QVT 103 Amber | 850 |
| Televideo | |
| 910+ | 549 |
| 925 | 699 |
| 950 | 899 |
| 970 | 975 |
| Wyse | |
| Wyse 100 | 680 |
| Wyse 300 | 1020 |
| Visual | |
| Visual 50 Green | 599 |
| Visual 55 Green | 720 |
| Zenith | |
| Z-29 | 635 |

MODEMS

| | |
|----------------------|-----|
| Hayes | |
| Smart 300 | 199 |
| Smart 1200 | 485 |
| U.S. Robotics | |
| Password | 375 |

PRINTERS

| | |
|---|----------------|
| C. Itoh | |
| Pro-writer I (8510A) Par. | 339 |
| Pro-writer (8510A) Serial | 439 |
| 1550 Parallel | 529 |
| 1550 BCD SERIAL | 589 |
| F-10 40CPS | 949 |
| F-10 55CPS | 1269 |
| Comrex | Call - Save \$ |
| Daisywriter | |
| Daisywriter 2000 | 999 |
| Daisywriter Cable | 40 |
| Datasouth | |
| DS120 | 595 |
| DS180 | 1155 |
| DS220 | 1590 |
| Diablo | |
| 620 (25CPS/Serial) | 875 |
| 630 (40CPS/Multi-IF) | 1710 |
| Epson All models | Call - Save \$ |
| IDS p series color | Call - Save \$ |
| Juki | |
| 6100-18 | 469 |
| Oki-Data | |
| All models | Call - Save \$ |
| Mannesman-Tally | |
| 160L | 589 |
| 180L | 829 |
| NEC | |
| 3550 (For IBM PC) | 1589 |
| 3510 | 1365 |
| 7710 | 1890 |
| Qume | |
| 1140 W/IBM Interface | 1359 |
| 1155 W/IBM Interface | 1489 |
| Star Micronics | |
| Gemini 10X | CALL |
| Gemini 15X | CALL |
| Gemini 15 | 370 |
| Silver Reed | |
| EXP 550P | 575 |
| Toshiba | |
| P-1350 | 1499 |
| Transtar | |
| 120 P | 499 |
| 315 Color Printer | 499 |
| Sheet Feeders & Tractors | CALL |

COMPUTERS

| | |
|----------------------------|------|
| Altos | |
| 580-10 | 3550 |
| 586-10 | 6598 |
| 586-14 | 7680 |
| 8600-12 | 8399 |
| Columbia | Call |
| Eagle | Call |
| Franklin | Call |
| Pied Piper | Call |
| NEC Portable | Call |
| Northstar | |
| Advantage | 2160 |
| Advantage w/5MB | 3345 |
| Advantage w/15MB | 4315 |
| Televideo Systems | |
| 802 H | 4210 |
| 803 | 1815 |
| 1603 | 2150 |
| 806/20 | 4775 |
| 800 A (user station) | 999 |
| Teleport | Call |
| Zenith | Call |

MONITORS

| | |
|------------------------|-----|
| Amdek | |
| Video 300 GREEN | 129 |
| Video 300 AMBER | 145 |
| Color I Plus | 275 |
| Color II Plus | 425 |
| BMC | |
| 12" Green | 89 |
| 12" Color | 219 |
| NEC | |
| JB 1201 | 155 |
| JB 1260 | 115 |
| Taxan | |
| 12" Amber | 125 |
| Zenith | |
| 12" Green Screen | 95 |
| 12" Amber Screen | 120 |

DISK DRIVES

| | |
|---|----------------|
| Tandon | |
| 5 1/4" TM 100-1 SS/DD 160K | 150 |
| 5 1/4" TM 100-2ADS/DD 320K | 225 |
| TM101 496 TPI Quad Den) | 339 |
| Indus (for Atari) | Call - Save \$ |
| Pertec | |
| 5 1/4" FD200-5 (160 K SS/DD 40TR) | 139 |
| 5 1/4" FD250-5 (320 K DS/DD 40TR) | 195 |
| Micro-Sci | |
| A-2 (35TR) | 225 |
| A-40 (40TR) | 269 |
| Rana | |
| 1000 (for Atari) | Call - Save \$ |
| Elite I | 249 |
| Elite II | 399 |
| Elite III | 509 |

Text continued from page 236:

execution speed and precision by choosing the appropriate interpreter, but the drawback is that all related parameters and data files must be matched to the chosen interpreter or the program crashes. For example, a data file created by the 14-digit-precision interpreter cannot be read by the 8-digit one. An additional section in the manual is badly needed to help users interpret commonly encountered error messages and to suggest remedies. Without doubt, long-term experience with Microstat would permit users to avoid these errors.

Ecosoft is planning to release a new version of Microstat written in the C language about the time this review is published. The compiled version should greatly improve the speed of execution.

Micro-TSP: This package provides regression-based tools for modeling and forecasting time series. The tools are four varieties of multiple linear regression (one dependent variable): ordinary least squares (OLS), first-order autoregressive correction of OLS (the Cochrane-Orcut method), and two-stage least squares with and without the autoregressive correction. Each technique is executed by a command that produces a table of the coefficients with their standard errors and t-statistics and some summary statistics, such as the adjusted R-squared, standard error of the regression, and the Durbin-Watson statistic. Micro-TSP remembers the coefficients from the most recent regression and uses them in the command that automatically generates forecasts over a user-specified period. The only other statistical command provides summary statistics, including a covariance matrix, for a group of series.

Several time series can be plotted simultaneously versus time by typing the command PLOT followed by a list of series names. PLOT(N) produces normalized plots of time series (subtract mean and divide by standard deviation of the series). A plot of the residuals from the most recent regression can be obtained by PLOT(R). Scatterplots of one series versus another can be obtained from the GRAPH command. PLOT and GRAPH produce high-resolution graphics on the Apple but require a color/graphics monitor adapter for the IBM PC.

Micro-TSP is easy to use and well suited for handling time series of up to several hundred observations each. We have several minor criticisms that could be corrected in future versions. The requirement that the user describe the time dimension of data in a file before the file can be loaded is unforgivable, especially since there is no way to obtain the information from within the package, although it is stored at the beginning of the file itself. Next, although the workfile feature provides a quick way to save all time series currently in RAM under one filename (a handy method for interrupting your work), Micro-TSP has two sets of file-handling commands: one for the time series in the workfile and one for the series on disks. Why not have just one set of commands with a consistent single-letter parameter to reference the disk?

The manual has a good introduction on how to use two of the four regression types in three chapters featuring case studies of actual problems and real data. The

CUSTOMER SERVICE (602) 861 1141 TWX 910 950 1194
10439 N. CAVE CREEK RD. #111 PHOENIX AZ 85020

A TIMELY ANNOUNCEMENT FOR ProDOS™ USERS:

Congratulations! You not only have a powerful new operating system in Apple's* ProDOS, you can now get an incredibly versatile Clock/Calendar card to use with it. PROCLOCK™.

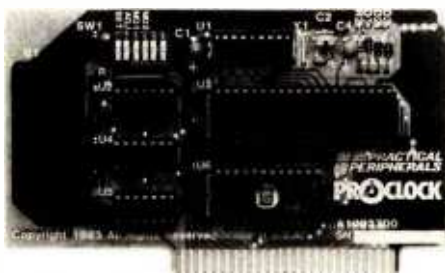

PROCLOCK is the first Clock/Calendar designed for ProDOS-based systems as well as other Apples running DOS 3.3, CP/M**, Pascal, Applesoft*, and BASIC.

What's more, PROCLOCK fully emulates Superclock II, Thunderclock Plus and Apple Clock*. So programs written for these products can be used without any modification.

Of course, PROCLOCK will time- and date-code files. And consider how much money you could save by timing your modem to transmit when the phone rates are cheapest. You can even use PROCLOCK as part of an automatic appliance control system.

Plus, PROCLOCK's powerful interrupt capabilities are invaluable to programmers working with time-sensitive routines and multi-tasking. It can generate interrupts at intervals of 1 millisecond, 1 second, 1

minute, 1 hour, or any combination of those. And all interrupts are software-controlled and handled through PROCLOCK's on-board PIA.

Speaking of software, you also get a diskette full of sample programs, utilities and applications like our Time-Clock II job/time logging program.

PROCLOCK even includes one feature we don't expect anyone to take advantage of—a 10-year lithium battery that keeps the clock running even if your computer is left off for long periods of time.

But just try to keep away from your Apple long enough to put that to the test! With PROCLOCK, you'll have a whole new world of applications to explore. And plenty of time to explore it. Because PROCLOCK is a reliable, well-built piece of hardware. So well-built, it's backed by a five-year warranty.

Ask your dealer about PROCLOCK. It's perfect timing for ProDOS users!

Another practical product from Practical Peripherals—makers of MICROBUFFER™, PRINTERFACE™, GRAPHICARD™, and SERIALL™.

**PRACTICAL
PERIPHERALS**

31245 La Baya Drive, Westlake Village, CA 91362
(818) 991-8200 • TWX 910-336-5431

*ProDOS, Apple, Applesoft and Apple Clock are registered trademarks of Apple Computers, Inc. **CP/M is a registered trademark of Digital Research, Inc.

ATTENTION LA36 USERS

The DS120 Terminal Controller makes your LA36 perform like a DECwriter® III.

The Datasouth DS120 gives your DECwriter® II the high speed printing and versatile performance features of the DECwriter® III at only a fraction of the cost. The DS120 is a plug compatible replacement for your LA36 logic board which can be installed in minutes. Standard features include:

- 185 cps bidirectional printing
- Horizontal & Vertical Tabs
- Page Length Selection
- 110-4800 baud operation
- 1000 character print buffer
- X-on, X-off protocol
- Self Test
- RS232 interface
- 20 mA Current Loop interface
- Top of Form
- Adjustable Margins
- Double wide characters
- Parity selection
- Optional APL character set

Over 9,000 DS120 units are now being used by customers ranging from the Fortune 500 to personal computing enthusiasts. In numerous installations, entire networks of terminals have been upgraded to take advantage of today's higher speed data communications services. LSI microprocessor electronics and strict quality control ensure dependable performance for years to come. When service is required, we will respond promptly and effectively. Best of all, we can deliver immediately through our nationwide network of distributors. Just give us a call for all the details.

datasouth computer corporation

P.O. Box 240947 • Charlotte, North Carolina 28224
704 / 523-8500

Monitor Mover Gives You Back Your Desk



Monitor Mover frees up valuable work space while keeping your CRT close at hand. It adjusts in four ways to each individual user. To free up even more space put your system on the side of your desk with the System Sidekick.

Monitor Mover \$129.95
System Sidekick \$79.95

Lintek 
Computer Accessories

Dealer inquiries
welcome.

P.O. Box 8056, Grand Rapids, MI 49508 (616) 241-4040

other two types are described briefly but not illustrated.

Number Cruncher: This unpretentious program performs many tasks simply and well. It would probably not be ranked first in any single area, but it provides the common procedures one might want in each area. The main menu offers three choices plus exit. To begin, it is always necessary to either create or open a data file. You then choose from an array of 31 transformations on the second menu or proceed directly to the third menu of 13 different statistical procedures. Once a file is opened, it stays open through all the procedures until a new file is opened, and a status comment stays at the top of the screen naming the open file. Entering data to a file is easy, but adding variables to a full file is more laborious, necessitating the creation of a new file and the merging of both files, naming all variables again in the process. "Naming" the variables really means re-assigning the variable numbers since the program does not accept character names.

A broad array of useful transformations is available, and new variables can easily be created, provided space for them was allocated when the data file was opened. When opened, all variables for all cases are initialized to 0, which lets most statistical procedures process the file without interference, even with "empty" variables allocated for future use. However, some statistical procedures get confused about zeros. One such case is the crosstab program, which leaves valid zeros off without accounting for them. Unlike many of the other procedures, the crosstab fails to document which variable numbers were used, so that the operator must religiously write down the appropriate numbers or be hopelessly confused two days later.

The regression results using the Longley data were among the most accurate of any program tested. Some procedures were simple enough to let a first-time computer user work independently after an hour of instruction. Though simple, certain aspects of the program are tedious, such as having to specify all 29 variables in our test data set over and over in the different procedures. For the most part, Number Cruncher was a pleasure to use and devoid of unpleasant surprises.

NWA Statpak: The wide range of procedures in NWA Statpak is attested to by the 78 separate programs provided. The mostly clear and comprehensive manual walks the user through each program with sample runs and organizes them in groups for easy reference. The very strength of such variety is also the package's major weakness, since each program must be run independently of the others. To perform a simple crosstab requires running several programs, each time entering the name of the file to open, the respective columns representing each variable (variable names are not supported), and all additional parameters requested by each program. The payoff, however, is ample. In return for this work, you can perform nearly any data manipulation or statistical task you might commonly encounter along with more than a few uncommon tasks.

The unorthodox approach used by NWA Statpak pro-

Tek's best-selling 60 MHz scopes: Now 25 ways better for not a penny more!

Now Tek has improved its 2213/2215 scopes with brighter displays. Greater accuracy. And more sensitive triggering. At no increase in price.

The 60 MHz 2213 and dual time base 2215 have been the most popular scopes in Tektronix history. Now, Tek introduces an "A" Series update with more than 25 specification and feature enhancements — things you have asked for such as single sweep — all included at no added cost.

A brighter display and new vertical amplifier design provides sharp, crisp traces.

That makes the 2213A/2215A a prime candidate for tasks like TV troubleshooting and testing, where fast sweeps are typical.

New features include 10 MHz bandwidth limit switch, separate A/B dual intensity controls (2215A only), and power-on light: additions customers have suggested for



1-800-426-2200



giving these scopes the final measure of convenience.

Triggering, sweep accuracy, CMRR and many more major specifications are better than ever. Check the performance chart: not bad for scopes already considered the leaders in their class!

The price: still \$1200* for the 2213A, \$1450* for the 2215A. Or, step up to the 100 MHz 2235 for just \$1650*! You can order, obtain literature, or get expert technical advice, through Tek's National Marketing Center.

Direct orders include operator manuals, two 10X probes,

15-day return policy, world-wide service back-up and comprehensive 3-year warranty.

Talk to our technical experts.

**Call toll-free:
1-800-426-2200
Ext. 155.**

In Oregon call collect:
(503) 627-9000 Ext. 155.

| Specification enhancement | 2213/2215 "A" Series | 2213/2215 |
|-----------------------------|--|---|
| CRT brightness | 14 kv accel. potential | 10 kv accel. potential |
| Vertical accuracy | 3%, 0° to 50°C | 3%, +20° to 30°C |
| Chop rate | 500 kHz | 250 kHz |
| Input capacitance | 20 pF | 30 pF |
| CMRR | 10 to 1 at 25 MHz | 10 to 1 at 10 MHz |
| Channel isolation | 100:1 at 25 MHz | Not specified |
| A Trigger sensitivity (int) | 0.3 div at 5 MHz | 0.4 div at 2 MHz |
| TV triggering | 1.0 div compos. sync | 2.0 div compos. sync |
| Sweep accuracy (in 10X) | 4%, 15° to 35°C | 5%, 20° to 30°C |
| Delay jitter | 20,000 to 1 (2215A) 10,000 to 1 (2213A) | 10,000 to 1 (2215) 5,000 to 1 (2213) |
| Holdoff Range | 10:1 | 4:1 |

*Price F.O.B. Beaverton, OR.
All scopes are UL Listed and CSA approved. 3-year warranty includes CRT and applies to 2000 family oscilloscopes purchased after 1/1/83

vides some unique benefits. For example, many of the stand-alone data-manipulation programs can be used as general utilities. And, since the BASIC source code is provided, it is possible to modify all the programs for unique applications. The programming is exemplary in its clarity. Like many of the packages using interpreted BASIC, many procedures are notably slow. In professional applications, where speed of execution is an important factor, the programs can be compiled using either the Microsoft or IBM Compiler, as appropriate. Some modifications are required, but the clear programming makes necessary alterations straightforward, and the improvement in speed is considerable. All things considered, this serious, comprehensive package merits consideration by any CP/M user doing a wide variety of statistical analyses who wishes a large library of well-documented statistical programs in BASIC source code.

SAM: Developed in the United Kingdom, SAM performs a wide range of statistical functions. We found SAM to be one of the weaker packages. The manual is a brief 40 pages. About half of it consists of example printouts, leaving a text portion of about 20 pages. While the manual's cover suggests that SAM can be useful for survey analysis, SAM does not allow specification of a weight variable for analyzing probability samples. The SAM manual cover also indicates time series capability. However, the only related function we found was the ability to lag or lead data through a conversion (i.e., transformation) function. Obviously, the user could employ the correlation features to compute autocorrelation coefficients, but this is a multistep operation, not a menu option. On the plus side, SAM is easy to use and is one of the few packages providing a stepwise regression option.

SpeedSTAT: This series of individual programs will, when completed, provide a complete set of statistical functions. Currently, only two programs, Frequencies and Regression, are available. The Analysis of Variance and Time Series programs will appear shortly, and we have received a test version of the ANOVA package. The programs are very easy to use. The philosophy behind the packages appears to be that statistics can be used by most businesses to assess the "whys" behind their operation. The programs do not look or "feel" like typical statistical programs in that little, if any, statistical jargon is used and little statistical knowledge is required to obtain results. The accompanying manuals are quite complete, clearly documenting both the formulas used and the limitations of the data. We should point out that, like AIDA, SpeedSTAT stores data as 2-byte integers. Thus, even though you can specify a format for a field, the number of digits of precision is quite limited.

SPS: The version we worked with was developed for use at a university. As such, it was a bit rough when compared with commercial products. However, it is particularly strong in the area of experimental design, being one of the few programs featuring the General Linear Model. SPS provides many useful regression diagnostics not computed by many other packages. Among these

are Press residuals and Mallows Cp. We recently received several new versions, including an improved version (4.2) for the Apple and another version for the IBM PC. The manuals for these are much more complete than those for the earlier versions.

STAN: This package provides complete support for linear models (regression, analysis of variance, etc.). It does not purport to be a general-purpose statistical program. With it, a knowledgeable user can analyze virtually any linear model likely to be encountered. STAN prepares dummy variables from qualitative ones, thus expanding its power beyond the limit on the number of variables found in table 5. That is, when performing an ANOVA, one qualitative variable with six levels requires five dummy variables in the analysis. Unlike the other packages, the table 5 entry for STAN refers to the number of variables, counting a qualitative variable as one, not one less than the number of its levels. Other packages may permit the user to create the five dummy variables and perform the analysis, but all five count against their limitations on number of variables. STAN computes the P-values (probabilities) of the test statistic. Most other packages require the user to look up the value in a suitable table.

Statpac: This program differs from most in that it is batch-oriented. While this initially seemed like an anachronism, in practice it proved to be quite useful. Before any runs could be carried out, it was necessary to first prepare a "codebook" file (giving variable names, value names, type of data, and so on), a "data" file (containing raw data), and an "analysis control" file (containing all the statistical commands and parameters for a run). While this slowed things up initially, it provided several advantages. For instance, you can correct any errors in the command syntax, variable names, or other entries without reentering **everything** else. Also, if you want to run parallel analyses on different variables, or slightly modified runs, it is simple to change one or two lines and rerun the entire procedure.

Other characteristics that set this package apart are value labeling, variable-recoding procedures, and a routine to handle multiple variable-responses. Value labeling lets you code values such as 1 = male and 2 = female, so that all tabular output will automatically include these labels for the appropriate rows or columns. Variable-recoding procedures include absolute recode, recode-if, select-if, compute, and compute-if. The multiple variable-response capability permits easy analysis of questionnaire items in which the respondent can give multiple answers.

Statpro: This is one of the most extensive and the most expensive of the packages we examined. Statpro runs under Softech Microsystems' UCSD p-System and performs many functions. (As a result of the extensive disk-storage requirements, the Apple version is delivered on sixteen 5¼-inch disks, most of which are double-sided.) The software comes in three subsystems, each with its own manual: one for database functions, one for statistics, and one for graphics. Among the programs we

One of Japan's leaders would like to go to work for you.



Fujitsu, Japan's largest computer company, sends you their best. The new Micro 16s personal business computer. A combination of thoughtful planning, innovative thinking and quality craftsmanship. Just what you'd expect from a Japanese company that's been making computers for three decades.

The Micro 16s is a complete computer system. The options of other computers are our standards. For example, its price includes the CP/M-86[®] operating system, SuperCalc^{2™} electronic spreadsheet, WordStar[®] word processing, a high resolution color graphics monitor, and two microprocessors, the Z80[®]A 8-bit and 8086 16-bit.

The Micro 16s will run any of the more than 3,000 CP/M[®] software programs on the market today. Optional operating systems for the Micro 16s include MS[™]-DOS and the

multi-tasking Concurrent CP/M-86.[™]

The Micro 16s also comes with a detachable keyboard, dual built-in 5¼" floppy disk drives, 128 kilobytes of internal memory expandable to over one megabyte, and expansion slots for future growth.

The unique and flexible design of the Micro 16s makes it easy to add advanced microprocessors of tomorrow, hard disks, mainframe communications or local area networking when the time is right.

Put a Japanese leader to work for you. Fujitsu's Micro 16s. For more information or the name of your nearest dealer call toll free 1-800-MICRO 16. Or write Fujitsu Microelectronics, Inc., Professional Microsystems Division, 3320 Scott Blvd., Santa Clara, CA 95051.



Fujitsu's Micro 16s.™

Computer problems? DON'T BLAME THE SOFTWARE!

Isolators prevent:

Pat. # 4,259,705

- CPU/printer/disk interaction
- Lightning or spike damage
- AC power line disturbances
- RFI-EMI interference



Commercial Grade Isolators

- ISO-1 3 Isolated Sockets \$ 81.95
- ISO-2 2 Isolated Socket Banks, 6 Sockets \$ 81.95

Industrial Grade Isolators

- ISO-3 3 Double Isolated Sockets \$122.95
- ISO-11 2 Double Isolated Banks, 6 Sockets \$122.95

Laboratory Grade Isolators

- ISO-17 4 Quad Isolated Sockets \$213.95
- ISO-18 2 Quad Isolated Banks, 6 Sockets \$180.95

- Circuit Breaker, any model (Add-CB) Add \$ 11.00
- Remote Switch, any model (Add-RS) Add \$ 20.00

ESP Electronic Specialists, Inc.
171 S. Main St., Box 389, Natick, Mass. 01780 (617) 655-1532
Toll Free Order Desk 1-800-225-4878
MasterCard, VISA, American Express

examined that run on an Apple, Statpro is far and away the most comprehensive package, computing more statistics and performing more analyses. Its graphics package is very thorough, containing options that include pie charts, triangular scatterplots, and normality curves for testing statistical assumptions. (The graphics package was not available in the prerelease IBM PC version we reviewed.)

While we have not tested Statpro in a hard-disk configuration, the user may want to operate it with such hardware. When using a floppy-disk system, the user is constantly requested to swap disks. Sometimes the user is requested to put a particular disk in one drive, yet for other purposes this same disk is to be put in the second drive. To use the complete system, eight separate work disks must be formatted using a utility provided with Statpro. The user will notice that Statpro has menus that duplicate entries from previous menus; that is, the same option may have to be requested twice from two consecutive menus to obtain the desired analysis.

SYSTAT: Although we have only recently begun working with this package, we find it to be one of the most powerful, with many mainframe characteristics. The version we reviewed ran on an IBM PC and required 256K bytes of RAM, although the CP/M version will run with only 64K bytes. It is command driven and uses a deceptively simple set of commands in view of the powerful procedures it provides. The manual presents examples of runs using all the commands in order to avoid the confusion that often results when generic commands are presented.

The real surprise came when we discovered the range, sophistication, and speed of SYSTAT's procedures. In addition to all the commonly used univariate statistics, SYSTAT was the only package to provide a multivariate general linear-hypothesis module, which includes multivariate analysis of variance, profile analysis of repeated measures, principal components analysis, and canonical correlation. It also provides modules for factor analysis with rotation and scoring and multidimensional scaling. The Tables module was the only one in our review to permit four-way and larger contingency tables, with analysis of log-linear models. The Graphics module offers a variety of options, including normal probability plots, contour plotting, stem-and-leaf diagrams, and detrended residual plots. However, graphical displays are formed by text characters, unlike the high-resolution color graphics of Statpro. Complex transformations of data are possible using an internal BASIC language that, like the rest of the package, was written in compiled FORTRAN. Other modules planned for release in the near future include cluster analysis of variables or cases, pen plotter graph routines, robust estimation routines, and time series analyses.

Another nice surprise was the speed with which the programs executed their calculations. When the output from the analysis of the Longley data was sent to the screen, the results were nearly instantaneous. Upon exiting each module, all RUN commands are printed auto-

THE PURCHASING AGENT

We can buy any microcomputer product for you from our 292 participating wholesalers. Here are the net prices on a few of the 7,000 products we can buy for you, acting as your purchasing agent.

| | | | | | |
|------------------------|-------|--------------------------|-------|------------------------|-------|
| COMPUTERS | | COMPUTERS | | MONITORS | |
| Altos 580-10 | 4,199 | Northstar Advantage | 2,107 | Andek RGB II | 450 |
| 586-20 w/o Term. | 6,018 | w/Dual Floppies | 3,249 | NEC 1203 | 536 |
| 986-40 | 9,027 | w/5 meg. | 3,249 | 1410 RGB | 780 |
| Compupro Godbout* | 4,065 | w/15 meg. | 4,315 | Princeton RGB w/cable | 485 |
| Sys. 816A RAM 17" | 4,179 | Onyx CS002A, 256K, 14M. | 3,022 | All others | CALL |
| Sys. 816A RAM 21" | 6,459 | Sage II, w/2 640K | 3,470 | PLOTTERS | |
| Sys. 816A H* | 6,459 | IV, w/12 meg. | 5,830 | Houston Instr., DMP 41 | 2,321 |
| Sys. 816C* | 6,462 | IV, w/18 meg. | 6,273 | Strobe M 100 | 461 |
| Sys. 816CH* | 8,856 | IV, w/40 meg. | 7,965 | All others | CALL |
| Sys. 8180* | 9,887 | Sanyo 555, w/2-160K | 1,100 | PRINTERS | |
| Sys. 818E* | 6,462 | Televideo TS-803 | 2,027 | Anadex 9625B, par. | 1,190 |
| Sys. 816Z* | 3,722 | TPC 2, port. | CALL | C. Itoh A 10-20 | 534 |
| *Completely Assembled | | Zenith ZF-100-21 | 2,157 | F-10, 40 cps. | 1,000 |
| M-Drive-H | 1,100 | ZF-110-22 | 2,585 | Diablo 630 API | 1,615 |
| RAM 21, 128K, 14 Mhz | 758 | ZW-120-32 | 3,945 | NEC 7710 | 1,900 |
| RAM 22, 256K | 1,292 | All others | CALL | Okidata | CALL |
| Pragmatic 20 meg. | 2,950 | HARD DISKS | | All others | CALL |
| Pragmatic 40 meg. | 4,686 | Talgrass 20 meg. w/tape | 3,097 | TERMINALS | |
| Columbia Sys., 2-320K | 2,779 | All others | CALL | Televideo 925 | 715 |
| Sys., 12 meg. | 4,119 | IBM PERIPHERALS | | WYSE WY-50 | 539 |
| Sys., portable | 2,320 | Keytronics 5150 Keyboard | 189 | All others | CALL |
| Eagle 1630 | 4,699 | MODEMS | | TAX SOFTWARE | |
| Molecular SM 8 10 meg. | 4,848 | Hayes 1200 | 499 | Microtax | CALL |
| Microw Micro D, MD 3 | 1,585 | US Robotics Password | 349 | | |
| NEC APC-H03 | 2,999 | | | | |
| APC-H12 Col. Graph. | 618 | | | | |
| APC-H26, 10 meg. | 2,172 | | | | |

CALL US FOR THE NET PRICE ON ANY OF THE 7,000 OTHER PRODUCTS WE CAN BUY FOR YOU AS YOUR PURCHASING AGENT.

Since 1980

B-84-4



THE PURCHASING AGENT, INC.
574 Weddell Drive, Suite 5
Sunnyvale, CA 94089
(408) 744-0646

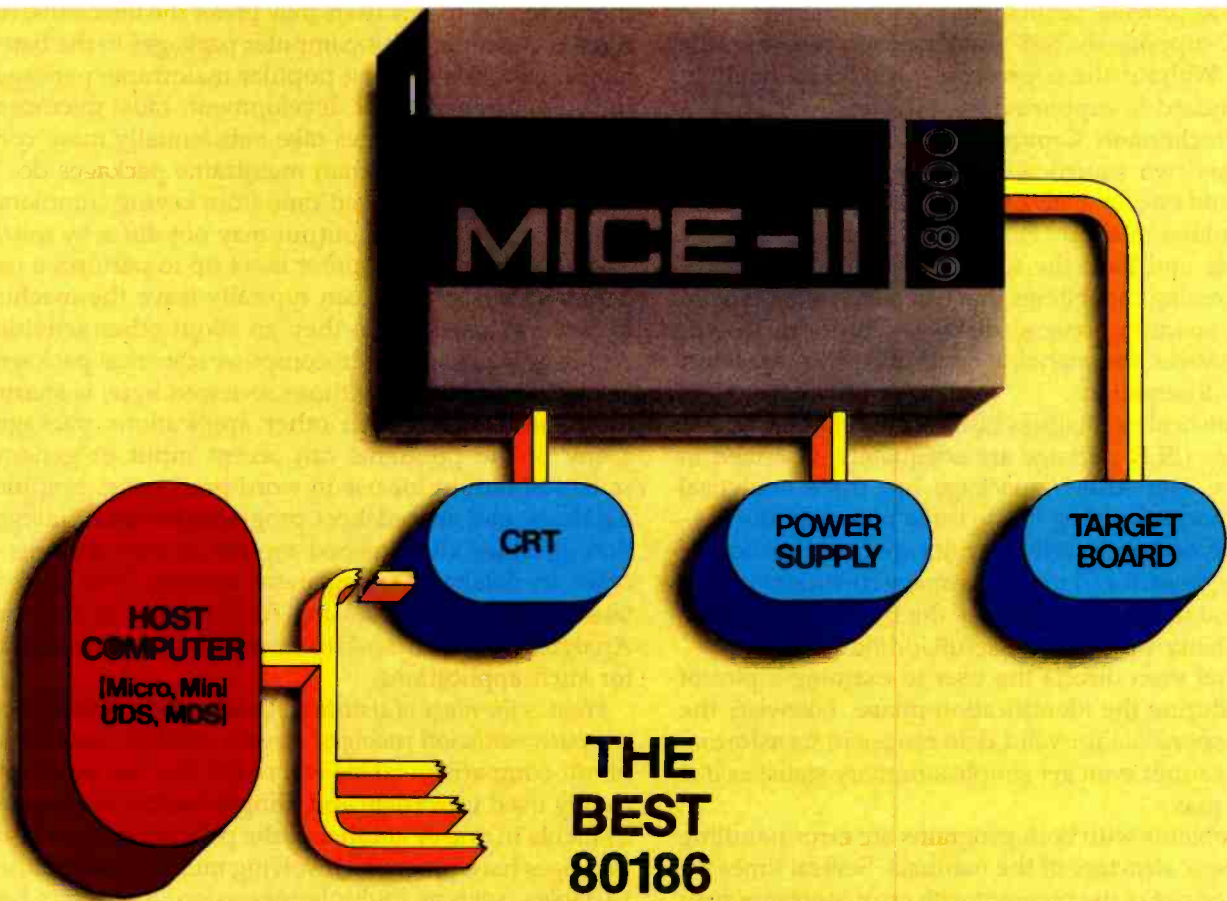

THE BEST 80186 DEVELOPMENT/ DEBUGGING

TOOL YOU CAN BUY FOR \$4,200

It's powerful, portable, configurable. Use it to turn your mini/micro computer into a cost-effective full-scale universal development system.

Use it to expand your full-scale development system into a multi-workstation system.

Use it with MULTIMICE to debug hardware/software in a multi-processor environment.

Use it to evaluate different micro-processors at a minimum change-over cost.

It's easy to use. MICE I/O drivers are available for Apple II, IBM-PC, PDP-11, VAX, MDS, iPDS, TI Professional and all CP/M systems. And symbolic debugging is available for some models.

MICROTEK INTERNATIONAL, INC.
2-1, Science Road 1
Hsinchu Science-based Industrial Park
Hsinchu, Taiwan, 300, R.O.C.

It gives you all these features. Real-time emulation with no wait state • Retain full memory and I/O space • Resident assembler/disassembler • Real-time forward/backward trace up to 2048 cycles • Instruction step, cycle step through program • Two hardware breakpoints • Interchangeable personality module • Up to 128K emulation memory.

It supports all these microprocessors. 8048 • 8085 • 8086/88 (MAX) • 8086/88 (MIN) • 80186/80188 • 6809/6809E • 68000 • 68008 • 68010 • 6502 • 65SCXX Series • 65SC1XX Series • Z80R • NSC 800.

And it's programmer supported. GP-256 micro based, system/gang EPROM programmer for JEDEC pinouts. MICE I/O driver or master loading.

MICROTEK LAB, INC.
17221 South Western Ave.
Gardena, CA 90247
(213) 538-5369



matically to provide permanent documentation.

SYSTAT supports the 8087 numeric coprocessor for the IBM PC. Without the coprocessor, the 80-bit floating-point standard is supported in software.

The Winchendon Group: The Winchendon Group (TWG) has two statistical packages: one for general statistics and one for analyzing time series by the ARIMA or Box-Jenkins method. The two packages are data-set compatible and have the same data-management and data-processing capabilities that can build and maintain data sets spanning several disks—a feature unique to TWG. However, the analytical limits of ARIMA are fewer than 500 observations.

The statistical capabilities of the Econometrics Linear Forecasting (ELF) package are adequately described in the tables. The ARIMA package has three analytical modules corresponding to the three phases of the Box-Jenkins procedure: model identification, estimation of the autoregressive and moving average coefficients of the model, and forecasting values of the time series. A plotting capability would be a useful addition to ARIMA—the manual even directs the user to examine a plot of the data during the identification phase. Likewise, the user is responsible for valid data ranges in transformations but cannot even get simple summary statistics like min and max.

Two problems with both programs are error handling and the basic structure of the manuals. Several times we were kicked out of the program with error messages such as BREAK IN LINE 2560, END OF DATA. After patiently following the example in the identification phase of ARIMA, we were rewarded with the message LOG OF NEGATIVE NUMBER. The structure of the manual does not correspond with the menus, and the menus are not even shown in the manual. This makes it hard to find what you need.

General Guidance

How practical are available microcomputer statistical packages for use in a research or business environment? Experienced mainframe statistical-package users tend to be especially suspicious of a microcomputer's capabilities. Yet, consider the wide range of features present in many of the packages shown in our comparison charts. The best of the packages are eminently practical for serious, professional applications. Many others look as though they would amply fill less demanding applications, sometimes at far less cost (although cost is an unreliable indicator of quality). Our tests show that the best of the packages equal or exceed the accuracy of many packages running on mainframes.

For both small data sets (e.g., fewer than 100 cases and 30 variables) and moderate ones (e.g., fewer than 2000 cases and 250 variables), it is not only possible to perform analyses on a microcomputer rather than a mainframe, it may even be the more desirable alternative. For example, in a professional research environment, the cost savings from using a microcomputer may pay for both the hardware and software in a relatively short time. Fur-

thermore, day-to-day users may prefer the interactive features common in microcomputer packages to the batch-mode operation of most popular mainframe packages. In their current state of development, most microcomputer statistical packages take substantially more computer time to execute than mainframe packages do. In practice, the total elapsed time from keying commands until receiving printed output may not differ by much. Also, once a microcomputer is set up to perform a particular analysis, users can typically leave the machine for several hours while they go about other activities.

One advantage of microcomputer statistical packages, frequently exploited by those reviewed here, is sharing input and output with other applications packages. Many of the programs can accept input or generate statistical output for use in word-processing, graphics, database, and spreadsheet programs for direct integration of tables into finished reports or easy analysis of cases in database-management systems. The rows in table 5 relating to Accessing Foreign Data and Storing Analytic Results are particularly important to consider for such applications.

What is the range of statistical procedures available in microcomputer statistical packages? Even a cursory examination of our comparison tables will reveal that the most commonly used univariate and nonparametric analyses are available in one or another of the programs. Most of the packages have programs involving multiple independent variables, such as multiple regression, and a few have even more complex programs, such as factor analysis, multiple discriminant analysis, and canonical correlation. In short, the most commonly used statistical procedures are now available. The issue for a prospective buyer is whether needed procedures can all be obtained in one package, and whether that package will handle the number of cases in the user's data set on the user's microcomputer with a style of operation compatible with the user's preferences. We believe, based on our own experience, that most buyers will need to purchase more than one package to get all the features they require. A combination of packages should be able to share a data set in a common format.

How many cases and variables will they process? Some packages are limited to small data sets; others process multidisk data sets. Unfortunately, few of the manuals provided much detail about the number of cases and variables that could be handled on particular microcomputers having different available RAM. Nor did we have the time and resources to test the limits for any of them. Thus, while we are convinced that very large data sets can be processed by some of the packages, although perhaps awkwardly, we strongly advise prospective buyers who need this capability to consult with the developer or dealer first, as well as to arrange a trial period if possible.

How fast do they perform calculations? In a word, slowly. Many packages were written using interpreted languages, primarily BASIC. For small test data sets of 20 cases, the calculations seemed quite fast. But when the



Introducing the Freedom 200. No other VDT gives you more, for less.

For only \$745, the Freedom 200 gives you more user-relevant functions and optimized ergonomic features than any other standard VDT.

You get 106 keys, clustered for maximum user efficiency.

Plus 10 user-programmable non-volatile function keys (256 bytes worth) for a host of applications.

Plus 11 cursor control keys, including tab by word for easy editing.

Plus flexible non-volatile set-up modes, full page or status line, to easily configure your terminal exactly the way you want it.

Plus user-definable smooth scrolling regions, with selectable scroll rates.

Plus split-screen capability.

Plus 128 ASCII characters, with 86 extended graphic characters for forms creation.

Plus non-embedded attributes (visual and data entry).

Plus double-high/double-wide characters.

Plus programmable answerback message for enhanced security.

Plus programmable time out, to prolong the life of your screen.

Plus easy serviceability, and space for add-on boards.

Plus two-page standard memory in emulation modes and one-page memory in native mode, with additional memory optional.

Plus 8 foreign character sets.

Plus TeleVideo 950 and Lear Siegler ADM 31 emulation.

Plus more.

To find out more, contact your local Liberty dealer or distributor.

Or call Liberty direct.

(415) 543-7000.

No other VDT gives you more, for less.

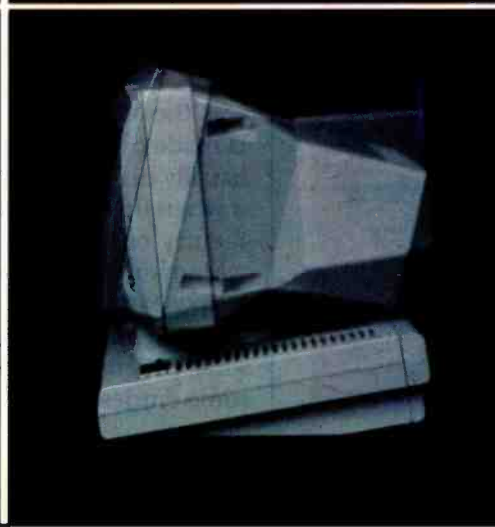
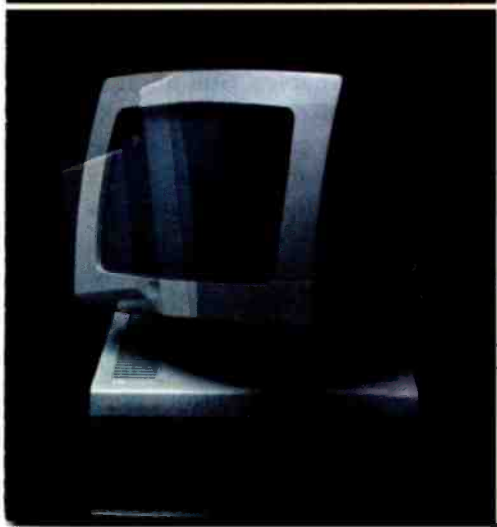
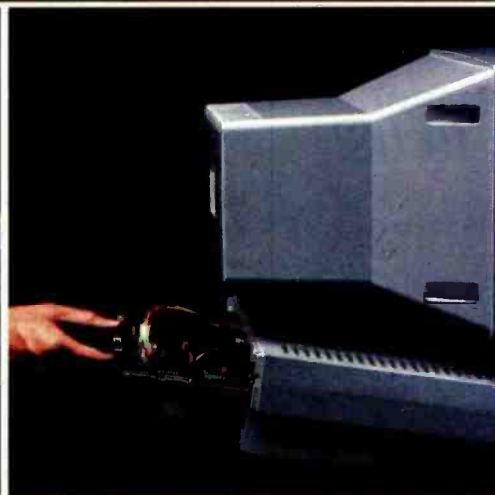
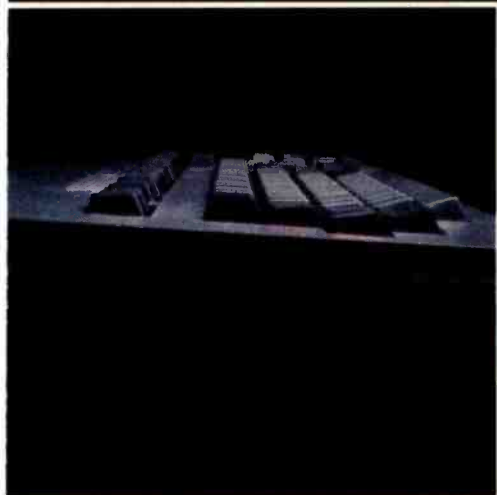

See us at COMDEX Atlanta
Booth 3432 West Hall.

 **LIBERTY**

© Liberty Electronics 1984.

Circle 220 on inquiry card.

JUKI 6100

LETTER QUALITY PRINTER

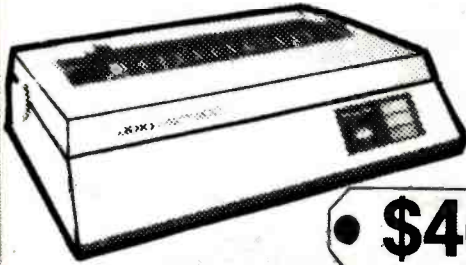

• **\$469.**

- 18 cps
- Word processing and graphic functions
- Proportional spacing control
- Uses IBM Selectric ribbons
- Compatible with Kaypro, IBM, Apple, Osborne, and others.



Free shipping in U.S.



COMPUTERS and more

2420 University Ave., To Order
San Diego, Ca. 92104 (619) 291-1442

number increased to 100, 500, or more, the time needed for processing increased substantially. Some of the faster packages held all the cases in memory at once, but this seriously limited the number of cases that could be processed. Others were bound by incessant read-write operations on the disks and with the attendant hardware inefficiencies. A select few appeared substantially faster than others, but since we did not make any direct speed comparisons, we cannot provide objective information.

However, some packages facilitated the batch mode of operation by permitting simulated batch processing, so the microcomputer could be left running overnight. Anyone who has experienced the frustrations of working on a badly overloaded timesharing mainframe might even find that the total elapsed time from input to output is less for microcomputers.

We suggest that you suspend your prejudices about speed until you can actually give some of the packages a fair trial. Also, the time is soon coming when packages that are fast by any standard will become available. A select few of those reviewed here appear to have already surpassed some of the traditional speed barriers for microcomputer statistical applications.

How easy are they to use? Many of them can be easily learned by persons who have never used a computer to analyze data before. However, nearly every package assumes that the user has a basic familiarity with the statistics involved. Several of them were exemplary in the simplicity of their structure from the user's point of view. These were as easy to learn and as foolproof as any complex statistical-analysis package is likely to be. Almost all of them were easier to use than most of the common mainframe packages, but typically they provided far fewer procedures so that there was less to learn.

On the negative side, though, there were many problems. All packages had traits that annoyed us as we used them. No doubt we could adjust, given more time, but we were puzzled by the frequent inconsistencies and lapses in some of the otherwise well-thought-through programs. One of the most irritating aspects of many programs was the need to enter the same information about the number of cases, number of variables, file-names, system parameters, and so on over and over again as one proceeded through a series of related operations. Another annoyance was having to always move lockstep through a series of menus time and time again, usually from the very beginning each time, when doing parallel operations on different variables. Still another was the lack of an escape mechanism when a mistake is made or a filename forgotten at a crucial time. It was usually necessary to restart the program or, worse, reboot it when this happened. Sometimes this necessitated the reentry of our data set as well.

Many of the programs use the same key for different purposes at different times, without prompting the user about the change. As noted in our comparison table, some programs required the use of the Return key after some entries but not others. Packages varied from poor

DECADES OF SERVICE

FROM THE NATION'S LARGEST NEC DEALER

Where Do You Turn To Solve Your Computer Puzzle?



TURN TO US!

We'll show you the easiest way to put the pieces together.

Matched. Compatible. Proven—
Use Someone Else's Engineering to Supplement Yours.

Our professional applications specialists are happy to assist you in configuring business and scientific computer systems from the thousands of hardware and software products we regularly handle.

Our specialties include:

- CAD/CAM Graphics
- Multi-user Databases
- Foreign Language Processing
- Communications

Our GSA Contracts:

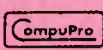

Washington Computer Services

97 Spring Street (212) 226-2121
N.Y., N.Y. 10012

an affiliate of
U.S. ELECTRIC COMPANY
SINCE 1912

HOURS: 9 AM - 5 PM / Monday-Friday TELEX: 12-5606 CABLE: WASHCOMP NYK

PLEASE! Do not confuse us with mail order dealers. We are a full service distributor serving the data processing & installation needs of business and industry from micros to mainframes. System houses, educational institutions & governmental agencies given special consideration. Dealer and international inquiries welcome.

Every option you'll ever need.

You're looking at ULTRAFRAME™, a powerful 8/16 bit multiprocessor you can configure to handle any application.

It's the one system that can tackle your toughest jobs today with the capacity to grow up to 32 users or tasks — within the same chassis.

Get 5" & 8" Winchester drives from 10-120MB (formatted). Also, 14" models from 145MB to 1,160MB. And backup systems appropriate to any system you design.

The super micro that almost configures itself.

Our version of TurboDOS™ is extremely easy to integrate thanks to the IBS TURBO-INTEGRATOR™ — a menu-driven utility that will help you

get the right system configuration into your customers hands in record time.

Save yourself hours of valuable time with the TURBO-INTEGRATOR, the fastest way to configure for peripherals and design multiuser system

security. Generate user-friendly shells with the IBS MenuMaster-T™

The industry's longest warranty.

We've built the ULTRAFRAME to last — and backed it with a full three year warranty. Plus, we give a level of old-fashioned factory support you won't get from anyone else. And on-site maintenance is available nationwide through 45 service centers.

FRONT



BACK



ULTRAFRAME™



INDEPENDENT BUSINESS SYSTEMS

Call collect (415) 443-3131 TWX: 910-386-6003 IBSNET
5915 Graham Court, Livermore, CA 94550

A feast for OEM's and system integrators.

- **MAINFRAME-LIKE CHASSIS & POWER SUPPLY ENGINEERING.** Continuous-duty cooling capacity. Solid state power supply circuitry for max. reliability.
- **FAST, HIGH CAPACITY HARD DISKS.** Full range of 5", 8" and 14" Winchester models from 10 to 1160 MB, including new high-capacity 5" drives.
- **UP TO 32 USERS — IN PARALLEL.** Add 8 or 16 bit SLAVENET™ processor boards — each a complete Z80 or 80186 computer — to maintain fast, multi-user performance. Both 12 and 20 slot S-100 models available.
- **LOW COST PER USER.** Higher performance and lower cost per user than any micro network. True multi-user, multitasking operation plus shared resources.
- **FAST, MULTIPROCESSOR OPERATING SYSTEMS.** IBS p-NET™ and TurboDOS — access to all UCSD Pascal™ and CP/M™ software.
- **CHOICE OF BACKUP SYSTEMS.** Integral 5" or 8" floppies to 1.2 MB. BACKSTOP™ video archiving; BACKSTOP II™ start/stop tape.

TurboDOS™ Is a registered trademark of Software 2000.

MenuMaster is a registered trademark of Borland International.

ULTRAFRAME and TURBO-INTEGRATOR are trademarks of IBS, Inc.

to excellent in the amount of on-line help and prompting provided. The manuals were generally poor when it came to the intricacies of actually finding answers to questions we encountered while in the middle of runs, although there were a few notable exceptions.

The most serious problem of all, however, was the inability of most programs to adequately handle errors. It became routine to have the programs crash at inconvenient times, leaving us with an uninterpretable error message from the interpreter, compiler, or operating system. The manuals typically provided no help in these situations. Users who are experienced with the language or operating system used will have a decided advantage over novices when running these programs. But even experienced microcomputer users will find themselves handicapped when they get a fatal error from, say, a package written in BASIC, and discover that because it is a protected program they cannot list the line in which the error occurred to get a clue about the nature of the problem. And even in those cases where they can list it, users may find they spend considerable time studying the program code before they can decipher the problem. It is fair to say that, as a group, these programs are inferior to typical word-processing and spreadsheet programs in error handling. However, some packages were notably better than others in this regard.

Having vented our irritation at some of the quirks of these packages, we will of necessity adjust to them. In

only a few programs are the benefits outweighed by the drawbacks of poor error handling, inconsistencies, and so on. Furthermore, as the market for these packages expands and users become more demanding, we can expect the same level of quality we now find in the best programs in other areas.

Which packages are best? We're going to hedge on this one and refer you to a careful study of the comparison tables. First of all, there was no clear favorite that we agreed on. This was partly dictated by our preference in operating systems and microcomputers. If you are used to Apple DOS, you might find yourself frustrated with CP/M, and vice versa, regardless of the merits of any particular program. Second, the needs of a specific application will usually tip the preference one way or another. Are your data sets large or small? Are you a novice or experienced? Do you prefer menu-driven or command-driven programs? Do you have an Apple, IBM, or CP/M microcomputer? Are you doing mostly crosstabs, regression, or time series analyses? Do you have to exchange data with other programs, such as spreadsheets or word processors? Do you need good graphics? All these questions and more will influence your buying decision. The best we can do is say that in our judgment many of these packages merit serious consideration, and we hope this review helps you find the right program to meet your specific needs. ■

James Carpenter (5036 Corun Rd., Jefferson, MD 21755) is a senior mathematical statistician with a government statistical agency. He is charged with evaluating new computing technology for use there.

Dennis Deloria (1009 North Potomac St., Arlington, VA 22205) is a research psychologist with a government agency.

David Morganstein (13424 Walnutwood Lane, Germantown, MD 20874) is a survey statistician and vice-president at Westat Inc., a national survey research firm. He is serving his third year as the president of the Washington Apple Pi, a 4000-member microcomputer users group.

References

1. Beaton, A. E., D. B. Rubin, and J. L. Barone. "The Acceptability of Regression Solutions: Another Look at Computational Accuracy." *Journal of the American Statistical Association*, 1976, volume 71, pages 158-168.
2. Lachenbruch, P. A. "Statistical Programs for Microcomputers." *BYTE*, November 1983, pages 560-570.
3. Longley, J. W. "An Appraisal of Least Squares Programs from the Point of View of the User." *Journal of the American Statistical Association*, 1967, volume 62, pages 819-841.
4. Longley, J. W. "Least Squares Computations and the Condition of the Matrix." *Commun. Statist: Simula. Comput.*, 1981, B10(6), pages 593-615.
5. Platt, W. G., and C. A. Platt. "Microcomputer Statistical Packages and Regression Performances." *American Statistical Association 1981 Proceedings of the Statistical Computing Section*, pages 309-316.
6. Walsh, P. J. "Algorithm 127: ORTHO." *Collected Algorithms from Communications of the ACM*, 1962, volume 5.
7. Wampler, R. H. "A Report on the Accuracy of Some Widely Used Least Squares Computer Programs." *Journal of the American Statistical Association*, 1970, volume 65, pages 549-565.
8. Wolach, A. H. "Accurate Statistical Calculations." *Computer*, September 1982, pages 92-94.
9. Woodward, W. A., and Elliott. "Statistical Packages on Microcomputers." *Computer Science and Statistics: Proceedings of the 15th Symposium on the Interface* (to be released).



5 1/4" DISK CONTROLLER

KEY FEATURES

- Full sector buffering
- Logical sector addressing
- Multiple sector, cylinder operation
- 11 bit burst ECC
- Self-diagnostic capability
- Automatic sector alternation for the defective sectors
- Automatic Error Retry
- Industry Standard SASI I/F

National Computer Ltd.

LIASON OFFICE IN CALIFORNIA
PHONE: (408) 734-1006 FAX: (408) 744-0708

AKEBONO BLDG. 2-6-12 IWAMOTO-CHO
CHIYODA-KU, TOKYO, JAPAN
PHONE: (03) 863-8705 TLX: J27542
FAX: (03) 864-4581

Infoscope ... Its magic happens right before your eyes

Thirty minutes with your new computer and Infoscope, and you can be showing off — entering information, sorting it, displaying it, putting it to work in ways you never dreamed possible.

Infoscope, a revolutionary new program for dynamic information management, opens up the potential of the personal computer. It's usable and useful now, even for a beginner, but it'll never get in the way in the long run.

From the first minute you use it, you'll discover some very interesting applications. It comes

Infoscope is a Trademark
of Userview Corp.

with demonstration "scripts" and sample data so you can sit back and watch it do its stuff without doing a lot of tedious data entry.

Infoscope helps you create "Scopes" to display data — windows on the screen that grow, shrink, move around, and overlap, while showing you just the information you want to see.

As you work with it, Infoscope adapts to your level of expertise. Its "choice-driven" approach makes it easy for a new user to get up to speed, but it doesn't

entangle an expert in a maze of menus he doesn't want to see.

In short, Infoscope is as simple or as complex as you want it to be, and it does virtually any information management chore you want it to do.

But you have to see it for yourself. Infoscope is available for most popular 16 bit microcomputer systems. Ask for a demonstration at your local computer store, or write us for details.

Microstuf, Inc.
1845 The Exchange, Suite 140
Atlanta, Georgia 30339
(404) 952-0267

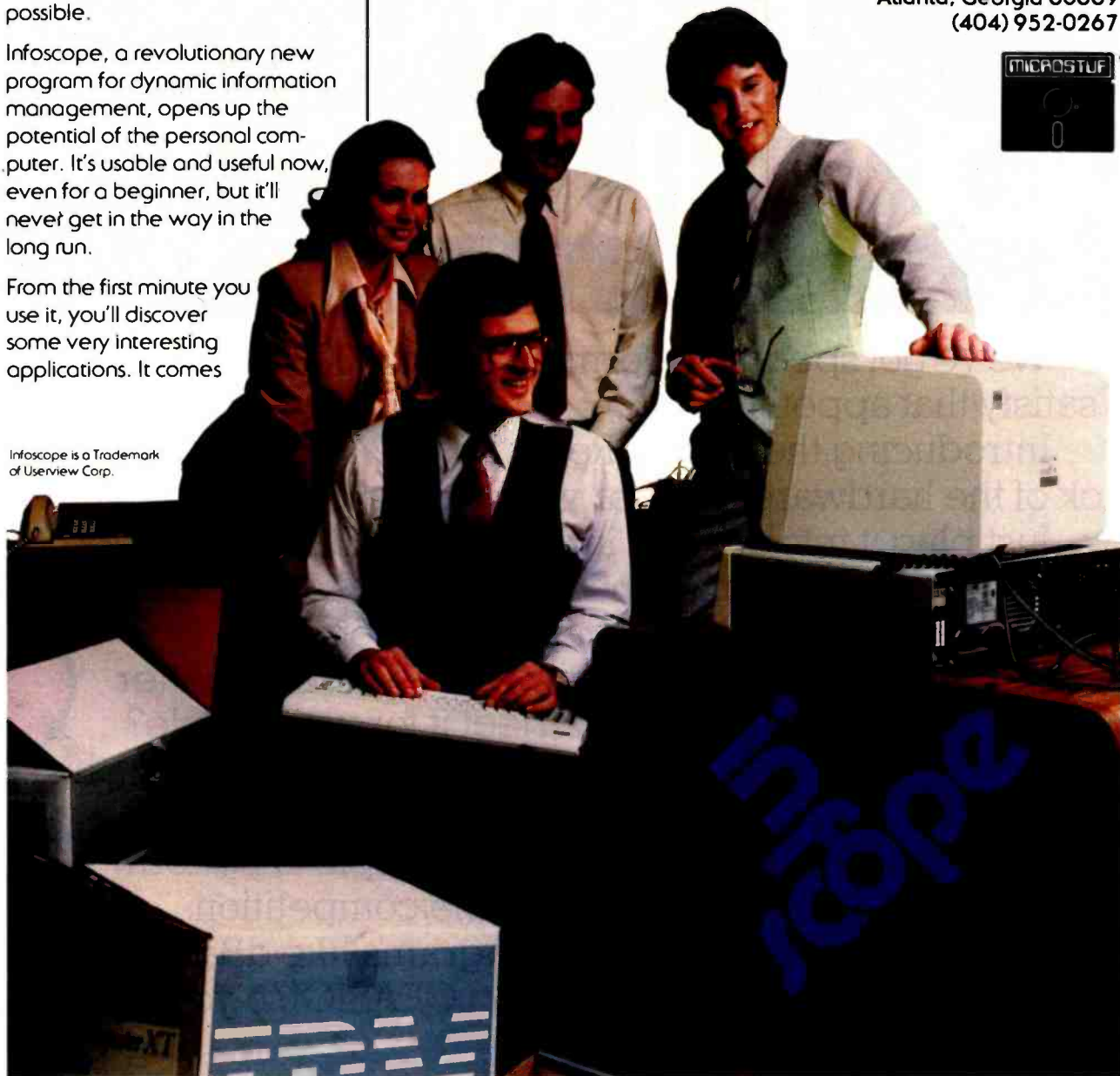

Does your Apple leave you hungry?



We've got speed, performance and 3,000 new applications to satisfy that appetite.

Introducing the Digital Research CP/M Gold Card.™ The pick of the hardware crop for your Apple® Computer

Just plug it into any slot in your Apple II, II+ or IIe, and you get a new generation machine that runs CP/M Plus™ and all those programs it could never handle before.

Impressive, but not surprising. After all, who better than the creators of CP/M® to perfect it for your Apple?

And if you thought your Apple was a bit slow, chew on this.

We combined CP/M Plus, the Z80B microprocessor and optional Disk Cache to push your Apple to perform up to three times faster than any of the competition.

With the speed to handle programs like dBase II™ in half the time. And we've included CBASIC® so you can write customized programs.



It even boosts your monitor's CP/M output to full 80 column video. And those are just the basics.

For serious programmers we also included a macro-assembler and symbolic debugger. Explaining it all in two complete manuals.

It all comes down to this. Soon

there will be two kinds of Apple users. Those with the CP/M Gold Card. And those who are still hungry for one.

 **DIGITAL
RESEARCH**[®]
We make computers work.SM

The products and corporate logos referred to herein may be trademarks or registered trademarks of the companies indicated. The Digital Research logo and products are either trademarks or registered trademarks of Digital Research Inc. ©1984 Digital Research Inc. All rights reserved.

Circle 123 on inquiry card.

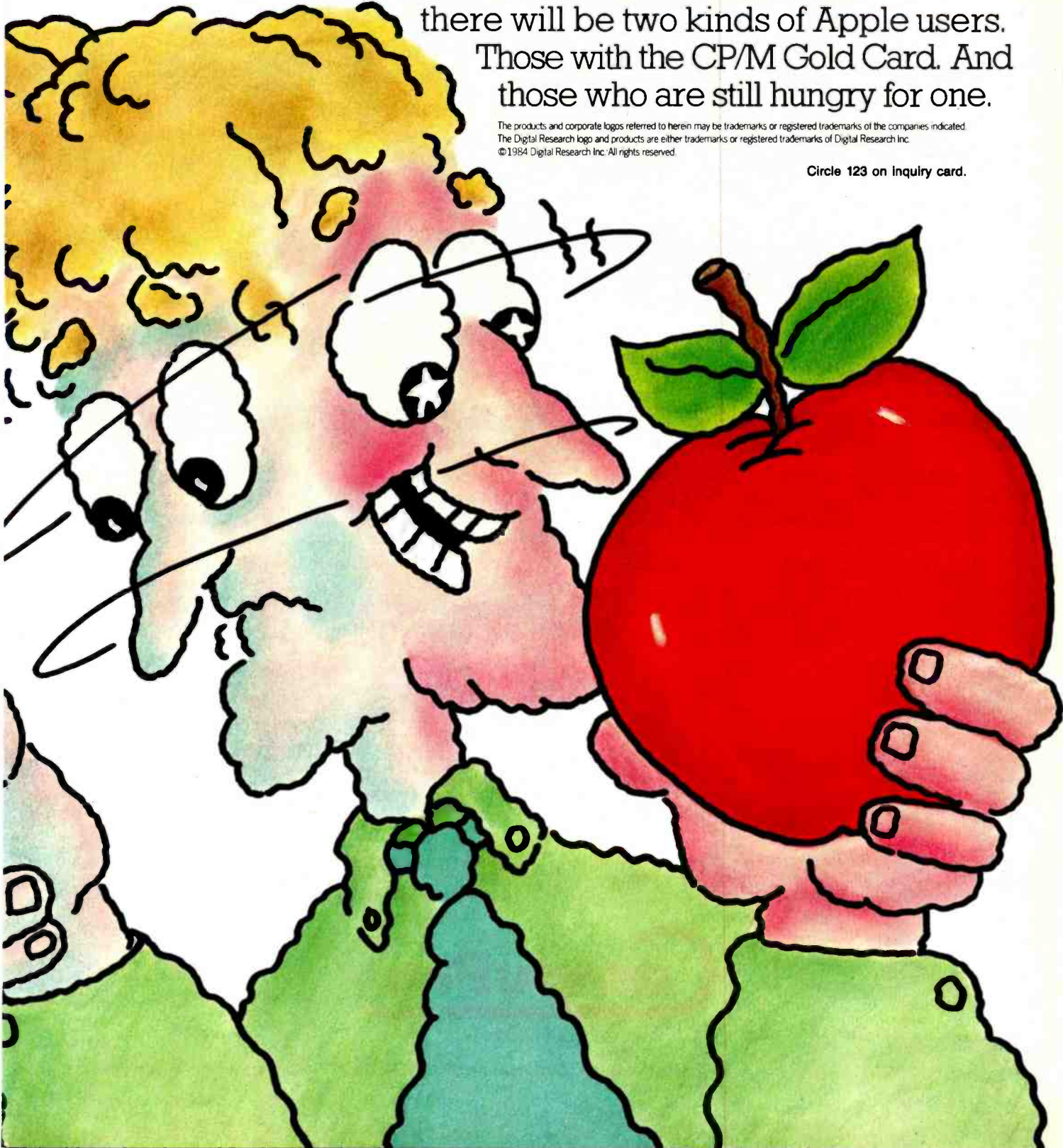

SEVEN ACES



CPU's nimble and swift — a card sharp's delight.

When CompuPro introduced the first CPU board with both 8- and 16-bit capabilities, it was like handing a royal flush to systems integrators. How could we top that?

You gave us the answer. "Make a CPU that will access 16 megabytes at a swipe," you urged. So we designed CPU 68K. "Make one for people who need top speed and 16-bit power," you pleaded.

CompuPro responded with CPU 286, the board with two brains: one to bundle bytes and the other to scan the conveyor belt ahead and fetch the necessary tools.

So, by giving you flexibility without sacrificing performance, quality or reliability, CompuPro has dealt all players a winning hand: Seven Aces.

They're worth betting on.

CPU 8085/88

Is CompuPro's pioneering dual processor, running the vast library of both 8-bit and 16-bit programs at clock speeds up to 8 MHz. *Maximum* software access. \$495, \$595 CSC.

CPU 86/87

uses Intel's widely favored 8086 chip, so you get the broadest range of time-tested 16-bit software. Includes sockets for the 8087 math co-processor and 80130 firmware chip. \$800 10 MHz, \$850 CSC 10 MHz. With 8087 chip, \$1050 5 MHz, \$1150 CSC 5 MHz.

CPU 68K

lets you rummage around in 16 Mbytes of memory at a time — not just the usual 64 Kbytes. Access huge databases, invert mammoth matrices, or turn titanic tables topsy-turvy. Includes socket for memory management unit. \$695 8 MHz, \$775 10 MHz, \$850 CSC 10 MHz.

CPU Z

brings the Z80 chip's sophisticated instruction set to bear on the whole range of 8-bit software at clock speeds of 6 MHz. Ideal for multi-user installations, with 24-bit addressing that handles up to 16 Mbytes of memory. \$325, \$425 CSC.

CPU 286

Is CompuPro's most far-sighted processor. It handles all 8086/8088 software, but many times faster with the help of a unique look-ahead capability. A memory management unit is *built-in*. \$1595 8 MHz, \$1750 CSC 10 MHz.

CPU 16032

features true 32-bit internal architecture that makes your micro byte off bigger words, like a mini. Ideal for Unix and other large operating systems. Includes sockets for floating point unit and memory management unit. Handles clock speeds up to 10 MHz. \$695, \$845 CSC. MMU available.

SPU-Z

lets multiple users share expensive resources such as disk drives, printers and modems — not to mention data. Let our slave processor give individual attention where it's needed, freeing the more expensive CPU for bus management. \$695, \$795 CSC.

For your business, industrial and scientific computing solutions, call (415) 786-0909, ext. 206 today for the location of the Full Service CompuPro System Center nearest you.

CompuPro products are backed by a one-year limited warranty — two years for boards qualified under the Certified System Component high-reliability program.

CompuPro®

A GODBOUT COMPANY

3506 Breakwater Court, Hayward, CA 94545

For dealer locations, see page 435.

Prices and specifications subject to change without notice.

©1983 CompuPro

268 BYTE April 1984

Circle 79 on Inquiry card.

This Month's Features

A new computer and an old language highlight BYTE's features in this issue. Any odd or peculiar articles, advertisements, or announcements can only be ascribed to that north-country, mid-winter affliction known as cabin fever—the theoretical cause of the wackiness common at April's arrival.

The new computer is the brainchild of a group of former Atari and Intel engineers headed by Roger Badertscher. The company and the computer are called Mindset. As Senior Technical Editor Gregg Williams explains, Mindset hopes to bring arcade-quality graphics to medium-priced personal computers.

The old language is BASIC, that standby of microcomputers that helped popularize the machines. Our examination of the current state of BASIC focuses on several new versions of the language that purport to improve on the evolved industry standard, Microsoft BASIC. The newer BASICs permit structured programming and use the increased power of the latest microprocessors. As you'll discover, windows mean a lot in this brave new world of BASIC, too. Our report looks at True BASIC, BetterBASIC, Macintosh BASIC, Professional BASIC, and BASIC-09. Will these new BASICs attract a following? Predictions not included.

You've no doubt been wondering what the Russians are up to. Ruth Heuertz reports on Soviet microprocessor technology in a feature beginning on page 351. Readers in the Commodore camp may find the VIC-20 Terminal Emulator program by John Russo of substantial interest (a VT100 for less than \$100?).

Mark L. Siegel delineates the proposed ANSI standard for video terminals, exploring what may be a way to make screen control consistent among differing terminal brands.

Not more than one or two of us have been wondering what Jim McQuaid might be up to these days, but we all find out as he reveals details on a new home appliance, Smart Blankie. (Yes, there was a full moon the night this article was written.)

Next month, look for features on using cache memory to maximize the performance of hard-disk drives, batch processing with MS-DOS 2.0, and a look inside the ROM of the TRS-80 Model 100 portable computer.

—G. Michael Vose, Senior Technical Editor, Features

270 **The Mindset Personal Computer**
Gregg Williams

298 **Is BASIC Getting Better?**
G. Michael Vose

300 **True BASIC**
Brig Elliott

302 **BetterBASIC**
G. Michael Vose

318 **Macintosh BASIC**
Scot Kamins

334 **Professional BASIC**
Donald P. George

344 **BASIC-09**
Brian Capouch

351 **Soviet Microprocessors and Microcomputers**
Ruth Heuertz

365 **Toward Standardized Video Terminals: ANSI X3.64 Device Control**
Mark L. Siegel

379 **A VIC-20/Commodore 64 Terminal Emulator**
John P. Russo

422 **Smart Blankie**
Jim McQuaid

The Mindset Personal Computer

Gregg Williams
BYTE Senior Technical Editor

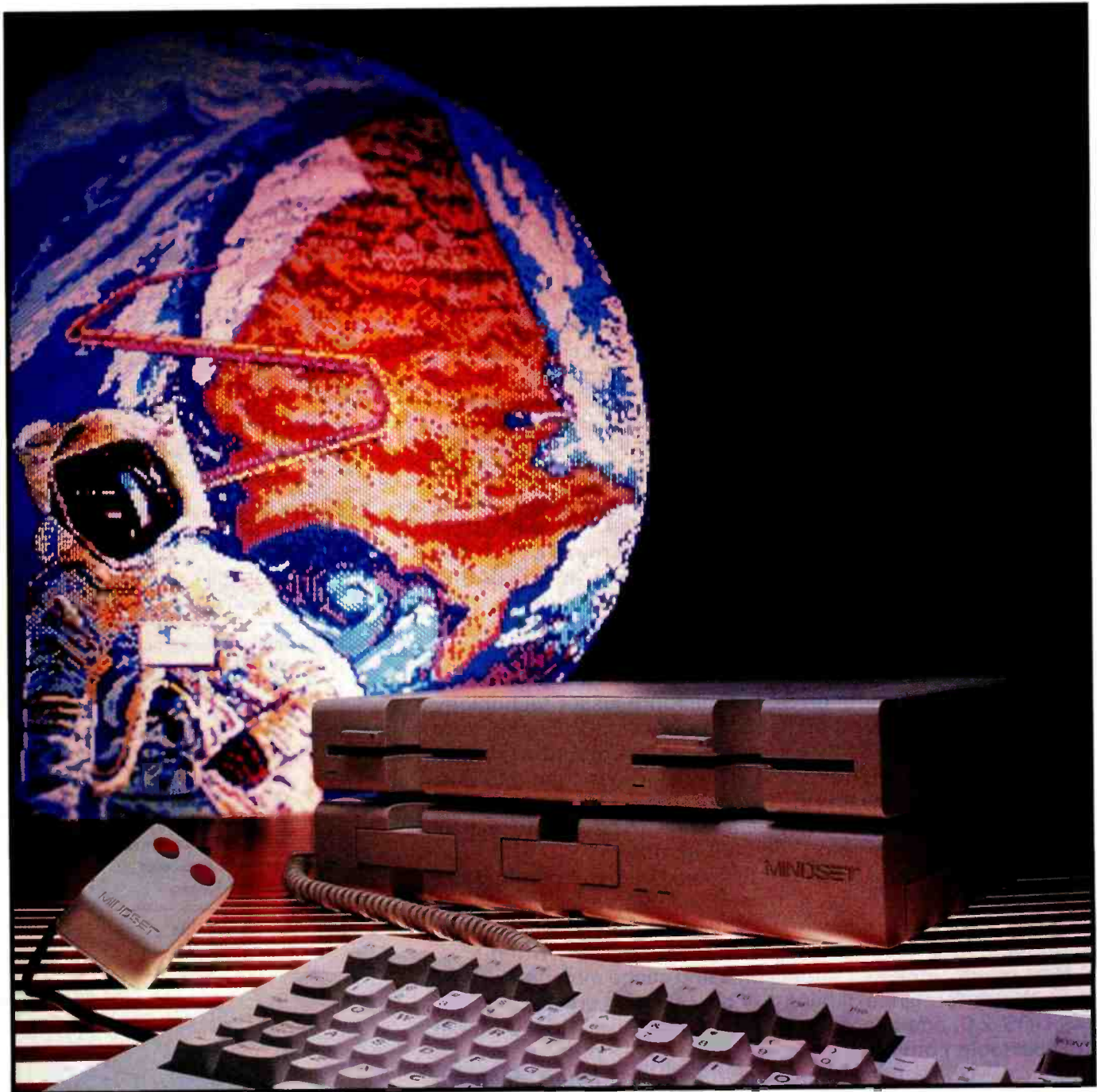

Custom VLSI chips bring \$50,000 technology to a \$2000 IBM PC-compatible computer

The Mindset Personal Computer (see photo 1) is a promising graphics-oriented computer that breaks new ground. It uses the Intel 80186 16/16-bit microprocessor (16-bit internal and external data bus) and two custom processor chips to create glitchless graphics at sufficient speed to make smooth animation possible. Taking its inspiration from graphics-oriented minicomputers costing more than \$50,000, Mindset uses this state-of-the-art microcomputer technology to bring its price down to about \$1200, with a full-blown two-disk system costing about \$2600—and it also throws in a good amount of IBM PC compatibility at no extra cost. Mindset is slated to be available sometime during the second quarter of 1984.

Configurations and Prices

The Mindset can be configured in three different ways. The top two configurations include some IBM compatibility (allowing the machine to run the IBM PC versions of most major application programs without change). All three configurations include hardware that gives you very fast graphics and animation, even in BASIC.

Its simplest configuration includes the System Unit, which is a stand-alone cartridge-based personal computer. It includes an Intel 80186 microprocessor running at 6 MHz, 32K bytes of system ROM (read-only memory), 32K bytes of user RAM (random-access read/write memory), 32K bytes of screen memory (called a *frame buffer* by Mindset and many computer-graphics users), a detached 84-key keyboard with cable and two



Photo 1: The Mindset Personal Computer. In the background are the System (bottom) and Expansion (top) units. In the foreground are the detachable keyboard, an optional two-button mouse, and the supplied GW BASIC programming language in cartridge form.

connectors for a mouse and/or Atari-style joystick, two cartridge slots, three I/O (input/output) module slots (for add-on hardware equivalent to Apple or IBM peripheral cards), a Mindset GW BASIC cartridge, and video outputs for a television, a composite color monitor, and an RGB (red-green-blue) monitor. At the time of this writing, Mindset estimates this computer's retail price will be about \$1200.

The next step up includes the addition of the Expansion Unit, which fits on top of the System Unit and adds 96K bytes more RAM (for a total of 128K bytes of user RAM), one 360K-byte 5¼-inch (IBM PC-compatible) floppy-disk drive, and three I/O module slots. This unit brings the total computer price to around \$2000 and gives you a disk-based computer with some IBM PC compatibility; it runs Microsoft's MS-DOS 2.0, available for about \$60 extra.

The top-of-the-line configuration includes all the above plus a second disk drive and an additional 128K bytes of memory, both of which are added to the Expansion Unit. This gives you a two-disk, 256K-byte sys-

tem that runs some IBM PC software for about \$2600.

Design Philosophy

The inspiration for the Mindset computer came from two markets: the CAD/CAM computer and terminal market (machines costing \$50,000 to \$100,000) and the IBM PC market. (CAD and CAM refer to *computer-aided design* and *manufacturing*, respectively.) Mindset's vision was to make a computer with most of the graphics power of a CAD/CAM system for a consumer-computer price. Its approach was to adapt CAD/CAM technology to a smaller and less expensive computer by using custom VLSI (very-large-scale integration) chips to perform complicated graphics quickly and cheaply.

By working with a custom chip manufacturer, VLSI Technology Inc. of San Jose, California, and drawing on the expertise of employees who came from companies like Zilog, Intel, and Atari, the Mindset design team created two custom VLSI chips, one for pixel-oriented graphics and one for handling the video display, and designed a computer around them and the Intel 80186 microprocessor (an enhanced chip that runs a superset of the 8086 instruction set

Using the Mindset, Saul Bernstein "painted" this view of an astronaut putting the world on line to represent this month's theme of real-world interfacing. (Photo by Michael Decastro.)

(2a)



(2b)

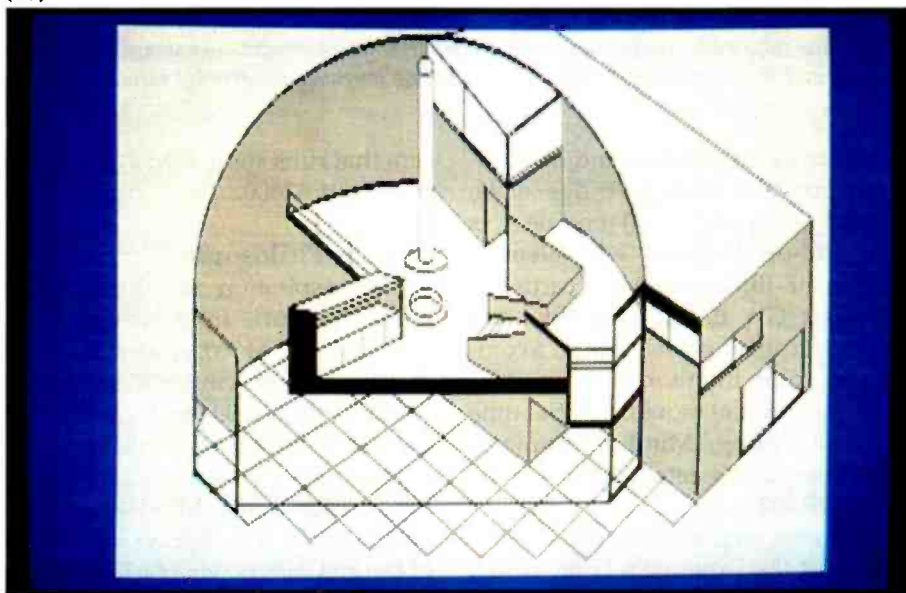

(2c)



and replaces about 20 chips in a comparable 8086-based design). Intel designed its 8086 family of microprocessors to be able to use a family of yet-to-be-designed coprocessor chips that, in effect, extend the instruction set of the Intel 80186 (Intel's 8087 floating-point arithmetic chip is the best-known coprocessor chip). The custom graphics chip in the Mindset computer is actually a coprocessor chip, the first to be designed outside Intel.

The resolution of Mindset graphics is not appreciably more than that of an IBM PC, but Mindset made that decision to allow itself to offer a low-cost computer: higher-resolution graphics would have forced the user to buy an RGB color monitor costing anywhere from \$1400 to \$4000. Still, the Mindset shares the following characteristics with its more expensive CAD/CAM counterparts: bit-mapped graphics; color indirection (the ability to choose from 512 possible colors the 16 that can be in use at one time); custom hardware to perform pixel-aligned graphics operations quickly, regardless of byte and word boundaries; and custom software that delivers a set of useful graphics-oriented subroutines. Photos 2a through 2c show representative Mindset graphics.

Mindset added limited IBM PC compatibility to give it a considerable base of ready-to-run software. The company would have liked to have had 100 percent software compatibility, but this conflicted with some of its other goals. The Mindset computer is BIOS-entry-point- and graphics-screen-compatible with the IBM PC; this means that if a program uses the Microsoft MS-DOS BIOS (basic input/output system) calls and manipulates the graphics screen directly (as all programs should, but many don't), the Mindset can run the same disk without modification. Mindset tested many popular IBM PC packages and, if they didn't work,

Photo 2: *Graphics on the Mindset. Photo 2a is an image created by PLP (presentation-level protocol) graphics commands. Photos 2b and 2c are done in the 640- by 200-pixel, 4-color mode.*

Delineating IBM PC Compatibility

Mindset did not set out to create a computer that is IBM compatible; rather, it created a computer using radically different hardware from the IBM PC that can run many IBM PC programs. The distinction is small but significant. For one thing, it means that Mindset has made no attempt to be hardware compatible: you cannot use IBM PC expansion boards in the Mindset because it has no hardware slots. The irony of this compatibility situation is that if software designers programmed the way they were supposed to—using operating-system routines instead of direct manipulation of the hardware—and IBM had designed the PC to make it easier to do so, virtually all IBM PC programs would run as is on the Mindset.

According to Mindset, "Mindset is compatible with PC programs which run with the color card and which use standard ROM OS calls and/or MS-DOS 2.0 functions, or with PC-DOS 1.1 programs which map into PC-DOS 2.0." In addition, the Mindset works with programs that address video-display memory directly and make use of the 6845 video-display-controller status registers. (Because the Mindset does not use the 6845 for video display, it does not respond to most manipulations of it; however, so many

IBM PC programs use it to find out when to write to video-display memory without causing visual glitches that Mindset emulates these registers.) In general, though, programs should call operating-system routines instead of manipulating the hardware directly (Mindset has provided a large number of operating-system routines in its computer to make direct hardware access unnecessary).

Differences between the characteristics of the IBM PC and the Mindset account for some inherent incompatibilities. Many of these have been discussed elsewhere: the "Keyboard" section of the main text, table 1 (operating-system-call differences), and table 8 (video-display-mode differences). For example, the Mindset will not run the popular Microsoft Flight Simulator because it uses the 160- by 100-pixel graphics mode, an IBM PC mode the Mindset does not allow. Also, the Mindset does not include BASIC in ROM or support the IBM-style light pen or joystick.

When using the IBM PC with a graphics-interface card in text mode, you can display characters with any combination of 16 foreground colors and 8 background colors and optional blinking. The Mindset supports blinking characters but only two color modes: black on white and white

on black. By changing the color palette, you can display characters in other colors, but you will be limited to only those two colors on the display. In addition, the IBM PC has memory space for up to eight pages of 40-column text or four pages of 80-column text; the Mindset has reserved only enough memory for half that many alternate pages.

Finally, another source of software incompatibility occurs because of a hardware incompatibility between the 8088 and the 80186. According to Mindset, the vector that is used for keyboard I/O on the 8088 is dedicated in the 80186 to refreshing the system's dynamic RAM. This means that a program that reassigns the keyboard interrupt vector will not work on the Mindset.

Although the Mindset promises to work with many IBM PC packages, Mindset owners will be faced with an annoying uncertainty every time they see a piece of IBM PC software. In some cases, Mindset will have tested the software and determined its compatibility, but it can't keep up with the explosion of software we have today. The user's best bet is to deal with a software vendor that will let him or her try it before buying.

modified the computer so that they would. Many word processors (Peachtext, Wordstar, Superwriter), spreadsheets (1-2-3, Multiplan, Supercalc 3, Visicalc), databases (dBASE II, Condor), and other programs work as is.

The Mindset computer is incompatible with the IBM PC in that the former does not have a cassette interface; however, the operating system was designed to interact with cartridges as sequential-file devices. The Mindset computer also does not support a monochrome graphics display, light pen, IBM-style resistive joysticks, and some color graphics modes. For a more detailed look at this issue, see the text box "Delineating IBM PC Compatibility."

Open Software/Closed Hardware

Mindset recognizes the important role of third-party product developers

in the success of a new computer, but it has taken a curious approach in its company policy toward them. It is actively promoting the development of third-party software (more on this

Mindset Is promoting the development of third-party software while discouraging third-party hardware vendors.

later) but is rigidly guarding all details about the hardware itself, thus discouraging third-party hardware vendors and forsaking the increased popularity that comes from the availability of a large amount of hardware for the system. Mindset gives two reasons for its closed-hardware policy: first, to allow future versions of the hardware to include changes

without making them incompatible with existing software; and second, to protect its design from imitation by competitors. Mindset's policy, for better or worse, limits the depth of technical information that follows.

Machine Architecture

Figure 1 shows a block diagram of the Mindset personal computer. The diagram shows the contents of both the System and Expansion units. The system, graphics, and expansion buses have a 16-bit data bus and a 20-bit address bus. The system and graphics buses are joined by a three-state bus buffer that can either isolate or connect the bus lines on either side of it. In some cases, the system isolates the two buses so that the graphics coprocessor and display processor can perform a lengthy function (e.g., clearing the screen or refreshing the video display) without

SYSTEM UNIT

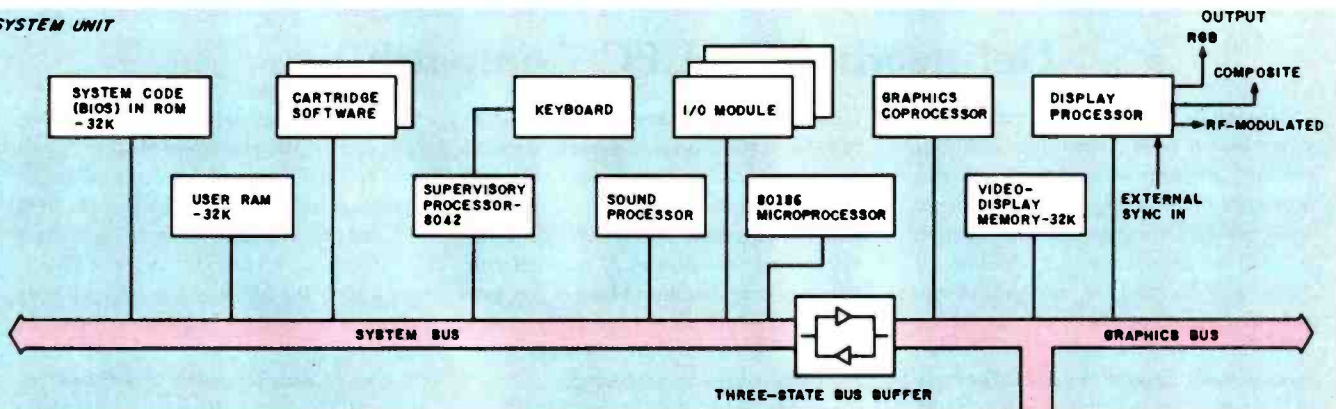

EXPANSION UNIT

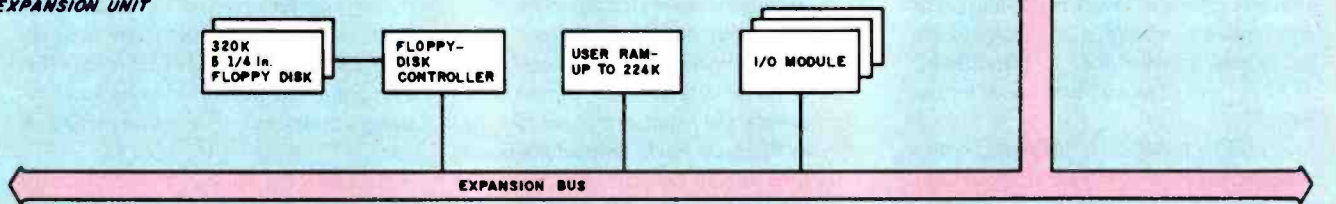

Figure 1: Block diagram of the Mindset personal computer.

tying up the 80186 and all the system components on the other side of the bus.

The Intel 80186 has a full 16-bit-wide data bus to complement its internal 16-bit architecture. Because it is not restricted by an 8-bit data bus (like the 8088 in the IBM PC), and because it runs at a higher clock rate

(6 MHz instead of the PC's 4.77 MHz), the Mindset should run faster than the IBM PC. (For details on the effect of bus width on microprocessor performance, see my "Benchmarking the Intel 8086 and 8088," July 1983 BYTE, page 147.) A spokesperson at Mindset said that the company chose the 6-MHz 80186 over the 8-MHz ver-

sion to ensure a "sufficient quantity" of the part for manufacturing the computer.

System Code in ROM

One significant feature of the Mindset is its use of system code in ROM (this is similar to the IBM PC); in this way, the computer can work as a stand-alone unit (without disk) or, if disks are present, software on the disk can "hook" the ROM software into itself and make it a disk-based system. The ROM software contains start-up instructions—what to do when the computer is first turned on. It also includes the computer's BIOS, a set of routines that let the programmer do character- and block-oriented input and output (and other elementary functions) without having to know the physical addresses or characteristics of the hardware being used. (The routines, when referred to by number, are called *interrupt vectors*.) For example, BIOS routine 16 decimal (called by the software-interrupt instruction INT 10, where "10" is the decimal number 16 in hexadecimal) controls 16 functions relating to the video display—setting the display type, reading the cursor position, putting a character to the display, and others.

| Interrupt Vector (Hexadecimal) | IBM PC Description | Mindset Description | Comments |
|--------------------------------|----------------------|---------------------|---|
| 2 | Nonmaskable | Reserved | Vector 2 is a hardware interrupt that is implemented differently on the 8088 and 80186; Mindset uses this vector for a proprietary purpose but knows of no conflict when trying to use IBM software |
| 10 | Video | Video I/O | There is full compatibility except in video modes not supported by the Mindset computer |
| 15 | Cassette | Dummy IRET | The Mindset places an IRET (return from interrupt) here because it does not support cassette I/O |
| 16 | Keyboard | Keyboard I/O | There is full compatibility except where the Mindset keyboard differs from the IBM PC keyboard |
| 18 | Cassette BASIC | Dummy IRET | The Mindset does not need this vector because its BASIC is not in ROM |
| 1D | Video Initialization | Reserved | The IBM vector returns information specific to its hardware; the Mindset ignores this vector |

Table 1: Deviations of Mindset interrupt vectors 0 through 1F hexadecimal from their IBM PC counterparts. The closer to identical these two are, the greater the degree of IBM PC compatibility; the differences here are very small.

| Interrupt Vector (Hexadecimal) | Value in AH Register (Hexadecimal) | Function |
|---|------------------------------------|---|
| Video Support | | |
| EE | 01 | Writes a character string to the screen along with string's attributes |
| EE | 02 | Selects TV or monitor as display device and reloads color palette |
| EE | 05 | Sets the cursor shape for character modes |
| EE | 06 | Supports synchronization with external video devices |
| EE | 07 | Specifies scan line that generates a display interrupt |
| EF | 0E | Returns frame-buffer address and sizes |
| Graphics Initialization | | |
| EF | 00 (01) | Sets (gets) screen-mode information |
| EF | 02 (03) | Sets (gets) transparent and combination modes |
| EF | 04 (05) | Sets (gets) address of destination buffer |
| EF | 06 (07) | Sets (gets) write mask |
| EF | 0A (0B) | Sets (gets) color-palette data |
| EF | 0F (10) | Sets (gets) address of user-defined display interrupt routine |
| EF | 12 (13) | Sets (gets) collision mask |
| EF | 14 (15) | Sets (gets) clipping rectangle |
| EF | 16 (17) | Sets (gets) the collision and clipping enable/disable flags and the address of the associated interrupt routine |
| EF | 1F (20) | Sets (gets) pointer to user-specified font |
| EF | 22 (23) | Sets (gets) the parameter-block mode value, which determines whether certain parameter lists are contiguous areas or linked lists |
| Graphics Primitive Operations | | |
| EF | 08 | Basic bitblt operation: moves one rectangular area of graphics to another |
| EF | 09 | Fills a rectangular region with a 16-bit pattern |
| EF | 0C | Draws a series of points of the same color |
| EF | 0D | Draws a series of lines of the same color |
| EF | 19 | Draws a filled convex polygon |
| EF | 1A | Draws a series of filled ellipses, circles, and pie sections |
| EF | 1B | Draws a series of hollow ellipses, arcs, and circles |
| EF | 21 | Displays character strings at any location with a user-specified font |
| Miscellaneous Graphics | | |
| EF | 11 | In a double-buffered graphics mode, switches display to alternate buffer |
| EF | 18 | Waits until the graphics coprocessor finishes current task, then returns collision and clipping results of the last 16 tasks |
| EF | 1C (1D) | Saves (restores) the current state of the graphics coprocessor chip |
| EF | 24 | Poles the current status of the graphics coprocessor chip |
| Miscellaneous Nongraphics Commands | | |
| EE | 08 (09) | Sets (gets) the mode for (from) the real-time clock |
| EE | 0C (0D) | Sets (gets) the time for (from) the real-time clock |
| EE | 0E (0F) | Sets (gets) the date for (from) the real-time clock |
| EE | 15 | Formats a RAM cartridge to accept information and support a directory |
| EE | 18 (19) | Reads (writes) blocks of data from (to) a RAM cartridge |
| EE | 1F | Reads status of both joystick ports |
| EE | 21 | Turns off the power to the system |
| EE | 24 (25) | Sets the sound mode (registers) |
| EE | 26 | Transfers sound data directly to the system D/A (digital-to-analog) converter |
| EE | 28 (29) | Writes (reads) a character to (from) the RS-232C output (input) buffer |
| EE | 2C (2D) | Sets up the RS-232C input (output) buffer |

Table 2: Important BIOS routines supplied by the Mindset ROM operating system.

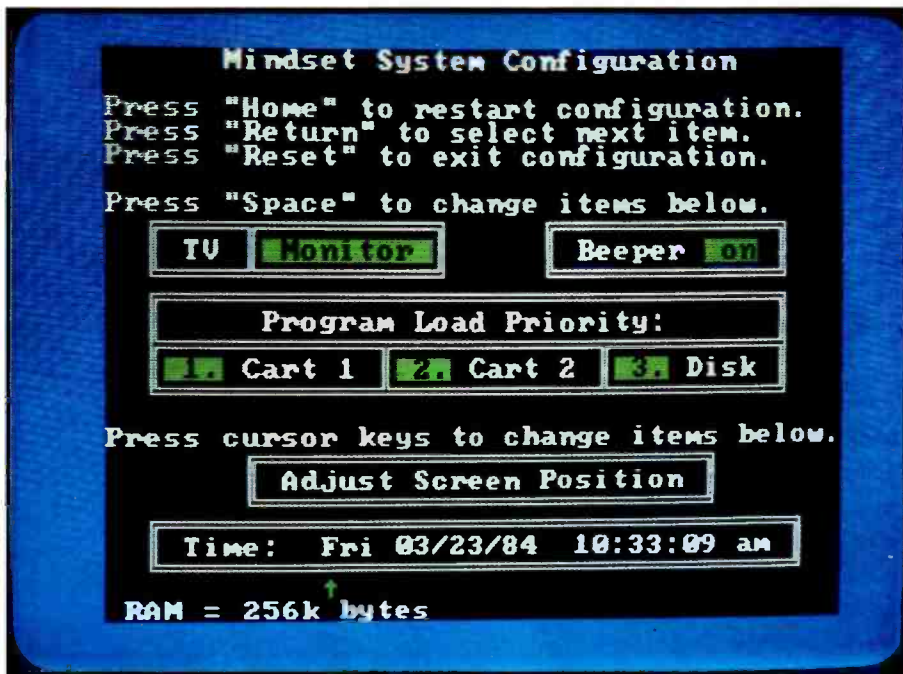

Photo 3: The System Configuration screen appears at the beginning of a session when you hit the Sys Config key. This screen shows how much memory you have (see lower left corner) and allows you to change certain system parameters.



Photo 4: Although this Mindset keyboard is quite similar to the IBM PC keyboard, Mindset has made several improvements. Note, among other things, the more conventional layout of the function keys F1 through F10 and the improved position of the Shift keys.

The Mindset BIOS routines are a superset of the IBM PC's, thus contributing to IBM compatibility. Interrupt vectors 0 through 1F hexadecimal are essentially the same as on the IBM PC (see table 1 for a list of differences). In addition, Mindset uses interrupt vector EE hexadecimal for 57 system-specific functions (distinguished by the value of the AH register when the interrupt is executed) and vector EF for 39 graphics-related functions (table 2 lists some of the more important EE and EF vectors).

By creating an interrupt structure that includes all the basic interactions needed between a program and the system hardware, Mindset is strongly encouraging programmers to create code that will work on the computer even if Mindset changes the control addresses and even the implementation of some functions in hardware.

The system-specific BIOS routines include a set of RS-232C-related routines that allow data transfers to occur, interrupt-driven, as a background process. You can set up both

input and output data buffers. Once you start an I/O operation, the system can send the data in the output buffer or receive external data into the input buffer automatically while the foreground program goes on to other tasks.

Many of the extended graphics BIOS routines will take a list of arguments, and one call to that routine will perform a given operation up to 65,535 times. For example, one BIOS call can draw 20,000 line segments of the same color, but you need to make two BIOS calls to draw two line segments, each in a different color.

Starting the Computer

If you want to use cartridge software in the Mindset, you insert the program in one or both of the cartridge slots and turn a dial on the left face of the computer to clamp the cartridge contacts in an internal zero-insertion socket. You can insert cartridges in either slot; the operating system can find the proper software to run, even if both cartridge slots are occupied.

The on/off switch is located on the back of the keyboard; however, it does not directly control the power. The supervisory processor (an 8042) remains active as long as the computer is plugged into a wall socket. It constantly "listens" for keypresses from the keyboard; the on/off switch is simply a keypress(es) that the 8042 uses to "wake up" the rest of the system.

The computer checks three sources for the code it will execute on start-up—the disk and the left and right cartridge slots. You can set the order of checking as well as other items such as time, date, and screen-image position (relative to the edges of the display area) by hitting the Sys Config key just after starting the system; this key causes the *System Configuration screen* to be displayed (see photo 3). The values chosen by modifying this screen remain in effect as long as the computer is plugged into an electrical outlet.

Keyboard

Photo 4 shows the Mindset keyboard. Mindset had the courage to

FIRST ANNOUNCEMENT OF A BREAKTHROUGH IN VIDEOTEX TECHNOLOGY.

NOW WORLD SYSTEM VIDEOTEX CAN BE IMPLEMENTED ON A MICRO FOR A MICROSCOPIC PRICE!

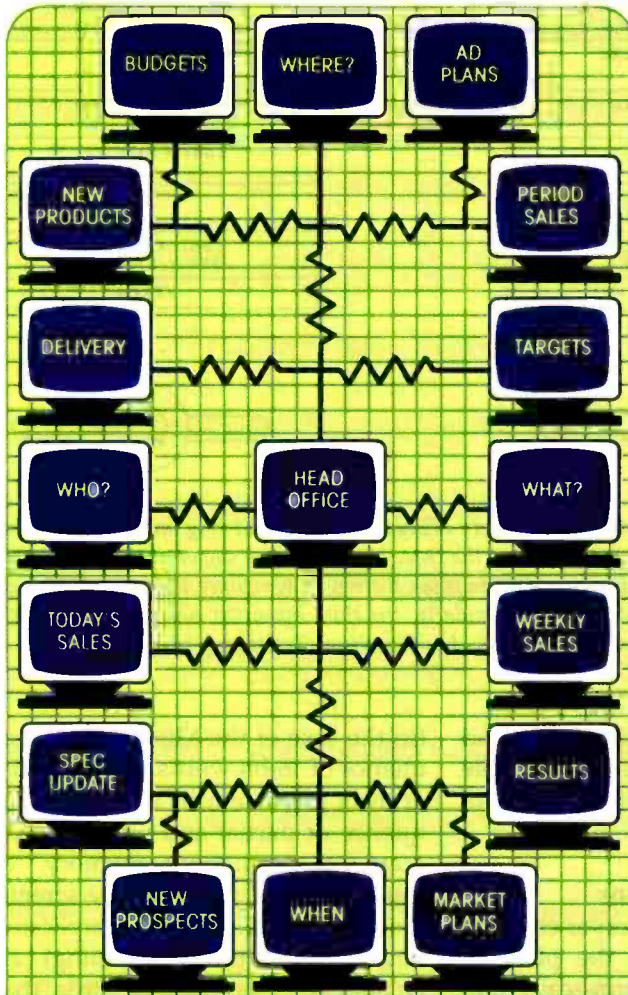

**16 PORT PRIVATE
VIDEOTEX SYSTEM**

for less than **\$625** per port

Metrotel, creators of the now world famous Videotex Editing Package, announce a major breakthrough. After years of development in the British market, Metrotel have created a Videotex Host Package which can be implemented on most CP/M, S100, Z80 based microcomputers and the BBC Micro.

A NEW BOON FOR BUSINESS!

The opportunities for business are endless – Head offices can keep in constant touch with their field sales force, remote branch offices or their more important customers.

Two way information can be provided quickly, efficiently and confidentially. Metrotel PVS features full local and remote editing. Mailbox and response frames, together with a two tier password and account number security system. Metrotel PVS can help business to become more responsive to today's demanding information requirements for a minimal cost.

SEE HOW LITTLE IT COSTS!

Until now the cost of implementing a private Videotex system has been prohibitive for most small/medium size businesses. In today's cost conscious business environment only a system which recognises financial accountability can ever succeed. Metrotel PVS has been predicted as: – "an affordable system which will undoubtedly advance business efficiency." All that is required to implement

your own Private Videotex system for up to 100 users is Metrotel PVS software, a Metrotel Modem Multiplexer and 16 Auto answer Modems supporting inexpensive Videotex terminals. Typical costs, less than \$10,000, which means a private Videotex system is within reach of every business.

EASY TO USE SOFTWARE

Metrotel software is written to a high professional standard to conform to the Videotex philosophy of a simple user interface. Metrotel PVS software is menu driven, self explanatory and designed for the end user. This feature, coupled with a high standard of documentation and after sales support, ensures that the user spends all his time in the active pursuit of his own business, rather than grappling with the software.

Send coupon for full details of Metrotel PVS.

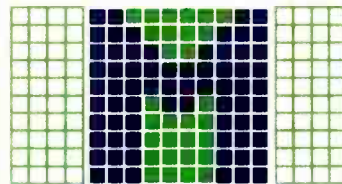

METROTEL

Distributor Enquiries to –
METROTEL VIEWDATA
SYSTEMS LTD., 6 HIGH STREET,
RUISLIP, MIDDLESEX HA4 7AP,
ENGLAND. Tel: +44 8956 77071.

To: Metrotel Viewdata Systems,
90 World System Videotex,
20th Floor, 341 Madison Ave.,
New York NY10017

Please send me full details of the
exciting Metrotel PVS system.

Name _____

Company _____

Address _____

Telephone _____

SEE US AT THE 'WORLD SYSTEM' STAND – VIDEOTEX '84 – CHICAGO APRIL 16-18

CP/M is a registered trade mark of Digital Research.

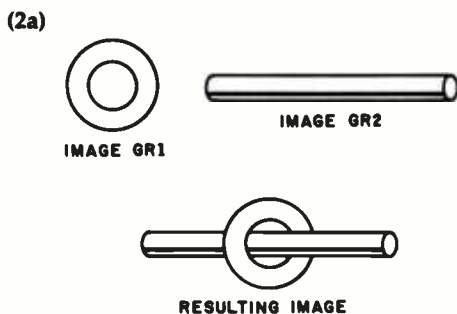

(2b)

| GENERAL BLT COPY PARAMETER BLOCK | |
|--|-------------|
| SOURCE RASTER ADDRESS | |
| SOURCE RASTER WIDTH | |
| X LOCATION IN SOURCE Y LOCATION IN SOURCE | |
| X LOCATION IN DESTINATION Y LOCATION IN DESTINATION | |
| X-SIZE } OF BLOCK Y-SIZE } | TO TRANSFER |
| SOURCE MASK | |

(2c)
OPERATION

| PARAMETER BLOCK FOR FIRST TRANSFER | |
|---------------------------------------|--|
| ADDRESS OF GR1 RASTER | |
| RASTER WIDTH OF GR1 | |
| (GR1 X-SIZE)/2 0 | |
| X-DEST + (GR1 X-SIZE)/2 0 | |
| GR1 X-SIZE/2 GR1 Y-SIZE | |
| FFFFH | |

| PARAMETER BLOCK FOR TRANSFER 2 | |
|-----------------------------------|--|
| ADDRESS OF GR2 RASTER | |
| RASTER WIDTH OF GR2 | |
| GR2 X-SIZE 0 | |
| 0 Y-DEST + (GR1 Y-SIZE)/3 | |
| GR2 X-SIZE GR2 Y-SIZE | |
| FFFFH | |

| PARAMETER BLOCK FOR TRANSFER 3 | |
|-----------------------------------|--|
| ADDRESS OF GR1 | |
| RASTER WIDTH OF GR1 | |
| (GR1 X-SIZE)/2 0 | |
| 0 0 | |
| (GR1 X-SIZE)/2 GR1 Y-SIZE | |
| FFFFH | |

RESULT

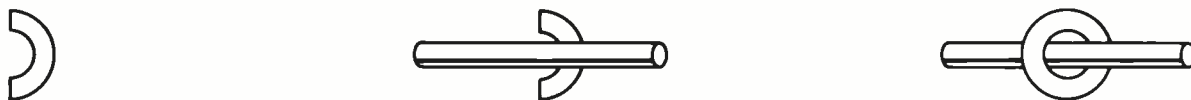

Figure 2: Mindset graphics at work. Using the Mindset block-graphics commands, you can easily create a rod-and-ring image from its two component images (see figure 2a). Figure 2b gives the format for the parameter block of the three block transfers shown in figure 2c. The first operation in figure 2c draws the right half of the ring. The second operation superimposes the rod image. Since the transfer is done in transparent mode, the space surrounding the rod image does not replace the ring. Similarly, the third operation superimposes the left half of the ring over the rod. Some computers would have to do considerable calculations to draw these overlapping images correctly.

break with the seemingly sacred (but annoying) IBM PC keyboard layout. Although I used the keyboard for only a few minutes, it looks like most of the changes are improvements. Note that the keypad does not double as a numeric keypad; because of this, the keyboard has no Num Lock key. The Start and Pause keys are new, returning extended key codes 133 and 134, respectively. The new Reset key resets the machine, replacing the Ctrl-Alt-Del combination on the IBM PC; it also returns the same key code (83 decimal). Also note the changed positions of the following keys: the 10 function keys, Alt, Caps Lock, the left Shift key, Backspace, the reverse slash key, Ins, Del, Pg Up, Pg Dn, Brk (Break), Scr Lk (scroll lock), Home, End, and the four cursor keys. I particularly like the placement of the

cursor keys in the modified diamond configuration, which is said to be the best cursor-key layout in terms of ergonomics.

Graphics Coprocessor

The graphics coprocessor chip is a VLSI chip that takes the place of about 300 MSI (medium-scale integration) chips. Its main function is *bitblt operations*, movement of *bit-aligned block transfers* within the video-display memory. The Mindset, like most other microcomputers, works on *bit-mapped graphics*, graphics in which the screen is composed of a rectangular array of dots and the dot array is stored in memory as a linear stream of bits, with one or more bits corresponding to one dot. Though the video display is organized as an array of bits, it is stored

(in the case of the Mindset) as a sequence of 16-bit words. An arbitrary array of pixels may be stored as a sequence of partial and whole words scattered throughout memory. To move such an image on the screen, most computers must do complicated (and therefore time-consuming) calculations to locate the words that comprise the image and, when necessary, move only the bits that correspond to part of the image. The Mindset graphics coprocessor does this function in hardware rather than tie up the microprocessor, which would otherwise do it more slowly in software. In addition, the graphics coprocessor can draw arbitrary straight lines as a built-in function. Figure 2 shows how *bitblt* operations can simplify the drawing of a composite three-dimensional image.

How to make your Apple run 3½ times faster.



Just plug in the Accelerator IIe™ and watch your Apple® II, II Plus or IIe take off.

Imagine running VisiCalc®, DB Master®, Applesoft, Apple Fortran or Pascal without long delays. With the Titan Accelerator IIe, your Apple II, II Plus or IIe runs these programs a true 3½ times faster. The Accelerator IIe also runs your Franklin, Basis and other Apple II compatibles 3½ times faster. This faster computer response time means less waiting for you and an increase in your productivity.

This Titan exclusive has its own fast 6502 processor, 64K of high-speed memory, and built-in fast language card. It is transparent to your software and is hardware compatible with most standard peripherals. And you can turn it off from the keyboard to run your Apple at regular speed.

Find out how to run faster and increase your productivity without breathing hard. For information on the Accelerator IIe and other Titan products, see your computer dealer or contact:



 **Titan**
TECHNOLOGIES, INC.

310 West Ann Street, Ann Arbor, MI 48104
Telephone (313) 662-8542

Apple is a registered trademark of Apple Computer Inc.
VisiCalc is a registered trademark of VisiCorp.

DB Master is a registered trademark of Stoneware, Inc.
Accelerator IIe is a trademark of Titan Technologies, Inc.

Sales and Marketing by The MARKETING RESOURCE GROUP, Fountain Valley, CA.

| Combination Mode Number | Data Placed in Destination Area |
|-------------------------|--|
| 0 | source |
| 1 | AND of source and destination |
| 2 | OR of source and destination |
| 3 | XOR (exclusive OR) of source and destination |
| 4 | NOT (inverse) of source |
| 5 | AND of destination and inverted source |
| 6 | OR of destination and inverted source |
| 7 | XOR of destination and inverted source |

Table 3: Block-graphics transfer modes. The graphics coprocessor can transfer a block of graphics in eight different ways, each one substituting a different image for the destination area.

A block-transfer operation has several options, two of which are its *transparent* and *combination* modes. Suppose that an irregularly shaped object is drawn within a rectangle of black and that this rectangle is moved to a new location. If the transparent mode is off, the image will carry its rectangle of black around with it. If transparent is on, only nonzero (non-black) pixels are transferred, and the object appears to be on top of whatever image was at the destination. This gives what I call "virtual sprites"—multicolored shapes that can be placed anywhere quickly but without the size, color, and position limitations associated with sprite-

creating hardware. This simple replacement of destination pixels by source pixels is only one of eight possible combination modes. The source pixel (or its inverse) can either replace the destination pixel or be combined with it using a logical AND, OR, or XOR (exclusive OR) operation; table 3 lists these combinations and their mode numbers.

The graphics coprocessor does its operations from an internal set of microcode. Because it uses internal microcode instead of external machine code, it is very fast. Although this approach is slightly slower than another chip design that hard-wires its functions through its structure, it

leaves Mindset with an interesting future option: by creating a chip with a different set of microcode, it can easily create a new graphics coprocessor chip with new capabilities.

Display Processor

The other custom VLSI chip Mindset created for its computer controls the translation of the video-display memory to some visible image on the monitor or television and other related functions. It specifies what graphics mode is in effect and how the color palette interprets each logical color (pattern stored in memory) as a physical color (shade of color as displayed on the monitor or television). As stated earlier, the Mindset can display up to 16 colors at a time, but, ironically, an RGB monitor does not give you the widest selection of colors. If you use an RGB monitor, you are limited to the 16 colors that can be produced from all 16 combinations of the red, green, blue, and intensity on/off inputs to the monitor. If, however, you are using a composite monitor or television, each of the 16 color palette definitions is defined by a 9-bit number, 3 bits each for the red, green, and blue intensities; this gives a total of 512 possible colors from which to choose.

The display processor maintains the synchronization and timing signals of the video signal, draws the colored border around the active portion of the display, and lets you shift the video image slightly to get the best view of the active display area. It also oversees the refreshing of the video display (every 1/60 second for noninterlaced modes, every 1/30 second for interlaced) and the dynamic RAM used to store the video display.

The display processor must take active control of the bus to read the video-display memory. To minimize the amount of time it does this, the designers included a 16-word buffer that the chip quickly fills, then more slowly empties while creating the actual video display.

Supervisory Processor

The supervisory processor is an Intel 8042 microprocessor that is active as long as the computer is plugged

At a Glance

Name
Mindset Personal Computer

Manufacturer
Mindset Corporation
617 North Mary
Sunnyvale, CA 94086
(408) 737-8555

Dimensions
System Unit—16 by 12.2 by 2.8 inches
Keyboard—16 by 7 by 1.5 inches
Expansion Unit—16 by 12.2 by 2.5 inches

Weight
System Unit—6 pounds
Keyboard—3 pounds
Expansion Unit—7.5 pounds with one disk drive, 11 with two disk drives

Standard Configuration
System Unit plus Expansion Unit—128K bytes of user memory, 32K bytes of screen memory, 64K bytes of system ROM, one 320K-byte 5¼-inch disk drive, keyboard, GW BASIC cartridge; see text for other configurations

Processor
6-MHz Intel 80186 microprocessor (16-bit architecture, 16-bit data bus)

Keyboard
Detached 84-key keyboard with 6-foot coiled cable; has two sockets for optional mouse and/or Atari-style joystick

Hardware Options
Second disk drive, mouse pointing device, 128K bytes of extra memory

Software Options
Mindset MS-DOS 2.0, about \$60

Prices
One-disk system (described above), about \$2000; two-disk system with 256K bytes of memory, about \$2600; cartridge-only system, about \$1200 [prices approximate at time of writing]

Both letter-quality and draft hard copy

Fastest document throughput in its class

Both friction and tractor paper feed

Industry standard serial and parallel interfaces.

Better, more versatile operator controls

TI reliability

Compatibility with third-party and proprietary software

Better, more durable easy-access font modules

Introducing the TI 855 microprinter. No other printer says better so many ways.

Feature for feature, no other microprinter can match the versatility, compatibility, reliability and productivity of the OMNI 800* Model 855 microprinter.

Here's why.
Two Printers In One. With the TI 855 you get the speed of dot matrix draft copy. Plus the precise clarity of the most advanced matrix technology for letter-quality print. It's two printers in one — at one low price.

A Great Family Name. Texas Instruments is known for providing the world with the industry standard for printers — the TI 810. TI builds the same reliability into every 800 series microprinter. Both the 855 and the data processing Model 850 are part of the expanding TI line of high-performance, low-cost microprinters.

Hardware Compatible. The TI 855 microprinter is compatible with all major PC hardware. And it provides both serial RS232C subset and "Centronics-type" parallel as standard interfaces.

Software Compatible. The TI 855 uses industry standard escape sequences for compatibility with virtually all third-party software. And for those with proprietary software needs, a model is available with ANSI standard escape sequences.

Tough Font Modules For Quick Character Change. Three font modules can be inserted into the front of the printer at one time, and are accessed individually. Each contains both draft- and letter-quality character sets. They're easier to use, more reliable and more durable than traditional metal or plastic daisy wheels.

More Productivity Than Any Other Microprinter. The 855 offers both friction and tractor paper feed, to handle all types of word and data processing applications. A quick-change snap-in cartridge ribbon. Raster and mosaic graphics. And intelligent printing which maximizes document throughput — regardless of format.

Get the printer that makes for better information systems. For more information visit your nearest TI authorized dealer or write Texas Instruments Incorporated, P.O. Box 402430, Dept. DPF-082BY, Dallas, TX 75240. Or call toll-free: 1-800-527-3500.



TEXAS INSTRUMENTS

Creating useful products and services for you.

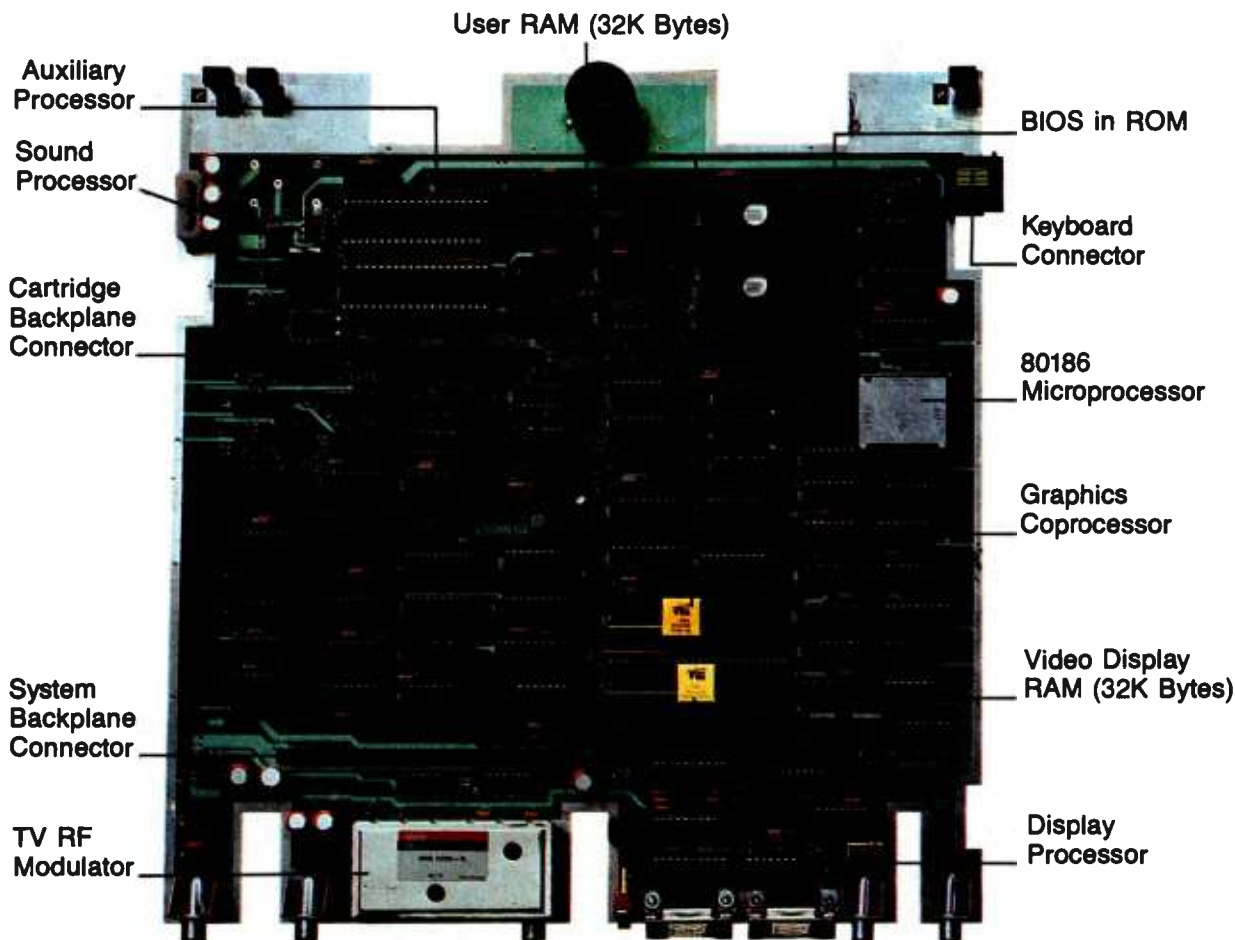

Photo 5: *The Mindset motherboard, which is a completely functional 80186-based computer.*

into an electrical outlet. It implements the Mindset clock/calendar (which is independent from the real-time clock provided for IBM PC compatibility). In addition, it receives and decodes keypresses from the keyboard and monitors "wake-up lines" from the keyboard and all I/O modules (see the section on I/O modules below). The supervisory processor, as well as other major components, can be seen in photo 5.

Cartridges

Mindset has designed three types of cartridges that can be placed into the two slots on the front of the System Unit: a cartridge can contain ROM (for programs or data), RAM (for data or extra memory) with battery backup, or a combination of both. Each cartridge has room for

four 28-pin ICs; compatible ROM or RAM chips can be put in each slot, as long as the total amount of each is a multiple of 4K bytes. The cartridge mates to the System Unit via a 44-pin connector that includes 16 data lines and 15 address lines (see table 4).

The ROM cartridges can hold up to 64K bytes (using 128-kilobit ROMs or EPROMs) or 128K bytes (using 256-kilobit ROMs); later, 128K-byte EPROM (erasable programmable read-only memory) cartridges will be feasible when the cost of 256-kilobit EPROMs goes down. A ROM cartridge can store either data or, more likely, a program to be executed.

The RAM cartridges can hold up to 8K bytes of memory (up to 32K bytes when higher-capacity dynamic-RAM chips become cheaper). The memory

can be used to store data (in sequential-file format) or programs. An internal battery (which is recharging whenever the cartridge is in the computer—a nice touch) keeps the contents of the memory active even when the cartridge is outside the computer; see photo 6. Most Mindset owners will find several uses for such a cartridge. It will also be important to people who buy the diskless \$1200 unit, where it will replace the cassette recorder and tape as the mass-storage medium.

The RAM/ROM cartridge will have half as much of each kind of memory, 4K bytes of RAM, 32K bytes of ROM (or, later, 16K RAM, 64K ROM), and the cartridge will include battery backup for the RAM.

The first four words of every cartridge give information about its con-

X-NET™ Local Area Network Broadens The Horizons Of All IBM PC's.*



X-NET: The affordable LAN that runs MBSI Accounting Software, Database, Electronic Mail and over 1,000 multi-user application packages.

Here are some of the reasons your company needs X-NET Local Area Network:

1. READY ACCESS TO ALL

INFORMATION. With X-NET, any computer can get information from any other computer on the network. This means more than one operator can be entering orders, invoicing, changing inventory ... all at the same time! But where security is needed, you can keep any file private while still within the network.

2. YOU CAN START SMALL ... Even if you have as few as two PC's, you'll have a system that is easily expandable and will grow with your company.

3. ...OR GET BIGGER. X-NET grows as you grow, networks up to 255 PC's, and best of all, expansion is so simple, you can do it yourself.

4. MBSI ACCOUNTING SOFTWARE.

X-NET's software includes Accounts Receivable, General Ledger, Accounts Payable, Order Entry, Inventory Control and Payroll. You can still use your Spread Sheet and Word Processing software, but now much more effectively because your computer power is tied together.

5. MULTI-USER DATABASE PACKAGE.

Now even non-programmers can create network databases (with access security) in minutes.

6. COBOL PROGRAMS. Over a thousand multi-user application programs designed for large computers now run on PC's networked with X-NET.

7. ELECTRONIC MAIL. X-MAIL gives you instant, infallible, confidential mail delivery in-house, and works 24 hours a day and has total recall!

8. AFFORDABILITY. X-NET offers more value for less money to any company doing computing on any level. And the software is priced comparably to what others are charging for no-growth single-user software.

9. NO COSTLY CENTRAL FILE SERVER.

X-NET eliminates the need of having an expensive computer to act as a Central File Server, something other networks require.

10. SHARE YOUR PERIPHERALS. No longer does each of your computers need its own set of peripherals. Any computer on X-NET is linked to your printers, plotters, disk-drives, etc. A huge money-saver!

*X-NET also operates on IBM PC compatibles.

Call your local dealer or XCOMP today.



XCOMP, Inc.
3554 Ruffin Road South
San Diego, CA 92123-2502
619-573-0077
TELEX: 182786

IBM is a registered trademark of International Business Machines Corporation. MBSI is a registered trademark and division of RealWorld Corp. X-NET is a trademark of XCOMP, INC.

© 1984 XCOMP, INC.

| Pin | Name | Function |
|--|---------------|------------------------|
| 1-2,42 | GND | Ground |
| 3,7,5,4,6,8,9,10,17, 15,13,11,14,16,18,20 | bD0-bD15 | Data bits 0-15 |
| 19,21,23,25,27,29,31, 32,30,28,24,12,33,38,37 | bA1-bA15 | Address bits 1-15 |
| 22 | -bSEL1 | Select 1 |
| 25 | -bSEL2 | Select 2 |
| 26 | -bRD | Read |
| 34 | -bWR | Write |
| 36 | not connected | |
| 39-40 | +5 V | +5 volts |
| 41 | -bCPRSNT | Cartridge present |
| 43-44 | TRCKLCHG | +5-volt trickle charge |

Table 4: Signals from the Mindset cartridge connector.



Photo 6: The Mindset RAM cartridge with battery backup. NVRAM stands for "nonvolatile RAM."

figuration. The first word is a cartridge identification number (used to confirm that the cartridge is meant for the Mindset computer). The second word tells whether the cartridge is structured as a sequential file, whether the memory needs to be given a wait state, and whether the cartridge is a master or slave cartridge. The third word tells how much RAM and ROM the cartridge contains. The fourth word is reserved for future use.

I/O Modules

I/O modules are Mindset's answer to the peripheral slots and cards used

in Apple and IBM PC computers—like peripheral cards, they let you add extra capabilities to your computer via add-on hardware, but they are easier to handle and install. The System and Expansion units can each hold three I/O modules, the slots for which are in the rear of the machine (see photo 7a).

The I/O modules connect to either unit through a 36-pin connector that includes eight data lines (all data transfer is done a byte at a time), five address lines, and various control lines (see table 5). One such line is a "wake-up" line. This is a signal that an outside device, through the I/O

module, can give to a Mindset computer that has been turned off. When the computer receives this signal, it turns itself on and begins executing a preset program. The I/O module interface also includes eight lines that constitute a device identification number. Because of this information, I/O modules do not need to be plugged into a certain I/O slot.

At the time this was written, Mindset was planning to announce the following I/O modules: a second-voice sound module (see below), an RS-232C interface, a Centronics-style parallel interface, a presentation-level-protocol (PLP) graphics receiver cartridge (for receiving videotex drawings), and both 300- and 1200-bps (bits per second) direct-connect modems. Both modems take two slots each and handle the HDLC protocol needed to do videotex. Photo 7b shows an opened RS-232C interface module.

Sound Processor

The Mindset sound processor is a simple but effective microprocessor-driven device that operates in four modes and can currently give up to six musical voices. In addition, a second sound processor can be added as an I/O module to create a stereo music synthesizer. Three of the modes give you three, four, and six musical voices, with more control on the modes that generate fewer voices. The fourth mode allows the 80186 to directly control the circuit's D/A (digital-to-analog) converters; this gives maximal control but, of course, ties up the 80186.

GW BASIC and MS-DOS 2.0

The only piece of software included with the Main Unit is a 70K-byte cartridge containing GW BASIC, an extended version of the graphics-oriented GW BASIC from Microsoft. In addition to the graphics commands supported by GW BASIC (which is itself a superset of the MBASIC supplied in most microcomputers), Mindset worked with Microsoft to include additional commands that exploit some of the computer's special graphics capabilities. All graphics commands are written to

The Micro-world's Most Powerful Editor is also the Easiest to Use.

Easy to Use

VEDIT is an exceptionally easy to use, flexible and powerful full-screen editor. Now you can perform word processing quickly and easily, yet have command of editing tools created for the most sophisticated programmer.

VEDIT helps you concentrate on creativity instead of devoting your attention to operating the program.

VEDIT is also forgiving - it allows you to make mistakes or experiment. If you don't like what you've just typed, 'undo' it with a single keystroke.

Need Help? Just press the help key, a summary of commands and your keyboard layout will be displayed. Even include your own help messages.



Powerful

VEDIT - the micro industry's most respected full screen editor - has evolved into a powerful programming language, with the flexibility, performance & features of SPF, TECO and other mainframe editors. The power of its command macro language is virtually limitless. Sophisticated search/replace with pattern matching of multiple strings in multiple files may be executed automatically. You can create a custom macro program to do virtually anything. Translate source code. Format printed output. Convert WordStar files to VEDIT. With a one line command you can selectively strip comments from programs. And macros may be loaded, saved and reused at a later time.

VEDIT is a 'virtual editor' with unlimited and automatic file handling capability - there is no limit to the size of files you can edit. Plus you can change disks at any time.



Other helpful features include a directory display, single key search and selective replace, line and column display, word wrap, adjustable margins, paragraph formatting & print functions, plus the unique ability to completely determine your own keyboard layout.

Acclaimed

VEDIT is highly acclaimed in every major computing journal. Reviewers say VEDIT is 'nothing short of outstanding', and 'the most flexible programming editor I've ever seen'. In InfoWorld's 1983 Report Card of word processing software, VEDIT scored highest of all CP/M-MSDOS word processors/editors reviewed.

VEDIT's Newest Features

- Horizontal Scrolling (Edit Spread Sheets)
- Single Key Search & Selective Replace
- Pattern Matching ● On-Line Help
- Numerical Capability

Expect a lot from VEDIT. While easy to use, VEDIT is specifically designed for complex text manipulations. VEDIT has 10 text registers for extensive 'cut & paste' on multiple files, plus special features for programming in Pascal, PL/1, C, Assembler and other languages.

- True Full Screen Editing
- Automatic Disk Buffering
- Compact (Only 16K) & Fast
- 'Undo' Key to Restore Line
- Automatic Indent/Undent
- Repeat Function Key
- Text Move and Copy
- Load, Save Buffers on Disk
- Powerful Command Macros
- Directory Display

- Insert Another Disk File
- Unlimited File Handling
- Recovery from Full Disk
- Change Disks While Editing
- Word Wrap
- Format Paragraph
- Printing
- 200 Page Indexed Manual
- Startup Command File
- Customizable Keyboard Layout



VEDIT runs on practically every computer, CRT terminal, and memory mapped display made. To order, please specify your computer make, operating system (CP/M, CP/M-86, Concurrent CP/M-86, MSDOS, etc.), and disk format.

VEDIT - Disk and Manual
 8080, Z80 or IBM PC. \$150
 CP/M-86 or MSDOS \$195
 Manual Only. \$18

CP/M is a registered trademark of Digital Research Inc. MSDOS is a trademark of Microsoft. IBM is a trademark of International Business Machines. WordStar is a trademark of MicroPro.

CompuView

PRODUCTS, INC.

Circle 96 on inquiry card.

1955 Pauline Blvd., Ann Arbor, Michigan 48103 (313) 996-1299 Telex - 701821
 Orders: P.O. Box 1349, Ann Arbor, Michigan 48106

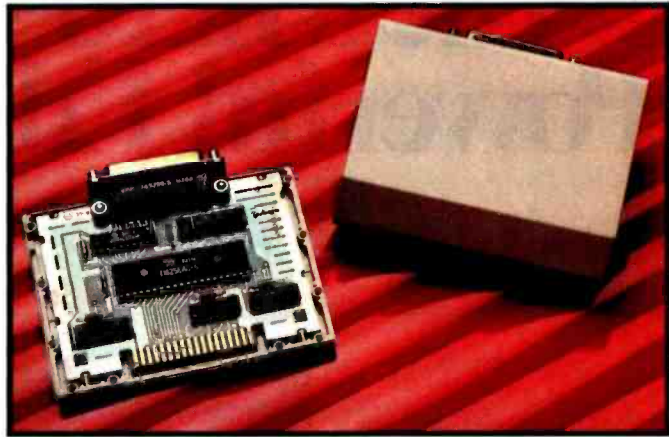
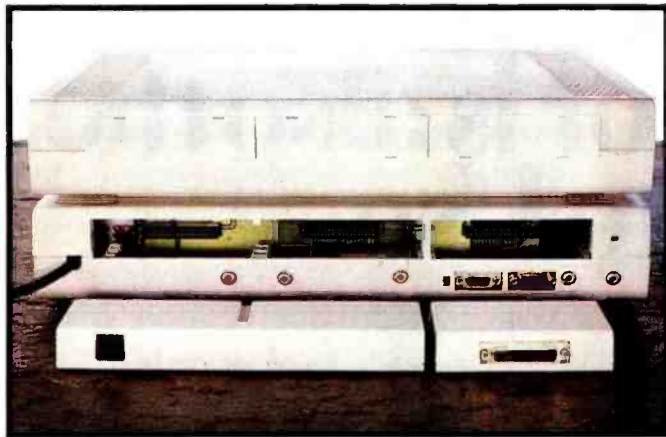

Photo 7: Photo 7a shows the rear panels of the System Unit (bottom) and Expansion Unit (top). Each unit contains connections for three I/O modules. At the bottom left of photo 7a is a modem module (which takes two module slots). The connectors on the bottom rear of the System Unit are, from left to right, audio out, composite video out, RF-modulated video out, channel 3/channel 4 switch, RGB video out, external sync in, auxiliary serial in, and auxiliary serial out. At the bottom right of photo 7a is the RS-232C module; photo 7b shows the same module disassembled.

make best use of the graphics functions available as BIOS calls.

Mindset GW BASIC handles rectangular images and animation as follows. A rectangular image, which I call a *view*, must first be drawn on screen; it can then be saved in a numeric array and, from there, manipulated. You can then create an *object* (which is identified by a number) as a series of one or more views. Then, with one or more GW BASIC statements, you can give the object a starting and ending location on the screen, and you can tell it how fast to move and how often to change from one view to the next. GW BASIC then keeps the image in motion *without supervision by the GW BASIC program* and automatically moves it until it reaches its destination, collides with an object, or moves outside a given rectangular boundary (you can cause a subroutine to execute at this time). In addition, objects can have their motion stopped or resumed or they can be deactivated (frozen in place and made invisible) or activated. See table 6 for a list of Mindset's graphics extensions to GW BASIC.

Mindset MS-DOS 2.0, an implementation of Microsoft's MS-DOS 2.0 tailored to make optimal use of the Mindset hardware and ROM operating system, is, like IBM's DOS, optional and does not come when you buy the Expansion Unit. It comes with an IBM-style book of documentation and will sell for about \$60.

Third-Party Software

The Mindset computer will run dozens of IBM PC programs as is (see the text box "Delineating IBM PC Compatibility" on page 273 for details of incompatibility). Although its internal hardware is very different from that of the IBM PC, the design team iterated the hardware design until a selected group of popular IBM PC products worked on it. I was given a list of 41 products that had been guaranteed to run correctly on the Mindset; among them are Adventure, Word, and Multiplan (Microsoft); Condor Series 20-1 Database; dBASE II and Friday (Ashton-Tate); Deadline, Starcross, Witness, and Zork I-III (Infocom); Lotus 1-2-3; Peachtext 5000 (Peachtree Software); PFS:File, Graph, Report, and Write (Software Publishing Company); PIE Writer (Hayden Software); Spellstar, Wordstar, and Wordstar 3.3 (Micropro); Supercalc 2 and 3 (Sorcim); Visicalc and Visicalc IV (Visicorp). The list is probably longer by now, and Mindset added that "most IBM PC programs" will also run as is on the Mindset computer.

In addition, Mindset has been working closely with software companies to get enhanced products for its computer; at the time that this was written, Mindset said that approximately 25 companies were working on business, educational, personal productivity, and entertainment programs. Parker Brothers, Odesta, and Synapse are working on

games, and Datasoft, Time Arts, and IMSI are working on graphics packages.

The Video Display

Graphics capabilities are at the heart of the Mindset computer, so we will look at them in more detail. As you can see from the memory map in table 7, the video-display memory starts at address B8000 hexadecimal, just as it does in the IBM PC. Whereas the IBM PC maintains 16K bytes of memory for color graphics, the Mindset computer reserves 32K bytes. With Mindset graphics modes that take 16K bytes of memory or less (see table 8), the computer can set up two areas for the video display and, at any given moment, display one of them; this is called *double buffering*. Double-buffered modes let you create glitch-free video graphics: the program alternates between showing the two buffers, always drawing the new image on the buffer not visible.

You will need a special monitor with a high-persistence phosphor to use the two interlaced graphics modes, modes 5 and 6. All the other modes are *noninterlaced*—that is, the entire video image is redrawn every 1/60 second. In the two interlaced modes, the image is drawn in two 1/60-second passes—the first draws all the even scan lines, and the second fills in all the odd scan lines. This means that each scan line is redrawn every 1/30 second. The human eye can detect 30-Hz flickering but not 60

VectorScan 512

Color and Monochrome Graphic Controller Provides High Resolution Graphics on any computer with a RS-232 serial port.

Features Include:

- High Resolution 512 x 480 Pixels x 16 Colors/Intensities.
- Color Lookup Table for each of the possible 16 pixel levels.
- Allows overlay of four independent text and graphic images.
- Non-Interlaced mode allows 8 overlays of text and graphics.
- Rack Mount option (19 inch) is only 1¾ inches in height.
- Parallel input option allows high speed image data transfer.
- Internal Character Generator for Horizontal and Vertical axes.
- Simple ASCII command structure allows system independence.
- Internal Line, Arc, Circle, Point, Programmable Shape and more.
- Extra RS-232 connector allows "Loophrough" operation.
- Internal microprocessor with 8K firmware and 128K video RAM.
- Internal printer port for hardcopy on low cost matrix printers.
- Firmware expandable to 16K, Programmable Shape Table to 3K.
- RGB output is IBM-PC compatible allowing low cost monitors.
- Monochrome output is RS-170 composite video and sync.
- Includes firmware for IDS Color PRISM printers.
- Allows 128K video RAM to be used as a 128K printer spooler.

Applications:

CAD/CAM, Medical, Business, Slide Generation, Industrial Process Control, Laboratory Data Display, Mapping, Meteorological Studies, Graphic Artwork, Typesetting, CRT Strip Chart Recorders, Printed-Circuit Artwork, Educational Graphics, Mathematical Modeling, Engineering, Bulletin Boards.

Computers:

IBM-PC, Apple, Epson, Morrow, North Star, Cromemco S-100, Radio Shack, Heath, DEC, and most others.

Operating Systems:

CPM-80, CPM-86, PC-DOS, MS-DOS, UNIX, OASIS, RT-11

Languages:

BASIC, PASCAL, FORTRAN, PL/1, FORTH, ASSEMBLY

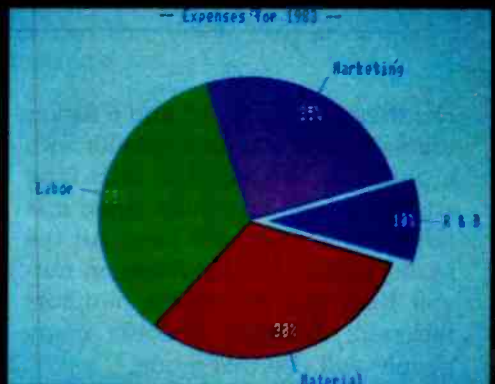
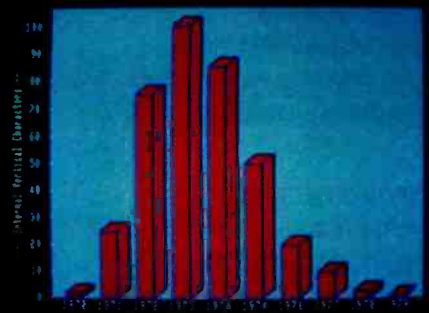
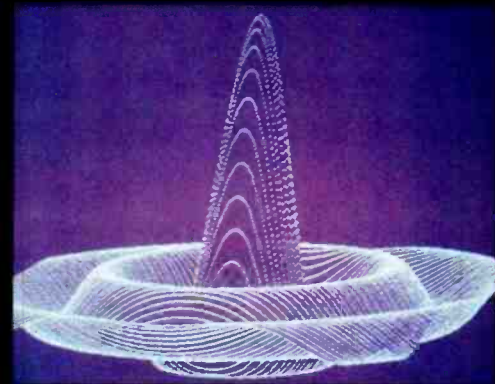

PRICES

| | |
|-----------------------------------|----------|
| VectorScan 512 with 128K RAM | \$975.00 |
| 12 Inch color monitor | CALL |
| Rack Mount Option | \$175.00 |
| Parallel Input Option | \$150.00 |
| Printer Cable | \$ 45.00 |
| Monochrome Monitor with P-39 tube | \$235.00 |
| VectorScan 512 Programmers Manual | \$ 3.00 |

Dealer and OEM discounts available.

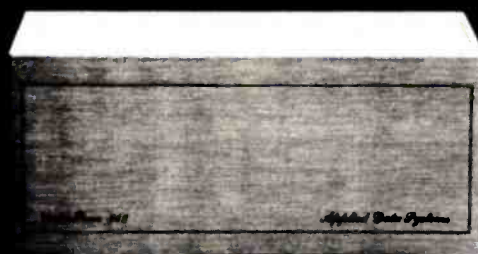

| Pin | Name | Function | Pin | Name | Function |
|-------|----------|-------------------------|-------|-----------|--------------------------|
| 1-2 | GND | Ground | 25 | RESET | Reset |
| 3-4 | + 5 V | + 5 volts | 26 | CLK0 | Clock 0 |
| 5 | + 12 V | + 12 volts | 27 | CLK1 | Clock 1 |
| 6 | - 12 V | - 12 volts | 28 | MODRDY | Module ready |
| 7 | TRCKLCHG | + 5-volt trickle charge | 29 | MODIRQ | Module interrupt request |
| 8 | LRESET | Long reset | 30 | -MODID | Module ID enable |
| 9-16 | D0-D7 | Data bit 0-7 | 31 | -WAKE-UP | Wake-up |
| 17-21 | A1-A5 | Address bit 1-5 | 32 | AUDIO IN | Audio in |
| 22 | -RD | Read | 33 | AUDIO OUT | Audio out |
| 23 | -WR | Write | 34 | SYSCLK | System clock |
| 24 | -MODSELX | Module select x | 35-36 | GND | Ground |

Table 5: Signals from the Mindset I/O module connector.

| BASIC statement | Function |
|-----------------------------------|--|
| DIM OBJECT BALL1(15,20) | Defines BALL as a numeric array large enough to hold a 15- by 20-pixel view |
| DEF OBJECT 3 AS BALL1,BALL2,BALL3 | Defines a numbered object as a series of one or more views |
| OBJECT 3,1 = 10,2 = 50 | Positions object 3 at screen location (10,50); this statement can set any or all of 10 parameters: beginning, ending, and offset X and Y locations, how long each view will be displayed, object transparency, the number of the current view, and the speed of movement |
| SPD = OBJECT(3,10) | Returns the current speed (parameter 10) of object 3 |
| ACTIVATE 2,3,5 | Restores animation of objects 2, 3, and 5 |
| DEACTIVATE 3,4 | Freezes objects 3 and 4 and makes them invisible |
| START 1 | Restores motion to object 1 |
| STOP 1 | Stops all motion in object 1 but leaves it visible |
| COL2 = COLLISION(2) | Determines if object 2 has collided with anything |
| COL23 = COLLISION(2,3) | Determines if objects 2 and 3 have collided with each other |
| ON COLLISION 2,3 GOSUB 20000 | Performs the subroutine at line 20000 if objects 2 and 3 have collided |
| COLLISION ON/OFF/STOP | Resumes, ends, or suspends reporting of object collisions in general |
| CL2 = CLIP(2) | Determines if computer tries to draw object 2 outside the clipping rectangle |
| ON CLIP 2 GOSUB 20000 | Performs the subroutine at line 20000 if computer tries to draw object 2 outside the clipping rectangle |
| CLIP ON/OFF/STOP | Resumes, ends, or suspends reporting of object clipping in general |
| AR23 = ARRIVAL(2) | Determines if object 2 has arrived at its destination |
| ON ARRIVAL 2 GOSUB 20000 | Performs the subroutine at line 20000 if object 2 has arrived at its destination |
| ARRIVAL ON/OFF/STOP | Resumes, ends, or suspends reporting of object arrivals in general |

Table 6: Animation extensions to Mindset GW BASIC.

Hz; therefore, modes 5 and 6 flicker unless you use a special monitor with a phosphor whose glow lasts long enough to still be visible when it is refreshed 1/30 second later. All the mode 5 and 6 images I saw on normal RGB and composite monitors flickered; therefore, I doubt many people will use this mode.

When the system is in a graphics mode, you can make it generate an interrupt at the end of any scan line.

The system defaults to generating this interrupt at the beginning of *vertical blanking*, the time between the drawing of the last line of active video and the first active-video line of the next frame. The vertical-blanking interval lasts about 4 milliseconds (ms) and is used by the system to update the video-display memory while it is not being used for display (to prevent visual glitches from appearing on the screen). The interrupt thus generated

is called the *VBLANK* interrupt. You can modify, replace, or add to the system *VBLANK* interrupt routine, thus allowing you to modify the video display (and do other things) on the fly—that is, while the display is being drawn. (The Atari home computers also use scan-line and *VBLANK* interrupts heavily.)

Also, as you can see from figure 1, the Mindset computer allows several video input and output options. The

AIM HIGH

A NASA space shuttle is shown on the launch pad, oriented vertically. The shuttle is white with black markings, including the word "USA" on the side. At the base of the shuttle, there is a large, intense fire and explosion, suggesting a launch or a test. The background is dark, and the overall scene is dramatic and high-contrast.

Before you work anywhere, take a look at the tools we work with.

NASA's space shuttle. For Air Force officers working as electrical or aerospace engineers, the challenge is just beginning. In fact, from laboratories to lasers to launch pads, we have exciting projects and management opportunities very few employers can offer.

For example, we are developing experiments that will be an important part of the space shuttle's cargo in the years to come. Experienced Air Force engineers will work as shuttle mission planners and as astronaut flight controllers.

If you have an electrical or aerospace engineering degree, or soon will have, we may have a challenging future for you as an Air Force officer. It's a future that demands the vision and commitment of people like you. And it's vital to our country.

For more information about Air Force engineering opportunities, mail the card. Or call toll-free 1-800-423-USAF (in California 1-800-232-USAF). Better yet, send your resume to HRS/RSAANE, Randolph AFB, TX 78150. There's no obligation.

AIR FORCE
A great place for engineers.

| Memory Location (Hexadecimal) | Length in Kilobytes | Function |
|-------------------------------|---------------------|--|
| 0-07FFF | 32 | 32K bytes of on-board RAM |
| 08000-3FFFF | 224 | 224K-byte slot for expansion RAM |
| 40000-7FFFF | 256 | Reserved |
| 80000-8FFFF | 64 | Cartridge slot 1, first half |
| 90000-9FFFF | 64 | Cartridge slot 1, second half |
| A0000-B7FFF | 96 | Reserved |
| B8000-BFFFF | 32 | 32,000 bytes of video-display memory followed by 768 bytes reserved by Mindset for unspecified use |
| C0000-CFFFF | 64 | Cartridge slot 2, first half |
| D0000-DFFFF | 64 | Cartridge slot 2, second half |
| E0000-F7FFF | 96 | Reserved |
| F8000-FFFFF | 32 | 32K bytes for ROM-based operating system |

Table 7: The Mindset memory map.

| Screen Resolution (Pixels) | Number of Colors | Double-Buffering? | Mindset Mode Number | IBM PC Mode Name |
|----------------------------|------------------|-------------------|---------------------|-------------------|
| 160 by 100 | 16 | no | NA | low-resolution |
| 300 by 200 | 2 | yes | 0 | NA |
| 300 by 200 | 4 | yes | 1 | medium-resolution |
| 320 by 200 | 16 | no | 2 | NA |
| 640 by 200 | 2 | yes | 3 | high-resolution |
| 640 by 200 | 4 | no | 4 | NA |
| 320 by 400 (interlaced) | 4 | no | 5 | NA |
| 640 by 400 (interlaced) | 2 | no | 6 | NA |

Table 8: A comparison of IBM PC and Mindset graphics modes. Modes are noninterlaced unless otherwise marked. NA means "not available" for a given computer.

computer has separate output jacks for composite, RGB, and RF-modulated video; these are outputs to a composite monitor, an RGB monitor, and an ordinary television set, respectively. In addition, the Mindset allows the video signal to be driven by an external video synchronization signal. If some colors in the color palette are defined as being keyed to external video, the computer video output can be combined with an external video signal; this allows the external image (from, say, a video camera or laser disk) to replace the area of the display where the keyed color would have appeared.

Bitblt Operations

Bitblts are, as I said before, bit-aligned block transfers—that is, oper-

ations that work on rectangular areas of video-display memory. Also mentioned were the transparent and combination modes that affect bitblt operations. They can also be affected by several other modifiers: the write mask, the collision mask, the clipping rectangle, and the user-defined collision/clip/task-done interrupt routine.

The *write mask* is a 16-bit mask that is consulted whenever a word in the destination area is about to be altered; only bits in the destination word corresponding to bits that are 1 in the write mask can be altered. A write mask of FF hexadecimal allows the bitblt operation to proceed normally (all bits are 1s), while a write mask of 0 forces the computer to make no changes to the destination

area. Other write-mask values can be used to limit or modify the bitblt operation taking place.

The *collision mask* is an n -bit mask (where n is the number of bits needed to represent a pixel in the current graphics mode) that defines what a collision is when a bitblt operation is performed. A collision is said to occur when the logical AND of the destination pattern and the write mask matches the value of the collision mask. (This situation is further modified by a "don't-care" mask that signals a collision when only certain specified bits match.) As noted below, a collision can cause the computer to execute a user-defined interrupt routine.

You can optionally define a *clipping rectangle* with a single BIOS call. Once a clipping rectangle is defined, no bitblt operation can change any area outside that rectangle; *clipping* is said to occur when the graphics coprocessor detects an attempted change outside the clipping rectangle. The clipping rectangle can be used for many things, from the creation of window-based software to protecting nonvideo-display memory from graphics commands.

You can establish which events will cause an interrupt (collision, clipping, the completion of an operation by the graphics coprocessor, or any combination) and specify the address of the interrupt routine. Although one routine must service as many as three conditions, the AH register holds a value that tells the interrupt routine which single condition caused the current interrupt. The interrupt-on-task-done is useful when you remember that the graphics coprocessor can work independently of the 80186. You might use such an interrupt routine to service a queue of graphics tasks, the first of which would be given to the graphics coprocessor as soon as the latter indicates it is free.

Finally, one bitblt operation deals with placing text within a destination buffer. Unlike many computers, the Mindset computer is always in graphics mode, and normally each character would have to draw alphanumeric characters a bit at a time.

Fortunately, the BIOS includes a routine that writes a string to the destination buffer given the string, the character font to be used, and the location and orientation (left, right, up, down) of the string. If you do not use the default font built into the computer, you can define your own—your font can be proportional or fixed-width and can be any number of pixels wide and high. The ability to use any number of character fonts of any size is a very nice feature.

Documentation

The Mindset System Unit will come with the *GW BASIC Reference Manual and Operation Guide for the Mindset Personal Computer*, both in the 3-ring-binder-and-slipcover size and format made popular by IBM PC documentation. The Expansion Unit, Mindset MS-DOS 2.0, and other Mindset products will come with documentation sections to be added to the *Operation Guide*. In addition, Mindset will be offering its Programmer's Reference Library for software developers at a price of about \$70. This will include an 8086 macro assembler on disk, a *Programmer's Reference Guide* (to explain DOS), and a *Technical User's Guide* (to explain the Mindset system). This is a particularly good buy (the macro assembler, if it's any good, is worth double that price) and shows Mindset's commitment to encouraging third-party software.

Distribution, Dealer Training, and Warranty

A spokesperson from Mindset said that it was putting together a network of dealers consisting of "full-service computer retailers," including "major chains" of computer stores. The dealers would also be authorized repair centers. Dealers would receive both in-person and videotape training to sell the Mindset; the spokesperson offered no details on these subjects. The computer's warranty will be for 90 days, including all parts and labor.

Caveats

This product preview was conducted after three days at Mindset

Animation and the Mindset

by the Mindset Design Team

We all know that movies and cartoons are a series of still pictures flashing by to give the illusion of motion. Children still play with the little books that they can "page flip" to produce a few seconds of animated movement. Those little books give a quick idea of the problem of the animator, whether doing cartoons or computer graphics. An hour of action takes 43,200 pictures at an animation rate of 12 frames a second, the minimum acceptable rate. If each image takes 32,000 bytes, we need storage for 1,382,400,000 bytes. Just as a cartoonist would not draw 43,200 images, neither would a computer animator keep more than a gigabyte of images on line. The Mindset contains special hardware that eases the job of animation in real time; these features both simplify and speed up the process. In many ways, it is a fast and enhanced form of cel animation.

Cel animation is a classic technique using sheets of transparent celluloid (called cels) with only part of the image drawn on each cel. As an example, take a simple scene of a dog running past a house. First, the background cel with the house is drawn. Next, a cel with the dog's body is placed over the first cel. Finally, the tail and legs are laid down with the final cel, and the composite cel is photographed. The top two cels are removed, the body laid down again but moved a little over, the new positions of the legs and tail are added, the composite cel is photographed, and so on. Cel animation is detailed and exacting work with a practical limit of about seven cel layers.

The Mindset graphics coprocessor offers all the techniques of cel animation and more. It is a special 16-bit microprocessor with the complexity of an 8086 but optimized to move and manipulate images. Each image is stored as a raster (or pixel array) of whatever size (up to 64K bytes) appropriate for that image. When moving the house, for example, onto the display, you tell the graphics coprocessor the size of the house image (which is, say, 40 by 87 pixels) and the destination area (which is, say, 320 by 200) and which pixel in the destination to move to.

An obvious advantage of the cel is that it overlays only what is painted on it. It is transparent where it is not painted. The

Mindset graphics coprocessor can be told to regard all zero pixels as transparent so that they will not affect the destination raster. If the house is surrounded by zero pixels, it will overlay the scene, just as in cel animation. The Mindset, of course, does not care how many cels overlay a scene. Beyond this, the graphics coprocessor permits all logical bit operations. Also, you can specify the logical NOT of either raster. This leads to many special operations, including bit planes, fade-in and dissolve of images, striping, color changes, etc. Clipping bounds can be specified so that an image can be easily made to disappear through a doorway and a Times Square sign effect is trivial.

A computer display is rewritten every 1/60 second. Changing part of the image will cause flicker if it occurs during the video display. The Mindset provides an interrupt to synchronize writing of the image with the display. There still comes a time when there is more to write than time allows. The Mindset has modes for double buffering of images so that page flipping can be used. At the slowest rate that produces acceptable animation, this gives almost five frames to change the image in the buffer not being shown and then to "flip" the pointer just before the fifth frame.

Power and function are obvious traits of the Mindset, but neither of them are any use if the machine isn't fast. The Mindset architecture has been designed with speed in mind. The graphics coprocessor and the display processor are on a separate graphics bus and have priority access to the video-display memory (the frame buffer). The graphics coprocessor and the 80186 work in parallel as long as the 80186 is not addressing the frame buffer while the graphics coprocessor is trying to run, or as long as the graphics coprocessor is not addressing main memory while the 80186 is. In effect, a lot of the display can be built by the graphics coprocessor while the 80186 is doing other useful things.

The Mindset achieves its animation speed and function through parallel processing and special processors optimized to move and manipulate pixels. Conceptually, it is the next logical step in cel animation and creativity tools.

SOFTWARE GALORE

CP/M-APPLE-IBM-PC-EPSON
Discounts up to 52% on
Software and Hardware

ULTIMATE SELECTION
LARGE INVENTORY
LIGHTNING FAST SERVICE
ROCK BOTTOM PRICES

SOFTWARE GALORE WILL
BUY YOU A SIX MONTH
SUBSCRIPTION TO BYTE.
(LIMITED OFFER)

| | LIST | OUR PRICE |
|--------------------------------|--------|-----------|
| dBase II/D Util/QuickCode | \$1120 | \$ 599 |
| WordStar/dBase II | 1195 | 615 |
| NEW! — SuperCalc III/dBase II | 995 | 599 |
| EasyWriter II/Mail II/Spell II | 650 | 219 |
| IUS-GL/AR/AP | 1785 | 1249 |
| MultiTool-Word w/Mouse | 475 | 339 |
| WordStar Pro Pack/Lotus 1-2-3 | 1190 | 695 |

SOFTWARE

| | |
|---------------------------|-----|
| dBase II | 379 |
| Friday! | 179 |
| Home Acct. Plus | 99 |
| Dow Jones Market Analyzer | 285 |
| Lotus 1-2-3 | 329 |
| WordStar | 239 |
| WordStar ProPack | 389 |
| MultiPlan | 165 |
| Champion GL/AP/AR each | 319 |
| SoftWord MultiMate | 319 |
| Keyboard Template | 15 |
| SuperCalc III | 249 |
| Micro RIM RBase 4000 | 379 |
| PFS:File | 89 |

HARDWARE

| | |
|--------------------------------|------|
| CORONA PC | 2450 |
| Taxan Monitors | 139 |
| NEC APC Mono/Drive | 2198 |
| Hayes-Smartmodem 1200B | 399 |
| Hayes-Smartmodem 1200 | 489 |
| Hayes-Smartmodem 300 | 239 |
| Rana 1000 Drives-Atari | 329 |
| Dynamic Ram (Set 9) | 55 |
| MicroSoft System Card 256K-IBM | 435 |
| Elgar 401 | 596 |
| Corvus 10MB | 2335 |
| Microtek RV611C | 79 |
| Videx Videoterm W/SS | 219 |
| Dumpling GX | 89 |
| Cool&Time Apple Fan | 70 |
| EPS Keyboards-Apple | 269 |

PRINTERS

EPSON * BROTHER * C. ITOM
OKIDATA * STAR * NEC

| | |
|---------------------|------|
| Oki 93 | 725 |
| Juki Letter Quality | 489 |
| NEC 3550 | 1895 |
| Epson FX-100 | 699 |
| Epson FX-80 | 529 |

ACCESSORIES

| | |
|-------------------------------|------|
| Verbatim-Single & Double Side | CALL |
| Flip n'Files | CALL |
| Ribbons | CALL |
| Cables | CALL |

(800) 423-6326

REFERENCES: Dun & Bradstreet.

Security Pacific Bank, Marina Del Rey FDIC, Rockwell Int. *We are a Membership Buying Service. Calif. (213) 827-1851

SOFTWARE GALORE: 4079 Glencoe Ave., Marina Del Rey, CA 90292 — Terms: M/O OK, M/C or VISA add 2%. American Express add 4%. NO C.O.D.'s. \$1.50 Handling and \$5.00 Freight except hardware. Prices subject to change without notice. California residents add 6 1/2% sales tax.

Glossary

bitblt: short for "bit block transfer." The steps required to move an array of pixels from one area in computer memory to another area.

color palette: an array in memory that contains the digital representations of the colors to be displayed on the screen.

frame buffer: the area of memory that contains all the pixels to be displayed on the screen. The frame-buffer size in bytes is determined by the equation

$$\frac{\# \text{ of bits/pixel}}{8} \times \text{pixels per scan line} \times \# \text{ of scan lines}$$

Also referred to as "video-display memory."

object: exists within a raster as a rectangular array of pixels.

pixel: short for "picture element." The smallest element of the display area. Each pixel is represented by a number of bits in memory.

raster: a word-aligned rectangular array of pixels (n words in width by m scan lines in height).

raster op: the operation used to modify pixel values during a bitblt.

scan line: one horizontal display line of pixels on a screen.

v-blank: the amount of time required for the cathode-ray display to retrace from the end of the last scan line in one frame to the start of the first scan line in the next frame (approximately 16 ms).

(less than two months before the product announcement), subsequent telephone calls to its technical people, and study of several technical documents. When I was at Mindset, I saw two breadboarded prototypes (using discrete ICs instead of the custom chips) and one preproduction unit (with custom chips and printed-circuit boards). I did not see GW BASIC. Although I saw several impressive demonstration programs, I saw no commercially available software meant to use Mindset graphics, either from Mindset or third-party vendors. The only documentation I saw was an internal document that will probably be part of the Programmer's Development Library; the document was clear and well organized. My only hands-on experience with the computer was less than an hour with a rudimentary in-house drawing program called Ida.

Commentary

If Apple had put this product out (and done it as well as it did the Macintosh), this computer would have become the next Apple II and dominated the under-\$5000 market. However, a new company like Mindset does not have the industry and consumer recognition of Apple and

IBM, and, for reasons that have nothing to do with product quality, Mindset's computer may not achieve as large a share of the market as it would have as part of an established company and product line.

This product looks solid, and the company has made more right decisions than most new companies. I like the design (enough IBM PC compatibility to be useful plus superior hardware), the custom chips (which demonstrate a significant jump in the performance/price ratio, even more than the Apple Macintosh), and the early and enthusiastic support of third-party software vendors.

My reservations come from the things I didn't see less than two months before the product announcement (documentation, finished software, GW BASIC, and marketing details), the closed-hardware architecture, and the lack of follow-through in developing the potential of the product. The last two points need further elaboration.

By choosing a closed-hardware architecture over an open one (i.e., by deciding to keep hardware details secret), Mindset has forced software developers to create software that will be compatible with future versions of the Mindset hardware. This lets

Mindset make small revisions to its product's hardware and software without having to worry about compatibility problems with existing software and hardware; it also allows the company to create more powerful computers in the future that can be upward compatible with existing Mindset-based software.

On the negative side, the closed-hardware policy prevents the establishment of a large volume of third-party hardware, such as that developed for the Apple II and IBM PC families (a factor that has contributed significantly to their continued success), and forces users to depend on Mindset as the sole vendor of I/O modules. (The one exception to this is that software developers will be told enough to create software cartridges.) In the past, a closed-hardware policy has not prevented companies from reverse-engineering the hardware to make new products, and it has ultimately had a significant negative effect on the popularity of the machine in question. I don't see

any reason why this case should be any different.

By saying that Mindset has not followed through on its product, I am only expressing my opinion that it should do something that it has decided not to (perhaps for no worse reason than lack of resources, a very real limitation). I was far more impressed upon first seeing the Apple Macintosh, even though it and the Mindset are equally important in terms of hardware. This leads me to believe that microcomputers are most effective when they are conceived and implemented with a single unifying vision. Apple did this; Mindset did not. Its vision of creating a powerful, graphics-oriented computer for around \$2000 comes through very strongly. However, by not dealing with the issue of what jobs this computer can uniquely do and creating the appropriate software, the company has caused its computer to stand out less than it deserves to. The unity of Apple's vision (embodied primarily in the

Macintosh's strong software design) ultimately makes its computer more interesting than the Mindset. As it stands, the Mindset is just another computer with more power but no new applications it can be used for; with the right software, it could easily eclipse anything now on the market.

Conclusions

The Mindset sets a new record in the price/performance ratio of a microcomputer, bringing most of the speed and function of a \$50,000 graphics minicomputer to a machine almost 1/20 the cost. If the computer is delivered as described and has a sufficiently high level of IBM compatibility, it promises to be an extremely attractive alternative to the IBM PC that, while paying tribute to a PC-driven market, breaks the hammerlock that PC-compatibility-mania has placed on technical innovation in the microcomputer marketplace. ■

Gregg Williams is a senior technical editor at BYTE.

COMPUTERIZED DATA ACQUISITION AND CONTROL—\$490

NO PROGRAMMING NECESSARY

ANALOG CONNECTION II

(For Apple)

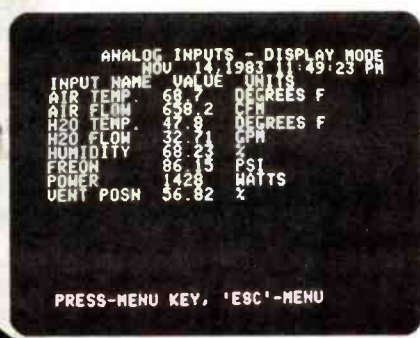
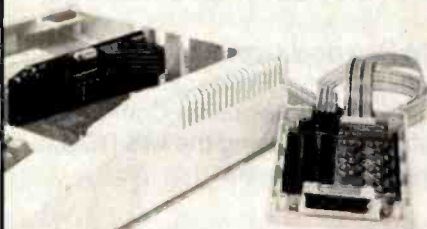

```

H2O LEVEL OFF
LIMIT SW OFF
FAN SW OFF
SPARE SW OFF

NOV 14 1983 12:10:10 PM
PRESENT ANALOG
AIR TEMP 47.8 DEGREES F
H2O TEMP 47.8 DEGREES F
AIR FLOW 658.2 CFM
HUMIDITY 68.35
FREON 84.98 PSI
POWER 1383 WATTS
VENT POSN 59.43

NOV 14 1983 11:00:00 AM
MAX/MIN
AIR TEMP 69.5 68.3
H2O TEMP 73.8 6
AIR FLOW 738.8 0
H2O FLOW 35.32 0
HUMIDITY 69.38 69.91
FREON 98.18 51.57
POWER 1563 259
VENT POSN 78.36 13.92
AVERAGE/NO. SAMPLES
AIR TEMP 68.8 719
H2O TEMP 47.7 719
AIR FLOW 628.4 719
H2O FLOW 29.41 719
HUMIDITY 68.35 719
FREON 84.98 719
POWER 1383 719
VENT POSN 59.43 719

DIGITAL I/O
FAN ON
H2O ON
COMPRES'R ON
VENT MOTR OFF
H2O LEVEL OFF
LIMIT SW OFF
SPARE OFF
SPARE OFF

NOV 14 1983 12:10:10 PM
PRESENT ANALOG
AIR TEMP 47.7 DEGREES F
H2O TEMP 47.8 DEGREES F
AIR FLOW 658.2 CFM
H2O FLOW
  
```



"Real world interfacing is no longer a mystery to me"

Inspector Free Soul

send to:



Strawberry Tree Computers
949 Cascade Dr.
Sunnyvale, Ca. 94087
or Call (408) 736-3083

- **ANALOG INPUTS**
thermocouples
pressure sensors
strain gauges
flow meters
current loops
voltages
currents
potentiometers
- **DIGITAL (CONTROL) OUTPUTS**
relays
solid state relays
anunciators
lamps
LEDs
- **DIGITAL INPUTS**
switches
level sensors
TTL, CMOS

laboratory-process control-engineering-heating
ventilating, and air conditioning-solar energy-chemistry

Setup data logging, process monitoring, process control. In simple menus! Don't spend 100s of hours programming.

The Apple becomes a control panel from which you can monitor ovens, control tests, log data, sound alarms, or control processes. Monitor and control temperature, pressure, flow, strain, or any other parameter. All you do is connect the sensors. Specify the input ranges and engineering units (such as degrees, volts, PSI) in easy to use menus.

Low cost, but high performance: high accuracy, high noise rejection, protected inputs, ten input ranges, 8 to 48 inputs, 8 to 48 digital I/O's. Automatic compensation for 10 different thermocouple types.

Starts at \$490 including the data acquisition and control software. For Apple II, II+, or IIE computer.

Apple is a registered trademark of Apple Computer, Inc.

89.6% chose ScratchPad Plus over Multiplan, Visicalc IV and Supercalc 2.

In a comparison survey, including both computer users and non-computer users, ScratchPad Plus was the spreadsheet of choice.

ScratchPad Plus
89.6%

The group was asked to rate the four spreadsheets on a variety of features, including:

| | |
|---------------------------|-------------------------|
| screen display | virtual memory |
| data entry | quick command summaries |
| cursor movement | long strings |
| multiple window splitting | cell locations |
| | and many other features |

89.6% chose ScratchPad Plus.

Why was ScratchPad Plus chosen by such a wide margin? In some cases it was found ScratchPad Plus' single hand entry was easier to use. Or they preferred the implementation of unlimited window splitting. Or they thought virtual memory, a unique ScratchPad Plus feature, was important to them.

But don't take our word for it. Try the ScratchPad Plus comparison for yourself. Go to your nearest dealer and get some hands-on experience. We want you to see for yourself why so many people prefer ScratchPad Plus.

Retail Price: \$195.00

For a complete copy of our survey results, write SuperSoft, Survey Results, P.O. Box 1628, Champaign, IL 61820.

Available for the IBM Personal Computer, NCR Decision Mate V, Texas Instruments Professional Computer, Rainbow 100, Wang Professional Computer, and other popular microcomputers using the MS DOS, CP/M-86, or CP/M-80 operating systems.

SuperSoft
FIRST IN SOFTWARE TECHNOLOGY

P.O. Box 1628 Champaign, IL 61820 (217) 359-2112 Telex 270365

Japanese Distributor:

ASR Corporation International, TBL Building, 7th Floor, 1-19-9 Toranomon, Minato-Ku, Tokyo 105, Japan. Tel. (03)-5025550, Telex: 222-5650 ASRTYO J.

European Distributor:

SuperSoft International Ltd., 51 The Pantiles, Tunbridge Wells, Kent, England TN2 5TE. Tel. 0892-45433. Telex: 95441 Micro-G.

All Others
10.4%

Decision Mate V is a registered trademark of NCR Corporation
Texas Instruments Professional Computer is a registered trademark of Texas Instruments, Inc.

IBM Personal Computer is a registered trademark of International Business Machines, Inc.

Rainbow 100 is a registered trademark of Digital Equipment Corporation
Wang Professional Computer is a registered trademark of Wang Laboratories, Inc.

MS DOS and Multiplan are registered trademarks of Microsoft Corporation

Visicalc IV is a registered trademark of VisiCorp.

Supercalc 2 is a registered trademark of Sorcim Corp.

DAX PLUS.

The data base manager that understands you.

Data base management used to be the source of endless frustrations. Secretaries, executives, and even programmers were forever having trouble understanding the data base and getting it to do what they wanted. Doing something new could take ages.

No longer. DAX PLUS has uncomplicated data base management on microcomputers.

The heart of DAX PLUS is its unique Inquiry Processor which understands commands written in your language, English. It's a snap to produce reports, add data, change file structure, or whatever you want. Spontaneous reports with endless variations can be produced almost instantaneously. It's like having "what if" available in your data base. An example inquiry might be:

sort staff by surname with salary greater than 5000 dollars show surname break-on age & total salary showing the heading

"SAMPLE REPORT --DATED: \$ Page: #"



From idea to report in two minutes, fifteen seconds.

The report produced by DAX PLUS was formatted automatically and includes the heading shown above, the current date and the page number at the top of each page. Using DAX PLUS, this report could be produced by a beginner in less than three minutes. Producing a similar report using most other popular data base managers would be a major undertaking.

Listed below are some features of DAX PLUS which are not found in dBASE II,* another data base manager for microcomputers:

| FEATURE | DAX PLUS | dBASE II |
|---|----------|----------|
| English language inquiry processor | YES | NO |
| User may easily design the layout of data input forms | YES | NO |
| A time data type allows calculations to be performed on hours and minutes—this is invaluable to time cost applications. | YES | NO |
| Automatic report generator eliminates the need to manually format each report | YES | NO |
| Full data entry validations includes case conversion, range checking, and pattern matching | YES | NO |
| Extensive on-line help is available | YES | NO |
| Menu or English language command driven | YES | NO |
| User may define new command vocabulary | YES | NO |
| Simple mail-merge facilities | YES | NO |
| Simple file structure allows easy access to data | YES | NO |
| Calculations may be included in an English inquiry | YES | NO |

RBP

To further simplify things for the end user, DAX PLUS has a special feature called RBP which allows a series of inquiries to be processed together. This means complicated applications can be easily operated by an inexperienced user with a few simple commands.

DAX PLUS also contains a file conversion utility which converts your old dBASE II files to DAX PLUS files fast.

Simplify your data management work with DAX PLUS, the data manager that understands your language, is dramatically faster and is simpler to use. See your local computer dealer or write SuperSoft, P.O. Box 1628, Champaign, IL 61820.

DAX PLUS: \$549.00
DAX PLUS with VoiceDrive: \$649.00
Available for MS DOS, PC DOS, and CP/M

SuperSoft®

FIRST IN SOFTWARE TECHNOLOGY P.O. Box 1628 Champaign, IL 61820 (217) 359-2112 Telex 270365

*dBASE II is a registered trademark of Ashton-Tate

SuperSoft Language Library

For PC DOS®, MS DOS,
CP/M-86®, and others

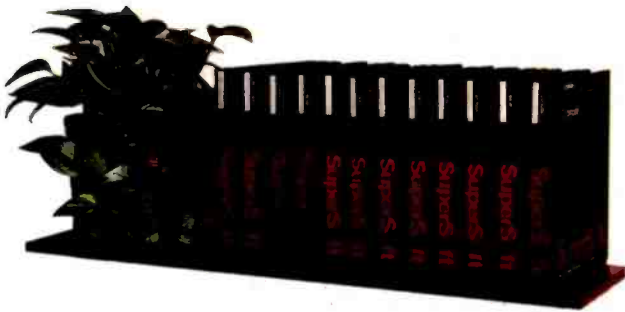

A programmer's most important software tool is the language compiler or interpreter he uses. He has to depend on it to work and work well.

At SuperSoft, we believe it. That's why we offer three fine compilers: SuperSoft FORTRAN, SuperSoft BASIC, and SuperSoft C, that answer the programmer's need for rock solid, dependable performance on 16 bit systems.



BASIC COMPILER

Compatible with Microsoft BASIC

The SuperSoft BASIC compiler, available under CP/M-86 and MS DOS, is compatible with Microsoft* BASIC and follows the ANSI standard.

Greater accuracy with BCD math routines

If you have used other languages without BCD math, you know how disconcerting decimal round off errors can be. For example:

With IBM PC*
BASIC

```
10 A=.99
20 PRINT A
30 END
Output: .9899999
```

With SuperSoft
BASIC with
BCD math

```
10 A=.99
20 PRINT A
30 END
Output: .99
```

As you can see, SuperSoft BASIC with BCD provides greater assurance in applications where accuracy is critical.

SuperSoft's BASIC is a true native code compiler, not an intermediate code interpreter. It is a superset of standard BASIC, supporting numerous extensions to the language. Important features include:

- Four variable types: Integer, String, and Single and Double Precision Floating Point (13 digit)
- Full PRINT USING for formatted output
- Long variable names
- Error trapping
- Matrices with up to 32 dimensions
- Boolean operators OR, AND, NOT, XOR, EQV, IMP
- Supports random and sequential disk files with a complete set of file manipulation statements
- IEEE floating point available soon as an option
- No run time license fee

Requires: 128K memory
BASIC compiler: \$300.00

For CP/M-86®, MS DOS, and PC DOS

*SuperSoft BASIC is compatible with Microsoft BASIC interpreter and IBM PC BASIC. Due to version differences and inherent differences in compilers and interpreters some minor variations may be found. Machine dependent commands may not be supported. The vast majority of programs will run with no changes.

FORTRAN

C Compiler

SuperSoft FORTRAN is the answer to the growing need for a high quality FORTRAN compiler running under CP/M-86 and IBM PC DOS. It has major advantages over other FORTRAN compilers for the 8086. For example, consider the benchmark program used to test the IBM FORTRAN in *InfoWorld*, p. 44, Oct. 25, 1982. (While the differential listed will not be the same for all benchmark programs, we feel it is a good indication of the quality of our compiler.) Results are as follows:

| | |
|--------------------------|--------------|
| IBM FORTRAN: | 38.0 Seconds |
| SuperSoft FORTRAN | 2.8 Seconds |

In its first release SuperSoft FORTRAN offers the following outstanding features:

1. Full ANSI 66 standard FORTRAN with important extensions
2. Standard data types, double precision, varying string length, complex numbers
3. Free format input and free format string output
4. Compact object code and run time support
5. Special functions include string functions, dynamic allocation, time/date, and video access
6. Debug support: subscript checking, good runtime messages
7. Full IEEE floating point
8. Full 8087 support available as option (\$50.00).
9. Ratfor preprocessor available as option (\$100.00).

Program developers:

SuperSoft's family of FORTRAN compilers means you can write your programs once and they will run under CP/M-80, CP/M-86, and MS DOS. This lets you get your applications running fast no matter what the environment.

SuperSoft FORTRAN: available NOW and working great!

Requires: 128K with CP/M-86 or MS DOS,
32K with CP/M-80
FORTRAN: \$425.00 (in each environment)
8087 Support: \$ 50.00
Ratfor: \$100.00

For CP/M-86®, MS DOS, IBM PC DOS®, and CP/M-80®

In conjunction with SuperSoft, SuperSoft FORTRAN was developed by Small Systems Services, Urbana, IL, a leader in FORTRAN development.

Japanese Distributor:
ASR Corporation International, TBL Building, 7th Floor,
1-19-9 Toranomon, Minato-Ku, Tokyo 105, Japan
Tel (03)-5025550, Telex 222-5650 ASRTYO J

European Distributor:
SuperSoft International Ltd., 51 The Pantiles,
Tunbridge Wells, Kent, England TN2 5TE
Tel 0892-45433 Telex 95441 Micro-G

In 1982 SuperSoft helped C programmers around the world move their applications from 8 to 16 bit operating systems with the first C compiler under CP/M-86®, PC DOS, and MS DOS.

Today there are several C compilers on the market, and you can look at them all. But if you want a C that's fully portable, syntactically compatible with UNIX version 7 C, rigorously tested, fast in both compilation and execution, packed with more library functions than any other, and produces a very highly optimized assembly code... then you'll find only one. The SuperSoft C compiler.

Professional Quality

SuperSoft started working on C over three years ago, and the work has never stopped. While others were struggling to put in features, SuperSoft was refining and polishing... adding the quality professionals depend on.

Thoroughly Tested

SuperSoft C has been tested with hundred of commercial application programs. And all this testing has paid off... with a compiler that's highly reliable in every phase of operation.

Portable

SuperSoft C is now available in most operating system environments. Since we don't sell operating systems, we can support them all. And as new operating systems become popular, SuperSoft C will be there.

Packed with Library Functions

SuperSoft now has the most complete set of library functions available. All provided with source code.

Thorough User Manual

The new user manual is extensive—jammed with thorough explanations to help you every step of the way. And our technical hotline can help answer any additional questions.

SuperSoft C: \$350.00

SuperSoft

FIRST IN SOFTWARE TECHNOLOGY

P.O. Box 1628 Champaign, IL 61820
(217) 359-2112 Telex 270365

Microsoft is a trademark of Microsoft Corporation
IBM PC is a trademark of International Business Machines Corporation
CP/M and CP/M-86 are registered trademarks of Digital Research
UNIX is a trademark of Bell Laboratories

Is BASIC Getting Better?

The language that made early microcomputers accessible is maturing to match the sophistication of a new generation of hardware

G. Michael Vose

BYTE Senior Technical Editor

BASIC is as comfortable as an old pair of jeans to those renegades who learned programming on microcomputers. On many early microcomputers, BASIC was more than a language—it was also the operating system of the machine, the interface between the electronics inside the beast and the gawk-eyed neophyte at the keyboard.

Learning to program in BASIC was thrilling. The first time you printed out your name 100 times with the help of a FOR...NEXT loop you experienced a rush comparable to serving an ace on the tennis court or hitting a 280-yard tee shot. Figuring out a sorting algorithm was akin to getting an A on an algebra final or getting a kiss from your first sweetheart.

In the last eight years, microcomputers have grown up, matured from 1K- and 2K-byte user memory, cassette-based novelties into 256K-byte, 16-bit microprocessor-based powerhouses. The language of microcomputers has evolved, too, through Pascal and FORTH, to C and Modula-2. BASIC hasn't stood still in the intervening years—the text box "A

OUTPUT

```
BASIC is
as comfortable as
an old pair of jeans
to those renegades who learned
about programming on microcom-
puters.
```

IS BASIC GETTING BETTER?
by G. Michael Vose

Source Code

```
. list 170-
170 PRINT:PRINT:PRINT
180 PRINT " BASIC is"
190 PRINT " as comfortable as"
200 PRINT " an old pair of jeans"
210 PRINT " to those renegades who learn
ed"
220 PRINT " about programming on microco
p-"
230 PRINT " puters."
240 SELECT 4
-
```

BASIC-09

Professional BASIC

Macintosh BASIC

Better BASIC

True BASIC

Brief History of Microsoft Basic" chronicles the evolution of Microsoft BASIC (MBASIC), the de facto industry standard for BASIC since its creation in 1974.

But is it fair to ask in 1984, a watershed year in the history of the information age, is BASIC getting any better? Has the language kept up with the needs of the programmers who use it? Has it kept pace with the Wizard of Oz machines it runs on?

The following pages will describe several significant new developments on the BASIC frontier. BYTE presents a look at five recent versions of BASIC that purport to improve on the Microsoft standard. These examinations are not reviews—three of the products have not been released as of this writing—nor do they compare the BASICs in question to one another. Instead, we offer descriptions of these new BASICs with an eye toward answering the question headlined above—is BASIC getting better?

These products collectively show several important trends for BASIC, including: a move away from interpreters to compilers; an emphasis on built-in program-development tools; and, in the newest products, a multiple-window environment for creating programs, offering the ability to view source code and its output simultaneously.

Interestingly, the new BASICs recognize the need for an interactive environment for BASIC (that's part of

what makes BASIC attractive as a tool for learning to program computers) and they avoid traditional compilers. A new class of compiler, the incremental compiler, has found favor among BASIC's recent innovators. This compiler permits the simulation of interactivity, provides another level of error checking, and would, by itself, be a significant improvement to BASIC.

But the new BASICs provide even more: user-defined procedures and functions, called by name; named subroutines; unlimited variable and label names; alternate screens for looking at source code, providing variable cross-reference tables, and examining output; and support of large user memory, math-coprocessors, and sophisticated graphics.

The first of the BASICs we'll look at is BetterBASIC, a product from a Massachusetts-based start-up firm called Summit Software Technology. Next, Scot Kamins examines the new Macintosh BASIC, a language developed to take advantage of the powerful new Apple computer (see "The Apple Macintosh Computer," by Gregg Williams, February 1984, page 30). Then, Don George investigates Professional BASIC from Morgan Computing Company Inc., of Dallas, Texas. On page 344, Brian Capouch explores the BASIC-09 language that runs on MC6809 microprocessor-based machines using the OS-9 operating system.

The recent announcement of a new version of BASIC by a company founded by BASIC's original authors, John Kemeny and Thomas Kurtz, prompts the text box "True BASIC" on page 300. Little concrete information was available about this product at the time of this report, and the claims of the text box's author, Brig Elliott (vice-president of True BASIC Inc.), could not be verified. But this announcement warrants attention because of the reputation of the principals involved in the effort.

The evolution of a standard for the BASIC language is mired in the complicated bureaucratic process required by the American National Standards Institute (ANSI). While a standard has been proposed, there is a lesson to be learned from the innovation that has been taking place in the absence of a standard: new products try to emulate what the market has determined to be a standard. In the case of BASIC, that standard is the Microsoft version. The following pages will show that you can improve on a standard while not getting too far away from it. ■

G. Michael Vose is features editor for BYTE. He can be reached at POB 372, Hancock, NH 03449.

A Brief History of Microsoft BASIC

Microsoft BASIC (MBASIC) is an industry standard for BASIC languages simply because it was the first—and for many years the only—version of BASIC available for microcomputers. MBASIC introduced a new generation of programmers to the esoteric art of writing instructions for computers.

The first microcomputer BASIC interpreter was written in 1974 by Paul Allen and Bill Gates on a PDP-8 minicomputer for an Intel 8080 microprocessor emulator. This project was an outgrowth of college work in computer science and freelance programming activity, and it explored the feasibility of producing a language product for the then new devices being marketed by Micro Instrumentation and Telemetry Systems (MITS). These machines were called microcomputers, the first of which was named the Altair 8800. This early BASIC interpreter required 4K bytes of RAM (random-access read/write memory) and was crude by today's standards.

MITS licensed the Gates/Allen BASIC for the Altair in late 1975, and Microsoft was born. By the end of 1976, over 10,000 Altairs had been sold with either the 4K-byte or the 8K-byte MBASIC. The fledgling company's work on an expanded version of the language using 8K bytes of RAM was spurred by a new machine under development by the office-machine company, Commodore Ltd. The Commodore PET debuted in mid-1976 with a licensed version of the 8K-byte MBASIC. Commodore's license was long-term and permitted alterations to the code supplied by Microsoft. Commodore has since modified this early version of 8K-byte MBASIC to produce its own versions of PET, VIC-20, and C-64 BASIC rather than going back to Microsoft for upgrades.

This early version of 8K-byte MBASIC is commonly referred to as version 2.0, the 4K-byte version is 1.0. In early 1978, Microsoft sold a license to Tandy Corporation for the TRS-80 Model I. This machine initially used a BASIC written in house, called Level I BASIC, a limited product that soon gave way to Level II, or MBASIC version 2.0. At the same time, the company

licensed version 2.0 to another recent entry into the computer business, a West Coast-based garage operation dubbed Apple Computer Inc.

By early 1979, a new version of the language was under development. Version 3.0 of MBASIC provided extended functions for program development (TRACE, AUTO, etc.) plus graphics and sound commands. These enhancements were made to comply with the requests of potential new licensees who wanted software that showed off the newest hardware capabilities.

Microsoft claims an installed base of two million; Digital Research claims a like amount for CP/M.

On the heels of version 3.0 came a version of MBASIC that supported floppy-disk drives. Known in house as version 4.0, the rest of the world called it Disk BASIC and its popularity spread quickly.

Late 1980 brought IBM and Microsoft together, an event that catapulted Microsoft into a leadership position in the microcomputer-software industry. Working with Seattle Computer, Microsoft created version 5.0, or GW (Gee Whiz) BASIC. Version 5.0, finally released in late 1981, was designed to take advantage of 16-bit processor environments and added many enhancements for sophisticated color graphics, windows and ports, music, softkeys, and other features.

Microsoft claims an installed base of 2 million machines licensed to run the various versions of its BASIC interpreter. This claim is conservative at best. Digital Research, Microsoft's major competitor in operating systems and language products, claims a like number of CP/M installations. It is likely that there are a substantial number of machines running MBASIC that don't use CP/M but that there are a much lower number for the reverse case.

True BASIC

Brig Elliott
True BASIC Inc.

Twenty years after inventing the BASIC language, Professors John G. Kemeny and Thomas E. Kurtz have teamed up again to develop a powerful and portable version of the new ANSI American National Standard BASIC. (For information on the proposed standard for the BASIC language, see "On the Way to Standard BASIC" by Thomas Kurtz, June 1982 BYTE, page 182, and "The Proposed ANSI BASIC Standard," by Ronald Anderson, February 1983 BYTE, page 194.)

Kemeny and Kurtz have started True BASIC Inc., and the company's first major product is a new version of the BASIC computer language called, appropriately, True BASIC. True BASIC's design goals are portability, power, ease of use, and speed.

The initial version of True BASIC will run on the IBM PC and PCjr, but its implementors will produce versions for other major microcomputers during the coming year. They estimate a three-month conversion process for each new machine.

The True BASIC system consists of a modern version of BASIC with good control structures, graphics, and file handling; an integrated screen editor; and helpful utility programs such as formatters and variable cross-reference generators.

The True BASIC Language

The True BASIC language is based on the proposed ANSI American National Standard, which has been in preparation since 1974. Tom Kurtz, a founder of True BASIC Inc., was chairman of the ANSI committee defining BASIC during this time. True BASIC has slimmed down the language from the proposed standard by removing clutter and features few programmers use but it has kept and enhanced the powerful core of the language.

In a nutshell, the True BASIC language has all the convenience of older BASICs, but has added many features to let programmers build large, complicated programs. These features include modern control structures, machine-independent raster graphics, separately compiled functions and procedures, error trapping, several types of files, double-precision floating-

nection can support as many as 48 analog inputs and 48 digital I/O lines.

Options include a battery-backed clock and a terminal box with cold-junction com-

pensation for thermocouples. Prices start at \$490. Contact Strawberry Tree Computers, 949 Cascade Dr., Sunnyvale, CA 94087, (408) 736-3083. Circle 601 on inquiry card.

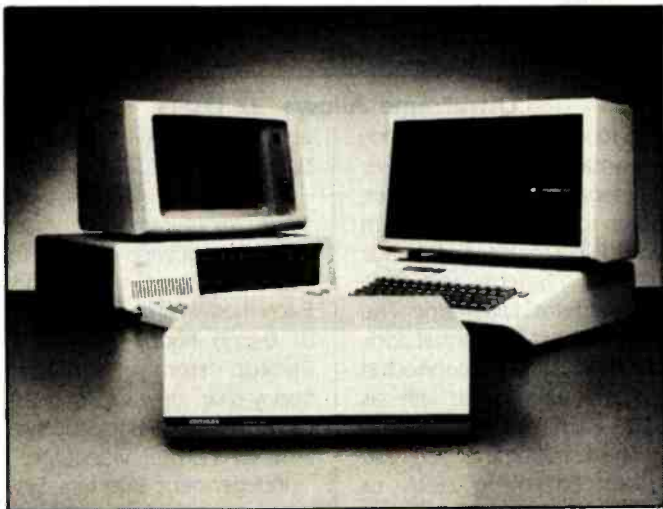

Workstations Provide Data Acquisition and Control

Keithley DAS Series 500 workstation measurement and control systems are compatible with Apple and IBM computers. The Series 500 can accept up to 10 expansion modules for analog, digital, and control functions. Its total capacity is 272 analog inputs, 50 analog outputs, 160 digital inputs or outputs, or 160 channels of AC or DC power control. The system is supplied with Soft500, an extension of BASIC for measurement and control applications. A real-time clock/calendar and three precision interval timers are standard.

Three preconfigured systems are available: the 510, 520, and 530. Designed for basic analog input and high-speed digitization, the Series 510 comes with a 12-bit A/D converter and provides 16 channels of single-ended input or 8 channels of differential, user-selectable by means of on-board DIP

switches. Global signal conditioning for all analog channels and a 25-microsecond A/D conversion time are featured.

The Series 520, an extension of the 510, has 5 independent high-speed 12-bit D/A converters and 16 channels of optoisolated TTL-compatible digital I/O. Its power-control module allows direct switching of four AC power channels. The 530 provides 14-bit A/D conversion, two channels of 16-bit analog output, a 35-microsecond conversion time, and two channels of independent transient-free 16-bit A/D conversion.

Series 500 prices range from \$2100 to \$5500. Expansion modules begin at \$250. For details on options and technical or ordering information, contact Keithley DAS, 349 Congress St., Boston, MA 02210, (617) 423-7780. Circle 602 on inquiry card.

Card/Software Turn IBM Into Logic Analyzer

Total Logic Corporation's LA-200 provides the necessary hardware and software for transforming an IBM PC or PC XT into a logic analyzer. System hardware is made up of a plug-in card, test cables, and a color-coded probe pod. The data path is 32 bits wide, and the memory depth is 1024 data words. When used with the IBM's clock, the LA-200 operates synchronously or asynchronously at rates up to 15 MHz. Six hardware clock qualifiers allow flexibility in selecting data points of interest in complex multiplexing applications. A sequential trigger mechanism lets you choose a variety of options, including one to eight sequential triggers for starting or ending a data trace. Multiple start/stop conditions can be created by using triggers. Captured data can be displayed in a variety of formats, including timing diagrams and binary, hexadecimal, octal, and ASCII codes.

LA-200 software gives you a menu from which to choose analyzer functions. Functions include setup, data collection, data display, data printing, data comparisons, and a data and setup parameter storage function. Full-screen editing and setup defaults are standard.

The LA-200 requires a 64K-byte IBM PC or PC XT with a single disk drive. It costs \$1950 and is available from Total Logic Corp., Suite 110, 343 West Drake, Fort Collins, CO 80526, (303) 226-5980. Circle 603 on inquiry card.

SYSTEMS

Vector 4-S Reads IBM Soft-Sector Disks

The Vector 4-S microcomputer is an 8/16-bit machine capable of reading IBM Per-

sonal Computer, PC XT, and other soft-sectored floppy disks. Its floppy-disk drive is said to automatically detect the nature of the disk being used and whether the disk was created under MS-DOS or CP/M-86. Single- or double-density 8- and 9-sectored 48- or 96-tpi disks can be read.

The 4-S comes with CP/M-86, 128K bytes of RAM, GSX-86 Graphics, an 8-bit Microsoft BASIC interpreter, and an 8-bit CP/M simulator. A detached keyboard, a green-phosphor display, two modified S-100 expansion slots, a tone generator, an RS-232C communications port, and one serial and two parallel ports complete the 4-S unit. Options include MS-DOS, an external color monitor, up to 256K bytes of RAM, and a communications board and software providing IBM 2770, 2780, 3741, 3780, and 3270 protocol emulation and access to remote mainframes.

The single-user 4-S is available with one or two floppy-disk drives or one floppy drive and a 5-, 10-, or 36-megabyte hard-disk drive. Prices range from \$3295 to \$9995. For further details, contact Vector Graphic Inc., 500 North Venture Park Rd., Thousand Oaks, CA 91320, (805) 499-5831. Circle 610 on inquiry card.

Single-Board Computer Runs Multiuser DOSes

Heurikon Corporation's MLZ-92A, a Multibus-based single-board computer, can run multiuser operating systems without the need for additional expansion cards. Targeted at systems integrators, the MLZ-92A has an 8-MHz Z80A microprocessor; VLSI technology provides up to 128K bytes of parity-protected DRAM capable of accommodating two or three users. This board can access up to 1 megabyte

What's New?

through its 20-bit memory-mapped Multibus interface. Off-card I/O can be accessed through its I/O map. The MLZ-92A communicates with the Multibus as the master, as a slave, or in a multimaster mode.

Four RS-232C serial ports, two of which are configurable for RS-422 operation, an on-board disk interface, and a streaming-tape interface are standard. All drive ports are set up for an on-board DMA to allow rapid data transfers.

A floppy-disk controller for either 5¼- or 8-inch drives is optionally available. Four counter/timers, user-definable DIP switches and LEDs, dual ROM sockets, 9511/9512 mathematics chip, and CP/M can be obtained. The base price for the MLZ-92A is \$1695. For complete specifications and ordering details, contact Heurikon Corp., 3001 Latham Dr., Madison, WI 53713, (800) 356-9602; (608) 271-8700. Circle 614 on inquiry card.



Ultraframe Allows 32 Users

A modular design permitting expansion from a single-user 10-megabyte business computer to a multiuser system with 110 megabytes of storage highlights Independent Business Systems' Ultraframe. The manufacturer asserts that additional users can be connected to Ultraframe for as little as \$598 each, plus terminal.

The Ultraframe is an S-100 system employing Z80A- or 80186-based single-board computers for multiple operators. When fully loaded, it provides more than 2 megabytes of RAM to as many as 32 users. A master Z80A handles disk and printer access, while each user works with a dedicated processor and RAM. Its operating systems are TurboDOS

and IBS p-Net, which is compatible with UCSD Pascal.

Versions are available with 5-, 8-, or 14-inch Winchester hard disks offering from 10 to 145 megabytes of storage. Each model carries either 5¼- or 8-inch floppy-disk drives. Backup storage includes floppy-disk drives, 3M cartridge, or the IBS Backstop system, which uses videotape.

Independent Business Systems markets its products through systems integrators and OEM outlets. Full specifications and details on Ultraframe configurations can be obtained from Independent Business Systems Inc., 5915 Graham Court, Livermore, CA 94550, (415) 443-3131.

Circle 609 on inquiry card.



MC68000 Trainer Is for School and Industry

The Micro 68000ECB Micro-computer Trainer, a self-contained 16-bit MC68000 computer from Computer System Associates, is intended for training and educational use, including college-level courses and industrial in-plant training. This single-board computer comes with a 4-MHz MC68000ECB processor, a 6-amp switching power supply, a base plate, a Centronics-compatible parallel printer port, a cassette-tape serial I/O port, and a back plate that allows easy access to a pair of serial RS-232C ports. It contains 32K bytes of dynamic RAM, a 24-bit programmable timer,

and a wire-wrap area for custom circuitry. A resident firmware package gives you a programming and operating environment and monitor, debugger, and disassembly/assembly functions.

The Micro 68000ECB comes in a hardwood and dark plastic see-through case. A briefcase to transport it is optional. The price is \$985. A similar version with a hexadecimal keyboard and display lists for \$1495. Contact Computer System Associates Inc., 7562 Trade St., San Diego, CA 92121, (619) 566-3911.

Circle 612 on inquiry card.

Multuser Micro for Business Environment

Digitex has introduced the Quadradisk 6000, a series of multidisk, multiuser microcomputers designed for business and professional environments. Quadradisk has an S-100 bus, a 6-MHz Z80B processor, floppy-disk controller, 128K bytes of RAM, two serial ports, and a Centronics parallel port. Expansion to 4, 8, or 12 users is available with up to 896K bytes of memory. A cache-like virtual disk improves performance and can be expanded from 128K by employing unused user memory. A removable 5¼-inch 5-megabyte cartridge is offered

in combination with a 1-megabyte floppy disk and 5-, 15-, 25-, or 40-megabyte Winchester drives. Up to four drives can fit into this desktop unit, and five slots provide space for other boards. Full-function displays and a complement of printers are offered.

System software includes Dataplus, a compiler and interpreter that allows operation of programs originally written for Datapoint computers. Quadradisk will operate under Oasis, CP/M, or TurboDOS. It can communicate with other microcomputers, Datapoint

What's New?

systems with bisync or async file send and receive, and IBM mainframes with IBM 2780/3780 bisync protocols. Vertical market application packages tailor the Quadradisk to office needs.

Retail prices start at \$6160 for a 16-megabyte multiuser system with 128K bytes of RAM and one parallel and two serial ports. For further information, contact Digitex, 2044 Armacost Ave., Los Angeles, CA 90025, (800) 345-4839; in California, (213) 826-4500. Circle 616 on inquiry card.



256K for Printer Spooling or RAM Disk

Companion Computers' CP/M 2.2 Companion adds the CP/M operating system and 256K bytes of storage, printer spooling, or port expansion capabilities to your portable computer or terminal. Typical applications for this 8-pound unit, which can serve as a stand-alone system, include expansion of single- and multi-user systems, bulletin-board host, and process control. Its Z80A processor partitions the 256K-byte RAM into 192K bytes of disk emulation and 64K bytes of user memory. CP/M 2.2 and utilities are supplied on a 5¼-inch floppy disk. The Companion is able to read and write IBM, Kaypro, Morrow, and Osborne double-density disks.

Two disk drives can be added to the Companion. Its four I/O ports are composed of two RS-232C serial ports with

automatic data-rate selection ranging from 110 to 19,200 bps, a parallel port that defaults to Centronics compatibility, and a bus port for external drives and additional RAM and ROM. Any computer with RS-232C facilities can employ the Com-

panion for disk-file access and RAM disk emulation.

The CP/M 2.2 Companion costs \$1095. For full details, contact Companion Computers, PO Drawer CC, Apex, NC 27502, (919) 362-6655.

Circle 613 on inquiry card.



Bundled Software Complements Sinclair QL

The Sinclair QL comes with word-processing, spreadsheet, database-management, and graphics software that taps the capabilities of its 128K-byte RAM, dual 100K-byte Microdrives, and high-resolution color graphics. Motorola's 68008 microprocessor, a 32-bit processor with an 8-bit data path and 1 megabyte of non-segmented address space, is at the heart of the QL. A second chip, the Intel 8049, tends to the QL's 65-key keyboard, sound, RS-232C receive, and real-time clock functions.

Character displays of 85 by 25 (normal), with a choice of character sets, and 40 by 60 (television) can be achieved, depending on the software. With a color or monochrome monitor, the high-resolution 512-by-256-pixel graphics give you eight colors and two operating modes. Nine rear-panel ports are provided: networking, serial communications, two joysticks, and ROM-cartridge and internal expansion. RGB monitor, power sockets,

and a television port are standard. Up to 64 QLs or ZX Spectrums can be linked. Six Microdrives can be stacked externally for a total of 800K bytes of storage. RAM is expandable to 640K bytes.

System software is based on a 32K-byte ROM chip containing SuperBASIC and the QDOS operating system. QDOS, developed by Sinclair, features single-user multitasking, a time-sliced priority job scheduler, display handling for multiple screen windows, and device-independent I/O. Pascal and 68000 compilers will be announced. Hardware options include a modem and A/D, Winchester hard-disk, and IEEE-488 and parallel printer interfaces.

In the United Kingdom, the list price is £399, including VAT (value-added tax). In the U.S., it's \$499 (third quarter availability). For information, contact Sinclair Research Ltd. USA, 50 Staniford St., Boston, MA 02114, (617) 742-4826.

Circle 615 on inquiry card.

Peripherals

High-Performance Color Graphics Card for IBM

IDE Associates' Ideagraph is a high-performance color graphics card for the IBM PC and PC XT. Based on the NEC 7220 color chip, Ideagraph comes in 28- or 40-MHz versions and with 128K or 256K bytes of memory. Both versions have the ability to generate four color planes (16 colors) at 640 by 200 pixels and hardware-driven functions that operate at 80 nanoseconds per pixel. Standard graphics features include automatic line, circle, vector, and space filling. A hardware-controlled zoom factor of 1 to 16 can be used to highlight specific areas, and display blinking is achieved on a pixel-by-pixel basis under software control.

Its optional color outputs are RGB intensity, TTL with color mapping, RGB analog, and NTSC composite video. An IBM-compatible BIOS, IDE-extended BIOS, and a virtual device interface designed to link with Digital Research's GSX are supplied. With 256K bytes of memory, Ideagraph can be programmed for eight color planes with 256 colors selectable from a palette of 4096.

Retail prices range from \$895 to \$1895, depending on configurations. For full particulars, contact IDE Associates Inc., 7 Oak Park Dr., Bedford, MA 01730, (617) 275-4430. Circle 618 on inquiry card.

Six-Voice Synthesizer

The SCI Six-Voice Board is a single-board polyphonic synthesizer from Sequential Circuits. This serial-interfaced Z80A-driven synthesizer allows you to program each voice

What's New?

with a different timbre. It has computer-corrected analog electronics and provides you with independent control over tone, loudness, and the character of the sound. By mixing inputs you can create sounds resembling such instruments as trombones, organs, or banjos. It measures 9 by 6.2 inches and weighs 9 ounces.

In OEM quantities, the SCI Six-Voice Board is under \$200. For more information, contact Sequential Circuits Inc., 3051 North First St., San Jose, CA 95134, (408) 946-5240.

Circle 617 on inquiry card.

HX-20 Parallel Port Marketed

Computer Resources markets a parallel-port interface for the Epson HX-20 notebook computer. This board provides 24 parallel bits of fully buffered input, output, or bidirectional data (user-configurable in 8-bit segments). Up to 16 parallel-port boards can be daisy-chained off the HX-20's expansion connector. The list price is \$250.

Additional boards to run off the parallel port include a connector/LED, a high-speed serial interface, an EPROM programmer, and D/A and A/D boards. Direct inquiries about prices and availability to Computer Resources Corp., POB 388, Provo, UT 84601, (801) 377-4446.

Circle 622 on inquiry card.

Stereophonic Sound Effects for Arcade Games

Stereophonic arcade sound effects can be created with the Soundmaster II from Kearsarge Industries. Soundmaster can be programmed through BASIC or

assembly-language programs to produce such sounds as lasers, explosions, and race cars. Once addressed, it latches the data and frees the computer for other activities. Refresh is not required.

The Soundmaster card is outfitted with two sound-generating circuits with six tone generators, two noise generators, six mixers, amplitude controls, two envelope generators, and six D/A converters. A pair of audio amplifiers that drive dual 8-ohm speakers are on board. RCA plugs permit direct connection to stereo systems for further amplification.

Soundmaster works with Apple II, II Plus, and IIe computers. It comes with a manual and demonstration disk. It costs \$119.95, plus \$3.50 for shipping and handling. Order from Kearsarge Industries Inc., 12310 Pinecrest Rd., Reston, VA 22091, (703) 620-5760.

Circle 619 on inquiry card.

Video Digitizer Uses Standard RS-170 Camera

PCVision Frame Grabber, model DFB-512, from Imaging Technology, is a single-board video digitizer and frame buffer capable of digitizing the images from a standard RS-170 video camera and simultaneously displaying the image. Resolution is 512 by 480 pixels. The input video is digitized by a 6-bit A/D flash converter at a rate of 10 MHz. Digitized data is stored in a frame buffer and sent to the output section by means of a set of four 256 by 8 lookup tables. The output section uses an 8-bit D/A converter to change the data back to RS-170 format. The resulting image can be displayed on a television monitor.

PCVision lets you access

and manipulate individual pixels. Accesses to the frame buffer are interleaved to prevent streaking. Each pixel is represented by 1 byte. A maximum of 512 by 512 by 4 pixels can be stored in the frame buffer. Other system features include a phase-locked loop circuit, a write-protect mechanism, a vertical blank interrupt,

and a system clock configurable via software.

The PCVision Frame Grabber costs \$2900 fully loaded. For details on options and purchasing procedures, contact Imaging Technology Inc., Suite 4350, 400 West Cummings Park, Woburn, MA 01801, (617) 938-8444.

Circle 620 on inquiry card.

SOFTWARE



PC Window Interface Supports Mouse

Visuall, a window interface for the IBM PC, PCjr, and PC XT, is manufactured by Trillian Computer Corporation of Los Gatos, California. Visuall creates a visual environment in which most actions and tasks can be selected from windows using a mouse or two keys. This arrangement eliminates complicated commands and speeds the training of novices. Visuall supports PC-DOS application programs without modifications.

When used in conjunction with application-specific shells, Visuall lets you customize up to 48 windows for a particular application. Windows can include Help screens explaining topics in paragraph form. Visuall lets you create shells for any

program that runs on PC-DOS 1.1 or 2.0.

Visuall works with most available mouse hardware. It requires 64K bytes of memory and a single floppy-disk drive. With full documentation and a PC-DOS shell, Visuall costs \$99.95. Application-specific shells for such programs as Lotus 1-2-3, Wordstar, Supercalc, Multiplan, and IBM Personal Editor are available for \$49.95. A French DOS shell is offered. For complete details, contact Trillian Computer Corp., 129 Central Ave., POB 481, Los Gatos, CA 95031, (408) 374-5001.

Circle 627 on inquiry card.

A Better BASIC Announced

Summit Software Technology has announced BetterBASIC for IBM Personal Computers. BetterBASIC is marketed in Starter Pack and Programmer versions, both of which are said to be totally interactive compilers. Major features of BetterBASIC include a modular architecture, structured design, and record-variable data types. It provides a group of text- and string-handling features, such as insert/delete and case conversions, and mathematic processing in binary-coded decimal form. It supports procedures, functions, and a range of block-structured commands and record-variable data types, including pointer variables, strings, and arrays of any type. The IBM PC's 640K-byte memory address space is supported.

BetterBASIC's modularity allows all new programming enhancements to be written into modules and added to the core language. The modules are self-contained, separately compiled software packages written in BetterBASIC and augmented by assembly language. They can be written, edited, renumbered, and listed just like standard BASIC programs. Modules include the main module, which supports the base language and contains fundamental MS-DOS key/screen I/O; the MS-DOS module, which adds statements for sequential and random access to MS-DOS files and devices; and an extension module with embedded BetterBASIC statements. Currently, modules for graphics and windows are offered. Future releases will support database management and virtual memory.

The BetterBASIC Starter Pack is \$189, and the Programmer is \$489. June shipments are planned. For more information,

contact Summit Software Technology, 40 Grove St., Wellesley, MA 02181. (617) 235-0729.

Circle 626 on inquiry card.

MS-DOS Formats Read by TRS-80s

Transfer from Michtron allows Radio Shack TRS-80 Models I, III, and 4 computers to read from and write to disks formatted by an MS-DOS-based machine, such as the Tandy 2000, Compaq, and Sanyo 550. Transfer offers five commands in its main menu: Read MS-DOS directory, Copy MS-DOS file to TRSDOS, Copy TRSDOS to MS-DOS, Sort MS-DOS directory, and Format an MS-DOS disk. You can use Transfer's Format function to format 40-track disks that your TRS-80 can read, and then let your Tandy 2000 convert these disks to an 80-track format. Transfer will copy any file from one disk format to another if the files are saved in ASCII. Also supplied is a utility, CONV, which adds spaces around keywords in BASIC programs written on the TRS-80 so that they will run on Microsoft BASIC.

Transfer requires two disk drives. On the Model I, a doubler and a 40-track drive are required. For the Model III, transfer will operate under TRSDOS, NewDOS, DOSPlus, or LDOS. Available for \$59.95 from Michtron, 1691 Eason, Pontiac, MI 48054. (313) 673-1205.

Circle 638 on inquiry card.

Light Pen and Software Create Graphics on 64

Inkwell Systems' Flexidraw for the Commodore 64 is a graphics program coupled

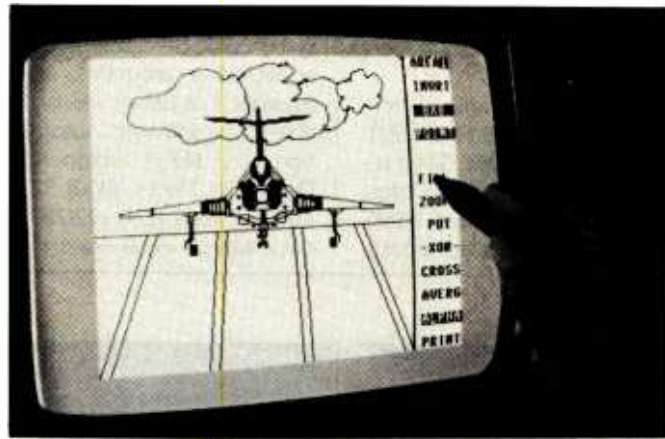

with a light pen. It provides the means for producing simple freehand sketches or complex CAD drawings using pencil-and-paper routines and all the speed and graphics capabilities of the 64. The program features a dynamic menu for operator convenience and a variety of automatic graphic selections. A few of the graphics abilities are point-to-point lines; box, circle, and fill choices; zoom; two separate work areas; and Put/Get commands for manipulating images on screen or transferring images between the two work areas. Graphics can

be stored on disk or output to a printer.

The light pen will work on standard televisions and black-and-white, color, and most green-screen monitors. Response time is purported to be 175 nanoseconds with a two-line capability.

Flexidraw is \$149.95 and includes the light pen, software, keyboard overlay, and manual. Further information can be obtained from Inkwell Systems, 7760 Vickers St., POB 85152 MB 290, San Diego, CA 92138. (619) 268-8792.

Circle 630 on inquiry card.

Natural-Language Interpreter at Heart of DBM

Salvo is an information manager from Software Automation. At the heart of Salvo is a relational database-management system and a natural-language interpreter that translates syntax-free user requests into commands. It has a knowledge-based algorithm that permits automatic navigation through the database without user direction. An Expert Command Assistant feature helps you formulate commands in a nontechnical manner. A command set capable of complete application generation independent of external host languages is standard. Salvo's Virtual Join

capability dynamically creates views of joined relations without physically creating result tables.

Salvo is designed to operate in both stand-alone and distributed data-processing modes. When operating in an executive workstation, it is capable of accepting data from a host processor. You can then develop custom application programs without programming by using Salvo as a common front-end language. It automatically generates detailed how-to instructions, which allow you to communicate in a natural language the results you wish to obtain. In addi-

tion, you can use graphics to help formulate information requests.

Compatible with such DOSes as MS-DOS 1.1 and 2.0, CP/M, and CP/M-86, Salvo requires a minimum of 64K bytes of memory and dual 256K-byte floppy-disk drives. It costs

\$495, complete with manual, system disk, data disk, sample applications programs, and tutorials. Full details are available from Software Automation Inc., 14333 Proton Rd., Dallas, TX 75234, (800) 527-4070; in Texas, (214) 392-2802. Circle 629 on inquiry card.

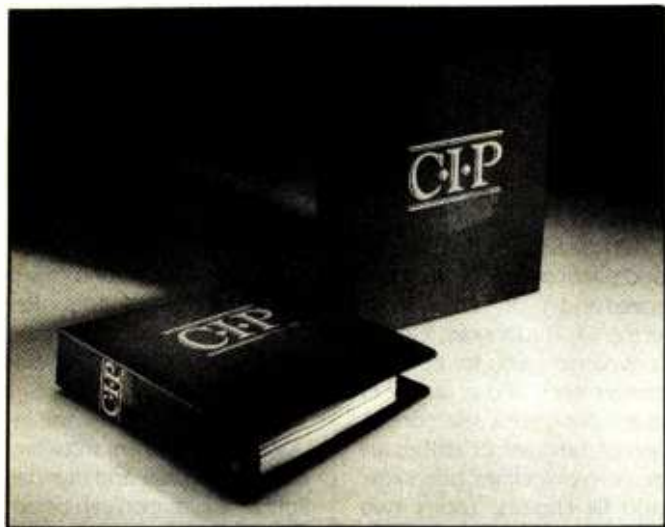

Database/Information Manager Handles Report Writing

A database/information management and report-writing program for the IBM Personal Computer is marketed by Concentric Data Systems. With the Concentric Information Processor (CIP), what you see on screen is what you get on hard copy. CIP offers a horizontal scrolling capability so that 132-column documents can be visually defined using an 80-column display. Titles and footnotes can be created on screen and formatted in conjunction with the report. Information definition, collection, and reporting are done through the visual interface.

CIP does not require a command language, and complicated key combinations, parameters, switches, and user-defined screen positions have

been eliminated. All options are presented on screen, and the use of command keys and pointing techniques are consistent. A calculation facility that includes date arithmetic is provided. Standard features include context-sensitive instructions, key graphics, flexible file reorganization, and Help screens.

CIP will work with such products as Visicalc, Mailmerge, and Lotus 1-2-3. It can read files from PFS: or dBASE II. The suggested retail price is \$395. Further information is available from Concentric Data Systems Inc., 18 Lyman St., Westboro, MA 01581, (617) 366-1122.

Circle 628 on inquiry card.

Business Software Line for HP 150

The Accounts Journal (TAJ) business-software line from Production Data Systems is available for the Hewlett-Packard HP 150. The product line for the HP 150 includes Accounting Pac, TAJ Job Costing Pac, TAJ Financial Graphics Pac, and TAJ Forms Pac. The Accounting Pac is an integrated single-disk package containing general ledger, accounts receivable/payable, and payroll functions. TAJ Job Costing Pac, which is capable of operating as a stand-alone program, tracks all labor time, costs, and revenues per job. Pie, line, and bar charts of financial data contained in the Accounting Pac can be generated with the Financial Graphics Pac. Forms Pac produces billing statements, payroll checks, accounts payable checks, and W-2 forms.

The Accounting Pac is \$850. Job Costing lists for \$425. Financial Graphics Pac and Forms Pac are \$250 each. All prices include documentation. For more information, contact Production Data Systems, Suite 210, 2386 Fair Oaks Blvd., Sacramento, CA 95825, (916) 484-0155.

Circle 636 on inquiry card.

Preview-Paks Demo Software on Reusable Disks

Preview Publishing has announced Preview-Pak, a 10-pack of reusable floppy disks containing full demonstrations of IBM PC programs. Each disk represents one of ten categories, which range from word processing and database management to graphics, operating systems, and small business accounting. When you are through with a disk, you can reformat it for personal use.

Preview-Paks are supplied

with tutorial booklets and discount coupons. The manufacturer intends to feature different demonstration software on a monthly basis. A 10-pack costs approximately \$40. For details, contact Preview Publishing, 534 Third Ave., San Francisco, CA 94118, (415) 752-3336. Circle 633 on inquiry card.

Microsoft Releases Programs for Macintosh

Microsoft has announced a line of software for the Apple Macintosh. Available products include Multiplan, Word, Chart, File, and Microsoft BASIC. Each Microsoft program works with the Macintosh's graphics environment by providing you with a set of icons from which to choose desired functions. Microsoft's programs support cutting and pasting of information in Macintosh windows and among each other.

Multiplan for the Macintosh has been enhanced with an Undo command for reversing the last change to the spreadsheet. Word uses the Macintosh's graphics capabilities for full visual representations of text and graphics on screen, including proportional spacing and support for all Macintosh fonts. Chart, a business graphics program that lets you enter, edit, and format graphics data directly on screen, accepts data from Multiplan, File, or other Macintosh programs. File offers forms-based data entry and retrieval. Microsoft BASIC uses the Macintosh's 68000 processor to provide you with a decimal mathematics pack with 14-digit precision, string variables, string expressions as large as 32,767 characters each, and three window areas.

Microsoft intends to announce more programs for the Macintosh. Microsoft Multiplan, Word, and File cost \$195

What's New?

each. Chart is \$125, and Microsoft BASIC lists for \$150. Contact Microsoft Corp., 10700 Northup Way, Bellevue, WA 98004, (206) 828-8080. Circle 637 on inquiry card.

Apples Draw with Flying Colors

A low-cost color graphics package for Apple computers, Flying Colors is marketed by the Computer Colorworks division of Jandel Inc. Flying Colors has a windowed screen menu that contains all the options you require to create drawings on your Apple II Plus or IIe. Choices include thick and thin lines, automatic circles and boxes of any size, erasures, and enclosed-area fill. A "micro" mode lets you focus on detailed work or paint with a selection of colors, patterns, and brush sizes. Text can be intermingled with graphics on screen. A projection program is provided for generating slide shows or presentations. Flying Colors lets you store drawings on disk as standard binary files that can be used in or combined with other programs.

Flying Colors is designed for use with a joystick. Versions of the program are available for Atari and Commodore computers. The price for the Apple program is \$39.95. Contact the Computer Colorworks, Suite 201, 3030 Bridge Way, Sausalito, CA 94965, (800) 874-1888; in California, (415) 331-3022.

Circle 632 on inquiry card.

Integrated Utilities

Filedriver, an integrated collection of utilities for use in CP/M, MP/M, and TurboDOS systems, furnishes you with tools for generating application-specific, customized utilities. Its custom feature lets you

create your own COM files with all the utility functions desired, specified options selected, and an entire command line consisting of one or more file IDs. Directions to read file IDs from a text file previously created are included. This arrangement lets you invoke complex utilities with a minimum number of keystrokes.

You can access Filedriver utilities from individual COM files, all-in-one COM files, or a menu interface. Among the basic utility functions constituting Filedriver are Archive, CSUB, Copy, Erase, Rename, Print, and Verify. Each function has built-in features that expand upon the utilities supplied with the DOSes. These features include multiple wild cards on a command line, wild-card user-areas and disk drives, as well as the ability to exclude lists of files from wild-card designations, write to and read from text files, and copy/archive to sequential floppy drives.

Filedriver does not modify existing operating systems; rather it runs in consort with other utilities and menu interfaces. With a user manual, the 8-inch version of Filedriver is \$85. Most 5¼-inch floppy-disk formats are \$90. In-depth documentation containing application notes, summary charts, and appendixes is supplied. Descriptive literature can be obtained from Dunbar-Ridge Corp., 102 Sterling Court, Syosset, NY 11791, (516) 496-4431.

Circle 634 on inquiry card.

PUBLICATIONS

Catalog Outlines Data-Communications Products

International Data Sciences' IDS Data Direct catalog describes more than 60 data-

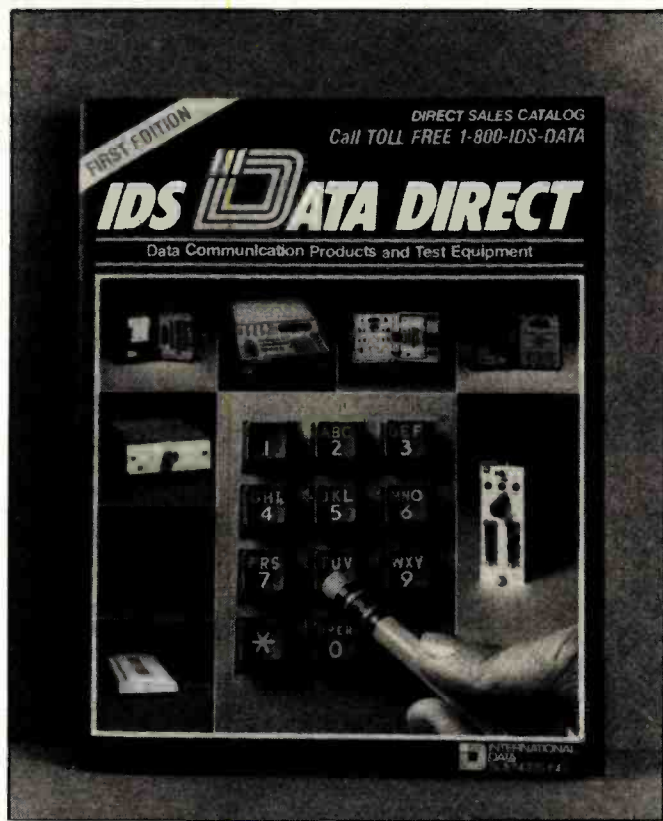

communications products. This 36-page catalog and buyer's guide profiles such equipment as an RS-232C hand-held test set and breakout box, data switches, modems, and cables. Product descriptions include illustrations, schematic diagrams, specifications, and pricing information. Many of the items are available in both stand-alone and rack-mounted configurations. Articles offering

guidelines for testing data-communications networks and practical applications for the use of switching, patching, and monitoring modules are interspersed throughout.

IDS Data Direct is free of charge. For your copy, contact International Data Sciences Inc., 7 Wellington Rd., Lincoln, RI 02865, (800) 437-3282; in Rhode Island, (401) 333-6200. Circle 650 on inquiry card.

Where Do New Products Items Come From?

The information printed in the new products pages of BYTE is obtained from "new product" or "press release" copy sent by the promoters of new products. If in our judgment the information might be of interest to the personal computing experimenters and homebrewers who read BYTE, we print it in some form. We openly solicit releases and photos from manufacturers and suppliers to this marketplace. The information is printed more or less as a first-in first-out queue, subject to occasional priority modifications. While we would not knowingly print untrue or inaccurate data, or data from unreliable companies, our capacity to evaluate the products and companies appearing in the "What's New?" feature is necessarily limited. We therefore cannot be responsible for product quality or company performance.

TOLL FREE

1-800-545-2633

Mail Order Hours:

Monday - Friday 8 a.m. to 6 p.m.

Sat. 10 a.m. to 5 p.m.

(Sometimes much later)

The Great Salt Lake Computer Company, Inc.

DISK DRIVES

| SHUGART | |
|--|--------|
| 5 1/4" SA400 (35 TR) 160K | 169.00 |
| 5 1/4" SA400L (40 TR) 190K | 189.00 |
| 5 1/4" SA455L (40 TR) 320K 1/2 HGT | 200.00 |
| 8" SA801R(SS/DD) 600K | 355.00 |
| QUME | |
| 5 1/4" 142 (40 TR) 320K 1/2 HGT | 200.00 |
| 8" DT8 (842) | 490.00 |
| MITSUBISHI | |
| 8" M-2896-63 Thinline 8" DS/DD 1.2 MG | 419.00 |
| 8" M-2894-63 (110V) Standard 8" DS/DD 1.2 MG | 419.00 |
| CDC | |
| 5 1/4" 9409-DS/DD | 225.00 |
| TANDON | |
| 5 1/4" TM100-1 SS/DD 160K | 150.00 |
| 5 1/4" TM100-2A DS/DD (320K) | |
| FOR IBM-PC | |
| TM101-4 (96 TPI Quad Den) | 339.00 |
| 8" TM848-2 (DS/DD) 1.2 MG | 400.00 |
| TM 100-4 (96 TPI Quad Den) | 299.00 |
| SIEMAN'S | |
| 8" FD100-8 (SS/DD) 110V (801 R) | 169.00 |
| 8" FD100-8 (SS/DD) 220V (Compatible) | 199.00 |
| MPI | |
| 5 1/4" B-51 40TR SS/DD 180K | 169.00 |
| 5 1/4" B-52 40TR DS/DD 320K (FOR IBM PC) | 180.00 |

DRIVE CABINETS

| 8" CABINETS | |
|--|--------|
| 8" DDC88V28 w/PS vertical for 2-8" drives | 269.00 |
| 8" DDC88T-1 w/PS vertical-for 2 or 4-8" thinline drives | 269.00 |
| 8" DDC88T-2 w/PS vertical for 2-8" thinline drives | 155.00 |
| 8" DDC8V w/PS vertical for 1-8" drive | 249.00 |
| 8" DDC88H w/PS horizontal for 2-8" drives | 269.00 |
| 5 1/4" CABINETS | |
| 5 1/4" DDC5H w/PS horizontal-for 1-5 1/4" drive | 55.00 |
| 5 1/4" DDC5V w/PS vertical-for 1 ea. 5 1/4" drive | 50.00 |
| 5 1/4" DDC55V w/PS vertical-for 2-5 1/4" drives (NEW) | 85.00 |
| NEW "SLIMLINE" DRIVE CABINET | |
| 5 1/4" DDC55H 1/2 w/PS horizontal for 2 ea. 5 1/4" drive - Specify DRIVE | 75.00 |
| All Cabinets Available with Extender Connector Add \$10.00 ea. | |

DISKETTE STORAGE

| SRW LIBRARY CASES | |
|--|-----------|
| CAS-5 1/4 (Holds 10 ea. 5 1/4" Disks) | 2.35 ea. |
| CAS-8 (Holds 10 ea. 8" Disks) | 2.80 ea. |
| Color Burst Packs (5 colors of CAS-5) | 10.95 ea. |
| Color Burst Pack 8 (5 colors of CAS-8) | 12.50 |

OUR BEST BUY

OUR BEST QUALITY DISKETTE STORAGE
Holds 75 Disks —
Heavy Duty w/Lock & Key
Available in Red, Clear & Smoke

RING KING MD-70 .. 19.00

DATA CABLES

| | |
|--|-------|
| 8" DSC 88-2SKT-for 2-8" drvs w/skt. conn. | 20.00 |
| 5 1/4" DSC55-2SKT-for 1-5 1/4" drvs w/skt. conn. | 20.00 |
| RS232MM-5 (male to male) | 19.00 |
| IBM to PAR or COLUMBIA to PAR | 26.00 |
| Osborne to PAR | 26.00 |
| Kaypro to PAR | 26.00 |

Many Others Available

PRINTERS

| BROTHER | |
|--|----------|
| HR-25 25 CPS Daisywheel | 775.00 |
| HR-1A 17 CPS Daisywheel 3K Buff | 495.00 |
| DATA-SOUTH | |
| DS 180 180CPS/Serial or Par/Tractor | 1,400.00 |
| DAISYWRITER | |
| Daisywriter 2000-48K Buffer/20TO40CPS Letter Quality Par or Serial | 1,095.00 |
| DIABLO | |
| 620 (25CPS/Serial) | 920.00 |
| 630 (40CPS/Multi-IF) | 1,719.00 |
| 630 ECS/IBM | 2,100.00 |
| DYNAX | |
| Dynax-15 Par-13CPS Daisywheel 2 color PTG-3K buff | 469.00 |
| Dynax 15 Serial-13CPS Daisywheel | 525.00 |
| EPSON | |
| FX80 (160 CPS-Par 10") | CALL |
| FX100 (160 CPS-Par 15") | CALL |
| C. ITOH | |
| Pro-writer I (8510A) Par 120 CPS | 359.00 |
| Pro-writer I (8510A) Serial 120 CPS | 529.00 |
| F-10 40CPS/Diablo/Par or Serial | 1,125.00 |
| F-10 55CPS/Diablo/Par or Serial | 1,425.00 |
| F10 Tractor | 469.00 |
| JUKI | |
| 6100-18CPS/Diablo Compatible Par/Daisywheel | 569.00 |
| MANNESMAN-TALLY | |
| Spirit 80CPS Par 10" | 330.00 |
| 160L (160CPS-40CPS Letter Quality 10") | 599.00 |
| 180L (160CPS-40CPS Letter Quality 15") | 839.00 |
| NEC | |
| NEC2010 20CPS Serial Daisywheel | 950.00 |
| NEC2050 20CPS for IBM Daisywheel | 1,050.00 |
| NEC3550 35CPS for IBM | 1,850.00 |
| NEC7710 55CPS Serial Daisywheel | 1,995.00 |
| NEC7715 55CPS Diablo Compatible Daisywheel | 1,995.00 |

OUR BEST BUY

RITEMAN — Briefcase Size - 120 CPS - Par Port - Epson Compatible 289.00
1 Year Warranty

| OKI-DATA | |
|--|--------|
| Microline 82A (SER & PAR-120CPS 10") | CALL |
| Microline 83A (SER & PAR-120CPS 15") | CALL |
| Microline 92 (PAR-160CPS-LTR-10") | CALL |
| Microline 93 (PAR-160CPS-LTR-15") | CALL |
| Microline 84P (PAR-200CPS-LTR-15") | CALL |
| Microline 84S (SER-200CPS-LTR-15") | CALL |
| STAR MICRONICS | |
| Gemini 10X NEW VERSION (PAR-120CPS-10") | CALL |
| Gemini 15X (PAR-120CPS-15") | CALL |
| Gemini Delta 10 (Par-160CPS-10" 8K buffer serial) | CALL |
| Star Radix 10 (Coming Soon) | CALL |
| SILVER REED | |
| EXP 550P-17CPS Daisywheel-PAR | 650.00 |
| EXP 550S-17CPS Daisywheel-Serial | 680.00 |
| TOSHIBA | |
| P1340 - Smaller version of 1350 / 10" Carriage / 112 CPS Draft Mode / 54 CPS Ltr Quality (List Price \$1395) | CALL |
| P-1350 — 192 CPS Draft Mode / 120 CPS Ltr Quality / Specify Par or Serial | CALL |
| P-1351/1360 — Same as 1350 and has "Downloadable Font" | CALL |

Minimum Shipping \$3.00

TOLL FREE 1-800-545-2633

in the Continental U.S.A.

Prices subject to change without notice

PRINTER ACCESSORIES

| BROTHER | |
|--|----------|
| HR1A Tractor | 110.00 |
| HR25 | 110.00 |
| HR25 Cut SHT FDR | 195.00 |
| DAISYWRITER | |
| Bi-Di Tractor | CALL |
| Uni-Di Tractor | 159.00 |
| Portrait SHT FDR | 600.00 |
| Landscape SHT FDR | 895.00 |
| DIABLO | |
| Diablo 620-Uni-Direct Tractor | 110.00 |
| Diablo 630-Bi-Direct Tractor | 275.00 |
| Diablo 630-DBL Sheet Feeder | 1,395.00 |
| DYNAX | |
| Tractor | 95.00 |
| Cut SHT FDR | 195.00 |
| Keyboard | 175.00 |
| JUKI-6100 | |
| RS232 Interface | 60.00 |
| Uni-Di Tractor | 100.00 |
| Bi-Di Tractor | 145.00 |
| NEC | |
| Vertical Tractor | 219.00 |
| Bi-Dir. Tractor | 330.00 |
| Cut Sheet Feeder | 1,100.00 |
| OKI-DATA | |
| 82/92 Tractor | 55.00 |
| Serial Intf. w/2K Buffer (For 92 & 93) | 110.00 |
| Okigrah I 82A or 83A Graphics ROM | 50.00 |
| Okigrah II 82A or 83A Disk for Apple | 60.00 |
| STAR-MICRONICS | |
| Serial Intf. Bd | 70.00 |
| Serial Intf. Bd w/4K Buffer | 120.00 |
| TOSHIBA | |
| P-1350 Cut Sheet Feeder | 800.00 |
| P-1350 Bi-Dir. Tractor | 210.00 |

ALL RIBBONS AVAILABLE

DISKETTES

15% Discount for Qty 100

| FOR APPLE, ETC. | |
|---------------------------------------|----------|
| 5 1/4" Soft Sector SS/DD | 17.00/10 |
| For IBM PC & PARTNERS | |
| 5 1/4" Soft Sector DS/DD | 22.00/10 |
| • Lifetime Warranty | |
| • All have Hub Rings and PLASTIC CASE | |

CENTECH

Color code your files: 5 colors in each pkg. (Red, Yellow, Blue, Green, Brown)

| | |
|-------------------------------------|----------|
| 5 1/4" Sgl side/dbl den—Rainbow Pak | 23.00/10 |
| 5 1/4" Dbl side/dbl den—Rainbow Pak | 30.00/10 |
| 5 1/4" 10 sector—Rainbow Pak | 24.00/10 |
| 5 1/4" 16 sector—Rainbow Pak | 24.00/10 |
| 8" Sgl side/dbl den—Rainbow Pak | 30.00/10 |
| 8" Dbl side/dbl den—Rainbow Pak | 40.00/10 |

• Lifetime Warranty • Hub Rings • Also Available in Solid Color Specify Color

OUR BEST BUY

MAXELL

| | |
|------------------------------------|-------|
| Sgl. side/dbl. den 5 1/4", 48 TPI | 24.00 |
| Dbl. side/dbl. den 5 1/4", 48 TPI | 36.00 |
| Dbl. side/quad. den 5 1/4", 96 TPI | 45.00 |

Apple™ Apple Trademark of Apple Computer
IBM™ IBM Trademark of International Business Machines
CompuPro™ CompuPro Trademark of Grainbow Electronics



Circle 482 on inquiry card.

1780 West 2300 South Salt Lake City, Utah 84119

SYSTEMS

CUSTOMER SERVICE

CALL DAVID 1-801-972-2739

AND RETURNS

Prices subject to change without notice

The Great Salt Lake Computer Company, Inc.

Larger PS for IBS can be purchased to run 4 drives 10A or 12A PS.

COLUMBIA



COLUMBIA (1600-1) 16 bit. 128K RAM 2 ea. 320K Disk Drive-2 SER, 1 PAR, Key Bd. 8 slots Display Cd., bundled software **CALL**
COLUMBIA 1600-4 Same as 1600-1 except has 12MB Hard Disk & only 1 F.D. **CALL**
COLUMBIA MPC-VP Portable 16/BIT 128K RAM 2 each 320K, drives SER & PAR Port, 9" monitor, bundled software **CALL**

Service —

Bell & Howell Co. Nationwide

IBM



IBM PC-1—Includes 64K RAM, 1 ea. 320K Disk Drive 1,995.00
IBM PC-2—Includes 64 RAM, 2 ea. 320K Disk Drive 2,250.00
IBM PC-3—Includes 256K RAM, 2 ea. 320K Disk Drive, IBM Mono Adapter, IBM Mono Display 2,999.00
IBM PC-4—Includes 256K RAM, 2 ea. 320K Disk Drive, Peacock Color Card, Princeton HX 12 Display 3,395.00

IBM-XT

• 128K RAM • 1 ea 320K F.D. • 1 ea. 10MG Hard Disk 4,695.00
 8087 CPU 198.00

IBS



IBM "LOOK-A-LIKE"

PC-2000 — Basic Mainframe 995.00
FEATURES • 5 Slot Mother Bd w/64K (Expands to 256K)
 • Power Supply w/Fan
 • Lo-Profile Keybd - 96 Key
 • 2 ea Serial • 1 ea PAR
 • Space for 4 ea. 1/2 HGT Drives or 2 Full Size
 • Will run PC/DOS or MS/DOS
 • Will run all MS/DOS Compatible Software

PC-2001 — Includes 64K RAM, 1 ea. 320K F.D. 1,395.00
PC-2002 — Includes 64K RAM, 2 ea. 320K F.D. 1,650.00
PC-2003 — Includes 256K RAM, 2 ea. 320K F.D., Video CD, 12" 310A Mono Display 1,995.00
PC-2004 — Includes 256K RAM, 2 ea. 320K F.D., Color Cd, Princeton Color Monitor 2,499.00

NEC PORTABLE



PC8201A—Portable 2.4 MHZ CPU 16K Ram/ Expands to 64K-32K RAM LCD Display—Keybd (67 key-5 function) Modem, Serial and Par Port-FD and Cassette Interface—Uses 4AA Batt—bundled software 660.00
 8201-06 Ram Chip - (8k) modl 105.00
 8206-A 32k Ram Cartridge - modl 329.00
 8221-A Thermal Printer - print 149.00
 8271-02 AC Adapt/Print & Rec. - accs 15.00
 8271-A AC Adaptor - accs 17.00
 8281-A Cassette Recorder - accs 105.00
 8201A-90 Nicad Battery Pak - accs 16.00
 Modem Communication Cable - accs 25.00
 Thermal paper for 8221-A - accs (5 rolls per pack) 13.00

EAGLE



PC-2 — "The ORIGINAL Version"
Features • 128K RAM • 2 ea. 320K F.D. • Serial • Parallel • MS/DOS • 12" Grn Monitor • Bundled Software 2,595.00

PC+2 — "The NEW Version"
 • Same as PC-2 except has no Monitor or Mono Adapter • Software consists of GW Basic, MS/DOS & CPM 86 2,295.00

APPLE FRANKLIN



APPLE IIE Starter—Includes CPU 1 F.D. Monitor, and Stand 1,325.00
FRANKLIN ACE 1000 w/color 799.00
FRANKLIN ACE 1200 OMS includes CPU-2 F.D. and bundled software 1,699.00

SANYO PORTABLE



MBC-550 — 128K, 1 FD w/Word Star, Easywriter, Calcstar 849.00
MBC-555 — 128K, 2 FD, w/Word Star, Easywriter, Calcstar, Mailmerge, Spellstar, Infostar 1,149.00

Circle 482 on inquiry card.

IBM SOFTWARE

ASTON-TATE — D-Base II 389.00
CONTINENTAL — Home Accountant 89.00
MICRO-PRO — Mail Merge 129.00
MICRO-PRO — Spell Star 129.00
MICRO-PRO — Word Star 279.00
MICRO-PRO — Calc Star 119.00
MICROSOFT — Word with Mouse 329.00
 Multi-Plan 175.00
 Multi-Plan Financial 69.00
T-MAKER — T-Maker 3 169.00
S.S.I. — Word Perfect 349.00

TELECOMMUNICATIONS FOR MODEM SOFTWARE

UNITED SOFTWARE — ASC II Express 99.00
MICRO-STUFF — Cross-Talk 139.00
LOTUS 1-2-3 339.00

APPLE SOFTWARE

APPLE — Apple Writer 2 79.00
ASHTON-TATE — D-Base II 409.00
MICRO PRO — Word Star 249.00
MICROSOFT — Macintosh Basic 125.00
MICROSOFT — Multi-Plan (Specify) 175.00
MICROSOFT — Multi-Tool Financial 75.00
MICROSOFT — Typing Tutor II 17.95
SILICON VALLEY — "The Handlers" (3 pkg) 39.00
SILICON VALLEY — List Handler 35.00
SILICON VALLEY — Spell Handler 50.00
SILICON VALLEY — Word Handler 39.00
SILICON VALLEY — Easy Learner 11.95
SILICON VALLEY — Rapid Reader 11.95
SILICON VALLEY — Toddler's Tutor 11.95
SILICON VALLEY — Turbo Charger 11.95
SILICON VALLEY — The Collector 11.95
SILICON VALLEY — Lancaster (Shoot Game) 9.95
T-MAKER (Needs CPM Card) 149.95

VISICORP

Visicalc (Specify 2 or E) 179.95
 Visidex (Specify 2 or E) 179.95
 Visitrend/Plot (Specify 2 or E) 229.00

TOLL FREE

1-800-545-2633

CUSTOMER SERVICE

AND RETURNS

CALL DAVID 1-801-972-2739

Prices subject to change without notice

The Great Salt Lake Computer Company, Inc.

QT PRODUCTS

S-100



QT 8" THINLINE MAINFRAME

•Provisions for 2 ea 8" thinline drives• 6 ea DB 25 cutout•2 ea 50 pin•2 ea 34 pin•1 ea Centronic •EMI filter (fused)•2 AC outlets•Power supply (+8V16A/-5V/+24V6A+5V6A)
QTC-IMF +DD6F (6 slot MB) 350.00



QT 5 1/4" MAINFRAME

•Provisions for any 2-5 1/4" drives
QTC-MF + MD12 (12 slot MB) 560.00



QT 8" MAINFRAME

•Provision for any 2-8" drives (hard or floppy)

Desk Top Version
QTC-MF + DD6 (6 Slot MB) 575.00
QTC-MF + DD8 (8 Slot MB) 625.00
QTC-MF + DD12 (12 Slot MB) 675.00

All mainframes have EMI filter, 2 AC outlets, 15 ea. DB25, 2ea. 50 pin, 2 ea. 34 pin, 1 ea. Centronic cutouts, power supply for 8" MF (+5V1A/+5V5A/+8V14A/+16V3A/+24V5A)



QT STANDARD MAINFRAME

•Provisions for any 2-5 1/4" drives•15 ea DB 25 cutout•2 ea 50 pin•2 ea 34 pin•1 ea Centronic•EMI filter (fused)•2 AC outlets•Avbl with 6-8-12-18 or 22 slot MB•Power supply (+8V16A-16V3A)

Desk Top Version
7014/QTC-MF + 12 499.00
7016/QTC-MF + 18 525.00
7015/QTC-MF + 22 550.00

CARD CAGES/MOTHERBOARDS

*IEEE-696-No termination required

| Slots | Bare Bd | A + T | w/card cage | bare card cage |
|-------|---------|--------|-------------|----------------|
| 4 | 20.00 | 45.00 | 65.00 | 20.00 |
| 6 | 25.00 | 53.00 | 75.00 | 22.00 |
| 8 | 30.00 | 74.00 | 105.00 | 31.00 |
| 12 | 35.00 | 104.00 | 145.00 | 41.00 |
| 18 | 50.00 | 155.00 | 205.00 | 50.00 |
| 22 | 65.00 | 190.00 | — | 75.00 |

All card cages will accommodate a 4" fan
Add \$20.00 for 1 fan-Add \$30.00 for 2 fans

CLOCK/CALENDAR

S-100•Time in hrs, min, sec. •AM/PM or Military Format•Date in Mo., Day, Yr., Day of Week & Leap Year recognition•4 hard interrupts (1024 Hz, 1 Hz 1 min, 1 hr)•On board battery (will last 14 mos. w/no power on)

QTC-CCS-BB (S-100) 45.00
QTC-CCS-A (A+T) for S-100 105.00

QT/COMPUTE BOARD SET

Best Bare Board Set Available

QTC-SBC 2/4 CPU (SBC 880)
QTC-EXP + III 256K (CT256) Memory bd./Expandable to 1 MG
QTC-FDC 5/8 Floppy disk controller

Bare Board Set 165.00

1) Includes manuals & assembly instructions
2) Parts available 3) Monitor & BIOS available

CPU MEMORY BOARDS

QTC-SBC 2/4 BB (SBC880) 50.00
QTC-SBC 2/4 A A+T (SBC880) 265.00
DYNAMIC (64K/256K or 1 MEG)
QTC-EXP + III Bare Bd. (CT256) 75.00
QTC-EXP + III 64K A + T (CT256) 375.00

Minimum Shipping \$3.00 in the Continental U.S.A.

COMPUPRO PRODUCTS

S-100

SYSTEMS

| | |
|-------------------------|-----------|
| System 816A | 4,395.00 |
| System 816A with RAM 21 | 4,569.00 |
| System 816A - H40 | 7,169.00 |
| System 816B | 5,595.00 |
| System 816B - H40 | 8,349.00 |
| System 816C | 7,150.00 |
| System 816C - H40 | 9,999.00 |
| System 816D | 11,099.00 |
| System 816D - H40 | 13,995.00 |
| System 816E (68K) | 7,150.00 |
| System 816E - H40 | 9,999.00 |
| System 816Z | 3,999.00 |
| System 816Z - H40 | 6,725.00 |

CPU BOARDS

| | |
|-----------------------|--------|
| CPU Z 6 MHz | 245.00 |
| CPU 8085/88 - 6/8 MHz | 369.00 |
| CPU 8086 - 8 MHz | 650.00 |
| CPU 8086 - 10 MHz | 750.00 |
| CPU 68K - 8 MHz | 575.00 |
| SPUZ (March '84) | 575.00 |

MEMORY BOARDS

| | |
|-----------|----------|
| RAM 16 | 475.00 |
| RAM 17-64 | 369.00 |
| RAM 21 | 839.00 |
| RAM 22 | 1,475.00 |
| M-DRIVE H | 1,199.00 |

INTERFACE BOARDS

| | |
|--------------|--------|
| Interlacer 1 | 220.00 |
| Interlacer 2 | 245.00 |
| Interlacer 3 | 575.00 |
| Interlacer 4 | 349.00 |

DISK CONTROLLERS

| | |
|------------------------|--------|
| Disk 1 | 399.00 |
| Disk 1A | 575.00 |
| Disk 2 (In 1. CP/M 80) | 750.00 |
| Disk 3 | 750.00 |

DISK DRIVE SUBSYSTEMS

| | |
|--------------------------|----------|
| 8" Floppy/H-40 | 4,595.00 |
| 8" Dual H-40 w/enclosure | 6,000.00 |
| Dual Floppy Subsystem | 2,695.00 |

MOTHERBOARDS AND COMPUTER ENCLOSURES

| | |
|---------------------|--------|
| 6 Slot Motherboard | 129.00 |
| 12 Slot Motherboard | 149.00 |
| 20 Slot Motherboard | 220.00 |
| Enclosure 2-D | 739.00 |
| Enclosure 2-R | 795.00 |

MISCELLANEOUS BOARDS/CONTROLLERS

| | |
|--------------------------------|--------|
| Memory Manager | 75.00 |
| System Support 1 | 349.00 |
| MPX 1 | 495.00 |
| Active Terminator | 60.00 |
| 8087 Support Board for 8085/88 | 379.00 |

WARRANTY: 1 year from date of purchase by end user.

OPERATING SYSTEMS

| | |
|--------------------------|--------|
| CP/M 2.2 (Disk 1) | 150.00 |
| CP/M 86 (Disk 1 8085/88) | 199.00 |
| MP/M 8-16 (For 8085/88) | 495.00 |
| MAP FORTH OS | 169.00 |
| CP/M 68K | 269.00 |

SIERRA DATA

SIERRA DATA S-100 BOARDS

| | |
|--|--------|
| SDS-SBC-100-Z80 (4mhz) master 2 serial 2 par/floppy controller/64k ram | 655.00 |
| SDS-SBC-100S4mhz slave/2 serial 2 par/64k ram | 565.00 |
| SDS-ZSIO/4-4 serial port I/O bd | 250.00 |
| SDS-MUX-RS232 multiplexer bd | 235.00 |
| SDS-HDI-M-Hard disk bd for micropolis | 129.00 |
| SDS-CPM/B105-cp/m for SBC 100 w/BIOS | 150.00 |
| SDS-Turbodos-Multi-user for master & slaves | 645.00 |

E-PROM ERASERS

E-PROM ERASERS

| | |
|-------------------------------------|-------|
| QUV-T8/1H (hobby) | 49.95 |
| QUV-T8/2 I (Industrial version) | 68.95 |
| QUV-T8/2P (w/timer & safety switch) | 97.50 |

MODEMS

Anchor Volkmodem — 300 Baud Orig/Answer
Direct Connect 69.00
Cable for Above 9.95
Hayes 300 219.00
Hayes 1200 499.00
Novation D-CAT 159.00
Novation J-CAT 109.00
U.S. Robotics "Password" — 300/1200 375.00

OUR BEST BUY

ANCHOR MARK XII

300/1200 Band Auto Answer/Auto Dial Direct Connect Intelligent Modem w/RS 232 Cable Included 2 Telephone Jacks, Low Power (60 MA) Dial Tone Detect 279.00

DISPLAY MONITORS

GREEN
BMC 12AU (15MHZ) 80 Col/12" 80.00
USI PI-1 (20 MHZ) Hi-Res/9" 119.00
USI PI-2 (20 MHZ) Hi-Res/12" 129.00

AMBER
USI PI-4 (20 MHZ) Hi-Res/80-Col/9" 125.00
USI PI-3 (20 MHZ) Hi-Res/80 Col/12" 119.00

COLOR
Amdek I-12" Composite (For Apple) 259.00
Amdek I + Composite w/audio 275.00
Amdek II-12"-RGB (For IBM-PC) w/audio 419.00

OUR BEST BUY

OUR BEST BUY FOR APPLE

SAKATA SC-100 Best Composite Video for Apple According to Creative Computing Analysis 275.00

OUR BEST BUY FOR IBM

Princeton HX-12-RGB (For IBM-PC) 469.00

TERMINALS

ADDS
Viewpoint-A1 (White) 509.00
Viewpoint-A2 (Green) 539.00
Viewpoint-3A + (Green) 509.00
Viewpoint 60-Same as Teletideo 925 715.00

QUME
QVT-102 80 Col. Green (910 comp) 549.00
QVT-102 80 Col. Amber 560.00
QVT-103 80/132 Col. Green 865.00
QVT-103 80/132 Col. Amber 895.00
QVT-108 80/132 Col. Amber (925 comp) 715.00

TELEVIDEO
TV910 529.00
TV910+ 565.00
TV925 715.00
TV950 925.00
TV970 1,019.00
2nd Page Memory ADD 25.00
RG 1000/TV60 Graphics Upgrade for 925/950 1,100.00

AC SURGE ELIMINATORS

Lemon (6AC outlets-3 prong) 44.00
Lime (5'-3 prong pwr cord w/on-off switch) 69.00
Orange-AC surge + EMI filter (6 outlets) 95.00
Peach (3 outlets) AC surge/EMI filter 69.00
Grizzly (200W) uninterruptible power system + surge protection 799.00
Grizzly (500W) uninterruptible power system + surge protection 1850.00

RELAX TECHNOLOGY

Both in Metal Enclosures

POWER CONTROL 1 59.95
• Master Control, Switch, 3 PWR Switch, AC Surge Protect, 6 ft. cord, 4 PWR Outlets Metal Enc.

POWER CONTROL 2 79.95
Same except has RFI Noise Suppressor
Circle 483 on Inquiry card.

8 YEARS (1976)

EXPERIENCE IN

COMPUTER MAIL

ORDER BUSINESS

CALIFORNIA RESIDENTS

SAVE 6% SALES TAX

The Great Salt Lake
Computer Company, Inc.

IBM ACCESSORIES

AST PRODUCTS

Combo Plus (Serial/Par/CLK 64 to 256K) 259.00

OUR BEST BUY

Str Pak Plus (Serial/Par/CLK/64K)
Expands to 384K 279.00
Str Pak Plus (Serial/Par/CLK/384K) 569.00

Meg-A-Plus (Serial/CLK/64K)
Expands to 256K 270.00
Meg-A-Pak (Expands Meg-A-Plus
to 512K) 270.00
AST-5251 (Allows connection of IBM PC
to System 340038) 749.00
Game Port Kit (Specify Board) 45.00
Par Port Kit (Specify Board) 45.00
Serial Port Kit (Specify Board) 45.00

COMPUERVE D.C. HAYES

Smartmodem 1200B-Smartcom 2
w/software 429.00
Smartcom II 79.00

KEYTRONICS

Enhance your PC-with a superior
keyboard 210.00

MAYNARD

Floppy Controller 160.00
Floppy Controller (Serial) 230.00
Floppy Controller (PAR) 210.00

SANDSTAR MOD-FDC

(for 5 1/4" or 8" drives) 205.00
Parallel MOD 60.00
Serial-MOD 79.00
Clock Calendar MOD 69.00
Game Adapter MOD 49.00

Sandstar Multi-Function Bd (Holds up to
6 modular add-ons) 82.00
NEW — 10 MG Hard Disk (Internal)
w/Controller 1,195.00

APPLE FRANKLIN

ACCESSORIES

APPLE

Disk II 269.00
Monitor II 99.00

ALS

CPM 3.0 Card 269.00
Z-Card II 119.00
Smarter 2 139.00

ASTAR

RF Modulator 18.00

COMPUERVE

Beginner's Kit (5 hrs. time) 32.00
Vidiotex Software for IIE 59.00

COOL TIME

Fan, Surge Protection, Real Time Clock 2 Outlets
for Printer & Monitor 85.00

GENERIC

80 Col. Video (Videx Compatible) 99.00
Joy Stick 20.00
Keyboard 175.00
Parallel Interface 49.00
RF Modulator 15.00
16K RAM Add-on 40.00

HAYES JOYSTICKS

Mach II (For II & IIE) 33.95
Mach III (with firing button) 42.95

HAYES MODEM

Micro-Modem IIE 259.00
Micro-Model IIE w/terminal package 279.00

KENSINGTON

System Saver/Fan & Surge Protection 75.00

KOALA

Graphics Tablet 89.00

KRAFT

Joystick for IIE 44.00

1-801-972-2717

Circle 483 on Inquiry card.

IBM ACCESSORIES

P.C. PRODUCTS CORP

Rainbow Color Card 375.00
• 4 Times Better Than IBM Color
• Expands to 128K RAM • PAR Port
• Serial Port • Game Adapter • Light Pen Intf.
• Mono Output • Composite Output

PLANTRONICS COLOR PLUS

Color + Color Display Card (16 colors) .. 379.00

PRINCETON GRAPHICS

NEW PGS HX12-Hi-Res Color, The Best 469.00

PGS-SR-12 NEW CALL

PGS-MAX 12 NEW CALL

QUADRAM

Quadlink—Allows Apple Software to be used in
IBM PC HAS 64K Ram-Game Port Display
Gen-Disk Intf. w/software 450.00
Quadcolor 219.00

Quadboard I w/64K CALL

Quadboard II w/64K CALL

VISTA

Diskmaster (controls 5" & 8") drives
Software included 169.00

IBM COLOR CARDS

Amdek MAI 495.00
PC Peacock 299.00

OUR BEST BUY

IBM UP-GRADE KIT

INCLUDES 9 EA. 4164 200NS FOR EXPANSION
ON ALL IBM PRODUCTS WITH PARITY
\$52.00/per set

5 KITS \$48.00/per set

10 KITS 46.00/per set

APPLE FRANKLIN

MICRO-MAX

View Max 80 (80 Col for II +) 149.00

View Max 80E (80 Col w/64K Memory
Expands to 128K) 139.00

MICRO-SOFT

Premium Soft Card IIE 379.00

Multi-Plan 175.00

Softcard (Z80) 239.00

MICROTEK

Dumpling O (Expands to 64K) 139.00

Dumpling 64K/Interface and Graphics
64K Buffer 235.00

Dumpling GX-P/Par Interface Card
and Cable 99.00

Parallel Interface Board (RV611C) 61.00

BAM 16 (16K Add-on Memory) 55.00

Serial Interface 99.00

NOVATION

Apple Cat II w/software 269.00

ORANGE MICRO

Parallel Interface (No Graphics) 61.00

Grappler + (Graphics Interface) 119.00

Grappler + 16K (Buffer and 5 to 64K) 175.00

Buffer Board 135.00

TG PRODUCTS

Joy Stick—For Apple II + 38.00

Paddles 29.00

Selecta Port 38.00

VIDEX

Ultraterm 279.00

Videterm 179.00

VISTA

A800 Floppy Controller for 8" Drives 300.00

A-800-1 Cable 27.00

OUR BEST BUY

WESPER

WIZARD BPO (Same as Grappler + 16K
Specify Printer) 149.00

WIZARD IPI (Same as Grappler +
Specify Printer) 79.00

WIZARD EBO (Internal Buffer for Epson) 109.00

IBM DISK DRIVES

CDC

CDC 5 1/4" 9409 DS/DD 320K Quiet Drive 225.00

QUME

5 1/4" #142 - (40 TR) 320K 1/2 HGT Belt Drive
w/Brackets 200.00

PANASONIC — BEST BUY IN 1/2 HGT

5 1/4" JA-155 (40 TR) 320K 1/2 HGT Direct Drive
w/Brackets 199.00 ea.
2 for 385.00

TEAC

5 1/4" F-55B (40TR) 320K 1/2 HGT Direct Drive
(For Sanyo & IBM) w/Brackets 199.00 ea.
2 for 385.00

SHUGART DISK DRIVES

SA455L-1/2 HGT 320K DS/DD
w/BRACKETS 200.00 ea.
2 for 385.00

TANDON DISK DRIVES

TM 100-2A 320K DS/DD 209.00
TM55-2 1/2 HGT 320K DS/DD 249.00 ea.
w/BRACKETS 440.00 for 2

OUR BEST BUY

M.P.I.

B-52 (DS/DD) 320K (Saves Disk's & Disk Head)
Standard Size 180.00

TRADE YOUR 5 1/4" DRIVE

STANDARD SIZE
SGL SIDE/DBL DEN FOR DBL SIDE/DBL DEN
DRIVE \$75.00 ALLOWANCE
STANDARD SIZE
DBL SIDE/DBL DEN FOR 1/2 HGT DRIVES
(Your choice)
\$140.00 ALLOWANCE

APPLE DISK DRIVES

STANDARD SIZE

Micro Sci A-2 (35TR) 199.00

OUR BEST BUY

Micro-Sci XL (35TR) NEW .. 179.00
Same as A-2 Except Plastic Case

1/2 SIZE

Super 5" "Green" Thinline 163K 40TR
Belt Drive 189.00

Super 5" "Blue" Thinline 163K 40TR
Direct Drive 199.00

Super 5" "Red" Thinline 163K 40TR
Teac Drive 225.00

RANA

RANA 1 245.00

RANA 2 Dbl Sided 359.00

RANA 3 Quad Density 469.00

ALL DRIVES 1 YR. WARRANTY

APPLE DISK CONTROLLERS

Micro-Sci (35TR) 60.00

Generic (35TR) 50.00

Micro-Sci (40TR) 89.00

RANA 85.00

MAIL ORDER TOLL FREE

1-800-545-2633

TERMS

Open account to state supported universities &
companies with high Dun & Bradstreet rating.
3% surcharge on American Express only.
Visa, MC, Check or Money Order
U.S. funds only.
Minimum order \$15.00.

SUNNY LOW LOW COST POWER SUPPLIES (LINEAR & SWITCHING) FOR S-100, DISK DRIVES

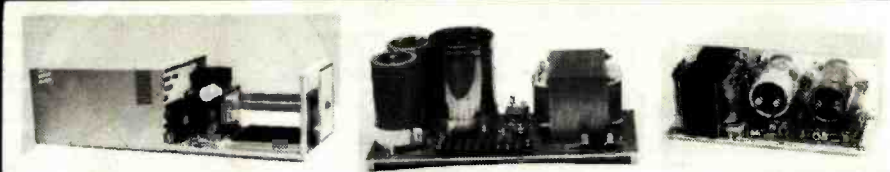

S-100 & DISK POWER SUPPLIES: OPEN FRAME, ASSY. & TESTED, 6 OUTPUTS, ADJU. & FUSES PROTECT.

| ITEM | IDEAL FOR | +5V OVP | -5V (or -12V) | +24V (OR +12V) | +8V | ±16V | SIZE W x D x H | PRICE |
|----------------|--|---------|---------------|----------------|-----|------|----------------------|--------|
| S ₃ | 12 SLOT & 2 FLOPPY (1 Floppy & 1 Hard Disk) | 5A | 1A | 5-7A PEAK | 13A | 3A | 10" x 6" x 5" | 105.95 |
| S ₄ | 6 SLOT & 2 FLOPPY | 4A | 1A | 4-5A PEAK | 8A | 3A | 8 3/4" x 5" x 4 3/4" | 95.95 |

No. 806 & No. 516 Mainframes Kit 1, 2 & 3 for S-100 R₂, R₃ for 2 Drives (Floppy & Hard)

DISK POWER SUPPLIES: OPEN FRAME, ASSY. & TESTED, REGULATED, ADJUSTABLE & FUSES PROTECT.

| ITEM | IDEAL FOR | +5V OVP | -5V (or -12V) | +24V (or +12V) | +8V Unreg. | ±12V | SIZE W x D x H | PRICE |
|----------------|---------------------------|---------|---------------|----------------|------------|------|-----------------------|-------|
| R ₀ | 2 x 8" SLIMLINE | 2.5A | | 2.5A - 5A Peak | | | 5" x 4" x 4" | 51.95 |
| R ₁ | 2 x 8" or 2 x 5 1/4" DISK | 4A | 1A | 3A - 5A Peak | 2A | | 8" x 4" x 3 3/4" | 56.95 |
| R ₂ | 3 x 8" (or 5 1/4") FLOPPY | 6A | 1A | 6A - 8A Peak | | | 10" x 4 7/8" x 3 3/4" | 71.95 |
| R ₃ | or 1x Floppy & 1x Hard | 6A | 1A | 6A - 8A Peak | | 1A | 9" x 6 1/4" x 4 3/8" | 98.95 |



S₃, S₄ for S-100 & 2 Drives

AC & DC POWER CABLES WITH CONNECTOR FOR 2 DRIVES 8.00

S-100 POWER SUPPLY KITS (OPEN FRAME WITH BASE PLATE, 3 HRS. ASSY. TIME)

| ITEM | (IDEAL FOR) | +8V | -8V | +16V | -16V | +28V | SIZE: WxDxH | PRICE |
|-------|-------------|-----|-----|------|------|------|-----------------------|-------|
| KIT 1 | 15 CARDS | 15A | --- | 2.5A | 2.5A | --- | 12" x 5" x 4 7/8" | 54.95 |
| KIT 2 | 20 CARDS | 25A | --- | 3A | 3A | --- | 12" x 5" x 4 7/8" | 61.95 |
| KIT 3 | DISK SYSTEM | 15A | 1A | 3A | 3A | 5A | 13 1/2" x 5" x 4 7/8" | 69.95 |

SHIPPING FOR EA. PWR SUPPLY: \$5.50 IN CALIF.; \$8.00 IN OTHER STATES; \$18.00 IN CANADA. FOR EA. TRANSFORMER: \$5.00 IN ALL STATES; \$12.00 IN CANADA. CALIF. RESIDENTS ADD 6.5% SALES TAX.

DEALER INQUIRIES INVITED

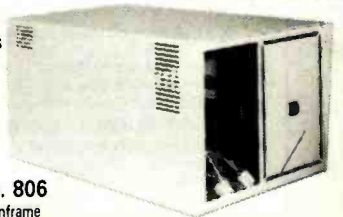

No. 806 Mainframe

6 SLOT MAINFRAME ASSY. & TESTED ONLY ~~\$399.95~~ \$299.95 + SHIPPING \$18.00

EACH MAINFRAME (ITEM NO. 806 OR 516) CONTAINS: EMI FILTER • FUSE HOLDER • AC POWER CORD • POWER SWITCH & INDICATOR • RESET SWITCH • 4 1/2" COOLING FAN • S-100 BUS 6 SLOT CARD CAGE • (110/220 VAC, 50/60 HZ.) POWER SUPPLY FOR DISK DRIVES & S-100 SLOTS • 2 EA. DC POWER CABLES WITH CONNECTOR AND MOUNTING HARDWARE FOR DISK DRIVES • 9 EA. CUT-OUTS; 7 FOR DB25 CONNECTOR, 1 FOR 50 PIN CONNECTOR & 1 FOR CENTRONICS • CUSTOM FINISH & LOGO-LESS • COMPACT SIZE • LIGHTWEIGHT, 28 LBS. ITEM #806 FOR 2 EA. 8" THINLINE FLOPPY (TANDON TM848-1 & 848-2 OR EQUIV.), OR ONE HARD DISK. POWER SUPPLY: +8V/8A, ±16V/3A, +5V/5A OVP, -5V/1A & 24V/5A. SIZE: 12" (W) x 19.5" (D) x 9.8" (H).

MAILING ADDRESS:
P.O. BOX 4296
TORRANCE, CA 90510
TELEX: 182558

SUNNY INTERNATIONAL
(TRANSFORMERS MANUFACTURER)
(213) 328-2425 MON-SAT 9-6

SHIPPING ADDRESS:
22129 1/2 S. VERMONT AVE
TORRANCE, CA 90502



COMPUTER CONNECTION
Printers, Monitors, Modems and Much, Much More!
SAVE 20% to 40%

STOP, LOOK & SAVE WITH OUR LOW, LOW PRICES

PERSONAL SYSTEMS

| | | |
|--|--------|--------|
| FRANKLIN | | |
| Ace 1000 w/color | \$ 799 | |
| Ace 1200 w/driver | 1399 | |
| 1200 OMS straight from the factory | 1689 | |
| Ace 1000 Pro Pak, drive, 80 col., s/twr. | 1169 | |
| KAYPRO | | \$1445 |
| Kaypro II w/software | | |
| APPLE | | \$1395 |
| Apple IIe Starter System | | |
| IBM | | \$1995 |
| IBMPC 64K, 1 Drive | | |
| IBMPC 64K, 2 Drives | | 2224 |
| SANYO | | \$ 795 |
| MBC 550 | | 369 |
| MBC 555 | | 1179 |

DISK DRIVES

| | | |
|--|--|--------|
| SIEMENS | | \$ 154 |
| FD 100-8 | | |
| TANDON | | \$ 219 |
| TM100-2 for IBMPC | | |
| TEAC | | \$ 189 |
| Double Sided 320K for Sanyo | | |
| Drives For Apple & Franklin | | |
| MICRO-SCI | | \$ 209 |
| A2 | | |
| QUENTIN RESEARCH | | \$ 199 |
| Apple Mate | | |
| RANA SYSTEMS | | \$ 229 |
| Elite I | | 369 |
| Elite II | | 369 |
| Elite III | | 439 |

PRINTERS

| | | |
|--------------------------------------|--|--------|
| OKIDATA | | \$ 299 |
| MLB2A, 10" carriage | | |
| MLB3A, 15" carriage | | 545 |
| ML92P, 160 cps | | 429 |
| ML93P, 160 cps | | 689 |
| STAR MICRONICS | | \$ 278 |
| Gemini 10X, 10", 120 cps | | |
| Gemini 15X, 15", 120 cps | | 409 |
| Delta 10, 10", 160 cps | | 469 |
| C. ITOH | | |
| Prowriter 8510 AP, 120 cps | | 339 |
| Prowriter II 1550 AP, 15", 120 cps | | 545 |
| Starwriter F10-40PU, 40 cps | | 989 |
| Printmaster F10-55PU, 55 cps | | 1345 |
| EPSON | | \$ 389 |
| RX80FT, 120 cps | | |
| FX80, 10" 160 cps | | 520 |
| FX100, 15" 160 cps | | 735 |
| JUKI | | \$ 469 |
| 6100 LQ 15", 18 cps w/propor. spac. | | |
| TOSHIBA | | \$1495 |
| P1350 (I) Dot Matrix, L.Q., graphics | | |

DISPLAY MONITORS

| | | |
|--------------------------------|--|--------|
| USI | | \$ 135 |
| PI 2 (12" Green) | | |
| PI 3 (12" Amber) | | 139 |
| GORILLA | | \$ 85 |
| Hi-Res. 12" Green | | |
| Hi-Res. 12" Amber | | 95 |
| AMDEK | | \$ 129 |
| V300G | | 149 |
| V300A | | 165 |
| V310A for IBMPC | | 289 |
| Color I, 13" Color Composite | | 399 |
| Color II, RGB | | |
| BMC | | \$ 89 |
| 12 UW (12" Green) | | |
| 9191 Color Composite | | 229 |
| 12 EUN 20MHz (Hi-Res) | | 129 |
| NEC | | \$ 109 |
| JB 1260, 12" Green | | |
| JB 1201M, 80 col. | | 155 |
| JB 1205M(A) w/audio | | 165 |
| JC 1203 Hi-Res Color IBM comp. | | 465 |
| TAXAN | | \$ 129 |
| 12N (12" Green) | | |
| 12NUY (12" Amber) | | 139 |

MODEMS

| | | |
|------------------------------|--|--------|
| HAYES MICRO | | \$ 205 |
| 300 Baud Smart Modem | | 475 |
| 1200 Baud Smart Modem | | 409 |
| 1200 B for IBMPC | | 259 |
| Micro Modem IIe w/Term. pkg. | | |
| NOVATION | | \$ 119 |
| J Cat 300 Baud | | 269 |
| Apple Cat II | | |

IBM ACCESSORIES

| | | |
|---------------------|--|--------|
| AST RESEARCH | | \$ 279 |
| Six Pak Plus | | 279 |
| Mega Plus II | | 289 |
| Combo Plus | | 129 |
| Io Plus II | | |
| QUADRAM | | \$ 459 |
| Quadlink | | 229 |
| Color Graphics Card | | |
| USI | | \$ 389 |
| Multidisplay Card | | |

PRINTER ACCESSORIES

| | | |
|-----------------------------------|--|--------|
| ORANGE MICRO | | \$ 119 |
| Grappier + | | 179 |
| Buffered Grappier +, 16k exp. 64K | | |
| WESPER | | \$ 89 |
| Wizard Personal Card & Cable | | |
| FOURTH DIMENSION | | \$ 49 |
| Par. Card & Cable for Apple | | |
| TRACTORS | | \$ 49 |
| Okidata for 82A & 92 | | 129 |
| Juki Bi-Directional | | 199 |
| Toshiba Bi-Directional | | |
| MICROTEK | | \$ 99 |
| Dumpling GX Graphic Interface | | 149 |
| Dumpling GX w/16K | | 165 |
| Dumpling GX w/32K | | 16 |
| Additional Buffering, 16K | | |
| CABLES | | \$ 29 |
| Any Computer to Parallel Printer | | |

IF YOU SEE IT ADVERTISED FOR LESS, CALL US FIRST FOR LOWEST QUOTE!

MAIL ORDER:

12841 S. Hawthorne Blvd., No. 585
Hawthorne, California 90250

ORDER DESK:
[213] 514-9019

Mon.-Fri. 8 a.m. to 6 p.m.
Saturday 11 a.m. to 3 p.m.

We accept VISA, MasterCard, C.O.D. (w/deposit), Certified Checks or Wire Transfers. Some items subject to back order. CA Res. add 6 1/2% Tax. Prices subject to change.

LycO Computer Marketing & Consultants

TO ORDER
CALL US

TOLL FREE 800-233-8760
In PA 1-717-327-1824

PRINTER
INTERFACING

PRINTER PAPER
AVAILABLE

SAVE on these in-stock PRINTERS

Available for IBM PC, Apple, Atari, Vic 20 & Vic 64

EPSON

LETTER QUALITY
SMITH CORONA TP2...\$449.00
DIABLO 630 ..\$1719.00

ALPHACOM 42\$89.00
ALPHACOM 81\$129.00
NEC 8023\$369.00
NEC 8025\$699.00
NEC PC-8200
COMPUTER\$CALL

RX-80\$SAVES
RX-80FTON
FX-80In-Stock
FX-100EPSON
MX-80FTPRINTERS
MX-100\$SCALLS\$

MANNESMANN TALLY

SPIRIT 80\$CALL
MT 160L.....\$CALL

OKIDATA

80\$SAVES
82ACALL for
83ALOWEST
84PRICES
92on these
93In-Stock
PACEMARK 2350...PRINTERS

**ATARI 850
REPLACEMENTS
IN-STOCK**

CITOH

GORILLA GX100\$179.00
PROWRITER 8510\$339.00
PROWRITER II\$659.00
8600\$1025.00
STARWRITER\$1099.00
PRINTMASTER\$1499.00

STAR MICRONICS

GEMINI 10X\$269.00
GEMINI 15X\$CALL
DELTA 10.....\$479.00

MODEMS

ANCHOR MARK I ..\$79.00
ANCHOR MARK II..\$79.00
HAYES SMART ...\$239.00
HAYES MICRO II \$309.00
Micro Bit
MPP-1000.....\$129.75
NOVATION
CAT\$144.00
D-CAT\$155.00
J-CAT\$115.00
APPLE CAT II\$279.00
212 APPLE CAT ..\$589.00

MONITORS

Sakata Color\$229.00
Amdek Color I\$275.00
Amdek 300 Green ..\$149.00
Amdek 300 Amber ...\$149.00
Gorilla Green\$99.00

HES 64

Sound Box\$9.95
64Forth\$55.75
Hesmon\$25.75
Turtle Graphics ..\$37.75
Heswriter\$28.75
Gridrunner\$19.75

DUST COVERS

800\$3.99
400\$3.99
1200\$3.99
410\$3.99
810\$3.99
1050\$5.99
PROWRITER\$5.99
GEMINI 10X\$5.99
PERCOM DISK\$5.99

SSI

Battle of Shilo\$26.75
Tigers in the Snow...\$26.75
Cosmic Balance\$26.75



APPLE DUMPING GX\$99.75
APPLE DUMPING 64 (16 Buffer)\$179.75

INFOCOM

Zork I, II, or III\$26.75
Deadline\$33.75

CARDCO

Cardprinter / LO1\$499.00
Cardprint DM1\$109.00
5 Slot Expansion 64\$54.00
64 Write NOW.....\$39.00
64 Mail NOW.....\$29.00
2 Write NOW.....\$29.00
64 Keypad\$29.00
Universal Cass. Int.\$29.75
Printer Utility\$19.75
6 Slot Expansion ..\$79.95
3 Slot Expansion ..\$24.95
PRINTERINTERFACE\$39.75
PRINTER INTERFACE with
full graphics\$65.75
LIGHT PEN\$29.75

SPINNAKER 64

Kindercomp\$21.75
Story Machine\$23.75
Face Maker\$23.75
Snooper Trooper.....\$29.75
Delta Drawing\$34.75
Shamus II c/d\$24.95
Pinhead c/d\$22.95

SYNAPSE 64

ZEPELIN C/D\$24.75
BLUE MAX C/D\$24.75
DIMENSION X C/D\$24.75
EPYX 64
ASPH R\$28.75
JUMPMAN JR R\$28.75
PIT STOP R\$28.75



BRODERBUND 64

BANK STREET
WRITER\$49.75
CHOPLIFTER\$24.75
LODE RUNNER\$24.75
DROL\$24.75
KOALA TOUCH TABLET...\$69.75



Computers for people:
Voice Box 2 ..\$99.75

600XL ...\$CALL
800XL..... for
1400XL... Lowest
1450 Prices
1050 DISK DRIVE\$SAVES
1010 RECORDER\$74.75

PARKER BROTHERS

Tutankham R.....\$33.75
Super Cobra R.....\$33.75
Astro Chase R.....\$33.75
Frogger R\$33.75
QBert R\$33.75
Popeye R\$33.75

Monkey Wrench 2 ..\$52.75
SPINNAKER
Story Machine R ..\$26.75
Face Maker R\$24.75
Kinderomp R\$20.75
Fraction Fever R ..\$24.75
Delta Drawing R.....\$26.75

BLANK DISKETTES ELEPHANT

Single Side 5D (10).....\$17.75
Single Side DD (10).....\$21.75
Double Side DD (10).....\$26.75

MAXELL

MD I (10)\$28.75
MD II (10)\$36.75

CERTRON CASSETTES

CC-10 12 for\$15.99
CC-20 12 for\$17.99

INNOVATIVE CONCEPTS

Disk Storage (holds 10).....\$4.95
Disk Storage (holds 15).....\$9.95
Disk Storage (holds 50).....\$26.95

TRAK DISK DRIVES

AT-D1\$379.00
AT-D2\$399.00
PRINTER CABLE\$22.95
Software for ATD-2\$22.95

RANA DISK DRIVE

COMPUTER CARE

BIB
5 1/4 DISK DRIVE
CLEANER\$12.75
COMPUTER CARE
KIT\$19.75

HARD DISK DRIVES for APPLE IBM-PC

5MEG.....\$1349.00
10MEG ...\$1599.00
15MEG ...\$1999.00
20MEG ...\$2359.00

*Add \$50.00 for TRS 80 Drives

TEXAS INSTRUMENT

Disk Drive...\$245.00



FOR ATARI COMPUTERS

AT88S1\$299.00
AT88S2\$535.00
AT**S1PD...\$439.00
RFD40S1...\$399.00
RFD40S2...\$675.00
RFD44S1...\$449.00
AT88 doubler



TO ORDER



Circle 232 on inquiry card.

POLICY

CALL TOLL FREE
800-233-8760

Customer Service 1-717-327-1825 Jersey Shore, PA 1774C

or send order to
LycO Computer
P.O. Box 5088

In-stock items shipped within 24 hours of order. Personal checks require four weeks clearance before shipping. No deposit on C.O.D. orders. Free shipping on prepaid cash orders within the continental U.S. PA residents add sales tax. All products subject to availability and price change. Advertised prices show 4% discount offered for cash, add 4% for MasterCard or Visa. DEALER INQUIRIES INVITED.

THE LITTLE BOARD®

OEM — INDUSTRIAL — SCIENTIFIC

SECOND GENERATION SINGLE BOARD COMPUTER KIT!

4 MHZ Z80* CPU! 64K RAM! DOUBLE DENSITY!

New!

FREE CP/M* 2.1!!!
A \$139 VALUE! A FREE
5-1/4 IN. CP/M 2.2
DISKETTE IS INCLUDED
WITH EACH KIT.

A. & T. UNITS
\$349

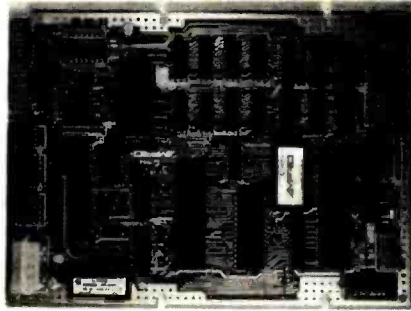

\$295⁰⁰
(COMPLETE KIT)

MINI-SIZE:
ONLY
5-3/4 x 7-3/4 INCHES

FULLY SOCKETED! PERFECT MATE TO OUR ZRT-80 TERMINAL BOARD. THROUGH SPECIAL ARRANGEMENT WITH AMPRO COMPUTERS, WE ARE PLEASED TO OFFER THEIR LITTLE BOARD® IN KIT FORM.

FEATURES:

4 MHZ Z80 CPU!

DOUBLE DENSITY (5-1/4 IN.) FLOPPY CONTROLLER

64K DYNAMIC RAM!

CENTRONICS STYLE PARALLEL PRINTER PORT

USES +5VDC @ .75 A. AND +12VDC @ 50MA

TWO RS232 SERIAL PORTS

SAME SIZE AS A MINI FLOPPY

2732 BOOT EPROM

Digital Research Computers

(OF TEXAS)

P.O. BOX 461565 • GARLAND, TEXAS 75046 • (214) 271-3538

TERMS: Shipments will be made approximately 3 to 5 weeks after we receive your order. VISA, MC, cash accepted. We will accept COD's with a \$75 deposit. Balance UPS COD. Add \$4.00 shipping.

USA AND CANADA ONLY

LITTLE BOARD® — AMPRO Z80™ — ZILOG CP/M™ DIGITAL RESEARCH (CA.)

RIBBON RE-INKERS

Introducing the **Pika-Ink™**, an incredible new device which extends the life of your fabric printer ribbons by a factor of TEN! Works with any fabric ribbon with 1/2-inch or narrower width. Automatically re-inks your ribbons either on or off the printer for consistent dark black print. Pays for itself on the first ribbon!

The **Pika-Ink™** is a kit which includes • Stainless steel ink reservoir • ball bearing assembly • transfer felts • 115v 60Hz electric motor • power cord • special computer ribbon ink (extra ink available). Comes with complete instructions. Requires assembly and fabrication with hand tools.

| | list | each | 3+ | 10+ |
|--------------|-------|------|------|------|
| Pika-Ink kit | \$129 | \$89 | \$84 | \$78 |

TERMINALS & PRINTERS

| | | | |
|-----------------|--------|-------------------|--------|
| Micro-Term E301 | \$875 | Datasouth DS220 | \$1945 |
| Visual 55 | \$850 | Daisy M45 | \$4385 |
| Visual 102 | \$1050 | Qume Sprint 11/40 | \$1495 |
| Visual 500 | \$2430 | Qume Sprint 11/55 | \$1795 |
| Qume QVT-102 | \$675 | Sprint Interface | \$90 |
| Qume QVT-108 | \$850 | Sprint Tractor | \$235 |

RS-232 BREAKOUT BOX

The **Pika-Box™** RS-232 I/O tester is the most advanced breakout box on the market today. An absolute necessity for anyone who uses or works with RS-232 peripherals, interfaces, or data lines. Saves hours of aggravation. Available in standard or deluxe tri-state models. **Lifetime warranty!**

- 25-pin male DCE and female DTE connectors.
- Individual LED's monitor pins, 2, 3, 4, 5, 6, 8, 15, 17, 20, 21, 22, 25, plus MARK and SPACE.
- 24 DIP switches allow signal lines to be individually interrupted.
- 25 test pins for monitoring or cross patching with included jumpers.
- Tri-State model displays signals as high, low, or invalid. 5 extra DIP switches for modem tests.
- Fits in shirt pocket. 2.9"x5.5"x1.5", wt. 8 oz., with batteries (included).
- Fully assembled, ready to use.



| | list | each | 3+ |
|--------------------|-------|-------|-------|
| Pika-Box | \$199 | \$179 | \$174 |
| Tri-State Pika-Box | \$249 | \$229 | \$221 |

RS-232 SWITCHES SAVE 40% TO 80%!

Allows several devices to share a single RS-232 data line. Enhances flexibility of your system and puts an end to juggling cables. You've heard them called AB switches or T-switches, and they have outrageous prices!

The **Pika-Switch™** is an economical alternative in kit form. You assemble it yourself and save 40% to 80%! Available in two models: 2-device (AB + common) with 3 female connectors, and 5-device (ABCDE + common) with 6 female connectors. Switches any 8 lines. Silver plated switch contacts, gold plated connector contacts. Complete, nothing else to buy.



| | each | 3+ |
|-------------------------|-------|-------|
| Pika-Switch # 2 (AB) | \$69 | \$67 |
| Pika-Switch # 5 (ABCDE) | \$145 | \$135 |
| Male Connector Option | \$5 | \$3 |

TERMS: All Sales exclusively by mail/phone order. Cash, check, money order, MC, Visa. No COD. Add \$4.50 shipping, NM residents add 4% tax. (Foreign customers: payment must be in U.S. funds drawn on a U.S. bank, add 10% for air shipment).

pika

ORDERS ONLY

Ask for Dept. 502

1-800-547-4000



In Oregon, and outside the U.S. call (503) 620-1602



Pika-Box

Div. of Applied Computing
Dept. 502

1808 Pomona Dr.

Las Cruces, N M 88001

Apple Country Ltd. has your Number for

ROCK BOTTOM PRICES



1-800-222-2602

MONITORS

| | |
|--------------------------|--------|
| AMDEK COLOR I PLUS | 294.95 |
| AMDEK COLOR II PLUS | 424.95 |
| AMDEK COLOR III | 369.95 |
| AMDEK COLOR IV | 749.95 |
| AMDEK VIDEO 300 (GREEN) | 134.95 |
| AMDEK VIDEO 300 (AMBER) | 144.95 |
| AMDEK VIDEO 310 (AMBER) | 164.95 |
| BMC 12" GREEN | 89.95 |
| BMC 13" COLOR | 249.95 |
| BMC 13" RGB AP2 COLOR | 349.95 |
| BMC 13" RGB IBM | 419.95 |
| COMMODORE COLOR 1702 | 289.95 |
| COMREX 13" COLOR W/SOUND | 269.95 |
| COMREX 12" HI-RES AMBER | 134.95 |
| COMREX 12" HI-RES GREEN | 129.95 |
| COMREX 12" HI-RES LT GRN | 129.95 |
| COMREX 13" RGB COLOR | 269.95 |
| GORILLA 12" AMBER | 99.95 |
| GORILLA 12" GREEN | 89.95 |
| NEC 12" HI-RES GREEN | 154.95 |
| NEC 12" ECONO GREEN | 109.95 |
| NEC 12" LO-RES COLOR | 289.95 |
| NEC 12" AMBER SCREEN | 164.95 |
| NEC 12" COLOR - IBM | 469.95 |
| PRINCETON GRAPHICS HK-12 | LOW 11 |
| SAKATA 13" GREEN | 264.95 |
| SAKATA 13" RGB COLOR | 499.95 |
| SAKATA SUPER RGB | 679.95 |
| SAKATA 12" GREEN | 109.95 |
| SANYO CTR-70 HIRE COLOR | 599.95 |
| SANYO AWC-255 25" RGB | 749.95 |
| SANYO DMC-6500 13" RGB | 399.95 |
| TAXAN 12" GREEN | 124.95 |
| TAXAN 12" AMBER | 129.95 |
| TAXAN RGB VISION I | 294.95 |
| TAXAN RGB VISION III | 439.95 |
| ZENITH 12" AMBER | 119.95 |
| ZENITH 12" GREEN | 99.95 |
| ZENITH RGB ZVM-135 COLOR | 549.95 |
| USI 9" AMBER PI-4 | 129.95 |
| USI 9" GREEN PI-1 | 119.95 |
| USI 12" AMBER PI-3 | 149.95 |
| USI 12" GREEN PI-2 | 139.95 |
| USI 14" LO-RES COLOR | 289.95 |

MODEMS

| | |
|---------------------------|--------|
| ANCHOR MARK I (RS-232) | 79.95 |
| ANCHOR MARK II (ATARI) | 79.95 |
| ANCHOR MARK III (TI99/4A) | 99.95 |
| ANCHOR MARK V (OSBORNE) | 94.95 |
| ANCHOR MARK VI (IBM PC) | 194.95 |
| ANCHOR MARK VII (RS-232) | 109.95 |
| ANCHOR MARK X11 (RS-232) | 279.95 |
| ANCHOR VOLKS MODEM | 64.95 |
| NOVATION J-CAT | 104.95 |
| NOVATION 212 AUTO CAT | 579.95 |
| SMARTCAT 212 (1200 BAUD) | 429.95 |
| SMARTMODEM 300 BAUD | 194.95 |
| SMARTMODEM 1200 BAUD | 484.95 |
| SMARTMODEM 1200B - IBM | 449.95 |
| US ROBOTICS AUTODIAL 212 | 449.95 |
| US ROBOTICS PASSWORD | 359.95 |

PRINTERS

| | |
|---------------------------|---------|
| ANAEX DP-9501A | 1029.95 |
| ANAEX DP-9625A | 1339.95 |
| ANAEX DP-9620A | 1129.95 |
| ANAEX WP-4500 | 1159.95 |
| ANAEX DP-6500TR 500CPS | 2329.95 |
| APPLE IMAGewriter | LOW11 |
| CENTRONICS 352 DP | 1999.95 |
| C.ITOH A10 DAISY WHEEL | 539.95 |
| C.ITOH 8510SP | 499.95 |
| C.ITOH 8600BP | 979.95 |
| COMREX CR-II DAISY WHEEL | 629.95 |
| COMREX CR-II DAISY WHEEL | 469.95 |
| DAISYWRITER 2000 48K | LOW11 |
| DELTA-10 | LOW11 |
| EPSON FX-80 W/TRACTOR | LOW11 |
| EPSON FX-100 F/T | LOW11 |
| EPSON MX-100 F/T | LOW11 |
| EPSON FX-80 | LOW11 |
| EPSON FX-80 F/T | LOW11 |
| GEMINI 10X | LOW11 |
| GEMINI 15X | LOW11 |
| GORILLA BANANNA | 189.95 |
| IDS MICROPRISM 480 | 479.95 |
| IDS PRISM 132 | 239.95 |
| IDS PRISM 132 - COLOR | 1499.95 |
| JUKI 6100 PRINTER (P) | 449.95 |
| MANNESMANN TALLY MT160L | 599.95 |
| MANNESMANN TALLY MT180L | 799.95 |
| MANNESMANN TALLY MT1802 | 1499.95 |
| MANNESMANN TALLY SPIRIT | 399.95 |
| NEC 3550 SPINWRITER-IBM | 1754.95 |
| OKIDATA MICROLINE 80 | LOW11 |
| OKIDATA PACEMARK 2350S | LOW11 |
| OKIDATA PACEMARK 2410P | LOW11 |
| OKIDATA PACEMARK 2410S | LOW11 |
| OKIDATA 82A W/OKIGRAPH | LOW11 |
| OKIDATA 83A W/OKIGRAPH | LOW11 |
| OKIDATA 84P | LOW11 |
| OKIDATA 84P | LOW11 |
| OKIDATA 92P | LOW11 |
| OKIDATA 93P | LOW11 |
| OKIDATA 93S | LOW11 |
| PANASONIC P1090 | 329.95 |
| PRINTMASTER (DAISY) | 1549.95 |
| PROWRITER I (8510P) | 344.95 |
| PROWRITER II (1550P) | 619.95 |
| QUME SPRINT 11/40+ | 1399.95 |
| SANYO PR5500 DAISY WHEEL | 659.95 |
| SILVER-REED 550 DAISY | 699.95 |
| STARWRITER DAISY WHEEL | 1099.95 |
| TOSHIBA P-1350 LP | 1579.95 |
| TRANSTAR 315 COLOR | 449.95 |
| TRANSTAR 120P 14CPS | 464.95 |
| TRANSTAR 130P 18CPS | 699.95 |
| TRANSTAR 140P 40CPS | 1229.95 |
| MICROBUFFER (EPSON RS232) | 134.95 |
| GRAFITTI CARD (APPLE) | 84.95 |
| GRAPPLER + (APPLE) | 119.95 |
| MICROBUFFERII 16K (APPLE) | 144.95 |
| PKASO PRINTER I/F (APPLE) | 429.95 |
| WIZARD BPO 16K (APPLE) | 129.95 |
| WIZARD SOB 16K (APPLE) | 179.95 |

OTHER PRINTERS AVAILABLE

COMPUTERS

| | |
|-----------------------------------|--------------------------------|
| APPLE IIe STARTER SYSTEM | LOW11 |
| APPLE MACINTOSH COMPUTER | LOW11 |
| COMMODORE 64 COMPUTER | LOW11 |
| COMMODORE 1541 DISK DRIVE | LOW11 |
| COLUMBIA VP PORTABLE | LOW11 |
| COLUMBIA 1600-1 COMPUTER | LOW11 |
| IBM-PC COMPATIBLE SYSTEM | 499.95 |
| 128K, 2-DS/DD DRIVES, KEYBOARD | WITH COMPLETE SOFTWARE PACKAGE |
| EAGLE PC PLUS-2 SYSTEM | 3199.95 |
| 128K, 2-DS/DD DRIVES, | MONITOR, EAGLEWRITER, MS-DOS, |
| EAGLECALC, & CP/M-86 | |
| EAGLE SPIRIT-II | 2549.95 |
| EAGLE SPIRIT-XL | 3649.95 |
| PORTABLE 128K EXPANDABLE TO | 640K ON BOARD, 1 320K FLOPPY, |
| 10 MEGABYTE HARD DISK, IBM | COMPATIBLE KEYBOARD, 2 SERIAL |
| 1 PARALLEL PORT, MS-DOS 2.0, | MONOCHROME MONITOR, CP/M 86 |
| NEC APC-H01 | 2049.95 |
| NEC APC-H02 | 2549.95 |
| NEC 8201 COMPUTER | 609.95 |
| SANYO 550 COMPUTER | 769.95 |
| SANYO 555 COMPUTER | 1049.95 |
| TELEVIDEO TPC-1 | LOW11 |
| IBM COMPATIBLE SYSTEM | |
| WILDCAAT STARTER SYSTEM | 1399.95 |
| APPLE II COMPATIBLE SYSTEM | 64K, DETACHABLE KEYBOARD, |
| 2 APPLE COMPATIBLE DISK DRIVES, | HI-RES 12" GREEN MONITOR, |
| RGB & COMPOSITE COLOR OUTPUT, | 2 CPU'S (2-80 A & 6502), |
| 80-COLUMN CARD & JOYSTICK | |
| ZORBA PORTABLE COMPUTER | 1399.95 |
| BUILT IN 7" GREEN SCREEN, | 2 DS/DD DISK DRIVES, RS-232, |
| PARALLEL, IEEE488 BUS, KEYBOARD | EMULATION MODE FOR OSBORNE I, |
| KAYPRO II, XEROX 820, DEC VT-180, | CROMEMO 520, TELEVIDEO 802 |
| AND MANY MORE! | |
| WORDSTAR, MAILMERGE, CALCSTAR, | C-BASIC, CPM 2.2, M-80 |
| ATARI HARDWARE | |
| ALIEN VOICE BOX | 99.95 |
| KOALA PAD TOUCH TABLET | 79.95 |
| RANA 1000 DS/DD DRIVE | 299.95 |
| TRAK AT-D2 DS/DD DRIVE | 399.95 |
| DISKETTES | |
| SS/SD ELEPHANT 16.95 | OPUS 15.95 |
| SS/DD ELEPHANT 19.95 | OPUS 17.95 |
| DS/DD ELEPHANT 25.95 | OPUS 24.95 |

APPLE HARDWARE & SOFTWARE

| | |
|---------------------------|--------|
| 4TH DIMENSION DRIVE-ONLY | 199.95 |
| 4TH DIMENSION DRIVE+CTRL | 289.95 |
| ALS CP/M CARD | 299.95 |
| APPLE-CAT II MODEM | 264.95 |
| BANK STREET WRITER | 54.95 |
| BUFFERED GRAPPLER+ | 189.95 |
| d-BASE II (REQ Z-80) | 449.95 |
| HAYES MICROEMD IIe | 234.95 |
| MACH II JOYSTICK IIe | 34.95 |
| MASTERTYPE | 29.95 |
| MICROBUFFER II+ 16K (P) | 99.95 |
| PKASO/U PRINTER I/F | 134.95 |
| PREMIUM SOFTCARD IIe | 334.95 |
| QUADRAM 64K80COL CRD IIe | 124.95 |
| VIDEX VIDEOTERM W/SFTSW | 239.95 |
| VIDEX ULTRATERM | 279.95 |
| WORDSTAR W/ APPLICARD | 299.95 |
| IBM | |
| HERCULES GRAPHICS CARD | 379.95 |
| KOALA PAD TOUCH TABLET | 99.95 |
| KRAFT JOYSTICK | 54.95 |
| MICROPRO PRO PACK | 429.95 |
| MICROSOFT SYSTEMCRD 256K | 229.95 |
| MICROSOFT MOUSE | 134.95 |
| MOUSE SYSTEMS PC MOUSE | 224.95 |
| QUADCHROME MONITOR | 549.95 |
| QUADLINK APPLE EMULATOR | 489.95 |
| QUADRAM QUADBOARD I 64K | 289.95 |
| QUADRAM QUADBOARD II | 229.95 |
| RANA DS/DD DISK DRIVE | 299.95 |
| STX SUPER I/O MULTIFUNCT | 169.95 |
| TG JOYSTICK W/TOGGLE | 49.95 |
| TRANSEND P.C. MODEM 1200 | 399.95 |
| VERSAWRITER GRAPH TABLET | 239.95 |
| WIZARD SPOOLER P/S 16K | 239.95 |
| COMMODORE 64 | |
| CALC RESULT ADVANCED | 109.95 |
| CARDBOARD/5 5 SLOT EXPAN. | 54.95 |
| CARD? GRAPHICS INTERFACE | 64.95 |
| DATA20 Z-80 VIDEOCAP | 224.95 |
| DELPHI'S ORACLE DATA BASE | 99.95 |
| DISKEY | 39.95 |
| DONKEY | 37.95 |
| EASY SCRIPT64 | 34.95 |
| EASY SPELL 64 | 34.95 |
| ELECTRONIC CHECKBOOK | 19.95 |
| FLIGHT SIMULATOR II | 39.95 |
| HOME ACCOUNTANT | 59.95 |
| HOMEWORD WORD PROCESSOR | 49.95 |
| KOALA PAD TOUCH TABLET | 79.95 |
| MSD-SD1 DISK DRIVE | 339.95 |
| MULTIPLAN | 74.95 |
| OMNI-CALC | 39.95 |
| PAPER CLIP W/P | 69.95 |
| PAC-MAN | 37.95 |
| PEBEY | 39.95 |
| ROBOTRON | 37.95 |
| S.A.M. | 44.95 |
| SARGON II | 27.95 |
| VOICE BOX | 99.95 |

We will try to meet or beat any advertised price!
CALL US... WE CAN HELP! 1-800-222-2602

For technical assistance, order status and California calls (619) 765-0239
 Apple Country, Ltd., P.O. Box 1099, 2602 Washington St., Julian, Calif. 92036

Terms. We accept American Express. No extra charge for Visa/MasterCard, Cashier's Check, personal check (allow 2 weeks to clear) Shipping & Handling: 5% (\$5 min.); APO FPO Alaska Hawaii & Monitors 5% (\$10 min.) Foreign orders 15% (\$15 min.) All items are new with manufacturer's warranty. Prices are subject to availability & change without notice. Purchase order must include check. California residents add 6% sales tax. Send \$1 (good toward first purchase) for new fall catalog.

Apple Country, Ltd. is a **DISCOUNT MAIL ORDER HOUSE** for the micro computer industry and is a California corporation not affiliated with Apple Computer Inc. Apple is a trademark of Apple Computer Inc.



MICROMAIL™

THE PC SYSTEM SPECIALIST

PRICES AND AVAILABILITY SUBJECT TO CHANGE WITHOUT NOTICE



SPECIAL OF THE MONTH!



A Superior quality IBM PC Compatible Personal Computer. Runs DOS 1.1, 2.0, 2.1, CP/M86[®] UCSD p-System[®], Runs Lotus 1-2-3[®], Multiplan[®], Word Star[®], PFS[®], dBASEII[®], and many more! Hardware includes 128K CPU, Floppy Controller, Two DS/DD Disk Drives, Video Monitor, Video Adaptor, Parallel & Serial Ports.



IBM
PERSONAL COMPUTER
Special of the Month!

IBM PC[®] COMPLETE LINE

COMPLETE SYSTEM VERY SPECIAL PRICE

64K, Two Disk Drives, Floppy Disk Controller, Video Card and High Res Monitor **\$2590**

256K RAM, 360KB Disk Drive, FDC, Video Monitor & Adaptor 10MB Hard Disk Sub-System. **\$3990**

CALL FOR LOW PRICE

Suggested List \$2395.00

HARD DISKS FOR IBM PC[®]

10 MB Hard Disk Sub-System by TAVA CORP. includes Software, Cables, etc. Internal. **\$1295**

SLIMLINE DISK DRIVE FOR IBM PC

DS/DD 320KB By TAVA CORP **\$190**

ADD-ON Disk Drive for IBM PCjr[®] **CALL**

MEMORY BOARDS

CONOGRAPHIC

High Res. Color Graphics Card **\$995**

QUADRAM

Quad Card. Fully pop. 256K **\$450**

QUADLINK

CALL

AST SIXPAK 384K

CALL

HERCULES Graphics Card

\$490

APPLE IIe

Computer System, Controller, Two Disk Drives, Monitor **\$1590**

ROMAR II Apple Compatible Computer W/Z-Card Controller, Two Disk Drives and a Monitor for **\$1195**

DISK DRIVE FOR APPLE

Slimline, or Standard **\$190**

NEC TANDON TAVA IBM APPLE QCS MAYNARD

PRINTERS

DAISYWRITER 2000 **CALL**

OKIDATA

| | | | |
|-----|-------|-----|-------|
| 82A | \$425 | 84A | \$975 |
| 83A | \$650 | 92A | \$525 |
| 93A | | | \$850 |

BROTHER

| | |
|-------|-------|
| HR-1 | \$675 |
| DX-15 | \$450 |

MONITORS

AMDEK

| | | | |
|------|----------|-----|-----------|
| 300A | \$190.00 | I | \$340.00 |
| 300C | \$160.00 | II | \$690.00 |
| 310A | \$190.00 | III | \$390.00 |
| IV | | | \$1190.00 |

PRINCETON GRAPHICS SYSTEMS

Hi-Res Color **\$490**

LNW ROMAR TOSHIBA PRODUCTS AVAILABLE

MICROMAIL

631 E. First St., Tustin, CA 92680

(714) 838-9100

*IBM PC is a registered trademark of IBM Corp.
*dBASE II is a registered trademark of ASHTON-TATE, Inc.
LOTUS 1-2-3 is a registered trademark of Lotus Development
Wordstar, Spellstar, Mailmerge are registered trademarks of Micropro International
Visicalc is a registered trademark of Visicorp

Multiplan is a registered trademark of Microsoft Corp
PFS is a registered trademark of Software Publishing Co.
CP/M86 is a registered trademark of Digital Research, Inc.
MS-DOS is a registered trademark of Microsoft Corp.
UCSDp is a registered trademark of Softech Microsystems

The World's Lowest Prices Are Now A Reality!

COLUMBIA DATA PRODUCTS

• IBM PC Compatible • 128K Main Memory
• 8 Expansion Slots • 2 Serial and One Parallel Port Built In • 2 Double Sided/Double Density 320K Drives • Over \$3000 Free Software Including:

- Perfect Writer/Speller
- Perfect Filer/Calc.
- Home Accountant
- Fast Graphs
- MS DOS/CP/M and more!

**PRICES
TOO
LOW TO
PUBLISH**

**CALL FOR PRICE OF IBM PC
FOR IBM PC**

| | |
|-----------------------------------|----------|
| QUADRAM | |
| Quadboard I w/64K | \$275.95 |
| Quadlink | \$475.95 |
| Microfazer | \$CALL |
| MAYNARD CONTROLLERS | \$CALL |
| BABY BLUE CP/M card w/Z-80 | \$CALL |
| AST | |
| Six Pak Plus | \$285.95 |
| Mega Plus | \$385.95 |
| Combo Plus | \$285.95 |
| I/O Plus | \$245.95 |
| KEYTRONICS KEYBOARDS | \$225.95 |
| AMDEK | |
| MAL Monochrome + RGB | \$495.95 |
| TECMAR | |
| Captain | \$CALL |
| 1st Mate | \$CALL |
| Graphics Master | \$CALL |

FRANKLIN COMPUTER SYSTEMS

Complete Starter System

Ace 1000 Pro Pak Plus featuring:

- Ace 1000 computer w/64K
- Ace 10 disk drive w/controller card
- 80 column card
- Franklin monitor
- FREE SOFTWARE PACKAGE Including:
 - Ace writer
 - Ace calc
 - Data Perfect
 - Welcome package

**CALL
FOR
LOWEST
PRICE**

Complete Business Starter

Ace 1200 OMS package featuring:

- Ace 1200 computer (128K total)
- 2 Ace 10 disk drives w/controller card
- CP/M carr w/Z-80 & operating system
- 80 column card
- Parallel and serial interface
- FREE SOFTWARE PACKAGE Including:
 - Wordstar
 - Ace calc
 - Mailmerge
 - Welcome package
 - CP/M

**CALL
FOR
LOWEST
PRICE**

SOFTWARE

| | APPLE | IBM |
|--------------------------|----------|----------|
| Supercalc 3 | — | \$274.95 |
| Visicalc IV | \$ CALL | \$ CALL |
| Home Accountant | \$ 44.95 | \$104.95 |
| Dollars And Sense | \$ 69.95 | \$124.95 |
| Micro Cookbook | \$134.95 | \$134.95 |
| Bank Street Writer | \$ 44.95 | \$ 44.95 |
| Tax Advantage | \$ 41.95 | \$ 41.95 |
| Multiplan | \$184.95 | \$184.95 |
| The General Manager | \$154.95 | — |
| TK Solver | — | — |
| BPI-GEN Acct/Inv/Payroll | \$274.95 | \$414.95 |
| BPI-Job Costing | \$414.95 | — |
| Word W/Mouse | — | \$334.95 |
| Wordstar Professional | \$434.95 | \$434.95 |
| Screenwriter II | \$ 64.95 | — |
| Sensible Speller | \$ 84.95 | — |
| PFS: Write/File/Report | \$ 79.95 | \$ 94.95 |
| Peachtext 3000 | — | \$284.95 |
| Lotus 1-2-3 | — | \$314.95 |
| DB Master (Version 4) | \$284.95 | \$394.95 |
| DBASE II | \$444.95 | \$444.95 |
| Friday | — | \$194.95 |

DISK DRIVES FOR IBM

| | |
|--------------------------------|----------|
| TANDON | |
| TM 100-2 DS/DD 320K | \$215.95 |
| TM 55-2 DS/DD 320K half-height | \$215.95 |
| CDC DS/DD 320K for IBM | \$235.95 |
| PANASONIC/NATIONAL | |
| Half-height 320K DS/DD | \$195.95 |

DISK DRIVES FOR APPLE

| | |
|-----------------------|----------|
| Alps half-height | \$185.95 |
| Quentin | \$195.95 |
| Rana Elite I | \$CALL |
| Rana 1000 (for Atari) | \$CALL |
| Micro Sci | \$CALL |

HARD DISK DRIVES

We carry a full line of Winchester hard disk drive systems for IBM and Apple computers all at...

LOW, LOW PRICES

MODEMS

| | |
|---|----------|
| D.C. HAYES | |
| Smartmodem 300 BAUD | \$199.95 |
| Smartmodem 1200 BAUD | \$475.00 |
| Smartmodem 1200B w/SC II | \$419.95 |
| Smartmodem Ite w/SC II | \$239.95 |
| Chronograph | \$189.95 |
| U.S. ROBOTICS | |
| 300 BAUD | \$169.95 |
| Auto Dial 1200 | \$449.95 |
| Password | \$339.95 |
| NOVATION | |
| J-Cat | \$119.00 |
| Apple-Cat II | \$CALL |
| ZOOM | |
| Networker™ apple modem w/software | \$119.95 |
| Netmaster™ advanced communications software | \$ 39.95 |

MEMORY CHIPS

*** RAM SPECIAL ***

4164 64K Dynamic Ram per chip \$5.95

DISKS

| | |
|--------------------------|----------|
| Dysan SS/DD box of 10 | \$ 26.95 |
| Dysan DS/DD box of 10 | \$ 36.95 |
| Verbatim SS/DD box of 10 | \$ 23.95 |
| Verbatim DS/DD box of 10 | \$ 31.95 |
| ESK SS/DD box of 10 | \$ 18.95 |
| ESK DS/DD box of 10 | \$ 25.95 |

Apple Special of the Month

Graphics Printer Interface Card \$89.95
For Apple II family and Franklin
Just like Grappler

MONITORS

| | |
|----------------------------|----------|
| AMDEK | |
| Video 300 (Green) Med-Res | \$134.95 |
| Video 300A (Amber) Med-Res | \$144.95 |
| Video 310 (Amber) for IBM | \$175.95 |
| Color I+ composite | \$290.95 |
| Color II+ RGB | \$394.95 |
| TAXAN | \$CALL |
| NEC | \$CALL |
| LEADING EDGE | |
| Gorilla (Green) Hi-Res | \$ 89.95 |
| Gorilla (Amber) Hi-Res | \$ 95.95 |
| ZENITH | |
| ZVM-123 (Green) Med-Res | \$109.95 |

*** PRINCETON GRAPHICS ***

RGB MONITOR \$475.00
Special this month only

PRINTERS

| | |
|--------------------------------|----------|
| C. ITOH | |
| NEW HOT DOT | |
| Lightning fast 180 CPS | \$CALL |
| Prowriter I | |
| 8510 Parallel 120 CPS | \$354.95 |
| 8510 Serial 120 CPS | \$475.95 |
| Prowriter II | |
| 1550 Parallel | \$595.95 |
| 1550 Serial | \$675.95 |
| OKIDATA | |
| ML-82A 120 CPS Par/Ser | \$319.95 |
| ML-92P 160 CPS 80 Col Par | \$459.95 |
| ML-93P 160 CPS 132 Col Par | \$779.95 |
| EPSON | \$CALL |
| STAR MICRONICS | |
| Gemini 10X 120 CPS 80 Col Par | \$CALL |
| Gemini 15X 120 CPS 132 Col Par | \$CALL |
| LETTER QUALITY PRINTERS | |
| JUKI 6100 | \$439.95 |
| C. ITOH F-10 40 CPS | \$995.95 |
| BROTHER | |
| Dynax DX-15 | \$478.95 |
| Dynax DX-25 | \$769.95 |
| NEC Splnwriter | \$CALL |

PAPER/CABLES/RIBBON

Send orders and inquiries to:

Computer Apparatus™

5025 Ward Road, Box 414 • Wheat Ridge, Colorado 80033
Telephone Inquiries: (303) 759-9251
Monday thru Friday — 9:00 a.m. to 5:00 p.m. (Mountain Standard Time)

**We built our reputation on low prices
for the informed computer user.**

DELIVERIES: 2 - 4 weeks average.
PERSONAL CHECKS: Cashier's check and money order will receive shipping preference.
VISA & MASTERCARD: Add 4% to total.
CATALOG: Send for full pricing details.
Prices subject to change without notice.
SHIPPING: UPS add \$2.00 plus 3% of order total, or we calculate exact freight.
ALL BRANDS ARE REGISTERED TRADEMARKS

The **FD-PC8™** is a new 8" double-sided disk drive sub-system



IBM PC styling.

The FD-PC8 looks like your other IBM PC components. Same styling. Same color. Same dimensions. It stacks neatly under, on top of, or next to your IBM PC, and better still, is only one-half the height of standard 8" drives. Matches Z100 & others also.

2 Drive System—\$1495 complete with cables.

SPECIFICATIONS

- Full one year warranty on materials and workmanship.
- Two fully assembled and tested Shugart double-sided 8" drives also available in one drive configuration.
- Exactly 1/2 the height of standard 8" drives.
- IBM PC styled and painted cabinet.
- All cabling included.
- IBM 3740 format compatible.
- No-mar rubber feet.
- Sturdy construction easily supports PC or monitor.
- Power supply designed for long life, trouble-free operation.
- Requires Maynard controller for use on PC.

NEW! FD-PC5™

This versatile new disk drive enclosure comes completely tested and assembled with a 4" cooling fan, and is designed to offer a variety of mounting options, with the power supply rated for any of the following:

- full-size floppy disk drive
- full-size hard disk
- one or two half-height floppy disk drives
- one or two half-height hard disks
- one or two 3.5" drives

Full 1 year warranty—cable choice optional

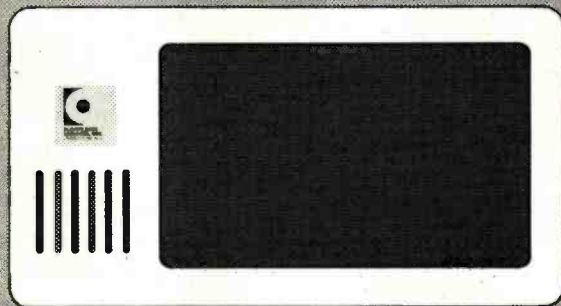

DISK DRIVES and other Goodies!

| | |
|--|---------------------|
| Shugart (1 year war.) | |
| sa-860 ds/dd half hgt 8" | \$505.00 2 @ 495 ea |
| sa-455 ds 48tpi 1/2 hgt 5.25" | 245.00 2 @ 230 ea |
| sa-465 ds 96tpi 1/2 hgt 5.25" | 295.00 2 @ 275 ea |
| sa-300 ss 96tpi 3.5 inch | 265.00 2 @ 250 ea |
| sa-851 ds 8" full size | 495.00 2 @ 480 ea |
| W.S.T. (formerly SIEMENS) | |
| FDD-100-5B4 floppy 5.25" | 235.00 |
| FDD-211-5 DS 48tpi for PC | 265.00 |
| FDD-221-5 DS 96tpi full size | 335.00 |
| FDD-100-5C3 (sa-400 compatible) | 175.00 |
| Heath H-89 TWOET kit ... | |
| put 2 half height floppies internal to the H-89 with our exclusive mounting kit, call for details! | |
| Maynard Electronics for the IBM-PC | |
| Memory module (bare) | 210.00 |
| 64K | 305.00 |
| 128K | 410.00 |
| 192K | 510.00 |
| 256K | 615.00 |
| With serial port add | 100.00 |
| With 2 serial ports | 160.00 |
| Controller w/mod ports | 265.00 |
| FDC8 8" controller | 245.00 |

| | |
|-----------------------------------|-------------|
| Standard controller | \$195.00 |
| Controller w/par port | 275.00 |
| Controller w/ser port | 285.00 |
| Hard disk module | 495.00 |
| Modular board | 110.00 |
| Multidisplay (mono & color board) | 575.00 |
| PGS, HX-12 RGB color monitor | 525.00 |
| Magnolia controller for the H-89 | 375.00 |
| Data connectors of all types | CALL |
| Power connectors for all drives | CALL |

We offer a wide assortment of enclosure sizes, styles and systems, including both 5 1/4" and 8" IBM look-alikes, and more. All are well constructed, attractive and immediately available at competitive prices. Call for details and prices.

IMPORTANT NEWS!

We are moving, please take note of our address. Our new and expanded facilities will permit us to offer a higher level of service than ever before. Our growth is the result of your patronage; we thank you for it sincerely.

TERMS: MC, VISA, PREPAID. NO COD'S. PERSONAL CHECKS HELD FOR 10 DAYS. WE ALSO ACCEPT P.O.'S FROM MAJOR BUSINESSES & UNIVERSITIES, CALL FIRST.

Toll Free Order Line 800-223-0306

Ask for our free catalog.

MEGA-BOARD™

new!

Ideal for

- **COMPUTERISTS**
- **OEM MANUFACTURERS**
- **DEVELOPMENT LABS**
- **UNIVERSITIES**
- **INDUSTRIAL APPLICATIONS**

THE ULTIMATE OEM/PC COMPATIBLE SINGLE BOARD COMPUTER

FULL IBM - PC* COMPATIBILITY!

DEALERS AND OEM MANUFACTURERS QUANTITY DISCOUNTS AVAILABLE

Standard Keyboard Interface
(Full PC compatible)

Hardware Reset
(Overcomes reset flaw in PC)

Eight Compatible I/O Interface Connectors

(Full PC compatible)
(compatible with all IBM-PC* plug-in cards)

Power Connector
(Full IBM* pinout compatible)

Special J1 Interface

(Allows horizontal mounting of compatible expansion cards for easy bus expansion and custom configuring) (Board has 62 pin gold plated compatible connector)

8088 Processor
(Same as PC)

8087 Numeric Processor
(Same as PC)

Peripheral Support Circuits
(Same as PC)

Extended ROM Capability

(Runs all compatible PC ROMS) (Jumper programmable to accommodate all popular 8K, 16K, 32K and 64K ROM chips and NEW EE ROMS! VPP power pin available for EP ROM burning!) (External VPP voltage required)

Configuration Switches
(Same as PC)

Speaker/Audio Port
(Same as PC)

Board Size

10.5 inch X 13.5 inch

Wire Wrap Area
To facilitate special custom applications!

ORDER NOW!!!

Full Mega-Byte Ram Capacity! On board!

- (With parity)
- 256K Bytes using 64K chips
 - 1 Mega Bytes using 256K chips

ONLY!
\$99.95
Evaluation Board Kit

MEGA-BOARD™ Evaluation Board Kit!

(Blank board with full assembly instructions and parts list.)

Includes highest quality PC board with gold plating, silk screen, solder mask

- MEGA-BOARD™** with full assembly instructions \$99.95
- USERS MANUAL** with theory of operation, schematics, block diagram, application notes \$19.95
- MEGA-BIOS™** fully compatible MS-DOS/PC-DOS BIOS \$29.95

ORDER NOW!!!

SATISFACTION GUARANTEED!

10-day money back guarantee if not completely satisfied.

DTC™ DISPLAY TELECOMMUNICATIONS CORPORATION

4100 SPRING VALLEY ROAD
SUITE 400
DALLAS, TX 75234
(214) 991-1644

TERMS: Shipment made 2 to 5 weeks from receipt of order. VISA, MC, money order, company check accepted. COD'S require \$25 deposit. Balance UPS COD. Please add \$2.00 shipping and handling per order.

*IBM and IBM PC are trademarks of International Business Machines

Freedom - Freed the Prices!

We have met or have beaten most advertised prices.

Buy Direct!



DTC 380 Z
 32 CPS
 48K Buffer
 Serial and Parallel
 1 Year Warranty
 380 Z \$ Unbeatable
 38K STARWRITER .. \$ Unbeatable



Mannesmann Tally
 • Standard — 7 x 9 160 CPS
 • NLO — 40 x 18 40 CPS
 • 2K Buffer and Tractor Standard
 160 L 80 col. Call **Best Seller**
 180 L 132 col. Call **Best Seller**
 Spirit Call **Best Seller**



IDS
 • Proportional Spacing
 • 8 Character Styles
 • 200 CPS Bi Directional
 • Color Optional
 • Sheet Feed • Graphics
 • 3.4K Buffer
 Prism 80 \$ Call
 Prism 132 and Micro Prism \$ Call
 Auto Cassette Sheet Feed \$ Call



Star Micronics
Gemini 10X + 15X
 120 CPS \$ Call
 Delta 10X
 160 CPS \$ Call
 STX-80 \$ Call



EAGLE
OUR PC FLYS
 IBM Compatible
 Simply a better PC. All models
 available for immediate delivery
 Call **Lowest \$**



Juki 6100
 18 CPS IBM Ribbons
 Diablo Compatible 2K Buffer
Best Value Yet \$ Call



THE BENCHMARK
It's a Piece of Cake!
 High Quality Software
 for Personal Computers

- Word Processor
 - Mail List
 - Spelling Checker
 - Telecom
- NEW!**
- Graphics Package
 - Financial Planner
 - Data Manager

Call for Prices!



Red Hot Special!
Novation J-CAT

- 300 BPS Modem
 - Originate/Auto Answer
- Sizzling** **\$89.50**

DAISYWRITER
 FRANKLIN
 ALTOS
 ZENITH
 TELEVIDEO
 SANYO
 USI
 TRANSTAR
 PIED PIPER
 RANA
 STB
 QUADRAM
 PRINCETON GRAPHICS

VENTEL
 AMDEK
 BMC
 TAXAN
 DIABLO
 NEC
 EPSON
 PRINTEK
 MOLECULAR
 UDS
 SILVER-REED

U.S. ROBOTICS
 OKIDATA
 COMREX
 JUKI
 STAR
 NORTHSTAR
 ADDS
 KIMTRON
 INTERCOLOR
 COLUMBIA
 CORONA
 TEXAS INSTRUMENTS

C. ITOH
 DEC
 AMPEX
 TOSHIBA
 VEW
 RIXON
 HAZELTINE
 SEIKOSHA
 TTX
 WYSE

SANYO P.C.
 OTRONA
 BLUE CHIP
 PRINTACOLOR
 QUME
 KEYTRONICS
 ANCHOR
 BROTHER
 VISUAL
 DAISY

Everything in computer related products:

- Computers
- Modems
- Printers
- Software
- Monitors
- Terminals
- Accessories
- Paper
- Ribbons
- Diskettes
- Office Furniture
- In-Store Training

For Price Quotes and Ordering, Call:

1-800-821-4128

For Technical Information and
 Order Status, Call:

602-952-1057



3370 North Hayden Road • Suite 123-314
 Scottsdale, Arizona 85251

Prices listed reflect a cash discount and are subject to change without notice. C.O.D.s are shipped with a minimum C.O.D. charge. Allow 3-7 days for personal checks to clear. Product is subject to availability. Equipment is in factory sealed boxes with manufacturer's warranty. There will be a re-stocking charge for returned merchandise. Call first for an RMA number. Software not warranted for suitability. No return of Software which has been opened. Add 2% for shipping & handling charges (minimum \$2.50). All equipment shipped F.O.B. Scottsdale, AZ 85251. **Circle 166 on Inquiry card.**

PIPELINE

COMPUTERS

**We will BEAT all Competitors PRICES in this Magazine
CALL and get your LOW PRICES — (213) 970-0177
The Source!**

PC COMPATIBLE DISK DRIVES

TANDON

TM100-1 2 for \$350 1 for \$199
 TM100-2 (360K) 2 for \$400 1 for \$205
 TM101-4 (Quad) 2 for \$540 1 for \$279

CDC

9409 (360K) 2 for \$440 1 for \$229

SHUGART

SA 455 Slimline (360K) 2 for \$390 1 for \$199

PANASONIC

Slimline (360K) 2 for \$340 1 for \$179

TEAC

FD55A (160K) 2 for \$330 1 for \$160
 FD55B (360K) 2 for \$370 1 for \$189

MODEMS

ANCHOR

Mark VII, 300 Baud \$ 139
 Mark XII, 1200 Baud 269

HAYES

300 Smart Modem \$ 199
 1200 Smart Modem 489
 1200B Smart Modem 399

NOVATION

Access 123 Call

PROMETHEUS

ProCom 1200 \$ 369

RIXON

PC212A \$ 409
 P212A 409

PRINTERS

OKIDATA

Microline 92A (160 cps) \$ 419
 Microline 93A (160 cps) 699

C. ITOH

Prowriter 8510AP \$ 339
 Starwriter F10, 40 cps 979

MONITORS

AMDEK

300G, 12" Green \$ 129
 300A, 12" Amber 139
 310A, 12" Amber Monochrome 169
 Color I + Color Composite 289
 Color II + RGB w/ Cable 409

PRINCETON GRAPHICS

PG5HX12 \$ 469
 Other Models Call



**64K
UPGRADE
KIT**

★ Prime Parts
 ★ Works with all PC's
 & Compatibles

64K \$50 128K \$95



**IBM PC
SYSTEM**

★ 2, 360K Teac Disk Drives
 ★ 64K Memory
 ★ Hi-Res Green Monitor
 ★ Color Graphics Interface
 Card

\$2595



**TANDON
DISK DRIVE**

★ TM100-2
 ★ 360K Dbl/Dbl

\$209



**AST MULTI-
FUNCTION
CARD**

★ Par. & Ser. Ports w/clock
 ★ 384K of Memory
 ★ Optional Gameport

\$479



**5 1/4"
DISKETTES**

★ Dbl. Side/Dbl. Density
 ★ 5 Year Guarantee
 ★ Reinforced Hub Ring

100 for \$190



**SANYO
COMPUTER**

★ MBC 550

\$799

IBM & COMPATIBLE COMPUTERS

CORONA DATA SYSTEMS

PC II, 1 Drive (128K) \$1995

COMPAQ

PC Compatible \$2695

EAGLE

PC-2, 128K, 2-Drives, Monitor, Software \$2595

COLUMBIA

1600-1 2-Drives Software \$2595

IBM

PC Jr. \$ 689

PC w/64K, 1-Drive 1995

PC w/64K, 2-Drives 2245

XT w/Hardisk, 128K 4695

SANYO

MBC-550, 1-Drive \$ 799

MBC-555, 2-Drives, more software 1199

TOSHIBA

T-300 PC Compatible List \$2995 \$2595

ALL INTERFACE CARDS FOR PC

AST No. 1

SixPac + \$ 269

Io + 119

Mega + 269

MegaPack 269

Additional Ports 50

QUADRAM

Color I \$ 209

Color II (640 x 200) 199

Quadlink 479

KEYTRONICS

Keyboard \$ 199

64K UPGRADE

9/4164 \$ 49

HERCULES

Color Graphics Card \$ 339

PLANTRONICS

Color Plus \$ 379

IBM

Dos 2.1 \$ 59

Monochrome Monitor or Adaptor 309

Color Monitor 649

DISKETTES

Dbl/Dbl (lifetime guarantee) \$ 19

MORE ACCESSORIES

Koala Graphics Tablet \$ 89

8087 Co-Processor 109

Kraft Joystick 39

Sigma Controller Card 159

Cable for Printer 29

Amdek MAI Card 499

• Shipping Minimum 4.50
 • Purchase Orders Accepted
 • This Ad Supersedes all Others



Prices Subject to Change
 Mon.-Fri. 7:30 a.m. to 7:30 p.m.
 Saturday 9:00 a.m. to 4:00 p.m.

The Source!

PIPELINE

COMPUTERS

MAIL ORDER
 1142 Manhattan Avenue, CP21
 Manhattan Beach, CA 90266

WAREHOUSE:
 12308 Burl Avenue
 Hawthorne, CA 90250

ORDER DESK: (213) 970-0177



We Accept MC, Visa, Wire
 Transfers, Certified Checks
 • COD's Available
 • All Prices Reflect a Prepaid
 Discount

The Source!

Let your fingers do the shopping in the

"Electronic Mall"



For all of your **Radio Shack** and **TRS-80™** Needs
Save Time - Save Money!

GO PE-1 Now on CompuServe

Pan American Electronics
(800) 531-7466/(512) 581-2766
Telex 767339
1117 Conway Ave.
Mission, Texas 78572

Circle 284 on inquiry card.

UNDERSTANDING MICROPROCESSOR-BASED EQUIPMENT

AND TROUBLESHOOTING

Learn to diagnose and repair microprocessor-based devices at system, board, and component levels.

SEMINAR DATES AND LOCATIONS

- Cincinnati, OH - April 24-27, 1984
- St. Louis, MO - May 1-4, 1984
- Chicago, IL - May 22-25, 1984
- Detroit, MI - May 29-June 1, 1984
- Minneapolis, MN - June 12-15, 1984
- Portland, OR - July 17-20, 1984
- Sacramento, CA - July 24-27, 1984
- Washington, DC - Sept 11-14, 1984
- Boston, MA - September 18-21, 1984
- Phoenix, AZ - October 9-12, 1984
- Los Angeles, CA - Oct 16-19, 1984
- Atlanta, GA - November 6-9, 1984
- Miami, FL - November 13-16, 1984

MICRO SYSTEMS INSTITUTE
Garnett, Kansas 66632
(913) 898-3265

Circle 254 on inquiry card.

NEW Mini-Tester Monitors 7 Most Important RS-232 Lines



2 3/4" x 2 3/4" x 3/4"

A compact version of our popular standard RS-232 Tester. LED's clearly display status of: TD, RD, CTS, DSR, CD, DTR. Requires no power; may be left in permanently. Satisfaction guaranteed.

ORDER NOW. Only \$49.95. Optional 2-color LED's indicate low, high, or open. \$59.95. Add \$1.75 for shipping (IL Res. add 6% tax) MC. Visa accepted. Ask for Free Catalog. Phone: (815) 539-5827. Make checks payable to

B & B electronics
MANUFACTURING COMPANY
Box 688 • MENDOTA, IL 61342

Circle 45 on inquiry card.

THE OFFICIAL NUMBER TO CALL TO FIND OUT MORE ABOUT THE UNOFFICIAL APPLE LOGO: 617-492-8816



Terrapin, Inc., 380 Green Street,
Cambridge, MA 02139, (617) 492-8816

Circle 358 on inquiry card.

12 Bit A/D Converter FOR YOUR APPLE®



AD1GB 16 CHANNEL \$299⁹⁵

- * I/O OR NMI INTERRUPT
- * EXTERNAL START CONVERT
- * HIGH SPEED - 25,000 CONV./SEC
- * 7 VOLTAGE RANGES
- * PRECISION SAMPLE & HOLD

Bolt On Signal Conditioning FITS INSIDE APPLE®

A16G \$79⁹⁵

- * 16 OP AMPS- EACH WITH SEPARATE GAIN & FILTERING

A8D from \$149⁹⁵

- * TRUE DIFFERENTIAL INPUTS
- * 2 to 8 CHANNELS
- * SEPARATE GAIN EACH CHANNEL

Hollywood Hardware (818) 989-1204
6842 Valjean Ave. *APPLE is a registered trademark of APPLE Computers, Inc.
Van Nuys, CA 91406

Circle 186 on inquiry card.

ELECTRONIC COMPONENTS



MANUFACTURERS OF QUALITY ELECTRONIC COMPONENTS

OVER 15,000 DIFFERENT ITEMS IN STOCK!

MOUSER ELECTRONICS
11433 WOODSIDE AVE SANTEE, CA 92071
PHONE (619) 449-2222 TWX 910-331-1175

Circle 269 on inquiry card.

Need Low Cost I/O?

FOR: HP • COMMODORE SAGE • OSBORNE



IEEE-488 GP-1B

The 6450 General Purpose Parallel Interface will connect to your computer via the IEEE-488 Bus and give you:

- 8 Input Bits, 8 Output Bits, Clear and Trigger pulses, a Service Request Interrupt, and more.

All IEEE-488 Functions are Supported. The 6450 also allows connecting Centronics type printers to the IEEE-488 Bus. Two versions are available: PC board and complete unit. Prices start at \$249. Application notes describing interfacing to A/D converters, UARTs, and multiple byte data are included.

Call or Write for Details:

SEITZ Seitz Technical Products, Inc.
PO Box 76, New London, PA 19360
(215) 255-5111

Circle 323 on inquiry card.

6800 Family Cross-Software

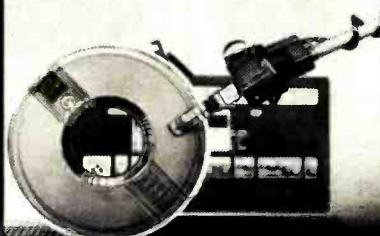

6800/01/05/09 microprocessor software development tools for PDP-11, VAX, IBM or other mainframes: Cross-Assemblers, High-level Language PL/W Compilers, Linker, and Simulators.

WINTEK Corp.
1801 South Street
Lafayette, IN 47904
317-742-8428

Circle 391 on inquiry card.

VOICE CONTROL OF THE APPLE II PLUS.

Computer programming and environmental control all by your voice.

- Shadow Vot voice recognition system.
- Keyboard/Voice entry-used interchangeably.
- Basic, Applesoft, Pascal, Machinecode.
- Modems, printers, BSR control
- Immediate delivery
- Discount on quantity orders.

\$599.00

CALL OR WRITE TODAY (216) 567-2001

PRC

**8769 Township Road 513
Shreve, Ohio 44676-9421**

Circle 298 on inquiry card.

"More Computer for Your Calculating Dollar"

Try the New

XPC-XT by XDS

Introductory Offer

(Offer expires May 31, 1984)

\$1995⁰⁰

SYS-8100-00

"Need a 16-bit IBM-PC™ to process your data?"

The first IBM™ compatible that IS compatible! A complete system including the PC-DOS™ operating system from IBM™. Two thinline double-sided 5 1/4" Disk Drives hold 360K of formatted storage each, the other drive opening is fitted with a close-out plate. Removal of the plate will allow room for a Winchester Hard Disk. The Power Supply is like that of an IBM-PC XT™. Hard Disk ready! How compatible is the XPC-XT? It will run 1-2-3™, Flight Simulator™, dBASE II™, WordStar™, SuperCalc™, VisiCalc® and hundreds of others. The system will also support MS-DOS™ 1.1 and 2.1, PC-DOS™ 2.2, CP/M-86™ and Unix Operating Systems. Add-on an additional 192K of RAM for a full 256K of on-board Memory for only \$195.00. This computer comes standard with 2 Serial and 1 parallel ports (IBM™ COM1 and COM2). No need to purchase Add-On cards.



Standard Features:

- PC-DOS™ Operating System Vers. 2.1
- 64K of parity checked RAM, expandable on-board to 256K
- 8088 16-bit CPU
- 5 IBM compatible expansion slots
- 4 DMA and 3 Timer channels
- Up to 32K of EPROM (supplied with full 8K)
- DOS BIOS on EPROM
- Full size capacitance touch keyboard with 10 function keys and calculator type numeric keypad
- High resolution, 12" Monitor with Green Screen and 18MHz bandwidth.
- Two Slimline 5 1/4" DS/DD 48 TPI Floppys @ 360K storage each.
- Floppy Disk Controller expansion card, runs up to four SS or DD Floppys
- ALSO supports MS-DOS™ and CP/M-86® Operating Systems
- Power Supply is Hard Disk ready, no need to add-on additional power
- Full One Year Parts and Labor Warranty on all XDS Manufacturing products!

BASIC XPC SYSTEM

If that incredibly LOW Total System price doesn't suit you, try this "Do It Yourself System" and take your pick of the wide range of options listed below.

- The Features:
- 64K RAM •Expandable to 256K
 - 4 DMA channels •5 Expansion Slots
 - Runs MS/DOS™ and CP/M-86™ (not included)
 - Multi-function Keyboard and Cable
 - Hard Disk Ready Power Supply
 - 2 Serial and one Parallel Port
 - and MORE!

Only \$895



The following are registered Trademarks and their Companies: 1-2-3-Lotus Development Company; MS-DOS, PC-DOS, Flight Simulator-MicroSoft; dBase II-Ashton-Tate; WordStar-MicroPro International Corp.; SuperCalc-Sorcim, Inc.; VisiCalc-VisiCorp, Inc.; CP/M-86-Digital Research Inc.; IBM, IBM-PC, IBM-PC XT-International Business Machines.

Call or Write for Nearest Dealer and Full Catalog

FLOPPY INTERFACE

This is the standard Floppy Interface Card supplied in all systems not using Tape Back-up. It can access up to four drives in 48 or 96 TPI formats. The same high quality data separator as used in IBM™ counterparts, insures data integrity. BOA-6001-00.....\$255.00

EXPANSION MEMORY

This super reliable, four layer design Memory Card can be expanded from 64K to 576K in 64K increments (at \$75.00 ea.). We've tested them all and can recommend this one with confidence. The price below is with 64K and includes Spooler and RAMDISK software. BOA-8650-00.....\$255.00

CALENDAR CLOCK

This simple but effective Card should be ordered with every system. Battery Back-up (naturally) keeps your Disk Log right up to date. Saves typing in the date everytime you "boot up" the system. BOA-8700-00.....\$149.00

300/1200 BAUD MODEM

If this is your first computer, you will soon want it to Communicate. Comuser and The Source are on your screen minutes after you plug-in this Custom Made Unit. Supplied with cable to plug into any wall outlet. Auto-Dial Software "remembers" phone numbers and log-in sequences to ease operation. Software included for each operating system. BOA-8725-00.....\$295.00

SUPER 12 PAK MULTI-FUNCTION

Now we need a full page to describe this fantastic Card! Since we only have a little room, here are the features: IBM™ compatible Joystick Port (2), Real-Time Chronograph (Battery Back-up), Parallel Port, Serial Port, 64K to 384K of Parity Memory, Print Spooler and RAM-DISK software, and supplied with 0K of Memory. BOA-8680-00.....\$345.00

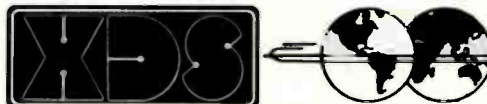

MANUFACTURING

HARD DISK ADD-ON Complete Packages

Includes BIOS Software, 5 1/4" Winchester Hard Disk, mounting hardware, Interface P.C.B. for expansion slot, and all the necessary power and data cables (the Power Supply in the XPC-XT is Hard Disk ready).

- | | |
|-------------------------------------|--------------------------------------|
| 10 Megabyte \$995 | 65 Megabyte \$2495 |
| 20 Megabyte \$1295 | 105 Megabyte \$3295 |
| 40 Megabyte \$1795 | 140 Megabyte \$4195 |

Archive Tape Back-up unit shown above is of 20 and 40 megabyte capacity. Memtek unit will soon be available at 10 megabyte capacity at approximately One-Half the cost! Circle 397 on Inquiry card.

MONOCHROME ADAPTOR

If you are impressed with all the rave reviews that the Hercules Graphics Card gets, you will love ours! Made expressly for the XPC-XT by Hercules themselves, it runs everything the Hercules Card does (1-2-3™, dBase II, etc.). BOA-8500-00.....\$395.00

COLOR ADAPTOR

Color and monochrome combinations, can be run simultaneously. Flight Simulator™, 1-2-3™ all perform without modifications. NO FLICKER! Besides performing perfectly, included are: Light Pen Interface, Print Spooler, and RAM Disk options! BOA-8400-00.....\$495.00

COLOR
MON-1500-00 \$345.00



Three models of Color to choose from, each with higher and higher resolution. Price from \$345.00 to \$750.00. Monochrome Unit is outstandingly clear and easy on the eyes. In Green or Amber screens.

MONOCHROME
MON-1000-00 \$125.00



HARD DISK ONLY INTERFACE

A simple, quick solution to adding a Hard Disk to your XPC. All you need is this card, a Cable, and the Drive. Handles from 5 to 140 megabytes with minimum software configuration. Order with your System now or order later. Compatible with all the operating systems. BOA-8050-00.....\$375.00



H.D./TAPE CONTROLLER

This package consists of a combination Interface Adaptor having SCSI H.D./TAPE Connector as well as the Floppy Controller. Two additional 5" form factor Boards are included and mount over the Tape Drive and Hard Disk. 10, 20, & 40 megabytes of Back-up is added to your Hard Disk. BOA-8675-00.....\$750.00

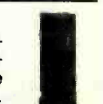

APPLE COMPATIBLE HARDWARE

INTERFACE FOR TYPEWRITER, CENTRONICS AND WORDSTAR COMPATIBLE

| Model # | Price |
|--|-------|
| T1 Olivetti Praxis 30, 35, 40 | \$99 |
| T2 Olivetti Praxis 41 | |
| T3 Silver Reed Ex 42, 43, 44 + Penman | |
| T4 Adler Satellite 11 and Alpha Royal 2001 | |
| T5 Olympia Compact and Sinterc 1146 CM | |

INFRARED INTERFACE FOR REMOTE OPERATION WITHOUT CABLES

| | |
|--------------------------------------|-------|
| IRR Board, Receiver station | \$99 |
| for use with one or all: | |
| IRN Numerical Pad VisiCal Compatible | \$49 |
| IRK Full keyboard with lower case | \$129 |
| IRC Four direction cursor control | \$29 |



TO ORDER CALL (408) 734-4631

or write



INTERFACE

Advanced Transducer Devices, Inc.
1287 Lawrence Sta. Rd., Sunnyvale, CA 94089

Additional \$2.50 per order for shipping
Calif. residents add 6% tax

Circle 20 on inquiry card.

LOW LOW PRICES

Elephant Floppies

- 5 1/4" SS/SD \$18.75
- 5 1/4" SS/DD \$22.50
- 5 1/4" DS/DD \$28.75
- 8" (All Formats) CALL
- EPSON Printers CALL

We carry a complete line of best selling software, accessories and supplies. Visit our showroom for EPSON QX-10, TI Professional, Kaypro TeleVideo Systems.

APEX COMPUTER CENTER

Valley Mall, Hagerstown, Md 21740
301/542-4678
Major credit cards or C.O.D.

Circle 32 on inquiry card.

Apple II/IIe® Robotic Development Package



2 Axis Stepper Motor System \$365

- A6 T/D Plug-in Interface (PMS 23)
- R2 D23 Driver with (2) Size 23 Motors (35 oz. in.)
- Positioning Command with Ramping from Applesoft® BASIC

Also Available with: **\$595**

- (2) Size 34 Motors (220 oz. in.) & R2 D34 Dual Axis Driver (PMS 34)
- Power Supply for PMS 23 System, 12/24V-2A/5V-1A Reg **\$145**

ROGERS LABS (714) 751-0442
2710 S. Croddy Way, Santa Ana, CA 92704

Circle 315 on inquiry card.

FREE CATALOG LOWEST PRICES

3M DISKETTES AUTHORIZED DISTRIBUTOR



\$19.99
SSDD
DSDD
DSDD (96TPI) **\$36.99**

CHECKS, MO, VISA, M.C.
P.O. TO RATED COMPANIES

ALMANAC COMPUTER SUPPLY COMPANY

521 Front St., Santa Cruz
CA 95060 (408) 425-1980 EXT. 25

Circle 22 on inquiry card.

TeleVideo USERS

RETAIL

- Fast Dump/Restore CP/M, TurboDOS over 600k per disk \$90.00
 - New! • BasicZ with GraphZ \$345.00
 - TurboDOS for TeleVideo from \$300.00
 - LYNC Communications Package \$195.00
 - 8" Disk Drive for 802 and 800A Drive, board and software \$1200.00
 - RM/COBOL Systems from \$250.00
 - New! • DataFlex 2.0 from \$750.00
 - New! • 803, 803H, TPC-1 and MOUSE programs: Draw! \$90.00
 - Games Pak I \$34.95
 - B16 and 806C Tape Backup from \$175.00
 - Soft Standby Power Systems: 2000A/400A/800A from \$550.00
 - New! • Anti-Static Products from \$39.95
 - RM/COBOL trademark of Ryan-McFarland Co.
 - CP/M trademark of Digital Research
 - TurboDOS trademark of Software 2000
 - LYNC trademark of Norton-Lambert
 - DataFlex trademark of Data Access
- PLUS OTHER GOOD TELEVIDEO STUFF!
COGITATE, INC.
SPECIALISTS IN UNIQUE TELEVIDEO SOFTWARE
24000 Telegraph Road, Southfield, MI 48034
(313) 352-2345
VISA/MasterCard Accepted

Circle 70 on inquiry card.

LOWEST PRICES

APPLE® Compatible Computers from **\$439**
LASAR 48K **\$439**

ELITE - 3 64K Dual CPU 6502 + Z80A
Detached Keyboard, Run APPLE® & CP/M **\$639**

We Have All APPLE® Cards CALL! SAVE!
MORE MODELS TO CHOOSE FROM! CALL!

THIS ONE BEATS BIG BLUE
FUJITSU 8086 + Z80 Opt. 68000 128K 2 Drive
CALL

| TERMINALS | COMPUTERS |
|----------------------------|----------------------------------|
| TeleVideo 910 \$419 | Radio Shack SAVE! CALL |
| TeleVideo 914 \$506 | Advance Digital Z80B 6Mhz |
| Adds 3A+ \$442 | Super Six 128 w/PS Net/1 |
| Zenith Z-29 \$655 | CompuPro B16A \$555 |
| Visual 50 \$653 | Altos 580-2 3 user \$4106 |
| | CompuStars & Headstart |

PRINTERS
Smith-Corona TP-1 **\$246** North Star Advantage CALL
Okidata - NEC - Epson **\$442** APPLE is a registered trademark
CALL of APPLE Computers, Inc.
Anadex CALL

WE SELL ENTIRE LINE OF MOST COMPANIES
Call For Latest Prices & Availability
Factory Guarantees We Beat Prices!
AMERICAN COMPUTERS

4167 Knett Dr., Jamestown, North Carolina 27282
Tel.: (919) 883-1105 (919) 885-4577

Circle 29 on inquiry card.

EPROM PROGRAMMER

ONLY
\$295.95

COMPLETE WITH
PERSONALITY
MODULE

110V AC POWER-RS232 3 WIRE
-6 BAUD RATES

ALLOWS READ, WRITE & VERIFY

Comes complete with BASIC Driver Program
Listing for most small micros (or easily adapted)

Full 1 Year Warranty

Programs the following: 5 Volt 24 or 28 pin
devices: 2716, 2732, 2732A, 2764, 27128,
27256, 25xx series, 68766 plus others.
Specify Personality Module desired with order.
Additional Personality Modules only \$19.95 ea.

CALL OR WRITE FOR DETAILS

APROPOS TECHNOLOGY
1071-A AVENIDA ACASO Add
CAMARILLO, CA 93010 \$4.00 Shipping
(805) 482-3604 VISA or MC Add 3%

Circle 38 on inquiry card.

SUPER FAST! Z80 DISASSEMBLER

- Two pass operation - generates labels at referenced locations.
- Generates Zilog mnemonics.
- Allows user defined labels.
- Allows define byte, define word and define space directives.
- COMPLETE cross-reference
- Output to console, list or disk device(s) in any combination.
- Generates mnemonics for CP/M system calls.
- Start and stop at any location in file.
- Source or complete listing type output.

Most formats available
for Z80 CP/M, CDOS, **\$6995**
and TURBODOS.

S L R Systems

For more information or to order call:

1-800-833-3061

In PA, (412) 282-0864

1622 North Main Street, Butler, PA 16001

Circle 329 on inquiry card.

BITS 100 WATT AC-PUPS \$300.00

NO SWITCH TIME
1 YEAR MFG. WARRANTY
214-637-0066

Circle 71 on inquiry card.



S-100
ESTABLISHED 1977

MODEM ORDERS 602-948-1387
SALES 800-528-3138
TECHNICAL 602-991-7870

CompuPro.

A GODBOLD COMPANY

| | |
|--------------------------|---------|
| SYSTEM 816/A A&T | \$3,999 |
| SYSTEM 816/B A&T | \$4,999 |
| SYSTEM 816/C* A&T | \$6,399 |
| SYSTEM 816/D* A&T (8086) | \$9,899 |
| SYSTEM 816/E* A&T (68K) | \$6,399 |
| TO ADD 40Mb H.D. | \$2,475 |

S-100's 40Mb HARD DISK SUBSYSTEM
w/DISK 3 & CP/M80 & 86 \$2,895

100 HR SYSTEM "BURN-IN"
*XEROX SERVICE WHERE AVAIL.

| | |
|-------------------------|---------|
| CPU Z 6MHz A&T | \$229 |
| CPU 8085 A&T | \$349 |
| CPU 8086 10MHz A&T | \$569 |
| CPU 86/87 5MHz A&T | \$739 |
| CPU 68K 8MHz A&T | \$489 |
| CPU 68K 10MHz CSC | \$599 |
| CPU 286 6MHz A&T | \$1,119 |
| RAM 17 64K STATIC A&T | \$349 |
| RAM 21 128K STATIC A&T | \$699 |
| RAM 22 256K STATIC A&T | \$1,229 |
| M-DRIVE/H 512K RAM-DISK | \$895 |
| INTERFACER 3 A&T | \$489 |
| INTERFACER 4 A&T | \$319 |
| SYSTEM SUPPORT 1 A&T | \$319 |
| DISK 1 A&T | \$349 |
| DISK 2 A&T | \$559 |
| DISK 3 A&T | \$559 |

MORROW

| | |
|--|---------|
| MD3 W/MDT60 TERMINAL & TALLY SPIRIT PRINTER | \$1,999 |
| MD3 SYSTEM AS EQUIP ABOVE W/8088 CO-PROC & 256K RAM UPGRADE | \$2,399 |
| MD2 SYSTEM AS EQUIP ABOVE | \$1,699 |
| MD11 SYSTEM AS EQUIP ABOVE | \$2,745 |
| W/CP/M 3.0, 128K RAM, DSDD FLPY & 11Mb H.D | |
| MDP-3 PORTABLE Same as MD-3 w/5x7 Screen And Detachable K.B. | CALL |



A whole computer system in one little box.SM

| | |
|---|------|
| MODEM, MX80 PRINTER, XTRA 12" MONITOR, 2 SSDD DRVS, FULLY STOCKED SOFTWARE PKG. | CALL |
| INCLD. DUAL DSDD 5 1/4" DRVS | CALL |
| INCLD 8088 CPU & 256K RAM | CALL |

ZENITH data systems CALL

ZF-110-22 w/ZVM-135 \$3,395

FLUKE FLUKE 77 \$119
MULTIMETER
0.3% DC Accuracy

DIGITAL RESEARCH

| | |
|-----------------|-------|
| MP/MII | \$270 |
| MP/M-86 | \$390 |
| CONCURRENT CP/M | \$210 |
| CP/M PLUS | \$210 |
| "C" COMPILER | \$210 |
| PASCAL MT+86 | \$360 |
| SPEED PROG PKG | \$150 |
| ACCESS MNGR-86 | \$240 |
| DISPLAY MNGR-86 | \$300 |
| PL/1-86 | \$450 |



| | |
|--|---------|
| SUPERSIX W/128K RAM | \$575 |
| SUPERSLAVE, 6 MHz, 128K RAM | \$519 |
| HDC-1001 H.D. CONTROLLER | \$398 |
| CP/M 3.0 | \$350 |
| TURBODOS MULTI-USER | \$449 |
| DMA MICRO-MAGNUM 5Mb FIX + 5Mb REMOV H.D. | \$1,675 |

TECMAR FOR IBM-PC

| | |
|--|---------|
| TIME MASTER W/ BATTERY BACK-UP | \$109 |
| DYNAMIC MEMORY 256K | \$349 |
| 1st MATE 256K | \$419 |
| CAPTAIN 384K | \$557 |
| GRAPHICS MASTER | \$549 |
| IEEE 488 BD. W/Software | \$368 |
| 5Mb CART WINCH IN PC | \$1,479 |
| 33Mb + 5Mb REMOVE ABLE CARTRIDGE IN AN EXPANSION CHASSIS | \$3,219 |

Qume TERMINAL QVT 102G \$469

LIBERTY

| | |
|------------------------------------|-------|
| FREEDOM 100 TERMINAL | CALL |
| FREEDOM 200 TERMINAL | CALL |
| (EMUL TELEVIDEO 950 & ADM 31) | |
| TAXAN RGB 420 (IBM LOOK- ALIKE) | \$495 |
| USI Pi 3 12" AMBER MON. | \$119 |

SEATTLE COMPUTER CPU SUPPORT \$165



| | |
|-----------------------|-------|
| CPZ 48000 SBC 4MHz | \$779 |
| CPS-6A 64K SLAVE 6MHz | \$479 |
| 256K RAM BOARD | \$795 |

Votrax Personal Speech System \$285

SPECTRONICS CORPORATION

| | |
|-----------------------------------|-------|
| PE-14 Erases 6 Eproms | \$65 |
| PE-14T Same as PE-14 w/Tjmer | \$89 |
| PE-24T Erases 9 Eproms in 15 Min. | \$135 |

DEALER INQUIRIES WELCOME



| | |
|---|-------|
| MICROBUFFER/EPSON™ CARD | |
| MBS-16/32K SERIAL | \$119 |
| MBS-32K SERIAL | \$153 |
| MBP-64K PARALLEL | \$195 |
| MICROBUFFER IN-LINE™ STAND ALONE | |
| MBIS SERIAL 64K | \$244 |
| MBIP PARALLEL 64K | \$244 |
| MICROBUFFER II™ 16K, APPLE II, II+ IIe | \$181 |

PRINTERS

| | |
|------------------------|-------|
| DAISYWRITER 2000 W/48K | \$998 |
| OKIDATA 92 | \$475 |
| EPSON MX100 | \$439 |
| EPSON RX80 FT | \$379 |
| TALLY "SPIRIT" | \$299 |
| TALLY MT160L | \$595 |
| TALLY MT180L | \$819 |
| BROTHER HR-15 SERIAL | \$509 |
| BROTHER HR-25 SERIAL | \$819 |



U.S. ROBOTICS

| | |
|--|-------|
| TELPAC w/MODEM PURCHASE | \$55. |
| S-100 BOARD MODEM 300/1200 BAUD AUTO ANS/DIAL | \$299 |
| PASSWORD 1200 BAUD AUTO ANS/DIAL | \$299 |
| AUTO DIAL 212A | \$399 |
| PERSONAL MODEM W/SOFTWARE IBM-PC PLUG-IN BD. | \$299 |
| PERSONAL W/64K, SERIAL, PARA., CLOCK/CAL-BATTERY, SOFTWARE | \$469 |

DISK DRIVES

Qume 270 DAY WARRANTY

| | |
|------------------------|-------|
| 142 DSDD 5 1/4"-1/2 HI | \$179 |
| 242 DSDD 8"-1/2 HI | \$395 |
| 842 DSDD 8"-STD HI | \$455 |

Tandon 100-2 5 1/4" DSDD \$219

| | |
|-----------------------|---------|
| S-100's DMA SUBSYSTEM | \$2,395 |
| DMA SUBSYSTEM/IBM-PC | \$2,395 |
| QUANTUM 40Mb WINCH. | \$1,895 |

INDUSTRIAL QUALITY CABINETS

| | |
|----------------------------------|-------|
| DUAL 1/2 HI HORIZ. 5 1/4" | \$75 |
| SINGLE STD HI HORIZ. 5 1/4" | \$69 |
| DUAL 1/2 HI VERT. 8" | \$195 |
| SINGLE STD HI VERT. 8" | \$195 |
| WINCH, 5 1/4" H.D. (DUAL 1/2 HI) | \$219 |

14425 North 79th Street
Scottsdale, Arizona 85260
TELEX 16 5025 FTCC SEC PHX

FULL DEALER SUPPORT
VISIT OUR SHOWROOM
Hrs. 9:00AM - 5:30PM M-F

Subject to Available Quantities
Prices Quoted Include
Cash Discounts
Shipping & Insurance Extra
Circle 316 on inquiry card.



**RS232C IBM PC Compatible
Paper Tape Transmitter/Model 612**

Stops and starts on character at all speeds, uses manual control or X-on, X-off 90-260 volt, 50-60 Hz power. 50-9600 baud, up to 150 char/sec synchronous or asynchronous; gated internal or external clock, RS 232C, current loop or parallel output, reads 5-8 level tape, 7-11 frames per character, even or odd parity. Desk top or rack mount.

Addmaster Corporation, 415 Junipero Serra Drive, San Gabriel, CA 91776, (213) 285-1121, Telex 874770 Addmaster SGAB

Circle 14 on inquiry card.

A Spooler that will Spoil You

Addmaster Paper Tape Handler with Big New 7 1/2" Reels



Optional serial interfaces for RS232C or TTY or parallel interface/TTL. X-on/X-off capability, bi-directional reading and slew, reads 150 CPS, rewinds 300 CPS. Stops on character, contains power supply and Addmaster Model 601 paper tape reader. Sensibly priced. **Addmaster Corporation, 416 Junipero Serra Drive, San Gabriel, CA 91776. (213) 285-1121.**

Circle 15 on inquiry card.

S-100 EPROM PROGRAMMER

EPROM-32

- High quality S-100 board meets or exceeds IEEE-696.
 - Programs 1K through 32K (byte) EPROMs.
 - Textool zero-insertion-force programming socket.
 - EPROM is programmed through I/O ports and can be verified through I/O ports or located in memory space for verification.
 - Programming voltage generated on-board.
 - Personality Modules simplify adaptation of board to different EPROM types:
- | | | |
|----------------|-----------------|------------|
| PM-1—2508 2758 | PM-3—2732 2732A | PM-6—68764 |
| 2516 2716 | PM-4—2564 | PM-8—27128 |
| PM-2—2532 | PM-5—2764 | |
- CP/M-compatible control software includes commands for programming, verification, disk I/O and editing.

\$269.95*
(A & T)

MicroDynamics Corporation

6363 Poplar Ave • Suite 105
Memphis, TN 38119

ORDER DESK:
1-800-237-8400 ext 440
Technical Inquiries:
(901)-682-4054

*Price includes EPROM-32, documentation and two Personality Modules (specify). Additional Modules—\$7.95. Control software on 8" SSDD diskette—\$9.95 UPS ground—\$2.00, UPS air—\$4.00, COD—\$1.50, foreign add \$15.00, TN add 6% sales tax. VISA and MASTERCARD welcome.

Circle 256 on inquiry card.

Davidge

Is now offering their OEM quality high performance Z80 based single board microcomputers at a substantial savings

\$495⁰⁰ Includes:
 ■ CP/M 2.2
 ■ Davidge Utilities
 ■ Completely assembled, burned in and tested

These Boards Feature:

- 4 or 6 MHz* ■ 2 or 4 serial ports*
- 5 1/4" and 8" floppy disk controller
- 2K Boot ROM with monitor
- 64K RAM ■ Centronics parallel port
- High speed bidirectional parallel port
- DMA Controller ■ SASI Interface*

* Options

Send Check or Money Order to:

Davidge Corporation
1951 Colony Street, Suite X
Mountain View, California 94043
or Call (415) 964-9497

Circle 120 on inquiry card.



FLEXIBLE DISCS

WE WILL NOT BE UNDER-SOLD!! Call Free (800)235-4137 for prices and information. Dealer inquiries invited and C.O.D.'s accepted.

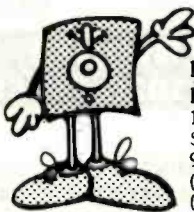

PACIFIC EXCHANGES
100 Foothill Blvd.
San Luis Obispo, CA
93401. In Cal. call
(800)592-5935 or
(805)543-1037

Circle 282 on inquiry card.

maxell

Floppy Discs

**CALL NOW — TOLL FREE
1-800-328-DISC**

Dealer inquiries invited. C.O.D.'s and charge cards accepted.

All orders shipped from stock, within 24 hours. Call toll FREE.



North Hills Corporation

3564 Rolling View Dr.
White Bear Lake, MN 55110

1-800-328-DISC

MN Call Collect 1-612-770-0485

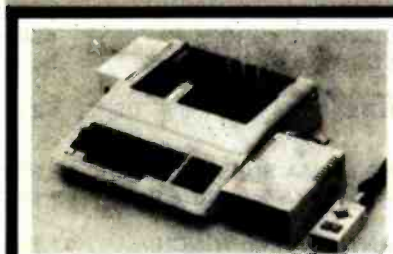

APPLE COMPATIBLE

Disk Drive \$150.00 ea.
Controller Card \$35.00 ea.
Computer Case \$55.00 ea.
Keyboard \$70.00 ea.
(Numeric and Function Keys)
Switching Power Supply .. \$49.50 ea.
Joystick (Heavy Duty) \$17.50 ea.
Slim Fan \$25.00 ea.

Prices for dealers in quantities of 25 or more.
End Users Inquiries welcomed.

ELECTRADE CO. (408) 946-2541
780 Trimble Rd. Suite 605
San Jose, CA 95131

Circle 146 on inquiry card.

Printer Cables

— Parallel —

| | | |
|----------------------|------------|----------------------|
| \$35.00* | ALDOS | \$35.00* |
| | ATTACHE | |
| | ATARI | |
| | CENTRONICS | |
| | COLUMBIA | |
| FREE SHIPPING | EAGLE | FREE SHIPPING |
| | IBM-PC | |
| | KAYPRO | |
| | OSBORNE | |
| | SANYO | |
| \$35.00* | TI-99 | \$35.00* |

— SERIAL —

ATTACHE COM.
RS232 (DB25P)
(9 conductor 1-8, 20)

CABLES BY WORSWICK

4898 Ronson Ct., Suite J
San Diego, CA 92111
(619) 223-9750

*C.A. Resident Add'l. Sales Tax 5.75%

Circle 57 on inquiry card.



PC/XT COMPATIBLE OEM COMPONENT SALE

Computer Case \$140.00
Key Board \$199.00
Power Supply Call
Mother Board-Bare \$ 95.00
Mother Board without ICs ... \$225.00
Mother Board with ICs \$525.00

Dealers/OEM Buyers
Quantity Discounts Available.

All items are fully PC/XT Compatible. Case comes with interchangeable rear panel for PC Users. Bare board comes with complete instruction with part list, 90 days manufacturers warranty on all items.

VISA and MasterCard welcome

Price change without notice

IBM is a trademark of
International Business Machine



HiTech International, Inc.
4966 El Camino Real, Suite 101
Los Altos, CA 94022 (415) 949-0141
TEL 171854 HHC

Circle 184 on inquiry card.

APRIL SPECIALS

"MOST OF OUR BUSINESS IS BY REFERRAL FROM SATISFIED CUSTOMERS. FIND OUT WHY."

IBM-PC SYSTEMS

| | |
|---|--------------|
| #1 SYSTEM: 2-360K DRIVES, 64K GRAPHICS VIDEO CARD | \$ 2400 |
| #2 SYSTEM: 2-360K DRIVES, 64K, IBM MONOCHROME COLOR & CRT | \$ 2725 |
| #3 SYSTEM: 2-360K DRIVES, 64K GRAPHICS w/ PRINTER FIRST | \$ 2745 |
| IF YOU SPECIFY THESE OPTIONS, THE PRICE WILL INSTAL AND TEST AT NO EXTRA CHARGE | |
| OPTION A: RAM SETS (64K BY SET), MAXIMUM OF 3 SETS | \$59 PER SET |
| OPTION B: IBM HARD DISK - INTERNAL | \$ 1150 |
| OPTION C: 8087 CO-PROCESSOR w/SOFTWARE PATCHES | \$ 285 |
| OPTION D: 2 THINLINE 360K DRIVES***SWAP*** | \$ 120 |
| IBM-XT LIST \$4995 | \$ 4300 |

CALL THE EXPERT
(213) 344-6063 (800) 528-9537

PC ACCESSORIES

| | |
|---------------------------------|---------|
| KEYTRONICS KEYBOARD | \$ 195 |
| QUADLINK IBM TO APPLE CONVERTER | \$ 495 |
| 10 MEGABYTE HARD DISK | \$ 1575 |
| 64K RAM EXPANSION SET | \$ 59 |
| RANA 2.5MB FLOPPY | CALL |
| TANDON TM100-2 DSSD DRIVE | \$ 237 |
| AST RESEARCH EXPANSION CARDS: | |
| I/O PLUS | \$ 120 |
| COMBO PLUS | \$ 257 |
| SIXPAK | \$ 270 |
| MEGA PLUS | \$ 305 |
| MEGA PAK | \$ 75 |
| MA PEACOCK VIDEO w/PARALLEL | \$ 344 |
| PLANATIONS COLORPLUS | \$ 449 |

CALL THE EXPERT
(213) 344-6063 (800) 528-9537

SOFTWARE FOR IBM

| | |
|---------------------------------------|--------|
| LOTUS 1-2-3 | \$ 935 |
| DBASE II | \$ 425 |
| FLIGHT SIMULATOR | \$ 40 |
| MEGAWRITER (WORD PROCESSOR FOR PC/XT) | \$ 90 |
| MEGASORTER | \$ 90 |
| MAIL MERGE | \$ 95 |
| FRIDAYS | \$ 265 |
| CATALIST (UNIVERSAL "MAIL MERGE") | \$ 70 |

CALL THE EXPERT
(213) 344-6063 (800) 528-9537

VIDEO MONITORS

| | |
|--|--------|
| *****MONTHLY SPECIAL***** JCS-RGB 13" FOR PC | \$ 395 |
| PRINCETON GRAPHICS HX-12 | \$ 475 |
| BMC RGB | \$ 445 |
| AMDEK AMBER 300A | \$ 160 |
| AMDEK GREEN 300 | \$ 140 |
| DYNAX AMBER 20MHz | \$ 140 |
| DYNAX GREEN | \$ 125 |
| MB122G GREEN 12" (PC MONOCHROME) | \$ 200 |
| MB122A AMBER 12" - BY ROLAND | \$ 110 |
| NEC JB1260-M GREEN | \$ 132 |
| SAKATA SC-200 RGB w/ADJUSTABLE | \$ 155 |

CALL THE EXPERT
(213) 344-6063 (800) 528-9537

DISKETTES

| | |
|---------------------------------|---------|
| VERBATIM VERBS DSSD | \$ 17 |
| DATALIFE SSDD | \$ 25 |
| DATALIFE DSD | \$ 33 |
| HEAD CLEANER KIT | \$ 8 |
| FLIPIT (USE BACK SIDE OF DISKS) | \$ 17 |
| DISKETTE HAMPER | \$ 24 |
| LIBRARY CASE - HOLDS 10 DISKS | \$ 2.25 |

DAISYWHEEL PRINTERS

| | |
|---------------------------|---------|
| DIABLO 620 | \$ 950 |
| DIABLO 630-R155 | \$ 1850 |
| DIABLO 630-E104 (IBM) | \$ 2150 |
| DYNAX DX-15 (15 CPS) | \$ 465 |
| BROTHER HR-1 (19 CPS) | \$ 630 |
| BROTHER HR-25 (25 CPS) | \$ 795 |
| F-10 STARWRITER (40 CPS) | \$ 1050 |
| F-10 PRINTMASTER (55 CPS) | \$ 1400 |
| NEC 3530 | \$ 1689 |
| NEC 3550 | \$ 1844 |
| NEC 7710 | \$ 1995 |
| QUME 1140 | \$ 1360 |
| QUME 1155 | \$ 1600 |

CALL THE EXPERT
(213) 344-6063 (800) 528-9537

DOT MATRIX PRINTERS

| | |
|----------------------------|---------|
| EPSON FX-80 | \$ 550 |
| OKIDATA 92 | \$ 440 |
| 92-TINYRIP | \$ 46 |
| 88-PLUG-N-PLAY | \$ 45 |
| EPSON 93 | \$ 720 |
| 88-PLUG-N-PLAY | \$ 45 |
| OKIDATA 84 | \$ 1050 |
| PROWRITER 8510 | \$ 360 |
| PROWRITER-II 1550 | \$ 650 |
| GEMINI 10X | \$ 279 |
| GEMINI 15X | \$ 415 |
| MANNESMANN-TALLY 160L | \$ 699 |
| IDS PRISM-80 COLOR | \$ 1150 |
| RITEMAN PORTABLE PRINTER | \$ 385 |
| SUPER 5 CP-80 w/CARBON INK | \$ 265 |

CALL THE EXPERT
(213) 344-6063 (800) 528-9537

MODEMS

| | |
|------------------------------------|--------|
| ANCHOR AUTOMATION "SIGNALMAN" | \$ 89 |
| MARK II (ATARI) | \$ 110 |
| MARK III (TI) | \$ 120 |
| MARK IV (COMMODORE PET/ORBICLON) | \$ 100 |
| MARK V (OSBORNE) | \$ 345 |
| MARK XV (1200 BAUD SMARTMODEM) | \$ 159 |
| THE NETWORKER FOR APPLE w/SOFTWARE | \$ 110 |
| THE NETWORKER - NO SOFTWARE | \$ 215 |
| HAYES SMARTMODEM 300 | \$ 505 |
| HAYES SMARTMODEM 1200 | \$ 295 |
| HAYES MICROMODEM II | \$ 445 |
| NOVATION ACCESS 1200 | \$ 445 |

CALL THE EXPERT
(213) 344-6063 (800) 528-9537

APPLE ACCESSORIES

| | |
|----------------------------------|--------|
| ALS CP/M CARD | \$ 285 |
| ALS SMARTERM II (80 COLUMN CARD) | \$ 145 |
| INDUS GT DRIVE w/ 3 SOFTWARES | \$ 250 |
| RANA ELITE I | \$ 265 |
| RANA ELITE II | \$ 435 |
| RANA ELITE III | \$ 565 |
| MCROTEK DUMPLING - 16K | \$ 160 |
| GRAPPLER + | \$ 125 |
| PROMETHEUS 16K RAM CARD | \$ 60 |
| SUPER 5 THIN DRIVE | \$ 190 |

NBI WORD PROCESSOR FOR PC

| | |
|--|-------------------|
| THIS COMBINATION OF HARDWARE AND SOFTWARE MAKES THE IBM-PC INTO A DEDICATED WORD PROCESSOR. PC MAGAZINE REVIEWED THIS EXTENSIVELY IN THE FEB. 7, 1984 ISSUE. | |
| NBI PACKAGE | List \$695 \$ 545 |
| ADDITIONAL RAM SETS (64K PER SET) | \$ 55 |

CALL THE EXPERT
(213) 344-6063 (800) 528-9537

CALL THE EXPERT
(213) 344-6063 (800) 528-9537

OTHER COMPUTERS

| | |
|------------------------------------|---------|
| COLUMBIA 1600-1 DESKTOP w/SOFTWARE | \$ 2750 |
| COLUMBIA PORTABLE VP | \$ 2599 |
| COLUMBIA HARD DISK DESKTOP | \$ 3900 |
| CORONA DESKTOP - 2 DRIVES | \$ 2475 |
| CORONA PORTABLE - 2 DRIVES | \$ 2375 |

EAGLE

| | |
|----------------------|---------|
| EAGLE PC-2 | \$ 2750 |
| PC-2 COLOR | \$ 2500 |
| SPIRIT XL | \$ 3900 |
| COLOR GRAPHICS BOARD | \$ 240 |
| SASI INTERFACE | \$ 110 |
| MONOCHROME ADAPTOR | \$ 240 |
| MONOCHROME MONITOR | \$ 280 |

FRANKLIN

| | |
|---------------------|---------|
| FRANKLIN FAMILY PAK | \$ 1045 |
| PRO PLUS | \$ 1267 |
| ACE 1000 | \$ 795 |
| ACE PRO | \$ 1137 |
| ACE 1200-1 DRIVE | \$ 1399 |
| ACE 1200 OMS | \$ 1595 |

NEC

| | |
|---|---------|
| NEC'S ADVANCED PERSONAL COMPUTER NOW HAS BUNDLED SOFTWARE - NO EXTRA CHARGE | |
| NEC APC-1 DRIVE, GREEN #H01 | \$ 2095 |
| NEC APC-2 DRIVES, GREEN #H02 | \$ 2550 |
| NEC APC-2 DRIVES, COLOR #H03 | \$ 3150 |
| NEC APC-1 DRIVE, COLOR #H04 | \$ 2575 |
| EPSON QX-10 | \$ 2195 |
| APPLE II-E STARTER SYSTEM | \$ 1375 |

SANYO

| | |
|-------------------------------|---------|
| SANYO MBC550 | \$ 795 |
| MBC550 w/ADDED 360K 2ND DRIVE | \$ 1055 |
| MBC555 | \$ 1195 |

SANYO EXPLANATION: THE STANDARD MBC550 HAS ONE SINGLE SIDED DRIVE AND 3 PIECES OF SOFTWARE. THE STANDARD MBC555 HAS TWO SINGLE SIDED DRIVES AND 6 PIECES OF SOFTWARE. THE ENHANCED MBC550 HAS ONE SINGLE SIDED DRIVE, ONE DOUBLE SIDED DRIVE, AND 3 PIECES OF SOFTWARE.

SANYO: WE BID ON LARGE QUANTITIES AND ACCEPT CORPORATE AND SCHOOL P.O.'S. WE OFFER EXTENSIVE OPTIONS, INCLUDING HARD DISK AND NETWORKS.

TAVA PC



| | |
|---|---------|
| TAVA PC-2 DRIVES, 128K, 2 SERIAL, 1 PARALLEL, GRAPHICS VIDEO, GREEN CRT | \$ 1865 |
| TAVA PC - SAME AS ABOVE EXCEPT IBM-TYPE MONOCHROME VIDEO AND CRT | \$ 1865 |

EXPERT COMPUTERS

21804 ROSCOE BLVD., SUITE 18
CANOGA PARK, CA 91304
(213) 344-6063
(800) 528-9537

Circle 156 on Inquiry card.

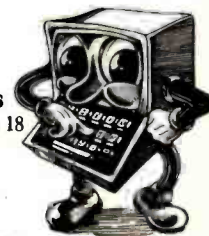

ADD 2% FOR VISA/MASTERCARD. 20% PREPAID DEPOSIT REQUIRED ON COD ORDERS. CALIFORNIA RESIDENTS ADD SALES TAX. PRICES MAY CHANGE - CALL TO VERIFY PRICES AND DELIVERY.

PRINTER RIBBONS

| | PRICE | PER RIBBON | PER DOZEN |
|--------------------------------|-------|------------|-----------|
| Anadex 9500 | 13.50 | 137.00 | 147.00 |
| Apple DMP | 5.95 | 68.40 | |
| Centronics 150/152 | 7.00 | 81.00 | |
| C. Itoh Prowriter | 5.95 | 68.40 | |
| Commodore Pet 8023P | 7.00 | 81.00 | |
| Epson MX-FX 70/80 | 5.25 | 60.00 | |
| Epson MX-FX 100 | 9.95 | 108.00 | |
| Gemini - 10 | 2.50 | 27.00 | |
| NEC 3500 M/S Single Sided | 6.95 | 80.40 | |
| NEC 3500 Nylon | 9.75 | 114.00 | |
| NEC PC 8023A | 5.95 | 68.40 | |
| Okidata 80/82/83/92 | 2.50 | 27.00 | |
| Okidata - 84 | 5.00 | 57.00 | |
| Radio Shack D.W. II M/S | 5.00 | 57.00 | |
| Radio Shack D.W. II Nylon | 6.75 | 78.00 | |
| Radio Shack DMP - 2100 | 7.50 | 87.00 | |
| Radio Shack LP I II III IV & V | 6.00 | 69.00 | |
| Silver Reed EX55 Single Strike | 5.00 | 57.00 | |
| Toshiba - 1350 | 7.50 | 87.00 | |
| Wang Bearclaw | 9.00 | 105.00 | |
| Xerox 610/620 M/S | 7.75 | 84.00 | |

Add \$2.00 Shipping

To Order Call (313) 569-3218 or Write for our Catalog

DWIGHT COMPANY, INC.

15565 Northland Drive - West Tower
Southfield, Michigan 48075-6496

Circle 137 on inquiry card.



flexible disks

Call Free (800)235-4137

for prices and information.

Dealer inquiries invited.

C.O.D. and charge cards accepted.

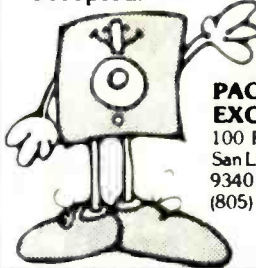

PACIFIC EXCHANGES

100 Foothill Blvd
San Luis Obispo, CA
93401 (In Cal. call
(805) 543-1037)



Circle 282 on inquiry card.

Contractor

Accounting & Management

JOB COSTING
with
Bonding Reports



Multi-state/multi-union variable-rate payroll with certified reports, subcontract management, accounts payable, equipment costing, accounts receivable, general ledger, estimating and critical path. Fully integrated, excellent audit trail, source code supplied. Mature installed 5 1/2 years nationwide. Multi-user available.



A-SYSTEMS CORPORATION

Written for
**CP/M 80, CP/M 86
and MS DOS**

1610 South Main - Dept. HB
Bountiful, Utah 84010
801-298-0052

Circle 4 on inquiry card.

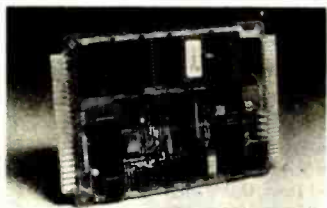

CONTROL THE WORLD!

The SYS-3A is a low cost, powerful microcontroller card with a Tiny BASIC language. Used in robotics, energy management, process control, science and education. Contains everything needed to write, debug, and permanently store programs that auto run on powerup. The 46 input/output lines include A/D, D/A, TTL I/O, and high current drivers. Multiple input ranges and drive capabilities. 4K RAM, 4K EPROM space, 2K software, & Tiny BASIC included. I/O and memory expandable. Programs both EPROM's and EEPROM's. RS-232C port connects to CRT terminals, printers, or personal computers. Software, hardware, peripheral cards available. 4.5" x 6.5". 5V operation.

OCTAGON SYSTEMS CORPORATION
6501 W. 91st Ave., Westminster, CO 80030
(303) 426-8540

Circle 278 on inquiry card.

DATA ACQUISITION and control for ANY computer



The Model 8232 communicates via RS-232, and has 8 analog inputs (0-5 VDC; 8 bits), 8 digital inputs and outputs, and a 2000 point buffer. Suitable for field data logging or lab use, the 8232 costs only \$540. Direct bus-connect unit for TRS-80/III & 4 is \$295. Detailed manual, \$6. Phone our applications engineer or write:

★★ **STARBUCK DATA COMPANY** ★★

PO Box 24, Newton, MA 02162 (617) 237-7695

Circle 340 on inquiry card.

Like-new products

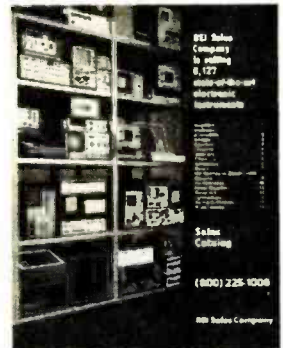

For free catalog, phone toll-free (800) 225-1008 In Massachusetts (617) 938-0900
Genstar REI Sales Company
6307 DeSoto Ave., Ste. J / Woodland Hills, CA 91367

Circle 170 on inquiry card.

CONVERSE WITH YOUR COMPUTER

AT LAST! A FULL IMPLEMENTATION of the original ELIZA program is now available to run on your microcomputer.

Created at MIT in 1966, ELIZA has become the world's most celebrated artificial intelligence demonstration program. ELIZA is a non-directive psychotherapist who analyzes each statement as you type it in and then responds with her own comment or question—and her remarks are often amazingly appropriate!

Designed to run on a large mainframe, ELIZA has never before been available to personal computer users except in greatly stripped down versions lacking the sophistication which made the original program so fascinating.

Now our new microcomputer version possessing the FULL power and range of expression of the original is being offered at the introductory price of only \$25. And if you want to find out how she does it (or teach her to do more), we will include the complete SOURCE PROGRAM for only \$20 additional.

Order your copy of ELIZA today and you'll never again wonder how to respond when you hear someone say: "Okay, let's see what this computer of yours can actually do!"

ELIZA IS AVAILABLE IN THE FOLLOWING FORMATS:

- 5 1/4 inch disk for the 48K Apple II, II Plus, IIe or III
\$25 for Protected Version—\$45 for Applesoft Source Version
- 5 1/4 inch disk for the 64K IBM Personal Computer
\$25 for Protected Version—\$45 for IBM Disk BASIC Source Version
- 5 1/4 inch disk or tape cassette for the Commodore 64 (specify which)
\$25 for Protected Version—\$45 for C-64 BASIC Source Version
- Standard 8 inch single density disk for all CP/M based computers
\$25 for ELIZA.COM—\$45 with Microsoft BASIC-80 Source
- 5 1/4 inch disk for most CP/M based computers (specify computer)
\$25 for ELIZA.COM—\$45 with Microsoft BASIC-80 Source

Please add \$2.00 shipping and handling to all orders (California residents please add 6% sales tax)

ARTIFICIAL INTELLIGENCE RESEARCH GROUP

921 North La Jolla Avenue, Dept. B
Los Angeles, CA 90046
(213) 856-7368 (213) 854-2214
MC, VISA and checks accepted



Circle 39 on inquiry card.

Daisy Wheel Printer



\$249

- * Dynax DX-15 Daisy Wheel 13 cps . . . \$425
- * Silver Reed EXP 550 Daisy Wheel . . . \$595
- * Brother HR-1 Daisy Wheel 16 cps . . . \$645
- * Daisywriter 2000 w/48K . . . \$999
- * C. Itoh F-10 40 cps . . . \$1095
- * Prices subject to availability or change.

MICRO MART

8764 Complex Dr., San Diego, CA 92123
(619) 268-0169

Circle 252 on inquiry card.

NORTH STAR USERS UNITE!

★ Get the information you need from the user's point of view

★ Over 150 pages of members newsletter articles last year

★ D's and cp/m disk library for members

★ Solve problems

★ Get assistance

Membership dues \$20

International North Star Users Association
P.O. Box 2789 B Fairfield, CA 94533

Circle 195 on inquiry card.



COMPUTER DISCOUNT PRODUCTS FAIR PRICE POLICY

CDP GUARANTEES THE LOWEST AVAILABLE PRICE ON ALL COMPUTER PRODUCTS!

You pay either our discount price OR the lowest advertised price from any other display ad in this issue.
*Ultimate proof of price rests with customer. CDP will match both published price and terms. Excludes typographical errors, items out of stock and products sold only through authorized outlets unless we are also authorized.



CDP SHOW SCHEDULE:
NY COMPUTER SHOW
Long Island, Apr. 28-29
APPLE/IBM EXPO
Chicago, May 3-6
APPLE/IBM EXPO
New York, Sept. 20-23
PC FAIRE
San Francisco, Oct. 28-28
WIN CITIES COMPUTER SHOW
Minneapolis, Oct. 25-28
NORTHEAST COMPUTER SHOW
Boston, Nov. 1-4

CDP SPECIALS

| | |
|---------------------------------|-------|
| 16K RAM CARD | 39.99 |
| POWER STRIP w/Surge | 17.99 |
| APPLE FAN w/Surge, 2 Outlets | 39.99 |
| PAR. PRINTER CARD & CABLE | 39.99 |
| 16K UPGRADE 4116 200 NS (Set/8) | 9.99 |
| 64K UPGRADE 4164 200 NS (Set/9) | 79.99 |

DISKETTES

| | |
|-----------------------|--------|
| DYSAN 5" 5SD (10) | 31.99 |
| DYSAN 5" 5SD (100) | 299.99 |
| DYSAN 5" 5SD (10) | 36.99 |
| DYSAN 5" 5SD (100) | 369.99 |
| MAXELL 5" 5SD (10) | 27.99 |
| MAXELL 5" 5SD (100) | 259.99 |
| MAXELL 5" 5SD (10) | 37.99 |
| MAXELL 5" 5SD (100) | 359.99 |
| VERBATIM 5" 5SD (10) | 24.99 |
| VERBATIM 5" 5SD (100) | 229.99 |
| VERBATIM 5" 5SD (10) | 36.99 |
| VERBATIM 5" 5SD (100) | 349.99 |

EDUCATIONAL SOFTWARE SPECIAL

Additional 10% OFF with order of any 5 educational programs from DLM, SPINNAKER, LEARNING CO.



MicroPro

| | |
|--------------|--------|
| CALCSTAR | 80.99 |
| DATASTAR | 179.99 |
| MAIL MERGE | 130.99 |
| REPORTSTAR | 199.99 |
| SPELLSTAR | 139.99 |
| STARINDEX | 100.99 |
| SUPERSORT | 130.99 |
| WORDSTAR PRO | 379.99 |

INFOSTAR OR WORDSTAR ea. 249.99

APPLE SOFTWARE

| | |
|----------------------------|------------------------|
| BPI (GL, AP, AR, PAY, INV) | 274.99 |
| BRODERBUND Arcade Machine | 39.99 |
| Bank Street Writer | 44.99 |
| Drot | 24.99 |
| Loderunner | 24.99 |
| CENTRAL POINT Copy II + | 25.99 |
| DATAMOST Zaxxon | 26.99 |
| Ap, IBM, Comm.Books | ea14.99 |
| DATASOFT Zaxxon | 24.99 |
| DLM Alien Addition | Sch - 37.99, H - 27.99 |
| Alligator Mix | Sch - 37.99, H - 27.99 |
| Demolition Division | Sch - 37.99, H - 27.99 |
| Dragon Mix | Sch - 37.99, H - 27.99 |
| Meteor Multiplication | Sch - 37.99, H - 27.99 |
| Minus Mission | Sch - 37.99, H - 27.99 |
| Verb Viper/Word Invasion | ea37.99 |
| Word Man/Word Master | ea37.99 |
| Word Radar/Spelling Wiz | ea37.99 |
| HAYDEN Piewriter | 94.99 |
| Sargon II | 24.99 |
| INCREDIBLE JACK | 129.99 |
| Jack Report | 74.99 |
| KENNINGTON Format II | 128.99 |
| L&S Crossword Magic | 39.99 |
| LEARNING CO Bumble Games | 29.99 |
| Stumble Plot/Magic Spell | ea26.99 |
| Gertrudes Puzzle/Secret | ea23.99 |
| Juggles Rainbow | 19.99 |
| Mogwam Parade/Hotel | ea26.99 |
| Rocky's Boots | 34.99 |
| LIGHTNING Mastertype | 29.99 |
| MICROLAB Miner 20-49er | 27.99 |
| MICROSOFT A.L.D.S. | 75.99 |
| Multipian | 165.99 |
| Multitool Budd | 109.00 |
| Multitool Fin. Stmt. | 69.99 |
| ODESTA Chess | 45.99 |
| Odin | 37.99 |
| PENGUIN Graphics Magician | 38.99 |
| SIERRA ON LINE Frogger | 21.99 |
| Screenwriter II | 81.99 |
| Ultima II | 36.99 |
| General Manager | 148.99 |
| ULTRASOFT Serpents Star | 29.99 |
| Mask of the Sun | 29.99 |

SPRING CLEARANCE

| | |
|------------------------|-------|
| Argos AP | 19.99 |
| Canyon Climber, AP-AT | 11.99 |
| Crazy Mazzy, AT | 14.99 |
| Crossfire, AP-NEC-V20 | 14.99 |
| Curse of Ra, AP-AT-IBM | 9.99 |
| Dark Crystal, AP | 19.99 |
| Datestones of Ryn, AT | 9.99 |
| David's Magic, AP | 16.99 |
| Dragons Eye, AP | 14.99 |
| Flight Sim, TRS 80 | 19.99 |
| Gorgon, AP | 19.99 |
| Heilfire Warrior, AP | 14.99 |

SOFTWARE FUN

| | |
|------------------------|-------|
| High Rise, AP | 14.99 |
| Jawbreaker, AP-AT | 14.99 |
| Jumpman, AP-AT-IBM | 19.99 |
| Marauder, AP-AT | 16.99 |
| Mars Cars, AP | 14.99 |
| Micro Mother Goose, AP | 19.99 |
| Missing Ring, AP | 14.99 |
| Money Munchers, AP | 14.99 |
| Mooseattack, AT | 11.99 |
| Pandora's Box, AP | 14.99 |
| Pegasus II, AP | 14.99 |
| Perception, AP | 11.99 |
| PieMan, AP | 9.99 |
| Police Artist, AP | 16.99 |
| Rescue at Rigel, AT | 14.99 |

GREAT GIFTS

| | |
|----------------------------|-------|
| Ricochet, AP | 11.99 |
| Sabotage, AP | 11.99 |
| Sigma 7, AP | 11.99 |
| Snack Attack, AP | 14.99 |
| Space Guardians, IBM | 14.99 |
| Space Strike, IBM | 14.99 |
| Spoc, IBM | 19.99 |
| Starblazer, AP | 15.99 |
| Thorolian Tunnels, AP | 14.99 |
| Thief, AP | 14.99 |
| Thunder Bombs, AP | 9.99 |
| TubeWay II, AP | 16.99 |
| Ulysses, AP-AT-IBM | 15.99 |
| Upper Reaches/Apsn., AP-AT | 9.99 |
| Vortex, AP | 15.99 |

FOR THE PRO

| | |
|---------------------------|--------|
| Data Base Mgr. II, IBM | 132.99 |
| Graph & Calc., IBM | 89.99 |
| Perf. Calc., AP-IBM-CP/M | 99.95 |
| Perf. File., AP-IBM-CP/M | 189.95 |
| Perf. Write., AP-IBM-CP/M | 159.95 |
| Real Est. Invest. AP-IBM | 58.95 |
| Spreadsheet, AP-IBM | 35.99 |
| Write-On, IBM | 58.95 |

IBM

| | |
|-------------------------------|----------|
| 1/2 Height DS/DD Drive | 239.99 |
| ALPHA Typewriters | 79.99 |
| ASHTON TATE dBase II | 429.99 |
| Friday | 184.99 |
| Encyclopedia | 59.99 |
| AST Boards | \$CALL |
| BRODERBUND Serpentine | 26.99 |
| Lode Runner | 24.99 |
| CAI Masters | ea31.99 |
| Subjects | ea16.99 |
| CENTRAL POINT Copy II PC | 25.99 |
| EDUWARE Algebra I | 29.99 |
| HAYDEN Piewriter | 129.99 |
| HAYES 1200B Modem | 438.99 |
| KRAFT Joystick | 44.99 |
| LIFETREE Volkswriter | 119.99 |
| LIGHTNING Mastertype | 26.99 |
| LOTUS 1-2-3 | \$CALL |
| MICROLAB Miner 20-49er | 27.99 |
| MICROSOFT | |
| Mouse | 129.99 |
| Multipian | 165.99 |
| Multitool Budd | 109.99 |
| Multitool Fin. Stmt. | 69.99 |
| Word | 289.99 |
| Word (w/Mouse) | 319.99 |
| NORTON Utilities | 59.99 |
| PC CRAYON | 49.99 |
| PC TUTOR | 47.99 |
| PFS Write | 109.99 |
| File | 109.99 |
| Report | 109.99 |
| Graph | 109.99 |
| POOL 1.5 | 27.99 |
| PLANTRONICS ColorPlus | 375.99 |
| SIERRA ON LINE Frogger | 26.99 |
| SIR-TECH Wizardry | 44.99 |
| SUBLOGIC Pinball | 29.99 |
| TG Joystick | 44.99 |
| TITAN 64K BOARD | 499.99 |
| VISICORP. Viscalc or Visidex | 184.99 |
| Visifile, TrendPlot, Schedule | ea199.99 |
| Visikim | \$CALL |
| Visispell | 179.99 |
| Visiword | 269.99 |

Beagle Bros

| | |
|----------------|-------|
| ALPHA PLOT | 24.99 |
| APPLE MECHANIC | 18.99 |
| BEAGLE BASIC | 24.99 |
| DOS BOSS | 15.99 |
| DOUBLE TAKE | 24.99 |
| FLEX TEXT | 18.99 |
| FRAME-UP | 16.99 |
| PRONTO DOS | 18.99 |
| TIP DISK #1 | 14.99 |
| TYPEFACES | 14.99 |
| UTILITY CITY | 19.99 |

ALL OF ABOVE 234.99

Continental

| | |
|-----------------------------|--------|
| APPLE GRAPHICS BOOK | 14.99 |
| CPA (GL, AP, AR, PAY) ea | 149.99 |
| FCMFL 1st CLASS MAIL (AP) | 61.99 |
| FCMFL 1st CLASS MAIL (IBM) | 71.99 |
| HOME ACCOUNTANT + (IBM) | 84.99 |
| HOME ACCTNT + (TI PRO, OSB) | 58.99 |
| HOME ACCTNT + (TI PRO) | 119.99 |
| PROPERTY MANAGEMENT | 299.99 |
| TAX ADVANTAGE (Ap) | 39.99 |

ULTRAFILE (IBM) 155.99
HOME ACCTNT (AP) 44.99

KENNINGTON MICROWARE



SYSTEM SAVER

- Surge Suppression
- Fits Apple, Stand
- Dual Outlet
- U.L. Listed
- Great Gift

\$ 65

INFOCOM

| | |
|-----------------|----------|
| DEADLINE | 32.99 |
| ENHANCER | 32.99 |
| PLANE/FALL | 32.99 |
| SUSPENDED | 32.99 |
| WITNESS | 32.99 |
| STARCROSS | |
| ZORK I, II, III | ea 24.99 |

APPLE HARDWARE

| | |
|-----------------------------------|--------|
| ALS CP/M 3.0 | 259.99 |
| AUTO REPEAT KEY | 19.99 |
| BASIS 106 | \$CALL |
| DAN PAYMAR Lower Case 1 (rev 1-6) | 25.99 |
| Lower Case 2 (rev 7) | 19.99 |
| DARK STAR Snapshot II | 65.99 |
| EASTSIDE Wildcard II | 109.99 |
| FOURTH DIMENSION Drive | 219.99 |
| HAYES Microdemon IIe | \$CALL |
| KOALA PAD | 85.99 |
| KRAFT Joystick | 39.99 |
| KRAFT Paddles | 31.99 |
| MICRO-SCI Drive | 219.99 |
| MOUNTAIN OPS Card | 159.99 |
| NOVATION Appocal II | 249.99 |
| Appocal Upgrade 1200 Baud | 309.99 |
| ORANGE MICRO Grappier + | 114.99 |
| Bufferboard | 119.99 |
| Buttered Grappier + | 179.99 |
| PADDLE ADAPPLE | 24.99 |
| SATURN 128K Ram | 379.99 |
| Accelerator II | 444.99 |
| Neptune 64K | 199.99 |
| S. CORONA TP-2 PRINTER | \$CALL |

QUADRAM

| | |
|---------------------------|--------|
| APIC (APPLE III PARALLEL) | 129.99 |
| ERAM 80 column 64K IIE | \$CALL |
| MICROFAZER | \$CALL |
| QUADBOARD I or II (64K) | 289.99 |
| QUADCOLOR I | 219.99 |
| QUADCOLOR II | 209.99 |
| QUAD 512 + (64K) | 219.99 |

QUADLINK 479.99

SPINNAKER

| | |
|-----------------------|-------|
| ALPHABET ZOO | 19.99 |
| DELTA DRAWING | 32.99 |
| FACEMAKER | 21.99 |
| FRACTION FEVER | 21.99 |
| KINDERCOMP | 19.99 |
| MOST AMAZING THING | 26.99 |
| SNOOPER THROOP I & II | 29.99 |
| STORY MACHINE | 21.99 |

ACCESSORIES

| | |
|------------------------------|---------|
| 1984 API/AT/IBM Book | ea15.99 |
| EPSON Printers | \$CALL |
| FINGERPRINT (Enhancer) | 44.99 |
| Flip'n File (original) | 17.99 |
| Flip'n File w/Lockray (25) | 17.99 |
| Flip'n File w/Lockray (50) | 27.99 |
| HAYES 300 Baud Smartmodem | 199.99 |
| 1200 Baud Smartmodem | 474.99 |
| Library Case | 1.99 |
| KENNINGTON PC Saver | 28.99 |
| NOVATION J Cat | 99.99 |
| NOVATION Access 123 | 469.99 |
| NOVATION 103/212 Auto Cat | 399.99 |
| NOVATION 103 Smart Cat | 199.99 |
| NOVATION Expansion Mod | 29.99 |
| PAGEMATE Book Holder | 14.99 |
| Printer Stand Small (plgxis) | 24.99 |
| Printer Stand Large (plgxis) | 29.99 |
| RIBBONS-Brother | \$call |
| MX & FX 80 | 4.99 |
| MX & FX 100 | 7.99 |
| Oki 82, 83, 92, 93 & Gemini | 34.99 |

MAIL & PHONE ORDERS:

860 S. Winchester Blvd.
San Jose, CA 95128
(408) 985-0400

COMPUTER DISCOUNT PRODUCTS

SAN FRANCISCO
1230 Market St.
San Francisco, CA 94102
(415) 626-2244

SAN JOSE
860 S. Winchester Blvd.
San Jose, CA 95128
(408) 985-0401

SAN MATEO
4228 Olympic Ave.
San Mateo, CA 94403
(415) 571-1658

MON-FRI 10AM-7PM • SAT-SUN-HOL 10AM-5PM • San Jose Store Open Daily At 8AM

- No Charge For Credit Cards
- Prices Subject To Change
- Software Sales Are Final
- Canadian Orders Welcome
- Min. UPS Chg. \$4 + Ins.
- Min. US Postal Chg. \$10
- P.O.'s Welcome - Call First



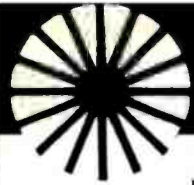

FORMULA INTERNATIONAL INC.

12603 Crenshaw Blvd., Dept. B. Hawthorne, CA 90250

For information (213) 973-1921 • Orders Only (outside Calif.) (800) 672-8758



pinecom™

No Copyright Problems!

Compare These Features with Our Competitors:

- Powerful Utility Program (100% Apple Compatible)
- 68-Key Upper & Lower Case Keyboard with Numeric Keypad
- 25 Pre-programmed Function Keys
- 2 Speed Auto Repeat Function
- 64K User Memory—expandable to 192K
- 5A Switching Power Supply (110/220VAC)
- All ICs Are Socketed for Easy Service
- Nation-wide Dealer Network for Convenient Technical Support

And best of all, the price Assembled and Tested is just.

Pioneer of Low Cost Apple* Compatible Computer



Now with New Improved Keyboard and 64K RAM
\$499⁰⁰



pinecom™ DP-64

- Dual Processor (6502 and Z80A)
- Detached Keyboard
- 64K RAM Expandable to 192K
- 25 Function Key Keyboard
- Auto Repeat Keys w/Upper/lower Case
- 2 Slim Disk Drives (optional)
- 100% Apple II Compatible
- 40/80 Column Display (optional)
- Runs Both Apple Soft and CP/M Software



Model DP-64 Fully Assembled ... \$650⁰⁰

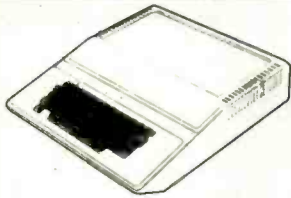

AP-II COMPUTER A&T

Apple Look Alike
 48K User Memory
 Supports Upper & Lower Case
 100% Apple II* Compatible

\$455⁰⁰

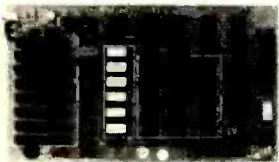

AP-II MOTHERBOARD

Apple II + * Compatible
 48K Memory Space
 8 Expansion Slots

Bare Board **\$69.95 ea.**
 Assembled & Tested **\$295.00 ea.**

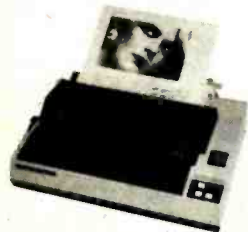

PRINTER by Super-5

Parallel Interface (Centronics Compatible) Standard
 Microprocessor Electronics
 80cps Bidirectional with Logic Seeking
 96 Character ASCII
 Adjustable Sprocket and Friction Feed

Model CP-80 \$265⁰⁰

MICRO-II COMPUTER

100% Apple Compatible • No Copyright Problems!

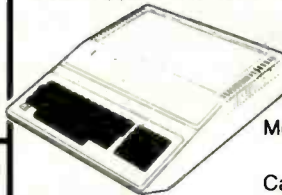

Model I 48K RAM **\$475⁰⁰**

Model II 64K RAM **\$515⁰⁰**

Model III 64K RAM w/Dual CPU .. **\$555⁰⁰**
(6502 for Applesoft & Z80A for CP/M)

Case and Keyboard Only **\$159.95**

All above models are standard with Numeric Keypad, Function Keys, Auto Repeat Keys, Upper/lower Case Function, Fully Assembled and Tested.

PERIPHERALS

- Autoterm 80-Col. w/Softswitch **\$99.95**
- 80-Column Card **99.95**
- 80-Column for Apple IIe* **49.95**
- Z80 CP/M Card (no software) **99.95**
- 16K RAM Card w/Cable **47.50**
- Parallel Printer Interface **85.00**
- Buffer for Printer Interface (16-64K) **85.00**
- Serial Printer Interface Card w/Adj. Baud **85.00**
- Disk Controller **85.00**
- Disk Controller DOS 3.2/3.3 Auto Select. **75.00**
- EPRM Writer Card (2716/2732/2764) **75.00**

3M DISKETTES SALE

Single Sided / Double Density Soft Sector

10 for **\$24⁵⁰**

SEND ONE DOLLAR FOR OUR DETAIL CATALOG

Inside California
 Outside Calif. (incl. Mexico & Canada)
 Overseas

Shipping & Handling Charges
 Under \$50.00 Purchase 10%
 Over \$50.00 Purchase 15%
 5%
 10%
 20%

Minimum Order \$10.00/Calif. Residents add 6.5% Sales Tax. Phone Orders Accepted on VISA or MC ONLY. NO C.O.D.'s. Prices subject to change without notice.



STORE HOURS
MON-FRI—10-7
SAT—10-6

*Apple and Apple II are the trademark of APPLE COMPUTERS, INC.

Circle 163 for Dealer inquiries. Circle 164 for End-User inquiries.

74LS00

| | | | |
|---------|------|---------|------|
| 74LS00 | .60 | 74LS166 | 2.50 |
| 74LS01 | .60 | 74LS168 | 1.35 |
| 74LS02 | .60 | 74LS169 | 1.35 |
| 74LS03 | .60 | 74LS170 | 2.50 |
| 74LS04 | .75 | 74LS173 | 1.50 |
| 74LS05 | .75 | 74LS174 | 1.50 |
| 74LS08 | .75 | 74LS175 | 1.50 |
| 74LS09 | .75 | 74LS181 | 2.50 |
| 74LS10 | .65 | 74LS190 | 1.45 |
| 74LS11 | .75 | 74LS191 | 1.45 |
| 74LS12 | .75 | 74LS192 | 1.35 |
| 74LS13 | .95 | 74LS193 | 1.35 |
| 74LS14 | 1.25 | 74LS194 | 1.45 |
| 74LS15 | .75 | 74LS195 | 1.35 |
| 74LS20 | .60 | 74LS196 | 1.35 |
| 74LS21 | .75 | 74LS197 | 1.35 |
| 74LS22 | .75 | 74LS221 | 1.35 |
| 74LS26 | .75 | 74LS240 | 1.85 |
| 74LS27 | .75 | 74LS242 | 1.85 |
| 74LS28 | .75 | 74LS243 | 1.85 |
| 74LS40 | .75 | 74LS244 | 2.25 |
| 74LS42 | .95 | 74LS245 | 3.95 |
| 74LS48 | .95 | 74LS247 | 1.65 |
| 74LS51 | .60 | 74LS248 | 1.65 |
| 74LS54 | .60 | 74LS249 | 1.65 |
| 74LS55 | .60 | 74LS251 | 1.75 |
| 74LS73 | .95 | 74LS253 | 1.75 |
| 74LS74 | 1.42 | 74LS258 | 1.50 |
| 74LS75 | .95 | 74LS259 | 2.95 |
| 74LS76 | .95 | 74LS260 | 1.15 |
| 74LS78 | .95 | 74LS261 | 3.75 |
| 74LS83A | 1.15 | 74LS266 | 1.35 |
| 74LS85 | 1.25 | 74LS273 | 1.75 |
| 74LS86 | .75 | 74LS275 | 4.95 |
| 74LS90 | .95 | 74LS279 | .95 |
| 74LS92 | .95 | 74LS283 | 1.25 |
| 74LS93 | .95 | 74LS290 | 1.25 |
| 74LS95 | .95 | 74LS293 | 1.25 |
| 74LS96 | 1.25 | 74LS295 | 1.65 |
| 74LS107 | .75 | 74LS298 | 1.65 |
| 74LS109 | .75 | 74LS323 | 4.95 |
| 74LS113 | .95 | 74LS324 | 2.15 |
| 74LS114 | .95 | 74LS347 | 2.55 |
| 74LS122 | 1.05 | 74LS348 | 2.55 |
| 74LS123 | 1.35 | 74LS352 | 1.65 |
| 74LS124 | 1.35 | 74LS353 | 1.95 |
| 74LS125 | .95 | 74LS363 | 1.95 |
| 74LS126 | .95 | 74LS365 | 1.25 |
| 74LS132 | 1.35 | 74LS366 | 1.25 |
| 74LS133 | .95 | 74LS367 | .95 |
| 74LS136 | .95 | 74LS368 | .95 |
| 74LS138 | 1.10 | 74LS373 | 2.50 |
| 74LS139 | 1.10 | 74LS374 | 4.95 |
| 74LS145 | 1.75 | 74LS375 | 1.25 |
| 74LS148 | 1.75 | 74LS377 | 1.95 |
| 74LS151 | 1.25 | 74LS378 | 2.55 |
| 74LS153 | 1.25 | 74LS385 | 1.95 |
| 74LS154 | 1.70 | 74LS379 | 2.55 |
| 74LS155 | 1.25 | 74LS386 | 1.25 |
| 74LS156 | 1.35 | 74LS381 | 3.95 |
| 74LS157 | 1.25 | 74LS390 | 2.55 |
| 74LS158 | 1.25 | 74LS393 | 2.55 |
| 74LS160 | 1.25 | 74LS395 | 2.55 |
| 74LS161 | 1.25 | 74LS424 | 3.95 |
| 74LS162 | 1.25 | 74LS640 | 3.95 |
| 74LS163 | 1.25 | 74LS668 | 2.75 |
| 74LS164 | 1.65 | 74LS645 | 4.95 |
| 74LS165 | 1.25 | 74LS670 | 2.50 |
| | | 74LS690 | 2.50 |

74S00

| | |
|--------|------|
| 74S00 | .75 |
| 74S02 | .75 |
| 74S03 | .75 |
| 74S04 | .75 |
| 74S05 | .75 |
| 74S08 | .95 |
| 74S09 | .95 |
| 74S10 | .95 |
| 74S11 | .95 |
| 74S15 | .95 |
| 74S20 | .95 |
| 74S22 | .95 |
| 74S30 | .95 |
| 74S32 | .95 |
| 74S38 | 1.95 |
| 74S40 | .95 |
| 74S51 | .95 |
| 74S64 | .95 |
| 74S65 | .95 |
| 74S74 | 1.50 |
| 74S86 | 1.25 |
| 74S112 | 1.25 |
| 74S113 | 1.25 |
| 74S114 | 1.25 |
| 74S124 | 3.65 |
| 74S133 | .95 |
| 74S134 | 1.25 |
| 74S135 | 1.65 |
| 74S136 | 2.25 |
| 74S138 | 1.95 |
| 74S139 | .95 |
| 74S140 | 1.25 |
| 74S151 | 1.95 |
| 74S153 | 1.95 |
| 74S157 | 1.95 |
| 74S158 | 1.95 |
| 74S160 | 2.95 |
| 74S161 | 3.95 |
| 74S163 | 3.95 |
| 74S174 | 2.25 |
| 74S175 | 2.25 |
| 74S188 | 3.55 |
| 74S194 | 2.55 |
| 74S195 | 2.55 |
| 74S196 | 2.55 |
| 74S225 | 7.75 |
| 74S240 | 2.95 |
| 74S241 | 2.95 |
| 74S242 | 3.95 |
| 74S243 | 3.95 |
| 74S251 | 2.25 |
| 74S253 | 2.25 |
| 74S257 | 1.95 |
| 74S258 | 1.95 |
| 74S260 | 1.25 |
| 74S280 | 2.95 |
| 74S283 | 3.95 |
| 74S287 | 3.95 |
| 74S288 | 3.95 |
| 74S289 | 4.95 |
| 74S373 | 3.95 |
| 74S374 | 3.95 |
| 74S387 | 3.95 |
| 74S471 | 7.95 |
| 74S472 | 7.95 |
| 74S473 | 7.95 |
| 74S474 | 9.95 |
| 74S475 | 9.95 |

7400 SERIES CALL FOR PRICE

| | | |
|------------------|-------------------|--------------------|
| MOS EPROM | STATIC RAM | SOUND CHIPS |
| 2708 5.95 | 2101 2.95 | 76477 2.95 |
| 2716-450 3.95 | 5101 4.95 | 76489 8.95 |
| 2732-450 5.95 | 2114-450 1.95 | AY3-8910 9.95 |
| 2732-250 6.95 | 2114-200 2.15 | AY3-8912 12.95 |
| 2764-450 7.95 | 2147 4.95 | |
| 2764-250 9.95 | 6116-4 5.75 | |
| 2764-300 9.95 | 6116-3 6.75 | |
| 27128-250 25.95 | 6116-2 7.95 | |
| TMS2516 4.95 | 6116LP-4 6.75 | |
| TMS2716 7.95 | 6116LP-3 6.95 | |
| TMS2532 5.95 | 6116LP-2 8.95 | |
| MISC | DYN. RAM | CRYSTALS |
| 6502 4.95 | 4116-200 1.95 | 32.758khz 1.75 |
| 68000 49.95 | 4116-150 2.25 | 1.0mhz 3.95 |
| 8748 24.95 | 4116-120 2.95 | 1.8432 3.95 |
| 8255-5 5.95 | 4164-200 6.75 | 20 2.95 |
| 82S123 2.55 | 4164-150 6.95 | 2.097152 2.95 |
| 82S129 2.99 | | 2.4576 2.95 |
| 82S131 3.99 | | 3.2768 2.95 |
| 93422 8.95 | | 3.579535 2.95 |
| 93L422 9.95 | | 5.0 2.95 |
| 93425 3.95 | | 5.0 2.95 |
| 93427 8.95 | | 5.0688 2.95 |
| D2125AL-2 3.95 | | 5.185 2.95 |
| D2104 1.95 | | 5.7143 2.95 |
| AY5-3600 12.95 | | 6.0 2.95 |
| 6810 3.95 | | 6.144 2.95 |
| 8304 3.95 | | 6.5536 2.95 |
| | | 8.0 2.95 |
| | | 10.0 2.95 |
| | | 10.738635 2.95 |
| | | 12.00 2.95 |
| | | 14.31818 2.95 |
| | | 15.0 2.95 |
| | | 16.0 2.95 |
| | | 17.430 2.95 |
| | | 18.0 2.95 |
| | | 18.432 2.95 |
| | | 20.0 2.95 |
| | | 22.1184 2.95 |
| | | 32.0 2.95 |

GENERAL PURPOSE BOARDS

| BLANK BOARD — HOLES ON 100" GRID, NO ETCHED CIRCUIT EXCEPT CONTACT FINGER | | | |
|---|-------|-----------------|-------|
| No. Contacts | Size | Contact Centers | Price |
| P 441-1 | 22/44 | 4.5" x 6" | 156" |
| P 442-1 | 22/44 | 4.5" x 9" | 156" |
| P 721-1 | 36/72 | 4.5" x 6" | 100" |
| P 722-1 | 36/72 | 4.5" x 9" | 100" |

| D — SUBMINIATURE CONNECTORS | | | | | | |
|-----------------------------|------------|--------|-------------------------|--------|--------|-------|
| Description | Solder Cup | | Right Angle PC Mounting | | Hood | |
| | Pin | Socket | Pin | Socket | Grey | Black |
| Part No. | DXXP | DXXS | RDXXP | RDXXS | DXXCGY | DXXC |
| Contacts | 9 | 2 05 | 2 65 | 3 90 | 3 20 | 1 55 |
| | 15 | 2 05 | 3 60 | 3 70 | 5 40 | 1 55 |
| | 25 | 2 50 | 3 25 | 4 50 | 4 80 | 1 55 |
| | 37 | 4 75 | 7 10 | 9 40 | 10 95 | 2 95 |
| | 50 | 6 00 | 9 25 | --- | --- | 3 50 |

| MODEMS | | | |
|-----------|----------|---|--------|
| SINGLEMAN | MARK I | RS 232C, 300 BAUD, DIR CONN. | 89.00 |
| | MARK VI | IBM COMPATIBLE 300 BAUD, DIR CONN., AUTO ANS/DIAL | 199.00 |
| | MARK VII | RS 232C, 300 BAUD, DIR CONN., AUTO ANS/DIAL | 139.00 |
| | MARK XII | RS 232C, 300/1200 BAUD, DIR CONN., AUTO ANS/DIAL | 359.00 |
| ADAPTER | | 115VAC TO 9V DC | 9.00 |

| | | |
|-------|--|--------|
| HAYES | IBM PC SMARTMODEM 1200B, Plug-in SMARTCOM II COMMUNICATIONS SOFTWARE | 449.00 |
| | SMARTMODEM 300, AUTO ANS/DIAL, 300 BAUD, RS232 | 99.00 |
| | SMARTMODEM 1200, AUTO ANS/DIAL, 1200 BAUD, RS232 | 199.00 |
| | SMARTMODEM IIe, 300 BAUD, AUTO ANS/DIAL, Plug-in | 475.00 |
| | SMARTCOM I COMMUNICATIONS SOFTWARE | 279.00 |
| | | 79.00 |

| RIBBON CABLE | | | | EDGE CARD CONNECTORS | | | |
|-------------------------|------|-------------|-------|----------------------|-----------|-----------|-----------|
| GREY | | COLOR CODED | | 44 PIN WW | 44 PIN ST | 72 PIN WW | 72 PIN ST |
| Contacts | 3' | 10' | 3' | 10' | 2.95 | 5.95 | 6.95 |
| 10 | 1.45 | 4.50 | 1.95 | 5.95 | | | |
| 14 | 1.95 | 4.70 | 2.40 | 7.25 | | | |
| 16 | 1.75 | 4.90 | 2.50 | 7.50 | | | |
| 20 | 2.10 | 5.50 | 3.10 | 9.25 | | | |
| 24 | 1.70 | 6.50 | 2.95 | 9.50 | | | |
| 25 | 1.75 | 6.50 | 3.05 | 10.05 | | | |
| 40 | 3.95 | 11.50 | 3.75 | 18.30 | | | |
| 50 | 4.15 | 12.00 | 7.50 | 22.75 | | | |
| 60 | 4.35 | 15.50 | 9.00 | 27.30 | | | |
| CENTRONIC PRINTER CABLE | | | 12.95 | | | | |

| D- SUBMINIATURE CONNECTOR JUMPERS | | | |
|-----------------------------------|-----|------------------|-------|
| 25DP36 | 36" | Single Male | 12.00 |
| 25DS36 | 36" | Single Female | 12.80 |
| 25DP60P | 36" | Male to Male | 18.95 |
| 25DP60D | 60" | Male to Male | 19.95 |
| 25DS60D | 36" | Female to Female | 18.95 |
| 25DS60S | 60" | Female to Female | 19.95 |
| 25DP36DS | 36" | Male to Female | 18.95 |
| 25DP60DS | 60" | Male to Female | 19.95 |

| FLOPPY DISK DRIVES | | | |
|----------------------|----------|------------------|-------------------|
| FOR IBM PC | | | |
| Shugart | SA455L | 5 1/4" 320 KB | 1/2 High 209.00 |
| Panasonics | | 320KB | 209.00 |
| Toshiba | | 320KB | 209.00 |
| Tandon | TM100-2A | 320KB | 209.00 |
| FOR APPLE II AND IIe | | | |
| Handwell | HD-40 | 5 1/4" Full High | 175.00 |
| Handwell | HSD-80 | 5 1/4" 1/2 High | 185.00 |
| MONITORS | | | |
| Taxan | 12 in. | green | 130.00 |
| Taxan | 12 in. | amber | 135.00 |
| Taxan | | color monitor | Vision 420 550.00 |
| Taxan | | color monitor | Vision III 500.00 |

| | |
|--|---|
| FOR APPLE II & IIe | FOR IBM P/C |
| 16K RAM CARD | MULTIFUNCTION BOARD WITH |
| Compatible with: DOS 3.3 CP/M Visicalc, PASCAL 1 YR WARRANTY | 128K, 2 Serial Port: 1 Parallel Port, Real Time Clock |
| \$39.95 | \$399.00 |

| | |
|---|-----------------------------------|
| Apple II/IIe Compatible Disk Drive | Color Graphic Display Card |
| \$175.00 | \$270.00 |

| | |
|------------------------|---|
| CONTROLLER CARD | IBM MEMORY EXPANSION KIT IBM 64K |
| \$49.95 | \$52.95 |

| | |
|---|------------------------------|
| Speedy ERROM Programmer for Apple II | Joy Stick for IBM P/C |
| \$149.00 | \$35.00 |

| |
|--------------------------------------|
| 8087 MATHEMATICS CO-PROCESSOR |
| \$199.00 |

| | |
|------------------------------|-------------------------|
| JOYSTICK FOR APPLE II | U/V EPROM ERASER |
| \$32.00 | \$37.50 |

| | |
|---|-------------------------------|
| RESISTORS | BARE BOARDS |
| 1/2 WATT 5% CARBON FILM FROM 1 OHM TO 10M OHM | P 25 x 45 2.5" x 4.5" 2.50 |
| 50 pcs 1.25 0.25 ea | P 45 x 65 4.5" x 6.5" 4.95 |
| 100 pcs 2.00 0.020 ea | P 45 x 85 4.5" x 8.5" 6.50 |
| 1000 pcs 15.00 0.015 ea | P 45 x 170 4.5" x 17.0" 11.95 |
| 5000 pcs 50.00 0.010 ea | P 85 x 170 8.5" x 17.0" 19.95 |
| 1/2 WATT 5% CARBON FILM | |
| 50 pcs 2.50 0.050 ea | |
| 100 pcs 4.00 0.040 ea | |
| 1000 pcs 30.00 0.030 ea | |
| 5000 pcs 100.00 0.020 ea | |

| | |
|-------------------------------------|---|
| CENTRONICS RIBBON CONNECTORS | SUPER COOLING FANS For APPLE WITH SURG |
| CEN 36 M 8.75 | \$39.50 |
| CEN 36 F 9.75 | |
| CAPACITORS | |
| Ceramic Disk | |
| Electrolytic | |
| Tantalum | |
| Mylar | |
| Monolithic | |

TERMS: For shipping include \$2.00 for UPS Ground or \$3.00 for UPS Blue Label Air. Items over 4 lbs. require additional shipping charges. \$10.00 minimum order.

1-(800) 821-3628

Handwellcorp

4962 EL CAMINO REAL, SUITE 119 • LOS ALTOS, CA 94022

(415) 962-9265 • TLX: 171947 HANDWELL LTOS

BUILD YOUR OWN *Super* PC/XT COMPUTERS

IBM™ PC/XT COMPATIBLE; SAME PHYSICAL DIMENSIONS

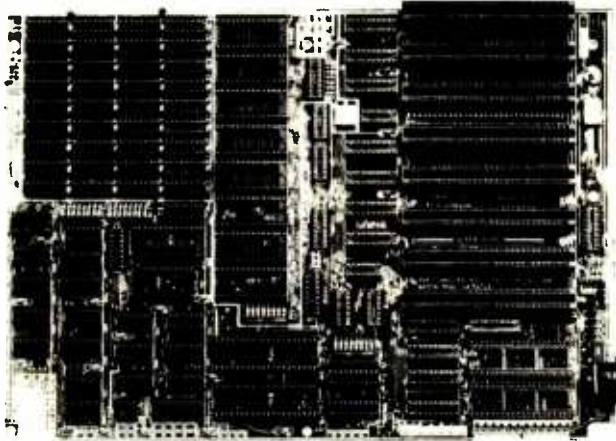

FEATURES:

- *8088 16 Bit Micro Processor W/8087 Co-processor
- *256K on board dynamic RAM with parity
- *4 CHANNEL DMA
- *8 CHANNEL INTERRUPT
- *8 I/O SLOT FOR SUPER XT
- 5(7) I/O SLOT FOR SUPER PC
- *SAME POWER CONNECTOR AS IBM PC™

SUPER PC/SUPER XT BARE BOARD W/MANUAL \$100.
LOADED BOARD W/128K RAM \$525 (W/O ROM)

EASY BOARD \$225.
8K BIOS \$35.

MANUAL ONLY \$25.

LIMITED TIME OFFER COMPLETE SYSTEM: 2-360K DRIVE W/COLOR BOARD AND DYNAX MONITOR \$1995.00

ADD ON BOARDS

| | BARE BOARD | LOADED BOARD |
|---|------------|--------------|
| *DISK PLUS I/O: DISK CONTROLLER W/SERIAL & PARALLEL | \$60.00 | \$295.00 |
| *MONOCHROME GRAPHIC BOARD: HI-RES. MONOCHROME W/720x348 GRAPHICS & PRINTER PORT | \$60.00 | \$399.00 |
| *SUPER COLOR I: COLOR GRAPHICS BOARD | \$75.00 | \$240.00 |
| *ASYNC & BLASTER PROGRAM UP TO 128K EPROMS | \$70.00 | \$245.00 |
| *PARALLEL PRINTER BOARD | \$40.00 | \$100.00 |
| *EXTENSION BOARD | \$25.00 | \$ 35.00 |
| *PROTO-TYPE BOARD | \$25.00 | |

OTHERS

| | | | |
|--------------------------------|-----------|-------------------------------|-----------|
| *INTERNAL HARD DISK 10MB W/PS | \$1395.00 | *TEAC SLIM DRIVE 360K | \$ 399.00 |
| *EXTERNAL WINCHESTER 10MB W/PS | \$1495.00 | *PANASONIC 320K SLIM DRIVE | \$ 209.00 |
| *MOUSE SYSTEM W/SOFTWARE | \$ 249.00 | *MPI 320K FULL SIZE | \$ 199.00 |
| *HAYES 1200B MODEM | \$ 429.00 | *AMDEK 310A | \$ 179.00 |
| *QUADLINK-RUN APPLE PROGRAM | \$ 449.00 | *PRINCETON PGS RGB | \$ 499.00 |
| *KEYBOARD | \$ 200.00 | *NEC RGB 1216 | \$ 499.00 |
| *CASE (METAL) | \$ 150.00 | *62 PIN CONNECTOR | \$ 4.00 |
| *AST 6 PACK PLUS W/64K | \$ 299.00 | *65W POWER SUPPLY W/CASE/FAN | \$ 170.00 |
| | | *130W POWER SUPPLY W/CASE/FAN | \$ 220.00 |

PCjr™ EXPRESS

| | |
|----------------------------------|---------|
| *PCjr™ JOYSTICK (AVAILABLE SOON) | \$35.00 |
| *PCjr™ GAME CARTRIDGE BARE PCB | \$ 8.00 |
| *PCjr™ GAME CARTRIDGE BOX | \$ 8.00 |

ATTENTION: SOFTWARE HOUSE, CARTRIDGE PRODUCTION AND MASK ROM SERVICE AVAILABLE.

IBM & PCjr IS REGISTERED TRADEMARK OF I.B.M.

TERMS: CALIFORNIA RESIDENTS ADD 6% TAX
ADD \$5 FOR PACKING & SHIPPING IN
NORTH AMERICA COMPUTER, PRINTER,
AND MONITOR ADD \$5 EXTRA EACH.

Super Computer, Inc.

1101 S. GRAND AVE., SUITE J., SANTA ANA, CA 92705

NO COPYRIGHT PROBLEM CPM® / APPLE® COMPATIBLE COMPUTERS



MIART-2001

- FEATURES**
 *128K RAM ON BOARD
 *Z-80/6502 DUAL CPU
 *RGB OUT PUT



PC-55

- Computer \$599.00
 System I: \$899.00
 System II: \$1099.00
 System III: \$1359.00

EACH COMPUTER COMES WITH SOFT APPLE DISKETTE



MIART-1500

- FEATURES** *64K RAM ON BOARD
 *Z80/6502 DUAL CPU
 *Built-in Disk Drive
 *Detachable Keyboard

64K Dual Processor Mother Board \$295 (W/O ROM)

- Computer \$625.00
 System I: \$923.00
 System II: \$1129.00
 System III: \$1385.00

- SYSTEM I. Computer W/1 Drive & Disk Controller
 SYSTEM II. Computer W/2 Drives & Disk Controller
 SYSTEM III. 2 Drives 80-column and monitor

ADD-ON BOARDS

- 128K RAM CARD \$199.00
- 16K RAM CARD \$ 39.00
- 80 Column Card \$ 69.00
- Auto Term \$ 99.00
- Disk Controller \$ 45.00
- Parallel Graphic Card \$ 69.00
- Messenger (RS-232) \$ 85.00
- Z-80 Card \$ 59.00

OTHERS

- Joy Stick \$ 29.00
- RF Modulator \$ 15.00
- Cooling Fan \$ 39.00
- Koala Pad \$ 89.00
- Power Supply (5A) \$ 69.00
- Micromodem IIe \$269.00

DISK DRIVE

- Shugart Drive \$185.00
- Super 5 35/40T \$199.00
- Teac Drive 35/40T \$225.00

MONITOR

- Dynax Green \$139.00
- EA Green \$109.00

BUILD YOUR OWN COMPUTER MIART-1500

- *Case \$ 99.00
- *Keyboard \$150.00
- *Case/KB \$240.00
- *Case/KB/PS \$309.00

BARE BOARD

- *128K RAM Card \$ 25.00
- *16K RAM Card \$ 15.00
- *80 Column Card \$ 18.00
- *Disk Controller \$ 15.00
- *EPROM Writer \$ 18.00
- *Mother Board (DUAL CPU) \$ 75.00
- *Parallel Interface \$ 15.00
- *ROM Card \$ 12.00
- *Serial Card \$ 15.00
- *Z-80 Card \$ 18.00

ACCESSORIES

- Monitor Stand \$ 38.00
- Diskette Box \$ 23.95

- 50-Pin Connector \$ 2.50
- 40/80 Column Switch \$ 10.00

PC-55

- Case \$ 85.00
- Case/KB \$225.00
- Case/KB/PS/Fan \$300.00
- Keyboard \$130.00
- PS/Fan \$ 75.00

PRINTERS

- Gemini 10X \$275.00
- Riteman (120CPS) \$275.00
- EPSON FX-80 \$525.00
- EPSON FX-100 \$750.00
- Juki-6100 \$499.00
- Brother DX-15 \$469.00
- Brother HR-25 \$749.00

MODEM

- Hayes 300 (Baud) \$199.00
- Hayes 1200 (Baud) \$499.00

Super Computer, Inc.

1101 S. GRAND AVE. STE J
 SANTA ANA CA92705

DEALER & OEM INQUIRES INVITED : (714) 543-2927
 MAIL ORDER : (714) 543-2901

See us at Comdex Winter Show, Booth 168

**BROAD LINE OF
A/D PRODUCTS
FOR APPLE II®**

**TIMER/CLOCK - 4-YEAR CALENDAR,
TIMES INTERVALS TO THE
MILLISECOND, INTERRUPTS...\$175**

**12-BIT A/D - 40,000 SAMPLES/SEC.
0.1% ACCURACY, 8 INPUTS...\$375**

**8-BIT A/D - 60,000 SAMPLES/SEC.
0.4% ACCURACY, 8 INPUTS...\$165**

**FULLY DIFFERENTIAL A/D -
1 MILLIVOLT RESOLUTION
12 SAMPLES/SEC, 4 INPUTS...\$195**

**THERMOCOUPLE THERMOMETER -
2 OR 6 CHANNELS...\$135 or \$155**

**ALSO: INPUT MULTIPLEXERS,
OUTPUT CONTROLLERS,
AND CUSTOM SYSTEMS**

LAWSON LABS, INC.

5700 RAIBE ROAD
COLUMBIA FALLS, MONTANA 59912
406-387-5355

CHIPS & DALE

THE INFLATION FIGHTERS!

| | | |
|--------------|-----------------|--------------|
| 4116 | 200ns | 8/\$12.00 |
| 4116 | 150ns | 8/\$13.75 |
| 2114L | 300ns | 8/\$12.00 |
| 2114L | 200ns | 8/\$13.00 |
| 4164 | 200ns | \$5.50 each |
| 4164 | 150ns | \$5.95 each |
| 6116 | 150ns | \$5.20 each |
| 6116 | 200ns | \$4.85 each |
| 6116LP | 150ns | \$5.85 each |
| 1791 | Disk Controller | \$20.00 each |
| 1771 | Disk Controller | \$16.75 each |
| Z80A,Z80ACTC | | \$3.50 each |
| Z80A P10 | | \$4.00 each |
| 8231A | | \$4.00 each |
| 8255A | | \$4.25 each |
| 2716-1 | 5V 350ns | 8/\$4.25 |
| 2716 | 5V 450ns | \$3.35 each |
| 2732 | 5V 450ns | \$3.85 each |
| 2532 | 5V 450ns | 8/\$4.25 |
| 2764 | 5V 300ns 28 pin | \$5.95 each |
| 2564 | 5V | CALL |
| 8087 | | CALL |
| 68000 | | CALL |

Allow up to 3 wks. for personal checks to clear. Please include phone number. Prices subject to change without notice. Shipping & Handling for Chips \$3.50. FOB Bellevue, WA. for all else. Washington state residents add 7.9% Sales Tax.

CHIPS & DALE 1-206-451-9770
10655 N.E. 4th St., Suite 400
Bellevue, WA 98004

LSI COMPILER
for 8080/8085/Z80

New version of this compiler is available now!

The object code is **COMPACT** and is **FASTEST** in current C compilers.

Our **Save** program runs in

8.0 seconds (standard)

and 6.2 seconds (optimized)

(See January 1983 BYTE, pp. 283-286)

price: \$500 (FOB Japan)

for pamphlet write:
P.O. Box 508 STA. CRUZ
CA. USA 95062

for further information contact:

LSI JAPAN CO., LTD.

2-24-9 YOYOGI SHIBUYAKU TOKYO (151) JAPAN
PHONE(03)379-2427

Circle 218 on inquiry card.

Circle 61 on inquiry card.

Circle 229 on inquiry card.

HOFACKER

Books • Software • Hardware Add-Ons • for your ATARI 800XL/800 XL, Commodore-64, VIC-20, Sinclair, Times, Apple II, Osborne-DSI

BOOKS FOR ATARI 800/800XL/800XL 1300XL
ATARI BASIC - Learning by Using. An excellent book for the beginner. Many short programs and learning exercises. All important features of the ATARI computers are described: screen drawings, special sounds, keys, address, pointers, specialized screen routines, graphics, sound applications, ports, colors and special stuff.
Order No. 184 \$7.95
Small Business Software for all ATARI computers!
SUPERBASIC (500 addresses on 1 disk) SUPERBASIC (500 addresses on 1 disk) Completely written in FORTH. Comes on a subdisk disk. No carriage, no DOS, no FORTH language required.
Order No. 7312 \$49.00
SUPERINVENTORY (1000 items guide) Completely written in FORTH. Same as above. (Disk only)
Order No. 7320 \$49.00
BUSIFACE-I (written in FORTH). Complete order entry, inventory, mailing and invoicing (Disk only)
Order No. 7313 \$98.00
ATCASH Convert your ATARI 800 into a powerful cash register. (Disk only)
Order No. 7303 \$49.95
Invoking program in BASIC
Order No. 7201 (CI) \$28.95
Order No. 7200 (DI) \$28.95
Mailing List in BASIC
Order No. 7212 (CI) \$18.95
Order No. 7213 (DI) \$24.95
Inventory control in BASIC
Order No. 7214 (CI) \$18.95
Order No. 7215 (DI) \$24.95
Dealer and Distributor inquiries are invited.
LCS&P PUBLISHING, INC.
82 Foothill Lane
Pomona, CA 91766
Phone: (714) 822-8314, Tlx: 29 81 81



**INDUSTRIAL CONTROL
MICROCOMPUTERS**

We have six single board computers, two video boards and 20 other control products. You can use our products for security systems, heat control, light control, automated slide show, traffic lights, irrigation systems, home computer systems, automated process control, and robot control just to name a few. OEM prices available. For catalog call or write to:

JOHN BELL ENGINEERING, INC.
1014 CENTER STREET
SAN CARLOS, CA. 94070
(415) 592-8411

Circle 145 on inquiry card.

Circle 48 on inquiry card.

Circle 77 on inquiry card.

Serial ← → **Parallel**



**Convert What You Have
To What You Want!**

- * RS232 Serial
- * 8 Baud Rates
- * Latched Outputs
- * Centronics Parallel
- * Handshake Signals
- * Compact 3/4" x 4 1/4" x 1 1/4"

No longer will your peripheral choices be limited by the type of port you have available! Our Serial Converters provide the missing link. Based on the latest in CMOS technology, these units feature full baud rate selection to 19.2K, with handshake signals to maximize transfer efficiency. Detailed documentation allows simplified installation. Order the Model 770 (Ser/Par) or Model 775 (Par/Ser) Today!

Buffer Products Coming Soon!
Ligertronics only \$89.95
Connector Option \$10.00
CA Residents 8% tax UPS Shipping \$3.00
1501 B Pine Street
Post Office Box 2233
Oxnard, California 93030
CALL (805) 487-1665 or 487-1666
For FAST Delivery

**MEMOREX
FLEXIBLE DISCS**

**WE WILL NOT BE UNDER-
SOLD!** Call Free (800)235-4137
for prices and information. Dealer
inquiries invited and C.O.D.'s
accepted.

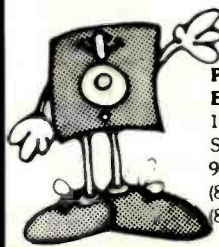

**PACIFIC
EXCHANGES**
100 Foothill Blvd.
San Luis Obispo, CA
93401. In Cal. call
(800)592-5935 or
(805)543-1037



Circle 152 on inquiry card.

Circle 282 on inquiry card.

Circle 265 on inquiry card.

5 1/4" DISK DRIVES

- ★ **QUME 142A**
Half Height, Double Sided, 40 TRK/Side **\$229**
Free Shipping
- ★ **TANDON: TM 100-2**
Double Sided, 40 TRK/Side **\$235**
Free Shipping
- ★ **CDC: 9409**
Double Sided, 40 TRK/Side **\$235**
Free Shipping
- ★ **SHUGART: SA 455**
Half Height, Double Sided, 40 TRK/Side **\$229**
Free Shipping

Order Toll Free:
1-800-531-5475 (Outside Of Texas)
(512) 250-1489 (In Texas)
Texas Residents Add 5% Sales Tax.

CompuAdd Corp.

13010 Research Blvd., Suite 101
Austin, Texas 78750



**LC NETWORK
LINE FILTER**

Model C-519-L1 EMI/RFI filter protects against high energy transients...varistor clamps higher voltages to safe levels...Max Rating: 15 A, 125 VAC, 1875 Watts continuous duty...\$97.50.

**J. W. MILLER
DIVISION/Bell Industries**
19070 Reyes Ave., Rancho Dominguez, CA 90224
(213) 537-5200

**TOLL-FREE
ORDERING:
800-222-8686**

**FOR TECHNICAL SUPPORT/
SERVICE / IN ARIZONA:
602-282-6299**

CCT[®] CUSTOM COMPUTER TECHNOLOGY

1 CRAFTSMAN COURT — BOX 4160 — SEDONA, ARIZONA 86340

Purchase your Hardware and Software directly from an OEM / Systems Integrator. Take advantage of our buying power! We stock a full line of Board Level Components, Software and Peripherals. Call for your needs. We'll give you the Lowest Prices, and the Technical Support and Know-How we are quickly becoming well-known for. Satisfied Customers Nationwide. The Nation's Custom Systems House for Business, Education and Science. Call for a system quote.

• FOREMOST QUALITY • ADVANCED SUPPORT • REASONABLE COST •



THE CCT EXCLUSIVE WARRANTY

With any system we build, we provide, in writing, an unconditional 12 month **direct** warranty on the entire system, including mainframe, boards, drives, power supplies, cabling and peripherals! We offer guaranteed 24-hour in-house repair and/or replacement with just a tech-line phone call. We can offer this, since we are so sure of our level of quality and reliability. It's great to know that in the event of a problem, you're not out of business waiting on service turnaround. We deliver!

Our various OEM contracts with all the manufacturers of the components we integrate, allow us this unprecedented flexibility. No factory O.K.'s necessary — just get it running - **NOW!**

• 8" CP/M SOFTWARE SPECIALS •

dBASE II - Latest Version 2.4 **\$349**
Supercalc 86 - for CP/M 86 & MP/M **\$ 99**
Wordstar **\$299 Pro-Pak** **\$429**
Microsoft BASIC **\$299 Compiler** **\$339**
Supersoft FORTRAN IV **\$339 C Comp** **\$399**

Peachtree Series 8 Modules each **\$599**

• TOP SELLING PERIPHERALS •

CCT-90K Parallel S-100
Amber Screen - 90K Baud **\$749**
Wyse 100-14" Green **\$699**
Wordstar Prom Option **\$ 75**
Wyse 50 **\$529** 75 **\$609**
200/300 **\$1069**
Visual 50 **\$599** Televideo 925 **\$749**
950 **\$950** 970 **\$1099**
Liberty Freedom 100 — **\$479** 200 — **\$679**
Okidata 82 — **\$349** 83 — **\$619** 84 — **\$1029**
92 **\$459** 93 **\$779**
NEC 7710 **\$2150** 7730 **\$2150**
Diablo 620 **\$969** 630 **\$1899**

**INDUSTRIAL GRADE
SUPERIOR QUALITY**

CCT DISK DRIVE SYSTEMS ROLLS ROYCES OF THE INDUSTRY

S-100 HARD DISK SUBSYSTEMS

Professionally engineered ST-506 type systems for the business market S-100 Computer user. Includes industry top quality drives, CompuPro Disk 3 DMA controller, all cabling, A&T, formatted, burned-in. Provisions for up to two hard disks in each system. We include operating system update. CP/M 80, CP/M 86, CP/M 8-16, MP/M 8-16, CP/M 68K. Soon to be supported - MS-DOS. (// 1 Systems are CCT innovated hard/floppy combinations, with Mitsubishi DSDD 8" drive.)

| | | | |
|-------------------------|---------------|----------------|---------------|
| CCT-10 (11 + MEG) | \$2349 | CCT-10/1 | \$2849 |
| CCT-20 (22 + MEG) | \$2749 | CCT-20/1 | \$3249 |
| CCT-40 (36 + MEG) | \$3349 | CCT-40/1 | \$3849 |

Drive capacities shown are **after** formatting! We are working on tape cartridge back-up units.

CCT-2.4 • Dual 8" DSDD

Mitsubishi 2.4 Megabyte in Extra Heavy horizontal enclosure, removeable filter air system, all cabling, A&T, Burned in. The fastest system available: **\$1199**
with (2) half-height - CCT-2.4S **\$1229**
Special configurations available — Call!

FLOPPY SYSTEMS

CCT-5 • 5 1/4" DSDD

IBM Compatible Tandon 320K. Extra Heavy Cabinet accommodates two drives, hard or floppy. All cabling, A&T, Burned-in. Perfect for our MS-DOS Package **\$369**
with Hard Disk Power Supply **\$389**
Two Drive Unit (720K) CCT-5/2 **\$649**

★ SUPER PRICES ★ COMPUPRO COMPONENTS ★ IN STOCK ★

SYSTEM SPECIAL—ALL CCT A&T, BURNED IN: 816A - **\$4299** 816B - **\$4999** 816C - **\$6499**

CCT-2 - **\$6799** • CCT-3 - **\$6699** • Disk 1 w/CP/M - **\$469** • CPU 8086/87 - **\$819** • M-Drive/H - **\$1099**
CPU 8085/88 - **\$329** • CPU 8086 - **\$559/10Mhz** - **\$599** • CPU 68K - **\$519/10Mhz** - **\$639**
CPU-Z - **\$249** • Disk 1 - **\$369** • Disk 2 - **\$579** • Disk 3 - **\$539** • RAM 16 (12Mhz) - **\$369** • RAM 21 (128K) - **\$779**
RAM 22 (256K) - **\$1359** • Interfacer 3 - **\$459** • Interfacer 4 - **\$349** • System Support 1 - **\$329**
Enclosure 2 Desk - **\$599/Rack** - **\$649** • CP/M 80 (CCTHMX) - **\$125** • CP/M 86 (CCTTMX) - **\$175**
CP/M 8-16 (CCTTMX) - **\$199** • MP/M 8-16 (CCTSX) - **\$499** • CP/M 68K (CCTCX) - **\$279**
CP/M 86 Upgrade Kit: CP/M 86, RAM 16, Sys. Supt. 1, Cable - **\$829**
Call for CSC Boards — New Releases — CCT Mods Updates - **\$30/O.S.**

CCT-1 — ENTRY LEVEL S-100 BUSINESS SYSTEM

- Enclosure 2-Desk-20 Slot Mainframe •
- CPU 8085/88 - 6Mhz 8085/8Mhz 8088 •
- Disk 1 - DMA Floppy Disk Controller •
- RAM 16 - 64K Static RAM - 12Mhz •
- Interfacer 4 - 3 Serial/2 Parallel I/O •
- CCT-2.4-Dual 8" Mitsubishi DSDD Drive System - 2.4 Megabytes •
- CP/M 80 - 2.2 HMX - CCT Modified •
- All Cabling, Complete CCT Assembly, Testing, and Minimum 20 Hour Burn-in •

**SPECIAL PRICE
\$3,449**

RUNS ALL STANDARD 8" CP/M SOFTWARE - INCLUDES OUR EXCLUSIVE 12 MONTH DIRECT WARRANTY

OPERATING SYSTEM NOTE: Latest CP/M, CP/M 86, MP/M 8-16, CP/M 68K, have each been restructured and optimized by CCT, for utmost flexibility, power and speed.

MS-DOS FOR COMPUPRO - IBM COMPATIBLE CCT MODIFIED SYSTEM

For any CP/M 86 CompuPro System — Includes MS-DOS Version 2.0 and 5 1/4" DMA Disk Controller, All Manuals - **\$699**

Prices & availability subject to change. All products new, and carry full manufacturer's warranties. Call for catalog. Free technical help to anyone. All products we sell are CCT individually tested and set up for your system - Plug-In & Go! Arizona residents add sales tax CCT[®] Trademark — Custom Computer Technology; MS-DOS[®] Trademark — Microsoft; IBM[®] Trademark — International Business Machines; CompuPro[®] Trademark — W.J. Godbout; CP/M[®] MP/M[®] Trademarks — Digital Research

Maxell Floppy Disks

The Mini-Disks
with maximum quality.



Dealer inquiries invited. C.O.D.'s accepted. Call FREE (800) 235-4137.

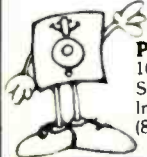

PACIFIC EXCHANGES
100 Foothill Blvd., San Luis
San Luis Obispo, CA 93401.
In Cal. call (800) 592-5935 or
(805) 543-1037.

Circle 282 on inquiry card.



Best Prices On TRS-80 Computers

Our 6th year of discounts
Ed or Joe McManus

Fgt. Prepaid. Save Tax.
Toll Free 800-231-3680

Marymac Industries, Inc.
22511 Katy Fwy., Katy
(Houston) Tx 77450
1-713-392-0747
Telex 774132

See us in the Wall Street
Journal every Tues., Wed., Thurs.

Circle 237 on inquiry card.

IBM PC COMPATIBLE

Slimline Disk Drive.....\$215.00 ea.
(Shugart SA 455. DS/DD 320KB)
Slimline Hard Disk.....\$495.00 ea.
(Shugart SA 706 5MB)
Computer Case.....Call
Keyboard.....Call
Power Supply.....Call
Disk Controller Card.....Call
Color Graphic/Monochrome/Printer
Interface Card.....Call
Compatible Bare PCB.....Call
3M Diskette SS/DD.....\$20/box
3M Diskette DS/DD.....\$28/box

Dealer Inquiries Welcome

ELECTRADE CO. (408) 946-2541
780 Trimble Rd., Suite 605
San Jose, CA 95131

Circle 147 on inquiry card.

FREE SOFTWARE

RENT THE PUBLIC DOMAIN!

User Group Software isn't copyrighted, so no fees to pay! 1000's of CP/M and IBM software programs in .COM and source code to copy yourself! Games, business, utilities! All FREE!

CP/M USERS GROUP LIBRARY

Volumes 1-92, 48 disks rental-\$45

SIG/M USERS GROUP LIBRARY

Volumes 1-90, 48 disks rental-\$40

Volumes 91-154, 30 disks rental-\$40

SPECIAL! Rent all SIG/M volumes for \$75

IBM PC-SIG (PC-DOS) LIBRARY

Volumes 1-100, 5 1/4" disks \$99.50

MOST FORMATS AVAILABLE! SPECIFY.

Public Domain User Group Catalog Disk \$5 pp.
(payment in advance, please)

Rental is for 7 days after receipt, 3 days grace to return. Use credit card, no disk deposit.

Shipping, handling & insurance-\$7.50 per library.

(619) 941-0925 information,

(619) 727-1015 anytime order machine

Have your credit card ready!

Public Domain Software Center

P.J.S. Co.

993 S. Sante Fe "C"

Vista, CA 92083

AM-EX



Circle 295 on inquiry card.

IBM-PC

64K 2 DS/DD DRIVES

\$ 2350

TAVA PC.....\$1950

SANYO MBC-555..\$1119

EAGLE PC 2 Plus..\$1995

COLUMBIA 1600-1..\$2695

DYNAX DX 15 lqp..\$ 435

JUKI 6100 lqp...\$ 435

Okidata 92 P dmp \$ call

Taxan 210 col.mon.\$ 330

FOR Computers, Printers & more

Call: THE COMPUTER CLUB Inc!!

VISA 7 Days (619) 578-5654

Master Card

Circle 84 on inquiry card.

SYMBOLIC DEBUGGING for IBM PC-DOS

The Mylstar Symbolic Debugging Program enhances your IBM PC-DOS Debug Program to make your work easier and simpler. Employing the same command structure, the Mylstar Program lets you use:

- *Symbol Names
- *Mathematic Expressions
- *Batch Files
- *On-Line Help
- *Multi-Command Macros
- *Loop Structures

Shorten your debugging process and work time. Designed for PC-DOS 1.1, 128K RAM minimum. Send \$125 check or money order to: Dept. 115B Mylstar Electronics.



MYLSTAR ELECTRONICS INC.
163 West Lake Street
Northbrook, Illinois 60064
Tel (312) 943-7400
Telex 73-9663
A Commodore/Peterson Industries Company

Dealer Inquiries Invited

Circle 272 on inquiry card.

maxell

DISKETTES

5 1/4" Specify Soft, 10 or 16 Sectors \$10 \$50 \$100

| | | | | |
|---------|------|-------|--------|--------|
| MD1-M | SSDD | 26.50 | 130.00 | 255.00 |
| MD2-DM | DSDD | 38.00 | 185.00 | 360.00 |
| MD1-00M | SSQD | 35.00 | 170.00 | 325.00 |
| MD2-00M | DSQD | 43.00 | 210.00 | 410.00 |

8" Specify Soft or 32 Hard Sectors \$10 \$50 \$100

| | | | | |
|----------|------|-------|--------|--------|
| FD1-128M | SSDD | 39.00 | 190.00 | 370.00 |
| FD2-X-DM | DSDD | 44.50 | 220.00 | 435.00 |

CALL TOLL FREE

800-824-7888

OPERATOR 906

(VISA, M.C., COD, ORDERS ONLY)

7 Days a Week, 24 Hours a Day

Creativity Unlimited

• Add \$2.00 Shipping Per Order

• CA Residents Add Sales Tax

(408) 252-4210

M-F, 9:00 AM - 5:00 PM

FOR NEXT DAY

SHIPMENT

Inquiries Also

1741 Saratoga Avenue, Suite #201

San Jose, California 95129

Send for Our Free Catalogue • Dealer Inquiries Invited

Circle 108 on inquiry card.

300 BAUD MODEMS 1200 BAUD

HAYES SMARTMODEM 1200.....\$429

Includes Smartcom Software!

SIGNALMAN..Free hour on 'SOURCE'

MARK 12...300/1200 AUTO.....\$279

MARK 10...300 AUTO.....\$169

VOLKSMODEM & cable.....\$ 79

US ROBOTICS.....'Hayes Compatible'

'PASSWORD' 300/1200 baud.....\$339

'S100' card 300/1200.....\$339

'AUTO 212' d1xe. 300/1200.....\$419

LETTER QUALITY

DOT MATRIX PRINTERS

CABLES 6 feet IBM CP/M.....\$ 22

GEMINI 10X 120 cps graphics.....\$279

PROWRITER 120 cps hi density....\$344

DAISYWRITER fast! 40 cps 48K.\$CALL!

IBM HARD DISKS CP/M

Complete Systems...controller & drive & software

10 Mbyte half height.....\$1295

23 Mbyte...\$2195 40 Mbyte.....\$2795

IMAGE COMPUTERS

P.O. Box 1164, Cardiff, CA 92007

(619) 942-7373

(619) 270-3600



DEALER INQUIRIES INVITED

Circle 192 on inquiry card.



Scotch

DISKETTES

3M

Call Toll-Free

1-800-328-DISC for prices and information. Dealer inquiries invited. C.O.D. and charge cards accepted.

All orders shipped from stock, within 24 hours. Call toll FREE



NH

North Hills Corporation

3564 Rolling View Dr.

White Bear Lake, MN 55110

1-800-328-DISC

MN Call Collect 1-612-770-0485

Circle 147 on inquiry card.

Computer Components Unlimited's

APRIL SHOWERS SPECIALS

Star Micronics Gemini 10X

- 120 cps
- Friction & Tractor Feed

\$279

Quentin Research

- Apple Mate Disk Drive
- Fully Apple Compatible

\$189

Siemens 8" Disk Drive

- FDD-100-8
- Sgl. Side/Dbf. Density

\$139

5 1/4" Diskettes

- Sgl. Side/Dbf. Density
- Reinforced Hub

10 for \$17
Not Bulk Packed

Toshiba Printer

- P1340 New
- See Toshiba Ad in this Issue

\$895

Franklin Computer

- 1200 OMS
- 2 Disk Drives
- Apple & CPM Compatible

\$1599

IBMPC (In Stock)

- 256K
- 2 Tandem 360K Drives
- AST Six Pak
Multifunction Card
- Color Graphics Card
- Hi-Res 80 Col. Monitor

\$3495

Printer Cables

- For IBM, Kaypro, RS232

All Only \$22

Apple 1/2 Height

- Slimline Disk Drive
- Fully Apple Compatible
- 1 Year Warranty

\$179

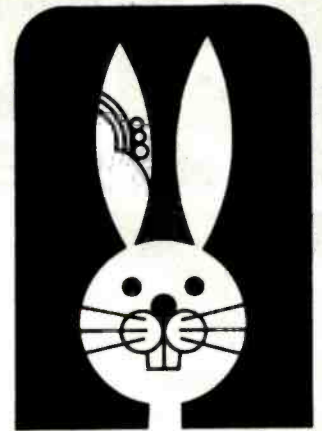

**SAVE 20% to 40%
LIST OFF**

Dual 5 1/4" Cabinet

- Power Supply for 2 Drives
- 1 Year Warranty

\$69

Grappler w/Buffer

- Graphics Interface
- 16K of Buffer exp. to 64K

\$169

Hayes Micro Computer

- Smartmodem 1200B
- w/Smartcom Software

\$389

Panasonic Disk Drive

- Fully PC Compatible
- 360K Drive

\$179² for \$340

Kaypro

- Kaypro II w/Software

\$1449



**WE DON'T
HIDE OUR
LOW
PRICES!**



**Computer
Components
Unlimited**
A California Corporation

Circle 74 on inquiry card.

800-847-1718
OUTSIDE CALIFORNIA

RETAIL STORE:
11976 Aviation Blvd.
Inglewood, CA 90304

MAIL ORDER:
P.O. Box 1936
Hawthorne, CA 90250

**This Ad Supersedes All Others
(213) 643-5188**

All merchandise new. We accept MC, Visa, Wire Transfer, COD, Cash, Certified Check, P.O.'s from qualified buyers. APO accepted. Shipping Minimum \$4.50 (incl. 5 Pounds). Tax: California Res. Only. and 6% sales tax.

Prices Subject to Change

**Mon.—Fri. 7 a.m. to 6 p.m.
Sat. & Sun. 10 a.m. to 5 p.m.**

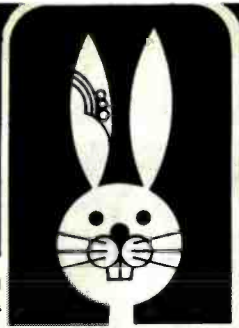

CCU WILL BEAT ALL Check Below for This

MONITORS

| | |
|--------------------------------|--------|
| Amdek | |
| Color I + Composite Video | \$ 279 |
| Color II + RGB Video | 419 |
| 300G, 12" Green | 139 |
| 300A, 12" Amber | 149 |
| 310A, Monochrome Amber | 179 |
| BMC | |
| 12 AUW, 80 column | \$ 78 |
| 12 EUN HI-Res Green | 109 |
| 9191 Color New Version | 239 |
| IBM | |
| Monochrome HI Res Green | \$ 319 |
| RGB Color | 699 |
| Princeton Graphics | |
| PGS HX12, IBM Copy | \$ 469 |
| PGS SR-12, HI-Res Color | 649 |
| PGS MAX-12, 12" Monochrome | 199 |
| USI | |
| PI 1, 9" Green, HI Res, 20MHZ | \$ 119 |
| PI 2, 12" Green, HI Res, 20MHZ | 119 |
| PI 3, 12" Amber, HI Res, 20MHZ | 119 |
| PI 4, 9" Amber, HI Res, 20MHZ | 119 |
| Zenith | |
| ZVM122, HI-Res Green | \$ 109 |
| ZVM123, HI-Res Amber | 109 |



PRINTERS

| | |
|--------------------------------------|--------|
| Dynax | |
| DX15, Letter Quality | \$ 459 |
| DX25 | 749 |
| Epson | |
| RX-80 (120 cps) | \$ 279 |
| RX-80FT (120 cps) Friction & Tractor | 399 |
| FX-80 (160 cps) | 519 |
| FX-100 (160 cps) 15" Carriage | 729 |
| NEC | |
| 8023A-C New Version (120 cps) | \$ 399 |
| 8025 (15" Carriage) | 699 |
| Okidata | |
| 82A (120 cps) Par & Ser Inter. | \$ 299 |
| 83A (15" Carriage) | 569 |
| 84P (200 cps) Friction & Tractor | 999 |
| New Series Okidata | |
| 92P (160 cps) | \$ 429 |
| 93P (15" Carriage) | 739 |
| Star Micronics | |
| Gemini 10X (120 cps) | \$ 279 |
| Gemini 15X (120 cps) 15" Carriage | 399 |
| Power type (18 cps) Ltr. qual. | 479 |

COMPUTER SYSTEMS

| | |
|---------------------------------|--------|
| Apple | |
| IIe Starter System | \$1326 |
| CPU Only | 999 |
| Mcintosh | 2295 |
| Compaq | |
| Portable (PC Compatible) | \$2595 |
| Franklin | |
| Ace 1000, 64K | \$ 749 |
| Ace 1200 OMS | 1599 |
| Kaypro | |
| Kaypro II | \$1449 |
| Kaypro 4 | 1695 |
| Kaypro 10 | 2495 |
| IBM | |
| PC 64K, 2-Drives | \$2250 |
| XT Hard Disk Drive, 128K | 4695 |
| SANYO | |
| MBC-550 PC Compatible | \$ 799 |
| MBC-555 2-Drives, more software | 1199 |

5 1/4" DISKETTES

| | |
|------------------------|------|
| CCU | |
| Sgl/Dbl reinforced hub | \$17 |
| 100 for 150 | |
| Dbl/Dbl reinforced hub | 22 |
| 100 for 200 | |
| Not Bulk Packed | |
| Dysan | |
| Sgl/Dbl | \$33 |
| 100 for 300 | |
| Dbl/Dbl | 39 |
| 100 for 370 | |
| Maxell | |
| MD1 Sgl/Dbl | \$25 |
| 100 for 235 | |
| MD2 Dbl/Dbl | 38 |
| 100 for 360 | |
| Memorex | |
| Sgl/Dbl | \$26 |
| 100 for 230 | |
| Dbl/Dbl | 35 |
| 100 for 320 | |
| Verbatim | |
| Sgl/Dbl | \$26 |
| 100 for 240 | |
| Dbl/Dbl | 36 |
| 100 for 340 | |
| Wabash | |
| Sgl/Dbl | \$22 |
| 100 for 200 | |
| Dbl/Dbl | 29 |
| 100 for 270 | |

8" DISKETTES

| | |
|-----------------|------|
| Dysan | |
| Sgl/Sgl | \$34 |
| 100 for 320 | |
| Dbl/Dbl | 53 |
| 100 for 480 | |
| Maxell | |
| Sgl/Dbl | \$44 |
| 100 for 380 | |
| Dbl/Dbl | 50 |
| 100 for 469 | |
| Memorex | |
| Sgl/Sgl | \$27 |
| 100 for 250 | |
| Dbl/Dbl | 38 |
| 100 for 350 | |
| Verbatim | |
| Sgl/Sgl | \$30 |
| 100 for 280 | |
| Dbl/Dbl | 40 |
| 100 for 360 | |
| Wabash | |
| Sgl/Sgl | \$24 |
| 100 for 220 | |
| Dbl/Dbl | 34 |
| 100 for 320 | |

DISK ACCESSORIES

| | |
|-----------------------------------|------|
| Verbatim | |
| 8" or 5 1/4" Head Cleaning Kit | \$ 9 |
| Flip Tub | |
| 5 1/4" Holds 50 disks, plexiglass | 17 |
| 5 1/4" Holds 70 disks, plexiglass | 21 |

APPLE DRIVES

| | |
|------------------------------|--------|
| Apple | |
| Disk 2 | \$ 269 |
| Disk 2 controller w/ DOS 3.3 | 89 |
| Micro Sci | |
| A-2 Fully compatible | \$ 199 |
| Controller w/ diagnostics | 79 |
| Quentin Research | |
| Appimate | \$ 189 |
| Controller | 75 |
| Rana Systems | |
| Elite I | \$ 239 |
| Elite II Dbl Sided | 379 |
| Elite III Quad Density | 479 |
| Controller, controls 4 | 85 |
| Super 5 | |
| Slimline | \$ 189 |
| Controller | 75 |

For the **WIDEST VARIETY OF PERIPHERALS**
and the **LOWEST PRICES** in this Magazine
CALL 800-847-1718



PRICING IN BYTE MAGAZINE Month's Special Low Prices



DISK DRIVE CABINETS

5 1/4" Cabinets

| | |
|---------------------------------|-------|
| Single Cab. w/ power supply | \$ 59 |
| Dual Cab. w/ power supply | 69 |
| Dual Thinline Cab. w/ pwr. sup. | 69 |

8" Cabinets

| | |
|-----------------------------------|--------|
| Single Cab. w/ fan & power supply | \$ 209 |
| Dual Cab. w/ fan & power supply | 259 |



5 1/4" DISK DRIVES

CDC

| | |
|--------------------|--------|
| 9409 dbi/dbi | \$ 229 |
| 9409T Quad Density | 179 |

Panasonic

| | |
|------------------------|--------|
| Slimline 320K PC comp. | \$ 189 |
|------------------------|--------|

Tandon

| | |
|----------------------|--------|
| TM100-1, 160K | \$ 179 |
| TM100-2, 320K | 219 |
| TM101-4 Quad Density | 279 |

8" DISK DRIVES

Mitsubishi

| | |
|--------------|--------|
| 2894 Dbi/Dbi | \$ 419 |
|--------------|--------|

Qume

| | |
|-------------|--------|
| DT8 Dbi/Dbi | \$ 479 |
|-------------|--------|

Shugart

| | |
|--------------|--------|
| 801R Sgl/Dbi | \$ 349 |
| 851R Dbi/Dbi | 469 |

Siemens

| | |
|-------------------|---------------|
| FDD 100-8 Sgl/Dbi | \$ 139 |
| FDD 100-8 Sgl/Dbi | 2 For 260 ea. |

Tandon

| | |
|--------------------------|--------|
| TM848-1 Sgl/Dbi Thinline | \$ 299 |
| TM848-2 Dbi/Dbi Thinline | 399 |



PRINTER INTERFACES

Cables

| | |
|-------------------|-------|
| IBM to Printer | \$ 22 |
| Kaypro to Printer | 22 |
| RS232 Cables | 22 |

Fourth Dimension

| | |
|--------------|-------|
| Card & Cable | \$ 49 |
|--------------|-------|

Microtek

| | |
|-----------------------------------|-------|
| Dumpling GX (Grappler Compatible) | \$ 89 |
| Dumpling GX exp to 64K | 149 |
| Dumpling GX 16K w/16K exp to 64K | 169 |
| for each additional 16K | 15 |

Okidata Options

| | |
|---------------------|-------|
| Tractor for 82 & 92 | \$ 59 |
| Serial interface | 99 |

Orange Micro

| | |
|------------------|--------|
| Grappler + | \$ 119 |
| Grappler + w/16K | 169 |

Star or Epson

| | |
|------------------------|--------|
| Epson Serial Interface | \$ 119 |
| Star Serial Interface | 59 |

Wesper Micro

| | |
|--------------------------------|-------|
| Wizard Full Graphics Interface | \$ 89 |
|--------------------------------|-------|



MODEMS

Anchor

| | |
|---------------------|--------|
| Mark VII 300 Baud | \$ 159 |
| Mark XII, 1200 Baud | 279 |

Hayes Micro Computer

| | |
|--------------------------|--------|
| Smart Modem 300 Baud | \$ 199 |
| Smart Modem 1200 Baud | 489 |
| Smart Modem 1200B For PC | 389 |
| Micro Modem IIE | 239 |

Novation

| | |
|--------------|--------|
| J-Cat | \$ 119 |
| Apple Cat II | 259 |

APPLE ADD ON'S

ALS

| | |
|--------------|--------|
| ZCard | \$ 119 |
| CPM 3.0 Card | 269 |

Apple

| | |
|------------|--------|
| Disk II | \$ 269 |
| Monitor II | 99 |

Astar

| | |
|--------------|-------|
| RF Modulator | \$ 15 |
| Fan w/Surge | 39 |

Kensington

| | |
|--------------|-------|
| System Saver | \$ 69 |
|--------------|-------|

Koala

| | |
|-----------------|-------|
| Graphics Tablet | \$ 89 |
|-----------------|-------|

Kraft

| | |
|----------|-------|
| Joystick | \$ 49 |
|----------|-------|

Micro Max

| | |
|-----------------------------|--------|
| Viewmax 80, 80 col. card | \$ 139 |
| Viewmax 80E (F for IIE) 64K | 129 |

Micro Soft

| | |
|-----------------------|-------|
| 16K Card | \$ 69 |
| Premium Soft Card IIE | 369 |
| Multiplan | 189 |
| Soft Card (Z80) | 239 |

Micro Tek

| | |
|--------------------|-------|
| Bam-16, 16K Memory | \$ 59 |
| Serial Interface | 89 |

TG

| | |
|---------------|-------|
| Joystick | \$ 44 |
| Select-A-Port | 31 |
| Paddles | 34 |

IBM ADD ON'S

Ast Research

| | |
|------------|--------|
| Six Pack + | \$ 269 |
| Mega + | 269 |

IBM

| | |
|--------------------|--------|
| Monochrome Adapter | \$ 319 |
| Color Card | 275 |

Plantronics

| | |
|-----------------|--------|
| PC + w/Software | \$ 389 |
|-----------------|--------|

Quadram

| | |
|-----------------|--------|
| Quad Color Card | \$ 219 |
| Quad Link | 479 |

64K Upgrade

| | |
|---------------|-------|
| 64K of Memory | \$ 49 |
|---------------|-------|

USI Research

| | |
|-------------------------------------|--------|
| Paradise Systems multi-display card | \$ 399 |
|-------------------------------------|--------|

Computer Components Unlimited

A California Corporation

RETAIL STORE:
11976 Aviation Blvd.
Inglewood, CA 90304

MAIL ORDER:
P.O. Box 1936
Hawthorne, CA 90250

Mon.--Fri. 7 a.m. to 6 p.m.
Sat. & Sun. 10 a.m. to 5 p.m.

This Ad Supersedes All Others
No Surcharge for Credit Cards

Sales Desk

(800) 847-1718 (213) 643-5186
Outside California Inside California

Customer Service & Technical
(213) 643-5191

All merchandise new. We accept MC, Visa, Wire Transfer, COD Call, Certified Check, P.O.'s from qualified firms. APO accepted. Shipping Minimum \$4.50 first 5 pounds. Tax: California Res. Only add 6 1/2% sales tax.

Prices Subject to Change

CALIFORNIA DIGITAL

Post Office Box 3097 B • Torrance, California 90503

FREE

Plastic library case supplied with all diskettes purchased from California Digital.

DISKETTES AS LOW AS **\$16.50**

FIVE INCH SINGLE SIDED DOUBLE DENSITY

| Soft Sector Ten Sector Sixteen | Each box | 10 Boxes | 100 Boxes |
|---|----------|----------|-----------|
| CAL DIGITAL CAL-901 CAL-810 CAL-816 | 19.95 | 18.50 | 16.50 |
| SCOTCH MMM-7440 MMM-7442 MMM-74416 | 26.50 | 24.50 | 21.75 |
| VERBATIM VRB-823/0 VRB-825/10 VRB-825/16 | 26.50 | 25.25 | 23.50 |
| MEMOREX MRX-3481 MRX-3483 MRX-3485 | 26.50 | 22.25 | 18.75 |
| MAXELL MXL-M0110 MXL-M0117E | 26.50 | 24.50 | 23.25 |
| DYSAN DYS-104/1D DYS-107/1D DYS-109/1D | 35.00 | 33.00 | 30.50 |

FIVE INCH DOUBLE SIDED DOUBLE DENSITY

| | | | |
|---|-------|-------|-------|
| CAL DIGITAL CAL-851 CAL-561 | 24.95 | 22.75 | 20.50 |
| SCOTCH MMM-7450 MMM-74510 MMM-74516 | 39.95 | 37.95 | 31.25 |
| VERBATIM VRB-850/0 VRB-850/10 VRB-850/16 | 39.95 | 37.95 | 32.75 |
| MEMOREX MRX-3481 MRX-3483 MRX-3485 | 35.00 | 31.25 | 26.25 |
| MAXELL MXL-M0210 MXL-M0216 | 39.95 | 37.95 | 34.75 |
| MAXELL / 96 MXL-M0216 N/A | 45.00 | 43.00 | 41.25 |
| DYSAN DYS-104/2D DYS-107/2D DYS-109/2D | 42.50 | 40.50 | 35.50 |
| DYSAN / 96 DYS-204/2D N/A | 49.95 | 47.95 | 45.75 |

EIGHT INCH SINGLE SIDED SINGLE DENSITY

| | | | |
|-----------------------------|-------|-------|-------|
| SCOTCH MMM-740/0 | 29.50 | 27.50 | 23.80 |
| MEMOREX MRX-3062 | 27.75 | 26.60 | 22.25 |
| VERBATIM VRB-34/9000 | 31.50 | 29.50 | 25.60 |
| DYSAN DYS-3740/1 | 35.75 | 32.75 | 29.75 |

EIGHT INCH SINGLE SIDED DOUBLE DENSITY

| | | | |
|-----------------------------|-------|-------|-------|
| SCOTCH MMM-741/0 | 37.75 | 35.15 | 29.15 |
| MEMOREX MRX-3090 | 35.50 | 33.50 | 27.15 |
| VERBATIM VRB-34/8000 | 35.25 | 33.25 | 28.75 |
| DYSAN DYS-3740/1D | 40.75 | 38.75 | 32.25 |
| MAXELL MXL-FD1 | 45.50 | 39.75 | 35.15 |

EIGHT INCH DOUBLE SIDED DOUBLE DENSITY

| | | | |
|-----------------------------|-------|-------|-------|
| SCOTCH MMM-743/0 | 47.50 | 44.25 | 37.50 |
| MEMOREX MRX-3102 | 39.25 | 36.75 | 31.50 |
| VERBATIM VRB-34/4001 | 41.75 | 37.50 | 32.25 |
| DYSAN DYS-3740/2D | 54.65 | 49.75 | 40.50 |
| MAXELL MXL-FD2 | 52.50 | 48.75 | 40.45 |

Switching Supply

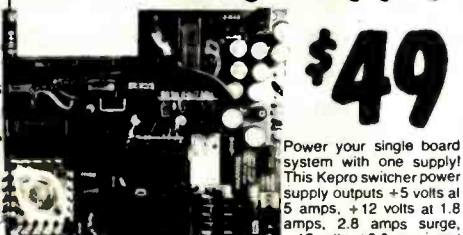

\$49

Power your single board system with one supply! This Kepro switcher power supply outputs +5 volts at 5 amps, +12 volts at 1.8 amps, 2.8 amps surge, -12 volts at 0.5 amps, and a second +12 volts at 2.0 amp output. It is jumper selectable for both 120 volt and 220 volt operation. Units measures approximately 6" by 8". This board is capable of supplying power for two 5 1/4" Winchesters, a single board computer along with a hard disk controller. Also suitable for use with all IBM look-a-likes. Priced at only \$49.95 this power supply offers excellent value along with high reliability. Please phone for volume pricing. KPT-512

MEMORY

| | | |
|-------------------------------|-------------|-------------|
| 16K DYNAMIC 2732 EPROM | 1.95 | 4.95 |
| 4116 150ns. | | 450ns. |
| 2764 EPROM | 6.95 | 4.95 |
| 350ns. | | 6116 200ns. |



4164 DYNAMIC MEMORY 150ns

\$5.95

DYNAMIC MEMORY

| | | | | |
|-----------------------------|--------------|-----------|-------|-------|
| 4027 4K dynamic 250ns. | ICM-4027250 | 1.31 | 32 - | 100 - |
| 2716 450ns. 2K x 8 | KCE-2716 | 1.93 | 1.85 | 1.75 |
| 2716 450ns. 2K x 8 | KCE-2716 | 1.75 | 1.65 | 1.45 |
| 4116 200ns. 16K | ICM-4116200 | 1.75 | 1.65 | 1.45 |
| 4164 150ns. 64K 128 refresh | ICM-4164150 | 5.95 | 5.85 | 5.55 |
| 41256 150ns. 256K | ICM-41256150 | Available | | |
| DP8401 dynamic controller | ICT-8408 | 39.00 | 35.00 | 29.00 |

EPROMS

| | | | | |
|----------------------|-------------|-------|------|------|
| 2708 450ns. 1K x 8 | KCE-2708 | 4.95 | 4.75 | 4.55 |
| 2716 450ns. 2K x 8 | KCE-2716 | 4.50 | 4.25 | 3.97 |
| 2716 450ns. 2K x 8 | KCE-2716 | 7.95 | 7.65 | 7.25 |
| 2732 450ns. 4K x 8 | KCE-2732 | 4.50 | 3.75 | 3.55 |
| 2732 250ns. 4K x 8 | KCE-2732350 | 8.50 | 8.00 | 7.60 |
| 2532 450ns. 4K x 8 | KCE-2532 | 10.50 | 9.90 | 9.50 |
| 2764 350ns. 8K x 8 | KCE-2764 | 8.95 | 8.95 | 6.95 |
| 27128 350ns. 16K x 8 | KCE-27128 | 18.95 | | |

STATIC MEMORY

| | | | | |
|------------------------------------|--------------|------|------|------|
| 21102 200ns. 1K static | ICM-21102200 | 1.49 | 1.19 | 1.15 |
| 21102 450ns. 1K static | ICM-21102450 | 1.29 | 1.15 | .99 |
| 2112 450ns. 2K static | ICM-2112450 | 2.99 | 2.85 | 2.75 |
| 2116 300ns. 1K x 1 | ICM-2116300 | 1.95 | 1.85 | 1.75 |
| 60641785 450ns. 4K x 1 | ICM-60641785 | 3.49 | 3.25 | 2.99 |
| 5257 300ns. 4K x 1 | ICM-5257300 | 2.50 | 2.25 | 1.99 |
| 8116 84 200ns. 2K x 8 | ICM-8116200 | 4.85 | 4.85 | 4.50 |
| 8118 83 150ns. 2K x 8 | ICM-8118150 | 5.25 | 4.05 | 4.85 |
| 6167/2187 100ns. 16K x 1 (20 pins) | ICM-6167100 | 9.95 | 9.50 | |

CONNECTORS



| S-100 Gold | "D" TYPE | catalog | each 10-99 100+ | |
|--|-----------------------------|--------------|-----------------|----------------|
| GOLD S-100 EDGE CARD CONNECTORS | DB9P | CND-9P | 1.50 1.40 1.30 | |
| Imbol 8/1 250 | CNE-IMS | CND-9S | 2.25 2.00 1.30 | |
| Sullins M/F 250 | CNE-M100 | CND-9H | 1.50 1.35 1.20 | |
| S-100 Wire W | CNE-M110 | DA15P male | CND-15P | 2.25 2.10 1.90 |
| Airtel 140 3/1 | CNE-100A | DA15S female | CND-15S | 3.25 3.10 2.90 |
| .156" CENTER EDGE CARD CONNECTORS | DB15P | CND-15P | 1.50 1.35 1.30 | |
| 22/24 Even# | CNE-44E | CND-25P | 1.95 1.75 1.35 | |
| 43/32 Odd# | CNE-72S | DB25P male | CND-25S | 2.95 2.55 1.65 |
| 36/72 D/G 3/1 | CNE-72S | DB25P female | CND-25F | 1.95 1.35 1.35 |
| Other connectors available upon request. | DC37P male | CND-37P | 4.20 3.95 3.65 | |
| | DC37P female | CND-37F | 5.95 5.75 5.50 | |
| | DC37P hood | CND-37H | 2.25 1.95 1.65 | |
| | DDSP male | CND-50P | 5.50 5.10 4.75 | |
| | DDSP hood | CND-50H | 2.80 2.40 2.10 | |
| | Hardware 2/2et | CND-2HS | 89 69 62 | |
| | AMPHERL / CENTRONICS TYPE | | | |
| | 37-30360 26/P | CNP-36P | 7.95 6.35 3.97 | |
| | IEEE-488 C/26 | CND-24P | 7.95 6.35 3.35 | |
| | DISK DRIVE POWER CONNECTORS | | | |
| | 8 pin D.C. | CNP-6DC | 1.95 1.29 89 | |
| | 8 3 AC Sign | CNP-3SS | 1.69 1.39 69 | |
| | 3 4 pin D.C. | CNP-3DS | 1.69 1.09 69 | |
| | 5 pin D.C. | CNP-5DC | 1.79 1.19 95 | |
| | 3 pin D.C. Repl. | CNP-3DP | 2.59 1.99 1.59 | |

BLOWOUT SALE

\$169



California Digital has recently participated in the purchase of several thousand Siemens FDD 100-8 floppy disk drives. These units are electronically and physically similar to that of the Shugart 801R. All units are new and shipped in factory sealed boxes. Manual and power connectors supplied free upon request. Your choice 115 Volt, 60 Hz, or 230 Volt, 50Hz.

NOTE: European customers, we have a large quantity of 230 volt 50 Hz units warehoused in Frankfurt Germany. Arrangements can be made to will call these drives in quantities of 50 or more in Frankfurt reducing export duty and freight charges.

REMEX DOUBLE SIDED \$219

California Digital has just purchased a large quantity of Remex RFD-4000 Eight inch double sided disk drives. Remex is the only double sided disk drive that has a double gmbal mounted head assembly that guarantees lower head tracking. This drive is mechanically solid. Remex has always been known for producing premiere products for the floppy disk market. The Remex company is a subsidiary of the Ex-cell Corporation, a Fortune 500 Company.

Eight Inch Single Sided Drives

| | One | Two | Ten |
|----------------------------------|-----|-----|-----|
| SHUGART 801R | 385 | 375 | 365 |
| SIEMENS FDD 100-8 | 169 | 169 | 159 |
| TANDON 848E-1 Half Height | 369 | 359 | 349 |

Eight Inch Double Sided Drives

| | | | |
|-------------------------------------|-----|-----|-----|
| SHUGART SA851R | 495 | 485 | 475 |
| QUME 842 "QUME TRACK 8" | 459 | 459 | 449 |
| TANDON 848E-2 Half Height | 459 | 447 | 435 |
| REMEX RFD-4000 | 219 | 219 | 209 |
| MITSUBISHI M2894-63 | 447 | 439 | 433 |
| MITSUBISHI M2896-63 Half Ht. | 459 | 449 | 409 |

Five Inch Single Sided Drives

| | | | |
|------------------------------------|-----|-----|-----|
| TEAC FD-55A half height | 179 | 169 | 165 |
| SHUGART SA400L | 235 | 229 | 225 |
| SHUGART SA100 96TPI/80 Trk. | 129 | 129 | 119 |
| SHUGART SA200 1/2 Height | 159 | 149 | 139 |
| TANDON TM100-1 | 189 | 179 | 175 |

Five Inch Double Sided Drives

| | | | |
|--|-----|-----|-----|
| TEAC FD55B half height | 219 | 209 | 199 |
| CONTROL DATA 9409 IBM/PC | 259 | 249 | 239 |
| REMEX RFD480 IBM/PC | 199 | 189 | 175 |
| SHUGART SA450 | 319 | 309 | 299 |
| SHUGART SA455 Half Height | 259 | 249 | 239 |
| SHUGART SA465 Half Ht. 96TPI | 289 | 279 | 269 |
| TANDON TM50-2 Half Height | 215 | 209 | 199 |
| TANDON TM55-4 half Ht. 96TPI | 329 | 319 | 309 |
| TANDON 100-2 | 279 | 269 | 259 |
| TANDON 101-4 96TPI 80 Track | 369 | 355 | 350 |
| MITSUBISHI 4851 Half Height | 259 | 249 | 245 |
| MITSUBISHI 4853 1/2 Ht. 96TPI | 339 | 329 | 319 |
| MITSUBISHI 4854 1/2 Ht., 8" elec. | 465 | 449 | 439 |
| QUME 142 Half Height | 239 | 229 | 219 |

Three Inch Disk Drives

| | | | |
|------------------------------------|-----|-----|-----|
| SHUGART SA300 with diskette | 229 | 219 | 209 |
|------------------------------------|-----|-----|-----|

Five Inch Winchester Hard Disk Drives

| | | | |
|---------------------------------------|-----|-----|-----|
| SHUGART 612 13 M/Bytes | 895 | 865 | 825 |
| SHUGART 706 6 M/Byte, Half Ht | 795 | 775 | 755 |
| SHUGART 712 13 M/Byte, 1/2 Ht. | 895 | 865 | 825 |
| TANDON 503 19 M/Byte | 895 | 875 | 855 |

Upon request, all drives are supplied with power connectors and manual

ENCLOSURES

California Digital manufactures an assortment of stock and custom disk drive enclosures. If the volume is justified we will custom design an enclosure for your application. The following stock disk drive enclosures are available. All include power supplies the B' enclosures are supplied with exhaust fans.

| | | | |
|--|----------|---|----------|
| Horizontal mount two 8" full height drives. | \$279.00 | Horizontal mount one full height or two half height 8" disk drives. | \$239.00 |
| Vertical mount two full height 8" disk drives. | \$299.00 | Vertical mount two full height 5 1/4" disk drives. | \$139.00 |

New Location



California Digital has just purchased a new distribution center six times the size of our existing facility. The new warehouse and retail store is in the city of Carson at 17700 Figueroa Street. We are located just off the San Diego Freeway near the Good-year Blimp. Please stop by and visit our retail store when in the Los Angeles area. Store hours are 10 AM to 5 PM Monday through Saturday.

Telex 753607



Shipping: First five pounds \$3.00, each additional pound \$.50. Foreign orders: 10% shipping, excess will be refunded. California residents add 6 1/2% sales tax. • COD's discouraged. Open accounts extended to state supported educational institutions and companies with a strong "Dun & Bradstreet" rating. Retail location: 17700 Figueroa Street, Carson CA. 90248.

TOLL FREE ORDER LINE
(800) 421-5041
TECHNICAL & CALIFORNIA
(213) 217-0500

ALL CALIFORNIA DIGITAL

Post Office Box 3097 B • Torrance, California 90503

Dragon 39

Your Choice
Second Drive or Monitor

SANYO

IBM COMPATIBLE

\$995

The world famous Dragon computer is now available in the United States. Manufactured by the Tano Corporation under license of the British Broadcasting Company. The Dragon comes complete with 64K Byte of memory, serial modem port along with a Centronics printer interface. This unique microcomputer features Motorola's advanced 6809E microprocessor and comes standard with Microsoft Color Basic, data base manager, spread sheet, and a complete word processing package. The computer outputs color composite video along with R.F. video that allows the unit to be used in conjunction with any color television.

This is the ideal low cost computer to be used with any dial up information system such as the Source, Western Union's EasyLink or any other time share service.

California Digital has agreed to act as exclusive agent for North America in an effort to assist The Tano Corporation in reducing their overstock. For a limited time California Digital can offer the Dragon computer for only \$139.

Sanyo Electronics has just released the long awaited IBM/PC look-a-like, the MBC-550. This is a complete microcomputer that includes 128K/byte of memory, a 5 1/4" 160K/byte disk drive upgradeable to 320K/byte drives. Also includes both color composite and RGB graphics interface, low profile keyboard, and parallel printer port. Extensive software such as Sanyo Basic, disk utilities, Wordstar word processing software, Calcstar spread sheet & Easy Writer I. MS-DOS is supplied with the Sanyo computer. Most programs written for the IBM/PC will operate on the MBC-550.

Along with all this California Digital offers "FREE" your choice of either a second disk drive, or a high resolution green or amber screen monitor. All at the super low price of only \$995.

We are currently experiencing an initial shortage of this computer. Please place your orders early. The MBC-550 will be shipped on a first ordered basis.

PRINTERS

\$289

Star Gemini

MATRIX PRINTERS

| | |
|----------------------------------|---------|
| Star Gemini 10K 120 char./sec. | 290.00 |
| Star Gemini 15K 150 char./sec. | 419.00 |
| Star Gemini 20K 200 char./sec. | 495.00 |
| Star Gemini 30K 300 char./sec. | 599.00 |
| Star Gemini 40K 400 char./sec. | 699.00 |
| Star Gemini 50K 500 char./sec. | 799.00 |
| Star Gemini 60K 600 char./sec. | 899.00 |
| Star Gemini 70K 700 char./sec. | 999.00 |
| Star Gemini 80K 800 char./sec. | 1099.00 |
| Star Gemini 90K 900 char./sec. | 1199.00 |
| Star Gemini 100K 1000 char./sec. | 1299.00 |
| Star Gemini 110K 1100 char./sec. | 1399.00 |
| Star Gemini 120K 1200 char./sec. | 1499.00 |
| Star Gemini 130K 1300 char./sec. | 1599.00 |
| Star Gemini 140K 1400 char./sec. | 1699.00 |
| Star Gemini 150K 1500 char./sec. | 1799.00 |
| Star Gemini 160K 1600 char./sec. | 1899.00 |
| Star Gemini 170K 1700 char./sec. | 1999.00 |
| Star Gemini 180K 1800 char./sec. | 2099.00 |
| Star Gemini 190K 1900 char./sec. | 2199.00 |
| Star Gemini 200K 2000 char./sec. | 2299.00 |
| Star Gemini 210K 2100 char./sec. | 2399.00 |
| Star Gemini 220K 2200 char./sec. | 2499.00 |
| Star Gemini 230K 2300 char./sec. | 2599.00 |
| Star Gemini 240K 2400 char./sec. | 2699.00 |
| Star Gemini 250K 2500 char./sec. | 2799.00 |
| Star Gemini 260K 2600 char./sec. | 2899.00 |
| Star Gemini 270K 2700 char./sec. | 2999.00 |
| Star Gemini 280K 2800 char./sec. | 3099.00 |
| Star Gemini 290K 2900 char./sec. | 3199.00 |
| Star Gemini 300K 3000 char./sec. | 3299.00 |
| Star Gemini 310K 3100 char./sec. | 3399.00 |
| Star Gemini 320K 3200 char./sec. | 3499.00 |
| Star Gemini 330K 3300 char./sec. | 3599.00 |
| Star Gemini 340K 3400 char./sec. | 3699.00 |
| Star Gemini 350K 3500 char./sec. | 3799.00 |
| Star Gemini 360K 3600 char./sec. | 3899.00 |
| Star Gemini 370K 3700 char./sec. | 3999.00 |
| Star Gemini 380K 3800 char./sec. | 4099.00 |
| Star Gemini 390K 3900 char./sec. | 4199.00 |
| Star Gemini 400K 4000 char./sec. | 4299.00 |
| Star Gemini 410K 4100 char./sec. | 4399.00 |
| Star Gemini 420K 4200 char./sec. | 4499.00 |
| Star Gemini 430K 4300 char./sec. | 4599.00 |
| Star Gemini 440K 4400 char./sec. | 4699.00 |
| Star Gemini 450K 4500 char./sec. | 4799.00 |
| Star Gemini 460K 4600 char./sec. | 4899.00 |
| Star Gemini 470K 4700 char./sec. | 4999.00 |
| Star Gemini 480K 4800 char./sec. | 5099.00 |
| Star Gemini 490K 4900 char./sec. | 5199.00 |
| Star Gemini 500K 5000 char./sec. | 5299.00 |
| Star Gemini 510K 5100 char./sec. | 5399.00 |
| Star Gemini 520K 5200 char./sec. | 5499.00 |
| Star Gemini 530K 5300 char./sec. | 5599.00 |
| Star Gemini 540K 5400 char./sec. | 5699.00 |
| Star Gemini 550K 5500 char./sec. | 5799.00 |
| Star Gemini 560K 5600 char./sec. | 5899.00 |
| Star Gemini 570K 5700 char./sec. | 5999.00 |
| Star Gemini 580K 5800 char./sec. | 6099.00 |
| Star Gemini 590K 5900 char./sec. | 6199.00 |
| Star Gemini 600K 6000 char./sec. | 6299.00 |

TERMINALS

Perkin Elmer 550S

California Digital has recently purchased an OEM liquidation, of new Perkin-Elmer Bantam 550S terminals. These units feature direct cursor addressing, numeric cluster, conversational or block mode transmission and RS-232 printer port. Self diagnostics and function keys make this terminal an excellent value at only \$339.00, PRK-550S

| | |
|--|---------|
| Perkin-Elmer Model 550S Bantam Terminal | 339.00 |
| Freeform 100 split screen; detachable keyboard | 495.00 |
| Freeform 100 green phosphor terminal | 539.00 |
| Visual 50 Green screen | 650.00 |
| Amper Dialogue 125 green screen | 675.00 |
| Amper Dialogue 175 amber screen two page func. keys | 719.00 |
| Wise 100 14" green phosphor | 795.00 |
| Wise 100 14" vert. split screen metal enclosure | 895.00 |
| Wise 300 8" right color display, split screen | 975.00 |
| Televideo 925 detachable keyboard, 22 function keys | 1159.00 |
| Televideo 925 9" graphic char. split screen, 22 func. keys | 1299.00 |
| Televideo 970 14" green screen, 132 column, European | 1399.00 |
| Zerith 29 terminal, V132 compatible, detachable keyboard | 1719.00 |

256 KILOBYTE MEMORY BOARD

\$495

256 kilobytes of memory using 64K dynamic RAM
Over one megabyte of memory using the new 256K dynamic RAM chips
Error detection/rate capability
Individual 1Mk block can be relocated to any boundary within a megabyte of RAM
24 bit addressing and phenomenon mode capability

The California Digital 256K RAM board represents an outstanding value in S-100 memory technology. Priced slightly above earlier generation 64K dynamic RAM boards it gives you these additional features: 256K of memory with parity parity error detection; 24 bit addressing; a status port; ERROR LED or IEEE 696; ERROR signal; 24 or 16 bit addressing with memory management.

Proper operation with front panel equipped systems, DMA data controllers, and IEEE 696 Temporary Bus Masters assured with an on board 141 generator for memory refresh timing. CAS and RAS timing is controlled with tapped digital delay lines for proper operation over the entire operating temperature range.

The board is very recent in design using the National Semiconductor 19F 8409 RAM Controller chip. Split termination networks are used on all address lines. CAS line, and RAS lines eliminating the last traces of ringing. The board uses two separate voltage regulators. One for the DRAMs and one for the interface logic, increasing the noise immunity of the ram array. Typical power dissipation is 8 watts.

Documentation includes theory of operation, configuration guide, a schematic, and application notes on the use of the memory management options. CAL 256K - 2 lbs.

WORD PROCESSING PRINTERS

| | | |
|--|------------|---------|
| NEC 7710 55 char/second serial interface | NEC 7710 | 1979.00 |
| NEC 7730 55 char/sec serial interface | NEC 7730 | 1979.00 |
| NEC 8250 copular printer designed for the IBM/PC | NEC 8250 | 1979.00 |
| NEC 8250 designed for IBM/PC 20 char/sec. par'l. | NEC 8250 | 995.00 |
| Silver Reed EXP 500 14 char/sec. par'l interface | SRD EXP500 | 699.00 |
| Silver Reed EXP 550 17 Char/sec. par'l interface | SRD EXP550 | 695.00 |
| Dialco 630 40 char/sec. serial | DAL 630 | 1765.00 |
| Dialco 620 proportional spacing horiz & vert tabs 20 cps | DAL 620 | 879.00 |
| Just 6100 18 char/sec graphic mode | JK-6100 | 539.00 |
| Brother H111 daisy wheel parallel interface | BTH-H111 | 779.00 |
| Brother H111 serial interface | BTH-H111S | 779.00 |
| Stamwriter F10 serial 40 char/sec | PRO-F10S | 1125.00 |
| Stamwriter F10 parallel 40 char/sec | PRO-F10P | 1125.00 |
| Comex CR1 word processing printer, serial int. | CRX-CR1 | 729.00 |
| Comex CR2 5k buffer, proportional spacing par'l. | CRX-CR2P | 495.00 |

APPLE

\$929

Apple II/e, 64K computer only
Apple II/e starter kit, monitor, disk, 80 col. card
Advanced Business Tech, 13 Key Pad
Call. Computer 7710A Async. Serial Interface
Call. Computer 7710B Same but for modem
Call. Computer 7114A 12K PRoM module
Call. Computer 7720A parallel interface
Call. Computer 7724A Calandar/clock modular
Call. Computer 7729A Centronics interface
Call. Computer 7740A programmable timer
California Digital 16K card for standard Apple II
Hayes Microcom II for Apple II
Kensington Micro. System saver int.
Microsoft Softcard with CP/M: 2.80
Mountain Computer The Clock
Mountain Computer AD-DA 16 input, 8bit
Mountain Computer ROM Plus with keypad, fitter
Mountain Computer FOM writer/socket socket
Orange Micro "GRAPPLER" parallel interface
Sorrento Valley 8" controller double side D/D.
TEAC 5 1/4" disk drive for Apple II
Vista Vision 80/80 column card for std. Apple II
Vista B disk controller double side D/D.

MONITORS

| | | |
|--|------------|--------|
| BMC 12A green phosphor 15 MHz composite video | BMC 12A | 79.00 |
| BMC 12 high resolution 15 MHz composite video | BMC 12EH | 129.00 |
| Zenith ZVM122 Amber Phosphor 12 40/80 column switch | ZTH-122 | 119.00 |
| Zenith ZVM123 green phosphor 12 40/80 column switch | ZTH-123 | 105.00 |
| NEC JB1201 green phosphor 18 MHz composite video | NEC-JB1201 | 169.00 |
| NEC JB1260 commercial grade composite | NEC-JB1260 | 129.00 |
| USI Amber screen 12" composite monitor | USH-12A | 169.00 |
| Motrola 23" open frame flat white composite video | MOT 23W23 | 159.00 |
| Motrola 12" open frame requires horz sync & 12v supply | MOT BW12 | 69.00 |
| Conrac 9" open frame requires horz sync & 12v supply | CON-8W9 | 59.00 |
| BMC AL919 11U Color composite video with sound | BMC 9191 | 249.00 |
| BMC B191M RGB designed for use with the IBM computer | BMC-B191M | 499.00 |
| NEC JC1203M RGB color monitor | NEC-JC1203 | 499.00 |
| NEC JC1201 color compo | NEC-JC1201 | 339.00 |
| Zenith ZVM134 RGB color suitable for IBM PC | ZTH-134 | 379.00 |
| Comex color compo with sound | COM-6600 | 329.00 |
| Amplex color 1" parallel video | AMK-100 | 329.00 |

ASCII KEYBOARD \$49

California Digital has purchased over 3000 of these Microsoft keyboards from the General Dynamics Corporation 93 ASCII encoded Half effect switches includes 8 function keys and 14 numeric cluster make this keyboard an excellent value at only \$49. MKC 9300 5 lbs.

We also have available a matching General Dynamics steel trim panel \$10.

Non encoded Hyrax 58 key metal contact keyboard. HIK-58 \$24.95. Matching 15 key numeric cluster \$9.95. HIK-15. Both for only \$29.95. HIK-5818.

Not pictured: 49 key eight bit modified Microsoft coded Microsoft Half effect keyboard. REMOVED from punch card equipment \$14.95. DIT-1849 ASCII encoded available.

MODEMS

DIRECT CONNECT \$75

| | | |
|---|------------|--------|
| Hayes Smart Modem 1200 baud auto answer, auto dial | HYS-120AD | 499.00 |
| Hayes 1200B for use with the IBM/PC, 1200 baud | HYS-1200B | 449.00 |
| Hayes Smartmodem 300 baud only, auto answer, auto dial | HYS-103AD | 229.00 |
| Hayes Microcommod II 110 baud, auto connect | HYS-110A | 279.00 |
| Hayes Microcommod 100, 3-100 auto answer, auto dial | HYS-100 | 319.00 |
| Hayes Chronomodem 300 baud, auto answer, auto dial | HYS-300 | 359.00 |
| Hayes Chronomodem 1200 baud, auto dial/answer | HYS-1200 | 399.00 |
| U.S. Robotics Faxmodem 300/1200 baud | USR-FM300 | 199.00 |
| Farris 300/1200 auto dial/answer | FRS-300 | 389.00 |
| Universal Data 1031P, line power, answer & originate | UDS-1031P | 169.00 |
| Universal Data 1031P, auto answer | UDS-1031P2 | 219.00 |
| Universal Data 201, 1200 baud, half duplex only | UDS-201 | 219.00 |
| Universal Data 212LP, full 1200 baud duplex, line power | UDS-212LP | 359.00 |
| Novation 17 Cat. auto connect, auto answer, auto dial | NOV-CAT | 159.00 |
| Novation SmartCat 103, auto answer, auto dial | NOV-SC103 | 219.00 |
| Novation SmartCat 110, 1200 baud auto dial | NOV-SC110 | 329.00 |
| Signamax Mark 1, direct connect with terminal cable | SGL-MK1 | 75.00 |

CP/M SOFTWARE

| | | |
|--------------|----------|--------|
| AdaSoft CP/M | ADA-445C | 395.00 |
| D-Base II | ASH-015C | 429.00 |
| MACS | DGR-401C | 85.00 |
| CP/M 3.0 | DGR-410C | 249.00 |
| Dual System | DGR-367C | 45.00 |
| Pascal Plus | DGR-004C | 429.00 |
| CP/M 86 | DGR-186C | 239.00 |
| MP/II | DGR-208C | 379.00 |
| Supersoft | MPR-309C | 149.00 |
| MPC | DGR-401C | 85.00 |
| CP/M 3.0 | DGR-410C | 249.00 |
| Dual System | DGR-367C | 45.00 |
| Pascal Plus | DGR-004C | 429.00 |
| CP/M 86 | DGR-186C | 239.00 |
| MP/II | DGR-208C | 379.00 |

Telex 753607



Shipping: First five pounds \$3.00, each additional pound \$5.00. Foreign orders: 10% shipping, excess will be refunded. California residents add 6 1/2% sales tax. COD's discouraged. Open accounts extended to state supported educational institutions and companies with a strong "Dun & Bradstreet" rating. Retail location: 17700 Figueroa Street, Carson CA. 90248.

TOLL FREE ORDER LINE
(800) 421-5041
TECHNICAL & CALIFORNIA
(213) 217-0500

Additional Software available for Apple, IBM/PC and Atari. Please telephone for price and availability.

ADVANCED COMPUTER PRODUCTS



IBM PC MULTICARD™

"MULTICARD" multifunction card for the IBM PC & XT expandable to 256K. Thousands of this popular card have already been shipped by ACP.

- 84-256K
 - Parallel Port
 - Serial Port
 - 1 Year Warranty
 - Disk Emulator Software
 - Printer Spooler Software
 - Clock/Calendar
 - Clock Software
- \$229.00 w/64K \$229.00**

S-100 64K "CMOS" RAMCARD

Unbelievable Price!

\$299.00

Assembled and Tested

- ACP has sold over 1000 of these IEEE compatible, low-priced, high-reliability 64K Static RAM Cards.
- Single 5-Volt operation.

SIEMEN'S SALE

You can now purchase Shugart compatible 8" Disk Drives below your existing factory direct pricing!

These Prices are the lowest ever published!

*Siemens's \$500 FD0100-8... **\$169.00**

Also, with purchase of Disk Drive you can buy the Vista V-1000 Dual Case with Power Supply and Cable for only \$375.00... Regular Price \$495.00

Offer Limited! Factory Warranty 90 Days! Shipped Immediately from Stock! *OEM Quantities

8" Disk Drives \$169.00

DOT MATRIX PRINTER

COEX 80-FT

9x7 Dot Matrix, 80 CPS, Bi-Directional Printing

2K Buffered Memory

80, 96, 132 Columns, Graphics and Block Printing

Selectable Char Pitch, Line Spacing and Feed

COEX Interface Card to Apple... **\$48.95**

\$199.00

ACP HAS DISK DRIVES

APPLE II™ COMPATIBLE

Thin Line Drive

\$199.00

APPLE COMPATIBLE DISK DRIVES

| | |
|----------------------------|----------|
| VISTA Solo 5 1/4" Std. | \$199.00 |
| CUMANA 5 1/4" Std | 249.00 |
| RANA Elite 1 | 249.00 |
| Elite 2 | 309.00 |
| Elite 3 | 499.00 |
| Elite Controller | 82.00 |
| SUPER 5 Alpha A40 Thinline | 199.00 |
| TEAC T40 Thinline | 239.00 |
| TEAC T80 Doublesided | 329.00 |
| Controller | 58.00 |

TANDON 100-2

PC Compatible • Double Sided

Mounting Kit for IBM PC \$4.95

\$229.00

TM100-1.....\$179.00

TOSHIBA Half-High

PC Compatible • Double Sided

\$179.00

OTHER DRIVES WE STOCK

| | | | |
|------------------------|----------|--------------------------|----------|
| TANDON 640-2 Thinline | \$479.00 | SHUGART 801R | \$399.00 |
| TEAC FD558 | 199.00 | QUIME Databack 8 | 449.00 |
| SEAGATE 10MB Hard Disk | 699.00 | CDC 1800 DS (320K) | 249.00 |
| MPI B52 | 239.00 | SEAGATE ST508 (6MB Win.) | 499.00 |

64K RAMS Set of 9 \$50.00

Apple Compatible Software

| SOFTWARE | ACP PRICE |
|---------------------------------------|------------|
| APPLIED SOFTWARE Versalom | \$299.00 |
| Versalom Hard Disk | 299.00 |
| ARTSCI Magic Window II | 95.00 |
| Magis Combo | 148.00 |
| ASHTON-TATE DBASE II (CPM) | 385.00 |
| Friday (CPM) | 198.00 |
| BPI (GL, AR, AP, Pay, Inv) | ea. 299.00 |
| BRODERBUND Bank Street Writer | 49.00 |
| BUSINESS SOLUTIONS The Incred Jack | 148.00 |
| CONTINENTAL (GL, AR, AP, Pay) | ea. 189.00 |
| Home Accountant | 49.00 |
| DATA-MOST Real Estate Inv. | 99.00 |
| DOW JONES Market Manager | \$499.00 |
| Market Analyzer | 298.00 |
| Market Microscope | 548.00 |
| EAGLE Money Decisions | 149.00 |
| FOX & GELLER Checkcode | 199.00 |
| d Utility | 199.00 |
| HAYDEN File Writer | 99.00 |
| Compiler Plus | 78.00 |
| Basic Compiler | 65.95 |
| HOWARDSON Tax Preparer | 148.00 |
| Real Estate Analyzer | 199.00 |
| KENSINGTON Form II | 99.00 |
| LIGHTNING Massotype | 36.00 |
| LIVING VIDEOTEK Think Tank | 130.00 |
| MICROPRO Wordstar | 248.00 |
| Mailing or Spellstar | 139.00 |
| Wordstar Prof. 4 Pak | 449.00 |
| Info Pak or InfoStar | Call |
| MICROSOFT Multiplan | 178.00 |
| MultiTool Financial | 79.00 |
| MultiTool Budget | 119.00 |
| MEGALAN Management | 99.00 |
| PEACHTREE Series 40 (GL, AR, AP) | 378.00 |
| Series 9 (Text, Spell, Mail) | 399.00 |
| PERFECT SOFTWARE | Call |
| QUARK Word Juggler (Ile) | 199.00 |
| Lockstep (Ile) | 99.00 |
| Call for Apple III | |
| SIERRA ON-LINE | |
| Screenwriter II | 99.00 |
| Screenwriter Professional | 148.00 |
| General Manager II | 199.00 |
| Dictionary | 79.00 |
| SOFTWARE Publishing PFS/File | 89.00 |
| PFS/Graph or PFS/Report | 89.00 |
| STATE OF THE ART | Call |
| STONEWARE DB Master 4.0 | 248.00 |
| DB Utility I or 2 | 79.00 |
| SYSTEMS Plus Act Plus (GL, AR, AP) | \$499.00 |
| VISICORP Visicalc 3.3 | 199.00 |
| Visicalc Enhanced | 199.00 |
| VisiFile or VisiDesk | 179.00 |
| HOME & EDUCATION | |
| BRODERBUND Chopstrip | \$28.00 |
| Drill or LodeRunner | 28.00 |
| Arcade Machine | 44.00 |
| Apple Panic | 24.00 |
| BUDGECO Raster Blaster | 24.00 |
| Pinball Construction | 29.00 |
| COUNTERPOINT SOFTWARE | |
| Easy Games for Young Children | 26.00 |
| DATAMOST Aztec | 29.00 |
| Pig Pen or Shark Attack | 23.00 |
| DATASOFT Zaxxon | 31.00 |
| EDU-WARE Computer | 31.00 |
| Algebra I, II or III | 30.00 |
| CompuCard or CompuSpell | 23.00 |
| ERINSTEIN Memory Trainer | 73.00 |
| ELECT. ARTS Music Construction | Call |
| HARCOURT Computer SAT | 29.00 |
| HAYDEN Sargon II | 29.00 |
| INFOCOM Zork I, II or III | 29.00 |
| Deadline | 36.00 |
| KOALA Modules (8 available) | Call |
| LEARNING COMPANY | |
| Juggler | 36.00 |
| Bumble Games | 48.00 |
| Genius's Secrets | 58.00 |
| L & S Crossword Magic | 41.00 |
| MICROFUN Miner 2049er | Call |
| MICROSOFT DESTINY | 25.00 |
| Typing Tutor II | 19.00 |
| MONOGRAM Dollars & Sense | 74.95 |
| ORIGIN Exodus: Ultima III | 41.95 |
| PENQUIN The Quest | 16.00 |
| SENSIBLE Sensible Speller | 99.00 |
| SIERRA/ON-LINE Frogger | 28.00 |
| SIRTECH Legacy of Lyngmyra | 28.00 |
| Knight of Diamonds | 28.00 |
| SOUTHEASTERN Data Capture 4.0 | 54.95 |
| SPINNAKER Alphabet Zoo | 28.00 |
| Delta Drawing | 33.00 |
| Fraction Fever | 23.00 |
| Kindergarten | 21.00 |
| Facemaker | 28.00 |
| SUBLOGIC Flight Simulator or Pinball | 28.00 |
| SUNDEX No. 1 Rated Home Finance | 74.95 |
| CPA Personal Accountant | 74.95 |
| CPA Personal Investor | 74.95 |
| Personal Payables | 42.95 |
| TERRAPIN Logo | 899.00 |
| TRAXIS Trade | 79.00 |
| VIRTUAL Micro Cookbook | 29.00 |
| UTILITIES/SYSTEM | |
| BEAGLE Apple Mechanic | 82.00 |
| Apple Plot or Promo DOS | 26.00 |
| Beagle Basic | 26.00 |
| DOS Boss | 17.00 |
| Double Take or Utility Fly | 26.00 |
| CENTRAL POINT File | 18.00 |
| Copy It Plus | 31.00 |
| LOCKSMITH | 79.00 |
| MICROSOFT A.L.D.S. | 309.00 |
| Cobol 80 | 575.00 |
| Fortran 80 | 155.00 |
| PENQUIN CGS System | 79.00 |
| PHOENIX Zoom Graphics | 31.00 |
| SOUTHWEST Merlin | 49.95 |
| Send for Complete Catalog of Software | |

APPLE™ COMPATIBLE DISK CONTROLLER

Only **\$49.95**

Apple Compatible Printer Interface

w/Apple to Epson Cable **\$49.95**

Apple IIe Compatible 80 Column Card w/64K

\$99.95

APPLE COOLING FAN

with Surge Suppression **\$49.95**

VISTA "SOLO" Apple II/Ile Compatible Disk Drive

Totally compatible to Apple Drives.

Only **\$199.95**

Controller..... **\$49.95**

Just plug in and run.

Apple II 16K RAM CARD

Compatible with Z80 Software™ . PASCAL CP/M™

Full 1 year Warranty. Top Quality by COEX

NEW LOW ACP PRICE **\$49.95**

Also from COEX, NEW EPSON Parallel Interface for Apple. With cable **\$49.95**

VISTA A800 8" Disk Controller for Apple

\$299.95

VISTA "DISKMASTER" IBM Compatible

3", 5", 8" and V1200 Compatible **\$169.95**

MONITORS

TAXAN

| MODEL | ACP PRICE |
|---|---------------|
| 210 RGB Composites, Sound (Apple) | \$329.00 |
| 400 RGB Vision I Mod. res. (Apple, IBM, etc.) | 329.00 |
| 410 RGB Mod. res. (Apple, IBM, etc.) | 429.00 |
| 415 RGB Vision III Hi Res. (Apple w/10, IBM) | 559.00 |
| 420 RGB III Hi Res. (IBM Cabinet) | 559.00 |
| 121 TTL Green 12" (IBM Cabinet) | 179.00 |
| 122 TTL Amber 12" (IBM Cabinet) | 189.00 |
| 100/108 Green/Amber | 199.00/149.00 |

Clearance Sale (Quantities Limited)

| QTY | LIST | ACP |
|--|--------|---------|
| 120 Apple III Switching Power Supplies | 859.95 | |
| 13 Zenith 280X Computer | 2199 | 1149.00 |
| 26 Zenith 290-0 Computer | 2499 | 1299.00 |
| 20 TI ProII 64K exp to 192K Ramcard | 1599 | 899.00 |
| 12 Zenith 287 Disk Drive | 999 | 549.00 |
| 1 Zenith 287 Hard Disk | 5995 | 3199.00 |

*All Zenith items in original boxes with 90 day Factory Warranty from nearest dealer.

GREENANCE SALE

2 TI 840RO w/printer 995 \$780.00

2 TI 840RO w/ractor 1045 \$89.00

2 TI 840RO Package Opt/ractor 1265 \$99.00

5 TI 840RO Package Opt/ractor 1315 749.00

7 TI 80 Series Printer 449.00

7 TI Professional Multiphan 350 179.00

20 TI ProII 64K exp to 192K Ramcard 1499.00

1 Fortune System 10 7995 2995.00

1 Fortune System 20 10990 3995.00

3 Fortune 256K Ramcard 1095 599.00

35 Olivetti M20 Computer 2495 995.00

200 General Terminals CTC RS232 289.00

40 Zenith 8003/9003 Terminals 248.00

Apple Computer Authorized Dealer

Complete Apple Support Facility Complete Apple Service Center

We service most Floppy Disk Drives

Apple IIe w/128K, 80 columns \$1199.00

Apple IIe Starter System \$1395.00

Includes Apple IIe w/64K, 80 Column Card, Monitor II & Disk II w/Controller \$369.00

Disk II w/Controller \$329.00

Disk II \$29.00

Monitor II Green lit \$179.00

Super Game Card \$49.95

80 Column Start Card w/64K \$189.00

Imagewriter Dot Matrix Printer \$549.00

Apple Products Available In-store Only

Apple Compatible Hardware

| LIST | ACP |
|------------------------------------|----------|
| ALL CPM 3.0 Plus Card | \$399.00 |
| COMPUTER ACCESSORIES | |
| Power Control Center P12 | 99.00 |
| COEX 16K Ram Card | 99.00 |
| Parallel Printer Card w/Cable | 99.00 |
| Apple II Prototype Card | 29.00 |
| Apple II Extended Card | 29.00 |
| 64K Extended 80 Column | 199.00 |
| CORVUS Hard Disk Omnitrac | Call |
| EASTSIDE Wildcard (11 + w/64) | 99.00 |
| Wildcard 2 (Ile) | 118.00 |
| Wildcard Plus (64K in 10 sec) | 148.00 |
| FINGERPRINT Epson Enhancer | 299.00 |
| GIBSON Light Pan | 249.00 |
| IS PKASO Interface (II/Ile) | 199.00 |
| PKASO Interface (III) | 199.00 |
| KENSINGTON System Saver | 89.95 |
| PC Saver | 49.95 |
| KEYTRONICS KB200 II + Keyboard | 298.00 |
| KOALA Graphics Pad | 125.00 |
| KRAFT Joystick | 65.00 |
| Game Paddles | 50.00 |
| MCT Speed Demon | 295.00 |
| MPC 128K Bubble Memory | 875.00 |
| MAR Sup' Mod II RF Modulator | 69.00 |
| Sup' Fan | 50.00 |
| MICROPRO 6MHz Appicard + Word | Call |
| MICROSOFT Z-80 Software | 395.00 |
| Z-80 Software Plus | 645.00 |
| 80K Software Pak (II +) | 695.00 |
| Software Premium Pak (Ile) | 495.00 |
| MOUNTAIN COMPUTER | |
| CPS Multifunction | 239.00 |
| Music System | 395.00 |
| AD Plus DIA | 350.00 |
| MicroTEK Dumping Buf. w/64K | 349.00 |
| ORANGE MICRO | |
| Grappler Plus | 175.00 |
| 16K Bufferboard | 175.00 |
| Grappler Buffered w/16K | 245.00 |
| PCP Applicard w/128K, 64K | 595.00 |
| 8088 Coprocessor | 595.00 |
| Appicard w/128K, 4MHz | 495.00 |
| PERSOFT (All w/1 Year Warranty) | |
| Printerlink Intell. Printer I/O | 99.00 |
| Messiah II | 79.00 |
| TimeLink Realtime Clock | 110.00 |
| Gratlink Graphics I/O | 175.00 |
| Bufferlink w/16K Buffer | 189.00 |
| PRACTICAL PERIPHERALS | |
| Microbus 16K (Epson Parallel) | 159.00 |
| Microbuffer 32K (Epson Serial) | 199.00 |
| Microbuffer 16K (Epson Serial) | 179.00 |
| Microbuffer 32K (Epson Serial) | 219.00 |
| Microbuffer In-line 64K (Parallel) | 349.00 |
| Microbuffer In-line 64K (Serial) | 449.00 |
| PRO-MOUSE Versacard 4 in 1 | 199.00 |
| QUADRAM Quadlink | 680.00 |
| Microfazer 16K (Parallel) | 189.00 |
| Microfazer 16K (Serial) | 220.00 |
| Microfazer 32K (Parallel) | 225.00 |
| SATURITTAN | |
| 32K Ramcard | 219.00 |
| 64K Ramcard | 349.00 |
| 128K Ramcard | 499.00 |
| Accelerator II Card | 599.00 |
| Neptune 64K + 80 | 199.00 |
| Neptune 128K + 80 | 249.00 |
| Neptune 192K + 80 | 389.00 |
| STREET Echo II (Apple) | 149.00 |
| Echo II Serial (In-line) | 249.00 |
| Symtek II | 149.00 |
| Symtek III | 249.00 |
| Enhance II | 395.00 |
| Flashcard 144K | 449.00 |
| Flashcard 288K | 629.00 |
| TG PRODUCTS | |
| Joystick | 59.95 |
| Select-a-port | 59.95 |
| Trackball | 64.95 |
| Joystick w/Toggle I/O | 64.95 |
| VIDEX Videoliner (80) | 345.00 |
| Ultraliner (132) | 379.00 |
| Enhance II | 149.00 |
| VISTA COMPUTER | |
| A800 8" Disk Controller | 379.00 |
| A500 5 1/4" Disk Controller | 99.00 |
| V1200 Amlyn 8 1/2MB | 1549.00 |
| VOTRAX Type II Talk | 259.00 |
| Personal System | 395.00 |

ROBOTS

| ANDROBOT | LIST | ACP |
|------------------------------|-----------|------|
| Topo w/Speech | \$1595.00 | Call |
| Andrewagon | 95.00 | Call |
| Topoloch (II, Ile) | 149.00 | Call |
| Topoloch (II, Ile) | 159.00 | Call |
| Topoloch | 319.00 | Call |
| F.R.E.D. (Educational Robot) | 349.00 | Call |
| F.R.E.D. Soft (II, Ile) | 79.00 | Call |
| RRSX | | |
| RRSX Robot w/8K | 1795.00 | Call |
| 16K Memory Add-in | 125.00 | Call |
| Robot Arm Option | 895.00 | Call |
| Voice Option | 195.00 | Call |
| Power Pack | 94.00 | Call |
| Robot Language (II, Ile) | 395.00 | Call |
| ZENITH HERO I | 2495.00 | Call |

Apple™ Apple Trademark of Apple Computer

IBM™ IBM Trademark of International Business Machines

Tandem, we accept VISA, MC, MD, Discover and Personal checks. School Company P.O. We do not charge credit card sales tax. Personal checks require drivers license and credit card #. No Shipping Address in USA or CAN. CDD's over \$500 require 20% deposit with order. Add 7% shipping and handling for UPS. We offer same-day shipping. Prices subject to change without notice. We reserve the right to substitute manufacturer. We are not responsible for typographical errors.

Robot Sales Policy Vary

TOLL FREE **800-854-8230**

Mail Order: P.O. Box 17329 Irvine, CA 92713

Retail: 1310B E. Edinger, Santa Ana, CA 92705

(714) 553-8813

542 W. Trimble, San Jose, CA 95131

(408) 946-7010

ADVANCED COMPUTER PRODUCTS

Serving Computer Professionals Since 1976

TOLL FREE 800-854-8230

IBM PC



★ COLOR SPECIAL ★
THE COLOR GRAPHICS CARD
(same designer as Colorplus Card)
PRICE \$269.00
BREAKTHRU 1 year Warranty \$269.00

MULTI CARD II™ (exp. OK-384K) \$199.00

(INTRODUCTORY OFFER)

Advanced Computer Product's best selling multifunction card for the IBM PC & XT (plus compatibles) now has been improved with expansion capability to a full 384K and at no charge an additional game port. You also get Print Spooler and Disk Emulation Software plus a full year SWAP-OUT Warranty at no extra charge. Why pay more when you can get the same function and performance as Quadboard II™ and AST Sixpak Plus™ for substantially less money. You compare! Try it at no obligation. 10 day no questions asked return privilege.

| FUNCTION | Multicard II | Quadboard II | Sixpak Plus |
|-------------------|--------------|--------------|---------------------|
| Memory | 0 to 384K | 0 to 384K | 0 to 384K |
| Parallel/Serial | Yes | Yes | Yes |
| Clock/Calendar | Yes | Yes | Yes |
| Game Port | Yes | Yes | No (\$50 list Opt.) |
| Software | Yes | Yes | Yes |
| Warranty | 1 Year | 1 Year | 1 Year |
| ACP Price with OK | 199.00 | 229.00 | 229.00 |

EXPANSION MEMORY

- 64K Upgrade (Set of 9 64K RAMS) \$50.00
- 256K RAM's (256K x 1) \$79.00 ea
- 16K RAM's (16K x 1) 10/\$9.99
- 8087 CPU (Arithmetic Processor) \$199.00

IO/XT

(Serial, Parallel, Clock/Calendar) . . . \$129.00

The most popular expansion card for the short slot of your IBM XT. All these functions on one card optimized to fit in one slot. 1 year warranty.

COLOR/GRAPHICS/COLOR/GRAPHICS

- Plantronics COLORPLUS™ \$429**
- Hercules GRAPHICS CARD \$375**
- Quadram QUADCOLOR I&II Call
- Scanoptik COLORGRAPHICS \$269**
- Amdek MAI \$479**
- Paradise MULTIDISPLAY \$489**
- CONOGRAPHIC CARD \$895**
- MA Sys PEACOCK \$349**

IBM PC COMPATIBLE DISK DRIVES

- Tandon TM-100-1 Single Sided (160K) . . . \$179.00
- Tandon TM-100-2 Double Sided (320K) . . . 229.00
- Control Data 9409 Double Sided (320K) . . . 259.00
- TEAC* 55B 1/2 high Double Sided (320K) . . . 199.00
- Shiba* 1/2 high Double Sided (320K) 179.00
- *IBM PC Mounting Hardware for 1/2 highs. . . . 4.95
- Vista "Diskmaster" 5 1/4" & 8" Diskcontroller . . . 169.00

HARDWARE

- AST Sixpak Plus w/OK(SPC) \$229.00
- Megaplus II w/OK(SC) \$229.00
- IO Plus II (CS) \$115.00
- Game/Serial/Parallel Options \$35.00
- 64K Memory Upgrade \$50.00
- CHALKBOARD Call
- COEX IBM PC Extender Card \$29.00
- IBM PC Prototype Card \$36.00
- DAVONG Hard Disk Drives Call
- KENSINGTON PC Saver \$39.00
- KEYBOARD IBM PC Compatible \$149.00
- KEYTRONICS WP Keyboard KB5150 \$199.00
- KOALA \$99.00
- KRAFT or TG
- IBM PC Joystick \$49.00
- Game Paddles \$39.00
- MICROSOFT Mouse \$169.00
- M&R PC/XT Exp Chassis (6 slots) \$439.00
- MOUSE SYS Mouse for PC \$239.00
- PERSYST Time Spectrum w/64K \$289.00
- PTI Back-up Power 200/400W Call
- QUADRAM Quadboard II w/OK \$229.00
- Quadlink (Apple Flag.) \$499.00
- Quaddisk (up to 72Mb) Call
- Microfazer MP64 w/64K \$199.00
- VISTA Turbocard w/OK Call
- Maxicard w/64K (up to 576K) \$229.00
- PC Master (10 I/O) \$329.00
- Diskmaster (Floppy Cont.) \$169.00
- Dynalframe Hard Disk Call
- PC Clock I/O \$129.00

SOFTWARE

- dBASE II/Friday \$389.00/\$179.00
- Condor \$389.00
- SuperCalc I/II/III \$79.00/\$159.00/\$249.00
- Multiplan Vers. 1.1 \$179.00
- Microsoft Mouse/Word \$369.00
- Wordstar 3.3 \$269.00
- Micropro Pro Pak \$379.00
- Rbase II \$329.00
- T. K. Solver! \$319.00
- PFS File/Graph \$95.00/\$95.00
- Context MBA Call!
- Lotus 1-2-3 Vers. 1A Call!
- Copy II/PC Sideways Volkswriter
- Home Account Peachtree Crosstalk Digital Research
- Send for Free Catalog 96 Pages of Selected Values

PRINTERS/MONITORS

- BROTHER HR-25 (23cps daisy) Call
- HR-1A (16cps daisy) Call
- COEX 80FT (80cps) Sale \$199.00
- DYNAX DX-15 (daisy, 2-color) \$529.00
- DAISYWRITER 2000 (17cps) \$1049.00
- EPSON RX-80 (100cps) \$299.00
- FX-80 FX100 Call
- NEC Spinwriter 3550 \$1875.00
- OKIDATA Model 82/83 \$399.00/\$619.00
- Model 84P/84S \$193.00/\$83.00
- Model 92P/92S \$495.00/\$595.00
- Model 93P/93S \$769.00/\$899.00
- SILVER REED EXP550 (17cps) \$649.00
- STAR Gemini 10X (120cps) \$309.00
- Gemini 15X (120cps) \$429.00
- Delta 10/15 (160cps) Call
- TTX Model 1014 (12cps) \$529.00
- TRANSTAR 130P (16cps daisy) \$699.00
- Model 315 Color Printing \$119.00
- AMDEK Video 300G/A \$145.00/\$155.00
- Video 310A amber (IBM) \$159.00
- Color I (composite) \$299.00
- Color I Plus (earphn/nonglare) \$329.00
- Color II RGB (IBM) analog \$449.00
- Color II Plus \$479.00
- Color III RGB (IBM) \$399.00
- Color IV RGB (IBM) analog \$779.00
- BMC 12" Green-Low cost \$89.00
- PGS HX-12 RGB (IBM) \$499.00
- ZENITH ZVM-121 12" green \$99.00
- ZVM-134 12" RGB color \$399.00

DISKETTES

- DYSAN 5 1/4" SS DD 10/\$55 \$36
- DYSAN 5 1/4" DS DD 10/\$65 \$46
- IBM 5 1/4" SS DD 10/\$60 \$43
- IBM 5 1/4" DS DD 10/\$65 \$47
- VERBATIM 525-01 SS DD 10/\$45 \$23
- VERBATIM 550-01 DS DD 10/\$55 \$34
- MAXELL MD1 SS DD 10/\$50 \$29
- MAXELL MD2 DS DD 10/\$60 \$39
- Flip Storage Box 5 1/4" (80 disks) \$19
- BULK SPECIAL SS 10/\$25 \$19
- With Sleeve and Box 100/\$195 \$149

IBM ACCESSORIES

- COMPUABLE
- Keyboard/dive dust covers \$16.00
- Computer/keyboard vinyl cover \$9.00
- CURTIS PC Pedestal \$66.00
- PGS Adapter \$11.00
- Vertical PC Stand \$20.00
- Mono Extension Cable \$45.00
- Keyboard Ext Cable (9-9') \$35.00
- EDP PROTECTION DEVICES
- The Lemon Peach \$43.00 \$68.00
- The Orange Lime \$122.00 \$76.00
- GILTRONIX SWITCH BOXES
- 2 Way 8 Lines \$90.00
- 4 Way 8 Lines \$179.00
- 2 Way Centronics \$199.00
- RIBBONS Each Dozen
- Epson MX-80 \$7.75 \$9.00
- Epson MX-100 \$10.95 \$120.00
- Star Gemini 10/15 \$2.50 \$26.00
- Okidata 80/82/83 \$3.95 \$44.00
- Okidata 84/92/93 \$4.95 \$55.00
- NEC 3550 \$1.95 \$135.00

MODEMS

- BIZCOMP Model 2120 (Internal) Call
- HAYES Smartmodem 1200B \$475.00
- Smartmodem 1200B (w/Smartcom III) \$445.00
- Smartmodem 300 \$199.00
- Smartmodem II \$99.00
- Smartmodem/IBM Cable \$25.00
- NOVATION Access 1-2-3 Call

TERMS: We accept VISA, MC, MO, Cashiers and Personal checks. School and Company PO's. We do not charge your card until we ship. Personal checks require drivers license and credit card #. No Surcharge Added on VISA or MC. CDD's over \$500 require 20% deposit with order. Add 3% Shipping and handling for UPS. We offer same day shipment. Prices subject to change without notice. We reserve the right to substitute manufacturer. We are not responsible for typographical errors. Retail Sale Prices May Vary. IBM™ trademark of International Business Machines. Quadboard II™ trademark of Quadram Corp. Sixpak Plus™ trademark of AST Research Inc.

MAIL ORDER: P.O. Box 17329 Irvine, CA 92713
Retail: 1310 E. Edinger, Santa Ana, CA 92705 (714) 558-8813
542 W. Trimble, San Jose, CA 95131 (408) 946-7010

TOLL FREE
800-854-8230
TWX
910-595-1565

1984 CATALOG AVAILABLE SOON • 64K UPGRADE KITS - ONLY \$50.00

64K UPGRADE - ONLY \$50.00 • CUSTOM CABLES AVAILABLE

WE STOCK CABLES • RIBBONS • DISKETTES • SPARE PARTS

Do Kay

COMPUTER
PRODUCTS,
Inc.

ORDER TOLL FREE

(800)
538-8800

(CALIFORNIA RESIDENTS)

(800)
848-8008



TERMS: Minimum order \$10.00. For shipping and handling, include \$2.50 for UPS ground or \$3.50 for UPS Blue (air). For each additional air pound, add \$1 for UPS Blue shipping and handling. California residents must include 6% sales tax; Bay area and LA residents include 6 1/2% sales tax. Prices are subject to change without notice. We are not responsible for typographical errors. We reserve the right to limit quantities and to substitute manufacturers. All merchandise subject to prior sale.

HOURS: Mon. - Fri. 7:30 to 5:00
Saturdays 10:00 to 3:00

VISIT OUR RETAIL STORE

2100 De La Cruz Blvd.
Santa Clara, CA 95050
(408) 988-0697

ALL MERCHANDISE IS
100% GUARANTEED

Do Kay

STATIC RAMS

| | | |
|-------------|-------------------------------|---------|
| 2101 | 256 x 4 (450ns) | 1.80 |
| 5101 | 256 x 4 (450ns) (comes) | 3.80 |
| 2102L-1 | 1024 x 1 (450ns) | .88 |
| 2102L-4 | 1024 x 1 (450ns) (LP) | .98 |
| 2102L-2 | 1024 x 1 (250ns) (LP) | 1.46 |
| 2111 | 256 x 4 (450ns) | 2.46 |
| 2112 | 256 x 4 (450ns) | 2.85 |
| 2114 | 1024 x 4 (450ns) | 8/7.85 |
| 2114-25 | 1024 x 4 (250ns) | 8/8.85 |
| 2114L-4 | 1024 x 4 (450ns) (LP) | 8/8.85 |
| 2114L-3 | 1024 x 4 (300ns) (LP) | 8/10.85 |
| 2114L-2 | 1024 x 4 (200ns) (LP) | 8/11.85 |
| 2147 | 4096 x 1 (55ns) | 4.80 |
| TMS4044-4 | 4096 x 1 (450ns) | 3.46 |
| TMS4044-3 | 4096 x 1 (300ns) | 3.95 |
| TMS4044-2 | 4096 x 1 (200ns) | 4.45 |
| MK4118 | 1024 x 8 (250ns) | 9.90 |
| TMM2016-200 | 2048 x 8 (200ns) | 4.10 |
| TMM2016-150 | 2048 x 8 (150ns) | 4.90 |
| TMM2016-100 | 2048 x 8 (100ns) | 6.10 |
| MM6116-4 | 2048 x 8 (200ns) (comes) | 4.70 |
| MM6116-3 | 2048 x 8 (150ns) (comes) | 4.80 |
| MM6116-2 | 2048 x 8 (120ns) (comes) | 5.80 |
| MM6116LP-4 | 2048 x 8 (200ns) (comes) (LP) | 8.00 |
| MM6116LP-3 | 2048 x 8 (150ns) (comes) (LP) | 6.80 |
| MM6116LP-2 | 2048 x 8 (120ns) (comes) (LP) | 9.85 |
| Z-6132 | 4096 x 8 (300ns) (Qstat) | 33.85 |

LP = Low Power Qstat = Quasi-Static

DYNAMIC RAMS

| | | |
|----------|------------------------|------|
| TMS4027 | 4096 x 1 (250ns) | 1.85 |
| UPD411 | 4096 x 1 (300ns) | 2.95 |
| MM5280 | 4096 x 1 (300ns) | 2.95 |
| MK4108 | 8192 x 1 (200ns) | 1.90 |
| MM5288 | 8192 x 1 (250ns) | 1.80 |
| 4116-250 | 16384 x 1 (250ns) | .88 |
| 4116-200 | 16384 x 1 (200ns) | .88 |
| 4116-150 | 16384 x 1 (150ns) | 1.20 |
| 2110 | 16384 x 1 (150ns) (5v) | 4.90 |
| 4164-250 | 65536 x 1 (250ns) | 4.46 |
| 4164-200 | 65536 x 1 (200ns) (5v) | 5.46 |
| 4164-150 | 65536 x 1 (150ns) (5v) | 6.46 |

5V = Single 5 Volt Supply

EPROMS

| | | |
|----------|--------------------------------|-------|
| 1702 | 256 x 8 (1us) | 4.46 |
| 2708 | 1024 x 8 (450ns) | 2.49 |
| 2758 | 1024 x 8 (450ns) | 2.48 |
| 2758 | 1024 x 8 (450ns) (5v) | 5.90 |
| 2715 | 2048 x 8 (450ns) (5v) | 2.95 |
| 2716-1 | 2048 x 8 (350ns) (5v) | 5.90 |
| TMS2516 | 2048 x 8 (450ns) (5v) | 5.45 |
| TMS2716 | 2048 x 8 (450ns) (5v) | 7.90 |
| TMS2532 | 4096 x 8 (450ns) (5v) | 5.90 |
| 2732 | 4096 x 8 (450ns) (5v) | 3.95 |
| 2732-250 | 4096 x 8 (250ns) (5v) | 8.80 |
| 2732-200 | 4096 x 8 (200ns) (5v) | 10.95 |
| 2784 | 8192 x 8 (450ns) (5v) | 5.95 |
| 2784-250 | 8192 x 8 (250ns) (5v) | 13.95 |
| 2784-200 | 8192 x 8 (200ns) (5v) | 23.95 |
| TMS2564 | 8192 x 8 (450ns) (5v) | 16.95 |
| M68764 | 8192 x 8 (450ns) (5v) (24 pin) | 38.95 |
| 27128 | 16384 x 8 (5v) Call | 19.95 |

5v = Single 5 Volt Supply

74LS00

| | | | |
|--------|------|---------|------|
| 74LS00 | .23 | 74LS92 | .54 |
| 74LS01 | .24 | 74LS93 | .54 |
| 74LS02 | .24 | 74LS95 | .74 |
| 74LS03 | .24 | 74LS96 | .88 |
| 74LS04 | .23 | 74LS107 | .38 |
| 74LS05 | .24 | 74LS109 | .38 |
| 74LS08 | .27 | 74LS112 | .38 |
| 74LS09 | .28 | 74LS113 | .38 |
| 74LS10 | .24 | 74LS114 | .38 |
| 74LS11 | .34 | 74LS122 | .44 |
| 74LS12 | .34 | 74LS123 | .78 |
| 74LS13 | .44 | 74LS124 | 2.85 |
| 74LS14 | .58 | 74LS125 | .48 |
| 74LS15 | .34 | 74LS126 | .48 |
| 74LS20 | .24 | 74LS132 | .58 |
| 74LS21 | .28 | 74LS133 | .58 |
| 74LS22 | .24 | 74LS136 | .38 |
| 74LS26 | .28 | 74LS137 | .98 |
| 74LS27 | .28 | 74LS138 | .54 |
| 74LS28 | .34 | 74LS139 | .54 |
| 74LS30 | .24 | 74LS145 | 1.15 |
| 74LS32 | .28 | 74LS147 | 2.45 |
| 74LS33 | .54 | 74LS148 | 1.30 |
| 74LS37 | .34 | 74LS151 | .54 |
| 74LS38 | .34 | 74LS153 | .54 |
| 74LS40 | .24 | 74LS154 | 1.85 |
| 74LS42 | .48 | 74LS155 | .68 |
| 74LS47 | .74 | 74LS156 | .68 |
| 74LS48 | .74 | 74LS157 | .64 |
| 74LS49 | .74 | 74LS158 | .58 |
| 74LS51 | .24 | 74LS160 | .68 |
| 74LS54 | .28 | 74LS161 | .64 |
| 74LS55 | .28 | 74LS162 | .68 |
| 74LS63 | 1.20 | 74LS163 | .64 |
| 74LS73 | .38 | 74LS164 | .68 |
| 74LS74 | .34 | 74LS165 | .94 |
| 74LS75 | .38 | 74LS166 | 1.90 |
| 74LS76 | .38 | 74LS168 | 1.70 |
| 74LS78 | .48 | 74LS169 | 1.70 |
| 74LS83 | .59 | 74LS170 | 1.45 |
| 74LS85 | .68 | 74LS173 | .58 |
| 74LS86 | .38 | 74LS174 | .64 |
| 74LS90 | .54 | 74LS175 | .54 |
| 74LS91 | .88 | 74LS181 | 2.10 |

| | | | |
|---------|------|----------|-------|
| 74LS189 | 8.90 | 74LS363 | 1.30 |
| 74LS190 | .88 | 74LS364 | 1.90 |
| 74LS191 | .88 | 74LS365 | .48 |
| 74LS192 | .78 | 74LS366 | .48 |
| 74LS193 | .68 | 74LS367 | .44 |
| 74LS194 | .88 | 74LS368 | .44 |
| 74LS195 | .68 | 74LS373 | 1.35 |
| 74LS196 | .78 | 74LS374 | 1.35 |
| 74LS197 | .78 | 74LS377 | 1.35 |
| 74LS221 | .88 | 74LS378 | 1.13 |
| 74LS240 | .94 | 74LS379 | 1.30 |
| 74LS241 | .98 | 74LS385 | 1.85 |
| 74LS242 | .98 | 74LS386 | .44 |
| 74LS243 | .98 | 74LS390 | 1.15 |
| 74LS244 | 1.25 | 74LS393 | 1.15 |
| 74LS245 | 1.45 | 74LS395 | 1.15 |
| 74LS247 | .74 | 74LS399 | 1.45 |
| 74LS248 | .98 | 74LS424 | 2.90 |
| 74LS249 | .98 | 74LS447 | .36 |
| 74LS251 | .58 | 74LS490 | 1.90 |
| 74LS253 | .58 | 74LS624 | 3.95 |
| 74LS257 | .58 | 74LS640 | 2.15 |
| 74LS258 | .58 | 74LS645 | 2.15 |
| 74LS259 | 2.70 | 74LS668 | 1.65 |
| 74LS260 | .58 | 74LS669 | 1.85 |
| 74LS266 | .54 | 74LS670 | 1.45 |
| 74LS273 | 1.45 | 74LS674 | 9.60 |
| 74LS275 | 3.30 | 74LS682 | 3.15 |
| 74LS279 | .48 | 74LS683 | 3.15 |
| 74LS280 | 1.95 | 74LS684 | 3.15 |
| 74LS283 | .68 | 74LS685 | 3.15 |
| 74LS290 | .88 | 74LS688 | 2.35 |
| 74LS293 | .88 | 74LS889 | 3.15 |
| 74LS295 | .98 | 74LS783 | 23.95 |
| 74LS298 | .88 | 81LS95 | 1.45 |
| 74LS299 | 1.70 | 81LS96 | 1.45 |
| 74LS323 | 3.45 | 81LS97 | 1.45 |
| 74LS324 | 1.70 | 81LS98 | 1.45 |
| 74LS352 | 1.25 | 25LS2521 | 2.75 |
| 74LS353 | 1.25 | 25LS2569 | 4.20 |

6500 1 MHZ

| | |
|------|-------|
| 6502 | 4.90 |
| 6504 | 6.90 |
| 6505 | 8.90 |
| 6507 | 9.90 |
| 6520 | 4.30 |
| 6522 | 6.90 |
| 6532 | 9.90 |
| 6545 | 21.50 |
| 6551 | 10.85 |

2 MHZ

| | |
|-------|-------|
| 6502A | 6.90 |
| 6522A | 9.90 |
| 6532A | 10.85 |
| 6545A | 26.95 |
| 6551A | 10.95 |

3 MHZ

| | |
|-------|------|
| 6502B | 9.90 |
|-------|------|

6800

| | |
|-------|-------|
| 68000 | 58.95 |
| 6800 | 3.90 |
| 6802 | 7.90 |
| 6808 | 12.90 |
| 6809E | 18.95 |
| 6809 | 10.95 |
| 6810 | 2.90 |
| 6820 | 4.30 |
| 6821 | 3.20 |
| 6828 | 13.95 |
| 6840 | 11.95 |
| 6843 | 33.95 |
| 6844 | 24.95 |
| 6845 | 13.95 |
| 6847 | 10.95 |
| 6850 | 3.20 |
| 6852 | 15.70 |
| 6860 | 9.90 |
| 6862 | 10.95 |
| 6875 | 6.90 |
| 6880 | 2.20 |
| 6883 | 21.95 |
| 68047 | 23.95 |
| 68488 | 18.95 |

6800 1MHZ

| | |
|--------|-------|
| 68B00 | 9.95 |
| 68B02 | 21.25 |
| 68B09E | 28.95 |
| 68B09 | 28.95 |
| 68B10 | 6.90 |
| 68B21 | 6.90 |
| 68B45 | 18.95 |
| 68B50 | 5.90 |

8000

| | |
|----------|-------|
| 8035 | 5.90 |
| 8039 | 6.90 |
| INS-8060 | 16.95 |
| INS-8073 | 49.95 |
| 8080 | 3.90 |
| 8085 | 5.90 |
| 8085A-2 | 10.95 |
| 8086 | 28.95 |
| 8087 | CALL |
| 8088 | 38.95 |
| 8089 | 88.95 |
| 8155 | 6.90 |
| 8155-2 | 7.90 |
| 8156 | 6.90 |
| 8165 | 28.95 |
| 8185-2 | 38.95 |
| 8741 | 38.95 |
| 8748 | 49.95 |
| 8755 | 23.95 |

8200

| | |
|--------|-------|
| 8202 | 23.95 |
| 8203 | 38.95 |
| 8205 | 3.45 |
| 8212 | 1.75 |
| 8214 | 3.80 |
| 8216 | 1.70 |
| 8224 | 2.20 |
| 8228 | 1.75 |
| 8228 | 3.45 |
| 8237 | 18.95 |
| 8237-5 | 20.95 |
| 8238 | 4.45 |
| 8243 | 10.95 |
| 8250 | 18.95 |
| 8251 | 4.45 |
| 8253 | 8.90 |
| 8255 | 14.95 |
| 8255-5 | 18.95 |
| 8257 | 7.90 |
| 8257-5 | 8.90 |
| 8259 | 8.85 |
| 8259-5 | 7.45 |
| 8271 | 38.95 |
| 8272 | 38.95 |
| 8275 | 28.95 |
| 8279 | 9.90 |
| 8279-5 | 9.00 |
| 8283 | 6.45 |
| 8284 | 14.95 |
| 8286 | 6.45 |
| 8287 | 6.45 |
| 8288 | 24.00 |
| 8289 | 48.95 |

Z-80 2.5 MHZ

| | |
|-----------|-------|
| Z80-CPU | 3.90 |
| Z80-CTC | 3.95 |
| Z80-DART | 10.95 |
| Z80-DMA | 13.95 |
| Z80-PIO | 3.95 |
| Z80-SIO/0 | 11.95 |
| Z80-SIO/1 | 11.95 |
| Z80-SIO/2 | 11.95 |
| Z80-SIO/9 | 11.95 |

4.0 MHZ

| | |
|------------|-------|
| Z80A-CPU | 4.29 |
| Z80A-CTC | 4.90 |
| Z80A-DART | 9.95 |
| Z80A-DMA | 12.95 |
| Z80A-PIO | 4.29 |
| Z80A-SIO/0 | 12.95 |
| Z80A-SIO/1 | 12.95 |
| Z80A-SIO/2 | 12.95 |
| Z80A-SIO/9 | 12.95 |

6.0 MHZ

| | |
|-----------|-------|
| Z80B-CPU | 9.95 |
| Z80B-CTC | 12.95 |
| Z80B-PIO | 12.95 |
| Z80B-DART | 12.95 |

ZILOG

| | |
|-------|-------|
| Z6132 | 33.95 |
| Z6671 | 38.95 |

DISC CONTROLLERS

| | |
|--------|-------|
| 1771 | 15.95 |
| 1791 | 23.95 |
| 1793 | 25.95 |
| 1795 | 48.95 |
| 1797 | 48.95 |
| 2791 | 53.95 |
| 2793 | 53.95 |
| 2795 | 58.95 |
| 2797 | 58.95 |
| 6843 | 33.95 |
| 8272 | 36.95 |
| UPD765 | 36.95 |
| MB8876 | 28.95 |
| MB8877 | 33.95 |
| 1691 | 16.95 |
| 2143 | 17.95 |

UARTS

| | |
|----------|------|
| AY3-1014 | 6.90 |
| AY5-1013 | 3.90 |
| AY3-1015 | 6.90 |
| PT-1472 | 9.90 |
| TR1602 | 3.90 |
| 2350 | 9.90 |
| 2651 | 6.90 |
| TMS8011 | 6.90 |
| IMS402 | 7.90 |
| IMS403 | 6.90 |
| INS8250 | 9.95 |

INTERFACE

| | |
|--------|------|
| 8T26 | 1.54 |
| 8T28 | 1.84 |
| 8T95 | .88 |
| 8T96 | .88 |
| 8T97 | .88 |
| 8T98 | .88 |
| DM8131 | 2.90 |
| DP8304 | 2.24 |
| DS8835 | 1.94 |
| DS8836 | .98 |

VOLTAGE REGULATORS

| | | | |
|--------|------|---------|------|
| 7805T | .74 | 7905T | .84 |
| 78M05C | .34 | 7908T | .84 |
| 7808T | .74 | 7912T | .84 |
| 7812T | .74 | 7915T | .84 |
| 7815T | .74 | 7924T | .84 |
| 7824T | .74 | 7905K | 1.44 |
| 7805K | 1.34 | 7912K | 1.44 |
| 7812K | 1.34 | 7915K | 1.44 |
| 7815K | 1.34 | 7924K | 1.44 |
| 7824K | 1.34 | 79L05 | .78 |
| 78L05 | .68 | 79L12 | .78 |
| 78L12 | .68 | 79L15 | .78 |
| 78L15 | .68 | LM323K | 4.90 |
| 78H05K | 9.90 | UA78S40 | 1.90 |
| 78H12K | 9.90 | | |

C, T = TO-220 K = TO-3 L = TO-92

DIP SWITCHES

| | |
|------------|-----|
| 4 POSITION | .84 |
| 5 POSITION | .89 |
| 6 POSITION | .89 |
| 7 POSITION | .94 |
| 8 POSITION | .94 |

IC SOCKETS

| | | |
|-----------|------|------|
| 8 pin ST | .12 | .10 |
| 14 pin ST | .14 | .11 |
| 16 pin ST | .16 | .12 |
| 18 pin ST | .17 | .17 |
| 20 pin ST | .28 | .26 |
| 22 pin ST | .28 | .26 |
| 24 pin ST | .29 | .28 |
| 28 pin ST | .36 | .31 |
| 40 pin ST | .48 | .38 |
| 84 pin ST | 4.20 | call |

ST = SOLDERTAIL

| | | |
|-----------|------|------|
| 8 pin WW | .58 | .48 |
| 14 pin WW | .68 | .51 |
| 16 pin WW | .68 | .57 |
| 18 pin WW | .98 | .89 |
| 20 pin WW | 1.04 | .97 |
| 22 pin WW | 1.34 | 1.23 |
| 24 pin WW | 1.44 | 1.30 |
| 28 pin WW | 1.84 | 1.44 |
| 40 pin WW | 1.94 | 1.75 |

WW = WIREWRAP

| | |
|------------|------|
| 16 pin ZIF | 5.90 |
| 24 pin ZIF | 7.90 |
| 28 pin ZIF | 8.90 |

ZIF = TEXTTOOL (Zero Insertion Force)

CRYSTALS

| | |
|-----------|------|
| 32.768khz | 1.89 |
| 1.0 mhz | 3.69 |
| 1.8432 | 3.69 |
| 2.0 | 2.69 |
| 2.097152 | 2.69 |
| 2.4576 | 2.69 |
| 3.2768 | 2.69 |
| 3.579535 | 2.69 |
| 4.0 | 2.69 |
| 5.0 | 2.69 |
| 5.0688 | 2.69 |
| 5.185 | 2.69 |
| 5.7143 | 2.69 |
| 6.0 | 2.69 |
| 6.144 | 2.69 |
| 6.5536 | 2.69 |
| 8.0 | 2.69 |
| 10.0 | 2.69 |
| 10.738635 | 2.69 |
| 14.31818 | 2.69 |
| 15.0 | 2.69 |
| 16.0 | 2.69 |
| 17.430 | 2.69 |
| 18.0 | 2.69 |
| 18.432 | 2.69 |
| 20.0 | 2.69 |
| 22.1184 | 2.69 |
| 32.0 | 2.69 |

RESISTORS

1/4 WATT 5% CARBON FILM, ALL STANDARD VALUES FROM 1 OHM TO 10 MEG OHM

| | |
|----------|-------|
| 50 pcs | 1.25 |
| 100 pcs | 2.00 |
| 1000 pcs | 15.00 |

5 1/4" DISKETTES ATHANA

| | |
|------|-------|
| 888D | 18.95 |
| 88DD | 22.95 |
| D8DD | 27.95 |

BULK DISKETTES 5 1/4" DISKETTES NO LABEL

SINGLE SIDED DOUBLE DENSITY
(WITH JACKETS AND HUB RING)

| | |
|-------------|----------|
| Pack of Ten | \$ 16.95 |
| Pack of 100 | \$149.00 |

SPRING SPECIALS

| | | |
|------|-------|--------|
| 4116 | 250ns | 49¢/ea |
| 4116 | 200ns | 89¢/ea |

| | | |
|-------|-------------|-------|
| 2708 | 8K EPROMS | 2.49 |
| 2716 | 16K EPROMS | 2.95 |
| 2732 | 32K EPROMS | 3.95 |
| 2764 | 64K EPROMS | 5.95 |
| 27128 | 128K EPROMS | 19.95 |

| | | |
|------|-------------------|------|
| 4164 | 64K DYNAMIC 250ns | 4.45 |
|------|-------------------|------|

| | | |
|------|-------------------|------|
| 4164 | 64K DYNAMIC 200ns | 5.45 |
|------|-------------------|------|

| | | |
|------|-------------------|------|
| 4164 | 64K DYNAMIC 150ns | 6.45 |
|------|-------------------|------|

| | | |
|------|-------|--------|
| 2114 | 450ns | 8/7.95 |
|------|-------|--------|

QUV-T8/1 EPROM Eraser

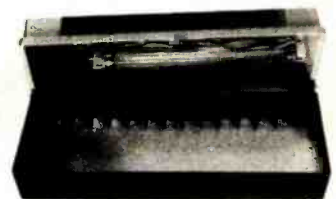

\$57.95

QUV-T8/1 Economy Model: This is a low cost EPROM Eraser housed in a plastic enclosure. The UV element and components are installed in the top lid and you place the EPROMS in the bottom half. No timer or switch option is included.

- Erases up to 8 EPROMS in 15 to 20 minutes.
- 12,000 u Watts at 1" distance.
- 90-Day Warranty

Do Kay

2100 De La Cruz Blvd.
Santa Clara, CA 95050

SANYO 1150 CP/M® COMPUTER, LETTER QUALITY PRINTER, MICROPRO SOFTWARE, AND MORE!!!

\$1795



BDPDBSY01
(Shipped in two boxes:
35 lbs., and 25 lbs.)

Hardware

- SANYO PR5000 12 cps Letter Quality Printer with Cable
- SANYO MBC1150 Creative Computer
- Z-80A CPU with 64K Memory
- Two Double-Sided/Double-Density 5 1/4" Disk Drives (620K Bytes Total Formatted Capacity)
- 12" Green Screen Display (80 Characters by 25 Lines)
- Detachable Keyboard
- One Centronics Printer Port
- One RS-232 Serial Port

Software

- 6 MicroPro Software Programs:
 - WordStar® • MailMerge® • SpellStar®
 - CalcStar® • DataStar® • ReportStar®
- SANYO Enhanced BASIC with Graphics and CP/M 2.2® Operating System (Complete with Interpreter, Editor, and All Utilities!)
- **Exclusive Priority One Software Enhancements To Make Getting Started Even EASIER!!**

SANYO MS-DOS™ Computer with Color RGB Monitor, Printer, and MicroPro Software

Hardware
SANYO MDC555

- 16 Bit 8088 CPU
- Socketed for Optional 8087 MPU
- Expandable to 256K RAM
- Centronics Printer Port
- 2 Single Sided Disk Drives (160K Bytes Each)
- 10 Programmable Function Keys
- Speaker and Joystick Port

Software

- MS-DOS™ Operating system
- SANYO BASIC

MicroPro Software:

- WordStar® • ReportStar®
- SpellStar® • InfoStar®
- CalcStar® • MailMerge®
- DataStar®

With Medium Resolution RGB Color Monitor, Star Gemini 10X 120 cps Dot Matrix Printer with Printer and Monitor Cables
Total Value: \$2338.90

\$1695

BDPDBSY0650M555
(Shipping weights on above items: 3 boxes: 30 lbs., 30 lbs., and 20 lbs.)

With High Resolution RGB Color Monitor, Star Gemini 10X 120 cps Dot Matrix Printer, with Printer and Monitor Cables
Total Value: \$2568.90

\$1849

BDPDBSY0750M555



Runs Many Off-The-Shell Programs for IBM-PC™

SOFTWARE **The Best Sellers At The Best Prices!**

IBM PC/MS™ DOS™ 5 1/4" FORMAT

| Part Number | Description | SALE PRICE |
|--------------|--|-----------------|
| BDASTDBIM | ASHTON-TATE - dBASE II | \$389.00 |
| BDMPRPROPAK | MICRO-PRO - WordStar professional, includes WordStar, Mail-Merge, SpellStar & Star Index | \$425.00 |
| BDMSFMLTPLM | MICROSOFT - Multiplan | \$169.00 |
| BD SWSMATEI | SOFTWORD SYS. - Multimate | \$299.00 |
| BDASTFRIDAYI | ASHTON-TATE - Friday! | \$189.00 |
| BD OASTYWDI | LIFETREE - Volkswriter Deluxe | \$189.00 |
| BD SORSRC3I | SORCIM - SuperCalc III | \$249.00 |
| BD MCRBASEI | MICRORIM - R:Base | \$319.00 |

| Part Number | Description | SALE PRICE |
|---------------|--|-----------------|
| BDSTSTARPARI | STAR SOFTWARE - Star Partner | \$249.00 |
| BD WLFMOVI | WOOLF SOFTWARE - Move-It | \$ 89.00 |
| BDHARPJMORI | HARVARD SOFTWARE - Harvard Project Manager | \$249.00 |
| BD SWPCENAI | SOFTWARE PRODUCTS, INT. - Open Access | \$369.00 |
| BD SMC1040TXI | SUCCESS MGT. CONSULTANT - Model: 1040 Tax (Requires Micro-Soft MBASIC) | \$119.00 |
| BDMSFRASB01 | MICROSOFT - MBASIC | \$219.00 |

CP/M-80™ 8 BIT 8" SSSD FORMAT

| Part Number | Description | SALE PRICE |
|--------------|---|-----------------|
| BD DIRC80 | DIGITAL RESEARCH - CBASIC 80 | \$ 99.00 |
| BD LEXSPBND | LEXISOFT - Spellbinder | \$259.00 |
| BD SORSRC280 | SORCIM - SuperCalc II | \$179.00 |
| BDMPRPROPAK | MICROPRO - WordStar Professional (Includes WordStar, SpellStar, Mail-Merge, and Star Index) | \$399.00 |
| BD MCSRSTLK | MICROSTUFF - Crosstalk | \$119.00 |
| BDMSFRASB0 | MICROSOFT - MBASIC | \$219.00 |

| Part Number | Description | SALE PRICE |
|---------------|---|-----------------|
| BD FXG0C80 | FOX & GELLER - Quickcode | \$179.00 |
| BDSTSTARPAR80 | STAR SOFTWARE SYST. - Star Partner | \$249.00 |
| BDASTDB80 | ASHTON-TATE - dBASE II | \$389.00 |
| BDASTFRIDAY8 | ASHTON-TATE - Friday! | \$189.00 |
| BDMSFMLTPLM | MICROSOFT - Multiplan | \$169.00 |
| BD SMC1040TX8 | SUCCESS MGT. CONSULTANTS - Model: 1040 Tax (Requires Micro-Soft MBASIC) | \$119.00 |

APPLE CP/M® & DOS™ FORMAT

| Part Number | Description | SALE PRICE |
|---------------|---|-----------------|
| BDASTDB80A | ASHTON-TATE - dBASE II | \$389.00 |
| BDMPRWDSTRZA | MICROPRO - WordStar 3.3 w/6MHz Z80 Card, 64K RAM, & CP/M 3.0* | \$299.00 |
| BDMSFMLTPLM | MICROSOFT - Multiplan | \$169.00 |
| BDMSF357760 | MICROSOFT - Softcard Premium Iie (Z80A, 64K, & CP/M™, MBASIC) | \$299.00 |
| BD LEXSPBND A | LEXISOFT - Spellbinder | \$229.00 |

| Part Number | Description | SALE PRICE |
|---------------|--|-----------------|
| BD OASWDPLUSA | OASIS - Word PLUS | \$ 99.00 |
| BDMPRPROPAKPA | MICROPRO - Prof. Optional Pack (Includes MailMerge, SpellStar, and Star Index) | \$189.00 |
| BD WLFMOVA | WOOLF SOFTWARE - Move-It | \$89.00 |
| BD SMC1040TXA | SUCCESS MGT. CONSULTANT - Model: 1040 Tax | \$119.00 |
| BD BRDBNKWRA | BRODERBUND - Bank Street Writer | \$ 49.00 |

DRIVES & ENCLOSURES

5 1/4" FLOPPY DISK DRIVES

| | | |
|-------------|-----------------------------------|----------|
| 00MFM1* | MPI Full Height SS 48TPI (5 lbs.) | \$266.00 |
| 00MFM2* | MPI Full Height DS 48TPI (5 lbs.) | \$276.00 |
| 00MFM1* | MPI Full Height SS 96TPI (5 lbs.) | \$276.00 |
| 00MFM2* | MPI Full Height DS 96TPI (5 lbs.) | \$406.00 |
| 00MFM01 | MPI 1/2-Height SS 48TPI (4 lbs.) | \$266.00 |
| 00MFM02 | MPI 1/2-Height DS 48TPI (4 lbs.) | \$306.00 |
| 00TNDTM1001 | Tandon Full Height SS 48TPI | \$196.00 |
| 00TNDTM1002 | Tandon Full Height DS 48TPI | \$246.00 |
| 00TNDTM1014 | Tandon Full Height DS 96TPI | \$336.00 |

* Replace with ■ for MPI Door, or ■ for Shugart SA400 Type Door

5 1/4" Disk Drive Cabinets

| | | |
|------------|-------------------------------------|----------|
| 00JMR1CS | Single Drive Cabinet (5 lbs.) | \$ 79.00 |
| 00JMR2CS | Dual Drive Cabinet (9 lbs.) | \$ 99.00 |
| 00JMR2CS C | Dual w/Internal Data Cable (9 lbs.) | \$116.00 |

8" Floppy Disk Drives

| | | |
|-----------------|-------------------------------------|----------|
| 00SH0001B | Shugart Full Height SS (18 lbs.) | \$346.00 |
| 00SH0001D | Shugart Full Height DS (18 lbs.) | \$476.00 |
| 00SHEF01000 | Siemens Full Height SS (18 lbs.) | \$149.00 |
| 00QMETRA0342 | Qume Full Height DS (18 lbs.) | \$406.00 |
| 00MITSUBI00463B | Mitsubishi Full Height DS (18 lbs.) | \$376.00 |
| 00MP41S | MPI Full Height SS (11 lbs.) | \$306.00 |
| 00MP42S | MPI Full Height DS (11 lbs.) | \$406.00 |
| 00MP41D | MPI Dual 1/2-Height SS (22 lbs.) | \$796.00 |
| 00MP42D | MPI Dual 1/2-Height DS (22 lbs.) | \$836.00 |
| 00MP41M | MPI 1/2-Height SS (9 lbs.) | \$306.00 |
| 00MP42M | MPI 1/2-Height DS (9 lbs.) | \$406.00 |
| 00TNDTM0401 | Tandon 1/2-Height SS (9 lbs.) | \$306.00 |
| 00TNDTM0402 | Tandon 1/2-Height DS (9 lbs.) | \$436.00 |



Dual 8" Disk Enclosures

All of these rugged enclosures feature forced, filtered air cooling, hefty power supply, with the heat producing elements mounted to outside for cool, reliable operation. The rear panels are punched for the appropriate data cables.

FDE02. Economical design for two standard size 8" floppies. Hinged lid for easy drive access. Power supply: 5V@4A, -5V@.8A, +24@3A.
DTL02. Cabinet for two 1/2-height 8" drives or 1 full height 8" floppy or Winchester. Includes Shugart type AC power cable.

| Part Number | Description | List Price | SALE Price |
|-----------------|---------------------------------|------------|------------|
| 00IIFDE02 | FDE002 Dual Enc. (35 lbs.) | \$359.95 | \$329.00 |
| 00DTL020200 | DTL002 Dual Thin Line (12 lbs.) | \$225.00 | \$176.00 |
| 00IIFTL02KIT | MPI 1/2-Height DTL adapter kit | \$ 24.00 | |
| 00IIC0LS00304FM | Shugart to Qume AC Cable | \$ 4.00 | |

BUY CABINETS WITH DRIVES AND SAVE! Combinations with FDE002

| | | |
|---------------|------------------------|-----------|
| 00PDBIIFDE2S2 | w/2 SHU801R Drives | \$ 600.00 |
| 00PDBIIFDE2M2 | w/2 MFM289463BS Drives | \$1040.00 |
| 00PDBIIFDE2Q2 | w/2 QMETRAK842 Drives | \$1100.00 |
| 00PDBIIFDE2S1 | w/2 SHU851R Drives | \$1230.00 |
| 00PDBIHS2E | w/2FDD1008 Drives | \$ 400.00 |

Combinations with DTL002

| | | |
|------------|----------------------|-----------|
| 00PDBIHT01 | w/2 TNDTM8481 Drives | \$ 670.00 |
| 00PDBIHT02 | w/2 TNDTM8482 Drives | \$1030.00 |
| 00PDBIIMP1 | w/2 MP41M Drives | \$ 670.00 |
| 00PDBIIMP2 | w/2 MP42M Drives | \$1030.00 |

Due to UPS regulations, drives and cabinets will be shipped separately. Please include shipping for each disk drive and cabinet.

5 1/4" Hard Disk

| | | |
|------------|-----------------------------------|-----------|
| 00MCP1302 | Micropolis 20.4/25.9 Mb (12 lbs.) | \$1400.00 |
| 00MCP1303 | Micropolis 33.9/43.2 Mb (12 lbs.) | \$1676.00 |
| 00TNDTM001 | Tandon 6 Mb (9 lbs.) | \$ 600.00 |
| 00TNDTM002 | Tandon 12 Mb (9 lbs.) | \$ 640.00 |
| 00TNDTM003 | Tandon 19 Mb (9 lbs.) | \$ 600.00 |

DUAL 5 1/4" HARD DISK DRIVE CABINET

All of the necessary power for two TANDON TM500 series or equivalent hard disk drives. Just imagine, you can have 100Mbytes of storage using two of the Micropolis 5 1/4" Winchester disk drives and this cabinet! Power supply: +5V@6A and +12V@6A. The rear panel is punched for two 20, two 34, and one 50 pin header connector. Fan cooled.
 00IHS0002 Dual Hard Disk Enclosure (Sh. Wt. 20 lbs.) \$300.00

BUY CABINET WITH DRIVES AND SAVE!

| | | |
|--------------|--------------------|-----------|
| 00PDB001000 | w/2 TM501 Drives | \$1000.00 |
| 00PDB002000 | w/2 TM502 Drives | \$1000.00 |
| 00PDB003000 | w/2 TM503 Drives | \$2140.00 |
| 00PDB1302000 | w/2 MCP1302 Drives | \$2900.00 |
| 00PDB1303000 | w/2 MCP1303 Drives | \$3700.00 |
| 00PDB1304000 | w/2 MCP1304 Drives | \$4300.00 |

Due to UPS regulations, disk drives will be shipped separately from cabinets. Don't forget to include shipping for each disk drive cabinet.

ADD ON DRIVES FOR IBM PC™

EPSON



JMR



Tandon

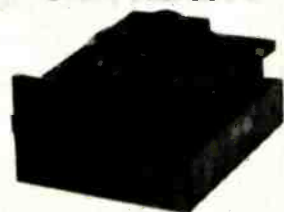

HALF HEIGHT
5 1/4" 40 TRACK 48 TPI

5 1/4" FLOPPY CABINET
Holds 2 Half- or 1 Full-Height
Drive - Power Supply Included

TM100-2 FULL HEIGHT
5 1/4" 40 TRACK 48 TPI

DOUBLE SIDED
\$189
00EPM021
(Sh. Wt. 4 lbs.)

\$69
00JMR2376
(Sh. Wt. 7 lbs.)

\$219 DOUBLE SIDED
00TNDTM1002
(Sh. Wt. 4 lbs.)



International
Instrumentation
Incorporated

MICROPOLIS

UP TO 104M BYTES IN ONE CABINET!



52M Byte Drive In A
Single Drive Cabinet
\$2295.00
00PDB1304H01

Two 52M Byte Drives In A
Dual Drive Cabinet
\$4390.00
00PDB1304H05

SIEMENS



FDD1008
8" Drive
Single Sided
Double Density

\$149.00 each

DUAL SIEMENS FDD1008s
With IIFDE002 Cabinet

\$499.00

00PDBIHSIE

NOW! The Affordable UPS
For Your Personal Computer!
\$359.00



200 Watts For 5 Minutes of Uninterruptable Power With
AC Surge and EMI/RFI Filtering Built-In!
Perfect for Morrow Micro Decision, IBM PC™, Apple IIe,
and many, many more!
00PTPC200 (Sh. Wt. 21 lbs.) **\$359.00**

Circle 301 on inquiry card.



PRIORITY



ELECTRONICS



9161 Deering Ave., Chatsworth, CA 91311-5887

ORDER TOLL FREE (800) 423-5922 - CA, AK, HI CALL (818) 709-5111

Terms: U.S. VISA, MC, BAC, Check, Money Order, U.S. Funds Only. CA residents add 6 1/2% Sales Tax. MINIMUM PREPAID ORDER \$15.00. Include MINIMUM SHIPPING & HANDLING of \$3.00 for the first 3 lbs. plus 40¢ for each additional pound. Orders over 70 lbs. sent freight collect. Just in case, include your phone number. Prices subject to change without notice. We will do our best to maintain prices through April, 1984. Credit card orders will be charged appropriate freight. We are not responsible for typographical errors. Sale prices for prepaid orders only.

ORDER TOLL FREE (800) 423-5922 - CA, AK, HI CALL (818) 709-5111

4164

64K DYNAMIC
200 NS

\$595

TMM2016

2KX8 STATIC
200 NS

\$415

STATIC RAMS

| | | |
|-------------|-----------------------------|---------|
| 2101 | 256 x 4 (450ns) | 1.95 |
| 5101 | 256 x 4 (450ns) (cmos) | 3.95 |
| 2102-1 | 1024 x 1 (450ns) | .89 |
| 2102L-4 | 1024 x 1 (450ns) (LP) | .99 |
| 2102L-2 | 1024 x 1 (250ns) (LP) | 1.49 |
| 2111 | 256 x 4 (450ns) | 2.49 |
| 2112 | 256 x 4 (450ns) | 2.99 |
| 2114 | 1024 x 4 (450ns) | 8/9.95 |
| 2114-25 | 1024 x 4 (250ns) | 8/10.95 |
| 2114L-4 | 1024 x 4 (450ns) (LP) | 8/12.95 |
| 2114L-3 | 1024 x 4 (300ns) (LP) | 8/13.45 |
| 2114L-2 | 1024 x 4 (200ns) (LP) | 8/13.95 |
| TC5514 | 1024 x 4 (650ns) (cmos) | 2.49 |
| TC5516 | 2048 x 8 (250ns) (cmos) | 9.95 |
| 2147 | 4096 x 1 (55ns) | 4.95 |
| TMS4044-4 | 4096 x 1 (450ns) | 3.49 |
| TMS4044-3 | 4096 x 1 (300ns) | 3.49 |
| TMS4044-2 | 4096 x 1 (200ns) | 4.49 |
| MK4118 | 1024 x 8 (200ns) | 9.95 |
| TMM2016-200 | 2048 x 8 (200ns) | 4.15 |
| TMM2016-150 | 2048 x 8 (150ns) | 4.95 |
| TMM2016-100 | 2048 x 8 (100ns) | 6.15 |
| HM6116-4 | 2048 x 8 (200ns) (cmos) | 4.75 |
| HM6116-3 | 2048 x 8 (150ns) (cmos) | 4.95 |
| HM6116-2 | 2048 x 8 (120ns) (cmos) | 8.95 |
| HM6116LP-4 | 2048 x 8 (200ns) (cmos)(LP) | 5.95 |
| HM6116LP-3 | 2048 x 8 (150ns) (cmos)(LP) | 6.95 |
| HM6116LP-2 | 2048 x 8 (120ns) (cmos)(LP) | 10.95 |
| Z-6132 | 4096 x 8 (300ns) (Qstat) | 34.95 |
| HM6264 | 8192 x 8 (150ns) (cmos) | 49.95 |

LP - Low Power Qstat - Quasi-Static

EPROMS

| | | |
|----------|---|-------|
| 1702 | 256 x 8 (1us) | 4.50 |
| 2708 | 1024 x 8 (450ns) | 3.95 |
| 2758 | 1024 x 8 (450ns) (5v) | 5.95 |
| 2716 | 2048 x 8 (450ns) (5v) | 3.95 |
| 2716-1 | 2048 x 8 (350ns) (5v) | 5.95 |
| TMS2516 | 2048 x 8 (450ns) (5v) | 5.50 |
| TMS2716 | 2048 x 8 (450ns) | 7.95 |
| TMS2532 | 4096 x 8 (450ns) (5v) | 5.95 |
| 2732 | 4096 x 8 (450ns) (5v) | 4.95 |
| 2732-250 | 4096 x 8 (250ns) (5v) | 8.95 |
| 2732-200 | 4096 x 8 (200ns) (5v) | 11.95 |
| 2732A-4 | 4096 x 8 (450ns) (5v) (21vPGM) | 6.95 |
| 2732A | 4096 x 8 (250ns) (5v) (21vPGM) | 9.95 |
| 2732A-2 | 4096 x 8 (200ns) (5v) (21vPGM) | 13.95 |
| 2764 | 8192 x 8 (450ns) (5v) | 6.95 |
| 2764-250 | 8192 x 8 (250ns) (5v) | 7.95 |
| 2764-200 | 8192 x 8 (200ns) (5v) | 19.95 |
| TMS2564 | 8192 x 8 (450ns) (5v) | 14.95 |
| MCM68764 | 8192 x 8 (450ns) (5v) (24 pin) | 39.95 |
| MCM68766 | 8192 x 8 (350ns) (5v) (24 pin)(pwr dn.) | 42.95 |
| 27128 | 16384 x 8 (300ns) (5v) | 29.95 |

5v - Single 5 Volt Supply 21vPGM - Program at 21 Volts

CRYSTALS

| | |
|------------|------|
| 32.768 khz | 1.95 |
| 1.0 mhz | 3.95 |
| 1.8432 | 3.95 |
| 2.0 | 2.95 |
| 2.097152 | 2.95 |
| 2.4576 | 2.95 |
| 3.2768 | 2.95 |
| 3.579545 | 2.95 |
| 4.0 | 2.95 |
| 5.0 | 2.95 |
| 5.0688 | 2.95 |
| 5.185 | 2.95 |
| 5.7143 | 2.95 |
| 6.0 | 2.95 |
| 6.144 | 2.95 |
| 6.5536 | 2.95 |
| 8.0 | 2.95 |
| 10.0 | 2.95 |
| 10.738635 | 2.95 |
| 14.31818 | 2.95 |
| 15.0 | 2.95 |
| 16.0 | 2.95 |
| 17.430 | 2.95 |
| 18.0 | 2.95 |
| 18.432 | 2.95 |
| 20.0 | 2.95 |
| 22.1184 | 2.95 |
| 32.0 | 2.95 |

CMOS

| | | | |
|-------|-------|--------|-------|
| 4000 | .29 | 4528 | 1.19 |
| 4001 | .25 | 4531 | .95 |
| 4002 | .25 | 4532 | 1.95 |
| 4006 | .89 | 4538 | 1.95 |
| 4007 | .29 | 4539 | 1.95 |
| 4008 | .95 | 4541 | 2.64 |
| 4009 | .39 | 4543 | 1.19 |
| 4010 | .45 | 4553 | 5.79 |
| 4011 | .25 | 4555 | .95 |
| 4012 | .25 | 4556 | .95 |
| 4013 | .38 | 4561 | 1.95 |
| 4014 | .79 | 4562 | 1.95 |
| 4015 | .39 | 4564 | .75 |
| 4016 | .39 | 4565 | .75 |
| 4017 | .69 | 4702 | 12.95 |
| 4018 | .79 | 74C00 | .35 |
| 4019 | .39 | 74C02 | .35 |
| 4020 | .75 | 74C04 | .35 |
| 4021 | .79 | 74C08 | .35 |
| 4022 | .79 | 74C10 | .35 |
| 4023 | .29 | 74C14 | .59 |
| 4024 | .65 | 74C20 | .35 |
| 4025 | .29 | 74C30 | .35 |
| 4026 | 1.65 | 74C32 | .39 |
| 4027 | .45 | 74C42 | 1.29 |
| 4028 | .69 | 74C48 | 1.99 |
| 4029 | .79 | 74C73 | .65 |
| 4030 | .39 | 74C74 | .65 |
| 4034 | 1.95 | 74C76 | .80 |
| 4035 | .85 | 74C83 | 1.95 |
| 4040 | .75 | 74C85 | 1.95 |
| 4041 | .75 | 74C86 | .39 |
| 4042 | .69 | 74C89 | 4.50 |
| 4043 | .85 | 74C90 | 1.19 |
| 4044 | .79 | 74C93 | 1.75 |
| 4046 | .85 | 74C95 | .99 |
| 4047 | .95 | 74C107 | .89 |
| 4049 | .35 | 74C150 | 5.75 |
| 4050 | .35 | 74C151 | 2.25 |
| 4051 | .79 | 74C154 | 3.25 |
| 4053 | .79 | 74C157 | 1.75 |
| 4060 | .89 | 74C160 | 1.19 |
| 4066 | .39 | 74C161 | 1.19 |
| 4068 | .39 | 74C162 | 1.19 |
| 4069 | .29 | 74C163 | 1.19 |
| 4070 | .35 | 74C164 | 1.39 |
| 4071 | .29 | 74C165 | 2.00 |
| 4072 | .29 | 74C173 | .79 |
| 4073 | .29 | 74C174 | 1.19 |
| 4075 | .29 | 74C175 | 1.19 |
| 4076 | .79 | 74C192 | 1.49 |
| 4078 | .29 | 74C193 | 1.49 |
| 4081 | .29 | 74C195 | 1.39 |
| 4082 | .29 | 74C200 | 5.75 |
| 4085 | .95 | 74C221 | 1.75 |
| 4086 | .95 | 74C244 | 2.25 |
| 4093 | .49 | 74C373 | 2.25 |
| 4098 | 2.49 | 74C374 | 2.45 |
| 4099 | 1.95 | 74C901 | .39 |
| 11C90 | 13.95 | 14A09 | 12.95 |
| 11C90 | 13.95 | 14A10 | 12.95 |
| 14411 | 11.95 | 74C905 | 10.95 |
| 14412 | 12.95 | 74C906 | .95 |
| 14419 | 7.95 | 74C907 | 1.00 |
| 14433 | 14.95 | 74C908 | 2.00 |
| 4502 | .95 | 74C909 | 2.75 |
| 4503 | .65 | 74C910 | 9.95 |
| 4508 | 1.95 | 74C911 | 8.95 |
| 4510 | .85 | 74C912 | 8.95 |
| 4511 | .85 | 74C914 | 1.95 |
| 4512 | .85 | 74C915 | 1.19 |
| 4514 | 1.25 | 74C918 | 2.75 |
| 4515 | 1.79 | 74C920 | 17.95 |
| 4516 | 1.55 | 74C921 | 15.95 |
| 4518 | .89 | 74C922 | 4.49 |
| 4519 | .39 | 74C923 | 4.95 |
| 4520 | .79 | 74C925 | 5.95 |
| 4522 | 1.25 | 74C926 | 7.95 |
| 4526 | 1.25 | 74C928 | 7.95 |
| 4527 | 1.95 | 74C929 | 19.95 |

★★★ HIGH-TECH ★★★

HITACHI HM6264 8K x 8 STATIC RAM

- Fast - 150 ns • +5V Supply
- 28 Pin - Compatible w/2764 EPROM
- Low Power CMOS (TTL Compatible)
- 200 mW Operation / .01 mW Standby (LP)

HM6264P-15 \$39.95 HM6264LP-15 \$49.95

★★★ SPOTLIGHT ★★★

- * Computer managed inventory - virtually no back orders!
- * Very competitive prices!
- * Friendly staff!
- * Fast service - most orders shipped within 24 hours!

UARTS

| | |
|----------|-------|
| AY3-1014 | 6.95 |
| AY5-1013 | 3.95 |
| AY3-1015 | 6.95 |
| PT1472 | 9.95 |
| TR1602 | 3.95 |
| 2350 | 9.95 |
| 2651 | 8.95 |
| IM6402 | 7.95 |
| IM6403 | 8.95 |
| INS6250 | 10.95 |

GENERATORS

| | |
|---------|-------|
| MC14411 | 11.95 |
| BR1941 | 11.95 |
| 4702 | 12.95 |
| COM5016 | 16.95 |
| COM8116 | 10.95 |
| MMS307 | 10.95 |

BIT-RATE

| | |
|---------|-------|
| MC14411 | 11.95 |
| BR1941 | 11.95 |
| 4702 | 12.95 |
| COM5016 | 16.95 |
| COM8116 | 10.95 |
| MMS307 | 10.95 |

FUNCTION

| | |
|--------|------|
| LM4024 | 3.95 |
| LM566 | 1.49 |
| XR2206 | 3.75 |
| 8038 | 3.95 |

MISC.

| | |
|--------------|-------|
| UPD7201 | 29.95 |
| TMS99532 | 29.95 |
| ULN2003 | 2.49 |
| 3242 | 7.95 |
| 3341 | 4.95 |
| MC3470 | 4.95 |
| MC3480 | 9.00 |
| 11C90 | 13.95 |
| 95H90 | 7.95 |
| 2513-001 UP | 9.95 |
| 2513-002 LOW | 9.95 |

CLOCK CIRCUITS

| | |
|----------|-------|
| MMS314 | 4.95 |
| MMS369 | 3.95 |
| MMS375 | 4.95 |
| MMS5817 | 12.95 |
| MMS58174 | 11.95 |
| MSM5832 | 3.95 |

KEYBOARD CHIPS

| | |
|--------------|-------|
| AY5-2376 | 11.95 |
| AY5-3600 | 11.95 |
| AY5-3600 PRO | 11.95 |

DYNAMIC RAMS

| | | |
|------------|------------------------|---------|
| TMS4027 | 4096 x 1 (250ns) | 1.99 |
| UPD411 | 4096 x 1 (300ns) | 3.00 |
| MMS280 | 4096 x 1 (300ns) | 3.00 |
| MK4108 | 8192 x 1 (200ns) | 1.95 |
| MMS298 | 8192 x 1 (250ns) | 1.85 |
| 4116-300 | 16384 x 1 (300ns) | 8/11.75 |
| 4116-250 | 16384 x 1 (250ns) | 8/7.95 |
| 4116-200 | 16384 x 1 (200ns) | 8/12.95 |
| 4116-150 | 16384 x 1 (150ns) | 8/14.95 |
| 4116-120 | 16384 x 1 (120ns) | 8/29.95 |
| 2118 | 16384 x 1 (150ns) (5v) | 4.95 |
| MK4332 | 32768 x 1 (200ns) | 9.95 |
| 4164-200 | 65536 x 1 (150ns) (5v) | 5.95 |
| 4164-150 | 65536 x 1 (150ns) (5v) | 6.95 |
| MCM6665 | 65536 x 1 (200ns) (5v) | 8.95 |
| TMS4164-15 | 65536 x 1 (150ns) (5v) | 8.95 |

5V = single 5 volt supply

6800

| | |
|---------------|-------|
| 68000 | 49.95 |
| 6800 | 2.95 |
| 6802 | 7.95 |
| 6803 | 19.95 |
| 6808 | 13.90 |
| 6809E | 14.95 |
| 6809 | 11.95 |
| 6810 | 2.95 |
| 6820 | 4.35 |
| 6821 | 2.95 |
| 6822 | 14.95 |
| 6840 | 12.95 |
| 6843 | 34.95 |
| 6844 | 25.95 |
| 6845 | 14.95 |
| 6847 | 11.95 |
| 6850 | 3.25 |
| 6852 | 5.75 |
| 6860 | 7.95 |
| 6875 | 6.95 |
| 6880 | 2.25 |
| 6883 | 22.95 |
| 68047 | 24.95 |
| 68488 | 19.95 |
| 6800 = 1MHZ | |
| 68B00 | 10.95 |
| 68B02 | 22.25 |
| 68B09E | 29.95 |
| 68B09 | 29.95 |
| 68B10 | 6.95 |
| 68B21 | 6.95 |
| 68B40 | 19.95 |
| 68B45 | 19.95 |
| 68B50 | 5.95 |
| 68B00 = 2 MHZ | |

6500

| | |
|-------|-------|
| 6502 | 4.95 |
| 6504 | 6.95 |
| 6505 | 8.95 |
| 6507 | 9.95 |
| 6520 | 4.35 |
| 6522 | 6.95 |
| 6532 | 9.95 |
| 6545 | 22.50 |
| 6551 | 11.85 |
| 6502A | 6.95 |
| 6522A | 9.95 |
| 6532A | 11.95 |
| 6545A | 27.95 |
| 6551A | 11.95 |

DISC CONTROLLERS

| | |
|--------|-------|
| 1771 | 16.95 |
| 1791 | 24.95 |
| 1793 | 26.95 |
| 1795 | 29.95 |
| 1797 | 49.95 |
| 2791 | 54.95 |
| 2793 | 54.95 |
| 2795 | 59.95 |
| 2797 | 59.95 |
| 8643 | 34.95 |
| 8272 | 39.95 |
| UPD765 | 39.95 |
| MB8876 | 29.95 |
| MB8877 | 34.95 |
| 1691 | 17.95 |
| 2143 | 18.95 |

8035

| | |
|----------|-------|
| 8035 | 5.95 |
| 8039 | 5.95 |
| INS-8060 | 17.95 |
| INS-8073 | 49.95 |
| 8080 | 3.95 |
| 8085 | 4.95 |
| 8085A-2 | 11.95 |
| 8086 | 24.95 |
| 8087 | CALL |
| 8088 | 29.95 |
| 8089 | 89.95 |
| 8155 | 6.95 |
| 8155-2 | 7.95 |
| 8156 | 6.95 |
| 8185 | 29.95 |
| 8185-2 | 39.95 |
| 8741 | 29.95 |
| 8748 | 24.95 |
| 8755 | 24.95 |

CRT CONTROLLERS

| | |
|-----------|-------|
| 6845 | 14.95 |
| 68B45 | 19.95 |
| HD46505SP | 15.95 |
| 6847 | 11.95 |

2114

450 NS

8/\$995

2114

250 NS

8/\$1095

74LS00

Table of 74LS00 chips with part numbers and prices.

74S00

Table of 74S00 chips with part numbers and prices.

VOLTAGE REGULATORS

Table of voltage regulators including 7805T, 7808T, 7812T, etc.

SOUND CHIPS

Table of sound chips including AY-8910, AY-8912, etc.

BYPASS CAPS

Table of bypass caps including .01 UF DISC, .01 UF MONOLITHIC, etc.

INTERFACE

Table of interface chips including 8226, 8228, 8229, etc.



EPROM ERASERS SPECTRONICS CORPORATION

Table of EPROM erasers with capacity and timer information.

DATA ACQUISITION

Table of data acquisition chips including DAC0808, ADC0804, etc.

7400

Table of 7400 chips with part numbers and prices.

CONNECTORS

Table of connectors including RS232C Male, RS232C Female, etc.

EXAR

Table of EXAR chips including XR2206, XR2207, etc.

INTERSIL

Table of Intersil chips including ICL7106, ICL7107, etc.

9000

Table of 9000 series chips including 9316, 9324, etc.

LINEAR

Large table of linear chips including LM3001, LM3008, LM3090, etc.

RCA

Table of RCA chips including CA3023, CA3039, etc.

TI

Table of TI chips including TL494, TL496, TL497, etc.

BI FET

Table of BI FET chips including TL071, TL072, TL074, etc.

... It is a pleasure to deal with a firm that operates as you do. You are a rare gem! I tell all my computer owning friends about the "good guys" at JDR. Your service is appreciated, and I am sure, pays off in the long run.

Your customer, Evan H. Foreman

AT MICROPRICES

Circle 205 on Inquiry card.

© Copyright 1984 JDR Microdevices

2716 16K EPROMS

\$395 EA

4116 250 NS

8/\$795

BARGAIN HUNTERS CORNER

D-SUBMINIATURE CONNECTORS

- DB25F 25 PIN MALE 10/19.95
- DB25S 25 PIN FEMALE 10/24.95
- HOOD25 GREY HOOD 10/9.95

CENTRONICS CONNECTORS

- CEN36 36 PIN MALE 5.95

IC SOCKETS

- 14 PIN ST LOW PROFILE 100/7.95
- 16 PIN ST LOW PROFILE 100/7.95

SPECIALS END 5/31/84

RF MODULATOR

(ASTECC UM1082) QUANTITIES LIMITED

- * PRESET TO CHANNEL 3
- * USE TO BUILD TV-COMPUTER INTERFACE
- * +5 VOLT OPERATION

NOW ONLY \$695

OPTO-ISOLATORS

- | | | | |
|-------|------|---------|------|
| 4N26 | 1.00 | MCA-7 | 4.25 |
| 4N27 | 1.10 | MCA-255 | 1.75 |
| 4N28 | .69 | IL-1 | 1.25 |
| 4N33 | 1.75 | ILA-30 | 1.25 |
| 4N35 | 1.25 | ILQ-74 | 2.75 |
| 4N37 | 1.25 | H11C5 | 1.25 |
| MCT-2 | 1.00 | TIL-111 | 1.00 |
| MCT-6 | 1.50 | TIL-113 | 1.75 |



WE HAVE THE COMPLETE LINE OF DISC. TANTALUM AND ELECTROLYTIC CAPACITORS IN STOCK!

CAPACITORS

TANTALUM

| | 6V | 10V | 15V | 20V | 25V | 35V |
|-------|------|------|------|-----|-----|------|
| .22uf | | | | | | .40 |
| .27 | | | | | | .40 |
| .33 | | | | | | .40 |
| .47 | | | | .35 | | .50 |
| .68 | | | | | | .45 |
| 1.0 | | | .40 | .40 | .45 | .45 |
| 1.5 | | | | .45 | | .50 |
| 1.8 | | | | | | .75 |
| 2.2 | | .35 | .40 | .45 | | .65 |
| 2.7 | | .40 | .45 | | | .90 |
| 3.3 | | .45 | .50 | .55 | .60 | .65 |
| 3.9 | | .45 | | | | |
| 4.7 | .45 | .55 | | .60 | .65 | .85 |
| 6.8 | | | .70 | | .75 | |
| 8.2 | | | | | | 1.00 |
| 10 | .55 | .65 | .80 | .85 | .90 | 1.00 |
| 12 | .65 | | .85 | .90 | | |
| 15 | .75 | .85 | .90 | | | |
| 18 | | | 1.25 | | | |
| 22 | | 1.00 | 1.35 | | | |
| 27 | | | 2.25 | | | |
| 39 | | 1.50 | | | | |
| 47 | 1.35 | | | | | |
| 56 | 1.75 | | | | | |
| 100 | | 3.25 | | | | |
| 270 | 3.75 | | | | | |

DISC

| | | | |
|------|---------|--------|---------|
| 10pf | 50V .05 | 470 | 50V .05 |
| 22 | 50V .05 | 560 | 50V .05 |
| 25 | 50V .05 | 680 | 50V .05 |
| 27 | 50V .05 | 820 | 50V .05 |
| 33 | 50V .05 | .001uf | 50V .05 |
| 47 | 50V .05 | .0015 | 50V .05 |
| 56 | 50V .05 | .0022 | 50V .05 |
| 68 | 50V .05 | .005 | 50V .05 |
| 82 | 50V .05 | .01 | 50V .07 |
| 100 | 50V .05 | .02 | 50V .07 |
| 220 | 50V .05 | .05 | 50V .07 |
| 330 | 50V .05 | .1 | 12V .10 |
| | | .1 | 50V .12 |

MONOLITHIC

| | | | |
|-------------|---------|------------|---------|
| .1uf-mono | 50V .18 | .47uf-mono | 50V .25 |
| .047uf-mono | 50V .15 | .01uf-mono | 50V .14 |

ELECTROLYTIC

| RADIAL | | AXIAL | |
|--------|---------|-------|---------|
| .47uf | 50V .14 | 1uf | 50V .14 |
| 1 | 25V .14 | 4.7 | 16V .14 |
| 2.2 | 35V .15 | 10 | 16V .14 |
| 4.7 | 50V .15 | 10 | 50V .16 |
| 10 | 50V .15 | 22 | 16V .14 |
| 47 | 35V .18 | 47 | 50V .20 |
| 100 | 16V .18 | 100 | 15V .20 |
| 220 | 35V .20 | 100 | 35V .25 |
| 470 | 25V .30 | 150 | 25V .25 |
| 2200 | 16V .60 | 220 | 25V .30 |
| | | 330 | 16V .40 |
| | | 500 | 16V .42 |
| | | 1000 | 16V .60 |
| | | 1500 | 16V .70 |
| | | 6000 | 16V .85 |

COMPUTER GRADE

DIODES

- | | | |
|--------|----------------------|---------|
| 1N751 | 5.1 volt zener | .25 |
| 1N759 | 12.0 volt zener | .25 |
| 1N4148 | (1N914) switching | 25/1.00 |
| 1N4004 | 400PIV rectifier | 10/1.00 |
| KBPO2 | 200PIV 1.5amp bridge | .45 |
| KBPO4 | 400PIV 1.5amp bridge | .55 |
| VM48 | Dip-Bridge | .35 |

NEW UN-USED MUFFIN FANS

- | | |
|---------------|-------|
| 4.68" Square | 14.95 |
| 3.125" Square | 14.95 |

HEAT SINKS

- | | |
|--------------|-----|
| TO-3 style | .95 |
| TO-220 style | .35 |

SWITCHES

- | | |
|----------------------|------|
| SPDT mini-toggle | 1.25 |
| DPDT mini-toggle | 1.50 |
| SPST mini-pushbutton | .39 |

TRANSISTORS

- | | | | |
|---------|------|---------|------|
| 2N918 | .50 | MPS3706 | .15 |
| MPS918 | .25 | 2N3772 | 1.85 |
| 2N2102 | .75 | 2N3903 | .25 |
| 2N2218 | .50 | 2N3904 | .10 |
| 2N2218A | .50 | 2N3906 | .10 |
| 2N2219 | .50 | 2N4122 | .25 |
| 2N2219A | .50 | 2N4123 | .25 |
| 2N2222 | .25 | 2N4249 | .25 |
| PN2222 | .10 | 2N4304 | .75 |
| MPS2369 | .25 | 2N4401 | .25 |
| 2N2484 | .25 | 2N4402 | .25 |
| 2N2905 | .50 | 2N4403 | .25 |
| 2N2907 | .25 | 2N4857 | 1.00 |
| PN2907 | .125 | PN4916 | .25 |
| 2N3055 | .79 | 2N5086 | .25 |
| 3055T | .69 | PN5129 | .25 |
| 2N3393 | .30 | PN5139 | .25 |
| 2N3414 | .25 | 2N5209 | .25 |
| 2N3563 | .40 | 2N6028 | .35 |
| 2N3565 | .40 | 2N6043 | 1.75 |
| PN3565 | .25 | 2N6045 | 1.75 |
| MPS3638 | .25 | MPS-A05 | .25 |
| MPS3640 | .25 | MPS-A06 | .25 |
| PN3643 | .25 | MPS-A55 | .25 |
| PN3644 | .25 | TIP29 | .65 |
| MPS3704 | .15 | TIP31 | .75 |
| | | TIP32 | .79 |

LED DISPLAYS

- | | | | |
|---------------|-------|-------------|------|
| HP 5082-7760 | .43" | CC | 1.29 |
| MAN 72 | .3" | CA | .99 |
| MAN 74 | .3" | CC | .99 |
| FND-357 (359) | .375" | CC | 1.25 |
| FND-500 (503) | .5" | CC | 1.49 |
| FND-507 (510) | .5" | CA | 1.49 |
| TIL-311 4x7 | .270" | HEX W/LOGIC | 9.95 |

LED LAMPS

- | | | |
|-----------------------|------|--------|
| | 1-99 | 100-up |
| JUMBO RED | .10 | .09 |
| JUMBO GREEN | .18 | .15 |
| JUMBO YELLOW | .18 | .15 |
| LED MOUNTING HARDWARE | .10 | .09 |

RESISTORS

- 1/4 WATT 5% CARBON FILM ALL STANDARD VALUES FROM 1 OHM TO 10 MEG OHM
- | | |
|----------------------|------|
| 50 PCS. SAME VALUE | .025 |
| 100 PCS. SAME VALUE | .02 |
| 1000 PCS. SAME VALUE | .015 |

IC SOCKETS

- | | | |
|--|------|------|
| | 1-99 | 100 |
| 8 pin ST | .13 | .11 |
| 14 pin ST | .15 | .12 |
| 16 pin ST | .17 | .13 |
| 18 pin ST | .20 | .18 |
| 20 pin ST | .29 | .27 |
| 22 pin ST | .30 | .27 |
| 24 pin ST | .30 | .27 |
| 28 pin ST | .40 | .32 |
| 40 pin ST | .49 | .39 |
| 64 pin ST | 4.25 | call |
| ST = SOLDER TAIL | | |
| 8 pin WW | .59 | .49 |
| 14 pin WW | .69 | .52 |
| 16 pin WW | .69 | .58 |
| 18 pin WW | .99 | .90 |
| 20 pin WW | 1.09 | .98 |
| 22 pin WW | 1.39 | 1.28 |
| 24 pin WW | 1.49 | 1.35 |
| 28 pin WW | 1.69 | 1.49 |
| 40 pin WW | 1.99 | 1.80 |
| WW = WIREWRAP | | |
| 16 pin ZIF | 5.95 | call |
| 24 pin ZIF | 7.95 | call |
| 28 pin ZIF | 8.95 | call |
| ZIF = TEXT TOOL (Zero Insertion Force) | | |

DIP SWITCHES

- | | |
|------------|-----|
| 4 POSITION | .85 |
| 5 POSITION | .90 |
| 6 POSITION | .90 |
| 7 POSITION | .95 |
| 8 POSITION | .95 |

VISIT OUR RETAIL STORE

HOURS: M-W-F, 9-5 T-Th., 9-9 Sat. 10-3

PLEASE USE YOUR CUSTOMER NUMBER WHEN ORDERING

TERMS: Minimum order \$10. For shipping and handling include \$2.50 for UPS Ground and \$3.50 for UPS Air. Orders over 1 lb. and foreign orders may require additional shipping charges — please contact our sales department for the amount. CA residents must include 6% sales tax. Bay Area and LA residents include 6 1/2%. Prices subject to change without notice. We are not responsible for typographical errors. We reserve the right to limit quantities and to substitute manufacturer. All merchandise subject to prior sale.

© Copyright 1984 JDR Microdevices

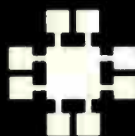

JDR Microdevices

1224 S. Bascom Avenue, San Jose, CA 95128

800-538-5000 • 800-662-6279 (CA)

(408) 995-5430 • Telex 171-110

2732

32K EPROM

\$495

2764

64K EPROM

\$695

MICROCOMPUTER HARDWARE HANDBOOK FROM ELCOMP — \$14.95

Over 800 pages of manufacturers data sheets on most commonly used IC's.

Includes:

- * TTL — 74/74LS and 74F
- * CMOS
- * Voltage Regulators
- * Memory — RAM, ROM, EPROM
- * CPU's — 6800, 6500, Z80, 8080, 8085, 8086/8
- * MPU support & interface — 6800, 6500, Z80, 8200, etc.

BEST SELLING BOOKS

OSBORNE/MC GRAW-HILL

| | |
|-------------------------------------|-------|
| Apple II User's Guide | 16.95 |
| CRT Controller's Handbook | 9.95 |
| 68000 Assembly Language Programming | 16.99 |
| CBASIC User Guide | 15.00 |

SYBEX

| | |
|---------------------------------------|-------|
| Your First Computer | 8.95 |
| The CP/M Handbook | 14.95 |
| The PASCAL Handbook | 18.95 |
| Microprocessor Interfacing Techniques | 17.95 |

DISK DRIVES TANDON

| | |
|--------------------------------|--------|
| TM100-1 5 1/4" (FOR IBM) SS/DD | 229.00 |
| TM100-2 5 1/4" (FOR IBM) DS/DD | 259.00 |

SHUGART

| | |
|---------------------------------|--------|
| SA 400L 5 1/4" (40 TRACK) SS/DD | 199.95 |
| SA 400 5 1/4" (35 TRACK) SS/DD | 189.95 |

PERTEC

| | |
|---------------------|--------|
| FD-200 5 1/4" SS/DD | 179.95 |
| FD-250 5 1/4" DS/DD | 199.95 |

MPI

| | |
|------------------------------|--------|
| MP-52 5 1/4" (FOR IBM) DS/DD | 249.00 |
|------------------------------|--------|

NOTE: Please include sufficient amount for shipping on above items.

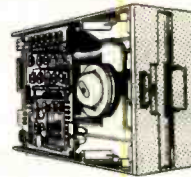

8-INCH DISK DRIVE SALE

FD 100-8
SHUGART 801 EQUIV.
SS/DD — 10/\$175 EA.

FD 200-8
SHUGART 851 EQUIV.
DS/DD — 10/\$220 EA.

\$18900

\$23900

EDGE-CARD CONNECTORS

| | |
|-----------|------|
| S-100 ST | 3.95 |
| S-100 WW | 4.95 |
| 72 pin ST | 6.95 |
| 72 pin WW | 7.95 |
| 50 pin ST | 4.95 |
| 44 pin ST | 2.95 |
| 44 pin WW | 4.95 |



CABINETS FOR 5 1/4" DISK DRIVES

CABINET #1 \$29.95

- * DIMENSIONS 8 5/8 x 5 1/16 x 3 1/16"
- * COLOR MATCHES APPLE
- * FITS STANDARD 5 1/4" DRIVES, INCL. SHUGART
- * INCLUDES MOUNTING HARDWARE AND FEET

CABINET #2 \$79.00

- * COMPLETE WITH POWER SUPPLY, SWITCH, LINE CORD, FUSE & STANDARD POWER CONNECTOR
- * DIMENSIONS: 11 1/2 x 5 3/4 x 3 1/16"
- * +5V @ 1 AMP, +12V @ 1.5 AMP
- * FITS STANDARD 5 1/4" DRIVES
- * PLEASE SPECIFY GRAY OR TAN

NOTE: Please include sufficient amount for shipping on above items.

TRANSFORMERS FRAME STYLE

| | |
|-----------------|-------|
| 12.6VAC 2amp | 4.95 |
| 12.6VAC CT 2amp | 5.95 |
| 12.6VAC CT 4amp | 7.95 |
| 12.6VAC CT 8amp | 10.95 |
| 25.2VAC CT 2amp | 7.95 |

PLUG CASE STYLE

| | |
|-------------|------|
| 12VAC 250ma | 3.95 |
| 12VAC 500ma | 4.95 |
| 12VAC 1amp | 5.95 |
| 12VAC 2amp | 6.95 |

DC ADAPTER

6, 9, 12 VDC selectable with universal adapter 8.95

NOTE: Please include sufficient amount for shipping on above items.

VISIT DURING OUR EXPANDED RETAIL STORE HOURS SATURDAY 10 to 3

CENTRONICS

| | | |
|------------------------|---------------|------|
| IDCEN36 Ribbon Cable | 36 Pin Male | 8.95 |
| IDCEN36/F Ribbon Cable | 36 Pin Female | 8.95 |
| CEN36 Solder Cup | 36 Pin Male | 7.95 |

DIP CONNECTORS

| DESCRIPTION | HIGH RELIABILITY TOOLED ST IC SOCKETS | COMPONENT CARRIERS (DIP HEADERS) | RIBBON CABLE DIP PLUGS (IDC) |
|-------------|---------------------------------------|----------------------------------|------------------------------|
| ORDER BY | AUGATxx-ST | ICCxx | IDPxx |
| CONTACTS 8 | .99 | .65 | |
| 14 | .99 | .75 | 1.45 |
| 16 | .99 | .85 | 1.65 |
| 18 | 1.69 | 1.00 | |
| 20 | 1.89 | 1.25 | |
| 22 | 1.89 | 1.25 | |
| 24 | 1.99 | 1.35 | 2.50 |
| 28 | 2.49 | 1.50 | |
| 40 | 2.99 | 2.10 | 4.15 |

For order instructions see "IDC Connectors" below.

RIBBON CABLE

| CONTACTS | SINGLE COLOR | | COLOR CODED | |
|----------|--------------|-------|-------------|-------|
| | 1' | 10' | 1' | 10' |
| 10 | .50 | 4.40 | .83 | 7.30 |
| 16 | .55 | 4.80 | 1.00 | 8.80 |
| 20 | .65 | 5.70 | 1.25 | 11.00 |
| 25 | .75 | 6.60 | 1.32 | 11.60 |
| 26 | .75 | 6.60 | 1.32 | 11.60 |
| 34 | .98 | 8.60 | 1.65 | 14.50 |
| 40 | 1.32 | 11.60 | 1.92 | 16.80 |
| 50 | 1.38 | 12.10 | 2.50 | 22.00 |

D-SUBMINIATURE

| DESCRIPTION | SOLDER CUP | | RIGHT ANGLE PC SOLDER | | IDC RIBBON CABLE | | HOODS | |
|-------------|------------|--------|-----------------------|--------|------------------|--------|--------|------|
| | MALE | FEMALE | MALE | FEMALE | MALE | FEMALE | BLACK | GREY |
| ORDER BY | DBxxP | DBxxS | DBxxPH | DBxxSR | IDBxxP | IDBxxS | HOOD-B | HOOD |
| CONTACTS 9 | 2.08 | 2.66 | 1.65 | 2.18 | 3.37 | 3.69 | — | 1.60 |
| 15 | 2.69 | 3.63 | 2.20 | 3.03 | 4.70 | 5.13 | — | 1.60 |
| 25 | 2.50 | 3.25 | 3.00 | 4.42 | 6.23 | 6.84 | 1.25 | 1.25 |
| 37 | 4.80 | 7.11 | 4.83 | 6.19 | 9.22 | 10.08 | — | 2.95 |
| 50 | 6.06 | 9.24 | — | — | — | — | — | 3.50 |

For order instructions see "IDC Connectors" below.

MOUNTING HARDWARE 1.00

IDC CONNECTORS

| DESCRIPTION | SOLDER HEADER | RIGHT ANGLE SOLDER HEADER | WW HEADER | RIGHT ANGLE WW HEADER | RIBBON HEADER SOCKET | RIBBON HEADER | RIBBON EDGE CARD |
|-------------|---------------|---------------------------|-----------|-----------------------|----------------------|---------------|------------------|
| ORDER BY | IDHxxS | IDHxxSR | IDHxxW | IDHxxWR | IDSxx | IDMxx | IDExx |
| CONTACTS 10 | .82 | .85 | 1.86 | 2.05 | 1.15 | — | 2.25 |
| 20 | 1.29 | 1.35 | 2.98 | 3.28 | 1.86 | 5.50 | 2.36 |
| 26 | 1.68 | 1.76 | 3.84 | 4.22 | 2.43 | 6.25 | 2.65 |
| 34 | 2.20 | 2.31 | 4.50 | 4.45 | 3.15 | 7.00 | 3.25 |
| 40 | 2.58 | 2.72 | 5.28 | 4.80 | 3.73 | 7.50 | 3.80 |
| 50 | 3.24 | 3.39 | 6.63 | 7.30 | 4.65 | 8.50 | 4.74 |

ORDERING INSTRUCTIONS: Insert the number of contacts in the position marked "xx" of the "order by" part number listed. Example: A 10 pin right angle solder style header would be IDH10SR.

FOR APPLE COMPUTER USERS

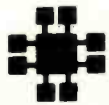

JDR Microdevices

THOUSANDS SOLD!

JDR 16K RAM CARD FOR APPLE II+

- * Expand your 48K Apple to 64K
 - * Fully compatible with Apple Language System — Use in place of Apple Language card
 - * Highest quality card features: gold edge connector, sockets for all IC's.
 - * 2 YEAR WARRANTY
- Kit with Instructions \$40.95 **\$44.95**
 Bare PC Card \$14.95

GET SLIM IN 1984!

JDR HALF-HEIGHT DISK DRIVE

- * 35 Track if used with Apple Controller
- * 40 Track Controller and DOS Available (Call for Price)

\$209.95

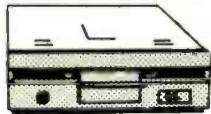

MA SYSTEMS FD-35 DISK DRIVE

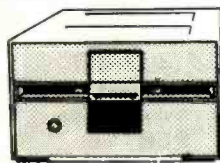

\$199.95

- * Shugart Mechanism — Made in U.S.A.
- * Direct Replacement for Apple Disk II
- * Compatible with Apple Controller or other Apple compatible controllers
- * Specially designed electronics with low power consumption
- * DOS 3.3 and 3.2 compatible
- * One Year Warranty

**CONTROLLER CARD
\$69.95**



APPLE COMPATIBLE POWER SUPPLY

- * Use To Power Apple-Type Systems
- * +5V @ 5A +12V @ 3A
- * -5V @ .5A -12V @ .5A
- * Instructions Included

\$79.95

BMC BMX-80 PRINTER

- * 80 CPS Dot Matrix Printer
- * Prints Bi-Directional in 40, 80, 71 or 142 Columns in Normal, Double Width or Compressed Text.
- * Print Superscript As Well As Superb Graphics in Character or Bit Image

\$279



micromax

VIEWMAX-80

NOW ONLY \$159.95

- * 80 Column Card for Apple II+
- * Video Soft Switch
- * Inverse Video
- * 2 Year Warranty

VIEWMAX-80e

NEW \$129.95

- * 80 Column Card for Apple IIe
- * 64K RAM Expandable to 128K
- 64K RAM Upgrade \$47.60**

GRAPHMAX \$129.95

- * Hi Resolution Graphics
- * Printer Card
- * Centronics Parallel Interface

Graphmax with Color & Zoom Options ... \$149.95

NASHUA DISKETTES

| 5 1/4" WITH HUB RING | |
|-----------------------------------|-------|
| MD1 SOFT SECTOR, SS/SD | 19.95 |
| MD1D SOFT SECTOR, SS/DD | 26.25 |
| MD2D SOFT SECTOR, DS/DD | 30.75 |
| MD2F SOFT SECTOR, DS/QUAD DENSITY | 45.00 |
| MD110 10 SECTOR HARD, SS/SD | 19.95 |
| MD210D 10 SECTOR HARD, DS/DD | 30.75 |
| 8" WITHOUT HUB RING | |
| FD1 SOFT SECTOR, SS/SD | 24.75 |
| FD1D SOFT SECTOR, SS/DD | 30.00 |
| FD2D SOFT SECTOR, DS/DD | 36.75 |

OTHER ACCESSORIES FOR APPLE II

THUNDERCLOCK \$129.95

- * Real-Time Clock Calendar
- * Software Included
- * Mountain Software Compatible
- * BSR Control Options Available

KRAFT JOYSTICK \$39.95

VERBATIM DATALIFE DISKETTES

| | |
|----------------------|----------------|
| SS/DD SOFT SECTOR | \$29.95 |
| SS/DD 10 HARD SECTOR | \$29.95 |

5 1/4" DISKETTE FILE

- * ATTRACTIVE, FUNCTIONAL DISK STORAGE SYSTEM
 - * 75 DISK STORAGE CAPACITY
 - * MOLDED FROM DURABLE SMOKED PLASTIC WITH FRONT CARRYING HANDLE
- \$16.99**

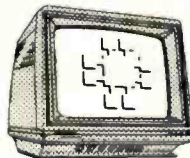

MONITORS

**BMC MONITOR STAND
MODEL PA-900**

Your Display Will
Tilt & Swivel **\$29.95**

MONOCHROME

| | |
|---|-----------------|
| BMC BM 12AUW GREEN 12" | \$89.95 |
| BMC BM 12EUY 18 MHZ AMBER | \$139.95 |
| BMC BM 12EUN 18 MHZ HIGH RES GREEN | \$115.00 |
| NEC JB1201M - 20 MHZ GREEN | \$169.00 |
| ZENITH ZVM-121 - 15 MHZ GREEN | \$99.00 |

COLOR

BMC BM-AU9191U COMPOSITE 13" \$279.00

NO C.O.D. ORDERS PLEASE

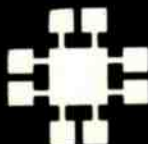

JDR Microdevices

1224 S. Bascom Avenue, San Jose, CA 95128

800-538-5000 • 800-662-6279 (CA)

(408) 995-5430 • Telex 171-110

VISIT OUR RETAIL STORE

HOURS: M-W-F, 9-5 T-Th., 9-9 Sat. 10-3

PLEASE USE YOUR CUSTOMER NUMBER WHEN ORDERING

TERMS: Minimum order \$10. For shipping and handling include \$2.50 for UPS Ground and \$3.50 for UPS Air. Orders over 1 lb. and foreign orders may require additional shipping charges — please contact our sales department for the amount. CA residents must include 6% sales tax. Bay Area and LA residents include 6.5%. Prices subject to change without notice. We are not responsible for typographical errors. We reserve the right to limit quantities and to substitute manufacturer. All merchandise subject to prior sale.

© Copyright 1984 JDR Microdevices

Apple is a trademark of Apple Computer Corporation

Unclassified Ads

NEEDED: For care and training of mentally and physically disabled persons nonprofit institute needs small computers, peripherals, printers, monitors, and programs (educational, games, administrative) for VIC-20, C-64, TRS-80, or whatever. All donations tax exempt. We pay shipping. Community Support Services Inc., 333 Lincoln St., Saco, ME 04072. (207) 282-6113 collect.

WANTED: Tax-deductible donations of computers, peripherals, and software for use by a public charity organization to teach computer skills to economically disadvantaged young people. San Pablo Institute, 234 Mullen St., San Francisco, CA 94110.

WANTED: Receive a tax deduction and help the Africa Fund's education and relief work by donating your Kaypro or other computer. Paul Irish, The Africa Fund, 198 Broadway, New York, NY 10038. (212) 962-1210.

WANTED: Tax-exempt educational organization needs used computers or unused manufacturer's over-runs or obsolete models. K.C. Hill, Appalachian Educational Communication Corp., POB 2061, Bristol, TN 37621-2061. (703) 563-0371 ext 445 days and (615) 538-7877 evenings.

WANTED: Your fully tax-deductible donation of any computer (large, small, mini, personal), printers, disk drives, monitors in any condition for teaching programming and computers to incarcerated men. PGT, POB 574, Stanton, CA 90680.

WANTED: A computer science university student with experience in UNIVAC, CDC, BASIC, FORTRAN, and 6800 assembly seeks a two-month training course during summer 1984 in USA or Canada. Any advice welcome. Kilicaslan Mertan, Kasadar sok, 13-19, Bostanci, Istanbul, Turkey.

FREE: You pay small postage and I'll send you for free a box of left-over, mostly unused electronic components. Originally parts were to be used in an Electrotones Music Synthesizer system. It goes to the most convincing letter received within one month of this ad. Chuck Markham, 362 Commonwealth Ave. #2E, Boston, MA 02115.

WANTED: Maintenance manual or schematics for Beehive 12-inch terminal, PN 112-0014-3037, (manufactured about 1974), eight 7- by 10-inch plug-in boards. Dan Schacher, 20-08 Greenwood Dr., Fair Lawn, NJ 07410.

WANTED: College student would appreciate any unwanted computer equipment: boards, drives, etc. to be used for research. I will pay all shipping charges. Johnathan Jones, 1426 St. Marks Ave., Brooklyn, NY 11233. (212) 773-5983.

WANTED: TRS-80 users willing to exchange information or programs on designing a computer-controlled burglar-alarm system and control for lights, furnace, stove, sprinklers, and other noncomputer devices. I would also like information on voice recognition. I am using a Model III 48K but will convert to Model 4 128K. Patrick Baehl, 4652 126 Ave., Edmonton, Alberta T5A 4K9, Canada. (403) 476-7093.

WANTED: Atari 800 software to swap, especially utilities and entertainment. Send disk or tape with your programs and I will promptly send it back with mine. Matthew Meyerson, 8 Phyllis Circle, Garneville, NY 10923.

FOR TRADE: Disk cartridge: seven Texas Instruments DS10 disk cartridges and one Control Data Corp. 847-51 CE disk cartridge, in perfect condition. Will consider donating to a worthwhile IRS-approved charity if unable to sell. Win Schaeffer, 3 Waters Edge Place, Lexington, KY 40502. (606) 268-0308 days.

WANTED: Junior high student seeks Apple II Plus DOS 3.3 for programming. Whole working parts or complete system. Will pay shipping and handling. Hans Hess, POB 4406, Carmel, CA 93921.

WANTED: HP-67 programmable calculator or HP-41C programmable calculator with a card reader. Indicate age, use, and/or condition. If you have additional peripherals or software, please include a list. Ken Harmel, Rt. 5 Box 162, Watertown, WI 53094.

FOR SALE: For the benefit of the Mercer Island Area Computer Users Group (MIACUG): Eamon starter kit of 18 adventures (set 1) on 9 disks for \$35. Set 2 of 18 more for \$35, or all 36 for \$60. Jeff Bianco, 7210 North Mercer Ways, Mercer Island, WA 98040.

FOR SALE: Hewlett-Packard HP85A, 32K RAM, Matrix ROM, BCD interface, additional hardware and software. Must sell. Stanley J. Cudnik, 712 Pennsylvania Ave., Trenton, NJ 08638. (609) 392-3725 evenings.

FOR TRADE: TS 1000/ZX-81 software. Send cassette of your best software (up to 64K) and I will promptly return an equal number of my best on your original tape. A. S. Cavaliere, 49 Grand View Blvd., Miller Place, NY 11764.

FOR SALE: Viewmax-80, 80-column video card for Apple II with 2-year warranty: \$130. John Chen, 1602 Arlington, Caldwell, ID 83605.

FOR SALE: 8-bit AD/DAC IBM PC plug-in by Lab Tender #20028. Data-processing subsystem A/D 32 single-ended channels. 50KHz conversion rate. DAC 16 analog outputs. Digital 24 parallel I/O lines. Timer 5 independent. 16-bit timing counter 5MHz max. software is easy high level or assembly language: was \$495, asking \$385. John Vavrik, 2818A East Lake Sammamish N., Redmond, WA 98052. (206) 881-7414.

FOR TRADE: Send a list and/or disk of your better Apple software and I'll send mine. I'm interested in utilities, games, and educational programs. Prompt return guaranteed. George Velez, PSC Box 4146, APO NY 09109.

FOR SALE: Apple IIentype printer and interface card: \$100 or best offer. Gene Stagner, 8420 East Appomattox, Tucson, AZ 85710. (602) 721-1251.

WANTED: Eagle II users interested in bumping heads on any subjects relating to the Eagle and/or forming a user group. G. David Yaros, 1006 2d Nat. Bldg., 830 Main St., Cincinnati, OH 45202.

FOR SALE: Two TRS-80 Model I disk drives to be used with a 16K Level II BASIC TRS-80 microcomputer. One is catalog #26-1160; other is #26-1161: \$800 each. Anne Heitz, 2807 Ave. C, Ft. Madison, IA 52627. (319) 372-3058.

FOR SALE: Microsoft FORTRAN, 8-inch CPM format, unused: \$250. Strobe Plotter for Apple, unused: \$350. Showad Voice-Entry term for Apple: \$400. Howard Rothman, 218 Huntington Rd., Bridgeport, CT 06608. (203) 579-0472 days. 333-6436 evenings.

FOR SALE: Timex/Sinclair 1000 with 16K RAM, tape recorder, and books. Also, Flight Simulator, Chess, Stock Option Analyzer, and Backgammon. All in excellent condition: \$110 or best offer. David Patterson, 2151 West Rialto #12, San Bernardino, CA 92410. (714) 888-1050.

FOR SALE: Electronic Typewriter Interface (ETI2) for connection of IBM Electronic Model 50, 60, or 75 typewriter to parallel printer port of your computer. This unit has only one hour's usage. Cost \$525, will sell for \$400. K. C. Hartman, 200 Gateway Towers, Pittsburgh, PA 15222. (412) 281-1914.

FOR SALE: Printers: DECwriter II LA 36 with ASCII keyboard and adjustable paper width: \$350. Desktop CDI 1030 with keyboard and built-in modem: \$150. N. A. Westman, 11209 Hwy U, Wausau, WI 54401.

WANTED: Users of NEC PC-8001A series who are willing to exchange programs and/or information. George G. Bulick, 4228 Wilson Ave., Rolling Meadows, IL 60008.

FOR SALE: BYTE April 1977 to December 1977, 9 issues: \$45. July 1978 to March 1980, 21 issues: \$40. All plus postage. Mark Walbrun, 1326 Spruce St., Philadelphia, PA 19107.

FOR SALE: Netronics equipment, all in perfect condition. Smarterm 80-column terminal: \$150. 64K Jaws 5-100 RAM card: \$100. HEX keypad: \$25. All 1 year old. Bryan Bergeron, 1431 Josephine Apt. 7, New Orleans, LA 70130. (504) 524-1042.

FOR SALE: SS-50 assembled boards. Percom 6809 CPU: \$50. Percom video board: \$50. Datasystem-68 Disk Controller: \$75. Tandem TM-100A disk drive with power supply and case: \$100. RS-232C cassette interface: \$25. Complete documentation with equipment. James A. Forsman, 136 Glenoak Rd., Wilmington, DE 19805. (302) 994-6312 after 5 p.m.

FOR SALE: Complete Commodore system includes 32K Commodore CBM 2001, 2040 dual disk (with write/protect switches), matrix printer, Word Pro II, Visicalc, Toolkit (programming aids), FORTH language with assembler, games, and numerous utilities. Full documentation: \$4000 value, \$1500 takes it. Steve Potlter, 8715 Datapoint Dr. #904, San Antonio, TX 78229. (512) 691-2890.

FOR SALE: APF black-and-white monitor, 9-inch screen, excellent condition: \$49. Pick-up preferred. Marvin Leifer, 185 West End Ave., New York, NY 10023. (212) 362-9097.

WANTED: Two Polish students/computer-enthusiasts seek donations of any computer equipment. Wojciech Studek, 80-260 Gdansk, ul. Lesny Stok 31, Poland.

WANTED: Apple's Lisa assembly-language programmers to test new library of assembly subroutines and library-maintenance program. These subroutines use a unique address structure that simplifies coding of large machine-language programs. Send name, address, system description, and brief statement of experience with Lisa Assembler. M. A. Iannce, 1009 Country Hills Rd., Santa Maria, CA 93455.

WANTED: Hardware accessories for H/289, with documentation. Interested in cassette interface, 64K RAM expansion, parallel interface, A/D converter, breadboards, soft-sector disk controller (5 1/4- or 8-inch), external disk drives (5 1/4- or 8-inch). Orville R. Weyrich Jr., POB 562, Auburn, AL 36831.

FOR SALE: Ohio Scientific C2-OEM 2MHz with two 8-inch disk drives, 48K static RAM, CA-10-2 (serial-interface board with printer and modem ports configured). Includes Word Processor, 6502 Assembler/Editor, and Extended Monitor: absolutely excellent condition. \$3850 now, sell for \$1200. Bob Duffett, POB 5548, Athens, GA 30604. (404) 353-3229 after 5 p.m.

FOR SALE: Inter-Tec Super Brain II, quad-density, dual drive 750K, 280 CPU 64K RAM, manuals, and CPM operating system software. APL keyboard and character-generating chip: \$1695 or best offer. Bill Gibson, POB 428, Amherst, MA 01004. (413) 549-6334.

FOR SALE: SWTPC 6800 computer system MP-A, AC-30, MP-S, MP-C, MP-R: EPROM programmer currently has 34K RAM and 4K EPROM expandable to 10K additional RAM or EPROMs. 4K EPROM monitor plus documentation, BASIC, Pascal, and lots of other programs. Best offer. T. Preston, 119 Hickory Lane, Medford, NJ 08055.

FOR SALE: ADDS CONSUL 980, excellent condition with 80 by 24 screen; serial, parallel, and RS232C (EIA) ports; switch-selectable data rates: 1/2 full duplex; Mosaic high-resolution graphics; manuals included. Plus Anderson-Jacobson acoustic-coupler modem; EIA-RS232C 6-foot ribbon cable included. F. G. Voipicelli, 331 8th Ave., Peinam, NY 10803. (914) 738-1071.

FOR TRADE: OSI C-24P cassette-based with 4K RAM (expandable to 4K), 3-speed data rate, serial port, power supply, and two open slots on main board for Sharp 1500 with cassette interface. Needs capacitor replaced in the speed generator. Also, have expanded Gold Miner for TI 99/4A and will trade programs on tape. H. A. Etchason, Box 147, Sage, AR 72573.

FOR SALE: George Risk keyboard as used with Cromemco System; asking \$75. M. D. Beck, 170 Hillside Ave., San Rafael, CA 94901.

FOR SALE: Radio Shack Line Printer VIII, 1 year old, excellent condition, cover included: \$425. Also, RS direct-connect modem II, 5 months old, excellent condition: \$150. Model 3 RS-232 cable: \$15. Videotex: \$35. RS Communications Package: \$25 or will trade disks or tapes for TRS-80 Model III. Tom Trepanier, 35 Lincoln Ave., Ardley, NY 10502.

FOR SALE: S-100 16K, \$20. Double-density controller: \$85. Z-80 CPU: \$45. 5 1/4-inch 5M Winchester: \$300. Z-80 big board: \$150 assembled. Cherry PRO keyboard: \$25. Send for complete list. Noor Singh Khalsa, 1562 North Hill, Pasadena, CA 91104.

FOR SALE: Texas Instruments Silent 700 (TI-745) and user's manual. Used less than six months, refurbished. Paul Berg, 31 Taunton Rd., Scarsdale, NY 10583. (914) 725-0261.

FOR SALE: HP98217A flexible disk ROM for 9825-plus 98034A HP(B)GP(B), Also, 98036A serial interface. Want HP 9845 mass storage ROM, HP9885M5 flexible disk drives. W. R. Flocks, 700 West Jackson #120, McAllen, TX 78501. (512) 682-6008.

WANTED: Information on any P/PM 2.2-compatible map-making programs for microcomputers similar to SYMAP program for mainframes. Bill Thomas, 532 University Ave., Missoula, MT 59801.

WANTED: I'd like to exchange programs and information for the Sinus/Victor personal computer. Maurizio Lazzaretti, Via Furni 14, 27058 Voghera (PV), Italy.

FOR SALE: SVA 8-inch drive controller with software for DOS and CPM: \$150. Oume D78 8-inch drive just rebuilt by Oume: \$200. Bill Kimball, 244 North Orange Grove, Pasadena, CA 91103.

FOR SALE: Heath H-8 computer includes mainframe, terminal, and double-disk drives. Bus-oriented system enables expansion in almost any direction, including (but not limited to) color graphics, hard disk, multiuser, etc. Software and a complete manual set are included: cost \$2500, \$1150 or best offer, Jon Swindle, 1506 East 1650 N., Provo, UT 84604. (801) 377-1506.

FOR TRADE: ZX-81, much software, 17-inch black-and-white monitor, for any TI-99/4A items. Would like to exchange TI information with yours. Bill Axsom, 661 Northwest 75th Terrace, Plantation, FL 33317.

FOR SALE: High-resolution color monitor. Zenith ZVM-134 with RGB inputs, 640 by 225 pixels, 80 characters by 25 lines. Used only 3 months, was \$699, asking \$390, including postage within continental US. Len Whitten, 7613 Jadedite Ave., Cucamonga, CA 91730. (714) 382-5405 days. 980-2509 evenings.

FOR SALE: BYTE, July 1976 and October 1976 to present (missing May 1978), Interface Age, January 1977 to present, Dr. Dobbs Journal, March 1976 to August 1982, Klobaud Microcomputing, January 1977 to present, Lifelines, June 1980 to present. Sell complete sets only; each set sold to highest bidder; you pay postage. Dr. J. Williams, 902 Anderson Dr., Fredericksburg, VA 22405.

FOR SALE: Victor 9000 16-bit microcomputer with 256K expandable to 896K has 2.4 mg disk storage on two double-sided, 5 1/4-inch floppy-disk drives. Also Codec digitized voice, green phosphor high-resolution (800 by 400) graphic display, CPM-86, MS-DOS and BASIC86 included. More software available. List \$4795, asking \$3800. Used MX-100 dot-matrix 80-cps printer: \$400. Diablo 1641 send/receive daisy-wheel printer, cost \$3300, asking \$2000. Robert De Boer, 3354 Louise Dr., Lansing, IL 60438. (312) 474-2634.

UNCLASSIFIED POLICY: Readers who have computer equipment to buy, sell, or trade or who are requesting or giving advice may send a notice to BYTE for inclusion in the Unclassified Ads section. To be considered for publication, an advertisement must be noncommercial (individuals or bona fide computer clubs only), typed double spaced on plain white paper, contain 75 words or less, and include complete name and address. This service is free of charge; notices are printed once only as space permits. Your confirmation of placement is appearance in an issue of BYTE as we engage in no correspondence. Please allow at least three months for your ad to appear. Send your notices to Unclassified Ads, BYTE/McGraw-Hill, POB 372, Hancock, NH 03449.

Unclassified Ads

FOR SALE: Single supply 2716 EPROMs: \$3. 8279 keyboard and display interface: \$7. Quantities limited, send check or money order. James Major, 1002 South 45 St., Omaha, NE 68106. (402) 551-3240.

FOR TRADE: Apple II Plus and IIe programs ranging from business to games. Let's trade programs; I'll even pay for disk and shipping costs. Mike Klemens, 3208 Los Prados, San Mateo, CA 94403. (415) 341-1747.

WANTED: Information exchange with persons building the Garcia MPX-16 computer. I also am interested in trading programs for the PC that will run on the MPX-16. Send your list and I'll send mine. S. A. Glick, 404 Griffin St., West Point, MS 39773.

FOR SALE: HP-85A microcomputer with 32K RAM, built-in tape drive, printer, monitor, all in very good condition, excellent as a controller. Also, HP-IB interface, various ROMs, and Visicalc. Will sell complete, or in parts. Everything comes with original documentation. Cornelia Soderquist, Box 1176, Sun Valley, ID 83353. (208) 726-3816 evenings.

FOR SALE: TRS-80 software: Accounts Payable, Accounts Receivable, Order Entry/ICS, General Ledger, \$375 each or best offer. Compiler BASIC: \$150. May be purchased separately or as package. B. Lawrence, 2049 Brown Ave. Apt. #C-19, Bensalem, PA 19020. (215) 639-1318.

FOR TRADE: I would like to exchange IBM PC software: different languages, business, games. Send a list. Winfred Schlessner, 19600 Gulf Blvd., Indian Shores, FL 33535. (813) 595-8078.

FOR SALE: OSI C4P-MF, 28K plus two 4K boards (not yet installed), disk drive, RS-232C interface, printer port, modem port, two joystick ports, sound, color, software documentation, and article collection. Novation modem, extra: \$650, negotiable. Ted Morris, 6306 Kincaid Rd., Cincinnati, OH 45213. (513) 731-3451 evenings.

WANTED: West Australian NEC PC8001 owner would like to communicate with any interested users or user groups. Very little information or software available here, need any technical information, particularly memory expansion. Will exchange local information, Australiana. Michael Brown, 5 Baring St., Mosman Park 6012, West Australia.

WANTED: BYTE back issues: vol. 1: #1 to #10, #12 to #16. Vol. 2: #1, #2, and #4. Vol. 3: #1 and #11. Will pay \$4 each. Terry J. Deveau, Site 17, Box 40, RR#5, Armdale, Nova Scotia B3L 4J5, Canada.

FOR SALE: 151 Century computer, 256K memory, 6 disk drives, 36 disks, 1200 line-per-minute printer, MMI Preparatory School, POB 89, Freeland, PA 18224-0089. (717) 636-1108.

FOR SALE: Personal Computing, January 1977 (first issue) through July 1981, complete: \$15 plus UPS. Gordon E. Nelson, 12005 Millstream Dr., Bowie, MD 20715. (301) 464-0732.

FOR TRADE: My cross assembler for Apple II using cassette interface for interesting applications programs for Hero-1 robot. Dave Fentress, Pergolistr. 6, CH-3184 Wunnwil, Switzerland; tel: 1141/37/361720.

FOR SALE: Unused S-100 bus with 64K: \$250. Cromemco Z-2D with extras, software, and documentation: best offer. Centronics printer 101-A: freight collect (75 lbs.) and best offer. Three memory boards 16K. OSI C2-4P: best offer. (For an OSI CIP with 32K and more, call Pete.) Walt Thomas, RD#1, Box 135, Linden, PA 17744. (717) 398-1893.

WANTED: Student enthusiastic about computer information needs donation of any personal computer. T. Jarosinski, 41/16 Michaelowskiego, 80-300 Gdansk, Poland.

WANTED: Any technical information regarding the Victor 9000 computer. Specifically, I would like instructions for the use of graphics and the CODEC voice digitizer through MSBASIC or CBASIC. Also, I would like to form a user's group for the Victor 9000 computer and any subsequent Victor models. Mike Frey, 20048 Shoshonee, Apple Valley, CA 92307.

FOR SALE: Back issues of BYTE, Microcomputing, Interface Age, Dr. Dobb's, 68 MicroJournal, and Computer. Make an offer. Phil Hughes, POB 7, Northgate Station, Seattle, WA 98125. (206) 367-8649.

FOR SALE: Quick printer uses 5-inch aluminum paper for quick output (2.5 lines per second). No ribbon needed; parallel interfacing; prints up to 80 characters per line; prints true descending lowercase and underlines; good working condition; two extra rolls of paper. First check received for \$75 that clears takes it or offers. Tom P. Douglas, POB 9046, Colorado Springs, CO 80932. (303) 635-2061 Sundays.

BOMB

BYTE's Ongoing Monitor Box

| ARTICLE # | PAGE | ARTICLE | AUTHOR(S) |
|-----------|------|--|---------------------------------|
| 1 | 32 | Build a Scrolling Alphanumeric LED Display | Ciarcia |
| 2 | 57 | User's Column: | |
| | | The Most Fabulous Object in the Entire World | Pournelle |
| 3 | 82 | BYTE West Coast: Stylish Output | Shapiro |
| 4 | 94 | Personal Computer Signal Processing | Englemann, Abraham |
| 5 | 114 | Planning a Computerized Measurement System | Wyss |
| 6 | 127 | Designing Systems for Real-Time Applications | Isaak |
| 7 | 137 | Interfacing for Real-Time Control | Genet, Boyd, Sauer |
| 8 | 152 | Putting the Apple II Work, Part 1: The Hardware | Hallgren |
| 9 | 170 | The Rainbow 100 | Suits |
| 10 | 186 | Peachtext 5000 | Lehrman |
| 11 | 206 | The Coleco Adam | Gilder |
| 12 | 224 | Micro-Logic | Krajewski |
| 13 | 234 | Statistical Software for Microcomputers | Carpenter, Deloria, Morganstein |
| 14 | 270 | The Mindset Personal Computer | Williams |
| 15 | 298 | Is BASIC Getting Better? | Vose |
| 16 | 300 | True BASIC | Elliott |
| 17 | 302 | BetterBASIC | Vose |
| 18 | 318 | Macintosh BASIC | Kamins |
| 19 | 334 | Professional BASIC | George |
| 20 | 344 | BASIC-09 | Capouch |
| 21 | 351 | Soviet Microprocessors and Microcomputers | Heuertz |
| 22 | 365 | Toward Standardized Video Terminals | Siegel |
| 23 | 379 | A VIC-20/Commodore 64 Terminal Emulator | Russo |
| 24 | 422 | April Tomfoolery | |

CORRESPONDENCE

Address all editorial correspondence to the editor at BYTE, POB 372, Hancock, NH 03449. Unacceptable manuscripts will be returned if accompanied by sufficient first-class postage. Not responsible for lost manuscripts or photos. Opinions expressed by the authors are not necessarily those of BYTE. Entire contents copyright © 1984 by McGraw-Hill Inc. All rights reserved. Where necessary, permission is granted by the copyright owner for libraries and others registered with the Copyright Clearance Center (CCC) to photocopy any article herein for the flat fee of \$1.50 per copy of the article or any part thereof. Correspondence and payment should be sent directly to the CCC, 21 Congress St., Salem, MA 01970. Specify ISSN 0360-5280/83. \$1.50. Copying done for other than personal or internal reference use without the permission of McGraw-Hill is prohibited. Requests for special permission or bulk orders should be addressed to the publisher. BYTE® is available in microform from University Microfilms International, 300 North Zeeb Rd., Dept. PR, Ann Arbor, MI 48106 USA or 18 Bedford Row, Dept. PR, London WC1R 4EJ, England.

JANUARY'S WINNING WORDS

First place in January's BYTE goes to Steve Ciarcia's "Build the Circuit Cellar Term-Mite ST Smart Terminal, Part I: Hardware." Steve wins the \$100 bonus. Richard Mateosian, author of "1984, the Year of the 32-bit Microprocessor," wins \$50 for capturing second place. In a close third place is Jerry Pournelle's User's Column, "Too Many Leads, or What In *;?#!" *? Goes First?" "Computer-aided Design," written by Rik Jadrnicek is the fourth winner. In fifth place is Louis Wheeler's "Bubbles on the S-100 Bus, Part I: The Hardware." Congratulations to these authors.

Reader Service

| Inquiry No. | Page No. | Inquiry No. | Page No. | Inquiry No. | Page No. | Inquiry No. | Page No. |
|-------------|----------------------------------|-------------|-------------------------------|-------------|--------------------------------|------------------------------|---------------------------------|
| 480 | 1ST NATIONAL COMPUTER 427 | 84 | COMPUTER CLUB INC. 516 | 171 | G&G ENGINEERING 385 | 258 | MICROMAIL 496. |
| 2 | 1ST PLACE SYSTEMS 110 | 85 | COMPUTER CONNECTION INC. 492 | 171 | GIFFORD COMP.SYS. 385 | 259 | MICROPROCESSORS UNLTD. 477 |
| 3 | 800 SOFTWARE 101 | 86 | COMPUTER DISCOUNT PROD. 509 | 172 | GILTRONIX, INC. 432 | 260 | MICROPROCESSORS UNLTD. 477 |
| 4 | A-SYSTEMS CORP. 508 | 87 | COMPUTER HUT OF N.E. 429 | 173 | GMS SYSTEMS 409 | | MICROSOFT CORP. 54, 55 |
| 5 | A.S.T. RESEARCH 21 | 88 | COMPUTER MAIL ORDER 332, 333 | 174 | GRADUATING ENGINEERING 353 | | MICROSOFT CORP. 184, 185 |
| 6 | A.T.&T. TECHNOLOGY 165, 166, 167 | 90 | COMPUTER PLUS 450 | 175 | GREAT LAKES COMP. PERI. 203 | | MICROSOFT CORP. BLAZING |
| 8 | ABC COMPUTERS 433 | 90 | COMPUTER PRICE CLUB 417 | 182 | GREAT SALT LAKE COMP. 488, 489 | | BASIC 217 |
| 9 | ABC COMPUTER LTD 524 | 91 | COMPUTER PUBLISHING CO. 164 | 483 | GREAT SALT LAKE COMP. 490, 491 | | MICROSOFT CORP. RAGING C 219 |
| 10 | ABC DATA PRODUCTS 371 | 91 | COMPUTER WAREHOUSE 418 | 178 | GTEK INC. 310 | | MICROSOFT CORP. FEROCIOUS |
| 247 | ABATI 199 | 92 | COMPUTERLINE-A 124, 125 | | H&E COMPUTRONICS 411 | | FORTRAN 221 |
| 12 | ACL INC. 341 | 93 | COMPUTERS AND MORE 324 | 177 | HAMMER INDUSTRIES INC. 477 | 261 | MICROSTUF, INC. 265 |
| 13 | ACOM ELECTRONICS 374 | 94 | COMPUTERS AND MORE 262 | 178 | HANDWELL CORP. 511 | 262 | MICROTECH EXPORTS 16 |
| 14 | ADDMASTER CORP. 506 | 95 | COMPUTERS WHOLESALA 126 | 179 | HAYES MICROCOMP.PROD. 80, 81 | 263 | MICROTEK LAB 259 |
| 15 | ADDMASTER CORP. 506 | 96 | COMPVIEW PROD.INC. 285 | 181 | HELIX SYS.&DEV.CORP. 211 | 264 | MICROWARE 480 |
| 16 | ADV.BUSN.COMPUTERS 131 | 97 | CONROY-LOPOINTE 222, 223 | 182 | HEWLETT-PACKARD 150, 151 | | MID AMERICA WHOLESALERS 372 |
| 17 | ADV.COMP.PROD. 522, 523 | 98 | CONROY-LOPOINTE 222, 223 | 183 | HIERATIC COMP.SYS. 477 | 265 | MILLER, J.W. 514 |
| 18 | ADV.DIGITAL CORP. 391 | 99 | CONROY-LOPOINTE 222, 223 | 184 | HITECH INT'L INC. 506 | 266 | MINI MICRO MART 388 |
| 19 | ADV.SYS.CONCEPTS 438 | 99 | CONROY-LOPOINTE 222, 223 | 185 | HOLIDAY INNS, INC. 418 | 481 | MITSUBA 70 |
| 20 | ADV.TRANSDUCER DEVICES 504 | 485 | CONTROL DATA CORP. 134, 135 | 186 | HOLLYWOOD HARDWARE 502 | 268 | MOUNTAIN VIEW PRESS 227 |
| 21 | AFTERTHOUGHT ENG. 473 | | CONTROL DATA CORP. 233 | 187 | HUMAN DESIGNED SYSTEMS 111 | 269 | MOUSER ELECTRONICS 502 |
| 22 | ALF PRODUCTS, INC 196 | 101 | COPY COVER 458 | 188 | I.B.C. 17 | 270 | MPI 59 |
| 23 | ALMANAC COMP.SUPPLY 504 | 102 | CORONA DATA SYS. 181 | 489 | I.B.C. 17 | 470 | MUSYS CORP. 389 |
| 22 | ALPHA BYTE COMP.PROD. 182 | 103 | CORVUS SYS INC 415 | 189 | I.B.S. CORP. 406 | 471 | MUSYS CORP. 389 |
| 24 | ALPHA NUMERIC INT'L. 386 | 104 | COSMOS 106 | 190 | IBM CORP. 204, 205 | 272 | MYLSTAR ELECTRONICS 518 |
| 25 | ALPHA OMEGA COMPUTER 26 | 105 | CRE WHOLESALE PROD. 473 | 192 | IMAGE COMP.PROD. 518 | 273 | NATIONAL COMPUTER LTD. 264 |
| 26 | AMARAY CORP. 149 | 106 | CRE WHOLESALE PROD. 473 | 193 | IMAGING TECHNOLOGY 45 | 274 | NATIONAL INSTRUMENTS 158 |
| 27 | AMDEK CORP. 43 | 107 | CRE WHOLESALE PROD. 473 | | INDEPENDENT BUSN.SYS.INC. 263 | 275 | NEBS COMPUTER FORMS 438 |
| 29 | AMER.SQUARE COMP. 504 | 108 | CREATIVITY UNLTD. 518 | 194 | INFOCOM 337 | 276 | NEC INFORMATION SYS. 133 |
| 30 | AMPRO COMPUTERS INC. 417 | 109 | CROMEMCO INC. 5 | 195 | INMAC 65 | | NORTH HILLS CORP. 506, 516 |
| 31 | ANADEX 453 | 110 | CUESTA SYSTEMS 524 | 195 | INTEL NORTH STAR USERS 508 | 277 | NORTHWEST DIGITAL SYS. 340 |
| 32 | ANDERSON-BELL 31 | 111 | CUSTOM COMP.TECH. 515 | 196 | INTEGRAL 425 | 278 | OCTAGON SYSTEMS CORP 508 |
| 32 | APEX COMPUTER CTR. 504 | 472 | DANA COMPUTER DISCOUNT 468 | | INTEL CORP. 80, 81 | | OLD PROGRAMMERS HOME 390 |
| 33 | APERAT INC 405 | 113 | DATA SPEC 455 | 197 | INTERACTIVE STRUCT. 395 | 279 | ORBYTE SOFTWARE 308 |
| 33 | APPLE COMPUTER INC. CII, 1 | 114 | DATA SPEC 455 | 486 | INTERFACE INC. 88 | 280 | ORIX SYSTEMS 348, 349 |
| 34 | APPLE COUNTRY LTD. 495 | 118 | DATA TRANSLATION INC. 198 | 487 | INTERFACE INC. 88 | 281 | P.C. NETWORK 451 |
| 35 | APPLEWARE, INC. 424 | 117 | DATAPRODUCTS CORP. 145 | 200 | INTERC DATA SYS. 8 | | PACIFIC COMPUTERS 194 |
| 36 | APPLIED DATA SYS. 287 | 118 | DATASOUTH COMP.CORP. 254 | 202 | J.A.S. ELECTRONIC CORP 180 | 282 | PACIFIC EXCHANGES 406, 432, |
| 37 | APPLIED DIGITAL DATA SYS. 161 | 119 | DATASOUTH COMP.CORP. 311 | 201 | J.M.I. SOFTWARE CONS INC 118 | 489, 506, 508, 514, 518, 524 | |
| 38 | APPROPOS TECHNOLOGY 504 | 120 | DAVIDGE CORP. 506 | 203 | JADE COMP.PROD. 525, 526, 527 | 283 | PACIFIC INFOTECH CORP. 104 |
| 39 | ARTIFICIAL INT'L RESEARCH 508 | 121 | DIAMOND SFTW.SUPPLY 326 | 204 | JAMECO ELECTR. 318, 317 | 284 | PAN AMERICAN ELEC. INC. 502 |
| 40 | ASHTON-TATE 26 | 122 | DIGITAL RESEARCH 18, 19 | 205 | JDR MICRODEVICES INC. 536, | 285 | PANASONIC SR. PAPER 109 |
| 41 | ASHTON-TATE 378 | 123 | DIGITAL RESEARCH 266, 267 | 537 | JDR MICRODEVICES INC. 538, | 286 | PC PIPELINE 354 |
| 42 | ATS CASES INC. 400 | | DIGITAL RESEARCH COMP. 419 | 206 | JDR MICRODEVICES INC. 538, | | PENCEPT INC. 175 |
| 43 | AVATAR TECH. INC. 363 | | DIGITAL RESEARCH COMP. 494 | 539 | JDR MICRODEVICES INC. 540 | 289 | PERCOM DATA 11 |
| 44 | AVOCET 431 | 125 | DIRECT SOFTWARE 457 | 207 | JDR MICRODEVICES INC. 540 | 290 | PERCOM DATA 473 |
| 45 | B&B ELECTRONICS 502 | | DISCOUNT SOFTWARE 402 | 208 | JUKI INDUSTRY OF AMERICA | 291 | PERMA POWER ELECTRONICS 472 |
| 46 | BASF SYSTEMS 136 | 126 | DISKETTE CONNECTION 456 | 405 | KEYTHLEY/DAS 112, 113 | 292 | PERSONALIZED COMP.PAPER 400 |
| 47 | BAY TECHNICAL ASSOC. 475 | 127 | DISK WORLD 478 | 210 | KEYTRONICS CORP. 159 | 293 | PHONE I, INC. 75 |
| | BECK MFG 314 | 128 | DISK WORLD 477 | 211 | KNOWLEDGE SYS. 439 | 294 | PIKA-BOX, DIV.APPLIED COMP. 494 |
| 48 | BELL, JOHN ENGR. 514 | 129 | DISPLAY TECHNOLOGMCTNS. 499 | | KORSMEYER ELECT. DESIGN | 295 | PIPELINE COMPUTER 501 |
| 49 | BHRT 229 | 130 | DMA 309 | 122 | KUN YING ENT.CO. 472 | 296 | PJS 516 |
| 50 | BIZCOMP 393 | 131 | DOKAY COMP.PROD.INC. 528, 529 | 212 | L.F. COMPUTER PRODUCTS 524 | | PLUM HALL INC. 454 |
| 51 | BLUE CHIP 51 | 132 | DOKAY COMP.PROD.INC. 530 | 214 | LABORATORY MICROSYS. 120 | 298 | PRACTICAL PERIPH. 79 |
| | BORLAND INT'L. 47 | 133 | DOW JONES 313 | 215 | LANIER BUSN.PROD. 193 | 297 | PRACTICAL PERIPH. 253 |
| 52 | BOTTOM LINE, THE 339 | 134 | DOW JONES SOFTWARE 121 | 216 | LANIER BUSN.PROD. 193 | 298 | PRC 502 |
| | BYTE BACK ISSUE 214, 215 | 135 | DRIAS ENTERPRISES 473 | 218 | LAST ENTRY 473 | 299 | PRIMAGES INC. 463 |
| | BYTE PUBL. INC. 210 | 136 | DUAL SYSTEMS CORP. 237 | 219 | LAWSON LABS 514 | 300 | PRINCETON GRAPHIC SYS. 399 |
| | BYTE PUBL. INC. 376, 377 | 137 | DWIGHT CO., INC. 508 | 220 | LEADING EDGE PROD. CII | 301 | PRIORITY ONE 532, 533, 534, 535 |
| 54 | BYTEK COMP. SYS. CORP. 148 | 138 | DYNAMIC BUSN.PROGRAMMING 477 | 221 | LIBERTY ELECTRONICS 261 | 63 | PRO MICRO SYS 524 |
| 55 | BYTEWRITER 30 | 139 | DYNAX, INC. 157 | 222 | LIBERTY GROUP INC. 381 | 64 | PROFESSIONAL DATA SERV 354 |
| | C WARE 373 | 140 | DYSAN CORP. 359 | 222 | LINTEK INC. 254 | 302 | PROMETHEUS PRODUCTS 387 |
| | C-SYSTEMS 469 | 141 | EASTERN ENTERPRISES 350 | | LIQUIDATORS COMPANY 477 | 303 | PURCHASING AGENT, THE 258 |
| 479 | C.H. SYSTEMS 232 | 142 | EASTMAN KODAK CO. 470, 471 | 224 | LOGICAL DEVICES 58 | 304 | QUANTX DIV. 183 |
| 56 | C.S.D. INC. 440 | | ECOSOFT 368 | 225 | LOGICAL DEVICES 524 | 305 | QUADRAM CORP. 49 |
| 57 | CABLES BY WORSWICK 506 | 144 | EDUCATIONAL MICROCOMP. 469 | 226 | LOGITECH INC. 430 | 306 | QUANT SYSTEMS 434 |
| | CALIF. DIGITAL 520, 521 | 145 | ELCOMP 514 | 227 | LOMAS DATA PRODUCTS 383 | 307 | QUARK INCORPORATED 147 |
| | CALIF. MICRO COMP. 458 | 146 | ELECTRADE CO. 506 | 229 | LSI JAPAN 514 | 308 | QUBIE DISTRIBUTING 397 |
| 58 | CAPITAL EQUIPMENT 325 | 147 | ELECTRADE CO. 516 | 231 | LYBEN COMP.SYS. 406 | 309 | RADIO SHACK CIV |
| 59 | CDR SYSTEMS 434 | 148 | ELECTRADE CO. 516 | 230 | LYBEN COMP.SYS. 473 | 310 | RANA SYSTEMS 23 |
| 497 | CHAMPION SOFTWARE 327 | 148 | ELECTRALOGICS 338 | 232 | LYCO COMPUTER 493 | 311 | RAPITECH SYS.INC. 68 |
| 498 | CHAMPION SOFTWARE 327 | 149 | ELECTRONIC SPECIALISTS 258 | | M-H RECRUITMENT 202 | 312 | RELSM 398 |
| 60 | CHANNEL CONNECTION 437 | 150 | ELEK-TEK 308 | | M-H RECRUITMENT 404 | 313 | REMOTE MEASUREMENT SYS. 382 |
| 61 | CHIPS & DALE 514 | 151 | ELLIS COMPUTING INC. 420, 421 | 233 | MA SYSTEMS 370 | 473 | RESTON COMP. GROUP 441 |
| 62 | CHROMOD ASSOC. 408 | | EMPIRICAL RESEARCH GROUP 328 | 234 | MACROTECH INT'L. 413 | 314 | RIXON 487 |
| 67 | CLEVELAND CODONICS 108 | 153 | EPSON AMERICA 90, 91 | 236 | MANX SOFTWARE SYS. 78 | 315 | ROGERS LABS 504 |
| 68 | CLEYDALE ENGINEERING 524 | 154 | EPSON AMERICA 168 | 237 | MARYMAC INDUSTRIES 516 | 316 | S-100 DIV. 696 CORP. 505 |
| 70 | COGITATE 504 | 155 | ESPRIT SYSTEMS INC. 342, 343 | 238 | MAYRAND ELECTRONICS 143 | | SAFWARE 120 |
| 71 | COM SYSTEMS 504 | 156 | EXECUTIVE MANAGEMENT SYS. 155 | 239 | MC-P APPLICATIONS 315 | 319 | SAGE COMP. TECH. 357 |
| 72 | COMMERCIAL BUSINESS SYS. 531 | 157 | EXPERT COMPUTERS 507 | | MCGRAW-HILL BOOK CO. 464 | 320 | SAKATA 369 |
| 73 | COMMUNICATIONS ELECTR. 362 | 158 | EXPOTEK 252 | 242 | METROLET VIEWDATA SYS. 277 | 321 | SCOTSDALE SYSTEMS 117 |
| 74 | COMP. COMPNTS. UNLTD. 517 | 158 | EXTENDED PROCESSING 478 | 243 | MFJ ENTERPRISES, INC. 307 | 322 | SDSYSTEMS 367 |
| 75 | COMP. COMPNTS. UNLTD. 518, 519 | 159 | EXON OFFICE SYS. 329 | 244 | MICRO AGE COMP.STORES 355 | 322 | SEEQUA COMP.CORP. 7 |
| 76 | COMPAQ COMPUTER CORP. 12, 13 | 160 | FALCON SAFETY PROD. 123 | 245 | MICRO COM 62, 63 | 323 | SEITZ TECHNICAL PROD. 502 |
| 77 | COMPETITIVE EDGE 194 | 161 | FLAGSTAFF ENGINEERING 449 | 246 | MICRO CRAFT CORP 65 | 325 | SEMIDISK SYSTEMS 103 |
| 393 | COMPUADD 514 | 162 | FLOPPY DISK SERV. INC. 498 | 248 | MICRO DATA BASE 89 | 326 | SENSIBLE SOFTWARE 100 |
| | COMPU MEDIA 374 | 163 | FORMULA INT'L. 510 | 249 | MICRO DESIGN INT'L. 104 | 327 | SENTINEL COMP.PRODUCTS 20 |
| | COMPUPRO 71 | 164 | FORMULA INT'L. 510 | 250 | MICRO FOCUS 163 | | SILICON SPECIALTIES 218 |
| | COMPUPRO 288 | 165 | FOX & GELLER INC. 213 | 251 | MICRO MANAGEMENT SYS. 446 | 328 | SILVER/REED 459 |
| | COMPUPRO 435 | 166 | FREEDOM COMP. MART 500 | 252 | MICRO MART 508 | 329 | SLR SYSTEMS 504 |
| 60 | COMPUUSER 308 | 167 | FUJITSU PROFESS.MICROSYS. 257 | 254 | MICRO SYSTEMS INSTITUTE 502 | 330 | SOFTLINE CORP. 77 |
| 81 | COMPUSEARCH 443 | 168 | FUTECH INT'L. CORP. 6 | 255 | MICRO-TAX 177 | 331 | SOFTRENT 402 |
| 82 | COMPUTER APPARATUS 497 | 478 | GENERAL MICRO SYSTEMS 374 | 256 | MICRODYNAMICS 506 | 332 | SOFTWARE ARTS 190 |
| 83 | COMPUTER CHANNEL 466 | 169 | GENERAL TECHNOLOGY 107 | | | 333 | SOFTWARE BANC 375 |
| | | 170 | GENSTAR REI SALES CO. 508 | | | 334 | SOFTWARE GALORE 292 |

To get further information on the products advertised in BYTE, fill out the reader service card with your name and address. Then circle the appropriate numbers for the advertisers you select from the list. Add a 20-cent stamp to the card, then drop it in the mail. Not only do you gain information, but our advertisers are encouraged to use the marketplace provided by BYTE. This helps us bring you a bigger BYTE. The index is provided as an additional service by the publisher, who assumes no liability for errors or omissions. *Correspond directly with company.

Reader Service

| Inquiry No. | Page No. | Inquiry No. | Page No. | Inquiry No. | Page No. | Inquiry No. | Page No. |
|-------------|------------------------------|-------------|-------------------------------|-------------|-------------------------------|---|----------------------------|
| 346 | SUPERSOFT 294, 295 | 361 | TEXAS INSTRUMENTS 281 | 379 | VEN-TEL 189 | 395 | WYSE TECHNOLOGY 87 |
| 347 | SUPERSOFT 296, 297 | 362 | THOUGHTWARE INC. 98, 99 | 380 | VERBATIM CORP. 322 | 396 | X COMP INC. 283 |
| 349 | SYSTAT INC. 323 | 362 | THREE M COMPANY 89 | 381 | VIDEX 180 | 397 | X.D.S. 503 |
| 350 | SYSTEMS STRATEGIES 232 | 152 | TIGERTRONICS 514 | 382 | VISUAL COMPUTER 72, 73 | 398 | XOR CORP. 27 |
| 351 | TALLGRASS TECH. 14 | 363 | TINNEY, ROBERT GRAPHICS 450 | 383 | VISUAL TECH, INC. 56 | <i>*Correspond directly with company.</i> | |
| 352 | TATUM LABS 524 | 364 | TITAN TECHNOLOGY 279 | 384 | VISUAL TECH, INC. 407 | INTERNATIONAL ADVERTISING SECTION | |
| 353 | TAVA CORP. 231 | 385 | TOPAZ, INC. 401 | 385 | VLM COMPUTER ELECTR. 524 | 550 | ABTEX COMPUTER SYS 464B |
| 370 | TAXAN 187 | 386 | TOSHIBA AMERICA, INC. 86 | 240 | VOTRAX 481 | 551 | AMER. BUYING & EXPORT 464A |
| 371 | TAXAN 187 | 387 | TOSHIBA AMERICA, INC. 87 | 386 | WADSWORTH PROFESSNL SFTW. 195 | 552 | ULTRA SPECIALTY INC. 464C |
| 355 | TDK ELECTRONICS 360, 361 | 389 | TRANS WORLD AIRLINES 200, 201 | 387 | WANG ELECTR. PUB. INC. 74 | | BYTE PUBL. INC. 464D |
| 370 | TEKTRONIX, INC. 255 | 373 | U.S. AIR FORCE 288 | 388 | WAREHOUSE SOFTWARE 28 | NO DOMESTIC INQUIRIES, PLEASE | |
| 476 | TELEBYTE TECH 474 | 372 | U.S. ROBOTICS 119 | 389 | WASHINGTON COMP SYS. 262 | | |
| 357 | TELETEK ENTERPRISES, INC. 41 | 375 | UNIPRESS SOFTWARE, INC. 228 | | WHITESMITHS LTD 179 | | |
| 358 | TERRAPIN INC. 502 | 378 | VANKELL INDUSTRIES 192 | 390 | WILLIAMS, MARK CO. 384 | | |
| 359 | TEXAS COMPUTER SYS. 132 | 377 | VANTEC 432 | 391 | WINTEK CORP. 502 | | |
| | TEXAS INSTRUMENTS 24, 25 | 378 | VECTOR ELECTR.CO. 191 | 392 | WORLD ALMANAC 473 | | |

BYTE ADVERTISING SALES STAFF:

J. Peter Huestis, Advertising Sales Manager, 70 Main Street, Peterborough, N.H. 03458 Tel (603) 924-9281

NEW ENGLAND

ME, NH, VT, MA, RI
Paul McPherson, Jr. (617) 262-1160
McGraw-Hill Publications
607 Boylston Street
Boston, MA 02116

ATLANTIC

NJ (NORTH), NY, NYC, CT
Eugene Duncan (212) 512-2096
McGraw-Hill Publications
1221 Avenue of the Americas—39th Floor
New York, NY 10020

Dick McGurk (212) 512-3588

McGraw-Hill Publications
1221 Avenue of the Americas—39th Floor
New York, NY 10020

EAST

PA (EAST), NJ (SOUTH), MD, VA, W.VA., DE, D.C.
Daniel Ferro (215) 496-3833
McGraw-Hill Publications
Three Parkway
Philadelphia, PA 19102

SOUTHEAST

NC, SC, GA, FL, AL, TN
Maggie McClelland (404) 252-0626
McGraw-Hill Publications
4170 Ashford Dunwoody Road—Suite 420
Atlanta, GA 30319

MIDWEST

IL, MO, KS, IA, ND, SD, MN, WI, NB
Jack Anderson (312) 751-3740
McGraw-Hill Publications
Blair Building
645 N. Michigan Ave.
Chicago, IL 60611

GREAT LAKES, OHIO REGION

MI, OH, PA (ALLEGHENY), KY, IN, EASTERN CANADA
Dennis Riley (313) 352-9760
McGraw-Hill Publications
4000 Town Center—Suite 770
Southfield, MI 48075

SOUTHWEST, ROCKY MOUNTAIN

UT, CO, WY, OK, TX, AR, MS, LA
Alan Morris (214) 458-2400
McGraw-Hill Publications
Prestonwood Tower—Suite 907
5151 Beltline
Dallas, TX 75240

SOUTH PACIFIC

Southern CA, AZ, NM, LAS VEGAS
Page Goodrich (714) 557-6292
McGraw-Hill Publications
3301 Red Hill Ave
Building #1, Suite 222
Costa Mesa, CA 92626

Karen Niles (213) 480-5243, 487-1160

McGraw-Hill Publications
3333 Wilshire Boulevard #407
Los Angeles, CA 90010

NORTH PACIFIC

HI, WA, OR, ID, MT, NORTHERN CALIF, NV (EXCEPT LAS VEGAS), W. CANADA
David Jern (415) 362-4600
McGraw-Hill Publications
425 Battery St.
San Francisco, CA 94111

Bill McAfee (415) 964-0624

McGraw-Hill Publications
1000 Elwell Court—Suite 225
Palo Alto, CA 94303

WEST COAST SURPLUS AND RETAIL ACCOUNTS

Tom Harvey (805) 964-8577
3463 State St.—Suite 256
Santa Barbara, CA 93105

Post Card Mailings

National
Bradley Browne (603) 924-6166
BYTE Publications
70 Main Street
Peterborough, NH 03458

International Advertising Sales Representatives:

Mr. Hans Csokor
Publimedia
Relsnerstrasse 61
A-1037 Vienna, Austria

Mrs. Gurit Gepner
McGraw-Hill Publishing Co.
115 Yosephthal St.
Bat Yam, Israel
866 561 321 39

Mr. Fritz Krusebecker
McGraw-Hill Publishing Co.
Liebigstrasse 27C
D-6000 Frankfurt/Main 1
West Germany
72 01 81

Mrs. Maria Sarmiento
Pedro Telxela 8, Off. 320
Iberia Mart 1
Madrid 4, Spain
45 52 891

Mr. Andrew Karnig
Andrew Karnig & Associates
Kungsholsgatan 10
112 27 Stockholm, Sweden
08 51 68 70

Mr. Ken Davey
McGraw-Hill Publishing Co.
17 rue Georges Bizet
F 75116 Paris
France
720 33 42

Mr. Arthur Scheffer
McGraw-Hill Publishing Co.
34 Dover St.
London W1X 3RA
England
01 493 1451

Ms. Sandra Micheletto
McGraw-Hill Publishing Co.
Via Flavio Baracchini 1
20123 Milan, Italy
86 90 656

Seavex Ltd.
05-49/50 Tanglin Shopping Center
19 Tanglin Rd. Singapore 1024
Republic of Singapore

Seavex, Ltd.
Room 102, Yu Yuet Lal Bldg.
43-55 Wyndham St. Central
Hong Kong

Hiro Morita
McGraw-Hill Publications
Overseas Corp.
Room 1528
Kasumigaseki Bldg.
3-2-5 Kasumigaseki,
Chiyoda-Ku
Tokyo 100, Japan