

BYTE

12490



DECEMBER 1983 Vol. 8, No. 12
\$3.50 In USA
\$3.95 in Canada/£2.10 in U.K.
A McGraw-Hill Publication
0360-5260

the small systems journal

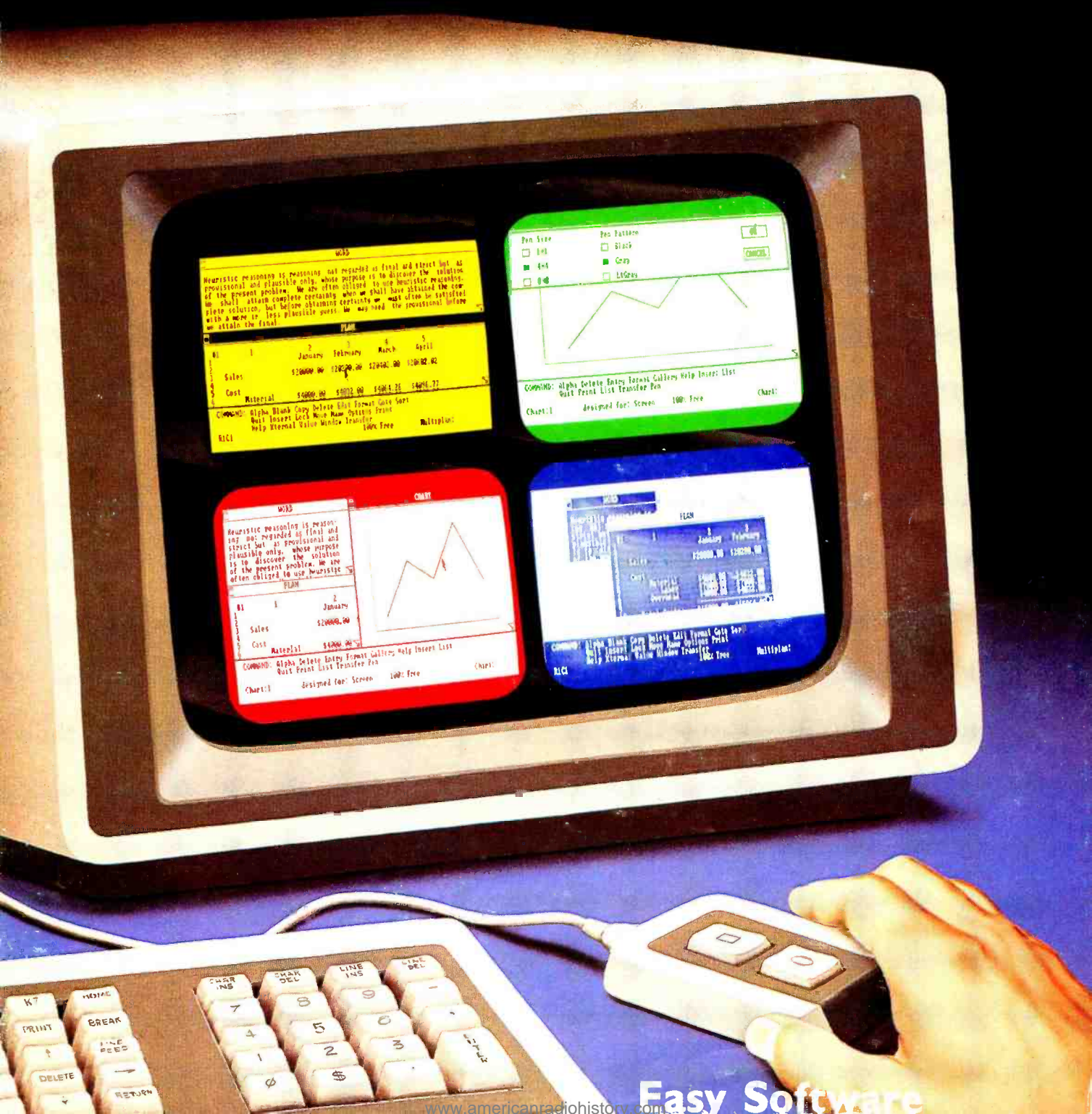

W33

Heuristic reasoning is reasoning not restricted to final and strict but as provisional and plausible only, whose purpose is to discover the solution of the present problem. We are often obliged to use heuristic reasoning, we shall attain complete certainty when we shall have obtained the complete solution, but before obtaining certainty we must often be satisfied with a more or less plausible guess. We may need the provisional before we obtain the final.

	1	2	3	4	5
	January	February	March	April	
Sales	\$20000.00	\$28000.00	\$20400.00	\$20000.00	\$20000.00
Cost	\$4000.00	\$4000.00	\$4000.00	\$4000.00	\$4000.00

COMMAND: Alpha Blank Copy Delete Entry Format Gallery Help Insert List
Quit Insert Lock Menu Main Options Print
Help Window Window Transfer 100% Free Multipoint

Pen Size: 1pt 4pt 8pt

Pen Pattern: Black Gray LightGray

COMMAND: Alpha Delete Entry Format Gallery Help Insert List
Quit Print List Transfer Pen

Chart:1 designed for: Screen 100% Free (Chart)

W33

Heuristic reasoning is reasoning not restricted to final and strict but as provisional and plausible only, whose purpose is to discover the solution of the present problem. We are often obliged to use heuristic reasoning, we shall attain complete certainty when we shall have obtained the complete solution, but before obtaining certainty we must often be satisfied with a more or less plausible guess. We may need the provisional before we obtain the final.

	1	2
	January	February
Sales	\$20000.00	\$28000.00
Cost	\$4000.00	\$4000.00

COMMAND: Alpha Blank Copy Delete Entry Format Gallery Help Insert List
Quit Insert Lock Menu Main Options Print
Help Window Window Transfer 100% Free Multipoint

W33

	1	2
	January	February
Sales	\$20000.00	\$28000.00
Cost	\$4000.00	\$4000.00

COMMAND: Alpha Blank Copy Delete Entry Format Gallery Help Insert List
Quit Insert Lock Menu Main Options Print
Help Window Window Transfer 100% Free Multipoint



Easy Software



Inside Apple

Vol. 1, No. 4

A dot matrix printer that will improve your image.

Meet the Apple® Imagewriter, the newest dot matrix printer for your Apple Personal Computer.

And with all that it has going for it, just maybe the best dot matrix printer on the market.

Take legibility, for instance.

The Imagewriter crams 140 x 160 dots into each square inch. So you get text that's highly readable and high resolution graphics, besides.

And is it fast.

The Imagewriter cruises at an unbelievable 120 characters per second. And that's just in the text mode. It's even faster printing graphics. 180 characters per second, to be exact.

What's more, the graphics dump is up to 60% faster than other comparably priced dot matrix printers. And that makes the Imagewriter fast enough to handle the Lisa™

Yet it's just as at home with an Apple III or Apple IIe. Thanks to Apple software experts who designed the control electronics to give the Imagewriter perfect compatibility. Not to mention some special capabilities

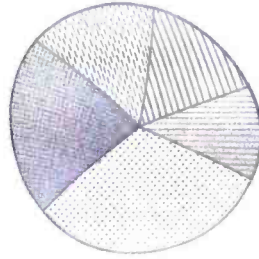

like superscript and subscript, to name just two.

Now, with all this high-speed performance, you'd expect the Imagewriter to make the Devil's Own Noise. It doesn't. In fact, the Imagewriter is specially constructed — with overlaid seams and special sound-deadening materials — to achieve a remarkable 53 dB. How loud is a remarkable 53 dB? You'd make more noise if you read this aloud.

The Imagewriter even has quiet good looks, since we designed it to look like the rest of the Apple Family.

Yet even with all its improvements, the Imagewriter is a better deal than any other dot matrix printer with comparable

performance. And you can print that.

**APPLE PRESENTS THE
E IMAGewriter APPLE PR
ESENTS THE IMAGewriter APPLE PRESENT
S THE IMAGewriter APPLE PRESENTS THE IMAGewriter APPLI**

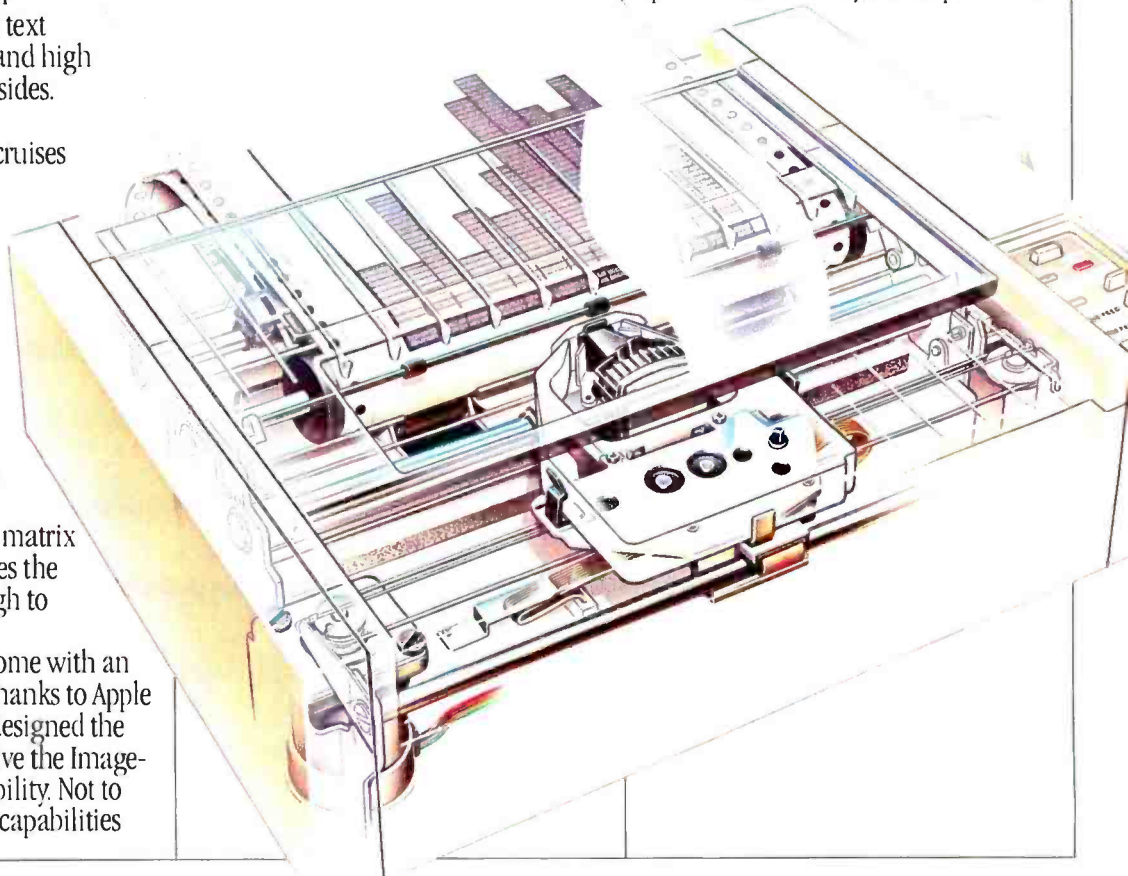



Charge!

Go out there and get the Apple Personal Computer System you really want. Now. Without laying out your extra cash. Without tying up your other lines of credit. With the Apple Card. The only consumer credit card reserved exclusively for the purchase of Apple Computers, peripherals and software.

Like all our products, it works simply:

Fill out an application (short, to the point and annotated in English) at an authorized Apple dealer honoring the Card. Your salesperson will call in the application and in most cases get an approval for you right on the spot.

You can then take your Apple system home. You don't even have to wait for the Card; we'll mail it out to you. And by the time you get it, you'll probably be well into doing whatever you bought your Apple system to do.

There is no annual fee for the Card, although a couple of restrictions do apply. The first purchase must include an Apple Personal Computer and you have to put 10% down. And subsequent purchases need to be at least \$100 if made with the Card. Oh, yes — you'll also have a credit limit.

When you use the Apple Card to make additional purchases, all you have to do is show the Card and sign the invoice. As long as it's within your credit limit, of course. Our dealers get a little nervous when someone signs for half their inventory. You understand.

You'll also receive monthly statements that include the latest purchases, credit available, and the minimum payment due. You'll also be happy to know Apple Card credit terms are affordable and the payments can be spread out. It's all

spelled out for you at the time your Card is approved.

So stop by a participating authorized Apple dealer and get an Apple Card. Just think of it as credit where credit is due.

Give your floppy disks the boot.

We call it the "floppy disk shuffle." It happens when you have two or more software programs on floppies and you need to work with both. What do you do? You put one disk in, boot it, do your work, take it out, put the other disk in, boot it, do your work — you get the idea.

Well, you can stop shuffling any time now.

Thanks to a unique new software program called Catalyst™ from Quark, Inc. Specially designed for your Apple III and ProFile™ hard disk.

Catalyst allows you to take a wide variety of software programs and store them on your ProFile. Once they're on your ProFile, you just select the program you want from the Catalyst menu that appears on your monitor — then Catalyst does the rest. You'll never have to boot those programs again.

What kinds of programs will work with ProFile and Catalyst?

Almost anything written for the Apple III including copy-protected programs like VisiCalc,™ Quick File™ and Apple Writer III. Or languages like Pascal, BASIC, or COBOL.

And once you've loaded these programs into your ProFile, the only diskette you may ever need is the Catalyst.

So if you have an Apple III and a ProFile and more floppies than you care to flip through, get yourself a Catalyst. And boot those disks for good.

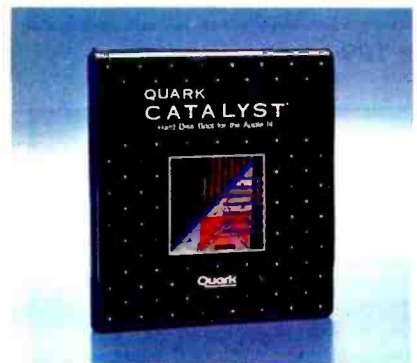



Page 36



Page 48



Page 189

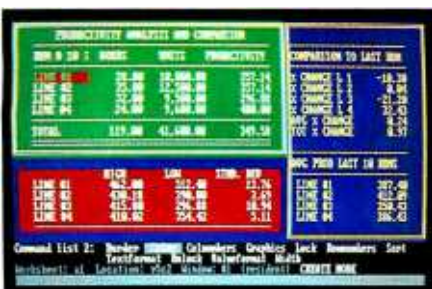

Page 199

Columns

36 Keep Power-Line Pollution Out of Your Computer by Steve Ciarcia / When lightning struck his home and did \$3000 worth of damage, Ciarcia decided to strike back with this month's Circuit Cellar project.

48 BYTE West Coast: Microsoft Windows by Phil Lemmons / Microsoft Windows lets you test the effectiveness of the desktop metaphor and the mouse.

59 User's Column: Buddy, Can You Spare a Door Latch? by Jerry Pournelle / What to do when your disk-drive door is on the fritz and other comedies of errors at Chaos Manor.

Themes

100 Easy Software by Phil Lemmons / Making software easy to use is simpler to say than to do. This month's theme articles explore a variety of approaches to user-interface technology and sample programmers' attempts at making software do more with less effort.

103 An Introduction to Integrated Software by Dash Chang / Concurrency, shared technology, and functional integration are three ways of integrating software.

113 Presentation and Form in User-Interface Architecture by John M. Carroll / With the help of a test group, the author and his colleagues developed an interface that facilitates ease of use and ease of learning.

127 Why Is Software So Hard to Use? by Sam Edwards / Chances are it's the software's fault and not yours.

143 Walt Disney and User-Oriented Software by Paul Heckel / Software designers can learn a few things from Mickey Mouse about communicating ideas.

155 Making Life Easier for Professional and Novice Programmers by Andy Pope, Geoff Kates, and Dan Fineberg / A debugger that "animates" the program's source code on the screen and lets the programmer engage in what-if analysis to find logic errors can drastically reduce debugging time.

161 Simplify, Simplify, Simplify by Martin Dean / In an attempt to design a truly easy-to-use database manager, the author disregarded nifty features and clever, complex functions in favor of starting fresh.

177 Integrating Voice in the Office World by Robert T. Nicholson / The ability to record a spoken message and store it digitally on a computer system makes possible a whole new range of applications.

189 The Starburst User Interface by Steven Vandor / This software package helps you build efficient, powerful menus.

199 The Complete Information-Management System by Michael J. Brown / The ideal information-management package maximizes hardware attributes and minimizes user interaction.

210 The Allegory of Software by Tom Houston / Tired of the same old desktop metaphor? Maybe the digital kitchen is more up your alley.

218 The New Interface Technology by Robert W. Warfield and George M. White / A close-up look at mice, windows, and other software and hardware developments that make computer systems easier to use.

234 Trackball Interfacing Techniques for Microprocessors by Edward W. Andrews / This simple hardware/software interface device is easy to adapt to your interactive personal computer applications.

247 The User Interface: Two Approaches by Martin Herbach, Richard Katz, and Joseph Landau / The philosophical vs. the pragmatic approach to the construction of an efficient user interface.

263 The Future of Metaphor in Man-Computer Systems by Chuck Clanton / Learnability is the single most important concern in user-interface design.

BYTE is published monthly by McGraw-Hill Inc., with offices at 70 Main St., Peterborough, NH 03458, phone (603) 924-9281. Office hours: Mon—Thur 8:30 AM — 4:30 PM, Friday 8:30 AM — Noon, Eastern Time. Address subscriptions to BYTE Subscriptions, POB 590, Martinsville, NJ 08836. Address changes of address, USPS Form 3579, and fulfillment questions to BYTE Subscriptions, POB 596, Martinsville, NJ 08836. Second-class postage paid at Peterborough, NH 03458 and additional mailing offices. USPS Publication No. 528890 (ISBN 0360-5280). Postage paid at Winnipeg, Manitoba. Registration number 9321. Subscriptions are \$21 for one year, \$38 for two years, and \$55 for three years in the USA and its possessions. In Canada and Mexico, \$23 for one year, \$42



Reviews

282 Reviewer's Notebook by Rich Malloy / BYTE's product-review editor comments on products slated for review.

286 The Texas Instruments Professional Computer by Mark Haas / Based on Intel's 8088 16-bit chip, TI's Professional Computer is the Data Systems Group's entry into the personal computer arena.

329 The ATR8000 by Dave Small and Sandy Small / With SWP's Z80 computer, Atari users can run CP/M-based programs.

343 The Hercules Graphics Card by Tom Wadlow / If you want crisp, attractive text as well as graphics on the IBM PC, the Hercules Graphics Card is for you.

360 The Wang Professional Computer by Elaine Long / This 16-bit microcomputer provides an easy-to-use word-processing program with sophisticated features.

372 In Search of the Most Amazing Thing by Elaine Holden / This adventure game for the IBM PC, Apple, Atari, and Commodore 64 offers you an entire world to explore in your quest for a hidden object.

Features

380 Color Graphics from Any Computer by Frederick B. Essig / How to make high-quality full-color graphics from your black-and-white monitor.

400 Mainframe to Micro: Adapting a Financial-Modeling Language by Greg Dunn / As the microcomputer moves into the office, software developers face new challenges in translating existing mainframe software to the microcomputer environment.

417 POKEing Around in the IBM PC, Part 2: Subroutines for the BIOS Interface and Screen-Display Disk Storage by Hugh R. Howson / In this final article, the author develops a general-purpose BIOS-interface subroutine that can transfer parameters from a BASIC program to the BIOS and can store BIOS results in memory.

443 The CMOS 6502 by Steven Hendrix / Rockwell's CMOS version of the 6502 microprocessor fills a number of gaps in the standard 6502's instruction set and offers low power-consumption advantages.

457 A Tiger Meets a Dragon by Dan Rollins / A look at dragon-curve designs and how to print them on an IDS Paper Tiger printer.

481 A Computer-Algebra-Based Calculating System by Stuart Edwards / By performing automatic unit conversion, this super-calculator saves time and effort and prevents common errors.

519 The User Looks at Books by Jerry Pournelle / Jerry takes time out to round up the best and worst books on CP/M, Pascal, C, and Ada.

Nucleus

- | | |
|--|--|
| 4 Editorial: Christmas in Chapter XI | 568 Event Queue |
| 7 MICROBYTES | 574 What's New? |
| 11 Letters | 596, 598 Book Reviews: Electronically Speaking: Computer Speech Generation: Mastering CP/M |
| 358, 594 BYTE's Bits: IBM Announces the PCjr; Two New Office Products from IBM | 653 Unclassified Ads |
| 499 User to User | 654 BYTE's Ongoing Monitor Box, BOMB Results |
| 530 Software Received | 655 Reader Service |
| 546 Clubs and Newsletters | |
| 550 Books Received | |
| 554 Ask BYTE | |



Page 286



Page 372

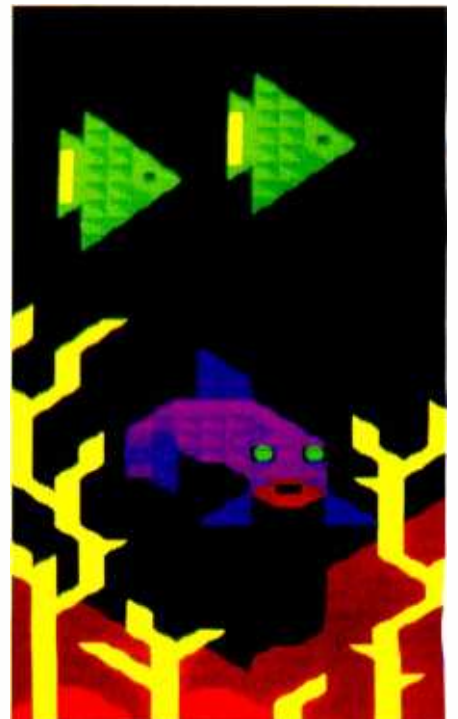

Page 380

Cover painting by Robert Tinney; photographs courtesy of Microsoft

for two years, \$61 for three years, \$53 for one year air delivery to Europe, 17,100 yen for one year surface delivery to Japan, \$37 surface delivery elsewhere. Air delivery to selected areas at additional rates upon request. Single copy price is \$3.50 in the USA and its possessions, \$3.95 in Canada and Mexico, \$4.50 in Europe, and \$5.00 elsewhere. Foreign subscriptions and sales should be remitted in United States funds drawn on a US bank. Printed in the United States of America.

Subscription questions or problems should be addressed to:
 BYTE Subscriber Service, POB 328, Hancock, NH 03449



Editor in Chief: Lawrence J. Curran

Managing Editor: Pamela A. Clark

Senior Technical Editors: Gregg Williams, Richard Malloy, G. Michael Vose

Technical Editors: Richard S. Shuford, Arthur A. Little, Stanley Wszola, Bruce Roberts, Gene Smarte; Anthony J. Lockwood, New Products Editor; Steve Ciarcia, Consulting Editor; Mark Welch, Staff Writer; Alan Easton, Drafting Editor.

West Coast Editors: Philip Lemmons, Bureau Chief; Donna Osgood, Assistant Editor. McGraw-Hill, 425 Battery Street, 4th Floor, San Francisco, CA 94111 (415) 362-4600

Copy Editors: Nancy Hayes, Chief; Warren Williamson, Elizabeth Kepner, Joan V. Roy, Dennis E. Barker, Anne L. Fischer, Bud Sadler, Margaret Cook

Assistants: Faith Kluntz, Beverly Jackson, Lisa Jo Steiner, Jeanann Waters, Peggy Dunham

Production: David R. Anderson, Assoc. Director; Jan Muller, Virginia Reardon, Michael J. Lonsky; Sherry McCarthy, Chief Typographer; Donna Sweeney, Valerie Horn, Len Lorette

Advertising: Deborah Porter, Supervisor; Marion Carlson, Rob Hannings, Cathy A. R. Drew, Lisa Wozmak, Jeanne Cilley, Jeanna Reenstierna; Patricia Akerley, Reader Service Coordinator; Wai Chiu Li, Quality Control Manager; Linda J. Sweeney, Advertising/Production Coordinator

Advertising Sales: J. Peter Huestis, Sales Manager; Sandra Foster, Administrative Assistant

Circulation: Gregory Spitzfaden, Director; Andrew Jackson, Subscriptions Manager; Barbara Varnum, Asst. Manager; Agnes E. Perry, Louise Menegus, Jennifer Price, Jane Varnum, Phil Dechert, Mary Emerson; James Bingham, Single-Copy Sales Manager; Deborah J. Cadwell, Asst. Manager; Carol Aho, Linda Turner

Marketing Communications: Horace T. Howland, Director; Vicki Reynolds, Coordinator; Stephanie Warnesky, Graphics Design Manager; Michele P. Verville, Research Manager

Business Manager: Daniel Rodrigues

Controller's Office: Kenneth A. King, Asst. Controller, Mary E. Fluhr, Acct. & DIP Mgr.; Karen Burgess, Linda Short, Vicki Bennett, Vern Rockwell, Lyda Clark, Janet Pritchard, JoAnn Walter, Julie Ferry

Traffic: N. Scott Gagnon, Manager; Brian Higgins, Cynthia Damato

Receptionist: Linda Ryan

Personnel/Office Manager: Cheryl A. Hurd

Associate Publisher/Production Director: John E. Hayes

Publisher: Gene W. Simpson;
Doris R. Gamble, Publisher's Assistant

Editorial and Business Office: 70 Main Street, Peterborough, New Hampshire 03458 (603) 924-9281

Officers of McGraw-Hill Publications Company: President: John G. Wrede; Executive Vice Presidents: Paul F. McPherson, Operations; Walter D. Serwatka, Finance & Services. Senior Vice President-Editorial: Ralph R. Schulz. Senior Vice President Publishers: Harry L. Brown, David J. McGrath, James R. Pierce, Gene W. Simpson, John E. Slater. Vice President Publishers: Charlton H. Calhoun III, Richard H. Larsen, John W. Patten. Vice Presidents: Kemp Anderson, Business Systems Development; Shel F. Asen, Manufacturing; Michael K. Hehir, Controller; Eric B. Herr, Planning and Development; H. John Sweger, Jr., Marketing.

Christmas in Chapter XI

Personal computers are priced within the reach of many potential buyers looking to reward themselves or their companies with some special indulgence at this time of year. If you've been thinking about buying a machine, you've probably been weighing the performance specifications of several vendor offerings. But have you included in your list of questions about hardware and software one that could prevent you from making a selection you'll later regret: Will the hardware manufacturer still be in business a year from now?

You know that software availability usually lags behind hardware introduction, sometimes by months, so you'll want to know that a new machine can run most of your existing software. And you'll certainly want assurance about who will repair a new computer and how quickly. But in the midst of mutterings about a pending shakeout in the personal computer business and hard evidence of company failures, how can you assure yourself about the very viability of a vendor?

One attribute of a "survivor" company is solid financing, especially if the company is a young one. The dollar drain triggered by graduation from the start-up phase to volume production has ruined many a fast-growing new company that found itself unable to deliver finished goods because of a cash shortage that resulted in an inability to pay for parts.

Innovative start-ups sometimes get distracted by an infatuation with technology, regardless of the technology's market appeal. Such a situation often leads to the development of a computer that has esoteric appeal but that will not attract enough software development to assure market acceptance for the product and company.

The breadth of its product line is another characteristic of a successful computer vendor, whether the company is a start-up or a proven survivor. Firms that hitch their fortunes to narrow niches—those that serve only the portable computer market, for example—face more risks than those whose product lines have entries in several niches at several price points.

Buyers should consider other important attributes of successful computer companies as well, including the company's approach to mass distribution, which often assures quick delivery and repair, when needed. But perhaps the most important question that should be answered is whether the company whose product you're considering is truly a computer company. If nobody in top management in the company has sound computer hardware or software credentials, the company may be a conglomerate or a semiconductor manufacturer whose long-term commitment to the computer business is questionable.

Several years ago, the then Philco-Ford Corporation and GTE Sylvania, both broadly recognized as reputable manufacturers of consumer and military electronic products, were also in the merchant semiconductor market. They aren't today, probably because when their commercial semiconductor operations ran into financial difficulties, as any business will, nobody in top management came from semiconductor roots; there wasn't any senior "sponsor" to sustain a commitment to that business.

So read all you can about the companies whose products are on your list, and ask a lot of questions. Otherwise, you could end up with a computer from a supplier who spends this or next Christmas in Chapter XI bankruptcy proceedings.

—Lawrence J. Curran, Editor in Chief

How Cromemco plugs you into the state of the art.

Cromemco offers you the most complete line of S-100 boards and peripherals in the business. These boards use the new IEEE-696 state-of-the-art standard. One-stop shopping can satisfy your design needs the easy way.

You can build one system, or a hundred, exactly the way you want, and upgrade existing systems with a simple board swap or addition. And since we design our own boards for our own systems, we always take advantage of the latest developments in IC technology.

68000 microprocessor performance. Cromemco's Dual Processor Unit gives you the best of both worlds: the

68000 and the Z-80A microprocessors on the same board. It's the easiest way to move into 68000 performance and still use your existing 8-bit software. Or use Cromemco's Z-80A CPU board or our Z-80A-based single board computer.

For selection, Cromemco can't be matched. From the well-known SDI High Resolution Color Graphics board to the new 512MSU, 512K byte RAM board. From our highly reliable Local Area Network interface (C-NET) to our wide variety of general purpose interface boards. And you can put them in one of our 8-, 12-, or 21-slot card cages with our 12 amp PS-8 power supply to get your system into operation fast.

We have over 30 S-100 boards to fill your needs. And all are supported by a broad line of software. Our Board Products Catalog has the latest information. Call today for your copy, or to get the name of our nearest dealer or distributor. Or, write Cromemco, Inc., 280 Bernardo Avenue, P.O. Box 7400, Mountain View, CA 94039. Tel: (415) 964-7400. In Europe: Cromemco A/S, Vesterbrogade 1C, 1620 Copenhagen, Denmark.

In the U.S., contact your local Hall-Mark or Kierulff distributor.

Cromemco

Circle 127 on inquiry card.



CHAMELEON

by SEEQUA

\$1995 Complete

The IBM® Compatible Computer

BOTH WORLDS OF PROCESSING

Using a unique dual processor technology, the Chameleon by SEEQUA is both IBM-PC compatible and CP/M-80™ compatible providing the largest software support available.

TWICE THE MEMORY

128K bytes RAM are standard, internally expandable to 256K. And 320K formatted disk storage is included.

SOFTWARE INCLUDED

Your computer is delivered with SEEQUA's MS-DOS, compatible with the IBM

standard 16 bit PC-DOS operating system. It includes Perfect Writer for word processing and Perfect Calc for financial analysis. And it has MBasic to let you write your own routines. Chameleon comes standard with 640 x 200 resolution black and white graphics and 320 x 200 resolution color graphics.

EXPANDABLE

Chameleon has both serial and parallel ports standard. You can add an additional serial port or the IEEE-488 port. You can even use IBM PC compatible add-on boards in our optional expansion interface package.

FITS IN YOUR ENVIRONMENT

Chameleon is at home in your office. But its compact packaging makes it easy to carry elsewhere.

To learn more about Chameleon's power, call us at 800-638-6066. We'll put you in touch with our closest dealer.



8305 Telegraph Road
Odenton, MD 21113
(301) 672-3600 or
(800) 638-6066

The following are registered trademarks:
CP/M-80 — Digital Research Inc.
MS-DOS — Microsoft®
PC-DOS — IBM
Perfect Writer — Perfect Software
Perfect Calc — Perfect Software
MBasic — Microsoft®
IBM — International Business Machines



Circle 382 on inquiry card.

MICROBYTES

Staff-written highlights of late developments in the microcomputer industry.

IBM SHOWS TWO VERSIONS OF THE PCjr, PROMISES DELIVERY IN '84

IBM announced the PCjr, its long-awaited home computer that was code-named "Peanut." This new machine features an 8088 microprocessor, 64K bytes of RAM, and a detached keyboard linked via infrared light. The new machine also features two cartridge slots for game cartridges, a joystick, a light pen, and serial connectors. Two configurations will be offered. The "Entry" system, which has no disk drive, will sell for \$669. The "Enhanced" system, which features a 5¼-inch half-height floppy-disk drive (360K bytes) and 128K bytes of RAM, will cost \$1269. The Enhanced system will run many, but not all, IBM PC programs. Deliveries of these machines should begin in the first quarter of 1984. For more details, see page 358.

IBM ALSO ANNOUNCES A COLOR PRINTER

In what seemed to be a flurry of new product announcements, IBM added yet one more: the IBM Personal Computer Color Printer. This new printer features three printing modes: data-processing quality (200 characters per second), text quality (110–150 char/sec), and near-letter-quality (30–40 char/sec). With a "Process" ribbon, which has four bands of color (black, magenta, cyan, and yellow), the printer can print eight colors. The printer also supports proportional spacing and bit-mapped graphics and is compatible with the IBM Graphics Printer.

TWO CHIP MAKERS ANNOUNCE NEW VERSIONS OF MICROPROCESSORS

National Semiconductor, Santa Clara, CA, is shipping samples of its 32032 microprocessor, with full production of the CMOS chip scheduled for April 1984. The NS32032 shares the same 32-bit internal architecture as the NS08032 and NS16032 (the 8- and 16-bit data-bus versions), but its 32-bit data bus allows it to execute more than 1 million instructions per second. While the NS32032 now sells for \$220 in quantity, National Semiconductor expects the price to drop to between \$20 and \$60 by 1985.

The Western Design Center, Mesa, AZ, is preparing to begin test production of the 65816, a 16-bit CMOS version of the popular 6502 microprocessor used in Apple, Commodore, and Atari computers. The processor, which uses an 8-bit data bus and allows 24-bit addressing (to address up to 16 megabytes of RAM), will come in two versions, one of which will be pin-compatible with the existing 6502 so that it can be used in the same equipment, according to the designer. The Western Design Center plans to begin full production in the first half of 1984, with a price of about \$20 per chip. Once that chip is in production, WDC also hopes to prepare a 32-bit version with a 16-bit data bus.

Hayden Software, Lowell, MA, is preparing an assembler and a Pascal compiler for the 65816, to be available in early 1984.

WANG INTRODUCES DIGITIZING IMAGE SCANNER FOR THE PROFESSIONAL COMPUTER

Wang Laboratories, Lowell, MA, has given its Professional Computer "eyes" in the form of a desktop scanner that digitizes images at a resolution of 200 dots per inch (1728 by 2200 pixels for the maximum 11- by 14-inch image). Images can be enlarged, reduced, or rotated 90 degrees and merged with word-processing text. The complete Professional Image Computer, with a 10-megabyte hard disk (to store about 100 images), monitor, thermal printer, and image scanner, sells for \$14,965.

CALIFORNIA COMPANY DEVELOPING GALLIUM ARSENIDE COMPUTER CIRCUITS

Gigabit Logic Inc., Newbury Park, CA, expects to have GaAs semiconductor devices ready for customer sampling by February or March. Gallium arsenide is superior to silicon for high-speed logic and memory components because it permits greater mobility for electrons moving through the semiconductor.

Gigabit Logic says GaAs RAM devices could have access times of 1 nanosecond, compared to 5 to 7 nanoseconds for the fastest silicon RAMs. Logic circuits made with GaAs are expected to operate 3 to 10 times faster than today's fastest silicon logic. Gigabit's first products will include various small- and medium-scale ICs; the first 1-nanosecond RAMs could be available for sampling in the first quarter of 1985. GaAs circuits will be priced substantially higher than similarly sized silicon logic and memory devices, but computer manufacturers may be willing to pay an initial premium to get the higher speed offered. One of the first applications of GaAs devices in small computers may be as display generators, offering high-speed, high-resolution graphics.

SHUGART UNVEILS A \$6000 OPTICAL-DISK DRIVE WITH 1 GIGABYTE OF STORAGE

Shugart Corp., Sunnyvale, CA, has announced a 1-gigabyte (1-billion character) laser-based optical-disk drive with a volume price of \$6000 each (plus \$1500 for an SCSI controller). The drive uses nonerasable 12-inch optical disks, which cost between \$100 and \$150 each. Shugart suggests that the first use of optical storage might be as a file server for networked personal computers. Shugart sells 3½-, 5¼-, and 8-inch disks to computer manufacturers and will target the optical drive to the same market.

NEW SOFTWARE INTRODUCED FOR IBM PERSONAL COMPUTER

Mosaic Software, Cambridge, MA, has announced Integrated Six, a \$495 integrated-software package including spreadsheet, database-management, word-processing, graphics, communications, and terminal-emulation capabilities. . . . **Symmetric Software**, Newport Beach, CA, is offering Blue, a multiple-window color word processor for \$150. . . . **Quicksoft**, Seattle, WA, sells PC-Write, a word-processing package, for \$10. Quicksoft encourages users to copy the program but charges \$75 to register the program. Registered users receive updates and bound documentation. . . . **Scientia Inc.**, Wellesley, MA, introduced Concept VP, a window-oriented operating environment for the IBM PC. The \$350 program will enable users to switch between application programs using a mouse or cursor keys. . . . **Excalibur Technologies Corp.**, Albuquerque, NM, is now selling IBM PC versions of Savvy, its natural-language database-management system previously available only for the Apple II Plus and IIe. Three versions are available, ranging from \$349 to \$950. . . . **Concentric Data Systems**, Westborough, MA, plans to offer an easy-to-use database-management program for the IBM PC. The Concentric Information Processor will sell for \$395.

NANOBYTES

IBM has announced two new versions of the Personal Computer: the XT/370 and the 3270 PC. See page 594 for details. . . . **Apple Computer**, Cupertino, CA, has announced a \$325 database-management program for the Apple III. Apple has also developed a programmer's toolkit for the Lisa computer. Lisa Port provides the complicated software needed to manage the mouse- and window-based environment, thus enabling most software developers to run their applications on the Lisa. . . . **Compuserve**, Columbus, OH, will test the effects of advertisements and direct-marketing offers on its information service beginning in January. One- or two-line spot ads will be used on menu pages, and catalog and product information will also be available during the four-month pilot program. . . . **Hitachi Ltd.**, Tokyo, has developed an 8-inch floppy-disk drive using a special disk with an unformatted capacity of 9.6 megabytes. Samples of the drive will be available next month for about \$1075. . . . **Microcom Inc.**, Norwood, MA, has introduced ERA-2, a communications system for the IBM PC and the Apple IIe. Including software and a 1200-bps modem, ERA-2 will sell for \$429. . . . **Intel Corp.**, Santa Clara, CA, has announced a nonvolatile 4K-byte RAM chip made by backing up 4K bytes of RAM (with an access time of 200 nanoseconds) with a 4K-byte EEPROM. The 2004 nonvolatile RAM will be available in early 1984 at a price of \$25.10 each in 100-unit quantities. . . . **Texas Instruments**, Lubbock, TX, cancelled plans to introduce the 99/8 home computer this fall. . . . **Compaq Computer Corp.**, Houston, TX, is shipping the Compaq Plus, a hard-disk version of its IBM PC-compatible portable computer. The \$4995 machine includes a 3½-inch hard disk mounted with a shock-isolation system. . . . **Seagate Technology**, Scotts Valley, CA, is shipping samples of a 12-megabyte half-height 5¼-inch hard-disk drive. The ST212 is designed for portable computer applications and will sell for \$690 in 1000-unit quantities. . . . **Enter Computer**, San Diego, CA, has introduced a six-pen plotter, the Sweet Pea Model 600, for \$1075. . . . **Bridge Communications**, Cupertino, CA, has announced Communications Server/100, which connects 10 RS-232C devices to Ethernet for as little as \$3900. . . . **Micro Office Systems Technology**, Fairfield, CT, has introduced the Road Runner, a 5-pound notebook-size portable computer with cartridge-based software and memory and an 8-line by 80-character LCD built into its flip-up cover. The Z80-based system with 64K bytes of RAM, bundled software, a serial port, and a built-in 300-bps modem sells for \$1895. . . . **Compugraphic Corp.**, Wilmington, MA, has introduced the Personal Composition System, which links the Apple Lisa to a Compugraphic typesetter. The system, which is priced from \$26,895 including the Lisa and typesetter, was designed for office users who want typeset-quality computer output.



“Your Portfolio, Sir.”

DOW JONES INVESTMENT EVALUATOR™— the computer software that serves your personal investment needs at home, accurately and efficiently.

A Personalized System

With the INVESTMENT EVALUATOR, your home computer and a telephone modem, you have a personalized system for managing your portfolio. A system that automatically updates and tracks only those stocks you want to follow — allowing you to evaluate your position at a glance.

Easy Access to News/Retrieval®

This software automatically dials and connects you with Dow Jones News/Retrieval®, the world's leading supplier of computerized information on demand. It allows you and your family access to current quotes, financial and business news, general news, movie reviews, sports, weather and even the Academic American Encyclopedia.

The Right Amount of Software for the Job

The INVESTMENT EVALUATOR gives you the capabilities you need without making you pay for a lot of complex functions you may never use. Menu screens lead you to what you want with one-touch commands. The program is completely reliable, comes with an easy-to-follow manual and is fully supported by the Dow Jones Customer Service hotline.

From Dow Jones, Publishers of The Wall Street Journal

Dow Jones has been serving the business and financial communities for over 100 years. Now Dow Jones Software™ serves you at home.



For a free brochure call:
1-800-345-8500 ext. 262

(Alaska, Hawaii and foreign call 1-215-789-7008 ext. 262)

DOW JONES SOFTWARE™

Dow Jones Investment Evaluator™

Available for Apple II, Apple IIe, IBM PC and T1 Professional. Compatibility with Atari and Commodore to follow.

...Bank on it.

Copyright © 1983 Dow Jones & Co., Inc. All rights reserved.

With all the clamor about personal computers, a fundamental fact is often overlooked: some simply *work* better than others.

Consider the COMPAQ Portable.

A computer will make you more productive. A computer will make you more efficient. You hear it everywhere. But you don't hear about which computer actually *works* best.

A computer isn't magic. It's a tool. And just like other tools, some computers work better than others.

The COMPAQ™ Portable is a combination of 20th-century electronics and 19th-century pragmatism. It simply does personal computing better. Here's why.

Works in more places

You don't do all your thinking in one place. Why have a computer that stays in one place?

The COMPAQ Portable has all the capabilities of a large desktop computer. But now those capabilities can go where you go.

You can move it from office to office to share its resources. You can move it into the conference room to answer questions when and where they come up.

With the COMPAQ Portable, you can be as productive in your hotel room or your lake house as in your own office. It's a reliable companion on a business trip. It's a powerful sales aid in your customer's office.

What's more productive than a computer? A computer that works for you in more places.

Works with the greatest number of programs

The most important consideration when you choose a computer is "what programs will it run?" And that's one more reason for choosing the COMPAQ Portable.

The COMPAQ Portable runs more programs

The COMPAQ Portable was designed to fit under a standard airline seat so you can take it on business trips.



The unique aluminum frame of the COMPAQ Portable has cross-members that strengthen it front-to-back, side-to-side, and top-to-bottom. It's a design practice commonly used in race cars.

than any other portable. In fact, it runs more than most non-portables. That's because it runs all the popular programs written for the IBM® Personal Computer. There are hundreds of them. They are available in computer stores all over the country, and they run without any modification, right off the shelf.

Imagine the power of a *portable* word processor. There are dozens of different word processing programs available for the COMPAQ Portable.

Planning, problem-solving, and "what-ifs" are a cinch with a variety of popular electronic spreadsheet programs. The COMPAQ Portable runs them all.

There are accounting programs for anything from computerizing your family budget to full-scale professional management of payables, receivables, inventory, and payroll for your company.

There are programs for making charts and programs for communicating with other computers. Or if you want something really specialized, there are even program languages for writing your own programs.

So, you get portability and you don't give

up problem-solving power. The combination adds up to the most useful personal computer on the market today.

Works better because it's easy to read

The display screen of the COMPAQ Portable measures nine inches diagonally. It shows a full "page width" of 80 characters on a line so tasks like word processing are easier. And those characters are big enough to read even if you're leaning back in your chair.

The display shows both high-resolution graphics and easy-to-read, upper- and lowercase characters. One screen



There are hundreds of useful programs for the COMPAQ Portable because it runs all the popular programs written for the IBM.

for all the information. With some personal computers, including the IBM, you can have either the graphics or the legible characters, but you can't have both unless you buy two different displays.

Incidentally, computer prices are often quoted without a display. The display of the COMPAQ Portable is built in, of course.

Add-on options make it work the way you work

Inside the COMPAQ Portable are three open slots. Electronic devices called expansion boards fit those slots and give the COMPAQ Portable new powers.



Just like the programs, expansion boards designed for the IBM work with the COMPAQ Portable, so there are dozens available right now. With them, you can make your personal computer more personal.

Want to check a stock price? Or look up something in The New York Times Information Service? One expansion board enables the COMPAQ Portable to handle those communications over ordinary phone lines.

Want to use your company's central computer files while you're on a trip? There are boards that allow the COMPAQ Portable to communicate with a variety of large mainframe computers.

Other boards let you hook up controllers for computer games or increase memory capacity. Still others let you connect personal computers in a network so several people in your office can share the same information.



Inside the COMPAQ Portable are three slots for optional electronics that can add new capabilities. Most portables have none.

Works better because it's tough enough for the road

Portable doesn't just mean smaller. Portable means tough, too.

The COMPAQ Portable was built to withstand the hard knocks of constant travel. An aluminum frame within the case completely surrounds the computer's working components. Each disk drive is mounted in rubber shock absorbers instead of being bolted directly to the frame.

To test internal components, the COMPAQ Portable was subjected to impacts of 40 G's while running a program. After impacts on each side, there was no internal damage and the program was still running. Without error.

Computers are for getting rid of worries, not giving you new ones.

Designed to help you work better, too

The COMPAQ Portable was designed to feel good.

Specifications

Software

- Runs all the popular programs written for the IBM PC

Memory

- 128K bytes RAM
- Expandable to 640K bytes

Storage

- One 320K-byte minifloppy disk drive, second drive optional

Display

- 9-inch (diagonal) monochrome screen
- 25 lines by 80 characters
- Upper- and lowercase, high-resolution text characters
- High-resolution graphics

Expansion board slots

- Three IBM PC-compatible slots

Interfaces

- Parallel printer interface
- RGB color monitor interface
- Composite video monitor interface
- TV RF modulator interface
- Communications interface optional

Physical specifications

- Totally self-contained and portable
- 20"W x 8 1/2"H x 16"D

The keyboard is detached so it can fit into your most comfortable working position.

The keyboard cable remains connected at all times. So you don't have to unpack it and hook it up every time you use your computer.

Because the display is built in, the COMPAQ Portable makes a neat,

small package on your desk, instead of a big obstacle you have to talk around. The built-in display also avoids the usual cable clutter because there's no need for separate cables for the display.

The COMPAQ Portable even has an electronically synthesized sound to create the familiar keyclick of a typewriter. With a simple keyboard command you can adjust the volume to suit the level of background noise in your office.

The added usefulness is free

The COMPAQ Portable can do what desktop computers do and do it in more places. But it doesn't cost any more than an ordinary desktop.

In fact, it costs hundreds less than a comparably equipped IBM or Apple® III. The COMPAQ Portable comes standard with one disk drive and 128K bytes of memory, both of which are usually extra-cost options. A second disk drive and additional memory are available to make your COMPAQ Portable even more powerful.

The bottom line is this—you just can't buy a more practical, useful, productive computer. Before you decide on a computer, you owe it to yourself to compare the COMPAQ Portable.

For the location of the Authorized Dealer nearest you, call 1-800-231-9966.

©1983 COMPAQ Computer Corporation
COMPAQ™ is a trademark of COMPAQ Computer Corporation.
IBM® is a registered trademark of International Business Machines Corporation.
Apple® is a registered trademark of Apple Computer Inc.



COMPAQ™

The most computer you can carry

SERIAL PORT EXPANDER AND MORE



BTA's MODEL 524 MULTI-PORT CONTROLLER is a code activated one to four serial port expander — but that's not all since it has separate and independent UARTS, buffers and handshaking each port can operate with a different configuration, i.e. different baud rates, stop bits, etc. These features also permit two or more devices to communicate with the 524 simultaneously.

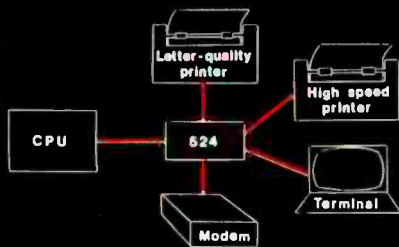

Full duplex with EIA RS-232 protocol

Baud rates up to 19,200

Expansion to 16 ports by cascading

Peripheral ports may be configured by user software

One year warranty



• **MODEL 524** \$249.00

• **MODEL 524A** \$279.00
same as model 524 except has 256 byte rx/tx buffers per port

• **MODEL 524 D** \$269.00
same as model 524, plus continuous polling of each peripheral device for data transfer requests. The device is automatically connected when its 'turn comes up'. ON, BUSY and OFF messages are sent to the peripheral device.

• Other models available — Contact us or your dealer for additional information.



BAY TECHNICAL ASSOCIATES, inc.

HIGHWAY 803, P.O. BOX 387
BAY ST. LOUIS, MISSISSIPPI 39520
1801487-8231

Letters

Subtle Features of the HP-75

While I liked Rowland Archer's review of the HP-75 (September, page 178), I found that it hardly scratched the surface of this remarkable machine and did not address many of its strongest, albeit subtle, features.

Perhaps this machine's most attractive feature is its ability to enable a RAM-based BASIC program to interact with other RAM-based files and its ability to transform a text file to BASIC and vice versa. This may not sound like much, but it opens the door to many advanced applications. For example:

- A BASIC program can be written to take a FORTRAN source in a text file and "edit" it into BASIC under program control.

- A program generator for numerical-equation solving can be written in less than 3.5K bytes. Allowing unlimited length variables, it enables the user to specify only equations, rewriting them to the required BASIC syntax, determining I/O (input/output) variables, and automatically supplying all I/O and control statements.

- A friendly relational database allowing multicharacter field names and permitting complex Boolean inquiry expressions takes but 2.5K bytes.

- Artificial intelligence types take note: an HP-75 program can be made to edit itself (shades of LISP). A few BASIC statements are all it takes.

The multiple-file structure allows other seemingly impossible feats. A user can manually interrupt a running program, call another from the keyboard, then continue the first from where he or she left off—no loss of data, pending returns, etc.

The HP-75 operating system is beautifully integrated with the BASIC, and all catalog information is accessible, permitting BASIC to perform as a job control language. I wrote a full menu-driven operating system in 931 bytes.

The editor is very nice. The Fetch key performs a "find" function, a sorely missed feature on most other machines. Additionally, the keyboard is totally redefinable. Keys can be redefined as other letters, strings, commands, whatever.

The one-line display is not as bad as some would think, and an 80-column, 25-line video adapter is now available

from Mountain Computer Corporation.

Lastly, the HP-75 is extremely fast for floating-point number crunching. While it is slow using an empty FOR/NEXT loop or prime-number program as a measure, it will easily outdistance an Apple, TRS-80, or TRS 80/M-100. The IBM is faster, but the IBM Personal Computer's transcendental functions are accurate to only 6.5 digits compared to the HP's 15 digits. The recently released Math ROM adds matrix operations, complex variable types, and root solvers (to name a few) to the language, giving the HP-75 the most convenient BASIC available for numerical work.

I am admittedly biased toward my HP-75 but I feel it has been overlooked by many, probably because of its form factor. It is not just another hand-held computer but a unique and powerful computer system, and it warrants greater attention from the technical press. The article in the September BYTE was a first step.

James A. Walters
4171 Antler Trail
Smyrna, GA 30080

I am a proud owner of an HP-75 portable computer and I think I know almost everything there is to know about this incredible machine.

Rowland Archer's review (September, page 178) describes the machine fairly well. But I think he should have done more research before attempting to review this product.

Archer says in his conclusion: "However, it does tie you to HP's devices, rather than letting you use devices that interface to standard serial or parallel ports such as modems."

This is false. I use my HP-75 with an Epson FX-80 printer with a parallel interface, and with a Muraphone 300-bps (bits per second) modem. This little machine can be used with almost any interface (serial, parallel, or HPIB bus). There are HP-IL interface converters on the market that enable you to use this computer with any other interface.

Walter Yadegar
POB 687
Skokie, IL 60076

Rowland Archer Jr. replies:

I am glad to hear that these interfaces are

Get The Computer That Blew Their Socks Off At Comdex.



The name is HeadStart,[™] the microcomputer that wowed the crowd at Las Vegas.

We're accepting orders now for the smallest, smartest, fastest, most powerful business computer you can buy.

For the Intertec dealer nearest you, call or write: Intertec, 2300 Broad River Road, Columbia, SC 29210.

Phone: 803-798-9100.

intertec[™]

**Scheduled availability
January, 1984.*

Circle 236 on inquiry card.

Letters

available. None of the literature accompanying the review machine mentioned this capability, and I have never seen it advertised. Interested HP-75 owners should contact Mr. Yadegar or their HP dealer for details on availability and prices.

Poor Support from Epson Riles User

David Ramsey was much too lenient in his comments on Epson's poor support of the HX-20 ("Epson's HX-20 and Texas Instruments' CC-40," September, page

193.) Sure, the people at Epson hurt themselves by not taking advantage of their early lead in this market of the future, but they also hurt their early customers. (I am one of them, and not very happy about it!)

Consider the HX-20 from a customer's point of view—mine. In October 1982 I called Epson and asked if the HX-20 would support machine language. Sure, they said, so I bought a shiny new HX-20 (without the cassette drive or Skiwriter). The only documentation that came with the HX-20 was a skinny little "Operations

Guide" that didn't help much. Two months later the BASIC manuals and a couple of Mickey Mouse (apologies to Walt Disney) software cassettes showed up, together with the extra-cost microcassette drive. The BASIC manuals describe the BASIC adequately, but for information on the machine language the manuals refer you to the *HX-20 Technical Reference Manual*. I promptly (in February 1983) ordered the manual. The dealer said he didn't have it yet, but promised it by April 15. That date came and went and still no manual. Ditto May 15, June 15, July 15, and August 15.

During this time, I sent numerous letters to Epson yielding prompt replies that said nothing about the *HX-20 Technical Reference Manual*, the promised display controller, disk drive, software, user group, or anything else that would have been useful.

Of course, the display controller will only be a 32-column, 16-line TV toy anyway, so I might as well write the whole thing off as a loss and start over. But let it be known that this buyer is more wary now. Next time the support comes first, then I put out the cash.

B. H. Geyer
108 Sun Harbor Dr.
Liverpool, NY 13088

Starting FORTH as a Textbook

I have several disagreements with Thomas Clune's review (September, page 494) of *Starting FORTH* by Leo Brodie.

I used *Starting FORTH* when teaching a course in 1982. We found many of the pictures quite helpful. In particular, making people out of INTERPRET, WORD, EXECUTE, and the compiler provided students with memory "hooks" that made explanations easier.

It's true that Brodie covers all the built-in features of FORTH including the hard, subtle things. But it's these features that account for much of FORTH's power. Virtually all tutorials avoid serious discussion of things like CREATE DOES > leaving a misleading impression of the language. *Starting FORTH* worked well in my class; it needed little extra explanation compared to most texts I use. (I must admit that the students were already good programmers; Clune may be right about the effect of the latter part of the book on less experienced readers.)



See us at Comdex Booth -R8624

GANGPRO-8™ MULTIPROGRAMMER \$995.00

GANGPRO-8™ allows user to program up to 8 EE/EPROMS simultaneously using the latest state of the art programming algorithms. It can test and duplicate a wide variety of devices from 16K to 256K. There are no personality modules to buy. 8 digit alphanumeric display prompts user with messages. This unit is extremely easy to operate and is ideally suited for a production environment.

QUV-T8™ series UV EPROM ERASERS

QUV-T8/2T (\$97.50) is an industrial quality eraser designed in a steel enclosure with a 5" wide tray UV indicator lens, antistatic pad, 60 minute rugged timer and safety interlock switch are standard. Capacity is 24 EPROMS 15-20 minutes erase time for 15 EPROMS.

QUV-T8 / Z (\$124.95) Similar to QUV-T8/2T with 40% faster Erase Time.

QUV-T8/2N (\$68.95) Same as the QUV-T8/2T version without the timer and safety interlock switch.

QUV-T8/1 (\$49.95) Economy model in a molded two part plastic case. Erases 15 EPROMS in 15 minutes.

*MCS-48 is a registered trademark of Intel Co.

PROMPRO-7™ SERIAL RS-232 STAND-ALONE \$489.00

MCS-48™ FAMILY PROGRAMMING WITH PROMPRO-7™ PROMPRO-7™ is an intelligent self-contained unit, ideally suited for engineering development, or for field service & production. It can program and verify a wide variety of 8K to 128K EPROMS. This unit has a 32K (4K BYTES) internal RAM Buffer that could be accessed by the user through a computer or terminal. This unit can also program the micro chips such as the 8748, 8749, 8751, 8741, 8742, 8755. The price includes all modules up to 32K EPROMS & The 8748 & 8749H Micros Upload/download is done by either Motorola or Intel Hex format.

PROMPRO-8™ SERIAL RS-232 STAND-ALONE \$689.00

This extremely versatile programmer has as much as 128K (16Kx8) of internal RAM dedicated to the EE/EPROMS. This RAM buffer can be accessed either through a computer terminal, or by user target system (EPROM emulation). PROMPRO-8™ 8 digit alphanumeric display prompts user with the system messages. A keypad option is available for standalone editing. An impressive range of devices are programmed (as standard feature).

The Right Equipment for Your Eprams at the Right Price!

LOGICAL

AVAILABLE SOFTWARE DRIVERS
1 IBM PC 2 APPLE II 3 MDS:ISIS 4 CPM
5 TEKTRONICS 8002 6 ATARI 7 TRS-80 COLOR 8 FLEX

LOGICAL DEVICES, INC.

1321 E N W 65th PLACE, FORT LAUDERDALE, FLORIDA 33309
TEL. (305) 974-0967 • TWX: 510-955-9596
DISTRIBUTORS: WEI.COM: FOR QUALIFICATIONS

Circle 265 on inquiry card.

INTRODUCING ULTRATERM™



YOU'LL LOVE THE VIEW!

With UltraTerm, the revolutionary new card from Videx, you'll enjoy sweeping panoramas of spreadsheets that you've never seen before: 128 columns by 32 lines, 132 columns by 24 lines and even 160 columns by 24 lines. You'll revel in the scenics of a whole year of records stretching out across your screen.

You'll also delight in the new horizon of 80 columns by 48 lines—double the lines you normally have. So your word processing will reveal a "depth of character" never possible before!

Another breath-taking view of UltraTerm—it delivers absolutely flicker-free, state of the art display, with 8x12 character matrix giving you preposterously clear, readable characters. Not only will you see more characters on your screen (a whopping 4096 possible), but they'll also be larger and more readable than the characters you read every day in Circle 445 on inquiry card.

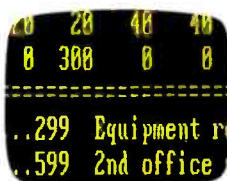

Photo of actual-size characters on Apple Monitor III.

your newspaper! And you can differentiate those characters in several modes: normal (white on black), inverse (black on white), bright intensity and dim intensity.

UltraTerm. Come on over and enjoy the view.
Suggested retail price: \$379



897 NW Grant Ave. • Corvallis, Oregon 97330
(503) 758-0521

UltraTerm features a built-in soft video switch and has complete firmware support for BASIC, Pascal and CPM®. Use it with the Apple® II, Apple IIe.

Apple and the Apple logo are registered trademarks of Apple Computer, Inc.

CPM is a registered trademark of Digital Research, Inc.

See us at Comdex Booth #1977.

We've always said SuperCalc[®] is the world's most useable spreadsheet.

At first, all spreadsheets seem to give you about the same things. Until you put them to work. Then you'll find out if they do everything you expected. Or make you do everything the hard way.

You know what makes the difference? It's not just having the newest, whizziest features, but what those features actually do for you in the real world. And that's the whole idea behind SuperCalc and SuperCalc2. Because they've been designed to work with you in a natural, intuitive way.

What we're really talking about here is useability. When you get right down to it, it's not any one big thing, but a combination of little things. Like the number of keystrokes it takes to get a job done. Or the effort it takes to switch from one function to another. Maybe a few keystrokes here and there doesn't seem like much of a difference. Or having to change disks to plot a graph. But when you multiply those little things by the thousands of times you do them, they make all the difference in the world.

Even the size of the spreadsheet is important. Some programs promise you a huge area to work with. Unfortunately, they can use so much of the computer's available memory just keeping track of all the blank cells that you're left with only a handful. But we've designed SuperCalc to give you the largest useable spreadsheet.

If you look at the printout below, you'll see a lot more examples of what we mean. And we think you'll realize why this is the most useable spreadsheet in the world.

Text can "spill over" into next column

Calendar/Date calculations

Dictionary sort order (not ASCII)

Two key sort

User-set decimal places

Floating \$ signs

Data management capability

Individually variable column widths

Negatives shown in ()

Level	Name	Rate	Jan	Feb	Mar	Apr	May	Jun	Jul	Aug	Sep	Oct	Nov	Dec	Total	Hours	Rate	Total
PARTNER																		
1-12	Boyd	\$120	85	80,700	97	50	18,400	124	70	10,080	80	80	120,400	269	1	1,451		
1-13	Tulliver	\$92	80	10,070	100	50	8,750	94	50	8,300	80	80	27,300	300	1	1,000		
MANAGER																		
2-05	Dean	\$85	70	110,200	132	70	19,440	110	70	14,000	120	70	124,000	373	1	1,070		
2-33	Spilka	\$92	70	17,604	137	70	11,200	106	70	11,310	123	74	25,542	366	1	1,070		
2-92	Taber	\$82	50	10,414	127	70	10,350	126	70	10,000	123	70	30,000	376	1	1,070		
SENIOR																		
3-102	Baldicci	\$50	80	17,500	150	80	17,100	143	80	17,000	150	80	120,100	443	1	1,070		
3-113	Calahan	\$55	90	8,040	150	80	7,800	143	80	7,700	141	80	24,310	442	1	1,070		
3-124	Roy	\$40	80	7,000	140	80	6,800	143	80	6,700	141	80	20,600	430	1	1,070		
STAFF																		
4-91	Smith	\$41	90	17,134	174	90	10,100	166	90	17,000	172	90	120,992	512	1	1,070		
4-134	Mollensky	\$43	99	7,482	174	99	7,130	166	90	7,267	169	90	21,907	509	1	1,070		
OFFICE TOTAL		80		\$91,162	1401	70	184,517	1304	70	184,704	1,518	77	\$260,423	4020				

OFFICE SUMMARY STATISTICS:

Lowest Utilization	55%	50%	50%	52%
Highest Utilization	99%	99%	98%	98%

Staff Complement & Average Rates:

Partner	2	\$97,500
Manager	3	\$84,667
Senior	3	\$51,000
Staff	2	\$42,000

10

Now you can draw your own conclusions. SuperCalc³

Now we're introducing our newest version, SuperCalc3, which comes complete with the kind of graphics you'd expect to find in a program that does everything else so well. We give you full color. And presentation quality. Plus eight different type styles to choose from. And new financial features like internal rate of return. We've even integrated all these functions onto one single disk. Which means you don't have to change disks all the time. Or settle for a weak spreadsheet and low-resolution graphics just for the sake of getting

both in the same package.

As you might expect, we've made SuperCalc3 100% compatible with SuperCalc and SuperCalc2. So you can move up to it whenever you're ready. You can even convert your VisiCalc files. The SuperCalc family is available for CP/M, CP/M-86, Concurrent CP/M-86, MP/M, MS-DOS and PC-DOS operating systems. Right now, SuperCalc3 is available for the IBM PC, PC XT and IBM PC compatibles. It's only \$395. And soon it'll be available for a lot more personal computers.

SuperCalc3. When you're really serious about spreadsheets, this is the one you'll wind up using. But don't take our word for it. Go try SuperCalc3 at your computer store today. And draw your own conclusions.

CP/M[®] CP/M-86[®] Concurrent CP/M-86, and MP/M[®] are trademarks of Digital Research. MS[®]-DOS is a trademark of Microsoft Corporation. IBM[®] is a trademark of International Business Machines Corporation. VisiCalc[®] is a trademark of VisiCorp. © 1983 Sorcim Corporation.

SuperCalc³
SORCIM[®]
 2310 Lundy Avenue San Jose, CA 95131
 (408) 942-1727

Integrated presentation-quality graphics

Prints up to four charts on the same page

Components of graph resize to match size of text

Full color graphics

Exploding pie charts

Prints all available plotter colors

Eight font types

Labels print horizontally or vertically, for best fit

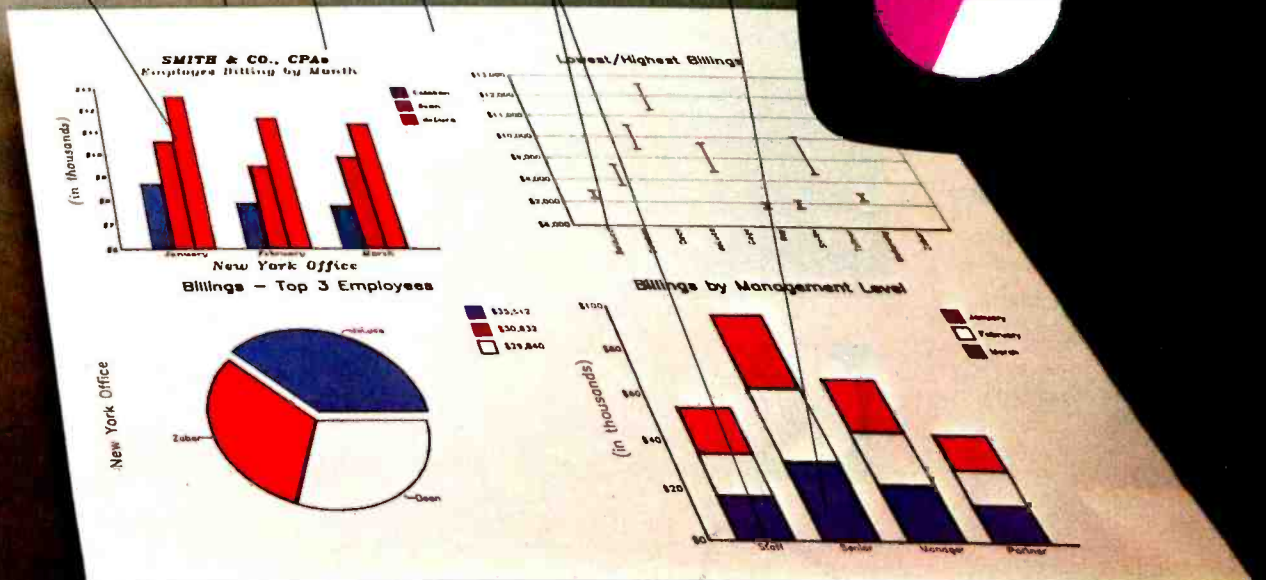

Letters

Before teaching the course, I had considered writing my own book on FORTH, one that would explain the really subtle and powerful features of the basic system. After studying Brodie's text and teaching from it, I decided that that particular publishing niche is well filled already.

I do agree with Tom Clune on a couple of points: "...[Starting FORTH] desperately needs a real index. Nonetheless, if you want to learn FORTH, you will need this book."

Vernor Vinge
Associate Professor
Department of Math Sciences
San Diego State University
San Diego, CA 92182

Wrong Aliases

Having an interest in the use of Unix in the commercial marketplace, I read "The Unix Tutorial Part 2: Unix as an Applications-Programs Base" (September, page 257) with anticipation. Since David Fiedler's intended audience was ap-

parently the Unix novice, I thought I had better point out a problem with his examples of renaming the "terse" command names.

While all of Mr. Fiedler's examples would work in most cases, he unfortunately decided to rename the "mv" and "cp" command. I use the term "command" rather than "commands" because they are one and the same program as in the "ln" command. This program knows which function it is to perform by the name used. If a name other than "cp," "mv," or "ln" is used, the program will default to the "cp" (copy) function. In this particular case, the user would not achieve the desired result either by renaming the command or by linking the desired name.

The alternative solutions of using the "alias" function for the UCB C-Shell or creating a shell program for the Bourne Shell are not only desirable in this case, but also necessary.

Ron Spizzirri, Technical Manager
Analysts International Corporation
650 Woodfield Dr.
Schaumburg, IL 60195

C Source-Code Formatting

I was overjoyed to see my preferred style of C source-code formatting in Houston, Brodrick, and Kent's article on CP/M-86 C compilers (page 82) in the August issue. I have always instinctively used that format, despite pressure to conform to convention, because it feels better to me.

I feel strongly that the matching-braces-in-the-same-column formatting style is preferable and hope that it will find wide acceptance, or at least tolerance, particularly by anyone who imposes formatting standards on programmers.

Peter Cann
Atari Incorporated
5 Cambridge Center
Cambridge, MA 02142

Unix Wasn't the First

"The History of Unix" (August, page 188) is interesting, but there is a major problem with the statement: "Until Unix, operating systems were written exclusively in assembly language."

GREAT DRIVES! GREAT PRICES!

APPLE® COMPATIBLE DRIVES

- 5¼" Floppy Disk Drive
- Interfaces to a standard Apple disk controller
- Compatible with popular operating systems (DOS 3.2.1®, DOS 3.3®, PASCAL®, and CP/M®)
- Features a track zero micro-switch
- A high quality unit providing quiet reliable operation
- Extended 12 month warranty



ORANGEWOOD BUSINESS CENTER
1701 East Edinger, Suite E12
Santa Ana, CA 92705

INTERNATIONAL OFFICE: PINES TRADING ESTATE, Broad Street, Guildford, Surrey, GU3 3BH

SERVICE & QUALITY

American made state-of-the-art engineering; reliable performance and an extended one year warranty.

DEALERS: Place your order by 11:00 AM (PST) for same day shipment. OEM quantity discounts available.

CALL TODAY!
(714) 953-7622

DOS 3.2.1 and DOS 3.3 are registered trademarks of Apple Computer Corporation. PASCAL is a trademark of USCD. CP/M is a registered trademark of Digital Research Corporation.

Net Results ...



Net results are what you get with **PerComNet™** ... the sophisticated, user-installable Local Area Network from PERCOM DATA CORPORATION.

PerComNet IBM® interface cards are available *now* to provide true networking capabilities for IBM and most IBM compatible personal computers. This includes the sharing of peripheral devices such as printers, modems, floppy disk drives, and all PERCOM DATA High Performance PHD™ Hard Disk Drives.

PerComNet provides these **net results**:

- Token passing reliability.
- Built-in 64K FIFO buffer, to speed data transmissions.
- Signal regeneration at each node to eliminate noise, regardless of network size.
- User installation simplicity.
- Optional NBS encryption for data security.
- Support for simultaneous voice/data transmissions.
- Operating system compatibility for MS-DOS™, CP/M®, UNIX™, and uNETix®. uNETix for PerComNet is distributed by Percom Data.

If you want **net results** ... PerComNet is the logical, economical and reliable choice. PERCOM DATA has a PerComNet OEM Evaluation Package* ready for your immediate use. The package includes all the hardware, and communications and file transfer utilities you need for configuring a network of three IBM PC computers. Package price is only \$1695.

To order your evaluation package or to get more information contact us today!

PERCOM DATA CORPORATION

11220 Pagemill Road · Dallas, Texas 75243

Name: _____ Title: _____

Company: _____

Address: _____

City: _____ State: _____ ZIP: _____

- I'd like you to send me more information.
 I'm very interested, please have your rep call me at _____
 I'd like to know more about your PHD Hard Disk.

PERCOM DATA
CORPORATION

Expanding Your Peripheral Vision

DRIVES • NETWORKS • SOFTWARE

11220 Pagemill Road, Dallas, Texas 75243 (214) 340-5800

1-800-527-1222

*Does not include operating system or application software.

PerComNet and PHD are trademarks of Percom Data Corporation. • IBM is a registered trademark of International Business Machines. • MS-DOS is a trademark of Microsoft, Inc. CP/M is a registered trademark of Digital Research. • UNIX is a trademark of Bell Laboratories. • uNETix is a registered trademark of Lantech Systems Incorporated.

COPYRIGHT Percom Data Corporation 1983 • All prices, and descriptions subject to change with notice.

A name to remember for memory in a hurry.

flashcardTM

disk emulator for Apple[®] computers



Packaged with business software for lightning fast processing.

Or, *flashcard* is packaged alone with drive diskettes for DOS 3.3, CP/M[™] and Pascal for software compatibility with popular programs such as Word Star[®] and dBase II:

Bonus Offer: For a tidy turnkey solution to boosting business output, *flashcard* also comes packaged with MagiCalc[®] spreadsheet software from Artsci. MagiCalc is a superior, state of the art program that is fast, friendly and filled with features. And it is fully compatible with VisiCalc files.

Why *flashcard*?: Plug *flashcard* into your Apple and enjoy fast, smooth, no-wait computing. No more "disk wait" messages. No mechanical delays. No more noise as the disk chatters and clatters through a file search. And no wear and tear on your program diskettes. Instead, *flashcard* displays your data the instant you ask for it.

Your computer store should have *flashcard* in stock. If not, ask him to order one for you.

***flashcard* with MagiCalc \$595**
***flashcard*, 144k disk \$349**
***flashcard*, 288k disk \$529**



Synetix Inc.

10635 N.E. 38th Place
Kirkland, WA 98033
(206) 828-4884
(800) 426-7412

Circle 411 on inquiry card.

TM Flashcard is a registered trademark of Synetix, Inc. 1983

TM Apple is a registered trademark of Apple Computer, Inc.

TM MagiCalc is a registered trademark of Artsci, Inc.

TM CP/M is a registered trademark of Digital Research, Inc.

TM dBase II is a registered trademark of Ashton-Tate

TM WordStar is a registered trademark of MicroPro

Letters

Wrong!

The Burroughs B-5000 computer released in 1963 and later rereleased as the B-5500 used a multiprogramming/multi-processing operating system written in a superset of ALGOL-60 called ESPOL. There has never been an assembly language and assembler for any of the Burroughs large computers including the B5700, B6500, B5900, B6700, B6800, B6900, B7700, B7800, B7900.

Harlan S. Barney, Jr.
Chief, EDP Technical Services
NYS Department of Transportation
Albany, NY 12232

What About MP/M-86?

In your Unix series, several authors pointed to 8-bit CP/M's deficiencies when compared to Unix. This is like accusing the IBM PC of serious deficiencies in numeric-processing ability when compared to the Cray X-MP.

None of the articles mentioned MP/M-86, Digital Research's 16-bit multiuser/multitasking operating system. Was MP/M-86 ignored because the authors' livelihoods are somehow tied to the success of Unix?

The switch to MP/M-86 is easy for the millions of CP/M users. The commands, with few exceptions or additions, are the same. Increasing numbers of CP/M packages are available for CP/M-86; most of these will run under MP/M-86 without modification. The result is a greater variety of familiar software.

Digital Research's operating systems would not win any prizes for user friendliness. However, their prompts and commands are generally more logical than those of Unix.

Despite all the recent Unix hype, I am nonplussed by the implied propensity for disk contention and its belated support of record locking.

BYTE should review MP/M-86.

Larry Koerv
Fortrex Corporation
POB 3610
Wichita, KS 67201

Speed Not the Issue

If Mr. Harp and Mr. Stone (Letters, October, page 20) of Oklahoma State University bought Radio Shack Model 16s to win BASIC-language benchmark contests

We Do Windows ...And More!

PERCOM DATA is now distributing **uNETix**... a new operating system for the IBM® PC, and most IBM compatibles. **uNETix** offers both standalone computer users and networking participants a powerful array of system options.

uNETix is the **FIRST** personal computer operating system with versions **DESIGNED** for networking **AND** standalone use, and versions are now available to run on PerComNet™, and the PERCOM DATA High Performance PHD™ Hard Disk Drive.

uNETix DOES WINDOWS:

- **uNETix Standalone**—A single-user/multi-tasking operating system—capable of MS-DOS™ emulation, multiple-window screen division for transfer of data among application software, and data transfer to and from a remote mainframe



(task) to another without complex commands!
Window size can be expanded or reduced at user discretion.

As a standalone, **uNETix** from PERCOM DATA is optimized on the PERCOM DATA High Performance PHD Hard Disk Drive.

WINDOWS...AND MORE!

- **uNETix DFS**—Has all the features of **uNETix** standalone **PLUS**... it is a distributed file system and network operating system—capable of resource sharing in the PerComNet multi-user network environment. **uNETix** offers true multi-tasking power, whether used standalone,*

uNETix®
does
windows
...and more

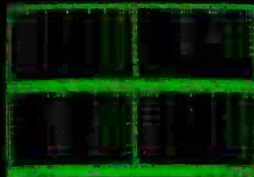

environment. **uNETix** is compatible with **UNIX™** and **MS-DOS**, and runs **MS-DOS** as one of many tasks.

uNETix allows a user's screen to be divided into as many as 10 windows, each of which can be assigned a separate task, all running simultaneously. Data can be transferred from one window

PERCOM DATA CORPORATION
11220 Pagemill Road · Dallas, Texas 75243

Name: _____ Title: _____

Company: _____

Address: _____

City: _____ State: _____ Zip: _____

I'd like you to send me more information.

I'm really interested! Have your rep call me at _____

I'm also interested in your NETWORK.



with a PERCOM DATA High Performance PHD Hard Disk Drive or in PERCOM DATA'S multi-micro network ... PerComNet.

PERCOM DATA has **uNETix** available now... and to determine which version best suits your needs simply complete our coupon and send it to us.

Expanding Your Peripheral Vision

DRIVES • NETWORKS • SOFTWARE

11220 Pagemill Road, Dallas, Texas 75243 (214) 340-5800
1-800-527-1222

Descriptions and specifications subject to change without notice. • *Minimum 256K required.

IBM is a registered trademark of International Business Machines. • **uNETix** is a registered trademark of Lantech Systems Incorporated. PerComNet and PHD are trademarks of Percom Data Corporation. • **UNIX** is a trademark of Bell Laboratories. • **MS-DOS** is a trademark of Microsoft, Inc. Copyright Percom Data Corporation 1983.

The new 384K Quadboard by Quadram is the most comprehensive board you can buy for the IBM PC or XT. Now with added hardware features and advanced software. But our same low price.

NEW EXPANDED QUADBOARD
 Quadboard now delivers 9 of the most needed PC functions/features. To let you get the most out of your Personal Computer. And help you work better and faster.

All of these features are standard on the new Quadboard:

- **Parallel Port:** With the new Quadboard, you get a Parallel Port. Perfect for operating most printers and other parallel devices.
- **Serial Port:** There's

a Serial Port, too. Fully programmable, use it to connect to plotters, modems, and other serial devices.

- **Chronograph:** And Quadboard's Chronograph (Real time clock/calendar) keeps your system's clock up to date.

- **Game Port:** The new Quadboard has an IBM compatible Game Port. Plug in a joystick or game paddles, and fire away.

- **I/O Bracket:** Quadboard now comes with a special I/O bracket. Use it to

organize your expansion port connectors. Snaps right onto the back of the PC.

EXPANDABLE TO
384K

**THE WORLD'S
 BEST SELLING
 MULTIFUNCTION
 BOARD IS NOW
 EVEN BETTER**

NEW



\$295

Socketed with no RAM installed

QUADBOARD™

• **Expandable to 384K:**

The new Quadboard is expandable in 64K increments for up to 384K additional RAM. With full parity checking standard. With the new Quadboard and a fully populated system board, you can take your PC's memory up to the 640K limit.

• **QuadRAM Drive:** Plus, with Quadboard you get advanced QuadMaster Software. Including the QuadRAM Drive program. Use it to set up multiple RAM Drives in Quadboard memory. Solid state drives that let you store and retrieve data quickly and easily. Or take advantage of QuadMaster disk caching. To access frequently

used data whenever you need it.

• **MasterSpool:** QuadMaster Software also includes MasterSpool. Use it to set up a software print buffer quickly and easily. This advanced spooler lets you pause at any time, back up or move forward in a file. Choose just the amount of buffer space you need and stop waiting on your printer.

• **Qswap:** Another feature of QuadMaster Software is Qswap. With Qswap change line printers 1 and 2 back and forth, with just a few keystrokes, as often as you like.

QUADBOARD STANDS OUT FROM THE PACK

Now more than ever Quadboard is the first and only board your IBM PC or XT may ever need. No other board even comes close. Because Quadboard is designed for performance. Engineered for dependability.

And built in the continuing tradition of Quadram Quality.



There are many imitators, but only one leader. So make sure you ask for Quadboard by Quadram, the leader in micro-computer enhancement products.

Compare. See why more Quadboards are bought than any other multifunction board...

Features/Functions	Quadboard	SixPakPlus
Memory Available	0-384K	0-384K
Parallel & Serial Port	Yes	Yes
Clock/Calendar	Yes	Yes
I/O Bracket	Standard	Optional
Game Port	Standard	Optional
Diagnostic Testing	Yes	Yes
Advanced Spooler	Yes	No
Simple Menu Setup	Yes	No
Disk Cache	Yes	No
LIST PRICE WITH 384K*	\$795	\$970

* Manufacturer's suggested list price for board with all available features/functions as shown (options included). SixPakPlus is a trademark of AST Research Inc.



QUADRAM CORPORATION
An Intelligent Systems Company



4355 International Blvd./Norcross, Ga. 30093
(404) 923-6666/TWX 810-766-4915 (QUADRAM NCRS)

INTERQUADRAM In Europe

Interquadram, Ltd.
442 Bath Road/Slough, England
Interquadram GmbH.
FASANENWEG 7/6092 Kelsterbach/West Germany
Interquadram S.A.R.L.
41 Rue Ybry./92522 Neuilly/France

Circle 358 on inquiry card.

BY QUADRAM™

Letters

then they indeed bought the wrong iron. The TRS-80 Model 12 and Model 16 are COBOL-oriented business data-processing machines. For a single workstation, the Model 12 is the more practical choice. For multiple users, the Model 16 is the only game in town. I agree that the two operating systems offered are not speed demons. But if the user sees apparently instantaneous response when he calls up a screen format or randomly updates a record, then that is fast enough for the purpose for which these machines were designed. Their forte is the ability to handle large files efficiently—commercial data-processing.

This is not intended to let Radio Shack off the hook for failure to provide a really good operating system. TRSDOS is user-friendly but slow. Xenix is the usual incomprehensible mess of gobbledygook that we have come to expect from Unix and its derivatives. We have the engineering profession to thank for designing it and the academic community to thank for praising it to the skies.

Despite these defects, if Mr. Harp and Mr. Stone want to unload a Model 16 at an attractive price, please ask them to get in touch. I know how to use the machine

very effectively in a business-oriented environment, and my customers seldom do trigonometry in the middle of payroll.

John R. Culleton Jr.
President, Culleton Group Inc.
2401 Haight Ave.
Sykesville, MD 21784

Change of Address

I wish to point out an incorrect company address that ran in Dave Fiedler's "A Unix Tutorial" (October, page 134). The correct address for Unisoft Systems is 2405 Fourth St., Berkeley, CA 94710. The company's phone number is (415) 644-1230.

Trudi L. Jackson
Marketing Manager
Unisoft Systems
2405 Fourth St.
Berkeley, CA 94710

Praise for the HP-75C

As a salesman contentedly using an HP-75C for a year now, I read with in-

terest the September articles on the new entries in the lap/portable computer market. It seems to me logical but unfair to give a computer only to an author for testing: the HP machine (deemed a calculator by Hewlett-Packard), with its multiple internal-file structure, quick conversion between text and BASIC, automatic pausing during entry of BASIC lines, convenient renumbering facility, password-protection features, and built-in mass storage (even if only in the form of a card-reader) is a uniquely useful on-the-go computational tool.

True, it hasn't a full-size typewriter keyboard and its keys are not full-stroke. But it is easy for anyone without an article deadline in mind to touch-type on the unit. Corrections are easy with its Insert/Replace mode toggle. And 26 ounces is certainly easier to carry than 4 pounds!

Visicalc on ROM is a marvel despite the 1-line display, and now there is an 80-column monitor adapter available as well, useful for viewing both spreadsheets and text files to be formatted by the Text Formatter ROM.

I think this machine has features to cover just about all the niggling complaints mentioned with the TRS-80

Shift into Ultradrive with Targa™ by CMC

■ Targa is your answer for a quality, hassle-free hard disk subsystem.

■ Targa interfaces with most popular microcomputers and carries the finest limited warranty in the industry.

■ At under \$2000 (sug. ret. for 5MB), Targa is an exceptional buy in terms of price/performance.

■ Available in 5, 10, 15, 20, and 30 MB models.

■ Seriously interested? Call us toll-free at 1-800-CMC-INTL. In Washington dial 1-206-885-1600.

CMC International

Bellevue, Washington 98005

Circle 73 on inquiry card.



25 Mb the hard way.



25 Mb the Rana way.

Letters

Model 100 and other similar computers. And with the recently introduced RS-232C and IEEE-488 interfaces, the HP-75C becomes compatible with just about anything one may want to tie it to. The unit is powerful beyond its specification and deserves better press than it is getting.

W. Howard Cornelsen Jr.
2100 Tanglewilde #227
Houston, TX 77063

The Carnegie Foundation Report

The Carnegie Foundation for the Advancement of Teaching recently issued a report on secondary education in America. Its conclusions should deeply trouble everyone who is working to develop educational software and hardware.

The report states that "Computer companies are failing to prepare first-rate material linked to school curricula or objectives." It refers to a "moral obligation" and recommends that "every computer firm selling hardware to the schools also

establish a special instructional materials fund." The fund would be used to help teachers develop curricula-related programs.

The report conveniently overlooks a few things. Many computer manufacturers have been giving equipment to schools. IBM has been doing this for over 30 years. Apple has given almost 10,000 systems to schools in California. Educational discounts have often approached 30 percent of the purchase price for equipment. Possibly the Carnegie Foundation feels this is not enough.

The foundation's report goes on to suggest that a national commission be named to review the quality of current educational software. It also calls for the creation of a number of university-based centers which will be used to test and demonstrate educational hardware and software. These are the sort of suggestions that give me the creeps. It doesn't take much imagination to see an "approved list" coming out of a review committee. The "approved list" can then be used to control purchases of software in all cases where federal funds are involved. The really fun projects in educa-

tional hardware and software—the ones based on the idea that there are innovative things that can be done with the curriculum—will be stillborn. That should worry us.

The author of the report, Ernest L. Boyer, is a former U.S. commissioner of education. The Carnegie Foundation's opinions carry weight in educational and public policy circles. It is tragic that the foundation's report makes computer manufacturers the whipping boys for problems that occur in introducing computers in a classroom setting. Manufacturers of hardware and software do not develop educational products from completely altruistic motives. But their record of providing goods and services to the educational community deserve much better than the kick in the teeth received from the Carnegie Foundation.

John Boddie
Specialized Computer Software
213 Aronimink Dr.
Newark, DE 19711

Coping with Radiation

Having spent a number of years in front of a CRT monitor, I thought that I had experienced all of the evils that could befall a computerist. I felt that I must have a natural immunity to all of those vagaries described by workstation operators and CRT watchers. I had considered that these persons might be suffering from galloping hypochondria. It also had crossed my mind that they were trying to build a case for a massive class-action lawsuit against the inventors of the CRT (look out, heirs of J. J. Thomson, Dumont, et al). Maybe they were looking for lifelong employment-disability benefits.

Last week, during a massive data-research effort, I had occasion to spend two days in front of a microfiche reader. The results during the first day were interesting and possibly worth consideration by all who use CRT terminals or workstations:

After finishing seven hours, I had burning eyes, a tenseness in the shoulder muscles, a mild headache, an uneasiness in the lumbar region of the back, a dryness in the throat, a feeling of uneasiness as I left the parking lot, severe stress, fatigue, and irritability during the freeway commute to home. After dinner at home, I experienced definite eyestrain while reading the evening paper, a dis-

New!

BYTEWRITER®

**DAISY WHEEL
PRINTER/TYPEWRITERS**



• Full Olivetti typewriter warranty when purchased complete

Complete BYTEWRITER using:

Olivetti Praxis 30 portable	\$495
Olivetti Praxis 35 portable	\$545
Olivetti Praxis 40 office machine	\$645
Interface only-wired and tested	\$165

The parallel interface mounts entirely internally. Interconnecting cables available for most computers.

BYTEWRITER

125 NORTHVIEW RD., ITHACA, N.Y. 14850
(607) 272-1132



Introducing the First 2.5 Mb Minifloppy Drive.

Isn't it just like Rana Systems to introduce a floppy disk drive for the IBM® with the mass storage benefits of a hard disk, plus the floppy's strength of removable media. The first minifloppy that stores an incredible 2.5 megabytes on a single diskette. Imagine, storing a word processor, a spelling checker, mailing list, and dictionary on one floppy. With megabytes to spare.

Rana's new drive needs only 10 floppies to give you all the capacity of five 5-megabyte hard disks. And that's not the limit. In fact, there is no limit. Like any floppy with its removable media, you can use diskette after diskette to increase your storage. Our expanded capacity disk drive not only acts like a hard disk, it also serves as an ideal back-up for one.

And that's just the beginning, because Rana's drive introduces totally new "closed loop servo" minifloppy technology, making the drive insensitive to temperature or humidity. Rana's controller card can be used with standard internal drives also, so you don't have to

use an additional slot. Our drive comes with its own power supply, software enhancements for PC-DOS 2.0 and 1.1, and CP/M-86®, and a box of diskettes. Everything you'll need to make your IBM operate to its maximum potential.



The new 2.5 megabyte minifloppy drive, available first for the IBM® PC and XT and soon for the Apple®. It's Rana's latest proof that to stay a step ahead, you've got to lead the way.

Always a step ahead.



RanaSystems

© 1987 Rana Systems, Inc., Chatsworth, CA 91311 213 709 5404. For dealer information call toll free 1-800-431-2207. In California only call 1-800-262-1221. Source Number 1C1-654 Available at all participating Computerland stores, and other fine computer dealers. See us at Comdex Booth #326-427 Circle 38B on inquiry card.

® IBM is a registered trademark of International Business Machines, Inc. ® CP/M 86 is a registered trademark of Digital Research. ® Apple is a registered trademark of Apple Computer, Inc.

Hello, information.

Or, how the IBM Personal Computer can bring you the world.



Modem shown not supplied by IBM.

There's a world of information just waiting for you. But to use it, study it, enjoy it and profit from it, you first have to get at it.

Yet the facts can literally be right at your fingertips — with your own telephone, a modem and the IBM Personal Computer.

Plug into the network.

The modem that plugs into your phone takes the codes your IBM Personal Computer understands and turns them into signals that can be transmitted over the phone lines.

On the other end of the phone lines are independent information services* ready for you to access from your home, school, lab or office. So, in minutes, you can tap the resources of over a thousand data bases — and plug into a world of possibilities.

Something for everyone.

At home, for example, you can shop through an electronic catalog. Access mortgage amortization and tax depreciation schedules. Study the wines of France, the foods of Italy. Find property to sell, rent, swap or share. And play hundreds of games.

At school, you can bring news into the classroom — as it happens. You can teach and learn with facts about everything from

phrase origins to plane geometry. You can also tap instructional courses and learn how to program the very IBM Personal Computer you're using.

In the lab, you can call up a wealth of mathematical and statistical programs or retrieve scientific and technological data.

In the office, you can plug into the commodities market. Read abstracts of leading publications. Even get census figures to see who's in your major market. And when you're planning a business trip, your IBM Personal Computer can provide airline schedules and car rental information, as well as tell you what the weather is and where the best restaurants are.

Calling all computers.

And these outside data bases aren't your only information link, either.

With assigned passwords, you can also have access to data that's stored in your company's IBM minicomputer or mainframe via your IBM Personal Computer.

You can even exchange a sales forecast with a manager two floors down or two thousand miles away — one IBM Personal Computer to another.

So the IBM Personal Computer really *can* let you call the world. But there's one call to make first. For more information on where to buy the IBM Personal Computer, call 800-447-4700. In Alaska or Hawaii, 800-447-0890.



The IBM Personal Computer

A tool for modern times

* Information services are available by subscription at additional cost, and are not supplied by IBM.

With B4HR-80™ You'll Never Miss The Bus!

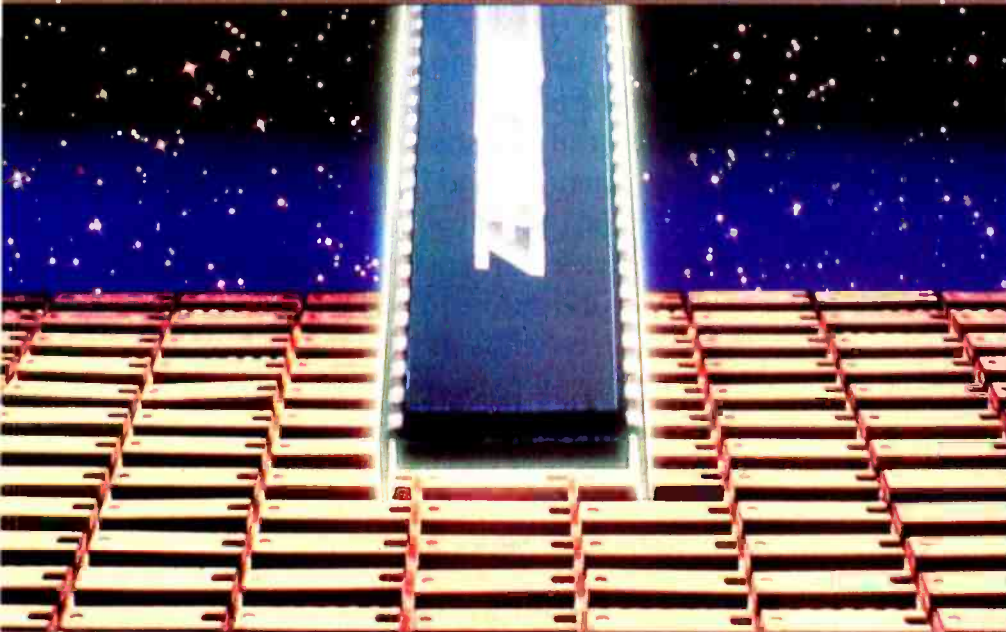

Imagine a single board computer with all the features you need. A quiet, multilayer board that wouldn't need to be plugged into an expensive external bus.

Meet a new high-powered friend – **B4HR-80™**, a compact single board computer. We've put all the features on one board for greater reliability and mechanical simplicity.

Powerful **B4HR-80™** features include:

- Z-80* CPU running at 5MHz
- Up to 32K of EPROMS/EEPROMS
- Up to 1 megabyte of DRAM with parity
- Flexible, mapped Memory Management system
- DMA controller
- Four serial ports, baud rates programmable (RS-232, RS-422)
- Clock Calendar Chip and CMOS RAM, battery backed up
- Counter Timer
- Floppy disk controller
- SCSI/SASI hard disk Interface
- Monitor EPROM
- Runs CP/M 2.2**, CP/M Plus**, and MP/M**
- Software available to run the RAM as a disk or as a cache buffer (CP/M Plus)
- SBX expansion connectors (in case you need even more)

Substantial OEM and dealer discounts are available.

B4HR TECHNOLOGIES, INC.™ does more. We designed **B4HR-80™** after years of consulting to success-oriented companies; we guided them from good ideas to finished products on the market. Today, we custom-design boards, interface systems, and software – in short, we offer unparalleled support.

We hope you have a question. Call Ken Clark today at **608-244-7080**. Ask what's on board at **B4HR TECHNOLOGIES, INC.™**

B4HR TECHNOLOGIES, INC.™
1842 Hoffman Street
Madison, WI 53704

Circle 42 on inquiry card.

*Z-80 is a registered trademark of Zilog.

**CP/M, CP/M Plus, & MP/M are registered trademarks of Digital Research Corp.

Letters

tinct backache, indigestion, and a headache which got worse when I went to bed.

The next day I took a pitcher of water, drinking glass, and pocket calculator with timer-alarm into the microfilm and fiche room and took a break every 15 minutes for a swallow of water. I made a point of correcting my posture and taking several deep breaths everytime I changed a fiche. A little isometric game also helped to reposition the muscles on my frame. I used a pair of dime-store reading glasses which moved my point of focus out to 24 inches instead of the 16 inches I use for reading and desk work. These placed me at a better position in relation to the screen. Using these tricks, I was free of the symptoms of the previous day.

Is there anyone who knows how much low-level radiation is emitted by a 150-watt, incandescent projection lamp?

Paul M. Hine
Engineer, Q.E.D. Systems Inc.
1525 Standlake St.
San Diego, CA 92154

Formatting Rainbow 100 Disks

I recently bought a DEC Rainbow 100 Personal Computer, but I was disappointed by the lack of a program to format disks. After a little search, I succeeded in writing one myself.

Last month I read some complaints about this problem, so I am offering my Format program to other Rainbow 100 users for the nominal charge of \$50 (media, copying, and postage included).

Paolo Prandini
Viale Europa, 72/G
25100 Brescia
Italy

In Praise of the TRS-80 Model 100

I enjoyed "The Radio Shack TRS-80 Model 100" by Mahlon Kelly (September, page 139). I have traveled with the Model 100 for the last six months, through seven countries. It is all that it is reputed to be. I have hooked this box to just about everything available; it has yet to let me down. I have even used it as a limited datascop. With a few more pins on the RS-232C bus connected, we could have the first truly portable model.

William N. Carter
514 48th Ave.
San Francisco, CA 94121

Circle 169 on inquiry card. →

**Now You Can Go
Swiftly and Painlessly
into Computer Technology
with the First and Only
Totally Interactive Learning System
in the World.**



Learning with Space Age Speed

Fastrain™ takes the learning process on a rapid ride into the space age with the rest of the computer industry. It will have you in the know 70% faster than any other method.

Three Senses Worth

Our revolutionary Tri-Sensory Response™ method makes the difference. Sight, sound and hands-on application will guide you through the learning process as you operate your computer. Audio cassettes as well as diskettes provide guidance, as the Fastrain™ and you interact with the computer and synchronize what you see with what you hear at whatever speed is comfortable for you. No matter how easy you go we still get you there faster.

Guiding Light

As well as spelling it out on the screen and talking you through as you work the keys, the Fastrain™ has indicator lights that let you know when to respond, informs you of correct and incorrect responses, and even gives you the answers when you need them. A brief quiz at the end of each lesson is carefully designed to increase your retention and measure your progress.

The Complete Learning System

With the Fastrain™ unit you get an interconnecting cable to plug into your computer, and the learning package of your choice containing audio cassettes and diskettes. It's all you need to get on the Fastrain™ and make high-tech life easier with an idea whose time has come.

DON'T PLUG IN WITHOUT US

EPD

Electronic Product Development, Inc.
P.O. Box 673, Waltham, MA 02254
(617) 891-6602 • 1-800-343-1813

Letter Shows Mathematical Naivete

G. M. Harding's letter (September, page 10) labeled "Bug-Free But Meaningless" is itself meaningless. Harding attacks the notion of the utility of the methods of calculus to analyze economic data "in the same way as a continuous function in mathematics." Harding seems to believe that because, on a very small scale, the events from which economic indices are derived are not discrete, the methods of differential and integral calculus are therefore invalid and cannot be applied.

This is mathematically naive, as anyone who has studied the science of statistics will be aware. To give a simple example, suppose one takes a coin and tosses it a given number of times. The probability that the coin will come up heads can be exactly determined by calculating the coefficients of the binomial expansion of the same order as the number of tosses. When the number of tosses in a run becomes large, however, this calculation can become tedious, and in this case the

Gaussian approximation (the familiar bell-shaped curve) is generally used. It is easily shown that the larger the number of tosses in a run, the more closely the probability distribution is modeled by the continuous Gaussian function.

On a more complex level, there is the treatment of the problem of a quantum-mechanical gas in a periodic lattice (a problem of some interest to computer science, for it is the understanding of this that led to the development of semiconductor electronics). The physical system is constrained to have discrete energies and momenta, which are thought of as points in a multiple-dimensioned "phase space." The calculation of certain important quantities, such as the number of available states the system may occupy, is simplified by assuming for purposes of calculation that the available states form a continuum whose volume can be calculated geometrically. Again, a large number of available states will entail that the difference between the true number and the number calculated by this means is insignificantly small.

Statistical mechanics may seem a far

cry from econometrics, but the mathematics that goes into them both is the same mathematics. Harding may choose to believe that the math is invalid, but the silicon chips in computers will continue to function as predicted by quantum statistics, and this is not a reasonable critique of modern economics.

Another remark Harding makes is that "even if" this sort of reasoning is acceptable, identifying the effects of certain events in time series of economic data is not reasonable. Although not entirely wrong, Harding is far from correct. It is possible to see structures not inherent in the data, structures that appear, perhaps, as an artifact of the analysis technique applied. However, there are methods of inferring the significance of statistical results. A savvy user of these methods is capable of discerning whether the results of a study are meaningful or not. Judging from the level of statistical literacy in the letter, Harding is not capable of making such discernments.

Alan L. Bostick
6400 Latona Ave. NE
Seattle, WA 98115 ■

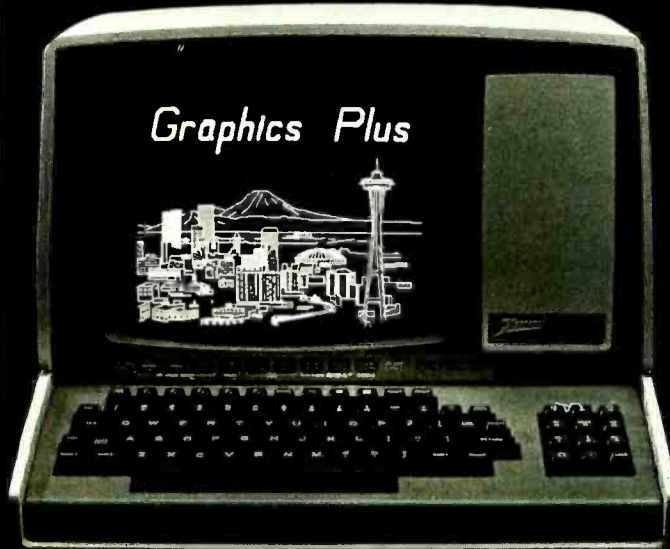

GRAPHICS-PLUS

an enhancement
For Z19 Terminals
from
Northwest Digital Systems

- Tektronix² 4010 Compatible Graphics
- 512 Horiz by 250 Vert Resolution
- 80/132 Col and 24/49 Line Text Displays
- Seven Page Off-Screen Text Memory
- Menu-driven "Plain English" Set-up Mode
- 16 Programmable Keys- 128 Chars Each
- Optional Hardcopy Port
- Simple Field Installation

GRAPHICS-PLUS is a field installable enhancement board for the popular Zenith¹ Z19 video terminal adding many powerful features found only on terminals costing much more. GRAPHICS-PLUS provides Tektronix² 4010 compatible vector drawing graphics, VT100³ compatible 80 and 132 column display formats, off-screen scrolling memory, programmable function keys, "Plain English" menu-driven Set-up mode, and a host of other enhancements. Installation can be accomplished within 15 minutes using only a screwdriver.

	1 TM Zenith
	2 TM Tektronix
	3 TM DEC
GP-19 Upgrade for Z19 Terminal	\$ 849
Z19 Terminal With GP-19 Installed	\$ 1495

Northwest Digital Systems
P.O. Box 15288, Seattle, WA 98115 (206) 362-6937

IT IS BETTER TO
OWN A GRIZZLY™
THAN TO CURSE THE
DARKNESS.



It's a warm, fuzzy feeling to know that when the dark thoughts of power failures and voltage sags invade your peace of mind you have a friend that will let you grin and bear it.

The Grizzly™ is standing behind you with battery back-up, surge protection and noise filtering. It's nice to know that when the lights go down low this uninterruptible power system will give you immediate full power while it warns you with a sonar alarm, giving you twenty minutes to shut down and avoid data loss.

To back up your back-up, anything you plug into The Grizzly is insured for \$2,500.

So go with a Grizzly (200 watt, 500 watt or 1000 watt). Just plug it in to any standard outlet, switch it on, and you have all the power of the king of the forest and all the security of your old teddy bear.

With The Grizzly there is no longer any reason to be afraid of the dark!

DON'T PLUG IN WITHOUT US.



Electronic Protection Devices Inc.
P.O. Box 673, Waltham, MA 02254
(617) 891-6602 • 1-800-343-1813

Circle 170 on Inquiry card.

SIEMENS

**We've rattled
the competition,
without making
a sound.**

**The silent PT-88 jet printer...
from Siemens.**

Since its recent introduction, our new ultra-silent PT-88 jet matrix printer has drawn a lot of attention not only for what it does, but also for what it doesn't do.

Sure, it has all the progressive features that can provide definitive operating advantages. Features like our "drop on demand" jet printing system that ensures consistent, high quality character formation...high speed (150 cps)...full graphics...tractor or single-sheet plain paper feed...downloadable character sets...minimal moving parts...8 resident user-selectable character sets...and self-test capability.

Now, as for the things the PT-88 doesn't do. Because it operates at 50 dBA or less, you'll quickly notice that our printer doesn't clang.

It doesn't shriek. It doesn't screech. That's good news for anyone who can genuinely appreciate a quiet working environment and the improved efficiency and productivity that result from it. It's bad news, however, for the competition.

Before you make a final decision on a printer and your own printing requirements, find out how much you can get with the ultra-silent PT-88. For complete information, contact:



Siemens Communication Systems, Inc.
Anaheim, CA - (714) 991-9700
Atlanta, GA - (404) 441-0882
Chicago, IL - (312) 671-2810
Boston, MA - (617) 935-2234
New York, NY - (516) 752-1323

Circle 366 on inquiry card.



CC3020-021 SIQ 830

Ciarcia's Circuit Cellar



Photo 1: Your computers and other electronic equipment are vulnerable to disturbances transmitted through the power line. Most of the components necessary for transient and noise suppression can be purchased from Radio Shack. Shown here are a commercial EMI/RFI line filter made by Corcom and two General Electric metal-oxide varistors.

Keep Power-Line Pollution Out of Your Computer

by Steve Ciarcia

A visitor once called the Circuit Cellar my mountaintop wilderness retreat. Since he lived in the center of Manhattan, the few oak and birch trees around my house seemed to him like a forest, and because he could view scenery further away than a block or two he must have felt like he was on Mount Whitney. Well, my area is one of the higher points in Connecticut, but that isn't very high. It's barely a prairie-dog mound to someone from Montana.

Life in a rural location has its special pleasures. I get to plow the

snow from my own driveway, trim back the ever-encroaching foliage and rake the leaves, pile four cords of wood for the stove each winter (see reference 1), fight off the local animal population, and spend large sums of money repairing damage done to my electronic equipment by electrical disturbances.

This last item is the only one that really annoys me. Every year I can count on experiencing some equipment failure attributable to an external electrical impulse, usually coming in through the power line. For

three years, just like clockwork, the first thunderstorm in June wiped out a DECwriter II terminal connected to one of my computers. After the first two times of spending a few hours replacing blown chips, I got smart and installed sockets. (Now I even know in advance which chips will be blown.) Last summer I kept the printer unconnected when I wasn't using it.

But the elements were not to be denied. During an August thunderstorm, lightning struck my house. I can't say for sure where the bolt ac-

An expensive lesson produces the cheapest Circuit Cellar project yet

tually hit (there were no burn marks or other visible clues), but I suspect the point of entry was the power line. I remember seeing an indistinct flash of light, hearing a tremendous crash, and then standing in darkness. My assistant Jeanette saw a bright blue glow behind one of the computers.

Such a tremendous power surge is not kind to semiconductor-based equipment. The casualties included one computer, one video camera, two video monitors, a microwave receiver, and probably several other assorted items I haven't found yet. The damage did not include the DECwriter (safely unplugged since May), but it was over \$3000.

In December, thunderstorms are not an immediate threat, but as I write this in early September the memory is still fresh and I still have a month of potentially violent weather to contend with. I am forced to consider some defensive measures. Perhaps by relating my experiences I can save you from a similar fate.

Of course, lightning isn't the sole cause of electrical disturbances; you don't have to wait for a thunderstorm to be a victim. Many kinds of trouble can be ducted into your computer through the power line.

In the January 1981 Circuit Cellar article (reference 2), I wrote about electromagnetic interference (EMI) and radio-frequency interference (RFI). This month I'd like to pick up the saga by describing other forms of electrical pollution that occur on power lines. Afterward, I'll describe a few simple, inexpensive means of dealing with them.

The Power Line: A Hostile Environment

The lines leaving your local utility company's generating plant carry electrical power that in most respects is pure, smooth, and constant. However, as the power is routed through the distribution network, it comes

under the increasing aberrant influence of external forces and the connection or shedding of electrical loads.

Your susceptibility to these aberrations depends on your location in the distribution system. If you are close to the power plant, you should have relatively few, with the low source-impedance of the generator and short distance of the transmission line limiting the influence of external forces. But rural customers at the end of the line usually experience the full effect. While the utilities try to distribute power evenly, the presence of a large-scale user of electrical power along the line between the generator and you can greatly affect the quality and quantity of the power you get.

If you own a personal computer, you should be concerned about the quality of the power you feed it. Power-line irregularities cause problems for computers and other digital equipment because certain kinds of extraneous electrical pulses can be interpreted as data or instructions, causing errors in operation. You face hazards every time you plug in a piece of electronic equipment, but there are certain precautionary measures that can protect your computer.

The degree of sensitivity depends somewhat on the type of equipment and the type of disturbances. As the operating speed of digital equipment increases, its tolerance to power-line pollution lessens. High-speed processors and memory components are susceptible to fast transients. (Dynamic memories, which must be periodically refreshed, are particularly susceptible.) Disk drives and displays, on the other hand, are more affected by lasting surges and sags in operating voltage.

Common Sources of Woe

Electrical power-line disturbances can come from either natural or man-made sources. Of the many ways the power line can be disturbed, the several varieties of voltage fluctuation

most often cause problems with computer equipment. These fluctuations can be categorized by source and severity, as follows:

Blackouts. A blackout is a total power outage—the voltage goes to zero. Obviously if no alternate source of power is available as a backup, computer equipment will be severely affected, and data will be lost. Blackouts generally affect only a small number of utility customers (fewer than 5 percent) during a year and generally last less than 10 seconds.

Brownouts. A brownout is typically a corrective action taken by the utility when power demand exceeds generating capacity. The utility reduces the output voltage from a nominal 120 V (volts) by 5 to 15 percent. When the voltage is thus reduced, the resistive load presented to the generators by the distribution network consumes less power.

Generally speaking, most consumer and industrial equipment designed for use in North America functions properly when supplied with current within the range from 105 to 130 V. But when operating at either extreme, the equipment is more vulnerable to disruption from some other power-line anomaly. Fortunately, power companies rarely reduce the voltage by more than 7 percent.

Voltage transients. The phenomena of voltage transients include surges of voltage above the specified normal, voltage sags below, and instantaneous voltage spikes that leap far above the nominal levels.

Surges and sags are long-duration events occurring at some point in the distribution network when electrical equipment is routinely turned on or off nearby. The magnitude of the surge or sag depends upon the size of the load being removed from or placed on the network.

Sags are often produced by the turning on of electric motors, which have high starting currents. (You've probably noticed lights dimming

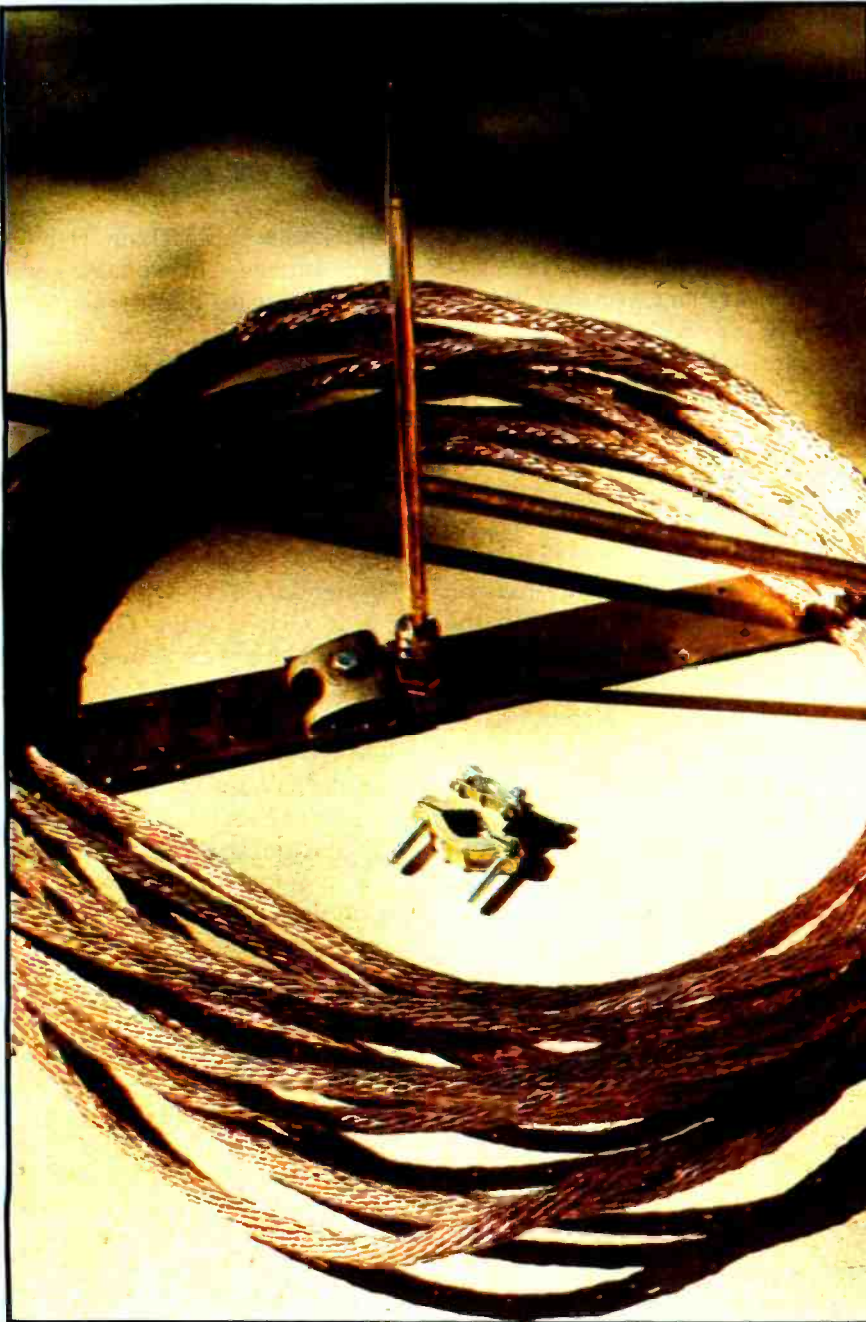

The important element in lightning protection is the lightning rod, a pointed shaft of copper to which a half-inch copper cable is fastened. The cable in run down the side of the building, where it is clamped to an 8½-foot copper-plated steel rod driven into the earth. The rod system pictured here costs \$150.

How Lightning Strikes

A lightning flash is characterized by one or more strokes with typical peak currents of 20 kA (kiloamperes) or higher. In the immediate vicinity of the stroke's impact on the earth, hazardous voltage gradients exist. It is difficult to establish a definite

grounding-conductance value necessary to protect equipment and personnel. The current in a lightning strike is so high that even 1 ohm of resistance can theoretically produce hazardous potentials.

When lightning strikes a building unprotected by a lightning rod, the stroke seeks out the lowest-impedance path to earth (most likely through the electric wiring or water pipes).

How It Starts

As the electric charge builds up in a cloud, the electric field in the vicinity of the charge center increases to the point where the air starts to ionize. A column of ionized air, called a pilot streamer, begins to extend toward the earth at a velocity of about 100 miles per hour. After the pilot streamer has moved perhaps 100 feet to 150 feet, a more intense discharge called the stepped leader occurs. This discharge inserts additional negative charge into the region around the pilot streamer and allows the pilot streamer to advance for another 100 to 150 feet, after which the cycle repeats. As its name indicates, the stepped leader progresses toward the earth in a series of steps, with a time interval between steps on the order of 50 microseconds.

In a cloud-to-ground flash, the pilot streamer does not move in a direct line toward the earth but instead follows the path through the atmosphere where the air ionizes most readily. Although the general direction is toward the earth, the specific angle of departure taken by each succeeding pilot streamer from the tip of the previous streamer is unpredictable. Therefore, each 100- to 150-foot segment of the stroke will likely approach the earth at a different angle. This changing angle of approach gives the overall flash its characteristic zig-zag appearance.

As a highly ionized column, the stepped leader is at essentially the same potential as the charged area from which it originates. Thus, as the stepped leader approaches the earth, the voltage gradient between the earth and the tip of the leader increases. The increasing voltage further encourages the air dielectric between the two regions to break down.

Attracting Lightning

Objects extending above their surroundings are likely to be struck by lightning. Thin metallic structures, such as flag poles, lighting towers, antennas, and overhead wires, offer a very small cross-sectional area relative to the surrounding terrain, but ample evidence exists to show that such objects apparently attract lightning.

The ability of tall structures or objects to attract lightning serves to protect shorter objects and structures nearby. In effect, a tall object establishes a protected zone around it; within this zone, other structures and objects are protected against direct lightning strikes. As the height differen-

tial between the shorter surrounding objects and the tall one decreases, the protection provided to the shorter objects decreases. Likewise, as the horizontal distance between the tall and short structures increases, the protection afforded by the tall structure decreases.

Lightning Rods

A protective device that makes use of this phenomenon is the lightning rod, shown in photo. Generally just a sharp copper spike, the lightning rod is attached to the highest point on the structure to be protected. When lightning strikes, the current is shunted directly through a heavy copper wire from the rod to a grounding electrode buried in the earth.

Although the duration of a strike is typically less than 2 microseconds, the voltage generated is high enough to cause flashover strikes to conducting objects located as much as 14 inches away from the conducting path. For this reason, metallic objects in close proximity to down conductors should be electrically bonded to the conductors.

But circuits not in direct contact with the lightning discharge path can experience damage, even in the absence of overt coupling by flashover. Because the high current associated with a discharge builds up so fast, large inductively produced voltages are formed on nearby conductors. Experimental and analytical evidence shows that the surges thus induced can easily exceed the tolerance level of many components, particularly solid-state devices. Inductive surges can be induced by lightning current flowing in a down conductor or structural member, by a stroke to earth in the vicinity of buried cables, or by cloud-to-cloud discharges occurring parallel to long cable runs, either above ground or buried.

The Moral

The objective of all lightning-protection systems is to direct the high currents away from susceptible elements or limit the voltage gradients developed by the high current to safe levels. In a given area, certain structures or objects are more likely to be struck by lightning than others; however, no object, whether man-made or natural, should be assumed to be immune from lightning. The voltages that could be induced by such discharges present a definite threat to signal and control equipment, particularly equipment employing semiconductor components.

Power-Line Conditioner Sources

Cuesta Systems Inc.
3440 Roberto Court
San Luis Obispo, CA 93401
(805) 541-4160

Dymarc Industries Inc.
21 Governor's Court
Baltimore, MD 21207
(800) 638-9098
(301) 298-2629

Electronic Protection Devices
Division CNS Electronics Corp.
5-9 Central Ave.
Waltham, MA 02154
(800) 343-1813

Electronic Specialists Inc.
171 South Main St.
Natick, MA 07160
(800) 225-4876 (orders)
(617) 655-1532

Isoreg Corporation
410 Great Rd.
Littleton, MA 01460
(617) 486-9483

RKS Industries
4865 Scotts Valley Dr.
Scotts Valley, CA 95066
(800) 892-1342
(408) 438-5760

Sun Research Inc.
POB 210
Old Bay Rd.
New Durham, NH 03855
(603) 859-7110

Power-Line Filter Sources

Cornell-Dubilier Electronics
Box B-967
New Bedford, MA 02741
(617) 996-8561

Corcom Inc.
1600 Winchester Rd.
Libertyville, IL 60048
(312) 680-7400

Curtis Industries Inc.
8300 North Tower Ave.
Milwaukee, WI 53223
(414) 354-1500

Genisco Technology Corporation
18435 Susana Rd.
Rancho Dominguez, CA 90221
(213) 537-4750

Hopkins Engineering Company
12900 Foothill Blvd.
San Fernando, CA 91342
(213) 361-8691

The Potter Company
Division of Varian
POB 337
Wesson, MI 39191
(601) 643-2215

Siemens Corporation
8700 East Thomas Rd.
Scottsdale, AZ 85252
(602) 941-6366

Sprague Electric Company
87 Marshall St.
North Adams, MA 01247
(413) 664-4411

Stanford Applied Engineering
3520 De La Cruz Blvd.
Santa Clara, CA 95050-1997
(408) 988-0700

when an air conditioner comes on.) Surges are generally the result of network switching by the utility or of a sudden reduction in demand for power in the network; during the period necessary for the utility's electromechanical compensation system to function, an overvoltage transient condition can exist.

The most damaging power-line disturbance is the high-speed, high-energy voltage spike. People speaking

loosely about "power-line transients" are probably talking about this type of event. Lasting usually less than 100 microseconds, spikes can be up to 6000 volts. Such high-energy transients are produced by the switching off of inductive loads by the opening of switch contacts, short circuits, or blown fuses; severe network load changes; or lightning. Inductive-load switching accounts for the majority of spikes.

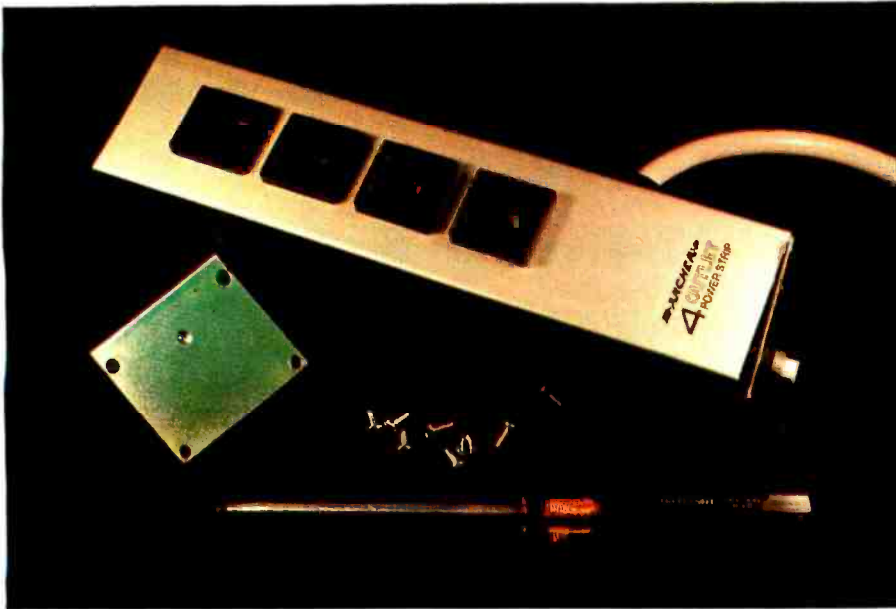

Photo 2: You can save approximately \$40 on the price of a transient-protected power strip by adding the protection yourself, as demonstrated on the Radio Shack Archer 61-2620 unit. First, unscrew the end plates.

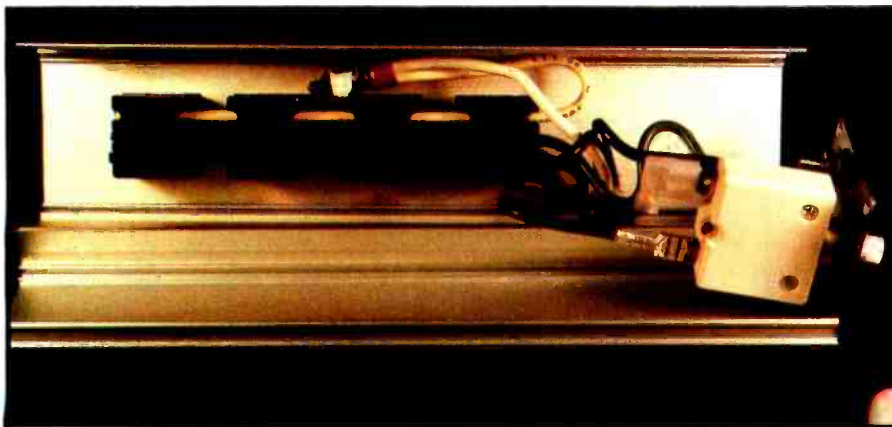

Photo 3: Open the strip case, exposing the four receptacles and the white circuit-breaker block. The three wires conducting power run the length of the strip: black is the hot side, white is the neutral return, and the green wire is earth ground.



Photo 4: Using an X-acto knife or similar tool, strip insulation from the wires between the receptacles (which I number 1 through 4, from left to right) according to the following system: between 1 and 2, strip the green and black; between 2 and 3, strip the green and white; between 3 and 4, strip the black and white.

When the coil of an inductive load such as a transformer or motor is suddenly deenergized, the collapsing magnetic field must dissipate its energy, and it does this by placing a large voltage back into the circuit that energized it. Let's examine the process in detail.

As the circuit through the inductor is broken, current in the inductor continues to flow, charging the distributed capacitance in the windings. At some point, the charge voltage becomes sufficient to leap across the switch gap as a spark. This sudden shorting action discharges the winding's capacitive charge back into the circuit until the spark ceases. This process repeats in a cycle until there is too little energy left in the coil to create an arc across the contacts. The waveform of inductance-generated transients is oscillatory. For example, a contact opening while conducting 100 mA (milliamperes) in a 1-H (henry) inductance will produce a 3000-V spike, assuming about a 0.001- μ F (microfarad) stray winding capacitance.

Whenever you plug in a vacuum cleaner, hair drier, or other appliance (even your computer), you could be creating some potentially serious transient disruptions for other equipment on the same power line. The equipment need not even be on the same wiring circuit. The capacitance of household wiring is often sufficient to couple a transient from one wire to another (differential mode) or from the wire to the ground (common mode).

Lightning is the most violent and most destructive source of transient energy. A direct lightning hit is catastrophic, but direct hits seldom occur. A more frequent danger is that a lightning strike on a power line miles away may result in a thousand-volt spike rushing throughout your home. Such hits happen frequently enough to cause much grief. (Because lightning is such a significant source of transients, I've explained it in detail in the text box "How Lightning Strikes.") A secondary, and more widespread, effect of a lightning hit on a power line is a voltage sag over a large part of the

network as the power company's safety circuits compensate for the spike.)

Electrical noise. Miscellaneous electrical noise is the final source of power-line disturbances. It is best understood as high-voltage high-frequency interference. Noise in the range from 10 kHz (kilohertz) to 50 MHz (megahertz) is the most common cause of computer failures. Because of its frequency, noise can be either broadcast through free space from its source or conducted directly through the power lines. Digital electronic equipment is a prime source of high-frequency noise.

Power-Line Protection

I'm not trying to make you afraid to plug your computer into the wall outlet. There are remedies for virtually all the problems I've mentioned, although some are more practical for some computer users than others.

If surges or sags are a constant problem for you, you can try having the power company change the tap on your local step-down transformer or installing a constant-voltage transformer on your premises. These measures, although expensive, are effective. If you are plagued by blackouts or have equipment that should never be shut down, I suggest that you consider obtaining an *uninterruptible power supply*, abbreviated UPS. Using a UPS gives you confidence in the quality of your power and effectively isolates your computer from damaging perturbations. However, a UPS is also quite costly.

In the case of electrical noise and EMI, there are filters and construction techniques that can be employed to reduce interference, but a better answer is to find the pollution at the source and eliminate it. My article in the January 1981 BYTE outlined most methods of filtration and preventive design. While I'll try not to belabor the point, a power-line filter is an important noise- and transient-suppression device.

The best answer to transients is to suppress their voltages to a harmless level, either with filters or a special category of components called *transient suppressors*.

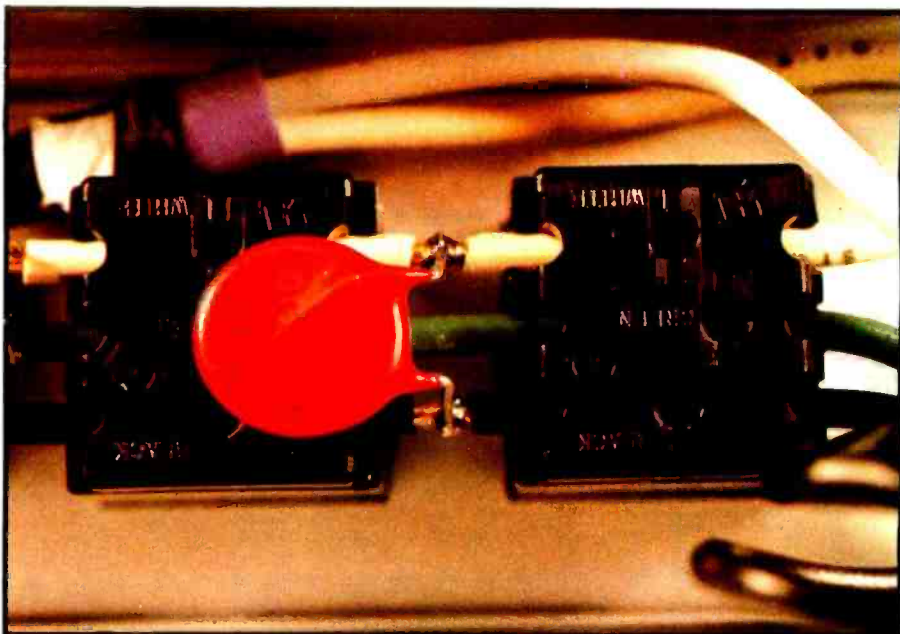

Photo 5: You can now solder a varistor between each of the stripped wire pairs, mounting it flat against the back face of the receptacle so that the case will fit together again.

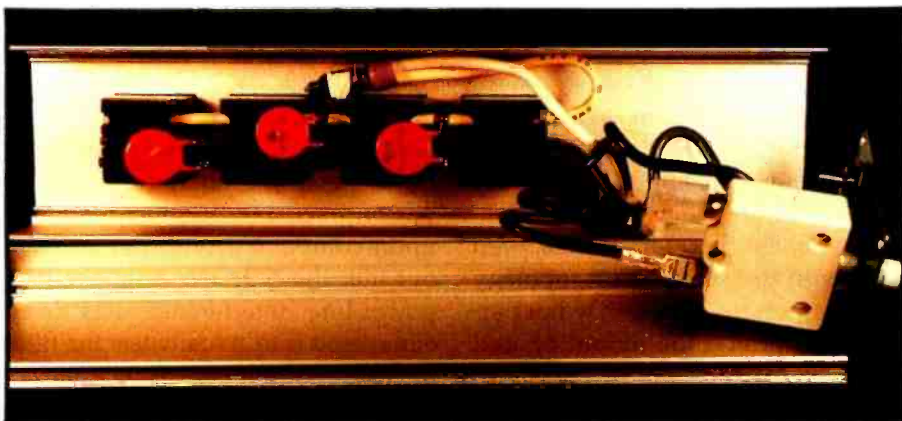

Photo 6: The outlet strip with three MOVs installed provides both common-mode and differential-mode transient suppression. After you have finished soldering, carefully reassemble the power strip's enclosure and screw it back together.

Power-Line Filters

A power-line interference filter is an electronic circuit used to control RFI and EMI conducted into and out of equipment. The filter is intended to provide unwanted interference signals with a high series impedance (into the vulnerable equipment) and low shunt impedance (to ground). It generally consists of a set of passive components that act as a mismatching network for high-frequency signals—a low-pass filter. The network attenuates RF energy above 10 kHz, while passing the 60-Hz power.

The simplest possible filter is a single capacitor wired in parallel or

a single coil wired in series with the power line. More typically, several capacitors and/or coils are used together, connected into different configurations variously called L, π , and T filters.

Though containing only a few components, such passive bilateral networks have complex transfer characteristics that are extremely dependent upon the impedances of the source and load. Because you can't predict these impedances for all applications, it is not possible to unequivocally state that a specific filter configuration will work the same way in two different environments. But to allow



Photo 7: For quicker and easier, though incomplete, protection, you can plug your computer into a simple voltage-spike protector such as the Radio Shack 61-2790. As you can see from the disassembled unit, the metal-oxide varistor (wrapped in fiberglass tape) is connected between only the hot and neutral lines (black and white). It has no varistor connection to the ground lead and therefore does not protect against common-mode transients.

electrical specifications to be minimally compared, however, resistive source and load impedances of 50 ohms each are generally used.

Two similar power-line filters, even built with the same circuit topology and component values, may not perform identically; the mounting and wiring of the filter can be critical influences on its performance. A power-line filter is best installed at the point in your equipment where the power line comes inside the case rather than at the far end of a long cord. The filter's purpose is to attenuate high-frequency signals: this purpose is defeated if these parasitic signals can gain access to the equipment by capacitively coupling to the power cord at a point behind the filter.

It's not always possible to disassemble your computer to add a line filter, but the best location for a power-line filter is bolted to the chassis of the electronic equipment it protects, or at least in the immediate vicinity, such as at the power receptacle.

While you could construct a line filter using the formulas and designs from a magazine article, I heartily recommend that you buy a packaged

unit instead. The selection is easier and much more controlled using commercial line filters (see the text box on page 39). So much depends upon component selection and layout that the only way to make sure power-line interference has been eliminated is to actually test the filter in your equipment. A circuit de-

signed according to theory using a 50-ohm assumed impedance probably won't work as well as one empirically derived using the actual equipment and power line.

Transient Suppressors

Protection from the various kinds of line transients is obtained by suppressing or diverting them. The three types of circuits most often used for this are filters, crowbars, and voltage-clampers.

As I previously alluded, *filters* comprising inductances and capacitances are widely used for interference protection, including transients. Since most transient signals are high frequency, the suppression by a filter is often effective, provided it can withstand the associated high voltages.

Crowbar circuits use a switching action, such as turning on a thyristor or arcing across a spark gap, to divert transients. But crowbars that incorporate SCRs (silicon-controlled rectifiers) and triacs are much too slow to effectively suppress 100- μ s (microsecond) transients. Most often they are incorporated in low-voltage DC power-supply output circuits where overvoltage conditions occur at more manageable speeds (milliseconds). Spark-gap devices, which include carbon blocks and gas tubes, are fast

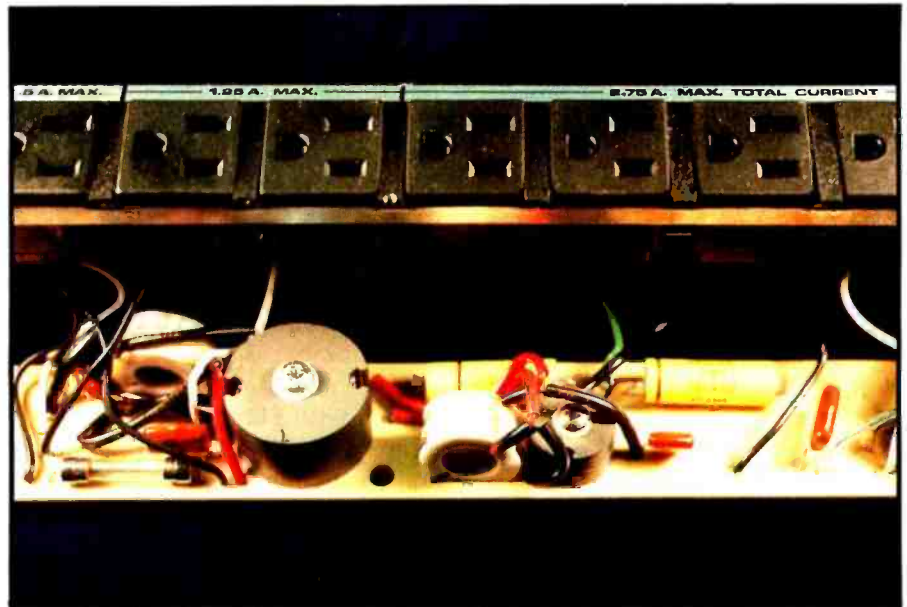

Photo 8: Some line filters are made to work in specific circumstances. This Radio Shack power-line-filter strip (stock number 26-1451) was devised to cure interference problems with the TRS-80 Model I computer; it contains two separate LC (inductance/capacitance) interference filters but no varistors. If you have this strip, I suggest you install some MOVs.

and effective, but they trigger at relatively high voltages, making them unsuitable as the sole protection for semiconductor circuitry.

Voltage-clamping devices, on the other hand, have impedances that vary as a function of either the voltage across or the current through them. The circuit being protected is unaffected by the presence of the clamping device unless the incoming supply voltage exceeds the clamping level, as would be the case when a transient hits. The various kinds of high-speed voltage-clamping devices include selenium cells, zener diodes, silicon-carbide varistors, and metal-oxide varistors. Of these, the *metal-oxide varistors*, or MOVs, hold a significant price/performance advantage and are highly applicable in personal computing applications.

MOVs to the Rescue

Metal-oxide varistors are voltage-dependent nonlinear devices that behave somewhat like a back-biased zener diode. When a voltage lower than its conduction threshold is applied across it, the MOV appears as a nonconducting open circuit. But if the applied voltage becomes greater than this set point (when a transient hits), the MOV begins to conduct, clamping the input voltage to a safe level. In effect, the MOV absorbs the transient and dissipates the energy as heat.

An MOV is made of zinc oxide combined with small amounts of bismuth, cobalt, and manganese. The individual zinc-oxide grains form many *p/n* (positive-doped/negative-doped) junctions that combine in a multitude of series and parallel arrangements. This diversity of microstructure causes its nonlinear semiconductor characteristics. An MOV is inherently more rugged than a single-junction semiconductor device (a zener diode, for example) because energy is uniformly absorbed throughout the bulk of the component.

The physical dimensions of the MOV determine its characteristics, its conduction-threshold voltage varying as a function of thickness, and its energy-dissipating capacity varying

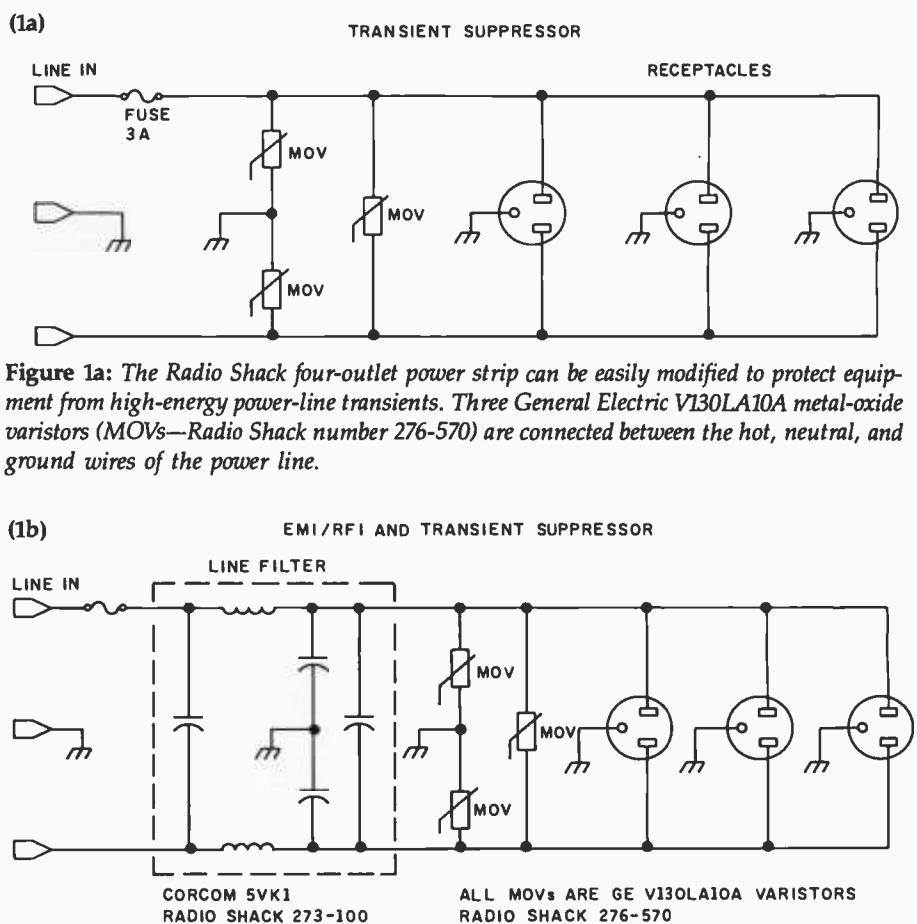

Figure 1a: The Radio Shack four-outlet power strip can be easily modified to protect equipment from high-energy power-line transients. Three General Electric V130LA10A metal-oxide varistors (MOVs—Radio Shack number 276-570) are connected between the hot, neutral, and ground wires of the power line.

Figure 1b: For added protection against low-energy electromagnetic and radio-frequency interference, the Corcom 5VK1 line filter (Radio Shack 273-100) can be installed in the circuit.

according to volume. MOVs are available in operating voltages from 6 to 2800 V, with peak current capacities of up to 50,000 A (amperes). MOVs respond to transients in only a few nanoseconds and are relatively inexpensive. The chief producer of MOVs is the General Electric Company.

Protect Your Computer

Large companies sometimes solve power-line problems by producing their own power. In the home or small office, it's more practical to protect your computer and peripherals through comprehensive application of filtering and transient suppression.

Most of the commercially available filtered power strips contain MOVs as their primary suppression device. Even those costing \$50 or \$75 rarely contain more than \$5 worth of transient protection. By purchasing the suppression components separately and installing them yourself, you can save a lot of money.

The majority of the projects I've presented in Circuit Cellar articles can be built for \$50 to \$2000, but the project this month wins hands down for economy. For the most part, line filters and MOVs are available off the shelf, and adequate transient suppression for your computer might cost as little as \$1.59!

You can take two approaches in installing suppression. If you are interested in protecting only a few items of equipment, MOVs can be wired across the AC line where it enters the enclosures. You can find the General Electric V130LA10A MOV component at Radio Shack for \$1.59 (stock number 276-570). This device is ideally suited to 120-VAC applications. It has an energy rating of 38 joules (watt-seconds) and will clamp to 340 V at 50 A within 35 ns (nanoseconds). Its peak-current rating is 4500 A. (For heavier duties, you'll need to use V130LA20A or V130PA20A MOVs.)

(As a rule, if you are going to be

COMPUTERS**PACKAGES: CREATE YOUR OWN CONFIGURATION. CALL**

IBM PC: (in stock) 256k, (2) 320k disk drives, Monochrome Display & Controller with printer port, C. Itoh F10-40cps letter quality printer, Diagnostic & Basic manuals	\$4999
COLUMBIA MPC 1600-1: 128k, (2) 320k disk drives, Amber or Green video display and controller, (2) serial & (1) parallel port, C. Itoh F10-40cps letter qual. print., and \$3000 of free software	\$3999
COLUMBIA HARD DISK MPC 1600-4: XT Compatible 128k, (1) 320k disk drive, 10meg Hard disk drive, Amber or Green video display and controller, (2) serial & (1) parallel port, C. Itoh F10-40cps letter quality printer, and \$3000 of free software	\$5699
COLUMBIA PORTABLE COMPUTER VP: 128k, (2) 320k half height disk drives, Monochrome display and controller, (1) serial & (1) parallel port, C. Itoh F10-40cps letter quality printer, and \$3000 of free software	\$3795
EAGLE PC-2: 128k, (2) 320k disk drives, monochrome display & controller, (2) serial & (1) parallel port, OKIDATA 92a near letter quality printer, with free software	\$3399
APPLE IIe: 128k, 80 columns display, Amber or Green screen, half height disk drive & controller, Fan and electrical surge protector, Gemini Star 10x dot matrix printer	\$2199
CANON AS 100: 128k, (2) 640k disk drives & controller, color display, (1) parallel port, with color printer	\$3599
DEC RAINBOW 100: 64k, (1) dual disk drive, Monochrome display, keyboard, MSDOS or CP/M 86 operating system, DEC LA50 RA dot matrix printer	\$3799

IBM PC & COMPATIBLE ACCESSORIES

64k memory chips	\$92	PFS report.	\$133
additional disk drives	\$450	PFS filter	\$110
DOS 1.1	\$40	TK! Solver	\$250
DOS 2.0	\$60	WordStar	\$327
Easywriter	\$165	MailMerge	\$165
Visicalc	CALL	Memorex disks	\$3.25
dBASE II	\$430	3M disks	\$2.99

APPLE IIe & COMPATIBLE ACCESSORIES

JAGUAR half height drives	\$249	Grappler	\$140
MICRO-SCI full height drives	\$220	System Saver Fan	\$55
80 column cards	\$275	WordStar	\$327
80 column with 64k cards	\$375	dBASE	\$430
		Memorex disks	\$3.25
		3M disks	\$2.99

PRINTERS

DOT MATRIX		GEMINI	
C. Itoh ProWriter	\$440	STAR 10X	\$335
OKIOTA		STAR 15	\$490
MICROLINE 82a	\$440	RIBBONS	\$4.99
MICROLINE 92	\$499	TRANSTAR	
MICROLINE 93	\$789	T315 COLOR PRINTER	\$499
RIBBONS	\$4.99	Ribbon	\$14.95
LETTER QUALITY		DIABLO	
C. Itoh		620	\$999
F10-40cps	\$1199	630	\$1999
F10-55cps	\$1499	Single sheet feeder	\$1350
Single sheet feeder	\$215	Tractor feed	\$215
Tractor feed	\$275	Ribbons-multistrike	\$6.99
Ribbons-multistrike	\$6.99	Ribbons-nylon	\$7.99
Ribbons-nylon	\$7.99	TTX-1014	\$499
NEC		SMITH CORONA TP-1	\$499
3550	\$1899		

MONITORS

ZENITH		TAXAN	
121	\$93	RGB I	\$325
122	\$129	RGB II	\$520
123	\$139	GREEN	\$159
AMOEBA		AMBER	\$169
COLOR I	\$299	GORILLA HI-RES GREEN	\$99
COLOR II	\$429	PRINCETON Graphic Sys	\$665

SOFTWARE

APPLE SOFTWARE		Sargon II	24.97
Temple of Apshai	29.99	MICROPRO products	
DOS Boss	19.99	WordStar/MailMerge/SpellStar	
Type Faces	14.99	CalcStar/DataStar/InfoStar	
Apple Panic	21.95	LOWEST PRICES	CALL
Chopfliter	24.95	MILTON BRADLEY educational software, All about Division, Fractions, Commas, Words	
Raster Blaster	21.95	We have them all	CALL
Ultima	29.95	Pie Writer IIe	99.97
Microwave	24.97		
Swashbucker	23.95		
Zaxxon	26.95		
IBM PC SOFTWARE		DIGITAL RESEARCH	
ALPHA SOFTWARE		CP/M 86	42.99
Database	99.97	Pascal/MI	270.00
Apple-IBM Conn'n.	136.75	IUS Software all in stock	
Data Base Manager	191.75	TIM	302.97
ASHTON-TATE		MICROPRO	CALL
Financial Planner	430.00	Microsoft Multiplan	175.00
Bottom Line Strgrst.	250.00	Crossstalk	125.00
EPYX		VISICORP software	
Temple of Apshai	26.95	Visicalc/VisiFile/Visiword	Too
Crush, Crumble & Chomp	22.99	Low to Mention	CALL
INFOCOM Zork I/II/III	79.00		

ACCESSORIES: Furniture, Modems, Cables, Disk Cases CALL

GOLDEN

1265 Broadway at 32nd St. New York, 10001

For Orders Call

800-221-3160

For Information Call 212 • 725 • 1234

OPEN 7 DAYS 8AM-8PM FOR PHONE ORDERS

VISA, MasterCard Welcome • Minimum Order \$50

\$2.50 Service Charge For Orders Under \$50

Minimum Shipping \$4.95 • Over 3 lbs. Add \$ 50 per lb.

Not responsible for Typo Errors or Manufacturers Price Changes

Quantities Limited

working inside the equipment you should also install line filters. You can buy Corcom type-5VK1 5-A RFI power-line filters at Radio Shack for \$11.95 (stock number 273-100). These units, like the one shown in photo 1, are adequate for most consumer applications and fit in very nicely with existing equipment.)

The easier alternative is to modify a regular power strip to include transient suppression. Radio Shack's 4-outlet strip (number 61-2620, costing \$15.95) is perfect for this application. Merely open it up and install three MOVs, as demonstrated in the series of photos 2 through 6, connected as shown in figure 1. One MOV is installed directly between the black (hot) and white (neutral) leads, the second MOV is connected from the black lead to the green (ground) wire, and the third from the white to the green. While you might squeak through by installing one MOV across the line, complete common-mode and differential-mode suppression requires three MOVs. (Photo 7 shows a commercial adaptation of the simplified scheme.) The price for all the parts of the protected power strip is \$20.72. If you were to buy a larger power strip or build your own distribution box, you could also add a power-line filter. And if you have a filter strip already on your computer, you might want to check its degree of transient protection (see photo 8).

An Ounce of Prevention . . .

This project may not seem very exciting. I didn't find the idea very exciting, either, until the flash and subsequent smoke coming out of my favorite article-writing computer provided all the excitement I'll need for months. Most of the \$3000 worth of damage I had was for equipment plugged into a single circuit, some of it on the same power strip. I had always known the protective value of MOVs, but I thought it wouldn't happen to me. A few dollars' worth of parts could have saved a lot of aggravation.

Voltage spikes and power-line disturbances aren't always the result of storm activity. Transient-caused equipment failures can happen any

time. The events I've described just served as a catalyst for presenting the subject. And even if lightning never hits you, you should know that many of the new computers I have been evaluating this year have shown an increased sensitivity to external interference, including power-line glitches. You wouldn't want to find your new computer rebooting suddenly at a critical point or discover the memory to be scrambled after you plug in a printer on the same outlet. Transient suppression constitutes an ounce of prevention. You can spend thousands for the cure.

Next Month:

A new integrated circuit from National Semiconductor permits an intelligent video-display terminal to be built from only 21 chips. ■

To receive a complete list of Ciarcia's Circuit Cellar project kits available from the Micromint, circle 100 on the reader service inquiry card at the back of the magazine.

Steve Ciarcia (pronounced "see-ARE-see-ah") is an electronics engineer and computer consultant with experience in process control, digital design, nuclear instrumentation, product development, and marketing. In addition to writing for BYTE, he has published several books. He can be contacted at POB 582, Glastonbury, CT 06033.

References

1. Ciarcia, Steve. "A Computer-Controlled Wood Stove." February 1980 BYTE, page 32.
2. Ciarcia, Steve. "Electromagnetic Interference." January 1981 BYTE, page 48.
3. Roberts, Steven K. *Industrial Design with Microcomputers*. Englewood Cliffs, NJ: Prentice-Hall, 1982.

Editor's Note: Steve often refers to previous Circuit Cellar articles as reference material for each month's current article. Most of these past articles are available in reprint books from BYTE Books, McGraw-Hill Book Company, POB 400, Hightstown, NJ 08250.

Ciarcia's Circuit Cellar, Volume I covers articles that appeared in BYTE from September 1977 through November 1978. Ciarcia's Circuit Cellar, Volume II contains articles from December 1978 through June 1980. Ciarcia's Circuit Cellar, Volume III contains articles from July 1980 through December 1981. Ciarcia's Circuit Cellar, Volume IV, soon to appear, will contain articles from January 1982 through June 1983.

Three ways to Speed up your Apple II & Apple IIe for \$295

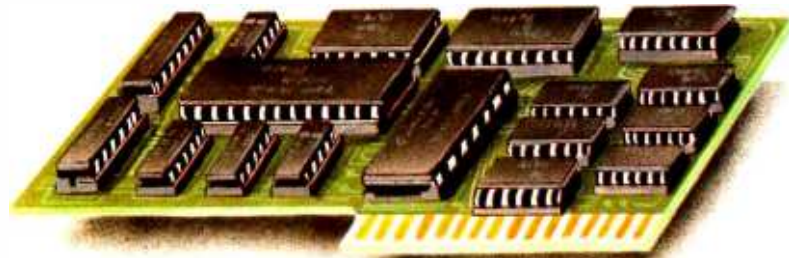

The Speedemon™ from M·c·T.

- Speedemon™ ● Makes any Apple II, II+, or IIe run 3½ times faster.
- Speedemon™ ● Makes your Applesoft, Apple Fortran, Word Processing, D.B. Master, Pascal, or Visicalc programs run up to 3½ times faster.
- Speedemon™ ● Costs less than any other speed up card.
- Speedemon™ ● Available immediately by mail. (We guarantee shipment within 7 days from receipt of order.)
- Speedemon™ ● Costs only \$295.

Circle 278 on inquiry card.

Dealer Inquiries Invited

Apple is a registered trademark of Apple Computers, Inc. VisiCalc is a registered trademark of VisiCorp, Inc. DB Master is a registered trademark of Stoneware, Inc.

Please send me _____ Speedemons™ by return mail at \$295 each. I have enclosed \$ _____
 I have an: Apple II Apple II plus Apple IIe This is for: Business Use
 Or charge my: Visa Mastercard American Express Personal Use
 My Acct.# is _____ Expires _____
 Name _____
 Address _____
 City _____ State _____ Zip _____
 Calif. Res. Add 6½% Sales Tax. Mail to: M·c·T • 1745 21st Street • Santa Monica, CA 90404

M·c·T

A COMPANY OF
 AMERICAN RADIO HISTORY

Out of the West con

**Just in the nick of time!
A six-pen graphics plotter
that's more compatible...
uses more software...
and costs only \$1095.
The Sweet-P™ Six-Shooter.
YahHOOO!**

Picture it: six-color presentation-quality graphics taken right off your spread sheets or D.I.F. files, and perfectly reproduced on paper or overhead transparency film.

Graphs of all kinds—bar, pie, line, scatter or surface. Quick-read graphs that make their point a lot faster than columns of numbers.

Graphs prepared in minutes. For pennies.

Fine, you say. Any quality plotter can do that, right?

Right.

The big difference is, *this* quality plotter costs only \$1095.

Another big difference is the people who make the Six-Shooter. Enter Computer, Inc. The Good Guys from out of the West who brought you Sweet-P The Personal Plotter.™

Sweet-P™

The Sweet-P was a real trail-blazer. In fact, the competition is still trying to catch up to it.

Now the Good Guys have got 'em on the run again with the Six-Shooter. It's *really* loaded.

You'll save a bundle!



For \$1095, you get a plug-and-go plotter with six pens, not just two.

Mounted on a revolver-like cylinder, they change automatically in a fraction of a second. No duds, either. The Good Guys supply the pens, too.

The Six-Shooter is desk-top size, but the plotting area expands from 8½" x 11" to 11" x 17" (engineers, take note!). The name may sound tough, but the Six-Shooter is really quite compatible.

With IBM and Apple.

STUDY



es the Six-Shooter.™

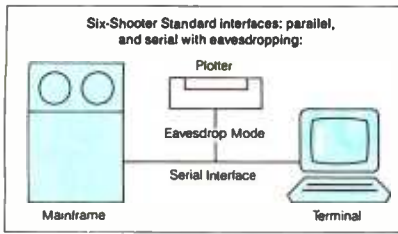

With major CP/M-based micros like DEC and Kaypro. How friendly can you get?

You can even introduce it to your network. Switch from parallel interface to RS-232 serial interface and back again... both ports are provided. The Six-Shooter will handle it. It'll also "eavesdrop" on the line between your mainframe computer and any terminal, just waiting for the right signal to trigger it into action.

Draw your own conclusions from over 50 software packages.

You can draw on lots of software to help you.

The Six-Shooter is supported by one of the largest graphics libraries available to any plotter. IBM and Apple plotters included.



To begin with, there are Sweet-P business graphics created for CP/M and MS/DOS based micros. Six-Shooter can work with programs for Apple and the IBM PC, too. Names like Lotus 1-2-3, pfs Graph, Graphwriter, BPS, Chartmaster Civilsoft and Autocad... to name a few. What's more, Six-Shooter can work with most software written for the H-P 7470, the H-P 7475 and our Sweet-P



Model 100. That's a library of over 50 packages. And growing.

If you still can't get what you need, let the Good Guys know. Chances are, we can help you write the program.

A quick-draw artist... at 14 inches a second.

That's how fast the Six-Shooter is. And wait'll you see the high-resolution quality of the graphics. The Six-Shooter literally puts an art department at your fingertips. Without the delays, the excuses and the egos.

You have a choice of fibertip pens in 12 colors. They can draw on paper or acetate (for overhead transparencies). Color-switching is automatic and lightning-fast. So is pen-capping.

You can even load the Six-Shooter with rapidograph-type pens for engineering drawings. The Six-Shooter will make short work of them. Short. And accurate.

Support your local Six-Shooter.

The Good Guys do. So does Xerox.

If your Six-Shooter ever needs servicing, just take it to any Xerox Service Center. There are over 80 of them throughout

the nation, backing our own service reps.

Xerox knows Six-Shooters. And respects them.

And if you need software advice or assistance of any kind, call the Good Guys direct. There's a special group of them to help you match the appropriate software to your specific needs.



In California, call them toll-free at (800) 227-4371. For anywhere else in the nation, the toll-free number is (800) 227-4375.

As for the Six-Shooter itself, you'll find it primed and ready at your nearest computer store. Go for it!



The good guys from out of the West.

Enter Computer, Inc., 6867 Nancy Ridge Drive, San Diego, California 92121. Telephone (619) 450-0601.

**Enter Computer.
The Sweet-P Personal
Plotter Company.
See us at COMDEX Booth 1324**

Circle 176 on inquiry card.

Trademarks: Sweet-P, Six-Shooter, Personal Plotter, Enter Computer, Inc.; Apple, Apple Computers; Auto Cad, Auto Desk; BPS, Business & Professional Software; Chart Master, Decision Resources; Civilsoft, Civilsoft; CP/M, Digital Research; DEC, Digital Equipment; Graphwriter, Graphic Communications; H-P, Hewlett-Packard; IBM, International Business Machines; Kaypro, Non Linear Systems; Lotus 1-2-3, Lotus Development; MS/DOS, Micro Soft; pfs Graph, Software Publishing

Microsoft Windows

A mouse with modest requirements

by Phil Lemmons

The desktop metaphor and the mouse present attractive concepts, but Apple's Lisa or IBM's PC XT running Visi On exceeds the budget of the average personal computer user. Both of these systems require a hard disk and great quantities of RAM (random-access read/write memory). Although the mouse itself is a small part of the expense, it is a symbol of this approach to software, and some computer users have been heard to mutter, "What price mice?"

Another factor keeping down the mouse population has been the shortage of things for them to point at (or the shortage of applications software). Until there is a large installed base of Lisa and Visi On systems, many software authors will forgo the expense of developing applications programs for these systems. Prospective buyers of personal

computers, on the other hand, are unlikely to buy a Lisa or Visi On until more software is available. Apple's own software for Lisa is magnificent, but other applications programs are only now emerging. Visicorp is making a major effort to induce programmers to write more for Visi On, but the requirement of a Unix development system is an obstacle to the smaller software houses and independent designers. The expense underlying the Unix development system is the hardware required to run it—once again, lots of memory and a hard disk.

This keeps most of us staring at the MS-DOS or CP/M command line and hoping that a sudden fall in the prices of RAM and hard disks will open the way to metaphors and mice. With the introduction of Microsoft Windows, however, the company

that brought us MS-DOS promises a mouse-and-window show running off two 320K-byte floppy disks and 192K bytes of RAM. (More RAM is required, of course, with each additional application.) To make Microsoft Windows even more attractive to personal computer users, Microsoft promises to price Windows "as an operating-system component"—that is, inexpensively.

The economics of Microsoft Windows will also appeal to programmers. Programmers don't need to buy special hardware or to learn Unix in order to develop software that runs under Microsoft Windows—they can use their own IBM Personal Computers. Moreover, programmers can take advantage of the ability to customize windows so that each software house retains its own distinct look within the Microsoft environ-



Photo 1

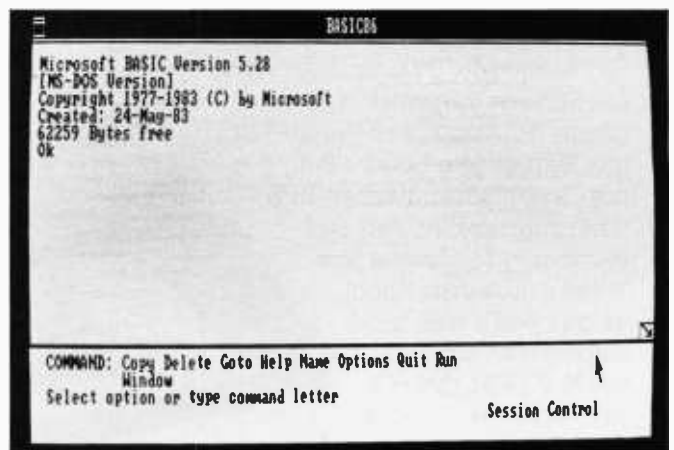

Photo 2

Device-Independent Graphics Output for Microsoft Windows

by John Butler

What makes it possible for Microsoft Windows to output graphics to different devices—printer/plotter devices as well as bit-mapped screens—without changing the graphics code?

Microsoft Windows works with a device-independent graphics system called Graphics Device Interface, or GDI. GDI consists of graphics routines that provide the interface between programs that want to draw images and different output devices. The graphics calls from these programs are not specific to any device. GDI mediates between the graphics calls and the actual devices. The calling program may be an operating-system extension like Microsoft Windows or an application program written in a high-level language.

The design of a device-independent graphics system like GDI begins with the definition of an abstract device. The abstract device is the collection of all the functions that ultimately will be performed by the actual graphics devices. (For example, "draw a circle" or "change hatch style" would be functions for devices to perform.)

When a function is called, GDI takes the function parameters, in abstract-device terms, and passes them to a logical-device driver. A logical-device driver is the software that translates abstract-device functions into a sequence of device-specific actions. These actions (communicated through a physical-device driver) result in the appearance of graphics on the device.

The GDI Abstract Device

The design of the abstract device ultimately determines the types of devices the system can talk to and to what degree the system will be device independent. To define the abstract device for GDI, Microsoft included graphics commands from the current ANSI-VDI (American National Standards Institute-Video Display Interface) standard for drawing on plotting devices. The raster frame-buffer class of device was included by adding the graphics functionality from IBM Personal Computer BASIC. A screen-dump facility and additional raster support provide hard copy and animation capability. GDI's abstract device can support any of the usual graphics subroutine libraries (for example, SIGGRAPH/ACM CORE, ISO GKS, Plot-10) as applications.

The Graphics Primitives

The language of the abstract device is made up of "primitives." The primitives are the calls to the graphics functions available at the lowest level of GDI—the level of the logical-device driver. They are described functionally as follows:

- Control Primitives. These primitives initialize, terminate, and clear the device.
- Output Primitives. These primitives result in the appearance of an actual image on a graphics device. Included are move, mark, polymark, line, polyline, polygon, rectangle, circle, arc, text, and

put/get/move bit maps.

- Attribute Primitives. These primitives describe something about the appearance of the output primitives. Each output primitive has a set of appearance commands, including size, color, and style. The filled-output primitives (those defining closed areas, such as polygon and circle) take on additional attributes for the color and style of the interior. Attribute primitives are also provided for using color translation tables and doing high-quality text.

- Viewing Primitives. These primitives control clipping, relative or absolute coordinates, and absolute sizing of images (to inches or meters). They define the border to which output primitives will be clipped. The viewing primitives also map coordinates from the logical device driver to the physical device driver and from one coordinate space to another, and they set up the resolution of the logical coordinate space.

- Inquiry Primitives. These primitives return information to the application program about the current attributes, viewing pipeline, and control flags from the logical-device driver.

GDI provides a language that application programs can use to create images. An application program can create images without knowing about the characteristics of the output device.

ment. The same enlightened attitude enabled Microsoft to resist the temptation to reserve Windows as an environment for its own applications programs. Microsoft is making Windows available to a number of applications software houses, including some major competitors.

Microsoft Windows is an installable device driver under MS-DOS 2.0 using ordinary MS-DOS files. Complete compatibility with MS-DOS means that Windows will at least let you run any application that runs under MS-DOS. In the worst case, Windows will turn the full display over to an MS-DOS application and return you to your place in Windows. "Language bindings" will enable programmers to write software for

Microsoft Windows in any Microsoft programming language.

Running Microsoft Windows

Photos 1–13 show a sequence of operations in Microsoft Windows. The photos on pages 52–53 show a variety of machines whose manufacturers have adopted Microsoft Windows as an applications environment.

During normal use, Microsoft Windows displays one or more windows, each with a different application. You can move the cursor from one window to another. You can move windows, change their size, scroll, get help appropriate to the context in which you are working, and transfer data among windows. Windows determines the highest level of data

transfer mutually acceptable to the two applications, with plain ASCII (American National Standard Code for Information Interchange) as the last resort.

The "session-control layer" becomes the equivalent of the empty desktop where you can manipulate files. The available commands appear near the bottom of the screen. Normally, Microsoft Windows will restore the desktop to the state at the time of its last use. In photo 1, we start from scratch.

To see the available applications programs, you either use the mouse to position the cursor on the command "Run" or type the letter "R." Windows lists all the applications programs as commands, and you

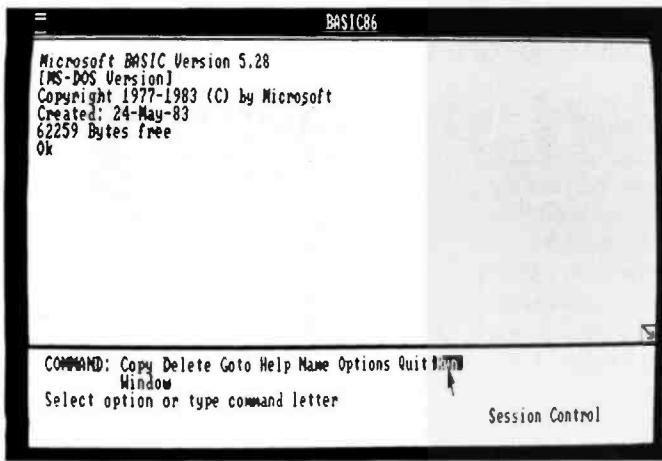

Photo 3



Photo 4

point at the desired program and click the mouse to run it. You could also type the appropriate letter instead.

In photo 2, BASIC 86 is running in a large window extending the full width of the desktop. Because BASIC 86 does all its input/output through MS-DOS, it can run in a Window. Microsoft calls such software "co-operative." The bottom of the screen shows the commands available in the session-control layer. You can use the session-control layer to run another program in parallel with BASIC 86.

The first step toward running a program is shown in photo 3, where the cursor points at "Run." Microsoft Windows will now display a list of the programs available.

Photo 4 shows the next application selected. In this case, the program that's run is "uncooperative"—that is,

it doesn't do everything through MS-DOS system calls, sometimes going beyond the operating system to write directly to hardware addresses such as those of screen memory. Microsoft Windows can't run such a program in a window and must give it the entire screen. That is why photo 4 does not

Certain programs can't use the multiple-window feature.

show the session-control layer beneath the display of "Piano."

Photo 5 shows the transition from the uncooperative program to a "smart" one that can live happily in a smaller window and share the screen with other programs that take full advantage of Microsoft Windows.

The smart program is Microsoft Word. Photo 6 shows two applications—Word in the upper window and Multiplan in the lower; both these programs were written to take advantage of Microsoft Windows. Because the cursor is pointing at one of the cells in the Multiplan spreadsheet, the command bar at the bottom of the screen shows Multiplan's commands. You can move either window by grabbing its title bar with the mouse. You could "grow" either window by grabbing the "grow box." Although these photos show the title bar at the top of the window and the grow box at the lower right, software developers can put them elsewhere if desired.

(In fact, Microsoft's own standard window has changed since these photos were taken. The latest version provides a question mark on the right

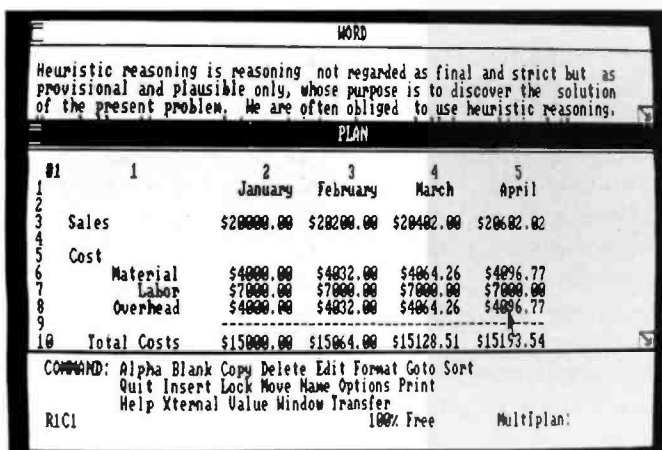

Photo 7

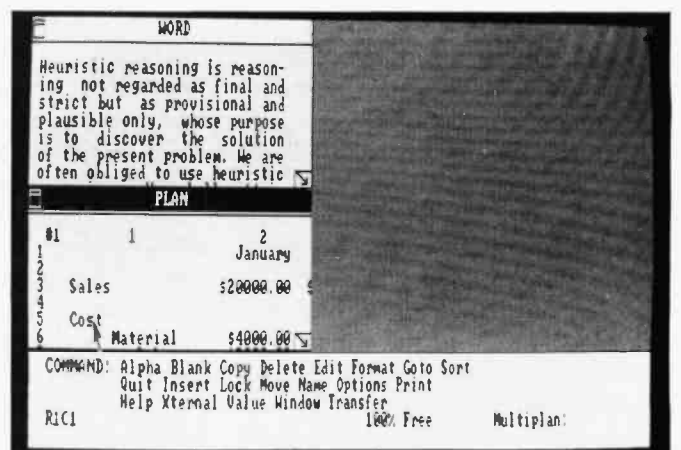

Photo 8

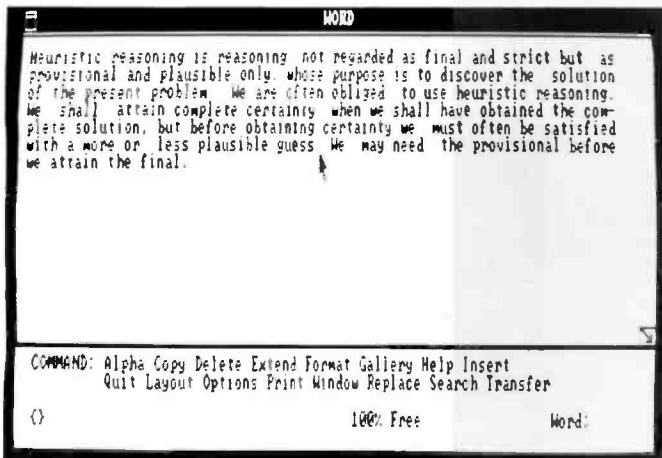

Photo 5

part of the title bar. Selecting the question mark brings help information. If you put the cursor on the title itself, it is replaced by little pictures that represent what you can do with the window. The new version also includes a status line at the top of the screen and an area for icons at the bottom.)

In photo 7, Multiplan's window has been enlarged to show more cells and more data, and Microsoft Word's window has been reduced as necessary.

Photo 8 shows both the Multiplan window and the Microsoft Word window reduced. (Since photo 8 was taken, Microsoft Windows has been adapted to use an automatic resizing process called "tiling." Rather than letting windows overlap or leaving part of the desktop empty, Microsoft Windows always gives all the space

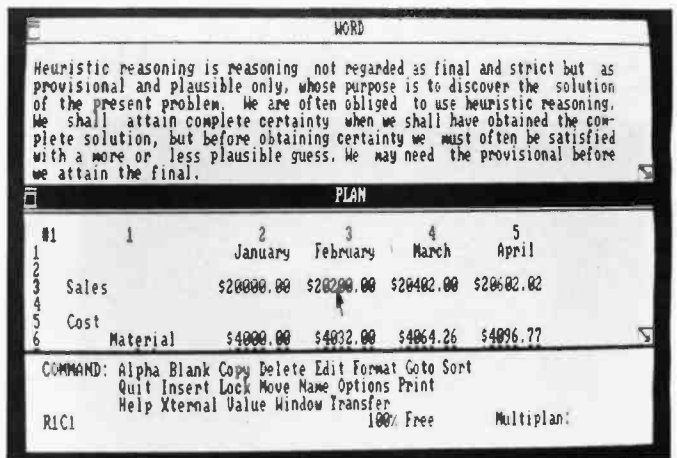

Photo 6

on the screen to the applications that are running.)

Photo 9 shows a charting program occupying a large window at the right-hand side of the screen. With the cursor in that large window, the command bar at the bottom of the screen lists charting commands. Note

Microsoft Windows can rescale graphics if desired.

that when the window containing the charting program is expanded by moving the title bar and grabbing the grow box, the line graph has been automatically rescaled (see photo 10). Microsoft Windows can rescale graphics if desired.

Photo 11 shows a sample "pop up"

menu for the charting program. Pointing at the PEN command on the command bar at the bottom of the screen has brought the display of the menu of pen sizes and patterns. You select sizes and patterns by using the mouse to point at one of the boxes shown in each list, then pointing at the "OK" box (see photo 12). As with other aspects of the Microsoft Windows displays, programmers can redesign menus to their own taste.

Photo 13 shows the graph displayed in accordance with the instructions entered—with a 4 by 4 pixel-pen size and a gray shading. The graphics capabilities of Microsoft Windows owe much to the device-independent graphics system described by John Butler in the text box "Device-Independent Graphics Output for Microsoft Windows" on page 49.

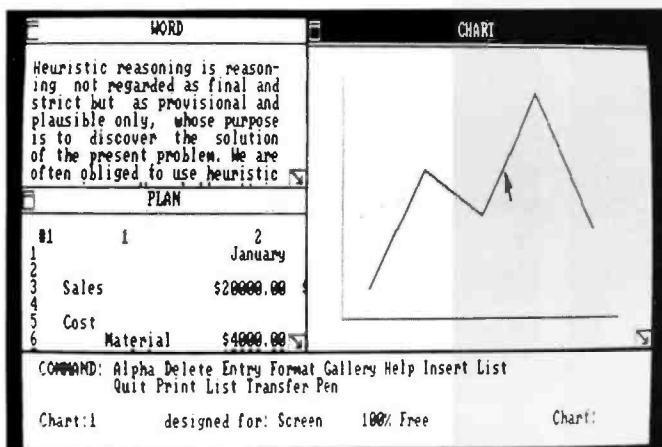

Photo 9

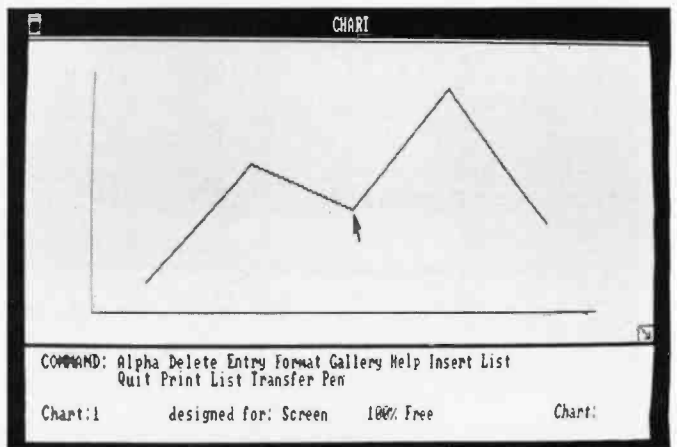

Photo 10

Some machines that run Microsoft Windows



Hewlett-Packard 150



IBM
Personal
Computer



DEC
Rainbow 100



Bytec
Hyperion



Apple IIe/
Rana Drive
System
with 8086

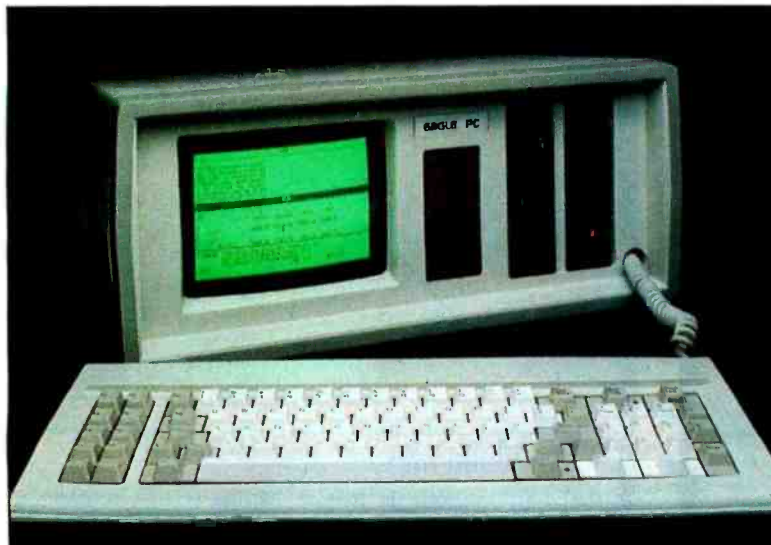

Eagle PC



Burroughs B20



Compaq Portable



Zenith Z-100



Wang Professional Computer

Texas Instruments Professional Computer



Honeywell Microsystem 6/10



A package from Radio Shack, not to be opened before December 1



Computer Devices Dot

Columbia Data Products MPC Portable



Conclusions

Microsoft Windows seems to offer remarkable openness, reconfigurability, and transportability as well as modest hardware requirements and pricing. As a result, the desktop metaphor and mouse, intended to bring computing power to nontechnical people, are finally going to reach the hands of many such people. Barring a surprise product introduction from another company, Microsoft Windows will be the first large-scale test of the desktop metaphor in the hands of its intended users.

It is natural to wonder whether Microsoft Windows' ability to run in limited memory and off floppy disks will result in noticeable delays during execution. Even Lisa with its megabyte of memory and 68000 microprocessor frequently asks the user to wait. Is the ease of use worth the waiting? Will Microsoft Windows somehow ingeniously avoid the problem of delays? The answers to these questions will shape the future of mass-market software.

The open approach and the presentation of Microsoft Windows as an extension of MS-DOS 2.0 will help attract the horde of programmers necessary to assure acceptable execution speeds on the IBM PC. Just as enough programmers working long enough on enough different approaches have made the Apple II perform feats that once seemed incredible, enough programmers working long enough on different approaches will make applications run fast under Microsoft Windows on ordinary hardware. Even if this judgment proves mistaken, Microsoft's policy of openness and low pricing will have made possible a major experiment in mass-market software. For many software authors as well as users, this will be the first chance to test an approach to the user interface that has hovered just beyond reach for several years. ■

Phil Lemmons, BYTE's West Coast Bureau Chief, can be reached at McGraw-Hill, 425 Battery St., San Francisco, CA 94111.

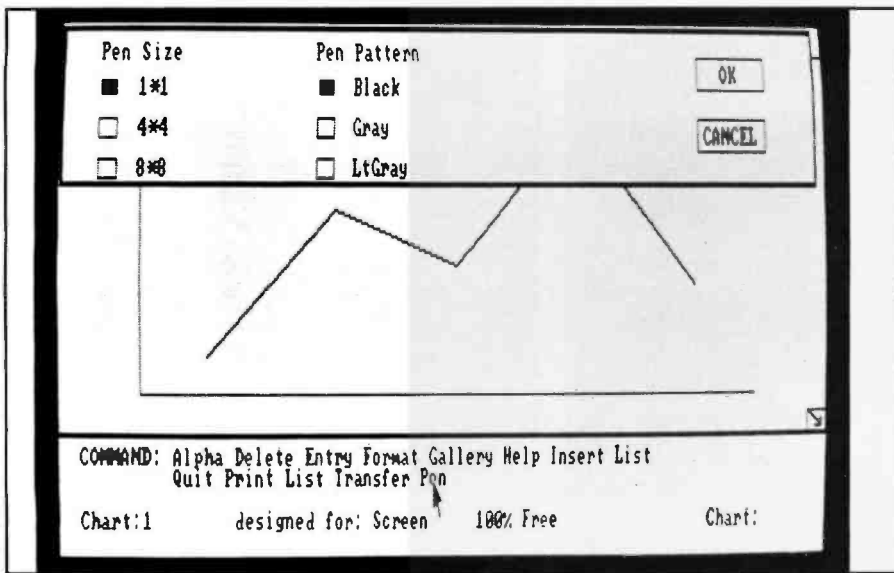

Photo 11

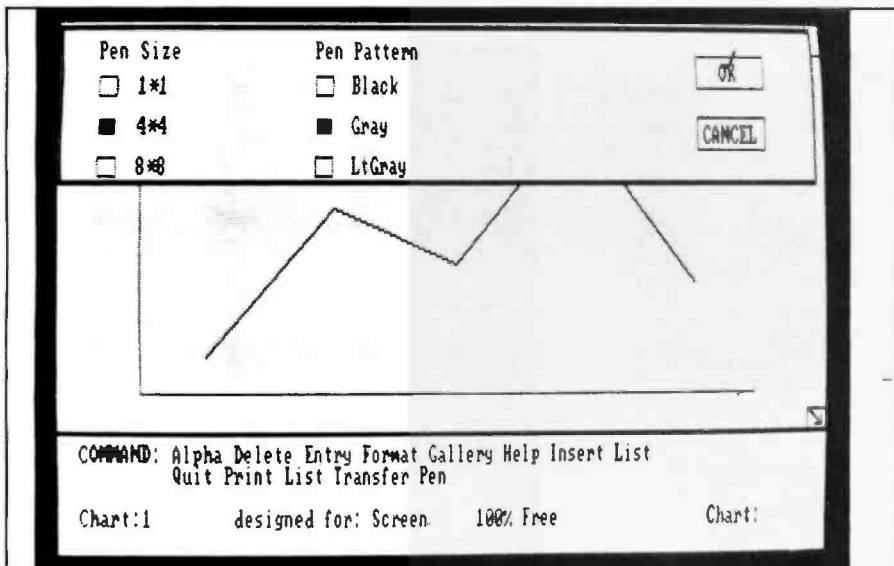

Photo 12

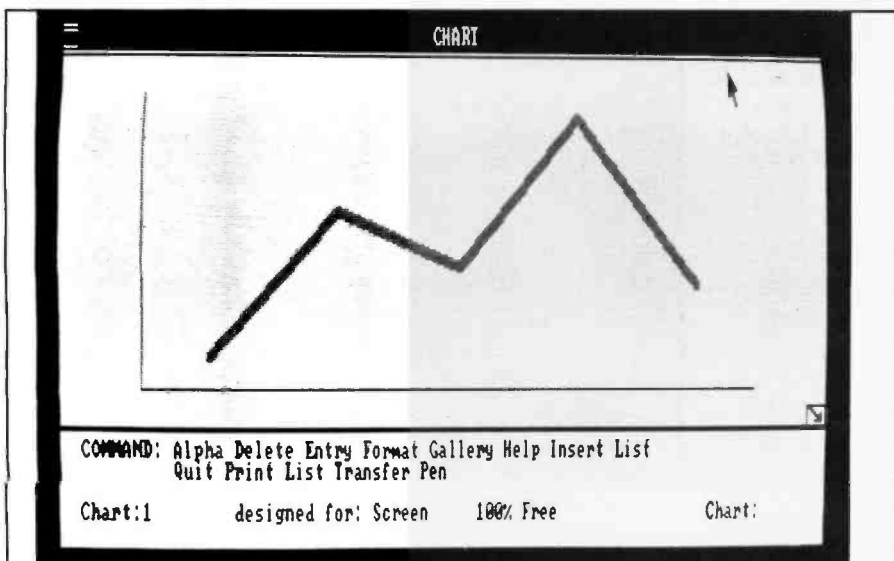

Photo 13

Teletek's New Combo Could Make You A Hero!

The SBC-II could be just the right ingredient for your latest concoction. The newest member of Teletek's family of multi-user, multi-processing S-100 products, the SBC-II essentially combines, or "sandwiches" two Teletek SBC-I's into one board. The SBC-II provides the capability to support two users from one standard size IEEE-696/S-100 slave board.

The SBC-II maintains full performance for each user with an independent CPU (Z80A or Z80B), 64K RAM, Serial I/O, and FIFO communications port to the system master. The system integrator benefits by getting complete support for two users for the price of one board.

TurboDOS and MDZ operating systems will support combinations of SBC-I's and SBC-II's offering system design efficiency and flexibility never before possible.

If you're hungry for value and efficiency, order an SBC-II from Teletek. You'll love every byte.



TELETEK

4600 Pell Drive
Sacramento, CA 95838
(916) 920-4600
Telex 4991834 TELETEK
Dealer inquiries invited.

© Teletek 1983

Circle 420 on inquiry card

NEW PRINT FORMATTER

from CompuView

FEATURES

- Right and Left Justified Text
- Centered Text and Underlining
- Variable Line Spacing
- Define Independent, Odd or Even Page Header/Footer Titles
- Set Variable Page Width and Length
- Set Top and Bottom Page Margins
- Variable Tab Settings
- Automatic or Manual Pagination
- Output Can Be Sent to a Disk File, or Directly to a Printer

VPRINT is the perfect companion of VEDIT or your favorite text editor to provide formatted output to either a printer or disk file. Combined with VEDIT you can now have an ideally matched set of word processing tools.

VPRINT is easy to use, requires no installation, and operates with virtually every microcomputer and printer made. And, it is upwards compatible with the UNIX formatting utility TROFF.

Disk and Manual \$75
Purchased with VEDIT \$50

Call or write for a complete descriptive brochure of CompuView's software products:

VSPool
CP/M Software Print Spooler \$79

VBUG
Z80 Debugger \$75

VCOM
Z80 - 8080 Disassembler \$80

VDISK Disk Production and File Transfer Program

Finally, you can solve most of your disk production and transfer problems without buying thousands of dollars of expensive hardware. VDISK is a unique software package that allows you to produce (Format, Read and Write) or transfer virtually all 5 1/4" soft sectored, double density diskettes on an unmodified IBM Personal Computer.

You may have already have tried VDISK. Chances are that the diskettes you have received from many of the well known software companies or distributors were made with VDISK. It is a proven and well received product.

VDISK is menu driven and easy to use. It also simplifies diskette production by allowing all diskettes to be produced on the same machine, in the same manner and with the same simple commands.

VDISK requires no hardware modifications and comes with our advanced CP/M-86 operating system - no other software is needed. PCDOS disks can also be read and written. Plus support for popular hard disks is available.

We can now help save you from the expense and headaches of one of the biggest problems in the microcomputer industry. VDISK is priced at \$1150 plus a \$60 fee per desired format. (Dealer discounts are also available). As new formats are developed, they may be purchased for only \$60 each.

READ,
WRITE,
FORMAT,
Altos
DEC VT180
DEC
Rainbow
Digilog
Eagle
HP 87
HP 125
IBM CP/M-86
Kaypro II
Morrow
Decision
NEC PC8000
NCR
Osborne DD
Otrona
Seiko
SuperBrain
Televideo 802
Xerox DD
Zenith 289
Zenith Z100
And Many
Others

MODEM-86 CP/M-86 and MSDOS Communicator

MODEM-86 is the first truly universal telecommunication program for the IBM PC, Displaywriter, other popular 8086 computers and many S-100 systems. A user may access a dial-up mainframe computer, capture and store the data on disk, or transfer files back and forth (using X-ON/X-OFF). Single and multiple files (both ASCII and Binary) may also be transferred reliably with error checking / correction between any two microcomputers running MODEM-86 or the popular CP/M MODEM4 and MODEM7 programs. The help command, command menu (expert mode turns menu off), and directory display simplify operation.

MODEM-86 may be run in batch mode or interactively. This software is available for both CP/M-86 AND MSDOS operating systems, and will operate, without hardware or software modification, on more computers than any communication package ever before.

Version for CP/M-86 or MSDOS \$89
Versions for CP/M-86 plus MSDOS \$120

SYSTRAN CP/M-86/MS-DOS File Transfer Utility

SYSTRAN is a set of utility programs that run on CP/M-86 systems. These programs perform basic file operations on MS-DOS disks, transfer files between MSDOS disks and CP/M-86 disks, and several other useful functions. SYSTRAN is distributed as eight command files on one 8" single sided, single density, standard CP/M floppy disk or on 5 1/4" floppy disks compatible with most CP/M-86 mini floppy systems.

The minimum hardware requirement is the same as the minimum requirement for CP/M-86. You must have at least two disk drives. The SYSTRAN utilities go through CP/M to access a MS-DOS disk so that there are no special requirements for the system's disk controller.

Disk and Manual \$120

UNIX & TROFF are registered trademarks of Bell Laboratories, Inc.

CompuView
PRODUCTS, INC.

1955 Pauline, Suite 300 Ann Arbor, Michigan 48103 (313) 996-1299 Telex - 701821
Orders: P.O. Box 1349, Ann Arbor, Michigan 48106

EXPECT A LOT *from* VEDIT

Newest Features:

- Horizontal Scrolling
- Single Key and Conditional Search and Replace with Pattern Matching
- Easier to Use than Ever

Widely acclaimed as an editor, VEDIT has evolved to be much more. VEDIT is not only a versatile full screen editor, its command mode has become a powerful text-oriented programming language based on TECO. For the first time you'll be able to perform complex text

manipulations that are impossible for any word processor. Just a few examples of VEDIT'S command macro power are:

- Hundreds of tedious search/replace operations, once performed by hand, can now be made automatically on dozens of files without your intervention.
- VEDIT macros are indispensable with source code translations. (Example ZILOG to/from INTEL translator macros are included). A complete line of translators will be available soon.
- An on-line tutorial and mail merge program, completely written with VEDIT macros, (source included) is available as an inexpensive option -- imagine what you can write for your own applications.

Word processing is a snap with paragraph formatting, word wrap, print functions, and VEDIT's unmatched 'cut and paste' capability.

VEDIT cuts programming time in half - with multiple file handling and special features for Pascal, PL/1, 'C', Assembler and other languages.

VEDIT is completely customizable -- you configure your own keyboard layout. Use any function or cursor key you wish. Plus our total commitment to hardware support ensures that VEDIT will be perfectly matched to any microcomputer you are ever likely to own.

Reviewers' Comments

'The performance of this product is nothing short of outstanding!'

'VEDIT is a 'virtual' text editor. The amount of memory in your computer does not limit the size of the file you can edit.'

Tim Daneliuk, InfoWorld - May '83

'At present there are three major entrants into the screen editor category for the PC...VEDIT is the front-runner for the definitive quality screen editor.'

Todd Katz, PC Magazine - October, '83



'VEDIT's 'visual' mode, where you will spend most of your time, has a multiplicity of valuable one-or-two-keystroke commands which make it very easy to enter and modify text.'

Frederick Zimmerman, Sextant - Fall, '83

'VEDIT's by all odds the most flexible programming editor I've ever seen.'

'One of its best features is multiple buffers; that is, you can store chunks of programs in various places and pull them out into your main file when needed.'

Jerry Pournelle, Byte - September, '83

True Full Screen Editing
 Edit Files One Disk in Length
 Automatic Disk Buffering
 Compact (Only 16K) and Fast
 Display of Line and Column
 Set/Goto Text Markers
 'Undo' Key to Restore Line
 Automatic Indent/Undent
 Adjustable Tab Positions
 Repeat Function Key

Text Move and Copy
 10 Scratchpad Buffers
 Load/Save Buffers on Disk
 Powerful Command Macros
 Directory Display
 Edit Additional (small)
 Files Simultaneously
 Insert Another Disk File
 Unlimited File Handling
 Recovery from 'Full Disk'

Change Disks While Editing
 Word Wrap, Format Paragraph
 Simple Printing
 150 Page Indexed Manual
 Startup Command File
 Menu Driven Installation
 Program CRT Function Keys
 Support Newest CRT terminals
 Flexible Memory Map Support
 Customizable Keyboard Layout

VEDIT is available for virtually every 8080, Z80 or 8086 microcomputer made. To order please specify your computer, operating system and disk format.

VEDIT - Disk and Manual



8080, Z80 or IBM PC. \$150
 CP/M-86 or MSDOS . \$195
 Manual only \$18
 On-Line Tutorial . . . \$15
 Mail Merge \$15



CP/M is a registered trademark of Digital Research Inc. MSDOS is a trademark of Microsoft. IBM is a trademark of International Business Machines. Quotes from InfoWorld review Copyright 1983 by Popular Computing, Inc. a subsidiary of CB Communications, Inc. - Framingham, MA. Reprinted from InfoWorld. Quotes from Byte review Copyright 1983 by Byte Publications, Inc. Quotes from Sextant review Copyright 1983 by Sextant Publishing Co. Quotes from PC Magazine review Copyright 1983 by PC Magazine.

CompuView

PRODUCTS, INC.

1955 Pauline Blvd., Suite 200 Ann Arbor, Michigan 48103 (313) 996-1299 Telex - 701821
 Orders: P.O. Box 1349, Ann Arbor, Michigan 48106



Reach out and byte someone!

Your desk-top computer system is only a beginning — plug a low-cost UDS modem into the RS-232 port and a whole new world of communications opens up!

UDS modems add a new dimension to personal computers. For professional use, a modem permits two-way, hard-copy communication between home office and branches or among the branches themselves. Electronic mail becomes a reality. Sales, cost and inventory updates can be sent over ordinary telephone lines at economical, after-hours rates.

When you use your computer for personal applications, the modem allows you to access up-to-date market information, receive news and weather summaries, check airline schedules or even electronically scan out-of-town newspapers. Long-distance game playing and computer-age personal correspondence become instant realities.

The wide range of UDS modems includes one that fits your requirement perfectly. Top of the line is the micro-processor-based 212 A/D which communicates at 0-300 or 1200 bps, stores and automatically dials up to five 30-digit numbers and includes a complete prompting menu and full



automatic test capabilities. Yet, with all these features, it costs only \$645.

At the other extreme is the \$145 103 LP, offering simultaneous two-way communications at 0-300 bps without an AC power cord. This unit siphons operating energy directly from the telephone line!

In between is a large variety of units — many of them in the LP no-power-supply design and all fully FCC certified for direct connection to the telephone system.

Don't be a computer hermit — treat your system to a UDS modem; then you can reach out and byte someone! For details, contact your favorite computer dealer or Universal Data Systems, 5000 Bradford Drive, Huntsville, AL 35805. Telephone 205/837-8100.

 **Universal Data Systems**

 **MOTOROLA INC.**
Information Systems Group
Circle 443 on inquiry card.

Buddy, Can You Spare a Door Latch?

A lack of spare parts almost causes a crisis at Chaos Manor

by Jerry Pournelle

My summer has been devoured by locusts. It's gone, and I don't know where it went. Actually, I do: it wasn't locusts, but our new novel *Footfall* (Larry Niven and Jerry Pournelle, Ballantine Books, January 1985) that ate my summer; so now I sit here writing this column while everyone else in the world is in San Francisco for the first IBM PC Faire.

I suppose it doesn't matter: although we ordered it two months ago, our IBM PC hasn't arrived. Since there's a ton of unreviewed PC software glaring balefully at me from the far corner of the office, it would be beyond reason to collect more until the machine arrives.

I confess we're looking forward to the machine. I already have a number of ideas for upgrading it, and I hope to test a bunch of expansion boards for it.

Then, too, Mrs. Roberta Pournelle has written a book on using computers to teach young and/or educationally handicapped children to read, and we plan to do the first implementation on the IBM PC, so we're eager to get started. Once we

have it for the PC, we'd like to get it running on the TI-99 (because it's a cheaper machine, and has a voice synthesizer already integrated to it, so more schools would be able to make use of her teaching system at

Logitech's Modula-2 compiler works on nearly any machine running CP/M-86.

lower costs), but, alas, our efforts to find reasonable programming languages for the TI have failed.

Anyway, that's for the future.

Flash

The American Society for Computers in Medicine and Dentistry will hold a meeting at Honolulu's Sheraton Waikiki Hotel from January 4-8, 1984. Speakers will include myself, Dr. Larry Weed, whose "diagnostic programs" have impressed me tremendously, and Marvin Minsky of the MIT Artificial Intelligence Laboratory.

Anyone interested should write Dr. John S. McDonald, President, ASCMD, POB 21483, Upper Arlington, OH 43221, (614) 421-8487. The ASCMD is a nonprofit professional society.

Hot Tip

I've heard from three sources now that Digital Research is no longer supporting CP/NET. It claims it will have something to replace it Real Soon Now. The company has also abandoned several previously announced modules of GSX, its graphics support package that was announced with such fanfare at Comdex last spring. This has not amused several equipment manufacturers who'd invested considerable time in CP/NET and/or GSX.

Modula-2!

We're running Logitech's Modula-2 compiler. It works on the Eagle, the IBM PC, and nearly any other machine that runs CP/M-86. It comes with System and Terminal modules (including source code) that allow it to adapt to whatever you're running;

the latest version I have is for the Compupro 8085/8088.

Because of the pressure of our novel, I've done little more than play with the compiler. That changes as soon as this book is done. I intend to write some serious code in Modula-2.

The Logitech Modula-2 compiler works. On the other hand, you'd better be a Modula-2 enthusiast. This is still a language implementation under development, and it lacks a lot of conveniences. The documents need work, too. No matter, if you're bent

on getting Modula-2 *now*, as I am; but fair warning if you're a casual user.

Understand, the compiler works. There are some significant limitations. No type REAL numbers yet, and no overflow and range checking code. Priorities in modules are not yet implemented—you can program them in, but they're ignored. These are not severe limits for the first version of a compiler, and they'll be corrected soon anyway, mostly before you read this. (Type REAL, based on

the 8087 chip for terrific speed, will be available as a test version in December and for general sale in February.)

The documents are very rough. There's no index, and no tutorial on how to use Modula-2. You have to rely on Wirth's book, *Programming in Modula-2*, and that's nearly unreadable. I'd like to do a good book on Modula-2 myself; I'd rather have one to read than have to write it, but I'm beginning to despair. However, Logitech's documents are good enough if you know something of what you're doing—for example, if you're somewhat used to C or Pascal on micro-computers.

SEATTLE GIVES YOU AN EDGE IN S-100 SYSTEM DESIGNS

You can unlock new system capabilities with high-performance S-100 boards from Seattle Computer. All are IEEE-696 compatible. But, for innovative systems that demand performance beyond the limits of conventional S-100 boards, you'll want to know more about these Seattle Computer products. For example, with our 8 MHz 8086 CPU, you'll be able to build systems that run faster and consume less power than before. Take a closer look:

8086 CPU Set: 8 MHz 8086 CPU • CPU Support board includes a console serial port, a second serial port, Centronics parallel port, vectored interrupt controller, four 16-bit timers and EPROM monitor for 8086 • MS-DOS 2.0 plus development utilities • 8087 numeric coprocessor is optional
• **Single Qty: \$595.00**

64k Static RAM Fully static design makes interfacing easy • Compatible with a variety of CPU and DMA devices • High-speed (85 ns) RAMs operate to 10 MHz with no wait states • 16k, 32k, and 48k OEM versions are available
• **Single Qty: \$495.00 (64k)**

Disk Master™ Controls as many as four 8" and four 5.25" floppy disk drives simultaneously, in any combination • Uses 1793 disk controller chip • Can be used with 10 MHz CPUs • **Single Qty: \$325.00**

Multi-Port Serial Card 2- and 4-port versions are available • These RS-232 ports operate as either "data sets" or "data terminals" • 36" cables included
• **Single Qty: \$280.00 (4-port)**
\$210.00 (2-port)

For the whole story on high-performance Seattle Computer S-100 boards, call:

1-800-426-8936

Dealer and OEM inquiries are invited.

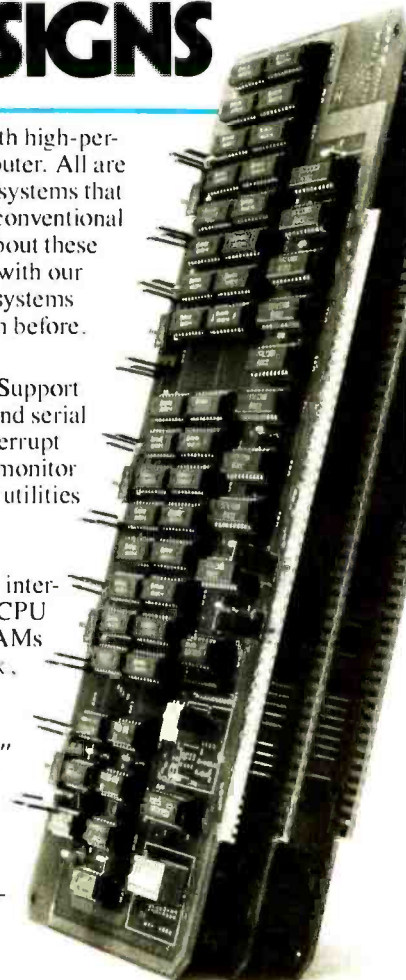

**SEATTLE
COMPUTER**
1114 Industry Drive
Seattle, WA 98188

Modula-2 is still a language implementation under development, and it lacks a lot of conveniences. The documents need work, too.

There is, for instance, a simple walk-through for getting "MyProgram" written, saved, compiled, and operating. Given that example, you can build up to more elaborate levels.

I say the Logitech package is a bit rough, but it's a little hard to give specific problems, because as fast as they're found, Logitech fixes them. The company has been really responsive to user reports. Moreover, many problems aren't all that severe. For example, the documents say that if you compile a source file, the compiler looks for a default of type .MOD (that is, if you don't specify a filename extent, the compiler assumes one of .MOD); in fact, though, it doesn't assume any such thing, and you must type in FILENAME.MOD, which is annoying although hardly fatal.

The compiler is pretty slow, too; it takes four passes at the code, and there's no precompiler to find trivial errors (such as undeclared variables and missing semicolons). However,

In the Hard Disk Jungle Tallgrass Clears a Path



In today's hard disk jungle, Tallgrass clears a path by offering high performance, integrated mass storage solutions for the IBM® PC and compatibles, the T.I. Professional and the Victor 9000 computers.

TALLGRASS INNOVATIVE FEATURES

MASS STORAGE SYSTEMS with formatted HardFile™ capacities of 6, 12, 20, 35 and 70 Mb, all with built-in tape backup.

CONVENIENT INTEGRAL TAPE BACKUP SYSTEM allows rapid tape "image" streaming, or incremental file-by-file backup and restore on ANSI standard inexpensive data cartridges, instead of the usual floppies, video cassettes, or low-capacity removable Winchester devices.

NETWORK READY and fully compatible with networks such as PCnet® and EtherShare.™

HIGH RELIABILITY with dual directory and read-after-write verify options. A dedicated landing zone, where the read/write heads reside when the disk is idle, provides data protection during powerdowns and transportation.

EtherShare™ is a registered trademark of 3Com Corp.

PCnet® is a trademark of Orchid Technology

IBM® is a registered trademark of International Business Machines Corp.

Follow the Tallgrass path to your local computer dealer and watch your personal computer transform into a powerful data processing system.

From \$2,995.00 U.S. including integral tape backup.

Available from COMPUTERLAND®, Entré® Computer Centers, MicroAge® Computer Stores and other participating computer dealers.

New! IBM-XT Cartridge Tape Backup

World Headquarters: Tallgrass Technologies Corp. / 11667 W. 90th St.
Overland Park, KS 66214 / 913-492-6002 / Telex: 215406 TBYT UR

Canadian Distributors: Micro-Ware / 440 Phillip St.
Waterloo, Ontario N2L 5R9 / 519-884-4541

CompuServe / 1675 W. 8th St. / Vancouver, B.C. V6J 1V2 / 604-733-7783

European Distributor: CPS Computer Group, LTD
Birmingham, England B276BH / (021) 7073866

Australian Headquarters: Tallgrass Technologies (Australia) / Five Dock Plaza,
Suite 12 / 50 Great North Road / Five Dock / Sydney, N.S.W. 2046 / (02) 712-2010



**Tallgrass
Technologies**
Corporation

Pierluigi Zappacosta, president of Logitech, tells me that in the past week (August 22-26) it has improved the speed of the CP/M-86 compiler by 20 percent.

Logitech has also identified a number of small but important improvements that ought to be made to the language itself. Logitech, Volition Systems, and Diser Inc., the three U.S. publishers of Modula-2, have agreed on a set of changes and hope to persuade Niklaus Wirth, Modula-2's inventor, to approve them. They're not major, but they will make life a lot easier for programmers. One change is type LONG INTEGER, so that you can handle really big numbers. Another is the ability to build a string by concatenating characters one at a time; at the moment, string handling is a bit awkward.

Late addition: Wirth's comment is that industry needs standards more than academia, and he won't oppose the proposed extensions.

Logitech is also working on a text editor that will be integrated with the compiler, much as the editor is in-

tegrated into the compiler in Digital Research's Speed Programming Package addition to its Pascal MT+. Modula-2 badly needs that feature.

It also badly needs a precompiler. That is: Modula-2 is case sensitive. All the reserved words (such as DO and WHILE and END) must be in uppercase letters. In addition, variable and function names are case sensitive. The new-line function is WriteLn and it must be written that way; Writeln or WRITELN won't do. That's not a bug, it's a feature. It's not a feature whose value is self-evident, although I'm beginning to understand its purpose. In any event, I'm writing a kind of precompiler, a sort of very primitive cousin of the C language's *lint*, which will look for silly errors such as missing semicolons, and also check for reserved words in the wrong case, and WriteLn and WriteString not spelled funny, and such like. Writing it is instructive: it's really a simple thing to do, and adding features to the program turns out to be very easy. Obviously I'm writing the program in Modula-2.

There's a whole lot to like about the Logitech implementation of Modula-2. For example, the company gives the source code for the Terminal and System modules, as well as a whole bunch of others. The library is quite extensive.

Despite my enthusiasm, I don't advise beginning programmers to buy Logitech Modula-2 for their CP/M-86 or IBM PC-DOS systems just yet. Wait a couple of months until it gets the bugs out.

You should also give Logitech a chance to polish up its documents. It's worth half your sanity to try to figure out how to open, close, read from, and write to CP/M files. The information is all there, in comments in the source code for the Library module FileSystem; but, alas, there are *no examples*, which almost drove me nuts when I tried actually to use the code.

Again, Logitech assures me it's dancing as fast as it can, and it takes my suggestions seriously; it recently hired document consultants to help improve documentation. Still, begin-

AZTEC C — 'C' PROGRAM DEVELOPMENT SYSTEM
PORTABLE SOFTWARE APPLE CP/M IBM

WHY PROFESSIONALS CHOOSE AZTEC C

SOFTWARE SYSTEMS

- AZTEC C is the most complete implementation of UNIX V7 'C' available for microcomputers.
- AZTEC C is portable. 'C' code can be freely moved between UNIX V7 and microcomputer systems. AZTEC C is available for PC DOS (MSDOS), CP/M 86 (MP/M 86), CP/M 80 (MP/M 80), APPLE DOS, MODEL III (IV), COMMODORE 64, and ATARI. All versions of AZTEC C are source compatible.
- AZTEC C is a complete development system that includes relocating assembler, linkage editor, library utility, debugging aids, overlay support, interfaces to Microsoft and Digital Research development software, and run time routines for I/O, utility, and scientific functions. Source for all library routines is provided.
- AZTEC C generates fast native code for the 6502, 8080, Z80, 8088, and 8086.
- Cross compilers are available from PDP-11, 8086, 8080, and 6502 processors.
- Since its release in 1981, AZTEC C has been acquired by several thousand users. Commercial applications include a wide variety of business, scientific, word processing, database, entertainment and financial applications.

PRICE LIST

AZTEC C86	PC DOS (MSDOS)	\$148
AZTEC C86	CP/M 86 (MP/M 86)	249
AZTEC C II	CP/M 80 (MP/M 80)	199
AZTEC C85	APPLE DOS	199
AZTEC C65	COM 64 OR ATARI	199
AZTEC Cross Compilers	PDP-11	2,000
AZTEC Cross Compilers	Other	500

Order by phone or mail. Specify product and disk format. Check, Money Orders, COD, VISA, MC, and purchase orders are acceptable. NJ add 6% sales tax.

MANK SOFTWARE SYSTEMS
 Box 55, Shrewsbury, NJ 07701

Order phone: (201) 780-4004
 Tech information: (201) 530-7997
 Tech support: (201) 530-7708

Shipping: COD, 2nd day delivery, or Canada, add \$5. Canada 2nd day or US next day delivery, add \$20. Outside North America, add \$20, and for 2nd day add \$75



Season's Greetings

AMDEK

WHOLESALE PRICES

TOLL FREE **800-422-6001**

ORDER DESK HOURS: 9AM TO 6PM PST MON-SAT

PRINTERS

	LIST PRICE	OUR PRICE
OKIDATA 82A...	\$ 499.00	\$ 359.00
OKIDATA 83A...	\$ 749.00	\$ 599.00
OKIDATA 92A...	\$ 599.00	\$ 439.00
OKIDATA 93A...	\$ 999.00	\$ 749.00
OKIDATA 84A...	\$1395.00	\$ 959.00
EPSON MX80FT...	\$ 525.00	\$ 399.00
EPSON FX80....	\$ 699.00	\$ 559.00
EPSON RX80FT...	\$ 599.00	\$ 399.00
EPSON RX80....	\$ 399.00	\$ 329.00
EPSON MX100...	\$ 699.00	\$ 629.00
EPSON FX100...	\$ 895.00	\$ 659.00
GEMINI 10X....	\$ 399.00	\$ CALL
GEMINI 15X....	\$ 599.00	\$ CALL
TRANSTAR 120...	\$ 599.00	\$ 479.00
TRANSTAR 130...	\$ 895.00	\$ 689.00
TRANSTAR 140...	\$1695.00	\$1199.00
TRANSTAR 315...	\$ 599.00	\$ 489.00
DAISYWRITER...	\$1495.00	\$1149.00

CALL FOR PRICES ON OTHER PRINTERS

PRINTER INTERFACES

GRAPPLER +....	\$ 165.00	\$ 119.00
GRAPPLER 16K-B.	\$ 239.00	\$ 179.00
BUFFERBOARD +..	\$ 165.00	\$ 119.00
MESSENGER SER..	\$ 129.00	\$ 99.00
ORANGE MICRO...	\$ 87.00	\$ 75.00

CALL FOR PRICES ON OTHER INTERF.

MONITORS

AMDEK COLOR I..	\$ 300.00	\$ 269.00
AMDEK COLOR I+.	\$ 399.00	\$ 279.00
AMDEK COLOR II.	\$ 529.00	\$ 385.00
AMDEK COLOR II+.	\$ 559.00	\$ 395.00
AMDEK COLOR III.	\$ 449.00	\$ 329.00
AMDEK 300C....	\$ 179.00	\$ 125.00
AMDEK 300A....	\$ 199.00	\$ 135.00
AMDEK 310A....	\$ 230.00	\$ 155.00
TAXAN VIS I...	\$ 399.00	\$ 310.00
TAXAN VIS III..	\$ 699.00	\$ 499.00
TAXAN AMBER....		CALL
TAXAN GREEN....		CALL

MONITORS

	LIST PRICE	OUR PRICE
ZENITH GREEN...	\$ 139.00	\$ 89.00
ZENITH AMBER...	\$ 169.00	\$ 139.00
ZENITH COL RGB.	\$ 599.00	\$ 499.00
ZENITH COL COM.	\$ 400.00	\$ 319.00

MONITOR INTERFACES

AMDEK RGB II...	\$ 179.00	\$ 125.00
AMDEK RGB-80COL	\$ 195.00	\$ 135.00

MODEMS & PLOTTERS

AMDEK DXY 100..	\$ 749.00	\$ 575.00
AMDEK AMPLOT II	\$1299.00	\$ 950.00
HAYES:		
MICROMODEM II	\$ 379.00	\$ 289.00
SMARTMODEM 300	\$ 289.00	\$ 205.00
SMARTMODEM 1200	\$ 699.00	\$ 499.00

APPLE SOFTWARE

PFS FILE II...	\$ 125.00	\$ 84.00
PFS GRAPH II..	\$ 125.00	\$ 84.00
PFS WRITE II..	\$ 125.00	\$ 84.00
PFS REPORT II.	\$ 125.00	\$ 84.00
MULTIPLAN....	\$ 250.00	\$ 179.00
VISICALC.....	\$ 250.00	\$ 179.00
WORDSTAR.....	\$ 495.00	\$ 250.00
BANKSTREET WRT	\$ 69.95	\$ 49.00
HOME ACCT....	\$ 74.95	\$ 55.00
DBASE II.....	\$ 700.00	\$ 450.00
DB MASTER....	\$ 229.00	\$ 154.00

IBM SOFTWARE

PFS FILE.....	\$ 140.00	\$ 97.00
PFS WRITE....	\$ 140.00	\$ 97.00
PFS REPORT...	\$ 125.00	\$ 85.00
PFS GRAPH....	\$ 140.00	\$ 97.00
MULTIPLAN....	\$ 250.00	\$ 179.00
HOME ACCT....	\$ 150.00	\$ 99.00
LOTUS 123....	\$ 495.00	\$ 329.00
DBASE II.....	\$ 700.00	\$ 450.00

CALL FOR PRICES ON OTHER SOFTWARE

CALL CALL CALL
FOR PRICES ON ITEMS NOT
FOUND IN THIS AD

COMPUTER RESOURCES

A DIVISION OF MCS, INC.

ORDERING AND TERMS INFORMATION: CASHIERS CHECK, MONEY ORDER, OR BANK TRANSFER. NO C.O.D. SHIPMENTS SENT. ALLOW 20 DAYS MIN. FOR PERSONAL CHECKS TO CLEAR. WE WILL HONOR FORTUNE 1000 AND GOVERNMENT CHECKS UPON RECEIPT. ADD 3% FOR VISA OR MASTERCARD ORDERS. ALL SALES ARE FINAL. WASHINGTON RESIDENTS ADD SALES TAX.

SHIPPING AND HANDLING CHARGES : IN THE CONTINENTAL US, ADD 3% FOR UPS GROUND WITH A \$5 MIN., 6% FOR UPS AIR WITH \$10 MIN., 12% FOR US POSTAL, APO OR FPO WITH \$15 MIN.. SHIPMENTS OF 50' & UP SHIPPED FREIGHT COL.

ALL MAIL: 2464 33rd AVE W., SUITE 515 SEATTLE WA. 98108

ners should be wary.

On the other hand, there's no reason for experienced programmers to wait. If you're used to writing Pascal programs and you're interested in Modula-2, I recommend the Logitech implementation. If you like Pascal MT+, you'll love Modula-2.

More Modula-2

The Logitech Modula-2 system generates native code (makes .CMD command programs) for machines running CP/M-86 and IBM PC-DOS, and is the only Modula-2 implementation I know of for machines with those operating systems.

There's another Modula-2. Volition Systems publishes Modula-2 for machines using the UCSD Pascal operating system. The two I know about are for Apple UCSD Pascal and the Sage, but I have a press release announcing it for the IBM PC, complete with operating system, editor, tutorial programs, and lots of utility programs. I should have the PC version about the time I get my PC.

Unlike Logitech Modula-2, Volition Systems Modula-2 generates an intermediate p-code (as does UCSD Pascal). Volition is currently working on a Modula-2 compiler to produce native code for the 68000 chip to operate under CP/M-68K. Volition promises to have that Real Soon Now. It ought to be significantly faster than its p-code implementation.

I haven't yet run competitive tests of Volition vs. Logitech Modula-2, although I know beforehand that Logitech's will be considerably faster (because it's native code). On the other hand, the current Volition documents are incomparably better than Logitech's. You can use the Volition documents to learn a lot about Modula-2. Oddly enough, though, the Volition documents are missing one *vital* ingredient: there's no walk-through for writing, saving, and compiling a simple program, and it turns out to be darned hard to puzzle out how that's done.

Indeed, I learned most of what I know about Modula-2, and caught my enthusiasm for the language, from the Volition Systems people.

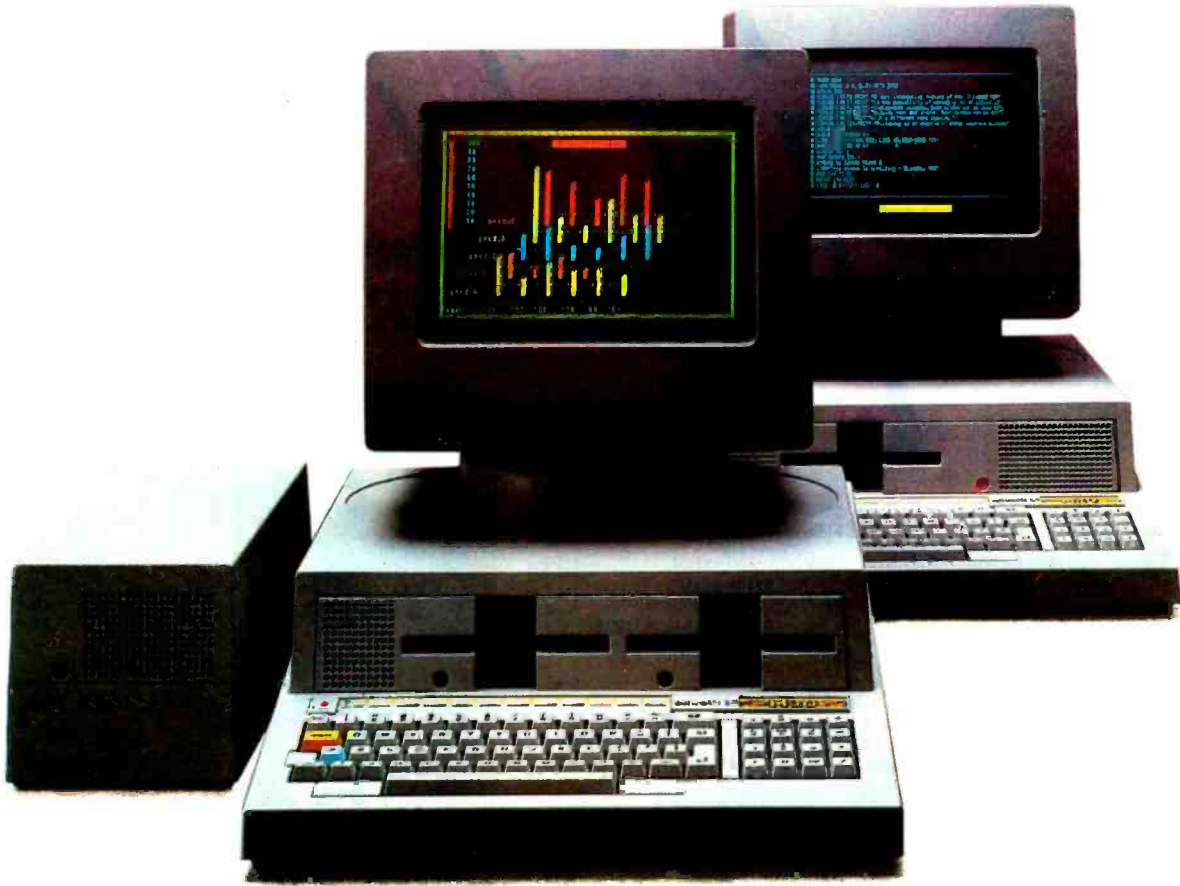

OLIVETTI M20 PERSONAL COMPUTER

WE'VE MADE A FAMILY OUT OF A PERSONAL

Olivetti, who invested its office know-how in the M20 personal computer now introduces you to another member of the family: the M20D model with a memory thirty times larger than the basic version. And when there's a need for even greater power and coordination in office jobs, the Olivetti M20D can manage a group of M20s working in conjunction with one another, integrated into a local area network. So from today there is a family of Olivetti personal computers with different storage capacities and a wide choice of operating systems (MS-DOS, CP/M-86, PCOS, UCSD-P) to satisfy different needs. And with



their 16-bit technology and communication capabilities they will keep abreast of change. In fact they are designed for integration into remote text/data processing and office automation as it is today and as it will be in the future. Olivetti protects your investment in equipment and software. The M20 personal computer family makes your problem solving less problematic leaving you far more time for the creative side of your job. Olivetti's personal computers embody all of the company's leadership in ergonomics and design which have become a consolidated part of its success in the office throughout the world.

MS-DOS is a trademark of Microsoft Inc.
CP/M-86 is a trademark of Digital Research.
UCSD-P system is a trademark
of the Regent of the University of California.

olivetti
brains & beauty

Softline

FOR YOUR BOTTOM LINE.

ALPHA SOFTWARE		IUS		PERFECT SOFTWARE	
Data Base Manager II	\$199	EasyWriter II	\$239	Perfect Writer	\$229
Apple IBM Connection	\$139	EasySpeller II	\$149	Perfect Speller	\$139
APPLIED SOFTWARE		Financial Management Series	\$939	Perfect Calc	\$139
TECHNOLOGY		LINK SYSTEMS		Perfect Filer	\$269
VersaForm	\$249	Datafax (for IBM PC)	\$219	PETER NORTON	
ARTSCI		LIJK		Norton Utilities	\$ 59
Magic Window II	\$109	Data Perfect	\$ 99	PROFESSIONAL SOFTWARE	
Magic Calc	\$109	Letter Perfect	\$109	Word Plus—PC	\$289
Magic Memory	\$ 74	LEXISOFT		ROESOFT	
ASHTON-TATE		Spellbinder	\$249	ProKey	\$ 59
Friday	\$199	LIFETREE		SATELLITE SOFTWARE	
Bottom Line Strategist	\$279	Volkswriter	\$129	Personal Word Perfect	\$159
Financial Planner	\$459	Volkswriter Deluxe	\$ CALL	SELECT INFORMATION SYSTEMS	
BPS		MARK OF THE UNICORN		Select Word Processing	\$299
BPS Business Graphics	\$279	Final Word	\$199	SIERRA ON LINE	
BUSINESS SOLUTIONS		METASOFT		Screenwriter II	\$ 99
Jack	\$139	Benchmark WP	\$319	Screenwriter Professional	\$149
CONDOR COMPUTER		MICRO PRO		The General Manager	\$169
Condor III	\$439	WordStar (for IBM PC)	\$279	SOFTWARE ARTS	
CONTINENTAL SOFTWARE		WordStar (for Apple II)	\$269	TK! Solver	\$219
Home Accountant (for IBM PC)	\$ 99	WordStar Professional (WS/MM/SS/SI)	\$429	SOFTWARE PUBLISHING	
FCM (for Apple II)	\$ 69	WordStar w/Z80 (for Apple II)	\$349	PFS: Write	\$ 99
FCM (for IBM PC)	\$ 85	MICROSOFT		PFS: File	\$ 99
Properly Management	\$349	C Compiler	\$349	PFS: Report	\$ 94
DIGITAL RESEARCH		Multitool—Financial Statement	\$ 79	PFS: Graph	\$ 99
C Compiler	\$259	Multitool—Budget	\$119	SOFTWARE TECHNOLOGY FOR COMPUTERS	
Concurrent CP/M 86	\$259	MICROSTUF		The Creator	\$219
EAGLE SOFTWARE		Crosstalk	\$129	SOFTWARE SYSTEMS	
Money Decisions	\$129	MUSE		Multi Mate	\$299
EMERGING TECHNOLOGY		Super Text Professional	\$ 79	SORCIM	
Edix/Wordix	\$279	NORTH AMERICAN BUSINESS		SuperCalc2	\$179
HAYDEN SOFTWARE		Memory Shift	\$ 79	SuperWriter	\$179
Pie Writer (for Apple II)	\$109	Answer	\$189	SpellGuard	\$129
Pie Writer (for IBM PC)	\$139	OASIS		T/MAKER	
HUMANSOFT		The Word Plus	\$119	T/Maker III	\$199
DBplus	\$ 89	PBL		VISICORP	
INNOVATIVE SOFTWARE		Personal Investor (for Apple II)	\$ 99	VisiCalc	\$169
TIM III	\$289	PEACHTREE		VisiFiles (for IBM PC)	\$219
Fast Graphs	\$189	Peachtext	\$169	VisiFiles (for Apple II)	\$189
INSOFT		Peachpak 4 (GL/AP/AR)	\$269	VisiSchedule	\$219
Data Design	\$169			VisiTrend/Plot	\$219
ISE				VisiWord	\$279
Knowledgeman	\$379				

For more information on our complete line of software and accessories call our toll-free number for a FREE copy of The Softline Catalog

FREE!

Diskette Library Case

... with your order. This attractive case protects, indexes and stores 10 diskettes for quick retrieval. Normally a \$10 value, it is now available **FREE** to Softline customers



TERMS:

Checks—allow 14 days to clear. Credit processing—add 3%. COD orders—cash, M.O. or certified check—add \$3.00. Shipping and handling UPS surface—add \$3.00 per item (UPS Blue \$6.00 per item). NY State Residents—add applicable sales tax. All prices subject to change.

1-2-3 \$339	PFS: File PFS: Report \$189
dBase II \$399	QuickCode \$184
VisiCalc IV \$179	Multiplan \$179
Personal Investor \$149 for IBM PC	WordStar MailMerge \$349
SuperCalc 3 \$279	Sensible Speller \$99
DB Master \$249 V 4.0	PeachText 5000 \$249

To Order call
1-800-221-1260
In New York State call (212) 438-6057

For technical support and information call
(212) 438-6057

Monday thru Friday
9:00 AM - 7:00 PM

Sundays
10:00 AM - 4:00 PM

Softline
Softline Corporation
1333 60th Street, Brooklyn, N.Y. 11219



The documents can be improved, but they're pretty good.

Me, I'm glad to have Modula-2 on two of my advanced machines, and I can hardly wait for the CP/M-68K version. I expect it's pretty obvious that I really like the language.

Zippping Up Your Z-100

Zorro the Z-100 has become a permanent fixture here. We like his color graphics a lot. For those few who don't know, the Zenith Z-100 is a dual-processor machine, with both 8085 (8-bit) and 8088 (16-bit) central processing unit chips. On the 16-bit side, it runs Z-DOS which is virtually indistinguishable from IBM PC-DOS; the 8-bit side runs standard CP/M 2.2x. We have WRITE, our favorite text editor (see below), running on the Z-100.

There is also the H-100, which is the Heathkit version of the Zenith Data Systems Z-100. A number of readers have written in to recommend getting a Z-100 that way. I don't myself have firsthand experience with the kit, but James Ransom, an L-5 Society associate and friend, recently put one together. He'd never built a large kit of any kind before.

Jim got his machine on Friday afternoon and had it running by Saturday night; and as I said, he's not at all experienced in kit building. So far as we can tell, the machine runs fine, and he saved a real bundle by building it.

In fact, there's not a lot to build. You do have to solder the disk-controller card. The Z-100 is an S-100-bus machine although the computer and its video driver are on a single non-bus card; the disk controller is a separate card, and thus easy to work on. The computer and video components are already assembled and tested.

Except for soldering the disk controller, building the kit consists largely of assembling the prewired parts and in general bolting things together.

Jim Ransom reports that not only did he save money, but he's got a better understanding of how his machine works. If that weren't enough, the two volumes of technical manu-

als for the Z-100, which normally sell for \$55, come free with the kit.

More Brain Cells

Heath/Zenith sells the Z-100 with a standard 128K bytes of memory. There are slots on board the machine for adding an additional 64K bytes. The Heath memory upgrade kit lists for \$165, and consists of the memory chips and instructions on how to disassemble the machine and install the chips.

If you buy the kit version, you can get the memory expansion kit for half price, or \$82.50, but that's not really a very good deal, because in fact there's no earthly reason why you'd want to pay that much. You can buy the chips for less, and certainly the kit builder knows how to take the machine apart.

In fact, any moderately intelligent user can upgrade a Z-100. Understand, I assume no responsibility for your success. I only report that I was able to do mine—and indeed I had an avoidable problem, which I'll detail below. If you decide to do your own, thus saving about \$100, you do it at your own risk, and don't blame me if it doesn't work well.

The only tool needed is a hex-nut driver, available in most hardware stores for a dollar or so. It takes a bit of thought to determine exactly how to take the machine apart, but in fact the relentless application of logic will do the job.

You'll also need the memory chips, of course. They're 4164 64K-bit dynamic-memory chips. I got mine from California Digital for \$6.95 each. I didn't have the instructions when I first conceived this scheme, and bought only eight of the chips, which seemed reasonable—we were adding 64K bytes of 8-bit memory, so eight 64K-bit chips ought to do it, right? Wrong, of course, because the Z-100, like most other 16-bit machines, does parity checking on the memory, and thus needs an additional 64K bytes (by 1 bit) of memory. Thus you need *nine* of the 4164 chips. If you're a worrier, get 10 so you'll have a spare in case you do something awful.

Incidentally, I recommend California Digital as a good source of chips,

MAINFRAME SOFTWARE FOR MICROS

Assembler programs that bring a set of functions available in IBM mainframes to small computers.

MenuWiz \$99

MENU DRIVER WITH PASSWORD CONTROL
Create easily menus to drive all your applications and optionally restrict access to them selectively with password protection.

No programming skills are required. Just write a few simple specifications to design a menu and tell MenuWiz for each menu option.

- Name of the program or of another menu to load (IBM DOS 2.0 users can also execute operating system commands)
- What level of security you want (if zero no security clearance is required).

To access a protected menu option the user has to have entered a password with a security clearance equal or greater than the security level for that option.

A password maintenance program included, let the master security officer maintain passwords, set its security level (from zero to 99), and define a password scrambling code.

— **MenuWiz Logger to record \$49**
accesses on a history file

ScreenWiz \$99

FULL SCREEN CONTROL
Define screen format specifications outside your programs and save them as a disk file. At execution time, call ScreenWiz to retrieve the screen formats and do all the I/O for you.

- One command input/displays a full screen
- Use all of your CRT video attributes
- Define up to 24 function keys
- Validate input while keying. Insert and delete characters to correct fields.
- Tab fields forward and backward.
- Draw figures using vertical field displays.
- Save memory using format overlays and virtual constants.
- Build help screens. Call them from any field with a function key then return to where you were.
- Cut your program code by as much as 50%.

— **ScreenWiz Tester to display \$49**
screen samples

ReportWiz \$99

FULL PRINTER CONTROL WITH DISK BACKUP
Define report format specifications outside your programs and save them as a disk file. At execution time, call ReportWiz to print the report for you.

- Handles automatically printing of heading, detail and total lines, on page overflow.
- Edits numeric fields (commas, zero suppress, date, sign, CR/DB, etc.).
- Automatic print of report page number.
- Uses ALL fancy printer controls your printer supports. For example you can print headings in double width, totals underlined, messages in italic, etc.
- Optionally redirects printer output to disk (like a spooler) to avoid printer jam problems. A print program included lets you print this disk file selecting the page range and the no. of copies.
- Cut your program code by as much as 50%.

— **ReportWiz Tester to print \$49**
report samples

Available for CP/M-80 and IBM DOS operating systems
ScreenWiz and ReportWiz can be called from most popular Basic, Cobol, Pascal, Fortran, Assembler and C programs
All prices are in U.S. dollars and include a comprehensive Reference Manual, extensive examples and tutorial demonstration programs. Call for CP/M-86 availability
Shipping costs per program (air parcel)
U.S. and Canada \$ 6 Overseas \$18

INTERDATA SYSTEMS INC.

15 Toronto St. Suite 700 Visa, M/C Am. Exp.
Toronto, Ontario Canada M5C 2E7 C.O.O.

CALL COLLECT TO ORDER

(416) 366-2136

fans, disks, small parts, and general computer hardware parts. The company is courteous, very efficient, ships the same day you order (if you give a credit card number), and is willing to answer fairly stupid questions. (My stupid question came about because I got eight chips, then had to order another; the new one didn't look like the other eight. It wasn't made by the same outfit and didn't have the same numbers. California Digital's people assured me they were the same, as indeed they turned out to be.)

Once you have the chips, you need to take the Z-100 apart. This involves removing the cover, then removing six hex nuts, two of which are topped by the posts that help lock the cover on. Once that's done, the two disk drives and their mounting bracket lift out as a unit. You have to disconnect the cables; make a note of how they were oriented *before* you disconnect them. There are two cables to each disk drive: a flat data cable and a power cable. Each comes off by simple pulling, but don't yank. Be gen-

tle; data cables aren't especially delicate, but you can pull them apart if you're too rough.

Take the disk drives completely out and lay them down carefully. This will expose some more screws that hold on the rest of the machine's case; you also take out the other two locking pins that held the upper part of the case on. Lift off the case. That exposes the keyboard, which simply lifts off—it's not even screwed down. Be careful of the keyboard cables. Don't disconnect them, just set the keyboard, still attached, on the table in front of the machine. The cables are long enough.

Now remove three screws that hold the video board on and tilt it back. You need not—and should not—disconnect anything here either; the cables are long enough.

You'll see nine empty chip sockets, eight right together and a ninth just below and slightly off to one side. They're marked U-137 through U-145, and you can't miss them.

If you bought your chips from California Digital, they arrived in a black

sticky foam thing that protects them from static damage. Before taking them out of that, *ground yourself* and take a lot of precautions about static electricity. Everyone I know warns me about how easy it is to destroy these chips.

Once the chip is removed from the protective foam, *do not* lay the IC down or let go of it until it is installed in its socket. If you need to bend the IC pins (you probably will), hold the chip in one hand, use a metallic work surface (such as the bottom of the Z-100 case), and touch the metal surface with the other hand before touching the chip to the surface.

IC leads are often splayed, and need to be bent perpendicular to the chip before the chip can be inserted. The ones I got from California Digital didn't need that, but it's best to anticipate.

Be sure to put the chips in the right way, which is to say with the little notch in the same direction as the little notches are on all the other chips on the board. If you get one in backward, that chip is *gone*. Get the chips

Text continued on page 72

MRS/OS Source Code

- Runs CP/M 2.2* and CDOS* application programs
- Contains 55 OS function calls
- Direct and Standard console I/O
- Standard console I/O includes numerical formatting and I/O steering
- User defined "CNTRL C" function
- Sequential and Random disk file access
- Provides Standard file management functions plus Direct Disk Access
- 12 system utility functions include PATCH, DUMP, and MERGE
- Supports Batch Mode Operations
- Directory utility provides directory error checking, statistics, and alphanumeric ordering
- "HELP" menus throughout

FULLY COMMENTED SOURCE CODE and 100 page manual provided

- Source code provided on hard copy and 8" SSSD diskette
- Requires 32K Z-80 computer with editor and assembler

ONLY \$59.95 COMPLETE

(includes shipping & handling)
Mass. orders include 5% sales tax



16 Bowman Lane
Westboro, MA 01581
(617) 366-8969
Phone orders welcome

CP/M is a registered trademark of Digital Research Corp
CDOS is a registered trademark of Cromemco Corp



NETWORK those IBM PC's without LAN prices!

Have both word quality and dot matrix printers on the same port without changing any of your software!
Share your printers, plotters or modems automatically!

Available at Watson Multimedia West, Sausalito, CA

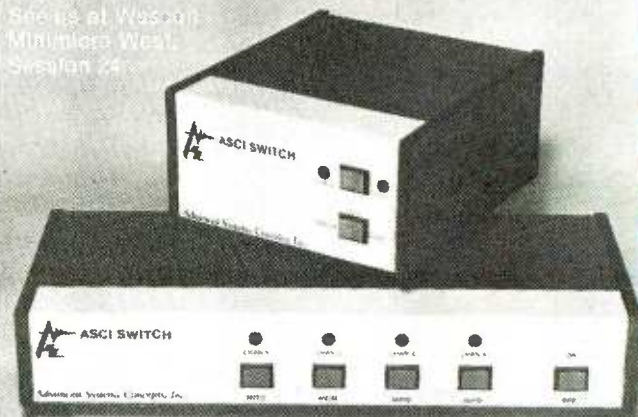

We have parallel switches designed especially for your PC

Call ASCI Today

Advanced Systems Concepts, Inc.
435 N. Lake Avenue, Dept. II
Pasadena, Ca 91101
(800) 824-7080

in California (213) 793-8971 Telex 701215



NEVADA

FORTRAN™

"If you want to learn or teach someone FORTRAN, this is the package to buy." *ACCESS*, March/April 1983.

Perfect for teaching FORTRAN. Perfect for learning FORTRAN. Perfect for Scientists and Engineers. Based upon the ANSI-66 standards (FORTRAN IV), advanced features include IF...THEN...ELSE constructs, COPY statement, CHAINing with COMMON. TRACE style debugging and 150 verbal error messages. What's more, you can intermix in-line FORTRAN and Assembly Language statements for those special Micro needs! Get yours today. Diskette comes with 214-page manual. (Requires 48K RAM).

NEVADA

PILOT™

The documentation (131 pages) by Professor Starkweather is exceptional! And, it meets all the PILOT-73 standards with many new features, including a built in full screen text editor. See review in *Microcomputing*, January 1983.

Perfect for training, testing, virtually all programmed instruction and word puzzle games. Order yours now! Diskette and manual comes with 10 FREE programs.

NEVADA

EDIT™

"A well-thought-out product with excellent documentation and an astoundingly low price." *Microcomputing*, May 1983.

Now, high quality text editing for micros. Nevada EDIT is great for program editing, as it was designed specifically to create COBOL, BASIC, and FORTRAN programs. It's a character-oriented full-screen video display text editor.

Simple to configure. You can customize tab stops, default file type, keyboard control key layout, and CRT by menu selection.

CP/M is a registered trademark of Digital Research, Inc. TRS-80 is a registered trademark of Tandy Corp. Apple II is a trademark of Apple Computer, Inc. Osborne is a registered trademark of Osborne Computer Corp. Xerox 820 is a trademark of Xerox Corp. Kaypro is a trademark of Non-linear Sys. Health/Zenith is a trademark of Health Corp. IBM is a trademark of International Business Machines, Corp. Nevada COBOL, Nevada FORTRAN, Nevada PILOT, Nevada EDIT and Ellis Computing are trademarks of Ellis Computing, Inc. © 1983 Ellis Computing, Inc.



SINCE 1977

ELLIS COMPUTING™

Circle 173 on inquiry card.

NEVADA

COBOL™

Nevada COBOL is based upon the ANSI-74 standards with many advanced features. It's field-proven with over ten thousand users world-wide in Business, Government and Education. The excellent documentation (165 pages) is used as a classroom text at a number of colleges.

Also available: COBOL Application Packages, Book 1, \$9.95.

NEVADA

NEW BASIC™

It's simply a better BASIC!

The interpreter has a great built in full-screen text editor (Professor Starkweather's). What's more, there are multi-line user defined functions, full matrix operations and much more. You get a diskette and 220-page manual.

This is a limited time offer, so order yours today!

\$ 29.95

each

Money back guarantee. If for any reason you're not completely satisfied, just return the package—in good condition with the sealed diskette unopened—within 30 days and we'll refund your money.

MAIL TODAY! TO: Ellis Computing, Inc.
3917 Noriega Street
San Francisco, CA 94122
(415) 753-0186

The CP/M® Operating System, a 8080/8085/ Z80 microprocessor, and 32K RAM are required.

Software Packages:

- COBOL FORTRAN PILOT EDIT BASIC
- Diskette Format: 8" SSSD (Standard IBM 3740 format)
- 5 1/4" Apple CP/M Xerox 820 SD Osborne SD
- Televideo Micropolis Mod II
- North Star DD North Star SD
- TRS-80 Mod I with CP/M @ 4200 hex TRS-80 Mod II/Mapper
- Heath Hard (Z-89) Heath Soft (Z-90)
- Superbrain DD DOS 3.X (512 Byte sectors)
- Kaypro DD DEC VT-180 Epson QX-10
- NEC PC 8001 Sanyo Access

Shipping/Handling Fees: Add \$4.00 for the first package and \$2.00 each additional package. OVERSEAS add \$15.00 for first package and \$5.00 each additional package. Checks must be in U.S. funds and drawn on a U.S. bank!

Send my order for _____ packages @ \$29.95 each Total _____

COBOL Applications package @ \$9.95 each Total _____

In CA add sales tax _____

Check enclosed MasterCard Visa Shipping/handling _____

Total _____

_____ Exp. Date _____

Signature _____

Ship to: Name _____

Street _____

City/State/Zip _____

Epson. For those who need it, simplicity.

One computer.

Two points of view.

The Epson QX-10 personal computer.

To many, the Epson represents the ultimate in simplicity.

Just press a single key for the function you require: word processing, scheduling, business graphics, address book or file management. One key-stroke produces your program. There are no rigamaroles to remember. No disks to change.

The result: you start to work immediately. And you start being productive, immediately. With step-by-step prompts. In plain English, not computerese.

Simplicity itself.

Or is it?

The plain fact is that the ease of operation the Epson offers today is accomplished with a degree of technological sophistication most other computers can only promise for tomorrow—specifically, fully integrated software, operating in an interactive environment.

The few other computers offering such "simplicity" cost \$5,000 to \$15,000 more. And most other computers can't offer it at any price. Which makes one wonder exactly what they do offer, in terms of either simplicity, or performance.

HOW MUCH CAN YOU DO ON THE EPSON? HOW MUCH ARE YOU READY TO DO?

The Epson's ease of operation may spoil you, but it certainly won't limit you.

Case in point: every Epson comes complete with an integrated software system—*Valdocs*®—to effortlessly provide the basic functions for which most people buy computers. But it is important to note that the Epson also comes with *CP/M*®-80 2.2. So you can choose from hundreds of programs: *dBase II*®, *Wordstar*®, *Personal Pearl*®, *Supercalc*®, *Microplan*®, *MBA General Ledger*®, *Multiplan*®, *Peachtext*®, *Spellwriter*®, and *Dataview*®, just to name a few.

Or, you can write your own, utilizing a variety of programming languages such as *COBOL 80*, *FORTRAN 80*; or *Microsoft*® *BASIC*, which is included, free.

Best of all, you will run the software of your choice on the computer of choice. The high-performance Epson. With 256k random access memory. 128k dedicated video memory. The breathtakingly sensible *HASCI*® keyboard. Dual 380k double density disk drives.



Graphics capabilities unequalled in its price range. A high resolution monitor, 640 by 400 pixels, for clarity few computers in any price range can offer. Plus, an RS-232C interface, a parallel printer interface, and internal space for up to five peripheral cards so you can expand your Epson as your needs require.

One further point: all these features, and quite a few more, are included in the Epson's \$2,995 price. Some com-

Epson. For those who can handle it, performance.

puter companies ask you to pay extra for features like these. Most can not offer them at any price.

That, too, is performance. The kind of performance that can make choosing a personal computer very simple, indeed.

EPSON QUALITY. OR, WHY WONDER WHAT TERRIBLE KLUDGES LURK IN WHICH SLEEK BOXES.

If you know computers, you know Epson. Epson printers set the industry standard for quality, reliability and value. Rest assured, the same can be said for the Epson personal computer.

The satisfying silence of the slim, Epson-designed disk-drives is one way for you to judge or, for an inside-out perspective, here is an excerpt from a review by Jim Hanson in the April, 1983 issue of *Microcomputing**

"The Epson QX-10 is soundly designed and executed. I looked hard and found no evidence of kludging or shorting out anything in the name of economy. All the connectors have gold on them and are of quality manufacture. The printed circuit boards are heavy, with soldermarks on both sides of double-sided boards. The circuit boards are completely silk-screened with component labels, and the layout is as professional and clean as you will find anywhere."

Isn't this what you expect? After all, it's an Epson.

**A WORD TO THE WISE:
GET YOUR HANDS ON
THE EPSON.**

Is the Epson a simple, easy-to-use computer for beginners? Or a sophisticated high-performance computer for the experienced? The answer is "yes." And when you think about it, aren't those two computers the one you need now.

For technical specifications, and the complete, 3-part *Microcomputing* review, along with the name of your nearby Epson dealer, call toll-free (800) 421-5426. California residents, call (213) 539-9140.

*Excerpt reprinted by permission of *Microcomputing Magazine*. All rights reserved.
CP/M is a trademark of Digital Research, Inc.
Valdres and HASCI are trademarks of BSLing Star Industries.
dBase II is a trademark of Ashton-Tate.
Wordstar is a trademark of Micropro.
Personal Pearl is a trademark of Pearlsoft.
Spellwriter and Supercalc are trademarks of Sorcim.
Microplan is a trademark of Chang Labs.
MBA General Ledger is a trademark of Micro Business Applications.
COBOL 80, FORTRAN 80, Microsoft, and Multiplan are trademarks of Microsoft.
Peachtext is a trademark of Peachtree Software.

EPSON
STATE-OF-THE-ART...SIMPLICITY.



Richard Lamb

Text continued from page 68:

in properly, making sure that every pin is in a socket. Inspect it with a strong flashlight.

Then put the machine back together, fire up Z-DOS, and run the MEMTST. If you get memory errors, it's likely a chip was improperly installed. We did, and it was easily fixable. The result is a 192K-byte system.

Megabyte, Anyone?

Of course if you're a *real* memory fanatic, you can install a Macrotech 1-megabyte memory board. Alas, there's not much software to make use of that much memory for the Z-100 because it doesn't (yet) run CP/M-86. It's also nontrivial to figure out how to get your Macrotech megabyte board running in a Z-100 from just the Macrotech documents.

You can install the Macrotech megabyte board in most S-100 systems. If you're running CP/M 2.2, only the first 64K bytes of that memory is available as work space, but the rest can be configured as a "virtual disk," i.e., the machine can be fooled into thinking that's a very fast disk drive. If you've read previous columns, you'll know I'm a believer in virtual disks.

To the best of my calculations, Macrotech's huge boards provide the lowest cost per kilobyte of memory. In the old days we all insisted on static rather than dynamic memory, because dynamic memory wasn't reliable. Really conservative designers

still think that way, but dynamic is getting more and more converts, and it sure costs a lot less.

Do We Care?

While we were taking the Z-100 apart, we managed to break one of the disk-drive door latches. I'm not sure how it happened. On the other hand, once it was broken and we'd taken the drive apart to examine it, I couldn't understand why it never broke before. That's a very poor design.

In any event, my \$300 drive was disabled for want of about a dime's worth of plastic. To make the disaster worse, Mrs. Pournelle's book was on Z-100 disks, and there was no way to access it until we got Zorro fixed. Needless to say, she was not pleased with me.

My first thought was glue, but I've never had much luck with those super glues, and didn't this time; all I managed to do was waste an hour or so. However, the drive latch is a simple mechanism, obviously easily replaced (I'd taken it off to try to glue it), so all I needed was a new plastic part.

First call was to the local Heath store. No spare parts for disk drives. No idea of where to get them. Indeed, they didn't even know these were Tandon drives. (See photo 1.)

Second call to California Digital. No spare parts. Priority One, ditto. Both referred me to Tandon.

Next day came. Roberta was getting icily polite. Time to Do Something, so I called Tandon and asked for the Director of Marketing.

Tandon is a big outfit, and it took about four levels of switchboards and secretaries before I got someone. He was very polite. I explained that I had two problems. One was acute, namely getting a vital but trivially cheap spare part; the other was more to the point, namely that I was acquiring an IBM PC, and it might be interesting to discuss how one might use Tandon drives to expand the PC's capabilities.

It turned out that I had the wrong man. My very polite contact told me he'd find the proper person from Product Support who'd call me. Moreover, he recognized my desperation, and would have someone call *soon*. I expect he could hear my sigh of relief all the way from Hollywood to the Tandon factory out in the northwest San Fernando Valley.

The call did come soon. This time the caller sounded as if he were at the bottom of a well; I presume he was using a telephone amplifier. I'm partly deaf, and I never did get the name properly. In any event, I had an enlightening conversation. First he gave his name. He already knew mine, and knew what I wanted.

Next he asked if I understood the computer industry. When I professed not to understand the question, he asked it again. "Do you understand the computer industry?"

"I really don't know what the question means."

"Do you understand the computer industry?"

By now it was obvious that I was in an endless loop, and I needed a Control-C, so I said, "I think so."

"I don't think you do."

This didn't seem a very good way to begin a relationship, but I wasn't sure what to do about it.

He proceeded to explain that Tandon is an OEM supplier. "We ship 200,000 drives a month. Your source was Zenith. You should ask Zenith."

I remembered when we put the late Ezekial I together. Zeke used iCOM disk drives, and when I had problems I called the company; an engineer explained precisely what I

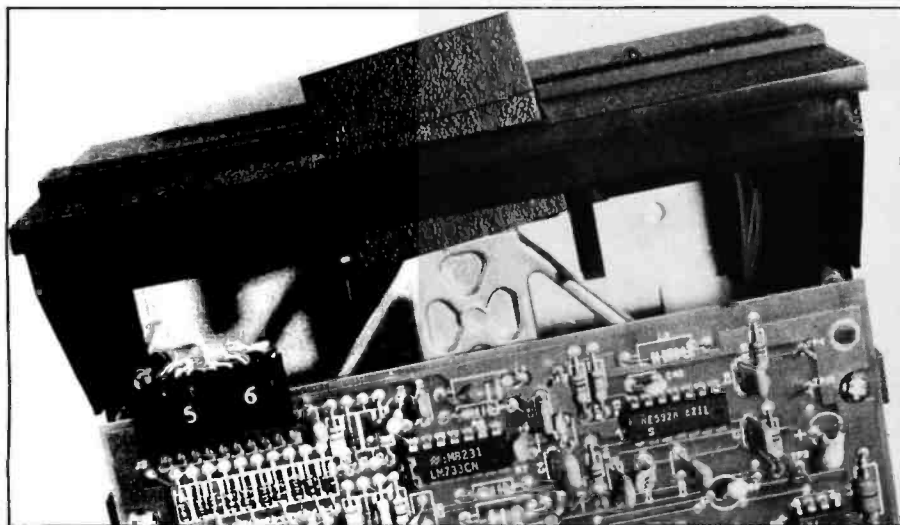

Photo 1: On the same day Jerry's manuscript arrived at BYTE, the door pins broke on one of our Tandon floppy-disk drives.

From Computer Plus to YOU...

PLUS after PLUS after PLUS



Model 100 8K \$679
Model 100 24K \$835



Color Computer II 16K \$185
w/16K Ext. Basic \$245
w/64K Ext. Basic \$305

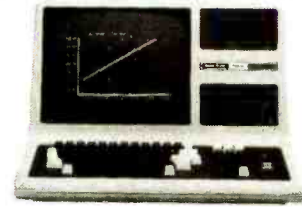

Model IV 16K \$849
Model IV 64K
2 Disk & RS232 \$1699



CITOH Prowriter \$375
CITOH Prowriter II \$649



CoCo Drive 0 \$329
CoCo Drive 1 \$235



DWP210 \$629

BUY DIRECT Here are just a few of our fine offers...
call TOLL FREE for full information.

COMPUTERS

Model 12 64K 1 Drive	\$2699
Model 12 64K 2 Drive	3375
Model 4 16K	849
Model 4 64K	
2 Disk & RS232	1699
Model 4 Portable	
64K 2 Disk	1525
Color Computer II 16K	145
w/16K ext. basic	210
w/64K ext. basic	305
Pocket Computer 2	165
Model 16B 1Dr 256K	4249
Model 16B 2Dr 256K	4915
Model 100 8K	679
Model 100 24K	835

MODEMS

Hayes Smartmodem II	235
Hayes Smartmodem 1200	565
Novation Smartcat 1200	459
Novation J-Cat	125
R.S. AC-3	129
R.S. Modem I	89
R.S. Modem II	160

PRINTERS

Smith Corona TPI D.W.	469
Silver Reed EXP500 D.W.	425
Silver Reed EXP550 D.W.	645
Daisy Wheel II	1745
DWP210	629
DWP410	1159
CGP115	159
CGP220 Ink Jet	545
DMP100	215
DMP120	395
DMP200	520
DMP420	735
DMP500	1219
DMP2100	1745
Gemini 10X	315
Delta-10	515
Gemini 15	425
CITOH Prowriter	375
CITOH Prowriter II	649
Okidata	CALL
Epson	CALL

DISK DRIVES

R.S. Model 4 Drive 0	515
Color Computer Drive 0	329
Color Computer Drive 1	235
Primary Hard Disk M12	2689
Primary Hard Disk Mill	1799

ETC.

CCR-81 recorder	52
C.C. Joysticks (pair)	22
16K Ram Chips	25
64K Ram Chips	75
8K Par/Par Microfaser	135
Printer Cables	
Printer Stands	
Printer Ribbons	
Printer Paper	
Dust Covers	
Computer Books	
R.S. Software 10% off list.	
Send for listing of brand name software.	

We have the lowest possible
Fully Warranted Prices AND
a full complement of Radio Shack
Software.

Prices subject to change without notice.
Not responsible for typographical errors.
TRS-80 is a registered trademark of Tandy Corp.



**TOLL FREE
1-800-343-8124**

computer plus

P.O. Box 1094
480 King Street
Littleton, MA 01460
617-486-3193

Write for your
free catalog

SINCE 1973 —

STATE OF THE ART, WORLD'S APART

The UCSD p-System™ bringing
the future closer to you.

Authorized distributor for NEC products.



SYSTEM CENTER FOR **NEC** PERSONAL COMPUTER

Trademark of the Regents University of California.

PASCOT

17981 Skypark Circle Suite B, Irvine, Calif. 92714 / Phone: (714) 261-5220

should do. That, however, was years ago. Evidently the industry has outgrown that kind of relationship with its customers.

Anyway, I didn't tell him that. Instead, I explained that Zenith was in Illinois, while both Tandon and I were in Southern California. "I have a \$5000 computer disabled for want of a 10-cent door latch," I said. "And we've got book deadlines, and text we can't access without that machine. We've got some real problems, and I'd really appreciate some help. All I need is a spare part, and I can't find anyone who'll sell it to me."

"We have 2000 employees, we ship 200,000 drives a month, and we can't be bothered with trivia like that. We can't handle spare parts. You don't expect General Motors to do that—"

But of course I *do* expect General Motors to have spare parts. I pointed out that I could go to any one of 50 auto parts stores to buy parts for my car.

"I wonder if that was the case in 1927?"

I allowed that it probably wasn't, although I recall from reading the biographies of Albert Sloan and Henry Ford that both were fanatics about making their dealers stock spare parts.

"I don't think you should be talking to Tandon," he continued. "However, I'll mail you the part."

Once again I breathed a huge sigh of relief, and practically spouted thanks. Then I asked if I could send a messenger for the part, since our need was desperate.

This got me *another* lecture. "We establish guidelines, we establish very definitive procedures, and you're not following them," he said.

I pointed out that if he were going to mail the part, it couldn't be that hard to have whoever would mail it simply take it to the receptionist's desk where we'd pick it up. After another lecture it was allowed that this wouldn't be any worse break in the procedure than sending me the part would be.

I sent Alex out to get it. Since by now I wasn't sure of the reception he'd get, I told him to go also to Priority One and buy a spare drive.

SuperSoft BASIC Compiler

for CP/M-86[®], MS DOS, and PC DOS

Compatible with Microsoft BASIC

The SuperSoft BASIC compiler, available under CP/M-86 and MS DOS, is compatible with Microsoft* BASIC and follows the ANSI standard. If you want to compile BASIC programs under CP/M-86, PC DOS, and MS DOS, SuperSoft's BASIC compiler is the answer.

Greater accuracy with BCD math routines

If you have used other languages without BCD math, you know how disconcerting decimal round off errors can be. For example:

With IBM PC* BASIC	With SuperSoft BASIC with BCD math
10 A=.99	10 A=.99
20 PRINT A	20 PRINT A
30 END	30 END
Output: .9899999	Output: .99

As you can see, SuperSoft BASIC with BCD provides greater assurance in applications where accuracy is critical.

SuperSoft's BASIC is a true native code compiler, not an intermediate code interpreter. It is a superset of standard BASIC, supporting numerous extensions to the language. Important features include:

- Four variable types: Integer, String, and Single and Double Precision Floating Point (13 digit)
- Full PRINT USING for formatted output
- Long variable names
- Error trapping
- Matrices with up to 32 dimensions
- Boolean operators OR, AND, NOT, XOR, EQV, IMP
- Supports random and sequential disk files with a complete set of file manipulation statements
- IEEE floating point available soon as an option

In addition, SuperSoft BASIC has no run time license fee. SuperSoft's line of fine language compilers includes FORTRAN, BASIC, C, and Ada.

Requires: 128K memory
BASIC compiler: \$300.00

SUPERSOFT LANGUAGES: THE STANDARD OF EXCELLENCE.

Circle 408 on inquiry card.

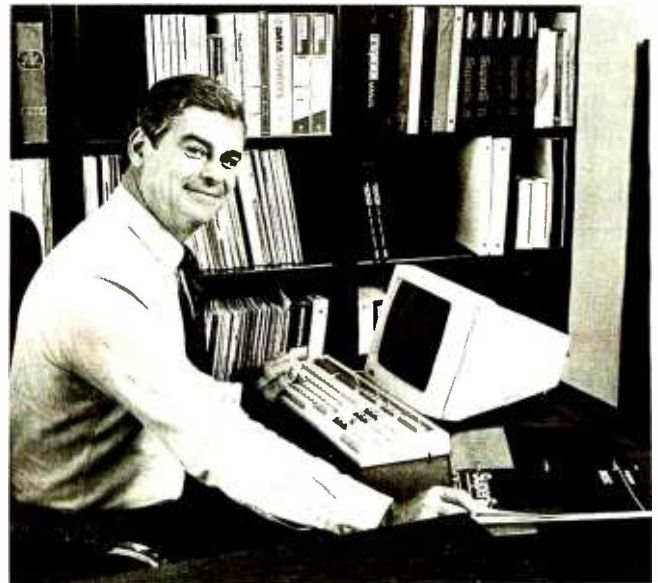

SuperSoft BASIC lets me run compiled BASIC programs under either CP/M-86 or MS DOS.

*SuperSoft BASIC is compatible with Microsoft BASIC interpreter and IBM PC BASIC. Due to version differences and inherent differences in compilers and interpreters some minor variations may be found. Machine dependent commands may not be supported. The vast majority of programs will run with no changes.

Japanese Distributor: ASR Corporation International, 3-23-8, Nishi-Shimbashi, Minato-Ku, Tokyo 105, Japan. TEL. (03)-4375371. Telex: 0242-2723.

European Agent: SuperSoft International Ltd., 51 The Pantiles, Tunbridge Wells, Kent, England TN2 5TE. TEL. 0892-45433. Telex: 95441 Micro-G.

SuperSoft[®]

FIRST IN SOFTWARE TECHNOLOGY P O Box 1628 Champaign, IL 61820 (217) 359-2112 Telex 270365

Microsoft is a trademark of Microsoft Corporation.
IBM PC is a trademark of International Business Machines Corporation.
CP/M is a registered trademark of Digital Research.

We could always use it, and that seemed to me good insurance. I wasn't at all sure what the gentleman at Tandon wanted. Product support at Tandon apparently consists of telling users that it doesn't provide any product support.

When Alex arrived, the chap came out to see him, and as Alex put it, he was trying to be polite, but there was this streak in him that insisted that he impress us with just how big a favor he was doing us.

In addition to the door latch, he

gave Alex some manuals for the drives. "We usually charge \$25 for these," he said. Alex didn't ask who usually paid the \$25, since he had made it very clear Tandon didn't deal with end users and didn't want to.

However, we're grateful for the manuals, which do tell us a lot about the care and feeding of Tandon drives. They're not very thick, and I can't think it would cost very much to print them. Surely in quantities of 200,000 they'd be less than a dollar, and they'd sure be useful to anyone

owning Tandon disks; they're really quite well done. Oh, well.

I'm not sure what the moral to this story is. I don't want to be unfair to Tandon. I'm trying to fight the conclusion that its attitude is, "We ship 200,000 drives a month. We're Tandon. We don't care. We don't have to." After all, at only the price of a lecture, he did do me the favor I needed, and I had after all asked for something I wasn't entitled to. I really am grateful. (I also bought a spare drive from Priority One, because I don't ever want another iteration of *that*.)

Additions: first, I have a very friendly letter from my first brief contact, saying Tandon does, too, care. I do want to emphasize that the company was very nice to me.

Second, the new drive we bought came without manuals, and is a new model, and as of now Priority One doesn't know how to set the jumpers; but it expects to hear from Tandon Real Soon Now.

Spare Parts

The bottom line of my quest was that Barry Workman and my son Alex have decided to offer Tandon spare parts kits at Workman and Associates. They don't expect to make much money on them. As far as I'm concerned, they're public benefactors, they are, they are. If you own an IBM PC, Zenith Z-100, or any other machine with Tandon 5 1/4-inch drives, you'd do well to get one of these kits. You may never need it, but if you do, you'll want it *bad*.

Editorial Conversion

Due largely to sloth, we've never converted from Wordmaster as the programming editor used here at Chaos Manor. At one time, Wordmaster was about the best *programming* editor available; however, it hasn't been maintained or supported at Micropro, and it has fallen behind progress. Still I continued to use it from habit, despite having better editors.

But of course I can't use Wordmaster, an 8080 editor, for my Modula-2 programs on the 8088. There were two choices: Superwriter from Sorcim, and Vedit from Com-

10 reasons why you should call DataSource™ for micro software and hardware...

- 1. Software and Hardware for all Popular Microcomputers.** We carry software in all popular formats and operating systems including PC-DOS, MS-DOS, CP/M-86 and CP/M-80. Always the current versions in stock.
- 2. Competitive Prices** Our volume enables us to offer you prices which are consistently competitive. Compare for yourself, then call us toll-free 800-328-2260.
- 3. Express Delivery** Time is money and we at DataSource understand that. Your order will be processed and shipped within 24 hours for all products in stock.
- 4. Discount Structures** We offer significant discounts to any individual, organization or user's group purchasing in quantity.
- 5. Key Account Program** For corporations and institutions, we offer a comprehensive program: volume discounts, complete maintenance packages, specially staffed technical support, a sales team experienced in micro applications, and several financing options.
- 6. Risk-Free Software** We stand behind every product we sell. All items are fully documented, backed by manufacturer's warranties, and are guaranteed by DataSource to be in perfect working condition.
- 7. Toll-Free Technical Support** We service what we sell. Our customers have direct access to our technical staff on a toll-free basis. 800-328-2260.
- 8. National Maintenance Network.** We offer a variety of maintenance agreements tailored to the specific hardware items you select. Call for more information.
- 9. Flexible Payment Options** We accept most major credit cards, checks, and money orders, as well as purchase orders from approved corporate accounts.
- 10. Proven Track Record.** Join our growing list of customers which include many Fortune 500 companies, major educational institutions and government entities.

Here's a small sampling of products available now from DataSource.™ (If you don't see what you need, just call us at the number below.)

Data Base Management		Graphics		Miscellaneous	
Empis Design - Insoft	\$199.00	Charisma - Decision Resources	375.00	The Home Accountant + Contingent	99.00
Friday! - Ashton Tate	499.00	PFS: Graph - Software Pub	105.00	Personal Investor - PBL	145.00
Camdial III - Condor	329.00	dGraph - Fox & Geller	115.00	superfile - PFI	125.00
Easy File - IUS	295.00	Visitrend/Plot - Visicorp	235.00	StdPack - NW Analytical	395.00
Visible - Visicorp	399.00	Fgl Graph - Innovative Software	199.00	Milestone 86 - Organic	245.00
Tim II - Innovative Software	325.00	Graphwriter - Graphic Communication	325.00	Easy Business Accounting Modules - IUS	450.00 ea.
Infostar - Micropro	297.00	Languages/OS		FCM - Continental	90.00
PFS File - Software Publishing	99.00	CP/M 86 - Digital Research	49.00	Financier Personal Series - Financier	130.00
Quiccode - Fox & Geller	215.00	Basic Compiler (IBM PC) - Microcal	285.00	TB Solver - Software Arts	225.00
DB Plus - Humansoft	99.00	Pascal NT+ 86 (IBM PC)	285.00	ProKey - Rossoft	60.00
Knowledge Man - MDBS	395.00	Digital Res.	285.00	Hardware	
Venta Form - Applied Software Tech	299.00	Fortran (IBM PC) - Supersoft	345.00	OkiData 92-A	575.00
Spreadsheets/Finance		Communications		C 10th F-10 Starwriter	1250.00
Supercalc - Sorcim	119.00	CommTalk - PSA	99.95	NIC 3550	1995.00
Supercalc 2 - Sorcim	149.00	Crosstalk - Microcal	145.00	Hayes 300 Smartmodem	235.00
Visicalc - Visicorp	189.00	PC/Intercom - Mark of the Unicorn	75.00	Hayes 1200 Smartmodem	535.00
Multiplan - Microsoft	145.00	Coax Link - MicroLink	1095.00	Hayes 1200B w/ Smartcom	489.00
Financial Planner - Ashton Tate	525.00	3278 emulation		Outboard 64 K	325.00
Bottom Line Strategist - Ashton Tate	285.00			secrite RAM - J	"CALL"
				AST Boards	"CALL"
Word Processing		CommTalk by PSA Intelligent Communication System			
Wordstar - Micropro	289.00	CommTalk is powerful communication software that transforms your Personal Computer into an effective communication tool for information access, retrieval and transfer.			
Wordstar/Maintenance - Micropro	375.00	• Easy to use: menu or command driven • auto-log-on • automated comm procedures • multiple file & data transfer protocols • data capture • printer echo • remote access • 36 # system directory • tutorial/automatic support.			
Spellbinder - Lexipac	295.00	Available now at the special introductory price of \$99.95 .			
The Final Word - Mark of the Unicorn	239.00	Currently available for the IBM PC and compatibles. Dealer inquiries invited.			
Easy Writer II - IUS	219.00				
Walkwriter - Litefree	118.00				
Superwriter - Sorcim	179.00				
Multimate - Software Systems	335.00				
Visiword - Visicorp	299.00				
Packlist 5000 - Packhire	245.00				
The Word Plus - Oasis	135.00				
Grammatik - Wang	80.00				
Punctuation & Style - Oasis	99.00				
Random House					
Thesaurus - Wang	115.00				

FOR MORE INFORMATION CALL TOLL-FREE

1-800-328-2260

IN MINNESOTA, CALL 612-544-3615

Prices reflect a 3 1/4% cash discount and are subject to change without notice. Purchase orders accepted from approved corporate accounts. All orders are shipped UPS. \$3 shipping charge on software items; 2% shipping charge on hardware items.

DATASOURCE

DATASOURCE SYSTEMS MARKETING CORP.

Your source for micro software and hardware™

1660 South Highway 100, Minneapolis, MN 55416



SuperSoft FORTRAN

Now for CP/M-86®, MS DOS, and IBM PC DOS®

SuperSoft FORTRAN is the answer to the growing need for a high quality FORTRAN compiler running under CP/M-86 and IBM PC DOS. It has major advantages over other FORTRAN compilers for the 8086. For example, consider the benchmark program used to test the IBM FORTRAN in *InfoWorld*, p. 44, Oct. 25, 1982. (While the differential listed will not be the same for all benchmark programs, we feel it is a good indication of the quality of our compiler.) Results are as follows:

IBM FORTRAN: 38.0 Seconds
SuperSoft FORTRAN: 2.8 Seconds

In its first release SuperSoft FORTRAN offers the following outstanding features:

1. Full ANSI 66 standard FORTRAN with important extensions
2. Standard data types, double precision, varying string length, complex numbers
3. Free format input and free format string output
4. Compact object code and run time support
5. Special functions include string functions, dynamic allocation, time/date, and video access
6. Debug support: subscript checking, good runtime messages
7. Full IEEE floating point
8. Full 8087 support—available as option (\$50.00).

Program developers:

SuperSoft's family of FORTRAN compilers means you can write your programs once and they will run under CP/M-80, CP/M-86, and MS DOS. This lets you get your applications running fast no matter what the environment.

The current compiler allows 64K code space and 64K data space with expansion anticipated in future releases.



"At last, a FORTRAN compiler that works great on my 8086, 8087, and 8088 based systems!"

SuperSoft FORTRAN: available NOW and working great!

Requires: 128K with CP/M-86® and MS DOS

Price: \$425 (in each environment)
CP/M-80 version also available.

In conjunction with SuperSoft, SuperSoft FORTRAN was developed by Small Systems Services, Urbana, IL, a leader in FORTRAN development.

CP/M and CP/M-86 are registered trademarks of Digital Research.

Japanese Distributor: ASR Corporation International, 3-23-8, Nishi-Shimbashi, Minato-Ku, Tokyo 105, Japan. Tel. (03)-437571 Telex: 0242-2723.

European Agent: Micro Technology Ltd., 51 The Pantiles, Tunbridge Wells, Kent, England TN2 5TH TEL 0892-45433. Telex: 95441 Micro-G.

Circle 409 on inquiry card.

SuperSoft®

FIRST IN SOFTWARE TECHNOLOGY P.O. Box 1628 Champaign, IL 61820 (217) 359-2112 Telex 270365

puview. Both have lots of nice features. I'm not entirely sure why I chose Vedit, but I did, and that's what we use for programming now.

I'm also changing over on the 8-bit systems, too.

Meanwhile, Compuview is sending me yet another update of Vedit, with its brand-new, completely rewritten documentation; Compuview claims the rewrite was due to my needling, and perhaps it was. Certainly its people have been more than cooperative on the phone.

If you need a programming editor, Vedit's a very good bet.

WRITE Now!

After much needling, wheedling, and plain threats, Tony Pietsch has got WRITE available and ready for publication. All the known bugs are fixed, the documents have been rewritten (from the crash text I did in one marathon session before the 1983 West Coast Computer Faire), and an Install program that knows a dozen printers and twice that many consoles has been done.

WRITE, for those who tuned in late, is the text editor that Larry Niven and I use to write our books. It began some years ago when we requested Tony to fix the bugs in Electric Pencil. That wasn't feasible, and Tony wrote a new editor from scratch. It incorporated the Pencil features we'd liked and added many others.

Over the years Larry and I kept notes of features we wanted and bugs we hated, and Tony produced new versions of WRITE. One of them incorporated the best Search/Replace function (called the macro view editor) I've ever seen. Alas, it was complicated to use, and Ashton-Tate talked Tony into removing it for a much more simpleminded Search/Replace. This was back when it appeared that Ashton-Tate would be the publisher.

The macro view editor isn't in the new release of WRITE, although Tony promises it as an upgrade Real Soon Now. That's a bit sad, because it means I don't have it either; I've always used the latest versions as they came out. The Search/Replace

we do have is more than adequate, indeed is as good as that in any text-oriented editor I know of; it doesn't approach the power available in Vedit, though.

However, WRITE is quite simply the best text-creation editor I know of. This conclusion is shared by every professional writer who has taken the trouble to learn WRITE. (Naturally I mean all those I know of who've tried WRITE; there may be some who tried it and didn't like it and haven't told me.) In addition to professional writers, a number of beginning writers, such as Dr. Trimpi, who's collaborating on a survival book with me, and Roberta, who just finished her book, are also WRITE enthusiasts. As I've said elsewhere, it's well to get confirmation of one's prejudices.

What we all like about WRITE is its transparency. WRITE doesn't get between you and what you're thinking about. It doesn't natter at you. There are no distracting flickers to give you row and column number each time you press a key (or each time you pause for thought). When you want WRITE to do something, it does it *now*, generally with a single keystroke. It's also very nearly bullet-proof. You can lose text with WRITE, but you have to work pretty hard—and even then there's a way to recover it from memory. You have to know a fair amount about CP/M to do that; we've been after Tony to write a Save-It program. The problem is that WRITE so seldom loses text—I can recall every instance over the past five years—and Tony prefers to fix the bug rather than provide the crutch.

It does lack one feature many want: there's no UNDO command. In practice I don't miss it; if you try to delete more than a single line of text, WRITE asks if you really mean it. I have sometimes hit the "Delete To End Of Line" key when I wanted the "Delete Next Word" key (they're right together on my Archive keyboard) and thus lost a line of text, but that's the worst that happens.

The WRITE philosophy is to keep it simple and clean. If you want to get complicated, you can go to a command mode and get complicated; but

Text continued on page 82



The Full Service Distributor for





- Corvus and Sanyo Computer Systems
- Sanyo, NEC, and Okidata Printers
- MicroPro and Peachtree Software

Full service and training on all products offered.
Call or write for dealer or distributorship information.



Creative Logic Equipment Corp
8240 Indy Lane, Indianapolis, IN 46224, 317-271-1100

See jane™ run



Once there was a  time,

before the written word, when  people used  pictures to communicate. Symbols representing entire  ideas were easy to  see and understand. And the people were comfortable with this language. And they were  happy.

But then came the  computer.

And symbols were replaced by complicated commands. Soon data processing meant learning a whole new vocabulary. And the  people became frightened of the new computer language. And they were  sad.

Then came Jane.

Absolutely, positively, unequivocally, unquestionably, the most simple way to operate a  computer. Jane does away with the keyboard . Instead, a simple, hand-held device called a  mouse selects from a variety of applications. From letters to lists, to calculations and spreadsheets. Jane does them all.

Jane does away with complex command words.

Instead, simple, easy-to-understand    pictures tell the computer what to do.

From one operation to many, all on one screen at the same time.

Best of all, Jane doesn't cost lots of  money. Now everyone can use a home computer. Jane gives back to the people a language they understand.

And they  Jane. You can too.

One word is worth a thousand pictures.

See jane run
at our COMDEX
booth #2284

jane

Jane comes complete with Janewrite™, Janecalc™, Janelist™, and of course, a mouse.

 arktronics 113 South Fourth Avenue, Ann Arbor, Michigan 48104, 1-800-Call ARK, in Michigan, (313) 769-7253

Jane is now available for the Apple II, II+, IIx, IIc, Commodore 64. Available soon for the new Atari™ series and the IBM PC™ and compatibles. Apple™, Commodore™, IBM™ and Atari™ are all registered trademarks.

Mini Micro Mart

Acquires

Personal

Computer

Systems

Mini Micro Mart, long the leader in Z-80 CP/M sales, is now taking the lead in PC type (8088/8086) 16 bit computers

Over 200 Product Lines Under One Roof

PRINTERS

Anadex
Axiom
C. ITOH
Centronics
Coex
Daisywriter
Diablo
Epson
Integral Data Systems/
IDS
Mannesmann Tally
NEC
Okidata
Qume
Silver Reed
Smith-Corona
Star Micronics
Texas Instruments
Transtar

PLOTTERS

Amdek
Hewlett-Packard
Houston Instruments
Mannesmann Tally
Sweet-P

MONITORS

Amdek
BMC
Electrohome
GBC
NEC
Sanyo
Taxan
USI
Zenith Data Systems

MODEMS

Anchor Automation

D. C. Hayes
Novation
Potomac Micro Magic
Racal-Vadic
Rixon
US Robotics
Universal Data Systems/
UDS

TERMINALS

Axlon
Esprit (Hazeltine)
Lear Siegler
Liberty
Novation
Qume
Soroc
TeleVideo
Wyse Technologies
Zenith

SYSTEMS

Advanced Micro Digital
Altos
Apple
Atari
California Computer/CCS
Columbia Data
Commodore
Compupro
Cromemco
Eagle
Franklin
Intertec
Morrow Designs
NEC
NorthStar
Pied Piper
Sharp
TeleVideo

Home Computers

Timex
Xerox
Zenith
BOARDS-Apple
ASAP Systems
Axlon
California Computer/CCS
Fourth Dimension
MBI
Microsoft
Micro Tech Products
Mountain Computers
Orange Micro Inc.
Practical Peripherals
Saturn Systems
SSM/Solid State Music
Videx
Vista

BOARDS-Atari

Axlon
Intec
BOARDS-IBM pc
AST Research
Computer Peripherals
MBI
Microlog
Mountain Computers
Princeton Graphics
Quadram
Saturn Systems
Technical Analysis Corp./
TAC (IRMA)
Tecmar
Vista
Xedex
BOARDS-S-100
Advanced Micro Digital

California Computer/CCS

Compupro
Consolink
Cromemco
Dual Systems
Godbout
Memory Merchants
Morrow Designs
Mountain Computers
Mullen
SD Systems
Scion
SSM/Solid State Music
Systems Group
Tarbell

DISK DRIVES

Amdek
Cameo
Control Data Corp./COC
Corvus
Davong
Konan
Maezon
Morrow
Mountain Computer
Percon
Persci
QTC Products
Qume
Rana
Shugart
Tall Grass Technology
Tandon
Vista

DISKETTES

Maxell
Memorex
Scotch/3M
Verbatim

CALCULATORS

Hewlett-Packard
Texas Instruments

ACCESSORIES

CABLES
Mountain Computer
DISKETTE STORAGE
Innovative Concepts Inc.
SRW Computer
Components
EPROM ERASER
Spectronics
EPROM PROGRAMMER
Extended Processing

FURNITURE

Datamate
PRINT BUFFERS
Consolink
Orange Micro Inc.
Practical Peripherals
Quadram

SURGE PROTECTORS/ POWER SUPPLIES

Dymarc
Electronic Protection
Devices/EDP
SGL Waber

TYPEWRITER CONVERSION

Escon
VOICE SYNTHESIZER
Allen Group, Inc.
Votrax

SOFTWARE

Our combined inventory
now consists of 75 product
lines for any software need

Call for the best prices or write
for our FREE 104 page catalog.

Mini Micro Mart

943 W. Genesee St. Box 2991
Syracuse New York 13220

(315) 422-4467 TWX 710-541-0431

PCS

P.O. Box 3126
Syracuse, N.Y. 13220
(315) 478-6800

Circle 301 on inquiry card.



for 6809
8080, Z80
8088, 8086

Real-Time Multitasking Executive

- ROMable (< 3K)
- No royalties
- Source code included
- Language interfaces
- Low interrupt overhead
- Inter-task messages

Options:

- C, Pascal, PL/M, Fortran i/f
- Extended memory (> 64K)
- Configuration Builder Utility
- Resource (semaphore) Manager
- Buffer Manager
- Integer Math Library
- Real-Time C Library

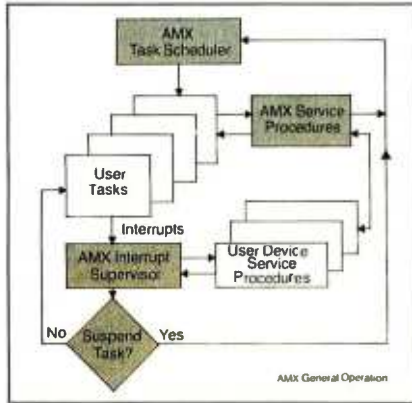

AMX, Real-Time C are TM of KADAK Products Ltd.
Z80 is TM of Zilog Corp.

KADAK Products Ltd.



206-1847 W. Broadway Avenue
Vancouver, B.C., Canada V6J 1Y5
Telephone: (604) 734-2796
Telex: 04-55670

AMX (for 8080) \$800 U.S.
manual only \$ 75 U.S.

Text continued from page 78:

while you're writing and editing text, I at least want things to happen fast, with simple commands I can remember, and WRITE has been designed that way.

The bottom line is that I can write 10,000 words, editing as I go; go back and edit again; check spelling (with Wayne Holder's The Word Plus); print the text; and get it out the door in one night. I can't imagine doing that with any other editor.

The text formatting is quite good enough for me, and there's a "print to screen" feature that lets you see precisely what you'll get, including where the paper ends, before you print.

WRITE is no good for mass mailings and computer-generated letters. Peachtext (Magic Wand) is about the best I've seen for that. WRITE isn't useful as a programming editor. It is plenty good enough for letters, now that Tony has added a "letterhead" feature that causes it to skip down to below the letterhead before it begins to print (for first page only unless you tell it different). Larry and I have written movie scripts with WRITE, but there are editors that know the complex indentation scheme scriptwriters use; with WRITE you have to figure out most of that for yourself. I wouldn't recommend WRITE for scriptwriters or programmers; other creative writers may find it the best thing since microcomputers.

WRITE is available for a variety of machines, including Kaypro, Otrona (I expect the keyboard-configuration program I use will be included if you get an Otrona version), Televideo terminals, Lear Siegler terminals, and a whole bunch of others. It knows how to use most standard printers.

WRITE is marketed by Workman and Associates. It will also be available when you purchase new Compupro machines; those with older Compupro equipment will have to buy WRITE from Workman. I obviously recommend it.

Siemens Drives

When Tony built Ezekial way back in the dark ages of 1976, we used iCOM disk drives. Single-sided single-density, 241K bytes per drive,

TOTAL CONTROL:

FORTH: FOR Z-80®, 8086, 68000, and IBM® PC

**GRAPHICS • GAMES • COMMUNICATIONS • ROBOTICS
DATA ACQUISITION • PROCESS CONTROL**

● **FORTH** programs are instantly portable across the four most popular microprocessors.

● **FORTH** is interactive and conversational, but 20 times faster than BASIC.

● **FORTH** programs are highly structured, modular, easy to maintain.

● **FORTH** affords direct control over all interrupts, memory locations, and i/o ports.

● **FORTH** allows full access to DOS files and functions.

● **FORTH** application programs can be compiled into turnkey COM files and distributed with no license fee.

● **FORTH** Cross Compilers are available for ROM'ed or disk based applications on most microprocessors.

Trademarks IBM, International Business Machines Corp., CP/M, Digital Research Inc., PC/Forth+ and PC/GEN, Laboratory Microsystems, Inc.

FORTH Application Development Systems include interpreter/compiler with virtual memory management and multi-tasking, assembler, full screen editor, decompiler, utilities, and 130 + page manual. Standard random access files used for screen storage, extensions provided for access to all operating system functions.

Z-80 FORTH for CP/M 2.2 or MP/M II, \$50.00;
8080 FORTH for CP/M 2.2 or MP/M II, \$50.00;
8086 FORTH for CP/M-86 or MS-DOS, \$100.00;
PC/FORTH for PC-DOS, CP/M-86, or CCPM, \$100.00; **68000 FORTH** for CP/M-68K, \$250.00.

FORTH+ Systems are 32 bit implementations that allow creation of programs as large as 1 megabyte. The entire memory address space of the 68000 or 8086/88 is supported directly.

PC FORTH+ \$250.00
8086 FORTH+ for CP/M-86 or MS-DOS \$250.00
68000 FORTH+ for CP/M-68K \$400.00

Extension Packages available include: software floating point, cross compilers, INTEL 8087 support, AMD 9511 support, advanced color graphics, custom character sets, symbolic debugger, telecommunications, cross reference utility, B-tree file manager. Write for brochure.



Laboratory Microsystems Incorporated
4147 Beethoven Street, Los Angeles, CA 90066
Phone credit card orders to (213) 306-7412



\$\$ "LOWEST PRICES" \$\$



SMITH CORONA

LETTER QUALITY PRINTERS

SMITH CORONA PTII	\$ 444
TPI STOCK SALE ONLY 7 LEFT	375
TELETEX TTX-1014 S & P	506
STARWRITER 40 cps S or P	1112
PRINTMASTER 55 cps S or P	1436
NEC 3510 33 cps SERIAL	1409

DOT MATRIX PRINTERS

GORILLA BANANA Graphics	221
PANASONIC KX-PI090 Fr&Tr	371
Emulates FX-80	321
STAR MICRONICS GEMINI	307
10X 120cps dot graphics	307
15X 120 cps like MX-100	484
OKIDATA	
82A Serial & Parallel 120cps	CALL
84 Parallel 15" Fr&Tr 200cps	CALL
92 Parallel 10"Fr&Pin 160cps	CALL
C. ITOH	
PROMWRITER 8510 10"Par 120cps	404
8600 Near Letter Quality Par	1031
IDS MICROPRISM	510
EPSON FX-80	595



SUPERBRAIN

SUPERBRAIN II

DOUBLE DENSITY	\$1970
QUAD DENSITY	2376
SUPER DENSITY	2684
COMPUTARS FOR NETWORKING	CALL
Prices too low to advertise	
SYSTEMS GROUP Multi-User	
SYSTEM 2966 w/17Mb Tape Backup	
8"Floppy+19Mb Hard Disk	\$7434

RADIO SHACK TRS-80 SAVE! CALL

AMERICAN SQUARE COMPUTERS is organizing a World Wide Association of Computer Dealers. Open a Store or Start Work Out of Your Home! No Charge NO FRANCHISE FEE! (Our Competitors charge a FRANCHISE FEE of \$15,000.00 to \$45,000.00.) Be a Winner! Let US help YOU get started MAKING MONEY by HELPING PEOPLE to put COMPUTERS TO WORK. Write or Phone Today.

Which Computers are Best FREE

Insured Shipping at Low Rates.

ADVANCED DIGITAL

ADVANCED DIGITAL 6MHz COMPUTER
SINGLE BOARD Z80B RS232 S-100 128K
with DISK CONTROLLER for 5"or 8"
SUPER SIX (Includes PSNET/I) \$ 555
SUPER SLAVE=Z80B-PSNET/I+128K 491
SUPER STAR has 5Mb removableHD 4460
CPM 3 350
TURBODOS MULTI USER 518

ALTOS COMPUTERS

ALTOS S-100 COMPUTERS	
580-2 3-User 2 5 1/4"	\$2111
580-10 3-User Hard Disk	3806
580-20 3-User 20Mb	4562
8000-14 with 208K RAM	8340
586-10 16-bit 12Mb Hard Disk	5807
586-30 16-bit 30Mb Hard Disk	7176

TRAXX 5 1/4" ADD ON DRIVES

TRAXX 5 1/4" ADD ON DRIVES	
Bare drive SSDD	\$ 222
SSDD w/cabinet & power supply	322



TELEVIDEO

TERMINALS

TELEVIDEO 910 Emulates	\$ 419
TELEVIDEO 910+ Smart	538
TELEVIDEO 914 NEW Detach Kbd	506
TELEVIDEO 924 NEW Non-volatile	614
TELEVIDEO 925 Detach Keybrd	674
TELEVIDEO 950 Prog funct keys	863
TELEVIDEO 970 VT-100 compat	935
ADDS Viewpoint 3A+ Emulates	442
ADDS Viewpoint G Graphics	1371
ADDS Viewpoint 60G Graphics	1511
ADDS Color Terminal NEW!	998
Zenith Z-29 Z19&VT100 compat	655
Zenith ZT-1 Terminal+modem	483
Visual 50 Ergonomic	653
Visual 55 New! Enhanced #50	734
Visual 102 80/132 columns	890
V102 Graphics option for 102	653
Visual 300 ANSI&VT100 compat.	842
Visual 330 VT52&Haz1500 comp.	842
Visual 500 Graphics 14"screen	1970
Visual 550 Graphics,Buffered	2138

MONITORS

ZENITH	
ZVM-122 Amber Phosphor	\$ 117
ZVM-123 Green Phosphor	134
ZVM-131 Composite Color	322
ZVM-RGB-135 Color Monitor	491
USI 12" Amber 20 MHZ	\$ 149

NEC

JB1205M 12" Amber Phosphor	\$ 190
JC1215 12" Color w/Audio	312

AMDEK

AMDEK 13" COLOR I Demo.1 left	257
-------------------------------	-----

GRAPHICS & COLOR GRAPHICS

VECTRIX

VX 128 8 colors 322x560 Pix.	\$1795
VX 384 16.8 million colors	3595
VXM Hi Res. 13" RGB Monitor	1221

MICROANGELO

MA 512 512x480 Monochrome	\$ 674
MA 520 512x480 + Screen Pak2	890



Morrow Terminal

COMPUTERS

COMPUPRO

Compupro computers come as mainframe, boards, and drives, and you must set the switches.

816A Computer 8085/8088 128K	\$4106
816B Computer 8085/8088 256K	5180
816C 8085/8088 512K 3 users	6613
816D 10 MHZ 8086 512K	10194
816-08 CPUZ 208K Oasis	CALL
816-016 10 MHZ 8086 512K	CALL
816-68K 8 MHZ 68000 256K	6471

SEATTLE Pure 16 bit computer is the fastest microcomputer by actual test!

S-100, 128K Static Ram, 8 MHZ	
8086 18-slot Mainframe, 3 serial & 1 parallel ports.	
Gazelle II Avail. Nov/Dec	CALL
Hard Disk Gazelle II	CALL

TARBELL with 2-8" disk drives

TARBELL REBEL S-100 64K Z80B 6Mhz	
REBEL 2 2 5 1/4" Flpy=800K	\$2479
REBEL 5 1/4" Floppy + 5Mb HD	3009
REBEL 5 1/4" Floppy +10Mb HD	3139
REBEL 5 1/4" Floppy +16Mb HD	3268
TARBELL EMPIRE S-100 64K 2 8"Drvs	
EMPIRE I Single sided	\$3304
EMPIRE II Double sided	3775

MEDICAL SOFTWARE

MICROMED or MICRODENT	\$1656
STARDOC for OASIS SYSTEMS	350



NORTH STAR ADVANTAGE

NORTH STAR ADVANTAGE 8 BIT	8/16
Work Station	\$1996
2 Floppies 360K ea.	2298
5 Mb Hard + 360K Floppy	3432
15 Mb Hard+ 360K Floppy	4566
	4899

NORTH STAR HORIZON

	1 User	Multi	
2 Floppies 360K ea	\$2775	N/A	
5 Mb Hard + Floppy	3833	\$6948	
15 Mb Hard + Floppy	4595	7147	
18 Mb Hard + Floppy	6101	8647	
CALIFORNIA COMPUTER SYSTEMS			
CALSTAR 2 8" Drvs 2.5Mb 128K	\$2295		
2210-01 ONLY 4 LEFT IN STOCK	615		

Micro Decision II

MICRO DECISION

"A DEAL YOU CAN'T REFUSE"

64K RAM Z80 4MHz 2 serial ports
1 parallel port 2 5 1/4" drives.
Free Software: CPM 2.2, MicroSoft Basic, BaZic, WordStar, LogiCalc spreadsheet, Correct-It spelling checker, Personal Pearl data base ONLY

MD2 2 Single sided drives \$ 938
MD2 + MDT50 Terminal 1272
MD2 + MDT50 + MP100 Printer 1705
MD3 Business Computer: Featuring Free Software above + Free QUEST BOOKKEEPER SYSTEM FANTASTIC BUY!
MD3 2 Double sided drives \$1165
MD3 + MDT50 Terminal 1499
MD3 + MDT50 + MP100 Printer 1932
MD11 has 10Mb HARD DISK+1DSDD flpy and 128K RAM and CPM 3+ \$1695
ABOVE PACKAGES INCLUDE ALL CABLES

DECISION I

SingleUser=FREE CPM, MicroSoft Basic.
S-100, IEEE 696, 14-slot, 4 MHZ Z80
Realtime clock, Interrupts, 3 Serial & 1 parallel port, 64K RAM expandable to 1 Megabyte

D100 \$1712
D120 = D100 + DSDD 5 1/4" + 10Mb HD + Wordstar, Correct-It, LogiCalc, BaZic, Personal Pearl, and Quest Bookkeeper Software 3538

MultiUser = Hardware & Software as D120 w/256K RAM & Memory Protect + Micronix Operating System runs 16 programs simultaneously!
D200 w/10 Mb DMA Hard Disk 3889
D210 w/16 Mb DMA Hard Disk 4240
D220 = D210 w/512K RAM & 6 Serial & 2 Parallel ports. A 6-user system, can be upgraded for 15 users. 5293

MORROW DISK DRIVES

Complete systems include S-100 controller, power supply, cabinet, & fan, CPM & Basic 80.
Add Drives include power supply, cabinet & fan.

	System	Add Drive
5 1/4" Win. 10Mb	\$1572	\$1081
5 1/4" Win. 15Mb	1713	1362
8"Winchester 10Mb	2625	2134
8"Winchester 20Mb	3187	2766
MORROW 8" FLOPPY DISK DRIVES w/DMA		
One 1 sided	\$ 870	\$ 576
One 2 sided	1081	800
Two 1 sided	1418	1011
Two 2 sided	1839	1432

APPLE, IBM OR MORROW, WHICH IS BEST? FREE BROCHURE!

Call for latest prices & availability

Factory Guarantees

We Beat Prices

AMERICAN



COMPUTERS

919-889-4577

4167 Kivett Dr.

Jamestown N.C. 27282

919-883-1105

Circle 22 on inquiry card.

BYTE December 1983

83

they cost over \$2000 for the pair.

Things sure change. A recent BYTE has a number of ads for two Siemens 8-inch single-sided double-density drives, with power supply and cabinet, for less than \$700.

I have no personal experience with these Siemens drives, but Barry Workman used them for Ralph, his Lobo Max-80, and has had no problems after six months of hard use.

I previously mentioned these drives, and we've had a number of letters asking how to configure the drives properly. I asked Barry to write up how he does it. The following is a paraphrase of his reply.

First, the Siemens FDD 100-8 drives have to be configured. Drive A is 0, and drive B is 1. This is done with "U" jumpers on the PC board on the drive. Put the jumper on the selected pin, and be sure it's securely fastened to both pins. These things aren't too strong, and can easily be bent. If you have a wire-wrapping tool, use that. If you get "Select Error," your jumper may not be making proper contact.

Check the PC board carefully. There is another jumper on some of these drives that designates them as hard-sector drives. This will not be on all drives, only some of them. If the selector is hard-wired, it will be hard-wired for soft-sectored disks. If it has the jumper, it will probably be set for hard sector. Make certain the sectoring is what you want. If you don't know what this means, you probably want *soft* sectoring; almost everyone does.

There is a *terminating resistor* on the board. It looks like a blue integrated-circuit chip (the only blue one on the whole board). Remove the terminating resistor from one of the boards; leave it in place on the other. It's usual to leave the resistor in place on drive 1 (B), or the last one in the line if you have more than two.

Now mount the drives in the cabinet and plug in the power cables. Turn on the power. Both drive motors and the cooling fan should come on. If not, check the power-supply fuses, then your connections. *Do not work on any component when the power is on.*

The FDD 100-8 uses a 50-pin edge-

card connector. The #1 pin is closest to the slot cut into the connector board. The ribbon cable's #1 pin is closest to the stripe on the cable, if you have a standard cable.

Use the data cable to connect the drives to the computer, and turn on the drives, but *do not* turn on the computer. Take a *blank* disk and insert it into drive A, and close the door. The red LED should *not* go on. Do the same thing with the B drive.

If the red LED on the disk drive is *on*, it means the data cable is connected upside down. This is a lot easier to do than you'd think. Connecting the cable upside down can be fatal to disks if the computer is trying to read.

Now that you have the cable connected properly, turn on the computer, insert the system disk, and make a copy of your system master.

Troubles

Barry Workman goes on to say, "If you have been running for some time, and you begin to get bad sector error messages, open up the cabinet and see if the stepper motor is catching on anything. I had one drive that started to do this with greater regularity than Ex-Lax. What was happening was that the stop was hanging the head at about track 1 or 2, and the computer was trying to find track 0 information there.

"If the drives are still under warranty, don't muck with them, take 'em back. If you have to work on them yourself, look for burrs on the worm gear. Also look to see if the lubricant has got sticky.

"The FDD 100-8s are sound drives, and I'm not afraid to recommend them to anyone trying to get a system running at low cost. Because of their low cost, don't buy two drives, buy three. If you have problems with one, you can swap out while you have repairs made. Anyone who can repair Shugart drives ought to be able to work on Siemens."

Barry has put together a two-page tattle sheet about Siemens drives, including tips on maintenance. He also includes a diagram showing the location of the critical jumpers. This is available for \$1, and he'd appreciate

a stamped, self-addressed envelope since it costs more than a dollar in employee time to put these out. The above was cribbed from his tip sheet.

And Again the Epson

After my evaluation of the Epson QX-10 with Rising Star's Valdocs software appeared in the August BYTE, I received a letter from Steve Irving, Software Development Manager for Epson America. After some conversation, he sent out the standard Epson keyboard and CP/M software package.

That works a lot better, but, alas, my beta-test QX-10 had trouble with the B: drive. It seems to be an intermittent hardware problem. Diagnosis was complicated by CP+, which Epson puts onto the standard CP/M master it furnishes. When you boot up, you get CP+ whether you like it or not.

CP+ is a shell around CP/M. It's supposed to protect you from the horrors of having to learn PIP A:=B: and the like. Steve Irving says it's intended to allow naive users to have an instantly rewarding experience; they can turn on the machine and do something useful. To quote Steve, "Whatever phobia can be ascribed to turning on your first computer and staring "A >" in the face, I experienced several years ago. Consequently I wanted to find a way for Epson's first-time users to avoid this shock."

CP+ is menu-driven, and certainly is easier to use than CP/M if you've never had much to do with computers, but it's really slow, about as slow as Valdocs. In fact, CP+ is guaranteed to drive experienced CP/M users crazy. It's especially troubling when you first get it, because it must be "unlocked" through a fairly complicated series of moves I wasn't prepared to make. This is to prevent users from accidentally erasing or altering files. It also prevented me from copying the system disk.

Given the intermittent hardware problem, I almost went nuts trying to make a copy of the master disk. PIP * . *[r] ([r] causes PIP to copy "hidden" system files as well as visible directory files) worked just fine, but Epson hadn't provided SYSGEN, so

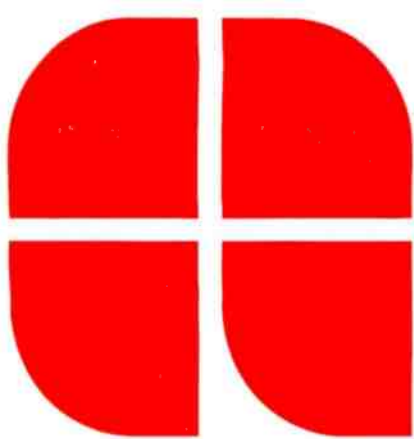

GenTech

HOLIDAY SPECIALS

LOTUS 123	\$Call
64K RAM for IBM	\$55
CABLES FOR ANY HARDWARES	
4FT PARALLEL	\$29
4FT SERIAL	\$32
Microsoft Premium pack	\$449
NEC Spinwriters ALL Models	\$Call
OTRONA ATTACHE	\$2595
BASIS 108 128K CP/M 3.0	\$1999
PROWRITER I	\$369
PROWRITER II	\$659
EPSON FX-100	\$725
RANA ELITE I	\$245
RANA ELITE II	\$380
RANA 1000 (FOR ATARI)	\$309
BUFFERED GRAPPLER	
16K	\$179
32K	\$199
64K	\$239
MULTIPLAN IBM, Apple II/Ile	\$169
IBM PC DSDD Drive	
RANA	\$299
QUENTIN	\$275
FOURTH DIMENSION	\$275
LOGO	
Terrapin	\$119
Krell	\$85

CUSTOMER SERVICE & TECH. SUPPORT

401-273-2420

Ask for New Catalog.

ORDERS ONLY

800-843-4302

150 Broadway, Suite 2212, N.Y. NY 11038

Money Order, Cashier's Check, Personal Check, C.O.D. Honored. Add 1% on Credit Card.



COMPUTERS

FRANKLIN	
ACE 1000 w/color	\$799
ACE PRO System	
ACE 1000 w/color, ACE 10 Drive, 80-Column Card, ACE Writer II, ACE Calc (80-Col. Spread Sheet)	\$1295
ACE 1200 (128K, Dual Processor, 1 Drive, 80-Col. CBASIC, CP/M & DOS)	\$Call
ACE Office Management System	
ACE 1200 w/2 Drives, I/O Card, WordStar, MailMerge, ACE Calc	\$Call



COLUMBIA	
128K RAM, Dual DSDD (640K) Drives, Fully IBM Compatible	
w/Superpack	\$2649
128K RAM, 10 MB Hard disk	\$3950
w/Superpack	\$Call
Portable VP w/Superpack	\$Call
COMPUPRO.	\$Call
CORONA PC & Portable PC	\$Call

EAGLE	
PC-2 128K RAM w/2 Drives (640K)	\$Call
PC-XL 128K RAM 1 Floppy, 10 MB Hard	\$Call

CO-POWER BOARD	
IBM Compatible 128K DR 256K	
w/MS-DOS & CP/M 86	\$Call

MORROW DESIGNS	
MD2 64K, 2 SSDD Drives, WordStar, LogiCalc, CorrectIt, Personal Pearl	\$Call
MD3 64K, 2 DSDD Drives, Above Software PLUS QUEST Accounting Package	\$Call
MD11 128K, 400K DR, 2 Serial, 1 Parallel	\$Call
DECISION Series D200, D210, D220	\$Call
Multi User Decision Series	\$Call

PIEO PIPER	\$995
SANYO MBC 550	\$Call

PLOTTERS

BAUSCH & LOMB	
DMP 40	\$879
DMP 29 (8 COLDR 11x17 PAPER)	\$1995
DMP 41 (SINGLE PEN 22x17 INCH)	\$2599

FOR APPLE II/Ile, Franklin Ace

3M SSDD Diskette	\$24
3M DSDD Diskette	\$Call
DYSAN SSDD	\$37
DYSAN DSDD	\$Call
Fourth Dimension Super Drive	\$219
80-Col. w/64K (Ile Only)	\$189
16K RAM	\$49
ALS CP/M Card.	\$289
ALS Dispatcher	\$109
MicroSoft SoftCard.	\$225
Grappler +	\$119
Graphitti	\$95
Pkaso card	\$129
IS Pipeline	\$Call
Microtek Dumping GX	\$99
Microtek Dumping 16(16K)	\$149
EPD Surge Protectors	\$Call

FOR IBM PC

AST RESEARCH INC.	
MEGA PLUS	
64K w/Serial & Clock/Cal	\$279
128K \$379, 192K \$449, 256K \$489	

64K w/Ser, Par & Clock	\$379
128K \$439, 192K \$499, 256K \$549	
MEGA PAK 256K Module	\$289

COMBO PLUS	
64K w/Serial & Parallel	\$279
128K \$369, 192K \$419, 256K \$469	

I/O PLUS	\$129
Serial \$39, Parallel \$39, Game \$39	

QUADRAM	
QUARBOARD	
64K	\$269
256K	\$419

512+ EXPANSION BOARD	
Quad 512+(64K)	\$219
Quad 512+(256K)	\$399
Quad 512+(512K)	\$639

QUADLINK	\$489
MICROFAZER	
P/P (Parallel/Parallel)	
8K \$125, 64K \$199, 128K \$309	
256K \$589, 512K \$899	
S/P, P/S, S/S	
8K \$145, 16K \$165, 32K \$195, 64K \$229	
9V Power Supply	\$16.99

HARD DISK



COMREX	
COMFILER 10 MB FDR OX-10	\$1995

CORVUS	
6 MB	\$1895
10 MB	\$2695
20 MB	\$3495

XCOMP	
10 MB	\$1895
16 MB	\$2095

DAVONG	
5 MB	\$Call
10 MB	\$1650
21 MB	\$2495

OCS	
10 MB	\$Call
Tall Grass	\$Call

DOT MATRIX PRINTERS

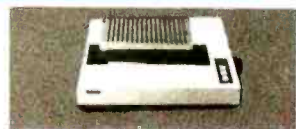

EPSON	
RX-80	\$299
MX-80 F/T III	\$419
MX-100	\$599
FX-80	\$535

STAR MICRONICS	
GEMINI 10X	\$299
GEMINI 15/15X	\$Call

OKIATA	
MICROLINE 92	\$449
MICROLINE 93	\$729
MICROLINE 84 P	\$779

C-ITOH	
PROWRITER I	\$369
PROWRITER II	\$659
PROWRITER 8600 BP	\$995

MANNESMANN TALLY	
MT160L (160 CPS)	\$599
MT 180L (15" Carriage)	\$Call
INFO RUNNER RITEMAN	\$Call
TOSHIBA P1350	\$Call

LETTER-QUALITY PRINTERS



C-ITOH	
F-10 STARWRITER	\$1169
F-10 PRINTMASTER	\$1589

COMREX	
COMRITER I (P or S)	\$799
COMRITER II Parallel	\$479
COMRITER II Ser (5K)	\$509

DAISYWRITER	
2000 EXP (48K BUFFER)	\$1019

JUKI (18 CPS 15")	\$525
--------------------------	-------

NEC SPINWRITER	\$Call
-----------------------	--------

QUME SPRINT 11/40	\$1345
--------------------------	--------

SILVER REED	
EXP 550P	\$639
EXP 550S	\$679
EXP 500P	\$439
EXP 500S	\$469

TRANSTAR T315, T120, T130 & T140	\$Call
---	--------

MONITORS



AMDEK	
300G	\$Call
COLOR I	\$Call
COLOR III	\$359

COMREX	\$Call
---------------	--------

QUADRAM	
QUADCHROME (RGB FDR IBM)	\$489

TAXAN	
RGB VISION I	\$275
WITH APPLE II+ CABLE & INTERFACE	\$345
RGB INTERFACE for Apple IIe	\$Call
RGB VISION III	\$519
KG 12N (12" green)	\$125
KG 12N-IJY (12" amber)	\$135
USI PI-1 (9" green)	\$79

TERMINALS



Freedom 100 (11 FTN Key green)	\$499
Visual 50 Detachable KYBD	\$589
Televideo 910 +	\$565
Televideo 925	\$725
Televideo 950	\$945

MODEMS

ANCHOR	
MARK I	\$Call
MARK VIII	\$Call

HAYES	
MICROMODEM II	\$275
SMARTMODEM (300 BAUD)	\$209
SMARTMODEM (1200 BAUD)	\$509
SMARTMODEM 1200B for IBM	\$439
SMARTCOM II (TERMINAL PROG)	\$89

NOVATION	
CAT 300 BAUD Acoustic	\$144
D-CAT 300 BAUD Direct	\$155
J-CAT 300	\$109
APPLE CAT II	\$269
212 APPLE CAT II	\$575
103 SMART CAT	\$179
103/212 SMART CAT	\$419

SSM	
300 BAUD MODEM CARD	\$239
1200 BAUD MODEM CARD	\$529
TRANSEND 1/2/3 \$69/\$109/\$209	

US ROBOTICS	
PASSWORD	\$Call
VEN-TEL	\$Call

SOFTWARE

FOR IBM PC SOFTWARE	
IUS A/R A/P G/L I/C O/E	\$389
ANY THREE	\$975

FOR DEC RAINBOW AND APPLE III	
PEATREE G/L A/R A/P I/C	\$499
PAYROLL	\$499

I couldn't make a new master that way. (It turns out SYSGEN is buried in the Epson Copydisk utility program.)

You can, with work, get past CP+ to regular CP/M. I'm also told that in the "demo" or "locked" mode "the new user is led through a complete tutorial of CP+, which includes a rather painless introduction to the operating system." After that CP+ is unlocked.

I haven't tried that yet, because I don't have *Using CP/M-80 with the QX-10*. This is normally supplied, but somehow got left out of the package sent to me. Once I have that, and stable hardware, I'll have John Carr try the CP+ tutorial.

Irving says, "I hope you will agree that among the options of requiring the novice user to install the auto boot feature to get to CP+ or requiring the experienced user to disable it, the latter is preferred."

I do agree with that; but I'd like it even better if Epson included an *additional* disk, plainly marked "Standard CP/M; not for the novice user."

That disk could have standard COPY, and PIP, and SYSGEN, and MOVCPM and DDT and ED and STAT and all the other stuff CP/M users have come to expect. It could also have the source code to the Epson BIOS (basic input/output system). It wouldn't cost much to provide, and it sure would make it easier for people who know CP/M.

I think Epson got so involved with making the QX-10 user-friendly to inexperienced people that it compromised the machine's ultimate usefulness. This is a pity, because it's such a nice machine. There are some excellent features to Epson CP/M. The operating system catches many BDOS (basic disk operating system) errors and deals with them. For example, my hardware problem manifests itself with a "Select Error," meaning that the hardware sometimes signals that the disk-drive door isn't closed when in fact it is. Epson sends the message "Drive Not Ready," and gives the opportunity to retry. A couple of retries fixes the problem. This sure beats heck out of

some systems that can't recover from any error. (Epson is taking care of my hardware problem, too. I had a *very* early beta-test machine; it's swapping for a later production model.)

In any event, the little machine is as fast as any 5¼-inch-drive machine I've seen. It also has a type-ahead buffer; if you get angry and hit Control-C 10 times, be prepared to see it execute 10 warm boots! This is a feature that takes getting used to. (It can also be disabled.)

Some impressions: first, the Epson standard keyboard isn't laid out the way I like keyboards. The ":" is lowercase, quotation marks are capital numbers, and in fact it's a Teletype keyboard. This seems odd, since the people who like this as opposed to a Selectric layout tend to be hackers—but the QX-10 is most assuredly not intended for hackers, else Epson would hardly have put the CP+ shell around CP/M!

The QX-10 has a completely reconfigurable keyboard, though, and I suppose the key tops are standard so that you could, with some effort, set

Text continued on page 91

Polish your WordStar with ... **MagicPrint** & **MagicBind**

MagicPrint makes CP/M-based word processors more powerful with over 60 functions, including:

- Type-set quality printouts in *true proportional spacing*
- Text screening with page break display; "widow/orphaning"
- Flexible page heading/footering
- Footnoting; column printing
- Kerning (æ, œ); micro-centering

MagicPrint has added major enhancements since reviews in *Creative Computing* (6/83) and *Interface Age* (8/83). Not all proportional spacing or footnoting is created equal. Our software produces image-making handsome documents—as if crafted by a professional typesetter (without greasing the hands).

Requires 48K RAM minimum, CP/M™-based text editing program, and a Diablo-compatible daisywheel printer or a NEC Spinwriter™.

Watch for our forthcoming **MagicIndex™**, **MagicLink™**, **MagicEditor™** ...

To order, you must specify disk format/computer model and the correct version: the WordStar Version for WordStar™ users, or the Standard Version if you use standard ASCII editors including Electric Pencil™, Magic Wand™, Mince™, P/Mate™, and Word Master™.

Price: MagicPrint \$195; MagicBind \$250; MagicIndex \$150. NY residents add sales tax. MC/VISA accepted (specify expir. date).

For COD/credit card orders only, call now 24-hour toll free number:

1-800-824-7888 (and ask for Operator 53) in 48 States, or in Hawaii and Alaska, call 1-800-824-7919 (ask for Operator 53)

For further information, ask your local dealer, or contact:

Computer EdiType Systems, 509 Cathedral Pkwy 10A, NY, NY 10025
(212) 222-8148

OEM/dealer inquiries invited.

MagicBind has all the functions of MagicPrint, plus:

- File merging with record selection
- Automatic numbering of chapters, paragraphs and articles
- Printing personalized form letters, labels, bibliographies
- Generating customized wills, contracts and other documents
- Automatic data file verification

How can your microcomputer talk to an IBM mainframe? CLEO.

The communications features of the CLEO-3270 Software package allows your microprocessor to emulate a cluster of IBM terminal devices.

The CLEO software provides the cluster emulation and makes the ASCII devices look like an IBM 3278 CRT and 3287 printer.

If your IBM mainframe doesn't support remote 3270 clusters, you need remote batch communications. CLEO-3780 Software is your answer.

For full details contact Phone 1, Inc., 461 North Mulford Road, Rockford, IL 61107; phone (815) 397-8110.

CLEO 

APPLE

Compatible

IBM-PC

Compatible

S-100

Compatible

• CROMEMCO •

Introducing the C-10MP Package. This new system couples the popular C-10 hardware and software developed by Cromemco with the most popular software offered by MicroPro.

Word Star - Info Star - Calc Star - Mail Merge
List Price \$2195 Our Low Price \$1975

— Other Cromemco Systems from
Mini Micro Mart —

C-10 Super Pack\$1599
CS-1 with Z-80A, 64KZ, 2DS/DD 5 1/4 Drives 3389
CS-1 with DPU, 256KZ, 2DS/DD 5 1/4 Drives 4239
CS-1HD with DPU, 256KZ, 21MB hard disc 6789

We also carry the entire Cromemco line of S-100 board level products and software
Cromex\$499 CDOS\$79

• EAGLE PC •

Simply, a better PC! 128k RAM (expandable to 512 on the main CPU board), DS/DD 320k disc drives, serial ports, 1 parallel port, MS-DOS, Eagle Calc and Eagle writer included. A portable version will be available soon.

• COLUMBIA VP PORTABLE •

Featuring IBM-PC compatibility teamed with the most comprehensive software package in the industry. Includes 128k RAM, 2 5 1/4, 320k drives, and a 9 inch 80x25 display.

• SANYO MBC550 •

Not only is the Sanyo MBC550 priced less than one-third that of a comparably equipped IBM-PC. It is also less expensive than most 8 bit computer packages. Includes a 160k drive, 128k RAM, M5-DOS, Word Star and Calc Star.

• MORROW DESIGNS •

Micro Decision w/terminal & software
MD2 — 2 drivesCall
MD3 — 2 DD drivesCall
MD11 — 1 floppy & 10 MB Hard discCall

• ZENITH Z-100 •

ZF-100-21\$2399
ZF-110-222889
ZF-120-222959

• PRINTERS •

Epson	
RX80399 ⁰⁰	FX80Call
RX80F/T.....Call	FX100739 ⁰⁰
Okidata	
82A399 ⁰⁰	92499
83A689 ⁰⁰	93749
Starmicros	
Gemini 10X...299	Stx-80.....179
Gemini 15....499	New Delta...Call
Diablo	
620.....998 ⁰⁰	630R-155...1849
NEC	
3510.....1599	7710.....1999
3530.....Call	7730.....Call
3550.....Call	7750.....Call
Qume	
11/40.....1410	11/55.....1599
Silver Reed	
Exp 550699 ⁰⁰	Exp 500499 ⁰⁰

We also carry Alphacom, Anadex, C.I.TOH, Daisywriter, IDS, Mannesman-Tally, Smith-Corona, Texas Instruments, and Transtar printers. We have cables, printwheels, ribbons, diskettes, surge protectors, and other accessories for your system, in stock at outstanding prices.

• TERMINALS •

Televideo		Esprite Systems	
910\$499	Esprit499		
914619	Esprit II.....549		
924739	Esprit III.....669		
925749	Esprit III (color) ...Call		
950945	Exec 10/102.....Call		
9701099	Exec 10/25.....Call		
Wyse		Lear Seagler	
WY-50.....Call	ADM3A.....535		
WY-100.....845	ADM11.....589		
WY-200.....1095	ADM22.....595		
WY-300.....Call	ADM36.....999		
Zenith Z-29 \$699	ZT-10 \$429	ZT11 \$499	

• MONITORS •

Amdek		Zenith		BMC		NEC	
300G.....139	123 12 in. Gr.118	12 AUW Green85	JC-1203DH				
300A.....159	122 12 in. Amber...145		High Res. Color...Call				
Color I.....299	131 Med. Res. RGB319		JB-1231M Green...115				
Color II.....449	135 High Res. RGB 549						
Color III.....385							

• IBM-PC BOARDS •

Amdek MAI Graphics Board\$499.00
AST Research I/O Plus\$139.00
AST Research 3270 Bisync EmulatorCall
Baby Blue CP/M Board499.00
CCS 132 Column Super Vision BoardCall
Plantronics Color Plus Board419.00
Quadram Quadboard 64K285.00
Quadram Quadlink Board549.00
64K RAM Chip kits79.00

We also carry Microsoft, Tecmar, and Vista boards for the IBM-PC.

• S-100 BOARDS •

Advanced Digital Super 6/6mhz Board .759.00
Advanced Digital CP/M 3.0350.00
CompuPro CPU-Z 6mhz 2-80249.00
CompuPro CPU-8085/88359.00

We also carry S-100 boards from California Computers Systems, Dual Systems, Memory Merchants, North Star, Scion, Systems Group and many more.

• DISC DRIVES •

Rana Elite I w/controller (Apple II)\$359.00
Rana Elite II w/controller (Apple II)529.00
Rana Elite III w/controller (Apple II)649.00
Rana 1000 (for Atari)359.00
Tandon TM100-2 DrivesCall
Tandon TM-55-2 1/2 Height DrivesCall
Shugart 8" SS Drives350.00
Shugart 8" DS Drives450.00
Corvus 6MB Hard Disc1869.00
Corvus Mirror Back-up639.00

• MODEMS •

D.C. Hayes		Novation	
Smartmodem 300 .Call	D-Cat155.00		
Smartmodem	J-Cat110.00		
1200529.00	Apple Cat II279.00		
Smartmodem	103 Smartcat199.00		
1200B499.00	212 Smartcat429.00		
Signalman Mk II .79.00	212 AutocatCall		
U.S. Robotics			
Password359.00			



MasterCard and Visa Accepted



Separate specialized sales staff for personal computer products

Mini Micro Mart, Inc.

943 W. Genesee St. Box 2991 Syracuse, N.Y. 13220

(315) 422-4467 TWX-710-541-0431

Personal Computer Systems

P.O. Box 3126
Syracuse, N.Y. 13220

(315) 478-6800

Undo.Windows.

New Microsoft® Word. It makes your IBM Personal Computer think it's better than a \$10,000 word processor.

With Microsoft Word, what you see on the screen is what you get on the paper. So it's easy to spot mistakes. **Boldface**, underline, and *italics* look like this, not this: ^Bboldface^B, ^Sunderline^S, ^Iitalics^I.

And, when you make changes, paragraphs are automatically reformatted. Flush right, flush left, centered or justified. It even gives you several columns on a page, like a newspaper.

Word forgives and doesn't forget.

There's an "uh-oh" command called Undo. Make a mistake? Or just want to experiment? Hit Undo.

A close-up photograph of a hand holding a large, black, three-dimensional block letter 'W'. The hand is positioned in the foreground, with the thumb and index finger gripping the top of the letter. The background is a plain, light color.

Mouse. Finally.

Word undoes your last change and remembers things the way they were.

Word does windows. Up to eight, to be exact. So you can transfer or edit between eight different documents. Or between eight different pieces of the same document.

Word travels fast.

Word has a Mouse, a handy little critter that lets you move copy, select commands and edit faster than you can say "cheese."



Word also lets you create your own style sheets, so you can standardize your documents, memos, files and letters.

It's not surprising that Microsoft has a way with Word. We designed the MS™-DOS operating system that tells the IBM® PC how to think. And we pioneered the first microcomputer BASIC, the language spoken by nine out of ten micros worldwide.

For a few final words, call 1-800-426-9400 (in Washington State call 206-828-8088) for a free Word brochure and the name of your nearest Microsoft dealer.

MICROSOFT
The High Performance Software

Introducing Panasonic Dot Matrix Printers. The high quality personal and small business computer printers that truly live up to your expectations.

They combine correspondence-quality performance, compatibility and high resolution graphics capability. Plus the quality and dependability that comes with the Panasonic name.

The 132-column KX-P1160 prints at 196 cps Elite, 165 cps Pica (half speed for correspondence quality). Performance? It's yours with a high resolution 16-pin head, and single-sheet front feed option.

Our 80-column version is the compact KX-P1090 - prints at 96 cps Elite, 80 cps Pica. Both models feature 8-bit parallel and optional RS-232C interfaces. Bidirectional, logic seeking operation. And our seamless ribbon cartridge's refresh ink reservoir, for consistent print quality ... and longer ribbon life.

See your local Panasonic Peripherals Dealer today. Or call the nearest Panasonic Information Systems sales office: Secaucus, NJ - (201) 348-5337; Chicago, IL - (312) 981-4824; Dallas, TX - (214) 258-6400; Cypress, CA - (714) 895-7413; Atlanta, GA (404) 923-9700.

Panasonic Matrix Printers. The name promises quality. The performance delivers it.



1-Year Limited Warranty

Panasonic Industrial Company

Circle 494 on Inquiry card.

SEE US AT COMDEX SHOW BOOTH #4327.

Text continued from page 86:

the keyboard up the way you'd like it. It might even be worth the trouble. The Epson is really a nice little machine, and with that wonderful memory-mapped video screen you can get really great graphics, half-tones, and such like. I really like the Epson's display and character set, and it's all very readable (if you like a green screen). Incidentally, the standard CP/M (without Valdocs) Epson emulates a Televideo 920 terminal. However, the company intends in the future to have an Epson QX-10 terminal type, "which will take full advantage of all the available keys and display attributes."

Meanwhile, all the applications software I've seen for the Epson tends to be Peachtree, and therein lies a problem. The Peachtext editor I have presumes that you're going to use the HASCI keyboard that usually comes with the Valdocs option; there's even a little paper template you can put over the HASCI function keys to show what their functions are in Peachtext.

HASCI is the name Rising Star's Chris Rutkowski has given to his special-design keyboard. The HASCI keyboard looks a lot like a Selectric, and it's really well designed, but it lacks some significant keys. No Escape key, for example. Also, the Control key is set down below the space bar; good enough for word processing since the Valdocs software intended to be used with the HASCI keyboard seldom uses control characters, but horrible if you intend to do any programming on your Epson QX-10.

Peachtext, incidentally, is the word processor once known as Magic Wand. It's a perfectly adequate text editor, although for reasons I've given in other columns it will never be my favorite.

While in Peachtext you can type as fast as you like, and you won't get ahead of the computer's ability to put the letters you typed onto the screen. Under Valdocs you can get from a couple of words to a whole sentence ahead of the screen display! This conclusively proves that the delay is in the Valdocs software, not in the QX-10 hardware.

My impression of the QX-10 is that it's a fine little machine. It would be a lot more useful, though, if instead of being so concerned for user friendliness when you first get it, Epson would worry more about utility after you've got it. A disk with standard CP/M would help. Adding a few general utilities, like a sorted directory with file sizes and the like, would help even more. (Barry Workman has already put his various utilities into Epson disk format, so these features are available if you want them.)

Agreed, there's a lot to be said for a shell around CP/M to help people get past the first few days. You pay a pretty hefty price in operation speed, but perhaps it's worth it—at first. However, most users will soon prefer to learn how to do things faster; there's nothing more boring than sitting at a computer whose screen say "Please Wait" for half a minute.

Meanwhile: I've just received a new revision of the Valdocs software. Rising Star swears it fixes most of the

DBPlus™
SORT, COMPRESS, and TRANSFORM
dBASE II™ DATA FILES

NOW AVAILABLE FOR IBM P.C.

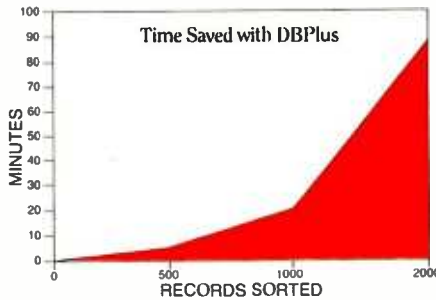

If you are serious about dBASE II,™ you need DBPlus.™ This program runs outside of dBASE II,™ and performs the following important functions on dBASE II™ data files:

- Sort
- Compress/Decompress
- Transform

DBPlus™ is designed to free you from the chore of typing, or memorizing a new language. In most cases all you have to do is move the cursor to the next menu item and press return!

SORT

DBPlus™ can sort a data file up to 15 times faster than dBASE II™ on a single field; 32 fields may be sorted in a single pass, and each additional field requires 1% more sorting time.

COMPRESS/DECOMPRESS

A copy of any dBASE II™ data file, can be produced which is only 30% to 40% of the original size.

The compressed file will save you transmission time and phone costs, when you send a data file over a modem.

Making backup copies of large data files can use up many floppy disks. Compressed files will save you space in archival storage.

TRANSFORM

You can now modify the structure of any data file, by adding, deleting, and modifying fields, without any programming knowledge.

DBPlus™ can also create a new file which is compatible with WordStar/MailMerge.™

Now retailing for \$125.

Manual and demo available.

Call for a dealer near you.

HumanSoft

661 Massachusetts Avenue
Arlington, Mass. 02174
(617) 641-1880

Dealer and distributor inquiries invited!

dBASE II is a registered trademark of AshtonTate, Inc.
WordStar/MailMerge is a registered trademark of MicroPro, Inc.
DBPlus is a registered trademark of HumanSoft

S-100

ESTABLISHED 1977



CompuPro

SYSTEM 816/C	\$6795
SYSTEM 816/68K	\$6795
SYSTEM 816/10	CALL
ALL OF THE ABOVE FULLY ASM., TESTED, & BURNED-IN W/ON-SITE XEROX Service	
CPU-Z 6 MHz	\$245
SPU-Z 192K RAM	\$525
CPU 68K W/MMU,	
CP/M 68K & MAP 4th	\$940
INTERFACER 3 Serial	\$515
RAM 22 256K 816 A&T	\$1395
SIX SLOT MOTHER BD	\$99

MCPI

a GODBOUT Affiliate

ICB-10 an 8 Channel I/O Controller/Sensor \$197

MORROW

MD3 W/LIBERTY TERMINAL & TALLY PRINTER \$1,899
 8" SUBSYSTEM / S-100 BUS W/1.2 MEG. FLPY, CP/M, DJDMA \$1,095

Actrix

CALL

COMPLETE PORTABLE NOW W/IBM-PC COMPATIBILITY AND 320K MEMORY

Votrax

Personal Speech System \$285

DIGITAL RESEARCH

CONCURRENT CP/M	\$265
CP/M PLUS	\$265
"C" COMPILER	\$450
PASCAL MT + 86	\$450
SPEED PROG. PKG.	\$189
ACCESS MNGR.	\$300
DISPLAY MNGR.	\$375
PL/I	\$565

ADVANCED DIGITAL CORPORATION

SUPERSIX W/128K RAM	\$800
SUPERSLAVE 6 MHz/128K	\$595

Cromemco C-10 \$1,495

S-100 BULLETIN BOARD

SAVE 1% ON MODEM ORDERS
300-1200 BAUD 24 HR. ACCESS
FOR SUPER DEALS, FAST ORDERS
OR TECH, ASSIST, CALL
(602) 948-1387

S-100's DUAL EXTENDER \$39

Hayes

IBM-PC 1200B MODEM \$479



U.S. ROBOTICS INC.™

S-100 300/1200	\$315
PASSWORD 300/1200 W/S.W.	\$369
AUTO DIAL 212A W/S.W.	\$475

ads

ACKERMAN DIGITAL

PROMBLASTER W/S.W.	\$299
KLUGE KIT	\$135

PC MATE by **TECMAR** FOR IBM-PC

1st MATE 256K, CLOCK, Plus SERIA & PARA	\$434
2nd MATE 2 SERIAL/2 PARA I/O, CLOCK/CAL	\$229
5 MEG. CART WINCHESTER	\$1495
Lab Quality D/A BDS for IBM-PC & S-100 BUS	



U.P.S. 400 WATT W/BATTERY \$450

GOOD FOR 1 HR. PWR. FAILURE



CPZ 48000 SBC	\$895
CPS-6A 64K SLAVE 6 MHz	\$495
256KMB RAM BD. FLOPPY DISK DRIVES	\$895

ADD-ON DRIVE SYSTEM
W/2 QUME 142 5 1/4" DSDD DRV \$475
2 QUME 242 8" DSDD DRV. CABINET, PWR, SUP., CABLES, & FAN W/FILTER INCLD. \$1095

Qume

842 8" DSDD	\$460
242 8" DSDD	\$445
142 5" DSDD	\$190

IBM has recently selected the QUME Drive for their PC.

Tandon

100-2 5 1/4 in. DSDD \$229

FULL DEALER SUPPORT VISIT OUR SHOWROOM
Hrs. 9:00AM - 5:30PM M-F
Subject to Available Quantities
Prices Quoted Include Cash Discounts
Shipping & Insurance Extra
Circle 372 on Inquiry card.

bugs, and speeds things up something wonderful. I'll try it as soon as I'm sure the hardware is working.

I also got a new, and excellent, manual for the FX-81 printer.

My bottom-line advice on the Epson is that if you're planning on getting a computer in its price range, do look at the Epson. You might like it a lot.

However, insist on a thorough demonstration. Make them copy disks, copy files, format stuff, run the text editor, and in general do all the things you're buying a computer for. Then look at something else, and see how long it takes. It's awful easy to say you'd rather have ease of use than speed, but most people find they're not willing to make that trade forever.

Kazango!

Everyone is coming up with powerful new machines. Bill Godbout has prototype S-100 computers based on the iAPX286 chip, 68000-based systems multiply, and everywhere you look the speed and capability of microcomputers soar almost without limit. I'm getting afraid to make predictions: sometimes things I predict for two years hence happen before my words get into print!

Example: this afternoon I had a call from Richard Mateosian, author of the excellent Sybex book *Inside Basic Games* (reviewed in the April 1983 column). Mateosian has access to an experimental microcomputer based on the 16032 chip. He reports using my matrix filler and multiplier benchmark: for the 20 by 20 case the time was well under a second, so fast that it's not really possible to measure it. I asked him to try the 100 by 100 and time that. Meanwhile, that's fast.

Shirley and Some Prognostications

I've known for more than a year about Bill Godbout's new multiuser all-in-one computer. It had a code name of "Shirley," and CompuPro is having trouble finding a real name for it; all the ones come up with so far sound hokey. Doubtless it will end up being something official and stuffy, and I'll prefer Shirley.

Flash: the announcement is out;

14425 North 79th Street
Scottsdale, Arizona 85260
TELEX: 16 5025 FTCC SEC PHX
SALES
800-528-3138
TECHNICAL 602-991-7870

THE FORTH SOURCE™

MVP-FORTH

Stable - Transportable - Public Domain - Tools

You need two primary features in a software development package - a stable operating system and the ability to move programs easily and quickly to a variety of computers. MVP-FORTH gives you both these features and many extras. This public domain product includes an editor, FORTH assembler, tools, utilities and the vocabulary for the best selling book "Starting FORTH". The Programmer's Kit provides a complete FORTH for a number of computers. Other MVP-FORTH products will simplify the development of your applications.

MVP Books - A Series

- Volume 1**, *All about FORTH* by Haydon. MVP-FORTH glossary with cross references to fig-FORTH, *Starting FORTH* and FORTH-79 Standard. 2nd Ed. \$25
- Volume 2**, *MVP-FORTH Assembly Source Code*. Includes CP/M®, IBM-PC®, and APPLE® listing for kernel \$20
- Volume 3**, *Floating Point Glossary* by Springer \$10
- Volume 4**, *Expert System with source code* by Park \$25
- Volume 5**, *File Management System with interrupt security* by Moreton \$25

MVP-FORTH Software - A Transportable FORTH

- MVP-FORTH Programmer's Kit** including disk, documentation, Volumes 1 & 2 of MVP-FORTH Series (*All About FORTH*, 2nd Ed. & *Assembly Source Code*), and *Starting FORTH*. Specify CP/M, CP/M 86, CP/M+, APPLE, IBM PC, MS-DOS, Osborne, Kaypro, H89/Z89, Z100, TI-PC, MicroDecisions, Northstar, Compupro, Cromenco \$150

NEW
NEW
NEW

- MVP-FORTH Cross Compiler** for CP/M Programmer's Kit. Can also generate headerless code for ROM or target CPU \$300
- MVP-FORTH Meta Compiler** for CP/M Programmer's kit. Use for applications on CP/M based computer. Includes public domain source \$150
- MVP-FORTH Fast Floating Point** Includes 9511 math chip on board with disks, documentation and enhanced virtual MVP-FORTH for Apple II and ILe. \$450
- MVP-FORTH Programming Aids** for CP/M, IBM or APPLE Programmer's Kit. Extremely useful tool for decompiling, callfinding, and translating. \$150
- MVP-FORTH** by ECS for IBM-PC or ATARI®. Standalone with screen editor. License required. \$100
- MVP-FORTH** by ECS for IBM-PC or ATARI. With color animation, multitasking sound, utilities, and license. \$175
- MVP-FORTH Professional Application Development System (PADS)** for IBM-PC, or APPLE. A three level integrated system with complete documentation. Complete system \$400
- MVP-FORTH Expert System** for development of knowledge-based programs for Apple, IBM, or CP/M. \$80
- MVP-FORTH File Management System (FMS)** with interrupt security for IBM, Victor 9000, or CP/M \$200

NEW
NEW

FORTH DISKS

FORTH with editor, assembler, and manual.

- APPLE** by MM \$100
- APPLE** by Kuntze \$90
- ATARI®** valFORTH \$60
- CP/M®** by MM \$100
- HP-85** by Lange \$90
- HP-75** by Cassidy \$150
- IBM-PC®** by LM \$100
- NOVA** by CCI 8" DS/DD \$150
- Z80** by LM \$50
- 8086/88** by LM \$100
- VIC FORTH** by HES, VIC20 cartridge \$50
- C64** by HES Commodore 64 cartridge \$60

NEW

NEW

Enhanced FORTH with: F-Floating Point, G-Graphics, T-Tutorial, S-Stand Alone, M-Math Chip Support, MT-Multi-Tasking, X-Other Extras, 79-FORTH-79.

- APPLE** by MM, F, G, & 79 \$140
- ATARI** by PNS, F, G, & X. \$90
- CP/M** by MM, F & 79 \$140
- Apple, GraFORTH** by I \$75
- Multi-Tasking FORTH** by SL, CP/M, X & 79 \$395
- TRS-80/II or III** by MMS F, X, & 79 \$130
- Timex** by FD, tape G, X, & 79 \$45
- Victor 9000** by DE, G, X \$150
- Extensions for LM** Specify IBM, Z80, or 8086
 - Software Floating Point \$100
 - 8087 Support (IBM-PC or 8086) \$100
 - 9511 Support (Z80 or 8086) \$100
 - Color Graphics (IBM-PC) \$100
 - Data Base Management \$200
 Requires LM FORTH disk.

NEW

NEW

fig-FORTH Programming Aids for decompiling, callfinding, and translating. CP/M, IBM-PC, Z80, or Apple \$150

CROSS COMPILERS Allow extending, modifying and compiling for speed and memory savings, can also produce ROMable code. •Requires FORTH disk.

- CP/M \$300
- 8086• \$300
- Northstar® \$300
- IBM• \$300
- Z80• \$300
- Apple III/II+ \$300

FORTH COMPUTER

- Jupiter Ace** \$150
 - 16K RAM Pack \$50
 - 48K RAM Pack \$125

Key to vendors:

- | | |
|-----------------------------|-----------------------------------|
| CCI Capstone Computing Inc. | MM MicroMotion |
| DE Dai-E Systems | MMS Miller Microcomputer Services |
| FD Forth Dimension | NS Nautilus Systems |
| I Insoft | PNS Pink Noise Studio |
| LM Laboratory Microsystems | SL Shaw Labs |

Ordering Information: Check, Money Order (payable to MOUNTAIN VIEW PRESS, INC.), VISA, MasterCard, American Express. COD's \$5 extra. Minimum order \$15. No billing or unpaid PO's. California residents add sales tax. Shipping costs in US included in price. Foreign orders, pay in US funds on US bank, include for handling

FORTH MANUALS, GUIDES & DOCUMENTS

- ALL ABOUT FORTH** by Haydon. See above. \$25
- FORTH Encyclopedia** by Derick & Baker. Programmer's manual to fig-FORTH with FORTH-79 references. Flow charted, 2nd Ed. \$25
- Understanding FORTH** by Reymann \$3
- FORTH Fundamentals, Vol. I** by McCabe \$16
- FORTH Fundamentals, Vol. II** by McCabe \$13
- Beginning FORTH** by Chirlian \$17
- FORTH Encyclopedia Pocket Guide** \$7
- And So FORTH** by Huang. A college level text. \$25
- FORTH Programming** by Scanlon \$17
- FORTH on the ATARI** by E. Floegel \$8
- Starting FORTH** by Brodie. Best instructional manual available. (soft cover) \$18
- Starting FORTH** (hard cover) \$23
- 68000 fig-Forth** with assembler \$25
- Installation Manual for fig-FORTH,** \$15
- 1980 FORML Proc.** \$25
- 1981 FORML Proc 2 Vol** \$40
- 1982 FORML Proc.** \$25
- 1981 Rochester FORTH Proc.** \$25
- 1982 Rochester FORTH Proc.** \$25
- 1983 Rochester FORTH Proc.** \$25
- A FORTH Primer** \$25
- Threaded Interpretive Languages** \$23
- META-FORTH** by Cassidy \$30
- Systems Guide to fig-FORTH** \$25
- Invitation to FORTH** \$20
- PDP-11 User Man.** \$20
- FORTH-83 Standard** \$15
- FORTH-79 Standard** \$15
- FORTH-79 Standard Conversion** \$10
- Tiny Pascal fig-FORTH** \$10
- NOVA fig-FORTH** by CCI Source Listing \$15
- NOVA** by CCI User's Manual Includes editor, assembler, and utilities \$25
- Jupiter ACE Manual** by Vickers \$15

NEW

NEW

NEW

NEW

NEW

Source Listings of fig-FORTH, for specific CPU's and computers. The Installation Manual is required for implementation. Each \$15

- | | | | |
|--------------------------------|----------------------------------|-------------------------------|--|
| <input type="checkbox"/> 1802 | <input type="checkbox"/> 6502 | <input type="checkbox"/> 6800 | <input type="checkbox"/> AlphaMicro |
| <input type="checkbox"/> 8080 | <input type="checkbox"/> 8086/88 | <input type="checkbox"/> 9900 | <input type="checkbox"/> APPLE II |
| <input type="checkbox"/> PACE | <input type="checkbox"/> 6809 | <input type="checkbox"/> NOVA | <input type="checkbox"/> PDP-11/LSI-11 |
| <input type="checkbox"/> 68000 | <input type="checkbox"/> Eclipse | <input type="checkbox"/> VAX | <input type="checkbox"/> Z80 |

and shipping by Air: \$5 for each item under \$25, \$10 for each item between \$25 and \$99 and \$20 for each item over \$100. All prices and products subject to change or withdrawal without notice. Single system and/or single user license agreement required on some products. **DEALER & AUTHOR INQUIRIES INVITED**

MOUNTAIN VIEW PRESS, INC.

PO BOX 4656

MOUNTAIN VIEW, CA 94040

(415) 961-4103

Now a professional CAD

For
Apple II
and //e

system for \$1,095!

Finally, there is a breakthrough in computer aided drafting and design that makes this work-saving technology affordable for every school, architect, engineer, designer and draftsman.

The new Robographics CAD-1 system works with a standard off-the-shelf Apple* II+ or //e computer. A complete CAD-1 hardware and software package sells for \$1,095, and you can add a drafting plotter for as little as \$1,495!

Yet, this is a serious drafting and design system emulating other CAD installations costing over \$15,000.

CAD-1 utilizes a unique handheld controller which serves as both drawing instrument and function selector . . . there are no key-

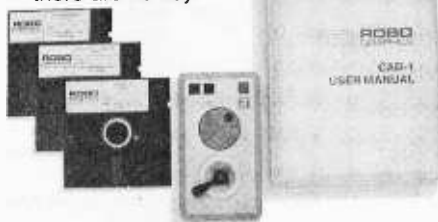

stroke commands to interrupt the workflow. And, when the drawing is completed, line work of reproduction quality can be plotted on paper, vellum or drafting film.

The easy-to-learn CAD-1 drafting process is fast, efficient and highly productive.

To preview this remarkable system, send for a free CAD-1 brochure, or send \$17 for your advance copy of the CAD-1 User Manual. Credit will be given when you order a system.



Major credit cards accepted.

See your Apple dealer today for a demonstration or contact us directly.

*A registered trademark of Apple Computer, Inc.

Shirley is officially named the MP-10. I see no reason to change the above paragraph. . . .

Anyway, we've now seen the prototype. Shirley will be in a metal box. Dr. Godbout prefers metal; it cuts down on extraneous electrical noise in the system. It's intended as a four-user system, and will have both hard and floppy disks, and will be the first all-up machine Compupro has put out; up to now it has stayed exclusively with the S-100 bus.

The Shirley operating system will be MP/M; when reporters asked Godbout about PC-DOS, he sort of chuckled, which is reasonable. There are persistent rumors that Digital Research will soon come out with a multiuser version of Concurrent CP/M that runs PC-DOS programs directly (not as an emulation). I suspect Shirley will have that feature.

Dr. Godbout sees a few more years for the S-100 bus. The iAPX286 and 16032 machines will work with it. The 8086 with the 8087 math chip will challenge the 68000, and they can be upgraded to the iAPX286. The 16032 with its highly advanced architecture waits like a dark horse in the wings.

The problem with the 68000, according to Bill Godbout, is that there's no clear upward migration for it. Of course 68000 enthusiasts—my son is one of them—say there's no need for upward migration for the 68000.

In any event, S-100-bus machines that are truly IEEE-696 standard will give the user a lot of flexibility, since you can convert from Z80 to 8088 to 8086/8087 to iAPX286, and then change the whole farshimelt mess to a 68000 if that's what's needed. Of course, eventually technology is going to run past all buses, because the distances between the slots in the box are just too long; but that won't happen for a while. Meanwhile, you find Compupro S-100 machines in the strangest places: all the special computer displays in the model "War Room" for the movie *WarGames* were controlled by a Compupro, as an example.

When Bill Godbout *called me* yesterday, he had a complaint: it certainly used to be true that Compupro

**ROBO
GRAPHICS**

CHESELL-ROBOCOM CORPORATION
125 Pheasant Run, Suite 2B
Newtown, PA 18940 (215) 968-4422

Score another first for ACE.



A lot of people who've never heard of ACE's impressive record of firsts in multiprocessing are about to sit up and take notice. Why?

It's our latest wonder: Multiprocessor CP/M Plus*.

ACE has developed a linkup between its powerful multiuser microcomputer, the Discovery, and the fastest and most powerful version of CP/M* ever marketed.

The result is a multiprocessor that does more than just emulate CP/M or rely on a lesser operating system that's "CP/M compatible." It actually delivers pure CP/M (either CP/M-86* or CP/M Plus) to any of Discovery's up to 16 on-line users.

With easy command line editing, quick file accessing through user-defined automatic search paths and comprehensive "help menus," CP/M Plus is as friendly as they come — and with big performance extras.

Like large files, directory hashing, data buffering, time and date stamping, and an extensive utility set that can accept English words.

All of which means that ACE's linkup with CP/M Plus will continue to give Discovery owners access to the largest selection of applications software in the world for years to come.

That's something to think about. Because who wants a multiuser system that's friendly and powerful today but unfriendly tomorrow when new software using CP/M

Multiprocessor CP/M Plus.™

Plus features hits the scene?

Our latest triumph is just one of a line of firsts.

ACE pioneered multiprocessing for microcomputers back in 1979 when we introduced a Discovery featuring what was then the revolutionary concept of dedicating a CPU to each on-line user.

Two years later, we moved further ahead of the pack with our next singular feat: the first user-processor on a single board, the dpc-180* Everything was there: memory, CPU, serial I/O.

Nice.

Which made our 1982 breakthrough — the amazing 16-bit dpc-186* mated with CP/M-86 — seem like business-as-usual to us even though it caught the competition flat-footed.

With room to grow from 128K to 1MB of expansion memory, and designed for systems also using our 8-bit board, this breakthrough let individual users tap into either 8- or 16-bit computing power with one

central Discovery unit.

And because each Discovery system is controlled by our own dpc-os*, tried and proven in more than 10,000 Discovery and OEM installations around the world, any user on line can take advantage of interprocessor communication, file and record locking, fully managed multiple printers, private directories, plus many other features.

So what little wonder does ACE have up its sleeve now? Stay tuned. Because soon you'll hear the news about our Concurrent CP/M-86*, which will give the owners of our Discovery all the benefits of 16-bit computing power, CP/M's comprehensive software selection, and efficient multi-tasking capabilities. So each user can get several projects underway with a few quick taps on the keyboard.

Meanwhile, it'll be business as usual for ACE, keeping ahead of the crowd while turning out the best multiuser multiprocessor micro on the market, backed by one of the best nationwide service networks you could hope for.

So if you're a computer dealer, distributor, or systems house who wants to join the group that scores high with a multitude of users, just give us a call at (800) 821-6596.

(In California, it's (213)351-5451.)

And do us a small favor. Tell us you've heard of us.



See us at Comdex booth #1884.

ACTIONCOMPUTERENTERPRISES
The Multiprocessing Company.

Action Computer Enterprise, Inc. (Corporate Headquarters): 430 No. Halstead St., Pasadena, CA 91107. TWX 910-588-1201 ACTION PSD / ACE/Europe: Boschdijk 189, Box 1275 5602 BG, Eindhoven, Netherlands. Tel. 040-452658, Telex 51767 ACE ENL / ACE/Asia, G/Floor Lee Wah Mansion, 171-177 Hollywood Rd, Hong Kong. Tel. 5-441692 or 5-442310. Telex 75332 PACIC HX / Canada: Future Electronics, Inc., 237 Hymus Blvd., Pt. Claire, Quebec H9R5C7, Canada. Tel. (514) 694-7710, Telex 05-823-554.

*CP/M Plus, CP/M, CP/M-86, and Concurrent CP/M-86 are either trademarks or registered trademarks of Digital Research, Inc. / *dpc-180 and dpc-os are registered trademarks of Action Computer Enterprise, Inc.

Items Reviewed

Disk Spare Parts Kit Star Trek WRITE

Workman and Associates
112 Marion Ave., Suite 7A
Pasadena, CA 91106
(213) 796-4401

products \$32.50
postpaid \$19.50
in U.S. \$239

Epson QX-10

Epson America
3415 Kashiwa St.
Torrance, CA 90505
(213) 539-9140

with 64K-byte RAM \$2495
with 128K-byte RAM \$2995

General Computer Supplies

California Digital
POB 3097B
Torrance, CA 90503
(800) 421-5041

Megabyte Memory Board

Macrotech International Corporation
20630 Lassen St.
Chatsworth, CA 91311
(213) 700-1501

\$2449

Modula-2

Logitech
165 University Ave.
Palo Alto, CA 94301
(415) 326-3885

\$495

Modula-2

Volition Systems
POB 1236
Del Mar, CA 92014
(619) 481-2286

Apple \$495
IBM and Sage \$595

Vedit

Compuview Products Inc.
1955 Pauline Blvd., Suite 200
Ann Arbor, MI 48103
(313) 996-1299

\$150

Zenith Z-100 Computer

Zenith Data Systems
1000 Milwaukee Ave.
Glenview, IL 60025
(312) 391-8865

\$2899

systems service people. Finally, it rewrote many of its documents.

"So I did everything you wanted. When are you going to admit it?"

I'll reserve my opinion on just how far he had his tongue rammed up his cheek when he told me of my vast influence, but in fairness I do have to report that it's all true. I wish all the computer manufacturers would insist that their salespeople know something about the product—including its limitations.

Time Waster

A few issues ago I mentioned I'd written the world's most complex Star Trek game. I may have exaggerated. In any event, we've had several inquiries about the game, so I've turned it over to Barry Workman. It's probably overpriced, but the realities of the software mail-order business prevent him from shipping disks postpaid for less.

My Trek game is written in CB-80 and runs really fast. I've stuck in all kinds of silly features, including exploration, enemy bases, enemy attacks on Federation merchant ships, enemy attacks on your star bases, Tholian Webs, Romulan invisibility, and such like. My kids like it, and I confess that I've wasted a bit of time with it myself. I'm too ashamed to recommend it; I'll merely say it's available.

By next time I surely will have my IBM PC. I hope to have a report on the PC vs. the Eagle, and also to reduce that stack of unreviewed PC software.

However, I know better than to make promises. . . ■

Jerry Pournelle welcomes readers' comments and opinions. Send a self-addressed, stamped envelope to Jerry Pournelle, c/o BYTE Publications, POB 372, Hancock, NH 03449. Please put your address on the letter as well as on the envelope. Due to the high volume of letters, Jerry cannot guarantee a personal reply.

Jerry Pournelle is a former aerospace engineer and current science-fiction writer who loves to play with computers.

machines were largely intended for hackers and system developers, and the company doesn't intend to let go of its dominance in that end of the micro field; but largely due to my needling him, both privately and in the column, about its lack of support for naive users, Compupro went out and hired the Xerox field service organization to provide servicing

agreements for Compupro equipment; every one of the Compupro Systems Centers was required to send at least one key employee through an intensive sales training course designed to show what's wrong with the customer service in the computer industry, and how to correct it; and Compupro has been doing more intensive training of its

New! Three Winchester Internal Hard Disc Drive Systems!

Now you can choose from three low-power 10 Mega-byte systems that convert your IBM® PC to perform just like the PC XT!

Maynard Electronics introduces three Winchester Hard Disc Drive Systems — the only drive systems to offer you 10 Mega-bytes of formatted capacity with complete internal installation! These systems offer the user countless benefits and features: capability of booting off the hard disc; additional functions while requiring only one card slot in your PC; and, use of available power, thereby preventing overheating problems which have affected other drives. Handling heavyweight data was never easier.

All three systems are quality engineered and work with DOS 2.0 without any special software drivers and also run with other operating systems designed to make use of the XT hard drive ready to run!

Each system is equipped with a low-power hard disc drive, complete software, cable, a SandStar™ Card and Hard Disc Controller Module. SandStar™ is the first family of modular peripherals created for the IBM® PC. Simple instructions for easy installation are included and all components are backed by an Unconditional One Year Parts and Labor Guarantee.

WS 1

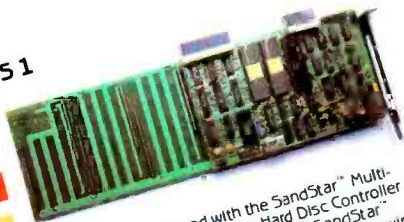

This System is equipped with the SandStar™ Multi-function card. In addition to the Hard Disc Controller Module, you can add up to three other SandStar™ Modules while using only one card slot. The following modules are available: Serial Port, Parallel Port, Clock Calendar, Game Adaptor, SASI Host Adaptor and Prototyping Module.

WS 2

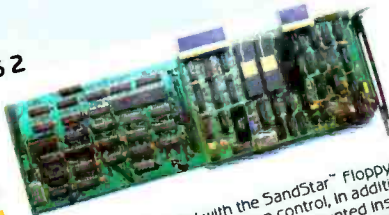

This System is equipped with the SandStar™ Floppy Drive Controller Card. The Card can control, in addition to the Hard Disc Drive, two floppy drives mounted inside your PC and optionally two additional 5 1/4" or 8" drives mounted externally. This leaves three system slots for other expansion boards.

WS 3

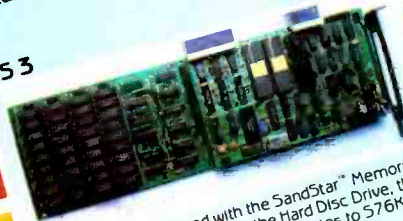

This System is equipped with the SandStar™ Memory Card. In addition to controlling the Hard Disc Drive, the Memory Card allows you to add 64K bytes to 576K bytes of memory using only one card slot.

To expand your PC to perform like the PC XT, one of our Winchester Hard Disc Drive Systems is right for you. And if you have already made the wise decision to install any of Maynard's SandStar™ Cards, the SandStar™ Hard Disc Controller Module may be purchased separately.

TO ORDER, CONTACT YOUR LOCAL DEALER OR DISTRIBUTOR.



MAYNARD ELECTRONICS
400 East Semoran Blvd. # Suite 207
Casselberry, Florida 32707
305/331-6402

We make modern times better.

Circle 277 on inquiry card.

IBM is a trademark of the International Business Machines Corporation.

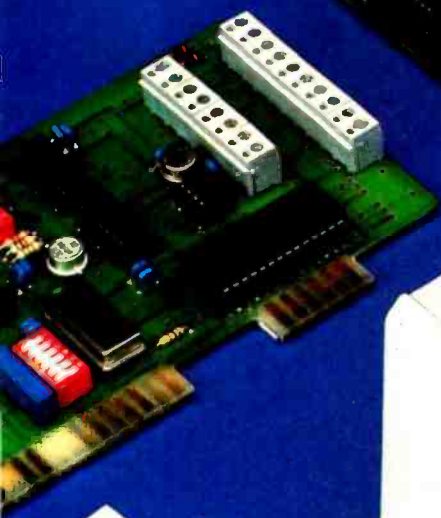
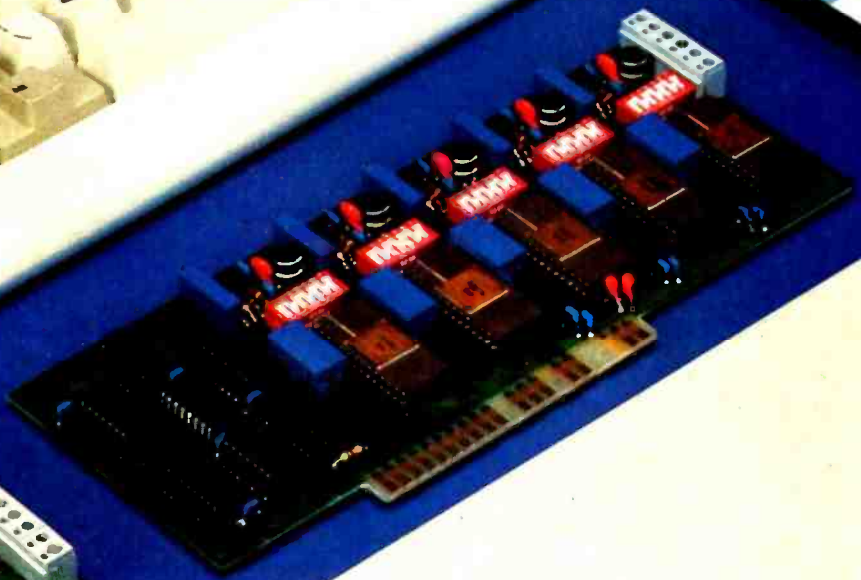

KEITHLEY *das*
SERIES 500
MEASUREMENT
AND CONTROL
SYSTEM

DON'T WASTE YOUR MONEY ON A WORKSTATION DATA ACQUISITION SYSTEM.

As you conduct your search for the ideal data acquisition system, we think you'll find a number of capable systems, all from fine makers.

But we also think you'll find this: there is really only one system likely to meet, and perhaps exceed, your own personal standards for accuracy, flexibility, performance and power. And do so for a bottom line investment that is truly easy to justify.

That system is the Keithley DAS Series 500 for the IBM PC and Apple II families of microcomputers.

To begin with, even a basic Series 500 configuration, like the one shown in the chart, comes out of its carton with enough power and capacity for most lab and test bench applications. So you needn't trade up to more expensive options to get basic capabilities.

And because the Series 500 is completely modular, you can start out with just the capacity you need. Then choose from our comprehensive library of plug-in function cards to instantly reconfigure your system for the most demanding applications—with up to 272 channels of discrete analog input, 50 channels of analog output, 160 channels of digital I/O, and AC/DC device control. With direct transducer connection and signal conditioning for each individual channel.

It's also the only system equipped with Soft500, the integrated measurement and control software that proves once and for all that easy doesn't have to mean simple.

Soft500 gives first time users the accessibility and friendliness they need to get excellent results the first time out. Yet it also provides experienced users with the depth and extended facilities needed for complex applications. Including unique features such as foreground/background architecture, powerful screen graphics and statistical analyses. Plus, automatic conversion of binary data to familiar engineering units.

In all, you'll find the features you need to make the Series 500 increasingly productive through years of new and more demanding applications.

	Keithley DAS Series 500	ISAAC 91A	ISAAC 2000	MACSYM 200	HP 3497A
System Base	\$4300(1)	\$3950	\$4100	\$3660	\$2990
Analog Input					
16 Channels	Yes	Yes	+ \$850	+ \$362(2)	+ \$2104(3)
Instrumentation Amplifier	Yes	+ \$700	+ \$700	Yes	Yes
± 0.035% Absolute System Accuracy	Yes	+ \$1100(4)	+ \$1100(4)	No	Yes(5)
30 kHz Sampling	Yes(6)	No	Yes(7)	Yes	No
High Speed Programmable Ranges	Yes	No	No	Yes	No
Digital I/O					
5 12-Bit Voltage Outputs	Yes	+ \$187(8)	+ \$937(9)	+ \$937(9)	+ \$2500(10)
16 Digital Inputs	Yes	Yes	+ \$175(11)	+ \$330	+ \$530
16 Digital Outputs	Yes	Yes	+ \$175(11)	+ \$350	+ \$710
4 120VAC Outputs	Yes	No	No	+ \$638(12)	+ \$265(13)
System Features					
Programmable Timers	Yes	Yes	Yes	Yes	+ \$555
Realtime Clock	Yes	Yes	No	Yes	Yes
Power Supply	Yes	+ \$350	Yes	Yes	Yes
Software System					
Data Acquisition BASIC	Yes	Yes	Yes	Yes	No
Foreground/Background	Yes	No	Yes(14)	Yes(14)	No
Data Analysis	Yes	No	No	No	No
Realtime Graphing	Yes	Yes	Yes	Yes	No
Engineering Units	Yes	No	No	No	No
Package Price	\$4300	\$6287	\$8037	\$6277	\$9654

1. System 520. 2. 16 channels of \$725 32 channel card. 3. \$1640 A/D card plus 16 channels of \$580 20 channel card. 4. ± 0.003% accuracy @ 200 Hz. 5. ± 0.006% accuracy @ 40 Hz. 6. Apple system 27 kHz, IBM system 31.4 kHz. 7. 200 kHz option available + \$3825. 8. 1 channel from \$750 4 channel card. 9. 5 channels from \$750 4 channel card. 10. 5 channels from \$1000 2 channel card. 11. 16 channels of \$350 32 channel card. 12. Price based on 16 channel rack @ \$550 plus 4 AC output relays @ \$22. 13. Four channels of \$525 8 channel card. 14. Or other multi-tasking structure.

Naturally, we'd like to suggest the Series 500 as the wisest choice in workstation data acquisition. But we also believe that as you compare and examine the facts, the Series 500 will eventually suggest itself.

For complete information on the Keithley DAS Series 500 workstation data acquisition system, call us toll-free at 1-800-552-1115. In Massachusetts call (617) 423-7691. Or write to us at Keithley DAS, 349 Congress Street, Boston, Massachusetts 02210.

SERIES 500



A JOINT VENTURE IN WORKSTATION DATA ACQUISITION

Information contained in the comparison chart is correct to the best of our knowledge as of October 1, 1983; however, Keithley DAS assumes no liability for its accuracy. IBM PC is a registered trademark of International Business Machines Corporation. Apple II is a registered trademark of Apple Computer, Inc. ISAAC is a registered trademark of Cyborg Corporation. MACSYM is a registered trademark of Analog Devices, Inc. HP is a registered trademark of Hewlett-Packard, Inc. © 1983 by Keithley DAS, Boston, Massachusetts



Easy Software

It isn't easy to make software that's easy for people to use. People think intuitively and symbolically, but computers don't think at all—they just manipulate voltage levels that people can most accurately represent as wave forms or strings of ones and zeros. Creative programmers and engineers are trying different ways of translating long strings of ones and zeros into symbols, expressions, and structures that people can manipulate easily.

This month BYTE offers a sampling of the efforts that programmers are undertaking to make software easy. Integration of software comes under discussion as well because it is inseparable from ease of use; giving separate programs a common user interface is a major step toward integrating them.

The theme articles in this issue provide several different views of what is now the most praised approach to user interface technology—the desktop metaphor that lets users choose actions by pointing at pictorial symbols on an imaginary desktop. In addition to an introduction to desktop-metaphor software, we compare different kinds of pointing devices, discuss the concept of metaphor in software, look at the future of metaphors, and preview Microsoft Windows, a new desktop-metaphor system that seems to be the first one capable of running without a hard disk and a lot of memory.

An implicitly skeptical view of the desktop metaphor emerges in Tom Houston's suggestions of new metaphors that appeal to human instincts far deeper than those associated with desks, file folders, and wastebaskets.

But the desktop metaphor is not the only approach to the user interface that this issue addresses. Jack Carroll of IBM takes a broader look at the evolution of the user interface in software. Bob Nicholson of Sydis considers the role of voice in the user interface. Sam Edwards of Software Publishing, publisher of PFS: File and other programs often praised for ease of use, reveals some of the thought behind them. Martin Dean of Select Information Systems looks beyond the easy-to-learn Select word processor to other issues in the user interface, including aspects that relate to databases.

Different disciplines often borrow important ideas from one another. Paul Heckel of Quickview Systems ventures into the world of Walt Disney cartoons to bring back some lessons for applications programmers. Steve Vandor of Micropro explains an approach to the user interface that is based on the concept of division of labor, as old as the industrial revolution.

Martin Herbach of Sorcim, Richard Katz of Osborne/McGraw-Hill, and Joe Landau of Applied Software Technology join in a forum on the user interface that ranges from the role of hardware advances to on-screen help information and the structuring of software in layers that hide everything from the users except what they need. Michael Brown of Innovative Software argues persuasively that the foundation of integrated software should be a database.

Programming languages, too, need improvements in the user interface, and Andy Pope, Dan Fineberg, and Geoff Kates of Microfocus describe one way of making debugging a more visual process.

Perhaps the best assessment of the state of user-interface technology today comes from Apple's Bill Atkinson, author of the unrivaled Quickdraw graphics software that runs on Lisa. "What we know about the user interface today," he says, "is 10 percent of what we will know in 1990." This issue lets you examine some portion of that 10 percent and invites you to speculate about the 90 percent still to be learned. —Phil Lemmons

- 103** **An Introduction to Integrated Software** by Dash Chang
- 113** **Presentation and Form in User-Interface Architecture** by John M. Carroll
- 127** **Why Is Software So Hard to Use?** by Sam Edwards
- 143** **Walt Disney and User-Oriented Software** by Paul Heckel
- 155** **Making Life Easier for Professional and Novice Programmers** by Andy Pope, Geoff Kates, and Dan Fineberg
- 161** **Simplify, Simplify, Simplify** by Martin Dean
- 177** **Integrating Voice in the Office World** by Robert T. Nicholson
- 189** **The Starburst User Interface** by Steven Vandor
- 199** **The Complete Information-Management System** by Michael J. Brown
- 210** **The Allegory of Software** by Tom Houston
- 218** **The New Interface Technology** by Robert W. Warfield and George M. White
- 234** **Trackball-Interfacing Techniques for Microprocessors** by Edward W. Andrews
- 247** **The User Interface: Two Approaches** by Martin Herbach, Richard Katz, and Joseph Landau
- 263** **The Future of Metaphor in Man-Computer Systems** by Chuck Clanton

Painting by Robert Tinney, photographs courtesy of Microsoft

"Help arrives for users of dBASE II."

— BYTE

"...it succeeds admirably."

INFOWORLD

"The real thrill of using QUICKCODE...like magic, a complex pattern of dBASE II command files is created."

Ashton-Tate Newsletter

QUICKCODE™

dBASE II made easy!

The dBASE II
Program Generator



"QUICKCODE clearly shines..."

Adam Green

"... we'll take dBASE II and QUICKCODE over any other application development system we have seen..."

Redwood Systems, Inc. Computer Consultants dBASE

"Thanks Fox & Geller!!!"

dBASE Ashton-Tate

CALL US AT (201) 794-8883



Fox & Geller, Inc. 604 Market Street, Elizabeth, NJ 07207 Fox & Geller, UK 17 Wigmore Street, London W1, England, UK 441 580 5816

An Introduction to Integrated Software

Concurrency, shared technology, and functional integration are three ways of integrating software

by Dash Chang

You may remember 1983 as the year of integrated software for microcomputers. We saw announcements of the Lisa workstation from Apple, 1-2-3 from Lotus, Visi On from Visicorp, and Concurrent CP/M from Digital Research. While the microcomputer audience experiences some confusion over what it all means, the promise of these new products is nothing short of exciting.

Before "integrated" becomes as overused a label as "user-friendly," we should define our terms. Integrated software means software that has a high level of functionality and is easy to use. Simply, integrated software lets you accomplish complicated tasks over a short period of time with a minimum of interaction with the computer.

Many computer users pose tasks that defy easy computerization. The following wish list is a case in point. "I want to store all my inventory on the computer so that I can look at my stocking items on request. In addition, it would be useful if I could experiment with the data and see the bottom-line effect if I change my stocking policy. I'd also like to see the results graphically. If I had all of my data on the computer, I could also produce computerized quotations. . . ."

Software integration promises a method of making dreams such as

these come true with a minimum of effort.

Software Technologies

Over the past few years, some software packages have emerged that enable customers to solve complex problems with relative ease. Visicalc, Visicorp's electronic spreadsheet, started the revolution; with it, you can ask "what if" questions and calculate the results. Wordstar, a word processor from Micropro Corporation, works with computers to

Integrated software is only the next step toward making microcomputers more useful.

help generate letters and lengthy documents.

Since then, new packages like Chang Laboratories' Microplan, Microsoft's Multiplan, and Visicorp's Advanced Visicalc make those originals appear rudimentary. Expanded functions let you solve more complicated problems with less effort, in both initial learning and continued use. As new packages offer more enhancements, the number of problems that you can successfully tackle increases. Yet a total integrated solution continues to evade software

designers. Word processors, financial-planning spreadsheets, data managers, and graphics packages will represent single solutions to specific problems.

Integration

Software developers propose to integrate databases with worksheets, graphics, and word processing, producing a single set of products that addresses a larger set of user needs. Integrated software is the next step toward making microcomputers more useful.

Similar product names, such as the Lisa (Apple Computer Inc.), Visi (Visicorp), Plan (Chang Laboratories), and Super (Sorcim Corporation) families are only the beginning. While a complete family of products is a necessary step toward integration, it doesn't result in the total package that software developers are aiming at.

Another approach focuses on the command interface. Products in this category require similar keystrokes in response to similar display screens. Again, this is an important part of integrated software, but it is still far from a complete implementation.

Generally, you can classify current integration technology as including one or all of the following: concurrency, shared technology, and functional integration.

Concurrency

Concurrency lets different products reside in the computer's memory at the same time. You can load word-processor and spreadsheet programs into memory and switch instantaneously from one to the other with a single keystroke. This spares you the time-consuming process of saving the results from one product, leaving the package, starting up another package, and continuing with the next step in the problem. (Although, technically, concurrency provides more benefits than just concurrent residence of programs in memory, for now I'll discuss only the memory aspect of concurrency.)

Lisa's Desktop Manager provides one example of concurrency. The programs that handle documents and worksheets are automatically loaded in memory. When you need one of the programs, you use a mouse to move the screen cursor to the program's symbol, and the software is instantly available for use. Visi On and Concurrent CP/M provide similar options but differ from the

Lisa software in that they can be implemented on different computers. This makes it possible for you to enhance the capabilities of a computer you already own.

[Editor's note: Depending on the amount of memory available, the Lisa computer may have some or all of every

Concurrency means that different products reside in the computer's memory at the same time.

current task in memory. All Lisa programs are segmented so that portions can be stored to disk or called into memory as needed. A similar situation exists with Visi On, which always has some code in memory that relates to each task. Given the above amplifications, we can say that both Lisa and Visi On software are concurrent. . . . G. W.]

Another important distinction is that these products are not applica-

tion programs but enhancements to the computer's operating system; they manage the hardware and provide a more friendly and responsive computer environment for users. In some ways, you can view these programs as part of the computer rather than applications that address specific user problems. As application programs begin to fully use the capabilities of concurrent operating systems, you will find integrated packages that are even easier to use than existing products.

Shared Technology

The second class of integrated solutions includes the shared-technology products. A single such product handles not only numbers but words and pictures, all at the same time.

For example, Graphplan from Chang Laboratories, 1-2-3 from Lotus, and MBA from Context all combine traditional spreadsheet technology with graphics capabilities and some database features such as sorting and searching. These products let you take a set of numbers and produce

FREE SHIPPING

Order line: 800-354-7330

SANYO SUPER SYSTEMS

SYSTEM #1 \$1195

SANYO MBC-550

- SANYO GREEN MONITOR
- GEMINI 10 X • SOFTWARE •

Sanyo MBC-550 Single Drive Computer • Sanyo CRT-36 Monitor • Star Micronics Gemini 10X • Cabling • WordStar • CalcStar • Easywriter • MS-DOS • Sanyo Basic •

SYSTEM #2 \$1525

SANYO MBC-555

- SANYO GREEN MONITOR
- GEMINI 10X • SOFTWARE •

Sanyo MBC-555 Dual Drive Computer • Sanyo CRT-36 Monitor • Star Micronics Gemini 10X • Cabling • WordStar • CalcStar • SpellStar • InfoStar • Mail Merge • Easywriter • MS-DOS • Sanyo Basic •

PRINTERS

C. ITOH

Prowriter 8510 \$345

F-10 Serial or Parallel \$940

8510SP (Prowriter SP) \$565

COMREX

CR-2 \$AVE

DIABLO

620 RO \$860

630 RO \$1715

EPSON

RX-80 \$AVE

RX-80 F/T \$AVE

MX-80 F/T \$AVE

FX-80 \$AVE

FX-100 \$AVE

JUKI

6100 \$480

NEC

2010 \$780

2050 \$905

8023A \$385

3510 \$1370

3550 \$1715

STAR MICRONICS

Gemini 10X & 15X \$AVE

Delta 10 \$AVE

PRINTERS

OKIDATA

82A \$359

83A \$559

84P \$980

84S \$1065

92 \$419

93 \$699

TALLY

MT 160L w/tractors \$AVE

MT 180L w/tractors \$AVE

Spirit 80 \$AVE

TOSHIBA

1350 Serial or Parallel \$1450

TRANSTAR

130P \$675

120P \$450

T315 \$450

TERMINALS

TELEVIDEO

910+ \$555

914 \$540

924 \$670

925 \$705

950 \$905

970 \$980

COMPUTERS

HYPERION

Single Drive System \$2325

Dual Drive System \$2665

PIED PIPER

Communication I \$975

TELEVIDEO

803 \$1799

SANYO

MBC-550 System \$1195

MBC-555 System \$1525

MODEMS

HAYES

1200 \$490

1200B \$435

300 \$205

Prices reflect 3% to 5% cash discount. Product shipped in factory cartons with manufacturer's warranty. Free shipping is on UPS ground only. Prices & availability subject to change without notice. Send cashier's check or money order...all other checks will delay shipping two weeks.

SILICON SPECIALTIES

2034 WEST SOUTHERN

MESA, ARIZONA 85202

602-969-0909

JAMECO

ELECTRONICS 1984 CATALOG



10th ANNIVERSARY

Mail Order Electronics • Worldwide
Jameco
ELECTRONICS

NOW AVAILABLE...
1984 10th Anniversary Catalog!

64 Pages
With Over 4,000 Items!

Send \$1.00 for postage & handling for immediate delivery of your FREE 1984 Catalog.

JAMECO ELECTRONICS • 1355 Shoreway Road • Belmont, CA 94002 • (415) 592-8097 or Telex 176043

Our new Optimizing = C86™ C Compiler controls Charlie...

Like a Puppet on a String!

Take control of Charlie with our new Optimizing = C86™ C Compiler...now available for the IBM PC-DOS and the MS-DOS operating systems. Take the upper hand with:



- Significantly faster and tighter code
- Standard object module format, linkable with the MS-DOS linker
- Compile time switch for big machine addressing (Programs can be as large as the memory you can afford!)
- Compile time switch to produce in-line 8087 code. (We still provide our floating point package, too!)
- Significant performance increases for our I/O library
- MS-DOS version 2.00 I/O library
- Many additional library functions
- Expanded manual with numerous examples
- Librarian for maintenance of MS/DOS libraries
- Optional assembly source output (It's not NECESSARY to produce assembly source, but it CAN be assembled using MASM!)

Pull Charlie's strings with our new Optimizing = C86™ C Compiler. See your local dealer or call Computer Innovations for information and to order the C86 Compiler Diskette and Manual...still only \$395.00!



Computer Innovations
10 Mechanic Street
Suite J-504
Red Bank, N.J. 07701
(201) 530-0995

**"They Say It All...
We Do It All!"**

Visa and MasterCard accepted.

C86 is a trademark of Computer Innovations, Inc. CPM-86 and MPM-86 are trademarks of Digital Research. MS-DOS is a trademark of Microsoft. PC-DOS is a trademark of International Business Machines.

graphic results as well as printed tables.

The shared technology concept isn't new. For example, most dedicated word-processing computers have always had the ability to handle mathematics, very much like an electronic worksheet.

Expect more shared technology products for microcomputers. Just as combining mechanical and electronic engineering produces breakthroughs in robotics, combining technologies in the processing of words, numbers, voice, and graphics promises innovative software products.

Functional Integration

Finally, the third type of integration provides functional results; the results of one product can be fed to another product for further manipulation.

Examples include spelling check-

Shared technology means that a single product handles not only numbers but words and pictures, all at the same time.

ers, form-letter generators, and integrated accounting packages. The purpose of a spelling checker is obvious. In form-letter generation, you might generate a mailing list using a data-management package, then create a skeleton letter using a word processor, and, finally, produce a stack of custom letters using a product that merges the two parts.

In integrated accounting packages, the orders module may change your inventory and accounts-receivable files. Then the accounts-receivable and accounts-payable packages will automatically create entries for the general ledger.

Functional integration offers the greatest challenge for application designers—not only to provide a generalized interaction between database management and electronic-worksheet technology, but also to handle the interface between the world of

Introducing the Most Powerful Business Software Ever!

TRS-80™ (Model I, II, III, or 16) • APPLE™ • IBM™ • OSBORNE™ • CP/M™ • XEROX™

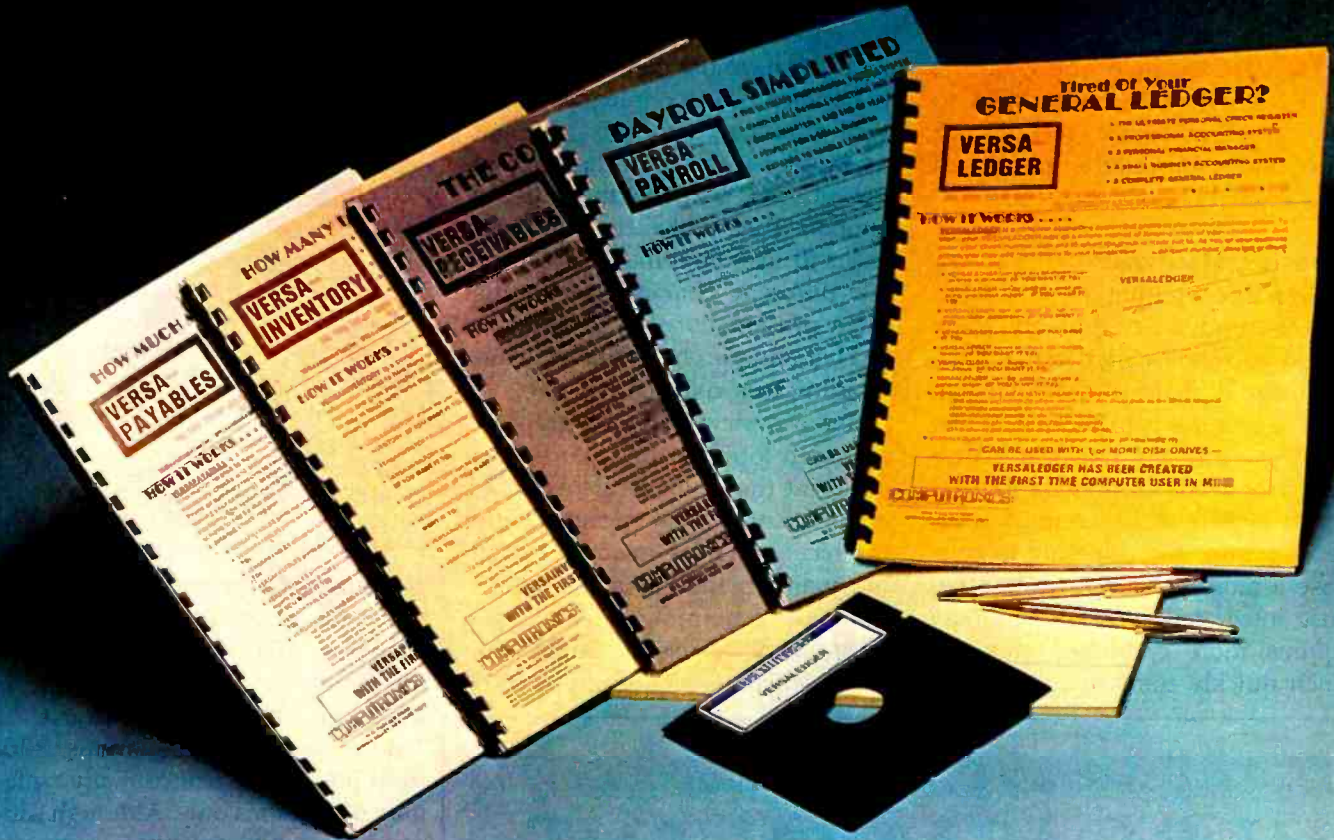

The VERSABUSINESS™ Series

Each VERSABUSINESS module can be purchased and used independently, or can be linked in any combination to form a complete, coordinated business system.

VERSARECEIVABLES™ \$99.95
 VERSARECEIVABLES™ is a complete menu-driven accounts receivable, invoicing, and monthly statement-generating system. It keeps track of all information related to who owes you or your company money, and can provide automatic billing for past due accounts. VERSARECEIVABLES™ prints all necessary statements, invoices, and summary reports and can be linked with VERSALEDGER II™ and VERSAINVENTORY™.

VERSAPAYABLES™ \$99.95
 VERSAPAYABLES™ is designed to keep track of current and aged payables, keeping you in touch with all information regarding how much money your company owes, and to whom. VERSAPAYABLES™ maintains a complete record on each vendor, prints checks, check registers, vouchers, transaction reports, aged payables reports, vendor reports, and more. With VERSAPAYABLES™, you can even let your computer automatically select which vouchers are to be paid.

VERSAPAYROLL™ \$99.95
 VERSAPAYROLL™ is a powerful and sophisticated, but easy to use payroll system that keeps track of all government-required payroll information. Complete employee records are maintained, and all necessary payroll calculations are performed automatically, with totals displayed on screen for operator approval. A payroll can be run totally, automatically, or the operator can intervene to prevent a check from being printed, or to alter information on it. If desired, totals may be posted to the VERSALEDGER II™ system.

VERSAINVENTORY™ \$99.95
 VERSAINVENTORY™ is a complete inventory control system that gives you instant access to data on any item. VERSAINVENTORY™ keeps track of all information related to what items are in stock, out of stock, on backorder, etc., stores sales and pricing data, alerts you when an item falls below a preset reorder point, and allows you to enter and print invoices directly or to link with the VERSARECEIVABLES™ system. VERSAINVENTORY™ prints all needed inventory listings, reports of items below reorder point, inventory value reports, period and year-to-date sales reports, price lists, inventory checklists, etc.

VERSALEDGER II™ \$149.95
 VERSALEDGER II™ is a complete accounting system that grows as your business grows. VERSALEDGER II™ can be used as a simple personal checkbook register, expanded to a small business bookkeeping system or developed into a large corporate general ledger system without any additional software.

- VERSALEDGER II™ gives you almost unlimited storage capacity (300 to 10,000 entries per month, depending on the system),
- stores all check and general ledger information forever,
- prints tractor-feed checks,
- handles multiple checkbooks and general ledgers,
- prints 17 customized accounting reports including check registers, balance sheets, income statements, transaction reports, account listings, etc.

VERSALEDGER II™ comes with a professionally-written 160 page manual designed for first-time users. The VERSALEDGER II™ manual will help you become quickly familiar with VERSALEDGER II™, using complete sample data files supplied on diskette and more than 50 pages of sample printouts.

SATISFACTION GUARANTEED!

Every VERSABUSINESS™ module is guaranteed to outperform all other competitive systems, and at a fraction of their cost. If you are not satisfied with any VERSABUSINESS™ module, you may return it within 30 days for a refund. Manuals for any VERSABUSINESS™ module may be purchased for \$25 each, credited toward a later purchase of that module.

To Order: **Write or call Toll-free (800) 431-2818**
 (N.Y.S. residents call 914-425-1535)

- * add \$3 for shipping in UPS areas
- * add \$4 for C.O.D. or non-UPS areas
- * add \$5 to CANADA or MEXICO
- * add proper postage elsewhere

DEALER INQUIRIES WELCOME

All prices and specifications subject to change / Delivery subject to availability.



COMPUTRONICS!

50 N. PASCACK ROAD, SPRING VALLEY, N.Y. 10977

* TRS-80 is a trademark of the Radio Shack Division of Tandy Corp. • APPLE is a trademark of Apple Corp. • IBM is a trademark of IBM Corp. • OSBORNE is a trademark of Osborne Corp. • CP/M is a trademark of Digital Research. • XEROX is a trademark of Xerox Corp.

data on mainframes and microcomputer application programs.

Although developers suggest that shared-technology products will make functionally integrated stand-alone products obsolete, this result is unlikely. The range of problems needing computerization exceeds the capabilities of any one system or package. For example, you wouldn't use 1-2-3 to write a book, MBA to store your inventory records, or either one to produce an integrated slide show.

Choosing Hardware

Given the amount of integrated software under development, how should you choose hardware to take advantage of its features? First, you must determine your requirements. Not every problem nor every computer user needs integrated software. If your problems do require a complex solution, then prepare to purchase a more expensive system because integrated software generally requires more computer memory, which quickly translates into more

dollars. For example, Lisa supplies 1 megabyte of memory storage, while Visi On and Concurrent CP/M can use up to 512K bytes of data. Therefore, you should consider 16-bit computers like the IBM PC, the DEC Rainbow, the TI Professional, or the Victor 9000. Eight-bit computers like the Apple II and the Osborne 1 simply don't have the memory capacity to handle the new integrated software products.

Graphics are an important consideration, too, because they display symbols that make the computer easier to use. Graphics also let you use different character fonts that make presentations more attractive and bar and pie charts that give new meaning to a collection of data.

If your system supports graphics, you need a printer or a plotter that can print the symbols displayed on your screen. Most printers offer graphics support as an added option, and many include it as standard.

Finally, a pointing device like a mouse may be useful. Some computers let you execute commands by

Plans for an Integrated Product Line

Chang Laboratories has been working on a line of integrated business software that is available on both 8- and 16-bit systems. The products are functionally integrated; that is, data can be shared among products. In addition, under operating systems like Digital Research's Concurrent CP/M, these programs can share data via a small satellite program used to facilitate communication. Three products, Profitplan, Microplan, and Graphplan, allow various levels of spreadsheet and graphing capabilities. A consolidation module allows data to be combined from various sources. Memoplan is a word processor, Docuplan is a sophisticated document formatter, and Fileplan is a data entry and management system. In particular, data from several sources can be printed in a single report, and information from a database can be transferred to a spreadsheet.

pointing to the items on the display with your finger (touchscreen) or a light pen. All these pointing devices are similar in that they attempt to make the software easier to use.

Because of their limitations, 8-bit machines offer functionally integrated programs only. Although software for 8-bit computers may not provide concurrency or shared technology, software developers continue to increase the amount of functional integration in their packages. You may have to insert and remove disks more often, but you will still get products to "talk" to each other.

Further Integration

Software development produces interesting products, but the work in integration continually uncovers a need for greater integration than existing products supply. The new, more powerful 16-bit microcomputers open a Pandora's box of promises and problems, but at least they move us one step closer to solving those dream computer tasks. ■

Dash Chang is president of Chang Laboratories (5300 Stevens Creek Blvd., Suite 200, San Jose, CA 95129-1088). He has a B.S. in electrical engineering from MIT and an M.B.A. from Stanford University.

HEROISM IN THE MODERN AGE

THE ROLE-PLAYING GAME OF TODAY

© Copyright 1983 Pacific Infotech Corp.



A sophisticated simulation of modern life and human psychology.

Includes: **BASIC MODULE** — create and guide characters through their lives...

PROJECT CONTACT (Scenario #1) — save the U.S.A. from a mad scientist and terrorist plot... you have only 60 hours to complete your mission...

HEROISM IN THE MODERN AGE is expandable to other modules and exciting scenarios.

At your computer store.

SYSTEM REQUIREMENTS:

IBM PC* with one double-sided or two single-sided disk drives, an 80-column monitor, and 64K RAM (96K for DOS 2.0). Color graphics/adaptor optional.

*IBM PC is a trademark of International Business Machines Corp.



Pacific Infotech Corp.

10850 Wilshire Blvd.,
Suite 800
Los Angeles, CA 90024
U.S.A.

**NOW,
FOR THE FIRST TIME,
BUYING AND OWNING A
PERSONAL COMPUTER
IS VIRTUALLY RISK-FREE.**

digital™

INTRODUCING DIGITAL'S EXCLUSIVE INVESTMENT PROTECTION PLAN.

digital[™]

Investment Protection Plan

This comprehensive plan is included with the purchase of every Personal Computer Digital makes – including the Rainbow[™] Professional[™] and DECmate[™] II.

One-Year On-Site Computer Warranty.

Digital will provide limited warranty service including repair and replacement of defective parts wherever your computer is located in the Continental U.S.

One-Year Software Warranty.

Digital will provide limited warranty support for operating systems including updates to selected operating systems, documentation and replacement of defective media.

On-Site Options Warranty.

If you add any of Digital's personal computer options (including printers) at the time of system sale, these options will be covered by your one-year On-Site Computer Warranty. Options purchased after system sale are covered for 90 days.

One-Year "Hotline" Advisory Service.

Digital's toll-free "Hotline" Advisory Service will answer questions about operating systems, Digital Classified Software and general use. There's no extra charge, use this service as often as you like during the warranty period.

30-Day Money Back Return Policy.

Covers your entire Digital system, including Digital Classified Software and Digital options purchased at time of computer sale. Limited to one return per customer.

Offer expires January 31, 1984.



IT COMES WITH THE FINEST PERSONAL COMPUTERS YOU CAN BUY.

Digital's Personal Computers. They're one of the surest investments you can make. Because Digital is the only major computer company that supports its promise of quality and its commitment to customer satisfaction with a comprehensive investment protection plan.

This plan will minimize your risk. Relieve your concerns about owning a personal computer. And it's included when you purchase any one of Digital's Personal Computers, including the Rainbow™ and new Rainbow 100+, from a participating dealer, distributor, or Digital Business Center.

Digital's Rainbow now lets you run the widest range of popular business software—including Lotus™ 1-2-3™, dBase II™, TK!Solver™, and Multiplan™.



With Digital's Rainbow, you can choose from hundreds of different software

programs because only Digital's Rainbow can run these five operating systems: MS™ -DOS, CP/M® -86/80, Concurrent CP/M,* and p-System.** That means you'll have access to the broadest array of solutions for your business, today and tomorrow.

The new Rainbow 100+.



The Rainbow 100 is perfect for most businesses. But if you need more power, Digital introduces the Rainbow 100+. It lets you store the equivalent of 5,000 typewritten pages on a built-in 10 Mbyte hard disk. You'll also run the most advanced business programs faster and easier—thanks to 128 Kbytes of main memory, expandable to 896 Kbytes.

A wider choice of options and accessories, too.

With either Rainbow, you get a choice of monitors: white, green, amber, or high-resolution, full-color display. A choice of high-quality printers. A graphics



option that lets you create bar charts, pie charts, and line graphs. And more.

Including personal computer accessories and furniture custom designed by

Digital to help you get the most out of your computer.

Call 1-800-DIGITAL this week.

For more details on Digital's Rainbow 100, the new Rainbow 100+, and Digital's Investment Protection Plan, call 1-800-DIGITAL and ask for the Rainbow desk.

*Concurrent CP/M is available from Digital Research, Inc.
**p-System is available from Ticom, Inc.
Rainbow is a trademark of Digital Equipment Corporation.
1-2-3 and Lotus are trademarks of Lotus Development Corporation.
dBase II is a trademark of Ashton-Tate.
TK!Solver is a trademark of Software Arts, Inc.
Multiplan and MS-DOS are trademarks of Microsoft Corporation.
CP/M is a registered trademark of Digital Research, Inc.

© Digital Equipment Corporation 1983.

digital™



Reliable.

You can count on 3M diskettes. Day after day.

Just like the sun, you can rely on 3M diskettes every day. At 3M, reliability is built into every diskette. We've been in the computer media business for over 30 years. And we've never settled in. We're constantly improving and perfecting our product line, from computer tape and data cartridges to floppy disks.

3M diskettes are made at 3M. That way, we have complete control over the entire manufacturing process. And you can have complete confidence in the reliability of every 3M diskette you buy.

Look in the Yellow Pages under Computer Supplies and Parts for the 3M distributor nearest you. In Canada, write 3M Canada, Inc., London, Ontario. If it's worth remembering, it's worth 3M diskettes.



3M hears you...

3M

Presentation and Form in User-Interface Architecture

Architectural form and the interrelationship of software functions suggest guidelines for developing user interfaces

by John M. Carroll

Among the many trends in end-user applications software, two seem to contradict one another. On one hand, software is getting more complex: word processors a few years ago were seen as a thrilling glimpse of the future. But now they're being superseded by office workstations with more powerful and diverse capabilities such as the availability of alternate fonts for text, voice annotation, and high-quality graphics.

On the other hand, momentum is gathering toward increased software usability. Emphasis on ease of learning and use is directed at that recently discovered software component, the user interface. Unfortunately, these two trends can often be at odds. If system capabilities were constant, the quality of user interfaces would certainly progress. For even without a deeply principled understanding of human-computer interaction, the problem of software complexity versus ease of use could be attacked on a case-by-case basis. But as functional complexity increases, this kind of approach is less feasible.

The upshot of the conflict is that people using end-user systems frequently lose track of where they are and what they are trying to do. They can produce tangles of errors and ad hoc recovery behaviors that no manual (on-line or off) can anticipate or analyze (see reference 5). This is not

As software becomes more complex, people frequently lose track of where they are and what they are trying to do.

just an issue for novices, as more experienced users, perhaps overwhelmed by available functions, often have trouble exceeding a mediocre performance level (see reference 10).

Presentation vs. Form

We will discuss here two directions we can pursue to achieve quality in

the user interface. At the level of architectural presentation we are concerned with the specific nature of interface elements—the objects and actions that make up the interface and its concepts—often called “metaphors,” which organize these primitive elements. The presentation of the function through interface elements (icons, menus) can be addressed, I believe, only on a case-by-case basis.

An example of a specific architectural-presentation case is the contrast between graphically conveyed interface metaphors, as in the use of display icons for actions and objects, and nongraphically conveyed interface metaphors, as in the use of metaphoric vocabulary for these actions and objects (e.g., mail, print, document, file). Other examples include the availability and nature of command-driven dialogue, of prompted specifications and/or selections via menus, and of status and error feedback.

A second direction we can pursue concerns architectural form. The focus here is on how system func-

tions are interrelated in typical user scenarios, but not specifically on how each is represented to the user in the interface. This formal organization in the interface (or architectural form, as we call it) can be addressed as a general-level issue, unlike presentation.

One general-level issue of architectural form, for example, is the contextual dependence of various functions. In an interface with high contextual dependence, the range of available functions is fixed strictly by the mode the user is in. The hierarchical access of functions, typical of menu interfaces, is a common example of contextual dependence (for example, property sheets in the Star-type interface; see reference 11). In an interface with low contextual dependence, any function can be accessed from any mode, in the same manner and with the same effects.

The distinction between architectural form and architectural presentation has important implications for the organization of research efforts on user-interface issues and in particular for the development of user-interface guidelines. For example, I have found that there are principles of architectural form that can be broken down into guidelines, but there are no such principles of architectural presentation. I recognize that this claim will be controversial and that my arguments for it will be incomplete. My purpose here, however, is to initiate and focus controversy, not to settle it.

Consider the examples mentioned earlier. It seems that the issue of contextual dependence can be simply and generally resolved by following this guideline: maximize contextual dependence in a user interface to facilitate interaction in typical user scenarios. As far as I know, this optimally eases system learning and use. The only trade-off is that atypical user scenarios would require circumventing contextual dependence. (The best we can ever do is the greatest good for the greatest number.)

But now consider the question of whether an interface metaphor should be couched as a display icon or as a labeled softkey. I don't think there is or will be a general principle to cover this case. In the balance of

this article, I will examine cases of architectural form and presentation.

Architectural Form

Our research examined techniques for "staging" the presentation of system functions to new users. A staged user-interface architecture makes it possible to turn off functional layers so that the basic applications software can be run by the user with no frills, but the advanced functions can easily be engaged when requested. A user interface designed this way, with staged access, i.e., accessible in layers of complexity, can always be conveniently made simpler or more complex by merely turning functional layers off or on.

There are two reasons why staging access to sophisticated functions might be a good idea: first, it deals

The Training System users were able to begin concrete work in less than half the time of the group using the Full System.

with the impact that increasing functional complexity can have on interface quality. The remedy is to block off enough of the function to make the system seem simple. Indeed, the pitfall of prematurely and inappropriately accessing advanced functions is a common new-user error and may lay the groundwork for timidity on the part of more experienced users when it comes to exploring advanced capabilities.

Second, by having the advanced functions available, this scheme provides a bridge for the user between understanding the basic functions and mastering the complete applications package.

To experiment with this idea, we designed a series of modifications in the user interface of a commercial word-processing system. David Boor and I managed to define a simpler level of functionality, which included only document creation, revision, and printing functions and which

specifically blocked the seven or eight most devastating new-user errors that we had observed in a study of people trying to learn the full system. Essentially, we imposed an alternate architectural form on the system by brute force. This is the basis of the Training System.

Physically, the Training System looked exactly like the Full System, the one with the advanced functions. All the menus and other displays were exactly the same. However, when a user selected one of the error-provocative choices, options, or functions we had isolated, the Training System displayed the message "X is not available on the Training System." (X was the name of the selection.) The error consequences had been blocked, and the user was immediately free to make another selection. The user could see the advanced function and even try it—only to be told it was not yet available, but the user would not suffer the penalty such self-initiative often carries. In the Full System in the same situation, the user's selection would have triggered an actual function and in most cases would have led to trouble quickly.

Subsequently, I experimented with the Training System in collaboration with Caroline Carrithers, Jim Ford, Georgia Gibson, and Penny Smith-Kerker, in a series of studies reported and to-be-reported elsewhere (see reference 3). Part of what we found is good but not altogether surprising news: novices can learn basic word-processing skills several times faster if they don't have to spend time recovering from the errors of prematurely and inappropriately accessing advanced system functions. In particular, the Training System users were able to reliably get to the typing display and begin concrete work in less than half the time of the best-performing group of learners using the Full System.

There was evidence that this advantage is more than merely a matter of reducing error time. The Training System users, at the end of our experiment, could type and print out a simple letter more than twice as fast as the Full System users could. The



PANTHER



UNLEASH THE POWER

Having been in the microcomputing industry for 10 years, V R Data Corporation has earned its reputation for microcomputing excellence. For over a year we have been making solid deliveries of the PANTHER establishing ourselves as THE SOURCE for proven, premium quality Winchester Disk Subsystems. The PANTHER satisfies the most demanding mass storage needs with capacities of up to 30 megabytes or more.

Utilizing 5 1/4" Winchester disk drive technology, and microprocessor based error correcting controller boards, the PANTHER continues to be the #1 choice of discerning professionals. Available with one or two drives in one enclosure, the PANTHER can support many combinations of fixed and removable drives.

Now V R Data Corporation proudly introduces the newest member in the Panther family of Winchester Disk Drives, the "CUB". The CUB is a sub-mini Winchester Disk Subsystem, representing the latest in innovative technologies. With advances such as 100mm thin film plated media with embedded digital servo, and switch mode power, the CUB placed V R Data well out ahead of the pack. Available in single (master) and dual (master/slave) drive configurations, the CUB provides the user with capacities up to 10 megabytes of fixed or removable storage media.

The CUB's sleek low profile design totally eliminates that overcrowded work area problem and adds a professional appearance to your system. The CUB removable media drives are ideal for 5 megabyte on-line storage as well as 5 megabyte backup for your fixed media drives. Adapter modules are available for the most popular microcomputers. The PANTHER family of drives are available at quality Computer Stores everywhere. If your dealer does not yet carry PANTHER Drives from V R Data, tell them the future has arrived.

VRdata

777 Henderson Blvd. • Folcroft, PA 19032 • (215) 461-5300

Circle 450 on inquiry card.

www.americanradiohistory.com

THE PRINTER STORE

SERVICE, COMPUTER AND SOFTWARE COMPATIBILITY, and LOW PRICE,

are among the many factors to consider when purchasing a printer. At the **PRINTER STORE** we specialize in printers, so our professional staff can help you choose the right printer for your personal and business needs. Every **Printer Purchase** includes:

- 1) **Low Prices**
- 2) **Same Day Shipping**
- 3) **Free Technical Support**
- 4) **Full Service Option**



C. ITOH 8510 Prowriter

120 CPS - 1.3K Buffer - 8 Character sizes - 5 unique alphabets - Greek character set - Graphic symbols - bi-directional, logic-seeking - Adjustable tractors - Single-sheet friction feed.

C.ITOH 8510 Prowriter
List.....\$795 **\$CALL**



BROTHER HR-15

- 13 CPS - Bi-directional - Super & Subscript
- 10, 12, 15 and Proportional Spacing Pitch
- Optional Tractor, Sheetfeed and Keyboard

Parallel **\$CALL**
Serial **\$CALL**

DOT MATRIX PRINTERS

EPSON SERIES

FX 80 **\$ CALL**
FX 100 **\$ CALL**

OKIDATA SERIES

82A **\$ CALL**
83A **\$ CALL**
92A **\$ CALL**
93A **\$ CALL**
84 (parallel) **\$ CALL**

C. ITOH SERIES

8510 Prowriter **\$ CALL**
Prowriter II **\$ CALL**

IDS SERIES

Microprism 480 **\$ CALL**
Prism 80 **\$ CALL**
Prism 132 **\$ CALL**

GEMINI SERIES

Gemini 10X **\$ CALL**
Gemini 15X **\$ CALL**
Delta 10 **\$ CALL**

Toshiba P 1350 **\$ 1750**

LETTER QUALITY PRINTERS

BROTHER SERIES

HR-1 (parallel) **\$ CALL**
HR-1 (serial) **\$ CALL**
HR-15 **\$ CALL**

COMREX SERIES

CR-1 (parallel) **\$ 795**
CR-1 (Serial) **\$ 865**
CR-2 **\$ CALL**

C. ITOH SERIES

F-10 40 CPS **\$ CALL**
F-10 55 CPS **\$ CALL**
Juki 6100 **\$ CALL**

Daisywriter 48K

..... **\$ CALL**

NEC SERIES

3510 **\$ CALL**
3530 **\$ CALL**
3550 **\$ CALL**
7710 **\$ CALL**
7730 **\$ CALL**

NEC Accessories **\$ CALL**

We carry a full line of Cables and Accessories
Call (714) 241-0701 and ask us about...

PHONE REBATE:

We are so confident of our **LOW PRICES** and **SUPPORT** that we are going to ask you to make the initial investment by calling us. In return, when you buy your printer from us, we will rebate the cost of your call and deduct it from your invoice.

HOW TO ORDER: Our phone lines are open from 8 a.m. to 6 p.m. PST, Monday - Friday. We accept VISA, MASTERCHARGE (at no extra charge), personal checks take two weeks to clear. COD's accepted. Same-day shipment on orders placed before 1 p.m. Manufacturer's warranty applicable on all equipment. Prices subject to change.

Training System users reduced the proportion of their time spent on errors almost 50 percent compared to the Full System users over the course of the experiment. And more than 90 percent of this improvement resulted from their spending less time on the errors that were not blocked in the Training System itself. Hence, the advantage of the Training System is not merely a matter of blocking errors, then observing that people spend less time on them.

At the end of the experiment, we administered a system-concepts test and a work-attitude test to our experimental subjects. The Training System people did better on both tests, indicating that they had learned more about the system and that they felt better about work in general after the experience.

We have learned some fairly specific lessons with regard to the design of training systems, in general, for computer users. The novices using our Training System were given opportunities to see where the advanced functions were and to make errors, but they were protected from the direct consequences and side effects of making the errors. Nevertheless, they learned to discern errors more successfully than their Full System counterparts. The Full System learners were punished more for making errors, but their learning was impaired rather than facilitated relative to the Training System group. The simple implication is that negative reinforcement has no useful role in the user interface.

The second lesson we learned from this work pertains more to the issue of architectural form. The system we studied was derived from a commercial system by ad hoc surgery—long after the original design had been set in silicon. We can imagine, however, that when the original architecture of a machine is developed, provisions can be made for the sort of function subsetting we had to graft on by brute force. This amounts to a user-interface guideline that dictates that the core of an applications package be a coherent package—and, in turn, perhaps that the secondary function, along with the core, constitute a

SORRY CHARLIE!

If you just bought a 16-bit, 8088 computer with a 160K drive, 128K RAM, MS-DOS, Wordstar, Calcstar, EZ Writer, Color graphics BASIC, a 12" Monitor and a printer part, you're going to be sorry when you read this ad. Why? Because Scottsdale Systems will give you all this for \$995.

The color graphics board built-in to the PC-Plus™ generates a resolution of 640x400 dots in monochrome, and generates 8 colors. The circuit board is presocketed for 256K, and on 8087 chip, and is warranted for a full year by 50 Sanyo Service Centers.

The PC-Plus will run many programs written for the IBM-PC®, yet costs less than one-third as much. Due to the huge demand for the PC-Plus you may have to wait, but give us a call for more information. Better safe than sorry!

PC PLUS™ \$995
 PC DELUXE™ Call

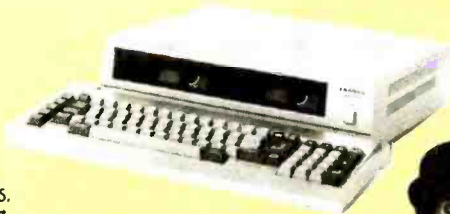

P.C. PLUS

TELEVIDEO



Single user systems now backed nationwide by Xerox. Single user systems now include Word processing, spreadsheet and graphics software (along with CP/M or CP/M-86). Local installation of multi-user systems available via TRW.

TPC	Call
803	\$1849
1603	\$2289
802H	\$4319
806/20 mb.	\$4859
816/40 mb.	\$9275

ALTOS

8000's ... 37.5% Off



From the lowest-priced dual-floppy multi-user systems to true 16-bit 10 Mhz. multi user systems. Local service available via TRW. We will configure, test and install your systems for an additional charge (call for prices).

5-80-2	\$1998
5-80-10	\$3629
5-86-10	\$5795
5-86-40	\$7995

SANYO



Our best-selling Z80 systems. With each system you get CP/M®, Sanyo Basic, Wordstar™, MailMerge, Spellstar, Calcstar, InfoStar, a games disk, modem software, user copies, a free test, and 2 boxes of disks. Nationwide service.

Sanyo Plus	\$1995
Sanyo Plus w/graphics (1.2mb)	\$2395

COLUMBIA



Each Columbia now comes with MS-DOS, CP/M-86, Basic (with IBM-PC® compatible color graphics), Perfect Writer™, Perfect Speller™, Perfect Calc™, Perfect Filer™, Fast Graphs, Home Acc't Plus, Space Commanders, Diagnostics, and The Columbia Tutor. The VP is 38 lbs. portable with a built-in 9" monitor. The 1601 is the desktop unit. Both computers come with dual 320K drives, and are backed by Bell and Howell.

VP	\$2349
1601	\$2479

TERMINALS



Adds Viewpoint 3A+-Emulates the ADM-3A, detached keyboard, keypad, 12" green display, nationwide Adds service.

	\$457
Viewpoint 60	\$589
Wyse 50	\$508
Wyse 100	\$694
Televideo 914	Call
Televideo 924	\$689
Televideo 970	\$1044
Altos II	\$724
Zenith Z-29	\$656
Zenith ZT-1	\$469
Qume 102	\$544

HOUSTON INSTRUMENTS

DMP-29	\$1795
DMP-40	\$745
DMP-41	\$2340

ZENITH Z110

\$2699



Closed Dec. 26 - Jan. 8
 HAPPY HOLIDAYS!

Scottsdale Systems Ltd.

617 N. Scottsdale Road, Suite B, Scottsdale, Arizona 85257

VISA (602) 941-5856 MasterCard

Call 8-5 Mon.-Fri.



We participate in arbitration for business and customers through the Better Business Bureau of Maricopa County.

SERVICE/ORDERING

INTEGRATION: Prices listed are for new equipment in factory sealed boxes with manufacturer's warranty. We will pretest your equipment, integrate your system, configure your software, provide special cables, etc., for an additional charge. Call for prices.

ORDERING: MAIL ORDER ONLY. Prices listed are for cash. No C.O.D.'s. We sell on a Net 30 basis to Fortune 1000 companies and Universities with good credit. P.O.'s, charge cards add 2%. Az. residents add 6%. Prices subject to change, product subject to availability. Personal checks take 3 weeks to clear. 0-20% restocking fee for returned merchandise. Shipping extra - products are F.O.B. point of shipment. CP/M and MP/M are registered trademarks of Digital Research. Wordstar is a registered trademark of MicroPro International. IBM and IBM PC are registered trademarks of International Business Machines Corporation.

SOFTWARE: Sold only w/systems, not warranted for suitability.

PRINTERS



Gemini 10X	\$284
Gemini 15, 15X	Call
Delta 10's, 15's	Call
Epson	Call
Tally 160L/trac	\$584
Tally 180L/trac	\$799
Tally Spirit	\$298
Anodex	Call
IDS-102 "Loaded"	\$1469



LETTER QUALITY

Silver Reed 500	\$409
Silver Reed 550	\$654
Sonyo PR5500	Less
Silver Reed 770	Call
NEC 7710	\$1965
NEC 2000's	Call

OKIDATA



The new Microline 92's and 93's feature 160 C.P.S. draft mode, 40 C.P.S. correspondence mode. Standard parallel, serial card add \$91.

Microline 92	NEW
Microline 93	LOWER
Microline 82	PRICES!
Pacemark 2050	

DTC-380Z

Replaces the Dalsywriter 2000. Uses the same printwheel, ribbons, and tractor feed. Will run serial, parallel, or IEEE 488. 48K buffer standard, uses Diablo codes.

\$1044



coherent application, and so on. This conclusion has two properties: first, empirical evidence supports it; second, the recommendation it makes is simple and general.

A question that remains is how users will progress from the core functions all the way to the full-function system. In the real world, experienced users sometimes limit themselves to subsets and never become experts on systems they use routinely (see reference 10). Our simple case study had only two levels of system complexity, and in the case in which we examined users switching from one level to the next, they were told explicitly to switch. However, the intent in the Training System is to motivate the user to see increasing but manageable functional complexity as a challenge.

Architectural Presentation

Architectural presentation is a design domain par excellence; as such, it is not amenable to deductive analysis (see reference 6). Rather, it is fundamentally a matter of iteratively re-

fining and developing a set of idiosyncracies.

Unfortunately, there can be no demonstrable arguments either way for such a claim. But that does not diminish the importance of the question, because even a tentative determination could help organize and allocate effort in user-interface development. I will illustrate the argument by

User-interface metaphors build upon what a user already knows.

discussing some recent interface metaphors for office systems.

Most simply, the motivation for developing user-interface metaphors is to build on what the user already knows and reducing what would be hard to understand. For example, a large proportion of intended users are professional typists, who know a lot about typewriting but not necessarily about computers. Analogous

points can be made for potential users of electronic spreadsheets and various other applications. Such observations suggest a simple design idea that has been very successfully exploited: help people learn and use unique systems by inviting them—via the interface—to engage their prior noncomputer knowledge (see reference 7). The current popularity of interfaces that are deliberate metaphors of typewriters, spreadsheets, and desktops is good evidence that this approach is on the right track.

However, I question whether the issue of metaphors is a simple one. There are two reasons for my concern. First, metaphors are inevitable in human thought, and, while they can be a source of insight and savings, they can as often be a source of interference and confusion. When we focus on success stories that contend, for example, that a word processor is a typewriter, we overlook the many classic examples of metaphor-induced troubles. Psychologists even have a special term to refer to the interference of prior knowledge

Making money is one thing. Managing it is something else.



Trademarks:

The Smart Checkbook—Softquest Inc. CP/M and CP/M-86—Digital Research, Inc. PC-DOS—IBM MS-DOS—Microsoft Corp.

The Smart Checkbook does the job. Manages your money the way you want it managed—easily.

Imagine: push a button and get family budget reports, net worth statements, tax records. Custom reports, too. Know where your monies go, accurate to the penny and well organized.

"Instant Reconciliation!" The Smart Checkbook doesn't just tell you if you're out of balance—it finds mistakes and corrects them on the spot. It even catches bank errors!

AND print checks, of course! With payee's name and address!

Advanced features? Split transactions and assign the amounts to the categories you choose. Track sales taxes and much more. And there's a practice account to get you started.

Yes: unlimited accounts, combined accounts, organized accounts. A 160k disk, holds up to 2,000 transactions. Bigger disks—even more.

The Smart Checkbook is available for the IBM-PC, PC-compatibles and most CP/M, CP/M-86 and MS-DOS computers.

Order today. \$149 complete. VISA and MasterCard accepted. Call 703-281-1621

Softquest Inc.
P.O. Box 3456
McLean, VA 22103



FREE dBASE II™ SALESMAN

At **SoftwareBanc Dealer Services**, we'll do anything to help you sell dBASE II™. We even tried sending the country's leading dBASE II™ authority, **Adam B. Green**, to all of our dealers. After the first time, Adam wouldn't agree to being shipped UPS again, even after we offered to punch holes in the carton.

Instead, we videotaped him explaining dBASE II™, and interviewing George Tate, Wayne Ratliff, and Fox & Geller.

Make us your dBASE II™ distributor and we'll send you a free copy of this innovative videotape, as well as the bestselling *dBASE II™ User's Guide*. We can also help increase your dBASE II™ profits with our full line of add-on products and **"Mix & Match" pricing**.

Meanwhile, we'll work on sending you the real thing. Do you think putting lettuce on the bottom of the carton would help?

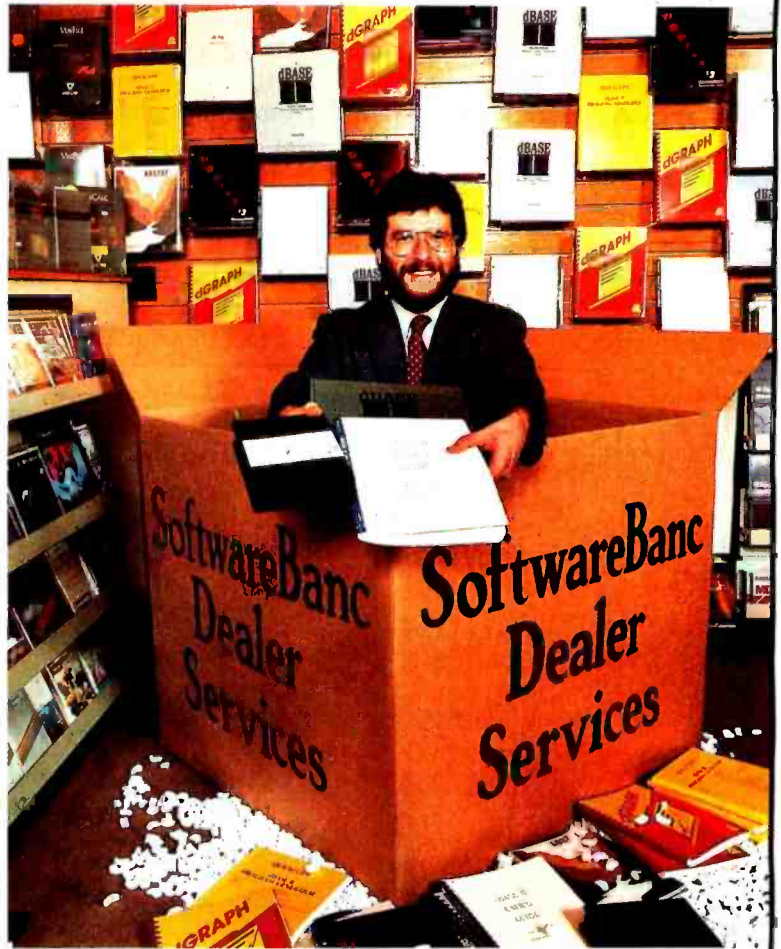

Location courtesy of Tech Computer Store, Cambridge, Massachusetts

SoftwareBanc Dealer Services

661 Massachusetts Avenue, Arlington, Massachusetts 02174



Hours: Mon-Fri, 9AM-8PM EST; Sat, 9AM-5PM EST

To order call: **(800) 451-2502** or **(617) 641-1241** in Massachusetts.

For technical support call: **(617) 641-1235**.

Call us today and join the thousands of smart dealers who enjoy great prices, unbeatable technical support, and fast deliveries.

on problem-solving activity: functional fixedness.

An experiment in which people were asked to mount candles on a vertical screen provides an example (see reference 1). The subjects were each given a small cardboard box containing candles, thumbtacks, and matches. A correct solution is to mount the candles on the boxes (by melting a little wax) and then to mount the boxes on the screen (with the thumbtacks). Because boxes are typically containers, not platforms, most of the participants did not use

them to support the candles. Their preconceived notions interfered with the required insight. When the materials for the problem were presented to the subjects in the boxes (reinforcing the container interpretation), only 10 percent of the participants could solve the problem. When the materials were provided with empty boxes, however, almost 90 percent solved the problem.

Even the typewriter metaphor has its problematic side. Users we have studied were often quite confused by the fact that such keys as the Space-

bar, Backspace, and Carriage Return insert blank spaces and line breaks instead of merely moving the typing point (as on a real typewriter). People often balk at instructions such as "backspace to erase" or "type to insert." And this can cost them failure and frustration. Users often try to change margins and tabs when doing so is needless because of system defaults and dangerous because of the risk of getting tangled in advanced functions (see reference 8). But the point is not to avoid metaphors, for this is not possible. Engaging prior knowledge in the service of present behavior and thought is a fundamental cognitive process.

The second reason interface metaphors may never become a matter of simple and general principles is that they often act as conceptual aids, both mismatching as well as matching their targets. A computer, for instance, is not literally a typewriter. Pressing a computer's keys elicits glowing dots on a TV screen rather than lines of ink on a paper—really very different effects. And typing over characters on a computer screen replaces those characters or inserts new ones, although both outcomes are unpredictable on the basis of literal metaphor projection. Indeed, given a simple view of the use of metaphors, it is remarkable that neither of these metaphor mismatches has a very troubling consequence for learners. Encountering these inequalities can, in fact, be an opportunity for developing an enhanced understanding of the electronic medium, e.g., the concept of dynamic storage (see reference 4).

These two properties of metaphors raise a host of questions. When is the metaphor trade-off favorable? When will metaphor mismatches be cognitively stimulating? We cannot resolve these questions in a general way, nor can we dismiss them, for aspects of metaphors pervade virtually all thought and certainly any user interface. The very notion of a user interface implies that what the user is seeing and conceptualizing is something at least one step removed from what the system is really doing. Adding iconic objects and actions may make

beautifully NEW...incredibly effective



Optech™
CRT FILTERS

for less than \$40.00* stop your CRT from being an eyesore

Any computer terminal operator will verify how tiring, frustrating, and downright inefficient CRT glare can be. Now, thanks to Optech CRT filters, this hassle can be eliminated.



Attached in minutes without any tools, Optech diffuses ambient light (external light) while dramatically improving contrast. The result? Data displayed as never before—clear, bright, and without interference. And since Optech CRT filters come in a variety of sizes to custom fit the most popular computer terminals on the market today, they actually appear to be built into the terminal when attached. Beautiful? Of course. Both in its effectiveness and appearance. And its price tag is less than an inexpensive program.

But you be the judge. Call toll free for your nearest Optech dealer. You'll see how to quickly, economically, and efficiently say good-bye to the CRT eyesore forever.

CALL TOLL FREE AT 800-346-7802

SGL HOMALITE CORPORATION 11 Brookside Drive • Wilmington, Delaware 19804 • Telephone 302-652-3686
A subsidiary of SGL Industries, Inc.

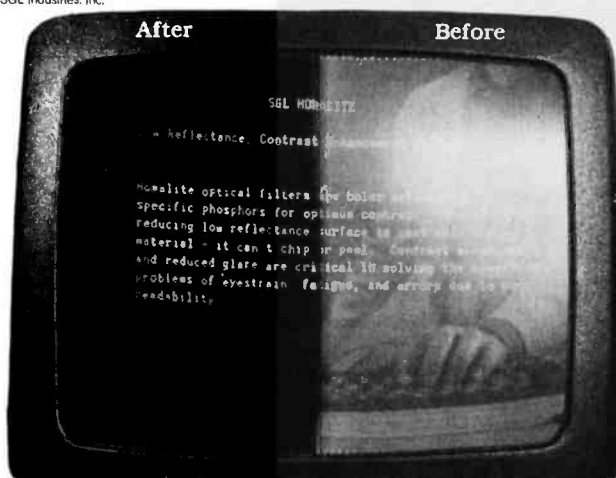

After Before

*suggested retail price

Start ahead. Stay ahead.

The Columbia Family:
IBM-PC compatibility
plus outstanding value
and performance.



Today, Columbia offers you the highest level of IBM-PC hardware and software compatibility.

Each Columbia microcomputer is delivered with software worth thousands of dollars for word processing, financial planning, communications, and more.

Stay ahead with Columbia's economic multi-user capabilities and quality expansion products.

Choose the very practical Columbia VP Portable, \$2,995. Or, the flexible Columbia MPC, \$3,395. The Columbia MPC with hard disk is

\$4,995. All prices include CRT controller with graphics and keyboard.

Call (301) 992-3400 for the name of the dealer or distributor nearest you. Serviced and supported worldwide. National service by Bell & Howell Service Company.

World Headquarters:
9150 Rumsey Road
Columbia, MD 21045
(301) 992-3400
TWX 710-862-1891

West Coast:
3901 MacArthur Blvd.
Suite 211
Newport Beach, CA 92660
(714) 752-5245
Telex 277778

Europe:
Limitenstr. 94
4050 Moenchengladbach 2
West Germany
02166-47097
Telex 852452

COLUMBIA
DATA PRODUCTS, INC.

Distributors in Australia, Belgium, Colombia, Denmark, Hong Kong, Israel, Italy, Malaysia, Netherlands-Antilles, Norway, Portugal, Spain, Sweden, Switzerland, United Kingdom, Venezuela.

IBM and IBM PC are registered trademarks of International Business Machines.

Circle 77 on inquiry card.

ERG/68000 MINI-SYSTEMS

- Full IEEE 696/S100 Compatibility

HARDWARE OPTIONS

- 8MHz, 10 MHz, or 12 MHz
68000/68010 CPU
- 68451 Memory Management
- Hardware Floating Point
- Multiple Port Intelligent I/O
- 64K/128K Static RAM (70 nsec)
- 256K/512K/1MB Dynamic RAM (150 nsec)
- Graphics-Digital Graphics
CAT-16000
- DMA Disk Interface
- SMD Disk Interface
- Tape Streamer Backup
- 5¼" or 8" Floppy Disk Drives
- 5MB-474MB Hard Disk Drives
- 7/10/20 Slot Back Plane
- 20 or 30A Power Supply
- Desk Top or Rack Mount Encl.

SOFTWARE OPTIONS

- 68KFORTH¹ Systems Language
- CP/M-68K²O/S with C, 68K-BASIC¹,
68KFORTH¹, FORTRAN 77, Z80
Emulator, Whitesmiths' C
- IDRIS³ O/S with C, PASCAL,
FORTRAN 77, 68K-BASIC¹, CIS
COBOL⁴, INFORMIX⁵ Relational
DBMS
- UNIX⁶ SYS III O/S with C, PASCAL,
FORTRAN 77, BASIC, RM COBOL⁷,
ADA⁸, INFORMIX⁵, Relational DBMS
- VED 68K Screen Editor
- Motorola's MACSBUG and FFP
Package

Trademark ¹ERG, ²Digital Research,
³Whitesmiths, ⁴Micro Focus, ⁵RDS,
Inc., ⁶Bell Labs, ⁷Ryan McFarland,
⁸U.S. DoD

30 Day Delivery - OEM Discounts



since 1974

Empirical Research Group, Inc.
P.O. Box 1176
Milton, WA 98354
206-631-1855

the desktop metaphor more explicit, but interface icons are not necessary to suggest the metaphor in the first place. Merely describing a system as an "office-application system" brings to mind rich and diverse physical office metaphors.

Having recognized that user-interface metaphors are complex and unavoidable design trade-offs, we cannot say much more than "try some out, test them, and try some more." For example, suppose that a document removed from a folder (directory) to be edited is not returned to the folder after editing. The office metaphor suggests that the document should then be "left out" (e.g., on a metaphorical desktop), to be returned to the folder only when the user explicitly moves it there. But what about printing the document? Suppose that a document removed from a folder for printing is not returned to the folder afterwards. Should it remain on the metaphorical printer's metaphorical paper table? Or should the printed document be automatically refiled?

I think both choices are unacceptable. If the document is automatically refiled, the consistency between editing and printing is compromised. If it is not automatically refiled, however, it will likely be forgotten and left in the printer. After all, when a document is sent to be printed, the user's attention ultimately shifts to the printer (not an icon or object label, but the actual equipment). What happens when the next document is left in the printer? We can find solutions to such architectural-presentation issues if we wish; however, these well-reasoned solutions will not always be appropriate. The trade-offs and interrelations are too rich and subtle; too often the key factors are completely idiosyncratic to a particular system or application. When one problem is solved, another, whose very existence depends on the prior solution, appears.

Architectural form, it seems to me, is very much a matter of general principles and could provide the user-interface guidelines for which every designer longs. For this reason, it may make sense to direct research on

matters of architectural form at general-level principles. Architectural presentation, however, seems less amenable to such a treatment. Presentation issues, I think, will remain case-by-case problems to be resolved by prototyping and user testing. If this world view is correct, then the distinction between architectural form and presentation could be an important guide in planning research on the quality of user interfaces. ■

References

1. Adamson, R. E. "Functional Fixedness as Related to Problem Solving." *Journal of Experimental Psychology*, 44, 1952, pages 288-291.
2. Carroll, J. M. "The Adventure of Getting to Know a Computer." *Computer*, pages 49-58, November 1982.
3. Carroll, J. M. and C. Carrithers. "Blocking User Error States in a Training System." Submitted to *ACM Communications*.
4. Carroll, J. M. and R. L. Mack. "Metaphor, Computing Systems, and Active Learning." IBM Research Report, RC 9636, 1982.
5. Carroll, J. M. and R. L. Mack. "Learning to Use a Word Processor: By Doing, by Thinking, and by Knowing." In J. Thomas and M. Schneider (Eds.) *Human Factors in Computer Systems*. Norwood, NJ: Ablex, 1983.
6. Carroll, J. M. and M. B. Rosson. "Usability Specifications as a Tool in Iterative Development." In H. R. Hartson (Ed.) *Advances in Human-Computer Interaction*. Norwood, NJ: Ablex, forthcoming.
7. Carroll, J. M. and J. C. Thomas. "Metaphor and the Cognitive Representation of Computing Systems." *IEEE Transactions on Systems, Man, and Cybernetics*, SMC-12, pages 107-116, 1982.
8. Mack, R. L., C. H. Lewis, and J. M. Carroll. "Learning to Use Word Processors: Problems and Prospects." *ACM Transactions on Office Information Systems*, 1, pages 254-271, 1983.
9. Malone, T. W. "Toward a Theory of Intrinsically Motivating Instruction." *Cognitive Science*, 4, pages 333-369, 1981.
10. Rosson, M. B. "Patterns of Experience in Text Editing." *Proceedings of CHI '83 Conference on Human Factors in Computer Systems*. Boston, MA: December 12-15, 1983.
11. Smith, D., C. Irby, R. Kimball, B. Verplank, and E. Harslem. "Designing the Star Interface." April 1982 *BYTE*, pages 242-282.

John Carroll is a research staff member at IBM's Thomas J. Watson Research Center (POB 218, Yorktown Heights, NY 10598).

WAIT REDUCTION™ MADE EASY.

You know how hard it is to wait for the printer to finish before using the computer again. It's wasteful! Counter-productive!

The solution: simply install Microbuffer printer buffer into the system, in seconds. And you can print and process simultaneously.

With one swift command, all printing data is dumped to Microbuffer—it handles the printer and frees the computer for other functions.

Presto! Instant wait reduction.

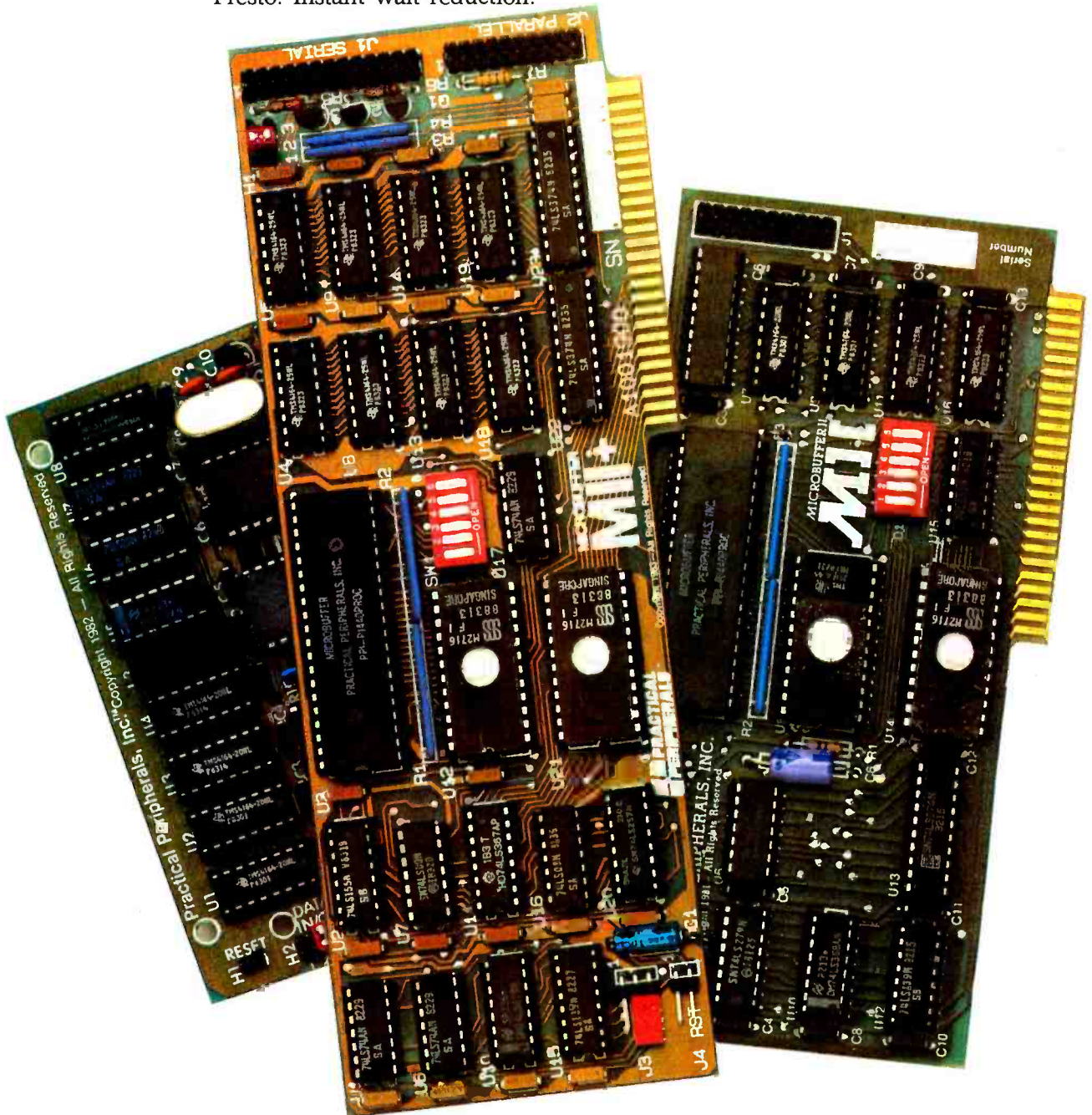

THERE'S A MICROBUFFER™

Because Microbuffer is so practical, it's a natural to complete almost every computer/printer combination.

Depending on the model, buffering capabilities vary from 8K to 256K of RAM.

Microbuffer II and II+ for the Apple II, II+, and IIE computers.

Microbuffer II comes in either a serial or a parallel version with 16K or 32K of RAM. Microbuffer II+, available with 16K, 32K or 64K, has both serial and parallel capabilities, so you can control two different printers at once. And all include expanded graphics capabilities and text formatting in addition to the inherent benefit of letting you use your computer while your printer is working.

Graphics routines include rotating the image 90 degrees, doubling the image size, mixed text and graphics dumping, reverse image dumping, dumping HI-RES page 1 or 2, and emphasized graphics.

Text formatting commands include setting line length, left and right margin control, text screen dumping, auto skip-over performance, linefeed control, video echo and more.

Microbuffer II and II+ easily install in auxiliary slots inside the Apple computer in seconds.

Microbuffer/E for Epson printers.

Fully compatible with Epson MX-80, MX-100, FX, RX and IBM-PC series printers, these easy-to-install boards simply plug inside the printer without modification. They require no changes in user software for control.

For parallel interfaces, the Microbuffer models MBP-16K AND MBP-64K are available. The MBP-16K has 16K of buffer memory. The MBP-64K can be purchased with either 32K or 64K of memory (the 32K version is easily upgraded by adding four 64K DRAM Chips).

For serial interfacing, Microbuffer models MBS-8K and MBS-32/64K are available. The MBS-8K has 8K of buffer memory and supports both hardware and software (X-ON/X-OFF) handshaking; the MBS-32/64K is available in 16K to 64K memory sizes and supports three handshaking configurations (hardware, software X-ON/X-OFF and ETX/ACK).

Both serial and parallel Microbuffers are compatible with all standard Epson commands, including GRAFTRAX-80, and 80+.

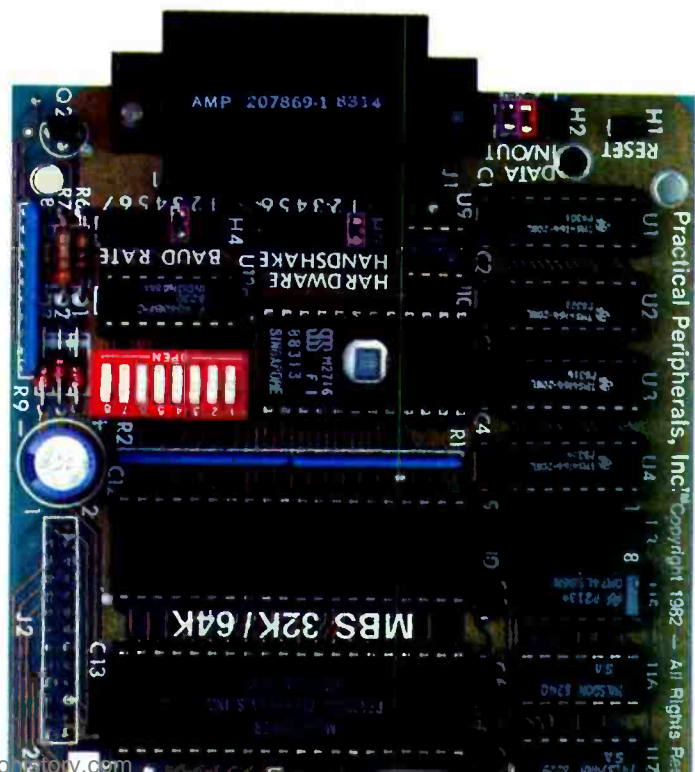
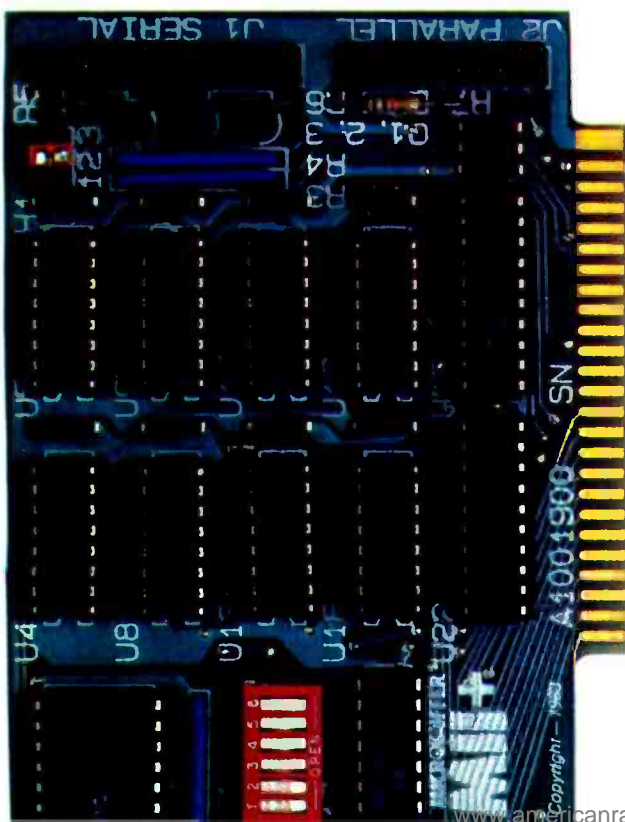

FOR EVERY SYSTEM:

Microbuffer In-line for virtually any computer/printer combination.

These are stand-alone units that install In-line between virtually any computer and printer.

Besides printer buffering, the In-line serial interface (MBIS) can be used to efficiently transmit data from the computer to almost any device using a serial RS-232C interface—like modems, typesetting equipment, word processors, plotters or even remote job entry stations. The MBIS can also buffer data coming into the computer, reducing expensive modem transmission time.

The parallel Microbuffer In-line (MBIP) is built exclusively for parallel interfacing, and works exceptionally well in virtually any parallel computer and any parallel printer.

Each of the stand-alone models has controls for making multiple copies (up to 255). With the pause control, printing may be halted at any point and continued later—it will pick up right where it left off. Additional files can be sent to the buffer and they will be processed in turn. Both come with either 32K or 64K of RAM, and are easily upgradable up to 256K for processing greater amounts of data.

See us at Comdex, Corner of 156 and 257

Microbuffer's quality and the warranty that guarantees it.

Each Microbuffer is constructed from the finest materials available. Every one must undergo countless tests to insure that it performs exactly like it's supposed to.

Microbuffer comes with a 5-year warranty that covers everything. If, for any reason, any Microbuffer doesn't work perfectly, we'll fix it or replace it quickly, without hassle.

And if you have any questions about using Microbuffer, answers from our technical personnel are only a phone call away.



31245 La Baya Drive, Westlake Village, California 91362
(213) 991-8200 • TWX 910-336-5431

Circle 346 on inquiry card.

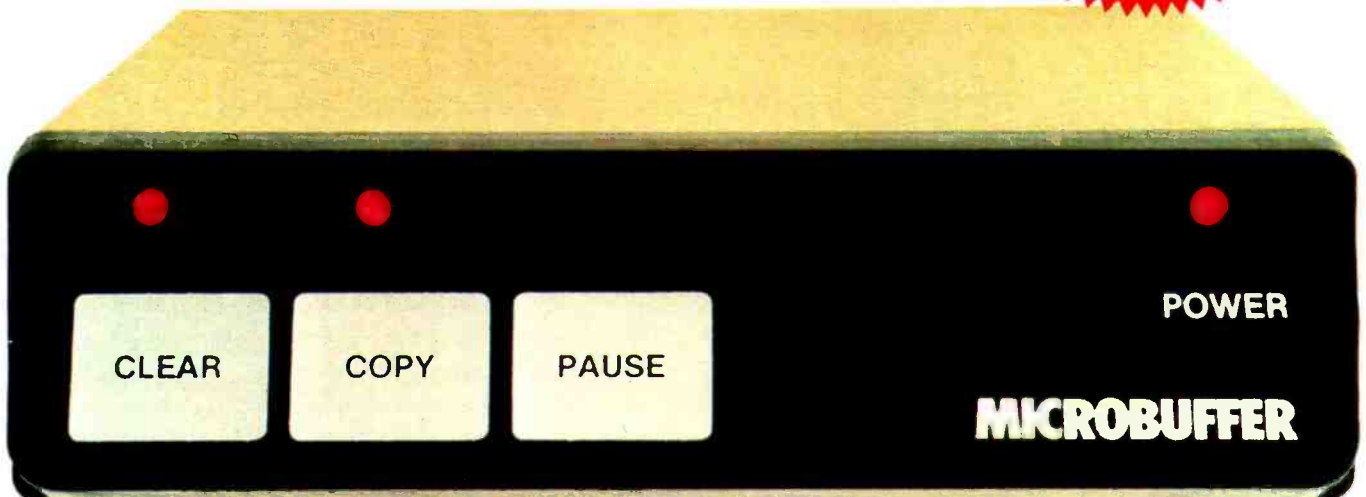

© 1983 PRACTICAL PERIPHERALS

Fast and restless.

The new Delta-15 printer kicks out AnyCalc, easy as 1,2,3!

In a 9 to 5 world full of changing spreadsheet data, you need a business printer that moves fast. A printer that constantly fires out printed information. A printer called Delta-15.

Delta has the ability to print multi-copy spreadsheets at an intense 160 cps. Its throughput never rests. In fact, it never even wavers in speed. That means that Delta constantly fits the most work into every single second.

Delta comes in a 10" or 15½" carriage size. It offers you the flexibility of standard 8K parallel and serial interface. And has the ability to underline, accept macro instruction, and print characters that range from full graphics to everyday printing to scientific notations.

Plus, as always, you get our unique 180 day warranty (90 days on print head).

So for everyone who needs their spreadsheet data "yesterday," this is as close as you can come! The new fast and restless Delta-15 business printer from Star.

starTM
MICRONICS • INC

THE POWER BEHIND THE PRINTED WORD.

Computer Peripherals Division

P.O. Box 612186, Dallas/Ft. Worth Airport, TX 75261 (214) 456-0052

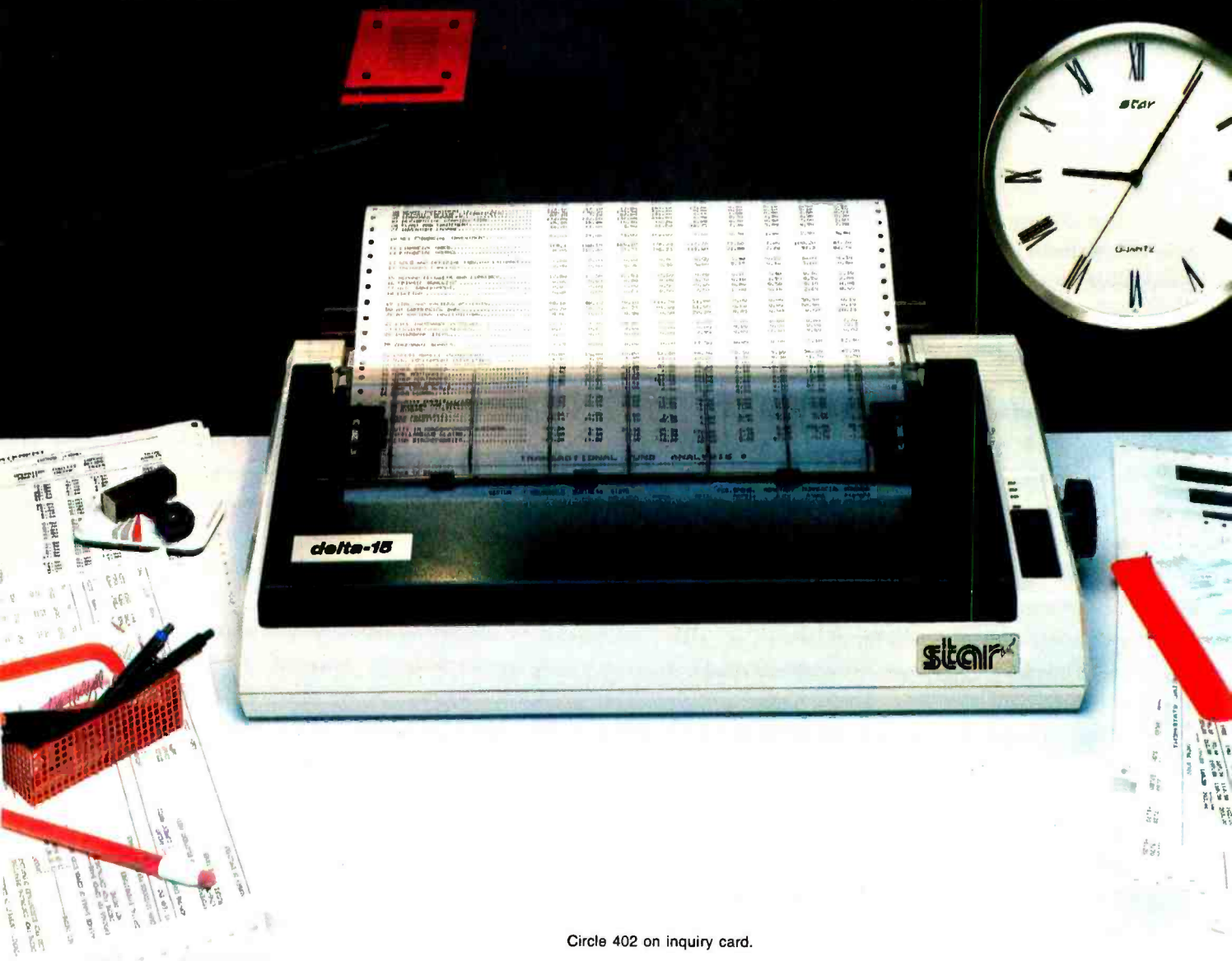

Circle 402 on inquiry card.

Why Is Software So Hard to Use?

So far, the "ease of use" idea has generated more advertising copy than easy-to-use software

by Sam Edwards

I divide microcomputer owners into two groups: those who use computers as tools to get a job done and those who see them as neat toys to be played with for their own sake. I call the first group users and the second hackers. I also have a confession to make: even though I am a computer programmer, both my feet are firmly planted in the users' camp. I don't enjoy complexity for its own sake. I dip into the innards of my personal computer by necessity, not curiosity. I use computers because they get my job done, but I don't really like them very much.

If you want to find out if you are a user or a hacker, compare figures 1a and 1b, screen displays you would see upon signing off from two imaginary computer systems. If you find yourself enchanted by the latter, read no further. You are a hacker, and this article is not written for you.

Software Is Not Easy to Use

Now that we've gotten rid of the

hackers, let's first agree, fellow users, that most software products are not easy to use. Even if you number yourself among the fortunate few who have experienced no problems installing, learning, and using your software, I am sure you know of friends with horror stories. They

(1a)

```
END OF SESSION
```

(1b)

```
END OF SESSION
```

```
CONNECT TIME: 00:12.34    # DISK ACCESSES   : 456
SESSION TIME: 00:11.27    # DISK UPDATES    : 98
CPU TIME      : 00:01.54    # DISK RETRIES    : 0
```

```
MAXIMUM PATH  : 4.7        # KEYSTROKES     : 315
MINIMUM PATH  : 1.1        # COMMANDS       : 14
AVERAGE PATH  : 2.6        # CHARS DISPLAYED: 847
STD. DEVIATION: 0.7        AVG. DISPLAY RATE: 43/SEC.
```

```
LOAD POINT    : 00CB      ACTIVE MEMORY     : 256K
ENTRY POINT   : 6A77      % UTILIZATION    : 14
```

```
VERSION A.09  REVISION 3  00083-57-0005###(XLA)22
```

Figure 1: If you prefer 1a to 1b, I'd call you a user. Read on. If you prefer 1b to 1a, you're probably a hacker.

WAREHOUSE SOFTWARE

TOLL FREE ORDER — 1-800-421-3135
TECHNICAL INFO — (602) 842-1133

Call for programs not listed. We will try to beat any legitimate price Software.

— MOST DISK FORMATS AVAILABLE —
CP/M Program names prefaced with # are also available for IBM PC.
DATA BASE MANAGEMENT SYSTEMS

BUY OF THE YEAR!

DBASEII+Everymans data base primer +Extra diskette with DBase Accounting, Mail List and Inventory Programs. IBM PC and CP/M — Call for our special price.
Fox and Geller Quickcode with DBase Package **\$175**

#DB+SORT **\$99**
#Condor III **\$445**
#NWA Statpack **\$349**
#TIMIII **\$285**
#Infostar Call

WORD-PROCESSING PACKAGES

#Wordstar, Mail Merge, Spellstar, Index **\$385**
#Wordstar **\$265**
#Mail Merge **\$135**
#Spell Star **\$135**
#Lexisoft Spellbinder **\$270**
#IBM PC Volkswriter **\$115**
#Aspen Spellchecker **\$36**
#Metasoft Benchmark **\$295**
#Multi-Mate **\$325**
Peachtext **\$265**

SPREADSHEETS

#Calcstar **\$95**
#Supercalc II **\$185**
#Microsoft Multiplan **\$185**

ACCOUNTING

#TCS*Equivalent of Peachtree* Specially Augmented By Warehouse Software Customized For Your IBM*Terminal and Printer-GL, AR, PA, AP for PC, XT, DOS 1.1, 2.0 Each Module **\$75** ... For All Four **\$275**

#CYMA Call
#Peachtree GL, AR, AP **\$265**
MBSI Accounting Call
Home Accountant Howardsoft **\$115**

TRANSFER PROGRAMS

Move-It for IBM PC **\$105**
Hayes Smartcom Program **\$80**
BMC RGB Monitor **\$425**
AMDEK 300 Monitor, Green **\$155**
AMDEK 300 Monitor, Amber **\$165**
Quadram Micro Fazer Print Buffer 64K **\$430**
Hayes 1200B Modem **\$400**
Hayes 1200 Modem **\$485**
Floppy Disk Controller **\$185**
S/S D/D Diskettes **\$20**
Plantronics Color + Board Call
MPI 320K D/S D/D Drives Call
Toshiba 1/2 height drives Call
64 K Ram Board Expandable to 256K **\$150**
AST Six Pack Board Call
Stediwatt Surge Protectors **\$65**
10 Meg Datamac Drives **\$1675**
Par Printer Cable **\$35**

Best Price in U.S. for IBM PC or Clones.

Seven Function Board—Includes Async Adapter, Parallel Adapter, Clock with Battery Back-Up and Software, Game Port, 64K Memory Expandable to 512K.
1 year warranty **\$277**

PCDOS

Versaform **\$275**
Lifeboat C Compiler **\$285**
Microsoft C Compiler **\$345**
Microsoft Pascal Compiler **\$245**
Prokey **\$55**
Norton Utilities **\$55**
PCII Copy Program **\$34**
Microsoft BASIC Compiler **\$285**
Howard Tax Preparer 83 **\$185**
Microsoft Flight Simulator **\$38**
Howard Real Estate Analyzer II **\$175**
CP/M 86 for IBM PC **\$49**
CBasic 86 **\$165**
CIS Cobol 86 **\$595**
Pascal MT+86 W/Spp **\$415**

TERMS: Prices include 3% cash discount. Add 3% for charge orders. Shipping on most items \$5.00.
AZ orders +6% sales tax. Prices subject to change.

TOLL FREE ORDER 1-800-421-3135

WAREHOUSE SOFTWARE

4935 West Glendale Ave., Suite 12
Glendale, AZ 85301

and the screen displayed INTERNAL ERROR 315, and my computer started to beep at me, and it just kept beeping and beeping..."); and applications that lead you down a decision tree into a cul-de-sac where your only exit is the power switch. The point is that not only is most software difficult to use, but it's the software's fault and not yours. Many users unfairly blame themselves for the deficiencies of their software. I want you to stand up now and say out loud, "My software is not easy to use, and I am not a dummy." There, I bet you feel a lot better.

Admittedly, the "ease of use" idea has caught the software industry's attention, but so far it has generated mainly advertising copy. Rare indeed is the advertisement that doesn't proclaim its program Easy to Use or User Friendly. Investigate these claims and

Creating easy-to-use software requires a good model, lots of attention to detail, and a constant effort to simplify.

you will usually discover just another hard-to-use product with a bunch of lessons and help screens tacked on. In fact, some popular software is so hard to use that an entire subindustry has sprung up to help the user figure out how to use it. A recent microcomputer magazine had 11 advertisements for seminars, keyboard templates, on-line tutorials, program interfaces, and so on, all designed to make money off of people who bought name-brand software and then found it too difficult to use.

Easy Is Difficult

One reason why so little easy-to-use software exists is that it is very difficult to create. Creating easy-to-use software requires a good model, lots of attention to detail, and a constant effort to simplify. (It also requires a lot of code. John Page, the creator of PFS:FILE, estimates that fully half of FILE's code is devoted to

the user interface.) It is easy to add "just one more" feature but difficult to integrate it smoothly with existing features. It is easy to provide an application with lots of options but difficult to avoid presenting those options to the user in formidable lists of menu choices, cursor-control keys, embedded printer commands, and so on. It is easy to expose the internal structure of a program as a model the user must understand but much more difficult to present a model with which the user is familiar.

Another reason software is not easy to use is that some potential customers won't buy it if it is. Some of these potential customers suffer from the Big System Syndrome, a carry-over from the days when computers were big and complicated and maintained by a priesthood of white-coated computer operators in special air-conditioned rooms. Today's Big System Syndrome sufferers derive pleasure in direct proportion to their software's complexity and obtuseness. There are others who feel somehow cheated if the programs they buy don't fill their screens, beep their speakers, and whir their disks to the maximum. They want their money's worth. Finally, some users equate difficulty with sophistication. These are the people who waited until IBM legitimized the microcomputer industry before they bought their personal computers; their image as professionals is at stake, and they can't risk "easy" software destroying that image.

The Feature Chase

Software is not easy to use mainly because the people who write it, market it, review it, and sell it aren't really interested in how easy it is to use. What programmers care about is how much it can do. In the inexorable drive toward more and more features, the players have lost sight of the software's only purpose: to get the job done with as little fuss as possible.

A programmer is a programmer because he is good at handling details and complexity. His world is made up of bits and bytes and hexadecimal numbers and balanced B-trees and

THE MOST OUTSTANDING MULTIPROCESSOR, MULTIUSER ORCHESTRA.

PERFORMING ARTS of COMPUTER SCIENCE

See us at
COMDEX/Fall '83

November 28-December 2, 1983
Las Vegas Convention Center

A314

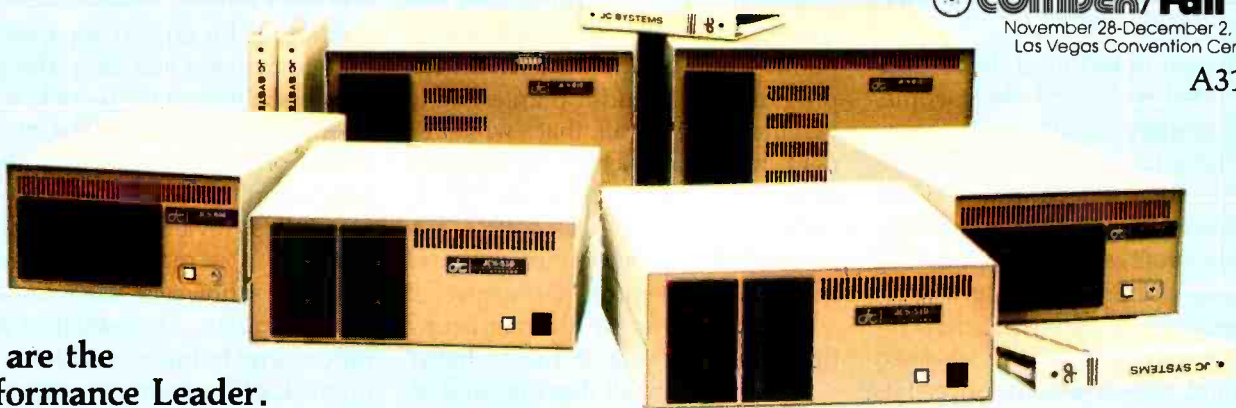

We are the Performance Leader.

Our Duet Product (MCM*80 and DCM*80), installed in thousands of multi-processor multi-user systems as well as in single user systems worldwide, certifies our field-proven performance. Our state-of-the-art products, first and best, have been soundly accepted by the various institutes, from the government to the universities, and utilized by the various applications, from office automation to control automation. Our product superiority is recognized for the following reasons.

Identical Master/Slave SBC (Single Board Computer) architecture results in a prime advantage, never letting the entire system down. Not only that, the master/slave status is programmable, so it is truly possible to build redundancy in a multiprocessor system.

Unlimited Expandability differentiates our products from other multiprocessor based systems which are bound to the networking limitation. Our TURBODOS implementation on multiple networks, which connect multiple multiprocessor systems, matches the capacity of a mainframe, thus surpassing the mini computers.

Low Cost Local Area Networking has always been a subject but never a solution. Our approach to the LAN of SBCs, with integrated LAN con-

CP/M is a trademark of Digital Research, Inc.
TURBODOS is a trademark of Software 2000, Inc.

trol thru the high speed and reliable IPC (Inter-Processor Channel), provides an ultimate low cost solution for each computing station in a network.

Superior S-100 board Products are the key to superior system products. We now provide two prominent single board computers: MCM*80, based on Z80 (4 MHz, 6 MHz, or 8 MHz) processor family, and MCM*186 based on 80186 (8 MHz) processor. There are two disk controller products, DCM*80 and DCM*80 II. DCM*80 is the first disk controller to integrate the floppy disk controller and the SASI (ANSI SCSI) hard disk host adapter in one board. DCM*80 II is DCM*80 plus 8K Track Buffer with on-board DMA for high performance.

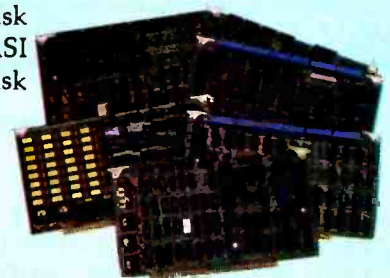

Our RAM*80 is the first memory board which has quad-mode capability. It works not only as an 8-bit and 16-bit memory board, but also as a memory disk board.

LINK*80 is an intelligent I/O board designed for high performance foreground processing capability with on board processor (Z80 A) and memory buffer.

JC SYSTEM
469 Valley Way
Milpitas, CA 95035
408/945-0318 TWX 910-381-7041

JC Systems products are available worldwide thru 60 dealer bases which are growing continually. All of our products are serviced factory-direct or by our dealers. We maintain highly confident technical support, both in the hardware and software products, CP/M and TURBODOS.

Circle 240 on inquiry card.

shell sorts, things he understands and loves. When fellow programmers ask him about his current project, he tells them about his neat data-compaction scheme and how he got it to fit in only 2K bytes. When they ask for a demo, he'll show them some exotic feature that no competitor's product offers ("Watch this: just press Control-V,X and the Escape key, and bingo! Your subscript is now underlined.")

Immersed in technical details and surrounded by like-minded people, the programmer quite naturally expects the end user to share his enthusiasm for the technical and the complicated. And so, little by little, technical details surface for the user's admiration. The programmer's spelling checker now tells what percentage of the words in the checked document appear exactly once. His database program now reports the average number of disk seeks per record accessed (it's the lowest average in the industry!). A chapter is added to his spreadsheet program's manual explaining in complete detail

the format for the storage of real numbers (an elegant scheme; it should be shared with all mankind).

But the programmer shouldn't bear all the blame for his program's creeping elegance. The marketing department of his company steadily feeds him advice during the product's development, and the advice is always More Features. Any feature the programmer hasn't included that the competitor's program includes is pointed out, and it is easier for the programmer to add it than argue to eliminate it. After all, that's what he's paid for, right? There is also the unstated challenge to his ego ("Well, if it's too difficult..."). Of course, any features the programmer includes that the competition has neglected are looked upon by the marketing department as just so much gravy.

After investing all that time and effort in adding features that the competition doesn't have, it would be silly not to point out their uniqueness in product advertisements. So a matrix is worked up with features along one axis and the product ver-

sus its competition along the other axis. (The features listed are mainly those that the competition lacks.) Unfortunately, the ad does not address the only question that really matters: will the product do the job for you without any fuss?

When the software reviewer enters the picture, his assignment often is to compare the programmer's creation with similar packages from competitors. If he doesn't have enough time to actually use all of the products he is reviewing (which is very often the case), he makes his own matrix of features versus programs, just like in the ads. I've got a whole file of these reviews. They are always entitled "<magazine name> Reviews <however many> of the Most Popular <spreadsheet/word-processing/ home-accounting> Programs for the <computer name>." Reviews like this are generally quite useless. After reading across the rows and down the columns, can you really say which product is best for you?

Finally, we have the dealer. He can carry only two or three programs in

JUST SAY THE PASSWORD™ TO GET 1200 BAUD, PROGRAMMABLE AUTO DIAL, FOR \$449*

- 300/1200 Baud
- Auto Dial, Telpac™ software available
- Full or Half Duplex
- Audio Phone Line Monitor
- Two-Year Limited Warranty

Password™ is the new USR™ friendly modem, designed for use with any small computer on the market today. We have compressed into its miniature (shown actual size) case every operating feature for unattended high speed telecomputing. With auto dial/answer and auto mode/speed select there is little to do but turn it on. So compact it mounts on the computer with Velcro®; when you carry your computer you can pocket your Password. So brilliantly conceived it achieves all this with just 12 tiny integrated circuits (a presage of long trouble-free service). If your dealer doesn't know the Password yet, write or call for complete specifications.

*Suggested list for Password complete with power, phone, RS232 interface cables. Telpac™ software optional extra, \$79.

Password, Telpac, USR logo and the U.S. Robotics corporate name are all trademarks of U.S. Robotics Inc.



U.S. ROBOTICS INC.™

1123 WEST WASHINGTON
CHICAGO, ILLINOIS 60607
(312) 733-0497

Circle 440 on inquiry card.



CAN YOU NAME THE WORLD'S THIRD LARGEST SUPPLIER OF PERSONAL COMPUTERS?



Naming the two largest suppliers of personal computers is easy.

The third one is a little harder. It's NEC.

That's right. NEC is the world's third largest PC supplier.*

We're not talking about video game players that double as computers.

We're talking about serious business computers that cost between \$1,000 and \$5,000. Like our APC Advanced Personal Computer.



THERE ARE HUNDREDS OF SOFTWARE PACKAGES THAT RUN ON NEC'S ADVANCED PERSONAL COMPUTER.

Our Advanced Personal Computer is graphically better.

The main reason we sell so many personal computers is that we offer so much.

Take, for example, our APC.

The APC is faster than both the IBM PC and Apple.

It has more storage capacity. And it offers the sharpest color graphics of any PC at any price.

The APC also has advanced communications capabilities that let it work with all major mainframes.

All in all, the APC is simply your best buy.

Every NEC APC personal computer comes with a \$6.1 billion company.

Buying an APC means you'll get the full support of a \$6.1 billion company. NEC.

And that means you get the service, technology and reliability that NEC is famous for.

decision, call NEC Information Systems at 1-800-343-4419.**



NEC'S PERSONAL COMPUTERS ARE BEING USED BY TENS OF THOUSANDS OF BUSINESSES WORLDWIDE.

The kind of service and support that's made our Spinwriter family the world's best selling letter quality printers for personal computers.

Is NEC on your bid list?

If we're not on your bid list, we should be.

But ask your Data Processing Manager to be sure. It you'd like more information to make your

You'll find out why more and more personal computer users are saying "NEC and me."

NEC AND ME



NEC'S ADVANCED PERSONAL COMPUTERS HAVE THE SHARPEST COLOR GRAPHICS IN THE INDUSTRY.

*Source: Dataquest
**In Massachusetts, 617-862-3120 x306

® The Apple Logo is a registered trademark of Apple Computer, Inc.

NEC Information Systems, Inc.
5 Militia Drive, Lexington, MA, 02173

Circle 312 on inquiry card.

each category for each computer he sells. How can he choose which ones? He reads the ads, dealer promos, and software reviews. Since every product claims to be easy to use, he concentrates on what each product can do, assuming that, all other things being equal, the more a product can do, the better it is. Hence he stocks those products that have the most features, confirming the programmer's wisdom in putting those extra features in and encouraging him to include even more in future versions.

The unfortunate result of this feature chase is that the user ends up with a program that does everything in the world except (you guessed it) get the job done with no fuss.

What Makes Software Easy to Use?

Easy-to-use software gets the job done with no fuss. That's because it stays out of your way by not drawing attention to itself and by offering you only what you need to know. It lets you concentrate on your work and not on using the program. Rather than try to be all things to all people, it contents itself with meeting the essential needs of most people.

Easy-to-use software does what you expect it to do. Its responses to your commands are natural and unexceptional. As you work with it, it may elicit from you an occasional murmur of contentment but never a cry of amazement, grief, or profanity. It satisfies what people in my company call the Principle of Least Astonishment.

Easy-to-use software offers you less. The thinner the manual, the less you'll have to read to learn the program. The fewer the choices on the menus and prompt lines, the less you'll have to think about before making your choices. The less a program does, the fewer things can go wrong with it (and, most probably, the less it costs). For me, less denotes simple, clean, uncluttered, and uncomplicated.

A Good Model

A good software product uses models of things you are already

familiar with. If you glance at figure 2a, a screen from an imaginary home-budgeting program, you might not be sure what it is for. If, however, I rearrange the prompts and add a border, its purpose becomes self-evident (see figure 2b).

I've seen many examples lately of databases that use a screen display of a filing cabinet as their model. This model can be extended to have the chosen drawer open up and the folders inside pop up for your inspection and choice. By using such a familiar object as a model, this program does away with any need to explain "master" and "detail" data fields or whatever the internal equivalents are for the drawers and the folders. Apple's Lisa computer comes with a program that uses a hand calculator as a model. You "press" its "keys" by selecting them with the mouse. This program's virtue does not lie in its efficiency (an actual hand calculator is faster to use) but in its familiarity; you don't need to read a manual or a help screen to find out how it works.

One danger with models is that in their effort to imitate the familiar object, they may imitate the object's limitations as well. A word processor

patterned after a typewriter so slavishly that you see a graphical image of the type ball swing up each time you type a character may be comfortably familiar but may eventually drive you crazy.

One of the most familiar objects of home and office is also one of the most difficult to model successfully: a piece of paper. Programs seldom show one of paper's most obvious characteristics: its edges. Nor do programs simulate the freedom of using a pencil or typewriter to write anywhere on the paper. Cut-and-paste operations rarely bear any resemblance to the cutting and pasting of real paper.

The sheet-of-paper model is ideal for a database program in which each screen represents a form to fill out. With care, the same model can also be used to represent menus and other command screens, thus eliminating the need for the user to learn different procedures for data entry and command entry. A popular alternative to the sheet-of-paper model for command entry is the sequential model; you select one item from a list, which in turn offers you a secondary list, and so on, until you have reached the list containing the item

(2a)

Number:
Date:
To:
Amount:
Memo:

(2b)

```

-----
|
|  Number ----
|
|                                     Date -----
|
|  Pay To The Order Of ----- $-----
|
|                                     Dollars
|
|  Memo -----
|
-----
  
```

Figure 2: An unclear screen from an imaginary home-budgeting program (a). With prompts and a border, the purpose of the screen becomes self-evident (b).

Taxan monitors when precision counts

Dedicated to quality and precision, TAXAN offers a complete line of monitors including green and amber, ultra-high resolution monochrome, plus medium and high resolution RGB monitors.



⊗ TAXAN also offers the 410-80, 80 column and RGB card to interface with the Apple IIe.

⊗ TAXAN monitors stand alone.

See your local ⊗ TAXAN dealer, or call us for details!

⊗ TAXAN

TSK Electronics Corporation
18005 Cortney Court
City of Industry, CA 91748
(213) 810-1291
Circle 439 on Inquiry card.

TAKE THE CATALOG

CHALLENGE

- For Savings
- For Selection
- For Service

Other companies waste time and overhead producing expensive catalogs. Computers and More doesn't. Putting the latest products and best prices in our customers' hands, not catalogs, is our goal. We challenge any catalog company to match our pricing, selection and service. Take the catalog challenge and save!

COMPUTERS

Desk Top		Portable	
IBM P/C 2-320K	2195	Columbia VP	2349
IBM XT	On Sale!	Corona 1-320K	1989
Columbia 1600-1	2289	Corona 2-320K	2295
Columbia 1600-4	3494	Kaypro II	CALL
Corona 2-320K	2389	Kaypro 4	1689
Eagle 1620	3995	Teletote	1289
Eagle 1630	4995	Epson HX-20	CALL
Televideo TS-803	1949	SKS Nano	New!
Epson QX-10	ON SALE!	SKS Pico	New!
DEC Rainbow 100	CALL	NEC - All Models	Sale!
Zenith - All Models	CALL	Compag 1 Drive	CALL
DEC Rainbow 100 Plus	CALL	Apple Compatible	CALL
Eagle II-1	1298	STM Pied Piper	989
Franklin DMS	CALL	Zorba 9 in.	1776

PRINTERS

Letter Quality		Dot Matrix	
NEC 3550 (IBM)	1695	C. Itoh 8510	339
Canon Ink Jet	634	C. Itoh 1550	645
JUKI 6100	489	Epson FX 80	CALL
Silver-Reed 550	669	Epson RX-80	CALL
Transtar 120	459	OKI 82A	349
Transtar 130	699	OKI 83A	589
Transtar 140	1089	OKI 80	319
NEC 2010	859	OKI 92A	449
NEC 2015	859	OKI 93	739
NEC 2050 (IBM)	CALL	Riteman	369
F-10 Starwriter	1099	Gemini Delta 10	549
F-10 Printmaster	1349	Toshiba P1350	CALL
S/C TP2	CALL	NEC 8023	389
HR-1	659	NEC 8025	699
HR-15	On Sale!	IDS Prism 80	Sale!
Diablo 630	CALL	IDS Prism 132	1165
Daisywriter 48K	1099	Mann-Tally 160L	619
DTC 380-Z	1049	Mann-Tally 160L	849
Brother HR-25	NEW!	Transtar 315	CALL

ACCESSORIES

IBM		Apple	
Supervision by CCS	679	Z-card by ALS	139
Z/Plus by CCS	699	Dual Interface (Par & Ser)	CALL
Graphics Card by Hercules	367	80 Col/64K for Ile	116
STB Video Board	349	PKASO card	127
Baby Blue by Microlog	459	Par. Interface	59
Vista PC Master	339	Koala Touch Tablet	89
Vista Multicard 64K	269	VIP Graphics Card	116
Smartmdm 1200B (w/soft)	538	Premium SFT cd Ile	349
PC Modem Plus	309	SUP R MOD	49
Tandon TM 100-2	235	Appli-Card w/6 HZ & 64K	299
CDC Disk Drive DS/DD	247	Disk Drive	199
Disk Controller by Maynard	157	Drive Controller	59
Davong 5 Meg	1189	Disk Emulator 294K	519
Davong 15 Meg	1889	UltraTerm	289
Keytronic New 5150	189	MicroModem II	269
Amdek MAL	CALL	Smart Modem 1200	519
USI Color/Graphics 1/4 Para	289	D-CAT	149
Corona-Corvus-Mtn	CALL	Kraft Joystick	44
Quadram Quadlink	469	Davong 5 Meg	1359
Quadram Quadboard II 64K	299	Microbuffer II	209
Tecmar 1st Mate	239	80 Col. cd.	99
Tecmar Expansion Chassis	769	Buf. Grappler+	CALL
MBI Monte Carlo GT 64K	289	Wizard 16K	53

Printer Accessories

Sooper Spooler	289	Microbuffer (In line 32KP)	219
Microspooler (P to P 16K)	189	Microbuffer (In line 32KS)	219
Microspooler (P to P 64K)	229	64K for MB	199
Soundtrap	89	Optimizer by ACT	CALL

Terminals

Wyse 300	1019	Mann-Tally Phxy 3	689
Wyse 200	1019	Sweet-P	528
Adds - All Models	CALL	Amplot-4	719
T.V. 910+	569	Amdek X-Y	569
T.V. 925C	749	Amdek 6 Pen Auto	995
T.V. 950C	969	Amdek II Digital	1069
Qume 102A	549	C. Itoh CX (Par)	549
Qume 102G	549	C. Itoh CS (Ser)	549
Qume 108A	679	Strobe B Pen	799
Zenith	CALL	Houston Ins. Hi-Pad	759

Plotters

MONITORS

Color		Monochrome	
Princeton HX-12	469	Taxan Amber	129
Amdek II+	427	Taxan Green	129
Amdek I	269	Zenith 122A	125
NEC JC1203 (IBM)	519	Zenith 123G	97
Taxan RGB-3	489	Amdek 310A	169
Quadram Quadchrome	609	Amdek 300	159
Zenith - NEW	CALL	NEC 1201	157

SOFTWARE

IBM		Apple	
Zork I	27	Tax Preparer	147
Millionaire	39	Home Accountant	49
Wizardry	39	Great Plains	CALL
Wordstar	269	Peacntree	CALL
Easywriter II	259	PFS: Solutions	CALL
Volkswriter	119	PFS: File	84
Visicalc (256K)	179	PFS: Report	84
Multiplan	189	PFS: Graph	84
1-2-3	329	dBase II	397
PFS: Graph	93	Visfile	169
PFS: File	93	Versalorm	264
PFS: Report	83	T.I.M.	CALL
PFS: Solutions	CALL	List Handler	59
dBase II	397	Word Handler	139
Visfile	209	Wordstar	249
Tax Preparer	169	Bank Street Writer	47
Versa Form	265	Screenwriter II	CALL
Infostar	319	Magic Window	97
Personal Pearl	199	Magic Calc	99
Home Acct Plus	112	Zork I	27
Peacntree	CALL	Zaxxon	27
Property Management	329	Chopflifer	26
Digital Research	CALL	Frogger	34
Vis-On	NEW!	Wizardry	29
Magawriter	69	Jumpman	29

COMPUTERS



and More

... The Catalog Challengers!

3620 - 30th Street
SAN DIEGO, CA 92104

TO ORDER
(619) 291-1442

TO ORDER: Phone orders invited using Visa, MasterCard, or bank wire transfers. Visa, MC, service charge of 2%. Mail orders may send charge card number (include expiration dates), cashiers check, money order, or personal check (allow 10 business days for personal or company checks to clear). Please add 3% (\$5.00 minimum) for UPS shipping, handling, and insurance. All equipment is in factory cartons with manufacturer warranty. Opened products not returnable. Restocking fee for returned merchandise. Equipment subject to price change and availability. Retail prices differ from mail order prices. Calif. residents add 6% State Tax. Company and school P.O.'s accepted on approval. IBM & Apple are registered trademarks. International inquiries welcomed. Telex 697120, Datamax Attn: Dept. 322

you want to change.

With the sheet-of-paper model as employed by PFS:WRITE, you select the Define Page option of the main menu by typing 2, which brings up the Define Page Menu. You then move the cursor to the Left Margin item and type the new value over the old one.

The advantages of the sequential model are that it often requires fewer keystrokes to select an option and it need occupy only one line of the screen. The advantages of the sheet-of-paper model are that it enables you to examine and change many items at the same time; it has fewer levels of nesting, thus reducing the need for additional commands to "back up" the command tree; item names need not be artificially shortened to squeeze onto a single line; and item names and even graphical elements can be more freely used on the screen for greater comprehension.

Consistency

Consistency may be the single most important factor in determining a program's ease of use. Unless a program is totally consistent in its menu displays, error detection, warnings, keystroke assignments, help messages, option lists, and so on, its users will never be able to totally trust it or relax while they're using it.

Imagine that you have just acquired a program to help you with your home budgeting. Every time you press the F3 function key, the program moves the cursor to the command line. That's great—an easy rule to remember, and it doesn't get you into trouble. Then one day you try to edit an existing budget item. You enter the Edit subsystem, press F3 to get to the command line, and—whoops!—all of your item values have just been converted to French francs, just as the manual (which you never read) said would happen. Not only have you messed up your budget, you have also lost all confidence in the F3 key, even when you aren't in the Edit subsystem. From now on, every time you use your budgeting program, you will worry about it and wonder when it will foul



For users of Apple, IBM, TRS/80, Atari, Commodore, Texas Instruments, and other brand name computers:

Here's the easiest way to buy quality diskettes at discount prices

Now you can get error-free double density diskettes by IBM, Control Data, Maxell and Verbatim delivered to your door. For some of the lowest prices around.

You save because we ship huge volumes of magnetic media in boxes of 10.

To order, use this form. **For even faster service, call toll-free.**

1-(800)-FLOPPYS or
1-(800)-521-5700

Michigan • 1-800-482-4770

Canada • 1-800-265-4824

Alaska/Hawaii • 1-800-821-9029

ALL MAJOR CREDIT CARDS ACCEPTED

Shipping & handling F.O.B. Southfield

Transaction Storage Systems Inc., Southfield, MI

Size	IBM Qty.	Verbatim Qty.	Control Data Qty.	maxell Qty.
5-1/4" SS	23.90	23.90	19.90	28.90
5-1/4" DS	34.90	34.90	29.90	41.90
8" SS	24.90	—	19.90	—
8" DS	39.90	—	29.90	—
Sub Totals	\$ _____	\$ _____	\$ _____	\$ _____

Name _____ Title _____
 Company _____
 Address _____
 City _____ State _____ Zip _____
 AMEX MASTERCARD VISA
 Card # _____ Exp. Date _____
 Shipping and handling 1-6 boxes add \$4.00 per order
 7 or more add \$6.00 per order.
Clip and mail today to: Transaction Storage Systems, Inc.,
22255 Greenfield Road, Southfield, MI 48075
 B12/83

EXPECT A MIRACLE

Circle 435 on inquiry card.

THE PURCHASING AGENT matches lowest prices!

COMPUTERS

Altos 5-15D, MP/IM	\$1,950
580-10	4,199
586-10	5,650
586-30	7,114
586-14/40	8,270
8000-10	5,424
8000-12	6,499
8600-14	7,750
CompuPro, Goudbout*	
Sys. 816A*	4,000
Sys. 816A**	3,850
Sys. 816A RAM 21*	4,075
Sys. 816A RAM 21**	3,925
Sys. 816B RAM 16*	5,038
Sys. 816C RAM 21*	6,632
Sys. 816C RAM 21**	6,470
Sys. 816D RAM 21*	10,324
Sys. 816D RAM 21**	10,052
816 08 RAM 17**	6,471
816 16 RAM 21**	10,052
816 68K RAM 21*	6,632
Gilford Sys. 321*	8,866

* Completely Assembled
** Unassembled Components

M-Drive-H	1,100
CPU 68K	500
CPU Z, 6 Mhz	234
RAM 21, 128K, 14 Mhz	798
Disk 2, Hard Disk Contr.	500
Pragmatic 20 meg.	2,990
Pragmatic 40 meg.	4,686
Columbia Sys. 2-320K	2,779
Sys. 12 meg.	4,119
Sys. portable	2,320
Corona desktop, 2-320K	2,437
desktop, hard disk	3,495
portable, 2-320K	2,387
Eagle II E-2	1,575
1620	2,999
1630	4,699
PC-1	2,320
PC-2	2,699
PC-XL	3,448
Fortune	CALL
Molecular SM 8 10 meg.	4,648
Morrow Micro D, MD-2*	880
Micro D, MD-3*	1,130
*w/terminal, add	455

Morrowriter	
MW1-MP100	1,856
MW1-MP200	2,243
MW1-MP300	2,441
MW2-MP100	2,321
MW2-MP200	2,596
MW2-MP300	2,786
NEC APC-H01	2,088
APC-H02	2,544
APC-H03	2,999
APC-H12	
Color Graphics	618

COMPUTERS

NEC APC-WPS 1	4,534
APC-WPS 2	5,013
APC-WPD 4	5,622
8801A, 64K	947
881 A, 2-320K	868
8881A, 2, 8	1,575
Northstar Advantage	
w/Dual Floppies	2,107
w/5 meg.	3,249
w/15 meg.	4,315
8/16 upgrade	3,309
Onyx 8001 MU 20, 256K	10,454
8002 MU 20, 512K	14,338
C5002A, 256K, 14M	9,022
Pied Piper	995
PMC Micromate 101	CALL
Sage IV, Low Profile	3,470
IV, w/16 meg.	5,385
IV, w/18 meg.	6,123
IV, w/18 meg.	6,275
Sanyo 1250	2,433
4000	2,677
Seattle Gazelle, hard disk	5,970
Televideo TS-802	2,525
TS-803	2,927
Vector 4-20	3,637
Victor 9000 S.S.	2,874
9000 D.S., hard disk	4,850
Zenith ZF-100-21	2,245
ZW-110-32	4,261

HARD DISKS

Cameo	CALL
Chatsworth 4200	3,340
Corvus, 6 meg., w/Inf.	1,629
Cyquest	1,391
Davong, 5 meg. Univ.	1,395
Morrow 20 meg., w/contr.	3,650
NEC APC 10 meg.	2,172
Pragmatic 10 meg.	2,445
Santa Clara Sys., 10 meg.	1,970
Tallgrass Tech., 6 meg.	1,781
Trantor 5 meg.	1,211

IBM PERIPHERALS

Hayes 1200 B Modem	449
Keytronic 5150 Keyboard	189
Plantronics Color Plus	CALL
Quadrink	549

MODEMS

Hayes 1200	499
US Robotics Auto 212A	479
Password	349

MONITORS

Amdex 300 G Hi-Res	130
300 A Hi-Res	145
310A	165
RGB II	450
BMC 12" Green	85
NEC 1201	154
1203	536
1260	115
1410 RGB	485
Princeton RGB w/cable	510
Quadram Quadchrome	181
Sanyo 12" G Hi-Res	125
Taxan 12" Amber	499
RGB 3	155
USI 12" Amber	

PRINTERS

Anadex 9501	1,300
9620	1,399
9625A	1,515
VFP6000	2,599
Brother, parallel, daisy	695
C. Itoh 8510 Pro I, par.	379
8600	1,017
F-10, 40 cps.	1,050
F-10, 55 cps.	1,425
C-1300, 300 ipm.	4,295
Daisywriter 2000, 48K	1,150
Dallasouth DS-180	1,150
Diablo 620, 25 cps., daisy	875
630	1,710
Epson FX-100	564
FX-100	750
MX-80FT	475
MX-100	657
Florida Data OSP-130	3,700
GE (General Electric) CALL	
Gemini 10	309
15	454
Gorilla Banana	199
IDS Prism 132 all options	1,385
NEC 2010	995
3510	1,365
7710	1,900
8023	499
Okidata 80	317
82A	359
83A	575
84P	960
84S	1,060
92P	445
92S	527
93P	738
93S	820
2350P	2,095
2350S	2,195
2410	2,323
Qantex 6000 P	1,086
7020	1,235
7030	1,548
7040	1,703

PRINTERS

Qume 11/40 w/int	1,395
Tally 160L, w/tractor	569
180L, w/tractor	784
Texas Instr. T1810 basic	1,240
T1810.LQ	1,789
Toshiba P-1350, parallel	1,499
P-1350, serial	1,499
Transtar 130	693
140	1,199
315 color	549

PLOTTERS

Amdex, X-Y	592
Houston Instr., DMP 29	1,778
DMP 40	740
DMP 42	2,321
Hi-Pad	763
461	573

TERMINALS

Strobe M 100	445
Sweet P	499
Adds Viewpoint A1	720
Viewpoint A3+	1,355
Ampex Dialogue 80 amber	1,016
Ann Arbor Ambassador	1,278
C. Itoh 80A	478
101E	540
Hazeltine Esprit I	511
Esprit II	542
Lear Siegler ADM 3A	538
Quadram MX700	905
CALL	1,015
Qume QVT102A	680
QVT102G	1,020
542	1,020
538	1,020
Televideo 925	635
950	
970	
Visual 330G	
Wyse WY-100	
WY-200	
WY-300	
Zenith Z-29	

ACCOUNTING SOFTWARE

Altos Accountant	1,899
CYMA, each module	750
Graham Dorian, ea. mod.	420
MBSI, each module	455
Micro Computer	450
Consultants, ea. mod.	CALL
Microtax	568
Open Systems, ea. mod.	
Structured Systems,	735
each module	
Systems Plus	345

DATABASE SOFTWARE

Condor III	437
DBase II	450
Personal Pearl	199

you up again.

I occasionally use an operating system that requires a Q to quit the main menu, an E to move from the main menu to the editor, and, depending on what I have done in the editor, either a Q, E, or the Escape key to return to the main menu. The net result is that I must pause and worry a bit before typing Q, E, or the Escape key at any menu. A minor inconsistency has planted a seed of mistrust in the decision-making part of my brain. My peace of mind has been subtly disturbed.

Let me offer another example. Many word processors have a cursor-movement mode for moving the cursor anywhere in the document, an insert mode for typing new text, and a replace mode for typing over existing text. In the cursor-movement mode, you can use the cursor-movement keys, but you can't type text. In the insert mode, you can type text, but you can't use the cursor-movement keys. In the replace mode, you can type text, but only where there was text before, and you can't use the cursor-movement keys.

In other words, you are never sure which keys are functional and which are not. Inconsistent keystroke definitions force you to devote more time to worrying about the software, leaving you with less time for your work.

PFS:WRITE's main menu expects you to enter a digit from 1 to 6, followed by pressing the F10 function key on the IBM PC to signify "I've filled out the menu; let's continue." I could have made the main menu even faster to fill out by having the program branch immediately after detecting a digit from 1 to 6, without waiting for the F10 key to be pressed. But that would be inconsistent with the way the other menus are handled. In the Define Page menu, for example, the F10 key is required because the program can't know when the user has finished filling out the menu. I chose consistency over efficiency here; the one keystroke I could have saved is not enough to compensate for the inconsistency of requiring the F10 key on all but the main menu.

Can consistency be carried too far?

Have a Happy Holiday Season

THE PURCHASING AGENT, INC.

574 Weddell Drive, Suite 5
Sunnyvale, CA 94089

(408) 744-0646

Open Monday thru Friday, 8-5 PST

SemiDisk™ and SemiSpool:™ SURE-FIRE WAIT-REDUCTION!

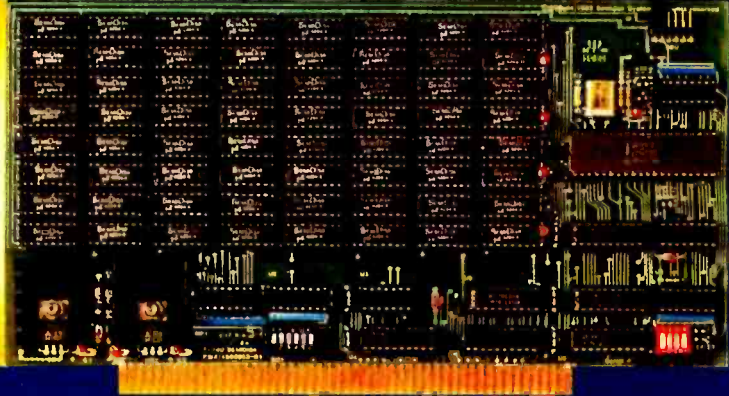

512Kbyte SemiDisk™ I \$1095

Time was, you thought you couldn't afford a SemiDisk. Now, you can't afford to be without one.

	<u>256K</u>	<u>512K</u>	<u>1Mbyte</u>
SemiDisk I, S-100	\$895	\$1095	\$1795
IBM PC		\$1095	\$1795
TRS-80 Model II		\$1095	\$1795
SemiDisk II, S-100		\$1395	\$2095
Battery Backup Unit	\$150		

Time was, you had to wait for your disk drives. The SemiDisk changed all that, giving you large, extremely fast disk emulators specifically designed for your computer. Much faster than floppies or hard disks, SemiDisk squeezes the last drop of performance out of your computer.

Time was, disk emulators were afraid of the dark. When your computer was turned off, or a power outage occurred, all your valuable data was lost. But the SemiDisk changed all that. Now, the optional Battery Backup Unit helps take the worry out of power interruptions. It keeps the SemiDisk powered for up to 5 hours during a power failure.

Time was, you had to wait until your printer finished printing to use your computer. That's changed, too. Now, the SemiSpool print buffer in our Version 5.0 software, running under CP/M 2.2, frees your computer for other tasks while your data is printing. With a capacity up to the size of the SemiDisk itself, you could implement an 8 Mbyte spooler!

But one thing hasn't changed. That's our continuing commitment to supply the fastest, highest density, easiest to use, most compatible, and most cost-effective disk emulators in the world.

SemiDisk.
It's the disk the others are trying to copy.

still

SemiDisk Systems, Inc.

P.O. Box GG Beaverton, OR 97075 (503) 642-3100

Call 503-646-5510 for CBBS®/NW, a SemiDisk-equipped computer bulletin board. 300/1200 BAUD
SemiDisk trademark of SemiDisk Systems, Inc. Copyright © 1983 SemiDisk Systems, Inc. CP/M Trademark Digital Research.



NO WAITING

Less for Your Money

If you do word processing on your personal computer, you probably know that there are many programs for sale to help you with your spelling. But the biggest spelling error you'll ever make is paying too much for your spelling correction software. The Random House ProofReader gives you less for your money – less trouble, that is, and fewer spelling errors. The Random House ProofReader is based on the world famous Random House Dictionary. It contains up to 80,000 words, depending on your disk capacity. You can add new words with the touch of a key. It shows you the error and the sentence it's in. It instantly suggests corrections. It even re-checks your corrections. And it costs half as much as other programs with far less power. The Random House ProofReader is compatible with all CP/M 2.2®, MS-DOS® and IBM Personal Computer® systems.

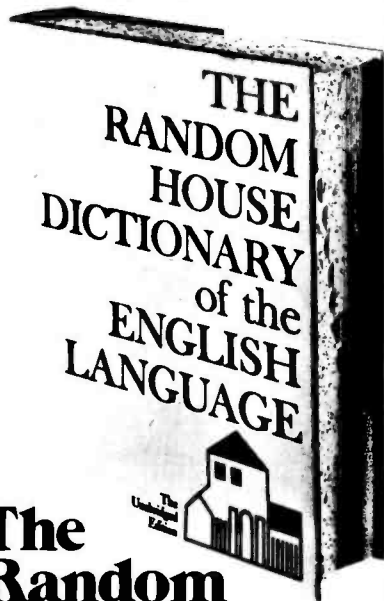

The Random House ProofReader

\$50

For orders or information, see your local dealer or call 505-281-3371. Master card and VISA accepted. Or write Random House ProofReader, Box 339-B, Tijeras, NM 87059. Please enclose \$50 and specify your computer model, disk size and memory.

Random House and the House design are registered trademarks of Random House, Inc. CP/M is a registered trademark of Digital Research, Inc. IBM and IBM Personal Computer are registered trademarks of International Business Machines, Inc. MS-DOS is a registered trademark of Microsoft, Inc.

Perhaps. PFS:WRITE moves the cursor to the beginning of the next line each time you press the Enter key, whether you are filling out a form or a menu. But as we just saw, WRITE's main menu requires you to type in only a one-digit number. Should the Enter key move the cursor to the beginning of the next line? That would be consistent, but it certainly doesn't help you fill out the main menu. Maybe it shouldn't do anything, or maybe it should mean "continue," just like the F10 key. These "trivial details" are the sorts of issues programmers must worry about if they decide to take ease of use seriously.

Consistency among several programs is perhaps more important than consistency within each separate program. If pressing the Escape key makes your word processor return to its main menu, your spreadsheet program undo the last command you entered, and your filing program remove the displayed form from your file, you are going to be awfully hesitant about ever pressing that key. Until independent software developers sit down together and agree on program conventions (which will never happen), you can minimize this problem by either buying integrated products that do the work of several individual products or buying the individual products from a single vendor who cares about consistency.

Product Integration

The integrated software you can buy off the shelves today looks like it was designed to cram the greatest number of features onto the fewest number of floppy disks and into the least amount of memory. This sort of packaging has imposed a certain amount of consistency within each integrated product (for example, it takes less code to make all prompt lines work the same way), but the products really aren't much easier to use than those they replaced. What they offer primarily are gains in speed and convenience. The disk shuffle you had to go through to get a graph printed with data from your spreadsheet program was so cumbersome and time-consuming that it was

hardly worth the effort. Now, with graphing and spreadsheet functions in the same application, the process has become quite feasible.

This space restriction will disappear as computer memories become larger, disk capacities increase, and hard-disk prices fall. The next restriction programmers of integrated software will face is the limitations of their models. Any application that tries to do too many different things is going to have problems keeping its model from becoming distorted. The more reasonable alternative to one program that does all is a small number of programs, each of which does as much as it can within the confines of its own model. For example, one program modeled after a spreadsheet might provide row and column calculations, graphs, and reports, and another program modeled after a piece of paper might provide data storage, word processing, and spelling checking.

Summary

The new operating systems will make these integrated programs much nicer to use by imposing standards of data interchange, by permitting the simultaneous display of multiple applications on the same screen, and by permitting the rapid switching from one application to another. But ease of use is not an inevitable result of these developments. Multiple windows, high-resolution graphics, rapid task switching, and all the other wonderful technical wizardry coming our way can still leave us with messy screens, complicated decision trees, ambiguous prompts, inconsistent keystroke conventions, bad manuals, and all the other faults that have made today's software so difficult to use. Until programmers, advertisers, reviewers, dealers, and users decide they won't settle for anything less than easy-to-use software, it's not likely to appear on the shelves. ■

Sam Edwards (2777 Pradera Way, Carmel, CA 93923) practices what he preaches as coauthor of the PFS:WRITE software package and in his position as software engineer at Software Publishing Corporation.

Your Apple's telephone. Hayes™

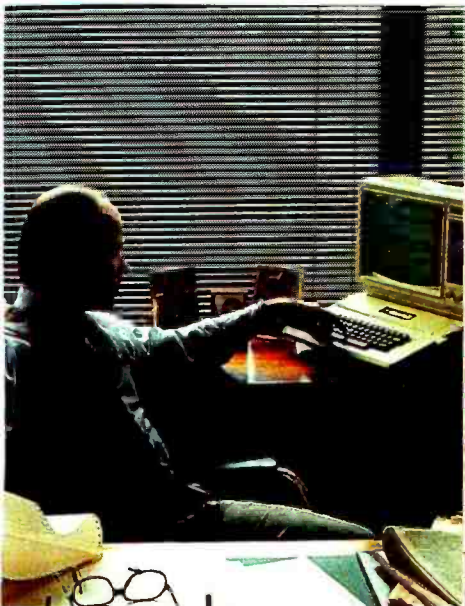

"Thanks for the prompt reply. Sure was a lot faster than waiting for the mail!"

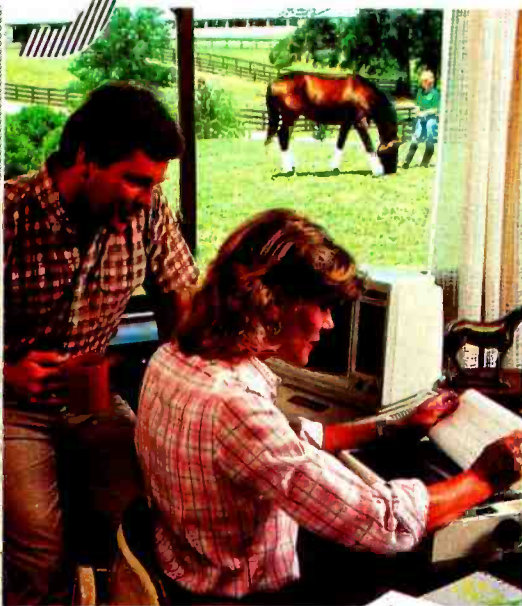

"Gary: The pedigrees for next week's auction are as follows..."



"Attn. Prod., Sales, Purch.: Recommend 50% blue, 30% red screen for closest match."

A complete plug-in communications system for Apple® computers. From Hayes, the established telecomputing leader: the simple but sophisticated Micromodem II® plug-in board modem and its companion software, Smartcom I.™ Everything you need to expand the world of your Apple II, IIe, II Plus and Apple III. In one, convenient communications package.

With Micromodem IIe and Smartcom I, you can access data bases, bulletin boards, and the varied resources of information services. Plan your travel itinerary via computer, including flight numbers, hotel and rental car reservations. Retrieve and analyze daily stock and options prices. Work at home and send reports to your office. You can even do your gift shopping by computer!

Micromodem IIe. Think of it as your Apple's telephone. It allows your computer to communicate with any Bell-103 type modem over ordinary telephone lines, at 110 or 300 bits per second. Micromodem IIe installs easily in an expansion slot, and requires no outside power source. It connects directly to either a single or multiline modular phone jack, to perform both Touch-Tone® and pulse dialing.

Micromodem IIe dials, answers and disconnects calls automatically. And, unlike some modems, it operates in full or half duplex, for compatibility with most time-sharing systems.

A built-in speaker lets you monitor your



calls when dialing. That way, you'll know if a line is busy. With Smartcom I, Micromodem IIe automatically redials your last number.

Discover how Micromodem IIe can help maximize the capabilities of your Apple. While Smartcom I software will minimize your efforts.

Smartcom I companion software. For effortless communications. Whether you're a newcomer to personal computing or a seasoned professional, you'll appreciate the ease and speed with which you can perform any communications function. Thanks to Smartcom I!

Let Smartcom I guide you through a few easy-to-answer questions to tailor the program to your particular needs. Then you're ready to go!

Make a selection from the Smartcom I menu to manage your communications, files or printer. Program prompts guide you along the way. And menu selections let

you easily make a call, end a call, or answer a call. When you're on the receiving end, your Micromodem IIe answers automatically, even if you're not there!

Convenient! And so is the Smartcom I memory for phone numbers. Smartcom I stores three of your most frequently called telephone numbers and one prefix. Plus, it also remembers the last number dialed.

Smartcom I also provides a directory of the files stored on your disk. And lets you create, list, name, send, receive, print or erase files right from its menu.

Smartcom I is as versatile as you need it to be. It accepts DOS 3.3, Pascal, CP/M™ 3.0 or CP/M Plus™ operating systems. And accommodates up to six disk drives and several printer interface cards.

Like all our products, Smartcom I and Micromodem IIe are backed by excellent documentation and full support. Including a two-year limited warranty on Micromodem IIe and a 90-day warranty on Smartcom I!

See your dealer today. Then plug into the exciting world of telecomputing.
Hayes Microcomputer Products, Inc.,
5923 Peachtree Industrial Blvd., Norcross, Georgia 30092. 404/441-1617.



FCC approved in U.S.A. Micromodem IIe is a registered trademark of Hayes Microcomputer Products, Inc. Smartcom I is a trademark of Hayes Microcomputer Products, Inc. Apple is a registered trademark of Apple Computer, Inc. Touch-Tone is a registered service mark of American Telephone and Telegraph. CP/M is a trademark of Digital Research, Inc. CP/M Plus is a trademark of Advanced Logic Systems. ©1983 Hayes Microcomputer Products, Inc.

This page is for people who want to buy a great multi-user system.

And who don't want to pay an arm and a leg for it.

For you we have the Octagon 8/16™. At only \$7350,* the Octagon 8/16 has the guts to handle any job you and three other people throw its way. And then some.

The multi-tasking Octagon 8/16 includes all the operating software you need to simultaneously run any of your 8-bit CP/M 80† applications and any of your 16-bit Concurrent CP/M 86† applications. (Or MP/M 86† if you're in a multi-user environment.)

It will also execute software written to run under MS-DOS.† And UNIX.† will be available by December '83.

So all your 8-bit software is as useful and productive as ever. But you still reap all of the advantages of a 16-bit system. Simultaneously.

All this performance is due to the Octagon 8/16's dual processor architecture. Its 8-bit NSC-800 CPU executes the full Z80† instruction set. Its 8088 CPU gives it the muscle to plow through 16-bit programs in a flash.

If you need a lot of number-crunching, there's an optional 8087 math co-processor.

Every Octagon 8/16 includes your choice of at least 256K of static RAM or 512K of dynamic RAM.

Either is expandable to 1 MB. No lack of power here.

It also includes RAM disk software for the fastest possible execution speeds.

And for unheard-of versatility, each Octagon 8/16 includes a 5¼" floppy (315K, IBM PC formatted), an 8" floppy (1.4 MB formatted), and a 5¼" Winchester (19.2 MB formatted). And there are other configurations to choose from, too.

So you not only get the kind of mass storage you need, you also get the kind of cost-effectiveness you can't get anywhere else. Call us today for complete details.

The Octagon 8/16. All the performance you need from a single- or multi-user system.

At a price that won't bust your budget.

*Basic configuration.

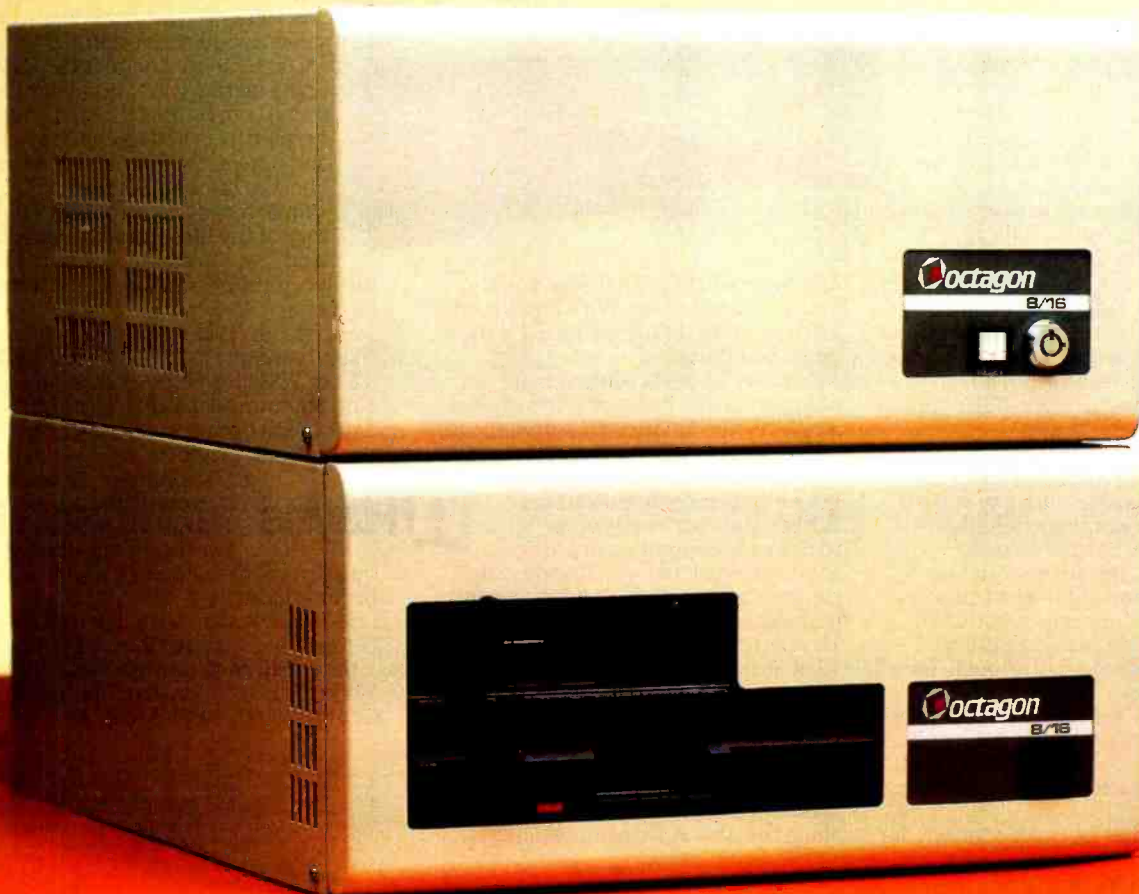
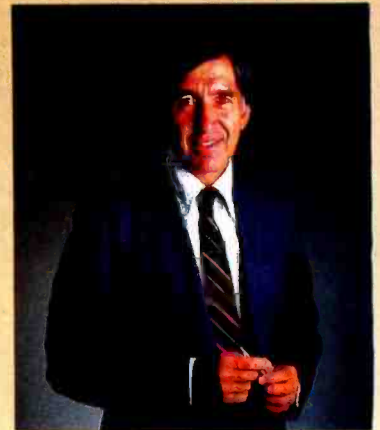

This page is for people who want to build a great multi-user system.

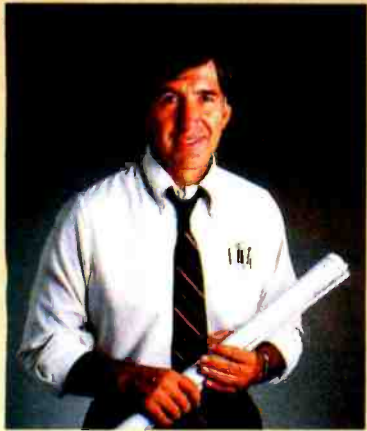

With the right ingredients, you can build almost anything. When you use advanced S-100 boards from Octagon, all you have to add is your imagination.

Start with the most powerful multi-processing CPU board available: The CPU Board 8/16.[™] For only \$895 you get an 8-bit 4 MHz NSC-800

(which executes the full Z80 instruction set) and a 16-bit 8 MHz 8088. An optional 8087 math co-processor is available, too.

Together they let you simultaneously run 8-bit CP/M 80 and 16-bit CP/M 86. (MP/M 86 in a multi-user environment.)

The board's 8272 floppy disk controller governs up to four 5¼" or 8" floppies at once in any combination.

An 8K PROM monitor boots the operating system and contains several key memory debugging routines.

Two serial ports feature software-selectable baud rates up to 19.2K baud.

And when you buy the operating system from Octagon—be it CP/M 86 for \$150, Concurrent CP/M 86 for \$195, or MP/M 86 for \$495—you also get a full CP/M 80 emulator at no extra charge.

As for memory, your multi-user system wouldn't be state-of-the-art without our 256K static RAM memory board.

The first of its kind, this board—for only \$1850—accepts either 8-bit or 16-bit bus requests. So it makes

a perfect match for the CPU board. (If 128K is all you need, it's all yours for just \$1095.)

Both versions feature a handy time-of-day clock with battery back-up that keeps track of seconds, day, month, and year.

If your tastes run more toward dynamic RAM, you need our unique 521K DRAM board. Use it as a standard memory card. Or flip a switch and it becomes RAM disk. \$1400 gets you the 512K version; \$800 for the 256K version.

The last major ingredient in your system is the hard disk controller. This board handles up to four 5¼" Winchester disk drives.

It includes automatic seeks and retries after error, both CP/M 80 and CP/M 86 bios, two serial ports, and one Centronics-compatible parallel port.

Plus, it will detect and correct single-bit errors and detect double-bit errors.

There's not another S-100 hard disk controller like it. Not at any price, let alone \$595. Or for \$2295, we'll include a 19.2 MB Winchester, complete with power supply, cables, and enclosure.

Call us today for all the mouth-watering details. Because with these ingredients, you'll cook up a terrific single- or multi-user system in no time.

A system you can really call your own.



2960 North First St., San Jose, CA 95134
408-262-7777

Octagon 8/16 and CPU Board 8/16 are trademarks of Octagon Corp. † CP/M 80, CP/M 86, Concurrent CP/M 86, and MP/M 86 are trademarks of Digital Research, Inc. Z80 is a trademark of Zilog Corp. MS-DOS 1s a trademark of Microsoft Corp. UNIX is a trademark of Bell Labs.

Circle 323 on inquiry card.

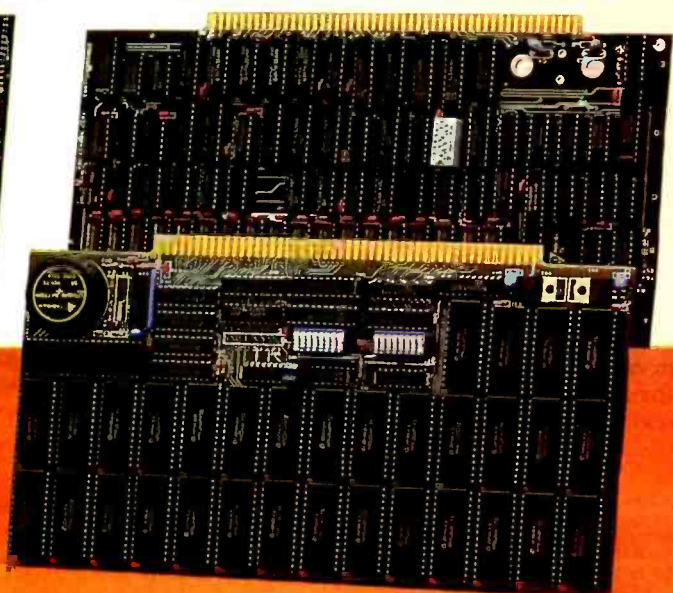
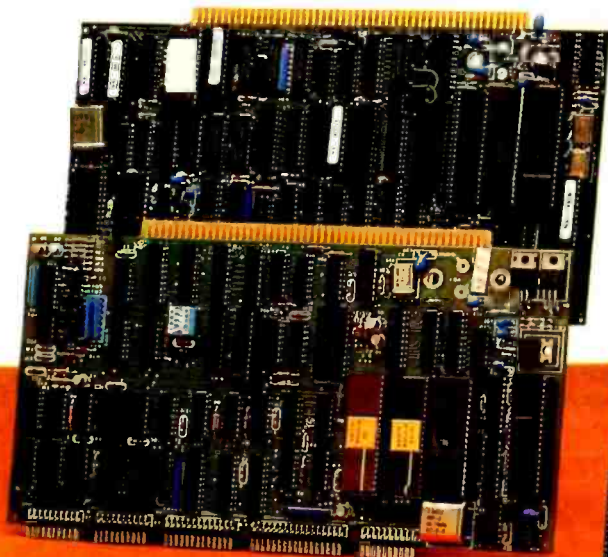

We've got the toughest QA Professionals in the Business!

Endura... the new standard for excellence

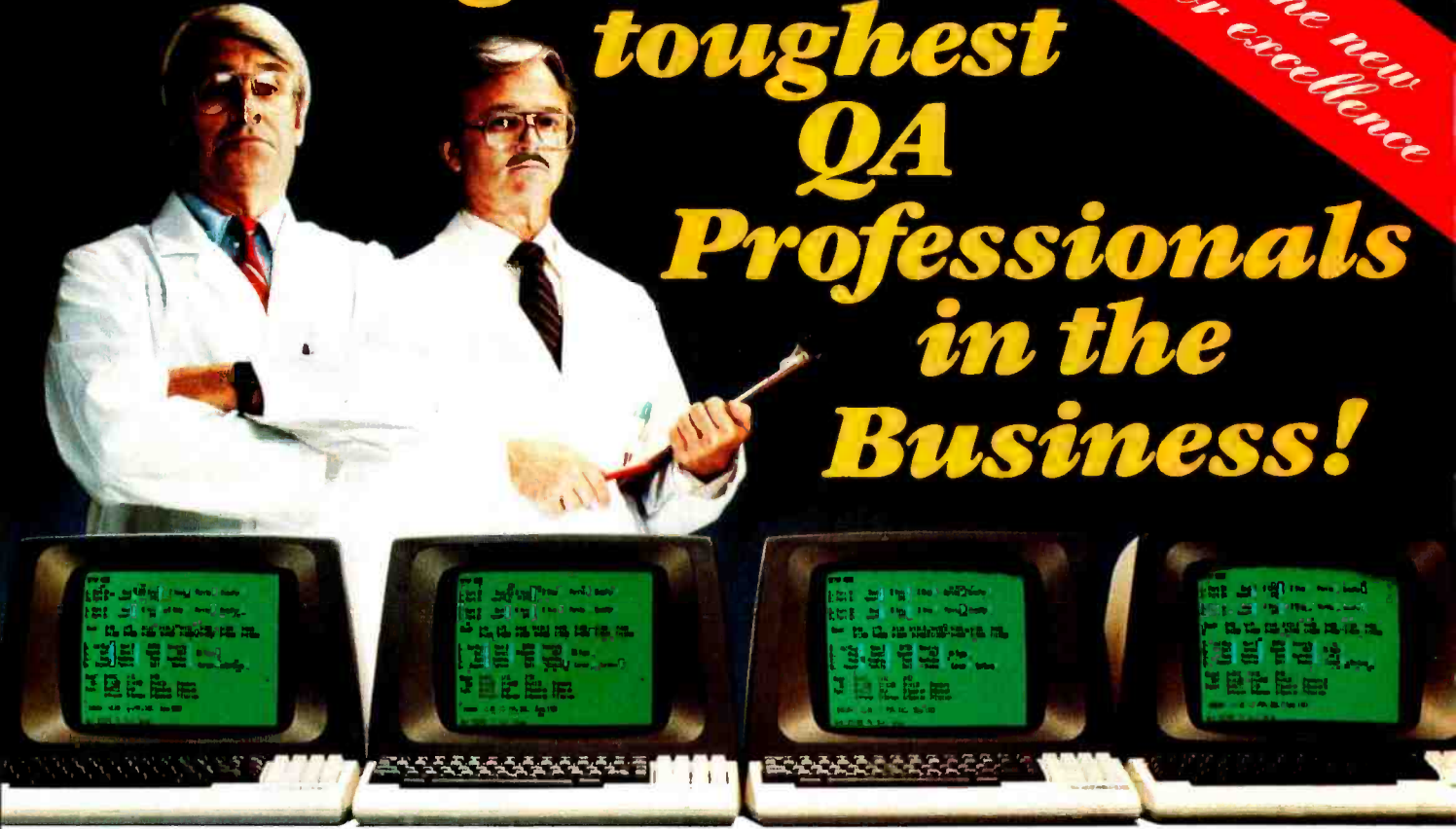

ENDURA

absolutely the finest low-cost ANSI terminal on today's market.

Falco Data Products has implemented the most rigid quality control program anywhere. We found the toughest, the pickiest Quality Assurance professionals in the business won't compromise quality for quantity. This is important to today's professionals as a terminal is a working tool...to be relied upon day after day, year after year, through many thousands of hours of use. To assure this kind of performance—a combination of ruggedness and precision—quality is a must!

At Falco, component parts are tested and re-tested throughout our entire manufacturing and assembling process to assure that the Endura meets the strict Falco standard for excellence. The results are a terminal that has a reliability history second to none.

The standardization of major components and the streamlining of up-to-date manufacturing techniques brings substantial savings to the end user. Not only does the Endura outperform everyone in price, but it offers many features and benefits that some high-priced terminals don't even have.

Circle 186 on inquiry card.

† Plot 10 is a registered trademark of Tektronix

† CP/M is a registered trademark of Digital Research

ENDURA supports ANSI x 3.64 • User-friendly soft set-up menu • Non-glare high resolution green screen • Detachable keyboard • 20 user-programmable function keys with 900 character non-volatile memory • 25th status line • Block mode • Split-screen with smooth scrolling • A wide range of video attributes that do not occupy a screen space.

ENDURA's multi-board adaptability makes it the proper choice for non-obsolescence and lasting value with many unique options, such as 212 Modem Board (300/1200 bps), Plot 10™ compatible Graphics Board, and 64K CP/M™ compatible CPU Board.

Falco Data Products is committed to the ultimate in quality, reliability and versatility... there is no other choice when it comes to lasting value.



Falco
DATA PRODUCTS

1286 Lawrence Station Road
Sunnyvale, CA 94089

CALL NOW FOR COMPLETE DETAILS
(408) 745-7123

CUSTOM AND OEM INQUIRIES ARE INVITED

Walt Disney and User-Oriented Software

Mickey Mouse teaches software designers a lesson

by Paul Heckel

When the outstanding violinist Isaac Stern was asked the difference between the great and the truly great, he replied, "The ability to communicate." It is the key ingredient in every art form and certainly the great strength of Walt Disney's genius.

—Frank Thomas and Ollie Johnson
Disney Animation, the Illusion of Life

Today we can look back on what Walt Disney did 50 years ago and learn a great deal about how to design friendly software. Disney created Donald Duck, Mickey Mouse, Goofy, and Pluto. He also created *Pinocchio*, *Bambi*, and *Fantasia*. Forty-five years after it was made, *Snow White and the Seven Dwarfs* was a box-office success this past summer. The Disney movies were a delight of our childhood; they still have the power to enchant us as adults.

Walt Disney used a new medium to develop a new art form (feature-

length animated movies) and in the process rediscovered the principles of effective communication. Twenty years earlier, D. W. Griffith helped make film an art form with *Birth of a Nation*. Both Disney and Griffith seized a new technology; in so doing, each rediscovered, or at least reapplied, fundamentals of communication.

"What," I am sure you are asking, "does that have to do with computers and writing friendly software?"

Computer software is a new medium, and writing easy-to-use software consists of treating it as a communications task. Software designers can learn from professional communicators such as writers, filmmakers, advertisers, and salesmen by examining the techniques they use and applying these techniques to software development. Visicalc uses many of these principles, as does Wordstar, the Xerox Star, and Apple's Lisa.

My main objective in the book from which this article is taken is to identify these principles and offer examples from prose, film, advertising, and successful software such as Visicalc and Wordstar. Software writers can learn by studying the formative stages of a communication art form

as well as the principles used in its mature stages. After all, we are in the formative stages of developing user-oriented software.

As I was finishing the manuscript for my book, I read *Disney Animation, the Illusion of Life* by Frank Thomas and Ollie Johnson (Abbeville Press, 1981). The authors, Disney studio animators from 1935 until they retired in 1978, wrote this book to record how the great Disney films were made. They describe the thought processes that go into creating an animated film, the atmosphere in which those great films (*Snow White*, *Fantasia*, *Bambi*, and others) were created, and much more.

For anyone seriously interested in designing user-oriented software, this book is must reading because it tells you how to think about communications. So much of what the authors say about creating animated cartoons is directly applicable to writing user-oriented software; a review of some of its high points serves to provide insights into what makes communication effective.

Disney Animation tells the story of the invention of an art form and the rediscovery of the principles of communication and theater. It is a constant iteration of those principles. Its authors, who are artists rather than

This article is taken from the book *The Elements of Friendly Software Design* by Paul Heckel, which is scheduled to be published by Warner Books in February 1984.

writers, show by the interest and excitement they arouse in the reader that they have mastered the principles of communication and that these principles are universal. It is worth reviewing here some of the fundamentals they discuss.

Make It Interesting

First and foremost, every scene and every sequence of a Disney film had to be interesting. A dull sequence would always be revised or eliminated and was never left in because it was needed for continuity. If in designing software we exerted one-tenth the effort that Disney did just to make his films interesting, our software would improve tenfold. (In an effort to avoid using repeatedly the awkward construction "Walt Disney and his artists," I use the word Disney throughout this article. When referring to Walt Disney specifically, I will use his first name.)

Disney storymen and animators constantly looked for "a piece of business" that would bring a character to life and make it interesting. A character never simply walked from one place to another: too dull. He might be angry and show it in the way he walks; he might drag something along; he might scratch his head. But he would do some piece of business that was in character, advanced the story, and was interesting.

The concept of a piece of business was new to me. Yet having software let you know that something is happening by displaying a piece of business is a good technique. It is far better than having the user stare at a blinking cursor and wonder whether his program is working or not. With Quickview Systems software you get a piece of business when a long message is displayed. Characters on the left side of the screen are deleted as new characters are brought in from the right side. This display technique is unusual and gives a certain personality to the software.

Exaggerate Reality

Early animators discovered that two related keys to making a character interesting are exaggeration and caricature. Reality must be the start-

ing point: it is necessary to identify the essence of an animal or a person, and at Disney this was researched in great detail. Once the essence of a character was identified, it was caricatured and its movements were exaggerated. This made the character more interesting than the real one it was based on. Thomas and Johnson point out that this is true of all art. Michelangelo's David is not proportioned like a real human being, nor is Disney's Bambi proportioned like a real deer. Bambi may be deceptively similar to the deer we know, but it is designed so that the animator can exaggerate its actions and thus make it fascinating. (The most difficult characters to animate are human ones such as Snow White. The animators' dilemma is that an accurately drawn human character is difficult to make interesting, but the audience won't identify with a character that is a caricature.)

Software is a visual medium; we should resort to words as a last resort.

This, too, was a useful insight. It suggests that the software designer's objective should not be to *accurately* model something the user is familiar with. For example, Visicalc provides an exaggerated spreadsheet, 254 rows of 64 columns, while a normal spreadsheet is approximately 15 by 50. Similarly, automatic calculation is an exaggeration of something that is done on a real spreadsheet. In both these Visicalc examples, the spreadsheet is used as a starting point, and a basic aspect of it is exaggerated. This combination of familiarity and showmanship gives the product its value.

Think in Visual Terms

From the earliest stages of a Disney film, the story was presented visually through sketches. "Walt usually left out the dialogue until a sequence had been developed to the point where he could see just how little was really needed. If the idea could be communicated with an expression, an action or a sound effect, or with music, he

would not use dialogue. The storyman had to think in visual terms first, and when he did write dialogue it had to tell something about the character and not be merely exposition," say Thomas and Johnson. The authors quote director Alfred Hitchcock with approval: "When we tell a story in cinema, we should resort to dialogue only when it is impossible to do otherwise."

Software also is a visual medium; authors should resort to words as a last resort. In designing user-oriented software, you start out with a blank screen to fill, just like a filmmaker. I think of filling it the same way—with pictures. Commands come later and then only to support the pictures.

Prepare the Audience

Walt Disney used several techniques to focus the audience's attention where he wanted it. These techniques seem particularly appropriate to friendly software design.

First, staging is considered carefully. How should a particular scene be shown? Should it be indoors or outdoors? What is in the background? Which characters should be in it? How should they be arranged? Should it be a frontal shot, a side shot, a down shot, or a moving shot? Should it be a long shot or a closeup? The major consideration in any part of a film is always what is the most effective way to communicate the desired image to an audience.

Software is staged, too. How should information be structured on the screen? I think it would be useful to think of software as consisting of a series of scenes, each of which needs to be staged appropriately. Much software staging is ill considered; the rest is unconsidered.

Walt Disney used an old theatrical principle—anticipation. Before an actor does something, he first telegraphs what he is about to do. Before a Disney character would jump, for example, he would first bend his knees in preparation. This readies the audience for what will happen so it is not taken completely by surprise. A related technique, slow in and slow out, is used when going from one pose (or extreme) to another. The

"dBASE II® is far, far better than a shoehorn."

*Rusty Fraser
President
Data Base Research Corp.*

"We laughed when our customers asked us to put our minicomputer-based real-time accounting system, The Champion™ on a micro.

"No way was it going to fit, we thought.

"We'd have to create our own database management system and, even then, it'd be a tight squeeze.

"Then we discovered dBASE II, the relational database management system for microcomputers from Ashton-Tate."

"dBASE II was a perfect fit."

"dBASE II is a program developer's dream come true. The dBASE II RunTime™ module quickly provided us with the powerful text editing, data entry speed and other 'building block' capabilities we needed to develop and deliver a new Champion to our customers—the leading real-time on-line accounting system available for a micro."

The short cut to success.

The dBASE II RunTime module has helped a lot of program devel-

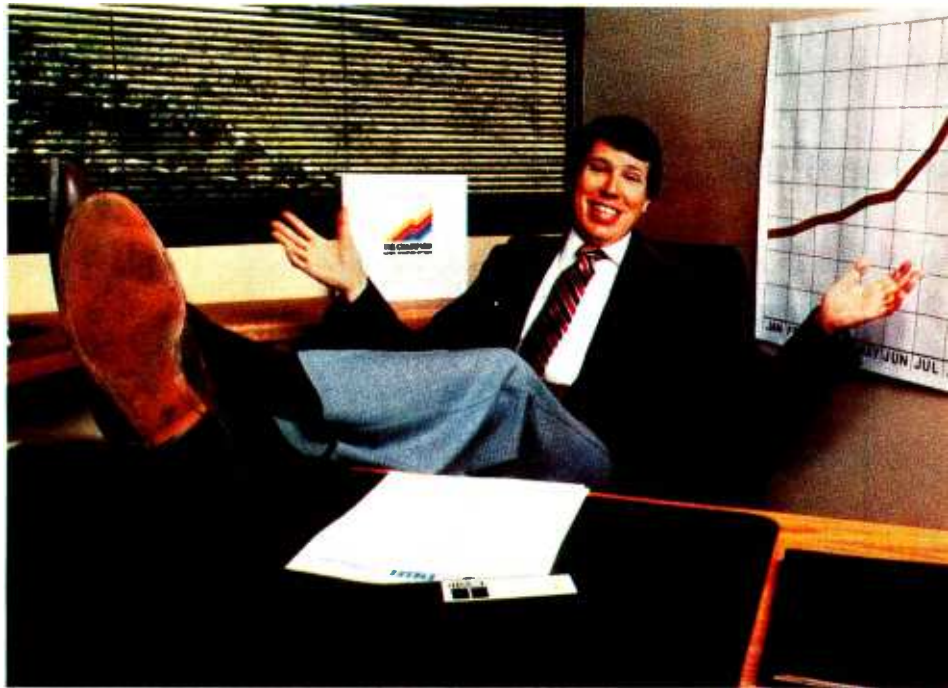

opers like Data Base Research become successful software publishers.

For more about dBASE II and RunTime, contact Ashton-Tate 10150 West Jefferson Boulevard, Culver City, CA 90230, (800) 437-4329, ext. 212. In the U.K., call (0908) 568866.

For more about The Champion, call Data Base Research at (303) 987-2588.

ASHTON · TATE 

See us at Comdex Booth #3554 & #3654.

dBASE II and RunTime are registered trademarks of Ashton-Tate.
The Champion is a registered trademark of Data Base Research Corporation.
©Ashton-Tate 1983.

LOOK NO FURTHER!
we'll get you low
prices and fast
service, or else!



ALPHA OMEGA

COMPUTER PRODUCTS

COMPUTERS

CORONA Desktop, 128K, 2-320K Drives, Monitor.....	\$2695
CORONA Portable (same as above).....	2645
ROMAN 64K Apple compatible.....	575
IBM PC Systems.....	Call
KAYPRO II Portable.....	Call

DISKETTES

SCOTCH 3M SSDD.....	\$23
MAXELL MD2 DSDD.....	39

PRINTERS

C. ITOH 8510 P. 120 cps.....	Call
EPSON FX80 160 cps.....	Call
EPSON FX100 160 cps.....	695
OKIDATA Microline 92 160 cps.....	475
OKIDATA Microline 84 200 cps.....	1035
GEMINI 10 100 cps.....	269
DELTA 10 160 cps.....	Call
GEMINI 10X 120 cps.....	Call
JUKI L/Q 18 cps.....	Call
DYNAX DX15 L/Q 13 cps.....	569
PRINTER Pal.....	24

MODEMS

HAYES Smartmodem 300.....	\$209
HAYES Smartmodem 1200.....	495
HAYES Smartmodem 1200B.....	449
HAYES Micromodem II.....	265
ANCHOR A. Mark I.....	81

MONITORS

TAXAN 12" Amber.....	\$125
GORILLA 12" Green.....	85
USI P13 12" Amber.....	145
AMDEK 300G 12" Green.....	135
AMDEK 300A 12" Amber.....	145
AMDEK Color I 13".....	275
AMDEK Color II 13" RGB.....	419
BMC 13" Color.....	219

APPLE PERIPHERALS & SOFTWARE

VIDEX Videoterm 80C.....	\$219
VIDEX Ultraterm.....	289
MICROSOFT 16K RAMcard.....	69
MICROSOFT 280 Softcard.....	245
MICROSOFT Premium Pack.....	479
MICROSOFT Premium Softcard IIE.....	345
KRAFT & TG Joystick.....	45

HAYES Mach II Joystick.....	29
QUENTIN Applemate Drives.....	233
LAZER 1/2 Height Drives.....	229
WIZARD BPO 16K Buffer Int.....	139
PROMETHIUS Versacard.....	149
EPS Keyboard.....	289
KENSINGTON Systemsaver.....	68
KOALA Pad.....	99
PFS Filing System.....	81
PFS Report.....	81
DBase II.....	389
Wordstar.....	249
Home Accountant.....	69
Multiplan.....	179
DB Master Version 4.....	249
DB Utility 1 or 2.....	95
Magic Window II.....	115
Zaxxon.....	29
Choplifter.....	25
Zork I/II/III.....	28
Wizardry.....	39
Sublogic Pinball.....	27

IBM PERIPHERALS & SOFTWARE

TANDON TM55-2 Thin Line.....	\$235
TANDON TM100-2.....	235
SHUGART 1/2 Height.....	235
MICROSOFT Mouse.....	145
QUADRAM Quadboard w/64K.....	275
QUADRAM Quadlink.....	489
QUADRAM Quadcolor I.....	215
64K RAM Kit 200 ns.....	55
KRAFT & TG Joysticks.....	46
HAYES Mach II Joystick.....	29
CORONA Int. 5MB Hard Disk.....	1545
Property Management.....	335
Home Accountant +.....	105
Volkswriter.....	119
PFS Filing System.....	93
PFS Report.....	81
Lotus 1,2,3.....	Call
DBase II.....	389
Friday.....	199
Wordstar.....	279
Multiplan.....	169
Flight Simulator.....	33
Deadline.....	38
Zork I/II/III.....	28

Hundreds of available items. Call for complete pricing information.

We do not charge for VISA or MASTERCARD.

(213) 345-4422



4847 La Montana Circle, Tarzana, CA 91356

All products are in factory sealed packages. We guarantee all items for 30 days. Within this period, defective merchandise returns must be accompanied by RMA number. All other returns will be subject to a 10% restocking fee. For prepaid orders there will be a 3% shipping charge; 5% for UPS Blue Label; \$5.00 minimum; all orders outside U.S. at 15% shipping. There will be an additional \$4.00 surcharge on C.O.D. orders. Cash or Cashiers Check is required on C.O.D. orders. Calif. residents add 6.5% sales tax. Prices subject to change without notice.

character moves slowly at first, then speeds up, then slows down before settling into the next pose.

Any time a software designer wants to move the user's focus of attention from one place to another, a "slow out" can get the user to anticipate the general direction of the new focus. A "slow in" draws the user's eyes to the new focus of attention. For example, with Wordstar I sometimes use a FIND command to locate a particular text string and lose sight of the cursor on the screen. An inexperienced user would have more trouble. The slow-out/slow-in technique might reduce that problem.

Don't Crowd the Screen

Whenever more than one thing is on the movie screen, the audience usually gets confused. Walt Disney and his animators were always concerned about identifying the essence of what should be communicated in a scene and determining the minimum needed to say it. Every scene had to be communicated clearly. Backgrounds, for example, were designed so they didn't distract the audience from the action. Secondary actions in a scene always reinforced the primary action. Thus, for example, if the main action was a character picking a flower, other characters in the scene looked or pointed in the direction of the flower, focusing the audience's attention on the flower. Action was always staged so it was easy to see and not obscured by some other aspect of the scene.

A major problem with many computer screen displays is that they show too much. This indicates laziness on the program designer's part. Instead of finding what is important to the user and showing only that, he shows everything and expects the user to find what he needs. The user is often overwhelmed; what he needs is often not clear to him. This can be particularly serious for the new user and an annoying problem for the experienced user. Software must be simple, clear, and easy to understand.

Involve the Audience

Audience rapport was important to

HOW DOES 1 = 50?

With **SUPER STAR**... The First S-100 Computer
To Use a 5 MB Removable Cartridge.



Advanced Digital's new **SUPER STAR™** is the first of a family of S-100-based computer systems to be equipped with a 5-1/4" 5-MB Fixed/5-MB Removable Cartridge Winchester disk drive (10 MB on-line storage capacity) as standard. Now you can have the capacity of up to 50 floppy diskettes and the speed and convenience of 100% backup using the industry-standard Dysan 5-MB cartridge.

SUPER STAR is the ideal system for business, professional, and educational applications. Its CP/M* operating system (standard) gives you access to a vast library of readily available software programs. The six-slot motherboard allows plenty of room for expansion.

And as your business grows, **SUPER STAR** can grow with you. If you need more memory, just plug it in. **SUPER STAR** is based on the S-100 IEEE standard. To add more users, simply add Advanced Digital's **SUPER SLAVE™** processor boards

and TurboDOS* operating system. Now you've got an extremely powerful, multi-user, multi-tasking, multi-processing **SUPER STAR** computer system for up to four users.

SUPER STAR is truly a Super computer system. Look at these outstanding features:

- New Slim-Line Profile
- 5-1/4", 10-MB Winchester Disk Drive, 5-MB Fixed, 5-MB Removable Cartridge
- 5-1/4", Half-High, 48TPI Floppy Disk Drive (Osborne Format Compatible)
- Six Slot Motherboard

- Switch-selectable 110/220V Power
- Up to 4 Users With **SUPER SLAVES** And TurboDOS
- CP/M Operating System Standard
- One Year Warranty

SUPER STAR is the perfect system for applications requiring large data storage capacity, speed, performance, reliability, and dependable, convenient back-up capability. And at a suggested retail price of \$5,000, **SUPER STAR** is a **SUPER VALUE**.

See the entire Advanced Digital product line, including the new **SUPER STAR**, at your local, quality computer dealer or contact:



5432 Production Dr.,
Huntington Beach, CA 92649
Phone: (714) 891-4004
Telex: 4722065 ITTSCSMA

*CP/M is a trademark of Digital Research Corp.
TurboDOS is a trademark of Software 2000 Inc.

SUPER STAR, **SUPER SIX**, **SUPER SLAVE** are trademarks of Advanced Digital Corp.

For European Distributor, contact: (714) 891-4004

See us at Comdex booth #378 and #481. See us at Compec '83, in Sitron Computer booth #9137.

Disney animators, Thomas and Johnson write. "We involve the audiences in our films. . . . We start with something they know and like. This can be either an idea or a character, as long as it is familiar and appealing. It can be a situation everyone has experienced. . . . But there must be something that is known and understood if the film is to achieve audience involvement."

Dave Hand, a Disney animation director, described his craft this way: "Our entire medium is transference

of thought. The thought is created first in the mind of the storyman . . . then transferred to the director, who attempts to transfer it to the animator. . . . The animator then attempts to transfer it pictorially. He takes out the intangible and places it in tangible form, in picture, for transference back to the mind of the audience . . . and picture presentation is clearer than any other means of transferring thought from one person to another."

Software designers should use the

same approach as Disney animators: involve the audience, start with something they know and like, and keep it familiar and appealing.

A Case in Point: Visicalc

Using an application program also involves the transference of thought. The software designer starts out with an idea of what a program must do. But for the program to be effective, the designer must transfer to the user the concept of what the application program can do. Visicalc serves as an excellent example. The designers, Bob Frankston and Dan Bricklin, had an idea for a new type of electronic spreadsheet. But to be successful it had to make sense to the program's potential users. Several techniques were employed to accomplish this task. First, the authors used a window to display only part of the spreadsheet on the screen. Second, the user can examine different parts of the spreadsheet by moving the cursor, much the same as a movie camera pans a scene too large to be taken in one static shot. Third, the designers selected formulas (e.g., SUM) and user commands (e.g., REPLICATE) that implemented operations similar to those done on paper spreadsheets. These techniques reinforce in the user's mind the image of a large spreadsheet.

The Animation Development Process

Disney's early animated shorts took only a few months to make. It was only after Walt improved his techniques of animated filmmaking and tackled full-length feature movies that the importance of planning and research became apparent. A typical Disney feature film took three and a half years to make: six months of research; one year of work on the story, styling, and experimenting; one and a half years of animation; and six months of follow-up to add color and music and photograph the 460,000 drawings that made a finished film. The making of a Disney movie was a constant process of prototyping, revising, and rewriting. The organization and the development

EXCEL SYSTEMS CORPORATION'S UNLIMITED WARRANTY

RESULTS

At Excel Systems we set our standards very high – to help you meet yours. We want to raise your expectations, your goals, and your effectiveness. We produce Software designed by real people for the real world.

ARIS Action Resource Information System is the *work processor* that leads you to success. ARIS organizes your needs, your priorities, and your activities, and goes on to create a more effective you in *action*. ARIS dials your calls, writes your letters, confirms your meetings, and prepares your schedule. ARIS prompts you to add personal, professional touches, for a style that gets noticed. ARIS is the new era of software – here for you today.

ARIS is results!

DECIDE Today's world demands clear decisions. How well you solve problems determines how good you feel and how well you perform. DECIDE is your personal counselor, leading you through a short series of processes to resolve your problem.

DECIDE is results!

PROTYPE Without effective keyboard skills you'll never harness the full power of your desktop computer. With PROTYPE you develop professional typing speed and accuracy in private, in a few weeks.

PROTYPE is results!

MNU Tired of searching through disk directories for your favorite programs and giving your computer endless commands? Create a master menu that lets you move in and out of programs with a single keystroke. Design reminders and use instructions that really work because you wrote them. And, you decide where they appear. MNU isn't for programmers, it's for you!

MNU is results!



655 Redwood Highway, Suite 311, Mill Valley, California 94941
Ask your Dealer to demonstrate the entire EXCEL SYSTEMS line for you.

PIECE OF MIND

The System 816.

The fastest, most cooperative computer you can buy.

OEMs and systems integrators are busy people. Too busy to waste time with an uncooperative computer system. That's why every System 816 from CompuPro is built to work long and hard without a whine or a whimper.

More Dependable.

With ten years of pioneering successes built into it, the System 816 is backed by the industry's longest warranty coverage. Depending on your needs, our warranties range from 12 to 36 months. Most other computer manufacturers expect you to be satisfied with 90 days, which typically covers parts only.

You can also depend on complete hardware and software support, flexible configurations and upgrades, and system training.

More Powerful.

The System 816 squeezes more performance out of the IEEE-696/S-100 bus than any other system you can buy. A choice of CPUs—and up to 4 Mbytes of our exclusive M-Drive/H™ RAM disk—give multiple work stations all the speed and power they can ask for. Standard RAM memory is expandable to one megabyte or more.

Disk storage capacity ranges up to 4.8 Mbytes on floppy drives and as much as 320 Mbytes per controller on hard disk.

CompuPro®

A GODBOUT COMPANY

3506 Breakwater Court, Hayward, CA 94545

CP/M and CP/M-86 are registered trademarks and CP/M-68K, MP/M-86, Concurrent CP/M-86 and FORTRAN 77 are trademarks of Digital Research Inc. CP/M 8-16 and MP/M 8-16 are compound trademarks of Digital Research Inc. and CompuPro.

Circle 93 on inquiry card.

More Versatile.

All family members share a common modular architecture. So it's a simple matter to upgrade or reconfigure any of them to keep up with your needs. All the while maintaining complete software compatibility up and down the line.

And the S-100 bus allows you the flexibility to plug in any compatible board to add graphics capabilities or boards for your own unique applications.

You also get your choice of operating environments, including CP/M® CP/M-86®, Concurrent CP/M-86™, MP/M-86™ and CP/M-68K™, and our own CP/M®8-16™ and MP/M™8-16™.

At the programming level, the

System 816 family supports Pascal, C, FORTH, BASIC, COBOL, PL/1, FORTRAN 77™ and more.

More Information.

Your customer's satisfaction is important to both of us, so don't get stuck with a system that's more of a hindrance than a help. Send in the coupon and find out what peace of mind is all about.

For business, scientific and industrial computing solutions, call (415) 786-0909 ext. 506 for the location of our dealers worldwide, or the Full Service CompuPro System Center nearest you.

- Send me your free System 816 brochure.
 Send me the name of my nearest Full Service CompuPro System Center or dealer.

NAME _____
TITLE _____
ADDRESS _____
CITY _____ STATE _____ ZIP _____

Mail to: CompuPro, Attn: Sales Dept.
3506 Breakwater Court, Hayward, CA 94545

Prices and specifications subject to change without notice.
System 816 front panel design shown is available from Full Service CompuPro System Centers only. ©1983 COMPUPRO

process were designed to facilitate this operation.

Throughout the development stage, everyone got to see a more and more complete version of the final film; they could relate what they had done to the whole and better see what needed revision. They could see what worked and what didn't work. Woolie Reitherman, a Disney animator, explained, "Many ideas that sounded great in those story meetings become sodden and lifeless when seen on the screen in relation to the rest of the business, and the sooner these elements can be discovered the sooner they can be corrected. Many other story ideas that were only 'touches' will come to life in animation with so much entertainment that it is foolish not to get the full value from them, even if it means adding considerable footage."

This is not an entirely smooth process; it is not supposed to be. Its purpose is to bring out what works and what doesn't work, the problems and the pleasant surprises, and to do it as early as possible. For example, if a particular animation sequence runs longer than the music scored for it, the composer might add another half-measure. If a particular sequence does not work as expected, it has to be redone or abandoned.

The Software Development Process

Program designers, like Disney animators, have had to improve their technique for producing personal-computer software. When microcomputers first became popular, the early

applications programs were relatively simple and required only a few months to write. But contemporary software such as Wordstar or Visicalc required more than a year's effort to produce. This trend has continued; Visi On and the newest software for the Lisa computer required a dozen or more programmers working for two to three years. With software becoming more sophisticated and users becoming more demanding, the development process will continue to take more time and effort.

Much of the best software has developed as a result of evolution. Many programs originate as a prototype to test the practicality of an idea. Visicalc was first prototyped in a BASIC program before it was developed into a consumer product. Some software is an improved version of an earlier product. Wordstar, for example, is based on the earlier Wordpro word-processing package.

In developing software at Quickview Systems, we start out with a primitive version of the product, similar to story sketches for a Disney film. We repeatedly test and modify the program to see how it "plays" in both formal and informal testing. We see what works and what doesn't and change the software to best reflect what we think it should do. This procedure allows our rough prototype to change into a final polished product.

Make the Best Guess

Disney created a set of tools that helped make films, just as software companies have developed a great

many tools to help make software. Some of Disney's tools were designed to ensure a quality product; studio management tools were designed to keep track of progress and ensure that all the details merged together correctly. But the main purpose of these tools was to enable studio workers to make a "best guess" of what the audience's experience would be. Everyone could quickly adjust his work to the reality and see the results of the adjustment. To develop quality software, designers need a similar environment that will give them the best guess of what the audience's experience will be.

Try Again

The final lesson that Walt Disney can teach us may be the most important. Hemingway, Frank Lloyd Wright, Beethoven, and Picasso couldn't get things right the first time. Walt Disney couldn't, either. And no software designer can get the user interface right the first time. But by carefully analyzing what the user needs and following the precepts that Walt Disney rediscovered, you can raise your software designing to a commercial art. ■

Paul Heckel is the founder and president of Quickview Systems (146 Main St., Suite 404, Los Altos, CA 94022), which develops software products for notebook and other small-screen computers. He has designed several user-oriented products, including the Craig M-100 Language Translator. He has 20 years' experience in developing software and holds a B.S. degree in electrical engineering from MIT and an M.B.A. from Stanford University.

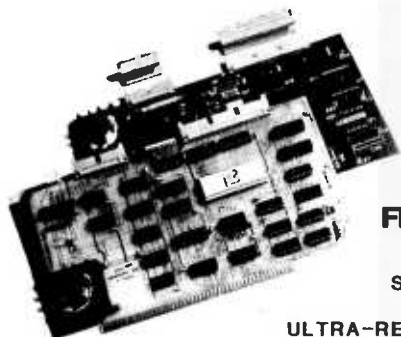

ULTRA-RES™ GRAPHICS

IEEE-696 S-100

IBM-PC

- 1 X 512 X 512 \$495
- 3 X 512 X 512 \$1250
- 1 X 1024 X 1024 \$995

- 1 X 512 X 512 \$495
- 1 X 1024 X 1024 \$995
- CONSOLE EMULATOR \$50
- 2D DRAFTING SOFTWARE \$200
- PLOT 10 \$150

FEATURES

Software drivers, Hardware zoom, Programmable Display Resolution, Windowing, Multi-Controller Capability, NEC UPD7220 Graphic Controller

Starting Prices

ULTRA-RES Trademark CSD Inc.
IBM-PC Trademark IBM

C.S.D. Incorporated
P.O. BOX 253 Sudbury, MA 01776
(617) 443-2750

Why buy an IBM® XT when you can buy an IBM PC or compatible, our Pegasus XT Conversion Kit™ and save yourself almost \$1,600?

For \$1,295 you can buy our internal 10 megabyte hard disk system installed in an IBM PC or compatible of your choice.

Think about it. When you consider buying an IBM XT or XT look-alike, you're after large storage, the convenience of IBM compatible software, and the peace of mind associated with a quality product. But one thing you're not looking for is paying more than you have to.

XT expansion chassis, we have a surprise for you. If you add the \$1,295 cost of the Pegasus XT Conversion Kit to the \$2,104 price of an IBM PC, you can have a second computer — instead of a dumb box — for less than the price of the XT expansion chassis.

vances in hard disk technology. Our controller card will work with our 10 megabyte hard disk all the way up to our 140 megabyte hard disk — and everything in between. With the IBM XT controller, you're limited to four manufacturers. The Pegasus controller board, on the other hand, configures to whatever hard disk you may want to install in the future. There is virtually no limit on hard disk size or number of manufacturers you can use.

Hard Disk Quality

Now, before you start thinking that IBM's hard disk is better than ours, remember that IBM doesn't make their own hard disk for the IBM XT. They go into the marketplace, just like we do, and strike the best price they can. If you were to buy an IBM XT, your hard disk might come from one



The Savings

If you buy an IBM XT, it's going to cost you \$4,995 for the XT system unit. You'll get 10 megabytes of hard disk storage, one 320 Kbytes floppy disk drive, 8 slots, a \$120 asynchronous communication adaptor, 128K of RAM and the three IBM initials.

We recommend instead, that you buy the IBM PC for \$2,104. You'll get one 320 Kbyte floppy disk drive, 5 slots, 64K of RAM, the same three IBM initials, a space for your dealer to put the Pegasus XT Conversion Kit, and an extra \$2,891 to buy it with. But since the Pegasus XT Conversion Kit costs only \$1,295 installed, you'll have an extra \$1,596 — almost \$1,600 — left over. With many compatibles you'll have even more.

But if you already own an IBM PC and were thinking you'd just get the



of four manufacturers. It's possible, in fact, that the IBM XT might have the same hard disk that you'd get in our Pegasus XT Conversion Kit.

The Role of the Controller

But the hard disk is not the whole story. It takes a controller card to get your files from the hard disk to your computer so you can use them.

The IBM XT has a good controller card. Unfortunately, it is not designed to take advantage of some of the ad-

Larger Disks

Pegasus offers an entire line of hard disks. You can expand your IBM PC far beyond the storage of the IBM XT. You can add our 23 megabyte hard disk for only \$1,995, or our 40 megabyte for only \$500 more. And if you really need storage, we offer a 65 and 140 megabyte hard disk that slides right into the same space that IBM and the compatible manufacturers put their 10 megabytes.

So, before you decide to spend more money than you have to, consider the Pegasus XT Conversion Kit. You'll get dealer support, the same 90 day warranty IBM gives, and have enough money left over to buy one of our larger hard disks. And isn't larger storage why you were looking at the hard disk in the first place? Contact your computer dealer today.

PEGASUS

A DIVISION OF

**GREAT LAKES
COMPUTER PERIPHERALS, INC.**

2200 West Higgins Road, Suite 245
Hoffman Estates, Illinois 60195

IBM is a registered trademark of International Business Machines, Inc. XT Conversion Kit is a trademark of Great Lakes Computer Peripherals, Inc.

In Illinois (312) 884-7272
800-323-6836
Dealer Inquiries Invited

**WE UNLEASH THE
POWERFUL GRAP**



THE WORLD'S MOST PHYSICS TECHNOLOGY.

You'll never see Infocom's graphics on any computer screen. Because there's never been a computer built by man that could handle the images we produce. And, there never will be.

We draw our graphics from the limitless imagery of your imagination—a technology so powerful, it makes any picture

that's ever come out of a screen look like graffiti by comparison. And nobody knows how to unleash your imagination like Infocom.

Through our prose, your imagination makes you part of our stories, in control of what you do and where you go—yet unable to predict or control the course of events. You're confronted with situations and logical puzzles the like of which you won't find elsewhere. And you're immersed in rich environments alive with personalities as real as any you'll meet in the flesh—yet all the more vivid because they're perceived directly by your mind's eye, not through your external senses. The method to this magic? We've found the way to plug our prose right into your psyche, and catapult you into a whole new dimension.

Take some tough critics' words about our words. SOFTALK, for example, called ZORK® III's prose "far more graphic than any depiction yet achieved by an adventure with graphics." And the NEW YORK

TIMES saw fit to print that our DEADLINE™ is "an amazing feat of programming." Even a journal as video-oriented as ELECTRONIC GAMES found Infocom prose to be such an eye-opener, they named one of our games their Best Adventure of 1983.

Better still, bring an Infocom game home with you. Discover firsthand why thousands upon thousands of discriminating game players keep turning everything we write into instantaneous bestsellers.

Step up to Infocom. All words. No graffiti. The secret reaches of your mind are beckoning. A whole new dimension is in there waiting for you.

(For more information on Infocom games contact: Infocom, Inc., P.O. Box 855, Garden City, NY 11530.)

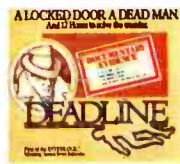

INFOCOM™

The next dimension.

For your: Apple II, Atari, Commodore 64, CPM 8; DEC Rainbow, DEC RT-11, IBM, MS-DOS 2.0, NEC APC, NEC PC-8000, Osborne, TI Professional, TI 99/4A, TRS-80 Model I, TRS-80 Model III.

Circle 227 on inquiry card.

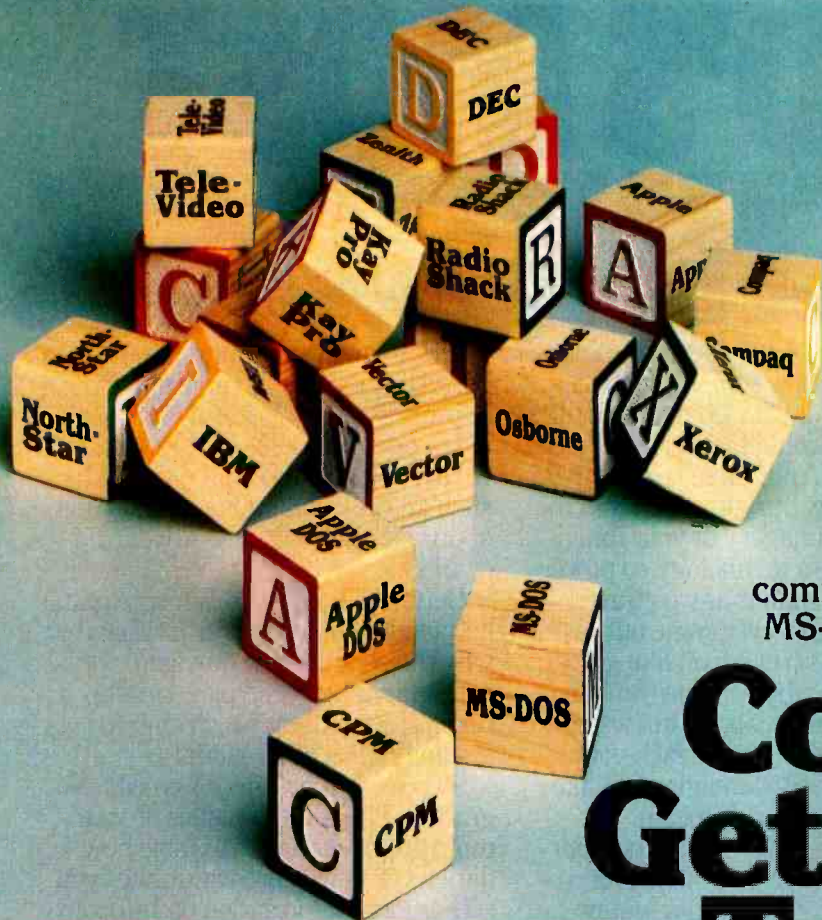

It's as simple as A B C . . .
 Converse offers you a very versatile, packed-with-features, communications package for CP/M, MS-DOS and Apple DOS systems.

Converse™ Gets Them Together

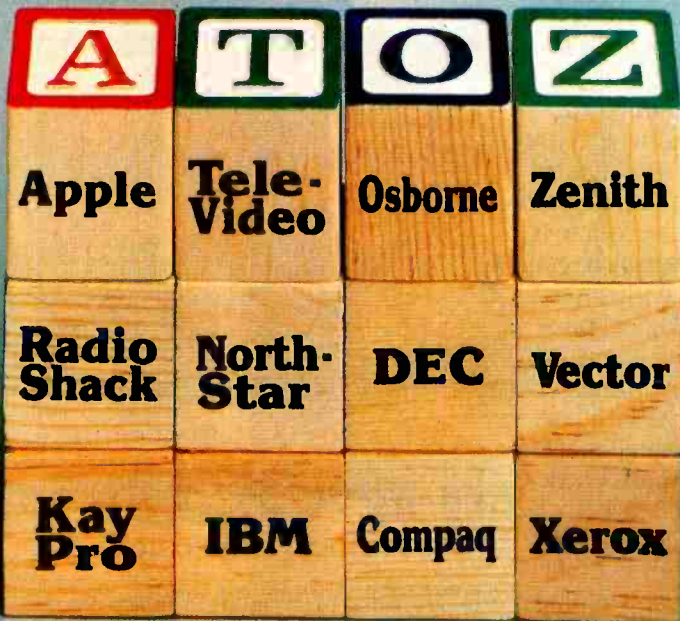

Converse is a unique file transfer and telecommunications program for the non-technical as well as the professional user.

Converse features include:

- Compatible with auto-answer and auto-dial modems
- Terminal Mode operation with data capture option
- Error detection with automatic retransmission
- Remote operation mode
- Multiple file transfer with wild card option
- Status display
- Display of transmitted data stream in ASCII or HEX
- Completely menu driven for non-technical user
- Flexible software interface
- Multi-CPU licensing agreement

Ideal for multi-computer environments: dealers, software developers, clubs and schools. Whether you own Apple, IBM, Osborne or any other personal computer, Converse is the vital communications link that gets them together.

Disk and manual configured for Apple Dos, CP/M or MS-DOS \$145.00.

For any two of the above operating systems \$195.00. Order your Converse today.

Order Desk: (609) 854-5228 Technical Information: (609) 854-5234

PROFESSIONAL SOFTWARE PRODUCTS

Sentry Plaza Office Bldg. / 216 Haddon Ave. Suite 503 / Westmont, NJ 08108

Circle 352 on inquiry card.



Making Life Easier for Professional and Novice Programmers

A visual programming technique simplifies program development

by Andy Pope, Geoff Kates, and Dan Fineberg

When the first microcomputers appeared on the market, most programmers coded their applications in assembly language because of limited memory (less than 64K bytes) and the need to optimize code for speed of execution. The first debugging programs, designed for assembly-language programs, came from semiconductor and operating-system vendors. These products let programmers single-step through a program, set software breakpoints, display and alter central-processor registers and system memory, and regain control of a system after an error caused by a program.

The next level of debugging included the ability to symbolically debug a program. Programmers no longer had to set breakpoints at machine addresses; breakpoints could be set at either a particular line in the program or at a particular name in the program. In addition, conditional breakpoints became more widespread, meaning that a program could be stopped when a condition was met, such as when a variable equaled a certain value.

Writing programs in assembly language was fine in the 8-bit world when only a limited number of microprocessors (e.g., the 6502 and the Z80) and operating systems (e.g., Apple DOS and CP/M) were prevalent. But the arrival of 16-bit micro-

computers made the use of existing high-level languages more attractive for several reasons. First, 16-bit microcomputers run faster and have less severe memory constraints. Second, a greater variety of microprocessors (the 8086, Z8000, 68000, and 16032) and operating systems (CP/M-86, MS-DOS, Unix, Oasis, etc.) make the transfer of software among different machines virtually impossible in assembly language but relatively sim-

As computer users and programmers rely more on screen icons, menus, and color graphics, they will be using their minds in a different way.

ple in high-level languages. The latest trend shows C to be the language of choice for systems software (because it is closest to assembly language); C and Pascal for word processors, spreadsheets, and database-management systems; and COBOL for the vast majority of business applications (see "Why COBOL for Business Application Development?" on page 158).

The next logical step moved the debuggers from operating at the assem-

bly-level language source level to debugging at the high-level language source level. The first such products simply took the various assembly-level capabilities and transferred them to the high-level languages. Although a great improvement, these products did not provide the necessary user interface for a truly productive program-development environment.

Visual Programming Tools to Improve Productivity

We studied the features needed to make debugging tools more user-friendly and productive. With the previous debuggers, only two ways existed to trace the flow of a program. The single-step method proves to be laborious with a large program. The second method sets breakpoints, creating a problem because a programmer knows only that the program has reached a defined point from a previously defined point; the interim remains a mystery.

Another important debugging issue was developing a "what-if" capability to enable programmers to simulate various scenarios. Other critical areas were the screen-handling capability and more flexible breakpoint handling.

Visual Programming

So far, the quest for more effective

Micro Focus Programming Tools

To help increase programmer productivity and reduce the toil involved in writing and debugging a COBOL program, Micro Focus has developed a variety of visual programming utilities. The Animator program solves COBOL debugging problems in a flexible manner. Animator lets a user actually watch a program execute on the screen. As each statement executes, the cursor moves to the next statement. A user can watch the flow of the program as it is executed or "animated." Nine different execution speeds are available, and the speed can be set before the program is animated or altered during the animation. This animation is stopped either by a command or when a breakpoint is reached. Normal full-speed execution is allowed. In addition, another command allows execution until an IF statement is reached, allowing the user to do what-if experiments when the program branches.

Another desirable feature for program debugging is flexible screen-handling. Too many debuggers let the user scroll up and down the screen only one line at a time. Animator is very flexible in this area. Screens can be scrolled up or down for either a partial or complete screen at a time. In addition, the user can jump to the start or end of a file with a single command.

One of the nicest features supported is split-screen operation. Two independent areas of the program can be worked on at the same time. Only the area where the cursor is positioned is "active." In addition, either window can be enlarged at the expense of the other.

It is sometimes necessary in debugging a program to find a variable in the source code and then monitor it as a program is running. Rather than search through the code line by line trying to locate the particular variable, Animator lets the programmer use a FIND command to locate the variable. Once the variable has been found, it can be monitored during anima-

tion, so after each line has been executed the new value of the variable is displayed.

Once the problem has been found, code normally has to be changed. In most other environments, the user has to go back to the original source code, alter it, and re-compile it in order to try out the patch. To save this effort, Animator allows the user to instantly compile and execute one or more lines of text. The programmer can check out his patch before altering the source code.

Other Visual Programming Tools

Advances in interactive, screen-oriented programming tools have been concentrated in the world of mini- and microcomputer-based COBOL development. One reason for this is that COBOL is popular in both the data-processing world and the microcomputer world, and these two segments are converging because of the FORTUNE 1000 sales success of microcomputer manufacturers such as IBM, Apple, DEC, and others. COBOL is popular for large and small business-application development because of its strengths for applications that are I/O (input/output) intensive and require heavy data manipulation.

With COBOL, a great deal of time can be spent defining screen input and output. This is a laborious task that can be automated with a forms generator. A forms generator enables programmers to enter the input and output screens they want directly onto the screen. It will produce the COBOL source code required to make the interactive screens functional.

Micro Focus's FORMS-2 is one example of an advanced forms generator. It is menu driven and easy to use. Experience has shown that even nonprogrammers can produce screens after only a few minutes with it. Once FORMS-2 has created a COBOL source file, the file can be incorporated into an application program by using the COBOL COPY command.

left side of their brains more than they normally do in everyday situations. The left hemisphere is, it is thought, the brain's center of language, calculation, and analytical thinking. It works with logic, reason, and the methodologies of computer science.

The right hemisphere is thought to be the visual side of the brain. It is active in visual comprehension, spatial construction, and nonverbal ideas. It works with intuitive thought and artistic creativity.

Recent advances in human interfaces to computers have worked to balance the use of both hemispheres. As a result, we can more intuitively understand and use a computer system and creatively apply artistic concepts through computers.

Interactive use of computers via visual devices not only makes computers more accessible to users but can make programming more productive as well. We'll define productivity as a function of effectiveness, efficiency, and quality. In turn, effectiveness is the ability to meet objectives, efficiency is how much output results from how much input, and quality is the level of satisfaction gained from the product by the customer.

Software tools to make programming more visual can increase a programmer's effectiveness by enabling him to meet more programming objectives. For example, a programmer may use a source-code generator that lets him "paint" interactive screen formats directly onto the screen with the keyboard (see "Micro Focus Programming Tools" on this page). He can automatically create interactive screen-handling programs and develop a more interactive application package. For example, a payroll application can include more interactive input screens and menus for data entry because the displays take less time to create.

Visual programming tools increase a programmer's efficiency by enabling him to get more done in less time or at a lower cost. A debugger that "animates" the program's source code on the screen and lets the programmer engage in what-if analysis

and friendly user interfaces has concentrated on developing new ways for the computer user and the programmer to interact with the system via the screen. The desktop metaphor, mouse, windows, and icons in Apple's Lisa computer provide an excellent example of this emphasis on interactive visual devices.

As computer users and programmers rely more on screen icons, menus, and color graphics, they will be using their minds in a different way. Previously, programming emphasized calculation, codes, and mathematical or verbal symbols. According to current medical theory, computers require people to use the

Plug into 2.5 Mb of additional online storage.



FD-PC81 SINGLE DRIVE UNIT
FD-PC82 TWO DRIVE UNIT

The FD-PC8 is a new 8" double sided disk drive sub-system that adds an impressive 2.5 megabytes of online storage capacity to your IBM PC. Coupled with the 640 kilobyte capacity of the two 5¼" internal drives in your IBM PC, the system gives you enormous data base capability from the moment you plug it in!

IBM PC styling.

The FD-PC8 looks like your other IBM PC components. Same styling. Same color. Same dimensions. It stacks neatly under, on top of, or next to your IBM PC, and better still, is only one-half the height of standard 8" drives.

IBM PC and mainframe compatible.

Total interface capability with both IBM mainframes and PC affords new and unique data base flexibility and computing opportunities to the serious PC user.

Long life design features.

The FD-PC8 utilizes Shugart drives; the standard for quality and reliability in the computer industry. Unlike most disk drives, the motor runs only when selected, greatly increasing the life expectancy of the FD-PC8.



FLOPPY DISK
SERVICES, INC.
741 Alexander Road
Princeton, NJ 08540

Circle 191 on inquiry card.

IBM PC is a registered trademark of International Business Machines Corporation.
Maynard Controller is a registered trademark of Maynard Electronics.
JFormat is a registered trademark of Tall Tree Systems.

SPECIFICATIONS

- Full one year warranty on materials and workmanship.
- Two fully assembled and tested Shugart double-sided 8" drives also available in one drive configuration.
- Direct drive DC motor.
- Exactly ½ the height of standard 8" drives.
- IBM PC styled and painted cabinet.
- All cabling included.
- IBM 3740 format compatible.
- No-mar rubber feet.
- Sturdy construction easily supports PC or monitor.
- Power supply designed for long life, trouble-free operation.

PRICING

FD-PC8 ... dual system/\$1495.00 ... single system/\$1095.00
*Maynard Controller/\$245.00 ... JFormat/\$50.00

*Use of the 8" system requires the Maynard 8" controller and Tall Tree Systems' JFormat™ software, allowing the use of two internal 5¼" drives and the two outboard 8" drives.

Plug into the perfect IBM PC add-on!

For more information about the FD-PC*, call (609) 799-4440.
Or call our toll free order line at (800) 223-0306.
Dealer Inquiries Invited.

Why COBOL for Business Application Development?

In May 1959, a group of computer users and manufacturers met at the Pentagon. They expressed the aim to design a "common business-oriented language (COBOL) independent of any make or model of computer, open-ended and stated both in an English and a narrative form."

This group grew into the Committee on Data Systems Languages (CODASYL), the guiding force behind the evolution of the COBOL language. The first version of COBOL appeared seven months later in January 1960. Now, almost 24 years later, there is more than \$100 billion invested in COBOL applications worldwide.

COBOL, the Business-Oriented Language

For a typical business application such as a general ledger, a programming language is needed that offers the ability to organize and handle large amounts of data and the facility to manipulate this data. For example, a business application developer needs to be able to add, subtract, multiply, and divide, and he also needs the facility to produce reports and printouts in an easy, efficient manner. He does not need the facility to handle matrices and complex mathematical functions as in a scientific application.

These needs have been addressed by

COBOL in several ways. First, approximately half of the language is dedicated to methods of file-handling. For example, a data-file can be accessed as a sequential file (one record following on from the previous one); an indexed sequential file (data can be accessed according to a key field that is contained in each record); or a relative file (a data record can be referenced according to its position in the file). Second, a sort module permits the reorganization of data files according to complex user-defined parameters. Third, COBOL provides simple commands such as ADD, SUBTRACT, MULTIPLY, and DIVIDE.

In addition to these basic features, COBOL offers an easy self-documenting format. A COBOL program looks like English composition, with paragraphs, sentences, verbs, and the ability to use easy-to-understand data names such as TAX REBATE, ACCOUNTING PERIOD, NET PROFIT, and so on. Superimposed upon this is a "dictionary" called the DATA DIVISION that relates the data names to memory locations within the computer.

These features mean COBOL application developers benefit by being able to create programs that are easily understood and can be read by nonscientific computer users, and the applications can provide an easier-to-use human interface.

COBOL Is Standard and Portable

COBOL evolved from the first meeting of the CODASYL committee. The committee still meets six times a year for four days at a time. The CODASYL committee currently has 23 members, which comprises 12 implementors (compiler writers and major mainframe manufacturers) and 11 users. The CODASYL committee produces the COBOL Journal of Development (JOD), which is regularly updated and re-published every two to three years.

Periodically, the American National Standards Institute (ANSI), through the COBOL committee (XJ34), produces a new standard version of the language. This standard was first published in 1968 (ANSI '68 COBOL) and then updated in 1974 (ANSI '74 COBOL). The ANSI standard is derived by examining the current standard and the latest CODASYL JOD and then including new features and removing some old features. The ANSI Committee itself cannot propose features.

ANSI COBOL consists of 12 modules. They are: NUCLEUS, TABLE-HANDLING, SEQUENTIAL I/O, RELATIVE I/O, INDEXED I/O, SORT-MERGE, REPORT-WRITER, SEGMENTATION, LIBRARY, DEBUG, INTER-PROGRAM COMMUNICATION, and COMMUNICATIONS.

Each of these modules, except for

to find logic errors can drastically reduce debugging time. More programs can then be written and stabilized in a given period, and that in turn reduces the cost of program maintenance, the most expensive aspect of large business-application programs.

In addition, programmer satisfaction increases because visual programming removes the laborious elements of application development and enables the programmer to spend more time developing creative solutions to application problems.

Programmers can also operate more intuitively. For example, the what-if analysis that is allowed by the animation technique lets programmers test alternatives freely without the risk of having to rewrite entire blocks of code.

Greater use of intuition and crea-

tive problem-solving means programming can be more fun and less alienating. With the current shortage of programmers, visual programming can increase program production by improving individual programmer productivity and by attracting more people to programming.

The Animation Technique

The animation technique, developed by Micro Focus for in-house programming, is now available in product form for programmers who use Micro Focus COBOL compilers. It makes programming easier the way a stethoscope makes medical diagnosis easier. The doctor's tool enables him to listen to the heart of a patient and, in turn, use his medical training and expertise to trace symptoms to find the cause of an illness. The animation technique lets the ex-

perienced programmer trace the effects of an error through a new or old COBOL program's logic and data structure.

A typical example is the 10-year-old payroll package that has been working fine week after week but suddenly pays an employee a negative amount. The programmer who wrote the program has long since left the company, and the data-processing staff has to find the very subtle anomaly in the program logic that caused the negative payment. Without a debugging tool such as Animator, the process would be done in one of two ways: the data-processing department would obtain a source-code listing and trace through it, trying to reproduce the error; or a DISPLAY statement and some debugging logic (e.g., IF < error condition > STOP RUN) would be inserted

REPORT WRITER, has been split into two subsets, the LEVEL I specification and the full LEVEL II specification. The minimum ANSI standard COBOL compiler consists of a LEVEL I specification for the NUCLEUS, TABLE-HANDLING, and SEQUENTIAL I/O.

Superimposed upon ANSI standard COBOL is a further standard that has been developed to meet the needs of the U.S. Government. It is called Federal Standard COBOL. The Federal Standard designates four ANSI COBOL levels of implementation: Low, Low-Intermediate, High-Intermediate, and High.

Furthermore, the Federal Computer Testing Center (FCTC), which is part of the U.S. Government General Services Administration (GSA), tests each COBOL compiler for compliance with the Federal COBOL standard. It does this by using a suite of programs comprising 225,000 lines and 5500 individual tests to check (and break, if possible) COBOL compilers. A compiler is tested at the implementor's claimed level and then placed on the Certified Compiler List either "with errors" or "with zero errors." For example, Micro Focus's LEVEL II COBOL compilers are GSA certified at the High Level with zero errors. The certification is valid for one year, then the compiler must be retested.

The result of these standards is that

COBOL source code is portable across different machines, operating systems, and even different implementations of a COBOL compiler.

A New ANSI Standard for COBOL

The ANSI COBOL Committee (X3J4) has prepared amendments to the COBOL language that are to be incorporated in a new ANSI standard. The new standard, while it clarifies many ambiguities and makes the language more structured, does not address interactive screen-handling or record-locking facilities.

The addition of nonstandard interactive screen-handling facilities, such as those used by Animator, is vital in microcomputer-based COBOL compilers because micros are more personal and interactive in nature than the larger, number-crunching mainframe machines.

Nonstandard record-locking facilities have also been developed to protect users from simultaneous record updates in multi-user microcomputer environments. An example of such a record-locking facility is Micro Focus's FILESHARE for MP/M-family and TurboDOS-based systems.

Until the ANSI standard addresses these facilities, implementors will have to continue developing nonstandard screen-handling and record-locking additions to

COBOL or agree on de facto standards to meet the needs of the emerging corporate microcomputer marketplace.

The current ANSI approach is to include in COBOL new program constructs and statements as well as rules governing nested programs.

New constructs include conditional statement terminators such as END-IF, a null statement called CONTINUE, a case-type multibranch statement called EVALUATE, an in-line looping construct called PERFORM that now includes END-PERFORM, and a "test after looping" construct.

Another significant change is a new INITIALIZE statement that is used to initialize an entire record or any type of data item to specified values. In addition, the new standard lets programmers MOVE data from an edited data item to an unedited one. Finally, the standard permits a new way of specifying the length of variable records. Each such record length can be stored in the name of the WORKING STORAGE data-item that is specified in the FILE DESCRIPTION ENTRY. Programmers will be able to read a record and rewrite it with a different length for indexed or relative files as well as SORT and MERGE variable-length records.

in the source code and the program then recompiled and run. The second method results in the computer displaying "snapshots" of the data at the points where DISPLAY statements were inserted. The programmer can then look through "windows" in the program to gain a better understanding (still using the printed listing) of what the program is doing.

With Animator, the situation is completely different. Programmers can not only set breakpoints to zero in on error conditions but can step through any portion of the source code, look at the data, modify the data, and go through the code again, thus engaging in "what-if" analysis as they go back and forth between the logic and the data.

Programmers can "zoom" through part of the program at near-normal

execution speed, then step through the source code line by line at any position in the program that they choose. This is done at any speed required to allow programmers to follow and understand the program logic.

Animator lets programmers interact with a COBOL program in a way that is not otherwise possible. It enables them to select the parts of a program to look at, choose how often they will look at them, choose what data to use to demonstrate the code being looked at, and control the speed at which the code will run.

A programmer using Animator can examine different blocks of the program to diagnose an error. He can chase the symptoms through the different areas of the program until he locates the error, without having to run the program over and over again.

Making Programming More Fun

The animation technique takes the routine debugging burden off programmers so they can devote their time to more creative tasks such as new-program development. And by cutting their backlog, programmers have more time to write better, higher-quality programs.

The animation technique eliminates the drudgery of debugging by making the computer do the computing tasks that programmers had previously done. Before the animation technique, programmers who were debugging programs had to simulate the operation of a computer in their minds.

Learning Someone Else's Program

Animator lets programmers learn someone else's program by showing



15 DAY NO-RISK TRIAL
MONEYBACK OFFER!

- Maximum Software Compatibility
- Highest Quality Construction
- 1 Year Warranty, Parts and Labor
- Made in USA



\$595

How many times have you thought "If it's as good as they say, they should prove it with a moneyback trial!" **FAIR ENOUGH.**

This is no rash experiment. We have the product, the compatibility, the quality, and the international marketing background to know that only a few percent will be returned.

Call us up. Order the computer, or the entire system. COD. Try it for 15 days. If, for any reason, you are dissatisfied, return it for a refund. The most you can lose is the cost of a phone call and the return shipping fee.

In fact, if you return the SEKON, and then buy a "fruit" computer, we will send you a \$25 box of diskettes FREE.

SEKON 64 (64K RAM / NUMBER PAD)...\$595
SEKON 64 SYSTEM (1 DRIVE / 12" CRT)...\$975
(213) 344-6063

Golden Computer International, Inc.
 15445 Ventura Blvd.
 Sherman Oaks, CA 91413

how blocks of code are related. Thus, programmers can understand the overall flow of the program. They can find out what the blocks are, what they do, and how they are linked together simply by tracing the program execution through the source code. By seeing the structure of a program, programmers can find where an error will show up once they have seen the symptoms.

To learn a COBOL program in more detail, programmers can use the Animator trace functions and engage in "what-if" analysis within the program blocks. This means programmers can, if need be, gain an expert understanding of the precise consequences of any data value change and its implications in each module of the program. They can watch the logic flow step by step and switch back and forth between the code and the data to see the precise relationship between individual source-code statements and incremental changes in the data structure.

A Concrete Programming Environment

The animation technique turns analysis of programs into a concrete process. Without animation, analysis is an abstract process because the programmer has to assume how the logic *should* operate. Using the abstract process, the novice may overlook a subtle yet catastrophic detail in the logic.

Animator makes program analysis concrete by enabling programmers to see the occurrence of the catastrophe right before their eyes, on the screen. Animation shows what the program says and does, not what programmers hope or think the program says. With concrete information on what their programs are doing, programmers can test various alternatives and choose the best logic routines for their applications, with zero errors.■

Andy Pope, technical specialist, Geoff Kates, product marketing manager, and Dan Fineberg, marketing communications manager, are part of Micro Focus Inc. (2465 East Bayshore Rd., Suite 400, Palo Alto, CA 94303), an international supplier of micro-computer software for business-application development.

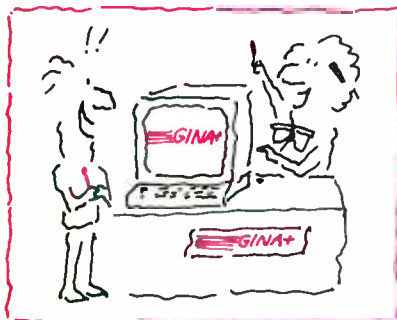

"Do you have one that will tell me which one to buy?"

Now you can say "YES...GINA+"



GINA+ is a Trademark of System Vision Corporation

- GINA+ Sells Your Inventory
- GINA+ Trains Your Staff
- GINA+ Collects Customer Follow-up Data
- GINA+ Helps Your Customer Buy-Today

For More Information on GINA+ Call:
 800/352-9999
 In California, Alaska, Hawaii 415/697-3861
SYSTEM VISION CORPORATION
 199 California Drive Suite 207
 Millbrae, California 94030



See us at



Simplify, Simplify, Simplify

*A logical program design, not fancy technology,
makes software more useful*

by Martin Dean

I have never yet seen an article in a computer magazine that could tell me how to design software. As a matter of fact, I have never seen an article anywhere that details the mysteries of software design. I've even wondered if it was a plot to deny users the inside information about how the software that we used was created. Surely there ought to be an article where the author says, "I had this problem, and I used this design philosophy to make a piece of software to solve the problem in the simplest, most direct way."

This is that kind of article.

Background

When I first discovered software, I was amazed that so many people knew BASIC. Four or five years ago, only two kinds of software design existed. The first (the kind that most of us learn first) is called basic BASIC. Because of BASIC's simple input and print statements, the design structure of a program can be rather simple and uncomplicated: input the information into the program, and print the information out when it has been

processed or organized. For example, if you want to calculate the distance from A to B, you ask: "What is the rate of speed?" and "What is the time it took to travel the distance?" Then you would put the values into variables named R and T. The BASIC programmer simply needs to say "D = R*T" and "PRINT D", and the answer appears on the screen.

Enter the more advanced programmer, conversant with machine language, C, FORTRAN, 8080 assembly language, cross-assembly language, and DIBOL. Now the distance program becomes more sophisticated. "Enter here the rate of speed traveled in the interval, as an average, in miles per hour," and "Enter here the period expressed in minutes and seconds that it took to travel the distance as described in the distance D." And then things became complicated. And, of course, when things became complicated, the programmers had an answer for those less fortunate: an innovation called "extensive documentation." They gave us eloquent definitions such as "a list is a set of values assigned to positional

element numbers." Oh! Often 400 pages of documentation described what the rest of American industry could explain in 8.

When it became clear that programmers couldn't solve their own problems, hardware manufacturers got into the act. Now we have mice and windows to make our computer lives easier and more user-friendly.

Let me state my opinion of this as clearly as possible: it's all nonsense.

First, computer software design got the wrong start when we, in our awe of programmers, let them get away with murder: murder of the English language, murder of common sense, and surely murder of the concept "easy to use."

Then we let the programmers design the software. This may sound obvious, but it isn't. Sure, programmers write the code that makes the computer work, but that doesn't give them the right to design how information goes in and how it comes out.

Imagine for a moment that we let experts in instructional technology or people with a sense of discipline and common sense design what is called

Visa/MasterCard — NO CHARGE

NATIONAL ORDER DESK

1-800-231-0616

ORDER STATUS AND INFORMATION

1-713-692-7100

FREE SHIPPING!!

EAGLE SOFTWARE

6121 Slobner Airline
Houston, Texas 77091
(713) 692-7100



<p>MODEMS</p> <p>Hayes Micro Modem II w/Terminal Program . . . \$299 Smartmodem 300 Baud \$199 1200 Baud \$490</p> <p>Novation J-Cat \$115 Appletalk II \$260 2/2 Auto Cat \$575 D-Cat Modem \$165</p> <p>Anchor Automation Mark I \$83</p> <p>CABLES</p> <p>IBM RS-232 M-F \$35 IBM Printer Cable (PAR) \$35</p> <p>DISKETTES</p> <p>Elephant (5 1/4") SS/DD Soft Sec. (10) \$18 SS/DD Soft Sec. (10) \$22 DS/DD Soft Sec. (10) \$28</p> <p>Maxel (5 1/4") SS/DD Soft Sec. (10) \$27 DS/DD Soft Sec. (10) \$39</p>	<p>DISK DRIVES</p> <p>Micro-Sci A2 143K w/Cont \$229 A2/40/70 Cont. Card \$79 A40 164K w/Cont \$285 A70 286K w/Cont \$365</p> <p>Rana Elite I \$269 Elite II \$459 Elite III \$595 Elite Controller \$95</p> <p>MONITORS</p> <p>Amdak Color I \$299 Color II \$439 300G Green \$139 300A Amber \$155</p> <p>PRINTERS</p> <p>C. I.TOM Prowriter 8510AP \$CALL Prowriter 1550P \$CALL Baana 50CPS \$195</p> <p>Star Gemini 10X, 10", 120CPS \$CALL Delta-10, 10", 160CPS \$CALL</p>	<p>APPLE PRODUCTS</p> <p>Videx Ulraterm \$275 Vidioterm \$225 Vidioterm/SS/INV \$245 Enhancer II \$99 Function Strip \$59 PSID Card \$176 Appletwriter II Pre-boot \$15 V-Calc 80 Pre-boot \$38 V-Calc 80 W/Mem. Exp. \$69</p> <p>IBM PRODUCTS</p> <p>Microsoft Flight Simulator \$33 Mouse \$139</p> <p>TG Joystick \$44 Track Ball \$45</p> <p>MICROMAX</p> <p>VIEWMAX-80 Videoterm comp \$175 VIEWMAX-80e 64K Apple IIe 80 \$134 Z-MAX Softcard Compatible \$119</p> <p>Multi-Function Cards for the IBM-PC & XT</p>  <p>SIXPACKPLUS CARDS</p> <p>Amount of memory 64K 128K 192K 256K 320K 384K Parallel, Serial ports clock \$275 \$345 \$425 \$485 \$535 \$595</p> <p>MEGAPLUS II CARDS</p> <p>Offers a maximum of 512K RAM, SuperDrive and SuperSpool Amount of memory 64K 128K 192K 256K w/1 Serial port & clock \$287 \$337 \$387 \$439 w/with 2nd Serial port or Parallel port \$320 \$370 \$420 \$470</p>
--	--	---

USI * TAXAN * PRINCETON CALL!!

TERMS: Please send money order or cashiers check. Free shipping, except monitors and printers. We will match any price providing it is not below our cost. All brands are registered trademarks. Products subject to availability.

▲ We'll Match Any Advertised Price in this Magazine

"the front end," that portion of the software that bridges the gap between the computer program itself and our eyes, brains, and fingers. Imagine what software would be like if we didn't ever have to read messages like "Do you want the seventh bit to be a stop bit . . . yes or no?" Imagine messages in real English, organized in a fashion that has real meaning for those of us who use them.

An Alternative

I was several months into the design of a database manager for my company before I realized what a strange turn the direction of software design had taken. There was no literature that described the fundamentals of microcomputer software design, and theorists were still postulating the discoveries of Piaget and Vygotsky as reliable beginning points for software design. What had become the established norm for good software design was not good software but simply software that sold. As recently as the fall of 1982, microcomputer software entering the marketplace was distinguished by fatter manuals, more commands, and a complexity approaching unusability.

Thus, I concluded that even before I could attack the particular problem that I had been given, I had to go back and look at the history of software screen design and then take a whole new approach to it. The result was amazing. Three words were the key to my design—simplify, simplify, simplify.

To do that, radical emotional surgery is required. You have to throw out your admiration for other software programs, clear your mind of brilliantly executed screens, disregard nifty features, and excise all thoughts of clever though complex functions. Pledge yourself instead to starting fresh. Think only of the first-time user, the scared, irritable novice who for the first time must not only work with a computer but do something useful with it.

Today's user is so different from yesterday's pioneer that the design criteria once applied are now totally inappropriate. Today's user is no

The best for less.



1.2 Meg

128K RAM, two single-sided floppy disks providing 1.2 megabytes storage. CPU, CRT and detached keyboard; communications and networking capabilities

10 Meg

256K RAM; fixed/removable storage device featuring 10.6 megabytes fixed; and 1.2 megabytes removable storage. CPU, CRT and detached keyboard; communications and networking capabilities

You'll pick Victor for price and performance.

Once you compare the features of Victor 9000 with other big name micros, you'll wonder how they got those big names in the first place.

You'll pick TriStar for fast delivery, service and support

800-257-5217

CALL: 609-424-4700
215-629-1289



2 Keystone Avenue
Cherry Hill, NJ 08003

ARE YOU MISSING THE BETTER BUSINESS SOLUTION?

COMPARE FOR YOURSELF!*

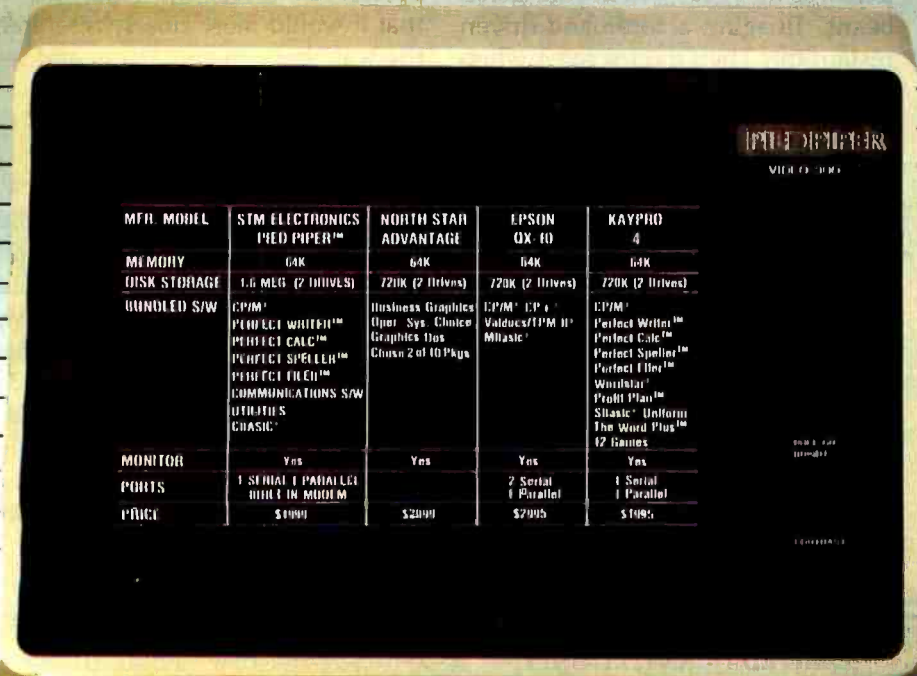

MFR. MODEL	STM ELECTRONICS PIED PIPER™	NORTH STAR ADVANTAGE	EPSON QX 10	KAYPRO 4
MEMORY	64K	64K	64K	64K
DISK STORAGE	1.6 MB (2 Drives)	720K (2 Drives)	720K (2 Drives)	720K (2 Drives)
BUNDLED S/W	CP/M™ PERFECT WRITER™ PERFECT CALC™ PERFECT SPELLER™ PERFECT FILER™ COMMUNICATIONS S/W UTILITIES CHASIC™	Business Graphics Oper. Sys. Choice Graphics Dos Choice 2 of 10 Pkgs	CP/M™ CP-1 Valdocus/CPM II™ Mhasic™	CP/M™ Perfect Writer™ Perfect Calc™ Perfect Speller™ Perfect Filer™ Wordstar™ Profi Plan™ Slasic™ Uniform™ The Word Plus™ 12 Games
MONITOR	Yes	Yes	Yes	Yes
PORTS	1 Serial 1 Parallel Built in Modem		2 Serial 1 Parallel	1 Serial 1 Parallel
PRICE	\$1999	\$2099	\$2995	\$1995

Introducing
the PIED PIPER™ Professional.

At \$1999,
the PIED PIPER™ Professional
combines standard features
of most systems with MORE
disk storage capacity PLUS
an auto-dial modem.

See the PIED PIPER™ at your local dealer,
or call for more information.

Dealer inquiries invited. (415) 326-6226

PIED PIPER™ THE COMPUTER WITH THE STORY

See us at Fall COMDEX'83



STM Electronics Corporation
525 Middlefield Road #130
Menlo Park, California 94025

Toll free in California (800) 772-3545 ext. 576
Outside California (800) 227-1617 ext. 576

PIED PIPER is a registered trademark of Semi-Tech
Microelectronics Corp.

CP/M, CBasic are trademarks of Digital Research Inc.
Perfect Writer, Perfect Speller, Perfect Calc, Perfect Filer
are trademarks of Perfect Software Inc.

*Information based on national advertisements of
competitors' products - correct at time of going to press.

longer the engineering-oriented hobbyist. Nor is he the adventurous, chance-taking, first-one-on-the-block user. All of these pioneers have already bought their computers and programs; now the field is left to those of us who waited for \$200 calculators to cost \$20.

Command-driven vs. Menu-driven Software

The first design idea I had to throw out was the way that choices are presented to the user, so I focused on the difference between command-driven and menu-driven software. Traditionally, command-driven software is identified by the appearance of a dot or a prompt on the screen and little else. This type of software is rich with hundreds of commands that are usually invoked by pressing the Control key and a series of additional alphabetic or numeric characters. Software of this family is advertised as being "complete, full of features, and very powerful."

But there's a problem with this method. Imagine walking into your

favorite gourmet restaurant one evening and having the chef come to your table and say, "Good news, we have changed the way that you order food. Now you can have anything that you want. Just tell me what you want and I'll make it for you." And there you sit, trying to remember what sort of sauce the veal came with last time and whether it was pepper or peppercorns that you liked in your green beans. Imagine a command-driven restaurant. Then mourn for it when it fails because no one knows what to order. The same is true with software. Users don't want to be able to order anything that they can imagine. They don't, in the main, even want to imagine. They only want to get a job done. Open-ended, command-driven software is dead.

On the other hand, menu-driven software is just what it says. The screen offers a choice of things that you can do and asks you to enter a number or a letter corresponding to your choice.

So I decided to have menus. Where should I go from there?

I then looked at what I had to make and how it had been made in the past. In this case, I had to create a relational database that could be used by first-time businesspeople to produce something useful, a program that was obviously worth the money they paid the first time that they used it. To do this, I knew I would have to change entirely the way that data is perceived, stored, and retrieved, so that it would more closely resemble the way that you and I store and retrieve information in our offices.

The Traditional Database

This is how it used to work: first, the program starts with a totally blank screen onto which you are allowed to design the form that would be filled in to create a record. Now, of course, to be able to design this form, you must designate the fields you want, what length those fields will be, what type of data will be in those fields, and so on. It leaves the beginner paralyzed because, like command-driven software, it offers too many open-ended choices. Once

MERRY MERRY CHRISTMAS

For a fruitful year, your subordinate and loved one deserves a computer.

PRINTER		
BANANA	50 cps	215
MICE PRISM	RS232/parallel pin & friction	459
Prism 132	200 cps 132 col. with graphic, color, friction	1,100
OKIDATA	ML 83A	580
	84 par.	960
	92 par.	450
	93	725
EPSON	FX-80, FX-100, RX-80	CALL
MT SPIRIT	80 cps	330
C.ITOH	Prowriter par.	410
TOSHIBA	P1350 Excellent print.	1,550
Geminim	10X 120 cps	310
Diablo	S-11 100 cps	530
Letter Quality		
DYNAX 15	13 cps (Brother)	480
SILVER REED	EX550 par.	699
Transtar	130 par.	727
DIABLO	620	985
CITOH	F-10 Starwriter 40 cps	1,150
NEC	7710, 7730	2,150
	3550 for IBM	1,850
QUME 11 +	40 cps	1,400

TERMINAL		
ZENITH	Z-29 Smart terminal	CALL
	ZT-1 with modem	450
HAZELTINE	Esprit II	588
	Esprit III	625
Televideo	925	740
Visual	102 emulate DEC VT100	895
	55 green	725
	550 graphic	2,150
Wyse	50	575
QUME	102	590
	103 132 col.	890
	108 A amber	750

HOLIDAY SALES, LIMITED QUANTITY ONLY!

PERSONAL COMPUTER		
CROMEMCO	C-10	\$1,490
COLUMBIA	128K RAM, 2 drives, software	CALL
CORONA	128K RAM, 2 drives, monitor graphic 640 x 325, software	CALL
ZENITH	Dual drives, 128K RAM, Color board, 640 x 225 graphic	CALL
EAGLE	Add on hard disk 128K RAM, 2 drives, monitor and software	CALL
Portable		
Teletote II	64K RAM dual drive	
Anderson Jacobson, Columbia, Corona		
EPSON QX-10 COMPUTER the best word processing system		
Multiuser system: CROMEMCO, DUAL, WICAT		
MODEMS		
D.C. HAYES	Smartmodem 300 baud	230
	Smartmodem 300/1200 baud	520
	1200B modem & software	470
USR	Auto Link 1200	450
	Password 1200/300 Auto Dial	380
UDS	212 LP	400
	212A	595
Novation	Smartmodem 300	200
	Smartmodem 300/1200	455
DISK DRIVE		
TANDON	TM 100-2 5 1/4" DD DS	250

Computer Channel

Come visit us in our New York city showroom.

MITSUBISHI		
DS, DD Qume & Shugart compatible		
M2394-63 bare drive	380	
M2396 slimline bare drive	410	
Full size dual cabinet	200	
PLOTTER/DIGITIZER		
HOUSTON INSTRUMENT DMP-29	1,798	
	DMP-40	770
	DMP-40-2, DMP-41 & DMP-42	CALL
	HIPAD Digitizer	CALL
Amdek XY plotter 1 pen	665	
	6 pens	1,095
Sweet-P *Plotter	599	
Mannesman Tally 3 pens plotter		
MONITOR		
ZENITH ZVM 123 12" green	115	
ZVM 135 RGB/CV	475	
Amdek color II RGB	450	
	300 green	149
COMREX 5600 Amber	175	
Color plus board for IBM	380	
Many accessories for Apple and IBM		
Many softwares also.		

For information CALL (212) 937-6363
To order CALL 800-331-3343

Computer Channel	TELEX:
21-55 44th Road	429418
Long Island City, NY 11101	CSTNY

Prices subject to change. American Express, Visa/Mastercard add 3%. F.O.B. point of shipment. 20% restocking fee for returned merchandise. Personal checks take 3 weeks to clear. COD on certified check only. N.Y. residents add sales tax. Manufacturers' warranty only. International customers, please confirm price before order. Accept P.O. from Fortune 500, schools and gov't.



Encounter REVELATION

For \$950, Revelation Software by Cosmos will give your PC capabilities that no microcomputer has ever had before. Through a versatile, high performance Relational Data Base Management System developed by Cosmos, Revelation will give your microcomputer all the power and sophistication of a minicomputer.

Revelation features a data base with variable-length fields and records, (up to 64K), and unlimited files and accounts. File size is

limited only by disk size.

Also featured: A powerful, hybrid programming language.

A fourth generation applications and program generator
Our programs write programs!

Communications functions that give your PC the power to utilize applications, programs, and data from thousands of existing mainframe and minicomputers.

8087 math chip support
Revelation co-exists with MS/DOS™ or PC/DOS™ 1.0, 1.1,

2.0 versions, and is compatible with the IBM PC™ XT™ COMPAQ™, Corona™, Columbia Multi-Personal® and the Eagle 1600™. It's also compatible with mini-computers utilizing the PICK Operating System™. Minimum configuration requires 320K memory and 8087 math chip.

MS/DOS™ of Microsoft Corp. IBM PC Registered TM of International Business Machines Corp. COMPAQ™ of COMPAQ Computer Corp. PICK Operating System™ of

PICK SYSTEMS. Eagle 1600™ of Eagle Computers. Corona PC™ of Corona Data Systems. Columbia Multi-Personal™ of Columbia Data Products Inc.

P. O. Box AH, Morton, WA 98356

COSMOS

Circle 124 on inquiry card.

Telephone 1-800-422-2511
Inside Washington 206-496-5974.

Col- Row ↓	A First Name Text = 20	B Last Name Text = 15	C Area Code Number	D Telephone Text = 20
1	Albert	Finney	212	345-9754
2	Bobby Sue	Jones	211	556-9088
3	Tom	Wilson	312	678-9073
4	Jeannette	Donner	313	567-9234

Table 1: An on-screen chart for data entry. If the contents of a field are greater than the chosen column width, the entry wraps around to display the entire contents.

Column- Compare ↓	First Name	Last Name	Area Code	Telephone
not =		W*	312	
LTE < =				
GTE > =				
LT <				
GT >				

Table 2: A "test chart" that replaces Boolean logic in selecting records from a database. Given the convention that * matches any string of characters, this chart asks for all records with an area code of 312 and with a last name that doesn't begin with W.

you have designed your form, you must enter the information into it, just as you would for a job application or an insurance policy.

But you're not done yet. Now that you've got the information, how do you get it organized and out? The organization of data is what differentiates the computer from a card file. Computers are best at sorting out all your friends who have the same telephone prefix you do or birthdays in May. Unfortunately, when the programmers designed the way you ask the computer for information, they chose to stick with the same Boolean logic they used to write their programs. Now for those of us who took symbolic logic in college, Boolean algebra is just a replay of old headaches. For those who didn't, forget it—truth tables, logical separators, and exclusive ORs are not what you want to spend your time figuring out.

An Alternative Database

Four and a half months later, it dawned on me that there was absolutely no reason to retain any semblance of the rules that had been de-

signed by database creators. With that in mind, I stood for many days at a large blackboard, trying to get to the root of what a database is, how it is perceived, and how it can be used. I finally derived from those sessions an intuitive breakdown of the basic database functions. First, I needed a new way to set up the format for storing information. This meant that I had to eliminate the requirement that the user understand the concepts of fields, records, and (of course) delimiters.

Before becoming involved with computers, I reasoned, I had stored information and had shown it to others without even knowing what a database was. Ever since I was a sophomore in high school and compared the economic, political, religious, and agricultural aspects of communism, socialism, and democracy, I had used charts. Why not use them now?

At the same time, why not make the definition of a data field as automatic as selecting choices from a menu?

The design I came up with is

shown in table 1. Across the top are three rows of information. The top row simply labels the columns A, B, C, and D. The next row is the description of the columns, which programmers call the field descriptors. The third row tells the program what type of information it should be expecting. Rather than adopt the standards once again, I chose to use more meaningful descriptors such as Date, \$, Number, Text, and Math (which is computed automatically when you enter a formula).

From there on the design of the chart was just plain puzzle-solving fun. How wide should the columns of the chart be? Should they be variable in width? Well, let's look at the charts I had made before I discovered computers. When there was too much text, what did I do? I started over with a new chart. Unfortunately, that wouldn't work here.

The main problem I had with my chart idea involved entering text. I wanted to make each field a "memo pad" area that could contain messages of widely varying lengths, and I wanted to display the whole field. Well, if I did that I could end up with a chart that was much wider than the screen. From word processing, I borrowed the idea of wrapping text onto multiple lines. From that, I conceived the notion that the user should be able to define both the number of characters that go into a field and the field's display width on the screen. If a given field is wider than its display area, its text "wraps around" and takes as many lines as is needed to display the entire field.

I decided that money, numbers, dates (in six different formats), times (in two different formats), and text would make up the choices of data styles. Then my mind hung up on the word "data." I had overheard this marvelous phrase: "data you store, information you use." I made a conscious decision then that I would never again refer to what was being stored as *data* but would use the term *information* instead.

Dealing with Logic

Now I had to solve the problem of how to sort information without re-

WE ALL AGREE



Auto Cut Sheet Feed (option)

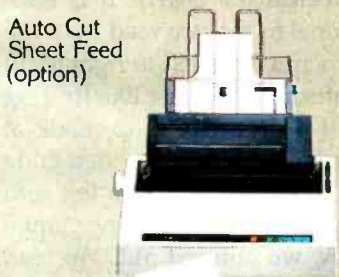

Tractor Feed (option)



Keyboard (option)



We can't think of anyone who isn't better off with A DX-15 DAISY WHEEL PRINTER.

Dynax's DX-15. And if you want the kind of printer that lives in the fast lane, the DX-15 is your printer. It does it all, certainly all that far more expensive models can do. The DX-15 offers you some important options like Keyboard, Tractor Feed and Auto Cut Sheet Feed. Not only that, the DX-15 is a very durable unit, be it for business, home or word processing applications. And who says a great printer has to be expensive? Not us! What we say is you'll be dumbfounded when your dealer tells you just how inexpensive the DX-15 happens to be. Give him a call or drop by. Dynax's DX-15 says it ALL.

See us at Comdex Booth W. 568 West hall
Dynax, Inc.

5698 Bandini Blvd., Bell, CA 90201
 (213) 260-7121

	Column— Compare	A First Name	B Last Name	C Area Code	D Telephone
I	not =		W*	312	
	LTE < =				
	GTE > =				
	LT <				
	GT >				
II	not =		W*	415	
	LTE < =				
	GTE > =				
	LT <				
	GT >				

Table 3: A more complicated test chart. The six lines of a test chart (called a section) are duplicated for each logical OR operation in the record-selection criteria. This test chart finds all records that have an area code of either 312 or 415 and a last name that doesn't begin with W.

Col. letter to sort by :B	_____	_____	_____	_____
Ascending = A	:A	_____	_____	_____
Descending = D		_____	_____	_____

Table 4: Sorting selected records. Records selected by a test chart can be sorted by as many as five keys (the keys are listed in order of decreasing importance). Here, the selected records are to be sorted in ascending order by Last Name (the name of a field in table 1).

sorting to complex formulas and Boolean logic. Traditionally, you had to use rigid algebraic equations to describe which pieces of data were to be extracted and the conditions for that extraction. Common requests such as the following required Boolean expressions more complex than simple and/or/not statements:

Invite to the awards banquet all those salespeople who sold at least 25,000 auto parts in August or September, or who exceeded their quotas in either of those months.

Imagine drafting a Boolean statement that describes this ordinary office request:

Give me the names of customers who live in California and who have made purchases in the last six months. I want the list ordered from the greatest number of purchases to the least with the customers' names alphabetized within the list.

As background, you should know that many years ago I had the Herculean task of teaching symbolic logic to college students. I was a total failure. Symbolic logic is easy for some and impossible for others, and my teaching could not change that. How, then, could I formulate a system to allow the average office worker to make these kinds of choices?

Task analysis was the answer. Let me explain. When we do something, it's usually done in measurable steps. The analysis of those steps—what is to be done, and in what order—is task analysis. Using that approach, it was easy for me to get rid of Boolean formulas. I just had to look at what I needed to do—break it down into discrete, definable steps, and look at it as if it were an instruction book for assembling a food blender.

Let's use a typical mailing list with names, addresses, and telephone numbers for our analysis. The first thing we have to do is to decide what is important: what criteria we want

to establish for the information we will extract from our list.

The best graphic example I can give is the test that I take every couple of years at the California Department of Motor Vehicles. (You've probably taken a similar test.) I bring the test to the counter, and the clerk lays a template over it to see what answers appear in the little windows of the template. This is the same way that I can test for certain information in my mailing list. When I say that I want only people with 312 area codes whose last names don't begin with W, I'm actually creating an electronic template. I imagined the telephone information in the form of a chart that looks like table 1. I figured that if I created an electronic template that would allow certain information on my chart to "show through" while other information would be concealed, I would have sidestepped the whole formula-writing process.

But the template would have to be different from a paper with squares cut out of it. It would have to specify which columns of the chart we wanted to test and what we want to test for. Look at the test chart in table 2, which selects only customers whose area codes are 312 and whose last names start with any letter except W (the asterisk is used to match any additional letters in that field).

Now, if you will excuse the fancy talk, what we've got here is a two-dimensional decision matrix (which we will call a *test chart*). It is two-dimensional in that we read from the top down and from left to right to fill in the information—just like finding location F-4 on a city map. Look at what we did. Under the area code column, we read from the left and found an equal sign. On the "equal sign" row, we entered 312. We read that as meaning "Pick out area codes that equal 312." Similarly, the next row reads "Choose any last name that does not equal a group of letters beginning with W."

A More Sophisticated Test Chart

If I thought of the test chart as a filter, everything made sense. But, you ask, "That takes care of the ANDs, but what about OR? How do

(5a)

Col- Row ↓	A Salesper Text = 20	B Quota Number	C #Parts Number	D Month Number	E % Quota Math	
1	Miller, Alan	20,000	21,000	9	1.05	
2	Alberts, Karen	30,000	28,000	8	0.93	
3	Martin, T.W.	1500	1800	7	1.20	
4						
5						

(5b)

Use formulas with (+, -, *, /) for example (A+B)*5, A-B/C, A+B+C
 Column E will be equal to:

Table 5: The Math data type. When a data column is given the type Math (as shown in table 5a), the database prompts for a formula by which to calculate that column's value for a given row (table 5b).

	Column- Compare ↓	A Salesper	B Quota	C #Parts	D Month	E % Quota	
I	not =						
	LTE < =				9		
	GTE > =			25,000	8		
	LT <						
	GT >						
II	not =						
	LTE < =				9		
	GTE > =				8	1	
	LT <						
	GT >						

Table 6: A test chart to select the employees who sold at least 25,000 parts in either August or September or who met their quota in either of those two months.

you select out area codes 312 OR 415?" Well, suppose I make another section of the test chart and add the rule "If you can pass one section of the test, you'll pass the whole test." Then the test looks like table 3. Notice that we have created two sections labeled with roman numerals. The line that divides them is the OR line. All area codes beginning with 312 OR 415 will pass the test, and last names beginning with "W" will be excluded in both cases. Simple enough.

Information Please, the product created out of this exercise, allows five different OR sections. The ANDs within the section are limited only by the number of columns in the chart—up to 255.

It took me more than four months to create this reduction of algebraic equations. I experimented with decision trees, sifting concepts, and reductions of choice pathways. Ultimately, I found that, as usual, common kitchen and schoolroom metaphors turned out to be the best: the filter and the test.

Sorting Results

With my test chart designed, it was easy to see how the program could do sorting. Because I alphabetized the columns across the top of my test chart, I could use the letters of the columns for sorting. First, the program gives me the option of sorting directly from the test-chart screen. When

I indicate that I want to sort, I then tell the program which column or columns I want to sort by, and in what order. If I want to alphabetize my mailing list, I should enter my criterion as shown in table 4.

Because I had specified whether a column was text or numeric when I created my information entry chart, the program now knows whether to sort alphabetically or numerically.

Solving Complicated Queries

Now let's go back to the office examples I gave earlier and see how they are handled with this charting method of entering and testing information.

The first problem asks us to find the salespeople who sold at least 25,000 auto parts in August or September or who exceeded their quotas in at least one of those months. Let's assume that we have some information entered into this chart (see table 5a).

On this information chart we specified that the Salesperson column would be text by pressing T, that the width of the column would be 10 by typing "10," and that the number of characters in the column could be up to 20 by typing "20." This allows for narrow columns (so more can be viewed at once on the screen) but also permits entry of an extensive amount of information. The next three columns were called Number columns by pressing N after each column name was entered.

Now the last column is interesting. It's a Math column. I wanted this chart to be able to calculate just like a spreadsheet, and that's how it works. After you press M for Math, the message of table 5b appears.

Then we enter the formula. To get the percent of quota each salesperson met, we enter the formula in terms of column letters: "C/B" (the number of parts sold divided by the quota). This formula is calculated instantly each time the cursor moves to a row in the % Quota column.

After all the information is entered (maybe we have figures for several months), we want to find out who sold over 25,000 parts or at least met their quotas in August or September.

QDP-300

The peace of mind computer.

Now, the QDP-300, our third generation computer, is available with the powerful TurboDOS† operating system as well as CP/M* and MP/MII*. The QDP-300 now offers you the ultimate in single or multi-user performance. Equipped with TurboDOS, the QDP-300 gives you a multiple-CPU system with Cache buffering to bring a new dimension of speed to microcomputers. Now you can have speed, versatility, and an abundance of compatible software for virtually any application. User-friendly has a whole new meaning with the QDP-300's on-line "Help" system. It even gives untrained operators access to its full power. Rugged and reliable, the QDP-300 is easily expandable and upgradeable as your computer needs grow. All this, plus a one year on-site warranty with service provided by General Electric Apparatus and Engineering Services, with more than 50 service locations nationwide. And last but far from least, you will be pleasantly surprised at the QDP-300's price tag. Now you know why we call it the peace of mind computer.

■ **More Versatility** – TurboDOS multi-user/multi-processor system offers advanced networking to give all users full access to disks, printers, modems, and other peripherals plus a minimum of 128 KB RAM per user.

■ **More Speed** – Unique integrated 'Cache Memory' operation permits faster loading of programs and files, making the QDP-300 one of the fastest micro-systems on the market.

■ **More Power** – Multi-processor QDP-300 system uses a 6 MHz Z80B** CPU for each user providing fast, efficient Master/Slave networking.

■ **More Storage** – 8" DSDD floppy disk drives or hard disk storage of over 30 MB, with magtape cartridge backup option.

■ **More Flexibility** – Readily upgradeable through modular and standard IEEE 696/S-100 bus construction.

Call or write for complete specifications and literature. Circle 360 on Inquiry card.

†TurboDOS is a trademark of software 2000, Inc.

See us at
 **COMDEX/Fall '83**
November 28-December 2, 1983
Las Vegas Convention Center
Booth #4727

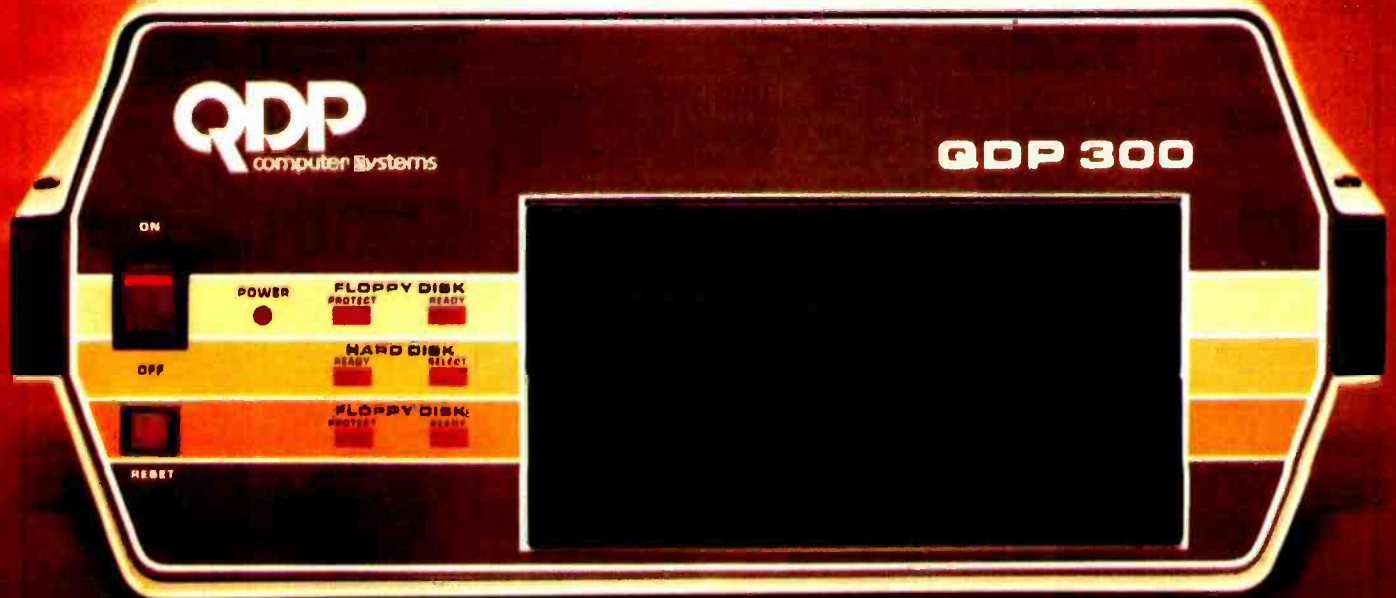

QUASAR DATA PRODUCTS

QDP
computer systems

10330 Brecksville Road, Cleveland, Ohio 44141
(216) 626-0838, Telex: 241596

Specifications subject to change

*CP/M and MP/M are trademarks of Digital Research Corp.
**Z80B is a trademark of Zilog Corp.

(7a)

Col-Row I	A Customer Text = 30	B Street Text = 30	C City Text = 20	D State Text = 20	E Zip Number	F Month Number	G Purchase \$
(7b)	Column → Compare I	A Customer	B State	C Month	D Purchase		
	=		CA				
	not =						
	LTE <=			11			
	GTE >=			6			0
	LT <						
	GT >						

Table 7: Another test chart. Given the information chart of table 7a, the test chart of table 7b selects the records of all California clients who have made a purchase between June and November.

then our test chart will look like table 7b. Once the test information is entered, we simply state that we want to sort the Purchase column in descending order and the Customer column in ascending order. Our problem is solved.

Notice that the graphics are simple yet clear. You don't need windows or mice to make charts or to analyze the information in them. The last thing that office workers with messy desks want is to have a messy computer screen. Fancy fonts, graphics, and anything that does not immediately enhance the user's understanding of the task are simply other learning barriers. Good software will lower barriers, not raise them, and will simplify work, not make it more complex. ■

Martin Dean, chairman of the board of Select Information Systems (919 Sir Francis Drake Blvd., Kentfield, CA 94904), was a lawyer for 15 years before beginning Select Information Systems, a company he started out of his dissatisfaction with existing microcomputer software. Among his interests are photography and furniture building.

We find this out once we create the test chart of table 6. When we give the test, the results are displayed immediately. Only Miller and Alberts pass.

The second problem, which I cited earlier (on page 168), is solved in the same way but also involves the extra step of sorting. We not only need to select the California customers who

made purchases in the last six months (let's assume it's December, and we'll be searching June through November), but we must arrange the purchase amounts numerically from largest purchase to smallest and then order the customers' names alphabetically from A to Z within the list. Assume that our information chart has the headings given in table 7a;

PRICE, SERVICE, INTEGRITY... YOU OWE IT TO YOURSELF TO CALL US! (800)392-7081
TOLL-FREE (800)392-7081
 Calif., Alaska, Hawaii & all info Call (213) 725-3080
 Hours: Monday-Friday 8:30am-4:30pm Pacific Time

STAR GEMINI
 Gemini-10X, 120 CPS, 80 Col., friction & tractor feed, parallel. SCall Gemini-15, above w/15" platen Call Delta-10, New! Like 10-X but with a faster speed of 160 CPS. SCall

BROTHER HR-25
 New! 23 CPS daisywheel printer w/ 2 color printing, 3K buffer, proportional spacing, etc. Parallel. \$769

BROTHER HR-1A
 This is the famous daisywheel printer that sets the industry standard for reliability & durability. 16 CPS, bi-directional & proportional spacing, 10,12,15 pitch. Uses standard typewriter ribbon. 16 1/2" paper. Parallel interface. We have purchased a huge quantity of this printer and offering to you at an unbelievable price. **\$599**

ASL Multi-Function
 Cards for IBM PC and XT (Each card now comes w/ SuperDrive & SuperSpool)

MONITOR SALE

IBM PC & XT COMPUTERS
 Call for price & availability

EPSON
 FX-80, 160 CPS, 80 Col., friction & tractor feed, parallel. Call FX-100, 160 CPS, 132 Col., friction & tractor feed, parallel. Call RX-80, MX-80 FT, MX-100. Call

SILVER REED EXP-550
 16 CPS daisywheel printer, bi-directional printing, proportional and incremental spacing. Parallel. \$649

ASL ComboPlus II Cards
 Amount of memory installed on board: none 64K 128K 192K 256K with serial, parallel & clock/calendar. \$225 \$265 \$315 \$365 \$415

SIX PAK PLUS CARDS
 Six-function card with 64K 384K RAM memory, Parallel port, Serial port, Optional Game port, Clock-Calendar, SuperDrive & SuperSpool Software. Memory installed on card: none 64K 128K 192K 256K 320K 384K with parallel, serial ports & clock & calendar. \$227 \$267 \$317 \$467 \$517 above plus game port. \$262 \$302 \$352 \$402 \$452 \$502 \$552

RGB COLOR
 BMC BM-AUB191MU, 13" RGB color, 640 dot, 16 color. \$449 Princeton HX-12, 12" RGB color, 690 dot, hi resolution, 56k. \$479 Amdek RGB Color II Plus. 640 dot, 16 colors. \$459 Quadchrome, 12" RGB Color, 690 dot. \$569 Zenith ZVM 134 RGB Color. \$399

SOFTWARE FOR IBM PC
 WordStar... \$195 \$209 MailMerge... \$250 \$149 SpellStar... \$250 \$149 Wordstar Professional... \$489 Infolstar... \$495 1-2-3 (Req. DS drive)... \$495 CALL dBASE II... \$700 \$395 Financial Planner... \$489 Friday... \$199 Bottom Line Strategist... \$295 Home Accountant Plus... \$150 \$99 TKISolver... \$129 \$219 Multiplan... \$275 \$175 Taxan KA12N, 12" amber, 800-dot, PFS Report... \$95 PFS Report... \$85 Versaform... \$389 \$249 PeachPak (GL/AR/API)... \$395 \$239 Peach Text 5000... \$237 The Tax Manager... \$250 \$179 VisiCalc 255K... \$250 \$169 Real Estate Analyzer... \$250 \$189 SuperCalc II... \$295 \$179 SuperCalc II... \$295 \$179 Spell Guard... \$195 \$119 Super Writer... \$295 \$165

NEC
 3550 Spinwriter, 30 CPS, 203 Col., letter quality. (Parallel) \$1,850 Tractor for NEC 3550. \$245 10023A, 100 CPS, 80 col., par., \$385

C. ITOH F-10
 40 CPS daisywheel (parallel) \$1,089 55 CPS daisywheel (parallel) \$1,349

MegaPlus II Cards
 Amount of memory installed on board: none 64K 128K 192K 256K w/serial port, 1 & clock. \$226 \$266 \$316 \$366 \$416 w/other parallel or serial port No. 2. \$274 \$314 \$364 \$414 \$464 w/both parallel & serial port No. 2. \$309 \$349 \$399 \$449 \$499 MegaPak - expands a fully buffered MegaPlus card (256K) to 512K \$299

GREEN SCREEN
 Dynax GM-120, 12" green, 600 line, 20 MHz. List \$200. \$129 USI PI-2, 12" green, 1,000 line, 20 MHz. \$155 Taxan KG-12N, 12" green 800-dot, List \$199.00. \$149

AMBER SCREEN
 Amdek 310A, 12" amber, 720-dot, runs on IBM monochrome card & multi-display cards only \$179 Dynax AM121, 12" amber, 600-dot, 20 MHz. List \$250. \$149 Taxan KA12N, 12" amber, 800-dot, List \$205.00. \$150 USI PI-3, 12" amber, 1,000-dot, 20 MHz. \$169

QUADRAM QUADBOARD
 Multi-Function board for IBM-PC. Full parity checking & memory selective addressing w/Spool & QDrive software. Amount of memory installed on card: none 64K 128K 192K 256K with parallel, serial ports, clock/calendar. \$235 \$275 \$325 \$375 \$425

C. ITOH
 8510AP Prowriter, 120 CPS, 80 col., graphics, (Parallel). SCall 1550 Prowriter-II, 120 CPS, 136 col., 2K buffer, graphics, (parallel). SCall

DYNAX DX-15
 13 CPS daisywheel printer, 2 color printing, 3K buffer, (parallel) SCall

I/O Plus II Cards
 Standard card w/one serial port (S1) and clock/calendar. \$129 Additional Parallel (P), Game (G), or Serial 2 (S2) Port. add \$35 ea.

QUADRAM QUADBOARD
 Multi-Function board for IBM-PC. Full parity checking & memory selective addressing w/Spool & QDrive software. Amount of memory installed on card: none 64K 128K 192K 256K with parallel, serial ports, clock/calendar. \$235 \$275 \$325 \$375 \$425

5 1/4 DISK DRIVES
 Tandon TM-100-1 SSD 160K. \$159 Tandon TM-100-2, DSD 320K \$225 Tandon Half Height, DSD 320K \$219 TEAC 558 Half ht. DSD 320K \$279 Control Data full ht. DSD 320K \$259 QUME half height DSD 320K \$249 Panasonic half ht. DSD 320K \$199

Columbia & Compaq
 Call for price & details

OKIDATA
 ML-82A, 120 CPS, 80 col., pin & friction feed, serial & parallel. \$379 ML-83A, 120 CPS, 136 col., tractor & friction feed, parallel, serial. \$629 ML-84P, 200 CPS, 136 col., friction & tractor feed, (parallel). \$989 ML-92P, 160 CPS, 80 col., friction & tractor feed, (parallel). \$499 ML-93P, 160 CPS, 136 col., tractor & friction feed, (parallel). \$849

TELETYPE TTX-1040
 TTX-1014, 12 CPS daisywheel with built-in tractor adjustable 2%-14% Parallel & serial interfaces. \$519

QUADRAM QUADBOARD
 Multi-Function board for IBM-PC. Full parity checking & memory selective addressing w/Spool & QDrive software. Amount of memory installed on card: none 64K 128K 192K 256K with parallel, serial ports, clock/calendar. \$235 \$275 \$325 \$375 \$425

TASCMASTER
 Add Multi-Tasking to your IBM PC and XT now!
 TASCMASTER software converts PC-DOS to concurrent PC-DOS to run up to 9 programs simultaneously. * 64-512K on a single board. * Real time clock/calendar w/NI-Cd battery that recharges itself. * RamSpool is hard disk supported under DOS 2.0. * RamDisk creates up to 2 electronic disks. AddRam Elite (parallel & serial ports) AddRam Plus (Two serial ports) Memory installed: -64K 128K 192K 256K 320K 384K 448K 512K \$399 \$459 \$519 \$579 \$639 \$699 \$759 \$819

5 1/4 DISK DRIVES
 Tandon TM-100-1 SSD 160K. \$159 Tandon TM-100-2, DSD 320K \$225 Tandon Half Height, DSD 320K \$219 TEAC 558 Half ht. DSD 320K \$279 Control Data full ht. DSD 320K \$259 QUME half height DSD 320K \$249 Panasonic half ht. DSD 320K \$199

Hayes Smart Modem
 300... \$209 1200... \$485 1200E... \$429

EASTERN ENTERPRISES, INC.
 Mass Merchandising Since 1969
 2937 S. VAIL AVE., LOS ANGELES, CALIF. 90040
 To order, please send money order or cashier's check. Personal or company checks require 2-3 weeks to clear. Prices reflect 3% cash discount. Visa/Mastercard accepted. Shipping, insurance & handling charges are 3% of total order value by UPS Surface, 5% by UPS Air or Parcel Post. COD's requires 20% deposit. Calif. residents add sales tax. No sales tax on out-of-state orders. Prices & availability subject to change without notice.

4

It's Fast In Any Language.

When it comes to software development, the difference between a Sage IV computer and other micros is like day and night.

With the Sage Computer it'll take you fewer days and nights to finish your program.

Speed is the reason. Speed resulting from the fast MC68000 microprocessor, fast architecture, fast operating systems, and blinding transfer rates.

The fact is, even we are surprised by the amount of software that's developed on Sage Computers.

So if you're a programmer, maybe you should spend some time learning how much time you could save using a Sage IV.



The Hottest Languages And Operating Systems.

Programs in nearly all of the important languages can be written on the Sage computer.

Included in the price is the **p-SYSTEM** operating system which supports **Pascal, BASIC, and FORTRAN.**

Other operating systems are optional. For **UNIX** fans there's **IDRIS**, which runs up to twice as fast (even without a Sage computer). **IDRIS** conforms to /USR/Group Standards Committee

standards and programs written under it are highly portable to other micros.

CP/M advocates please note that Digital Research has developed **CP/M-68K** for Sage hardware, providing a truly complete software development environment. Versions of **Pascal, BASIC, C-BASIC, C, and FORTRAN 77**, as well as a very fast **APL**, may be used under this operating system.

The Sage IV is also blindingly fast when

If you found your language here, you just found your computer. The 16-bit, 2-million operation/sec Sage IV micro with up to one MByte RAM and 18-MByte internal hard disk.

For more information and the name of your nearest SAGE dealer, call us today. And be sure to ask about our new software catalog describing over 200 application programs for Sage computers.

Sage Computer Corporate Office,
4905 Energy Way, Reno, Nevada
89502. Phone (702) 322-6868
TWX: 910-395-6073/SAGE RNO

Eastern United States
Sage Computer
15 New England
Executive Park
Suite 120, Burlington, MA
01803 (617) 229-6868

running **hyperFORTH** with its extended programmer and user interfaces.

Besides **IDRIS**, other **Multi-User** operating systems that run on the Sage Computer are **PDOS, MBOS, and MIRAGE.**

A log of excitement has been brewing in the Pascal World over Niklaus Wirth's new **MODULA 2**—and it's available for Sage computers. So is **ADA**, for the record.

© 1983 Sage Computer all rights reserved
Sage & Sage IV are trademarks of
Sage Computer



The computer you don't wait for!

**COMPLETE
DATA COMMUNICATIONS
SYSTEM NOW AVAILABLE
AT YOUR NEAREST
OUTLET.**

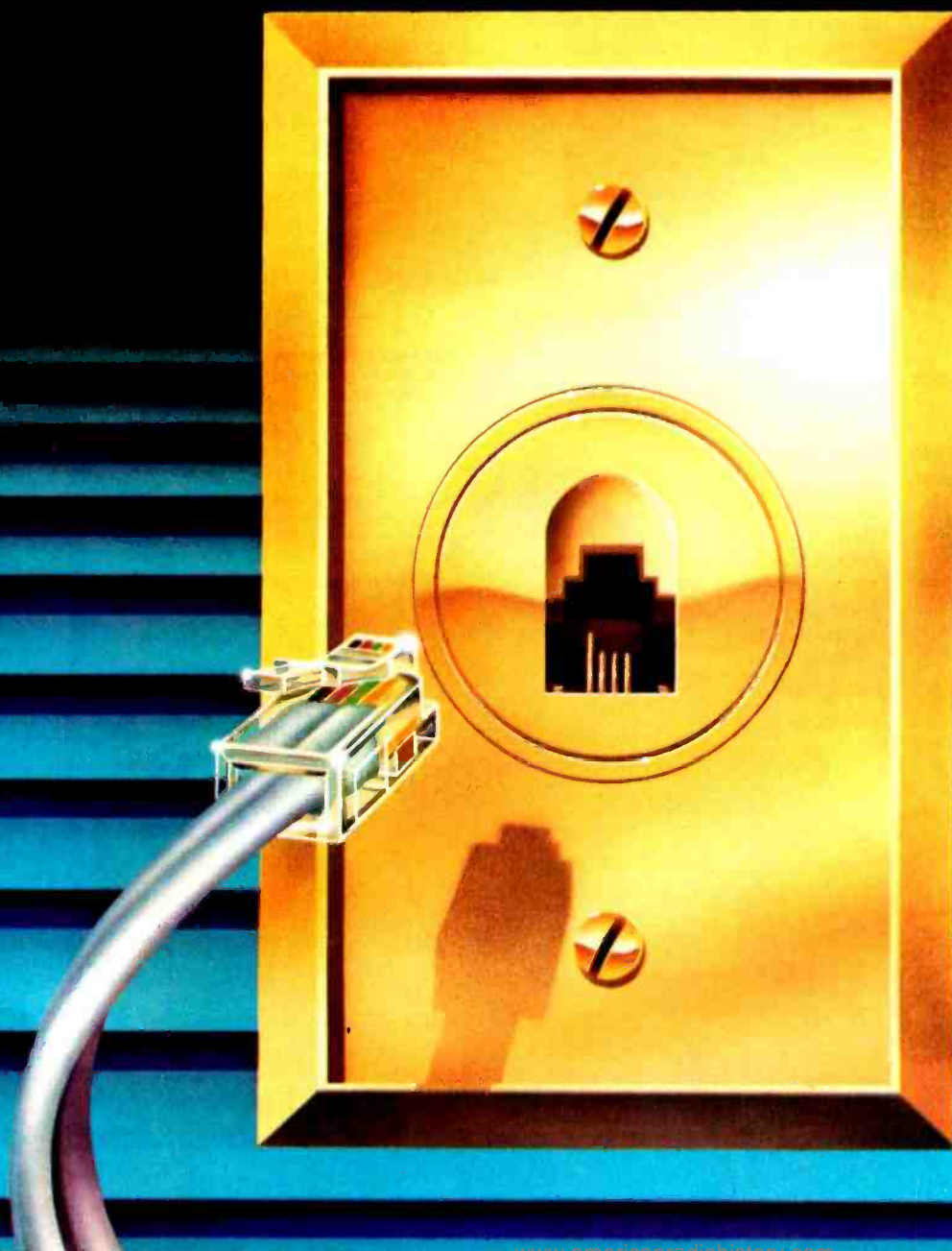

Introducing

ACCESS 1-2-3™

Now for the IBM PC and others.



Novation PC1200B™ Modem

+

Crosstalk XVI™ software

+

all accessories.

Access 1-2-3 is a simple idea. It means you can now walk into your nearest computer outlet, buy one package off the shelf and walk out with the best fully integrated communications system for your personal computer.

What we've done is taken the best 1200 Baud modem, our PC1200B—plus Crosstalk XVI, the best available software—added instructions and whatever else is needed for your particular computer—and put them all in one box.

The advantages:

First, you get a *total* system. No missing parts. No wrong parts, either. You can be sure you have all you need and all you need to know.

Second, it's the best *system* you can put together. Absolutely no compromises. You simply take it home, open the box, hook it up, and start up. Your only surprise will be how really easy it all works.

The best modem.

It's our PC1200B modem in a format to fit your particular computer.

The Large Scale Integrated circuitry is our own 3rd and 4th generation design. It's the most advanced technology, eliminating all kinds of parts and running better and cooler.

The right software.

The Crosstalk XVI programmers have pulled off a little magic. Without compromising a bit on all the things you want and need to do, they've made them all *easier* to do on our PC1200B modem.

No wonder Crosstalk XVI is recognized as the best in its field.



Easy 1-2-3 instructions.

The new instructions that go with the Access 1-2-3 series help make your life easier, too. You don't have to know a byte from a baud to get going. High-tech talk is out. Plain English is in.



Cables and connectors.

If your particular computer needs a cable and connector, they'll be in the package. No big deal, of course—unless you've gone through the frustration of piecing together a system with something less than expert help. Well, no need to worry here. With Access 1-2-3 it doesn't matter who's minding the store.

The expertise is built in.

Available now.

IBM PC, IBM PC XT, Columbia Multi-Personal, Compaq Portable, Corona Portable PC.



The first models in our Access 1-2-3 series are at your dealers right now.

More models are being added and we'll soon cover all of the important personal computers. See your dealer for the latest list.

And the price.

Packaging up a sensible system has let us do something sensible for the price, too. Entire system—only \$595.

Included: CompuServe

Your Access 1-2-3 system now carries an extra bonus—two hours of free demonstration time on one of the most extensive and best data banks, CompuServe. A nice way for your computer to meet the data world.

Talk to your dealer today.

All of the features you want and need.

- LSI smart modem, 300 or 1200 baud, full duplex, uses just one slot on all models.
- Crosstalk XVI software.
- Directory for single stroke log-on to 40 separate entries.
- Auto dial (TouchTone or rotary), auto log-on, auto answer.
- Telephone line status, busy detect and automatic redial.
- Auto monitoring through computer speaker.
- Captured data to printer, disk or buffer transfer.
- Disk to disk transfer.
- Extensive error-checking and automatic retransmission.
- Display of transmission time for each file with baud rate and available disk space.
- Complete on-line control of stop bits, parity, baud rates, duplex.
- Modem self-test.
- Full 2 year warranty.

ACCESS 1-2-3 by

Novation



Novation, Inc., 20409 Prairie St., Box 2875
Chatsworth, CA 91311 • (800) 423-5419
In California: (213) 996-5060
Access 1-2-3 and PC1200B are trademarks of Novation, Inc.
Crosstalk XVI is a trademark of Microstuf Inc.

Circle 320 on inquiry card.



Pulse
by
brown disc

**THE
COMPUTER'S
HEARTBEAT**

The Universal 5 1/4" Diskettes.

NEW - Pulse I - 48 TPI

Pulse II - 96 TPI Up to 1.0 MB.

NEW - Superior Magnetics for a LIFETIME.

NEW - Packaging - 2, 6, and 10 Pacs.

FOR USE WITH ALL PC'S



brown disc manufacturing, inc.

1015 Garden of the Gods Road Colorado Springs, Co 80907

(800) 654-4871 TELEX 450827

**We're Driving the
Drive Market.**

Integrating Voice in the Office World

How "voice recognition" and "voice as data" simplify the user interface in the business world

by Robert T. Nicholson

If industry predictions are correct, by the end of the decade 80 percent of the work force in the United States will be engaged in office work and information handling. As the number of office workers increases, so does the competition for the growing office computer market. Established workstation manufacturers, new start-up companies, and traditional word-processor and communications manufacturers are already rushing to introduce office systems.

Most of these systems perform some combination of these functions: word processing, electronic spreadsheet, electronic mail, and calendar appointments. Some systems also provide decision support and business-graphics capabilities. Typically, the purchase of such a system is justified by the need for a particular application; the user is willing to live with a poor user interface or an incomplete system to meet that immediate need.

However, as the number and diversity of users increases, office systems must offer more integrated sets of applications with far better interfaces to accommodate the needs of a broad range of users and to eliminate expensive and time-consuming training.

Office System Interfaces

Current systems attempt to do this by starting with a familiar model.

Some use the workstation screen to represent a desktop, with small icons (graphic symbols) used to depict objects that might be found in the office (such as file folders or memos). Windows on the screen contain the user's current work, and the user may freely interrupt one task to work on another simply by moving to another window (see photo 1).

To begin a new task, the user "opens" one of the objects on the desktop. The user selects the desired object by pointing to an icon on the screen using a mouse or cursor keys, and then opens the object by pressing a button or key. When the object is opened a new window is created to display its contents.

Other activities, such as deleting, mailing, or printing, can be chosen by pressing a *softkey*. As shown in photo 1, softkeys are function keys whose tasks are labeled on the workstation screen. Whenever the user selects a function by pressing a key, the labels change to show the new options or functions that become available.

These interfaces are a big improvement over older systems, but they still limit the user to communication via the screen and the keyboard. One way to overcome this limitation is to integrate voice communication into the computer system.

Voice is the most natural form of human communication. It is faster

than typing, can be done from anywhere in the office, and does not require a keyboard (a fact that will please many managers who have resisted the idea of typing). In addition, psychologists and learning specialists believe that listening to information, instead of reading it, may speed learning and improve retention.

Voice Applications

The ability to record a spoken message and store it digitally on a computer system makes possible a whole new range of applications.

Combined with electronic mail, the digital recordings can be used as *voice messages*. Office users can quickly create short, impromptu messages and dispatch them to other users of the system without ever using a keyboard. It is also possible to provide "mailbox" files for voice messages and to allow users to call in over a standard telephone to record and play back their voice mail. This voice-messaging process is especially important in large corporations where managers and professionals may spend 65 to 95 percent of their time in communication.

Integrating telephone functions into the desktop workstation has other advantages: the system can maintain a telephone directory for automatic dialing and can allow the user to leave a typed or recorded message



Photo 1: The workstation screen can be divided into several windows, each dedicated to a particular task. In the background window are the icons that represent various objects in the user's office. The two windows nearer the front are being used to work on a spreadsheet and a document. The labels on the softkeys at the bottom of the screen allow the user to select functions to be performed.



Photo 2: The small window in the foreground contains a visual representation of a recording made by the user. Solid lines show continuous speech, while breaks indicate pauses. The numbers mark reference points selected by the user. By moving the cursor around this display and using INSERT and DELETE keys on the keyboard, the user can edit the recording.

when someone doesn't answer.

Another important office function is dictation and voice editing. A voice editor allows the user to see and edit a visual representation of what is being recorded, just as a word processor allows the user to edit text. As shown in photo 2, a line is drawn while the user speaks, with breaks in the line to show pauses. (This feedback provides a reassuring indication that the system is working.) The numbers shown are points that the user has marked for future reference using a Mark key. The visual representation is important, because it allows the user to go back over the completed recording and insert or delete recorded material using editing keys. The user can also find parts of the recording to edit by using the Rewind, Fast Forward, Play, and Stop softkeys. Only when the recording says exactly what the user wants to say is it mailed to a secretary for typing.

Similarly, voice input can be used to "enter" data in a form, for later typing by a clerk or secretary. For example, an executive could be prompted for each of the fields on an expense-report form and could verbally record the expenses. The finished "form" could then be sent to the accounting department, where a clerk could play back the responses and

type them into the accounting system.

Voice recordings can also be used for document annotation. Frequently, paper documents are passed around an office for review and comments. These comments are usually scribbled in the margin or passed on verbally when the document is returned. To a large extent, this ability is lost when documents are circulated in electronic form using mail systems. With a voice annotation scheme, however, users can record verbal comments and then mail the "marked" document back to its creator. The location of each voice annotation is shown by a speaker symbol in the margin of the document, as shown in photo 3.

System output can also be enhanced via voice. To aid the user in learning to use sophisticated features, most systems today offer help functions that provide on-line information. The problem with these systems is that there is no way to try an operation while reading the help instructions. This problem can be overcome by providing an audio help facility (in addition to the standard help text). The user can then try out an operation while listening to a recorded help tutorial. Using prerecorded instructional material, full on-line training systems could be developed to

verbally correct the user as mistakes are made.

Other uses for voice output could include notification of events ("You have an urgent message waiting") and elaboration or emphasis ("Note that earnings are 60 percent over projections").

These applications share one important attribute: the system treats the recorded information as data and has no knowledge of its content or meaning. Applications of this type are called voice or *voice-as-data* functions, to distinguish them from *voice-recognition* applications, which involve processing and recognition of the audio input.

To date, speech input has been used mostly in applications where "hands-free" data entry was required and where the necessary vocabulary was limited. For example, workers unloading trucks for private postal services can read destination codes into a clip-on microphone before placing a parcel on the conveyor belt; the system can then automatically route the parcel to the correct outgoing truck.

Hands-free operation could also have some applications in the office. It might be useful for a typist to verbally give system commands while typing or for a graphic designer to give the machine verbal instructions

WE'RE LOOKING FOR A FEW GOOD DEALERS.

It's a software jungle out there. You're fighting amidst a deluge of product claims and counterclaims.

That's why you should join forces with the Champion. A superior software accounting system, written in dBASE II* on one small disk, that requires very little dealer support. In fact, Champion performs so well in the trenches that profits are no longer an uphill battle.

The system has received excellent reviews:

"... users will find this to be a very comprehensive software package with several features that make it superior to its competition."

— Carl Heinz, CPA,
INTERFACE AGE, 8/83

Other software dealers will tell you what they *think* their product will do. Only Champion dealers will *show* you how the software performs, feature by feature:

- If you have a question, you can ask the Champion for help.
- The system has built-in safeguards, so it will not crash.
- You get timely, professional-looking reports.
- The entire system is updated whenever any information is entered.

CHAMPION IS EASY TO DEMONSTRATE, SO IT'S EASY TO SELL.

The Champion system is very dealer-friendly. You don't have to be an accountant to demonstrate it. And the system will not crash. Champion gives you total confidence in being able to demonstrate any function to a prospective customer.

After the demonstration, customers can use Champion for a trial period. This allows them to examine the package on their own computers, risk-free for 30 days, or 200 transactions.

See what this system can do for your operations. Be among the few, the proud, The Champion Dealers.

*dBASE II is a registered trademark of Ashton-Tate.

NOTHING PERFORMS LIKE A CHAMPION.

Data Base Research Corporation
66 South Van Gordon,
Suite 155
Lakewood, CO 80228
(303) 987-2588

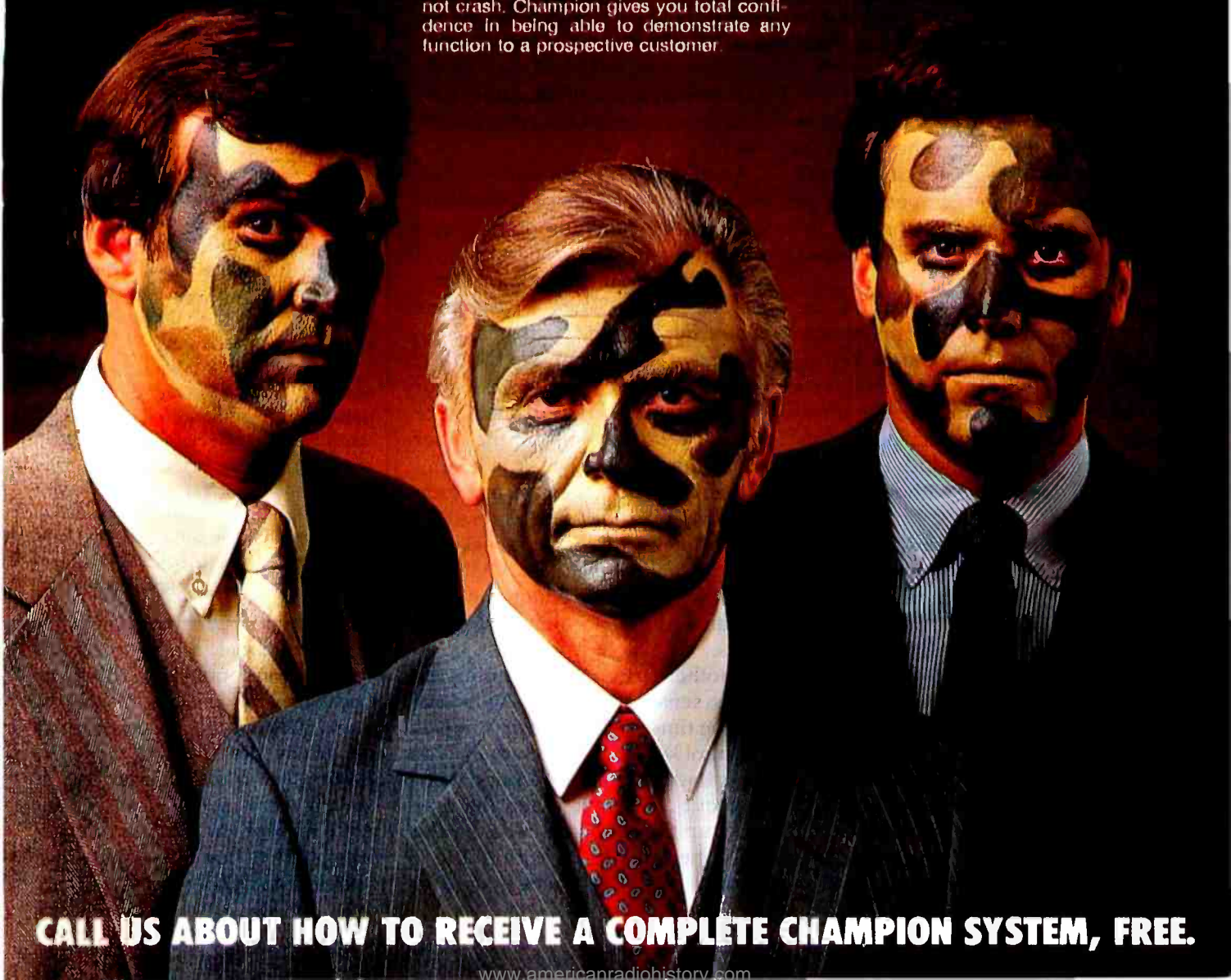

CALL US ABOUT HOW TO RECEIVE A COMPLETE CHAMPION SYSTEM, FREE.

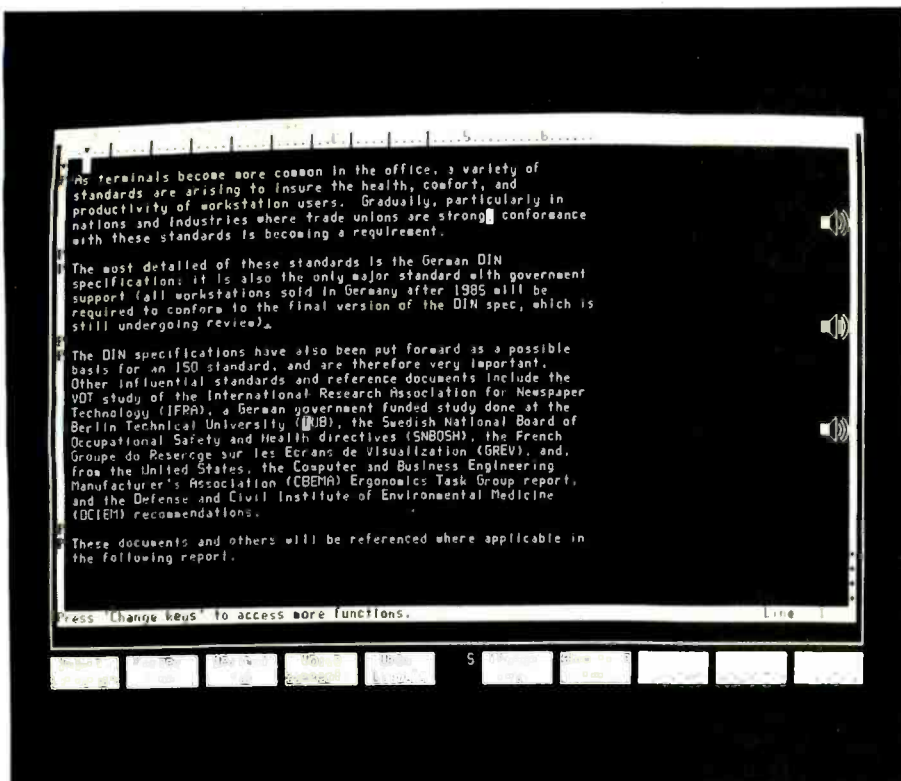

Photo 3: Speaker icons in the margin of this document show points where a reviewer has recorded voice comments that can be played back by the original author of the document.

while drawing with a mouse.

With improved speech recognition techniques, however, other kinds of applications are appearing. One new application combines speech input with a pseudo-natural-language interpreter to allow verbal database queries.

Farther out on the horizon are direct-speech-transcription systems. The idea of such a system is to produce ASCII (American National Standard Code for Information Interchange) text from spoken input, thus allowing users to produce and print finished documents without using a keyboard.

As attractive as these applications are, they also present serious challenges to the interface designer.

Voice Interface Challenges

The major obstacle to overcome is the intimidation that some people feel when presented with a microphone. A first step in this direction is integrating the telephone into the workstation. The telephone is a familiar device that we all use; by making it a part of the workstation, the interface designer gives the user

a chance to gradually become comfortable with the idea of talking to the machine.

Another way to ease the user over the microphone fear is to eliminate any system demands on the user and to maintain a strong feeling of user control. Many people, for example, freeze up when a telephone answering machine begins its familiar litany, "At the sound of the tone, you have 60 seconds to leave your message." With an integrated voice and data workstation, on the other hand, the user can be left in control of the situation: "When you are ready to leave your message, press the Record key and begin speaking." Also, visual feedback like that provided by the voice editor can be a valuable confidence-builder for new users.

Another factor in maintaining the user's sense of control is good response time. When the user presses a control key such as Record, Play, or Stop, the system must respond within about .1 second. When the user picks up the telephone receiver, the dial tone must begin within 2 to 3 seconds. Or, when voice is used in

Digital Voice Encoding

Digital voice encoding is a process that converts an analog waveform into a digitally coded representation that can later be reconverted to analog form. Once in digital form, the voice data can be transmitted, stored, and processed by a computer—an important attribute as voice and data integration become more common.

The standard form of encoding used in the telephone industry is referred to as pulse-code modulation (PCM). In PCM, an analog waveform is sampled at regular intervals, and the amplitude of each sample is represented as a binary number. With 8-bit PCM, for example, 1 byte is used to represent the amplitude; thus, the representable values range from -128 to 127, in 255 equal steps. This representation is called a linear encoding.

Better sound reproduction can be achieved, however, if the steps are fine at low amplitudes and coarse at high amplitudes where the human ear is not as discerning. Therefore, a U.S. standard has evolved that uses one bit for a sign, four bits for a mantissa, and three bits for an exponent. The resulting nonlinear code is called mu-law (or mu-255) encoding.

Mu-law encoding is capable of good telephone quality sound reproduction. In fact, it is the basis for most digital telephone systems within the United States (a similar system called A-law is used in Europe). Unfortunately, mu-law requires a great deal of data. Because the sampling rate used is 8000 Hz, 1 second of sound requires 8000 bytes of data, and 5 minutes requires over 2 megabytes!

Efforts to reduce the volume of data have resulted in a technique called differential pulse-code modulation, (DPCM), in which the data value stored represents the amplitude difference between samples, instead of the amplitude of the sample itself. This technique can be further improved by storing an adaptive differential pulse-code modulation (ADPCM). In this technique, the scale of the differential value

a conversational activity such as prompting, response time should be close to .5 second. This simulates the natural pace of human conversations and avoids the stress of rapid-fire questions from the system.

In any voice application the quality of voice reproduction is important. Voice prompts from the system need to be clear and understandable. Voice

is varied based on previous differentials. Thus, if several successive samples contain large differentials, each will be considered a multiple of the preceding data value, so that a steep slope can be approximated with few bits. In fact, ADPCM produces good sound with 2-, 3-, or 4-bit data values, instead of the 8-bit values used in standard PCM. (The ADPCM algorithm is available in IC form from Oki Semiconductor Corporation and is described in detail in the June 1983 BYTE.)

An alternate technique for encoding voice is called delta modulation. In delta modulation, each segment of the wave is approximated by a line segment with a slope of 1 or -1. The direction of the slope can be represented with a single bit, rather than the 4 or 8 bits used in PCM algorithms. Of course, simple delta modulation isn't good enough for most applications because restricting the slope to 1 or -1 makes it difficult to model steeply climbing or falling waves.

A somewhat better algorithm is called continuously-variable-slope delta modulation (CVSD). In CVSD, if the slope value of the data bit is the same for three or four samples, the slope is doubled. This prevents the approximation from falling too far behind when the slope of the wave becomes steep. Still, to get a close approximation with CVSD, many samples are required. For good-quality voice reproduction, as many as 32,000 samples (or 4000 bytes) per second may be required.

For applications where voice quality is less important, linear predictive coding (LPC) can store voice with very little data (200 to 300 bytes per second). LPC is based on a mathematical model of the human vocal tract. The data values stored at each sample point are actually coefficients of a formula for reproducing the desired sound. One of the most familiar products using LPC is Texas Instruments' "Speak & Spell."

messages must be reproduced with enough fidelity to allow the speaker to be recognized and to allow nuances of tone to be detected. In other words, the quality of sound must be at least as good as a good telephone connection. To provide this quality, the system must digitize and then regenerate the voice of the speaker via waveform encoding, in-



Photo 4: The Voicestation 1 provides the integration needed for office applications by combining a bit-mapped display and a telephone in a single compact unit. The workstation is connected to a central system over standard office telephone wiring.

stead of using artificial speech-synthesis chips.

Applications that process speech have an additional problem because available speech-input devices either have a limited vocabulary or must be trained to understand specific users. Device training is often viewed as a one-time process, but it really isn't; voices may change because of colds, temporary help may be hired, or people might use one another's workstations. Therefore, when designing a speech-input system, considerable effort should be spent to make the training process as simple as possible.

Virtual Personal Computer Architecture

Meeting the various user-interface requirements places some heavy demands on the office computer system. Chief among these is the ability to transfer and store large quantities of data. Storing 1 second of high-quality digitized-voice data can require 2000 to 8000 bytes of data, depending on what sort of compression is used (see the text box "Digital-Voice Encoding" for more information). Re-

coding just a few minutes of dictation can require that more than a megabyte of data be processed, compressed, and stored, all in real time. Moreover, the hardware to do this must not add too much to the cost of the system, or it will not be competitive in the office-systems market.

To meet these goals we need a "virtual personal computer," an architecture that allows expensive voice, storage, and communications resources to be shared, while delivering performance comparable to a dedicated personal computer. An example of such a system is the Sydis Information Manager (SIM) from Sydis Inc. (see figure 1). Its architecture, described later, is a direct product of the requirements for an integrated voice and data interface.

The SIM is a centralized facility containing all of the expensive resources required in the office. Processing power is provided by multiple 68000 microprocessors including a system master and multiple application servers, voice servers, and file servers. The system master, which can be made redundant for increased reliability, allocates and coordinates

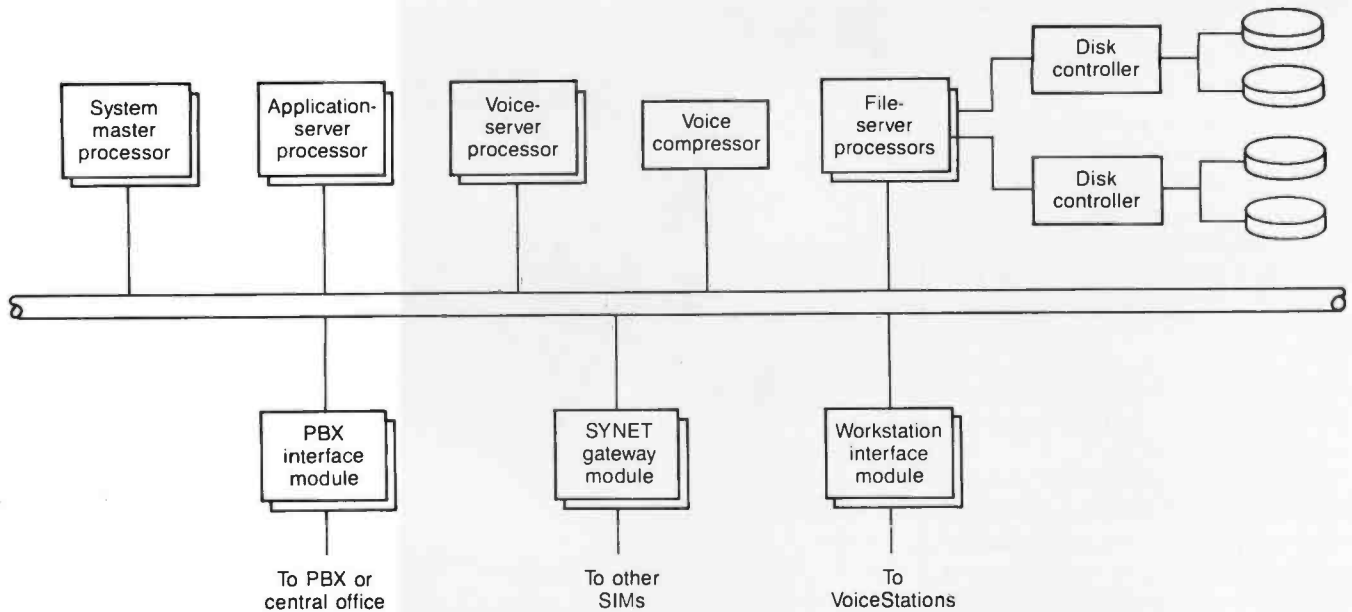

Figure 1: The Sydis Information Manager (SIM) architecture combines shared resources for many users in a central location. In addition to multiple 68000 processors used for application programs, voice processing, and file-systems I/O, the SIM includes interfaces to the office PBX and to local networks or other SIMs.

the other resources of the SIM. The application-server processors perform the general work of the system, running office application programs for users. One or more voice servers are used as "digital tape recorders" to handle the voice-to-disk and disk-to-voice transfers as well as voice editing. Finally, one or more file servers handle all mass-storage operations.

Mass storage within the SIM is provided by one or more 160-megabyte Winchester disks and a 160-megabyte streaming-tape drive for backup. Other shared resources include interfaces to the office Private Branch Exchange (PBX), which handles telephone functions such as forwarding and transferring calls, gateways to other SIMs, and interfaces for the desktop workstations.

The desktop workstations, called Voicestations, are connected to the SIM in a star configuration. Connections are made over standard two-wire telephone lines, eliminating the expense of rewiring the office. Each connection supports four 64K-bps (bits-per-second) communication channels, providing the high bandwidth required to match the performance of a desktop computer. One of the four channels is used by the

system for command and status information, another is reserved for voice, and the remaining two are available for data.

The Voicestation itself, shown in photo 4, features an integrated telephone, a speakerphone, and a high-resolution (832 by 608) bit-mapped display. A local 68008 processor and 128,000 bytes of RAM allow the workstation to perform the windowing functions required by the interface. Additional devices can be attached to the Voicestation, including a mouse, a foot pedal for use in transcribing dictation, and a local printer.

In summary, the architectural features needed to integrate voice capabilities into an office system include:

- a central facility to allow sharing of expensive resources such as mass storage and voice processors
- large mass-storage capacity to allow storage of voice data
- a low-cost, high-speed link to desktop workstations
- workstations with enough local power to support graphics, windowing, and useful local I/O (input/output) devices

Software Requirements

Integration of voice and data also

places demands on the system software. The Sydis system is based on Microsoft's Xenix operating system, which is fully compatible with Bell Laboratories' Unix System III. To provide the performance necessary for voice applications, Sydis has made several enhancements to the operating system.

One major addition is a network interprocess-communication facility (NIPC), which allows reliable and fast communication between processes even though they may be running on different processors. This facility has many uses, including resource requests and allocations among processors and communication within the file system.

To allow uses on different application servers to share mass storage, the file system has been networked. File-system calls on an application server are now converted to NIPC messages, which are transmitted to the appropriate file server over a 128-million bps system bus. In addition, the system has been enhanced so that multiple disks on multiple file servers can be made to appear to the application programs as a single file hierarchy, so that the physical location of any particular file is transparent to the program.

The almost perfect stocking stuffer.

It may not fit perfectly into a stocking, but it's perfect for everyone who has, or is about to get, a computer.

It's the Datalife[®] Holiday Pack: ten Datalife 5 1/4" minidisks in a plastic storage case and a free Head Cleaning Kit, too.

High-quality Datalife Disks are certified 100% error-free and warranted 5 years. The free Head Cleaning Kit

also ensures trouble-free computing by keeping disk drive heads free from dirt and debris.

For the name of your nearest Verbatim retailer, call toll-free 800-538-1793.

While it may not fit a stocking perfectly, the Datalife Holiday Pack will ensure years of perfect computing for every computer person on your list.

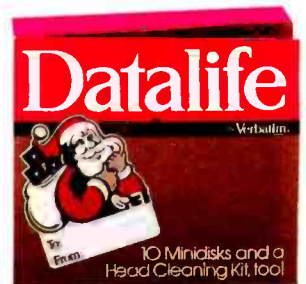

**The Datalife
Holiday Pack:
10 minidisks and a free
Head Cleaning Kit.**

Circle 444 on inquiry card.

The file system has also been optimized for the large files and large data transfers required for voice applications. Disk space is now allocated in blocks of 4096 or 8192 bytes, rather than the 512-byte blocks traditionally used on Unix systems. In addition, the linked list that Unix file systems use to keep track of free space has been replaced by a bit map showing the state of each cylinder and sector on the disk. In this way, blocks can be allocated in an optimum way, taking into account disk

latency, to ensure high-speed transfers for large streams of voice data.

The software requirements for the system master and voice server were somewhat different. These processors perform no direct disk I/O but must respond rapidly to interrupts to handle voice data in real-time. To meet this need, these processors run a stripped-down version of the operating-system kernel. All required software has been written as interrupt routines or as system processors, to minimize context switching times.

These and other enhancements provide an operating system capable of concurrently transferring multiple streams of voice data to and from disk, while still handling the requirements of more traditional office applications such as word processing and electronic mail.

At the user-interface level, the standard Unix shell or command interpreter has been replaced by a new shell that models the user's office environment and provides the object and softkey selection facilities seen in photos 1-3.

Conclusions

Integrated voice and data systems will be widely used in office automation because they enhance communications, the most time-consuming office activity. As always, some purchasers will accept a poor interface to have these features as soon as they can. But for these systems to be widely accepted, comfortable, responsive interfaces must be designed.

Supporting high-quality voice interfaces requires the ability to rapidly move and store large volumes of data and to effectively share limited or expensive system resources. The architectures needed to provide these capabilities may have as big an impact as the voice systems themselves. ■

References

1. Bair, James H. "Communication in the Office of the Future: Where the Real Payoff May Be," *Business Communications Review*, January-February 1979.
2. Ciarcia, Steve. "Use ADPCM for Highly Intelligent Speech Synthesis," June 1983 *BYTE*, page 35.
3. Lea, Wayne A. "Selecting the Best Speech Recognizer for the Job," *Speech Technology*, Volume 1, number 4, January 1983.
4. Loftus, Elizabeth F. *Memory*. Reading, MA: Addison-Wesley, 1980.
5. Miller, Robert B. "Response Time in Man-Computer Conversational Transactions," *Proceedings of the Fall Joint Computer Conference*, AFIPS, 1968.
6. Milne, Steve and William R. Stensrud. "Voice: Soon a Requirement for Office Workstations?" *1983 Office Automation Conference Digest*, AFIPS, 1983.

Robert T. Nicholson is a member of the technical staff at Sydis Inc. (410 East Plumeria Dr., San Jose, CA 95134).

New Home and Professional Computer Books.

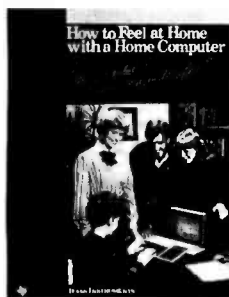

264
pages
\$12⁹⁵

How to Feel at Home with a Home Computer.

Finally—a book that answers the most asked questions about a Home Computer—what it is, what it does and what it can do for you. A "must read" for anyone who owns one or is thinking of buying.

You'll see that a Home Computer is useful, practical, educational, fascinating, and fun . . . For the whole family. This book tells you how. And why.

Two New Computer Books . . . available now at leading bookstores and computer retailers.

Or, if you choose to order direct, send check or money order, \$12.95 each book (plus state sales tax and \$1.25 handling), to: Texas Instruments, Dept. CB-11, P.O. Box 3640 M/S 54, Dallas, Texas 75265.

TEXAS INSTRUMENTS

Creating useful products
and services for you.



Instant one-button color printing.



Press here.

It's just that easy! Any time you want to print what's on your Apple's screen just hit the copy button on your Transtar 315 color printer with our PICS card installed, and it's done! No special programming, no lengthy code sequences, no need to exit your program! Just press the button and it prints!

By adding the optional PICS card to your \$599 Transtar 315 color printer, you've opened up a whole new world of easy color printing. For the first time ever, our PICS parallel interface card enables you to screendump virtually any program -- graphics, charts, games -- even copy-protected software! Specially designed only for the Apple II, II+, IIe, and Franklin computers, the Transtar 315 PICS card does the work of a parallel card and a lot more and costs only \$119.95.

At the push of a button, Transtar's innovative new 4-color diagonal ribbon will print up to 7 colors and more than 30 shades in a single pass.

The 315 is precision-built to exacting standards by Seikosha, the most experienced company of the famous Seiko group-- recognized worldwide for quality and dependability. In fact, one of the nicest things about Transtar's 6-month warranty on parts and labor is that you'll probably never use it!

Innovative, inexpensive, dependable, easy: the Transtar 315. Color printing has never looked so good!

Only \$599.

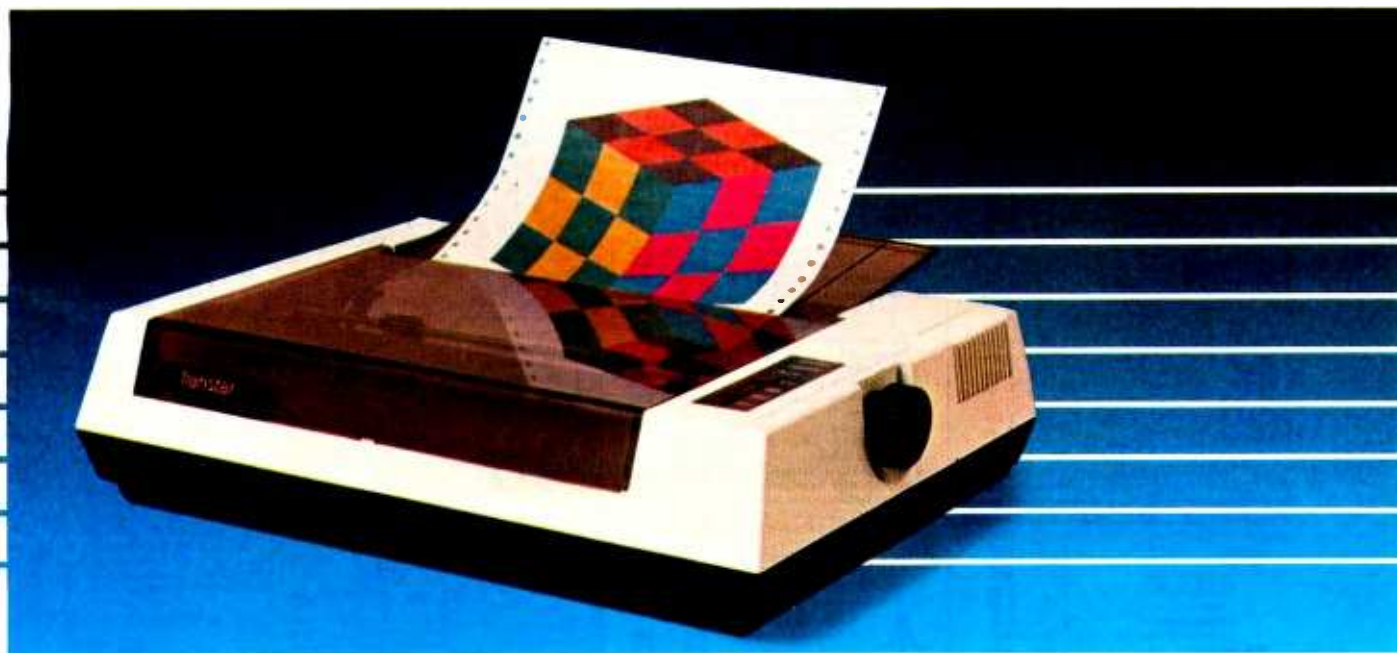

*PICS cards are currently available for Apples and Franklins.
PICS cards for other computers will be available in the future.

Transtar
A Vivitar. Computer Product

P.O. Box C-96975, Bellevue, WA 98009

BYTE December 1983 185

The Choice of

SAVE THIS AD IT IS YOUR CATALOG AND CHANGES MONTHLY

SAVE THIS AD IT IS YOUR CATALOG AND CHANGES MONTHLY. SOFTWARE on Disk for APPLE II/II+//e



HARDWARE For The APPLE II/II+//e



- APPLE IIe 128K 80 COLUMN** \$1,295
APPLE IIe STARTER SYS. BY APPLE (Sys. A)
 64K and 80 column Disk II with controller
 Apple Monitor III
 Monitor Stand \$1,650
- APPLE IIe STARTER SYSTEM BY CONROY-LA POINTE (SYSTEM B)**
 128K and 80 column
 1 Micro-Sci Drive with controller
 Fier, Utility and Apple DOS 3.3 Diskette
 Zenith 12' Green Monitor
 RF Modulator (for color TV)
 Game Paddles
 Game w/ color graphics and sound
 20 Blank Diskettes \$1,650

LIMITED WARRANTY: is 100% Parts & Labor for 90 days by us

DISK DRIVES

- * CENTRAL PT. Fier, Utility & Apple DOS** \$ 20 \$ 15
- H-SCI MICRO SCI**
 A2 143K Disk Drive \$ 479 \$ 219
 A2 Controller Card \$ 100 \$ 79
 *A42 160K Drive \$ 449 \$ 299
 *A70 268K Drive \$ 599 \$ 299
 A40 A70 Controller \$ 100 \$ 79
- Supers 5**
 1735 Belt Drive \$ 299 \$ 199
 1740 Direct Drive \$ 349 \$ 239
 1780 Direct Drive \$ 449 \$ 329
 Controller Card \$ 110 \$ 59
- Rana Elite**
 Elite 1 163K 40 TK \$ 379 \$ 249
 Elite 2 326K 80 TK \$ 649 \$ 399
 Elite 3 652K 160 TK \$ 849 \$ 499
 Elite Controller \$ 145 \$ 84
- TEAC**
 *143K Drive 1.2 High Controller Card \$ 379 \$ 259
 *Electronics by ComX
- VISTA**
 DiskPak 11200 6MB Backup Sys \$1549 \$1049
 *V1000 Dual 8" Sid. Format \$2195 \$995

VIDEO CARDS

- *ALS. SmartForm (I - ore) \$ 179 \$139
 ComX 80 col. 64K Adder (Ile) \$ 295 \$145
 Videx. Videoterm 80 col. (I - ore) \$ 345 \$229
 * UltraTerm (I - ore) \$ 379 \$279
 * SoftVideo Switch (II+) \$ 35 \$ 25
 Enhance (II - I) \$ 149 \$ 99
 Function Strip (II+) \$ 79 \$ 59
 We Have Full Video Line. Call. Up to 35% off
 Vista, Vision 80 \$ 289 \$199

OVERSTOCK SPECIALS

- WHILE THEY LAST**
- ★ALS. Synzyger - Scale Condor (II - I) \$ 749 \$199
 ★Axlon 320K RAM Disk System (I - ore) \$1000 \$650
 ★CCS. Serial Interface 7710A (I Set Baud) \$ 150 \$ 99
 ★ComX 16K RAM Card 1 Yr. Wty. (II - I) \$ 179 \$ 39
 *Microsoft 16K RAM Card for II - I \$ 100 \$ 69
 Silicon Valley Word Handler \$ 250 \$ 39
 * Last Handler \$ 90 \$ 35
 Videx. Videoterm 80 column card for II - I \$ 345 \$229

RAM EXPANSION

- *ComX 16K RAM Card \$ 295 \$145
 *ComX RAM Card 1 Yr. Wty. (II+) 16K \$ 179 \$ 39
 *ALS. ADDRam (II - I) 16K \$ 100 \$ 59
 *Microsoft RAM Card (II - I) 16K \$ 100 \$ 69
 *Saturn Systems RAM Card (II+) 32K \$ 249 \$169
 RAM Card (II+) 64K \$ 425 \$299
 RAM Card (II+) 128K \$ 599 \$399
 *Axlon RAM Disk System (I - ore) \$320K \$1000 \$650

MISCELLANEOUS

- ALS. The CP M Card V3.0 (+ ore) \$ 399 \$299
 Z Card (I - ore) \$ 169 \$129
 Color II (I - ore) \$ 179 \$139
 *ASTAR. RF Modulator, to use TV \$ 35 \$ 25
 *CCS. Serial Interface 7710A \$ 150 \$ 99
 *Central Point, Alaska Card (copier, + ore) \$ 130 \$ 99
 Eastside Wild Card (copier, + ore) \$ 130 \$ 99
 Kensington System Saver \$ 90 \$ 65
 Key Tronic KB200 keyboard (II+) \$ 299 \$219
 *Koala Graphics Pad \$ 125 \$ 85
 Market Microscope \$ 700 \$525
 Kraft Joystick (Ap II - I) \$ 65 \$ 49
 Paddle (Ap III+) \$ 50 \$ 39
 MBR, Slip Rlan (+ ore) \$ 50 \$ 39
 *Microsoft Z80 Softcard (+ ore) \$ 345 \$235
 Z80 Softcard Plus (+ ore) \$ 645 \$459
 Softcard Premium Pack (I+) \$ 695 \$495
 Softcard Premium Pack (IIe) \$ 495 \$395
 MicroTek Dumping 64, Buffer \$ 349 \$269
 *Orange Micro, Grappier Plus (e or +) \$ 175 \$119
 16K Buffer Board for Grappier + \$ 175 \$119
 Buttered Grappier - 16K \$ 245 \$179
 2 Chip Kit for above for 64K \$ 28 \$ 19
 Printer, Lower Case Chd (II+) \$ 50 \$ 39
 Practical Peripherals \$ 50 \$ 39
 MBP Ite 64K Par. (Epson Internal) (+ e) \$ 279 \$209
 MBS Ite 32K Ser. (Epson Internal) (+ e) \$ 219 \$169
 Microbuffer II +, 16K, (+ ore) \$ 60 \$ 45
 Par/Ser (specify) \$ 259 \$199
 Microbuffer II +, 64K, (+ ore) \$ 349 \$259
 *PCPI. Appl-Card, 14 features 6 Mhz \$ 375 \$275
 RH Electronics, Super Fan II \$ 75 \$ 59
 *Saturn Systems, Accelerator II \$ 599 \$449
 Transcend, SSM, A/C/D, Serial Paraf I \$ 225 \$169
 TG Products, Game Paddles (II - I) \$ 40 \$ 29
 Joystick (II - I) \$ 60 \$ 45
 Select-A-Port (II+) \$ 60 \$ 45
 Trk Ball (II+) \$ 65 \$ 44
 Videx, PSIO, Para/Ser Interface \$ 229 \$169

for the ATARI
RANA 1000 Drive, 320K \$449 \$369
KOALA Graphics Pad \$100 \$ 75

BUSINESS

- Applied Soft Tech. VersaForm \$ 389 \$259
 Artscl. MagicWindow II NEW! \$ 150 \$ 99
 *Ashton-Tate. dBase II (Req CP M 80) \$ 700 \$385
 Financial Planner (Req CP M 80) \$ 700 \$395
 Friday (Requires CP M 80) \$ 295 \$199
 BPI Systems. GL, AR, AP, PR or INV, each \$ 385 \$295
 Broderbund, Bank Street Writer \$ 70 \$ 47
 Continental. GL, AR, AP or PR ea \$ 250 \$165
 Home Accountant \$ 75 \$ 49
 FCM \$ 100 \$ 69
 Dow Jones. Market Analyzer \$ 350 \$275
 Market Manager \$ 300 \$235
 Market Microscope \$ 700 \$525
 Fox & Geiler. Quickcode (for dBase II) \$ 295 \$185
 dGraph (for dBase II) \$ 295 \$185
 dUtility (for dBase II) \$ 99 \$ 66
 Hayden, Pie Writer (Specify 80 col. board) \$ 150 \$ 99
 Howard Soft, Real Estate Analyzer II \$ 195 \$129
 Tax Preparer \$ 225 \$149
 LJK, Letter Perfect w/ Mail Merge \$ 150 \$ 99
 Micro Craft, (requires Z80 CP M Card) \$ 995 \$469
 Verdict or Billkeeper \$ 180 \$119
 Micro Lab. Tax Manager \$ 180 \$119
 Micro Pro. (all require Z80-CP M Card) \$ 995 \$469
 * WordStar w/ Applcard & CP M SPECIAL \$ 495 \$325
 WordStar - Training Manual SPECIAL \$ 495 \$239
 MailMerge - SPECIAL \$ 250 \$129
 SpellStar - SPECIAL \$ 250 \$129
 * WordStar Professional 4 Pak SPECIAL \$ 895 \$429
 Microsoft, Multi-Plan (CP M or Apple DOS) \$ 275 \$199
 Financial Multitool (CP M or DOS) \$ 100 \$ 75
 Budget Multitool (CP M or DOS) \$ 150 \$115
 *Osborne C.P. Soft. (Disk and Book) (Stat., Bus. & Math) \$ 100 \$ 49
 Some Common Base Programs (75 each) \$ 100 \$ 49
 Practical Basic Programs (40 each) \$ 100 \$ 49
 Peachtree, Requires CP M & MBasic, 40 columns \$ 595 \$365
 Series 40 GL & AR & AP, all 3 \$ 595 \$345
 Series 9 Text & Spell & Mail, all 3 \$ 495 \$199
 Perfect Letter Writer \$ 295 \$ 99
 Perfect Speller \$ 695 \$199
 Perfect Writer Speller 2 Pak \$ 595 \$259
 Perfect Fier \$ 149 \$ 99
 Quark Word Juggler (Ile) \$ 239 \$179
 Lexicheck Ite (use w Juggler) \$ 125 \$ 85
 Sensible Sens. Speller, specify 80 Col. Brd \$ 200 \$135
 Sierra On-Line ScreenWriter Professional \$ 330 \$ 89
 ScreenWriter II \$ 100 \$ 69
 The Dictionary NEW! \$ 230 \$155
 Word Manager II NEW! \$ 250 \$139
 *Silicon Valley, Word Handler \$ 90 \$ 35
 * Last Handler \$ 90 \$ 35

BUSINESS

- Software Publishing, PFS: File \$ 125 \$ 84
 (specify + ore) PFS: Report \$ 125 \$ 84
 PFS: Graph \$ 125 \$ 84
 Stoneware, DB Master Version 4.0 \$ 350 \$229
 DB Utility for II \$ 99 \$ 59
 System Plus. GL, A.P. & A.R. \$ 995 \$555
 Videx, Aptewriter II preboot disk \$ 20 \$ 15
 Viscatic 80 col. preboot disk \$ 50 \$ 39
 VisiCorp Personal Software. \$ 250 \$169
 Viscatic 3.3 \$ 250 \$169
 Viscatic Enhanced (Ile) NEW! \$ 250 \$169
 VisiFile for VisiDex, each \$ 250 \$169

UTILITY & SYSTEM

- Beagle, Utility City \$ 30 \$ 22
 DOS Boss \$ 24 \$ 18
 Apple Mechanic \$ 30 \$ 22
 Central Point, Fier, DOS 3.3 and Utility \$ 20 \$ 15
 Copy II Plus (bit copier) \$ 40 \$ 30
 *Einstein, Compiler, for Applesoft BASIC \$ 129 \$ 85
 Epson, Graphics Dump \$ 15 \$ 9
 *InfoSoft, GrafFORTH by Paul Lutus \$ 75 \$ 59
 Microsoft, A.L.D.S. \$ 125 \$ 75
 Cobol 80 \$ 750 \$559
 Fortran 80 \$ 195 \$149
 Complete Line in Stock

HOME & EDUCATIONAL

- Broderbund, Choplifter \$ 35 \$ 26
 BudgetCo. Pinball Constr. Set \$ 40 \$ 27
 *Continental, Home Accountant \$ 75 \$ 49
 Dallasoft, Aztec or Zaxxon, each \$ 40 \$ 27
 Edu-Ware, (Large Inventory) Call
 Einstein, Memory Trainer \$ 90 \$ 70
 Hayden, Sargon II (Chess) \$ 35 \$ 29
 Infocom, Zork I, II, III, or Starcross, each \$ 40 \$ 27
 Koala, Full line in stock, Call
 Learning Co., (Large Inventory) Call
 Lightning, Mastertype \$ 40 \$ 27
 Micro Lab, Miner 2049er \$ 50 \$ 27
 Sierra On-Line, Ultima II \$ 60 \$ 40
 Sir-Tech, Wizardry \$ 50 \$ 39
 Spinmaker, Kidcomp \$ 30 \$ 20
 Sub Logic, Flight Simulation or Pinball, ea. \$ 35 \$ 25
 Terrapin, Logo \$ 150 \$ 99

OTHER BRANDS AND PROGRAMS IN STOCK, CALL.

DISKETTES

- | BROWN DISC | LIST PRICE | OUR PRICE |
|--|------------|-----------|
| 10 each, Pulse I.D.S. DD, 48TPI | \$ 45 | \$ 32 |
| 10 each, Pulse II, DS, QD, 96TPI | \$ 60 | \$ 45 |
| CDC 100 each, SS, SD, 35T (Apple, Atari) | \$ 45 | \$ 169 |
| 100 each, SS, SD, 35T (Apple, Atari) | \$ 45 | \$ 18 |
| 100 each, SS, DD, 48T (Apple, IBM) | \$ 55 | \$ 179 |
| 100 each, SS, DD, 48T (Apple, IBM) | \$ 55 | \$ 119 |
| 100 each DS, DD, 48T, (IBM, H.P.) | \$ 75 | \$ 35 |
| DYSAN 10 each, (Apple, etc.) | \$ 69 | \$ 39 |
| 10 each, 48T (IBM, H.P. etc.) | \$ 89 | \$ 49 |
| MAXELL 10 each, M1, 1.1, SS, DD | \$ 75 | \$ 29 |
| 10 each, MD-2, DS, DD | \$ 75 | \$ 39 |
| VERBATIM 10 each, M0525-01, SS, SD | \$ 49 | \$ 25 |
| 10 each, D034, DS, DD | \$ 84 | \$ 45 |
| 10 each, Optima, DS, DD | \$ 121 | \$ 65 |

GENERIC™ DISKETTES - AS LOW AS \$1
 100 each SS, SD, 35 Track (Apple, Atari) \$ 115 \$ 130
 1000 each SS, SD, 35 Track (Apple, Atari) \$4150 \$995
 100 each DS, DD, 40 Track (IBM, H.P.) \$ 626 \$ 170
 1000 each DS, DD, 40 Track (IBM, H.P.) \$6260 \$1400

NO HASSLE MONEY BACK GUARANTEE ON GENERIC'S

I GIVE YOU MY WORD

GENERIC™ DISKETTES

SS SD \$1.00 Each
 DS DD \$1.40 Each

CDC
 SS SD \$1.79 Each

Minimum order quantities apply. See above money back guarantee by ComX Corporation not us.

MODEMS AND ACCESSORIES

- | ANCHOR, Signamax MkI (Modem (RS232)) | LIST PRICE | OUR PRICE |
|---|------------|-----------|
| ANCHOR, Signamax MkI (Modem (RS232)) | \$ 99 | \$ 75 |
| HAYES, IBM-PC Smartmodem 1200 B | \$ 599 | \$ 439 |
| IBM-PC Smartmodem II Software | \$ 119 | \$ 89 |
| Stack Chronograph (RS-232) | \$ 249 | \$ 189 |
| Stack Smartmodem (RS-232) | \$ 289 | \$ 235 |
| Smartmodem 1200 (RS-232) | \$ 699 | \$ 525 |
| Micromodem 100 (S-100 bus) | \$ 399 | \$ 275 |
| MicroModem II (for the Apple II) | \$ 379 | \$ 275 |
| Apple Terminal Program | \$ 100 | \$ 65 |
| IBM-PC to Modem Cable | \$ 39 | \$ 29 |
| NOVATION, AppleLink II (Modem, 300 BAUD) | \$ 389 | \$ 259 |
| 212 Apple Card, 1200 BAUD | \$ 725 | \$ 559 |
| PC-Cat with CrossTalk | \$ 595 | \$ 419 |
| Cat | \$ 189 | \$ 139 |
| D-Cat | \$ 199 | \$ 159 |
| J-Cat | \$ 149 | \$ 104 |
| 212 Auto Cat | \$ 695 | \$ 579 |
| Smart Cat 103212 | \$ 595 | \$ 415 |
| Apple Cat II | \$ 389 | \$ 269 |
| SSM, Transcend II for Apple IIe Data Comm. Modem/Modem for the Apple II | \$ 89 | \$ 69 |
| Transmodem 1200 (110,300,1200) | \$ 299 | \$ 299 |
| | \$ 695 | \$ 558 |

W/ jackets, no labels, top quality, 90 day limited warranty by us.

MONITORS AND ACCESSORIES

- ★AMDEK 12" Green, #300G \$ 200 \$ 135
 ★ 12" Amber, #300A \$ 210 \$ 149
 ★ 12" Amber, #10A for IBM-PC \$ 230 \$ 159
 ★ 13" Color II, Composite \$ 379 \$ 289
 ★ 13" Color II, RGB, Hi Res \$ 529 \$ 439
 ★ 13" Color II, RGB, (Ap. II, III) \$ 478 \$ 399
 DVM, Color II or III to Apple II HF \$ 199 \$ 175
 NEC, 12" Green, Model JB1201M \$ 249 \$ 159
 12" Color, Composite, JC1215M \$ 400 \$ 299
 12" Color, RGB, IBM Model JC 1203 \$ 699 \$ 569
 PRINCETON, RGB Hi Res, HK-12 \$ 795 \$ 599
 ★QUADRAM, Quadscreen 17" RGB 612K \$ 795 \$ 499
 Quadscreen 17" 968 x 512 \$1995 \$1595
 SANYO, 12" Green, Model DM812CK \$ 260 \$ 199
 ZENITH, 12" Green, Model ZVM121 \$ 150 \$ 89

★ MEANS A BEST BUY AD #984

ORDERING INFORMATION AND TERMS: All Mail: P.O. Box 23068, Portland, OR 97223. Include telephone number. All items usually in stock. Cashiers Checks, Money Orders, Fortune 1000 Checks and Government Checks, we immediately honor. Personal or other Company Checks allow 20 days to clear. No C.O.D. Prices reflect a 3% cash discount to add 3% to above prices for VISA or MC. For U.S. Mainland add 3% for shipping, insurance and handling. (SIAMI) by UPS with \$4 minimum for SIAMI. UPS ground is standard so add 3% more for UPS Blue with \$10 minimum for SIAMI. Add 12% total for SIAMI for US Postal. APO or FPO with \$15 minimum for SIAMI. For Hawaii, Alaska and Canada, UPS is in some areas only, all others are Postal so call, write or specify Postal. Foreign orders except Canada for SIAMI add 18% or \$25 minimum for SIAMI except for monies, add 30% or \$50 minimum for SIAMI. Prices subject to change and type errors, so call to verify. All goods are new, include warranty and are guaranteed to work. Due to our low prices, ALL SALES ARE FINAL. Cash before returning goods for repair or replacement. Orders received with insufficient SIAMI charges will be refunded. ORDER DESK HOURS 6 A.M. to 6 P.M. PST, Monday through Friday and 10 to 4 Saturday 6 A.M. here is 9 A.M. in New York.

OUR REFERENCES: We have been in computers and electronics since 1958. A computer dealer since 1979 and in mail order since 1980. Banks, 151 Interstate Bank (503) 643 4078. We bring to this Chamber of Commerce (503) 644 0123. Better Business Bureau and Direct Marketing Association or call Dunn and Bradstreet if you are a subscriber. Faxlink and Genbank are trademarks of ComX Corporation. WordStar, MailMerge, StarDraw, InfoStar are trademarks of MicroPro.

Professionals™



LOW PRICES TO PROFESSIONALS WHO KNOW WHAT THEY WANT AND KNOW HOW TO USE IT!

for the IBM-PC or XT DRIVES AND ACCESSORIES



CONTROL DATA OR Tandon

320K/360K DS DD DISK DRIVE
With Detailed Installation Instructions
60 Day Warranty by Factory Authorized Distributor

\$239 \$229 Two or more.
Same as now installed by IBM.

\$199
HALF HEIGHT

320K/360K DS DD DISK DRIVE

DAVONG LIST OUR PRICE PRICE

INTERNAL Hard Disk, 5-6MB (For PC-1, complete) CLOSE OUT \$1995 \$ 995

MAYNARD
Floppy Drive Control Bnd. for up to 4 drives \$ 195 \$ 165
same with Parallel Port \$ 275 \$ 205

VISTA IBM-PC XT 6MB
Backup for Hard Disk, V1200 \$1549 \$1049

★ Means a BEST buy
AD #984

THE IBM-PC SUPPLY CENTER

IBM-PC
System Includes
Two 320K Disk
Drives by CDC
90 Day Warranty By Us
Call For Details And
Configurations



IBM is a trademark of IBM Corporation.

MEMORY CHIP KITS

ADD-ON TO YOUR MEMORY CARDS OR mother board. 100% tested. With 90 day warranty.

★ 64K Kit, 200NS, 8 chips, 4164	\$ 150	\$ 45
16K Kit, 200NS, 8 chips, 4116 (for PC-1 motherboard)	\$ 50	\$ 16

AMDEK 4-IN-1 Multiple Board, Color Graphics, Mono, 128K \$ 599 \$ 519

AST ComboPlus, 64K S/P/C \$ 395 \$ 279
ComboPlus, 256K S/P/C \$ 695 \$ 475
MegaPlus II, 64K, 2-S/P/C \$ 495 \$ 345
MegaPlus II, 256K, 2-S/P/C \$ 795 \$ 495
256K MegaPlus II Expander \$ 395 \$ 295
SnPakPlus, 64K, S/P/C \$ 695 \$ 495
SnPakPlus, 256K, S/P/C \$ 895 \$ 595
SnPakPlus, 384K, S/P/C \$ 895 \$ 595
IO Plus II, 25/S/P/C \$ 315 \$ 195
PCNet™, LAN Kit \$1490 \$1290

CCS SuperVision, monochrome board \$ 850 \$ 680
Z/Pus 64, fast Z80B, 64K para port \$ 875 \$ 695

★ **ComX** 256K RAM Card with Fasttrak™ RAM disk emulator and spooler software, 2 Yr. Wty. \$ 695 \$ 256

CURTIS PC Prodata™ for Display \$ 80 \$ 65
8 Foot Cable for IBM keyboard (extends 3 to 9') \$ 50 \$ 35
3 to 9 foot keyboard cable \$ 25 \$ 19
Vertical CPU "System Stand" \$ 25 \$ 19

HERCULES, Graphics Board \$ 499 \$ 379

Key Tronic, KBS150, Std keyboard \$ 269 \$ 199

Koala Koala Pad™ \$ 150 \$ 109
Programmer's Guide \$ 15 \$ 12

MAYNARD Multifunction (6) Card, MFC \$ 89 \$ 79
SandStar, no RAM card \$ 199 \$ 169
SandStar, 256K Card \$ 499 \$ 395
64K Card \$ 875 \$ 495
256K Card \$ 625 \$ 465

MICROSOFT PCNet™, LAN 2.0 \$1490 \$1190
Monochrome Graphics Card \$ 499 \$ 379
Mouse \$ 195 \$ 145

ORCHID ColorPlus, 16 color brd, w/Para Port \$ 475 \$ 379

PLANTRONICS QuadPlus, 16 color brd, w/Para Port \$ 475 \$ 379

QUADRAM

★ Quadlink, Apple II Emulator IN STOCK	\$ 680	\$ 485
Quadboard, no RAM, expandable to 256K	\$ 295	\$ 215
Quadboard 64K, expandable to 256K	\$ 395	\$ 279
★ Quadboard 256K, 6 function	\$ 595	\$ 395
Quadboard II, no RAM, expand to 256K	Call	Call
Quadboard II, 64K, expandable to 256K	\$ 395	\$ 265
Quad 512 + 64K plus serial port	\$ 550	\$ 420
Quad 512 + 256K plus serial port	\$ 895	\$ 625
Quadcolor I, board, 16 colors	\$ 295	\$ 225
Quadcolor II, board, use with Quadcolor I	\$ 275	\$ 209
Quadscreen, 17" 968 x 512 Monitor	\$ 1995	\$ 1595
MicroLazer, w/Copy, P/P, BK, #MP8 w/P.S.	\$ 189	\$ 129
MicroLazer, w/Copy, P/P, 64K, #MP64 w/P.S.	\$ 319	\$ 219
MicroLazer, w/Copy, P/P, 128K, #MP128 w/P.S.	\$ 465	\$ 295
MicroLazer, Snap-on, BK, P/P, Epson, #ME8, w/P.S.	\$ 179	\$ 145
MicroLazer, Snap-on, 64K, P/P, Epson, #ME64, w/P.S. S3 (Snap-on to 64K)	\$ 389	\$ 295
1stIMATE, 64K \$ 589 \$ 439		
1stIMATE, 256K \$ 589 \$ 439		

Tecmar TG PRODUCTS, Joystick \$ 65 \$ 49



IBM-PC CHIP & MEMORY SPECIAL

\$45 \$40 Ten or more.
64K CHIP KIT
9 Each, 4164, 200 ns, MEMORY EXPANSION
90 Day Warranty by us.

\$256 \$239 Two or more.
ComX 256K RAM BOARD

Fully Compatible, 2 Year Limited Warranty by ComX
With Fasttrak RAM Disk Emulator and Spooler Software
Works on DOS 1.1 or 2.0.

SOFTWARE for the IBM-PC or XT

BUSINESS		LIST PRICE	OUR PRICE
★ ASHTON-TATE	dBase II, requires PC-DOS & 128K	\$ 700	\$ 385
	dBase II User's Guide	\$ 30	\$ 20
	Everyman's DB Primer (Book)	\$ 15	\$ 12
	The Financial Planner	\$ 700	\$ 395
	Friday	\$ 295	\$ 199
	APPLIED SOFT, TECH., Versalcom	\$ 389	\$ 265
★ CONTINENTAL, Home Accountant +	FCM (Filing, Cataloging, Mailing)	\$ 125	\$ 89
	Property Management	\$ 495	\$ 329
DATAMOST, Write-On (Word Processor)		\$ 130	\$ 89
★ DOW JONES, Market Analyzer	Market Manager	\$ 300	\$ 279
	Market Microscope	\$ 700	\$ 329
EAGLE SOFTWARE, Money Decisions		\$ 150	\$ 129
★ EINSTEIN, Writer NEW!	Memory Trainer NEW!	\$ 80	\$ 55
	Speller	\$ 150	\$ 95
	Mailer	\$ 80	\$ 55
	Letter Scores	\$ 300	\$ 195
★ FOX & GELLER, Quickcode (MSDOS)	dGraph (MSDOS)	\$ 295	\$ 179
	dual for IBM PC DOS	\$ 295	\$ 179
HAYDEN, IBM Pie Writer		\$ 200	\$ 139
HOWARDSON, Real Estate Analyzer II		\$ 250	\$ 185
★ INFOR, UNLIMITED, EasyWriter II (WP)	EasySpeller II	\$ 350	\$ 259
	EasyFiler (dBASEMS)	\$ 225	\$ 149
	Inventory Control	\$ 400	\$ 299
★ INSOFT, Data Design (No use dBASEMS)	Data Base Made Easy (Book)	\$ 595	\$ 169
		\$ 17	\$ 12
★ LOTUS, 1-2-3		\$ 495	\$ 329
MICROCRRAFT, Verdict or Bilkeeper, each		\$ 995	\$ 689
★ MICRO LAB, Miner 2049		\$ 40	\$ 29
MICROPRO, WordStar™		\$ 495	\$ 329
	MailMerge™	\$ 250	\$ 129
	SpellStar™	\$ 250	\$ 129
★ WordStar Professional, 4 Pak	StarIndex™	\$ 895	\$ 629
	InfoStar™	\$ 195	\$ 109
	Report Star™	\$ 495	\$ 259
★ MICROSOFT, Multiplan		\$ 350	\$ 199
	Word	\$ 275	\$ 175
	Word with Mouse	\$ 375	\$ 275
	Financial Statement	\$ 475	\$ 339
	Budget	\$ 100	\$ 69
		\$ 150	\$ 109
NORTH AMERICAN BUS, The Answer		\$ 250	\$ 169

BUSINESS		LIST PRICE	OUR PRICE
★ OSBORNE.COMIX (Book & Business)	Statistics & Math Programs on DS/DD Disks	\$ 100	\$ 69
	Some Common Basic Prog. (70 each)	\$ 100	\$ 69
	Practical Basic Programs (40 each)	\$ 100	\$ 69
PBL CORPORATION, Personal Viewer		\$ 145	\$ 94
PEACHTREE, Peach Pak 3 (GL, AR & AP)	Peach Text 5000	\$ 595	\$ 329
★ PERFECT, Perfect Writer™	Perfect Speller™ or Perfect Calc™, each	\$ 389	\$ 149
	Perfect Filer™	\$ 295	\$ 99
	Perfect Filer™	\$ 595	\$ 199
SOFTWARE ARTS, TKI Solver		\$ 299	\$ 219
SOFTWARE PUBLISHING, PFS-File	PFS-Report	\$ 140	\$ 84
	PFS:Write NEW!	\$ 140	\$ 95
	PFS:Graph NEW!	\$ 140	\$ 95
SORCIM, SuperCalc II	SuperWriter	\$ 295	\$ 195
		\$ 295	\$ 199
STONEWALL D.B. Master (dBASEMS)	SYNERGISTIC, File Manager	\$ 100	\$ 67
	SYNERGISTIC, Data Reporter	\$ 250	\$ 169
TYMAKER, T/Maker III		\$ 275	\$ 169
VISICORP, VisiCalc™/256K	VisiFile or VisiSchedule	\$ 250	\$ 189
	VisiFile or Desktop Plan I	\$ 300	\$ 239
	VisiWord with VisiSpell (128K)	\$ 375	\$ 269

UTILITY & SYSTEM		LIST PRICE	OUR PRICE
HAYES, Smartcom II		\$ 119	\$ 89
MICROCOM, Microterminal		\$ 100	\$ 65
	muMath/muSimp	\$ 300	\$ 225
	Business BASIC Compiler	\$ 600	\$ 450
	Pascal Compiler	\$ 350	\$ 255
	C Compiler	\$ 500	\$ 389
	BASIC Compiler	\$ 395	\$ 285
	Fortran Compiler	\$ 350	\$ 255
	COBOL Compiler	\$ 750	\$ 559
	BASIC Interpreter	\$ 350	\$ 255
★ HAGY SYSTEMS, Copy PC Backup		\$ 35	\$ 25
	NORTON, Norton Utilities, 14 programs	\$ 50	\$ 39
		\$ 80	\$ 65

HOME & EDUCATIONAL		LIST PRICE	OUR PRICE
EPYX/Auto, Sim., Temple of Apsah		\$ 40	\$ 29
	Oil Barons	\$ 100	\$ 75
★ ARMONIK, Executive Suite		\$ 40	\$ 27
	BLUE CHIP, Millaire	\$ 60	\$ 39
BPI SYSTEMS, Personal Accounting		\$ 195	\$ 139
★ BRODERBUND, Apple Panic (Color)		\$ 30	\$ 19
COMPREHENSIVE, PC Tutor (DOS 1.1)		\$ 60	\$ 40
CONTINENTAL, Home Accountant +		\$ 150	\$ 80
DATAMOST, Pkg Pen or Space Strike, ea		\$ 30	\$ 22
DAVIDSON, The Speed Reader II		\$ 75	\$ 49
INFOCOM, Deadline		\$ 50	\$ 33
	Zork for Zork II or Zork III, ea.	\$ 40	\$ 27
★ INSOFT, Word Tutor or Quotex, each NEW!		\$ 35	\$ 29
MICRO LAB, Miner 2049		\$ 40	\$ 28
PBL CORP., Personal Investor		\$ 50	\$ 33
SPINNAKER, Snapper Troops (1 or 2)		\$ 145	\$ 99
	Story Machine or Face Maker	\$ 35	\$ 24
STRATEGIC, the Warp Factor		\$ 40	\$ 30
SUBLOGIC, Night Mission Pinball		\$ 40	\$ 27

PRINTERS AND ACCESSORIES

DOT MATRIX PRINTERS:

EPSON, MX80F T, 80 CPS, w/Gratraz +	\$ 745	\$ 485	
FX80, CPS	Call	Call	
MX100FT, 80 CPS, w/Gratraz +	\$ 995	\$ 639	
FX100, CPS	Call	Call	
Apple II Graphics Dump Program	\$ 15	\$ 9	
LEADING EDGE, Gonila Banana	\$ 250	\$ 209	
OKIDATA, 82A, 30 col., 120 cps, Para.	\$ 549	\$ 448	
83A, 132 col., 120 cps, Para.	\$ 899	\$ 699	
92, 160 CPS, 30 Col., Para.	\$ 699	\$ 559	
93, 160 CPS, 136 Col., Para.	\$1249	\$ 969	
2350P, Pacermark, 350 cps, Para.	\$2695	\$2095	
2410P, Pacermark, 350 cps, Para.	\$2995	\$2395	
ORANGE MICRO, Grapple +, for Apple	\$ 165	\$ 119	
PRACTICAL, Microbuffer In-Line 64K, Para.	\$ 349	\$ 259	
Microbuffer In-Line 64K Serial	\$ 349	\$ 259	
★ STAR MICRO, Gemini 15 X, 120cps, 2.3K	\$ 499	\$ 289	
	Gemini 15 X, 120cps, 2.3K	Call	Call
IBM-PC to Epson or Star Micronics Cable	\$ 60	\$ 35	
Apple II and Cable for Epson or Gemini	\$ 95	\$ 59	

LETTER QUALITY - DAISSY WHEEL PRINTERS:

JUKI 6100, 17 cps, 80 Col., Parallel	\$ 700	\$ 530
SILVER REED, EXP550P, 18 cps, 3pitch	\$ 895	\$ 615
EXP550S, 18 cps, 3pitch	\$ 995	\$ 650
Tractor Feed for EXP 550	\$ 160	\$ 125
★ TTX, 13 cps, Para. & Ser, Pin & Friction	\$ 649	\$ 499

SUPPLIES: Tractor Feed Paper, Ribbons, Daisy Wheels.

PLOTTERS

BAUSCH & LOMB, HOUSTON	LIST PRICE	OUR PRICE
DMP-40, 1 pen	\$ 725	
DMP-29, 8 pen	\$1695	
DMP-41	\$2250	
ENTER COMPUTER, Sweet P	\$ 795	\$ 595
AMDEK, DXY-100, 10" x 14", Para.	\$ 749	\$ 599
Amplid II, 10" x 14", 6 color, S/P	\$1299	\$ 999

CORVUS

6 Meg	\$2095	\$1695
11 Meg	\$2750	\$2295
20 Meg	\$3750	\$3095

IBM-PC Interface Manual, S/W & Cable Kit \$ 300 \$ 239
Mirror built in for easy backup \$ 790 \$ 595
Apple Interface Manual, S/W & Cable Kit \$ 300 \$ 239
Other Interfaces, Omni-Net, Constellation, Mirror, CALL

THE WORLD'S LARGEST COMPUTER MAIL ORDER FIRM

CONROY-LA POINTE™

Formerly Computer Exchange

NATIONAL ORDER DESK **TOLL FREE (800) 547-1289**

Order Desk Hours: 6AM to 6PM PST

Oregon TOLL FREE [800] 451-5151 Hot Line For Information On Your Order
Portland: 245-6200 [503] 245-1030

The ideal choice for the OEM

A 32-bit multi-user virtual memory microcomputer by LMC.

The MegaMicro is a "big" computer in a small box. It allows one or up to 32 users to run big applications programs (ones so big they can't even be compiled by smaller 8- or 16-bit machines) simultaneously. Because the MegaMicro is a multi-user system, it allows easy

sharing of data bases and peripherals—obstacles that soon haunt business and scientific users of "personals" who find a need to "network" or to add devices such as laser-printers, multi-color plotters and the like.



LMC's MegaMicro is built around the newest state-of-the-art VLSI logic—the 16000 family developed by National Semiconductor. Each MegaMicro is supplied with UNITY—HCR's full Bell-licensed UNIX operating system—as well as FORTRAN and C. Also standard are hardware virtual memory and hardware floating point, a half Meg. of RAM and a very fast 20 Meg. Winchester hard disk. The result is a computer with the performance of a large mini, at a "micro" price. For example, the MegaMicro does 161,000 double-precision (64-bit) floating point multi-

lications per second. All this at a realistic price, and even less with OEM and quantity discounts (about the same as a single IBM XT or Apple LISA). The result is a cost per "work-station" far lower than similarly configured (and less powerful) "personals."

Because the MegaMicro is powerful, inexpensive and designed around the Multibus (IEE 796) (which means it has a completely "open" architecture), it is an ideal choice for the OEM wishing to supply powerful applications software solutions on a microcomputer.

LMC MegaMicros *The Logical Alternative*[™]



The Logical MicroComputer Company

140 South Dearborn, Chicago, IL 60603, (312) 580.0250, Telex 270384

The Starburst User Interface

Linking multiple programs via custom-menu software

by Steven Vandor

Micropro's Starburst, a software package that facilitates efficient menu design, can ease construction and modification of applications software by creating a new, more appropriate interface between the terminal screen and the system operator.

Starburst makes the interface between programs such as Wordstar and Calcstar more obvious, providing a link for Micropro's integrated software packages. More important, you can use the program to build an integrated system using almost any type of software. It works with Micropro software as well as with other programs, and it requires no special or experimental hardware.

Starburst streamlines and smooths the interface between programs, making it unnecessary for the user of a set of applications programs to know the commands needed to get each program running. It does not, however, address the deficiencies in the user interface of a particular program.

Uses for Starburst

A business that requires many different applications programs can benefit from Starburst. For example, a company might use Datastar (part of Micropro's database-management system, Infostar) to collect data and enter it into a database. A report on the entered data (created with a program such as Reportstar, also part of

Infostar) could then be produced and collated into a daily report written with Wordstar. This process—data entry through report distribution—requires the use of several programs and several files.

Indeed, such a task consists of a series of smaller ones. First, the data must be entered into a file, then processed (or reported), then inserted into a larger file so the report can be distributed. And along the way, backup copies of data and report files must be made. Starburst makes it appear to the user that these smaller tasks have been combined into one operation. This capability—taking the numerous steps involved in a large task and reducing them to one step—permits design of applications programs that suit operation by inexperienced users.

Starburst provides an interface that shields the user from the smaller steps a project often requires. And by protecting the user, it adds a measure of protection to the system. By using Starburst to set up a task in advance, you can ensure that a series of required tasks will be executed correctly. Steps such as backup, for instance, can be set up to occur at the appropriate time.

The System Interface

Micropro designed Starburst to be compatible with as many machines as possible. The program is designed

to work on virtually any business microcomputer. Starburst can use a system with a simple terminal and an addressable cursor. Screen updating is speeded by memory mapping on those computers that provide it. Starburst can also utilize graphics characters.

At a basic level, any user interface is under the control of system hardware. This is a curse to designers trying to provide hardware-independent software. Use of icons (symbols rather than words), windows, mice, and other advanced software features is impossible without substantial hardware dedicated to them.

Recent hardware innovations, however, such as oversized bit-mapped displays and the mouse, have appeared in advance of functionally complementary software. Although this hardware has captured the imagination of the marketplace, high prices have prevented its widespread purchase.

Other problems have slowed the mass marketing of this new hardware. Execution speed, for instance, has been a crucial factor. If a program's interface is interesting to look at, simple to learn, but slow as molasses, that software has severely limited potential.

Starburst does not require or support use of a mouse because only a limited number of applications programs take full advantage of the

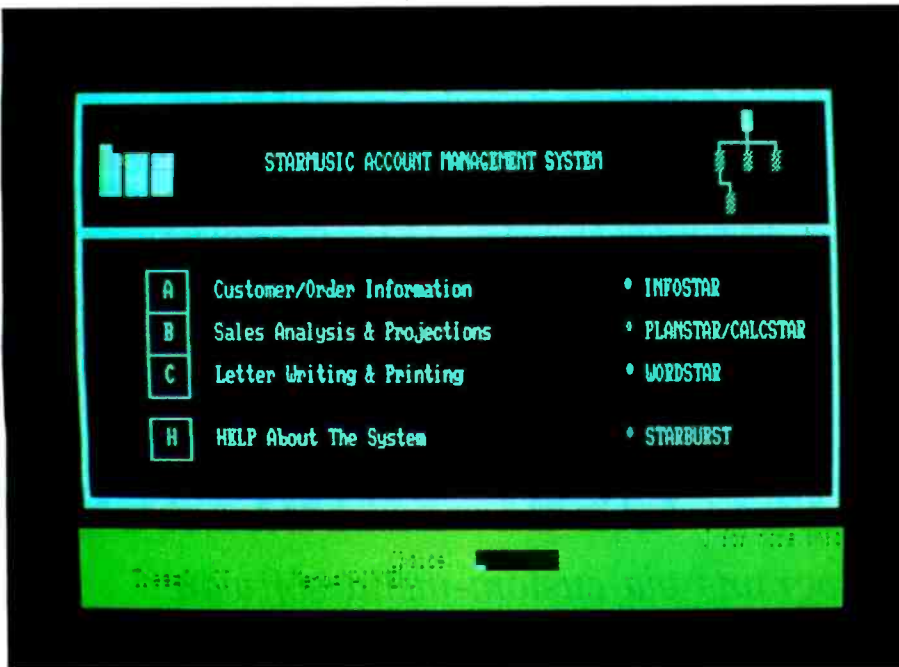

Photo 1: A typical user-designed Starburst menu. The graphics at the top of the screen were created using the IBM PC's graphics set.

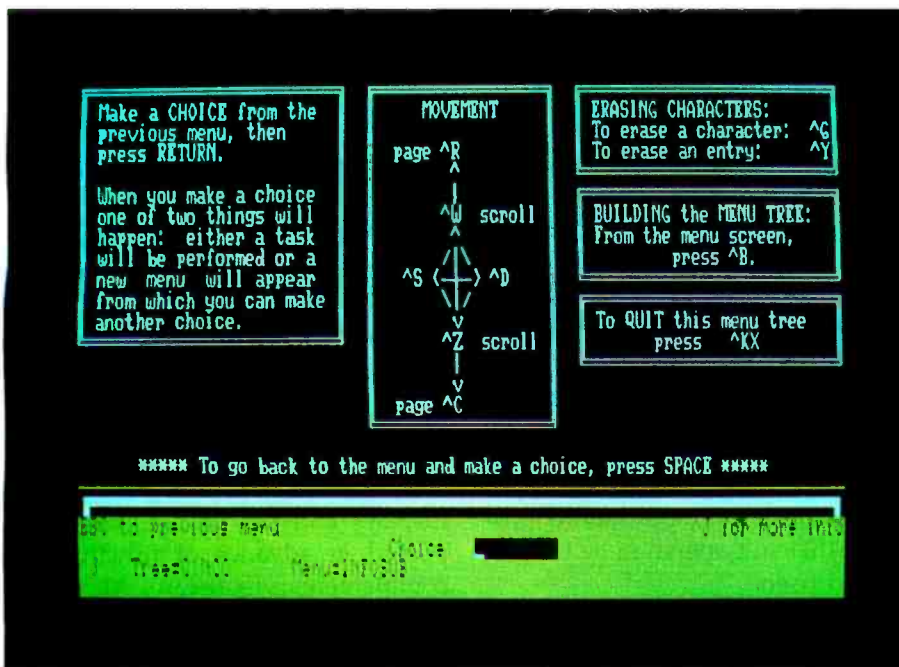

Photo 2: You could supplement this general Help screen with detailed Help screens that suit the system's specific menus and functions.

mouse's capabilities at this time. In addition, the mechanics of using a mouse can prove time-consuming and may not provide a productivity return proportionate to the effort of using one. Starburst will not be a mouse-oriented product until mouse-driven applications software becomes more standard.

Once the hardware problems are solved, software developers are responsible for providing most of the screen interfaces for microcomputers. (Companies such as Micropro and Visicorp provide many of those interfaces with their widely distributed software.) Even for firms that distribute software internationally, hard-

ware is a major concern. The trade-off is obvious: a software vendor can support just a few computers, taking a customized approach to the user interface, or (as in the case of Starburst) attempt a more general approach to afford products wider distribution.

Creating Menus

For the software designer/integrator, Starburst is a productivity tool. In a customized data-processing system, for example, it can handle all the external functions such as user input and output. You, the system designer (referred to as the "builder" in Starburst documentation), use the software to create menus for the user interface. You decide whether the menus are to be similar or dissimilar, and, depending on the hardware, you can use both text and graphics characters in the design. Starburst will then display the menu and execute the selections the operator makes. Using Starburst to string together individual programs that comprise a larger application can save a lot of programming time. It also gives the screen a polished appearance.

The menus in a system using Starburst all have the same general appearance, but you determine their contents. General information for functions such as cursor movement and menu choices is provided directly to the operator through a function or control key. In addition, you can write Help screens into the user interface to reduce your dependence on the documentation. Perhaps more significant, a menu system that includes help screens tied directly to the menus can reduce the amount of time required to learn to use the system.

Starburst also can provide other benefits for the system integrator. Beyond fast menu design, it can specify the tasks that a particular system will perform. It recognizes 24 commands to handle most system functions. Besides running applications programs, these commands allow the task design to include file copying and renaming, conditional logic, looping, variable assignment, and file locating. And you can write

programs in BASIC, Pascal, or any other language to accomplish complicated, nonstandard operations such as extractions. (A description of these task commands appears later in this article.)

Starburst offers a quick way to make every system look and behave similarly. Using Starburst, a partitioned accounting system (one that includes components such as programs that serve as a general ledger, a record of accounts receivable and payable, a payroll, and an inventory) can exhibit a high degree of visual and functional similarity. It may, of course, be advantageous to differentiate among this system's modules, and for that reason, Starburst permits instant visual identification because it can take advantage of the graphics capabilities of many computers.

A simple but effective way to use graphics is demonstrated in the training files included with Starburst. On each menu in the training system, a graphics figure that represents the system (starting at one menu and proceeding to other levels of menus) is displayed in the upper right-hand corner of the screen. The menu currently in use is highlighted in the figure (see photo 1). This design helps keep the user from getting lost.

Starburst's Screen Interface

The Starburst program uses an enhanced menu-driven interface and includes the basic Wordstar screen editor as one of its functional parts. Other commands for system building use mnemonics and graphics extensively. For example, when a menu has been laid out and you want to specify that its choice A should perform a particular series of actions, you merely place the cursor on the A character and press Control-L to link the choice to a set of task action statements. You can specify and name the actions then, or you can specify the actions at a later time.

When you are using Starburst to build a system, a brief summary of commands is displayed at the top of the screen. These commands serve as memory joggers for system-building commands, such as Control-L. To provide more working space on the



Photo 3: On this screen, the programmer specifies which actions will occur when an operator makes a menu selection. Although the final statement on the screen says to run Datastar, it could indicate any program.

screen, the list of commands can be removed and later replaced at any time. The commands displayed at any one time are limited to those representing options you would logically select, thus resulting in an uncluttered screen.

The more mundane commands, such as those for moving the cursor around the screen, are not given such prominence. Instead, if the user forgets how to perform a routine function, a Help key (either a Control command or a function key) invokes a full-screen display of helpful information. Starburst ensures that the screen display does not overwhelm the user with a list of too many commands from which to choose. Photo 2 shows a typical Starburst Help screen.

Starburst also addresses another commonly ignored area of the screen interface: placement of information on the screen. A video display is generally thought of as a page that users read from left to right, top to bottom. Depending on what is being sought, however, their eyes jump around the screen in different patterns, and Starburst is designed with those patterns in mind. Its Help commands, for instance, are listed in the

- ASK for variable with text
- CHECK for file
- CLEAR screen
- COPY source to destination
- DELETE file
- DISPLAY text
- EXIT (to terminate processing)
- LIST (to display each statement before execution)
- MOUNT disk name on drive name (to be sure the proper disks are in the proper drives)
- NOLIST (to turn off the LIST function)
- PAUSE
- PROMPT text
- REMARK (to document the code being written)
- RENAME old file as new file
- RESET (for CP/M disk resets)
- RUN (to begin execution of program other than Starburst)
- SET default drive to name
- SETSBODE integer (to directly change the system variable)
- IF condition then (to execute some commands only when the condition is true)
- ELSE (to specify an alternative set of commands to be executed when the condition in the IF statement is not true)
- ENDIF (to mark the end of the IF...ELSE construction)
- REPEAT (to begin a repeated loop)
- STOPREPEAT (to skip to the end of the loop)
- ENDREPEAT (marks the end of the loop)

Table 1: These 24 action statements can be strung together to perform almost all system functions.

Don't wait till it's too late to insure your computer

Now you can insure your computer against theft, fire, accidental damage, earthquake, even damage from power surges.

For as little as \$35/yr. SAFEWARE™ covers all hardware, media and purchased software for full replacement after a low \$50 deductible.

To obtain immediate coverage or more information, call toll-free today. (In Ohio call 1-800-848-2112)

1-800-848-3469

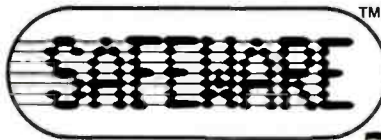

COLUMBIA NATIONAL GENERAL AGENCY
88 E. Broad St., Columbus, OH 43215



bottom right-hand corner of the screen, where research suggests a users' eyes will travel when they are in trouble. Building (creative) commands are positioned in the center of the top portion of the screen. This scheme is supported throughout the program.

A Natural Language

As mentioned earlier, you use 24 Starburst task statements to control the execution of a system operation. Stringing these statements together actually constitutes high-level program coding. Starburst also includes many features to aid the inexperienced programmer and to help the seasoned coder to stay out of reference manuals, concentrating instead on building the system.

The screen interface for specifying these statements is designed for speed and ease of use. Photo 3 provides an example. The keyword, or first word, of each statement is displayed in the command list at the top of the screen. If you have trouble remembering the use for a particular statement, you can type the keyword, press a function key, and a detailed message appears at the top of the screen. If you only need to know the syntax of a statement, you can press another function key and a template is written on the line where the cursor is positioned. From that point, all you have to do is fill in the statement's blanks.

The syntax of the statements is the most elemental part of this interface. See table 1 for a list of the statements and an explanation of what each one does.

The conditional logic (IF..ELSE...ENDIF) is driven by the system variable, which can be altered in any of three ways. First, a SETSBCODE statement can assign a new value to the system variable directly. Second, the CHECK statement, which looks for a specific file on a specific drive, can return a new value for the system variable, depending on the result of the file search. This feature allows elegant recovery from an improperly configured system—the applications program will never be executed if Starburst detects a file out of place.

Happy Holidays from Components Express . . .

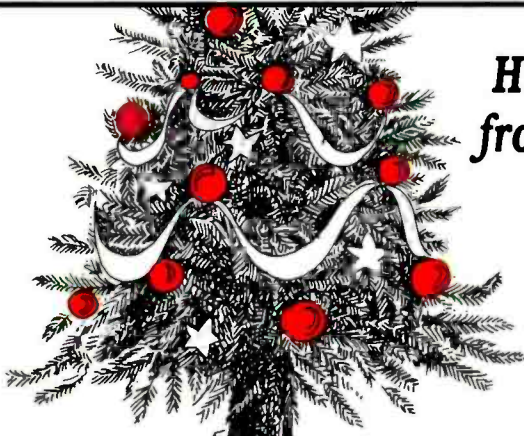

COEX 80 F/T
Parallel
Printer



*Bulk Boxes of 100 Diskettes. Tyvec Sleeves Available.

**Bulk Boxes of 100 Diskettes w/Hub Rings. Tyvec Sleeves Available.

offer Expires Dec 31, 1983.

"Kiss Your Computer For The Holidays"
Components Express, Inc.



1380 E. Edinger • Santa Ana, Calif. 92705 • 714/558-3972
TWX 910 595-1565 • ADVACON SNA • International Orders Welcome
Terms of Sale: Cash, Checks, Credit Cards, M.O. C.O.D. FOB Santa Ana Calif. residents add 6% sales tax

It's easy to make points when you're a pro.

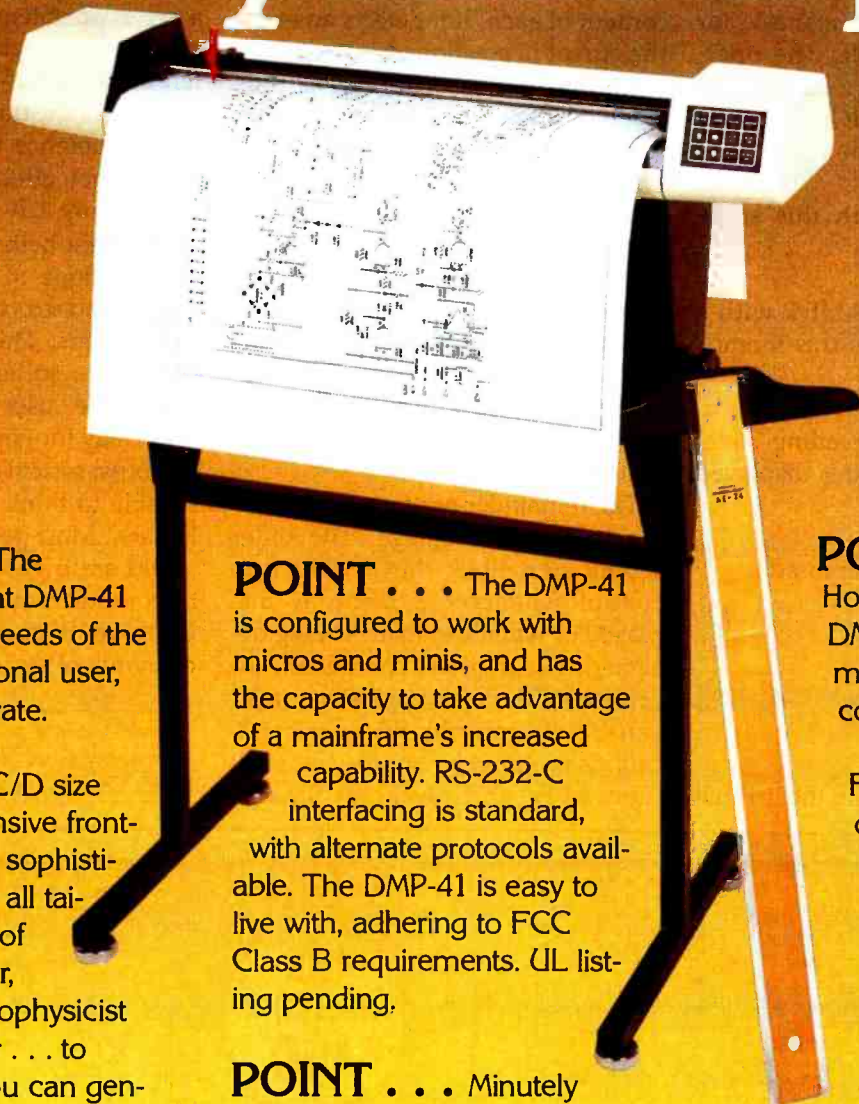

POINT . . . The Houston Instrument DMP-41 plotter meets the needs of the serious or professional user, yet it's easy to operate.

POINT . . . C/D size format, comprehensive front-panel controls and sophisticated firmware are all tailored to the needs of the surveyor, drafter, oceanographer, geophysicist and land developer . . . to name but a few. You can generate superior architectural elevations, contour maps, circuit-board layouts and assembly drawings quickly and accurately on bond, vellum or synthetic media.

POINT . . . The DMP-41 is configured to work with micros and minis, and has the capacity to take advantage of a mainframe's increased capability. RS-232-C interfacing is standard, with alternate protocols available. The DMP-41 is easy to live with, adhering to FCC Class B requirements. UL listing pending.

POINT . . . Minutely defined step size and high-resolution logic—combined with robust drives and optimized pen ballistics enable you to create plots of high precision and surpassing quality.

POINT . . . The Houston Instrument DMP-41 is one of your most cost effective considerations.*

For the name, address and phone number of your nearest distributor, write Houston Instrument, 8500 Cameron Road, Austin, Texas 78753. Phone 512-835-0900, or 800-531-5205 if outside Texas. In Europe contact Bausch & Lomb Belgium NV, Rochesterlaan 6, 8240 Gistel, Belgium. Tel 059-27-74-45, tlx 846-81339.

BAUSCH & LOMB 
houston instrument *division*

*suggested US retail \$2,995

Circle 216 on inquiry card.

www.americanradiohistory.com

4P009

Third, because the address in RAM where the system variable is stored is supplied in the documentation, you can write a program to be executed by Starburst (via a RUN statement) that will assign a new value as well.

Other variables, which have values assigned by direct operator response to ASK statements, are used, as are merge-print variables in a word-processing environment. A prompt displayed to the system operator asks for a value for one variable. The operator's response can then be plugged into other places in the list of statements. Here is a simple example:

The task begins with this statement:

ASK for &MEMONAME& with prompt "To whom is this memo addressed?"

As a result of the preceding statement, the following text is displayed on the screen:

"To whom is this memo addressed?"

The operator responds:

"MARY"

Then, in all statements in the list that

include a reference to the variable &MEMONAME&, the character string "MARY" is substituted. For example, the statement "RENAME TEMPLATE.MEM as &NAME&.MEM" would be rewritten automatically as "RENAME TEMPLATE.MEM as MARY.MEM."

The compiler for these statements is also a friendly programming aid. When you complete a set of commands, the compiler is automatically invoked to check the syntax and content of each. If it detects an error, the cursor is positioned at the offensive character. Correction can be aided through the Help functions described previously.

The Architecture of Starburst

The core of Starburst is the *resident*, a small section of code (about 12K bytes long) written in assembly language. It loads just above the operating system in RAM (random-access read/write memory) and monitors the progress of the application system.

The remainder of Starburst is written in the C language. The other significant module, the *transient*, is in control whenever a menu is displayed or when a system is being designed. The transient controls the execution of the task statements (e.g., variable assignment). When an applications program is run, the transient "goes away" and leaves only the resi-

dent in RAM, above which the applications program is loaded. When the applications program completes execution, the resident reloads the transient.

Starburst's architecture maximizes the limited RAM available on many 8-bit computers, while it allows the added RAM of the new generation of 16-bit machines to be fully used by the application. The transient functions like a super-overlay file. When a series of statements is about to be executed, a special action file is written on the disk, so that even in the absence of the transient, the resident has a reference for execution. This means that, effectively, Starburst occupies only 12K bytes of RAM.

Starburst helps eliminate some of the mystique of programming, the convoluted structures that confuse so many users. The idea behind Starburst is to soften the interface between the user and the system, especially for new users. To design a Starburst system effectively, you must be able to think logically or at least linearly. Most people in the business world are frightened or intimidated by computers and programming, and for them, Starburst helps clarify the elements of system programming. ■

Steve Vandor is product manager of Micropro International Corporation (33 San Pablo Ave., San Rafael, CA 94903).

NOT ONLY ANOTHER TECHNOLOGICAL BREAKTHROUGH BUT ALSO EASY TO USE AND TO INSTALL

Modems are the most important device used to link two products together through ordinary telephone lines at miles apart. The INCOMM STARCOM, a 300/1200 bps Auto Dial, Auto Answer, Auto Log On modem was introduced to

link two high speed devices together with having absolutely NO knowledge of computers or communications in general. Anybody can install and operate the STARCOM Family in a few minutes.

- STARCOM is a 300/1200 bps Auto Dial/Auto Log On/Auto Answer Modem.
- OSCOM is a 300/1200 bps Auto Dial/Auto Log On/Auto Answer with Osborne (TM) Computer Software (included) modem.
- COMSOFT is a communication software package.
- OEM MODEM BOARD is also available for custom installation.

FREE \$150.00 value subscription to Official Airlines Guide with purchase of each Starcom or Oskom. Get immediate electronic access to airline fare and schedule info. OAG Electronic Edition can save you at least 30% on most business trips and could save you thousands of dollars annually!

DEALER INQUIRIES INVITED
(312) 459-8881
or 1-800-323-2666

INCOMM

115 N. WOLF RD. WHEELING, IL 60090

THE STARCOM \$450.



THE OSCOM \$520.

SO COMPACT:
Only 1 1/4" x 6 1/2" x 7 1/2". 1.5 lbs.
Fits in your coat pocket!

WHEN YOU'RE READY OUR PC PLUS™ KIT WILL BE WAITING



10mb Internal Upgrade

When you're ready to boost your storage capacity from 640K to 10mb without boosting power and without eating up desk-top space, our internal **PC PLUS™** will be just a phone call away.

Waiting to give you all the capacity of the *XT at a price that saves you hundreds of dollars compared to the cost of trading up.

The DSS™ **PC PLUS™** kit uses a half-height 10mb Winchester disk drive that gives you all the benefits of Winchester technology — increased data integrity,

faster access — without taxing the power supply. The **DataMark™ HFC controller is a single board solution. It is inserted over the half-height Winchester disk drive. And it is totally IBM formatted.

The DSS™ **PC PLUS™** kit presents the storage solution you need now. What are your data storage needs? At DSS™, we do much more than sell components. We create solutions.

The DSS™ **PC PLUS™** kit includes:

- 10mb half-height disk drive
- DataMark™ HFC controller
- Full height front bezel
- Mounting hardware
- Cables

Features and Benefits

- Increased capacity
- Increased access time
- Upgradeability
- No additional power requirements
- Enhanced cooling
- One board controller solution
- Operates with 1.25 MS-DOS through 2.0 MS-DOS
- Internal upgrade
- 1 10mb half-height Winchester=31 floppy's
- Increased data integrity

Retail price: \$2250

from the dealer nearest you

See us at
COMDEX/Fall '83
November 28-December 2, 1983
Las Vegas Convention Center
Las Vegas, Nevada

DSS

2907 N. 55th St., No. 5 Boulder, Colorado 80301 303/449-7587 Toll-Free: 800-851-PLUS

Data Storage Solutions, Inc.

*XT is a registered IBM trademark

**Data Mark is a registered trademark of Memorex.

Diskette Users...

When you've heard from all the animals in the diskette zoo, but you need fast delivery and high quality diskettes...

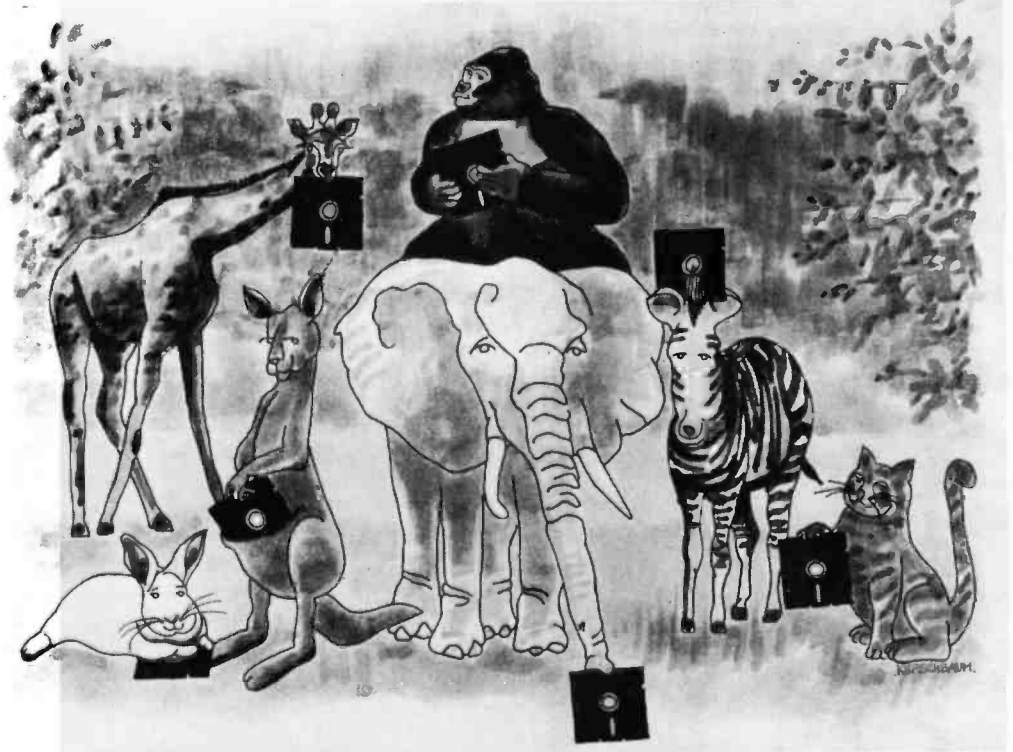

Call Communications Electronics

Diskette order desk
800-521-4414
 In Canada 800-265-4828

Choose your brand
Choose your price



Wabash diskettes for as low as
\$1.29 each

Ultra diskettes for as low as
\$1.39 each

Product Description	Wabash Part #	CE quant. 100 price per disk (\$)	Ultra Part #	CE quant. 100 price per disk (\$)
8" SSSD IBM Compatible 128B/S, 26 Sector	F111	1.89	81728	1.99
8" SSSD Shugart Compatible, 32 Hard Sector	F31A	1.89		
8" SSDD IBM Compatible (128 B/S, 26 Sectors)	F131	2.39	81701	2.49
8" DSDD Soft Sector (Unformatted)	F14A	2.99	82701	3.19
8" DSDD Soft Sector (256 B/S, 26 Sectors)	F144	2.99		
8" DSDD Soft Sector (512 B/S, 15 Sectors)	F145	2.99		
8" DSDD Soft Sector (1024 B/S, 8 Sectors)	F147	2.99	82708	3.19
5 1/4" SSSD Soft Sector w/Hub Ring	M11A	1.49	50001	1.79
5 1/4" SSSD Same as above but bulk product	M11AB	1.29	00153	1.39
5 1/4" SSSD 10 Hard Sector w/Hub Ring	M41A	1.49	50010	1.79
5 1/4" SSSD 16 Hard Sector w/Hub Ring	M51A	1.49	50016	1.79
5 1/4" SSDD Soft Sector w/Hub Ring	M13A	1.79	51401	1.89
5 1/4" SSDD Same as above, but bulk product	M13AB	1.59	00096	1.59
5 1/4" SSDD Soft Sector Flippy (use both sides)	M18A	2.69		
5 1/4" SSDD 10 Hard Sector w/Hub Ring	M43A	1.79	51410	1.89
5 1/4" SSDD 16 Hard Sector w/Hub Ring	M53A	1.79	51416	1.89
5 1/4" DSDD Soft Sector w/Hub Ring	M14A	2.69	52401	2.79
5 1/4" DSDD Same as above, but bulk product	M14AB	2.49	00140	2.49
5 1/4" DSDD 10 Hard Sector w/Hub Ring	M44A	2.69	52410	2.79
5 1/4" DSDD 16 Hard Sector w/Hub Ring	M54A	2.69	52416	2.79
5 1/4" SSDD Soft Sector w/Hub Ring (96 TPI)	M15A	2.59	51801	2.59
5 1/4" DSDD Soft Sector w/Hub Ring (96 TPI)	M16A	3.69	52801	3.69
5 1/4" Fileware Diskette for Apple® Lisa Computer				

For more information about this brand call:

6 year warranty
 For more info on Wabash call
800-323-9868
 In Illinois 312-593-6363

Lifetime warranty except bulk
 For more info on Ultra call
408-728-7777
 Monday-Friday 9 am-4 pm PT

CE...your best source for diskettes

For you the diskette buyer, it's a jungle out there. There are so many different brands to choose from, you need to go on a safari to find a good brand at a reasonable cost. Fortunately, CE has already hunted for the best diskettes and offers you an excellent choice at a CE price. To save you even more, CE also offers bulk product where 100 diskettes are packed in the same box without envelopes or labels. Since we save packaging costs, these savings are passed on to you. Diskette envelopes are also available from CE.

Other Useful Computer Accessories

When the read/write heads on your computer are dirty, that can cause you a lot of grief. Now...with **CE Head Cleaning Diskettes**, you can clean the read/write heads on the diskette drives yourself in just 30 seconds. Each kit contains two head cleaning diskettes, and enough solution for 30 cleanings. Order # 5-CLE for 5 1/4" drives and order # 8-CLE for 8" drives. Only \$25.00 each. Also available from CE are **3M data cartridges**. The DC100A data cartridge is a small version of the DC300A data cartridge. The DC100A contains 140 feet of 0.150" tape in a package measuring 2.4 x 3.2 x 0.5 inches. Cost is \$14.00 each. The DC300A is a pre-loaded tape cartridge containing 300 feet of one mil thick by 1/4" computer tape. The DC300A costs \$18.00 each. The DC300XL is an extra length data cartridge with 450 feet of tape. It is the same size and interchangeable with the DC300A. The DC300XL provides a total storage capacity of 34.5 million bits at 1600 BPI. The cost of the DC300XL is \$22.00 each. If you need **extra mini-diskette envelopes**, CE sells super strong and tear resistant Tyvek® envelopes for \$12.00 per 100 pack. Use order # TE-5 for a 100 pack of 5 1/4" diskette envelopes. **Smith-Corona TP-1 letter quality printers** are available in serial or parallel versions for only \$529.00 each.

Quantity Discounts Available

Our diskettes are packed 10 disks to a carton and 5 or 10 cartons to a case. The economy bulk pack is packaged 100 disks to a case without envelopes or labels. Please order only in increments of 100 units for quantity 100 pricing. With the exception of bulk pack, we are also willing to accommodate your smaller orders. Quantities less than 100 units are available in increments of 10 units at a 20% surcharge above our 100 unit price. **Quantity discounts** are also available. Order 300 or more disks at the same time and deduct 1%; 500 or more saves you 2%; 1,000 or more saves 3%; 2,000 or more saves 4%; 5,000 or more saves 5%; 10,000 or more saves 6%; 50,000 or more saves 7%; 100,000 or more saves 8%; 500,000 or more saves 9% and 1,000,000 or more disks earns you a 10% discount off our super low quantity 100 price. Almost all our diskettes are immediately available from CE. Our efficient warehouse facilities are equipped to help us get you the quality product you need, when you need it. If you need further assistance to find the flexible diskette that's right for you, call the appropriate manufacturers compatibility hotline telephone number listed at the bottom of this ad. **Dealer Inquiries Invited.**

Buy your diskettes from CE with confidence

To get the fastest delivery from CE of your computer products, we recommend you phone your order directly to our Computer Products Division and charge it to your credit card. Be sure to calculate your price using the CE prices in this ad. Written purchase orders are accepted from approved government agencies and most well rated firms at a 30% surcharge for net 30 billing. For maximum savings, your order should be prepaid. All sales are subject to availability, acceptance and verification. All sales are final. All prices are in U.S. dollars. Prices, terms and specifications are subject to change without notice. Out of stock items will be placed on backorder automatically unless CE is instructed differently. Minimum *prepaid* order is \$50.00. Minimum *purchase order* \$200.00. All shipments are F.O.B. CE warehouse. No COD's. Non-certified and foreign checks require bank clearance.

For shipping charges add \$8.00 per 100 diskettes and/or any fraction of 100 8-inch diskettes, or \$6.00 per 100 diskettes and/or any fraction of 100 5 1/4-inch mini-diskettes. For cleaning kits, add \$3.00 per kit. For tape data cartridges, add \$1.00 per cartridge. For envelopes, add \$3.00 per pack of 100 envelopes. For printers add \$20.00 each for U.P.S. ground shipping and handling in the continental U.S. For Canada, Puerto Rico, Hawaii, Alaska, or APO/FPO delivery, shipping charges are *three times* continental U.S. rates.

Mail orders to: Communications Electronics, Box 1002, Ann Arbor, Michigan 48106 U.S.A. If you have a Visa or Master Card, you may call and place a credit card order. Order toll-free in the U.S. Dial 800-521-4414. In Canada, order toll-free by calling 800-265-4828. If you are outside the U.S. or in Michigan dial 313-973-8888. Telex anytime 810-223-2422. Order today.

Copyright ©1983 Communications Electronics™

Ad #102783



Computer Products Division

818 Phoenix □ Box 1002 □ Ann Arbor, Michigan 48106 U.S.A.
Call TOLL-FREE 800-521-4414 or outside U.S.A. 313-973-8888

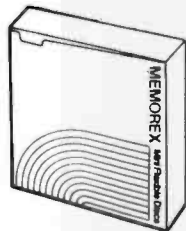
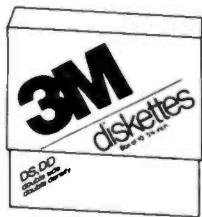

3M diskettes for as low as \$1.94 each

Memorex diskettes for as low as \$1.94 each

Burroughs diskettes for as low as \$2.09 each

Dysan diskettes for as low as \$2.99 each

3M Part #	CE quant. 100 price per disk (\$)	Memorex Part #	CE quant. 100 price per disk (\$)
8SSSD	1.94	3082	1.94
8SSSD-32	1.94	3015	1.94
8SSDD	2.49	3090	2.49
8DSDD	3.14	3102	3.14
8DSDD-1024	3.14	3104	3.14
5SSDD-RH	1.94	3481	1.94
5SSDD-10RH	1.94		
5SSDD-16RH	1.94		
5DSDD-RH	2.69	3491	2.69
5DSDD-10RH	2.69		
5DSDD-16RH	2.69		
5SSDD-96RH	2.79		
5DSDD-96RH	3.74	3501	3.74
5APPLE-FW	4.34		

Burroughs Part #	CE quant. 100 price per disk (\$)	Dysan Part #	CE quant. 100 price per disk (\$)
FD-101	2.09	800501	2.99
FD-105	2.09	800618	2.99
FD-108	2.64	800605	3.89
FD-109	3.29	800803	4.59
FD-110	3.29		
FD-111	3.29		
FD-112	3.29	800839	4.59
		801184	2.99
		801186	2.99
		801185	2.99
MFD-11	2.09	801187	3.19
MFD-12	2.09	801014	3.19
MFD-13	2.09	801188	3.19
MFD-14	2.84	802060	3.89
MFD-15	2.84	802062	3.89
MFD-16	2.84	802061	3.89
MFD-20	2.94	800439	3.89
MFD-23	3.89	802067	4.49

Lifetime warranty
For more info on 3M call
800-328-9438
In Minnesota 612-738-9524

5 year warranty
For more info on Memorex call
800-538-8080
In California 800-872-3525

1 year warranty
For more info on Burroughs call
800-448-1422
Monday-Friday 9am-4pm ET

1 year warranty
For more info on Dysan call
800-552-2211
In California 408-970-6096

Now also for IBM PC.

"I just eliminated eye fatigue by replacing the CRT Display Tube on my computer"

Now you can eliminate the strobe, flicker and fatigue from your computer terminal with a new **Soft-View™** replacement CRT from Langley-St. Clair.

Now you can upgrade your monitor with a new European amber phosphor tube.

Available for the TRS-80,* TeleVideo, Kaypro, Heath, DEC, Zenith and a wide variety of other monitors, these new replacement display tubes use amber or green phosphors which exceed the European standards for persistence and color.

And the "decay" or fade-out rate of the phosphor is the same as the "refresh" or scanning rate of the computer screen, so the display glows gently, rather than flickering like a strobe light - an annoying problem with black & white or inexpensive green phosphor tubes.

Now, you can upgrade your terminal or computer to world-class performance with the installation of a Langley-St. Clair **Soft-View™ CRT**!

Call our toll-free number to determine which tube will fit your computer or monitor.

LSIS Soft View™ CRT'S

- #DK34G Amber Phosphor w/Anti-Glare \$99.95
- #H234G Amber Phosphor w/Anti-Glare \$99.95
- #K34G Amber Phosphor w/Anti-Glare \$99.95
- #GN31G Green Phosphor w/Anti-Glare \$89.95
- #GN42 Green Phosphor \$79.95
- #GN42G Green Phosphor w/Anti-Glare \$89.95
- #OR34 Amber Phosphor \$89.95
- #OR34G Amber Phosphor w/Anti-Glare \$99.95

Also available:

- #R22G Red Phosphor w/Anti-Glare \$139.95
- #B22G Blue Phosphor w/Anti-Glare \$139.95

Plus: \$7.00 for packing and UPS shipping
\$17.00 for Overseas, Parcel Post or UPS Blue Label
Add Sales Tax where applicable.

Inquire about the CRT's we have available for many other computer models.

Phil DeLaney,
KAYPRO user.

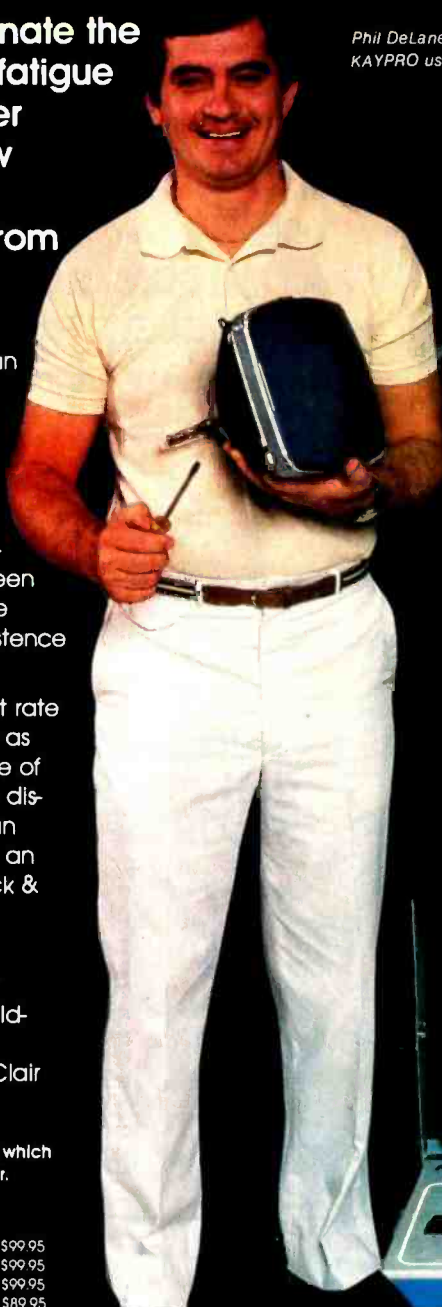

- Available in slow decay green or medium decay "European Amber" (the standard in Europe).
- Made with Lead/Strontium impregnated glass that stops X-ray emission.
- High-contrast face glass that also cuts U.V. radiation.
- Frosted glass with extra Anti-Glare benefits.
- Easily installed . . . comes with pre-mounted hardware.
- Warranted for one full year against manufacturing defects or tube failure.
- Ideal for word processing and programming, yet fast enough for games and graphics.



To order or for more information, call:

800 221-7070

In New York call 212 989-6876

Langley-St. Clair

Instrumentation Systems, Inc.
132 W. 24th St. New York, NY 10011



*Soft-View™ is a Trademark of Langley-St. Clair Instrumentation Systems, Inc.

TRS-80, TeleVideo, Kaypro, Heath, DEC and Zenith are Registered Trademarks of Tandy Corp., TeleVideo Corp., Non Linear Systems, Inc., Heath Co., Digital Equipment Co. Corp. and Zenith.

The Complete Information-Management System

Integrated software must satisfy human and machine requirements

by Michael J. Brown

While it is doubtful that a universally accepted definition has been penned, microcomputer users and software writers continue to search for the ideal, or total, information-management system. This integrated software package will utilize any special hardware features and minimize user interaction. It will be easy for the novice to use yet will have all the features and capabilities experienced users expect.

Information will pass effortlessly from one application program to the next, and user information will be stored, shared, and retrieved efficiently. Most important, though, is that integration will extend to provide complete project-processing capabilities; once a format is established, no other operator intervention will be necessary.

This article provides a brief history of software integration and lists the goals and requirements of one approach for a total information-management system. Also included are text boxes that discuss the data interchange dilemma and an actual integrated-system implementation.

Early Attempts at Integration

The earliest attempts at software integration made during the advent of the microcomputer industry simply

explained the file structures of various application programs so programmers could write code that could access this data for custom applications. Examples of this include custom report writers, better known as form generators.

The second level of integration involved the so-called families of integrated products, such as the Supers, Perfects, Visis, and Stars. Unfortunately, integration seemed to be an afterthought and usually consisted of an intermediate file output

Total Integration provides for complete project-processing capabilities.

and input capability. One program, a mailing-list record keeper, for example, could output its data (or a subset thereof) into an easy-to-use file structure. One of the more common configurations, though, was a standard ASCII (American National Standard Code for Information Interchange) file in which fields were delimited by commas and each record was terminated by a carriage return and line-feed character combination. Once a file was output in this fashion, another program—for example, a word

processor—could read this ASCII file and use the contents to generate form letters, memos, and the like.

Another example of this second level of integration was the DIF (Data Interchange Format) standard included in Visicalc. This was infinitely more useful to nontechnical computer users because programming was not required. Even so, this method was often cumbersome and required a significant understanding of files, fields, records, field delimiters, filenames, and extensions. Most important, this level of integration usually required user interaction on an operating system level. Thus, this second level was still too complex for neophytes and too constrained for technocrats.

The third level of integration was introduced and made famous by 1-2-3 from Lotus Development Corporation. No longer did you have to worry about ASCII or DIF files because spreadsheet capabilities and graphics shared the same file structure; no intermediary file interfacing was required. There can be some drawbacks when your information-management system requires database management in addition to spreadsheet and/or graphics programs.

Database management is a unique



Photo 1: Production-run information that is input and stored in a database record.

and very important piece of the information-management system. A database manager should give you total control of your data from start to finish. Data validation should be done upon entry, and full selection and retrieval of specific subgroups of information are musts. Form and report generators should be full-featured to make output of stored and manipulated data simple. Large files as well as multiple-file interaction should be accommodated.

The Complete System

The complete information-management system consists of four parts: database management, electronic spreadsheet, graphics, and word processing. Most business and office information-management systems include all of these to some degree.

The database-management program becomes the starting point. All current information is entered into the user's database. This information might include sales or invoicing information as it occurs, and each time a transaction (such as a sale) occurs, the new information is entered and accumulated. A business manager then uses this information to generate sales and commission reports. Selected information can be summarized by salesmen and then used by the spreadsheet program to project future period sales. Past, present,

and future information is compiled, summarized, and used for decisions. Graphics can be generated on screen or paper to make past, present, and future comparisons easier. Summarized information, graphs, and projections can then be included in end-of-period reports provided by the word-processing program. The word processor inserts these figures

The complete information-management system consists of a database manager, a spreadsheet, graphics, and a word processor.

and graphs into a template report and surrounds them with text. From project start to finish, user intervention is not required. And because this project is done at regular intervals, the information-management system just repeats the report's last procedure to generate the next one. This is a good overview of a complete information-management system. The problem is coming up with a data structure that maximizes hardware and software efficiencies. A short discussion is provided in "The Data-Interchange Dilemma" text box on page 203.

System Components

We can divide our complete information-management system into four areas: ease of use, full-featured programs, integration and project-processing capabilities, and technical feature strength. "Ease of use" and "user-friendly" are perhaps the most overused and nebulous terms in the industry. Their importance as concepts cannot be underrated, however, because more and more computer neophytes are operating microcomputers. First, then, to be easy to use, software must offer help options throughout. No matter what is on the screen, a designated key will provide useful information. This might be accomplished by using two levels of help—the first an abbreviated explanation, and the second level a more in-depth explanation.

Second, both help and system features should be divided into confidence levels. When you are just starting to work with a system, complicated features should not even appear on the menu. As your familiarity and confidence increase, more features can be accessed, and you move from foundation commands and features to the program's intricacies a step at a time.

Third, users should be able to create custom menus for their own applications. This is particularly important because it coincides with the integration and project-processing capabilities explained later. Custom menus allow you to define and name projects and tasks. This way, novice computer operators are able to choose between "End of period processing" and "Select and send past-due letters" without ever having to know what a spreadsheet or database manager really is. Whole projects may be predefined and executed using custom menus.

The second area of the complete information-management system is that of full-featured programs. Each of the four main programs (database manager, spreadsheet, graphics, and word processor) should be able to stand alone as a competitive state-of-the-art program. When integrated with another or with the remaining three, the result is an even more

THE BEST KEPT SECRET IS OUT.....

JUKI LETTER QUALITY, DAISY WHEEL PRINTERS ARE NOW AVAILABLE NATIONWIDE AT \$699⁰⁰



There's no mystery about it! Juki's Model 6100 bi-directional, daisy wheel printers are full featured and priced right!

Designed to perform word processing and graphic functions including bold face, subscript, superscript and shadow, the Model 6100 prints at 18 cps, has a proportional spacing control and utilizes 100 character drop-in daisy wheels. The Juki printer uses IBM Selectric Ribbons and is compatible to IBM, Apple, Osborne, Kaypro and most other personal computers. But that's no secret!

The news is that the Juki Model 6100 printers are now available through a reliable network of industry professionals strategically located throughout the country to give you the prompt, dependable sales and technical service you need. And Juki distributors are backed by a company who has been specializing in electronics for over 25 years.

So, contact the Juki distributor nearest you for the real undercover story on the best letter quality, daisy wheel printer around.



CONTACT YOUR JUKI DISTRIBUTOR FOR THE DEALER LOCATION MOST CONVENIENT FOR YOU:

ACORN DATA PRODUCTS 7304-L South Alton Way Englewood, CO 80112 303/779-6644 Serving: MT, WY, CO, UT, NM	BUTLER ASSOCIATES, INC. 82A Winchester Street Newton, MA 02161 617/964-5270 Serving: ME, NH, VT, CT, RI, MA	COMPUTER SERVICES INTERNATIONAL CORP. 905 Boulevard East Weehawken, NJ 07087 201/866-2880 Serving: METRO NY, E. PA, NJ	GENTRY ASSOCIATES, INC. 7665 Currency Drive Orlando, FL 32809 305/859-7450 Serving: TN, NC, SC, MS, LA, AL, GA, FL	INFORMATION SYSTEMS, INC. 2420 E. Oakton Street, Unit K Arlington Heights, IL 60005 312/228-5480 Serving: WI, IL, MN, IA, MO, NE, ND, KS, SO	INTERNATIONAL BUSINESS SYSTEMS CENTER 7023 Little River Turnpike Annandale, VA 22003 703/750-3882 Serving: MD, DE, DC, VA	OSSMANN COMPUTER TECHNOLOGIES, INC. 6666 Old Collamer Road Syracuse, NY 13057 315/437-6666 Serving: UPSTATE NY	SIGMA DISTRIBUTING 2110 116th Ave. N.E. Bellevue, WA 98005 206/454-6307 Serving: WA, OR, ID, AK
SOUTHERN MICRO DISTRIBUTORS 8708 Royal Lane Irving, TX 75063 214/258-6636 Serving: TX, OK, AR, LA	STAR-TRONIC DISTRIBUTOR CO. 23976 Freeway Park Drive Farmington Hills, MI 48024 313/477-7586 Serving: MI, IN, OH, KY, PA, W. PA, WV	TECHNOLOGY MARKETING CORP. 2300 Valley View Lane Suite 109 Dallas, TX 75234 214/243-7904 Serving: TX, OK, AR, LA	VITEK 930-G Boardwalk Avenue San Marcos, CA 92069 619/744-8305 Serving: S. CA	WESTERN MICRO TECHNOLOGY 10010 Balboa Road Cupertino, CA 95014 408/725-1660 Serving: N. CA, NV, AZ	NATIONAL HEADQUARTERS: JUKI INDUSTRIES OF AMERICA, INC. PA. DIVISION 289 Market Street Saddle Brook, NJ 07662 201/368-3666	WEST COAST JUKI INDUSTRIES OF AMERICA, INC. CALIFORNIA DIVISION 20437 South Western Avenue Torrance, CA 90501 213/320-9001	



ANADIX	\$1295
CITOH	\$ 595
DAISYWRITERS	\$1495
DIABLO	\$1195
DYNAX	\$ 599
EPSON	\$ 499
GEMINI	\$ 399
GE	\$1930
IDS	\$ 799
NEC	\$1915
QANTEX	\$1495
QUME	\$1995
SILVER REED	\$ 599
TALLY	\$ 399
TOSHIBA	\$2195

PRICES SO LOW— WE CAN'T LIST THEM!

ADDS	\$ 650
AMPEX	\$ 679
COMREX	\$ 149
ESPRIT	\$ 595
LEAR SIEGLER	\$ 595

All equipment is in factory cartons with manufacturers' warranty. Prices subject to change without notice. Most items in stock or shipped as received.

1 NATIONWIDE SERVICE. MOST PRODUCTS SUPER WAREHOUSE

P.O. BOX 373 WALLINGFORD, CONNECTICUT 06492
 ORDER LINE ORDER HOURS
203-265-1223 9:00 AM - 5:00 PM-EST
 MONDAY-FRIDAY

PHONE ORDERS FREE
 (ONE DOLLAR CREDIT FOR PHONE ORDERS)

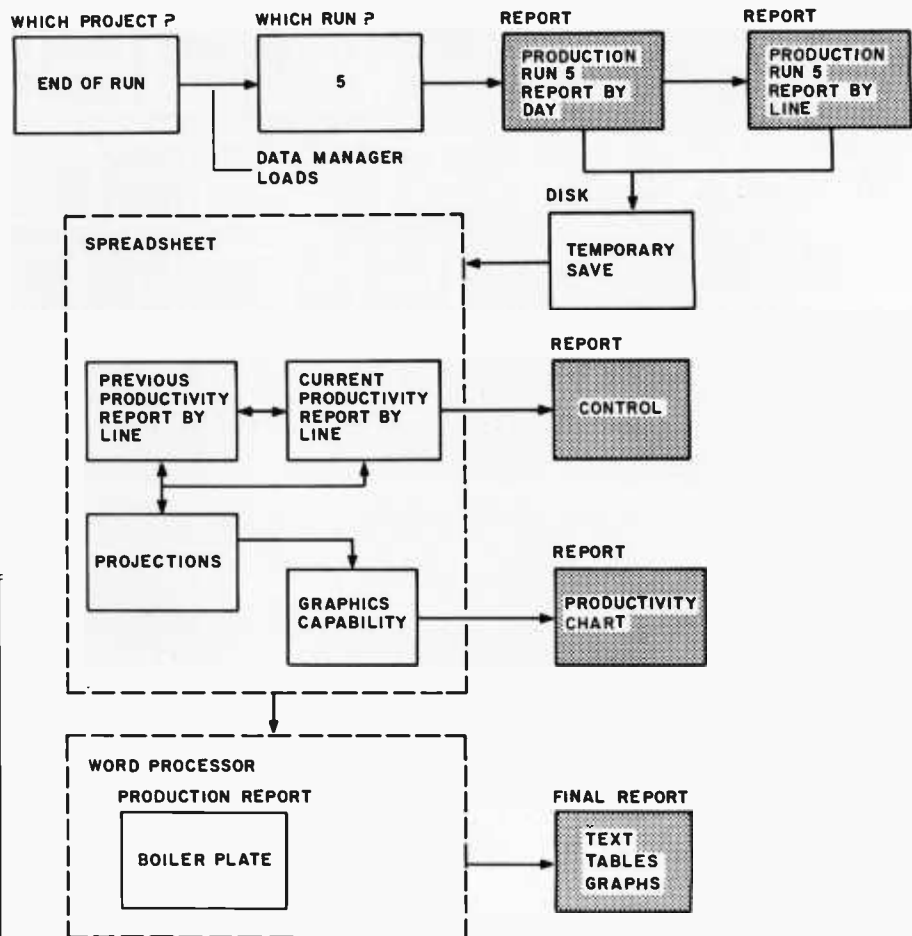

Figure 1: Process sequence and reports generated by "End-of-run full project" described in text.

powerful combination of features, the whole being a better system than just the sum of its parts. It is important to note that using only one or two of the four programs does not limit that program's capabilities. This also allows you to grow with the system as your needs and finances permit.

The third area is the key—the level of program integration and project-processing capabilities. Project processing is to all present information-management systems as a robot welding system is to a butane torch. Both get the job done, but both the butane torch and current integrated information-management systems require repetitive user intervention. Project processing is like the robot welding system. It may do a number of intricate tasks, in the order in which it was instructed, quickly and without outside intervention.

For instance, let's say your company manufactures six models of

diesel generators. Each time you finish with a production run, a productivity report is required. As each day of the production run is completed, the hours and amount of materials are entered into the database as shown in photo 1. You can then begin the productivity report. You have defined custom menus like the one that follows:

Babcock Diesel Generators
 Production Department
 Project Menu

- L = Production report line only
- P = Production report by product only
- E = End-of-run full project
- G = Go home and sack out

so that inexperienced personnel can complete the project.

For this project, you choose the "End-of-run full project." The data manager is loaded and you are

The Data-Interchange Dilemma

by Mark Callegari and Brian O'Connor

The Problem

One man's heaven is another man's hell. This phrase correctly describes the problem of data interchange among various application programs. The crux of the problem is that each type of application requires a unique type of data structure to operate at maximum efficiency. Unfortunately, the more unique the data structures, the harder it is to exchange data. This is analogous to the problems of people with different abilities who must work together. For example, let's say you have programmers, engineers, accountants, and product managers who specialize in each of their respective areas. The problem occurs when a project requires the interaction of two or more of these groups. Although each person is competent in a given field, some proficiency in the other fields is needed for a successful project. If we substitute those workers' unique abilities for our program's unique data structures, we can see that the problem of information flow exists in both areas.

In a totally integrated system at least four different types of structures exist.

Database Structure

The data in a database can be broken down into fields, records, and files, and each component has its associated attributes. Fields have field length and field type associated with them. Records have record length, and files have various header information stored with them. These attributes are used to describe the data, and without them the raw data on the disk would be useless. Various other files are associated with a database that includes those used for key fields or subgroups of the database. As you can see, many interrelated components make up the actual data in a database.

Spreadsheet Structure

A spreadsheet's structure is quite a bit different than that of a database. Here, each individual cell has one or more associated attributes. These describe whether the cell is calculated or contains data, whether it is alphanumeric or numeric, how many digits of precision to use, whether a dollar sign or percent sign is to be used, and so on. The database, on the other hand, has attributes associated only with an entire group of cells, which are fields.

Word Processor Structure

A word processor's structure is more complex than either a database or a spreadsheet. Here, we no longer have repeating groups like records in a database or rows and columns in a spreadsheet. A document created by a word processor is divided into three basic components: the character, the paragraph, and the document itself. On the new generation of word processors, each character has an associated font, size, and position (subscript or superscript). Each paragraph has associated margins, spacing, and justification. And, finally, the entire document has associated page controls, header and footer information, and page-size information.

A word processor also must be able to integrate two foreign types of data. These include graphic files for embedding images in a document and ASCII (American National Standard Code for Information Interchange) files for merging data from other programs for form-letter and other similar applications. The more difficult of these two is the graphic file. Because a graphic image can be any size and appear anywhere in the document, the program must perform certain transformations to ensure that the image is legible. Printing the graph is not necessarily difficult since the whole document must be printed as a graphic image anyway. This is the only way to change the font and size of the characters.

Graphics Structure

There are several ways to exchange graphic information, including using a bit map of the image and using a graphics language to recreate the image. The simpler of these two is the bit-map representation. Using this technique, a series of bits makes up the image, with each pixel (picture element) consisting of one or more bits. If one bit is used for every pixel, then you can make that pixel either on or off. If you use two or more bits for each pixel, then you can either associate a color or a gray scale with each pixel. A typical graphic image consists of 640 pixels per line by 200 pixels per row. This method is the easiest to reproduce, but it takes up great amounts of storage space; the preceding example requires 16K bytes of storage. If we increase resolution to 1024 by 1024, our storage requirements will be almost 132K bytes.

An alternative to bit mapping is a graph-

ics language. Here, you use a series of commands to recreate the graphic images as they are translated. This shrinks file sizes for high-density images but increases processing time and code requirements.

Diverse Data-Structure Problems

As we have seen, a wide range of data structures need to somehow be communicated if we are to have an integrated system. One way is to try to use one structure for several applications. Lotus chose this method when designing 1-2-3. The company designed a spreadsheet and added a database manager that uses the spreadsheet's structure. This simplifies writing the program but limits the database's specifications to those of the spreadsheet. Using our original analogy, this might be compared to giving an engineer's job to an accountant. Although the accountant could interact easily with the accounting department, his engineering skills would be limited.

Innovative Software has chosen to handle integration by enabling each application to use a structure that is most natural to it. Specialization of resources is as important in software as in manufacturing. If you are striving for maximum efficiency, each piece of the integrated system must be able to use data structures that suit the intended functions. This has several major advantages. First, it maximizes the speed of each application. Second, it maximizes the storage efficiency of each application. Lastly, it isolates each application from another.

But there are some drawbacks to this type of integration. It increases the complexity of program design, and there is a possibility that the program will be more complicated to use. Both of these objections are up to the program designer to solve. If they can be solved, the user gets the best program available. ■

Mark Callegari is vice-president of Innovative Software Inc. (9300 West 110 St., Suite 380, Overland Park, KS 66210). He holds degrees in management and computer science from Rockhurst College, and his interests include radio-controlled helicopters, karate, and computers.

Brian O'Connor is director of programming at Innovative Software. He has a B.S. degree in computer science from Rockhurst College and is interested in playing softball, the guitar, and gourmet chef.

RS-232

DATA ACQUISITION

Control & Measurement

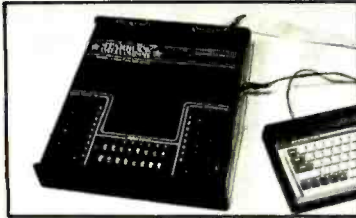

Starbuck Model 8232

A general purpose real-world interface: connects to ANY computer or terminal via RS-232

TYPICAL APPLICATIONS:

- Use with printing terminal: create low-cost data logger
- Use with modem and phone for remote acquisition & control
- Capture data bursts for subsequent analysis/plotting
- Monitor experiments; transfer data daily to main computer

FEATURES:

- 8 analog inputs, 0-5 VDC
- 8 digital input channels
- 8 opto-isolated outputs
- All inputs and outputs fully protected to withstand abuse
- 8 bit (0.4%) analog accuracy
- On-board 2000 point buffer
- Up to 5000 analog readings/s
- Triggered acquisition
- Units may be chained for extra channels
- Controlled by ASCII strings
- Application manual details interfaces for common sensors
- Applications engineer on call
- THRIFTY PRICE: \$540. complete! Applications manual only: \$5. TRS-80 version also available

★ STARBUCK ★
DATA COMPANY

PO Box 24, Newton, MA 02162
(617) 237-7695

Dealer and OEM inquiries welcome

PRODUCTIVITY ANALYSIS AND COMPARISON			
LINE #	HOURS	UNITS	PRODUCTIVITY
LINE #1	28.00	18,000.00	357.14
LINE #2	35.00	12,500.00	357.14
LINE #3	32.00	9,500.00	296.88
LINE #4	24.00	9,600.00	400.00
TOTAL	119.00	41,600.00	349.58

COMPARISON TO LAST RUN	
% CHANGE L 1	-10.30
% CHANGE L 2	0.04
% CHANGE L 3	-21.20
% CHANGE L 4	32.43
AVG % CHANGE	0.24
TOT % CHANGE	0.97

AVG PROD LAST 10 RUNS	
LINE #1	387.40
LINE #2	412.09
LINE #3	350.43
LINE #4	386.43

Command list 2: Border Columns Graphics Lock Rounders Sort
Textformat Unlock Valueformat Width
Worksheet: a1 Location: r5c2 Window: #1 (resident) CREATE MODE

Photo 2: Summarized production information extracted from the database and used by the spreadsheet for comparisons and projections.

Window 1
PRODUCTION REPORT

FOR PRODUCT: [PROD]
RUN NUMBER: [RUN]

Run number [RUN] compared [LINE] to the previous run. In comparison to all runs for product [PROD], the run covered [GHS/MS]. The following chart shows the units, hours, and productivity for this run of the product.

LINE #	HOURS	UNITS	PRODUCTIVITY
LINE #1	28.00	18,000.00	357.14
LINE #2	35.00	12,500.00	357.14
LINE #3	32.00	9,500.00	296.88
LINE #4	24.00	9,600.00	400.00

Command list 2: Change-font Footnote Header Margin Page-break
Spacing Tab Trailer

Page: 1 Line: 18 Col 12 File: prodrep2
normal 1 margins: 5 - 65 19:13:- Insert ON

Photo 3: An example of merge-print word processing; a portion of the production spreadsheet has been inserted within the text of this production report.

prompted for which run number you wish to get the reports on. The data manager automatically selects the information you request from an entire database of daily product/run records. This information generates a tabular production report by day. When finished, the run information is summarized by production line and another report is generated. This information is held temporarily on disk, and the spreadsheet automatically reads the temporary spread-

sheet form. The spreadsheet begins your productivity analysis by line and outputs a control report. These figures are compared with the last run's productivity figures, and projections are made based on the differential. These figures are printed in a control report. Project flow is illustrated in photo 1. A portion of this spreadsheet is shown in photo 2.

The spreadsheet now calls the graphic function, and productivity charts are generated (photo 3).

DATAEASE™

The Complete Application Development System With Features You Most Desire

Unequaled power with extreme ease of use

It is Easy to Use:



Fully menu driven to remove the guesswork.
Full use of function keys with the assignments always displayed. All cursor movement and editing functions on the keyboard are supported.
Provides full color support and screen style customization.

System Features:

A list of users can be kept, with passwords and security levels.
The print style is customizable.
Data can be interchanged with mainframe computers, other data bases or spreadsheet programs.
Data base back-up and restore functions are integrated to reduce errors.

System Requirements:

Available on the IBM-PC, DEC Rainbow, Wang/TI Professional, Victor 9000, etc. Compatible with MS-DOS and CPM/86.
Supports floppy or hard disk drives.
Any popular printer can be optionally supported.

It Provides

A Complete Range of Features:

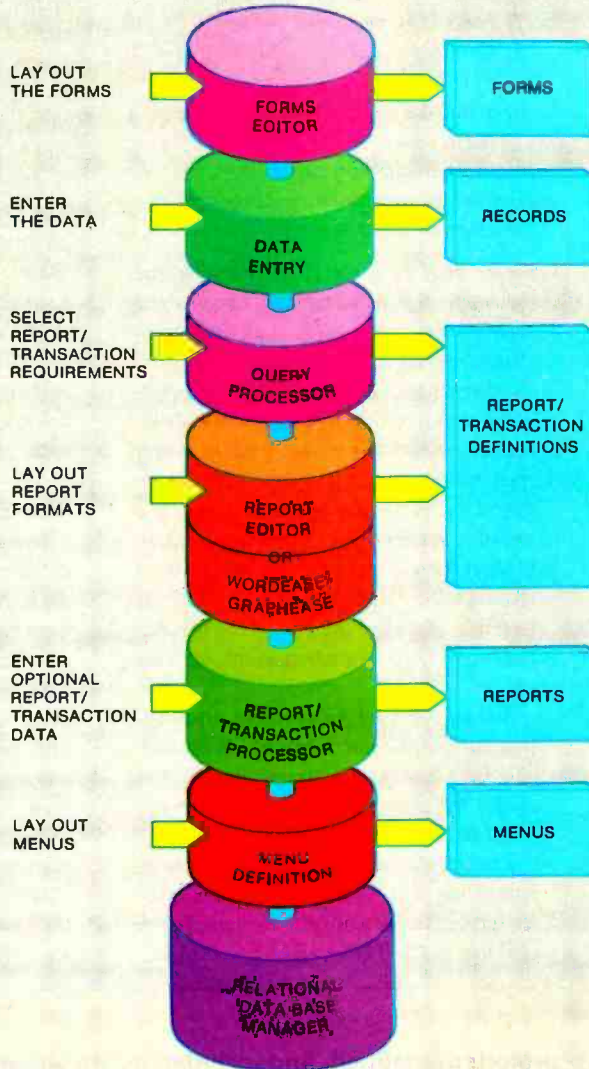

- Lay out forms on the screen. Define data-entry fields anywhere using: 8 field types; table look-ups; calculations; range checks; choice fields; defaults. Revise your forms simply.
- Easy, fast and accurate data-entry. View and update your records in the same simple manner.
- Define reports/transactions using the unique English-like, optionally menu driven query language. Access data from all your files; select records any number of ways; group/sort on any number of levels, perform calculations, obtain subtotals, totals and statistical summaries. Delete/update selected records. Post information between files.
- Use system defined/custom report formats. Create mailing labels/form letters. Use pre-printed forms.
- To format a report complete with text, data, and graphs; use the optional WORDEASE™ word-processor or the GRAPHEASE™ graphics facility.
- Display or print the report output, or take it to your spreadsheet, word processing, or graphics programs.
- Organize the access to your forms and reports by setting up your own menus.
- Large data bases: 64K records/file; 255 fields/record; 255 char/field; any number of indexes/file. Relate any number of files with this multi-user relational DBMS. Speedy access: B-Tree indices; cache memory; delayedwrites.

Create your DATAEASE Applications:

Inventory Control
Personnel Management
Job Accounting
Mailing List

Accounting
Order Processing
Market Analysis
Financial Portfolio

Medical Office Systems
Real Estate
Agriculture
Distribution Management

Social Sciences
Bibliography
Library Management
School Records

Circle 490 on inquiry card.



Software Solutions, Inc.

305 Bic Drive • Milford, CT 06460
(203) 877-9268 • (800) 243-5123 • Telex 703972

Contact your dealer or call directly.

www.americanradiohistory.com

See us
at COMDEX
Booth #S 9718
Sahara

An Integrated System Implementation

Innovative Software believes that the system should take advantage of current technology, so it provides for use of an optional 8087 arithmetic processor, a mouse, and large amounts of RAM. Additionally, it employs multiple windowing and full project-execution capability. The 8087 chip is extremely handy in the spreadsheet and database where large amounts of numerical processing take place. The mouse speeds editing of both the word processor and spreadsheet. As only a small number of programs presently take advantage of the large RAM-addressing capabilities of the 8086/8088, Innovative's system uses the large amounts of RAM that are being sold in current systems. Windowing allows several files to be seen and edited on the screen at the same time, or one file can be viewed from several different perspectives.

Project execution is the ability of one program to execute a series of tasks and then transfer control to another program to continue executing more tasks. As each task is completed, the project executor determines whether any errors have occurred, provides error messages if required, and continues with the next task. The project executor can transfer control among various sections of one application or to a completely different application program.

The language we used is C; portability and code efficiency dictated this choice. Where even higher efficiency and speed are needed, we used assembly language. Because of these choices, the system is very fast and is easily ported to other machines.

The total system consists of four basic parts: a database, spreadsheet graphics, word processing, and system utilities. These will be explored individually.

The Database

The database is the key component of the

entire system. It must be very powerful to handle the full complement of business needs. Our database includes the following specifications:

- 1) 255 fields per record
- 2) 12 field types with range checking and validation
- 3) Multiple screen layouts for each file
- 4) Over 100,000 records per file
- 5) Compaction of data on the disk
- 6) B-tree organization of key fields
- 7) Multilevel password protection
- 8) Complex equations, including IF-THEN-ELSE structures
- 9) Windows allowing multiple files on the screen
- 10) Project-execution capability
- 11) Custom programming language
- 12) User-definable menus

We feel that these specifications make our system more than adequate to handle most business applications. The underlying data structure consists of a file containing variable-length records with an index file pointing to each record. When records are added, the program checks to see if there is any open space in the file. If not, records are concatenated to the end of the file. If a record is updated, the program first checks to see if there is room to write the updated record in the old space. If not, the updated record is placed at the end of the file and the empty space is made available for later use.

B-trees are used for key-field organization, although a sort/merge utility is available for temporary organizations. B-trees enable the program to insert new or updated data or find old data very quickly.

The calculated fields use the same basic parser that is in the spreadsheet. This gives the program the ability to do conditional lookups (IF-THEN-ELSE, CASE,

SELECT, etc.), transcendental functions (sine, cosine, etc.), business functions such as NPV (net present value) and IRR (internal rate of return), as well as many other standard functions such as ROUND, INTEGER, etc. Selection of records for reports, lists, or forms can use the same basic parser using the AND, OR, and NOT operators combined with parentheses.

The program output can be directed to the form generator, the report generator, or the list generator. The form generator enables you to place fields anywhere on the screen, optionally include titles, read from multiple files, do conditional page breaks, calculate new fields, and put text anywhere on the page. You can create custom forms or print on existing forms such as invoices. The Report and List commands are really preprocessors to the form generator, eliminating much of the overhead associated with designing standard layouts.

The database accepts many types of files into its internal data structure. As a result, you can transfer data from other programs without having to rekey large amounts of data.

The Spreadsheet

Designing a spreadsheet becomes more art than science. A spreadsheet must handle large amounts of data in many different formats while performing many different commands. In addition to the standard features found in most packages, our spreadsheet contains the following features: multiple windows, built-in command language, interrelation of multiple spreadsheets, project-execution capability, context-sensitive help, and an efficient "sparse-matrix" data structure.

Perhaps the most interesting feature of the spreadsheet is the sparse-matrix data structure. In most spreadsheets, data space

The figures and the associated chart are saved for integration with the word processor. The word processor is automatically loaded, and the tables of figures and productivity graph are neatly inserted into the proper pieces of the boiler-plate production report and printed on a high-quality printer.

This is what project processing is all about. Starting with accumulated information in the database manager, information is summarized, printed,

projected, graphed, and included in word-processing documents without any additional intermediary user interplay.

The last area in the total information-management system incorporates technical features such as powerful arithmetic capabilities for spreadsheet number crunching, summarizations in the database, and graph generation. The system should also take advantage of large amounts of inexpensive RAM (random-access

read/write memory). Additionally, individual systems' screen and technical specialties should be exploited. The most efficient and quick data structures should be used for each individual program. Examples include B-trees for the database and sparse-matrix structures for the spreadsheet. Lastly, the entire system should be operating-system transportable.

The Innovative Software System

Innovative Software's complete

is allocated for each cell even if it is empty. Therefore, if you put a number in row 50, column 10, the program allocates 500 cells worth of memory. This is a waste if you consider that on a large model many cells are left blank to make things more readable. The sparse-matrix type of data structure eliminates this problem by using only as much space as needed—at the expense of program design complexity. In the sparse-matrix technique, swapping two rows in a work sheet is no longer a matter of swapping two blocks of memory. On large work sheets the memory savings is especially worth the effort. You can typically have work sheets two to five times larger than programs that simply allocate blocks of memory.

The graphics capability is built into the spreadsheet program. It also can be called during project execution. Some of the features included are three-dimensional bar and pie charts, multiple fonts, histograms, and a slide-show capability.

The Word Processor

The word processor is the most unique program of the system. It contains many features found only in dedicated word processors. Some of the features include:

- Attributes shown on screen (underline, bold, etc.)
- Multiple windows
- Multiple fonts and sizes
- Flying reform
- On-screen math capabilities
- Ability to include graphics in a document
- Project-execution capability
- Context-sensitive help

Each character is stored as a 2-byte integer. The lower 7 bits of the integer are used to store the character. The upper 9 bits

are used to store the character's attribute, font, size, and other pertinent information. When you move a character, the font and size follow it to its new location. If you do not have graphics capabilities, you may optionally display the fonts using special character attributes such as color or intensity.

A graph from the graphics program can also be included in the document. A window in the text is defined in the document where the graph will appear at print time. During printing, the word processor reads a plot file saved from the graphics program and recreates the picture to fit the size of the window. This plot file contains all the information to recreate the picture, including different fonts, colors, and shapes.

Flying reform is the process of keeping a document always formatted the way you have defined it. Many word processors have a manual Reform key to clean up a paragraph after you have made insertions and deletions. The flying reform does this job for you. Every time you insert or delete a letter, the paragraph stays formatted.

System Utilities

The system utilities contain many useful commands. For example, a calculator utility handles either standard or RPN (reverse Polish notation) data entry. It handles equations with embedded parentheses up to 255 characters long with full cursor editing. It also contains three memory locations and can output answers in binary, hexadecimal, and octal as well as decimal.

Other system utilities include file-directory, file-copy, file-rename, file-delete, and other operating-system commands.

information-management system consists of the three previously mentioned products: a database manager, a spreadsheet/graphics product, and a word processor. All three have a built-in command or task processor that will allow a series of tasks to be done in series without user intervention. If two or more parts of the system are used, these command processors can initiate sequences of commands from the other command processor(s) allowing truly integrated

project processing. For details, see "An Integrated System Implementation" text box on page 206. ■

Author's Note:

Research in the areas of data structures, integration, and project processing was done by Roger Schroff, University of Southern Maine.

Michael J. Brown is president of Innovative Software (9300 West 110 St., Suite 380, Overland Park, KS 66210).



BEST FRIENDS

CF&A is the "best friend" your computer terminal will ever have. Whether it's a specialized desk for your IBM or Apple Personal Computer, a stand for Qume, NEC, Diablo, T.I. and a host of other printers, or a Classic Series Desk in a wide range of sizes and configurations, we have the perfect companion for your personal or business computer system. In addition, our DR Series offers desk height RETMA rack mount enclosures, as either freestanding modules or integrated into the desk. Remember Computer Furniture and Accessories . . . Quality, features and style to bark about at prices that won't make you howl.

CF&A

**Computer Furniture and
Accessories, Inc.**
515 West 132nd Street
Gardena, CA 90248
(213) 327-7710

See us at Comdex booth #517.

THE COMPUTER FOR PEOPLE WHO LOVE MONEY.SM

People who love money want to pay for the brand names that are in their computer. Not for the name that's on it. People who love money want quality and lasting value, the best workmanship and the best return on investment for what they buy. If that's you, then this is your computer!

IT'S TIME SOMEBODY FINALLY SAID ENOUGH TO INFLATED RETAIL PRICES AND THE ENDLESS HOURS SPENT SHOPPING FOR A COMPUTER.

Prices are ridiculously high. Confusion reigns. And you're left with nowhere to turn until now.

Because we're eliminating those price-gouging middlemen with all their mark-ups and overhead, so we can sell you a brand-name, state-of-the-art, completely guaranteed total computer system for far less. Far less money and far less hassle.

Our innovative, competition-shattering, price-war breakthrough will turn the retail computer industry upside down. And you're going to profit.

NATIONALLY KNOWN, BRAND-NAME COMPUTER RENAMED "TCFPWLM"

(The Computer For People Who Love Money)

We made a deal with the manufacturer. He sells us thousands of new computers, without the nationally advertised label. We call them a much better name, and sell them for a fraction of the retail price to you.

The "TCFPWLM" computer is guaranteed to be exactly the same complete computer system you can buy in any leading retail store right now for \$2195 to \$2495. These aren't seconds, rejects or last year's models. But they are overpriced because of all those mark-ups. People Who Love Money can buy the same computer from us for \$1777. A savings of \$418 to \$718. But that's not the only reason to buy one.

THE IDEAL COMPUTER FOR THE ONE MAN BAND. (OR THE CONSULTANT. THE WRITER. THE SMALL BUSINESS. AND THE HOME.)

Everything you need is included for \$1777: A Computer, Printer, Display screen. A device that lets the machine communicate with other computers by telephone. A complete software library. Detachable keyboard. Dual floppy disk drives. All exquisitely built in one compact transportable unit.

For the first time, one ingenious system lets you conveniently and effortlessly work without a desk full of bulky equipment. Because it weighs only 33 lbs, you can take

it anywhere. It's ideal for the small business.

MADE FOR PEOPLE WHO HATE COMPUTER STORES

Ever tried shopping for a computer? It's a colossal waste of time and can take weeks, if not months to wade through the myriad of products, ambiguous sales pitches and unfamiliar jargon. But let's say you shopped your brains out at a store. Here are the best prices you could possibly get for the same equipment that comes standard in "TCFPWLM":

Correspondence quality Dot Matrix Printer:	\$400
Acoustical Coupler and Telephone Modem:	300
Two Double Density Disk Drives:	500
Complete 64K CP/M computer:	550
Detachable keyboard:	200
PLUS, a library of top rated business and home management software programs:	2,800
TOTAL SYSTEMS PRICE	\$ 4,750

And *that's* if you shopped like a maniac. You still have to put it all together. And you have a mess of components instead of a professionally integrated system. And any professionally integrated system starts at \$3,500 and goes up and up and up. (Don't you value your time?)

THE BIG NAME BRANDS HAVE BEEN MAKING A HUGE PROFIT FROM SELLING EVEN BIGGER NAMES. PEOPLE WHO LOVE MONEY KNOW WHICH NAMES TO BUY.

IBM, Apple, Radio Shack, Texas Instruments, Kaypro, and every micro-computer made today is a collection of parts made by much bigger names.

For example: Zilog makes the microprocessor inside Kaypro, Eagle, Altos and DEC. It's the same one we use.

The power supply inside the famous Apple Computer is made by the same manufacturer that makes ours.

The keyboard is made by Stackpole, the firm that makes Texas Instruments' and Hewlett-Packard's. Ditto for ours.

Even many of IBM's electronic components and integrated circuits are identical to ours because we both buy from the same big name manufacturer.

Same with our Display Monitor. It's the same one used by Compaq and Texas Instruments.

The printer is an Epson. The world leader. Of course you see the point: Not only will

you be buying a computer at a better price, you'll be assured that all the quality components inside "TCFPWLM" come from the world's leading big-name manufacturers. (And you thought those other computer companies made it all. They're just more expensive boxes, with far less features).

The Computer For People Who Love Money is for you.

WHAT GOOD IS A COMPUTER UNLESS IT WILL DO THINGS FASTER AND EASIER WITHOUT A LOT OF TECHNICAL MUMBO JUMBO?

Why have a wonderful computer system like this, and not be totally enthralled with it?

It would be a waste. And we're not in business to waste anyone's time. . . . least of all ours. So we're including a comprehensive library of #1 Rated, extremely easy-to-use software programs— Free! (The same stuff costs \$2,800 if you buy it at a store). Take a look at what you can do:

IN YOUR OFFICE, IT WILL DO MORE FOR YOU THAN MUCH LARGER, COSTLIER COMPUTERS.

Now writing, editing, formatting and printing of any document can be simple and quick. And its "spelling checker" with a dictionary of more than 50,000 words, conveniently points out typing errors.

You can draft letters, long documents, contracts or tables, all for rapid editing. Organize mass mailings, create invoices, print labels too.

Build computerized records on clients and customers for immediate access. Enter data only once, eliminating file drawers and, once and for all, the search for missing papers. When you create invoices, statements, form letters — whatever — the computer recalls the information instantly with a press of a button.

You can have several spreadsheets in memory at the same time, working together and sharing data for business projections. Two spreadsheets can be on the screen at the same time so you can compare "what is" to "what if?"

You'll be able to immediately use any of the 16 built-in business and financial programs, such as: Cashflow Assessment, Accounts Receivable and Payable; Income Statements; Net Worth; Stock Portfolio Evaluation and many more.

VERSATILITY AT HOME.

Take it home, where its *ease of use* makes it a wonderful educational tool for the family. An aid to home budgeting, checkbook balancing, and record keeping. It's like having a private secretary handle everything from writing out checks to answering the phone if you want. The Computer For People Who Love Money will do it all!

We admit this may sound too fantastic to be true. But it really does everything we say, and much more. That's why it makes so much sense to own one).

THERE'S NO OTHER COMPUTER SO WELL SUITED FOR THE EXECUTIVE ON THE MOVE.

You can work more productively wherever you are, phoning results back to the office over the built-in telephone modem. Since the entire system weighs only 33 lbs, it's completely transportable and very durable.

Take it anywhere, anytime and have the world at your fingertips. You can get up-to-the-minute stock reports, news updates direct from the wire services and tap into the largest collection of information data in the world via The Source, America's Information Utility. A one-year's subscription is included as our gift.

THE BEGINNER HAS NOTHING TO FEAR. AND THE EXPERT WILL REVEL IN ITS VERSATILITY.

Don't worry about learning how to use your computer. We thought of everything.

When you receive your new computer, all you have to do is take it out of the factory-sealed box, plug it in, and follow the step-by-step instructions written in plain English. At any time, if you get stuck while working on any of our software programs, type "help" and the answers will appear on the screen. Or you can call our 800 Toll Free Hot Line and get an expert to walk you through any problem you might encounter.

You'll also get a training guide and cassette tape.

First-time users who have never had their hands on a computer before can be typing away with confidence in about an hour. You can go back at any time for a quick refresher or train a new person in your office without spending your valuable time. It's simple, fun, and thoroughly thought out.

WHAT'S THE CATCH?

There is no catch. It's competition... hard and true. We're out to cut the cost of computers. It's that simple. And you can be the beneficiary.

Sure. The Computer For People Who Love Money won't do color graphics. But you're in business, not art school. And no, it's not IBM compatible. But its CP/M operating system is from Digital Research Inc., the most widely used computer operating system in the world, with more than 3,000 different software programs in use in hundreds of thousands of computers worldwide.

It won't iron shirts, improve your golf game or mix a dry martini. But it will give you dependable hardware and software to handle virtually ever personal or business need for years.

And there is no risk to you.

WE INSIST ON YOUR COMPLETE SATISFACTION.

\$1777 is an incredibly low price. But we know we must make a believer out of you.

First, you'll get a 15 day UNCONDITIONAL MONEY-BACK GUARANTEE. Return everything in its original shipping box unharmed and you will receive a full refund.

Second, if anything goes wrong during the first 90 days we'll fix it free, as long as it hasn't been misused. Send it back to our service center. We pay postage both ways. We promise to correct the problem within 48 hours of receipt, or call you if we have a question.

Third, a nationwide service contract is being offered to protect your computer for one year or longer. Details will be clearly spelled out for your review when you receive your computer. You don't have to decide if you want it now. Very few of these computers ever need repairs, but if you want extra protection, it's available.

Finally, our toll-free 800 Hot Line experts are standing by to help. They speak plain English, too.

A FINAL NOTE

We are *totally* convinced this is the best product on the market today. Clearly, there is no other computer so capable, so practical, so very affordable... and so portable.

\$ 1777
includes all this:

- Z-80A Main Processor
- 64K User RAM
- 5 Microprocessors
- CP/M 2.2 operating system
- 7" Amber adjustable Display, 80 characters x 25 lines
- Detachable Keyboard with 3-foot coiled cord
- 15 function keys with numeric keypad
- Also functions as Electronic typewriter
- 80 Characters per second bi-directional impact dot matrix printer with Graphics capability
- Two 5¼" double density Disk Drives
- 360K bytes disk memory
- Acoustical Coupler and Direct-Connect Modem
- Two RS232C Ports
- Real Time Clock

Application Software included:

- Perfect Writer: Powerful, easy to use word processor
- Perfect Speller: Automatic spelling checker program with 50,000 word dictionary
- Perfect Calc: advanced spreadsheet and financial modeler
- Perfect Filer: High-performance data management system
- Fancy Font: A variety of type styles and sizes
- Money Maestro: Home accounting and financial record-keeping
- Personal Pearl: Data base information manager
- M Basic and C Basic: Programming languages
- The Source: America's information utility

- Built-in diskette Storage
- Modular Servicing
- Size: 16-1/8" wide x 10" high x 10-13/16" deep
- Weight: 33 lbs
- Instruction manuals & training cassette tapes
- 15 day money-back guarantee
- 90 day service warranty
- 1-year optional service contract
- Toll Free 800 Service Hot Line



ORDER NOW

Call Toll Free 24 Hours
800-824-7888, ext. 356

800-824-7919, ext. 356
Alaska and Hawaii Only

TRY THIS COMPLETE COMPUTER SYSTEM RISK FREE

To order The Computer For People Who Love Money risk free with your credit card, call toll free or send your check or money order for \$1777. Postage and handling is included. NV residents add 5¾% sales tax. (If you're in a big hurry, add \$49 and we'll ship airfreight immediately). All other orders allow ten days to two weeks.

M*P*S Distributors, Inc. 1105 Terminal Way, Suite 202, Reno, NV 89502



Perfect Writer, Perfect Speller, Perfect Filer, Perfect Calc, and Perfect Software are registered trademarks of Perfect Software, Inc. CP/M and C Basic are registered trademarks of Digital Research, Inc. Fancy Font is a registered trademark of Softcraft, Inc. M Basic is a registered trademark of Microsoft, Inc. Money Maestro is a registered trademark of InnoSys, Inc. Personal Pearl is a registered trademark of PEARLSOFT. THE SOURCE is a service mark of Source Telecomputing Corporation, a subsidiary of The Reader's Digest Association, Inc. Apple is a registered trademark of Apple Computer, Inc. IBM is a registered trademark of International Business Machines Corporation. DEC is a registered trademark of Digital Equipment Corporation. Altos is a registered trademark of Altos Computer Systems. Epson is a registered trademark of Epson America, Inc. Compaq is a registered trademark of COMPAQ Computer Corporation. Kaypro is a registered trademark of Non-Linear Systems, Inc. Eagle is a registered trademark of Eagle Computer, Inc. Zilog is a trade name of Zilog, Inc. Radio Shack is a registered trademark, a division of Tandy Corporation. Texas Instruments is a registered trademark of Texas Instruments, Inc. Hewlett-Packard is a registered trademark of Hewlett-Packard Company. The Computer For People Who Love Money and TCFPWLM are service marks of M*P*S Distributors, Inc.

The Allegory of Software

Beyond, behind, and beneath the electronic desk

by Tom Houston

People, like computers, process information, using languages to encode and communicate the meanings of things. In our speech and in our ideas about the world, we are the inheritors of cultural traditions whose continuity can be traced backward to prehistory. For a few human endeavors, such as hunting or food preparation, the antiquity of our ideas and symbols is no handicap, because we do some things in pretty much the same way as our ancestors.

We do other things that they never dreamed of, but in our habits of thought and language we prefer to reuse old terms, coining new words only as a last resort. A diesel vehicle might be "driven" by a "teamster," though no nosebag of oats awaits his horsepower. He is directed in traffic by left- and right-pointing "arrows," though today only aborigines and anthropologists make stone projectile points. Most English words have more than one meaning, because there are more things than words. Recycling old symbols to denote new things reduces the need to learn new words, enabling people to get by with small active vocabularies. Most new meanings are acquired through analogy: some similarity is asserted between an established meaning of a word and a new notion that needs to be given a name.

In the very broadest sense, computers do the same thing that other tools like arrows and diesel engines do: they amplify the power of our fingers. But computers do things in ways so different that analogies with older technologies are

often not at all obvious. Proof of this is that the first few decades of the age of computers produced far more neologisms—previously nonexistent words such as "byte," "software," and "multiuser"—than other arts like arrow making or truck driving had required in their longer histories.

This concerned no one when a computer cost many times the price of a truck. In those days the few people who had to interact with computers tended to be an intellectual elite, people with big vocabularies who were comfortable with what laymen rightly regarded as esoteric terminology.

Suddenly, in the late 1970s, everything began to change, so that today the situation is reversed: the average truck costs many times the price of the average computer. Truck drivers, their spouses, children, and other people take smaller vocabularies to the computer console. The word "friendly" has a new, bitterly anti-technical meaning, and manufacturers and software publishers who hope to lead in the computerization of the home and workplace hasten to translate the special vocabulary of data processing into the vernacular.

This is an admirable, democratic, and perhaps profitable undertaking, but as with other matters that affect our life and culture, anything worth doing is worth doing right. One natural alternative to the engineering jargon and acronyms of the past is the use of metaphor; the unfamiliar procedures and tools of information processing are mapped onto an ac-

tivity that is already familiar to the user. Are some systems of metaphor or analogy superior to others? Certainly yes, if by "superior" we mean a choice of symbolism that speeds learning and makes it easier for the novice or scatterbrained user to remember how to use a computer in a way that increases his or her productivity. Consider the "electronic desk" metaphor of Apple's Lisa: most people with Lisas know what a desk is and what people do at desks.

Are some systems of metaphor less suitable? Yes, and most are much worse. Infinities of mathematical isomorphisms can be used to map anything onto anything else. Computer operations, for example, closely parallel certain metabolic processes of the giant squid, but this is an unhelpful metaphor for people unfamiliar with giant squids (see figure 1). In contrast, the legend on a light switch ("ON," "OFF") describes the two states of a circuit breaker in terms of a spatial metaphor that Beowulf could have quickly grasped, had he been able to read.

Yet there is something disquieting about Lisa's desk metaphor. If the computer is going to revolutionize the white-collar workstation, then the primitive desk described by the Lisa screen icons may soon be unrecognizable to business users. Fortunately, other metaphors are available that the poets and marketing types responsible for maintaining computer symbolism might find more useful, symbols drawn from fixed and unchanging aspects of our lives and culture. Several of these are proposed below.

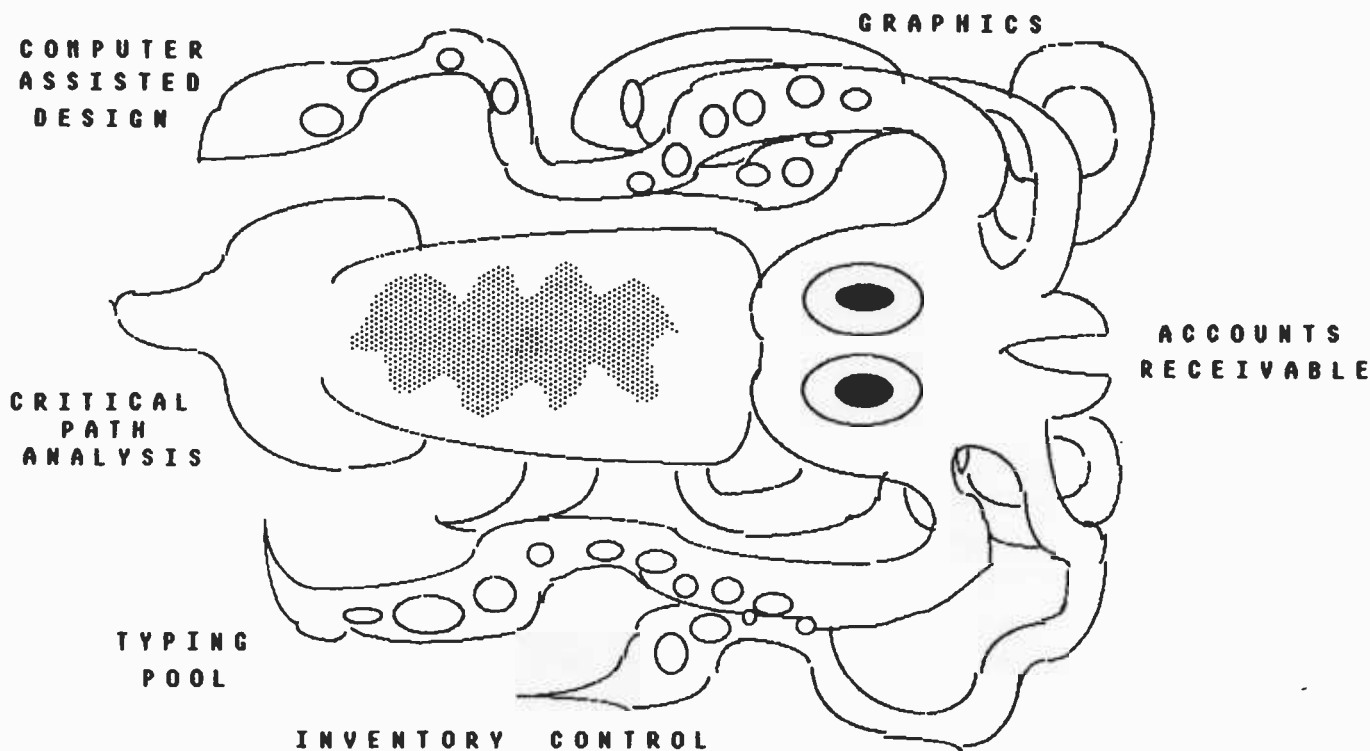

Figure 1: The inappropriate giant-squid metaphor.

Everyone who eats will appreciate the universal symbolism of the **Digital Kitchen**, based upon the striking similarities between information processing and food processing. Here the Refrigerator icon accesses removable disk storage, and the Freezer sends files to and from the hard disk. Selecting the Recipe Book icon provides Help files, and each of the six Burner symbols on the Stove offers a different delicious way of cooking one's data—word processing, spreadsheet, inventory control, database management, statistical package, and report generator, each coded with a different on-screen color and by the olfactory signals of an Aroma Synthesizer.

The little Telephone icon provides modem communications, and the Open Window activates the network controller for access to neighboring systems. Graphics work is accomplished through the Cake Decorating Kit icon, and various system utilities are accessed through the Spice Rack.

Floppy disks are formatted by selecting the Dish Washer, and the little Garbage Disposal symbol gives the erase command. The Flyswatter loads a debugging tool, and the Oven symbolizes compiler and interpreters—what language is indicated mnemonically by the type of cuisine selected (American for BASIC,

The Digital Kitchen analogizes information processing and food processing.

Chinese for COBOL, French for FORTRAN, Italian for Interpreted BASIC, etc.).

For dual processor systems, the "COLD" and "HOT" faucets of the Kitchen Sink icon choose between 8-bit and 16-bit CPUs. A Potholder is used to direct the cursor to any of the above symbols. Note that this iconography avoids nontraditional kitchen items such as trash compactors,

smoke detectors, bacon flatteners, and electric can openers, which might become obsolete or may not yet be familiar to some users outside the United States.

Some may regard the system of metaphors given above as excessively domestic and inconsistent with the prestige and power of an executive console. In recognition of the fact that many hard-hitting businesspersons rarely go home, we propose as an alternative the **Electronic Cocktail Lounge**. Rather than clutter the screen with gadgets whose real-world functions top-level executives leave to their staff, this system of symbols depicts a bar in which each software function is personified by icons of a Waitress (the Help menu), a Bartender (operating-system commands), and various Patrons.

The Patrons represent the applications programs available to the user: a Bookkeeper, with a distinctive green eyeshade, represents account-

ing software; a Bookmaker, with a loud tie, signifies spreadsheets; an efficient Secretary selects word processing; an exotic foreign Linguist stands for programming languages; an Artist, in beret and smock, does graphics work; a Security Officer, in full uniform, puts passwords on files and devices; a burly Warehouseman handles mass storage; a prim Librarian performs archival functions; a Middle Manager, in a three-piece suit, stands ready to provide database management; and a friendly Bouncer will 86 unwanted files. The cursor is directed with a Swizzle Stick. Less expensive systems would offer more sparsely populated Lounges, typically with a seedier clientele and no happy hour.

One difference between Lisa's electronic desk and an ordinary desk is that you can only hide a bottle inside a real drawer, but this Cocktail Lounge symbolism is likely to offend users who agree that alcohol poisoning is among the dominant factors in Western history. Less controversial is a different metaphor, which depicts more realistically how work gets done in a real office. Called the **Electronic Secretary**, it provides a number of unique capabilities, such as purchasing thoughtful gifts for the user's loved ones on anniversaries and birthdays and using its voice synthesizer to provide convincing misinformation on the user's whereabouts, via modem, to incoming calls from persons listed in the IMNOTIN file. Its screen is not illustrated here because, apart from the cursor, it uses icons very similar to those of the Lisa. ("Why reinvent the desk?" a spokesman asked rhetorically at the Lisa Imitation, Simulation, and Emulation (LISE) trade show in Kowloon last year.)

For vertical markets, the **Electronic Elevator** is an almost ideal image in terms of its familiarity to office workers, its established design, and the ease of drawing the array of circular icons. Here each Floor represents an applications program, so the user only needs to know where to get off. The Buttons repre-

senting each floor are selected by moving a cursor, which is imaginatively shaped like a finger.

Before desktop computers, CRTs were primarily instruments of escapist entertainment, and this traditional association can be exploited by software imagery to dramatize the Adventure of Data Processing (ADP). The icons create an **Electronic Jungle**, symbolizing the salient features of a typical business environment. The configurable cursor can be in the form of an Explorer, Adventuress, Apeman, Tribesman, or Field Representative, selectable by the user. The dense Foliage (paperwork) can be cleared away by the Machete (word processor), by Fire (the erase command), or by the other members of the Safari (electronic mail). Behind some of the bushes lurk dangerous Beasts (data files and creditors), who can be subdued by specialized software tools such as Cages (mass storage), Nets (spreadsheets), and Firearms (database-management software). To "bring 'em back alive," your Backpack (directory) has Cameras (graphics packages) and Tranquilizing Darts (report generators). A Witch Doctor version is available for medical applications.

A few readers may object that some of the metaphors proposed here are not worth implementing because the actual resemblance between the icons and the software functions that they symbolize is farfetched, arbitrary, obscure, ludicrous, or counterintuitive. Opinions of this sort reveal a literal-mindedness that should delight in the **Electronic Electronic Computer** (or EEC, as these are called in Europe). The on-screen image depicts a little Computer, complete with Keyboard, Screen, Disk Drives, Software, and Technical Manuals. The Cursor, controlled by a "bug," is in the form of a cursor. By using this to press the keys on the little Keyboard, programs can be invoked and systems commands given, just as on a real computer. Engineers, programmers, and other computer industry professionals who are already comfortable with pre-Lisa com-

puters are more likely than neophytes to prefer this iconography. Systems capable of concurrency can have several EECs on the physical screen at once, each running a program as a virtual console. Pressing the Help key on the Keyboard of the little Computer icon will cause an even smaller Computer to appear on the screen of the Computer icon, with helpful messages on the Screen of the Screen within a Screen. Systems with finite RAM are typically incapable of infinite regress.

Although most readers of this magazine tend to view the proliferation of computers with equanimity or approval and accept the computerization of the office as beneficial, others fear or mistrust the new technology and imagine that things were better in the good old days. Traditionalists may prefer iconography based on the metaphor of the **Low-Tech Electronic Stone Age (LESA)**, in which the cursor (called the Rock) is directed at targets representing different applications software functions. The Giant Parrot is a word processor; the Sabertooth Cat invokes accounting software; the Woolly Mammoth is a big spreadsheet; and the Cave provides both mass storage and walls on which graphics work can be performed. Figure 2 exhibits the Neanderthal version, set in a Pleistocene landscape. An Australopithecine version is designed for technological conservatives who absolutely dislike computers. The same icons appear as in the illustration, but instead of actually loading programs, their effect is to send guttural commands to coworkers who rank lower in the primate horde. While all this may seem like a clumsy metaphor, it provides more reassurance than a mere desk to those who long for the bygone days when typewriters ruled the earth.

All of these metaphors compare the computer to things from the present or past. Because computers seem to have more of a future than we do, shouldn't we compare them to things to come? In a few years, when today's adolescents take their

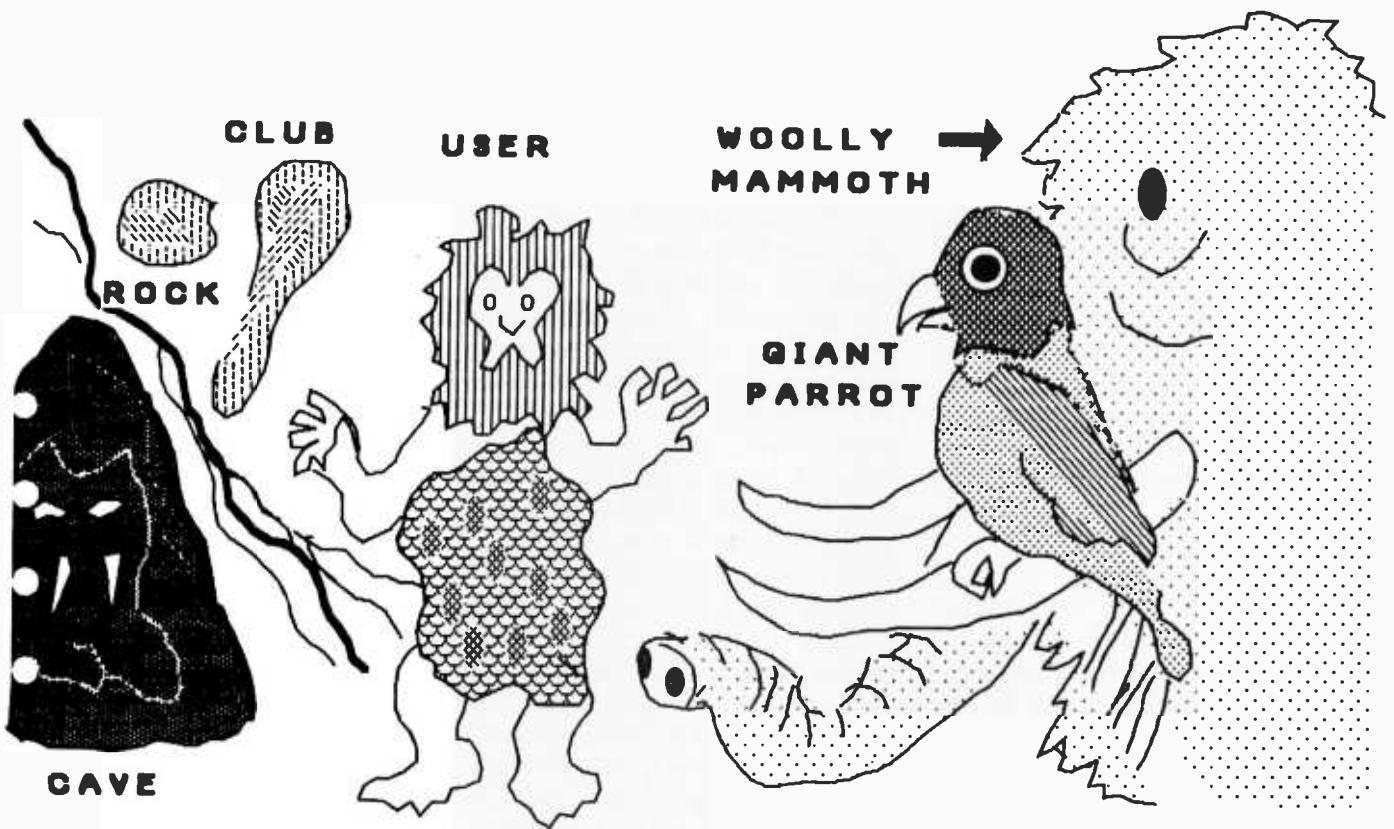

Figure 2: The low-tech electronic stone-age icons.

place in the office (or wherever they will work, if any of them ever get jobs), surely their arcade training will have prepared them not for the drawers and papers of our quaint desks, but for the joystick and fire button of a **Business Battlestation**, illustrated in Figure 3. The cursor is the crosshairs, and work tasks are shown as elements of the Enemy Fleet.

all, who would want to process data when it's more fun to blast it? This symbolism offers users a chance to use strategy, tactics, and advanced weapons against files and deadlines. This metaphor of combat may at first glance seem unbusinesslike, but it has long motivated lawyers, coaches, soldiers, cinema heroes, and other rugged individuals respected in our

culture. With a high-performance spacecraft and an arsenal of Phraser Beams (word processors), Debt Rays (accounting modules), Time Warp (scheduling utilities), and the like, these futuristic systems will quickly recover their development costs through the quarters inserted by their users.

Naturally, rather sophisticated soft-



Figure 3: The business battlestation icons.

ware will be required that can usefully process information by "blasting" it, but this is not the place to go into the tedious coding details of next-generation "smart" programs that can be used by operators who have no idea of what they are doing. Suffice it to say that these advanced routines will identify the user's problems and destroy them. Powerful icon-driven software that combines both operating systems and applications program functions may require great effort to develop, even if the iconography is borrowed from existing video games.

Conclusion

In this postindustrial age, computer literacy is already linked to economic survival. Our society may have no choice but to reallocate the resources that are now devoted to outmoded institutions like our educational system and instead to develop software that will minimize the skills necessary to operate a computer. Like the small mammals that ultimately displaced the dinosaurs, Lisa's mouse and visual imagery may be the first step toward of-

ice systems whose keyboard will devolve into something more simplified, like a light-switch, and whose screen icon will invoke a single program so versatile and so omniscient that it will not matter whether the user can remember anything.

A "friendly" computer is easier to imagine than to describe, but friendliness clearly has something to do with substituting symbols drawn from natural language and ordinary life in place of technical terms in the dialogue between user and computer. One celebrated attempt to make an advanced computer friendly is found in the icon-driven integrated software of Apple's Lisa, based upon the metaphor of a desk. Because desks as we currently know them will soon exist only in antique shops and Lisa manuals, this article has proposed a number of alternative metaphors that seem less subject to obsolescence. These seem more suitable for incorporating into school curricula or imitating in Hong Kong because they are based upon unchanging and eternal things: the kitchen, the tavern, the cave, the computer, and the flying saucer.

Readers who currently have or who

will soon have a Lisa can take advantage of any or all of these suggestions, at least regarding the names of the icons, because the Lisa software allows the user to replace the standard icon names with user-defined names, using the Lisa text-editing utility. If the metaphors recommended here or customized terms supplied by the user are substituted for the "electronic-desk" nomenclature, however, the printed manual provided by Apple may become less helpful. Readers who are currently developing integrated software packages for commercial distribution are invited to incorporate any or all of these suggestions into their iconography and documentation; we will regard as ample reward the satisfaction of advancing the state of the art, and a royalty fee that our lawyers can describe. ■

Tom Houston, Ph.D. (Gifford Computer Systems, POB 1917, San Leandro, CA 94577) is an educational psychologist and writer who has worked with small computers since 1976. Coauthor of the Gifford MP/M 8-16 User's Manual and of the Compupro Systems 816/A and 816/B User Guide, he edits the Gifford Observer, a multiuser CP/M and S-100 newsletter.

GTEK DEVELOPMENT HARDWARE/SOFTWARE

INC. (601) 467-8048

EPROM PROGRAMMER

Compatible w/all Rs 232 serial interface port * Auto select baud rate * With or without handshaking * Bidirectional Xon/Xoff and CTS/DTR supported * Read pin compatible ROMS * No personality modules * Intel, Motorola, MCS86, Hex formats * Split facility for 16 bit data paths * Read, program, formatted list commands * Interrupt driven, program and verify real time while sending data * Program single byte, block, or whole EPROM * Intelligent diagnostics discern bad and erasable EPROM * Verify erasure and compare commands * Busy light * Complete w/Textool zero insertion force socket and integral 120 VAC power (240 VAC/50Hz available)

DR Utility Package allows communication with 7128, 7228, and 7956 programmers from the CP/M command line. Source Code is provided. PGX utility package allows the same thing, but will also allow you to specify a range of addresses to send to the programmer. Verify, set the Eprom type.

MODEL 7316 PAL PROGRAMMER
Programs all series 20 PALS. Software included for compiling PAL source codes.

Software Available for CPM,¹ ISIS,²

TRSDOS,³ MSDOS.⁴

1. TM of Digital Research Corp.
2. TM of Intel Corp.
3. TM of Tandy Corp.
4. TM of Microsoft.

Post Office Box 289
Waveland, Mississippi 39576
(601)-467-8048

Avocet Cross Assemblers are available to handle 8748, 8751, Z8, 6502, 680X, etc. Available for CP/M and MSDOS computers. Order by processor type and specify kind of computer.

Model DE-4 U/V Products hold 8, 28 pin parts. High quality professional construction.

\$799 stand alone
MODEL 7956

MODEL 7956
GANG PROGRAMMER

Intelligent algorithm. Stand alone. copies eight EPROMS at a time. With RS-232 option \$999.

\$499
MODEL
7316

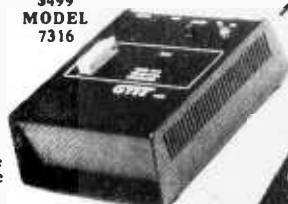

\$1195
MODEL
7324

MODEL 7324 PAL PROGRAMMER
Programs all series 20 & 24 PALS. Operates stand alone or via RS232.



\$499
MODEL
7228

MODEL 7228 EPROM PROGRAMMER
All features of Model 7128 plus Auto Select Baud, super fast adaptive programming algorithms. low profile aluminum enclosure. Programs 2764 in one minute!



\$389
MODEL
7128

MODEL 7128 EPROM PROGRAMMER
Programs and Read:

NMOS	NMOS	CMOS	EEPROM	MPU'S
2508	2758	27C16	5213	8748
2516	2716	27C32	5213H	8748H
2632	2732	C6716	X2816	8749H
2564	2732A	27C54	48016	8741
68766	2764		12816A	8742H
68764	27128			8741H
8755	27256			8751
5133				

Model 7128-L1,L2,L2A	\$209.00
Model 7128-24	\$289.00
DR8 or DR5	\$ 30.00
DR8PGX or DR5PGX	\$ 75.00
Cross Assemblers	\$200.00
XASM (for MSDOS)	\$250.00
U/V Eraser DE-4	\$ 78.00
RS232 Cables	\$ 30.00
8751 adapter	\$174.00
8755 adapter	\$135.00
48 Family adapter	\$ 98.00

SPECIAL
 California Computer's expandable single board micro featuring a Z80 CPU 64K 1 parallel, 2 serial ports-2 DSDD 8" floppys (2 meg) included Perfectwriter, Calc, Speller, Filer-Calcostar \$2650.

SPECIAL
 U.S. Robotics - Password 1200Baud-Autodial Virtually compatible with every Micro - 1 year warranty \$379.

ONLY AT MICROHOUSE
 Use our exclusive microcharge to finance all of your purchases.
 Call us!

FINANCIAL

Supercalc	\$119
Supercalc II	164
Visicalc	165
Visicalc Advanced	299
Visitrend/Plot	218
Desktop Plan	218
Visischedule	189
Multiplan	99
Calcostar	49
Home Accountant—Apple	395
Planstar	189
Scratchpad	259
Bottom Line Strategist	Call
Lotus	Call

WORD PROCESSING

Wordstar	\$269
Wordstar/Mallmerge	349
Wordstar/Mallmerge/Spellstar	444
Star Index	119
Final Word	185
Superwriter	169
Spellguard	119
Spellstar	139
Volkswriter	149
Multitool Word	269
Mallmerge	139
Visiword	269
Perfectwriter	239

IBM HARDWARE

Tandon 100-2	\$ 259
CCS 132 Columns	899
Quadboard 64K	295
Quadboard 256K	439
Quadcolor I	235
Microsoft Mouse	159
Datamac 19 Meg Int	2099

DATA BASE

dBase II	\$429
dBase II/dUtil	489
dUtil	68
Quickcode	199
Tim III	289
Datastar	169
Infostar	279
Alpha Data Base Manager II	209

COMMUNICATIONS

US Autodial	\$479
Password	379
Autolink 300	179
Hayes 1200 Band	544
Hayes Smartmodem	219
Micromodem II	299
Hayes Chronograph	199
Cross Talk	117

PRINTERS

Prowriter Parallel	\$ 399
Prowriter Serial	594
F-10	1259
Ribbons	Call
Grappler	125

PRINTER BUFFERS

16K Microfazer P-P	\$149
256K Microfazer P-P	649

FULL SERVICE AND SELECTION

SPECIAL
 Prices on Maxell Disks lifetime warranty
 MD1 \$28.95 MD2 \$40.95
 FD1 \$39.50 FD2 \$46.50
 In boxes of 10 each.

LANGUAGES

BASIC 80 Compiler	\$279
BASIC 80 Interpreter	249
MACRO 80	145
FORTRAN 80	269
COBOL 80	545
muLISP/muSTAR	144
muLISP/muSIMP	179
muMATH/muSTAR	189
C Compiler	249
PASCAL Compiler	439
Digital Pascal MT	489
Digital PLI	219
Supersoft ADA	219
Supersoft FORTH	129
RATFOR	79

We accept purchase orders VISA, MasterCard, American Express, COD's

CALL TOLL FREE
800-523-9511
 in Pennsylvania
 1-215-868-8219

MICROHOUSE

Prices subject to change without notice.

Dept. 100

See Software.

Dick is a programmer. Dick is bored. Harried. Overworked. Dick struggles with tedious trace chores and

debugging routines. Non-existent documentation. Hidden bugs. Dick is four months behind schedule as a result. And customers are angry when bugs slip through. They yell and make Dick upset. They make Dick's boss upset. Nobody is very happy.

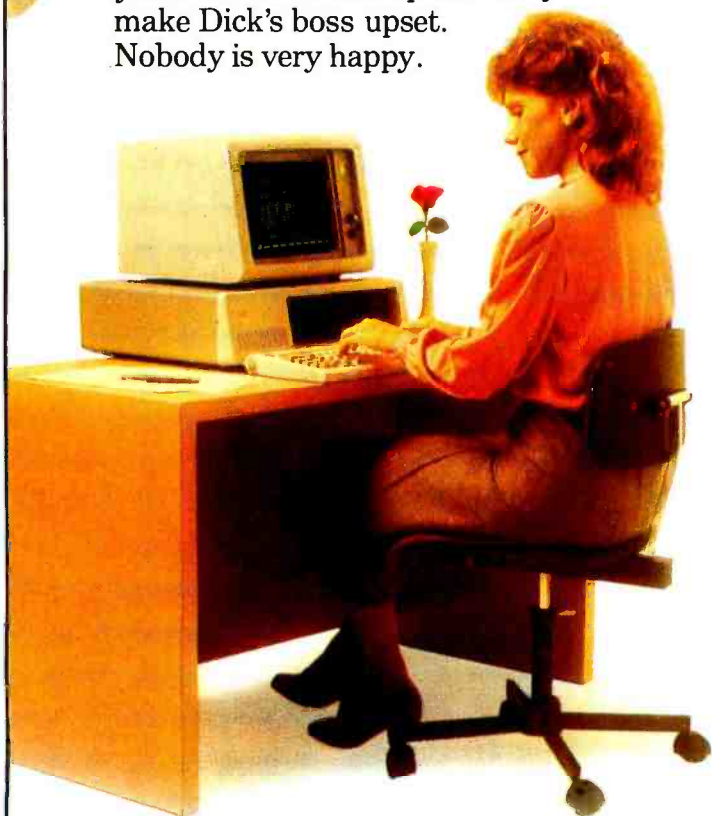

Dick dreams of a different sort of life. Where he's a programmer hero. Entertained by his work. Admired for his skill. Rewarded for his performance. Now his dreams can come true.

See Software Run.

Jane is a happy programmer. She uses ANIMATOR.[™] It's a unique Visual Programming[™] aid for Micro Focus COBOL. It runs on Jane's friendly microcomputer. It makes child's play of test and debugging tasks.

With ANIMATOR Jane sees a picture of the program explaining itself. In live action. In real time. In COBOL source code. As ANIMATOR displays the program listing, the cursor tracks the exact execution path. Including subroutine branches.

The view is precise. Compact. Unambiguous.

Jane can have the program run fast. Or slow. Or stop. All at the touch of a key. This makes it easy to spot problems. Insert fixes. Set breakpoints. Examine details. Instantly. Because of ANIMATOR's sophisticated debugging commands.

ANIMATOR gives Jane more freedom to innovate too. Her programs are best sellers. They're delivered on time. With no hidden bugs. Jane's boss likes this about Jane. Because he doesn't like customers to yell at him.

Run, Software, Run!

This software vendor just went public. Because he doubled productivity. Eliminated bugs. Cut costs. Compressed

development cycles. Produced terrific applications. Beat the competition to the market. And customers don't yell at him anymore. All thanks to ANIMATOR.

See ANIMATOR now.

Let ANIMATOR help speed your applications to market. ANIMATOR makes COBOL programs easy to comprehend. Fun to develop. A snap to maintain. Without the drudgery, you'll be happier. You'll do better work. In record time. This will make you richer. Faster. And your customers will stand up and cheer.



Write or call for a demo. Or detailed information. Right now.

MICRO FOCUS

2465 East Bayshore Road • Suite 400 • Palo Alto, California 94303 • (415) 856-4161

© 1983 Micro Focus Inc.

The New Interface Technology

An Introduction to Windows and Mice

The new computer systems will be easier to use and more productive than their predecessors

by Robert W. Warfield

A new breed of personal computer hardware and software is beginning to enter the marketplace. These systems will be both easier to use and more productive than their predecessors. People who are not computer experts will feel comfortable using these personal computers in their day-to-day work, and experienced users will make fewer errors.

This "new interface technology" encompasses developments in hardware and software that essentially reduce the number of things a user must remember in order to use a system effectively. On the hardware side, pointing devices such as mice, touchscreens, and high-resolution graphics displays simplify communication between the user and the system. The software offers integration, multiple windows, and commands issued by selection from menus using the pointing devices. The combination of these features ensures that the users can concentrate on how people work instead of on how computers work.

Examples of the new technology currently or soon to be on the market include hardware/software combinations such as Apple's Lisa and Hewlett-Packard's 150 and software such as Visicorp's Visi On and Microsoft's Windows.

History

How did all of this new technology come about? Much of the work can be attributed to Xerox PARC (Palo Alto Research Center) and its Learning Research Group (LRG). But the

seeds of the technology can be traced farther back to Douglas Englebart's work on using computers to augment human intelligence (reference 2). It was Englebart's group that first invented the now-familiar mouse and incorporated multiple windows into the design of text editors. Englebart's work is discussed in Ted Nelson's excellent book, *Computer Lib/Dream Machines* (Nelson is another visionary who has been discussing the new in-

terface technology since long before it was a reality on any computer).

The work at Xerox PARC began in 1971, when Alan Kay founded the Learning Research Group and initiated a project called Dynabook (reference 3). Dynabook was to have been a notebook-sized personal computer that anyone, even children, could use in day-to-day work and that everyone would want to use. The Xerox Alto personal computer (refer-

Video Pointing Devices: Enter the Touch Tablet

Popular video pointing devices include mice, touch tablets, joysticks, trackballs, touchscreens, light pens, and digitizing tablets. Of these, the mouse and the touch tablet are far superior for most video pointing needs. The mouse, virtually unknown a year ago, by now needs no explanation. The touch tablet as a pointing device is just beginning to be noticed.

Touch Tablets

Touch tablets are just emerging as viable pointing devices. The Koalapad touch tablet is one example. (Editor's note: Another example is the Powerpad from Chalk Board, Atlanta, Georgia.) The Koalapad is a hand-held touch tablet with a drawing surface that allows the movement of a finger to create pictures on video displays. Locations touched on the tablet's surface are converted into X,Y coordinates that are sent to a computer through a game port or a

digital interface. Game-port Koalapad touch tablets are analog devices and are comparatively inexpensive. The digital touchpad is more expensive and is compatible with any computer that will accept RS-232C inputs. The drawing area is pressure-sensitive; any blunt pointing device such as a finger or a retracted ball-point pen can be used.

Touch Tablets vs. Digitizing Tablets

A digitizing tablet is a flat panel that typically rests on a table top and produces accurate coordinate values for the location of a hand-held electrical stylus pressed against its surface. This has advantages and disadvantages in relation to touch tablets, which are actuated by touch rather than by special pens or styli. Touch sensing is an advantage in text editing, for example, when the typist must move a hand from the keyboard to manipulate a pointing device; the added step of picking up a stylus is a nuisance.

On the other hand, the digitizing tablet is superior to the touch tablet for the specialized application of digitizing drawings. Laying an arm or hand on the tablet

ence 14) was used to build a prototype Dynabook system.

Although hardware limitations prevented commercial production of Dynabook, many of the features of the new interface technology can be traced directly to the prototyping efforts behind it. One of the most important products to come out of the Dynabook project was the Smalltalk language (reference 5). From these efforts followed many others that expanded the basic concepts to make them usable in a general computing environment, including newer versions of Smalltalk that introduced overlapping windows, the Xerox Star workstation (reference 12), which introduced icons, and a number of similar projects conducted by the LISP community using personal computers that execute LISP as their machine language.

Hardware for the New Interface Technology

These systems are unique in their attempt to coordinate the design of hardware and software. Many of the

hardware features are predicated by the need to run more complex software while retaining an adequate level of system responsiveness. The systems use 16-bit processors (so far either the Intel 8088, found in the IBM PC and the HP 150, or the Motorola 68000, found in the Lisa). The integrated software requires at least 512K bytes of RAM and a half-megabyte of disk storage (often a Winchester hard disk).

Referring to these machines as microcomputers is misleading. Systems equipped with this much memory, a hard disk, and a 16-bit processor can approach the processing speed of modern minicomputers, since the personal computer need support only a single user.

The remaining hardware features, high-resolution bit-mapped graphics display and a pointing device, serve to increase the I/O (input/output) bandwidth. The high-resolution graphics display is important because it enables the computer to communicate information to the user far more efficiently than is possible with

text-only and low-resolution displays. The old adage about a picture being worth a thousand words is, if anything, too conservative an estimate of the value of these displays. Whenever possible, the new systems take advantage of graphics to enhance communication with the user. They provide constant visual feedback to help guide the user and enhance the overall quality of the system. It is possible to display text in different fonts and to space text proportionally just as it will appear when printed, a technique called "what you see is what you get." This means that the user will have to go through fewer edit-print iterations to produce a document that looks right.

The pointing device is the input counterpart of the graphics display. Without a pointing device, menus can become an endless series of delays for the user who already knows what he wants to do and how to do it. Of pointing devices that are widely available—among them mice, touchscreens, trackballs, joysticks, light pens, and graphics tablets—the

to steady the drawing finger would be fine for a digitizer but would activate a touch tablet at the wrong location.

Touch tablet linearity (guaranteed up to approximately 7 bits) is also inferior to that of digitizing tablets (typically guaranteed up to 11 bits). However, touch tablets can allow a single pixel to be selected by pointing on a video display with 10 bits (10,024 points) of resolution in each dimension. This is achieved with visual feedback, rocking the finger around the tablet surface. In other words, even though the absolute positional accuracy of touch-tablet sensing is only 99.0 percent (1 percent error) of the screen, the relative positional accuracy can be better than 99.9 percent (0.1 percent error). In the final analysis, touch sensing is adequate for most applications, including CAD/CAM (computer-aided design and manufacturing), where the visual feedback is sufficient to allow accurate pointing. For digitizing operations such as map tracing or graph tracing, the digitizing tablet is the better choice.

Touch Tablets vs. Mice

The mouse is a hand-held video pointing device with a sensor in the bottom to

detect motion over a flat surface. It has been adequately described in the many articles on the Apple Lisa computer (February 1983 BYTE). The mouse is the preferred pointing device for text-editing applications because it is the most comfortable to use and, with the exception of tablets, is also the fastest. (For a detailed analysis of the mouse's performance compared to other input methods, see reference 1.)

On the other side of the coin, the mouse is inferior to a tablet stylus or finger for drawing. Furthermore, the touch tablet is less expensive than the mouse and requires less desktop space. While most office-automation productivity tools in the near future probably will feature the mouse, I believe that the touch tablet will be the favorite on home computers and eventually will become an integral part of business systems.

Touch Tablets vs. Touchscreens

A touchscreen is essentially a touch tablet made of transparent material mounted in front of a video display. (Editor's note: The HP 150 uses an optical touchscreen. See October 1983 BYTE.) Touchscreens are primarily valuable for information retrieval from computers in public places where any

one particular user does not enter frequent queries. A user's pointing arm will tire with prolonged use of touchscreens. Furthermore, a finger obscures small detail (such as text) when pointing. Being too close to video displays for prolonged periods may create problems in terms of eyestrain and screen radiation.

Touch Tablets vs. Joysticks, Light Pens, Etc.

Joysticks and trackballs have been investigated as alternatives to the mouse and the touch tablet. Their speed of locating a randomly placed target on a video display is inferior to the mouse's (reference 1). Although joysticks are the least expensive of all video pointing devices, they are inadequate for drawing and rapid pointing.

Light pens are potentially as inexpensive as touch tablets, but they have the same drawbacks as touchscreens: user fatigue and proximity to video display, and obscuring detail when in use.

In summary, I believe that touch tablets have some real advantages, in performance and cost, over other video pointing devices for many applications.

—George M. White

mouse is the preferred one. (See "Video Pointing Devices: Enter the Touch Tablet" on page 218.)

Mice have been compared with several other types of pointing devices (reference 1) and have proven superior to other methods with one exception: a skilled touch-typist could do slightly better with control sequences. Mice are cheaper to manufacture than most of the other devices as well. Mice are high-resolution devices; it is possible to point to a single pixel on a high-resolution screen. I've done it often on a 1024-by-800-pixel screen—try that with a joystick or trackball! Also, a mouse stays put if you take your hand off it, an important property when you're constantly alternating between a pointing device and the keyboard.

Software for the New Interface Technology

The most important and revolutionary aspect of the new interface

technology is the software. It is possible to produce many types of systems with the hardware just mentioned that do not qualify as the new technology. There are three obvious components of this special software from the user's point of view: multiple overlapping windows, commands issued by selection from menus using the pointing device, and applications programs that can communicate information to other programs simply and consistently. Subsets of these features have been available in older products, but the whole package is more effective than any of the parts.

The use of windows and pointing devices is central to all of the new systems and is the most obvious improvement over older systems. When the system is in operation, the screen represents a workspace, often viewed as a desktop, and may be filled with several rectangular regions or "windows." (See "The Desktop Metaphor.") Usually, a single program is

associated with each window, and it is through its window that a program communicates with the user.

The Lisa system represents system objects, such as files, in picture symbols or "icons." The idea behind icons is similar to the idea behind pictorial road signs: to convey maximum information in minimum time. Icons are one reason high-resolution graphics capabilities are important. Systems with screen resolutions inadequate to display icons make do with small boxes containing text.

Located somewhere on the screen at all times is a cursor that is linked to the pointing device. When the user moves the mouse, for example, the cursor moves proportionately. This cursor represents the focus of attention for the user. It may be in the form of an arrow that can point to a precise point of the screen. All input to the system takes place near the tip of the arrow, which is the cursor's "hot-spot."

The Desktop Metaphor

A revolution is occurring in computing. It is based on techniques for controlling computers by pointing to video symbols instead of typing commands on keyboards. It has given rise to the "desktop metaphor," which will characterize user interaction with business computers in the future.

The desktop metaphor refers to symbols on computer displays that represent office equipment. These symbols are not passive pictures but are typically used to control computer simulations of activities performed at a desk. The desk is presumed to be equipped with a telephone, file folders, paper pads, wastebaskets, and so on. The video symbols of these desktop accessories are called "icons." Icons are computationally empowered to simulate the real objects they represent. They are activated when the user points to them with nonkeyboard video pointing devices. An activated icon performs a computational task. For example, pointing to a picture of a sheet of paper and then to a picture of a wastebasket indicates that you want the sheet of paper thrown away (or removed from the screen by the computer).

In general, you can create, send, file,

and/or discard messages, graphs, charts, electronic mail, and other documents on the computer by simply pointing to icons. The computer user no longer needs to be an expert to accomplish these tasks. Indeed, the user can rely on the shape and spatial arrangement of icons to provide clear and intuitive hints on their functions.

The intuitive nature of icons is no accident; it is the central point of the desktop metaphor. The user's knowledge of real-world desk equipment is designed to create analogies that carry over into the symbolic world of computer icons.

The desktop metaphor is actually a special case of a more general principle, the "physical metaphor" of computing, which was the brainchild of Alan Kay. Dr. Kay in this regard is the intellectual father of Xerox Star and Apple Lisa, which make extensive use of icons. His idea was that computers would be easier to learn to use if computer programs acted more like physical objects than like mathematical abstractions. People have good intuitions regarding physical objects. This intuition would help them to understand computers if computers were to exhibit similar properties.

In these systems the user might find overlapping sheets of paper symbolically displayed and might properly deduce that

he can see obscured pages by moving the uppermost pages. This certainly makes the storage and retrieval of text files more comprehensible than an admonition to type something like "LOAD FILENAME.EXT".

The degree to which the "physical metaphor" signals a fundamental advance for man-machine communication may not be obvious. To fully appreciate the metaphor, consider that controlling a computer by typing text on a keyboard involves different mental skills and different parts of the brain than are required for drawing pictures or pointing to icons. Visual thinking takes place in the right hemisphere of the brain, while verbal thinking takes place in the left hemisphere of the brain (assuming normal dominance). When the average western thinker communicates with phonetic language, he uses primarily his left cerebral cortex. This is also the part of the brain that dominates during keyboard text communication with computers. The right hemisphere of the brain, on the other hand, is involved more with visual thinking and is believed to be the source of artistic and creative thought. Perhaps even more important is the fact that spatial and visual information is easier to memorize than verbal/textual information.

—George M. White

IF YOUR DATA'S WORTH REMEMBERING, IT'S WORTH PROTECTING.



POWERMAKER® MICRO UPS

A split-second blackout or a sudden voltage sag can shut down your small business computer, completely wiping out critical data. Inventories, payrolls, receivables — whatever is in the memory may be lost instantly.

Although this type of data is just as important to a small business as it is to a large corporation, blackout protection has always been far too costly for small business applications. But now there is the Powermaker Micro UPS, an inexpensive standby power source specifically designed for small business computers.

This new rechargeable power system provides up to 35 minutes of steady sine-wave power, enabling even the most sensitive small computers to ride through blackouts and voltage sags completely unaffected.

Why sine-wave power? Because square-wave power impairs the performance of many printers, viewing screens and timing circuits. A Powermaker Micro UPS produces a sine wave that exactly matches the waveshape of

commercial power, ensuring compatibility with any computer system.

In addition to providing highly reliable blackout and brownout protection, a Powermaker system also protects against electrical noise, one of the major causes of computer errors and component malfunction. A Powermaker UPS is portable, completely automatic, maintenance free and plugs into any standard 120V outlet.

No matter how small your computer, your data is worth remembering. Protect it with an affordable Powermaker Micro UPS.

For complete information about the new Powermaker Micro UPS from Topaz, please fill out this coupon or call us.

As displayed at COMDEX
Booth #372.

TOPAZ®
SQUARE D COMPANY

Circle 432 on inquiry card.

**TOPAZ; 9192 TOPAZ WAY
SAN DIEGO, CA 92123-1165
PHONE: (619) 279-0831
TWX: (910) 335-1526**

- Please send me complete information about Powermaker® Micro UPS.
 Please have a representative call me.

Name _____

Title _____

Company _____

Address _____

City _____ State _____

Zip _____ Phone _____

A WHIZ of a Switch

RS-232 Transfer Switch lets you switch your computer between printers, modems, terminals, any RS-232 peripherals. No plugging and unplugging cables. Like having extra ports. Choice of 8 models.



Pictured: MFJ-1240
1 In-2 out
7x2x6 in.

\$ 79⁹⁵

Exclusive features:

- LEDs monitors data lines • Data lines spike/surge protected
- Switch reverses transmit-receive lines

These multi-function RS-232 transfer switches let you switch between peripherals, test for data and line failure, protect data lines and use as null modem for less cost than a switch alone.

Switches 10 lines (2, 3, 4, 5, 6, 8, 11, 15, 17, 20). LED data/line indicators monitor lines 2, 3, 4, 5, 6, 8, 20. Metal oxide varistors protect data lines 2, 3, 7 from voltage spikes and surges. Push button reverses transmit-receive lines. PC board eliminates wiring, crosstalk, line interference.

CHOOSE FROM 8 MODELS

- MFJ-1240, \$79.95, 1 input - 2 outputs.
- MFJ-1241, \$99.95, 2 inputs - 2 outputs.
- MFJ-1242, \$119.95, 2 inputs - 3 outputs.
- MFJ-1243, \$119.95, 1 input - 4 outputs.
- MFJ-1244, \$139.95, 3 inputs - 3 outputs.
- MFJ-1245, \$169.95, 3 inputs - 5 outputs.

- MFJ-1246, \$199.95, 5 inputs - 5 outputs.
- MFJ-1247, \$99.95, 1 in-2 out (switches 20 lines)
Order from MFJ and try it. If not delighted, return within 30 days for refund (less shipping).
One year conditional guarantee.

Order yours today. Call toll free 800-647-1800. Charge VISA, MC or mail check, money order for amount indicated plus \$4.00 each shipping.

CALL TOLL FREE ... 800-647-1800

Call 601-323-5869 in Miss., outside continental USA, tech/repair info. Telex 53-4590 MFJ STKV.

Write or Call for **FREE Catalog**

MFJ ENTERPRISES INCORPORATED

921 Louisville Rd., Starkville, MS 39759

Texas Instruments Model 850... the new American-made printer that beats the imports on price, performance and compatibility.

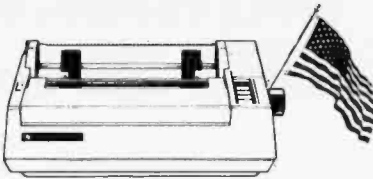

Buy, lease or rent the new TI 850 desktop printer from MTI.

150 cps, 9x9 dot matrix, both bit image and mosaic graphics with better resolution, easier font-changing, both parallel and RS232 interfaces standard. These are just a few of the features of the new TI Model 850. Truly a sensational printer designed to be compatible with your desktop personal computer.

MTI is an authorized distributor of Texas Instruments' full line of portable terminals, matrix printers and Professional Computers. Whether you buy, lease or rent our equipment, you'll find MTI is the one source for all the terminals, peripherals, systems, applications expertise and service you'll ever need. Priced right. Call us.

New York: 516/621-6200, 212/767-0677, 518/449-5959
Outside N.Y.S.: 800/645-6530
New Jersey: 201/227-5552
Ohio: 216/464-6688

"QED" Discounts
VISA & MasterCard



AUTHORIZED DISTRIBUTOR
TEXAS INSTRUMENTS
Data Systems Group

Applications Specialists & Distributors, New York, New Jersey and Ohio. DEC, Intel, Lear Siegler, Texas Instruments, Dataproducts, Diablo, 3Com, Hazeltine, Racal-Vadic, Digital Engineering, MICOM, Cipher, U.S.Design, Protocol Computers, MicroPro, Microsoft, Polygon and Select.

The cursor facilitates selection and insertion. The chosen object, be it a command from the menu, an icon, a fragment of text, or a graphic image, is easy to reach quickly. It can then be set apart (highlighted) and manipulated. Highlighting the selected object provides important visual feedback, a feature often overlooked in conventional interface design. Without feedback, it is impossible to tell whether the system has responded to the user's request, so the user may repeat the command in an effort to be sure the machine understands. This is undesirable, particularly in systems that have type-ahead buffers.

The mouse can conveniently accomplish a couple of other operations. For example, it can drag textual and graphical objects about the screen to achieve a desired arrangement. Some systems provide "knobs" and "levers" with which to control the objects on the screen. In Lisa, windows scroll when the cursor drags small "elevators" along the edges of the window.

Another mouse application is called "rubber-band graphics." An example is the rubber-band window, where one corner of the window remains fixed and the diagonally opposite corner is tied to the mouse cursor. The window remains rectangular, but the lengths of its sides are varied by dragging the corner around on the screen, which stretches the window (hence the name rubber-band). The visual effect associated with this operation is quite impressive and one of the more pleasing aspects of the system. The same technique may be used in graphical drawing programs where lines, curves, and other graphical objects can be stretched or moved in rubber-band fashion.

Menus in these systems typically present only the options that are useful for the job at hand and avoid confusing the user with massive, largely irrelevant lists of possibilities. Because of this, menus are usually kept short and invalid selections cannot be made.

A valuable software capability found in the new systems is the ability to transfer data easily between two

100 MHz scope, counter, timer, multimeter: All one integrated system.

100 MHz dual time base scope. 3.5 ns risetime; sweeps from 0.5 s to 5 ns/div; alternate sweep; $\pm 2\%$ vertical/horizontal accuracy; vertical sensitivity to 2 mV/div @ 90 MHz.

9-digit fluorescent display. Digitally accurate readouts accompany the CRT waveform. Error messages and prompts also appear on the display.

Dc volts and ac coupled true RMS volts. Measured through the Ch 1 scope input.

Gated measurements. Use the scope's intensified marker to measure frequency, period, width and to count events within specified portions of the signal.

Auto-ranged, auto-averaged counter/timer. Frequency, period, width, delay time, Δ -time, plus totalize to more than 8 million events—with 7 digits plus exponent displayed.

Auto-ranged DMM. Use floating DMM side inputs with up to 5000-count resolution. Get precise readouts of average dc and true RMS voltage. Measure resistance from milliohms to gigohms.

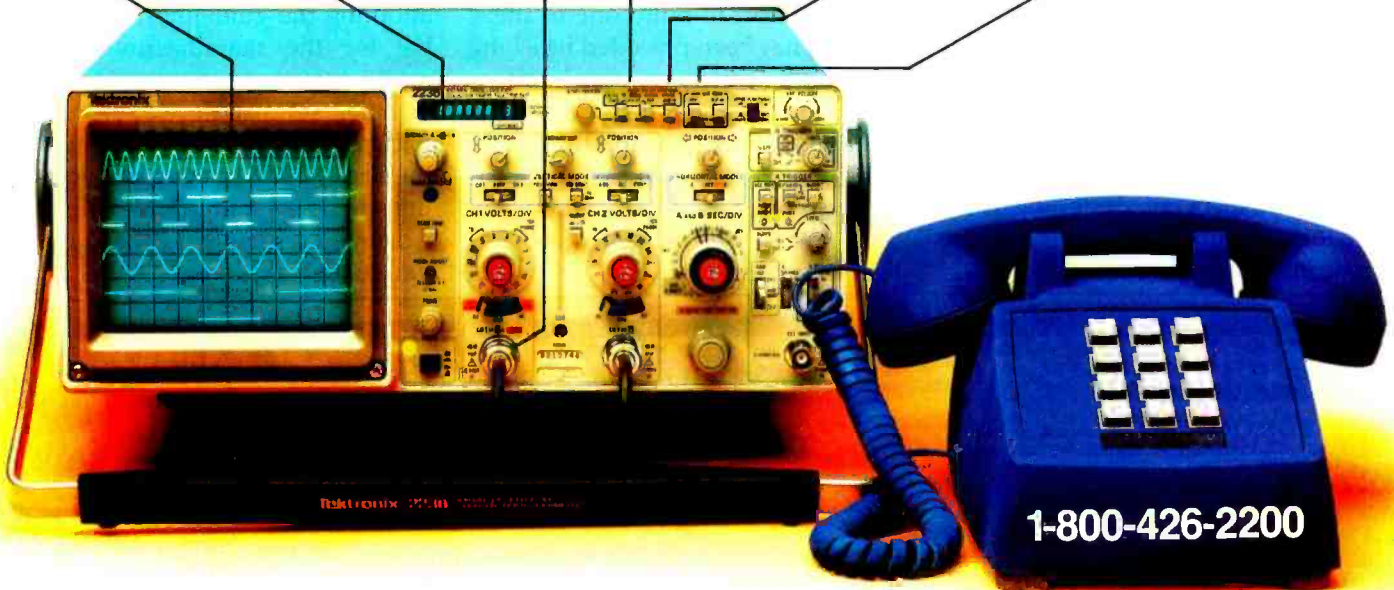

Now make measurements faster, easier, with greater accuracy and user confidence. The Tek 2236 makes gated counter measurements, temperature, time, frequency, resistance and voltage measurements pushbutton easy. You see results concurrently on the 9-digit numeric readout and CRT display.

Its complete trigger system includes pushbutton trigger view, plus peak-to-peak auto, TV line, TV field, single sweep and normal modes.

At just \$2650*, the 2236 includes the industry's first 3-year warranty on all parts and labor, including the CRT.

Integrated measurement system. 3-year warranty. 15-day return policy. And expert advice. One free call gets it all! You can order, or obtain literature, through the Tek National Marketing Center. Technical personnel, expert in scope applications, can answer your questions and expedite delivery. Direct orders include operating and

service manuals and worldwide service back-up.

**Call toll-free:
1-800-426-2200,
Extension 110.**

In Oregon, call collect:
(503) 627-9000, Ext. 110.
Or write Tektronix, Inc.
P.O. Box 1700
Beaverton, OR 97075

Tektronix®
COMMITTED TO EXCELLENCE

applications programs. This enables the user to view the programs as a set of tools with which to manipulate data. It doesn't make sense to have to use one sort of "cut" command with a text editor and another with a graphics package.

To make these applications programs compatible with one another, it is necessary to adopt a uniform means of transferring data between them. One may view the exchange of data as occurring between two windows, each window containing a program. Any information that passes beyond the confines of a window is controlled by the desktop-manager program (whose "window" is the gray desktop area under the windows), which sees to it that the transfer between two windows is always accomplished in the same way.

Providing the ability to exchange information among different programs in this way is one of the most difficult aspects of designing these systems. To underscore this difficulty, consider that in both Lisa and Visi

On, the initial offering does not support the complete transfer of information between any two programs. However, both companies claim that their products will eventually be able to support this kind of operation.

Psychology and Philosophy of the New Software

A great number of design decisions in the development of the new software were made on the basis of a few philosophical tenets. Many of these tenets were first analyzed in the design of the Smalltalk system (see "The Smalltalk Environment" by Larry Tesler, August 1981 BYTE, page 90, for a good description of these) and were later refined in the Xerox Star project.

Every effort to build one of these systems has been preceded by a long period in which a user-interface definition was hammered out. This definition specifies the allowable behavior of the system. All programs that run on the system are expected to conform to these guidelines. At least four reasons exist for proceeding

in this way.

First, by limiting the number of ways in which a program can interact with the user and forcing all programs to obey these rules, the user has less to remember when learning and using the system.

Second, a good deal of effort can be spent in choosing the best forms of interaction and in insisting that all programs use them. This is where most of the philosophical tenets come into play.

Third, the programs necessary to do the graphical manipulations and manage the mouse are very complex. Often, they have to be written in assembly language to achieve adequate performance (this was the case with both Lisa and Visi On). By adopting the guidelines, it is possible for the manufacturer of the original software to provide these facilities so that developers of applications won't have to. Considering the size of Lisa's desktop manager—10 megabytes of source code—this is a worthwhile savings to the software developer.

IBM PC-8087 SUPPORT FROM MICROWARE

87FORTRAN/RTOS™ is a MicroWare adaptation of the Intel Fortran-86 compiler, a full ANSI-77 subset with 8087 extensions and overlays. It generates in line 8087 code allowing use of all 8087 data types, including 80 bit reals and 64 bit integers. The complete subset I/O is supported including Internal and External Files and List Directed I/O. 87FORTRAN/RTOS uses the Intel large memory model, allowing data/code structures which utilize the full megabyte. The compiler provides direct access to 8088 ports and supports logical operations on 8 and 16 bit operands normally treated in assembly language. It is ideal for large applications which are number intensive or control hardware.

87PASCAL/RTOS™ is Intel's ISO-Standard Pascal with 8087-8088 exceptions. These make it possible to use all the 8087 data types directly, while generating modules in one of the three Intel Memory Models.

87FORTRAN/RTOS and **87PASCAL/RTOS** include RTOS and support for one year. each \$1350

PC TECH JOURNAL REVIEW: "The MicroWare package is preferable . . . it executes the basic operations more rapidly and MicroWare provides a free update service."

87BASIC™ includes patches to the IBM Basic Compiler and both runtime libraries for USER TRANSPARENT and COMPLETE 8087 support. Provides super fast performance for all numeric operations including trigonometrics, transcendental, addition, subtraction, multiplication, and division. \$150

87MACRO™ - our complete 8087 software development package. It contains a "Pre-processor" which converts 8087 instructions into 8088 escape codes, source code for a set of 8087 macros, and an object library of 8087 functions which include transcendental, trigonometrics, hyperbolics, encoding, decoding and conversions. \$150

PLM-86 with RTOS \$1100

MICROWARE BEST SELLERS!

8087-3 CHIP in stock with 180 day warranty and 8088 exchange \$223

FASTPAK™+8087 includes one runtime library (87BASIC or 87MACRO), the 8087 chip, the 87/88GUIDE, and installation instructions \$375

MATRIXPAK™ manages a **MEGABYTE!** Written in assembly language, our runtime package accurately manipulates large matrices at very fast speeds. Includes matrix inversion and the solution of simultaneous linear equations. Callable from MS Fortran 3.13, MS Pascal 3.13, SSS Fortran, and MicroWare 87MACRO, 87BASIC, and RTOS compilers each \$150

87/88GUIDE - an excellent tutorial on writing 8087 code and interfacing it with compilers. Full of code that runs! \$30

MICROSOFT FORTRAN 3.13
MICROSOFT PASCAL 3.13 These new IEEE compatible compilers support both double precision and the 8087. each \$289

MICROSOFT C COMPILER includes Lattice C and the MS Librarian. \$399

64K RAM Upgrade	59
SuperSoft Fortran	340
SSS 8087 Support	50
SuperSoft Voice Drive	895
87BASIC+	75
TRACE86 Utility	125
Microsoft Business Basic Compiler	495
Computer Innovations C86	345
STSC APL★PLUS/PC	545
HALO Graphics	call
Energraphics	call
Sandstar products	call

RTOS™ — Real Time Multi-Tasking Operating System
RTOS is a MicroWare configured version of iRMX-86, Intel's legendary operating system. It includes the Intel Assembler, ASM-86, which supports the 8086, 8087, 8088 and 80186. All modules produced by the compilers or ASM-86 are combined, loaded and managed with the Utilities LINK-86, LOC-86 and LIB-86. These products make it possible to load modules anywhere in RAM, and resolve external references between runtime modules. Overlays with a single root job are supported by the linker. RTOS/ASM-86/LINK-86/LOC-86/LIB-86 \$600
iRMX-86, LINK-86, ASM-86, LOC-86 and LIB-86 are trademarks of Intel Corp. IBM PC is a trademark of IBM Corp.

Micro Ware
P.O. Box 79
Kingston, MA
02364
(617) 746-7341

You Can Talk To Us!

Software Automation, Inc. Quietly Introduces

SALVO™. The Most Revolutionary New
Product For The Micro Since dBase II™.

Look For Yourself.

Anatomy of a Language

Fourth Generation Language

Most profound step forward since the invention of programming.

Report Generator

Flexible method of extracting data.

Powerful Language Command Set

Eclipses any third generation language.



True Relational DBMS

Links up to 16 files at once.

Query Facility

Natural communications capability.

Expert Command Assistant

Provides automatic navigation through the data base.

With SALVO, unlock the total potential of your personal computer. Easy to use. Easy to learn. Create applications in 1/10 the time compared to COBOL or BASIC. Reduce dBase II™ type work by 50% or more. A new natural fourth generation

language that rivals sophisticated mainframe packages. At a fraction of the cost. How? Send for our free brochure. Available now at your local computer store, or contact us directly.

It Knows How.

14333 Proton Road, Dallas, Texas 75234
(214) 392-2802

The fourth reason is that a precise specification for all interaction makes it easier to control the transfer of data among applications programs, which is one of the most difficult problems in designing such a system.

The philosophical tenets of these systems are very similar and revolve around the concept of consistency. The idea is that data objects that are manipulated by computers can be thought of in the same way we think of real physical objects. There are two components when describing any operation on an object: the subject, which is the object itself or some reference to it, and the verb, which is the action to be performed on the object. Just as in the real world, where the same verb may be applied to many different subjects, so too can the same action be applied to different data objects in the system.

Moving an object to a different window can be accomplished in the same way for a sentence, a graphic image, or a block of numbers from a spreadsheet. First the object is selected, then the verb "cut" is sent to the object, cutting it out of the window it currently lives in. Next, a new location for the object is selected with the mouse, and the verb "paste" is sent. At no time does the user have to worry about whether the object being moved is text, graphics, or spreadsheet numbers. Of course, the program underneath this user inter-

face has to be much more complex than a program with a separate kind of command for each type of object—it deals with many kinds of objects that can be "cut" and "pasted." Object-oriented languages like Smalltalk work particularly well for this kind of programming.

Simplicity is a component related to consistency. By using "point and click syntax," in which the user points to an object with the cursor and "clicks" (pushes a button on the

The new technology makes it possible to specify complex behavior in a simple consistent fashion.

mouse or lifts a finger from a touch-screen) to select it, it is possible to specify very complex types of behavior in a simple, consistent fashion. A system should be designed so that it is intuitive; when a user needs to do something he has never done before, he should be able to tell how to get started.

What Is to Be Gained from All of This New Technology?

So far, there has been a lot of talk about pretty graphics and philosophy, but what is to be gained from using one of these systems? The

answer to that question is simple: these systems will be easier to use, and the users of such a system will be more productive. Many people writing about this technology have the idea that these systems are primarily of use to novices. This is most emphatically wrong!

The Smalltalk system is in fact unavailable to this class of users (so far) and is used primarily by experts in preference to other systems. The same is true for similar systems developed by the LISP community. All of these systems are designed with a great deal of testing to determine what types of interaction are best for the user. While the emphasis is on testing with naive users, a great deal of testing with experts is also conducted. Arguments against their utility for experts center around two topics: it is inconvenient to switch back and forth between mouse and keyboard, and the new software is slower than the old-style software.

The argument against mice is wrong for three reasons. First, testing has shown that only a good touch-typist using control sequences can do better than a mouse (and most computer users aren't that good). Second, the systems incorporate keyboard control sequences as alternatives. Third, many people who have used such a system long enough to become proficient at it find they use the mouse far more than the keyboard.

We have developed an 8" diskette system that can be used to exchange source, data, and text files between the IBM PC and hundreds of other systems.

Our utilities work with all IBM models including the 3741, 5110, 8100, Series/1, System/34-36-38, 36XX, 43XX, etc. We also support the IBM DATAMASTER and the IBM DISPLAYWRITER using TEXTPACK or REPORTPACK. Other systems supported include CP/M, DEC, NCR, Univac, Radio-Shack, Xerox, Data General, Burroughs, and Honeywell.

Our system uses DOS 2.0 and can be used with either the PC or XT. Using our supplied device drivers, the 8" diskette can be used as a 1.2 MBYTE DOS drive for large data files or for backing-up the hard disk drive. The programs can read-write diskettes that are 1 or 2 sided, single or double density, and with sector sizes of 128, 256, 512, or 1024. EBCDIC-ASCII conversion is provided.

System price including Mitsubishi M2896 drive, controller card, cable, and software is \$1395. Software alone is \$695. Controller card and cable is \$195. Dealer discounts are available.



"THE FILE CONNECTION" 8" DISKETTE SYSTEM FLAGSTAFF ENGINEERING

2820 W. DARLEEN / FLAGSTAFF, AZ 86001
(602) 774-5188 TELEX 705609

The speed argument is true in part. The new programs can be slower than the old, but this does not have to be true if they are carefully written and optimized. Furthermore, many of the operations that are slow on the new systems are not even possible on the old systems. Certainly the delays I have encountered on the Lisa should not be irritating to the user of a CP/M system with floppy disks or, for that matter, a user of a Vax 750 Unix system with 10 or more users.

After having used several types of computer systems to do large programming projects, I have formulated my own theory about the usefulness of the new interface technology. When you become proficient at any system, you begin to think less and less about what command to use for a particular situation. A sort of subconscious level of thought processes handles this task. You simply think to yourself, "I need to go compile this program," and your fingers type the necessary commands with little conscious effort. Meanwhile, your mind is busy considering what the results of the compile will be. Unfortunately, my fingers are prone to making errors on most systems. When this happens, my stream of conscious thought is rudely interrupted by the realization that the system is not doing what I wanted it to, and I have to stop and figure out what went wrong.

Often this unpleasant sequence of events occurs not because of any typographical error; my fingers had typed a perfectly valid command. It's just that the particular mode I was in did not understand how to deal with the command. One system I use, for example, offers six different ways to accomplish an exit, depending on the mode. It's not surprising that I often type some exit sequence and find I'm in the wrong mode for it to work or, worse yet, that the sequence does something totally unexpected.

The new interface technology makes "exit" a generic verb that can be executed in the same way for every program. This is analogous to the behavior of the physical universe, which is governed by a small set of

WANTED!

**FOR LUCRATIVE MARKET OPPORTUNITIES
YOUR NEW PRODUCTS,
HARDWARE DESIGNS, PROTOTYPES**

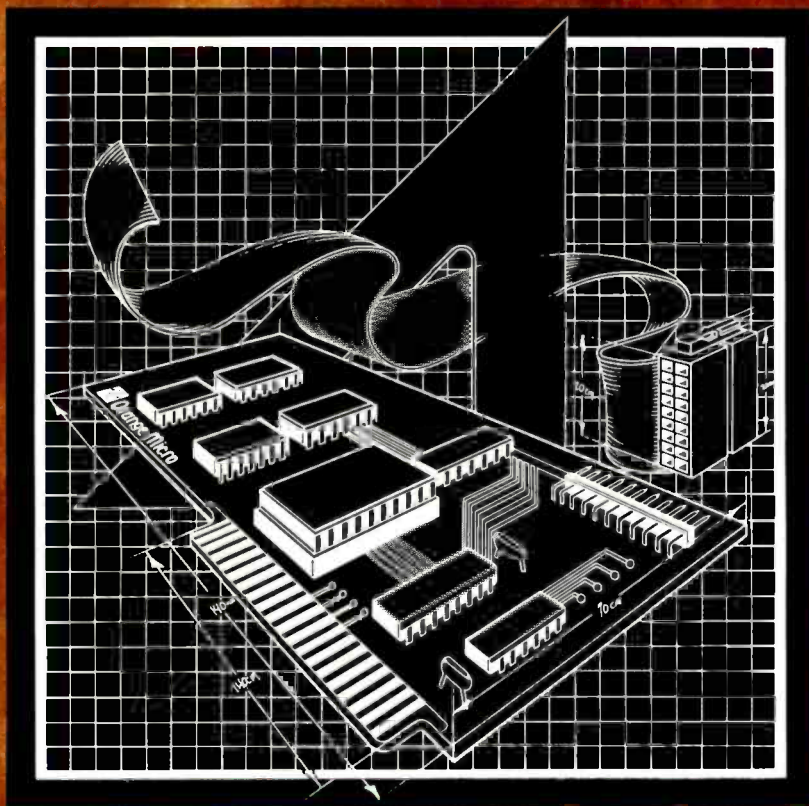

REWARD:

Orange Micro has a history of success in bringing new and innovative products to market. If you've developed an innovative computer peripheral or circuit board, don't let it die; bring it to us. We have the capital and marketing know-how needed to make your innovation a successful and profitable product. We have an industry proven track record. Consider our Grappler + the world's #1-selling Apple® printer interface.

The skills that have made

Grappler + the industry standard can make a winner of your product too.

We are seeking hardware-based peripheral products that are into the design stage and directed at the Micro Computer Market. If you have developed such a product and need a team of experts to bring it to market, we want to hear from you.

Royalties, license fees or outright purchases are negotiable.

All replies are treated confidentially and proprietary interests respected.



See us at Comdex Booth #2581.

© Orange Micro, Inc. 1983

Attn: George Reif
Orange Micro, Inc.
1400 North Lakeview Avenue
Anaheim, CA 92807
(714) 773-2772

Apple is a registered trademark of Apple Computer, Inc.

DIAMOND DELIVERS!

Visi On \$ call
 Multiplan \$159
 Quadlink \$499
 Volkswriter Dix \$179
 dBase II \$ call
 Infostar \$259
 Wordstar \$245
 Multitool Word \$269
 Wordstar/Mailmerge/Spellstar/Star Index \$379

	LIST	OUR PRICE		LIST	OUR PRICE
Micropro [®]	\$250	\$135	Lifetree [®]	\$250	\$169
MAILMERGE	\$250	\$135	VOLKSWRITER	\$375	\$279
SPELLSTAR	\$645	\$339	Visicorp [®]	\$300	\$199
WORDSTAR/MAILMERGE	\$195	\$99	VISICALC IV	\$300	\$205
STARBURST	\$195	\$99	VISIWORD	\$300	\$205
SUPERSORT II			VISIFILE	\$650	\$399
			VISITREND/PLOT		
			VISISCHEDULE		
Sorcim [®]	\$195	\$129	Condor [®]	\$425	\$329
SUPERCALC	\$295	\$169	CONDOR 20-3	\$500	\$359
SUPERCALC 2	\$295	\$169	Supersoft [®]		
SUPERWRITER			FORTRAN	\$350	\$259
Ashton-Tate [®]	\$700	\$199	C COMPILER	\$400	\$145
dBASE-II	\$295	\$199	Digital Research [®]	\$200	\$155
FRIDAY			CONCURRENT CP/M 86	\$200	\$215
			PASCAL MT + 86	\$300	\$279
Fox & Geller [®]	\$295	\$199	C BASIC 86	\$400	\$99
QUICKCODE	\$99	\$199	SPP	\$150	\$359
dUTL	\$295	\$239	ACCESS MANAGER	\$500	\$44
dGRAPH	\$495	\$239	DISPLAY MANAGER	\$60	
Lexisoft [®]			C BASIC		
SPELLBINDER	\$345	\$249	CB 80		
Microsoft [®]	\$195	\$139	CP/M 86	\$495	\$325
SOFTCARD			Softword Systems [®]		
MOUSE	\$495	\$329	MULTIMATE	\$295	\$225
MULTITOOl WORD	\$100	\$69	Quadram [®]	\$395	\$279
W/MOUSE	\$150	\$109	QUADCOLOR	\$595	\$425
MULTITOOl FINANCIAL	\$350	\$249	64K EXPANDABLE BOARD		
MULTITOOl BUDGET	\$350	\$249	256K	\$499	\$355
PASCAL	\$500	\$349	Hercules [®]		
FORTRAN	\$350	\$269	GRAPHICS CARD	\$395	\$279
C COMPILER	\$395	\$289	Ast [®]		\$ call
BASIC 80	\$645	\$409	6 PAK PLUS-64K		
BASIC COMPILER	\$695	\$459	ALL OTHER BOARDS		
SOFTCARD PLUS	\$495	\$339	Hayes [®]		
PREMIUM SYSTEM			SMARTMODEM 1200	\$699	\$499
PREMIUM SOFTCARD IIE			SMARTMODEM 1200B	\$599	\$429
Information Unlimited [®]	\$350	\$199			
EASYWRITER II	\$225	\$129			
EASYSPELLER II	\$595	\$ call			
ACCOUNTING SERIES					

At Diamond Software we offer the best selling business application software for your IBM PC, CP/M or Apple Computer at the lowest possible prices. And we maintain a complete technical department to assist you before, during and after your system purchase. Not only that, we offer same day shipment on most items and we accept Visa, Mastercard and also American Express. We'll even pay the shipping charges if you send us a money order, cashiers, company or personal check. Purchase orders are gladly accepted from qualified organizations and we welcome dealer inquiries. Call Diamond today, you'll be glad you did.

TO ORDER CALL TOLL-FREE 1-800-227-0545

Diamond Software Supply

481 Lake Park Ave., Suite 123 • Oakland, CA 94610
 For price quotes, information, or in California call 1-415-893-7676. We credit your order for the call. Technical Department (415) 893-7678. International Telex 338139 (attn. 149)

Support, Service and Price.

Shipping/Handling UPS surface \$3.00 plus an additional \$3.00 per item for UPS Blue. C.O.D. orders add \$4.00. For personal check allow 2 weeks for delivery.

laws that apply to objects no matter what they are.

Furthermore, the state of the system is always made readily apparent through visual feedback. Another nice feature of the new systems is that it is harder to make a typo using a mouse.

Simple, consistent computer systems make it easier for the subconscious lower level to do its work without interrupting the user's conscious stream of thought. This is the behavior that is expected from a good tool; a carpenter uses a hammer without pausing to remember how it works. Computer users who are competent technicians in this sense are rare, even among the experts that use a system every day. This need not be the case. The new interface technology can let most people become competent technicians for the applications they use on a day-to-day basis.

Disadvantages of the New Technology

The new interface technology is not without its drawbacks. Programs that use this technology are much more complex than older programs that accomplish similar tasks. As a result, software will be more expensive to produce. But such software will have a much broader market appeal, so the expense will be justified. The increased complexity of the new software will help to spur the introduction of more powerful personal computing languages such as Logo and Smalltalk. BASIC is no longer a suitable language for these machines. It doesn't have the power of expressibility needed to make full use of the graphics capabilities of the new machines.

There is a tradeoff in speed associated with these machines as well. If the old-style software were run with the resources of the new machines, it certainly would be faster. The new software runs as fast as the better 8-bit software of today. But the increase in usability of the new software justifies a slight decrease in performance. All the performance in the world is useless unless it can be harnessed and put to good use.



step into the future ... *COHERENT*[™]

COHERENT[™] is the most powerful UNIX[™]-compatible operating system available for the IBM PC[™], IBM XT[™] and compatibles.

Now you can have the multi-user, multitasking programming capability of a mainframe on a microcomputer. The UNIX-like environment of COHERENT lets you take C code developed using UNIX V7 system utilities and compile and run it on the IBM PC. Through COHERENT'S highly-optimized kernel you can access over 145 different commands including a C-compiler, a text-formatter and LEX and YACC.

Hard disk support presently includes the IBM XT, Genie (removable cartridge), Corona, Davong,

Corvus and Tecmar. Memory cards supported include the AST Megaplus (with or without clock), the Tecmar multifunction board and Tall Tree Systems (512K byte) JRAM cards. Support for more devices and more IBM PC compatibles will be available by the time this ad appears.

The cost of all this — far less than the cost of similar UNIX-based operating systems. Remember, when you buy COHERENT from NCI you receive all the documentation and technical support you need to operate it.

For more information call or write:



**Network Consulting Inc.
Discovery Park,
3700 Gilmore Way, Suite 110,
Burnaby, B.C. Canada V5G 4M1
(604) 430-3466**

Conclusion

The new interface technology represents the next era in user-interface design. The potential advances in productivity are at least comparable to the advances made in going from punched cards to full-screen editors. It will also finally be possible for the average person to use a computer in his day-to-day work. The advent of local-area networks will be another feature of this style of computing. Apple is committed to providing communications and database-man-

agement applications for Lisa in the near future. This provides some indication of the important role information processing and communication will play in the new systems. A great deal of work is also being done on voice recognition by computer, which would eliminate the final stumbling block to man-machine communication—the keyboard.

It is interesting to speculate on what the next step will be after the new interface technology has been assimilated. The new technology is

related to work on artificial intelligence. It represents an attempt to use the best capabilities of man and machine in synthesis. Once this has been accomplished, it will be easier to begin shifting more and more human capabilities to the computer. The eventual result would be an artificially intelligent computer. ■

References

1. Card, Stuart K., William K. English, and Betty J. Burr. "Evaluation of Mouse, Data-Controlled Isometric Joystick, Step Keys, and Text Keys for Text Selection on a CRT." *Ergonomics*, Volume 21, No. 8, 1978, pages 601-613.
2. Englebart, Douglas C., Richard W. Watson, and James C. Norton. "The Augmented Knowledge Workshop." *Proc NCC 1973*, pages 9-21.
3. Goldberg, Adele. "Introducing the Smalltalk-80 System." *BYTE*, August 1981, page 14.
4. Goldberg, Adele and David Robson. *Smalltalk-80: The Language and Its Implementation*. Reading, MA: Addison-Wesley, 1983.
5. Ingalls, Daniel H. "Design Principles Behind Smalltalk." *BYTE*, August 1981, page 286.
6. Ingalls, Daniel H. "The Smalltalk Graphics Kernel." *BYTE*, August 1981, page 168.
7. Kay, Alan and Adele Goldberg. "Personal Dynamic Media." *Computer*, March 1977, pages 31-41.
8. Lemmons, Phil. "A Guided Tour of Visi On." *BYTE*, June 1983, pages 256-278.
9. Nelson, Theodore H. *Computer Lib/Dream Machines*. South Bend, IN: The Distributors, 1974.
10. Reenskaug, Trygve M.H. "User-Oriented Descriptions of Smalltalk Systems." *BYTE*, August 1981, page 147.
11. Robson, David. "Object-Oriented Software Systems." *BYTE*, August 1981, page 74.
12. Smith, David C., Charles Irby, Ralph Kimball, Bill Verplank, and Eric Harslem. "Designing the Star User Interface." *BYTE*, April 1982, pages 242-282.
13. Tesler, Larry. "The Smalltalk Environment." *BYTE*, August 1981, page 90.
14. Wadlow, Thomas A. "The Xerox Alto Computer." *BYTE*, September 1981, pages 58-68.
15. Xerox Learning Research Group. "The Smalltalk-80 System." *BYTE*, August 1981, page 36.

WHY THE UNOFFICIAL APPLE LOGO IS BETTER THAN THE OFFICIAL ONE.



Logo is a simple, powerful programming language designed for natural and interactive learning. It's a fast, simple, fun way for you and your family to learn about your computer, while you use your computer.

But what makes Terrapin™ Logo better than the official Apple® Logo?

Terrapin Logo is true to the original Logo. Apple Logo isn't.

Terrapin Logo was extensively field-tested in schools. Apple Logo wasn't.

The Terrapin Logo tutorial is written for both novice and advanced programmers.

The Apple Logo tutorial is just for the novice.

Terrapin Logo comes with a utility disk that contains sample programs and educational games. Apple Logo doesn't.

For classroom users, Terrapin Logo is available for network environments. Apple Logo isn't.

And best of all, the list price of Terrapin Logo is \$25 less than Apple Logo.

When all is said and done, it's easy to see why Terrapin Logo, the Unofficial Logo, is better than the official one.

Ask your dealer for it. Or call us directly.

 **Terrapin™**
The Logo People
Terrapin, Inc., 380 Green Street,
Cambridge, MA 02139, (617) 492-8816

Terrapin Logo runs on the Apple® II, IIe and Franklin™ computers. Apple is a registered trademark of Apple Computer, Inc.

Robert W. Warfield (8429 Hearth #31, Houston, TX 77054) is a graduate student in computer science at Rice University.

George M. White received a B.S. from Michigan State University in math, chemistry, and physics; a Ph.D. in chemical physics from the University of Oregon; and was a postgraduate fellow at Stanford University. He worked for seven years with the Xerox Palo Alto Research Center and is currently chairman of the board of Koala Technologies (3100 Patrick Henry Dr., Santa Clara, CA 95050).

A PICTURE'S WORTH:

U.S. SHIPMENTS IN BILLIONS

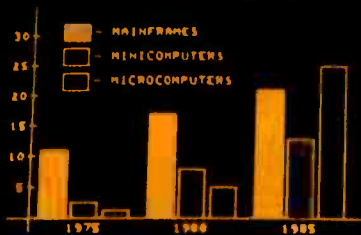

GRAPHICS CAPABILITIES

- ◆ High Performance graphics
- ◆ Tektronix 4010 Compatibility
- ◆ Automatic Scaling (1023-1023)
- ◆ with 250x512 resolution
- ◆ Alpha Mode (135 Lines x 73 cols)
- ◆ Optional Joystick
- ◆ Connection to Low Cost Printer for Graphics Hardcopy
- ◆ ASCII and APL character sets
- ◆ Block Fill, Dotted/Dashed Lines

DISPLAY TERMINAL CAPABILITIES

- ◆ ANSI Standard Conformance
- ◆ DEC Software Compatibility
- ◆ 80-132 Columns, Windowing
- ◆ 4 Pages of Memory Standard (up to 8)
- ◆ 43 Programmable Functions
- ◆ ASCII and APL models
- ◆ High Resolution Amber Phosphor
- ◆ Setup Mode



\$1895.

Single quantity.

NEW! AND THERE'S EVEN MORE IN THE NEW CONCEPT GVT

- ◆ New ergonomic features including ultra-low profile keyboard with adjustable height
- ◆ VT100-style numeric pad for DEC software compatibility
- ◆ Increased functionality, including four LEDs, volume control, more function keys
- ◆ Same low price

Whether used in video display mode or in its high-performance graphics mode, the concept GVT™ has more to offer at its price for terminal operators, interactive users, and applications developers than any other terminal available today.

Use the concept GVT graphics terminal for all its worth. Call 215-382-5000 or your local HDS sales/service office for a demonstration and free, no-obligation, trial in your office.

HDS human designed systems, Inc.

3440 Market Street □ Philadelphia, PA 19104 □ 215-382-5000

Circle 217 on inquiry card.

Atlanta — (404) 391-9763; Boston — (617) 329-3510; Chicago — (312) 825-2960; Dallas — (214) 437-1888; Delaware — Infocon: (302) 239-2942; Denver — (303) 469-1953; Hawaii — Gray Associates: (808) 261-3751; Los Angeles — (213) 410-9454; Northern New Jersey — Infocon: (201) 624-1372; New York City Area — Infocon: (212) 689-8833; New York State — Naco Electronics: Rochester: (716) 223-4490; Syracuse: (315) 899-2651; San Francisco — (415) 692-4184; Washington, DC — International Systems Marketing: (301) 279-5775; Argentina — Iron SA: (01) 744-9369; Australia — Computer Clarity Pty. Ltd.: (02) 241 3385; I. O. Peripherals Pty. Limited: (02) 427 3555; Belgium — BELCOMP: 091/25 22 88; Canada — CAIL Systems: Toronto: (416) 382-1063; Denmark — ADCOM Data Aps: 1-19 44 66; Finland — Modulsystem OY: 0-6926511; France — Walton: (1) 226.06.90; Singapore — DTS Singapore: (65) 33-88-566; Switzerland — Mitek ag: 02/461 22 52; United Kingdom — Shandell Systems Ltd.: 02407-2027; West Germany — COMKO Computersysteme GmbH: 0221-48 30 51. INTERNATIONAL DISTRIBUTORSHIP INQUIRIES INVITED.

GVT is a trademark of Human Designed Systems, Inc.



DIGITAL RESEARCH	with SpeedStart™	MicroPro
DIGITAL RESEARCH	SuperCalc ² with SpeedStart™	SORCIM
DIGITAL RESEARCH	MicroPlan with SpeedStart™	Chang Labs
DIGITAL RESEARCH	GraphPlan™ with SpeedStart™	Chang Labs
DIGITAL RESEARCH	TARGET Financial Modeling™ with SpeedStart™	COMSHARE
DIGITAL RESEARCH	SELECT™ with SpeedStart™	SELECT Information Systems
DIGITAL RESEARCH	personal pearl™ with SpeedStart™	Pearlsoft
DIGITAL RESEARCH	MOVE-IT™ with SpeedStart™	WOOLF SOFTWARE
DIGITAL RESEARCH	DR Graph™	
DIGITAL RESEARCH	Concurrent CP/M™	

Introducing software for the IBM® PC with a \$350 bonus!

Now's the time to invest in the business software you've wanted for your IBM PC. Because for a limited time, if you buy any two of the famous business programs in the CP/M Applications Library™, we'll give you the highly-acclaimed Concurrent CP/M™ operating system for your IBM PC—absolutely free. That's a bonus worth \$350*!

Introducing SpeedStart™—the exclusive load-&-go software system.

The CP/M Applications Library offers more than just the best name-brand IBM PC software in the business. Each of our applications delivers the unmatched convenience of our exclusive SpeedStart single disk system.

SpeedStart is a special version of the powerful CP/M-86® operating system that's built into each of our software disks.

When you're ready to work, just load the disk, turn on your IBM PC and go!

SpeedStart eliminates the time-consuming task of loading a separate operating disk and then "installing" the software.

In fact, the SpeedStart system gets you to work faster and easier than any other software available today.

Best of all, it's yours at no extra cost.

What's more, SpeedStart

can be by-passed to run software under the IBM PC operating system of the future—the remarkable, multi-tasking Concurrent CP/M.

The operating system of the future can be yours—free!

There's a good reason why Concurrent CP/M is receiving rave reviews by industry experts. It enables your IBM PC to run up to four separate jobs at the same time.

You can load all of your applications at once, and instantly switch from one program to the next with the touch of a key!

For example, by using WordStar® and SuperCalc®2 simultaneously, you can print documents while working on your budget. You can even exchange data from one application to another. The time-saving possibilities are endless.

Best of all, this \$350 operating system is yours for the asking when you buy any two IBM PC business software packages from the CP/M Applications Library at your computer store.

But hurry, this special offer ends January 1, 1984! For the name of the nearest participating dealer call toll free:

800-227-1617, ext. 404
(in California, 800-772-3545, ext. 404).

**DIGITAL
RESEARCH™**



***Buy any two applications
and get Concurrent CP/M
FREE!***

Circle 147 on inquiry card.

*Suggested retail price

IBM is a registered trademark of International Business Machines Corporation.
WordStar is a registered trademark of MicroPro International Corporation.
SuperCalc2 is a registered trademark of Sorcim Corporation.

The Digital Research logo and products are either trademarks or registered trademarks of Digital Research Inc. All rights reserved. ©1983 Digital Research Inc.

Trackball-Interfacing Techniques for Microprocessors

This interfacing approach lets you adapt trackball devices to your interactive personal computer applications

by Edward W. Andrews

The age of interactive computing is upon us, and a variety of I/O (input/output) devices have been developed to supplement the keyboard in providing convenient human-to-machine interfacing. Unfortunately, in the past only simple joysticks and pushbuttons have been priced low enough to suit home computer applications. The LT200, a recent product from Disc Instruments of Costa Mesa, California, has brought the trackball within reach of the home computer market. This product provides accurate positioning of the cursor displayed on a CRT (cathode-ray tube), and it provides TTL-compatible outputs that can be readily interfaced with a microcomputer without elaborate and costly circuitry. Moreover, the LT200 costs less than \$100, representing a major savings compared to the trackballs designed for commercial and military markets that cost more than \$1000.

This article describes general trackball-interfacing techniques and a simple hardware/software interface approach that can be adapted easily to any home system.

Trackball Concepts

A trackball is an interactive control

that consists of a solid ball, 1½ to 3 inches in diameter, mounted in a base such that part of the ball's surface is exposed, allowing the ball to be rolled with the palm or fingertips. The ball's rolling motion is coupled to optical encoders that generate pulses to indicate the direction and rate of ball rotation. These pulses can be coupled to a microprocessor,

**A simple hardware/
software-based
trackball-interfacing
approach can be
adapted to any
personal computer
system.**

which can then create proportional X-Y motion of a CRT-displayed cursor.

The precision with which a trackball can be moved suits it to detailed interactive graphics applications. Commercially it has seen wide use in computer-aided-design (CAD) systems. Other applications include interactive analysis of medical X-ray, nuclear, and ultrasound images. Some video-arcade games have also

featured trackball controls.

Figure 1 shows the internal construction of the LT200 trackball. Two optical interrupter disks (the slotted wheels) form the basis of an optical encoder for each trackball axis. The ball rests on two perpendicular rods on which the interrupter disks are mounted. Any movement of the ball causes at least one of the rods to rotate, in turn causing disk rotation and, thus, pulse-train generation. The frequency of these pulse-train signals is proportional to the ball-rotation speed along each axis. Most trackballs generate 200 to 500 pulses per revolution. The LT200, for example, generates 480 pulses per revolution.

Because the two rods are perpendicular, one encoder's output represents X-axis movement while the other encoder's output represents Y-axis movement. Each encoder includes sensing logic that determines forward or reverse (or left or right) movement along the corresponding axis; a trackball device therefore furnishes four signals indicating movement in +X, -X, +Y, and -Y directions. When used to control cursor positioning on a CRT, the trackball must be properly oriented with

respect to the CRT to obtain the proper correlation between ball movement and cursor movement.

Basic Interfacing Concepts

Note that a trackball is essentially an incremental or relative input device. By rolling the trackball, an operator signals his intent for the displayed cursor symbol to move in a given direction and at a given rate, away from the current cursor position. In response to trackball rotation, the cursor moves to a new position based on its current position.

A review of some fundamental CRT display-addressing concepts illustrates how the incremental trackball signals can be interfaced to a computer. Consider a CRT display having an X-Y matrix of 256 by 256 pixels (picture elements). Within such a matrix, the displayed cursor location on the CRT can be specified by an X, Y number pair. One 8-bit number can uniquely define all possible horizontal X pixel locations, or addresses, on the CRT display, starting with 0 on the left edge and extending to 255 at the right edge of the display. Similarly, a second 8-bit

value uniquely defines all possible vertical Y pixel locations of the CRT, starting with 0 at the bottom and ending at 255 at the top edge of the display. If the X and Y values defining the absolute cursor location can be varied in response to the trackball, an interactive control results.

Implementation Approaches

As figure 2 shows, a trackball interface can be built using two simple hardware up-down counter circuits.

A trackball is essentially an incremental or relative input device.

Here the X-axis uses one counter and the Y-axis uses a second. With the trackball +X output connected to the up-count clock, and the -X trackball output connected to the down-count clock, the counter increments and decrements appropriately in response to trackball X-axis movement. The Y-axis trackball outputs are connected similarly to a second counter, which in turn responds to Y-axis

trackball movement. These counter circuits can then be interfaced to a microprocessor's data bus through an input port, allowing the processor to read or periodically poll the input port to determine the current absolute X, Y trackball coordinate. Using this data, the microprocessor can position the cursor on the CRT. If this input port is read and the displayed cursor position is updated at a high rate (more than 25 times per second), an interactive control results.

As shown, upper- and lower-limit detection logic must be included in the counter design to prevent counter roll-over, which could occur if the trackball is unceasingly rolled in one direction. The X-axis counter, for example, must be inhibited from further up-counting when the rightmost pixel coordinate, 255, is reached. Should such limiting be omitted, further +X pulses from the trackball would cause the counter to overflow from 255 to 0. If this overflow were to occur, you would see the cursor jump abruptly from the far right side of the display screen (X address=255) to the far left side of the display screen (X address=0). With boundary limiting properly implemented, the trackball appears to slip whenever a display screen edge is encountered. Such boundary limiting must also be included for the left, top, and bottom cursor boundaries.

An Interrupt-Based Interface

We have seen the basic trackball interfacing concepts demonstrated with a hardware-intensive approach. While counters can be readily configured to directly implement a trackball interface, other less hardware-intensive approaches are also possible. One such method uses interrupt concepts and software-based up-down counters to respond to the trackball output pulses. In other words, the counters just detailed are functionally implemented in software, and the trackball output pulses are connected as vectored interrupts to a microprocessor system.

With an interrupt-based approach, you must think of the current trackball X- and Y-cursor coordinates as residing in two locations in the micro-

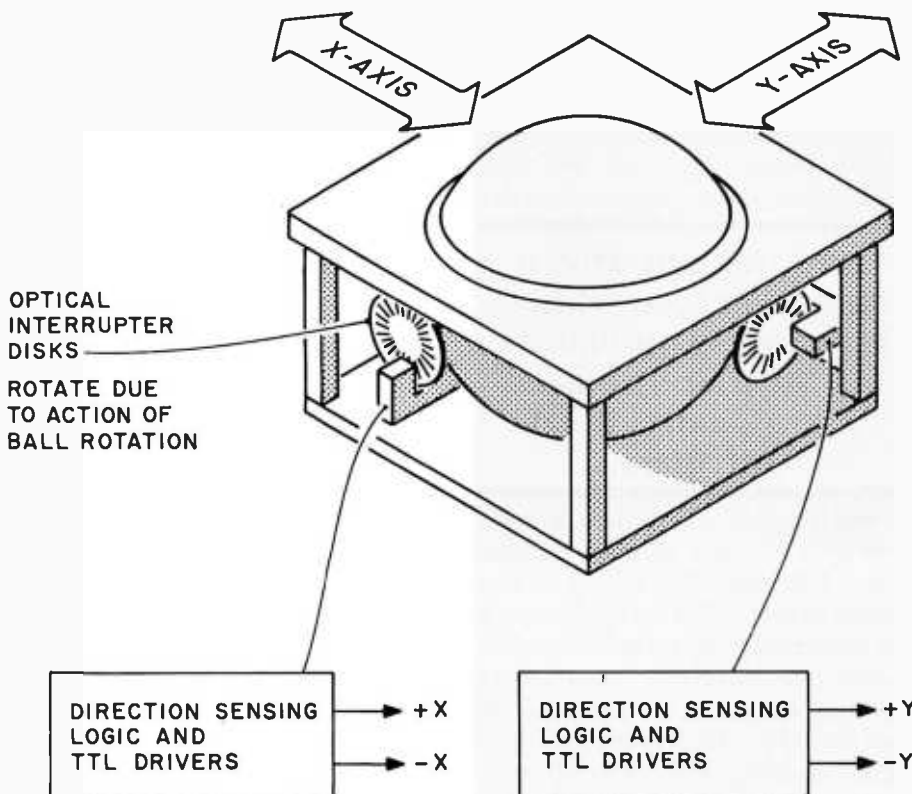

Figure 1: An internal look at Disc Instruments' LT200 trackball.

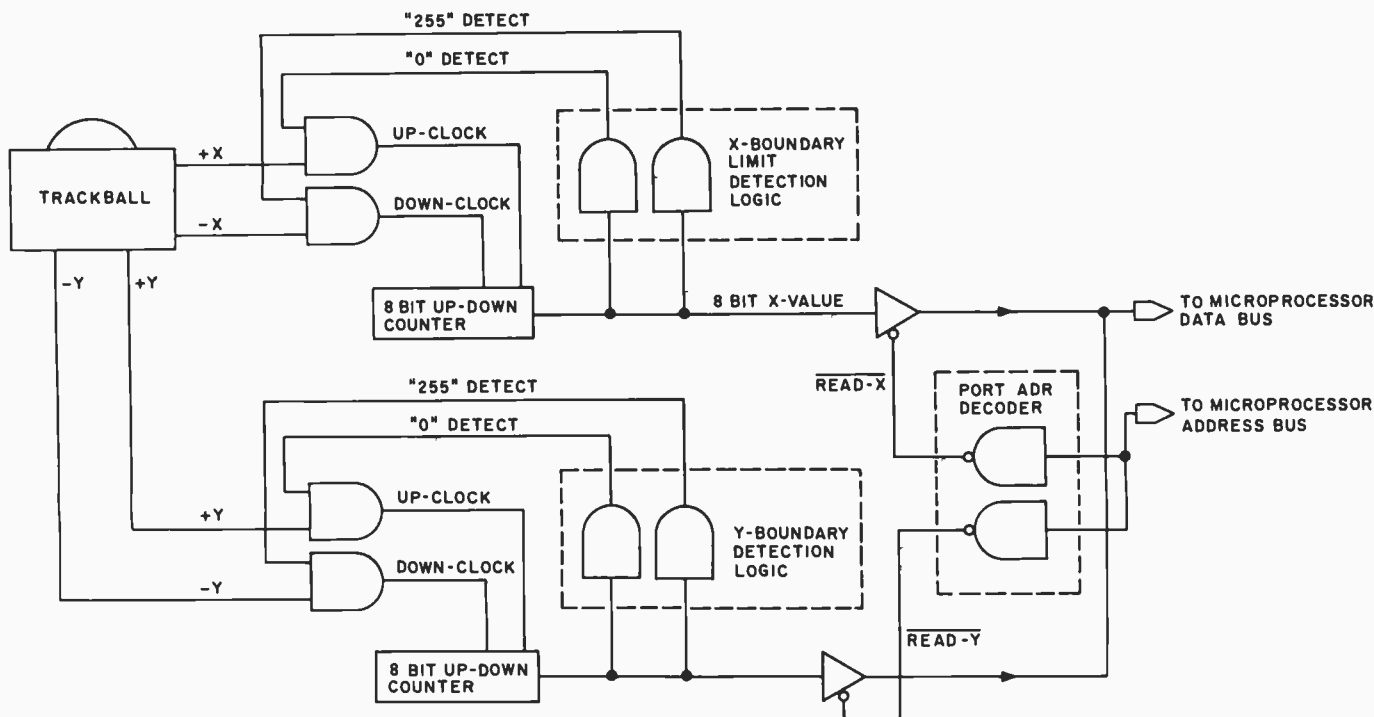

Figure 2: A block diagram of a fundamental hardware-based trackball interface.

processor's RAM (random-access read/write memory). Rather than drive a hardware-counter circuit, the trackball signals are now connected as vectored interrupts to the processor system. An interrupt controller, such as an Intel 8259, can be used to add vectored-interrupt capability to a computer system. Alternately, the trackball can be interfaced to an existing interrupt structure. In any event, with an interrupt-based approach, the software interrupt-handler routines operate as up-down, software-based counters.

With the trackball signals connected as interrupts, for example, as a +X trackball pulse is received, the microprocessor is vectored to an interrupt-service routine whose job is to increment the data contained in the X-cursor-coordinate memory location. Similarly, the -X interrupt-service routine decrements the data contained in the X-cursor-coordinate memory location in response to a -X trackball pulse.

Figure 3 shows simple flowcharts of the four interrupt-service routines required for a fully interrupt-based implementation. Notice that upper/lower boundary detection and limit-

ing is also included in these interrupt routines.

With the interrupt routines maintaining and updating the absolute cursor X, Y coordinates, the operating computer program would be responsible for monitoring and acting on the changing cursor-coordinate data. That is, the operating program (which the trackball signals interrupt) would continually read the two memory locations designated as the

An interrupt-driven approach to trackball interfacing minimizes hardware but places extra demands on software.

X- and Y-cursor coordinates and respond to changes in these values. Figure 4 illustrates this activity. In this simple example, the sole purpose of the operating program is to move the cursor interactively in response to trackball motion. An actual application would expand on this basic activity, enabling the trackball coordinates to interactively vary or control higher-level functions.

The TIP Approach

Although an interrupt-driven approach to trackball interfacing can minimize the interface hardware, it does place extra demands on the software. In addition, many home and personal computers and their operating systems are not interrupt-based. An effective yet simple interfacing approach, which I'll call TIP, for trackball input polled, is shown in schematic form in figure 5. This method offers a polled approach to accepting trackball data and is readily adapted to almost any microprocessor-based system.

The TIP interface consists of two 4-bit up-down counters driven directly from the trackball output signals. One counter is connected to the +X and -X signals and in turn registers trackball rotations in the X-axis. Similarly, the other counter is connected to the +Y and -Y signals, registering Y-axis trackball movement. These two signals are then connected to a single 8-bit input port that can be read by the microprocessor.

Each of the counters is configured to generate a two's complement, 4-bit signed number. As the TIP input port

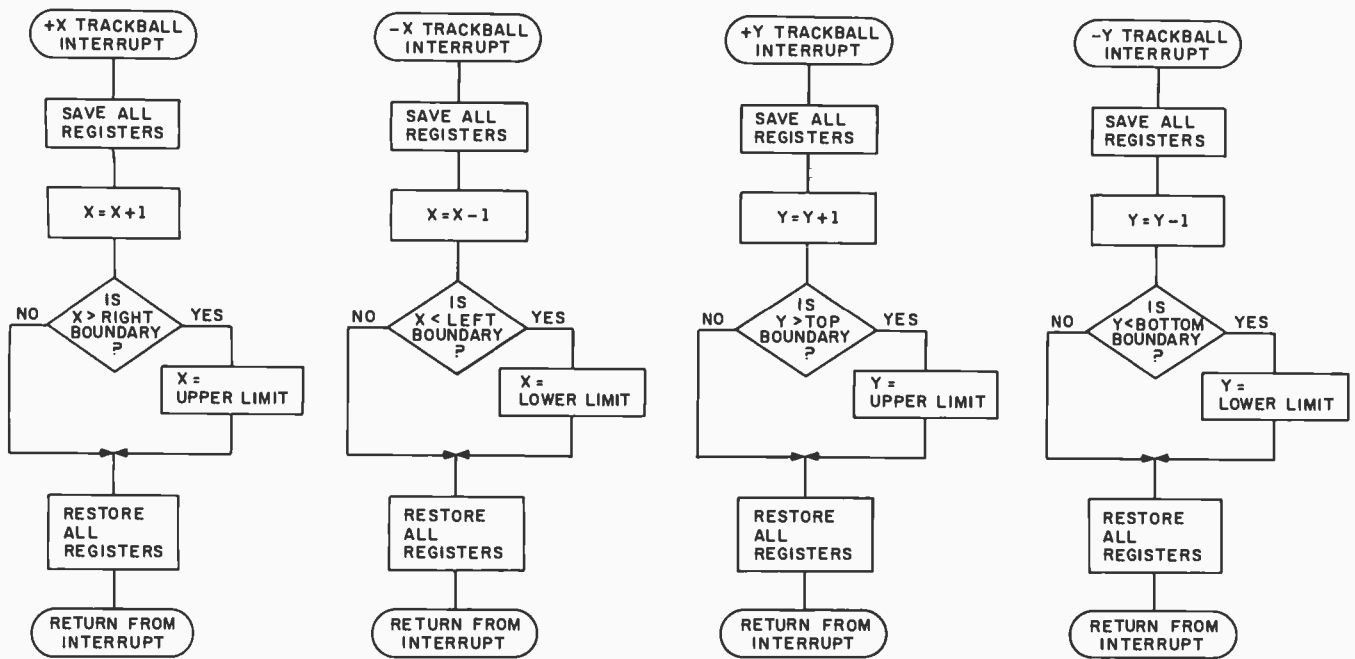

Figure 3: Flowcharts for the four interrupt-handler routines required for a vectored-interrupt trackball-interface approach. Note that boundary checking is included in these routines.

is read by the microprocessor, the two numbers retrieved represent an accumulation of the operator's most recent trackball actuation. In effect, the data read is an X, Y vector, indicating the direction and magnitude (speed) of trackball rotation. The software then alters the current cursor-location values based on this move vector. This method differs from the approach suggested by figure 2, in which the interface-counter hardware actually holds the absolute cursor location, rather than a relative move count. Figure 6 shows the data format as it is read from the TIP input port.

TIP Circuit Details

The four trackball signals, +X, -X, +Y, and -Y, are received and gated by the Schmitt-trigger device IC1 in figure 5. We chose a Schmitt device to increase the noise immunity of the input circuitry, therefore reducing the chance of random electrical noise from adversely affecting the counter operation. IC4 (X-axis) and IC5 (Y-axis) are TTL-type 74LS192 up-down, 4-bit binary counters. These counters are structured to count symmetrical-

ly from zero, each able to count within the two's complement number range from -7 to +7. NAND gates IC2b (X-axis) and IC3b (Y-axis) detect the uppermost count boundary, +7, and work in conjunction with IC1 to prevent an ongoing stream of up-count clocks (+X and +Y trackball signals) from causing an undesired counter overflow. Similarly, NAND gates IC2a (X-axis) and IC3a (Y-axis), detect the lowermost count boundary, -7, and, with IC1, prevent an ongoing stream of down-count clocks (-X and -Y trackball signals) from causing an undesired counter underflow.

IC7 is an 8-bit clocked register with three output states and is used as a combination data-latch and data-bus driver. A latch here ensures that a stable, unchanging data byte would be presented during the processor's READ operation. In addition, just after the data latch is clocked to hold the current trackball X, Y data pair, both X and Y counters are reset to zero. Thus, after every TIP register is read, the counters start over in accumulating operator input.

The LED (light-emitting diode) indicators are optional and not required

for circuit operation; however, I found them invaluable in debugging my wire-wrapped prototype.

Address and Data-Bus Interface

Comparators IC8 and IC9 form the address-bus decoder. These two

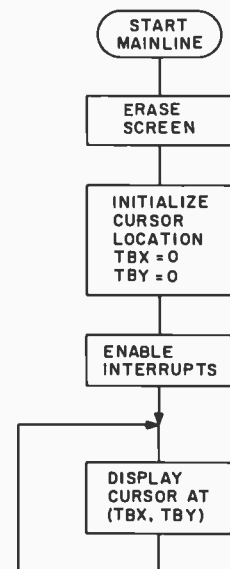

Figure 4: The flowchart of a simple main program designed to work with the figure 3 interrupt routines. The trackball-coordinate values TBX and TBY are the variables that the interrupt handlers update.

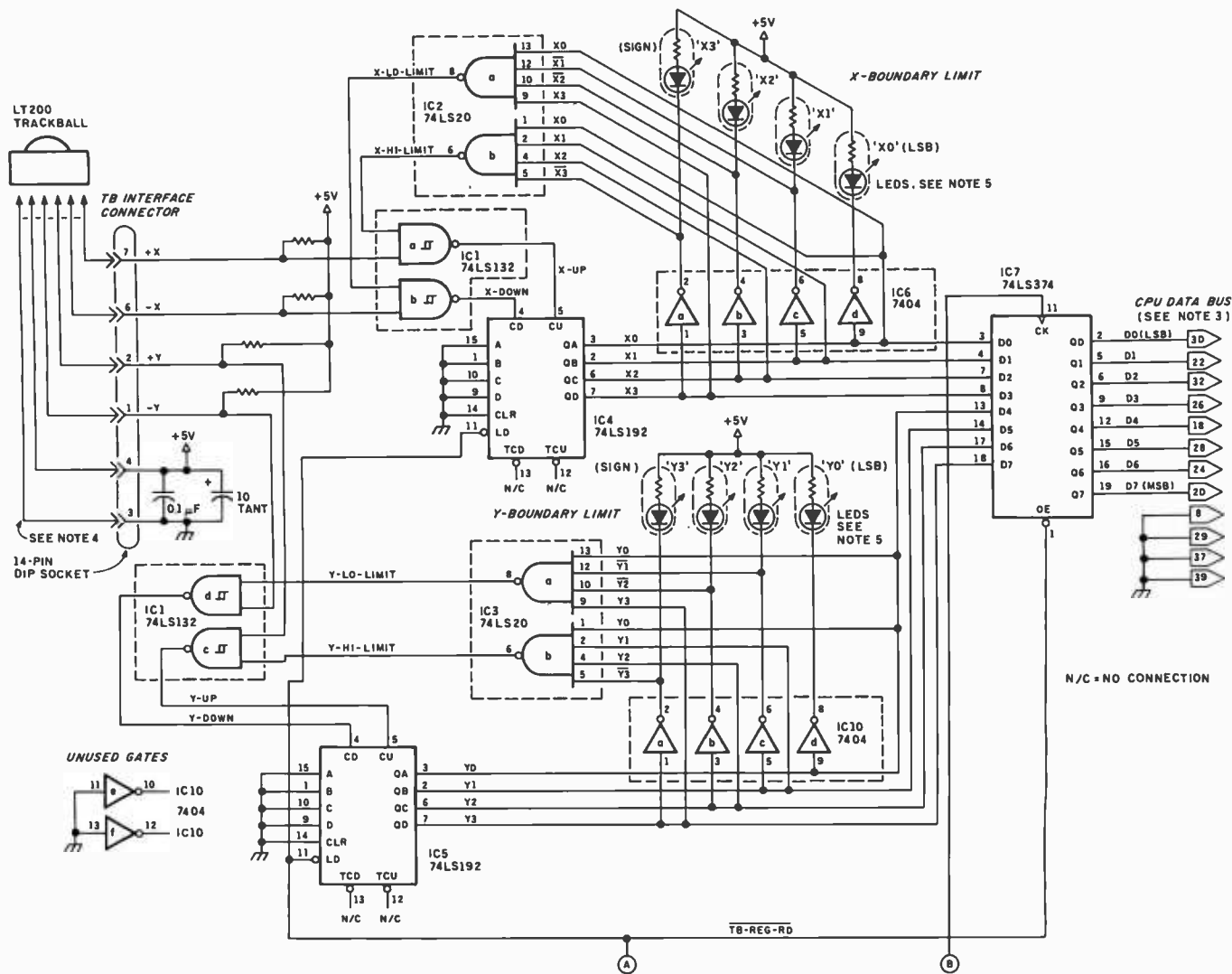

Figure 5: The TIP (trackball input polled) interface schematic. Connector pinouts are shown for a TRS-80 Model I computer.

chips are configured as an 8-bit comparator. As shown, the lower 8 bits of the microprocessor address bus are compared with a data value, set by an 8-station switch. The comparators are gated further by an IOREAD signal. In this way, the TIP

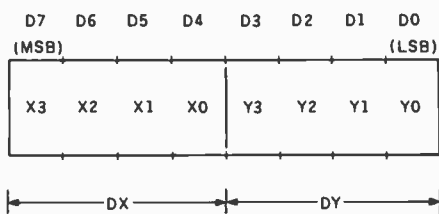

Figure 6: The TIP input-port data format. The lower 4 bits represent a delta Y (DY) value, and the upper 4 bits represent a delta X (DX) value. This pair of two's complement values, each having a number range from -7 to +7, represents the most recent operator actuation of the trackball.

input register is mapped into the microprocessor I/O space. The actual port assignment is determined by the switch settings of S0 (LSB) through S7 (MSB). When a given switch position is open (off), a logic 1 is set; closing the switch (on) results in a logic 0 state.

Although a TRS-80 computer was used to demonstrate concept feasibility, the corresponding address bus, data bus, and IOREAD signals of any microcomputer can be connected to the TIP interface. If desired, the TIP data port can even be memory-mapped. For this memory-mapped approach, the address-decoding circuitry has to be expanded to compare 16 bits (or more). Additional 74LS85 comparator chips can be cascaded, or other combinational logic techniques can be used. Any high-true, address-

decoding signal can be used to drive the point called "TB-REG-RD" of figure 5; however, TB-REG-RD must occur at least one gate delay before TB-REG-RD.

As shown, the microprocessor data bus is connected to the output of IC7. Data bit D7 is the most significant bit (MSB), and D0 is the least significant bit (LSB).

A TRS-80 Demonstration

The address and data bus pinouts shown in figure 5 correspond to the expansion-interface pin assignments for the TRS-80 Model I computer, which I used to evaluate and test the circuit concepts. This expansion interface connector makes available all the key Z80 processor signals needed to connect the TIP circuitry.

Listings 1 and 2 show simple

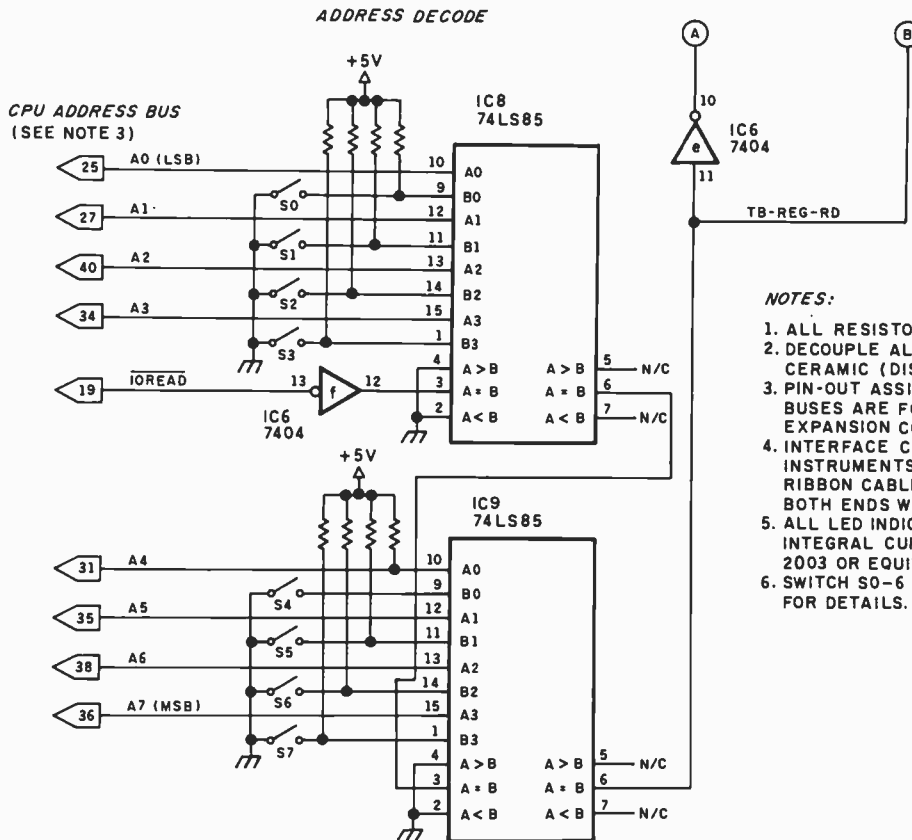

NOTES:

1. ALL RESISTORS ARE 2.2 K Ω , 0.25W, UNLESS NOTED.
2. DECOUPLE ALL CHIPS WITH 0.1 μ F, 50V MONOLITHIC OR CERAMIC (DISK) CAPACITOR.
3. PIN-OUT ASSIGNMENTS SHOWN FOR ADDRESS AND DATA BUSES ARE FOR CONNECTION TO A TRS-80 MODEL I EXPANSION CONNECTOR CABLE.
4. INTERFACE CABLE BETWEEN TIP CIRCUIT AND DISK INSTRUMENTS LT200 SHOULD BE 14-CONDUCTOR RIBBON CABLE, LENGTH AS REQUIRED, TERMINATED ON BOTH ENDS WITH A MALE, 14-PIN DIP PLUG.
5. ALL LED INDICATORS SHOULD BE PC-MOUNTABLE; WITH INTEGRAL CURRENT LIMIT RESISTORS (DIALIGHT 547-2003 OR EQUIVALENT).
6. SWITCH S0-6 SETS I/O PORT ASSIGNMENT. SEE TEXT FOR DETAILS.

Listing 1: A TRS-80 Model I (Level II BASIC) main program that controls cursor movement in response to trackball actuation.

```

10  REM *****
15  REM #
20  REM #     TIP DEMONSTRATION PROGRAM     #
30  REM #     -----                     #
40  REM # This program will move a block cursor #
50  REM # about the CRT screen in response to #
60  REM # the movement of the trackball. A #
70  REM # mode can be selected which will result #
80  REM # in "Etch-A-Sketch" like operation. #
90  REM # This program was written and tested on #
100 REM # a TRS-80, Model I, computer, with #
110 REM # Level II BASIC. Note. the TRS-80, #
120 REM # Model I computer has a CRT screen #
130 REM # resolution of only 128 X 48 PIXELS. #
140 REM # *****
150 REM
160 CLS
170 REM --- SET INITIAL X,Y VALUES
180 Y=20:X=50
190 REM --- ASK OPERATOR IF HE WANTS TO TRACE
200 PRINT "ENTER 1 FOR TRACE MODE, 0 FOR NO TRACE"
210 INPUT A
215 CLS
220 REM --- MAIN LOOP STARTS HERE-----
230 REM --- TURN CURSOR BLOCK "ON"
250 SET(X,Y)
260 REM --- READ TIP I/O PORT AND GET DX, DY
270 GOSUB 800
280 REM --- TURN CURSOR BLOCK "OFF"
290 REM THIS ON-OFF SEQUENCE CAUSES
300 REM CURSOR TO FLICKER SLIGHTLY WHICH
310 REM DIFFERENTIATES IT FROM OTHER
320 REM ON-SCREEN GRAPHICS BLOCKS
330 RESET(X,Y)
340 REM --- WAS TRACKBALL ROLLED? IF NO, LOOP BACK
350 IF DX=0 AND DY=0 GOTO 250
360 REM --- YES, TB WAS ROLLED; CHECK IF TRACE SELECTED
370 IF A=0 GOTO 410
380 REM --- IF TRACE SELECTED, TURN CURRENT BLOCK ON
390 SET(X,Y)
400 REM --- NOW UPDATE CURSOR COORDINATES
410 X=X+DX
420 REM --- NOTE: SUBTRACT DY BECAUSE "+Y"
430 REM DIRECTION IS "DOWN" ON TRS-80 SCREEN
440 Y=Y-DY
450 REM --- PERFORM BOUNDARY CHECKING AND LIMITING
460 IF X>127 X=127
470 IF X<0 X=0
480 IF Y>47 Y=47
490 IF Y<0 Y=0
500 GOTO 250

```

Listing 2: A subroutine that reads the TIP port and separates the DX and DY elements.

```

700 REM *****
710 REM *
720 REM * This subroutine will read the TIP I/O port,
730 REM * separate the X and Y values, and convert
740 REM * them into a pair of BASIC signed numbers
750 REM * which the mainline can use to update the
760 REM * cursor position. Here, the TIP I/O port
770 REM * was 0 (All address switches closed).
780 REM * This routine was written and tested on a
790 REM * TRS-80, Model I computer, level II BASIC
800 REM *
810 REM *****
850 REM
860 REM --- READ THE I/O PORT
870 TIP=INP(0)
880 REM --- SEPARATE X AND Y FROM THE SINGLE DATA BYTE
890 REM AND PLACE EACH IN THE LOWER 4-BITS OF A NEW
900 REM VARIABLE PAIR, DX AND DY
910 DX=(TIP AND 240) * .0625
920 DY=(TIP AND 15)
930 REM --- NOW CONVERT THESE NUMBERS INTO SIGNED VALUES
940 REM WHICH TRS-80 BASIC WILL UNDERSTAND! 1ST, X
950 REM --- IF THE 2'S COMP NUMBER IS +, WE'RE DONE
960 IF DX < 8 GOTO 1000
970 REM --- IF THE 2'S COMP NO. IS -, THERE'S MORE WORK
980 DX = DX - 16
990 REM --- NOW DO THE Y VALUES
1000 IF DY < 8 GOTO 1030
1010 DY = DY - 16
1020 REM --- ALL DONE.....
1030 RETURN

```

TRS-80 Level II BASIC main and sub-programs that read the TIP input port and move a graphics block around the screen in response to the trackball movement. The TIP port is easily accessed using the TRS-80 INP command. In my tests, I used input port address 0 (all address-compare switches closed).

You may notice that I turn a graphics block on using the SET command, read the input port, and then turn the graphics block off using the RESET command. With the cursor stationary (no trackball motion), this technique causes the cursor block to flicker slightly. This flicker is a great help in differentiating the cursor block from other graphics characters that may also be on the screen.

Another feature of the test program is a deposit mode. In this mode, the computer operates much like the Etch-A-Sketch toy, leaving a trail of dots (pixels) behind the moving cursor.

Design Variations

Since the LT200 produces 480

Low-cost Interface DiskSystems[®] for IBM PC-2.0 DOS



- 10, 15, 25 megabyte models available now!
 - DiskSystem includes Winchester disk drive, cabinet, power supply, cable, controller, I/O adapter and device driver ■ Fully compatible with 2.0 DOS (unmodified) ■ Exclusive double shock isolation system ■ Standard warranty includes 90 days parts and labor
- | | |
|--------------------------------|--------|
| 10 megabytes formatted storage | \$1695 |
| 15 megabytes formatted storage | \$2295 |
| 25 megabytes formatted storage | \$2995 |

- 5 1/4" Winchester Backup or Additional Storage For IBM PC XT or IBM PC DiskSystem
 - Slave compatible with 2.0 DOS
- | | |
|-------------------------------|--------|
| 10 megabyte formatted storage | \$1425 |
| 15 megabyte formatted storage | \$1645 |
| 25 megabyte formatted storage | \$2295 |

Dealer Inquiries Invited

I² INTERFACE INC

7630 Alabama Avenue
Canoga Park, CA 91304
(213) 341-7914 Telex: 662949

IBM is a registered trademark of IBM Corporation
DiskSystems is a copyright of Interface Inc



Prices are suggested retail and subject to change without notice
© 1983 Interface Inc

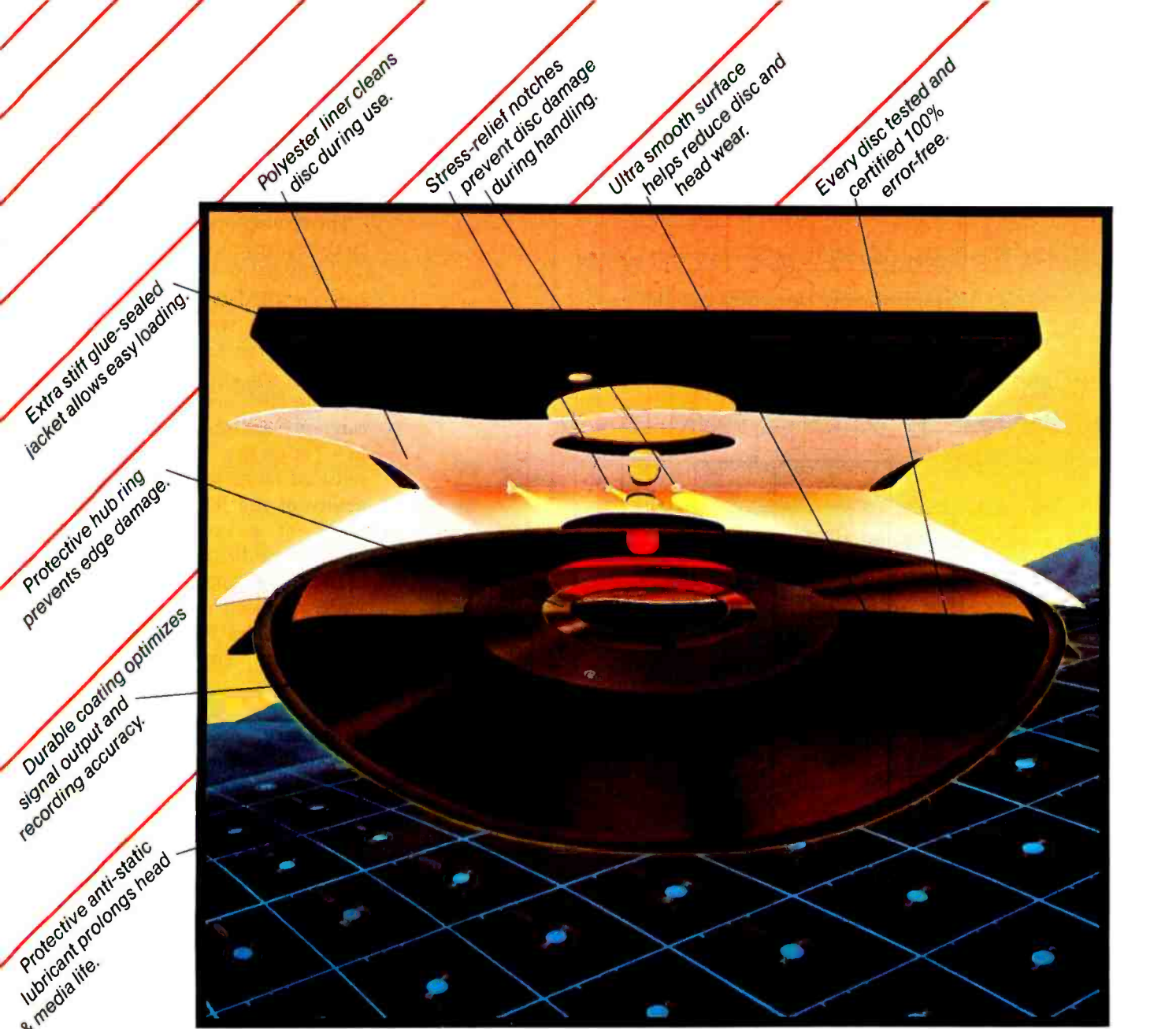

Polyester liner cleans disc during use.

Stress-relief notches prevent disc damage during handling.

Ultra smooth surface helps reduce disc and head wear.

Every disc tested and certified 100% error-free.

Extra stiff glue-sealed jacket allows easy loading.

Protective hub ring prevents edge damage.

Durable coating optimizes signal output and recording accuracy.

Protective anti-static lubricant prolongs head & media life.

We opened this quality disc to show how it stands up and performs. On the surface, flexible discs look alike. But if you inspect them closely, Memorex® sets itself apart.

The cross-linked oxide coating is unique. It results in a coating that will hold a stronger signal for greater recording and playback accuracy. Each disc is burnished to an ultra-smooth surface to reduce head wear and extend media life. A protective hub ring on mini discs eliminates edge damage to the drive access opening resulting in better alignment and dependable performance.

For durability, we constructed a disc jacket from extra-stiff vinyl that loads easier. Glue-sealed to prevent intermittent bonding and stress-notched for added protection, discs withstand the rigors of everyday usage better.

We added a self-cleaning jacket liner that cleans and removes debris from the disc while in use. The result is top performance throughout a long disc life.

You can trust Memorex flexible discs. You know they're reliable because we individually certify every one to be 100% error free.

For any application—5¼" or 8", one side or two, single or double density—look to Memorex Flexible discs. For more information, call (800) 222-1150, or your local distributor today.



MEMOREX
A Burroughs Company

©1983 Memorex Corporation. Memorex is a registered trademark of Memorex Corporation

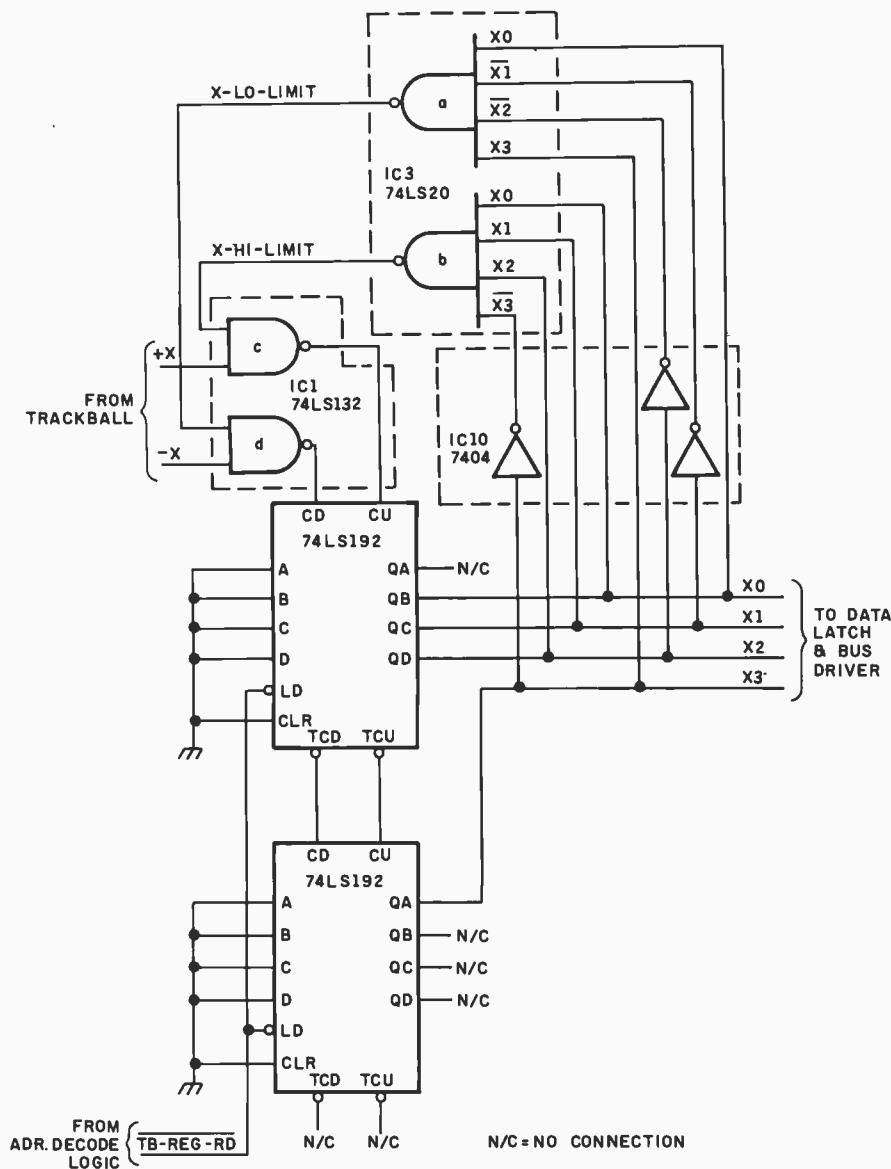

Figure 7: A design variation that allows the TIP trackball counters to prescale the trackball pulses.

pulses per revolution, just over half a rotation of the LT200 trackball element moves a displayed cursor from one screen edge to the other screen edge when operating within a 256- by 256-pixel matrix. For detailed cursor placement, at which a trackball device intrinsically excels, you may find the trackball excessively sensitive with the LT200/TIP interface scheme as shown. There are two ways to reduce the trackball sensitivity: a simple hardware change or a software approach.

To reduce the trackball sensitivity, it is necessary to prescale the incoming trackball pulses. Figure 7 shows how an additional 74LS192 counter

circuit can be connected to each axis of the TIP interface. This approach extends the effective range of the counter from 4 bits to 8 bits. The TIP interface port and the upper/lower boundary checking, however, are still connected to only 4 bits. As shown, the 4 bits selected ignore the LSB of the first counter chip, effectively dividing by two the trackball pulses seen by the TIP I/O port, resulting in a trackball that produces only 240 pulses per revolution. If desired, the two lowest order bits of the first counter can be ignored, resulting in a trackball that is prescaled by 4, effectively producing only 120 pulses per revolution.

These hardware variations can be made to the design as shown by the TIP schematic of figure 5. To maintain symmetry, both the X and Y axes should be treated in the same fashion.

The scaling operations performed by the hardware changes of figure 7 can also be performed in software after the TIP data port is read. A simple divide-by-two operation can be applied to the X and Y data values. However, the effective number range that the TIP X and Y trackball values can represent is reduced from the -7 to +7 range to a -3 to +3 range. This reduced range adversely affects the ability of the trackball interface to represent a vector-like value indicating the direction and magnitude of the desired cursor move. The hardware approach as discussed, however, prescales the trackball pulses while completely retaining this vector-like characteristic.

Summary

A trackball can be interfaced easily to a personal computer. The TIP approach is both simple and inexpensive. A TRS-80 demonstration validated the design approach. While the TRS-80 did prove effective for evaluating the concept, I feel that a trackball device is better suited to higher resolution graphics systems having a minimum of a 150- by 150-pixel matrix.

Overall, the Disc Instruments LT200 trackball is well constructed. The design is mechanically simple, having few moving parts. While perhaps a bit lightweight to survive the demands of a video arcade, it is well suited to the home and office environment.

With the advent of the low-cost LT200 and similar products that no doubt will soon be offered by other vendors, the time has come to add the power and convenience of the trackball to the home computer. ■

Edward W. Andrews (18640 Arden Ave., Brookfield, WI 53005) holds a B.S. degree in computer science and works at General Electric's Medical Systems Operation. In his spare time, he enjoys volleyball, racquetball, and home computing with emphasis on computer-graphics applications.

TCS Heart of TEXAS COMPUTER SYSTEMS

Toll Free 1-800-433-5184

Texas 1-817-274-5625

CORVUS

HARD DISK DRIVES Complete from \$1649

Single and multiuser HARD DRIVES for all brands of computers
One or several computers can share A HARD DISK.

Tandon

TCS DRIVE CABINET is industrial grade heavy gauge metal, safety fused, and comes with gold plated external connector with extender cable.

1 DRIVE in Cabinet

40 track single sided \$199
80 track (dual sided 40 track) \$299
160 track (dual sided 80 track) \$399

2 DRIVE Double Cabinet

40 track single sided \$399
80 track (dual sided 40 tracks) \$599
160 track (dual sided 80 tracks) \$799

1 DRIVE Double Cabinet

40 track single sided \$259
80 track (dual sided 40 track) \$349
160 track (dual sided 80 track) \$449

Drives in cabinets come assembled and tested with power supply. Order cable separately.

BARE DRIVES ONLY

40 track single sided \$165
80 track (dual sided 40 track) SCALL
160 track (dual sided 80 track) SCALL
8 inch Slimline sgl/dbl sided SCALL
Winchester Hard Drives 5 Meg. \$399

CALL IF YOU FIND A LOWER PRICE ON DRIVES

PERCOM

Hard Drives supporting both DOSPLUS and LDOS

5 Megabytes of storage \$1390
10 Megabytes of storage \$1690
15 Megabytes of storage \$1990
20 Megabytes of storage \$2490

PRINTERS



PRINTER CABLES AND INTERFACES AVAILABLE
Call for current pricing

PRINTERS

- * 100 - 120 - 160 CPS
- * Bidirectional Logic Seeking
- * Friction and Tractor
- * 9X9 Dot Matrix
- * True Decenders
- * High Res-Bit Image Block Graphics

- * Super Script-Subscript
- * Underlining
- * Backspacing Doublestrike
- * 5, 6, 8 1/2, 10, 12 and 17 Pitch
- * Programmable Line Spacing
- * SIX (6) MONTH WARRANTY

GEMINI 10X (9 Inch Carriage, 120cps) Friction and Tractor \$CALL
GEMINI 15 (15 Inch Carriage, 100cps) Friction and Tractor \$CALL
GEMINI 15X (15 Inch Carriage, 120cps) Friction and Tractor \$CALL
DELTA 10 (10 Inch Carriage, 160cps) Friction and Tractor \$CALL
STAR Printers can be interfaced with most computers on the market today, such as:
Apple II, III, IIIe / IBM PC / Osborne / Heath Kit H89 / TRS-80 Model I, II, III, 4, 12, 16, 100
Zenith Z89, Z90, Z100 / T199/4A / Kaypro / Atari 400, 800 / Commodore 64, Vic 20
CALL FOR OUR LOW PRICES

Smith-Corona® TP-I

LOW COST LETTER QUALITY DAISY WHEEL PRINTER
Your choice PARALLEL or SERIAL Interface

List Price \$895.....~~\$1199~~.....\$CALL

TCS has the LOWEST PRICES on IN-STOCK PRINTERS!

DOT MATRIX PRINTERS

EPSON RX/FX
C ITOH 8510/TEC/PMC
DMP 100
DMP 200
DMP 400
DMP 500
DMP 2100
ANADEx 9501-A
CENTRONICS 352/353
OKIDATA

LETTER QUALITY PRINTERS

SILVER REED/BMC (16cps)
BROTHER/COMREX/BMC (16cps)
DMP 2100 (160/wp/100cps)
RS DAISYWHEEL II (40cps)
DWP 410 (25cps)
C ITOH F-10 (40 CPS)
NEC 3520/3530/3550
NEC 7710/7730

IBM

320K Bytes Tandon Disk Drives \$CALL
QUADBOARD 64k - 256k memory, clock, serial, parallel \$279
BMC RGB Ultra Hi Res Color Monitor \$449
HARD DISKS from \$1390

TRS-80

TRS-80 equipment comes with original 90 day Manufacturer's Limited Warranty.

MODEL 12 and MODEL 16

MODEL 12, 1 drive \$CALL
MODEL 12, 2 drives \$CALL
TCS MODEL 12 version, 2 Tandon drives (like the original) \$2995

MODEL 16B...Support up to 6 users. Run your whole office with hard disk capabilities for about \$1000 per user!

MODEL 16B, 1 drive \$CALL
MODEL 16B, 2 drives \$CALL

Model 12 and Model 16 Accessories

128K memory board (256K Max.) \$629
128K extra memory chips (RS) \$269
128K extra memory chips (TCS) \$189
Xenix Microsoft Multi-user Basic \$269
Xenix Accounting Software \$CALL
Xenix Multiplan Spread Sheet Software \$263
MII/12 to M16 multi-user upgrade kit \$1399
DT/1 Video Terminal \$629

MODEL IV

MODEL IV, 16K Cassette \$825
MODEL IV, 64K, 2 drives, RS-232 \$CALL

Model III Color Computer

All Radio Shack equipment is shipped from our store
in Brady, Texas

TCS Model IV, 64K, 2 Disks

Systems come with 180 Day Warranty

\$1499

With standard 40 track
double density drives.
Over 340,000 bytes.

RS-232 FREE!

\$1699

With 2 dual headed 40
track double density drives
Over 730,000 bytes

Enhanced Model IV Operating System Enhanced Model IV Operating System

Fully assembled and tested systems that are software compatible and functionally identical to Radio Shack units sold at computer stores for \$hundreds more.

- * CONTROLLER BOARDS are high quality double sided epoxy boards with gold plated contacts.
- * POWER SUPPLY is the finest switching type available.
- * MOUNTING HARDWARE includes power and data cables.
- * DISK DRIVES are Tandon, the same ones used by Radio Shack.
40 track, double density, with a 5 millisecond stepping rate.

TCS MODEL III DISK EXPANSION KITS

1 Controller, Power Supply, Mounting Hardware & Instructions \$249
2 Controller, Power Supply, Hardware & one 40 track Tandon Drive \$429
3 Controller, Power Supply, Hardware, two 40 track Tandon Drives \$598
3a Kit 3 but with two 80 track drives (dual sided 40s) \$791
3b Kit three but with two 160 track drives (dual sided 80s) \$989

TCS MODEL IV DISK EXPANSION KITS

11 Controller, Power Supply, Mounting Hardware, one 40 Track Tandon Drive \$479
12 Controller, Power Supply, Mounting Hardware, two 40 Track Tandon Drives \$649
12A Kit 12 but with two 80 Track Tandon Drives \$629
12B Kit 12 but with two 160 Track Tandon Drives \$849

DAVONG HARD DRIVES

5 Megabytes of storage from \$1295
10 Megabytes of storage \$CALL
15 Megabytes of storage \$CALL
Networking systems for multiuser hard disks. Tape and cartridge back up systems are also available for IBM PC, APPLE II, and APPLE III.

APPLE DISK DRIVES

High quality slimline drives
1st drive w/controller \$279
2nd drive only \$229
Totally compatible with all apple software

\$CALL

TCS Heart of TEXAS COMPUTER SYSTEMS

P.O. Box 1327 Arlington, Texas 76004-1327

Toll Free 1-800-433-5184 Texas 1-817-274-5625

Circle 423 on inquiry card.

1-800-451-2502 to order
 or 617-641-1241 in Mass.
 617-641-1235 for
 Technical
 Support

Banc

WHAT IS SoftwareBanc?

Over the last two years SoftwareBanc has provided the nation's most complete package of dBASE II™ products and services. Our User's Guide and Seminars have introduced more than 60,000 people to dBASE II™. Even expert dBASE II™ users can benefit from our Advanced User's Guide and quality add-on products. When it comes to dBASE II™, SoftwareBanc is the source.



SOFTWARE WITH TECHNICAL SUPPORT

Data Base

dBASE II™ with
 free dBASE II™
 User's Guide \$439
 ABSTAT ... \$359
 DBPlus \$ 95
 dGRAPH ... \$199
 dNAMES .. \$109
 FRIDAY! .. \$199
 Quickcode . \$199

Word Processing

WordStar .. \$269
 SpellStar .. \$149
 MailMerge . \$149
 StarIndex .. \$149
 Volkswriter . \$129

Spreadsheets

1-2-3 with
 free 1-2-3 Trans
 \$399
 Supercalc2 . \$199
 Multiplan .. \$219



Our low software prices include unlimited, free technical support by our staff of software experts. You can trust us to be there for technical problems, tips or application advice.

SoftwareBanc

661 Massachusetts Avenue, Arlington, MA 02174

Circle 394 on inquiry card.

On Us

BOOKS



dBASE II™ User's Guide
by Adam B. Green
Join the 55,000 people who have made this the standard text on dBASE II™. \$29.00 - FREE with dBASE II™



Advanced dBASE II™ User's Guide by Adam B. Green This collection of previously unpublished tips and techniques is the perfect companion to the dBASE II™ User's Guide. \$29.00



Report Writing in dBASE II™ by SoftwareBanc Technical Services Everything you always wanted to know about dBASE II's™ Report Writer. \$11.95

VIDEO



dBASE II™ Fundamentals on Video Tape

Written and Narrated by Adam B. Green

This professionally produced, three hour video tape will help any viewer to create and manage dBASE II™ data files. Now you can have a SoftwareBanc Seminar in your home or office.

\$295.00 (VHS or Betamax formats). \$50 savings with dBASE II™.

SEMINARS



dBASE II™ and 1-2-3™ SoftwareBanc Seminars

Taught by Adam B. Green

Over 5,000 people have attended SoftwareBanc Seminars around the country. Our custom video presentation system will help you "Teach Your Computer Who's Boss."

dBASE II™ Fundamentals
Advanced dBASE II™

San Diego
Dec. 12, 13,
15, 16
\$175/Day

Washington, D.C.
Jan. 9, 10, 11, 13
\$175/Day

dBASE II Programming
Problem Solving With 1-2-3™

Orlando
Feb. 6, 7, 8, 10
\$175/Day

Chicago
Mar. 12, 13, 14, 15
\$200/Day

ORDERING

To order, please call 1(800) 451-2502 or 1(617) 641-1241 in Mass. Hours are 9 AM - 8 PM E.S.T. Monday-Friday and 9 AM - 5 PM E.S.T. on Saturday.

Payment may be made by: MasterCard, VISA, check, C.O.D., money order. Mass. Residents add 5% sales tax. Add \$5 for S&H. Prices subject to change without notice. TM-Manufacturer's Trademark. Dealer Inquiries Invited. Ask about our Discount Savings Plan.

CLIP & MAIL

Send me a free catalogue.

Have a representative call me.

Name

Company

Address

City/State/Zip

Phone Number

Computer/Disk Format:

Return to: **SoftwareBanc**

661 Massachusetts Avenue
Arlington, MA 02174

LOMAS DATA PRODUCTS PRESENTS:

THE S100-PC FOR \$2995 THAT LOOKS TO THE FUTURE.

Our S100-PC is more upgradeable and expandable than any other personal computer. And, now it's available with a 10 Megabyte harddisk drive!

The S100-PC is a cost effective, high performance personal computer. Because it is based on the IEEE 696 (S100) bus it is more upgradeable and expandable than any other personal computer. Software is no problem either, the S100-PC will run programs designed for CP/M-80, CP/M-86, and MSDOS (PCDOS). This offers the user wide flexibility in applications software. The S100-PC can read and write IBM-PC diskettes allowing for easy data and program interchange.

To insure against obsolescence, buy the personal computer with a future . . . the S100-PC.

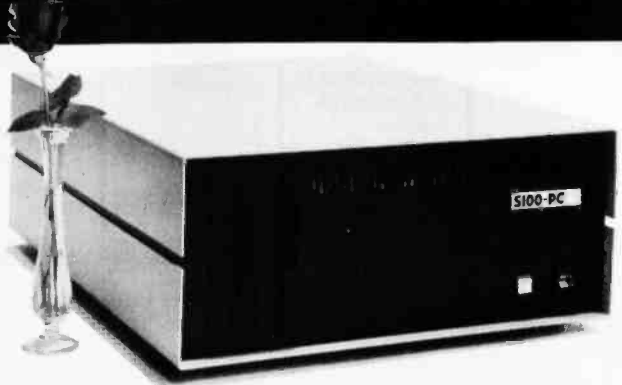

Standard features include:

- two double sided 5¼" disk drives
- two serial and two parallel ports
- battery protected clock calendar
- 8 MHz 8086 processor
- 128K RAM
- an attractive 15 slot desktop enclosure.
- Plus, a wide range of options are also available.

LDP also offers a complete line of high performance S100 bus board products & support for the system integrator . . .

■ **HAZITALL SYSTEM SUPPORT BOARD**

2 serial, 2 parallel ports, battery protected clock calendar, Hard disk controller host interface.
PRICE \$325.00

■ **LDP128/256K DYNAMIC RAM**

Advanced dynamic RAM with LSI controller for failsafe operation, parity.
Price 128K — \$495.00, 256K — \$795.00

■ **RAM67 HIGH PERFORMANCE**

STATIC RAM High speed (100ns) low power CMOS static RAM. 128K bytes, extended addressing.
PRICE \$995.00

■ **LPD72 FLOPPY DISK CONTROLLER**

Single/double density, single/double sided disks, both 8" and 5¼" inch drives simultaneously.
PRICE \$275.00

■ **LDP88 8088 SINGLE BOARD**

COMPUTER 8088 CPU, 1K RAM, 8K EPROM, Monitor RS232 serial port, 8 vectored interrupts.
PRICE \$349.00

■ **LIGHTNING ONE***8086/8088 CPU**

8086 or 8088, with 8087 and 8089 coprocessors. Up to 10 MHz operation.
PRICES start at \$425.00

■ **LIGHTNING 286 — 80286 CPU BOARD**

Offers 4 times the performance of a 5 MHz 8086 CPU while maintaining software compatibility.
PRICE \$1395.00

■ **OCTAPORT 8 PORT SERIAL BOARD**

8 serial ports 0 to 19200 baud operation real time clock interrupt. Ideal for multi-user systems such as MP/M-86.*
PRICE \$395.00

All of LDP boards are fully tested to exacting standards and carry a one year warranty. We specialize in 16-bit products & support the four major operating systems for 16-bit processors: CP/M-86*, MP/M-86, CONCURRENT CP/M-86*, and MS-DOS (PC-DOS).**

If your application requires 16-bit computing power and versatility, call Lomas Data Products today.

Dealer inquiries invited.

LDP

LOMAS DATA PRODUCTS, INC. □ 66 Hopkinton Road, Westboro, MA 01581 □ Tel: (617) 366-6434

*CP/M-86, MP/M-86 and CONCURRENT CP/M-86 are trademarks of Digital Research.
**MS-DOS is trademark of Microsoft.
***Lightning One is trademark of Lomas Data Products, Inc.

The User Interface: Two Approaches

Both philosophy and pragmatism are viable courses

by Martin Herbach, Richard Katz, and Joseph Landau

In this article we present two approaches to the construction of an efficient user interface. The first, by Martin Herbach, provides his philosophical point of view that too often software developers are so wrapped up in the video-display aspects that the functionality of the program suffers. A text box by Richard Katz provides some basic guidelines that can help in user-interface development. Joseph Landau follows by giving us an example of a philosophy that evolved from direct user feedback as his company began the process of increasing the capability of one of its products without complicating its use. While the user interface continues to be a topic of heated discussion, you will see from these two points of view that we are still far from any universal agreement about how to blueprint man-machine interaction.

How Is a Computer Like an Elephant?

by Martin Herbach

Perhaps no piece of computer jargon is more shrouded in mystique than "user interface." Like the blind men's elephant, the term means many things to many people. Rather than concentrate on the tasks that people are trying to perform, too many of us software people have gotten hung up in the mechanics of how users physically communicate the various elements of these tasks. We've transformed a willing servant into a wall of icons and windows, a snake of display management, a tree of gold to the minds of some marketing managers, and rope for a Gordian knot.

When you clear away the jargon-induced fog, a user interface is merely that part of a program that simulates a more appropriate computer to run the rest of the program. In other words, it's really the solution to a hardware problem. We're asking a vast segment of our population to use computers for all kinds of tasks, but we're stuck with a "standard" setup, a box with a processor and a

couple of floppy-disk drives, a 200-line-resolution monitor, and a keyboard without a key marked Return.

The most significant thing about this computer is the user, a technologically naive but competent business worker with limited time. Users include managers, secretaries, execu-

**A user interface
simulates a more
appropriate computer
to run the rest of the
program.**

tives, real-estate agents, dentists, financial analysts, and myriad others with a need to operate with more information more efficiently. Their tasks include creating and modifying documents, filing and retrieving documents and records, preparing presentations, free-form drawing, planning schedules, and manipulating spreadsheets as well as such vaguely defined objectives as analysis.

Software should be designed around the uses to which it will be applied; those applications of the software must come to the user easily and intuitively. Some ways to make a program easy to use are having fewer and simpler options, and a consistent structure, and hiding sophisticated options where unsophisticated users won't be intimidated by them. Having natural-language feedback to confirm command and option choices as well as friendly error-diagnosis messages that enable error correction in as few keystrokes as possible are other important elements. But many seemingly straightforward techniques are surprisingly overlooked in some of the most recent designs.

Only after "intuitive functionality" has been displayed should we look at how the user will physically operate the program. And this is where we tend to redesign the hardware.

One practical problem with spending many aggregate years on the development of such low-level phe-

nomena as multiple-window managers and wastebasket icons is that we might shortly find our code incorporated in the next generation of video-controller chips—assuming that our approach is as successful with the user as we hoped it would be. If it is, I feel that it will be much better implemented by hardware.

I have nothing personal against prototyping the next generation of professional computers, but I wonder how many man-years of software development will have to be amortized over how short a period. In any case, it's reassuring that there are pressures that will coax software vendors to return to solving higher-level problems. Heaven knows the user has them.

The specific use for office-automation computers is increased information-management efficiency. One metaphor that is in vogue to convey this capability is the top of a "cluttered" desk. Many capable minds expended tremendous efforts to produce a detailed simulation of file folders, in-baskets, clocks, pads of paper, and a ubiquitous moving arrow. Get the arrow squarely on the proper file folder and eventually you wind up with some of your desktop simulating a cumbersome word processor. Clearly the word processor is the afterthought, while the window manager, icon manipulator, rodent priority interrupt handler, and wastebasket janitorial routines got the bulk of the development resources. Some reasons for this state of affairs are

1. We computer types know more about video management than calendar management.
2. Redesigning hardware is fun.
3. There's hardly any fun in designing another word processor.
4. There's hardly any fun in selling another word processor.

To illustrate the varying approaches that can be taken in designing productivity software, let's examine a representative feature, multiple windows. At the lowest level (technology), multiple windows imply the management of screen regions, so that one region can be modified with-

out disturbing the rest and so that the original contents of the region can be restored later. If we start with that definition, we start asking questions like these:

1. How much resolution do we have or need?
2. What about color?
3. How do we scroll a portion, or region, of a screen?
4. What about nongraphics configurations of the target computer? Do we support them? Do we optimize for them?

Note that these are all really hardware questions. The danger is that we spend so much time investigating these topics that we forget to ask questions like the following:

Multiple-task windowing is the most natural way to express task concurrency.

1. What function will I put my windows to?
2. For word processing, can I have windows on separate documents simultaneously?
3. Can I have multiple windows on the same document? (This may actually be harder than 2! Consider rejustifying the contents of a window on page 100 because of a change in the window on page 1.)
4. For spreadsheet applications, can I view my data one way (say, as formulas in 20-character-wide columns) in window one and another (say, current values in 5-character columns) in window two? This is something that very few of the stand-alone spreadsheets (where windowing was pioneered) got right.

These functional capabilities of windows are what must be looked at first. They may not be as sexy as rubber-band borders and scrolling panels, but a proper user interface is one that defines the maximum func-

tionality in the most intuitive fashion. (For some all-purpose software-development guidelines, see the "Interfacing Users and Software" text box on page 250.)

The Xerox/Lisa/Visi On approach is predicated on the simultaneous viewing of multiple tasks (as opposed to multiple views of the same task). For some people, this may not provide an easy-to-use, productive environment. When my desktop contains four tasks, such as memos to read or write, correspondence to review, and a couple of designs in progress, my tendency is to push three aside and pick one to work on. The clutter that I referred to earlier is something that computers should eliminate, not reproduce. An additional problem is that the current generation of microcomputer systems hasn't sufficient video resolution to allow the display of adequate amounts of multiple tasks. This problem is not permanent, however.

Now that I have played the devil's advocate, let me state that many of the concepts introduced with the window-management style of user interface are very valuable. Object-oriented data flow could be the most important. The ability to communicate information among tasks visually is very natural. The only better way is to integrate the tasks so that the communication is not required.

Multiple-task windowing is the most natural way to express task concurrency. It's so natural, in fact, that many sophisticated observers are convinced of Visi On's ability to do more than one thing at a time. Of course, without some sort of task manager to schedule resources, concurrency is impossible, and this has not been provided for the microcomputer environment—yet. When it does happen, the window-manager scheme will get a real workout. Until then, I hope that software designers concentrate on improving what the user gets to do inside a window rather than getting to it. ■

Martin Herbach is a founder of and program designer at Sorcim Corporation (2310 Lundy Ave., San Jose, CA 95131).

More vivid graphics from your personal computer with Sakata CRT Monitors.

Your personal computer deserves a SAKATA CRT MONITOR.

Truly IBM compatible with resolution of 640 dots x 240 lines and distinguishes 16 colors. Exclusive tilt/swivel stand (Model STS-1) provides better viewing from variety of angles. Modern streamlined design, backed by SAKATA's more than four generations of demanding the utmost in quality. ... "We Promise Performance".

Also available: Model SC-100 13" Composite COLOR CRT MONITOR. Model SC-300 13" RGB super high resolution COLOR CRT MONITOR. Model SG-1000 12" monochrome high resolution CRT MONITOR (green). Model SA-1000

monochrome high resolution 12" CRT MONITOR (amber).

SAKATA CRT MONITORS are available wherever personal computers are sold or write for technical and illustrated literature and prices.

SAKATA U.S.A. CORPORATION
651 Bonnie Lane, Elk Grove Village, IL 60007
(312) 593-3211 800-323-6647 (outside Illinois)

Sakata

"Serving industry worldwide . . . since 1896"

Circle 379 on Inquiry card.

Illustrated: Model SC-200 13" RGB High Resolution CRT COLOR DISPLAY MONITOR with STS-1 Stand (option). Compatible with IBM and other fine personal computers

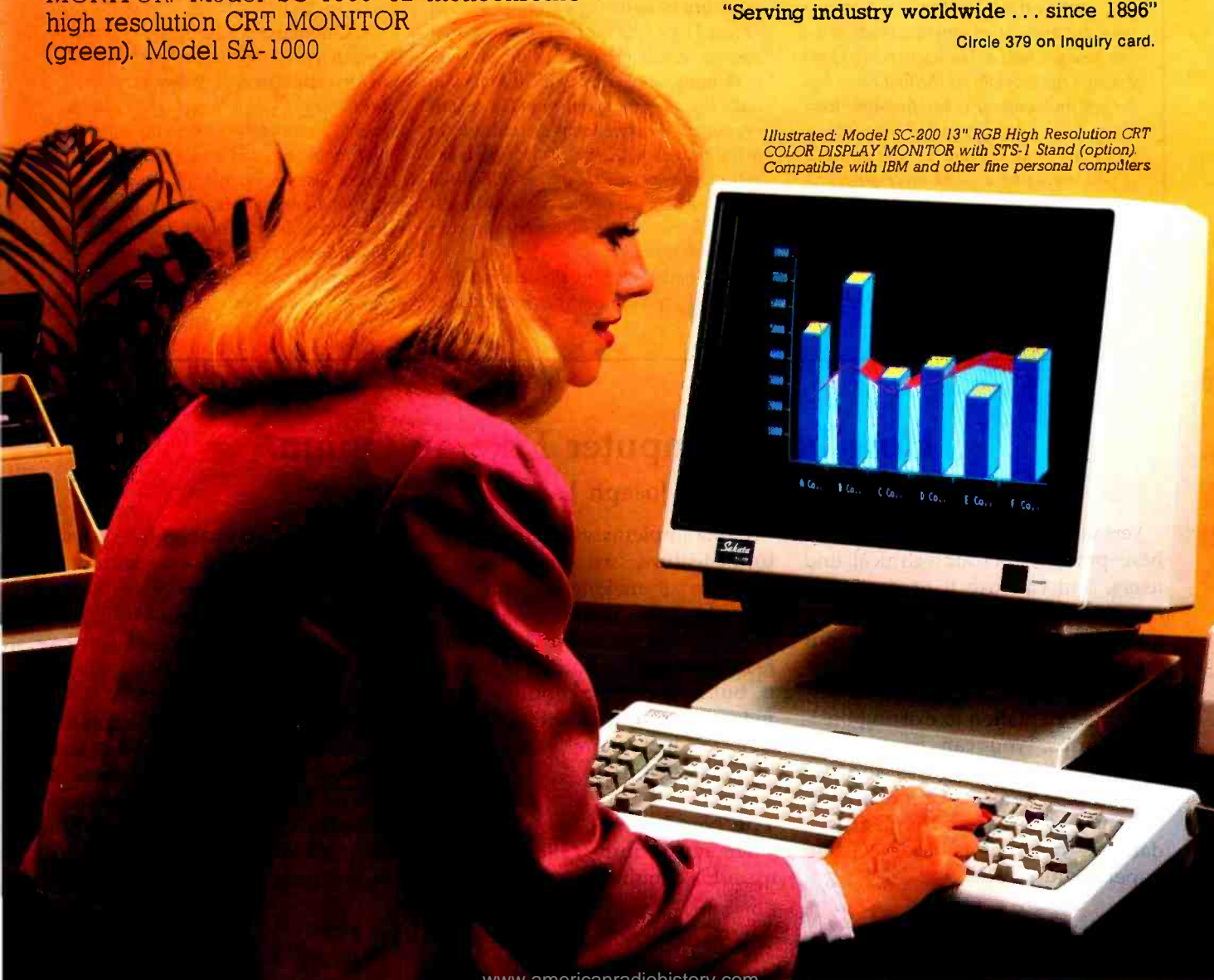

Interfacing Users and Software

by Richard Katz

As software developers trying to accomplish today what AI (artificial intelligence) may someday be able to assist with, you must apply your intelligence instead. Collect what you know about the program and express it as well as you can to clarify how to use it. Included here are several guidelines that you might think of as a sort of software extension for Strunk and White's *The Elements of Style*, for, indeed, the guidelines begin in that very place.

1. Practice clear writing techniques. Study books like *The Elements of Style and Clear Technical Writing* by John Brogan. Hire and work closely with an experienced technical writer during the development stage. A course on technical writing may also be a worthwhile investment.

2. Focus on the application. Consider what the application program needs to do. Imagine yourself as the user trying to get through the program for the first time. Better yet, find someone to be a first-time user. Write down what you expect the program to do and what it must do. For example, if you are using a word-processing program, you ought to be able to type in a letter, save it on disk, print it, retrieve it and look at it again, make changes, and save it again.

3. Include on-screen help capability.

A tutorial demonstrates what software can do, but it cannot provide immediate assistance. A good tutorial illustrates a meaningful use of a program and demonstrates how to use the program to make it do that one thing. Along the way, it shows the commands that must be entered and what they do within the framework of the example. However, the tutorial is of necessity separate from the program itself. It cannot give you information about program controls while you actually operate the program. On-screen help can do so.

Numerous approaches have been tried for on-screen help capabilities. While few are truly successful, the help capability nonetheless offers great potential for making program controls obvious.

Make it clear how to access the help capability by including a message such as "Press F1 for help" at the beginning or, if possible, continuously while the program is running. Also, clearly identify how to leave the program to return to the operating system. Few programs do this well. In many programs, either the exiting information is very obscure or it is difficult to get to the help screen that contains the exiting information. Thus, the trusting user can get trapped.

I recommend starting the design with a two-level approach that first presents the

user with an overview help menu. From this menu the user selects topics, thus providing individual control over the learning process.

For instance, a project-planning and management-control program informs the user at the beginning to press the question mark (?) key to get help. Then the overview help menu shown below appears on the screen.

What kind of help do you want? 1. Where am I, anyway? 2. How do I enter data in this field? 3. How can I make changes? 4. I'm done here. What do I do now? Press 1, 2, 3, or 4:
--

4. Orient users to program controls. Orientation is what happens your first day in high school or college. You learn where the library is, when to register for classes, how to get an adviser, where the laundries and restaurants are, and so on. In a help screen, use the orientation form to identify program controls. On the left side of the screen, describe in everyday language the things that the user will need to do. On the right side, show the keys to press or commands to enter. For example, sup-

How Is a Computer Like an Onion?

by Joseph Landau

Versaform is a forms-oriented database product for nontechnical end users. You can use it to design or copy a form on the computer, perform computations, produce output on preprinted forms, and create reports and analyses. Because of Versaform's orientation to existing business forms, you can continue to follow familiar procedures and use familiar data formats. Essentially, Versaform provides a way to construct a database from a business's existing paper-form records.

While implementing a new Versaform feature, we confronted the problem of making an inherently complex task seem as simple as possible. We realized that each new feature brings the burden of learning it, but how can we continue to provide more functions without making our product more complex and harder to learn?

The Need

The new feature, called File Look-up, adds a multifile access capability

to Versaform. It enables the system to search for data on a secondary file and automatically enter this data on the current form the user is filling in.

For example, suppose an invoice (the primary form) is being filled in (see figure 1). Versaform is able to check entries against an internal table of valid part numbers, find descriptions and prices, and compute extended totals and column totals, all automatically. Internal tables, however, are limited to 99 entries, which is adequate for professional offices

pose the user selects item 4 from the help menu. The next screen the user sees looks like this:

What to do next:

- To save your work, enter /S
- To print a report, enter /O
- To leave the program, enter /Q
- To clear the work area, enter /Z
- To retrieve an old plan, enter /L
- You can also work on the project plan from a different view
- To select another view, enter /V

The screen above could be enhanced further by listing the page number in the user guide that explains each of the subjects in greater detail.

5. Eliminate extraneous information on the screen. Brevity engenders clarity, provided you strengthen the verbs, use the active voice, and eliminate the deadwood. By being succinct and including only what is important, you will be able to clarify program use. Users won't have to dig through a lot of information that's not pertinent to their situation.

In the help screen above, each instruction begins with "To do this" on the left side. Descriptive verbs such as save, print, and retrieve provide more clarity than a

broad verb like use. The definite nouns your work, a report, etc., add to clear understanding. The verb enter on the right side explicitly directs the user's action.

6. Use help to document program error messages. Another aid for the user explains how to resolve situations that create error messages. Although this capability logically belongs in on-screen help, it rarely occurs. Possible reasons are that it requires extra programming or that it takes up additional disk space.

To provide this assistance requires that you give each error a separate number, write a detailed explanation of the error message, and describe some action to circumvent the error. Then create a data structure and triggering mechanism to present them at the proper times. For instance, suppose the user of a spreadsheet program makes an error while entering a formula. The user enters the formula "+A1+3*" and forgets to include an additional operand following the "*." Spreadsheet programs generally respond to this by printing a short message such as "FORMULA ERROR" or by producing an annoying beep. Now, the user is stuck; the only solution requires erasing the formula from the entry line. The beep or nebulous two-word message is more irritating than

helpful.

In most spreadsheet programs that have on-screen help, when the user requests help a full page of information appears. But it is the same descriptive page that is available even if the user had not made the error to begin with. A program that has true on-screen error help should print a message like the one shown below.

You have made an error in the formula you are trying to enter.

To continue, you must first correct the error or press (whatever) to clear the entry.

Note that no attempt is made in the message to diagnose the formula error; a diagnosis is not essential. The vital information tells the user how to continue. Including error message analyses such as the ones above further reduces the apparent and actual dangers in using a computer program.

Richard Katz (412 Green St., San Francisco, CA 94133) is a technical editor for Osborne/McGraw-Hill Book Company.

but not large enough for inventory information in many retail and wholesale businesses. Our solution was to allow the needed data to be accessed directly from a separate inventory file—either on a hard disk or on another floppy disk.

In addition to locating the values for description and price on the inventory (secondary form) and filling them in on the invoice, File Lookup also finds out from the inventory whether there is a large enough supply to fill the order and subtracts the quantity ordered from the quantity on hand. Or, if the quantity on hand is not sufficient to fill the order, back-

order information is automatically entered on the inventory. To handle these tasks, the new feature combines multifile access with user-defined procedures necessary for the conditional updates.

The Mechanics

We began the process of designing the user interface for the File Lookup feature with an outline of the functions involved:

1. Exactly when will the desired action be executed?
2. Where will the lookup data be found (which record, on which file, on which disk)?
3. Where will the system look for the information it needs to find the required record—that is, where is the key?
4. The system must be told what to do with the data it finds:
 - a. Instructions for moving data in both directions between the two forms (records).
 - b. What calculations to perform.
 - c. Under what conditions certain operations are to be performed.
5. If the lookup form has a columnar area (a repeating group), as in the Quantity Price-Break Table in the inventory in figure 1, which line

Primary Form		Secondary Form	
INVOICE		INVENTORY	
DATE 5/23/83	INV# GRE6	PARTNO ABC111	Key Item
NAME Joe Green		PARTNAME Widget	
ADDRESS 2310 Grant St		ONHAND ...136	
CITY Middle City	ST IL ZIP 60202	BACKORDERED	
		STDPRICE 20.00	
L# QTO QTS .PART. DESCRIPTION PRICE .COST.		Quantity Price-Break Table	
01 30. ... ABC111 Widget..... 17.00		L# .QTY. .UNITPRICE.	
02 25. ... DEF123 Gizmo..... 13.50		01 ...1020.00	
		02 ...2518.50	
		03 ..10017.00	
		03 .999916.00	
Inventory Key Item	SUBTOTAL		
	TAX		
	TOTAL		

Figure 1: Primary- and secondary-form interaction. While you are entering data on the invoice, the File Lookup feature discussed in the text finds information in the inventory on another file and automatically enters it on the invoice.

will contain the data? The desired line can be located in a number of ways:

- Look for an exact match with the values in one of the columns.
- Look for the first entry exceeding a certain value (as in a tax table).
- Find a figure in a range between two columns.

First Design

Consistent with its forms-related environment, Versaform provides throughout its programs a variety of on-screen forms you fill in with instructions for the system.

For the File Lookup feature, our first on-screen form appeared as illustrated in figure 2. It has been filled in as it would be to perform the functions described in the invoice/inventory example. In brief, it provides these instructions to the system:

Lookup Trigger Item—This is the item on the primary form that triggers the lookup. That is, the search will actually begin when the user fills in the item called Part on the invoice. This field is filled in automatically by the system when the form appears on the screen.

Secondary-File Disk, Secondary File—The form to be looked up will

be found in the inventory file on Mydisk.

Key-From1,2—Each Versaform file is identified by its unique key item, which may be a single field or a concatenation of two fields. To locate the secondary form, the system must know where it will find that form's key item among the data entered into the primary form (the current form in which information is being entered). In the example, that data will be found in the Part item on the invoice. The data from Part (the part number) is used as the key to find the proper record on the inventory file (whose key is the field called Partno).

Column Key-From—If the lookup operation is to extract values from a column line on the secondary form (i.e., from the Quantity Price-Break Table), the system must know the item on the primary form that will supply the value to be searched for. This is Qto (quantity ordered) on the invoice.

Lookup-Column1,2, Interval Search—This is an either/or set of fields, by which the user identifies which of the three available column-search options the system is to perform (match, first line exceeding value, or range between two columns). In the invoice/inventory ex-

ample, the system searches the item called Qty on the secondary form (the inventory) for a value equal to or greater than the value of Qto.

In the Transfer List, at the bottom of the form, the system finds these instructions:

Lines 1 and 2 transfer data to the primary form. The second column (headed "@") specifies the direction of transfer.

Line 3 checks to see if Qto is less than or equal to that Onhand. If true, the next three lines are skipped; the quantity Onhand in the inventory is reduced by the Qto (Line 7), and the value in Qto is moved to Qts (quantity shipped) on the same form (Line 8).

Lines 4 and 5 apply if Qto is greater than the quantity Onhand. They instruct the system to add the Qto to Backordered on the inventory (Line 4), enter 0 in Qts on the invoice (Line 5), and skip the next two instructions (Line 6).

Line 9 saves the new information on the lookup form (inventory).

Testing the Design

As an aid to understanding how

MEMORY PLUS MORE

LSI 11 MEMORY

MULTIBUS MEMORY

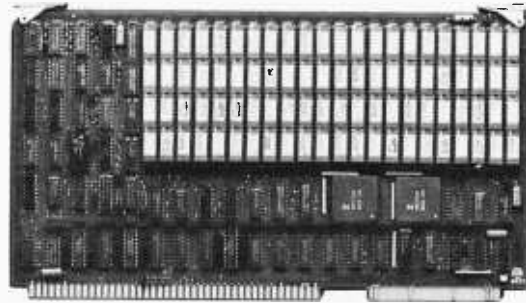
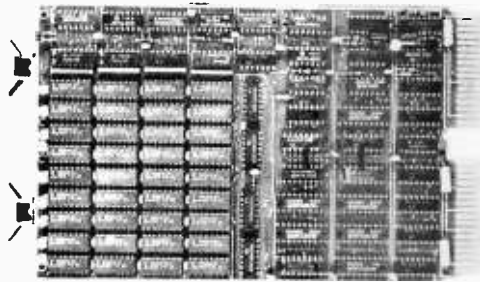

512 SINGLE BOARD W/RS232-C PORT MEMORY FOR IBM PC, XT

- On board parity with interrupt on parity error.
- Addressable as a contiguous block in 64KB increments thru 1 megabyte.

SINGLE QTY. PRICE:
512KB \$545.00

FREE with purchase of memory.

MEMDISK 1 Allows memory to emulate disks.

256KB TO 1 MB SINGLE BOARD LSI 11 MEMORY

- Control Status Register (CSR).
- On board parity generator checker.
- Battery back-up mode.

SINGLE QTY. PRICE:
256KB \$595.00
1MB \$3995.00

512KB TO 2MB EDC SINGLE BOARD MULTIBUS MEMORY

- Pin to Pin MULTIBUS compatibility for both 8 bit and 16 bit systems.
- Addressable up to 16 megabytes.
- On board parity with selectable interrupt on parity ERROR.

OR

- Error Detecting and Correcting (EDC).

SINGLE QTY. PRICE:

	Without/EDC	W/EDC
512KB	\$895.00	\$1495.00
2MB	\$5995.00	\$6495.00

MEMORY PLUS MORE from Chrislin means your getting the best in performance and pricing in the market today. Incorporating the 256K RAM technology into the LSI and Multibus memories offers you the most recent technology available. Act now while quantities still last.

140MB WINCHESTER DISK SYSTEM FOR LSI BASED SYSTEMS

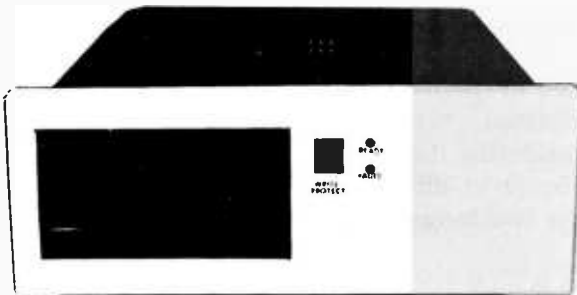

CI-1340-WF: 140MB formatted Winchester (8") disk system w/controller and 2MB floppy (8") backup w/controller.

PRICE:
\$9995.00

"OFFERING QUALITY WITH AFFORDABLE PRICING"



Chrislin Industries, Inc.

31352 Via Colinas • Westlake Village, CA 91362
Telephone: 213-991-2254 • TWX 910-494-1253 CHRISLIN WKVG

IBM is a Trademark of International Business Machines. Multibus is a Trademark of Intel Corporation. LSI is a Trademark of Digital Equipment Corporation.

FILE TRANSFER INSTRUCTIONS

Lookup trigger item PART

Select the file to look up, the key-from items, the column search items, and the items to transfer.

SECONDARY-FILE DISK Mydisk..... SECONDARY FILE Inventory.....

KEY-FROM1 Part..... KEY-FROM2

COLUMN KEY-FROM Qto..... (Item on primary form)

LOOKUP-COLUMN1 Qty..... (low value)

LOOKUP-COLUMN2

-or-

INTERVAL SEARCH (Y/N) y (on LOOKUP-COLUMN1 item only)

Transfer List

L#	PRIMARY-ITEM	@ CALC	LOOKUP ITEM	COMMAND
01	DESCRIPTION.....	<	PARTNAME.....
02	PRICE.....	<	UNITPRICE.....
03	QTO.....	. LE..	ONHAND.....	/skip 3.....
04	QTO.....	> +...	BACKORDERED.....
05	QTS.....	<	0.....
06	/skip 2.....
07	QTO.....	> -...	ONHAND.....
08	QTS.....	<	*QTO.....
09	/save.....

Figure 2: The first attempt at design of an on-screen form for the invoice/inventory example shows user-entered instructions in tinted areas. This arrangement proved to be too complicated for easy user acceptance.

the new feature would appear to users at this stage, a first draft of user-directed documentation was written from the specifications and circulated to reviewers. It served to inform those familiar with Versaform about the purpose of the new feature. The invoice/inventory illustration offered a simple example of how and why it would be of value to them.

In addition to the descriptions of fields on the File Transfer instructions in figure 2 similar to those just given, the documentation contained an explanation of the columnar area of the Transfer List form. We expected the reviewers to absorb these concepts:

The @ symbol, indicating the to-or-from direction of the transfer, has three legal options, or it can be left

blank to signal either no data transfer or to defer to a Command instruction.

The Calc column is used to specify calculations to be performed when transferring data, introducing the terms Target and Source to differentiate between the two forms involved.

The Command column is a catchall used for either commands, values, instructions, comparisons, or conditionals.

What we found, however, at this stage of development was that the File Lookup feature was a big lump for the reviewers to swallow and might, in fact, be indigestible. Before even the most basic of File Transfer operations could be managed, users

were required to understand the differentiation between the two files involved, the trigger concept, two applications of key, and the variations in the column lookup operation involving one column or two, whether inclusive or not. In addition, a small glossary of programming terms was introduced.

Two Conceptual Steps

Our documentation and product-support staff identified two areas of confusion for nontechnical users.

First, the variations in the column-line lookup operation could not be clearly defined in the limited space available at the top of the form. More important, however, the variations were specialized; in simple applications where they were not necessary

It Meets Your Needs... Whatever They Are

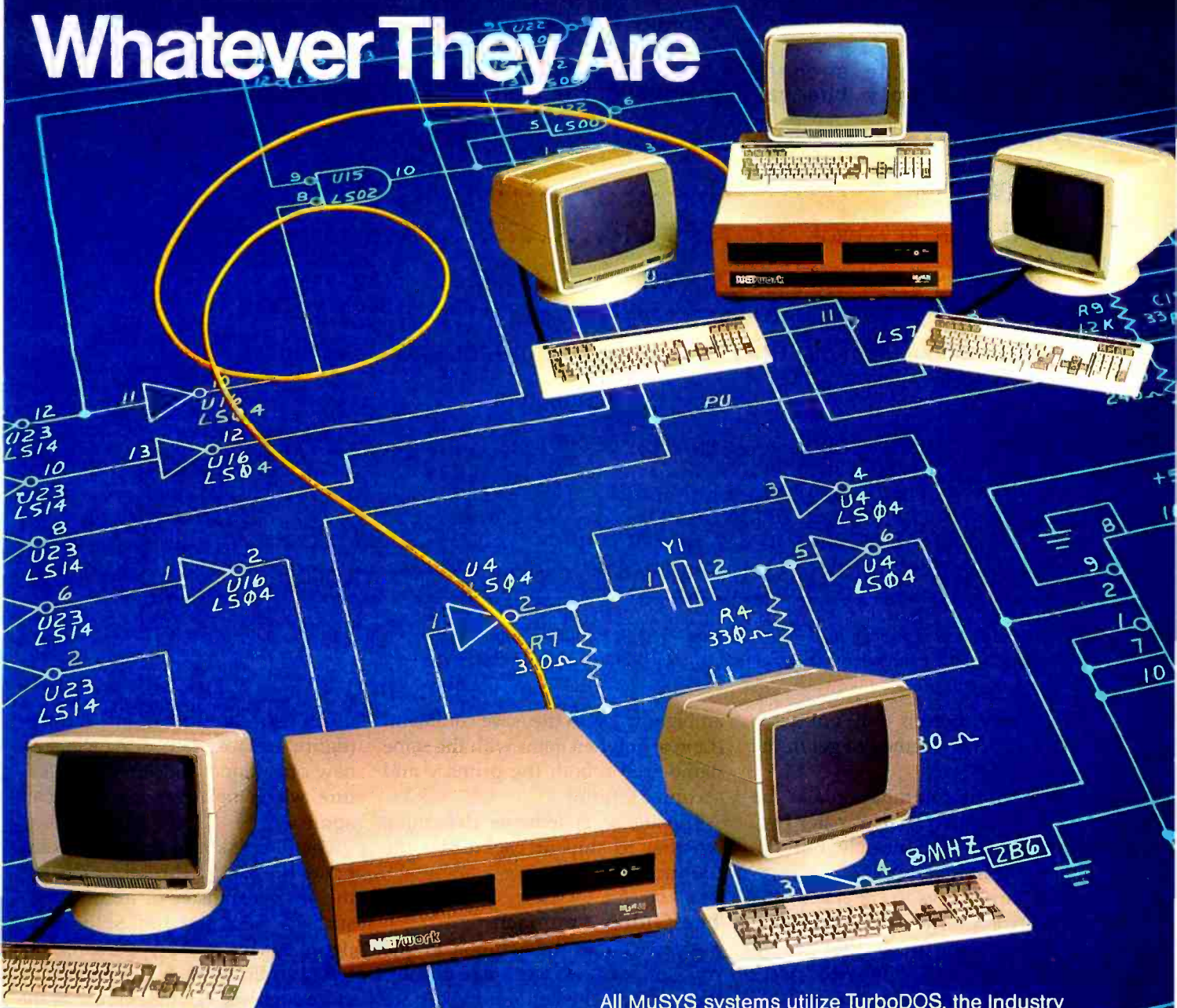

Large Multi-user Capability

A truly professional, reliable solution—the NET/work 8816 has been specifically designed for installation in demanding multi-user applications. The low starting price allows you to start with two users and grow later to many thousands without the expense of replacing existing equipment or software as you grow. We offer three types of Local Area Networking, including Ethernet, with full shared multi-system resources. AND IT WORKS. Gone are the bottlenecks that make shared-processor multi-user systems too sluggish for real time applications. What's more, we offer an unbeatable combination in a video terminal with our NET/work. You get styling, operating comfort, value and reliability.

All MuSYS systems utilize TurboDOS, the Industry Standard Multi-user Operating System. Mainframe capability at microcomputer prices, and compatible with virtually all CP/M Software. NET/work systems give you advanced features such as 8MHZ processors, high speed hard disk drives with storage capacities up to 280MB, and 16 bit future upgrade path.

This system meets your needs...WHATEVER THEY ARE. Call or write, MuSYS Corporation, 1752-B Langley, Irvine, California 92714. (714) 662-7387 toll free outside California 1-800-852-5362. TWX 910-595-1967. Cable MUSYSIRIN.

Dealer and OEM inquiries welcome.

MUSYS
CORP

We design the future.

NET/work is a trademark of MuSYS Corporation. TurboDOS is a trademark of Software 2000, Inc. CP/M is a trademark of Digital Research, Inc. Ethernet is a trademark of Xerox Corporation.

```

FILE TRANSFER INSTRUCTIONS

Lookup trigger item PART

Fill in the secondary disk and file name, the primary item(s) that
will supply the values needed for lookup, and Procedure.

SECONDARY-FILE DISK Mydisk ..... SECONDARY FILE Inventory....

KEY-FROM1 Part..... KEY-FROM2 .....

COLUMN KEY-FROM Qto..... (Item on primary form)

LOOKUP-COLUMN1 Qty..... (low value)
LOOKUP-COLUMN2 ..... (high value)
-or-
INTERVAL SEARCH (Y/NO) y (on LOOKUP-COLUMN1 item only)

PROCEDURE

L#
01 DESCRIPTION := PARTNAME;.....
02 PRICE := UNITPRICE.....
03 if QTO < ON_HAND then begin {ship it}.....
04 ONHAND := ONHAND-QTO; QTS := QTO;.....
05 end else BACKORDER := BACKORDER + QTO;.....
06 /save (b).....

```

Figure 3: This revised form for the invoice/inventory example substituted procedural instructions in place of the Transfer List. This arrangement was a definite improvement over figure 2 but still required entry of seldom-used data.

(e.g., where there is only one price for a part), they seemed to get in the way.

Second, the columnar area at the bottom of figure 2, the Transfer List, was versatile and flexible but decidedly unfriendly.

Our first revision attacked the problem of the Transfer List. Instead of a syntax made up of columnar entries, instructions to the system were now to be handled by procedural statements entered in more familiar syntax. The statements would resemble those of a programming language such as BASIC or Pascal. The revised form is illustrated in figure 3. It is filled in with the same system instructions that were given by the Transfer List method in figure 2. In this example, Description and Price (Lines 1 and 2) are to be assigned values.

The letters "a" and "b" designate which form the item is on; "a" is the primary form and "b" the secondary. These qualifications are necessary only in cases that would otherwise be

ambiguous, as in the /save command (Line 6) or when items with the same name are on both the primary and secondary forms.

The if/else statements determine whether to ship or back order the product.

The Onion Approach

After we had the solution to one problem area, we were able to solve the second. The column lookup information (in figure 3, the fields Column Key-From, Lookup-Columns 1 and 2, and Interval Search) was still confusing and always had to be filled in, even though useful only in a minority of cases, such as in the Quantity Price-Break Table.

We decided that the information heretofore entered in these items could be handled as procedural statements. In this form, they would be available when required but wouldn't have to be understood by those who were not using the feature.

The four fields were summarily removed, and the resulting form was

much easier to understand and use (figure 4). This opened the way to a new operational concept of the feature, which took the name the onion approach.

The outer skin of the onion comprises the basics. This might include the simple transfer of information, such as Partname and Stdprice in figure 1. This is the operation illustrated in figure 4. As users become more sophisticated in their use of the feature, layer after layer is peeled away, exposing some of the system's more complex capabilities.

Using this approach, the complexity of the operation does not intrude upon Versaform's basic nontechnical orientation. Users don't have to deal with or understand terminology or concepts beyond those needed at the time.

The procedure in figure 4 is filled in with the instructions that the user would give the system in the invoice/inventory example for two simple operations: the transfer of Partname and Stdprice information from the in-

GLOBAL THERMONUCLEAR WAR!™

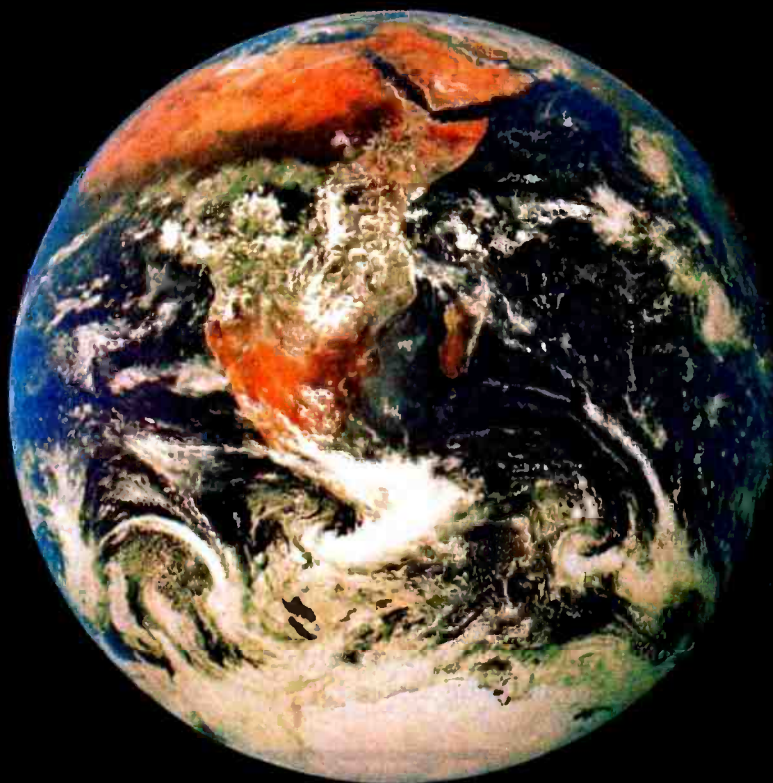

A fast-action, high-strategy game with full color graphics, exciting animation, and realistic sound effects. Features include HAL™ speech synthesis (without special hardware), option to play as enemy or defender, and top ten score display.

Action begins with you at the controls of the Defense Command Computer. A random error causes the computer to secure your nation's defense for full scale nuclear attack. You have 30 seconds before the first ICBM is launched at your enemy's capital. Decipher the secret code for aborting missile launch or prepare to fight World War III.

At launch, you discover the computer has deleted all targeting data for your weapons. Presented with NORAD style strategic displays, you watch the

trajectory of the missile track across the globe as you frantically retarget your weapon systems and prepare for your enemy's attack. Do you strike before or after the enemy launches its first wave? Do you target for military, industrial, or civilian targets? Perhaps some combination? You watch enemy strikes against your homeland and the casualties grow to staggering proportions as you attempt to deter or conquer the enemy before you are completely destroyed. The war has begun and your nation's destiny, even the destiny of the world, is in your hands.

Ask for Global Thermonuclear War™: \$34.95 at your local dealer or order direct. Visa, MasterCard, Money Orders, Checks accepted (Calif. residents please add 6½% sales tax), foreign orders add 15%, U.S. currency only. Dealer inquiries invited.

Global Thermonuclear War™ is available for your IBM PC or XT (64K, disk drive), Apple II+ or IIe (48K, disk drive, DOS 3.3), Commodore 64 (cassette or disk drive), Atari 400 and 800 (48K, disk drive). Joystick play optional in each version. TRS-80 version to be released soon.

STARFIRE GAMES
Division Omnisoft Corporation

Dept. B1, 9960 Owensmouth Avenue, Suite 32
Chatsworth, CA 91311 (213) 709-4900

Global Thermonuclear War is a trademark of Omnisoft Corporation. IBM PC and XT, Apple II+ and IIe, Commodore 64, Atari, and TRS-80 are registered trademarks of IBM Corp., Apple Computers Inc., Commodore Business Systems Inc., Atari Inc., and Tandy Corp. respectively

```

FILE LOOKUP INSTRUCTIONS

Lookup trigger item PART

Select the file to look up, the key-from items, the column
search items, and the items to transfer.

SECONDARY-FILE DISK Mydisk..... SECONDARY FILE Inventory....

KEY-FROM1 Part..... KEY-FROM2 .....

PROCEDURE

L#
01 DESCRIPTION := PARTNAME.....
02 PRICE := STDPRICE.....
03 .....

```

Figure 4: The final form design removed the column lookup operation and substituted a built-in procedure that doesn't intrude unless accessed for special operations.

ventory to the Description and Price fields on the invoice.

When Unitprice is needed, a built-in procedure (Find_Line) would be used to set the line number to find the appropriate line in the Quantity Price-Break Table for quantity ordered.

An Evaluation

The Transfer List method fit in nicely with Versaform's column-item structure and field-editing capabilities. However, the instructions took on an assembly-language appearance when burdened with the need for branching and error handling. There was no easy way to key in a meaningful error message in the space provided or to handle functions with more than one argument. We were sure that eventually the scheme would break down in a real-world application.

On the other hand, the procedure method required us to produce a language specification and define a set of built-in functions to take care of the lookup and column area search.

In effect, we created a "minilanguage" with a syntax similar to Pascal but with the simplicity of BASIC. This combination simplifies the handling of conditional execution and includes the flexibility to add more functions later.

The final design follows the onion approach, as does the documentation, presenting successive layers of complexity, starting with a File Transfer Instructions form and ending with the full syntax and functions available. Users can become thoroughly familiar with the elementary capabilities of the feature without having to understand the more ad-

User perspectives are critical to the successful revision of product design.

vanced operations. Later, when requirements become more complex, the facilities needed are available in the form of built-in functions.

The simplicity of the language is a result of those things taken care of automatically by Versaform. No data structures or data types need to be declared; the data structures for the primary and secondary forms are implicit declarations. File I/O (input/output) and storage management are built in. Data conversion is handled automatically, and exceptions are dealt with by ignoring missing or invalid data in computations and flagging the error to the operator.

File Lookup is now a part of the Versaform system. Although it was a difficult feature to design, it is compatible with the other programs in simplicity of operation and documentation.

Concepts in Development

The evolution of the new feature made us aware of two especially useful concepts in the design of new enhancements.

Much can be said for the drafting of documentation before the design is frozen, to test user perspectives and to work out revisions that will enhance the product from the user's point of view. At this point, the documentation will often drive the design. Put another way, if you can't document it simply, don't code it!

In addition, the onion approach has proven to be one of the best devices for making advanced functions accessible. A feature that seems overwhelming in its entirety becomes manageable when its complexities are hidden beneath layers of simple and familiar operations. These layers, peeled away as needed, build on a user's comfortable and gradually increased understanding. ■

Joseph Landau is president of Applied Software Technology (170 Knowles Dr., Los Gatos, CA 95030).

NEW ENGLAND'S HIGH TECH WAREHOUSE...SHOP AND SAVE

1-800-672-7277

COLUMBIA PC 1600



THE ENHANCED IBM ALTERNATIVE TRULY IBM COMPATIBLE

IBM Hardware & Software compatibility in a Multi-User 16 Bit computer. 128K two serial ports, one parallel port and 8 expansion slots. Runs MS-DOS, CP/M 86 or MP M 86. OASIS-16. MS-DOS "Super-Pak" includes Macro-Assembler, Diagnostics, Basica w/colorgraphics PLUS Perfect Writer, Speller, Calc and File, Fast Graph, Space Commanders & Home Accountant \$ CALL

COLUMBIA PORTABLE - COLUMBIA V.P. - 128K Slim Line Drives, 9" Monitor. comes w MS-DOS Super pak \$ CALL

IBM HARDWARE

KEY TRONIC, INC.
Enhanced Word Processing Keyboard Model KB-5150. Familiar key placement of touchtypists. Key legends instead of obscure symbols \$ 199.00

TANDON TM100-2 \$ 239.00
QUME HALF-HEIGHT 320K DRIVE
IBM Compatible \$ 199.00

STB SYSTEMS "SUPER RIO" CARD
The Truly ultimate IBM add-on Eight + Functions on one card.

- 64-256K (786K wlopt "PiggyBack" card)
 - Two RS232 ports, one parallel
 - Clock/calendar • Game Port
 - Parallel cable
 - Printer Buffer • RAM disk
 - Serial cable
- Simply The Best \$ CALL

USI MULTIDISPLAY CARD
IBM monochrome support, colorgraphics support & par printer adaptor all on a single expansion card \$ CALL

PLANTRONICS COLORPLUS \$ 369.00

QUADRAM CORPORATION
QUADBOARD Multifunction Board
Full expandability from 64K to 256K
Parallel Printer Port, Asynchronous RS232
Serial Modem Port
Programmable Clock/Calendar, RAM Disk Drive (software)
64K starts at \$ 279.00
QUADLINK Apple on a card \$ CALL

MICROFAZER Printer Spooler
Print Buffering from 8K to 512K
Any Printer/Computer Combination
Why wait on your printer?
Prices start at \$ 129.00

PRINTERS



DOT MATRIX

STAR MICRONICS		
Gemini 10X		\$ CALL
C-I-TOH		
Prowriter I - par		\$ 379.00
Prowriter II - par		\$ 649.00
EPSON		
FX-80, FX100		\$ CALL
MANNESMANN TALLY		
MT1601		\$ CALL
MY160L		\$ CALL
OKIDATA		
82A		\$ 649.00
83A		\$ 706.00
84 par		\$1055.00
92 par		\$ 479.00
93 par		\$ 839.00

LETTER QUALITY

C-I-TOH		
Starwriter F-10-40 par		\$1179.00
JUKI 6100, 18CPS		\$ CALL
NEC		
3550 IBM plug-in		\$1936.00
TTX-1014, Pin & friction feed, ser & par interface		\$ 516.00

MONITORS

GORILLA	Green Hi-Res	\$ 89.00
AMDEK	300 Amber	\$ 155.00
	300 Green	\$ 139.00
	310A including cable	\$ 179.00
	Color I composite	\$ 299.00
	Color II RGB (IBM compatible)	\$ 439.00
NEC	1201 Hi-Res	\$ 159.00
	1203 RGB (IBM compatible)	\$ CALL
	1205 Hi Res. Amber	\$ CALL
TAXAN	Amber	\$ 129.00
	Green	\$ 119.00
USI	Amber Hi-Res	\$ 149.00
QUADRAM	Quadchrome RGB	\$ CALL
PRINCETON GRAPHICS		\$ CALL

MODEMS

ANCHOR AUTOMATION	Signalman Mark 1	\$ 83.00
HAYES		
	Smartmodem 300	\$ 211.00
	Smartmodem 1200	\$ 499.00
	Smartmodem 1200B	\$ 459.00
NOVATION		
	D-CAT	\$ 168.00
	J-CAT	\$ 115.00
	Auto Cat	\$ 219.00
APPLE CAT II		\$ 273.00

IBM PC SOFTWARE

BUSINESS ASHTON-TATE		
dBase II		\$ 457.25
CENTRAL POINT, Copy II PC		\$ 29.00
IUS, Easywriter II		\$ 234.75
LOSTUS, 1, 2, 3		\$ CALL
MICROPRO, Wordstar		\$ 301.75
MICROSOFT, Multiplan		\$ 185.25
SOFTWARE ARTS		
Tk, Solver		\$ CALL
SOFTWARE PUBLISHERS		
PFS: File		\$ 93.95
PFS: Report		\$ 83.75
PFS: Graph		\$ 93.95
SORCIM, SuperCalc		\$ 130.00
VISICORP, Visicalc		\$ 182.75
VisiSchedule		\$ 226.75
Visiword		\$ 286.00

DISKETTES & STORAGE

MEMOREX	10 each 5 1/4 SS/DD	\$ CALL
	10 each 5 1/4 DS/DD	\$ CALL
ELEPHANT	10 each 5 1/4 SS/DD	\$ 19.95
	10 each 5 1/4 DS/DD	\$ 26.95
VERBATIM	10 each 5 1/4 SS/DD	\$ 25.95
	10 each 5 1/4 DS/DD	\$ 36.95
LIBRARY CASE, 5 1/4		\$ 2.50
DISK BANK, 5 1/4 interlock & swivel		\$ 5.50
DISK FILE, 5 1/4 Elephant "Trunk"		\$ 21.95

APPLE HARDWARE

FRANKLIN COMPUTERS		
	Ace 1000	\$ CALL
	Ace 1200	\$ CALL
DISK DRIVES		
	Rana Elite I	\$ 289.00
	Rana Elite II & III	\$ CALL
	Micro SCI A2	\$ 205.00
	Fourth Dimension	\$ 219.00
RAM EXPANSION		
	Microsoft (16K)	\$ 75.00
	Microtek (BAM 16K)	\$ 73.00
80 COLUMN CARDS		
	ALS Smarterm II	\$ 129.00
	Videx Ultraterm	\$ CALL
	Videx Vidoterm w ss	\$ 271.00
	Vista Vision 80	\$ 239.00

PRINTER INTERFACES BUFFERS

	Microtek RV611C par	\$ 63.00
	Apple Dumping 16K	\$ 160.00
	Orange Micro, Grappler + Buffered Grappler +	\$ 119.00 \$ 189.00
	KENSINGTON, System Saver	\$ 72.00
	KRAFT, Joystick	\$ 48.00
	Paddies	\$ 35.00
	M & R ENTERPRISES Super Mod (RF MOD)	\$ 55.00
	MICROSOFT Softcard w CP M 280 Softcard Pren: Pack	\$ 245.00 \$ 495.00
	T & G PRODUCTS Joystick Game Paddies Selectaport Trak Ball	\$ 43.00 \$ 28.50 \$ 43.00 \$ 47.00
	SATURN SYSTEMS Neptune 80 Cot Card w 64K or IIe	\$ CALL

APPLE SOFTWARE

ZAXXON		\$ 22.50
FROGGER		\$ 23.50
CHOPLIFTER		\$ 23.25
ZORK I, II, III		\$ 26.75
FLIGHT SIMULATOR		\$ 24.50
FACE MAKER		\$ 24.50
STORY MACHINE		\$ 24.50
BANK STREET WRITER		\$ 46.00
MASTER TYPE		\$ 29.00
VISI CALC		\$ 182.75
SNOOPER TROOPS I		\$ 37.75
PIN BALL		\$ 25.50
DEADLINE		\$ 33.50
PFS: FILE		\$ 79.00
PFS: GRAPH		\$ 83.95
PFS: REPORT		\$ 81.00
DBASE II		\$ 457.25
EASY WRITER		\$ 67.00
HOME ACCT		\$ 45.75
MULTIPLAN		\$ 179.00

WAREHOUSE SHOW ROOM OPEN TO THE PUBLIC
8 am to 6 pm M-F
10 am to 4 pm Sat.

CENTENNIAL Computer Products, Inc.
561 E. Industrial Drive
Manchester, New Hampshire 03103

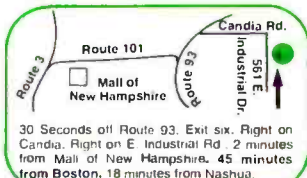

NATIONAL ORDER DESK 1-800-672-7277
IN NEW HAMPSHIRE 603-623-1010 PLEASE CALL

TERMS AND CONDITIONS:
• NO CREDIT CARD FEE • Personal checks (allow 10 days to clear), Visa, Master Card, wire transfers, include telephone number • COD orders accepted — \$300 maximum — \$10 nonrefundable surcharge • All products factory sealed with manufacturer's warranty • PO's accepted from qualified customers • Approval needed on all returns • 10% restocking charge unless defective, plus shipping • Shipping, Handling & Insurance \$5.00 minimum, 4% UPS ground, UPS Blue Label rate quoted at time of order • All prices subject to change without notice • Telephone Order Desk Hours: 8 AM to 6 PM, Monday through Friday, 10 AM to 4 PM Saturday, Eastern Standard Time

If you know

dBASE II \$389
Smartmodem 1200B \$439
Quickcode \$185
Multiplan \$169
Lotus 1-2-3 \$329

IBM

IBM PC SOFTWARE (PC/MS DOS)

Business

Product	LIST	SALE
American Training International		
Power for PC DOS	75	56
Power for Multiplan	75	56
Wordstar Combo	75	56
Ashton-Tite		
Financial Planner	700	479
Friday	295	198
dBASE II	700	389
+ wusers guide	729	409
Aspen Software		
Grammatik	75	56
Proofreader 32K	50	38
Proofreader 50K	50	38
Proofreader 80K	50	38
Best Products		
Personal Financial Pgm	95	64
Comprehensive Software Support		
PC Tutor 2.0	60	45
Continental Software		
FCM (First Class Mail)	125	79
Home Accountant Plus	150	94
Emerging Technology		
Edix	195	149
Wordix	195	149
Edix + Wordix	390	269
Edix/Wordix/Spellix	[5]	325
Howard Software		
Real Estate Analyzer	250	165
Information Unlimited Software		
Easy Planner	250	178
Easy Speller 2	225	129
Easy Writer II	350	195
Lexisoft		
Spellbinder	495	229
Librae		
Volkswriter	195	119
Mark of the Unicorn		
The Final Word	300	199
Mince	175	139
Molasso		
Benchmark Mail List	250	179
Benchmark Word Processor	500	299
Micro Pro		
Mailmerge	250	185
Spellstar	250	165
Word/Mail	[5]	695 426
Word/Spell	[5]	695 426
Word/Spell/Mail	[5]	845 558
Wordstar	[5]	495 327
Microsoft		
Multiplan™	275	169
Multitool Budget		109
Multitool Financial		69
Northwest Analytical		
Statpak	495	369
Oasis		
Punctuation & Style	125	99
The Word Plus	150	105
PBL Corporation		
Personal Investor	145	98

Product	LIST	SALE
Peachtree		
SERIES 4 PAK (GL,AR,AP)	[5]	595 349
Select Information Systems		
Select Word Processor		595 329
Software Arts		
TKISolver		299 219
Software		
Multimate		340
Sarcin		
Supercalc	195	115
Supercalc 2	295	159
Visicorp		
Visicalc	250	159
Visispell	225	159
Visword	375	269
Visischedule	300	195

Database

Product	LIST	SALE
Alpha Software		
Mail List	95	65
Database Mgr. II	295	269
Applied Software Technology		
Versalorm	389	245
Ashton-Tite		
dBASE II	[5]	700 389
dBASE II wuser's guide	[5]	729 409
Conceptual Instruments		
Desk Organizer		245
Condor Computer Corporation		
Condor 3	650	398
Fox & Geller		
Quickcode	295	175
dGRAPH	295	189
dUTIL	99	59
FYI, Inc.		
Superfile	195	129
Humansoft		
DBPlus	125	95
Information Unlimited Software		
Easy Filter	400	249
Innovative Software		
TIM III	495	279
Link Systems		
Data Fax	299	224
MDBS		
Knowledge Man	500	327
Micro Pro		
Infostar	[5]	495 327
North American Business Systems		
< Answer >		250 159
Optimal		
Accelerator	195	
dCLONE	295	
Software Publishers		
PFS: File	140	95
PFS: Report	125	79
Softsoft		
Personal Data Base	125	93
Visicorp		
Visifile	300	195

Home/Education/Games

Product	LIST	SALE
Bible Research		
THE WORD PROCESSOR	144	
Blue Chip		
Millionaire	100	75
Friendly Software		

PC Intro. Sel	50	38
Infocom		
Deadline	50	37
Starcross	40	30
Suspended	50	38
Zork I	40	30
ISM		
Mathemagic	90	65
Lightning		
Master Type	50	38
Microsoft		
Flight Simulator™	50	38

Language

Product	LIST	SALE
Digital Research		
SID66	150	94
Microsoft		
CBASIC 86	200	150
C Compiler™	500	349
Mumath/Musimp™	300	225
muLisp/MuStar™	250	188
Ryan-McFarland		
RM/Cobol		950 713
Full Dev System		250 188
RM/Cobol Runtime Only		

Utility/Comm/Graphics

Product	LIST	SALE
Alpha Software		
Apple-IBM Connection	195	129
Typefaces	125	79
Byron Software		
BSTAM	200	149
BSTMS	200	149
Central Point		
Copy II PC	40	35
Hayes		
Smartcom 2	119	79
Innovative Software		
Fast Graphs	295	159
Insolt		
Data Design	225	169
ISM		
Graphmagic	90	65
Graphmagic Combo	150	119
Microstat		
CrossTalk/Smartmodem	195	119
Peter Norton		
Utilities	80	59
Visicorp		
Vistrend/Plot	300	195
Woolf		
Move It	150	99

IBM PC HARDWARE

Corvus		
PC Interface, Cable, Man.	300	239
Hayes Microcomputer Products		
Smartmodem 1200B [5]	599	439
Hercules		
Graphics Card	499	359
Microsoft		
Mouse™	195	149
Programming International		
PC-Hayes Cable	35	29
QCS		
Big Blue	595	449
Quadrum		
256K QUADBOARD	595	435
64K Quadboard	395	269
TB Products		
Joystick	65	49
Randon		
TM100-2 Drive (5 1/4" DS)	[5]	650 249

PC SOFTWARE CP/M-86

Product	LIST	SALE
Ashton-Tite		
dBASE II	[5]	700 389
Fox & Geller		
Quickcode	295	175
dGRAPH	295	189
dUTIL	99	59
Digital Research		
CBASIC 86	200	150
CP/M-86	60	45
With SPP-86	600	450
Concurrent CP/M 86	350	249
Woolf		
Move It	150	99

APPLE

APPLE II/II- DOS

Business

Product	LIST	SALE
Artsci		
Magic Mailer	70	49
Magic Window II	150	99
Magic Words	70	49
BPI		
AP	395	295
AR	395	295
IMV	395	295
Broderbund		
General Ledger w/AP	495	305
Bank St. Writer	70	45
Continental		
CPA #1,2,3,4 (ALL 4) [5]	1000	609
CPA #1-GL	250	159
CPA #2-AR	250	159
CPA #3-AP	250	159
CPA #4-PAYROLL	250	159
FCM (First Class Mail)	100	68
Home Accountant	75	52
Decision Support		
Accountant With		149 112
DBCALC		129 97
Hayden		
Piewriter/ Multi 80 Column	150	99
Kansington		
Format II	150	113
LJK		
Letter Perfect W/Mail Merge	150	112
Microsoft		
Multiplan™	275	169
Multitool Budget	150	109
Multitool Financial	100	69
Time Manager	150	115
Musa		
Supertex Home Office	125	79
Supertex Professional	99	65
PBL		
Personal Investor	145	99
Program Design		
New Step by Step	80	50
Sensible		
Sensible Speller	125	85
Sierra On Line		
Dictionary	100	69
Screenwriter II	130	85
Screenwriter	200	149
Professional	199	139
Silicon Valley		
Word Handler	199	139
Sol/Sys.		
Executive Speller	75	56
Software Dimensions		
Accounting + II GL	395	289
Accounting + II AR	395	289
Accounting + II AP	395	289
Accounting + II		395 289
Inventory	395	289
Accounting + II	395	289
Payroll	395	289
Synergistic		
Global Program		65 49
Line Editor		
Visicorp		
Business Forecasting	100	78
Model	250	159
Visicalc	200	156
Visiplot	300	195
Visischedule	300	195

Database

Product	LIST	SALE
AST		
Versalorm	389	245
Micro Lab		
Data Factory	300	216
Musa		
Address Book	50	36
Silicon Valley		
List Handler	90	68
Software Publishers		

PFS: File	125	85
PFS: Graph	125	85
PFS: Report	125	79

Stoneware		
DBMaster	350	260
DBMaster/Hard Disk	499	359
Statpak	99	71
Utility Pak 1	129	96
Utility Pak 2	129	96

Synergistic		
Modifiable Database	80	59
Visicorp		
Visifile	250	159

Home/Education/Games

Product	LIST	SALE
Beagle Brothers		
Alpha Plot	40	28
IUS		
Yeststar Level I	40	30
Yeststar Level II	80	58
Lightning Software		
Master Type	40	30
Micro Lab		
English SAT #1	30	22
Learning System	150	108
US Constitution Tutor	30	22
Microsoft		
Typing Tutor II™	25	19
Quality Software		
Bag of Tricks	40	30
Sensible		
BEST	40	30
Synergistic		
Stargazer's Guide	30	23

Beagle Brothers		
Alpha Plot	40	28
IUS		
Yeststar Level I	40	30
Yeststar Level II	80	58
Lightning Software		
Master Type	40	30
Micro Lab		
English SAT #1	30	22
Learning System	150	108
US Constitution Tutor	30	22
Microsoft		
Typing Tutor II™	25	19
Quality Software		
Bag of Tricks	40	

what you want . . .

CP/M

Phoenix		
Zoom Graphics	50	38
Sensible		
Disk Organizer	30	23
Disk Recovery	30	23
Image Printer Epson	40	30
NEC Dot Matrix	40	30
Multi Disk Catalog	25	19
Super Disk Copy	35	26
Sirius		
Pascal Graphics Editor	100	75
Southeastern		
Data Capture Videx	90	65
Southwestern Data		
ASCH Express		
Professional	130	89
Printographer	50	38
Zterm Prof.	150	109
Videx		
Videoterm Utilities Disk	37	28
Visicorp		
80 Col prebook/Apple	29	21
80 Col prebook/Visicalc	49	27
Soft Video Switch	35	25
Visiterm	100	79
Visitrend/Plot	300	195

APPLE III™

Visicorp	LIST	SALE
Business Forecasting		
Model	100	78
Visischedule	300	195
Link Systems		
Data Fax	249	187
Software Publishers		
PFS: File	175	129
PFS: Report	125	79

APPLE IIc™

Most Apple II products also run on the IIc (call for details). Products below are specially designed for the IIc.

Sierra On Line	LIST	SALE
Screenwriter II	130	85
Software Publishers		
PFS: File	125	85
PFS: Graph	125	85
PFS: Report	125	79
Visicorp		
Visicalc	250	159

APPLE HARDWARE™

Hardware		
Eastside	LIST	SALE
Widcard (II/II+)	130	99
Widcard (for IIc only)	130	109
Hayes		
Micromodem II	379	259
w/Term Pgm	409	289
Kensington		
System Saver Fan	90	69
Kraft		
JoyStick	45	
LJK		
Lower Case Char Gen	25	19
Microsoft®		
16K RAM Card™	100	69
Premium System™ [5]	695	489
Softcard™	345	219
New Premium Card™	495	369
Personal Computer		
Applicard (6MHz)	375	305
TG		
Joystick	60	45
Videx		
Enhancer II	149	99
Ulratrerm	379	279
Videoterm with		
Softswitch	375	239

CP/M-80 (8" Standard SSSD)

Other formats are available as special orders thru Software to go.

Business

ATI	LIST	SALE
Power for CP/M	75	54
Ashlan-Tite		
Bottom Line Strategist	400	269
Aspen		
Grammatik	75	56
Proofreader (32K or 80K)	50	38
Designer Software		
Palamir	425	299
Dictronics		
Random House		
Thesaurus	150	102
Digital Research		
Display Manager	400	295
Epic		
Supervyz	150	94
Mark of the Unicorn		
The Final Word	300	199
Mince	175	127
Metasoft		
Benchmark Mail List	250	182
Word Processor	500	299
Micro Pro		
Calstar	145	96
Mailmerge	250	129
Spellstar	250	128
Starindex	195	150
Word/Mail	695	347
Word/Spell	695	347
Wordstar Prof.		
(Word/Spell/Mail)	845	395
Wordstar	495	248
Microsoft®		
Multiplan™	275	169
MultiTool Financial	100	69
MultiTool Budget	150	109

Northwest Analytical		
Starpak	495	369
Oasis		
The Word Plus	150	105
Punctuation & Style	129	99
Organic		
Milestone	295	229
Select		
Select Word Processor	595	329
Sarcim		
Supercalc	195	115
Supercalc 2	285	159

Database

Anderson-Bell	LIST	SALE
Abstat	395	339
Ashlan-Tite		
dBASE II	700	389
dBASE II		
w/user's guide	729	409
Friday	295	198
Caxton		
Cardbox	245	177
Condor		
Condor 3	650	395
DJR		
FMS 80	395	275
Digital Research		
Access Manager	300	219
FYI		
Supertile	195	112
Fox & Geller		
Quickcode	295	175
Quickscreen/dBASE II	149	119
dGRAPH	295	190
dUTIL	99	58
Human Soft		
DBPlus	125	95
Micro Pro		
Infostar	495	327
Microsoft®		
Sorting Facility (MSORT)™	195	151
Pearl City		
Personal Pearl	295	221

T/Maker Co.		
T/Maker III	275	215

Home/Education/Games

Infocam	LIST	SALE
Deadline	60	43
Starcross	50	38
Zork I	50	38
Zork II	50	38
Zork III	50	38
Suspended	50	38
Supersoft		
Dungeon Master	40	30
Nemesis	45	34

Language

Digital Research	LIST	SALE
CB80	500	369
CBASIC	150	94
PL/I 80	500	375
Pascal MT+	350	262
Pascal MT+ with SPP	500	395
RMAC	200	150
SID	75	63
ZSID	100	88
Microsoft®		
Basic 80 Interpreter	350	249
Basic Compiler	395	285
Cobol 80	750	562
Fortran 80	500	345
MACRO 80	200	150
μLisp/Star	200	156
Supersoft		
ADA Compiler	300	225
C Compiler	250	188

Utility/Comm/Graphics

Byram	LIST	SALE
BSTAM	200	149
Digital Research		
Despool	50	38
Microstat		
Crosstalk/Smartmodem	195	117
Supersoft		
Disk Doctor	100	75

Woolf		
Move II	125	83

HARDWARE, NOT MACHINE SPECIFIC

Amdak	LIST	SALE
Color II (RGB)	899	645
Hayes Microcomputer Products		
Chronograph	249	199
Smartmodem 1200	699	499
Smartmodem 300	279	209
NEC		
Monitor 12" Green		
Hi-Res	285	167
Novation		
J Cat	149	119
Smart Cat 103	259	207
Smart Cat 103/212	595	476

™ = Manufacturer's trademark
 ® = Indicates a manufacturer's registered trademark

• We ship within 24 hours on most items.
 • Both East coast & West coast shipping points.

Orders must be **PAID** by **December 31** to qualify for these special prices.

Programming International

505 Hamilton Ave. • Suite 301 • Palo Alto, CA 94301

TELEPHONE ORDERS
 Outside CA: **(800) 222-8811**
 Inside CA: **(800) 631-4400**
 Local: **(415) 324-3730**

Technical Support (415) 324-0311
Order Status (415) 324-0306
Sales Manager (415) 324-0305

Order lines are manned 6:30-6 Monday thru Friday and 9-5 Saturday. Other lines are open 9-5 Monday thru Friday.

More CPM®, APPLE®, IBM PC™, UCSD p-System™ software, hardware, etc.: call for quote.

TERMS: All prices subject to change without notice and availability. Cashier's check/MO/bank transfer. Allow time for company or personal checks to clear. Prices reflect cash prepaid discount. VISA/MASTERCARD/COD/PO's + 3%. CA residents add sales tax. All sales final.

SHIPPING: \$3 per item for UPS surface (\$6 for BLUE Label) within Continental USA, except where shipping cost is specified in square brackets. UPS does not go to Canada, Alaska, APO's, FPO's; call for ship charge or add 15%—we will refund/credit difference.

RETURNS: All returns subject to managers approval, must have authorization number, obtained at 415-324-0305. Unauthorized returns will be refused; damaged goods will be refused. All returns subject to 15% restocking fee. No return after 30 days.

WHY PAY MORE?

PRINTERS

C. ITOH

Prowriter

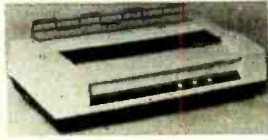

120 cps, 4 fonts (includes proportional), 8 sizes, 160 x 144 dpi, friction & tractor feed. A worthy rival of Epson.
Prowriter..... **\$399.88**
Prowriter 2..... **\$719.88**

Starwriter

Letter-quality, 40 cps, 136 columns 10 & 12 pitch, uses Diablo wheels & ribbons (Qume code). The **Printmaster** is the 55 cps version. The **A10 Starwriter** (18 cps) is the new, low-speed version with the same specs.
A10 Starwriter..... **\$609.88**
Starwriter..... **\$219.88**
Printmaster..... **\$599.88**
Tractor Feed..... **\$259.88**
Sheet Feed..... **\$69.88**

DIABLO

620..... **\$999.88**
630..... **\$979.88**
Series 32..... **\$1049.88**

EPSON

RX/FX Epsoms..... **CALL**

IDS

Micro 480..... **\$529.88**
P-Series
80..... **\$1079.88**
w/4-color..... **\$1439.88**
132..... **\$1239.88**
w/4-color..... **\$1669.88**

INFORUNNER

Riteman



A compact printer with 120 cps, 10/17 cpi, 160 x 144 dpi graphics, optional tractor (pin/friction std), Parallel..... **\$349.88**

MANNESMANN TALLY

MT-160 L



The **MT-160 L** (160 cps) features 8 fonts (including a correspondence font), parallel & RS-232C interfaces, friction/tractor feed. The **MT-160 L** is a 136 column version. The **Spirit** (80 cps) features 4 fonts, italics, dot graphics & friction/tractor feed.
MT-160 L..... **\$649.88**
MT-160 L..... **\$499.88**
Spirit..... **\$299.88**

NEC

2010/2030..... **\$879.88**
2050..... **\$999.88**
3510..... **\$1549.88**
3530..... **\$1839.88**
3550..... **\$1899.88**
7710/7730..... **\$2199.88**

Silver Reed EXP-550 & EXP-500

Silver Reed's printers are exceptional. Both the **EXP-550** (17 cps) and the **EXP-500** (12 cps) feature sub and super script, underlining, backspace, proportional printing capabilities, multiple pitch (10, 12 or 15 cpi) and Diablo 1610/1620 code emulation, which makes them compatible with nearly every word processing program available. The **EXP-550** features a page-inject system.



EXP-550 (Parallel)..... **\$669.88**
EXP-550 (RS-232C)..... **\$689.88**
EXP500 (Parallel)..... **\$439.88**
EXP-500 (RS-232C)..... **\$469.88**
EXP-550 Tractor Feed..... **\$139.88**
EXP-500 Tractor Feed..... **\$129.88**

OKIDATA

Microline Series



The **92/93** printers (160 cps) and the **84** (200 cps) are exceptional. Tough, reliable, they produce superior draft quality, correspondence quality & graphics. The **PC Plug-n-Play** ROMs turn the **92/93/84** into 100% IBM-PC compatible printers. Our very best selling printer line.
Microline 80..... **\$319.88**
Microline 82A..... **\$89.88**
ML82A-ML92 Adjustable Tractor Feed..... **\$9.88**
82A/83A Okigraph I (graphics ROM)..... **\$9.88**
82A/83A Hi-speed RS-232C Interface..... **\$29.88**
Microline 83A..... **\$79.88**
Microline 92..... **\$59.88**
w/RS-232C..... **\$59.88**
Microline 93..... **\$79.88**
w/RS-232C..... **\$79.88**
IBM PC Plug-n-Play Graphics ROM (92/93)..... **\$9.88**
92/93A Hi-speed RS-232C Interface..... **\$9.88**
Microline 84..... **\$1024.88**
w/RS-232C..... **\$1139.88**

SMITH CORONA

Messenger



The **Memory Correct III Messenger** (12 cps) features 10, 12 & 15 cpi, variable line spacing, backspace, auto-correction and a dual parallel/RS-232C interface. True daisy wheel printing makes it an exceptional typewriter & printer. Ideal for the home or small office.
Memory Correct III Messenger..... **\$19.88**

STAR MICRONICS

Gemini 10X/15



Gemini 10X..... **\$309.88**
w/RS-232C..... **\$99.88**
Gemini 15..... **\$59.88**
w/RS-232C..... **\$59.88**
Delta 10..... **\$29.88**
w/RS-232C..... **\$19.88**

TOSHIBA

P 1350..... **\$1759.88**

CABLES

IBM-PC..... **\$39.88**
Osborne-1..... **\$9.88**
TRS-80..... **\$9.88**
Model I/III/IV..... **\$9.88**
Model II/16..... **\$9.88**
Centronics Male/Male..... **\$9.88**
Male/Female..... **\$9.88**
VIC-20/Commodore 64..... **\$9.88**
Parallel Card/Cable..... **\$9.88**
Apple II/II+/IIe..... **\$9.88**
Parallel Card/Cable..... **\$9.88**

QUADRAM

Microfazer

A print buffer with pause, copy & reset controls. It comes with a 9V power supply and cable to printer. There are so many buffer sizes (from 8K to 512K), & so many configurations (Parallel/Parallel, Parallel/RS-232C, RS-232C/Parallel & RS-232C/RS-232C) that you should call **(800) 343-0726** for prices.

MONITORS

NEC

JB 1205M (amber)..... **\$179.88**
JB 1201M (green)..... **\$159.88**

AMDEK

300A (12" amber)..... **\$164.88**
300G (12" green)..... **\$149.88**
310A (amber)..... **CALL**

USI

Pi-3 (12" amber)..... **\$189.88**
Pi-4 (9" amber)..... **\$159.88**

QUADRAM

QuadChrome



690 x 240 resolution, 80 columns x 24 lines, 16 colors & exceptional performance. Cable included.
QuadChrome(RGB)..... **\$509.88**

PRINCETON GRAPHICS

HX-12

Same specs & performance as the **QuadChrome**.
PGS HX-12 (RGB)..... **\$499.88**

MODEMS

US ROBOTICS

Password



0-300/1200 baud direct-connect modem with auto-dial/answer, full/half duplex, voice/data. Uses LSI technology. Cables & power supply included (specify type of computer).
Password..... **\$379.88**
*Courier..... **\$479.88**
*Uses Osborne-1 modem port & Includes Telepac communications software for the Osborne.

DC HAYES

Smartmodem

0-300 or 0-300/1200 baud direct-connect modems with auto dial/answer, full/half duplex, power supply & modular cable (RS-232C cable optional). **1200B** is an in-board modem for the **IBM-PC** & Includes **Smartcom II**.
300..... **\$219.88**
1200..... **\$39.88**
1200B w/Smartcom II (IBM PC)..... **\$459.88**

PERIPHERALS

For the IBM-PC...

We carry a variety of peripherals for the IBM-PC, including: **Quadram Quadboards, Quad 512+, Quadlink, QuadDisk** & single-function boards; **AST** products; **Tandon's TM-100-2** double-sided drives; **QCS's Big Blue & Hard Disk, a Hard Disk/Tape** subsystem; **Tecmar's Graphics Master**, the **Paradise Multi-Display Card**; & the **Eagle PC** and **Columbia 1600-1** personal computers.
Call **(800) 343-0726** for prices & orders.

For the Apple II...

We also carry numerous Apple II/II+/IIe peripherals, including: **Plasma Printer Cards**, **Microsoft's Z80 Cards, RamCards & Premium Packs**; **Videx's VideoTerm, UltraTerm & Enhancer II**; **Rana Elite Disk Drives**; **AMT's MicroDrive**; **Saturn Systems Accelerator II & Memory Boards**; **Quadram's eRAM 80 Column Card**; & **Kensington's System Saver** & the **Novation Apple Cat II**. We also carry the **Franklin Ace 1000 & Ace 1200** personal computers.
Call **(800) 343-0726** for prices & orders.

Accessories

We also carry cables, diskettes, diskette boxes, switch boxes, surge protectors & printer paper.
Call **(800) 343-0726** for prices & orders.

Information/Orders:
(603) 881-9855

Orders Only:
(800) 343-0726

No Hidden Charges:

- You get **FREE** shipping on all orders within the 48 states.
- Most orders delivered within 10 days or less. **UPS 2nd Day** and **Overnight** available for most areas.
- Easy payment terms: We accept all major credit cards, certified checks, money orders, company checks or personal checks (allow 21 days for personal checks).
- We never charge extra for credit cards.
- Credit cards are not charged until order is shipped.
- We accept **CODs** up to \$1000 (add \$10 handling fee per order) payable with certified check or money order.
- We have a \$50 minimum order.

Comp. in Purchase Orders are accepted on a limited basis & upon approval only. Sorry, no APO or foreign orders accepted.

All our equipment is shipped with full manufacturer's warranty. We are an **authorized dealer** for all products we sell to insure full warranty support, & we're authorized for warranty work on a number of printers. We also offer extended warranty plans for many printers.

We prepared this ad in October, & prices do change, so call to verify them.

Our **Computer Showroom** is now open in Amherst, New Hampshire, five miles west of Nashua (one hour from Boston).

Circle 51 on Inquiry card.



HIGH TECHNOLOGY AT AFFORDABLE PRICES

THE BOTTOM LINE



MILFORD, NH 03055-0423 □ TELEPHONE (603) 881-9855

The Future of Metaphor in Man-Computer Systems

User interfaces from digital watches to digital computers

by Chuck Clanton

In the last few years, I have owned a succession of digital wristwatches. From the first moment I saw one, I knew it was functionally the same as my old Swiss 14-jewel analog watch, but somehow quite different. Interestingly, while the two are recognizably similar, they share almost nothing in visual appearance, the number and type of the controls, and the mechanism inside. They share only a single function, telling the time. Even the way they tell the time is quite different. My Swiss watch did so with a picture; a quick glance would give me a sense of what time it was. My new digital watch uses numeric language, which must be read—a process that is slower but much more accurate.

Why is this new object immediately recognizable as a watch? A microwave oven does not resemble a cooking fire, nor does an automobile recall a horse. A computerized accounting package is radically different from a set of bookkeeping ledgers and journals. The digital watch may not be an exact functional replica of its mechanical predecessor, but I immediately knew that this new device

was a watch and that I could expect it to perform certain tasks. Evoking this sort of inference from any product of a new technology is critical to its acceptance. The next step, of course, is to find a device that is easy to learn and use.

Documentation: Explicit and Implicit

Though my first digital watch had four buttons, it had more than four functions. Unfortunately, I never could discern any logic to the use of these buttons in controlling the watch's functions. For example, the way the alarm was set and the way the time was set were completely different. At the end of several months of ownership, I still had not learned how to use all of the features without going back to the owner's manual. One day I could no longer find the manual, so I threw the watch away and bought another. Admittedly, I am an unusual consumer. I actually do read instruction manuals and even have a file folder where I keep them. Of course, that folder contains many manuals for gadgets I no

longer own, and the folder occasionally refuses to disgorge the manual for the device that is bedeviling me at the moment.

When you are designing the interface for *any* device, you just cannot assume that your user has access to the manual. Even if the manual can be found, it probably will not be read. Training programs are no cure: if they're not completely misguided, they may help the original users, but what about all the other people who follow? The solution lies in the design of the device itself and how it interfaces to its user. The interface designer must take responsibility for the "learnability" of the interface. Paradoxically, the better the interface (i.e., the more the system fits what the user expects), the less documentation is needed, so nuances described in the manual tend to be overlooked.

My next digital watch had a few more functions and no more buttons. I was somewhat smarter, however, and found a watch interface that was easier to understand. The buttons perform functions in a more logical fashion, and the currently selected

function is indicated on the face. One button selects from among a small number of functions, and another chooses among various options for that function. Hence, the total number of functions is rather large, but they're easy to remember because they are logically categorized.

Mechanical watches use a rotating stem to set the time. In my digital watch, two buttons accomplish the same task, one to increase and the other to decrease the setting. These same two buttons are always used for setting times, whether for the current time, the 24-hour alarm, the second time zone, the count-up timer, or the count-down timer. I never finished reading the user's manual, so it probably is still stowed in my instructions folder.

Inherent "Watchness"

How is it that the digital watch gained the immediate benefit of recognition? Why did I assume that I knew its fundamental capabilities, even in the face of the first, terrible interface. And what critical features made the second interface so much better? Somehow, this new device seemed familiar. It impressed me with its similarity to my prior experience with watches, and this similarity made it possible for me to infer the existence of functions and controls from that experience. Fortunately, those inferences proved correct, so that I quickly gained confidence in my mastery of the new technology.

If I were to write a manual for a digital watch, I might well try to ease the reader into this new technology by pointing out how the digital watch resembles the mechanical watches of the past. An explicit comparison or *simile* in my digital-watch manual would not limit the new device to be just like the old but would create expectations from the reader's experience with the old. On the other hand, a *metaphor*, which makes a comparison without the use of "like," produces a stronger inference of similarity, even though the reader knows the two objects of the metaphor are not truly identical. In a user manual, prudence dictates the use of

simile to avoid overemphasizing the similarity.

However, I am not writing a manual for a digital watch, and in fact I'm not interested in writing manuals at all, because most people do not read them until hopelessly confused. *The device should document itself.* It should create the metaphor that directs its use, then give feedback that allows the user to learn more. Just as with the digital watch, the metaphor can be vague and inexact, so long as it helps the user understand what the device is and how it may be used.

The watch metaphor for the digital timepiece was instructive enough so even the bad control interface did not make the watch unusable. I was confident that I knew what it was and

The total number of functions is rather large, but they're easy to remember because they are logically categorized.

what it could do. Of course, this confidence meant that I blamed the first watch for my lack of understanding. Interestingly, when you know to blame a new device for its faults rather than yourself, the overall design is strong. I have no doubt that it is my toaster's fault when I burn myself often on its overly hot handle. I know how a good toaster should work. Most users blame themselves when a computer system does something nasty and unexpected because they do not have enough experience with systems that work well for them—not enough computer systems are designed well enough for them to know.

Computing Machines

By now, you may be wondering why an article on future metaphors for computer systems has spent so much time discussing digital watches. If you think of a computer as a *means* rather than an *end*, then the relationship may be clearer. The vast majority of all computers

manufactured in the future will not be enthroned in homes and computer centers with programmers in attendance. Most computers will be dedicated to specific tasks deemed important to those outside the computer priesthood. To prove my point, look at the distribution of computers today. Sure, I have several microcomputers in the computer system in my study (one in my video-display terminal, one in my printer, one in the tape-drive controller, and of course in the central processor). I also have microcomputers in my washing machine, my microwave oven, my furnace thermostat, my fire alarm, my two calculators, my digital watch, and probably a few other places I have not yet discovered.

Most people will never be programmers, but they will want the services of all the devices spawned by this new technology. These people will not be interested in learning how to get at these services through the operating system of a general-purpose computer, and indeed they will not really care that the computer makes these services possible. All that will be hidden away, just as it is in the microwave oven and digital watch. This is not a change or new direction for computers. Throughout the history of computers, their greatest strength has been the program's ability to create an abstract machine to fit the user's model of the computer's task.

The computer was aptly named because its original conception was as a mechanism for computation. Given this view of the machine as a "computer," FORTRAN was one of the most significant early transformations of the machine to match the user's task. It did so by providing an "abstract machine" for algebraic formula translation. Using FORTRAN, you could write algebraic expressions in a much more natural and convenient way than you could in assembly language. The machine became an *algebraic-expression processor*, an abstract machine that understood algebraic expressions the way its users did. Unfortunately, algebra does not include a model for control, since people evaluate each set of con-

Introducing the powerful, multi-processing HORIZON® 8/16 from North Star.

The turbo-charged system with outstanding performance.

The new North Star HORIZON 8/16 microcomputer can handle up to eight individual users, supporting both 8-bit and 16-bit applications simultaneously.

Its advanced, multi-processor architecture makes this powerful performance possible. Unlike other multi-user systems, the HORIZON 8/16 doesn't load up its users on a single processor; instead, it provides a dedicated processor for each individual user — at a cost no greater than that of conventional multi-user systems.

The result? No degradation in processing performance, even when there are eight users on the system.

And North Star's industry standard S-100 bus gives you the flexibility to choose your options and tailor the system to meet your specific requirements.

What's more, the new North Star TurboDOS® is many times faster than standard, multi-user operating systems — and is compatible with CP/M-80®, CP/M-86™ and MP/M.™

As for reliability, over 30,000 first generation HORIZONS are still in use. And each of these can be easily upgraded to the new 8/16 architecture.

The HORIZON 8/16 outperforms everything in its class. Costs no more. And is the only multi-user micro designed to

meet your needs for today, and tomorrow — simply by plugging in the options you select.

You can discover North Star's HORIZON 8/16 at more than 1,000 computer stores and system houses nationwide. Call 800-722-STAR for the location nearest you. Or write North Star Computers, Inc., 14440 Catalina Street, San Leandro, CA 94577.



TurboDOS is a registered trademark of Software 2000, Inc. CP/M-80, CP/M-86, MP/M and CP/M are either trademarks or registered trademarks of Digital Research Inc. The logo, tagline and HORIZON are either trademarks or registered trademarks of North Star Computers, Inc. © 1983 Systems serviced nationwide by M/A/I/Sarbus Service Division.

FLEXI-BUNDLE™

Now, select up to \$2,000 worth of free software of your choice, when you buy a North Star computer. See your dealer for details.

Circle 318 on Inquiry card.

www.americanradiohistory.com

GET FULL VALUE FROM YOUR VICTOR 9000™

with the UCSD p-SYSTEM™ IV.1

Get the most from your VICTOR 9000 as well as from your software development efforts. The power and portability of the UCSD p-System is available for the VICTOR 9000 from TDI.

The Standard Development System Includes:

- Full Screen Editor, Filer, Assembler and other Utilities
- The UCSD Pascal Compiler
- Native Code Generator
- Ram Disk Support Above 128K
- Turtlegraphics - full use of VICTOR screen (800 x 400)
- Complete documentation

Options:

- Fortran 77 and Basic compilers
- Hard disk support



TDI SYSTEMS, INC
620 HUNGERFORD DR.
ROCKVILLE, MD 20850
(301) 340-8700

TDI LIMITED
29 ALMA VALE RD.
BRISTOL, U.K. BS8 2HL
0272 742 798

VICTOR 9000 is a trademark of VICTOR TECHNOLOGIES, INC.
UCSD p-SYSTEM and UCSD PASCAL are trademarks of the Regents of the University of California



**NEW
HARD
DISK
SUPPORT**

ditions and decide the next step. Today, FORTRAN is justly criticized for its lack of good control mechanisms. Yet its algebraic model for computation has been propagated into most languages since that time because of its success in matching our expectations about computation.

Our inferences based on our experience with algebra are not entirely correct—the difference between “real” arithmetic and “floating-point” arithmetic has bitten many of us more than once, and most new learners have at least some problems with the “assignment” statement. Nonetheless, the introduction of FORTRAN was a significant step in making the machine match the needs of its users. Since that time, the audience for a “computing machine” has become far outnumbered by those desiring services that are not computational.

The Linguistics of Use

Programming languages have become the tools for implementing these services and have proliferated to best support development of different applications with different characteristics. As a result, programming languages have also become increasingly removed from the most common users. Today, the most common computers are dedicated to specific functions: buried inside microwave ovens for control, inside calculators for complex calculation, inside telephones for remembering phone numbers, and inside digital watches for side effects of very simple arithmetic and memory.

In many ways, the digital watch seems the archetype of the future for computers—replacing devices and procedures that have serviced our needs less well and creating new needs by extending our capabilities. Who knows or cares what language was used to program the computer in the microwave, the calculator, or the watch? Certainly not the audience for whom these products are intended.

The proliferation of the personal computer has created the expectation that many existing tasks can be supported more efficiently and more ex-

ATTENTION LA36 USERS

The DS120 Terminal Controller makes your LA36 perform like a DECwriter® III.

The Datasouth DS120 gives your DECwriter® II the high speed printing and versatile performance features of the DECwriter® III at only a fraction of the cost. The DS120 is a plug compatible replacement for your LA36 logic board which can be installed in minutes. Standard features include:

- 165 cps bidirectional printing
- Horizontal & Vertical Tabs
- Page Length Selection
- 110-4800 baud operation
- 1000 character print buffer
- X-on, X-off protocol
- Self Test
- RS232 interface
- 20 mA Current Loop Interface
- Top of Form
- Adjustable Margins
- Double wide characters
- Parity selection
- Optional APL character set

Over 9,000 DS120 units are now being used by customers ranging from the Fortune 500 to personal computing enthusiasts. In numerous installations, entire networks of terminals have been upgraded to take advantage of today's higher speed data communications services. LSI microprocessor electronics and strict quality control ensure dependable performance for years to come. When service is required, we will respond promptly and effectively. Best of all, we can deliver immediately through our nationwide network of distributors. Just give us a call for all the details.

datasouth
computer corporation

P.O. Box 240947 • Charlotte, North Carolina 28224
704/523-8500

PLURIBUS UNUM

LOWEST SOFTWARE PRICES GUARANTEED

We hereby certify that your purchase from Discount Software represents the lowest price sold anywhere. If you find a lower price on what you purchased within 30 days, send the ad and we'll refund the difference.

CP/M	Discount Price
ARTIFICIAL INTELLIGENCE	
Medical (PAS-3)	\$849
Dental (PAS-3)	\$849
ASHTON-TATE	
\$4??? dBASE II	call for price
dBASE User's Guide	\$15
\$224 Friday'	
Financial Planner	\$595
BLS	\$349
ASYST DESIGN/FRONTIER	
Prof Time Accounting	\$549
General Subroutine	\$269
Application Utilities	\$439
DIGITAL RESEARCH	
Graphics!	Call
CP/M Plus	\$319
CP/M 2.2	
Intel MDS	\$135
\$149 Northstar	
\$159 TRS-80 Model II (P&T)	
Micropolis Z-80	\$175
\$98 CBasic-2	
Display Manager	\$319
Access Manager	\$239
\$449 PL/1-80	
BT-80	\$179
MAC	\$85
RMAC	\$179
Sid	\$65
\$90 Z-Sid	
DeSpool	\$49
CB-80	\$459
Link-80	\$90

FOX & GELLER	
Quickscreen	\$135
Quickcode	\$265
\$65 Dutil	
DGraph	\$265
MICRO DATA BASE SYSTEMS	
Knowledge Man	\$429
HDBS	\$595
MDBS	\$1099
DRS or ORS or RTL	\$319
MDBS PKG	\$1999
MICROPRO	
\$279 WordStar	
Mailmerge	\$179
WordStar/Mailmerge	\$399
WordStar Professional Pkg	\$549
\$199 SpellStar	
DataStar	\$249
InfoStar	\$349
ReportStar	\$254
Wordmaster	\$119
Supersort I	\$199
Calc Star	\$165
MICROSOFT	
\$249 Basic-80	
\$329 Basic Compiler	
\$349 Fortran-80	
\$549 Cobol-80	
Multiplan	\$219
M-Sort	\$175
\$159 Macro-80	
MuSimp/MuMath	\$224
ORGANIC SOFTWARE	
Textwriter III	\$111
Datebook II	\$269
Milestone	\$269

OSBORNE (McGraw/Hill)	
G/L, or AR & AP, or PAY	\$59
All 3 + CBASIC-2	\$129
Enhanced Osborne	\$299
PEACHTREE	
PeachPack Series-4	
Accting	\$349
P-8 G/L, A/R, A/P, PAY (each)	\$559
Peachcalc	\$249
Other	Less 10%
STAR COMPUTER SYSTEMS	
G/L, A/R, A/P, Pay	\$349
All 4	\$1129
Legal or Property Mgt	\$849
STRUCTURED SYSTEMS	
Business Packages (call)	
SORCIM	
\$179 SuperCalc I	
SuperCalc II	\$265
SUPERSOFT	
Aria	\$270
Diagnostic II	\$89
Disk Doctor	\$89
Forth (8080 or z80)	\$149
Fortran	\$319
Ratlor	\$79
C Compiler	\$225
Scratch Pad	\$266
StatsGraph	\$174
Analiza II	\$45
Disk Edit	\$89
Term II	\$179
Utilities I or II	\$54
SOFTWARE DIMENSIONS/ACCOUNTING PLUS	
1 Module	\$399
4 Modules	\$1499
All 8	\$2799
UNICORN	
Mince or Scribble (each)	\$149
Both	\$249
The Final Word	\$270
WHITESMITHS	
C Compiler	\$600
Pascal (incl. C)	\$850
"PASCAL"	
MT+ Compiler	\$315

MT+ SP Prog	\$175
Pascal Z	\$349
Pascal/UCSD 4.0	\$744
DATA BASE	
dBASE II	\$477
Friday'	\$224
FMS-80	\$799
FMS-80-1	\$399
Condor I & III	Call
Selector	\$689
Superfile	\$159
WORD PROCESSING	
Perfect Writer	\$284
WordSearch	\$114
SpellGuard	\$139
Peachtext	\$219
Spell Blinder	\$349
Select	\$495
The Word	\$65
\$145 The Word Plus	
Palantier-1 (WP)	\$385
"COMMUNICATIONS"	
ASCAM	\$149
BSTAM or BSTMS	\$149
\$139 Crosstalk	
\$89 Move-it	
OTHER GOODIES	
Micro Plan	\$419
Plan 80	\$264
Target PlannerCalc	\$79
Target Financial Modelling	\$299
Target Task	\$299
MicroStat	\$224
vedtl	\$130
StatPak	\$449
Micro B+	\$229
Lynx	\$199
Supervyz	\$95
ATI Power	\$75
CIS Cobol	\$765
Forms II	\$179
Zip MBasic, CBasic (each)	\$129
APPLE II	
ASHTON-TATE	
(See CP/M Ashton-Tate)	

BRODERBUND	
G/L (with A/P)	\$444
Payroll	\$355
INFO UNLIMITED	
EasyWriter (Prof)	\$155
Datadex	\$134
EasyMailer (Prof)	\$129
MICROSOFT	
Softcard (Z-80 CP/M)	\$249
Fortran	\$179
Cobol	\$549
Tasc	\$139
Premium Package	\$549
RAM Card	\$89
MICROPRO	
WordStar w/Applicard	\$299
Other (See CP/M Micropro)	
VISICORP	
Visicalc 3.3	\$189
Desktop/Plan II	\$219
VlsIterm	\$90
Visidex	\$219
Visitrend/Visiplot	\$226
Visifile	\$219
Visischedule	\$259
PEACHTREE	
PeachPack P40	\$349
ACCOUNTING PLUS	
G/L, AR, AP or INV	\$385
OTHER GOODIES	
Dow Jones	\$314
Market Analyst	\$314
Incredible Jack	\$165
Super-Text II	\$127
Data Factory	\$269
Mini Factory	\$139
DB Master	\$184
Versaform VS1	\$350
FOUR STAR SPECIALS	
\$344 Multi-Tool Word & Mouse	
\$224 Friday'	
\$196 VisiCalc	
\$226 VlsITrend/Plot	



Complete Software Buyer's Guide (\$5.00 value)
Filled with facts and usable advice about scores and scores of software programs from accounting and business systems to word processing and utilities.

Exclusive "Hotline"
Our reputation for courteous and knowledgeable service has resulted in calls from people who never purchased our products. Now a separate "hotline" is available to customers only.

Confidential Software BargainGrams
Regular notices of insider's bargains not available to the general public.

Please add \$3.50 Postage and Handling for each item. Cal residents add 6.75% Sales Tax. CPS Blue Label is an additional \$3.50 per item. C.O.D. \$3.00 extra. Call for overnight delivery. Prices subject to change without notice. All terms subject to availability. *Mf: Trademark. CP/M is a registered trademark of Digital Research, Inc. Outside Continental U.S. Add \$10.00 plus Air Parcel Post.

ORDER TOLL-FREE VIA VISA OR MASTERCARD:

1 800 421-4003
or 1 213-837-5141
Calif: 1 800 252-4092

6520 Selma Avenue, Los Angeles, CA 90028

DISCOUNT SOFTWARE

BY1283

uberantly by this new generation of computers. What has been called the personal computer "revolution" will appear, historically, to be only the initial call to arms. This movement reflects the dramatically changing economics of digital electronics and promises a new era of products that better support our information-processing activities.

Microcomputers

When single-chip microprocessors first appeared, the potential power

and economy of this emerging computer hardware was soon recognized. Home-built computers with 256 bytes of memory and no nonvolatile storage began appearing in surprising numbers. The computer itself cost very little, though in this form you could do little with it. Despite rumors to the contrary, we have not come very far since that time—not when you consider the potential penetration of this technology into our lives.

Certainly, the small, general-purpose computer has come of age.

There is now software to support most of the obvious uses of such a system in the home and business. And those of us in the computer fraternity feel satisfied that much has been accomplished and that much of what we wanted is now available. The rest of the world will just have to learn some of what we know so people can pick the right software, find the best hardware to run it, and figure out the obscure incantations necessary to make it all work. You often hear us make comments like "Ignore that bug; it doesn't matter most of the time" and "Yes, that's confusing, but I can tell you what it means."

We are deceiving ourselves. People do not really care about the computer revolution any more than they care about any other item on the front page of their newspaper. Interested? Yes. Involved? No. Nor do they want to learn what is needed to use these miracle machines. They just want the miracle itself.

For now, we can force them to join the fringes of our fraternity because it's the only game in town. However, when a product appears that does what people want without all that elitist computerism about it, the market will prove that the users will buy what most directly satisfies their needs. An electronic accountant need be no more tainted by the presence of a microcomputer chip than the electronic typewriter or calculator has been.

People are already doing most of the tasks that they want and need to do. New products must solve the same problems but with better service and in a better way. My digital watch tells time, but not in the same way as its predecessor. It also reminds me of the passing of time with an hourly chime, like the old grandfather clock in my hall. It times parking meters for me so I do not have to try to calculate how much time I have left. When I travel, it tells me both the local time and the time back home so I no longer call the office at 6 a.m. This digital timepiece is only metaphorically the watch of my past experience. That is just the starting point for my understanding of it.

The MICROWRITER™ Daisy Wheel Printer.



Price \$480

Features:

- Microwriter parallel interface mounted internally in the Olivetti Praxis machine
- Built in self test
- Portable...comes with deluxe carry case
- Low noise level
- Slim modern styling
- Print quality is identical to the finest office typewriters on the market
- Can tab
- Rule single lines both vertically and horizontally
- Underline
- Print at 10, 12, or 15 characters per inch (switch selectable)
- Ten character memory automatic error correction, with lift-off carbon film correction ribbon (for typewriter use)
- Automatic or programmable page formats
- Handles letter, legal size sheet and fanfold paper in widths up to 12 inches wide
- 165 character/12 inch print width
- Wide selection of 21 interchangeable daisy print wheels available
- Ribbon cassettes just drop in
- Switch selectable European keyboard
- Centronics compatible parallel cables are currently available from stock

With the Microwriter you will never again have to send an important letter or a simple correspondence that doesn't look impressive. Why settle for just any printer when you can have a MICROWRITER... a fine letter quality typewriter for you and your computer. For more information, see your local computer dealer or contact Ammicro directly.

ammicro™ corp

122 East 42 Street, Suite 1700, New York, N.Y. 10168

(212) 254-3030



ORCA/M IS THE WORLD'S BEST 6502 ASSEMBLER.

You'll agree when you read what Peelings II and Softalk said:

"The amazing thing about ORCA/M" is that in addition to being clearly superior to its competition, it also was written with future improvements in mind. The combination of power and potential is what warrants the AAA rating." *Peelings II, Volume 4, Number 5*

ORCA/M is only the second product to ever receive the top AAA rating in the history of *Peelings II*.

Now. The kind of high-level support you'd only expect to find on a mainframe.

ORCA/M (Hayden's *Object Relocatable Code Assembler for Micros*) lets you develop sophisticated applications with the speed and ease of a high-level language, yet retain the control and efficiency that only assembly language can give.

Here's what ORCA/M gives you:

The Assembler

Macro language features:

- o Conditional assembly of source and macro files
- o Separate source and macro files
- o Nestable macros
- o Parameter mid-string and string search functions
- o Symbolic parameter assignment
- o Numeric, string, and boolean type parameters
- o Parameter subscribing
- o Global communication between macros
- o Macro expansion loop control
- o Count, length and type parameter-attribute functions

Extensive Macro Libraries

Memory Constant Declarations:

- o Integer
- o Character
- o Four-byte Integer
- o Hexadecimal
- o Floating Point

Relocatable object module generation

Fast assembly directly to disk

Program segmentation:

- o Selectively assemble individual subroutines
- o Global and local scope of symbols

The Linker

Produce executable binary files from relocatable object modules

Link routines from library files

Link subroutine re-assemblies

Define a new origin for previously assembled code

Invoke at assembly time or by command

Subroutine libraries:

- o Floating point and double-precision routines
- o Transcendental functions
- o Hi- and lo-res graphics
- o Multiple-precision integer math
- o Input and output

AAA, incidentally, stands for "absolutely astounding" software.

Softalk magazine had this to say: "ORCA's true destiny is to assemble creations of the greatest sort: programs so big we don't even tend to think of them as programs but rather as part of the soul of the machine. ORCA would be a good assembler to get you started on the great American Arcade Game..."

Softalk, May 1983

The Editor

Co-resident screen editor:

- o Global search and replace
- o Block move
- o Entry of non-keyboard characters

Supports lower case adapters and shift-key modification

80-column: horizontal scrolling with 40-column displays

The System

Monitor: transparent control of system from one command level

Extended Disk Commands:

- o File copy
- o File undelete
- o Catalog sort
- o Wildcard filenames

Disk ZAP: Built-in disk sector editor

Optimized DOS 3.3 compatible operating system

Operating system interface:

- o Supports a variety of configurations
- o User-modifiable to allow linkage of custom drivers for peripherals

64k RAM supported, 48k required

This unique array of features and functions speaks for itself: the power of ORCA is unsurpassed.

All features are documented clearly and extensively. Source listings for the subroutine and macro libraries, as well as the operating system, are included.

ORCA. If you're serious about developing 6502 software, it's the one to have.

Available from your local dealer, or call:
800-343-1218
(In MA call 617-937-0200)
ORCA/M: 21609
Apple II or IIe disk, 48k, DOS 3.3
Two drives and 64k recommended.

\$149.95

ORCA/M is now also the best 65C02 assembler, supporting all 27 new opcodes. New hardware support includes the IIe 80 column board and disk emulators for the Legend™ 128K card and IIe extended memory card.

HAYDEN SOFTWARE

GET ORGANIZED

With Our New Line Of Quality Products

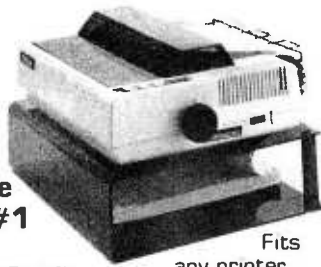

The PR#1

\$29.95

Fits any printer, made of 1/4" bronze acrylic. 16 x 13 x 4

The PR#2 fits larger printers. Measuring 24 x 13 x 4

For Only \$34.95

Both are available with bottom feed.

Sturdy Bronze Acrylic Copy Holder

\$24.95



Quality Constructed Desk 48" x 24" x 40"



\$149.90

+ Freight

Gas Operated

Chair \$99.99

5 1/4" Guaranteed BASF

Disks

SS-DD \$24.50

SS-QUAD \$31.50

DS-DD \$32.50

DS-QUAD \$39.50

MIDAMERICA WHOLESALE, INC. COMPUTER ACCESSORIES

8135 215th St. Lakeville, MN 55044

Personal checks allow 2 weeks. We accept VISA and Master Card. (Send card number and expiration date). MN residents add 6% state sales tax. Prices subject to change without notice.

TO PLACE ORDERS CALL ANYTIME

1-800-328-2977

MN residents 612-469-4666

From there, I have learned many new functions of time that I now relate to the concept of "watch." A study of the U.S. population of watch buyers would probably reveal an almost universal shift in the concept of "watch" due to this new product. The shift in expectations is little noticed because the metaphor provides continuity with our past experience. As control interfaces improve, it becomes easier to learn the new services these new machines provide, and the change in the sophistication of their users accelerates.

Metaphors

By now it should be apparent that the ability to infer from prior experience is critical to the human interface of these new "miracle products." To understand these metaphors and how they will evolve in the future, let's view them from the perspective of the type of service they must introduce.

A metaphor can make the function of a machine be more compatible with its user's view of the task, what is here called a *functional metaphor*. Our example, the digital watch, is built to look and act similar in many ways to its mechanical predecessor, so that we immediately assume certain operations will be available. Metaphors can also be used to unify sets of operations (*operational metaphors*), so that we have expectations about what is available and how to use those operations. Possibly the oldest of these is the computerized workstation, which implies that the computer has all of the operations present in the physical workstation that preceded it.

Unlike the operational metaphor that emphasizes functions, the *organizational metaphor* focuses on how people use the *location* and *distribution* of the information at their disposal to identify priority and categorization. (The In box and Out box on my desk are simple examples of how location can categorize information.) Finally, the *integrating metaphor* allows separate products to share a single conceptual model, much like the filing cabinet and the typewriter assume the same physical dimen-

sions of the piece of paper.

Functional Metaphors

I have created estimates for construction projects that used a spreadsheet with a series of interrelated tables for each subcontractor and class of material with amounts, unit pricing, and extended pricing. Inevitably, some amount or unit price must be changed, and changes must then be propagated through a number of other tables, which requires lots of erasure and is difficult to remember if the spreadsheet was not recently created. In frustration, I have often just thrown up my hands and fudged the final amount by a guess.

Then, Visicalc and its progeny were released. Without ever being conscious of it, I discovered that it was a product that I needed for years. Other tools were available to help with the spreadsheet problem, such as calculators for the computations and special paper to keep the columns neater, but here was the real thing: an electronic spreadsheet. This product "knew" what I was doing and helped me do it quite naturally. As soon as I used my first electronic spreadsheet, my world changed in a way that was perhaps more spectacular but no less fundamental than with my digital watch. No electronic spreadsheet that I have used seems just right, but the difference between having one and not is like the difference between a campsite with water and one without. I could never go back to pencil and paper again. For appropriate tasks, this product provides a very strong metaphor that closely matches my view of the task.

The match is not perfect. If it were, the electronic spreadsheet would be of little value. No paper spreadsheet allows you to instruct it in how the entries are related. Nor does it automatically refigure the values at your request. These and many other useful features of the electronic spreadsheet are new, but they are exactly what I had been waiting for.

In the future, people will no longer see their financial planning, estimating, and other spreadsheet tasks through eyes limited to a paperbased

MORROW

There's a certain kind of person who buys a Morrow business computer.

The kind of person who doesn't follow the crowd. In business. Or away from it. You've succeeded by making your own decisions.

And when it comes to a decision on computers, you know that you don't have to pay a lot of money to get a lot of computer. Morrow knows that too.

That's why we make a complete line of systems, including software, from \$1599 to \$2745. Plus letter-quality printers starting at \$595. All, with performance so reliable you'll probably never need the nationwide service we offer from Xerox.

But maybe you don't know this: We've just introduced a hard-disk system with more performance at a lower price than anything else on the market. Anything.

The new MD11 includes an 11MB hard disk; 400K of floppy memory; 128K RAM; 8K ROM; 2 serial, 1 parallel and a main frame communications port. Add the legendary speed of the Morrow controller, a complete package of software, plus a full-size terminal, and you may not be ready for the price: \$2745, complete.

Morrow has never built computers to please everybody. We build them for people who demand value.

It's simple. Those who know buy Morrow.

The computer for independent people.

Morrow, 600 McCormick Street, San Leandro, CA 95477
For the Morrow Dealer nearest you, call: (800) 521-3493
(415) 430-1970 in California

New 11MB MD11 for \$2745



Satisfying More Than With Innovation



GrapplerTM + Printer Interface

The Original Apple[®] graphics printer interface. Since its introduction three years ago, the Grappler has been imitated by many, but never matched. Now with exclusive features for the Apple IIe and full support of new Epson[®] graphics, the Grappler + remains the most intelligent interface available. Over twenty-seven commands give Apple users full control over any graphics or text on the Apple screen, including a new 80 column text dump. Performance, reliability and support have made the Grappler + the #1 selling intelligent Apple interface.



BufferboardTM For Apples and Printers

The innovator in "dock-on" printer buffering. The Bufferboard easily adds memory to your current Apple interface system, freeing your computer for additional input. Easily upgradable from 16K, the Bufferboard can store up to 20 pages of text. It fits neatly inside your Apple, "docking" onto your existing printer interface.* No clumsy boxes or cables, no external power supplies... just convenience and economy. With the Bufferboard, you might never wait for your printer again.

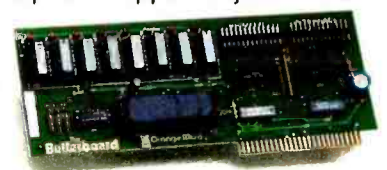

*Versions for standard Grappler +, Epson APL and Apple Parallel Interfaces.

135,000 Apple® Owners And Excellence.



BUFFERED Grappler™ +

The most sophisticated buffered Apple printer interface available. The New Buffered Grappler + combines the industry leading features of the Grappler + with the time saving economies of the Bufferboard.**

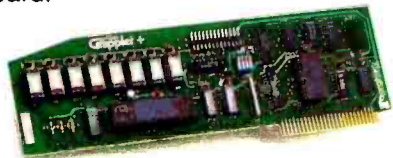

With this much interface power, you'll never need anything else. And the price will surprise you, too.

**Not available for IDS printers.

Apple is a registered trademark of Apple Computers, Inc.
Epson is a registered trademark of Epson America Inc.
See us at Comdex Booth #2581.

Over 135,000 Apple® computers are using Orange Micro products. Innovation and excellence have made us the #1 manufacturer of intelligent printer interfaces. The top selling Grappler + has become an industry standard, recommended by more software houses and Apple dealers. To meet your growing needs, Orange Micro will continue to introduce new products. Recent innovations include the Grappler + for IDS color printers and the new Orange Interface, with text screen dumps and formatting at a low price. There is an Orange Micro product designed for your application. For a complete demonstration, see your Apple dealer today.

Orange Micro
inc.

1400 N. Lakeview Ave., Anaheim, CA 92807 U.S.A.

(714) 779-2772 TELEX: 183511 CSMA

©Orange Micro, Inc., 1983

International Distributor Inquiries Invited.

HOLD EVERYTHING. MICROLINK II[®] MAKES IT EASY.

In this age of information, not knowing the answers is simply out of the question.

With MicroLink II you can know just about anything in the world.

The cost? Just \$99.

It's a small price to pay for such a powerful telecommunications software program.

The MicroLink II links your computer to information bases, time-sharing mainframes, and other micros.

It lets you send and receive electronic mail by modem anywhere in the world. Quickly. Inexpensively.

And you can forget about file transfer errors because MicroLink II uses the Christiansen Protocol to find and correct them. Automatically.

Need more information? Go right ahead and get it.

MicroLink II puts hundreds of services and programs at your fingertips with THE SOURCESM or CompuServeTM. The UPI news wire, 3100 stocks and 58 performance categories, investment analysis, commodity news service, research data, sports, ticket and travel information, discount catalogs with over 50,000 items, even games.

All you have to do is ask.

When you consider the kind and amount of information MicroLink II can put in your hand, there's really only one question left to ask: What in the world are you waiting for?

Learn more about MicroLink II.
Call **TOLL-FREE 800-826-2222.**

Or write to
Digital Marketing Corp.
2363 Boulevard Circle
Walnut Creek, CA 94595
(415) 947-1000
Telex 17-1852

MicroLink II requires 32K RAM and CP/M[®] CP/M 86[®] MS-DOS[®] or PC-DOS[®]. THE SOURCE is a service mark of Source Telecomputing Corporation, a division of the Reader's Digest Corp. CompuServe is a registered trademark of CompuServe Incorporated.



Circle 145 on inquiry card.

experience, but rather through eyes accustomed to the added functionality of the electronic spreadsheet. The perceptions and expectations of the people that make up this marketplace have been irrevocably changed because of the success of the electronic spreadsheet.

Operational Metaphors

The Xerox Star was a signal product that demonstrated the power of metaphor in the interface of an office workstation. This product and its progeny, including the Apple Lisa, use a desktop metaphor to provide a consistent interface to a system with office-automation functions. Because many of the concepts are new, each system has serious flaws, but it is much easier to see flaws when the whole has a consistency and integrity that highlights the problems rather than drawing one's attention away from them.

An interesting aspect of the user interface in these systems is the use of the mouse pointing device. This is obviously metaphorical, because you do not actually point with the mouse. The movements you make with the mouse are translated to movements of a cursor on the screen. The tight physiological hand-eye feedback loop reinforces the metaphor so well that it quickly becomes as natural as using your finger to point.

These systems package together a number of applications with a consistent style of interaction, using the mouse, overlapping screen windows, menus, and a *location-operation* syntax. This consistency has the advantage that it need be learned only once but the disadvantage that it forces all functions to share the same input and output concepts and mechanics. The functions themselves are distinct, and the desktop metaphor serves to suggest the presence and nature of the individual functions available in the workstation.

The sense of consistency in the interface of the various individual functions is gained because general-purpose operations are common to each of them. The number of operations is reduced because of their generality. Though "learnability" itself has not

SIMPLE.

Instant networking, independent of computer and peripheral brands.

Creating a micro and mini computer network has been costly and confusing. Communications hierarchy has prevented many types and various kinds of equipment from sharing information. *Until now.*

Introducing StationMate. One unit that joins mini computers, micro computers, terminals, and printers. It's transparent. So different brands and types of computers and peripherals can easily interface. StationMate allows you to construct a comprehensive communications network. *Inexpensively.*

Users can select the information they need from the unit they want. StationMate can

StationMate provides local area networking with XLAN™, the simple communications con-

only \$1,450.00. StationMate makes communications simple. *Incredibly.*

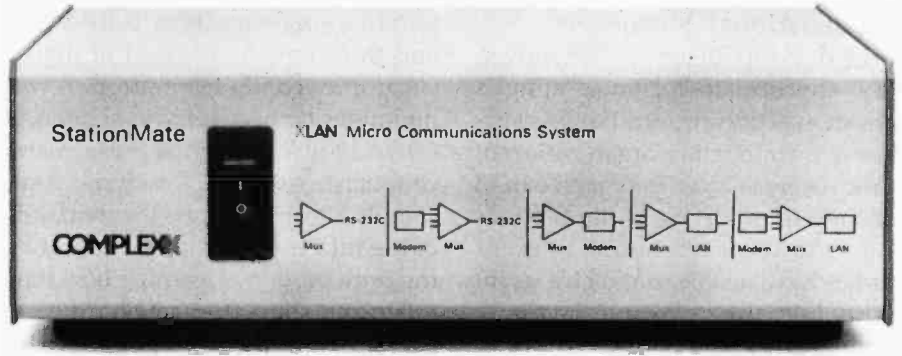

cept from Complexx. All you need is StationMate and an inexpensive shielded-pair cable. Besides local area net-

StationMate. The link you've been missing. See your local dealer or contact Complexx for the name

Teleprocessing

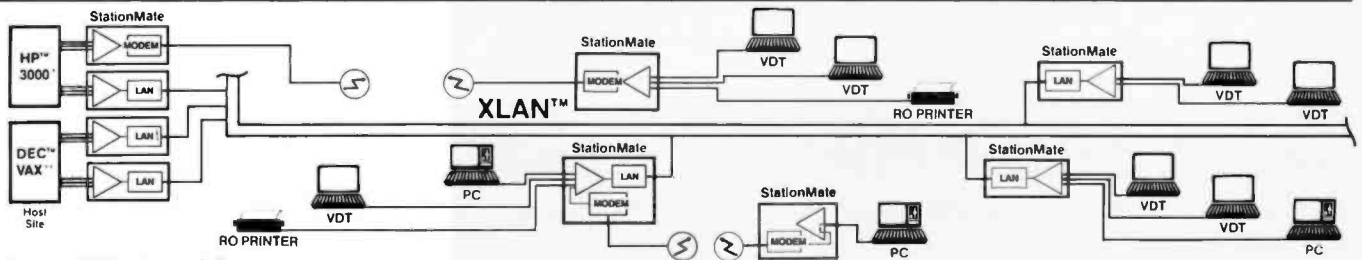
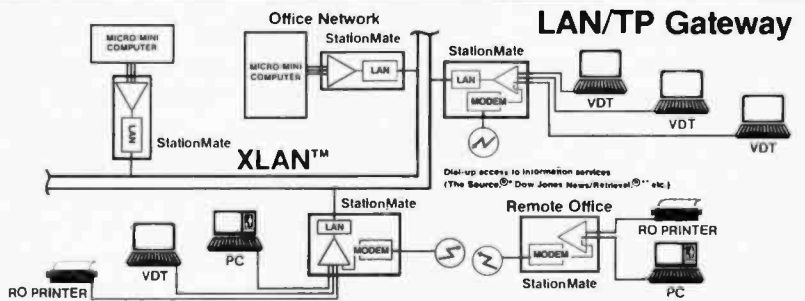
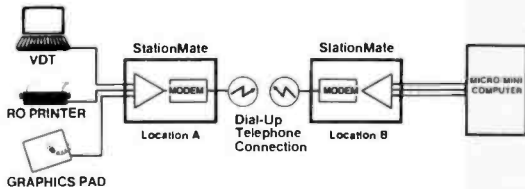

Local Networking

address any port in the network either by its assigned digital code or by its common identifying name. So everyone has access to all the local or remote computers, mass storage files, and peripheral devices connected in the network. *Immediately.*

working, StationMate permits access to remote workstations via an internal dial-up modem. And it serves as a gateway for teleprocessing access to all LAN resources. You couldn't get all of this in one unit. Until now. And the suggested retail price is

of the dealer or distributor nearest you. *Complexx Systems, Inc., 4930 Research Drive, Huntsville, AL 35805. 205/830-4310.*

COMPLEX™

*The Source is a registered trademark of the Source Telecomputing Company, a subsidiary of the Reader's Digest Association. **Dow Jones News/Retrieval is a registered trademark of Dow Jones & Company, Inc. †HP 3000 is a registered trademark of Hewlett Packard. ††DEC VAX is a registered trademark of Digital Equipment Corporation.

been as well addressed as consistency, it is certainly enhanced by the small number of consistently applied operations.

This electronic desktop is certainly not like my old oak desktop—it offers its user both more and less. Many new services are provided that were either not available or not as simple without the computer. On the other hand, the actual physical piles of paper on a desk organize and advertise work in a way that is difficult to do on these systems.

Organizational Metaphors

The desktop metaphor has proven very appropriate for integrating a cohesive set of functions but less successful for modeling organization of work. There is more to organize than the long-term storage of file cabinets and software operators. Recent studies have just begun to give us insight into how people actually organize their work and use the files, drawers, and horizontal surfaces in their offices to create an entire organizational ecology. Each stack of papers on my desk has a different significance, and the visibility of the items in the stack serves to remind me of what I need to do.

As yet, I have not been able to replace these well-worn conventions by the facilities of any computer system, at least not with anything approaching the same immediacy and evocative power. Future computer systems will undoubtedly focus more attention on metaphors that include visual cues to assist my short-term and intermediate-term memory in the or-

ganization of my work.

Integrating Metaphors

A small but growing number of current software packages attempt to integrate several functions into a common framework. A database, word processor, and spreadsheet seem to be a common selection. Although most of these are integrated only in the sense that there is some access to each from the others and some uniformity of display and input mechanism, they share the same interface hardware. This visible integration in a single machine is primitive and transient. As the cost of digital electronics continues to drop, it will no longer be necessary to share one set of hardware across these many products. After all, each is compromised somewhat by the demands of the others on the interface and by the extra burden of learning how they relate and share the same hardware. As hardware gets cheaper, the user does not need to suffer these compromises or learn the level of common control that integrates these products.

To the extent that a single product, such as a word processor, needs access to spreadsheet and database functions, they should be included in the word processor itself. To the extent that it need share only information with other products, that sharing should occur magically without intervention from the user. Once this magic becomes commonplace, it will gain acceptance, and only its absence will be noteworthy. The products themselves do not need to appear to

be shared. Each can have its own box, with its own input and display mechanism optimized for the tasks it performs.

After a short time, it will not be surprising that the results from the spreadsheet tablet can be displayed on the word-processor screen when needed, nor that the entries from the electronic sales order entry pad are available to the spreadsheet tablet and the inventory display instantly. This level of metaphor assumes the communication needed to share information—whether within or across products. The great burden of transporting data that mankind has carried since the first scribes, merchants, and bookkeepers will finally be lifted.

This distributed set of independent functional metaphors incurs less overhead than a single operational metaphor because functions have the support of implicit metaphors from prior experience with each of the separate devices replaced by its electronic counterpart. When your electronic phone and electronic telephone book can confer without direction from you, new forms of communication service become available. Once available, these services will rapidly become necessities.

The Future of User Interfaces

We are now seeing the emergence of hardware that is suitable for specialized machines dedicated to specific functions. This hardware includes hand-held computers and systems that replace mechanical devices in the home and business environment but that do more than their pre-

DATA TRANSFER PROBLEMS?

Your Simple Solution is **REFORMATTER®** Diskette Conversion Software



- Avoids serial communication protocols.
- Needs only one system to transfer data.
- Converts source code and data files.
- Allows 2-way transfer.
- Quick, reliable, and inexpensive.

VERSIONS	
Runs On	Reads/Writes
CP/M	↔ IBM 3740
CP/M	↔ DEC RT-11
CP/M-86*	↔ NEW IBM 3740
CROMIX	↔ DEC RT-11
DEC RT-11*	↔ CP/M
MS-DOS*	↔ NEW IBM 3740
TRSDOS II	↔ CP/M
TRSDOS II	↔ DEC RT-11
PRICE:	\$249 *\$350

Requires 8" floppy drive.

(415) 324-9114 TWX: 910-370-7457
467 Hamilton Avenue, Suite 2, Palo Alto, Calif. 94301

SPSS/PC™

NEW!
IBM PC and
DEC PRO 350

Statistical and Reporting Software

SPSS Inc. a leading producer of statistical software for over 15 years, with more than a half million manuals sold in 80 countries, is making micro waves with SPSS/PC and SPSS/Pro.™ Two powerful new statistical and reporting programs which were designed for the IBM Personal Computer and the DEC Professional 350.

POWERFUL STATISTICS

- ❑ Crosstabulations
- ❑ Analysis of variance
- ❑ Multiple regression
- ❑ Over 25 integrated procedures

TOTAL INTEGRATION

- ❑ File management of large or small data sets
- ❑ Input & output to popular PC programs
- ❑ Flexible data transformations

CUSTOM DISPLAYS

- ❑ Automatic or custom reports
- ❑ Fully labeled tables
- ❑ Plots & graphs

EASY TO LEARN

- ❑ Simple English commands
- ❑ Tutorial & demonstration diskette included
- ❑ Comprehensive documentation for all levels of users

Partners in Information

SPSS inc.

SPSS Inc.
444 N. Michigan Avenue
Chicago, Illinois 60611
(312) 329-2400



College Division
McGraw-Hill Book Company
1221 Avenue of the Americas
New York, New York 10020
(212) 997-6611

For the DEC Professional 350, and soon for the IBM PC with hard disk. To discover how SPSS can help you make waves, call us for the full story. (312) 329-2400.

SPSS, SPSS/PC and SPSS/Pro are trademarks of SPSS Inc. for its proprietary computer software. IBM PC is a trademark of IBM Corporation. DEC and DEC Professional are trademarks of Digital Equipment Corporation.

© Copyright 1983. SPSS Inc.

MICROXPRESS

COMPETITIVE PRICES / PROFESSIONAL SERVICES



8"	THINLINE FLEXIBLE DISK SUBSYSTEM (SHOWN ABOVE) FULLY ASSEMBLED & TESTED WITH COMPLETE DOCUMENTATION	
	I-8480* DUAL DRIVE, DOUBLE-SIDED, 2.4MB	\$1,495
	I-8481* SINGLE DRIVE, DOUBLE-SIDED, 1.2MB, INCL FILLER PANEL - SECOND DRIVE CAN BE ADDED LATER	995
8"	FLEXIBLE DISK CONTROLLERS FOR IBM PC & APPLE NO CONTROLLER NEEDED FOR TANDON/HEATH* 2-100	Call
5 1/4"	FULL HEIGHT INTERNAL MOUNTING FLEXIBLE DISK DRIVES FOR IBM PC & XT. TANDON/HEATH* AND OTHER SMALL COMPUTERS	
	CONTROL DATA CORPORATION	
	CDC 9409 DOUBLE-SIDED, 48TPI, 320/360KB	225
	Tandon	
	TM100-2 DOUBLE-SIDED, 48TPI, 320KB	225
	TM101-4 DOUBLE-SIDED, 96TPI, 640KB	285
5 1/4"	1/2 HEIGHT INTERNAL MOUNTING FLEXIBLE DISK DRIVES (INCLUDES STRAP KITS TO MOUNT IN FULL HEIGHT FOOTPRINT) 6 MS. STEP RATE	
	Tandon TM50-2 DOUBLE-SIDED, 48TPI (2) DRIVES FOR	395
	Tandon TM55-4 DOUBLE-SIDED, 96TPI (2) DRIVES FOR	550
	QUMETRAK 142 DOUBLE-SIDED, 48TPI (2) DRIVES FOR	425
	TEAC FD 55-B DOUBLE-SIDED, 48TPI (2) DRIVES FOR	450
	TEAC FD 55-F DOUBLE-SIDED, 96TPI (2) DRIVES FOR	550
	IBM 4 DRIVE ADAPTOR CABLE	Call
IBM PC	DOS SOFTWARE UTILITIES FROM TALL TREE SYSTEMS	Call

GD	CONTROL DATA CORPORATION DISKETTES	Guaranteed Error Free
1242-00	5-1/4" SINGLE-SIDED, SINGLE DOUBLE DENSITY, WRITE PROTECT NOTCH & HUB RING (Box of 10)	Special 19.95
1244-00	5-1/4" DOUBLE-SIDED, SINGLE DOUBLE DENSITY, WPN & HUB RING (Box of 10)	Special 29.95
-	8" SINGLE DR DOUBLE-SIDED, SINGLE/DOUBLE DENSITY, WPN & HUB RING, VARIOUS FORMATS	Call

RAM		
M9	SET OF 9 64K CHIPS	Special 49

PRINTERS		
DOT MATRIX		
EPSON	FX-80 (80 CPS)	499
	FX-100 (80 CPS)	729
OKIDATA	82 (120 CPS)	525
	93 (120 CPS)	849
NEC	8023 (100 CPS)	495
DAISYWHEEL		
BROTHER	HR-1 (16 CPS)	739
NEC	3500 SPINWRITER (33 CPS)	1,875
DUME	SPRINT II PLUS (40 CPS)	1,475

MICROXPRESS

(714) 632-8512

305 S. State College Blvd.
Suite 135
Anaheim, CA 92806



decessors. Telephones, clocks, appliance controllers, burglar alarms, checkbook calculators, notepads, and phone books are all potential candidates. We can expect these devices to continue to proliferate.

Network technology that allows machines to communicate is coming of age. Various types of local-area networks and communication software are available, and the rich potential for interconnected groups of small computers is just beginning to be realized.

Input and output devices for increasing the bandwidth of communication between the man and the machine are evolving rapidly as well. These include pointing and drawing devices for input and bit-mapped displays for output. Much has been accomplished with voice input and output as well. Used appropriately, verbal communication can be very valuable: an electronic typewriter could benefit from voice recognition of commands to keep typists from having to move their fingers from the home row of keys.

Some people advocate full recognition of spoken language as the best input technology. Even when we have this capability, this would not be the ideal way to interface to many products. To assume otherwise is to overlook some critical properties of the man-machine interface. The complexity of the interface should ideally mirror the complexity of the task to be specified or controlled. So-called natural language is a complex and cumbersome communication tool. It is so difficult and time-consuming for us to say what we want that we often point to something rather than describe it. Pointing is faster, simpler, and less ambiguous. When people discuss even simple topics, much repetition and restatement is often needed before everyone believes an understanding has been reached. Even then, people are often wrong.

If you wish to control a light, a simple on-off switch is fast and efficient. The task is well matched to the control. Even sound-activated lights, the form of natural language without the substance, prove surprisingly subject

to misinterpretation. Quiet contemplation of a new book is interrupted regularly by darkness, while inconsequential street noises waste electricity. Manual light switches are more certain.

Similarly, if I want to indicate a particular spot in my text in a word processor, I would rather point than talk. So-called natural language is more useful for those few occasions where the task itself is complex—for example, in database inquiry when the number of possible queries is very large.

Interface hardware is improving, and better hardware makes it easier and more natural to accomplish a broader range of tasks. Any product succeeds only if users can learn how to use it and decide it provides a necessary service. Better tools for communicating between the user and the product can do much to assure success. However, the design of the interface for these products must be firmly rooted in appropriately selected metaphors to promote learnability as well.

As interface designers, we sometimes defend our design with the premise that our system is designed to be powerful for the experienced user like ourselves and that obviously no system can be ideal for both naive and experienced users. Some preliminary experimental data in several areas suggest that this well-known trade-off is a myth. Several different types of studies have now shown that even experienced users prefer systems that are easy to use *and* powerful. We can build systems that are easy for the naive user, easy to learn and become an expert on, and powerful for the expert. Functional generality provides power that can be learned easily.

Learnability involves the ability of the user to quickly gain a conceptual mastery over the product that allows progress from simple initial exploration to more complex later uses. Learnability is the single most important concern in the interface design. This will be even more true in the future as products penetrate further into the market and further away from the computer fraternity. Meta-

Number One Add-On Products for IBM PC



The Multifunction Cards that let you get the most out of your IBM PC.

AST Research Number One Add-Ons let you realize the full potential of your IBM PC or PC-XT without wasting valuable slot space. By combining your memory and input/output requirements on a single card, you can take advantage of more of the capabilities IBM designed into the PC, while leaving space for future enhancements as they are introduced. AST Research multifunction boards can add user memory from 64K to 512K to your PC bringing your PC memory to its maximum of 640K. You also receive the added features of serial ports, parallel ports, a clock calendar, game adapter port, and SuperPak™ — the utility diskette with the most powerful disk emulator and print spooler software available.

SixPakPlus™ — Up to 384K memory, serial port, printer port, optional game port, and clock calendar on a single card.

I/O Plus II™ — Up to 2 serial ports, optional printer port, optional game port, clock calendar on a single card. No memory.

MegaPlus II™ — Up to 512K memory, up to 2 serial ports, optional printer port, optional game port, and clock calendar on a single card.

ComboPlus™ — Up to 256K memory, serial port, printer port, and clock calendar on a single card.

Communication Products — Other AST Research Number One products include system enhancements and mainframe communications products such as 3270 SNA and 5251 terminal emulation, 3780 RJE support and AST-PCnet™ — the Local Area Network specifically designed for the IBM PC.

AST Quality

All AST Research multifunction boards come with the **AST "Plus"** — our unsurpassed reputation for quality, reliability, after-the-sales support, and overall design excellence — which give our products the best price/performance ratio in the industry.

AST Research Number One Add-On Products are available at Computerland, Entré, Businessland and other computer stores worldwide. Contact AST Research, Inc. for the dealer nearest you. (714) 540-1333/863-1333 TELEX: 295370ASTR UR

PCnet is a registered trademark of Orchid Technology, Inc.

Circle 6 on Inquiry card.



AST
RESEARCH INC.

COMPUTER BRIEFCASES



- ... Lightweight, tough, molded ABS case
- ... Aluminum closure, cast chrome locks
- ... Customized foam padding on all sides

EXECUTIVE LINE (w. shoulder strap)

E-1 IBM PC, keyboard, cables \$149

PRESTIGE LINE (add \$15 for shoulder strap)

P-1 Transtar 120 \$ 99
 P-2 TRS-80 Model 100, Transtar 120 \$119
 P-3 Epson MX-80, IBM Printer \$ 89
 P-4 Epson MX-80 F/T \$105

Add \$5 for shipping/handling. TX residents 5% sales tax. Cashiers check. MO Allow 4 weeks for personal checks

CarryCase PO Box 721763, Houston, TX 77272

Circle 515 on inquiry card.

PROPORTIONAL SPACING on WordStar

Now you can have the professional appearance of typeset text using WordStar's built in print capability. PS is easier to read and allows up to a third more text on a page without appearing cluttered. Using it is as easy as turning on bold or underline and is done right in your document, then printed by WordStar automatically!

Easy to read instructions for printing in PS, setting two or more justified columns on a page, underlining spaces between words, and more. The techniques will work on all versions of WordStar, and will drive Diablo, Xerox, Qume, NEC, C. Itoh and other daisywheel printers. No technical knowledge is needed.

PS on WordStar - \$20 postpaid
 Please send me _____ Copies. Enclosed is my check (or Visa/MC# and exp. date) for \$_____, made out to:

WRITING CONSULTANTS

Suite 112
 11 Creek Bend Drive
 Fairport, New York 14450
 Call Toll Free 1-800-227-3800 Ext. 7018
 Dealer inquiries invited.

Circle 517 on inquiry card.

IBM PC COMPATIBLE

Slimline Disk Drive.....\$215.00 ea.

(Shugart SA 455, DS,DD 320KB)

Slimline Hard Disk.....\$495.00 ea.

(Shugart SA 706 5MB)

Computer Case.....Call

Keyboard.....Call

Power Supply.....Call

Disk Controller Card.....Call

Color Graphic/Monochrome/Printer

Interface Card.....Call

Compatible Bare PCB.....Call

3M Diskette SS/DD.....\$20/box

3M Diskette DS/DD.....\$28/box

Dealer Inquiries Welcome

ELECTRADE CO. (408) 946-2541

780 Trimble Rd., Suite 605
 San Jose, CA 95131

Circle 519 on inquiry card.

Apple II/IIe® Industrial Control Plug-In Boards (SOFTWARE INCLUDED)

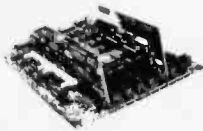

Opto-Isolated 16/32 I/O Board

- Individually Configurable
- Compatible with SSR Modules
- Opto-Isolated Interrupt Inputs

\$295

2 Axis Stepper Motor Interface

- Positioning Control
- Pulse Counting/Timing
- Frequency Measurements

\$195

ROGERS LABS (714)751-0442

2710 S. Croddy Way, Santa Ana, CA 92704

Circle 516 on inquiry card.

SUPER PRICES -- SUPER MICROS

SAGE
 COMPUTER TECHNOLOGY

SAGE IV computers use the 68000 CPU, come with UCSD p-System, PASCAL, Macro Assembler. Multi-user system, Word processor, Spreadsheet, 1 year warranty.

Available SAGE configurations include:

1 640K floppy & 256K RAM \$3120
 2 640K floppies & 256K RAM \$3760
 1 floppy, 256K RAM, 6mb Hard disk \$5840
 1 floppy, 1mb RAM, 18mb Hard disk \$8000

As software developers and authorized SAGE dealers we offer customer support.

MARITIME SOFTWARE ASSOCIATES

(503) 929-2552

6660 Reservoir Road Corvallis, OR 97333

Circle 518 on inquiry card.

DISK DRIVES

(For PC, Mod I, III & IV)

Tandon TM55-2\$229
 Tandon TM100-1\$175
 Tandon TM100-2\$229
 Tandon TM101-4\$315
 CDC 9409\$239
 Case and PS.\$ 45

PC EXPANSIONS

MAYNARD
 Disk Controller.....\$162
 Sandstar Series.....call

QUADRAM
 Quad board (64K).....\$269

AST
 Six Pak Plus: 64K SPC.....\$269
 Mega Plus: 64K & SC.....\$269
 I/O Plus (SC).....\$114
 2nd S or P or Game.....\$ 35

64K CHIPS
 Set of nine.....\$ 55

EPSON
 RX80, FX80, FX100.....call

VLM Computer Electronics

10 Park Place • Morristown, NJ 07960
 (201) 267-3268 Visa, MC, Check or COD.

Circle 520 on inquiry card.

phor provides the mechanism for gaining learnability by building up a user's prior experience. Consistency and generality are only necessary when they support the metaphor. If I have already learned an inconsistent way to undertake some task, learning a different, but consistent, way is harder than continuing with what I have already learned.

The methods and devices that help the user learn the product are still being explored—input devices that simplify giving information and commands to the machine, metaphors that increase the familiarity and inferability of the interface, and output devices that maximize the bandwidth of communication from the machine.

No one knows how to ensure learnability. Most current systems do not even use what little is known, but a select few have been carefully designed from a solid, if metaphorical, footing and have extended our knowledge considerably. Current research in the human factors of man-machine interfaces is uncovering basic information that is sometimes immediately useful and at other times is so simplistic that it's useful only as a basis for further research.

Good interface design is a dynamic concept because the exposure of our culture to computerized products is ever increasing. Just as the digital watch and electronic spreadsheet have changed our conception of the nature of watches and spreadsheets, other products have the capability to redefine the expectations of the users. To know your market, you must know an audience that is learning and changing all the time. As common experience accumulates, the metaphors to best serve a new product will change dramatically. ■

Dr. Clanton (#4 China Basin Bldg., 185 Berry St., Suite 4821, San Francisco, CA 94107) holds an undergraduate degree in experimental psychology from Harvard University, a medical degree from the University of California Medical School in San Francisco, and pursued interdisciplinary doctoral-level studies in computer science and psychology at Stanford University. He has consulted in the areas of practical applications of the Unix Operating System, man-machine interfaces, and word/text-processing applications.

Circle 428 on inquiry card. →

Now from Timex... a powerful new computer.

72K COLOR SOUND UNDER \$200*

Timex introduces a second generation of home computers designed with one purpose in mind: to be useful.

With 72K on-board memory, it's powerful enough to solve more problems in your home. Entertain you with brilliant color graphics and 8-octave sound.

Plus do word processing in addition to spread-sheet functions.

And while it does more, it does it with even greater simplicity.

Its one-touch keyboard means you don't have to know typing. New Timex Command Cartridges can be used without any knowledge of programming.

Finally. A home computer you can really use in your home: the Timex Sinclair 2068.

72K on-board memory.

More memory than any computer in its class. And more memory means you can do more.

8-octave sound.

Can be used to create four sounds simultaneously over a wide frequency range.

Unique one-touch entry.

Requires no typing skills; makes programming easier to learn.

Word processing capability.

This program provides a 64-character wide screen when used with a video monitor. An 80-column printer that provides hard copy will be available early 1984.



Sleek new compact design.

Fits easily on any desk or table.

Raised typewriter keyboard.

With full-travel keys is based on world's most popular electronic keyboard design.

Timex Command Cartridges.

Provide faster, easier program loading. Take up less space.

TIMEX SINCLAIR 2068

To purchase the Timex Sinclair 2068 computer see your local dealer, or call 1-800-24-TI-M-E-X.

*Suggested retail price.

© Timex Computer Corporation, 1983

Reviewer's Notebook

by Rich Malloy

[As I look upon the pile of cardboard boxes and three-ring binders where my desk used to be, one inescapable conclusion comes to mind: an awful lot of good products are out there. Of course, a few real turkeys lurk here and there, but most of the products that come to BYTE are close to being works of genius. The only thing that keeps them out of the computer Hall of Fame is the tremendous volume of similarly inspired products.

Every month, the question of how we should cover this deluge arises. We can do detailed product reviews of only a few products each month. But which ones do we choose? We have to briefly examine each product that comes in and then pick what look like the most significant or most interesting ones for reviews. Fortunately, some readers help us out by sending in reviews of good products that they have bought. The result is that most of the really significant products do get reviewed in BYTE—eventually. But, for some reason or another, a number of excellent products are passed over and never reviewed.

Even if a product does get picked for a product review, quite a bit of time may pass before the review appears in the magazine. This is partly because of the way reviews are written. Our reviewers are not full-time writers. Product reviews are usually done in the reviewer's spare time, a commodity that seems to be in short supply. And a BYTE review requires a tremendous amount of time. Reviewers have to examine all aspects of a product, not just those features that coincide with their personal interests. Reviewers then have to make a coherent, orderly, and interesting report of their findings. And that's only the start. Each review has to be checked for accuracy. It has to be edited so that it is even more coherent, orderly, and interesting. It has to be typeset, proofread, and assembled into an article, checked once more, transferred to a huge printing plate, and checked yet again. All this checking takes time, but as a result BYTE articles contain few mistakes.

For all those good products that may never get reviewed and for those readers who may not have time to wait for a product review and for that occasional dog of a product that should be duly noted, I've decided to initiate this semi-irregular page. It won't help lessen the pile of products that are on top of my desk, but who needs a desk, anyway? As long as I have my TRS-80 Model 100, a few batteries, and a reasonably comfortable chair, I'm in business.]

The DEC Rainbow 100

The best thing I've seen in the past few days is the DEC Rainbow 100 from Digital Equipment Corporation. You'd think that since BYTE is so close to DEC's headquarters, the company would be very quick in sending machines to us. No way. DEC moves very precisely, but very slowly, it seems. The Rainbow, however, seems worth the wait.

The Rainbow looks like a very slick package. It has two microprocessor chips (an 8088 and a Z80), a smooth-scrolling display, excellent documentation, and some nice touches such as thumbscrews on serial (DB-25) connectors.

But the Rainbow is no substitute for the proverbial pot of gold. Although CP/M and CP/M-86 were originally provided, MS-DOS was a long time coming. And—get this—until very recently you couldn't format your own floppy disks. You had to buy your floppy disks preformatted from DEC because "ordinary disks can't handle the high data density that DEC uses." Come on, guys, 390K bytes on a disk is not what I call

super-high density. But fear not. Given enough time, sanity reigns. A disk-formatting program has just been released, but I haven't seen it yet. Remember that DEC moves very slowly. . . . Look for a review of this machine in a month or two.

Seequa's Chameleon

Another interesting product to finally come our way is the Chameleon from Seequa, a new company located in Baltimore, Maryland. This new portable boasts compatibility with the IBM PC, CP/M compatibility, graphics, and an incredibly low price of only \$1995. That's just a bit more than half the price of an equivalent IBM PC.

Of course, when you buy a computer at a price like this you may have to forgo some incidental details. For example, our machine was lacking a user manual, and the printer port did not seem 100 percent reliable.

But rest assured that people at Seequa are very busy trying to iron out the kinks in their machine. They've promised to send us a newer, better version of it, and I'm sure they

will. As soon as I see an improvement, I'll let you know.

Microsoft's Flight Simulator

The Microsoft Flight Simulator for the IBM PC arrived here a few weeks ago, and the entire BYTE editorial staff has been talking about Imelmans and inversions ever since. This amazing package does an incredible job of making you think you're actually flying a small plane. You can even crash into a simulation of Chicago's Sears Tower (great fun at parties) or land at O'Hare Airport. The package, by the way, also runs on the above-mentioned Chameleon and on the Corona when it is equipped with an IBM Color Graphics Adapter.

Good as it is, the Microsoft Flight Simulator would be even better if you could use it with an RGB (red-green-blue) monitor and a joystick, but for \$49.95 you can't have everything. Go for a test flight at your local computer store. It's the cheapest (and safest) airplane you'll ever fly. ■

Rich Malloy is BYTE's product-review editor.

THANK YOU AND BEST WISHES

From All Of Us At

ROCKY MTN. MICRO, INC.

YOUR HIGH TECHNOLOGY COMPUTER PRODUCTS COMPANY



Only 24 more Shopping days 'til Christmas!

IBM-PC HARDWARE

PLANTRONICS Colorplus	\$ 429.00	HAYES 1200 B	\$ 405.00
QUADRAM CORPORATION		Internal modem on a card	
QUADBOARD Multifunction Board		TANDON TM	\$ 239.00
Full expandability from 64K to 256K		100-2 320K Drive	
Parallel Printer Port		TANDON "SLIM-LINE"	\$ 259.00
Asynchronous RS232 Serial Modem Port		TM50-2	\$ CALL
Programmable Clock Calendar		QUADLINK	\$ CALL
RAM Disk Drive (software)		AST	\$ 303.00
64K starts at	\$ 279.00	6 PACK PLUS 64K 364K, one ser. one par. c.c.	
MICROFAZER Printer Spooler			
Print Buffering from 8K to 512K			
Any Printer Computer Combination			
Why wait on your printer?			
Prices start at	\$ 137.00		
AMDEK MAI BOARD			
Puts Graphics & Multifunction			
in one slot	\$ CALL		
STB SYSTEMS "SUPER RIO" CARD			
The Truly ultimate IBM add-on Eight+ Functions			
on one card			
• 64-256K (786K w opt "PiggyBack" card)			
• Two RS232 ports, one parallel			
• Parallel cable	• Printer Buffer		
• Clock calendar	• Game Port		
• Serial cable	• RAM disk		
Simply The Best	\$ CALL		

QUME'S SUPERIOR HALF-HEIGHT 320K DRIVE
 QumeTrak 142 features
 Ceramic R/W Head,
 Advanced Steel Band Head
 Positioner & 4 Drive Daisy
 Chain capability . . . \$ 199.00

KEY TRONIC, INC.
 Enhanced Word Processing Keyboard
 Model KB-5150
 Familiar key placement for touch-typists. Key legends instead of obscure symbols \$ 199.00

IBM-PC SOFTWARE

TEMPLE OF APASHI	\$ 29.00	PC TUTOR	\$ 43.95
MULTIPLAN	\$ 185.00	WORDSTAR	\$ 301.95
DBASE II	\$ 457.00	HOME ACCOUNT PLUS	\$ 91.50
EASY WRITER II	\$ 234.75	LOTUS 1.2.3.	\$ CALL
PFS FILE	\$ 93.95	PFS GRAPH	\$ 93.95
PFS REPORT	\$ 83.75	DEADLINE	\$ 33.50
PFS GRAPH	\$ 93.95	FACEMAKER	\$ 24.95
PFS WRITE	\$ 93.75	COPY II PC	\$ 29.00
VISICALC	\$ 182.95	FROGGER	\$ 23.50

MILE-HIGH SAVER

NEW YEAR AND NEW LOW PRICE

OKIDATA 92 PRINTER - 479.00

OFFERS THESE HIGH SPEED MODES:

- 160 cps bi-directional data processing
- 40 cps correspondence quality
- 80 cps enhanced printing
- complete graphics capability

COLUMBIA DATA PRODUCTS

THE ENHANCED IBM ALTERNATIVE
 TRULY IBM COMPATIBLE!!

IBM Hardware & Software compatibility in a Multi-User 16 Bit computer. 128K two serial ports, one parallel port and 8 expansion slots. Can run MP M 86 OASIS-16 MS-DOS Super-Pak includes MS DOS & CPM 86 operating systems. Macro-Assembler, Diagnostics, Basics w colorgraphics, PI US Perfect Writer, Speller, Calc and File. Fast Graph, Space Commanders & Home Accountant \$ CALL
 COLUMBIA PORTABLE-COLUMBIA VP 128K Sims Line Drives 9 monitor. (amber or green) comes w MS-DOS super pak \$ CALL

APPLE/FRANKLIN HARDWARE FRANKLIN ACES-THE APPLE II+/III ALTERNATIVES

ACE 1000 (64K) Upper & Lower Case Automatic Key Repeat Numeric Keypad Large power supply with fan Call for Special package price	WITH COLOR!	ACE 1200 (128K) Two Disk Drives Serial and Par Inter. 80 Col Card & CP M Card True Upper & Lower Case Software: Wordstar, Mailmerge, Ace Calc	\$ CALL
MICRO-SCI A2 Disk Drive	\$ 205.00	MICRO BUFFER II 16K	\$ 209.00
FOURTH DIMENSION Disk Drive	\$ 219.00	VIDEX PSIO Dual Function Card Modem and Printer Ports	\$ 176.00
RAMA SYSTEMS - ELITE SERIES 300% Faster than Disc II Elite I (up to 163K) Elite II & III	\$ 289.00 \$ CALL	MISCELLANEOUS	
VISTA COMPUTER CO. INC. PRESENTS THE V1200: Removable mass storage for your Apple! 6 meg (formatted) per 5 disc cartridge. Comes complete w drive, cable, controller, software and one 6 meg Vistapak cartridge. All for only	\$1298.00	ANTI-STATIC TOUCH MATS	\$ 68.00
RAM EXPANSION Microsoft (16K) Microtek (BAM 16K)	\$ 75.00 \$ 73.00	KENSINGTON, System Saver	\$ 72.00
80 COLUMN CARDS ALS, Smarterm II Videx, UltraTerm VideoTerm ComboPkg Vista, Vision 80	\$ 129.00 \$ CALL \$ 271.00 \$ 239.00	KRAFT, Joystick Paddles	\$ 48.00 \$ 35.00
PRINTER INTERFACES/BUFFERS Microtek, RV611C par Apple Dumping 16K Orange Micro, Grappier+ Buffered Grappier+	\$ 63.00 \$ 160.00 \$ 119.00 \$ 189.00	M & R ENTERPRISES Sup'r Mod Universal Sup'r Fan	\$ 55.00 \$ 38.00
		MICROSOFT Softcard W CP M 280 Softcard Premium Pack Softcard Plus (Franklin)	\$ 245.00 \$ 495.00 \$ 445.00
		T & G PRODUCTS Joystick Game Paddles Select-a-port Trak-Ball	\$ 43.00 \$ 28.50 \$ 43.00 \$ 47.00
		SATURN SYSTEMS, INC. Neptune 80 column card w 64K for IIE	\$ CALL

CALL FOR APPLE SOFTWARE

PRINTERS - DOT MATRIX

C-ITOH Prowriter I par Prowriter II par	\$ CALL \$ 649.00
EPSON FX-80, FX100 GORILLA, Banana IDS, Prism Microprism	\$ CALL \$ 209.00 \$ CALL \$ 559.00
MANNESMANN TALLY MT1601 MT160L	\$ CALL \$ CALL
OKIDATA 82A 83A 84 par 92 par 93 par	\$ 419.00 \$ 649.00 \$1055.00 \$ 499.00 \$ 927.00
STAR MICRONICS Gemini 10X	\$ CALL
BROTHER HR-1	\$ 852.00
C-ITOH Starwriter F-10-40 pat	\$1179.00
JUKI 6100, 18 CPS	\$ CALL
NEC 3550 IBM plug-in TTX-1014, Pm & friction feed, ser & par interface	\$1936.00 \$ 516.00

LETTER QUALITY

MONITORS

AMDEK, 300 Amber 300 Green 310A including cable Color I composite Color II RGB (IBM compatible)	\$ 155.00 \$ 139.00 \$ 179.00 \$ 299.00 \$ 439.00
GORILLA, Green Hi-Res	\$ 89.00
NEC, 1201 Hi-Res, Green 1203 RGB	\$ 159.00 \$ CALL
TAXAN Amber Green	\$ CALL \$ 129.00 \$ 119.00
USI Amber Hi-Res	\$ 149.00
ZENITH Green Med Res	\$ 99.00
QUADRAM Quadchrome (R & B)	\$ CALL
PRINCETON GRAPHICS RGB Monitor	\$ CALL

DISKETTES & STORAGE

MEMOREX 10 each 5", SS DD 10 each 5", DS DD	\$ CALL \$ CALL
ELEPHANT 10 each 5", SS DD 10 each 5", DS DD	\$ 19.95 \$ 26.95
VERBATIM 10 each 5", SS DD 10 each 5", DS DD	\$ 25.95 \$ 36.95
ZIMAG 12 each 5", SS DD	\$ 19.95
LIBRARY CASE, 5"	\$ 2.50
DISK BANK, 5" , interlock & swivel	\$ 5.50
DISK FILE, 5" , Elephant Trunk	\$ 21.95

NEC APC

Color APC, 128K Bytes of User Memory, Dual 1 Megabyte FDD's, Communications Controller, Printer Controller, Auto Power off, Battery Back-up, 4K CMOS RAM & Hardware Clock Calendar Programmable Character Set, Detached Keyboard w Programmable Function Keys & Numeric Pad, Model H03 \$ CALL
CALL FOR INFO. ON NEC'S NEW PC8201

MODEMS

ANCHOR AUTOMATION Signalman Mark 1	\$ 83.00
HAYES Smartmodem 300 Smartmodem 1200 Smartmodem 1200B Micromodem II w terminal program	\$ 211.00 \$ 499.00 \$ 405.00 \$ 299.00
NOVATION CAT (Acoustic) D-CAT J-CAT Auto Cat Apple Cat II 212 Module (1200 baud opt. for Apple Cat II) 212 Apple Cat II (1200 baud)	\$ 153.00 \$ 168.00 \$ 115.00 \$ 219.00 \$ 273.00 \$ 345.00 \$ 626.00

VISIT OUR
 WAREHOUSE OUTLET STORE

Rocky Mountain Micro, Inc.

MAIL ORDERS AND WAREHOUSE SHOWROOM: 10890 E. 47th Ave. Denver, Colorado 80239

NATIONAL ORDER DESK:

1-800-862-7819

IN COLORADO CALL: 303-371-2430

TERMS AND CONDITIONS • NO CREDIT CARD FEE • Personal checks (allow 10 days to clear) Visa, Master Card, wire transfers, include telephone number • COD orders accepted - \$300 maximum - \$10 nonrefundable surcharge • All products factory sealed with manufacturer's warranty • PO's accepted from qualified customers • Approval needed on all returns • 10% restocking charge unless defective, plus shipping • Shipping, Handling & Insurance \$5.00 minimum, 4" UPS ground: UPS Blue Label rate quoted at time of order • All prices subject to change without notice • Telephone Order Desk Hours: 8 AM to 6 PM, Monday through Friday, 10 AM to 4 PM Saturday, Eastern Standard Time

• VISIT OUR STORE LOCATIONS • TECH ASSIST. & CUSTOMER SERVICE CALL 303-371-2430

Boulder: 440-0156
 2829 28th St. (28th & Valmont)
 Boulder, CO 80301 440-0156

Colorado Springs: 594-9919
 5164 N. Academy Blvd., (Academy Pl.
 Shopping Ctr.) Colorado, Springs, CO 80007

Denver: New Location
 Fox Ridge Shopping Center
 (Holly & County Line Rd.)

dBASE

BREAK THROUGH

dBASE II is a trademark of
Ashton-Tate

Announcing

the most sophisticated database program development tools available on any personal computer anywhere.

The Database

ACCELERATORTM

Automatic program, screen, menu, report generation.
Automatically checks, formats, documents your programs.
Now available for the IBM PC at an introductory
price of \$195. 30 day money back guarantee.

from
Optimal Software

The Database Accelerator is a
trademark of Optimal Software.

Distributed by Programming International
505 Hamilton Avenue, Suite 301, Palo Alto, CA 94301
(800)222-8811 inside California: (800)631-4400

Dealer inquiries welcome.

Also available at
SOFTWARE
Software
and other fine
software dealers

SOFTWARE

Chicago, IL, Pittsburgh, PA, Detroit, MI, Cleveland, OH, Denver, CO, Kansas City, MO, St. Louis, MO, Dallas, TX, Houston, TX

to go

opening soon:

Chicago, IL
Pittsburgh, PA
Detroit, MI
Cleveland, OH
Denver, CO
Kansas City, MO
St. Louis, MO
Dallas, TX
Houston, TX

opening soon:

Chicago, IL
Pittsburgh, PA
Detroit, MI
Cleveland, OH
Denver, CO
Kansas City, MO
St. Louis, MO
Dallas, TX
Houston, TX

LOCATIONS: New Jersey

Store Hours:
M-F 9:00-6:00
Sat. 10:00-5:00

Executive Mews #O-74
1930 E. Marlton Pike
Cherry Hill, NJ 08003
(609) 424-8575

Two Executive Drive
Fort Lee, NJ 07024
(201) 584-0007

Maryland (DC area)

Montrose Professional Park
6204 Montrose Rd.
Rockville, MD 20852
(301) 881-4080

New Hampshire

3H Taggart Dr.
(off Daniel Webster Hwy.)
Nashua, NH 03060
(603) 888-8560

California

505 Hamilton Ave.
Palo Alto, CA 94301
(415) 324-3730

16168 Beach Blvd.
Suite 151-S
Huntington Beach, CA 92647
(714) 841-5555

1370 E. Walnut St.
Pasadena, CA 91106
(213) 304-9166

dBASE II™ \$389

The most widely sold DMBS for micros, dBASE II defines the state of the art. An inexperienced user can create a dBASE file, begin data entry, and print out a report in minutes; the experienced programmer can create complex program systems using dBASE's unique programming language. Both can use automatic program generators and other programming tools to create applications quickly and easily.

- THE DATABASE ACCELERATOR:** Automatically creates menus and "intelligent" data entry screens which check input for correctness. Eliminates 80-100% of dBASE programming time! **\$195**
- QUICKCODE:** Fox & Geller's popular generator **\$175**
- dGRAPH:** Allows you to see your dBASE file in graphic form—a real aid to understanding **\$189**
- ABSTAT:** Allows you to analyze your data using a wide variety of statistical tests. Can be used with dBASE files or by itself. Also does bar graphs and plots **\$339**

MULTIPLAN™ \$169

The world's hottest-selling spreadsheet, Multiplan™ is now setting the standard for ease of use and quality of documentation. Each of the Multiplan™ series comes complete with sophisticated training programs.

- Multi-Tool Budget 'expert system':** used with Multiplan™, enables new users to get budgets out in minutes **\$69**
- Multi-Tool Financial Statement:** Expert help in getting out financials. **\$109**

LOTUS 1-2-3 \$329

Integrating spreadsheet, graphics, and database capabilities, Lotus' 1-2-3™ has become the number one selling package for the IBM PC and XT. 1-2-3™ is one of the most user-friendly products on the market. Excellent manual, sophisticated tutorial, complete on-line help facilities.

(Available at your local Software to go)

EDIX & WORDIX \$269

EDIX is a full-screen editor specifically designed to take advantage of the advanced features of the IBM PC; WORDIX is the best text formatter on the market. Together, they are an unbeatable combination, the finest word processor available on a micro—at an unbeatable price!

- EDIX alone** **\$149**
- WORDIX** **\$149**

SMARTMODEM 300 \$209

These Hayes Stack Modems link your computer's RS232 serial port directly to a modular phone jack. They will dial the phone for you, and answer it as well. The Smartmodem 300 runs at 0-300 baud; for those needing higher speed, the Smartmodem 1200 can run at 1200 baud.

- 1200** **\$499**
- 1200B** **\$439**

The Texas Instruments Professional Computer

Daring to be somewhat different

by Mark Haas

With everyone in the 16-bit world jumping on the IBM bandwagon—boasting compatibility, portability, and extended utility—it's a brave company that decides to strike out on its own and blaze a new trail. The Texas Instruments (TI) Data Systems Group reckoned that although it would have to contend with IBM's impact on the market, it could design a better machine. The engineers also decided that while compatibility was a desirable trait, it shouldn't get in the way of designing a better computer. Their efforts resulted in the TI Professional Computer.

Originally dubbed "Pegasus," the Professional Computer marks the Data Systems Group's entry into the personal-computer arena. This is *not* the same division that produced the 99/4A, now headed toward oblivion, but, rather, the group that has produced TI's more sophisticated minicomputers and terminals, including the ubiquitous Silent 700.

The TI Professional Computer is made up of three major components: the system unit, the display, and the keyboard (see photo 1). The system unit measures approximately 19 inches wide, 5¾ inches high, and 17 inches deep, and houses the main system circuit board, disk drives, and power supply. The standard display is a monochrome monitor; a color monitor is optional. The keyboard is, well, wonderful.

The System Unit

Out of the box, the Professional Computer is equipped with 64K bytes of main memory, one 320K-byte 5¼-inch floppy-disk drive, and a CRT (cathode-ray tube) controller card. The system unit provides space for another disk drive or a Winchester hard disk without adding an

expansion chassis. Four expansion slots are provided for additional functions; the CRT controller board occupies a fifth slot; and a sixth, dedicated slot holds a memory card containing up to 192K bytes of additional memory, for a total of 256K bytes of main memory.

The system unit main board is the heart of the machine. It contains the 8088 microprocessor, a socket for an 8087 coprocessor, 64K bytes of 9-bit-parity, dynamic RAM (random-access read/write memory), memory control logic for addressing and refreshing the memory, 8K bytes of ROM (read-only memory), a socket for additional ROM, a Centronics-type parallel printer port, an I/O (input/output) port for the keyboard, a floppy-disk drive controller, five expansion connectors for the CRT controller and other options, one slot for memory expansion, timer chips, and a speaker. Photo 2 shows the system unit with its cover removed. Unfortunately, the disk drives obscure a total view, but the expansion slots and power supply are clearly visible. A block diagram of the system board is shown in figure 1.

Like IBM, TI abandoned its own proprietary microprocessors and based this computer on Intel's 8088 16-bit chip instead. In the Professional Computer, the chip runs at a clock speed of 5 MHz, compared to 4.77 MHz in the IBM Personal Computer (PC). TI makes no secret of the fact that its system will support an 8087 coprocessor. In fact, TI states throughout its technical documentation that the term "CPU" refers to both processors. The 8087 chip is still a bit pricy, but that probably will change with time, and TI is already providing Microsoft's FORTRAN, Pascal, and COBOL compilers that support this chip's extended commands.

In the "bottom-of-the-line" version, the 64K bytes of



Photo 1: The TI Professional Computer is made up of the system unit, the display, and the keyboard. This computer also has a 5-megabyte Winchester-disk drive installed to the right of the 320K-byte floppy-disk drive.

9-bit RAM become nine chips of the 4164 type (64K by 1 bit), soldered directly to the system board. The optional memory-expansion board supplies 64K bytes of 9-bit RAM, and sockets can handle another 128K bytes of 9-bit RAM, bringing the total system RAM to 256K bytes. At first glance, 256K bytes seems to be the system limit, but a look at the technical manual shows the memory space from (hexadecimal) 40000 to BFFFF to be reserved for "expansion-bus memory." (Note: all addresses and machine-language instructions are in hexadecimal unless otherwise specified.) An additional 512K bytes can be installed through one of the remaining expansion slots, and TI is preparing such a board now.

The 8K-byte system ROM contains what are called "device service routines" for controlling the principal I/O

devices in the system unit. The liberal use of hardware and software interrupts and software vectors, or pointers, enables a knowledgeable programmer to truly customize the use of the machine. These vectors reside in the bottom 1K byte of system RAM and can be changed to point to custom service routines. Through the use of these vectors, you could, for example, create any keyboard layout desired (Dvorak, anyone?).

The device service routines contained in the system ROM are directly accessible for system programming. They include routines for complete floppy-disk and Winchester-disk control (read a sector, write a sector, etc.), keyboard translation and buffering, speaker control, display and graphics control, and many more functions. Generally, these functions are implemented by

At a Glance

Name

Texas Instruments Professional Computer

Manufacturer

Texas Instruments Inc.
Data Systems Group
POB 402430
Dallas, TX 75240
(800) 527-3500

Components (base system)

System Unit

19 by 17 by 5¾ inches; Intel 8088, 16-bit internal, 8-bit external, 5-MHz clock; 64K bytes of RAM, expandable to 768K bytes; one 320K-byte, 5¼-inch floppy-disk drive standard; five expansion bus connectors for peripherals, one for memory only (six slots total)

Keyboard

Low-profile enclosure, 20¼ inches wide, 8 inches deep, 1½ inches high, full-width tilt elevator; 97 keys, Selectric-style keyboard, diamond-pattern cursor pad, numeric keypad, 12 programmable function keys; Intel 8048 microcontroller, 2400/300-bps data link to system unit

Display

Monochrome CRT, 18-MHz bandwidth; 80-column by 25-line display of 7- by 9-dot characters in a 9- by 12-dot cell; eight color characters (with optional color monitor), reverse-video, blinking, underlining, blank, and eight color attributes on a character-by-character basis

Software

System diagnostics

Options

Hardware

Color monitor, 19.2-MHz bandwidth	\$695
300-bps internal modem, auto-dial, auto-answer	\$295
300/1200-bps internal modem, auto-dial, auto-answer	\$750
320K-byte floppy-disk drive	\$475
10-megabyte Winchester hard-disk drive	\$2295
One-plane graphics board (two colors)	\$190
Three-plane graphics board (eight colors)	\$325
Synchronous/asynchronous communications card, one serial port	\$225
Memory-expansion card with 64K or 192K bytes	\$300, \$600
Memory expansion for additional 512K bytes—768K total (available 12/83)	*
8087 coprocessor (available 12/83)	*

Software

MS-DOS operating system with MS-BASIC	\$100
MS-DOS 2.0 with MS-BASIC (available 1/84)	*
CP/M-86 operating system with CBASIC	\$240
Concurrent CP/M operating system	\$350
UCSD p-System operating system	\$350
MS-Macro Assembler (available 12/83)	\$100
MS-FORTRAN (with 8087 support)	\$500
MS-Pascal (with 8087 support)	\$300
MS-COBOL (with 8087 support)	\$750
Ryan-McFarland COBOL \$950 (\$238 for run-time package only)	
Multiplan	\$250
Easywriter II	\$350
TTY Communications	\$60
3780 Communications	\$150

Documentation

Operating Instructions manual

Price

Base system, \$2195; full system (two disk drives, 128K RAM, monochrome monitor, MS-DOS, MS-BASIC), \$3070; hard-disk system (monochrome monitor, 10-megabyte Winchester, 256K RAM), \$5090

* price to be announced

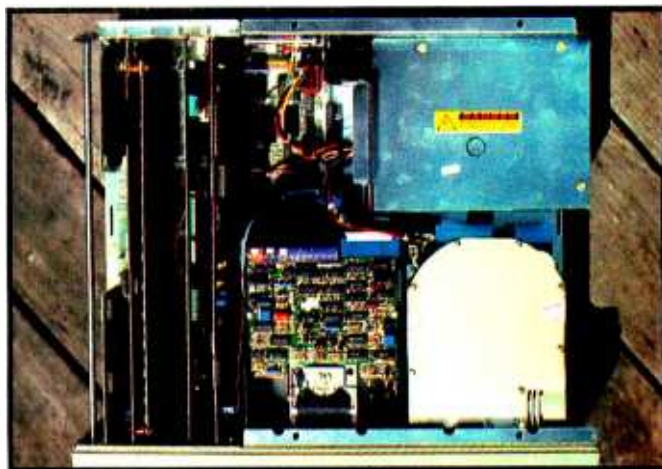

Photo 2: Inside the system unit (the front is at the bottom) you can see part of the system unit board that contains the 8088 microprocessor, 64K bytes of RAM, a disk controller, a parallel printer port, and expansion slots. The memory-expansion board is located on the left side of the unit toward the front. From left to right: the expansion cards installed in this unit are the synchronous/asynchronous communications card, the CRT controller card with the video graphics card mounted piggyback on it, the 300/1200-bps auto-dial/auto-answer modem, and the Winchester controller card. The disk drives obscure a large portion of the system board. The power supply is located at the right rear corner of the unit.

loading certain values into the 8088's registers and then performing a software interrupt. The interrupt causes the current program to cease execution, and control is transferred to a device service routine pointed to by one of the vectors located in the bottom 1K byte of memory. For example, if a value of 0 is placed in the 8088's AH register, and a value of 40 is loaded into the AL register, then the speaker will sound for 1 second when an INT 48 instruction is executed. By changing the vector in memory associated with the INT 48 instruction, you can cause control to be transferred to a custom routine.

Table 1 shows the various interrupt vectors. Note that the actual address of a vector can be determined by multiplying the vector number by 4. For example, the keyboard print-screen vector (called by interrupt 5E) would be a double word at 0:0178 ($5E \times 4 = 178$).

The memory map (table 2) also shows reserved space for "smart" peripherals or option boards that contain ROM and are installed in the expansion slots. The review unit contained one of these boards, the Winchester-disk controller. This board contains its own 8K bytes of ROM that controls the operation of the hard-disk drive.

Unlike the IBM PC, the Professional Computer does not have to use a slot for a disk controller; TI placed it on the system board. Notice that TI's expansion bus is *not* compatible with the IBM PC's. Though at first glance all the address, data, and power lines are in the same places, a closer look reveals that the various control and interrupt lines are not. A full description of the TI expansion bus pin-out is provided in table 3.

The floppy-disk controller held a couple of surprises. The basic controller subsystem is the now-standard

ANOTHER TECHNOLOGICAL BREAKTHROUGH FROM SHARP.

THE HAND-HELD COMPUTER WITH POWERFUL CONNECTIONS.

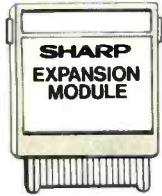

**24K
(8K + 16K)**

Now you can take 24K with you wherever you go—thanks to the new Sharp PC-1500A. It's the 8K hand-held computer that expands to a powerful portable 24K computer system when the optional 16K memory module is added. And because it's programmable in Basic, the most popular computer language, it gives you the power and capabilities to handle most scientific, engineering and management uses.

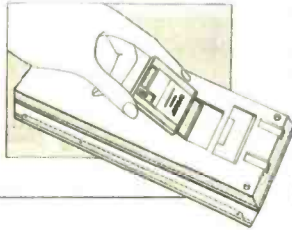

The PC-1500A also has a complete library of plug-in software programs including: Sharpcalc (Spreadsheet), Finance, Math, Electrical Engineering, Circuit Analysis, Business Graphics, General Statistics, Statistical Distribution and Graphics Development.

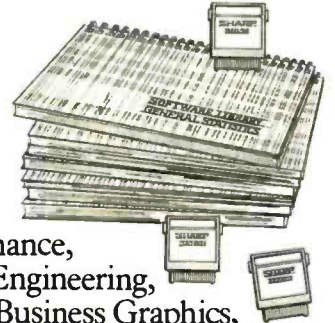

195(W) x 25.5(H) x 86(D) mm

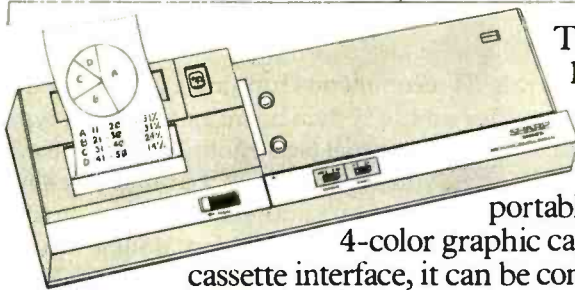
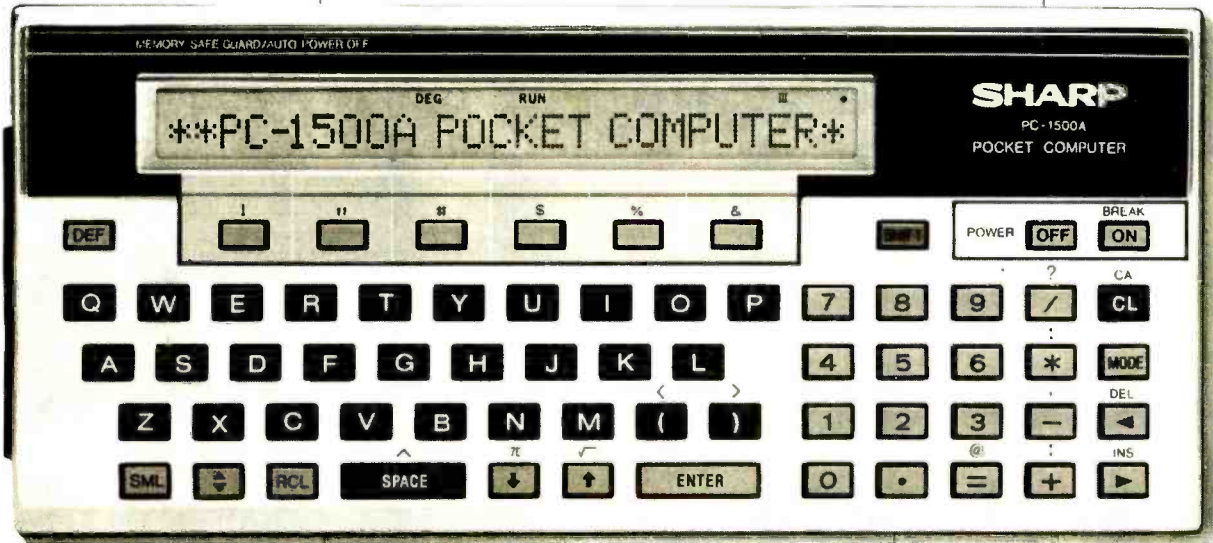

The optional CE-150 Color Graphic Printer/Cassette Interface not only gives the system portable printing but also 4-color graphic capabilities. And as a cassette interface, it can be connected with up to two cassette tape recorders—one for storage and one for recall. The CE-158's RS-232C Interface allows communication links to a wide variety of peripherals such as modems, bar-code readers, data bases, as well as other micro, mini or mainframe computers.

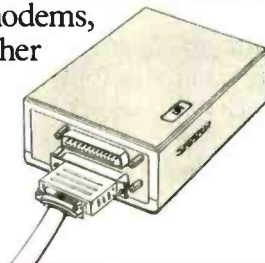

The optional CE-150 Color Graphic Printer/Cassette Interface not only gives the system portable printing but also 4-color graphic capabilities. And as a cassette interface, it can be connected with up to two cassette tape recorders—one for storage and one for recall.

Perhaps the only feature of our portable computer system that won't overpower you is its price. It's not only less than you'd expect, it's probably hundreds of dollars less. So before you spend a lot of money and get a lot less computer, call toll-free for more information, dial (800)-447-4700.



Watch for our TV commercial to learn more about the latest advance in computer technology from Sharp. We replaced a half-million transistors and diodes with one tiny "chip."

SHARP

FROM SHARP MINDS
COME SHARP PRODUCTS

Sharp Electronics Corp., 10 Sharp Plaza, Paramus, NJ 07652. Call for information on custom applications: (201) 265-5600, ext. 4361.

Circle 387 on inquiry card.

BYTE December 1983 289

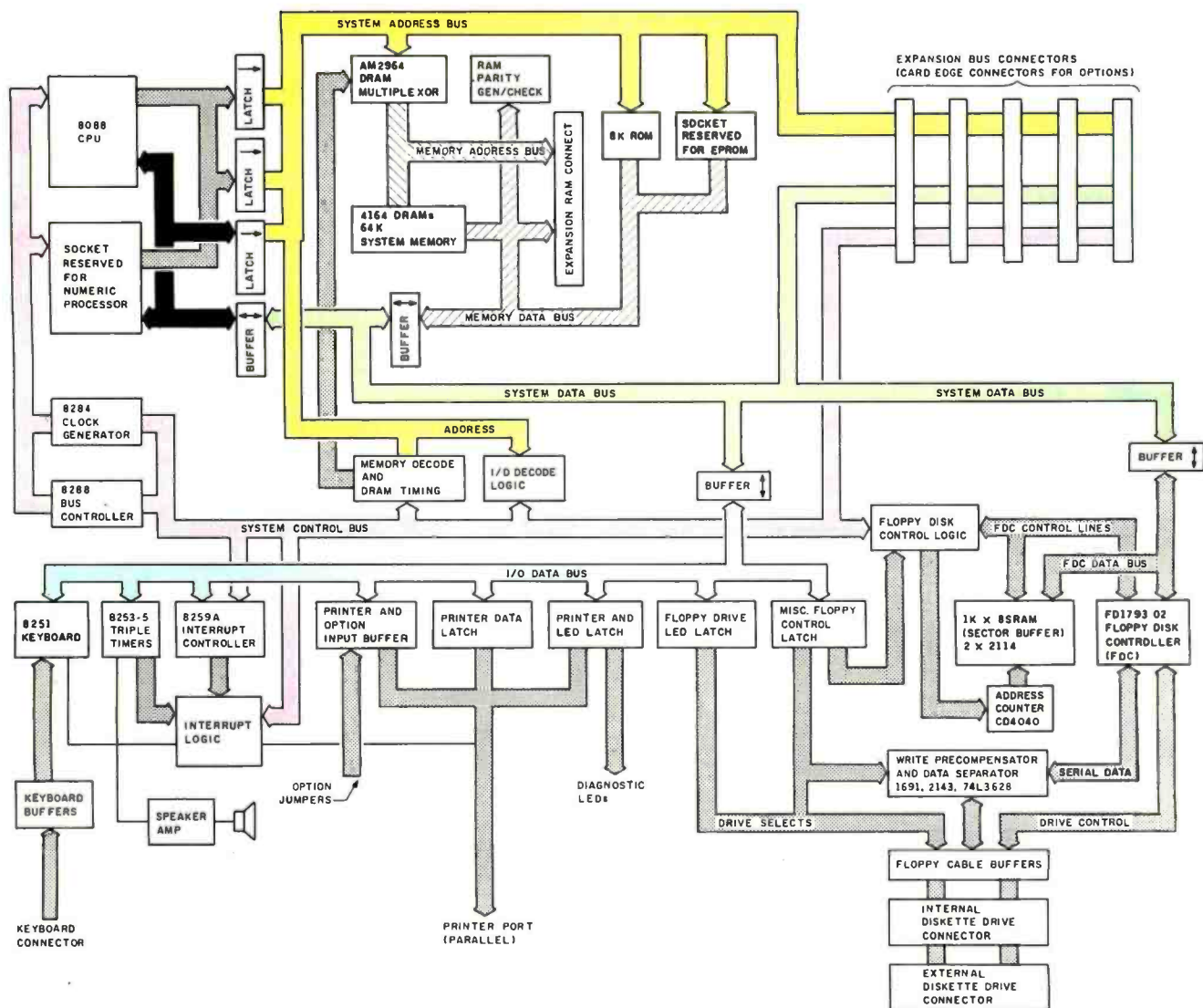

Figure 1: The Professional Computer's system unit board contains circuitry for controlling up to four floppy-disk drives, a parallel printer port, five expansion slots, sockets for an 8087 numeric coprocessor, and an additional 8K bytes of ROM. An additional expansion slot is provided for memory expansion.

Western Digital chip set comprising the FD1793-02 controller, WD1691 support logic, and WD2143 pulse delay. One surprise was the provision for 80-track drives (96 tracks per inch). Merely changing one jumper on the system board makes the system support 640K-byte drives. All the disk primitives for reading and writing sectors, locating, reading, or modifying the disk parameter tables, and turning motors on and off are contained in the system ROM, including support for the 80-track drives. The software in the system ROM reads the system configuration from the jumper and then calls the appropriate built-in routines. An undocumented option in the operating-system configuration program, CONFIG.COM, tells MS-DOS about these high-capacity drives; entering the command CONFIG *d*: = 2,80 at the MS-DOS prompt, in which *d*: is the drive letter, will do it.

A second surprise was an additional connector for two

external drives. TI recommends running a cable from the 40-pin connector on the system board to a 37-pin D-type connector on the back panel (see photo 3), but by using half-height drives, you can mount all four in the system unit. The power supply can handle it. And you can mix any combination of single-/double-sided, double-/quad-density drives if at least one (drive A) is an "MS-DOS standard" double-sided, double-density, 320K-byte drive.

The efficient, switching-type power supply is rated at 160 watts with three output voltage levels. TI claims this supply can handle a system with any combination of options, including two floppy disks and a Winchester disk or four floppy disks.

The Keyboard

The keyboard on the Professional Computer is one of the machine's nicest features; unlike the IBM keyboard,

PURE POWER CONTROL CENTER

Introducing a powerful new link for
your computer system.
The Power Directors
from Computer Accessories

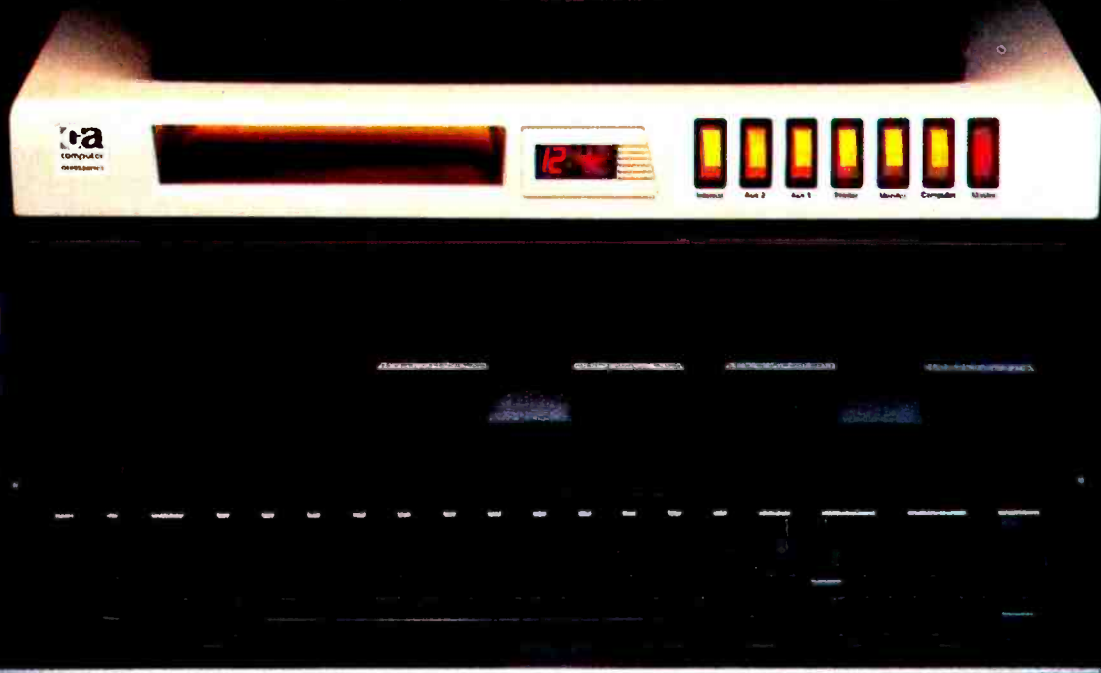

Power Directors incorporate UL approved TranZorb™ semiconductor technology and exceed the 1983 IEEE-587 Guide for surge voltages in low voltage AC power circuits. So you can protect your computer system from line surges and noise, giving it the pure power it needs. Voltage spikes are stopped in less than a nanosecond, EMI/RFI line noise is filtered out, and current overloads are prevented. Now your system can be truly integrated with

ca
computer
accessories

Computer Accessories Corporation, 7696 Formula Place, San Diego, CA 92121 (619) 695-3773

central power control like the Model P12 shown above. Instead of a haphazard maze of power lines and extension cords, each component plugs into the fully shielded Power Director. You can turn on each component individually, or power up the entire system with a single switch.

Look for the full line of Power Directors wherever personal computers are sold. TranZorb is a product of General Semiconductor Industries of Tempe, Arizona.

Vector	Description	Vector	Description
00	divide-by-zero trap	57*	CRT mapping vector
01	single-step trap	58*	system timing, 25 ms (time slicing)
02*	non-maskable interrupt	59*	common interrupt exit vector (ROM)
03	break (single-byte) software interrupt	5A*	system timing, 100 ms (timing service)
04	overflow trap	5B*	keyboard mapping vector
05-1F	reserved by Intel	5C*	keyboard program pause key vector
20-3F	reserved by Microsoft for MS-DOS	5D*	keyboard program break key vector
40	8259 interrupt 0	5E*	keyboard print screen vector
41	8259 interrupt 1	5F*	keyboard queueing vector
42	8259 interrupt 2	60	system ROM DS pointer (180H)
43*	8259 interrupt 3 (timer 1)		(F400:A000) DS size (182H)
44	8259 interrupt 4	61	factory ROM DS pointer (184H)
45	8259 interrupt 5		(F400:0000) DS size (186H)
46*	8259 interrupt 6 (disk controller)	62	option ROM DS pointer (188H)
47*	8259 interrupt 7 (keyboard USART)		(F400:2000) DS size (18AH)
48*	speaker DSR interface	63	option ROM DS pointer (18CH)
49*	CRT DSR interface		(F400:4000) DS size (18EH)
4A*	keyboard DSR interface	64	option ROM DS pointer (190H)
4B*	parallel port DSR interface		(F400:6000) DS size (192H)
4C	clock and analog interface board	65	option ROM DS pointer (194H)
4D*	disk DSR interface		(F400:8000) DS size (196H)
4E*	time-of-day clock DSR interface	66	memory size (in paragraphs)
4F*	system configuration call		outstanding interrupt count
50*	fatal software error trap **		(in paragraphs)
51*	restart timing event **		installed drive types (byte)
52*	cancel timing event **	67	extra system configuration
53*	SVC interface subroutine **		(config. word 1)
54*	activate task subroutine **		extra system configuration*
55-56	reserved for future use **		(config. word 2)
		E0-E3	reserved by Digital Research for CP/M

* Vector actually used by ROM
 ** Texas Instruments use only

Table 1: Hardware and software interrupts play an important role in the operation of the Professional Computer. The interrupt vectors listed here can be changed by system and application programs to provide a variety of custom functions, including keyboard redesign.

it uses a familiar, efficient layout. This keyboard remains quiet while still providing the necessary tactile feedback.

The main keyboard uses the familiar Selectric-style layout, as shown in figure 2. The left-hand Shift key is where most people expect to find it, and a handy red

Unlike the IBM keyboard, TI's uses a familiar efficient layout that's quiet, too.

LED (light-emitting diode) on the Caps Lock key reminds you when it's in use. The Control key's position provides easy use with word processors like Wordstar, and the ubiquitous Alt key sits directly under it, enabling a two-fingered system reset (by simultaneously pressing the Control, Alt, and Delete keys). Indentations on the F and J keys let you find the proper position on the home row easily.

A diamond-pattern cursor pad, with a Home key in the middle, sits to the right of the main keyboard. Although a T-configuration may work better, a diamond pattern beats a straight line any day.

To the right of the cursor diamond sits a numeric keypad. The little bump on the 5 key is for homing purposes; the keypad also contains comma, tab, and space keys.

Above the main keyboard, a row of 12 programmable function keys is arranged in three groups of four keys each. These keys send different codes in combination with the Shift, Control, and Alt keys for a total of 48 codes. The debate over the usefulness of function keys continues; if you like function keys, this will be heaven. These keys are easily accessible from BASIC with the KEY command. Unfortunately, the 25th display line only shows 10 key labels at a time. If you want to use these keys from outside of BASIC, you must provide a machine-language routine as discussed in the last paragraph of this section.

Text continued on page 298

IS THIS LEVEL OF RELIABILITY REALLY NECESSARY?

ACCUTRACK



If you've ever lost data due to a faulty disk, you know how important reliability can be.

That's why Accutrack disks are critically certified at 2-3 times the error threshold of your system. Why they're precision fabricated for higher signal quality, longer life and less head wear. And why we take such extra steps as testing single-density mini disks at double-density levels. So you don't have to worry about the reliability of your media.

Accutrack disks. OEMs have specified them for years. You can trust them for your data. Call toll-free (800 225-8715) for your nearest dealer.



ACCUTRACK
Dennison KYBE Corporation

82 Calvary Street, Waltham, Mass. 02254
Tel. (617) 899-0012; Telex 94-0179
Outside Mass. call toll free (800) 225-8715
Offices & representatives worldwide

Dealers: Give your customers a choice—Accutrack's OEM performance as well as your heavily advertised brand. We have the industry's only complete line of disks, cassettes and mag cards, including virtually all special formats. If you want a quality line, small minimums, the ability to mix and match, private labeling, fast delivery and great price, call today. Find out how responsive a media supplier can be.

Circle 138 on inquiry card.

MEMORABLE



CONCORDE

The new leader in the world of floppy disk drives introduces its new family of Apple® compatible peripherals! Combining the finest quality drives with their own advanced electronics, **CONCORDE** gives you proven reliability and superior performance at a dramatic cost savings.

- **CONCORDE** Model C-111, Single Sided Disk Drive, gives you as much as 163K bytes of data storage... form, fit and function compatible with the Apple Disk II.
- **CONCORDE** Model C-112, Double Sided Disk Drive, with double the storage capacity, up to 326K, is the perfect subsystem for your Apple or Apple compatible computer.

Remember **CONCORDE!**
Check it out with your favorite computer dealer, or contact:

® Apple is a registered trademark of Apple Computers Inc.



CONCORDE

CONCORDE PERIPHERAL SYSTEMS, INC.

[714] 859-2850

23152 Verdugo Drive
Laguna Hills, CA 92653

Address	Devices
Dynamic RAM:	
00000-0FFFF	64K-byte motherboard RAM
10000-FFFF	64K-byte expansion RAM board bank 1
20000-2FFFF	64K-byte expansion RAM board bank 2
30000-3FFFF	64K-byte expansion RAM board bank 3
40000-BFFFF	expansion bus memory
CRT controller:	
C0000-C7FFF	graphics RAM bank A
C8000-CFFFF	graphics RAM bank B
D0000-D7FFF	graphics RAM bank C
D8000-DDFFF	reserved
DE000-DE7FF	active character memory
DE800-DEFFF	phantom character memory
DF000	Bit 0—miscellaneous input buffer, BLUE feedback, read only
	Bit 1—miscellaneous input buffer, RED feedback, read only
	Bit 2—miscellaneous input buffer, GREEN feedback, read only
	Bit 3—miscellaneous input buffer, interrupt pending, read only
DF001-DF00F	miscellaneous input buffer
DF010-DF01F	graphics RED palette latch, write only
DF020-DF02F	graphics GRN palette latch, write only
DF030-DF03F	graphics BLU palette latch, write only
DF040-DF7FF	reserved
DF800-DF80F	attribute latch
DF810	CRT controller address register, write only
DF811	CRT controller status register, read only
DF812	CRT controller address register, write only
DF813	CRT controller address register, write only
DF814-DF81F	reserved
DF820	Bit 7—miscellaneous output latch, interrupt enable
	Bit 6—miscellaneous output latch, alphanumeric screen enable
Other peripherals:	
DF821-DFFFF	reserved
E0000-E7FFF	reserved for speech storage RAM
E8000-F3FFF	reserved
ROM usage:	
F4000-F5FFF	8K ROM space (clock/analog interface)
F6000-F7FFF	8K ROM space (local-area net option board)
F8000-F9FFF	8K ROM space (Winchester controller)
FA000-FBFFF	8K ROM space (reserved)
FC000-FDFFF	8K ROM space, 1 wait state (XU62)
FE000-FFFF	8K system ROM, 1 wait state (U63)

Table 2: The memory space of the system's 8088 microprocessor has been partitioned for use by the cathode-ray tube, graphics controllers, and other peripherals, and allowance has been made for the addition of "smart" peripherals by reserving ROM space.

Circle 348 on inquiry card. →

Users Love PRINTEK Performance

They love the way PRINTEK printers go about doing everything that needs printing. From data processing, to graphics, to executive letter quality correspondence. Day after day. With all the features needed to make your printer performance as good as your computer's.

- ♥ **Three models to choose from.** One for every requirement, every budget—Models 910, 920, 930.
- ♥ **Dual speeds**—up to 80 cps for correspondence and 340 cps for data processing and drafts.
- ♥ **Bidirectional/Logic Seeking.**
- ♥ **Multiple character sizes**—to fit every need. With true descenders for easier reading and proportional spacing for better appearance. Resident and downloadable fonts.
- ♥ **Multilingual**—to serve computers around the world. With 96 ASCII characters and up to 8 standard languages.
- ♥ **Dual density graphics**—144x144 dots per inch for detail, 72x72 for speed—in raster format with true data compression. Dot addressable.
- ♥ **Versatile paper handling**—up to 6 copies on 2½"-16" paper. For everything from labels to really big spread sheets (227 cols.)
- ♥ **User lover**—quiet (less than 60 dBA), easy-change cartridge ribbon, front panel controls and status indicators, self-diagnostics, easy interfacing, and ready-anywhere multi-voltage power supply.

You, too, can become a PRINTEK lover. Call for the name of your nearest sales representative.

Printek, Inc., Benton Harbor, MI 49022
616/925-3200 TWX 810-270-3112

1-800-368-4636

printek 
best thing next to your computer



"See Printek at Comdex, Booth #1181-83."

PGS did it.

With the no-compromise monitor, the Princeton HX-12, PGS set the industry standard for price/performance in a high resolution RGB color monitor.

Now, we've done it again with the SR-12: our new super-resolution RGB monitor that meets the most demanding expectations at a price that will surprise you.

And PGS has set new standards in monochrome monitors, too, with the new MAX-12 amber monitor that's as easy on the eyes as it is on your budget.

The monitor to meet your needs

All three PGS monitors are engineered for no-compromise performance: to provide you with a cleaner, sharper image than any other monitor in the same price class. The HX-12 and the SR-12 both feature uncompromising color convergence for crisp whites without color bleed. The MAX-12 offers impressive clarity in a monochrome monitor with easy-on-the-eyes amber phosphor.

And all three monitors come with a shielded cable that plugs directly into the IBM PC or XT.

And does it a

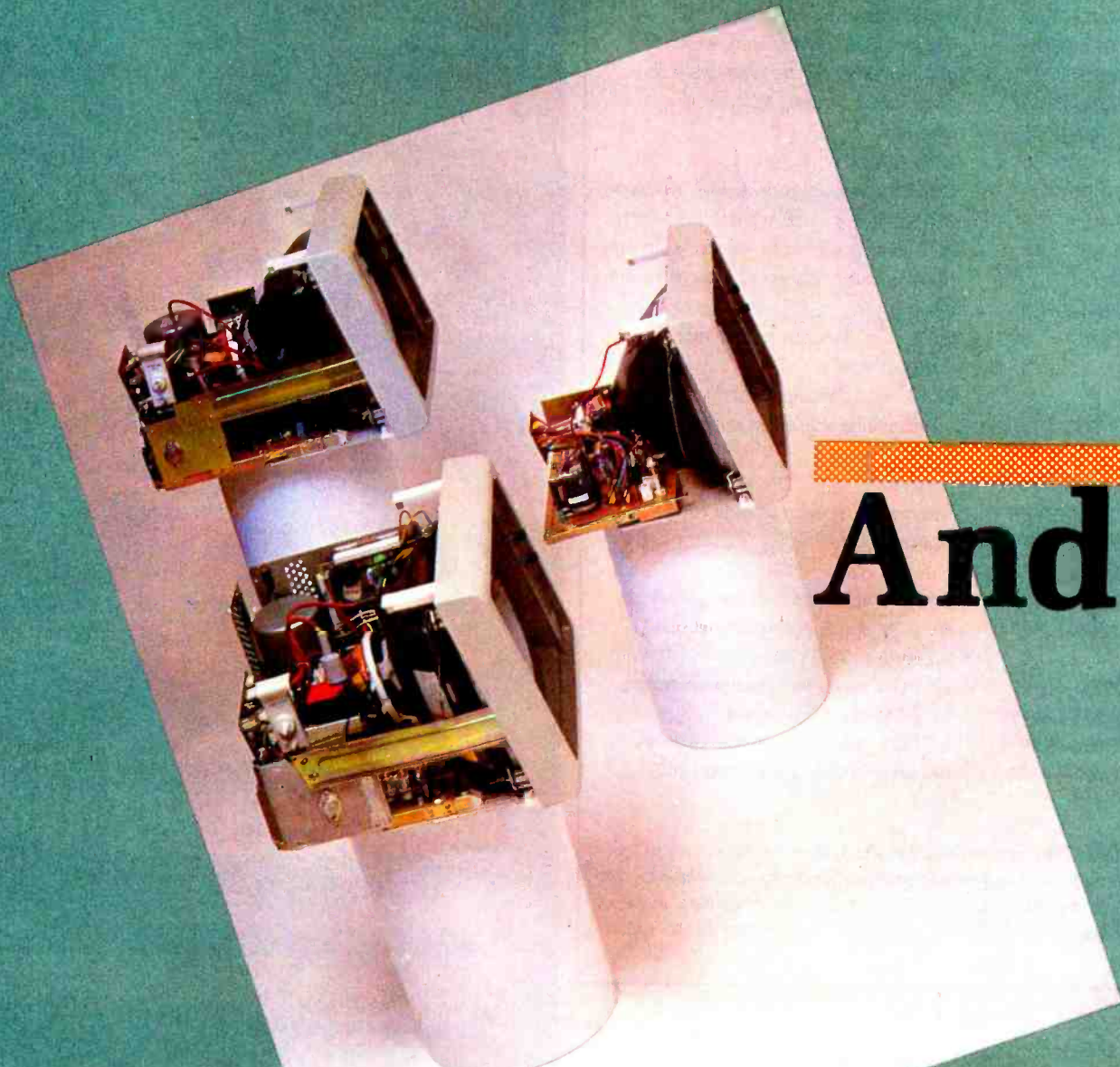

And a

Check the specifications

The HX-12 has the highest resolution (690x240) and the finest dot pitch (.31 mm) in its class. And yet its suggested retail price is comparable to many medium resolution monitors. The HX-12 brings no-compromise color to the PC and now, with the PGS RGB-80 board, to the Apple IIe as well.



gain.

The new SR-12 also features a .31 mm dot pitch supporting 690 horizontal resolution. However, by increasing the horizontal scan rate to 31.5 KHZ, the SR-12 can support 480 vertical resolution in non-interlaced mode. This results in a very high quality, flickerless image with the ability to generate text that is truly of monochrome quality, making it equally suitable for word processing and for color graphics. Suggested retail price, a remarkable \$799.



gain.

The new MAX-12 offers you an amber monitor with 720x350 resolution at a suggested retail price (\$249) that is actually lower than the leading green-on-black competitor. And the MAX-12, unlike many other amber monitors, runs off the IBM PC monochrome card—no special card is required. Clarity of the MAX-12 is enhanced by **dynamic focusing technology** which ensures sharpness not only in the center but also in the edges and corners.



A non-glare screen is standard on all PGS monitors, color or monochrome—a feature your eyes will really appreciate in a long work session.

Whatever your needs, from word processing to super resolution graphics, there's now a no-compromise PGS monitor that sets the standard. Ask your dealer for a demonstration and let your eyes decide. Or call for more information and the name of your nearest dealer.

You can look to PGS for the image your eyes deserve.

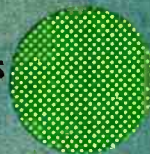

800-221-1490

Circle 347 on inquiry card.

PGS Princeton Graphic Systems

1101-I State Road
Princeton New Jersey 08540
609 683-1660
TLX 6857009 PGS Prin

MODEM Blow Out!

Hayes

1200
\$485.00

1200B
\$438.00

300
\$199.00

Micromodem IIe
\$229.00

(Replaces Micromodem II for Apple, Apple II,
Apple II Plus and Apple IIe.)

THE COMPUTER-LINE™

California
21054 Sherman Way
Canoga Park • 91303
1 (800) 255-4659 • 1 (213) 716-1812

Colorado
1136 S. Colorado Blvd.
Denver • 80222
1 (303) 279-2848

Customer Service
(213) 716-1824

Text continued from page 292:

Four keys, Insert, Delete, Break/Pause, and Print, are located above the numeric keypad. The Print key doesn't do anything on its own, but when used in conjunction with the Shift key, it generates a special interrupt that can be used by systems or applications software to send the contents of the display screen to the printer. The Insert and Delete keys do just that: insert or delete characters on the display. Normally, the unshifted Break/Pause key stops display scrolling and in BASIC causes a break to occur when shifted.

The keyboard's attractive, low-profile plastic enclosure (see photo 4) meets the European standard for the height of the home row, and the rows form a slight concave arc from top to bottom. The keyboard unit can be tilted by depressing two tabs at the upper corners of the keyboard housing, which causes a spring-loaded flap to drop from beneath the enclosure. The flap runs across the entire

Pin	Signal	Pin	Signal
A01	NMI	B01	Ground
A02	Data 7	B02	Reset
A03	Data 6	B03	+ 5 V
A04	Data 5	B04	IR0 (interrupt 0)
A05	Data 4	B05	no connection (bused)
A06	Data 3	B06	no connection (bused)
A07	Data 2	B07	- 12 V
A08	Data 1	B08	DMA (CPU enable)
A09	Data 0	B09	+ 12 V
A10	Wait	B10	Ground
A11	Logic ground	B11	AMWC (memory write)
A12	Address 19 (MSB)	B12	MRDC (memory read)
A13	Address 18	B13	AIOWC (I/O write)
A14	Address 17	B14	IORC (I/O read)
A15	Address 16	B15	no connection (bused)
A16	Address 15	B16	no connection (bused)
A17	Address 14	B17	no connection (bused)
A18	Address 13	B18	no connection (bused)
A19	Address 12	B19	no connection (bused)
A20	Address 11	B20	PCLK (5-MHz clock)
A21	Address 10	B21	IR6 (interrupt 6)
A22	Address 9	B22	IR5 (interrupt 5)
A23	Address 8	B23	IR4 (interrupt 4)
A24	Address 7	B24	IR2 (interrupt 2)
A25	Address 6	B25	IR1 (interrupt 1)
A26	Address 5	B26	no connection (bused)
A27	Address 4	B27	RFSH (refreshing)
A28	Address 3	B28	ALE (address latch)
A29	Address 2	B29	+ 5 V
A30	Address 1	B30	OSC (15-MHz clock)
A31	Address 0 (LSB)	B31	Ground

Table 3: Although many of the pins on the expansion bus connectors have the same function on both the TI Professional Computer and the IBM PC, the two buses are not compatible. The major differences occur in the control bus, including the signal lines for memory read and write, I/O read and write, and interrupt request lines.

THE SMART CABLE™ IS THE PERFECT RS-232 MATCHMAKER FOR COMPUTERS AND PERIPHERALS.

The Smart Cable's unique on-board logic "looks" at the RS-232 interface on each end of your connection, then correctly links your printer, modem or any other peripheral to your computer. Completes data lines, handshakes, everything.

NO MORE CUSTOM CABLES.

Now you can avoid the frustration and confusion of customized cables.

The Smart Cable instantly creates virtually any RS-232 interface. And if you want to swap equipment, or use other peripherals, the Smart Cable adapts. Automatically. It's one accessory that's never obsolete.

GET MORE OUT OF YOUR EQUIPMENT.

At work or at home, you can re-arrange your system with ease. One Smart

Cable lets you connect many different computers and peripherals. For example, you can connect portable computers to any available serial printer. Just plug in, watch for the status lights to indicate your circuit is complete, and start working.

Best of all, the Smart Cable is priced competitively with conventional cables and custom cables.

To be a success these days you've just got to have the right connections. Call us today at 800-227-6703 (in California 800-632-7979, in Canada 800-663-9767) to make yours a whole lot easier.

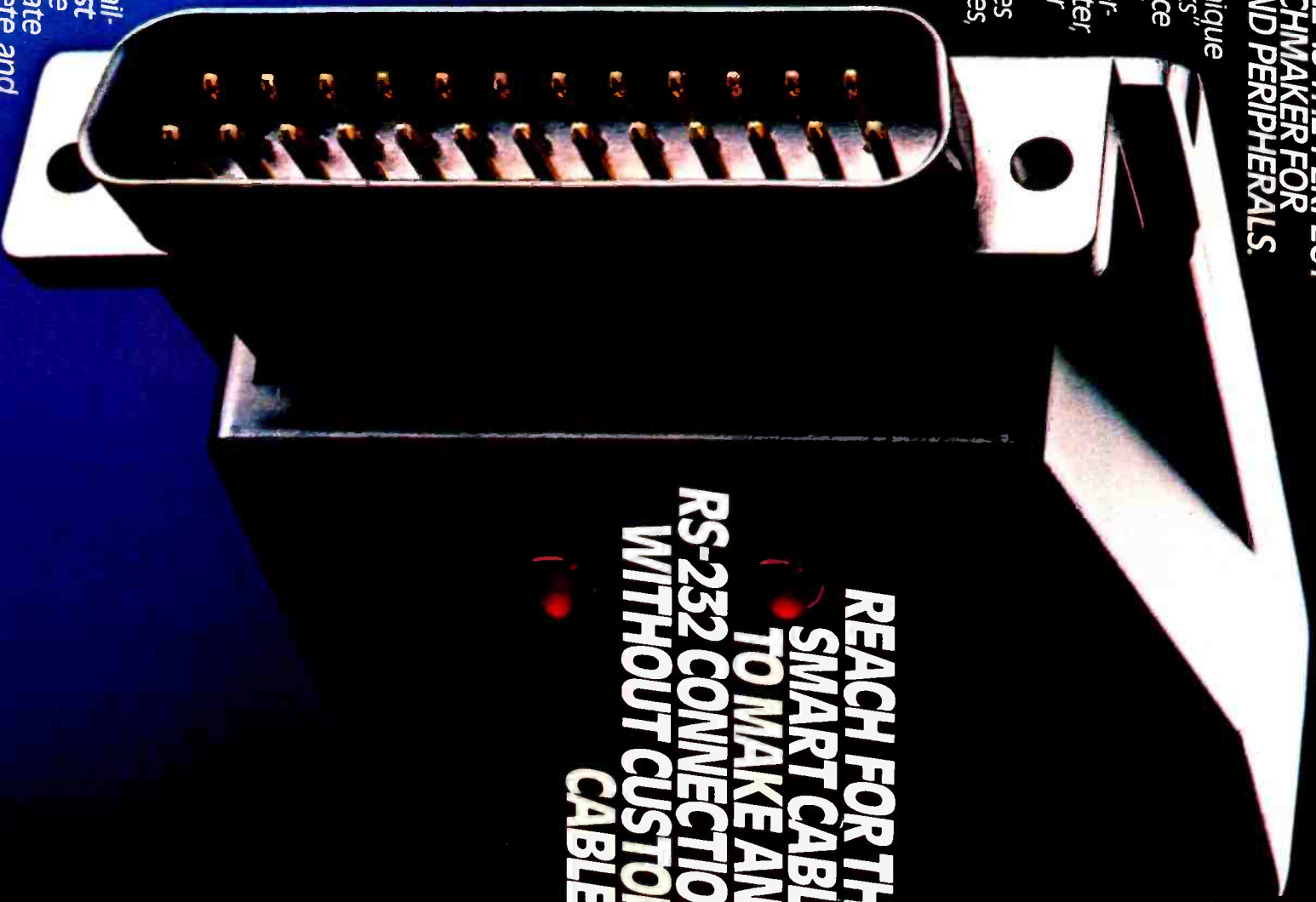

REACH FOR THE
SMART CABLE™
TO MAKE ANY
RS-232 CONNECTION
WITHOUT CUSTOM
CABLES.



IQ TECHNOLOGIES, INC.
11811 N. E. First Street
Bellevue, WA 98005
TELEX 701 472 10TECH UD

Smart Cable

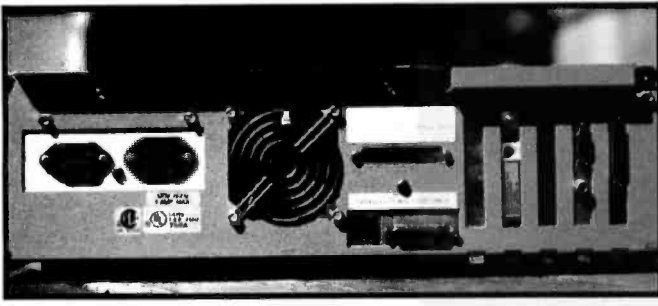

Photo 3: The rear panel of the computer holds (from left to right) the power cord connectors for the system unit and display, the fan, the keyboard DIN plug connector, the parallel printer port connector, a cutout for a DB-37 connector for expansion disk drives, two modular phone jacks on the modem card, an RCA jack for composite video output for a monochrome display (just below the RGB outputs for a color display), and the DB-25 connector on the synchronous/asynchronous communications adapter card. The two screws in the upper left- and right-hand corners are all that need to be undone to remove the system unit cover. The design is remarkably similar to that of the IBM PC, right down to the metal flaps that cover the unused expansion-slot openings.

width of the enclosure and lets the keyboard be elevated even when it's on your lap. The keyboard is attached to the system unit by a sturdy coiled cord that, when fully extended, can reach about 5 feet from the front of the system unit.

The keyboard unit contains an Intel 8048 controller that scans the keyboard and not only transmits character information to the system unit but also receives commands from it. The keyboard sends information over a serial communications link at approximately 2400 bits per second (bps) and receives commands at 300 bps.

Upon power-up or system reset, the system unit sends a command to the keyboard, telling it to perform a self-test. Depending on the results of this test, the keyboard responds with one of three codes: self-test OK, ROM error, or RAM error. The system unit can also tell the keyboard to turn the repeat function on and off, lock and unlock the keyboard, and return a version number. The

provision for turning a key click on and off is not supported and requires a hardware modification.

When you press a key, the keyboard transmits the code to an 8251 USART (universal synchronous/asynchronous receiver/transmitter) on the system board, which, in turn, generates a hardware interrupt. Then, 1 or 2 bytes are placed into the 8088's AX register (the first byte is generated only when the Shift, Caps Lock, Alt, or Control key changes states). Several things then happen, depending on which key was pressed; essentially, software interrupts pass control through the vectors residing in low memory, and the key code usually winds up in a small (15-character) buffer.

One of the keyboard interrupts can have a special purpose. Right after a key code is received from the keyboard, a keyboard-mapping interrupt is generated (INT 5B). Normally, the interrupt vector (located at $5B \times 4 = 16C$) points to an IRET instruction, essentially accomplishing nothing. But by changing the interrupt vector, you can give control to a custom routine to remap all or part of the keyboard or to filter out certain key codes. This technique can also be used to program the function keys.

The Display

When you turn on the TI Professional Computer, the quality of the display becomes immediately obvious. The characters exhibit sharpness not found on other computers (with the exception, perhaps, of the Victor 9000). Like that of the IBM PC, the Professional Computer's display system consists of two units: a controller board located in the system unit, and a CRT monitor. Unlike the IBM, however, TI's controller board can drive both an analog monochrome display and a TTL (transistor-transistor logic) color display (red-green-blue input). With a monochrome display, the "colors" are interpreted as eight levels of gray. With a color display, each character can be displayed in one of eight colors. An optional raster-graphics board can mount onto the CRT controller board piggyback style, thus preserving precious expan-

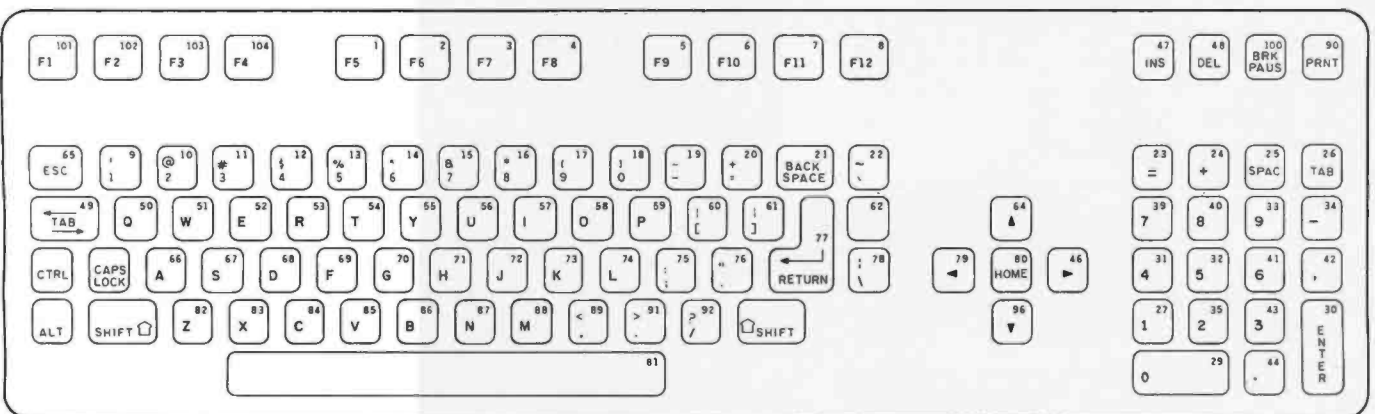

Figure 2: The keyboard layout of the TI Professional Computer reveals a more conventional approach to keyboard design: separate alphabetic, numeric, and cursor keypads, and 12 programmable function keys grouped at the top. The numbers in the upper right-hand corner of each key are the scan codes that are transmitted to the system unit for further processing.

HIGH TECHNOLOGY REQUIRES HIGH PERFORMANCE ACCESSORIES

PROPERTY BILL SUMMARY		
	PLANT	ACTION
SALES	40,000	11,000
COST OF GOODS	25,000	26,000
NET SALES	15,000	11,000
ADMINISTRATION	4,000	4,000
DEPRECIATION	1,000	4,000
REPAIRS	1,000	5,000
TOTAL COSTS	17,000	30,000

In the fast moving, high technology world of microcomputers, the need for high performance accessories often gets overlooked.

Discwasher, recognized as a world leader in audio/video care accessories, understands this need and has developed a line of computer accessories to allow users to get the most from their computer hardware.

The easy-to-use *Discwasher™ Disk Drive Cleaner* is both a problem preventer and problem solver. Its dry format safely cleans single or double-sided drives without altering the delicate head alignment or doing possible damage to rubber drive parts with solvents.

The *Discwasher™ Computer Cassette Drive CareSet™* is a total maintenance package for your cassette drive system. It includes both the *Discwasher™ Computer Cassette Drive Head Cleaner* and the *Computer Cassette Drive Mechanism Cleaner*. Together, these two maintenance units can keep the high resolution heads and the critical drive system of your cassette drive system in optimum performance.

The *Discwasher™ DiscKeeper™* is a magnetically shielded storage system for floppy disks that takes up no more space than conventional folder packs. *DiscKeeper* protects against stray magnetic fields which can destroy valuable software. Three *DiscKeeper* sizes provide loss-free storage and protection for transporting any size disk format.



discwasher

1407 NORTH PROVIDENCE ROAD, P.O. BOX 6021, DEPT. BY, COLUMBIA, MO 65205 USA

A DIVISION OF JENSEN an ESMARK Company

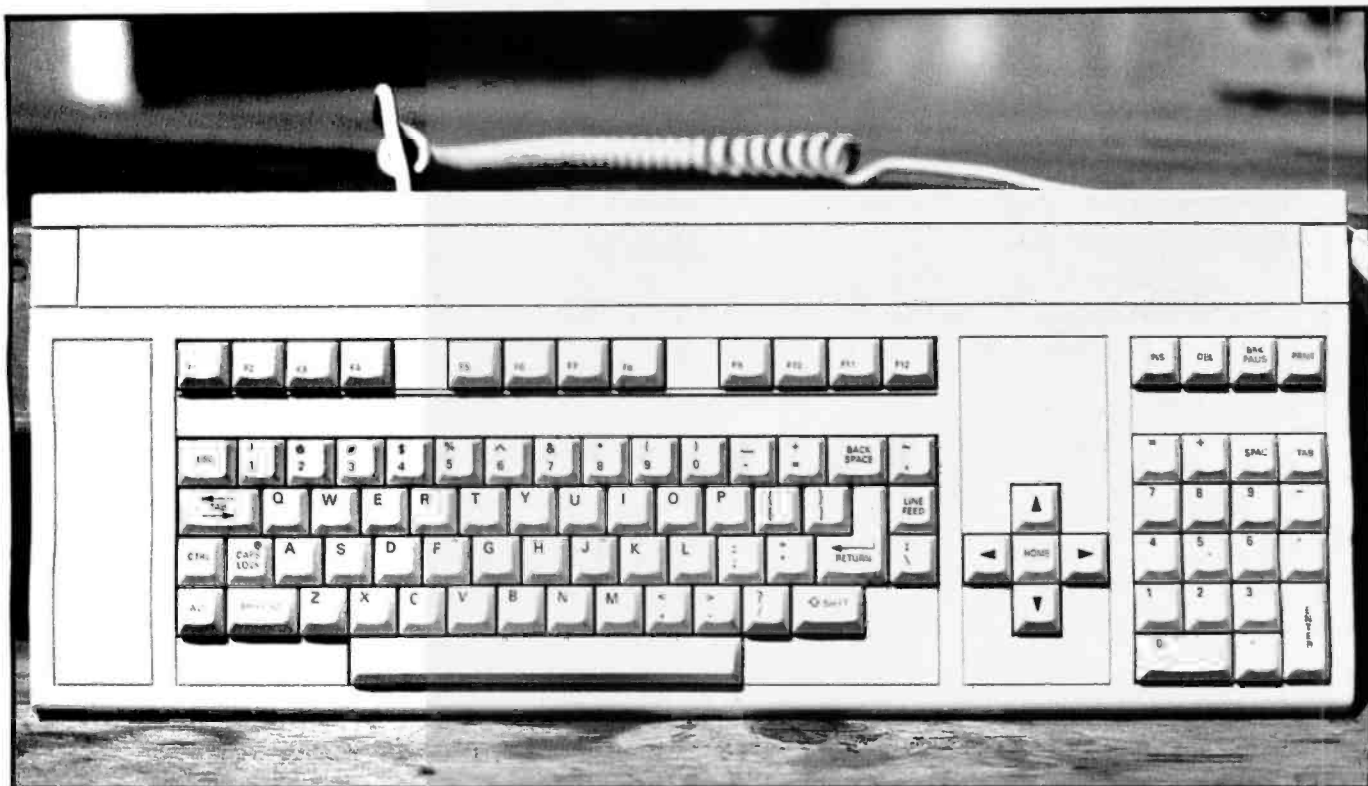

Photo 4: The low-profile keyboard unit has a more familiar layout than IBM's. Indentations on the J and F keys help you find the home row. The tabs on each side of the unit near the top control a flap on the back that elevates the keyboard.

sion slots. In addition, you can mix any combination of text and graphics on the display.

The basic CRT controller displays characters with a 7-by 9-dot matrix in a 9- by 12-dot cell. Twenty-five lines of 80 characters are displayed, thus requiring a resolution of 720 pixels horizontally (9 by 80) and 300 pixels vertically (12 by 25), which this system produces with excellent clarity, even on a color display. A full screen of text is shown in photo 5, and photo 6 is a close-up of the character formation.

Each character of the display uses 2 bytes of memory. The first byte is the actual character code. The second byte contains attribute information as follows:

- Bit 0—Intensity level 1 (blue)
- Bit 1—Intensity level 2 (red)
- Bit 2—Intensity level 3 (green)
- Bit 3—Character enable
- Bit 4—Reverse
- Bit 5—Underscore
- Bit 6—Blink
- Bit 7—Alternate character set

As mentioned earlier, the three intensity levels produce eight colors or levels of gray.

System software enters attributes for each character through an *attribute latch*. All characters to be displayed thereafter will then exhibit those attributes until new attribute values are entered. Characters can be read from the screen, too, and when this occurs the character's attribute is loaded into the attribute latch, facilitating block moves of characters and their attributes.

The attributes have a hierarchical order to resolve possible conflicts. Color attributes have the highest priority, followed by reverse video, character enable, blink, and lastly, underscore. For example, when you disable a character, its color attributes remain while blink and underscore are ignored. The result is an entire cell displayed in the color attribute(s) without visible blinking or underscore.

Although you get scrolling in four directions, it requires a fair amount of software support. Because the display "wraps," the software must clear either the top or bottom line of the screen before scrolling up or down, respectively. If a 25th "status" line is implemented, software must keep it in its place; otherwise it, too, would scroll with the rest of the screen.

The controller logic lets the 8088 have good access to screen memory. The screen memory's refresh logic enables two complete memory cycles to occur between character display refreshes. One fetches the character for display, and the other is then available to the 8088 for reading or writing. There is some slight synchronization overhead that brings the actual time to no more than 1 microsecond; the usual access time is 600 nanoseconds.

The characters themselves are produced by a 4K-byte character generator ROM in a fairly standard way, with row data loading into a shift register and dots shifted out at the dot rate. In effect, characters are painted across the screen, one row of dots at a time. The ROM contains 256 characters, but provision has been made for switching in an additional character ROM or EPROM

DATA MANAGEMENT SOFTWARE **T**AKES OFF

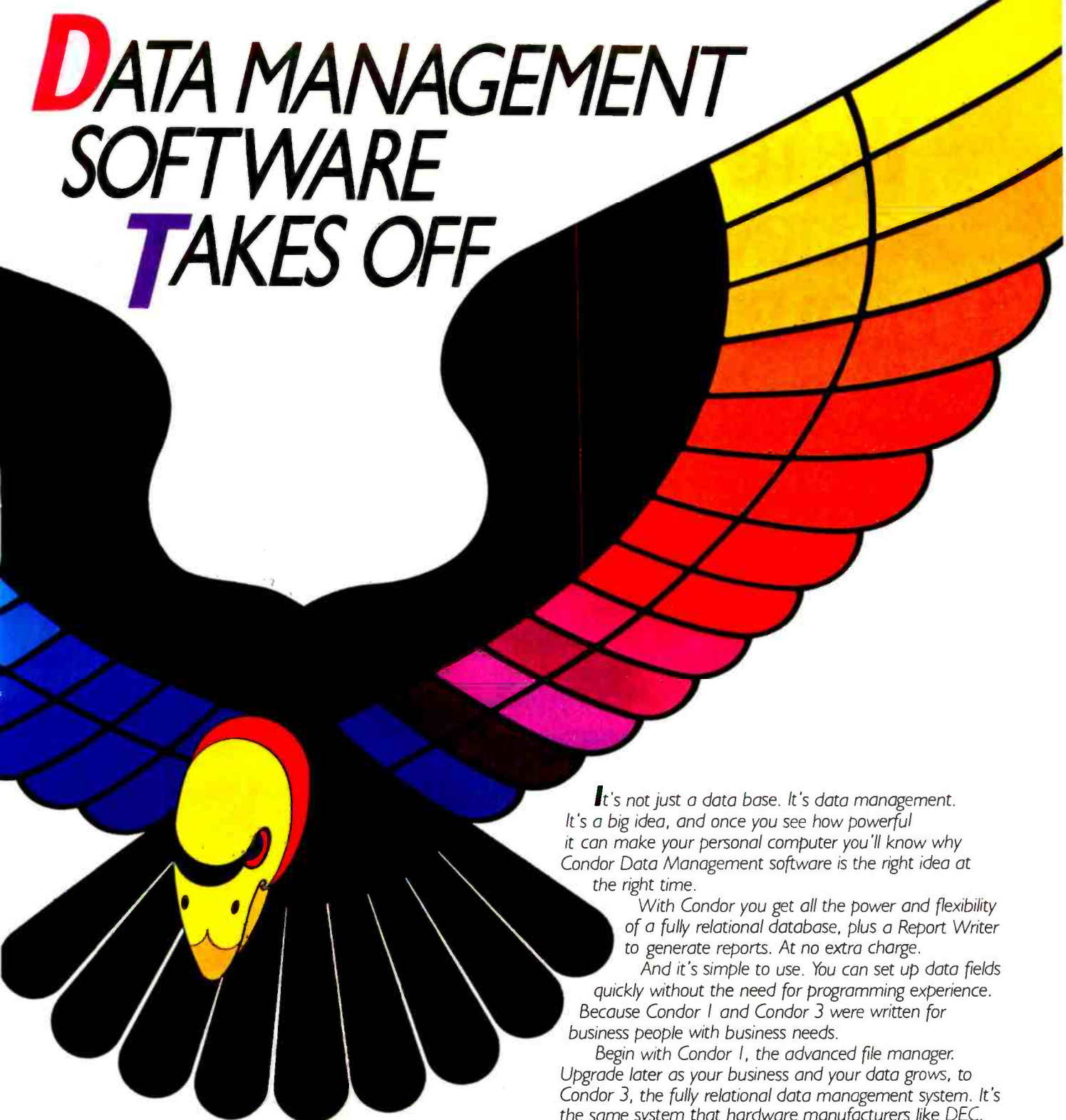

It's not just a data base. It's data management. It's a big idea, and once you see how powerful it can make your personal computer you'll know why Condor Data Management software is the right idea at the right time.

With Condor you get all the power and flexibility of a fully relational database, plus a Report Writer to generate reports. At no extra charge.

And it's simple to use. You can set up data fields quickly without the need for programming experience. Because Condor 1 and Condor 3 were written for business people with business needs.

Begin with Condor 1, the advanced file manager. Upgrade later as your business and your data grows, to Condor 3, the fully relational data management system. It's the same system that hardware manufacturers like DEC, Sony, Zenith, and Hewlett-Packard have selected to market with their personal computers.

To find out how Condor Data Management software can make your business take off, see your personal computer dealer, or call 1-800-854-7100 x165 (in California, 1-800-422-4241 x165) for the dealer nearest you.

He'll prove our point. That Condor is the data management software powerful enough to be useful to business, yet simple enough for business to use.



condor

2051 South State St., Ann Arbor, MI 48104 313/769-3988

Circle 119 on inquiry card.

We're finding new ways to connect people with the information they need.

Communications satellites,
tape drives, floppy discs, telecom-
munications, computer networks.
At McGraw-Hill, we're using the latest
advances in electronic technology
to tailor and deliver our vast stores
of information in exciting new ways.
To help people get at
needed facts more
efficiently. And, to



McGRAW-HILL PUBLICATIONS CO.
McGRAW-HILL BOOK CO.
McGRAW-HILL BROADCASTING CO.
McGRAW-HILL INFORMATION SYSTEMS CO.
STANDARD & POOR'S CORP.
DATA RESOURCES, INC.



help them make decisions with greater confidence in an increasingly complex world.

McGraw-Hill is already employing this technology, for example, to deliver instant access to information on corporate and municipal bonds for the financial community. To provide on-line distribution of economic data on construction trends and potential. And to make the world's largest private collection of economic data bases respon-

sive to the specific needs of business and government planners.

In these ways and more, technology is helping us make otherwise overwhelming amounts of information more valuable by making it more useful and instantly accessible. And by providing new

channels of information distribution with selectivity and built-in search capabilities.

These new applications of communications technology are a natural extension of McGraw-Hill's basic charter: to provide people with the information they need. Information that leads to action.

McGraw-Hill, Inc., 1221 Avenue of the Americas, New York, New York 10020.



Information that leads to action.

Turn Your FLOPPIES Into FLIPPES

5 1/4" FLIP-IT



aligned, accurate,
safe way to make
index-hole cutouts.



DOUBLES YOUR DISKETTE MEMORY IN SECONDS!

The self-aligning Write-Enable Punch has a special Deep-Grooved and "Case-Hardened" Steel Punch for making a clean write-enable cutout. Just insert into diskette and punch. Flip-it will pay for itself immediately — because every diskette you own or will buy is now like owning or buying two. Order yours today.

TOLL FREE 24 HRS ORDER LINE
1-800-227-3800 ext. 128

- a) 5 1/4" FLIP-IT: for all 5 1/4" computers incl. Apple, IBM, Osborne, Atari, Radio Shack, Commodore, Victor, Kaypro, Franklin & more **only \$29.95**
- b) 8" FLIP-IT: for 8" computers incl. IBM, Wang, Atlas, Radio Shack, DEC, DG, & more **only \$34.95**
- c) Labels: (self-sticking, 100 ea.) **\$3.00**
- d) Write Protect/Enable: (5 1/4" or 8") (100 ea.) **\$2.65**
- e) Hub-Reinforcing Kit: (positioning-tool for hub-opening)
5 1/4" disks: **\$10.99** 8" disks: **\$12.99**
- f) Hub-Reinforcer Rings: (50 rings ea. for hub-opening)
5 1/4" disks: **\$5.85** 8" disks: **\$7.20**
- g) Disk Sleeves: (lint free, 10 ea.)
5 1/4" disks: **\$2.55** 8" disks: **\$3.85**

Add \$2.50 for shpg and hdg. (AK, HI, PR, Canada=add \$5, Int'l orders add USD10.50)
— Mass. res. add 5% tax



Flip-It P.O. Box 201, Newton Hlds., MA 02161
Tel: (617) 527-FLIP Telex: 4991009 CHTRI
copyright 1983 D/Punch Corp. We acknowledge all trademarks

PROGRAMMERS FLIGHT SIMULATOR Apple II Plus DOS 3.3 48K



This total IFR System disk features gobs of menu selectable flight programs each with breath taking realistic picture graphics, moving scenery, airport approaches, holding patterns and much much more.

\$50.00 At your Computer Store or direct from
Visa Mastercard

Programmers Software
2110 N. 2nd Street
Cabot, Arkansas 72023
(501) 843-2988

and based this computer on Intel's 8088 sixteen-bit chip instead. The 8086 in the Texas Instruments Professional Computer runs at a clock speed of 5 MHz, compared to the IBM PC's 4.77 MHz. TI makes no secret of the fact that its system will support an 8087 coprocessor. In fact, TI states throughout its technical documentation that the term CPU refers to both processors. The 8087 is still a bit pricey, but that will change with time, and TI is already providing Microsoft's FORTRAN, Pascal, and COBOL compilers that support this chip's extended commands.

The "bottom of the line" Professional Computer is supplied with 64K of 3-bit RAM. Nine chips of the 4164 type (64K by 1 bit) are used, and they are soldered directly to the system board. RAM can be added to the system through the use of an optional memory expansion board that fits into the dedicated memory expansion slot. The expansion board is supplied with 64K of 9-bit RAM installed (soldered, too), and sockets are provided to allow another 128K of 9-bit RAM to be added, bringing the total system RAM to 256K. Though at first glance this seems to be the system limit, a look at the technical manual shows the memory space from 40000H to BFFFFH to be reserved for "expansion bus memory." The people at TI tell me that an additional 512K could be installed through the use of one of the remaining expansion slots, and they are preparing such a board now. Adding this much extra memory would mean a total of 768K of main memory.

The 8K-byte system ROM contains what are called "device service routines" for controlling the principle I/O devices in the system unit. The liberal use of hardware and software interrupts and software vectors or pointers allow

Photo 5: The display on the Professional Computer is one of its most outstanding features. The resolution is 720 dots horizontally and 300 dots vertically. A user can mix text and graphics in any way.

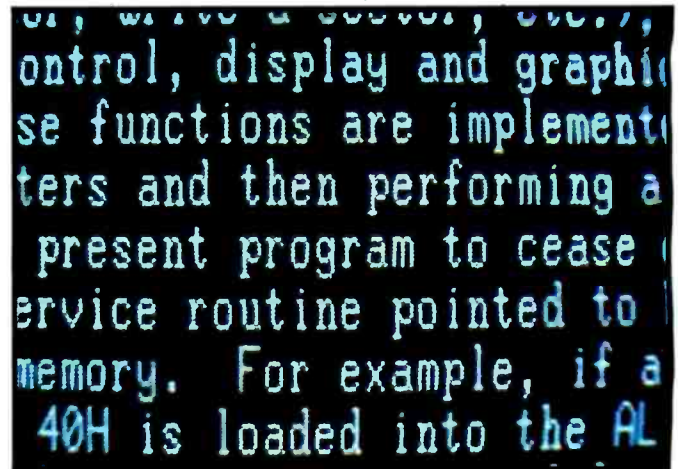

Photo 6: A close-up look at how the screen characters are formed.

(erasable programmable ROM). Bit 7 of the attribute byte controls this switching, and the controller board includes a socket for the extra ROM. The addition of another character ROM makes it possible to display 512 characters.

The Professional Computer supports block, or character, graphics, but in an unusual way. In order to draw a solid horizontal line, there must be a way to fill the entire width of a character cell. But a character cell is 9 bits wide and the character generator can only put out 8 bits per character. This problem is solved in an interesting way. If the dots for any row of a character coming out of the character generator has bit 7 set, the leftmost and rightmost dots of that row are copied into the leftmost and rightmost dot positions of the character cell, thus enabling the entire character cell to be filled and consecutive characters to be contiguous.

As previously mentioned, the optional graphics board mounts directly onto the CRT controller board. It has the same resolution as the CRT controller board, 720 pixels horizontally and 300 pixels vertically. The graphics board is available in two configurations: one-plane (two colors: black and a choice of any one of eight colors) and



Plug 3,000 new applications into your Apple.®

The CP/M CARD™ plugs CP/M Plus™ (3.0) into any Apple II series computers.

The CP/M CARD gives you the option of running your Apple II with the speed and capability of a professional Z-80® system with CP/M-compatible software. Just plug in the CP/M CARD. Then choose CP/M or your standard Apple software at your option.

Plug into a big, new world of software.

The CP/M CARD gives you instant access to the world's largest selection of microcomputer software—more than 3,000 CP/M-compatible applications, languages and programming utilities. So, you, too can use professional business programs such as WordStar®, SuperCalc,™ Condor,™ and other high-performance software starting today!

And, you still have access to your present library of Apple Software.

Plug into incredible performance.

Together, the super-fast CP/M CARD and CP/M Plus run applications up to 300% faster than your Apple system! The CP/M CARD is the only Apple II performance package that offers the speed and efficiency of CP/M Plus.

Why just keep plugging along?

The CP/M CARD provides everything you need—including 64K of additional on-board memory, CP/M Plus version 3.0, CBASIC® language, along with appropriate installation and reference guides. And, we have the CP/M CARD Programmer's Kit available for the serious-minded programmer. See your local microcomputer dealer today. Or contact Advanced Logic Systems' Sales Headquarters, 2685 Marine Way, Mountain View, CA 94043, 800-ADLOGIC or 415-964-5670 in California.

als

Advanced Logic Systems
The CP/M CARD for your Apple II+ or //e.

CP/M, CP/M Plus, the CP/M CARD and CBASIC are either trademarks or registered trademarks of Digital Research Inc. Z-80 is a registered trademark of Zilog, Inc. WordStar is a registered trademark of MicroPro International Corporation. SuperCalc is a trademark of Sorcim Corporation. Condor is a trademark of Condor Computer Corporation. Apple is a registered trademark of Apple Computer, Inc.

Circle 15 on inquiry card.

www.americanradiohistory.com

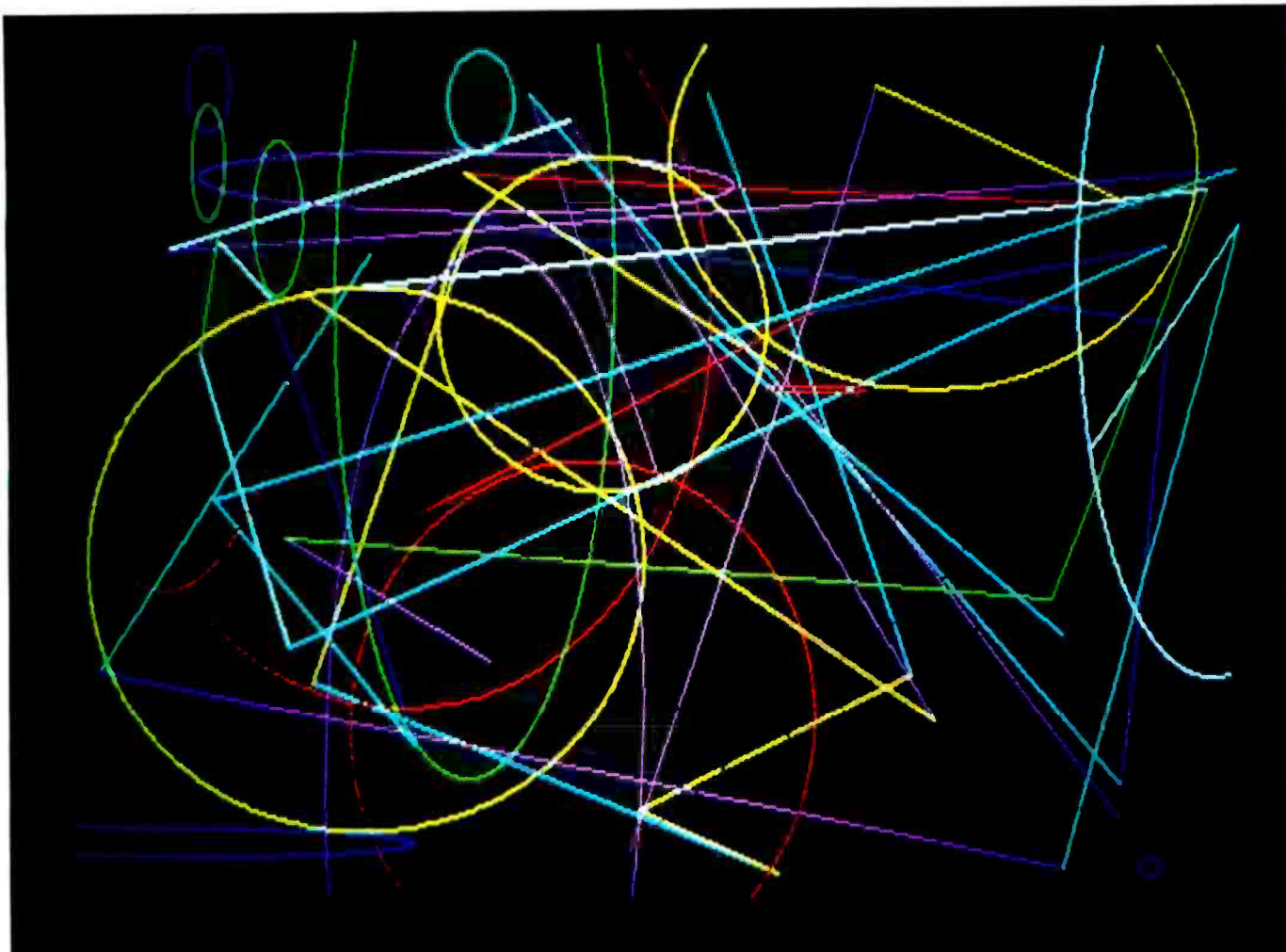

Photo 7: An example of the graphics capabilities of the Professional Computer.

three-plane (all eight colors). I had the eight-color option, in which each pixel is individually addressable and can contain up to three attribute bits that provide up to eight (2^3) colors. Some of the graphics capabilities are shown in photo 7.

Before you choose between the two- or eight-color graphics options, keep this in mind: the two-color version is not designed to be upgradable. If you think you'll want eight-color capability someday, get the three-plane board.

As implied above, the graphics boards contain color-mapping logic. The color information for each "palette" is held in one of three latches—one for red, green, and blue—on the graphics board. By changing the values in the palette latches, the code for cyan (101) could be converted to the code for, say, blue (001). Thus, all eight colors can be changed by loading new values into the palette latches.

Other Hardware Options

The synchronous-asynchronous communications board is capable of driving one RS-232C link in either asynchronous mode or one of several synchronous modes, including synchronous data-link control (SDLC)

and high-level data-link control (HDLC). The heart of this board is, interestingly, a Zilog Z8530 serial communications controller chip. Most of the remaining circuitry on board handles the interface of this chip to the system bus. The on-board data-rate generator is software programmable and is capable of generating 17 rates from 50 to 19,200 bps. One DB-25 connector is mounted on the board edge facing the rear of the system unit.

If you purchase the optional Winchester-disk drive, you receive a 5- or 10-megabyte drive, a controller card, and the connecting cable. The drive may be manufactured by TI or Seagate. The version installed in the review unit was built by TI and had a 5-megabyte capacity (formatted). The 8088 views the controller as a block of four consecutive I/O ports. The controller generates interrupts when data is ready to be read from or written to the controller and when an operation is complete and the controller requests a status read. An on-board 4K-byte ROM contains the driver routines for the controller and can cause the controller to perform a self-test.

The internal 300/1200-bps modem supports auto-dialing and auto-answer as well as originate and answer modes. It can detect dial tones and busy signals and communicate asynchronously at 300 or 1200 bps; at 1200

Today, you're doing more than ever. So should your phone.

AT&T introduces GENESIS™ Telesystem.

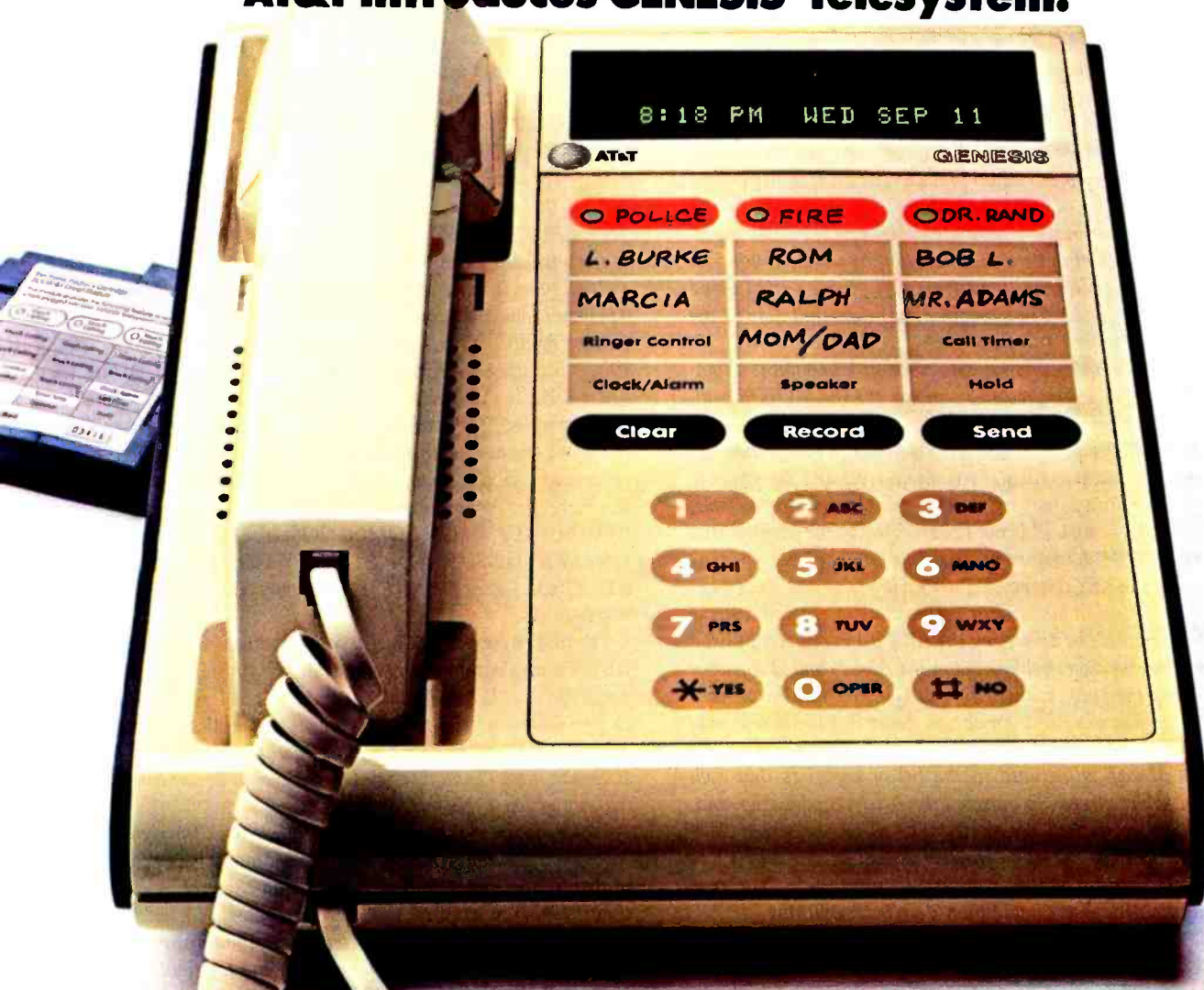

Genesis telesystem is designed to help organize and streamline your life in so many ways.

The Genesis telesystem remembers all your important numbers, including emergency numbers. And it dials with just a touch. It times your calls and even has a built-in speaker.

But the really terrific thing about the Genesis telesystem is that you can customize it to fit your own

needs. Add an optional cartridge, and you've got one-touch access to call forwarding, call waiting, and three-way calling. Or add another cartridge, and you have the convenience of automatic re-dial of busy or unanswered numbers. And that's only half of it.

Soon, you'll be able to add a module with an electronic directory that memorizes names and numbers in alphabetical order.

Or the reminder cartridge, to remind you of special occasions and appointments.

Genesis telesystem. The more you do, the more it will help you do it.

We set the standards.



bps, it can also communicate synchronously.

Software

The price of the basic Professional Computer doesn't buy any software—not even the operating system. MS-DOS cannot be called the standard operating system, but you can't help but notice that almost all TI-labeled software operates under MS-DOS.

I imagine most people buying this computer will buy the MS-DOS operating system. Currently TI only offers version 1.1 of this operating system, but version 2.0

should be available in December. Along with MS-DOS you get MS-BASIC, version 1.1. You can opt to purchase CP/M-86, which comes with CBASIC, but you'll pay more than twice as much. Concurrent CP/M is available, and the UCSD p-System is sold at three and a half times the cost of MS-DOS.

The MS-BASIC interpreter is similar to that supplied with the IBM PC (before its version 2.0) with the exception of some hardware-dependent commands and functions. I downloaded a fairly generic BASIC program from The Source that was originally intended for the IBM PC,

Text continued on page 314

TI's Improved BASIC

I actually tested two versions of BASIC, and therein lies a story. The first version I tested is the one currently being shipped, version 1.1. It contains several bugs.

The LOCATE command didn't always turn the cursor off. LOCATE ,,1 turns the cursor on and LOCATE ,,0 is supposed to turn it off. If you've previously turned the cursor on (using another program or in the immediate mode) and then run a program that's supposed to turn the cursor off, it won't. If you run the program a second time, the cursor will go off. I tried using two LOCATE commands in a program, but even that didn't turn the cursor off the first run-through.

As with IBM's BASIC, TI's BASIC version 1.1 contains a command to control a cassette-recorder's motor. It's the MOTOR command. The problem is, the TI computer doesn't support a cassette recorder. So what happens if you enter a MOTOR command? You may very well have to turn the computer off and on again to recover. It's not always that bad, but it's completely unpredictable.

The MOTOR command is not documented in the manual that comes with BASIC 1.1 except in one very obscure place. After the discussion of the KEY command, there's a brief description of what is called a "command super shift." This enables single-keystroke entry of 22 keywords by depressing the Alt key and one of the alphabetic keys. For instance, holding down the Alt key and at the same time pressing the I key produces the INPUT keyword. Pretty neat. But what in blazes is this information doing in the discussion of the KEY command? The MOTOR command, which is produced using the M key, is included in the list of keywords that each alphabetic key produces. So I pressed the Alt-M combination and, sure enough, up popped the word MOTOR on the screen. Hitting the Return key caused a complete system failure, and it was necessary to turn the machine off and then on again. Yes, even the Control-Alt-Delete combination didn't do anything.

While I'm on the subject of documentation, let me say that the manual for BASIC 1.1 is terrible. Besides the screwy placement of the command super shift summary, there is absolutely no information on the various switches you can control when you first invoke BASIC. (For the benefit of those seeking this information, these switches include /M:, which sets the maximum workspace used by BASIC to provide room for assembly-language subroutines; /S:, which sets the buffer size for random-access files; /F:, which sets the maximum number of files that may be open at any one time; and /C:, which controls the size of the communications input buffer when using the synchronous/asynchronous card.) Oh yes, these switches exist. In fact, they are referred to in several places in the manual (except for /F:), always as part of the discussion of something else. But nowhere are you told what they are or how they work.

One feature not explained in the user documentation but found in the technical manual is the special use of the Alt key. By holding down the Alt key and entering the three-digit number on the numeric keypad, you can generate any character code, decimal 0 to 255. For example, by holding down the Alt key while entering 155 on the numeric keypad, the character code 155 (i.e., €) is generated (CHR\$(155) in BASIC). It's a mystery to me why this is not included in the user documentation.

Then there is the case of the missing commands and statements. There are some very common commands and statements that are part of BASIC 1.1 but are not documented. For example, little things like the SYSTEM command to get you back to MS-DOS. Then there is the matter of the DATE\$ and TIME\$ statements (and variables). These work just fine if you know how to use them, but don't try to find them in the manual. Although the FILES command is in the documentation, you'd be hard pressed to find it. Here are some other undocumented commands: BEEP, COM(n), KEY(n), ON COM(n) GOSUB, ON KEY(n) GOSUB, ON PEN GOSUB, ON STRIG(n) GOSUB, STRIG, and STRIG(n). Lastly, the RESET command is in the index but nowhere else.

I think I've covered the really serious omissions. As far as I can tell, TI didn't put any extra effort into the BASIC 1.1 manual the way IBM did. IBM's is not that good, but at least Big Blue tried to give some examples to clarify the more complicated commands, and the company has organized its manual better than TI has. It appears that TI simply copied the Microsoft documentation verbatim and left parts out.

While discussing the preceding problems with the people at TI, I was informed that the company is about to release a new version of BASIC, version 1.2, that has fixed all these bugs and others that I hadn't uncovered, and that it comes with an improved manual that documents all the commands and features. TI packed up a copy of the new BASIC floppy disk and the final draft of the manual that afternoon and shipped them air express, through a hurricane, so I could review them before completing this article. I'm happy to report that, indeed, the previously mentioned bugs are gone. The MOTOR command is still there, but trying to execute it gives you a simple "Device Unavailable" message instead of a system failure. Also, the new manual will be beautiful; comparing it to the version 1.1 manual is like comparing night to day. Besides being complete, the manual has plenty of examples and illustrations to explain the more difficult commands. The material is organized in a more rational way, and it is evident that a lot of effort went into this revision. This manual will be better than IBM's.

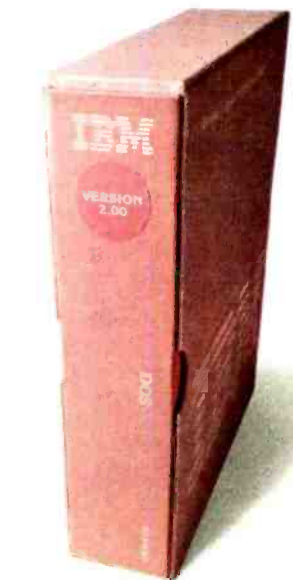

THIS IS ALL IT TAKES TO RUN OUR HARD DISK.

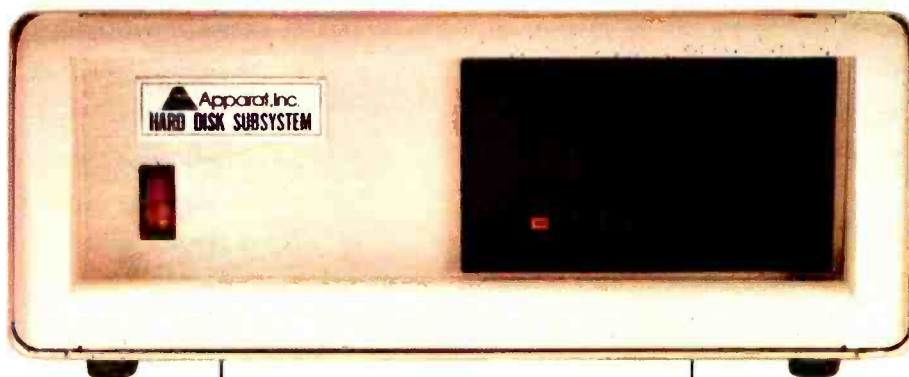

Compatibility. A lot of manufacturers talk about it. Mostly, compatibility is defined as something that almost works like the original. Our hard disk subsystem for the IBM PC runs on 2.0 without modifications, patches or use of device drivers. Just boot 2.0 and run.

And we haven't cut back on reliability either. The Apparatus hard disk uses the Xebec controller and connects via a host interface module to one of the slots in your PC. The HIM also contains an RS-232 serial async port for use with a

mouse, modem, etc. Even with compatibility and reliability built in, we've managed to provide some very competitive pricing. The 10, 15 and 26 megabyte drives are priced at **\$2,295, \$2,695 and \$3,395** respectively.

When you use a multifunction RAM Card, such as the Apparatus Combo II (with up to 512K of RAM, RS232, parallel printer, clock calendar, and game adapter) along with the HIM, floppy disk controller and CRT monitor adapter cards in your PC, you still have one slot available for future expansion.

If you're considering a fixed disk for your IBM PC, look at all the systems available. Look for compatibility. Look for reliability. Look for value. We think you'll pick ours.

For more information or to order yours call **800/525-7674** or write Apparatus, Inc., 4401 S. Tamarac Parkway, Denver, CO 80237, 303/741-1778. Dealer inquiries invited.

IBM PC is a registered trademark of International Business Machine Corp.
Price and specifications subject to change without notice.

 **Apparatus, Inc.**

Circle 25 on inquiry card.

*Others say, "The Sky's the Limit"
We go one step beyond.*

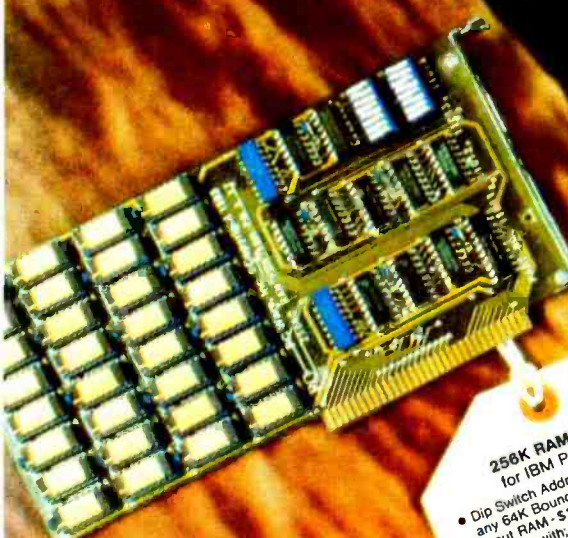

256K RAM Board
for IBM PC or XT

- Dip Switch Address Selectable on any 84K Boundaries
- Without RAM - \$189.95 Part No. 11010
- Populated with:
 - 64K \$229.95 Part No. 11011
 - 128K \$269.95 Part No. 11012
 - 192K \$309.95 Part No. 11013
 - 256K \$349.95 Part No. 11014



CLOCK CALENDAR
for IBM PC or XT

- DOS compatible
- Comes with software driver
- Will fit in any slot including the small slot in back corner
- 3 yr. Lithium battery backup

Part No. 21050 \$74.95

ROBOT ARM INTERFACE

- Interface the Tony Armatton robot arm to any Contronics port

To be announced in Jan. 1984

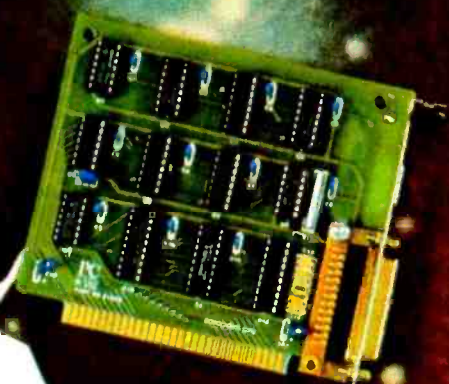

PARALLEL PRINTER ADAPTOR
for IBM PC or XT

- Fully IBM Compatible
- May be used as a general purpose I/O port
- 12 buffered TTL Latched outputs
- 5 buffered TTL inputs
- Fully Software programmable
- Software controlled interrupts
- Reset of target peripheral/device with system
- Industry standard D-shell connector for I/O

Part No. 21020 \$89.95



SERIAL COMMUNICATIONS ADAPTOR
for IBM PC or XT

- Fully IBM compatible
- Asynchronous EIA RS-232 I/O
- Hardware selection of I/O mapping (Jumper)
- Fully software programmable transmit, receive, error, line status and data set interrupts
- Diagnostic capability to provide loopback functions for transmit/receive and input/output signals (for equivalent)
- Powerful Intel INS8250 UART
- Supports full or half duplex header
- Simple DCE/DTE configuration
- Crystal controlled baud rates, software programmable from 50 to 19200 including 134.5
- Programmable control register error checks
- Parity, overrun, and framing
- Data is double-buffered
- External receiver clock input available
- Modem control functions supported (e.g. CTS, RTS, DTR, RI and carrier detect)
- False-start bit detection
- Line-break generation and detection (Jumper)
- Choice of 4 handshake signals
- DSR* and/or CTS* hardware override (Jumper)

Part No. 21010 \$94.95

PC
PERSONAL COMPUTER
WARE

PC Ware, Inc.
Dept B12
4883 Tonino Dr.
San Jose, CA 95136
(408) 978-8626

TO ORDER

In USA shipping paid by us for orders pre-paid. We accept C.O.D. orders (U.S. only). For VISA or MASTERCARD shipping charges will be added, CA residents add 6.5% for tax. Outside USA add 15% for shipping and handling. Payment must be in U.S. funds. Dealer inquiries invited. One year warranty.



Circle 337 on Inquiry card.

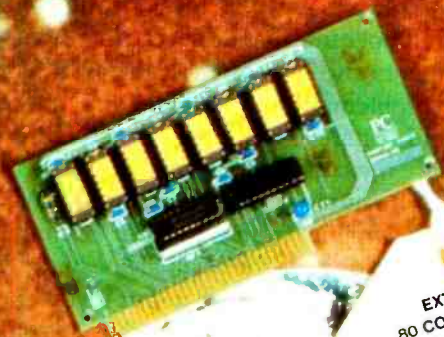

EXTENDED 80 COLUMN CARD for Apple II/e

- 64K RAM
- Functionally identical to the Apple version
- Part No. 22070 \$159.95

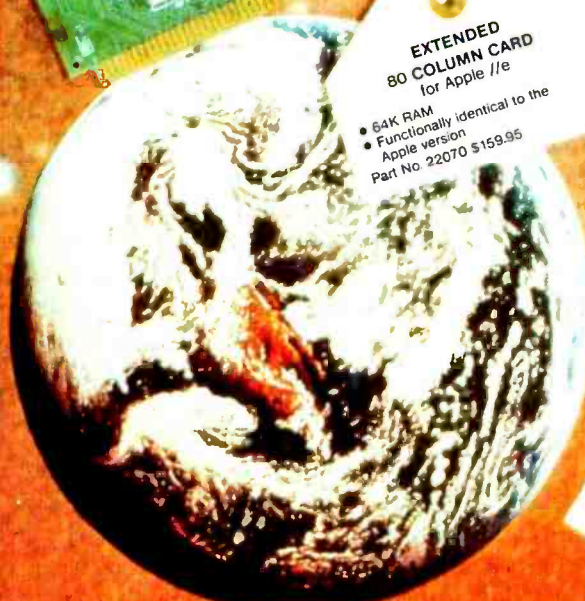

ENHANCED SERIAL INTERFACE for Apple II and IIe

- Asynchronous EIA RS-232C I/O
- Powerful 2K intelligent driver in EPROM (interchangeable 2K RAM)
- Applesoft, Pascal, and CP/M compatible
- Supports full & half duplex
- Crystal controlled baud rate, and 19200 (programmable from 50 to 19200)
- Programmable default setting
- Parity, overrun, and framing error checks
- Software programmable control register
- Choice of 4 handshake signals (Jumper)
- DCD*, DSR* and/or CTS* hardware override (Jumper)
- Simple header DCE/DTE configuration
- RS-232 Cable included
- Part No. 22030 \$184.95

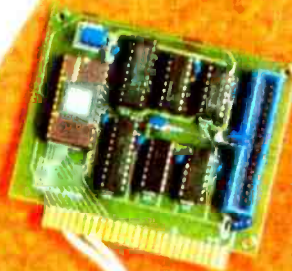

CENTRONICS PRINTER INTERFACE for Apple II and IIe

- Multiple drivers onboard in EPROM (interchangeable 2K RAM)
- Applesoft, Pascal, & CP/M Compatible
- 2 handshake lines (ACK* and strobe*)
- 4 status lines (select*, Busy, Paper out, and Prime*)
- Centronics data bit 8 may be jumpered low
- Conveniently located ribbon connector
- Part No. 22010 \$59.95
- With cable included
- Part No. 22011 \$79.95

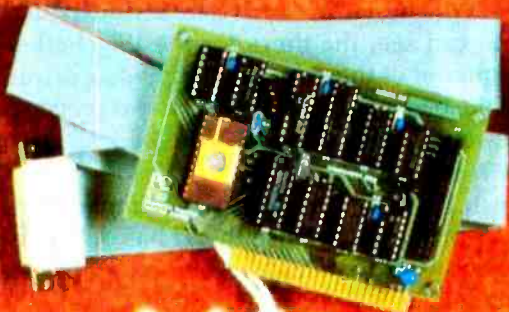

HI-RES GRAPHIC PRINTER INTERFACE for Apple II and IIe

- Keyboard controlled screen dumps
- 23 different commands for text and graphics
- Color graphic screen dumps
- Interfaces to any dot matrix printer
- On-board printer selection
- Two page side by side printout
- Cable included
- Part No. 22080 \$149.95

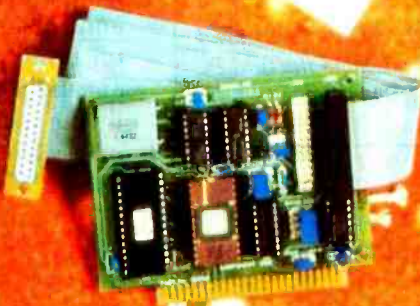

SERIAL INTERFACE for Apple II and IIe

- Asynchronous EIA RS-232C I/O
- Multiple drivers (up to 8) resident in EPROM optional 2K RAM
- Apple soft, Pascal, and CP/M compatible
- Full or Half Duplex
- Separate DCE and DTE Connectors
- Crystal controlled baud rate, software programmable from 50 to 19200 default setting
- Programmable control register
- Parity, overrun, and framing error checks
- Software programmable interrupts
- Data is double-buffered
- Choice of 4 handshake signals (Jumper)
- DCD*, DSR* and/or CTS* hardware override (Jumper)
- DMA and interrupt daisy-chain supported
- RS-232 cable included
- Part No. 22040 \$129.95

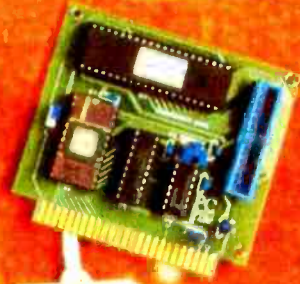

PARALLEL I/O INTERFACE for Apple II and IIe

- Multiple drivers onboard in EPROM (interchangeable 2K RAM)
- Applesoft, Pascal, & CP/M Compatible
- Dual 8-bit bi-directional parallel ports
- Four handshake lines
- Conveniently located ribbon connector
- Part No. 22020 \$89.95

Benchmark	Time (minutes: seconds)	
	Professional Computer	IBM PC XT (DOS 2.0)
1A Loop	0:05.5	0:06.9
1B Division	0:16.9	0:24.7
1C Gosub	0:09.7	0:12.8
1D Strings	0:19.9	0:23.8
1E Prime sieve	2:38.2	3:12.0
1F Disk write		
single-sided		
loaded	0:29.8	0:29.0
unloaded	0:30.4	*
double-sided		
loaded	0:29.5	*
unloaded	0:29.9	*
Winchester	0:07.1	0:08.0
1G Disk read		
single-sided		
loaded	0:19.4	0:23.0
unloaded	0:20.0	*
double-sided		
loaded	0:19.3	*
unloaded	0:19.7	*
Winchester	0:05.1	0:08.0
*not tested		

Table 4: A comparison of the BYTE benchmarks (see listing 1 on page 316) run on the Professional Computer and the IBM PC XT. Both versions of TI's BASIC ran the tests in the same time.

stance, that you have to enter 15 lines of code, and each line is almost but not quite identical. (Let's say it's a series of LINE statements and only one variable is different in each line.) No problem. Simply enter the first line as you normally would. Then, to enter each succeeding line, you merely place the cursor on the first line you entered, change the old line number to the new line number, and then change the variable (from A to B, for example) and press Return. You won't see the original line of code anymore because you've written over it, but if you entered a LIST command, you'd see both lines. You can continue to do this for each succeeding line until you're finished. In essence, you can build the remaining 14 lines of code from the first line by entering only what is different from one line to the next. The process is quite a time-saver.

I ran the standard BYTE BASIC benchmarks for comparison with other machines and the results are outlined in table 4. Because the floppy-disk drive in the review machine used a head-load solenoid, I ran the disk write and read benchmarks (6 and 7) both with the head initially loaded and unloaded. As the results show, head-loading takes approximately 0.5 second. I also ran these benchmarks using both single- and double-sided disks. As I expected, the times for a single-sided disk are slightly longer due to the extra head seeks involved, whereas a double-sided disk allows two tracks, one on each side of the disk, to be written or read without the head assembly moving. The timings for benchmarks 6 and 7 using the Winchester-disk drive are included just for fun. As you can see, the times for the Winchester are about one-quarter of those for the floppy-disk drive. By the way, all the benchmark times for the two versions of TI's BASIC were exactly the same. The benchmarks used are shown in listing 1.

The graphics in TI's BASIC are somewhat simpler than in IBM's BASIC, primarily because the TI has only one mode. You always work with high-resolution graphics: 720 pixels horizontally, 300 vertically, and any pixel can be one of eight colors. No distinction exists between text and graphics modes; you can mix the two freely. You can plot individual points, lines, boxes (filled or outline), circles, and ellipses. A PAINT command fills any odd shape with a color, and GET and PUT commands move whole shapes around on the screen. The PALETTE and PALETTE USING commands enable rapid changing of all eight colors simultaneously. And a DRAW command, as on the IBM PC, uses its own macro language that enables it to perform the functions of most of the other graphics commands. The macro language lets you move any distance in eight directions, plot points and lines, and set color and scale. By combining several macro commands into a single string variable, a simple command like DRAW A\$ can perform a complex series of movements. In addition, one command executes a substring, like a sort of subroutine, so that repeating patterns can be defined individually and then strung together by a series of commands that executes substrings.

Two commands control the speaker: SOUND and

Text continued on page 318

Text continued from page 310:

and it ran without modification on the TI. You'll encounter problems, however, if the program involves graphics or other hardware-dependent routines. The commands may look the same, but they don't always have the same range of parameters. See the text box on page 310 for software bugs and documentation deficiencies that have been repaired in version 1.2.

TI's BASIC contains some interesting enhancements. For example, when you first invoke IBM's BASIC, you are constrained by 128-byte random disk-file buffers and a maximum of three open files unless you specify switches /S: and /F:, respectively. TI's BASIC handles this dynamically, accepting file records of any size, and as many as 255 files open simultaneously without the need to specify this when invoking the language.

TI's version of MS-BASIC contains an editor similar to that in IBM's BASIC. Microsoft has produced one of the nicest BASIC editors I've seen. You don't even have to go into an edit mode to use it. For example, you've listed 10 lines of code you just wrote and notice that on one line you entered "THE" instead of "THEN." Just place the cursor after the E in "THE," tap the Insert key, type an N, and press Return. You've just corrected the line.

The editing features don't end there. Suppose, for in-

One of Japan's leaders would like to go to work for you.



Fujitsu, Japan's largest computer company, sends you their best. The new Micro 16s personal business computer. A combination of thoughtful planning, innovative thinking and quality craftsmanship. Just what you'd expect from a Japanese company that's been making computers for three decades.

The Micro 16s is a complete computer system. The options of other computers are our standards. For example, its price includes the CP/M-86[®] operating system, SuperCalc^{2™} electronic spreadsheet, WordStar[®] word processing, a high resolution color graphics monitor, and two microprocessors, the Z80[®]A 8-bit and 8086 16-bit.

The Micro 16s will run any of the more than 3,000 CP/M[®] software programs on the market today. Optional operating systems for the Micro 16s include MS[™]DOS and the

multi-tasking Concurrent CP/M-86[™]

The Micro 16s also comes with a detachable keyboard, dual built-in 5¼" floppy disk drives, 128 kilobytes of internal memory expandable to over one megabyte, and expansion slots for future growth.

The unique and flexible design of the Micro 16s makes it easy to add advanced microprocessors of tomorrow, hard disks, mainframe communications or local area networking when the time is right.

Put a Japanese leader to work for you. Fujitsu's Micro 16s. For more information or the name of your nearest dealer call toll free 1-800-MICRO 16. Or write Fujitsu Microelectronics, Inc., Professional Microsystems Division, 3320 Scott Blvd., Santa Clara, CA 95051.

FUJITSU

Fujitsu's Micro 16s.™

SuperCalc^{2™} is a trademark of Sorcim Corp. WordStar[®] is a trademark of MicroPro International. CP/M-86[®] and Concurrent CP/M-86[™] are trademarks of Digital Research, Inc. MS[™] is a trademark of Microsoft[®]. Z80[®] is a trademark of Zilog, Inc.

In Less Than 3 Minutes

Your IBM Model 50, 60, 65, 75, or 85
Electronic Typewriter
can be an RS232C PRINTER or TERMINAL



CALIFORNIA MICRO COMPUTER Models 5060 and 5061 can be installed easily and require NO modifications to the typewriter.

For additional information contact:

CALIFORNIA MICRO COMPUTER
17791 Jamestown Lane Huntington Beach, CA
92647 (714) 848-3947

COMING SOON TO A DEALER NEAR YOU!

CONTROL/NET (A TRUE STORY)



"A BRILLIANT DEBUT PERFORMANCE"

STARRING—The Control/Net as itself (1 to 10 users, 12.7 MB hard disk (20 & 40 MB OPT.) TurboDOS™ driven, S100 bus)

CO-STARRING—Select Wordprocessing™, SuperCalc™ & Tabsoft™ 7 module accounting package.

SPECIAL GUEST ... YOU (the Businessperson) in one week of training near Orlando, Florida (home of Walt Disney World & EPCOT center).

All of this for only \$58. per week!

SUPPORTING ROLE played by General Electric's Nationwide optional service contract.



707 NICOLET AVE., WINTER PARK, FLORIDA 32789 (305) 628-3850

TurboDOS is a trademark of Software 2000. SuperCalc is a trademark of Sorcim, Inc. Select is a trademark of Select Information

Listing 1: The standard BYTE benchmarks used in this review.

LISTING 1A

```
60 A=2.71828
80 B=3.14159
100 FOR I=1 TO 5000
320 NEXT I
```

LISTING 1B

```
60 A=2.71828
80 B=3.14159
100 FOR I=1 TO 5000
120 C=A/B
320 NEXT I
```

LISTING 1C

```
60 A=2.71828
80 B=3.14159
100 FOR I=1 TO 5000
120 GOSUB 1000
320 NEXT I
340 END
1000 RETURN
```

LISTING 1D

```
80 A$="abcdefghijklm"
100 FOR I=1 TO 5000
120 B$=MID$(A$,6,6)
320 NEXT I
```

LISTING 1E

```
10 SIZE=7000
20 DIM FLAGS(7001)
30 PRINT"only 1 iteration"
40 COUNT=0
50 FOR I=1 TO SIZE
60 FLAGS(I)=1
70 NEXT I
80 FOR I=0 TO SIZE
90 IF FLAGS(I)=0 THEN 170
100 PRIME=I+I+3
110 K=I+PRIME
120 IF KSIZE THEN 160
130 FLAGS(K)=0
140 K=K+PRIME
150 GOTO 120
160 COUNT=COUNT+1
170 NEXT I
180 PRINT COUNT," primes"
```

LISTING 1F

```
10 CLEAR 1000
40 A$="12345678123456781234567812345678"
60 B$=A$+A$+A$+A$
80 NR=500
100 OPEN "R", #1, "TEST"
120 FIELD #1, 128 AS Z$
140 FOR I=1 TO NR
160 LSET Z$=B$
180 PUT #1, I
200 NEXT I
220 CLOSE #1
240 PRINT "DONE"
```

Listing 1 continued on page 318

For people who want power.



And something more.



If you are seeking power in software we believe we have created the program you seek.

And our opinion is shared by a great many computer analysts who consider 1-2-3™ from Lotus® the most productive program in the marketplace.

Like many great ideas the essence of its success is its simplicity. With 1-2-3, you have spreadsheet, information management and graphic functions—all in one program.

You can switch from one function to another with the touch of a key, instantaneously. Although it seems faster.

In effect, it's a perfect combination of raw power and spectacular speed.

But for those who want more, 1-2-3 is specially designed so you can develop customized applications for your business needs. And the world's largest electronic spreadsheet has enough operators, functions and commands to perform virtually any task you ask of it.

In fact, the only limit is your imagination. 1-2-3 from Lotus is power and something more.

Call 1-800-343-5414 (In Massachusetts call 617-492-7870) and find out more about 1-2-3 from Lotus.

Lotus

The hardest working software in the world.

Circle 269 on inquiry card.

1-2-3 and Lotus are trademarks of Lotus Development Corporation. All rights reserved.

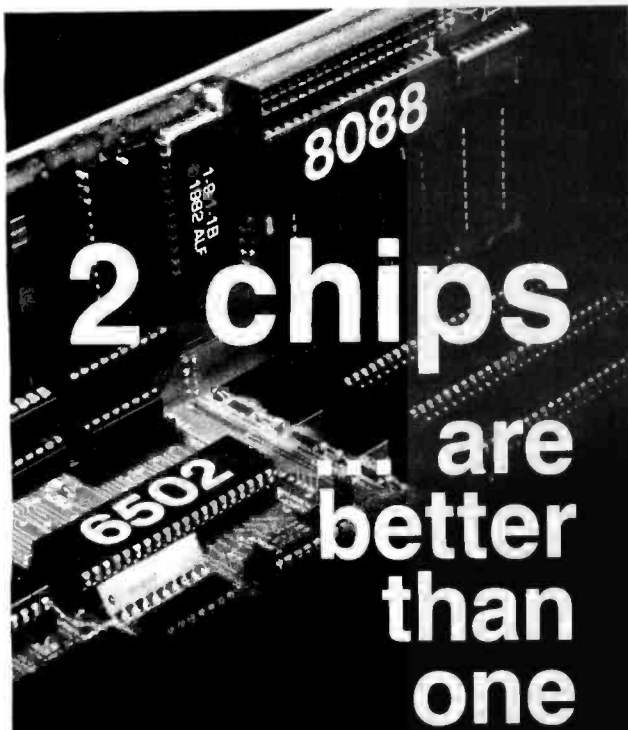

Is your Apple's 6502 processor chip a little overworked lately? Have you been eyeing one of those new, 16-bit systems? But you don't want to give up all your Apple programs ...

Add the powerful 16-bit 8088 processor to your Apple with ALF's Processor Card. Let the 6502 and 8088 work together to tackle your toughest problems—like speeding up your Applesoft and Apple Pascal programs. With the Processor Card, you can use the CP/M™ 86 or MS-DOS™ operating system to run the latest 16-bit software, including many IBM PC programs.

64K or 128K of high-speed memory is available for ALF's Processor Card. Use the Processor Card with 128K as a fast disk emulator or to view sixteen hi-res images in under a second. Or run Basic, C, COBOL, or Pascal with 16-bit performance!

The ALF Processor Card is just \$395 (Applesoft speed-up software included). See your Apple dealer today, or contact ALF for more information.

Trademarks: "Apple"; Apple Computer, "CP/M"; Digital Research, "MS-DOS"; Microsoft.

ALF

ALF Products Inc.
1315F Nelson St. Denver, CO 80215
(303) 234 0871 Telex: 4991824

Listing 1 continued:

LISTING 1G

```
10 CLEAR 1000
80 NR=500
100 OPEN "R", #1, "TEST"
120 FIELD #1, 128 AS Z$
140 FOR I=NR TO 1 STEP -1
160 GET #1, I
200 NEXT I
220 CLOSE #1
240 PRINT "DONE"
```

Text continued from page 314:

PLAY. SOUND takes a pitch and duration for its arguments and produces a single note. PLAY is to sound what DRAW is to graphics. With the PLAY command you can create a string of macro commands and then execute it. Notes can be normal ($\frac{7}{8}$ of the note time), staccato ($\frac{3}{4}$ of the note time), or legato (the whole note time), so that one note blends into the next. Octave and tempo can be changed, and pauses can be inserted. As with the DRAW command, a macro command is provided that will execute a substring. Here the notion of a substring is more apropos, being analogous to a repeating musical phrase.

The PLAY command provides another interesting macro command. The notes produced by the other macro commands can play in either foreground or background mode. When notes play in foreground mode, program execution pauses until all notes have been played. In background mode, however, the contents of the PLAY command are placed in a buffer and the notes play while the rest of the program continues. This command also affects the SOUND command. With a command like SOUND 1000,10 in a program, all activity ceases until that long note stops if you are in foreground mode. But background mode lets the program continue while the note plays at the same time. Combining graphics with background-mode music produces some remarkable results. Alas, it's still impossible to reproduce that total effect in a magazine.

TI's BASIC versus IBM's

Compatibility always looms as an issue with BASIC, especially when you have two versions of the same BASIC. TI's BASIC was, in fact, adapted from IBM's. How compatible are the two BASICS? In a word, very.

The new BASIC 1.2 manual contains one section that points out the differences between TI's BASIC and IBM's (and, of course, how TI's is better). Using this information, it would not be too difficult a task to convert any IBM BASIC program to TI BASIC and vice versa.

The major differences occur in commands affecting the display; differences in the hardware of the two machines become evident after looking at the commands. The IBM PC has a text mode and two graphics modes (medium and high), and the TI Professional Computer has a mixed text and high-resolution graphics mode only. And so TI's BASIC has no need for the SCREEN statement (the SCREEN command is the same). The structure of the COLOR command differs for the same reason; the

Release Your Potential



With the p-System™ from



For: IBM PC & XT CORONA COLUMBIA EAGLE COMPAQ COLBY DOT HYPERION

Do you feel stifled by your operating system? The p-System from NCI will release you. It is the complete program development environment for the IBM Personal Computer and compatibles. This is the fast p-System with the special p-machine emulator developed by NCI.

The p-System from NCI gives you everything you need in one system at far less than the cost to add similar utilities to any other OS. It includes a powerful screen editor, a multi-function file manager and RAMdisk support for fast access to files. Dynamic memory allocation lets you create programs larger than 64K and a print buffer frees your

computer to perform other tasks while printing.

This operating system is stable, friendly and easy to use. Command options are presented on a menu requiring only a single keystroke. The 8087 Numeric Coprocessor Support allows extremely fast floating point calculations and the asynchronous I/O lets you use serial printer and communications routines.

With the p-System you can choose either UCSD Pascal, Fortran 77 or Basic as your programming language. NCI also offers hard disk support for the IBM XT, Corona, Columbia, Corvus, Tallgrass, Davong, Genie 5+5, QCS, Datamac,

Microdisk and Santa Clara. Corvus OMNINET support can easily be added as well as memory cards from AST Research and Tall Tree Systems, the Colorplus card and the Hercules graphics card.

When you buy the p-System from NCI you get technical support and complete documentation.

For full details call or write:

Network Consulting Inc.
Discovery Park,
Suite 110 - 3700 Gilmore Way
Burnaby, B.C. Canada V5G 4M1
(604) 430-3466

SPEED. PORTABILITY. RELIABILITY.

Personal Computer and IBM Personal Computer XT are trade marks of International Business Machines Corporation. The p-System™ is a trade mark of Softech Microsystems, Inc. UCSD Pascal is a trade mark of the Regents of the University of California. DMNINET is a trade mark of Corvus Systems Inc. 5+5 is a trade mark of Genie Computer Corporation. Colorplus is a trade mark of Frederick Electronics.

www.americanradiohistory.com

TI has only one mode and only eight colors. The IBM and the TI PSET and PRESET statements are identical except that the higher resolution on the TI requires the parameter range to differ. TI BASIC also has a PSET STEP variation that defines the coordinates as an offset from the previous PSET statement instead of in absolute terms. TI's CLS (clear screen) function allows you to clear text only, graphics only, or both. IBM's and TI's POINT, LINE, CIRCLE, GET, PUT, PAINT, and DRAW functions are all identical except, again, for the parameter ranges. TI's BASIC also includes PALETTE and PALETTE USING statements but not the STICK function.

TI's BASIC version 1.2 and the new manual should be available by the time you read this article.

Communications

Along with the internal 300/1200-bps modem, the review unit came with a software package called TTY Communications. This sophisticated package features programmable function keys, lets you send and receive data at speeds up to 9600 bps manually or remotely, attended or unattended, and provides automatic dialing and answering of the modem. The package works with the internal modem, an external modem connected to the synchronous/asynchronous board, or a direct computer-to-computer link through the synchronous/asynchronous board. I found it fairly easy to use once I got past the documentation.

You begin by setting up the communications parameters for a particular communications link. These parameters are stored in a file to be called in as needed. Usually, you maintain a separate parameter file for each type of communications link. For instance, I created one parameter file for calls to The Source, another for remote sending and receiving of files from my office computer, and another that enabled me to automatically upload this text from the Model 100 into the Professional Computer.

The first of five parameter menus lets you set the port assignment, data rate, stop bits, parity, tone or pulse dialing, automatic or manual dialing, and a phone number.

The second menu enables you to define an *answerback message* (ABM). An answerback message is a string of characters sent to a remote computer to help identify who you are. You can designate that this message (if any) be sent either when answering a call or originating a call or both. You can even secure the ABM so that it won't be displayed on the local console.

Next, you can define what the TI computer will send as a *new-line* character (or characters) and what it will interpret as a new-line character in the incoming data stream. This can get confusing until you realize that, internally, the Professional Computer uses a carriage return/linefeed pair as a new-line sequence. If you define the incoming new-line sequence as a carriage return/linefeed, you'll wind up with double-spaced text on screen because the TI computer executes the incoming new-line sequence before its own. Instead, you need to define the incoming new-line sequence as only a carriage return and filter out all incoming linefeeds. It took me a while

to figure out why everything was double-spaced when connected to The Source.

You can specify whether the computer responds to remote commands and performs handshaking, such as XON/XOFF. And you can disable the keyboard so that a cat's march across the unattended keyboard will not have serious effects. Finally, for this menu at least, you can designate two batch files: one is executed upon a normal disconnect, the other is executed upon an abnormal disconnect.

The third menu lets you define the method of handshaking (XON/XOFF, reverse channel, or none), a maximum inactivity time before hanging up, an error limit, the method of disconnection (an EOT (end of transmission) character or an EOT-DLE (data-link enable) character pair), and whether transmitted data, received data, or both should be displayed on the local console.

The fourth menu defines the 12 programmable function keys. Each key may contain up to 32 characters, including control characters. A carriage return, for example, is depicted as <CR> and counts as four characters.

The fifth and final menu enables automatic replacement of any character transmitted or received with another character or no character. Only single characters can be searched for and only a single character can be used as a replacement. This is the menu I used to filter out the code for linefeeds (i.e., replace them with nothing).

All of the menus are extremely easy to use. Good use has been made of color and highlighting, and most parameters can be changed by using only the cursor keys. Once you understand the parameters, it shouldn't take more than a couple of minutes to configure a new parameter file. Table 5 summarizes all the parameters, their range of values, and their default values.

After the parameters have been established, the operation of the program is straightforward. When I want to call The Source, I enter the command COMTTY SOURCE.PRM from the MS-DOS prompt. This loads the communications software and the parameter file, which then waits for a dial tone, dials the phone according to the number in the file, waits for a carrier, connects, and drops me into terminal mode. While this is going on, the program keeps me informed of its activities on a status screen that disappears as soon as a valid carrier is detected. I can then log in and enter my password by pressing Shift-F1, Shift-F2, as these two function keys were programmed into the parameter file.

Auto-dialing can be used with both TI's own internal modem and with the Hayes Smartmodem.

While in terminal mode, a key label line displays your options. Function keys control everything in this program, and in this case I must admit that they make life easy. In terminal mode you can also perform a number of file-related activities. Of course, you can upload and download files and view the directory (interestingly, this command asks "which directory?"), view the contents of files, rename files, delete files, print files, and create an empty file. At every point along the way, pressing

Look, Ma, no hands!



If you don't type, you've probably longed for the day when you could simply talk to your computer. It's here.

Your voice can set you free.

With the Voice Input Module from VMC, you can "train" your Apple II, IIe,[®] or Franklin[®] to perform as many as 80 different spoken commands, in unlimited subsets, with near-perfect recognition.

So where you used to type `"/P return - " ^ CO return N39 return"` you can just say "print." **Command performance.**

The Voice Input Module works parallel to the keyboard with all existing applications software. So you can type if you need to, or do anything from electronic spread sheets to word processing to games with voice control alone. Either way, you'll

increase your productivity and have fun doing it.

Demand a demonstration.

You won't believe it until you see it. So see the Voice Input Module at your nearby computer store today.

And find out how little you'll miss typing.

Apple II and IIe are registered trademarks of Apple Computer, Inc. ■ Franklin is a registered trademark of Franklin Computer, Inc.

VIM

YOUR VOICE CAN SET YOU FREE.

VOICE MACHINE COMMUNICATIONS



COMDEX[™]

See us at Comdex booth 4544.

1000 South Grand Avenue ■ Santa Ana, California 92705 ■ Telephone (714) 541-0454 for the dealer nearest you.

Parameters	Range	Default
Port	1,2,3	1
Speed	110, 300, 1200, 2400, 4800, 9600, auto	300
Stop bits	1,2	1
Parity	odd, even, mark, space, None	even
Check parity	on, off	off
Display of transmitted data	on, off	off
Display of received data	on, off	on
Busy handling	DC1-DC3*, reverse channel, None	None
Busy sense	0,1	0
ABM**	0-32 character string	none
Call answer ABM	on, off	off
Call origination ABM	on, off	off
Secured ABM	on, off	off
Keyboard	on, off	on
Dialing mode	pulse, tone	tone
Dialing procedure	manual, automatic	automatic
Error limit	0-999 errors	0
Programmable keys	0-32 character string	none
Mapped characters	characters mapped	none
Transmit new line	0-10 character string	return, linefeed
Receive new line	0-2 character string	return, linefeed
Phone number	0-32 digits and separators	none
Normal disconnect batch file	(filename)	none
Abnormal disconnect batch file	(filename)	none
Inactivity time-out	0-999	0
Failsafe disconnects	on, off	on
DLE-EOT disconnect***	on, off	off
EOT disconnect	on, off	off
Print completions	on, off	off
Remote commands	on, off	on
Remote device control	on, off	on

* DC1 is the Control-Q or XOFF character; DC3 is the Control-S or XON character.
** ABM is the answer-back message.
*** DLE is the ASCII "data-link escape" character; EOT is the ASCII "end-of-transmission" character.

Table 5: TI's TTY Communications package allows the user to control a broad range of communications parameters. Note that the Busy-handling parameter's default is "None," while those parameters with no default are indicated by "none."

F1 brings up a Help screen.

The remote-command capability deserves some mention. By enabling the remote-commands parameter, a remote computer can control the sending and receiving of files, as well as creating, renaming, and deleting files. The remote computer simply sends an escape character followed immediately by a 0 and a series of commands. For example, the following command line from a remote computer sets up the TI Professional Computer to receive a file named TEST.DOC:

```
<ESC>
0REC FIL=TEST.DOC<NL>
```

in which <NL> is the recognized received new-line character sequence. Although only the first three letters of a command are necessary, you must specify the full filename.

From a personal-computer user's point of view, the TI Professional still lacks a few things. When you upload

files from this computer, your only protocol option is XON/XOFF. No provision exists for character echo or line-at-a-time transmission. Also, the system doesn't provide for any kind of block transmission with error checking and retransmission upon detection (à la Ward Christiansen). This wouldn't be so bad if you could exit from this program and call up MODEM7, but an exit causes the modem to disconnect.

The remote access of the TI computer is somewhat disconcerting because the operation is performed totally blind. There is no echo of the commands you enter, and, believe it or not, you cannot call up the Professional Computer's directory from a remote computer. Therefore, you must know the exact name of the file you wish to download.

One major question—how can a company produce such a beautiful piece of communications software and then render it practically useless with such an awful manual? I worked extensively with this program, includ-

Do You Run Your Business OR DOES IT RUN YOU?

The biggest headache you may be facing these days is getting better control of your business. Tracking unpaid bills, sending out second billings, monitoring which salesman sold how much and to whom, keeping track of inventories, and on and on.

There's a remedy. It's called VersaForm... the business database.

VersaForm is a powerful database designed specifically for business, but based on the simplicity and convenience of your familiar business forms.

If you can fill out a business form, you can create a database.

VersaForm starts with your existing forms and procedures. As you copy your forms onto the screen, VersaForm automatically creates a database for you. It records and saves information from Purchase Orders, Invoices, Job Estimates, Disbursement Ledgers... maybe even a few things you're not recording that you should be.

VersaForm is an electronic file cabinet that will store all this information, yet have it at your fingertips when you need it! It's designed with a non-technical user in mind, so you can concentrate on streamlining your business with none of the usual database headaches.

Adapts to your business... your way.

With VersaForm you don't have to completely re-orient your staff. It fits right into the way you're doing business now. Only now your operations will be completed more efficiently and with electronic speed.

- *A doctor in Moulton, Texas, posts his patient billing and completes his medical insurance forms with VersaForm.*
- *A small college in Wheaton, Maryland, uses VersaForm to create tuition invoices, class lists, accounts*

receivable, and accounts payable.
 • *A computer supplies company in Mountain View, California, writes payables checks and does expense distribution with VersaForm.*

VersaForm has the power to do these jobs and more because it's designed especially for business. It can also calculate taxes and prices, and can look up discounts, so you don't have to. VersaForm will even print on your own pre-printed forms.

Pull information together fast.

Pulling information together from paper files can be time-consuming and frustrating. Why make it tough? VersaForm puts vital reports like sales analyses, overdue payables, open purchase orders, and alphabetical employee lists at your fingertips. Minimum effort, maximum results.

All in one easy-to-use, integrated package.

VersaForm provides a screen formatter, a data entry program, a database, a report generator and a forms printer. And you can purchase pre-designed Templates for standard jobs like Purchasing, Invoicing, and Expense Journals. VersaForm is the all-in-one business productivity tool. Ask for a demonstration at your computer dealer. Or contact us directly.



- *A roofing company in Green Bay, Wisconsin, computes job estimates, contracts, invoicing, and tracks actual costs with VersaForm.*
- *A manufacturer in Beaver Falls, Pennsylvania, uses VersaForm to build his company's parts records, and generates "where-used" lists.*

VersaForm™



New! IBM PC/XT Release
 • DOS Files
 • Hard Disk Support

If you want to know more, send in this coupon. We've got a lot to tell you about.

Name _____

Company _____

Address _____

City _____ State _____ Zip _____

Type of Business _____

Mail to: Applied Software Technology
 170 Knowles Drive
 Los Gatos, California 95030
 (408) 370-2662

142-E

For use with the Apple II, IIe and III, and the IBM PC and compatibles.

EXPOTEK

2723 W. Windrose
Phoenix, Arizona 85029

1-800-528-8960

Guaranteed Low Prices

AT&T Big Blue Hercules Microsoft Maynard	IBM CALL SAVE \$ Persyst Profitsystems Quadram StB Tall tree	MONITORS Taxon PGS USI
--	--	--

for the IBM

TANDON 100 2DD	\$245
QUADRAMCARDS	CALL
16K RAM CHIPS	
SET OF 9	\$15.75
64K MEM/UPGRADE	\$65
SOFTWARE	CALL

COMPUTERS ALTOS

580-10	\$3500
586-10	\$5498
586-14	\$7680
8600-12	\$8399

ATARI SAVE \$ CALL NORTHSTAR

ADVANTAGE	\$2150
W/15MB	\$4310

TELEVIDEO

802	\$2515
802H	\$4449
803	\$1769
1603	\$2019

TERMINALS

ADDS

VIEWPOINT A1	\$485
VIEWPOINT A2	\$550

HAZELTINE

ESPRIT I	\$498
ESPRIT II	\$540

TELEVIDEO

910	\$555
925	\$699
950	\$865
970	\$975

DISKDRIVES

FOR APPLE	
MICRO SCI A2	\$235
RANA ELITE I	\$249
RANA ELITE III	\$540
FOR ATARI	
RANA 1000	\$375

ALL PRICES SUBJECT TO CHANGE
CUSTOMER SERVICE (602) 863-0759

PRINTERS

CITOH

F 1040	\$1090
F 1055	\$1499
1550P	\$599
8510P	\$345

SILVEREED SAVE \$ CALL DATASOUTH

DS120	\$595
DS180	\$1155

DIABLO

620	\$875
630RO	\$1699

NEC

3510	\$1365
3550	\$1705
7710	\$1900
8023	\$399

OKIDATA SAVE \$ CALL

MONITORS

AMDEK

300 GREEN	\$129
300 AMBER	\$145
310 AMBER (IBM)	\$199
COLOR I	\$275

BMC

GREEN	\$88
COLOR	\$299

APPLECARDS

16K RAM	\$69
Z80	\$235
VIDEX 80 COLUMN	\$199
VIEWMAX 80	\$175
MICROSOFT PREM. PK	\$465

DISKETTES

ELEPHANT SS/SD	\$18.00 BX
SCOTCH SS/DD	\$22.00 BX
DYSAN SS/SD	\$33.00 BX
(100 MIN. ON DISKS)	

ing several remote operations, and I'm still not sure how to use it to its fullest capacity. The section on remote commands is practically useless. Essentially it merely presents the commands; you must figure out how they're used. And the descriptions of some of the communications parameters are sparse, too.

Conclusions

After using the TI Professional Computer extensively for about five weeks, I have little doubt that it is superior to the IBM PC, both physically and electronically. The case is made of a heavier-gauge metal, the cover of the system unit detaches much more easily, the keyboard is of better quality and design, the display has a higher resolution, and thought has been given to preserving expansion slots for real peripherals. The system upgrades from a single floppy-disk drive to a 10-mega-byte Winchester, and support is provided for high-density (96 tracks per inch) drives. You can increase memory from 64 to 748K bytes. The capability to produce color text is standard; with the optional graphics board, you can mix text and graphics on the same display. The interrupt structure is flexible, and the manufacturer supports the 8087 coprocessor option. Most of the major software packages have been adapted to run on this machine, including Lotus Development Corporation's 1-2-3 (which performs superbly on the TI because of its higher resolution and combined text and graphics).

But this machine is not for a novice; most of the manuals don't contain hand-holding tutorials. In some, you'll be lucky to find what you need. A helpful dealer who gets you started with this machine is vital. And remember, third-party hardware support is not nearly as robust as it is for the IBM PC. Tecmar Inc. (23600 Mercantile Rd., Cleveland, OH 44122), however, claims that it will offer TI-compatible versions of its IBM PC boards.

So what does this mean for the purchaser of a TI Professional Computer? For now, you'll get most of your peripherals from TI, and you're limited to what they offer. However, TI plans to introduce the much-discussed voice system, a combination speech-digitizing, store, and forward system capable of serving as a kind of high-class phone-answering machine that will also be capable of speech recognition. A 512K-byte memory board that will increase the total system RAM to 768K bytes is due by year end. An analog/clock card has been designed and documented in the technical manual, but no release date is available. This card will support two joysticks, four paddles, switches, and a light pen, in addition to a clock/calendar.

With a lot of hard work and a little luck, TI has a chance to capture a significant portion of the high-end personal-computer market. Although its computer may appear to be just another IBM clone, a closer look reveals a machine that is superior in many ways. It definitely invites a closer look. ■

Mark Haas is technical director at Osborne/McGraw-Hill (2600 Tenth St., Berkeley, CA 94710).

computers wholesale

315-472-3055

Box 150 Brewerton, N.Y. 13029

Circle 115 on inquiry card.

-TERMINALS-

ESPRIT	
Esprit.....	\$489
Esprit II.....	499
Esprit III.....	715
Esprit III (Color).....	Call
LEAR SEIGLER	
ADM 3A.....	529
ADM II.....	539
ADM 22.....	589
ADM 38.....	979
QUME	
102.....	555
102A (Amber).....	569
108.....	715
108A (Amber).....	729
TELEVIDEO	
910.....	439
914.....	579
924.....	695
950.....	859
970.....	929
WYSE	
50.....	Call
300 (Color).....	Call
ZENITH	
Z-29.....	649
ZT-10.....	399
ZT-11.....	459

-MODEMS-

HAYES	
Micro Modem 100.....	289
Micro Modem II.....	239
Smartmodem 300.....	199
Smartmodem 1200.....	498
Smartmodem 1200B.....	Call
NOVATION	
D-Cat.....	149
J-Cat.....	105
Apple Cat II.....	259
103 Smart Cat.....	179
103/212 Smart Cat.....	419
212 Auto Cat.....	549
SIGNALMAN	
Mk I.....	\$ 79
Mk III.....	99
Mk V.....	89
NEW! Volkmodem.....	Call
Mk VII.....	\$109
Mk II.....	79
Mk VI.....	Call
U.S. ROBOTICS	
Auto Dial 212A.....	339
Password.....	339

Advertised prices reflect a cash discount on prepaid orders only. Most items are in stock for immediate delivery in factory sealed cartons with full factory warranties.

-SYSTEMS-

ALTO	
ACS-8000-10.....	\$5889
ACS-8000-12.....	8995
ACS-8000-14.....	8789
Series 5-5D.....	3990
Series 5-15D.....	2199
580-10.....	3995
586-10.....	5995
588-40.....	8795
MTU-4.....	2395
Altos II Terminal.....	849
COLUMBIA	
VP Portable.....	Call
MPC.....	Call
MPC w/Hard Disk.....	Call
CROMEMCO	
C-10 Super Pak.....	1429
C10MP w/MicroPro software.....	1819
CS-1.....	3195
CS-2.....	3755
CS-3.....	5595
64 FDC.....	475
TUART.....	255
EAGLE (Eagle cannot be shipped UPS)	
II E Series	
II E-1.....	II E-2
II E-3.....	II E-4
PC Series	
PC-E.....	PC-1
PC-2.....	PC-XL
1600 Series	
1620.....	1630

—Call us today for the best prices—

INTERTEC	
Superbrain II JR.....	1859
Superbrain II QD.....	2309
Superbrain II SD.....	2809
Compustar.....	Call
MORROW	
Micro Decision	
MD-2 w/2 drives & software.....	929
MD-3 w/DS drives & software.....	1199
MD-11 w/HD & software.....	1949
NEC	
PC-8801A Computer.....	Call
PC-8831A Dual 5 1/4" disk drive.....	Call
NORTHSTAR	
Advantage 2Q.....	Call
Advantage 1Q HD5.....	Call
Horizon 2Q 64K.....	2399
HD 18 Mb. hard disk.....	3879
SANYO	
.....	Call
TELEVIDEO	
TS-803.....	1989
Portable.....	Call
ZENITH	
ZF-100-21.....	2319
ZF-120-22.....	2869
ZF-120-32.....	4479

-PRINTERS-

ANADIX	
DP-9501.....	\$1099
DP-9620.....	1199
DP-9625.....	1299
DP-6500.....	2399
WP 6000.....	2159
CENTRONICS	
730-1 Parallel.....	200
739-3 Serial.....	469
COEX	
80 FT parallel.....	259
C.ITOH	
Prowriter 8510A Par.....	369
Prowriter 8510A Ser.....	569
Prowriter II Par.....	669
Prowriter II Ser.....	739
DIABLO	
620 RO 25 CPS.....	919
630 RO 40 CPS.....	1769
EPSON	
RX-80.....	Call
RX-80FT.....	Call
FX-80.....	Call
FX-100.....	Call
GEMINI	
10X.....	295
15X.....	435
MANNESMAN TALLEY	
MT-160 I.....	529
MT-160 L.....	599
MT-180 L.....	859
NEC	
3510.....	\$1445
3550.....	1845
7715.....	1949
8023.....	399
NEW NEC 2000.....	Call
OKIDATA	
ML-82A.....	379
ML-83A.....	579
ML-92 Par.....	449
ML-92 Ser.....	529
ML-93 Par.....	749
Pacemark 2350.....	Call
Pacemark 2410.....	Call
QUME	
Sprint 11/40.....	1299
Sprint 11/55.....	1499
SILVER REED	
EXP 500 Par.....	459
EXP 550 Par.....	659
EXP 550 Ser.....	689
TEXAS INSTRUMENTS	
TI-810 Basic.....	1199
TI-810 Package.....	1549
TI-810 LQ.....	1919
TI-820 Basic.....	1549
NEW TI-850.....	Call

-MONITORS-

AMDEK	
Color I.....	\$275
Color I+.....	319
Color II (RGB).....	399
Color III (RGB).....	349
300 G (12" green).....	135
300 A (12" amber).....	145
310 A (IBM PC).....	169
BMC	
15 MHZ (12" green).....	79
NEC	
JB-1260 (12" amber).....	109
JB-1201 (12" green).....	135
JC-1212 (12" color).....	339
JC-1203 (12" RGB).....	549
ZENITH	
Z-122 (12" green).....	109
Z-123 (12" amber).....	139
Z-131 (13" color + gr.).....	299
Z-135 (RGB).....	519

-HARD DISKS-

CORVUS	
Model 6.....	1869
Model 11.....	2549
Model 20.....	3399
Omnet 6.....	1695
Omnet 11.....	2375
Omnet 20.....	3225
Mirror Back-up.....	670
KONAN	
SPECIAL! 5Mb. for S-100.....	1429

3M/ Scotch

5 1/4" . . . \$21.95

(Single Sided, Double Density)

5 1/4" . . . \$30.95

(Double Sided, Double Density)

Call us for the lowest prices on other popular diskettes!

If you can't find what you need listed here, just call for the best prices on the items you require.

N.Y. residents, add appropriate sales tax. We accept VISA and Master Card. Personal and company checks, allow 2 weeks to clear. C.O.D.'s require a 25% deposit. All prices and offers may be withdrawn without notice.

We think you're calculating enough to

And we've devised a little test to prove it. All you have to do is compare our PC-8200's specs with the specs for Radio Shack's Model 100 or the HP-75. For someone who's savvy enough about computers to read this magazine, you shouldn't have any trouble picking the best one. So here goes:

	NEC	Radio Shack	Hewlett-Packard
Price	\$799*	\$799	\$995
RAM/ROM	16K/32K	8K/32K	16K/48K
RAM Expandability (Internal/External)	To 96K (64K/32K)	To 32K (32K/none)	To 24K (24K/none)
Free bundled software	Yes	No	No
Function keys	10	8	0
RAM cartridges	Yes	No	No
Bar Code Reader, RS232, Parallel Port, Cassette Port	Yes	Yes	Not Standard
Floppy Disk and SIO Port, Cursor Cluster	Yes	No	Not Standard

*Includes perpetual clock calendar. NiCad battery pack, AC adapter charger optional. The PC-8200 is a battery-operated CMOS-based system.

It all boils down to more power and better features for the same price. And, of course, more software—14 FREE programs to start, including linear forecasting and word processing.

The PC-8200 portable from NEC. We think you should be impressed. If you're not, maybe you picked up the wrong magazine.

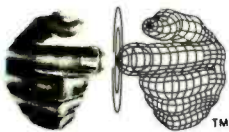

Productivity at your fingertips

NEC

NEC Home Electronics (U.S.A), Inc.
Personal Computer Division
 1401 Estes Avenue
 Elk Grove Village, IL 60007

NEC Corporation, Tokyo, Japan

Circle 310 on inquiry card.

get more computer for your money.



Unit shown actual size.

ARCADE
EXCITEMENT
FOR APPLE COMPUTERS

SuperSprite

Programmable
sprites of 256 hues
with sound
and speech

Transfer graphics and
animations to the
screen with a single
press of the keyboard



Revolutionary

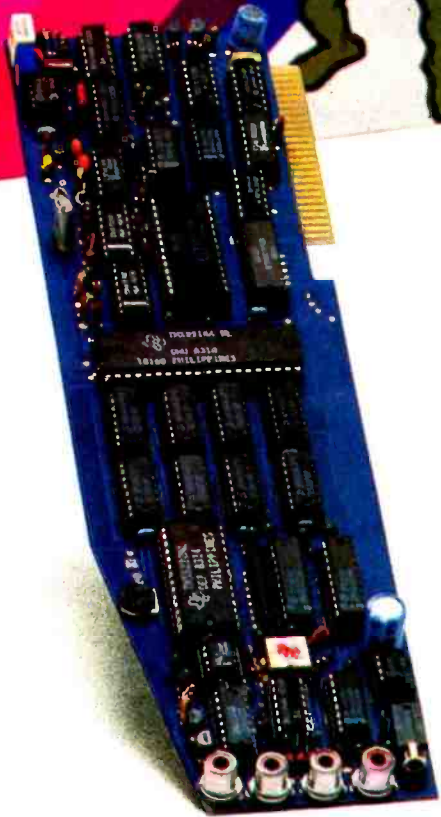

Sprite Graphics for Apple™ Computers

3 exciting ways to enter a new galaxy of action and adventure

SPRITE I™

Fast action animation. Smooth and flicker-free. Software included easily lets you create and move sprites and lets you paint colorful backgrounds. Enjoy unique multi-plane action where sprites move freely under and over each other. Sprite I plugs easily into any slot of your Apple computer to give you the excitement and quality of arcade graphics. **\$149.**

SPRITE II™

Add the dramatic dimension of realistic sound effects to all the action in Sprite I. Sound you can easily program yourself. Sound synchronized to the action on the screen. The Sprite II includes a sound generator that lets you create almost any imaginable effect—gunshots, explosions, music, the roar of an engine. **\$249.**

SUPERSPRITE™

The ultimate sprite package. Actual speech, thanks to the amazing ECHO II™ speech synthesizer. The ability to simultaneously join sprite graphics and Apple programs together on the screen. The STARSprite I™ diskette featuring the new Ampersprite language for creating and moving sprites, painting background scenes and programming sound effects. Yes, SuperSprite has it all. Sprites, sound, speech, software. **\$395.**

Call 800-426-7412 for your nearest dealer.

Circle 412 on inquiry card.



Synetix Inc.

10635 N.E. 38th Place
Kirkland, WA 98033
(206) 828-4884

™ Apple is a registered trademark of Apple Computer, Inc.
™ SuperSprite is a registered trademark of Syntex, Inc., 1983

™ Starsprite I is a registered trademark of Avant-Garde Creations, Inc.
™ Echo II is a registered trademark of Street Electronics Corp.

The ATR8000

This Z80 computer/peripheral enables Atari users to run CP/M-based programs

by Dave Small and Sandy Small

Capable of serving as an intelligent peripheral or as a stand-alone computer, the ATR8000 should prove to be of interest to Atari users because it enables them to access CP/M-based applications programs. It should also prove of interest to anyone looking for a machine that can run CP/M-80, CP/M-86, or MS-DOS.

The ATR8000, manufactured by SWP (formerly Software Publishers Inc.), owes its potentially wide appeal to its availability in four configurations. The lowest-priced version (\$350) employs 16K bytes of RAM (random-access read/write memory), 4K bytes of ROM (read-only memory), and a Z80 processor. Intended to serve as an Atari peripheral, this model can readily interface Atari computers with a host of additional peripherals, including standard-bus disk drives and devices with Centronics parallel or RS-232C serial ports. When used to interface a printer to an Atari, the ATR8000 allocates a 12K-byte buffer for printer-spooling operation.

(1a)



The intermediate and two top-of-the-line configurations can serve as stand-alone computers. The stand-alone versions can interface with standard terminals such as those offered by Televideo Inc. or use an Atari computer as a terminal.

The intermediate configuration (\$550) includes a Z80 processor and 64K bytes of RAM, which makes it capable of running the CP/M 2.2 operating system configured for 60K bytes of RAM. When used as an Atari peripheral, this configuration's 64K-byte RAM can be used as an additional printer-spooler buffer area.

Each of the two top-of-the-line models (\$800 or \$1050 added to the \$550 price of the intermediate version) incorporates an 8088 16-bit processor and either 128K or 256K bytes of RAM in addition to the Z80 and 64K bytes of RAM; these configurations can run the MS-DOS and CP/M-86 operating systems, enabling the ATR8000 to handle software available for the IBM Personal Com-

(1b)



Photo 1: Front (a) and rear (b) views of the ATR8000. The rear connections shown in photo 1b are, from left to right, an RS-232C serial I/O port, a 34-pin floppy-disk connector, a 34-pin parallel printer port, and Atari serial I/O daisy-chain-out and -in connectors. A Reset button is located to the right of the daisy-chain connectors; the power connector is located directly below them.

puter. In these 8088-based configurations, the 128K or 256K bytes of RAM associated with the 8088 processor can serve as a disk emulator that can be accessed by the Z80 processor, resulting in extremely fast disk-type I/O (input/output).

The Atari Peripheral Configuration

As an Atari peripheral, the ATR8000 plugs into the serial bus that the Atari uses to communicate with I/O devices. The ATR8000 is thus daisy-chained onto this serial bus, as are all Atari peripherals. This Atari serial bus uses a nonstandard 19.2K-bits per second communications protocol. All Atari devices that use this serial bus require some sort of processor to decode or encode data out of or into this data format. For instance, Atari uses a 6507 microprocessor to perform this task in its disk drives and Model 850 interface.

Unfortunately, this added encoding/decoding-hardware requirement increases the cost of Atari peripherals. Eliminating this requirement, the ATR8000 interfaces the Atari serial bus to a number of standard peripherals. (The term "standard" here means the de facto pin-out standards that the peripheral industry has more or less adopted in the interest of compatibility.) Among the better known "standards" are the 25-pin RS-232C serial bus, the 36-pin Centronics-type parallel bus, and the 34-pin (5¼-inch) or 50-pin (8-inch) disk bus.

The first, most important peripheral is a disk drive. Up to four single- or double-sided, 8- or 5¼-inch, single- or double-density drives can be plugged into the ATR8000. Moreover, the ATR8000 permits several track formats. The range of possibilities is nearly endless, given today's drive market; the ATR8000 can use almost any drive that has the standard 34-pin bus connection used by Tandon, Shugart, MPI, and others. An adapter, available from SWP for \$19.95, interfaces the ATR8000 to units employing the 50-pin standard 8-inch drive connector used by Shugart, Siemens, and Qume.

The disk-interfacing capability alone makes the ATR8000 a good buy from the Atari owner's point of view; until now, standard disk drives, lacking the capability to decode the signals on the Atari serial bus, could not be connected to the Atari. Until recently, the only Atari-compatible drives available have been the Atari 810, a single-density unit, and a few similar drives. Because of the hardware needed for the Atari's bus, the 810 lists for \$599, which is quite steep for a 5¼-inch single-sided single-density drive.

The 810 also suffers from design and reliability problems. The first problem involves use of a serial bus to transfer data. Although the bus runs at 19,200 bits per second, the handshaking slows the effective data-transfer rate considerably. The serial bus is extremely quiet according to radio-frequency interference standards, but the data-transfer rate is four to eight times slower than that of other systems. There are also rpm-regulation and data-separation problems that reduce the 810's capability to read disks accurately.

Finally, the 810 is a single-density disk drive. As Atari and Osborne owners have discovered, the 90K-byte capacity of such drives doesn't allow much data storage, especially when compared to other double-density double-sided, 80-track drives that offer 160K to 500K bytes of storage.

A few manufacturers are marketing replacements for the 810. Other manufacturers offer disk-drive mechanisms and cases with much better reliability than the 810's mechanism. A 5¼-inch Tandon TM-100 drive with case and power supply sells for \$200 to \$250. Our experience indicates this is a very reliable drive; for instance, speed is regulated within 1 percent, a far cry from the 10 percent drift found in many Atari drives. But these "raw" drive mechanisms lack the circuitry to connect to the Atari serial bus. With the ATR8000, however, these standard drives can be driven from the Atari.

The ATR8000 offers many features in addition to disk-drive interfacing. First, it provides a Centronics parallel and an RS-232C serial port. Until now, Atari owners needing to interface to a parallel or serial device required an Atari 850 interface, which connects the Atari serial bus to these devices. The 850 retails for \$219.

Second, the ATR8000 printer port is buffered, which enables the Atari to dump data as fast as it can and go on to other things while the ATR8000 handles the printing operations. A typical 16K-byte buffer retails for \$149.

Third, the ATR8000 handles double-density disk storage of 180K bytes (assuming a single-sided 40-track drive), a significant increase over the 810's 90K bytes. Percom's dual-density disk drive for the Atari retails for \$699 (single-drive unit), or \$100 more than the Atari drive. Thus, for \$575 (\$350 for the ATR8000 and \$225 for a TM-100 disk drive with case) you're getting performance that would otherwise cost \$1067—\$699 for a Percom dual-density drive, \$149 for a 16K-byte buffer, and \$219 for a Model 850 interface.

The ATR8000 readily accommodates increases in disk-storage capacity. To upgrade to a two-drive system, for example, only a \$225 drive mechanism need be added to the ATR8000. For an Atari drive, a whole new drive plus a controller board must be added—a \$699 cost.

A New Operating System

One problem that arises when using the ATR8000 as an Atari peripheral is that the Atari's disk operating system (DOS) is not configured to handle more than 720 sectors per disk, although it can handle single- or double-density sectors (128/256-byte sector sizes). Consequently, a new operating system is needed to handle 8-inch or other high-capacity disks. SWP offers MYDOS, an operating system capable of handling these large-capacity drives. It should be noted that copy-protected Atari software and any software with a custom DOS will not take advantage of the added space of higher-capacity drives that the ATR8000 can use. But for applications that use a new DOS, the ATR8000 and MYDOS offer a helpful tool.

NEVADA BASIC™ ^{\$}29.95 each!

A POWERFUL INTERPRETER FOR CP/M.®

Use Nevada BASIC in business, engineering, science and education. Now with the New Nevada BASIC, you can easily develop and tailor programs on your micro for business, science and education. What's more, you can do it for about one-tenth the cost of comparable BASIC interpreters.

The one you've been waiting for! It has a beautiful built-in full-screen text editor (Professor Starkweather's) where the cursor moves freely about the screen to make additions, deletions and corrections. And it automatically generates new line numbers saving you valuable time. Whether you're a beginner or a pro, you will love this feature. But there's more than screen beauty, much more.

What you'll love most about Nevada BASIC is its friendly personality. For example, user-defined functions can be single-line or multi-line. And there are full matrix operations: matrix copy, matrix add, matrix subtract, matrix multiply, scalar operations on matrices, matrix transpose and matrix invert. For business there is a complete Formatted PRINT, IF ... THEN ... ELSE constructs, BCD Math (no round off errors), and much more.

Take Advantage of our money-back guarantee. If you are not completely satisfied—just return the package in good condition, with the sealed diskette unopened—within 30 days, and we will refund your money.

Get yours today! The diskette comes with a 210 page instructional manual.



SINCE 1977

ELLIS COMPUTING™

Also available:

NEVADA FORTRAN™	\$29.95
NEVADA PILOT™	\$29.95
NEVADA EDIT™	\$29.95
NEVADA COBOL™	\$29.95
COBOL APPLICATIONS PACKAGE BOOK 1	\$ 9.95

MAIL TODAY! TO: Ellis Computing, Inc.
3917 Noriega Street
San Francisco, CA 94122
(415) 753-0186

The CP/M® Operating System, a 8080/8085/ Z80 microprocessor, and 32K RAM are required.

Software Packages:

- COBOL FORTRAN PILOT EDIT BASIC
- Diskette Format: 8" SSSD (Standard IBM 3740 format)
5 1/4" Apple CP/M Xerox 820 SD Osborne SD
- Televideo Micropolis Mod II
 North Star DD North Star SD
 TRS-80 Mod I with CP/M @ 4200 hex TRS-80 Mod I/Mapper
 Heath Hard (Z-89) Heath Soft (Z-90)
 Superbrain DD DOS 3.X (512 Byte sectors)
 Kaypro DD DEC VT-180 Epson QX-10
 NEC PC 8001 Sanyo Access

Shipping/Handling Fees: Add \$4.00 for the first package and \$2.00 each additional package. OVERSEAS add \$15.00 for first package and \$5.00 each additional package. Checks must be in U.S. funds and drawn on a U.S. bank!

Send my order for _____ packages @ \$29.95 each Total _____

COBOL Applications package @ \$9.95 each Total _____

in CA add sales tax _____

Check enclosed Shipping/handling _____

MasterCard Visa Total _____

_____ Exp. Date _____

Signature _____

Ship to: Name _____

Street _____

City/State/Zip _____

CP/M is a registered trademark of Digital Research, Inc. TRS-80 is a registered trademark of Tandy Corp. Apple II is a trademark of Apple Computer, Inc. Osborne is a registered trademark of Osborne Computer Corp. Xerox 820 is a trademark of Xerox Corp. Kaypro is a trademark of Non-linear Sys. Heath/Zenith is a trademark of Heath Corp. IBM is a trademark of International Business Machines Corp. Nevada COBOL, Nevada FORTRAN, Nevada PILOT, Nevada EDIT and Ellis Computing are trademarks of Ellis Computing, Inc. © 1983 Ellis Computing, Inc.

How a fireman and a broken leg made software simple.



What does a fireman know about designing software? Nothing. Usually.

Meet Dennis Jarvis, a firefighter from Southern California. About five years ago he broke his leg in a fire-related accident and was confined to the house for about six months. To keep him occupied, Dennis' wife bought him a computer.

Dennis had never used a computer before. But he proved to be a natural.

Dennis was soon writing his own programs. And Basic Accounting from Firefighter was born.

It was brilliant.

And so simple, you don't have to know anything about accounting theory to use it.

But don't get the wrong idea. Just because it's simple, doesn't mean it's not smart, too.

Basic Accounting from Firefighter has so many more features and capabilities than the best selling accounting package, there's no room to list them in this ad. You'll just have to ask your dealer to show you.

Dennis? He returned to the Fire Department soon after his leg healed, but remains the spearhead of Firefighter Software.

In fact, in his never-ending efforts to make Firefighter the most personal, most supported software, Dennis has set up a telephone hotline to answer your questions and provide consultation. That's just Dennis' way of insuring Firefighter remains superior, always simpler yet smarter.

Hotline: (213) 991-8200

**FIREFIGHTER.
SIMPLER. SMARTER SOFTWARE.**



31245 La Baya Drive, Westlake Village, CA 91362

At a Glance

Name

ATR8000

Manufacturer

SWP (formerly Software Publishers Inc.)
2500 E. Randol Mill Rd., Suite 125
Arlington, TX 26011
(817) 469-1181

Size

11½ by 12½ by 2½ inches; 8 pounds

Features

As an Atari peripheral, the ATR8000 interfaces the Atari serial bus to devices with RS-232C serial or Centronics parallel ports as well as to disk drives with standard bus interfaces; this version includes 16K bytes of RAM. As a stand-alone computer, the ATR8000 comes in versions with 64K to 256K bytes of RAM; a Z80-based version runs CP/M-80; and an 8088-based add-on (Co-Power-88) enables the ATR8000 to run CP/M-86 and MS-DOS

Hardware required

Interface cabling and connectors, available from SWP or other distributors

Software required

Atari DOS to use the ATR8000 as a peripheral; CP/M-80, MS-DOS, or CP/M-86 are provided with ATR8000 configurations that support those operating systems

Documentation

73 pages

Options

16K-byte Z80-based version, \$349; 64K-byte Z80-based version, \$550; 128K-byte 8088-based add-on, \$799.95; 256K-byte 8088-based add-on, \$1049.95; both add-ons require the 64K-byte Z80-based version

Interfaces

The ATR8000 supplies Centronics and RS-232C interfaces for the Atari. Both are edge connections and accept the usual clamp-on ribbon connectors. The parallel connection runs via a flat ribbon cable to a standard 36-pin Centronics parallel-interface connector. The RS-232C connector comes out to a 26-pin edge connector that hooks via a flat ribbon cable to the popular DB-25 connector. The pin connections that have become standard for RS-232C data transmission are used: 2 and 3 for data, 4 and 5 for handshake, and so forth. If you need to swap the two pairs of lines, the ATR8000 provides an internal jumper header that allows you to change them easily.

We were pleasantly surprised to find that the ATR8000 worked the first time when connected directly to an Okidata Microline 84 (a parallel printer) and a Hayes Smartmodem (a serial device). The total interfacing took only 10 minutes, which were spent clamping connectors onto ribbon cable.

In its smallest configuration, the ATR8000 ranks as a "best buy" for Atari owners who want to expand their systems with disk drives, parallel printers, and serial RS-232C devices.

ORDER DESK ONLY
(800) 272-3360
 TOLL FREE IN CALIFORNIA

ORDER DESK ONLY
(800) 292-3360
 TOLL FREE OUTSIDE CALIF.

Christmas Sale

"WHY PAY MORE"

COMPARE THESE PRICES

MC-P APPLICATIONS

Brings Software & Hardware

At Unbeatable Prices

SOFTWARE

	LIST	OUR
APPLIED SOFTWARE TECHNOLOGY		
VersaForm	\$389	\$252
ASHTON TATE		
Financial Planner	700	452
BPI ACCOUNTING SYSTEMS		
GL/AP/AR (Each)	395	285
FOX & GELER Quick Code	295	187
HOWARD SOFT		
Real Estate Analyzer II	195	135
LATTICE C Compiler	700	435
LIFETREE Volkswriter	195	129
METASOFT Benchmark	499	375
MICROSTUFF Crosstalk	195	129
MICROPRO		
Word Star w/Applicard	495	349
MICROSOFT		
Flight Simulator (IBM)	50	35
Flight Simulator (Apple)		29
PBL CORPORATION		
Personal Investor	145	98
PEACHTREE		
Peach Pack (AR, AP, GL)	595	300
SATELLITE SOFTWARE		
Word Perfect	495	325
SOFTWARE PUBLISHING		
Pfs: File		
Apple	125	85
IBM	140	95
Pfs: Report	125	85
SOFTWORD SYSTEM		
Multimate	495	315
SORCIM SuperCalc II	295	185
SYNPSE File Manager	150	97
WOLF Move-It	199	125
VISICORP		
Visicalc	250	175
Visifile (Apple)	250	187
Visifile (IBM)	300	225
VisiSchedule	300	225
VisaWord w/free VisiSpell	375	285

— TOLL FREE —
 ORDER DESK ONLY

LOTUS 1-2-3
\$329⁰⁰

WORD STAR PRO
\$445⁰⁰

DBASE II
\$385⁰⁰

EDIX/WORDIX
\$129⁰⁰

MULTIPLAN
\$178⁰⁰

HOME ACCOUNTANT
\$ 52⁰⁰

BANK STREET WRITER
\$ 49⁰⁰

TANDON T100-2
\$235⁰⁰

OKIDATA 92
\$475⁰⁰

AMDEK COLOR II
 HI RES RGB
\$445⁰⁰

AST MEGA PLUS 64K
\$295⁰⁰

NOVATION J-CAT
\$115⁰⁰

EPSON FX 100
\$745⁰⁰

HERCULES GRAPHICS CD.
\$375⁰⁰

KOALA TOUCH PAD
\$ 95⁰⁰

HARDWARE

	LIST	OUR
HAYES MICROCOMPUTER PRODUCTS		
Hayes Stack Chronograph (RS-232)	\$249	185
Hayes Stack Smart Modem (RS-232)	289	219
Smart Modem 1200 (RS-232)	699	511
ADVANCED LOGIC SYSTEM (Apple II)		
Z-Card	169	115
Printer Mate (Parallel)	99	55
CP/M Card (W/ CP/M 3.0)	399	315
MICROSOFT		
Softcard (Apple)	345	259
Ram Card (Apple)	100	75
64K Ram Card (IBM)	350	249
MPC PERIPHERALS (Apple)		
Parallel Interface Card (w/Cable)	90	68
NOVATION		
Apple - Cat II	389	275
212 Auto Cat	695	595
Smart-Cat 103/121	595	445
Smart-Cat 103	249	187
PERSONAL COMPUTER PRODUCTS		
Applicard 6 Mhz	375	280
KRAFT & TG Joystick		
IBM	70	49
Apple	65	45
CDC DISK DRIVE		
265		
VERBATIM DISC		
S/S D/D 10 Pk.	49	28
AMDEK MAI BOARD	599	495
ELECTRONICS PROTECTION DEVICES		
Lime	90	63
Peach	98	69
QUADRAM		
Quadboard 64K	395	295
Quadlink	680	525
MEMORY CHIP SET		
(64K/9 chips)	95	55
PRINTERS		
Mennesman Tally MT 160L	798	669
NEC 7730 RO Parallel	2595	2295
MONITORS		
Amdek 12" 310A	230	189
Quadchrome 17"	695	525
Princeton Graphics	795	495

CALL FOR OTHER SOFTWARE & HARDWARE PRICES
"International Dealer Enquiries Welcomed"

MC-P APPLICATIONS
 111 W. St. John St., Suite 307
 San Jose, CA 95113 Phone (408) 293-3360
 Telex: 294207 MCPA UR
 HOURS: 8 a.m. to 5:30 p.m. — Mon. - Sat.
 (Phone Orders Only on Sat.)

TERMS: All prices subject to change. Cashier's check/MO/ Bank Transfer. Allow time for company or personal checks to clear. Prices reflect cash prepaid discount. VISA/MASTER CARD/COD/PO's =3%. California residents add sales tax. **SHIPPING:** \$4 per item for UPS surface (\$8 for Blue Label); Monitors \$20, Printers \$25, within continental USA.

UNIX SPOKEN HERE

and MS-DOS, and VMS too!

UniPress, your UNIX source.

We have a line of software for a range of hardware, including VAX, MC68000 and IBM PC. Source code, as well as binary. Quantity and OEM terms. Maintenance available.

PACKAGING: VAX/VMS and UNIX, MC68000/UNIX on Sun, Masscomp, Apollo, Tandy 16, Apple Lisa, Sritek Board for IBM PC, Dual, Plexus, Callan, and Cyb. Perq and Perkin Elmer, too. Inquire regarding other hardware.

UniPress Software

Priced
from

UNIX SOFTWARE

- Full UniPlus + UNIX for Apple LISA\$ 495
- EMACS—Multi-window text editor (Gosling version)395
- LEX—Powerful word processor500
- PHACT—Isam file manager250
- /RDB—Relational database tools250
- MENU SYSTEM—Menu generation495
- UniCalc—Powerful spreadsheet350
- MIMIX—CP/M emulator495
- C cross compiler—to 8086 and 68000 (includes assembler, linker, etc.)5000

MS-DOS SOFTWARE

- Software tools—Unix-like facilities add power to MS-DOS: includes ed, grep, sort, diff, uniq, etc. . . .200
- PHACT—Isam file manager250
- C compiler—Full C language395

VMS SOFTWARE

- EMACS—Multi-window text editor (Gosling version)2500

Call or write for more information.

UniPress Software, Inc.

Dept. B10

1164 Raritan Avenue, Highland Park, NJ 08904
201-985-8000 Toll Free: 800-222-0550 (outside NJ)

Mastercard and Visa

Unix is a trademark of Bell Laboratories.
VMS is a trademark of Digital Equipment Corp.
MS-DOS is a trademark of Microsoft.
UniCalc is a trademark of Lattice, Inc.

The CP/M Configuration

The ATR8000 configured as a stand-alone computer uses the Atari as a terminal. If you do not own an Atari, any RS-232C device capable of running at 9600 bits per second will suffice. We used a Lear Siegler Inc. ADM 3A terminal for some time. You must move three jumpers in the ATR8000 depending on whether an Atari or an RS-232C terminal is used.

This configuration of the ATR8000 comes equipped with 64K bytes of RAM, 60K bytes of which are available as system RAM. A 4K-byte section is mapped into a 2732 EPROM (erasable programmable read-only memory) containing the Atari disk-emulation code and a monitor, used to boot up CP/M. CP/M 2.2 from Digital Research is supplied on either a 5¼- or an 8-inch disk.

The hardware difference between this ATR8000, a full CP/M machine, and the 16K-byte version, which is an Atari-only peripheral device, is in the memory upgrade (larger dynamic RAMs) and internal jumpers. The cost of this upgrade to an end user is \$200. Now, to a knowledgeable computer user, paying \$200 for upgrading 4116 RAM chips to 4164s ($\times 8$) seems a bit out of line. However, for that price, SWP is supplying not only the new RAM chips but also a licensed copy of CP/M, all the CP/M utilities, CP/M manuals (a thick stack), and, most of all, support.

Of course, if you still want to use your ATR8000 as an Atari interface, it will work as such in its 64K-byte configuration. The only difference is that 58K bytes, instead of 12K bytes, are available for print spooling. Unless the ATR8000 is specifically booted into CP/M, it remains an Atari peripheral.

In CP/M mode, the Atari serial bus direction is reversed, and the ATR8000 becomes a stand-alone computer; the Atari becomes a terminal instead of serving as the primary computer.

There is, however, a disadvantage to using the Atari as a terminal. The Atari's video-generator chip has a text-window resolution of 40 characters across by 24 characters high. (This format is consistent with 160 color clocks on an average TV screen; TVs do not have the bandwidth needed to run 80 characters across.) Hence, when the Atari is used as the I/O device for the ATR8000's CP/M, a 40-column screen is supported.

The system comes with software to make the Atari emulate an 80-column ADM 3A terminal with a scrolling window. With this technique, 80 characters across are maintained internally, and 40 of the 80 are shown on the text screen. The user can manipulate the window with keys and has the option of having the window follow the cursor across the screen, a rather dizzying effect.

If the Atari 800 is equipped with an 80-column video card, such as the Bit-3 Full-View 80, then true 80-column CP/M can be used. Interfacing is straightforward. Our system, for instance, has the Bit-3 board and a PI 3 monitor and functions very well. The Bit-3 board for the Atari 800 retails for \$349.95. A typical monitor capable of 80-column display costs \$150. (For details on the

80-column board, contact Bit-3 Computer Corp., 8120 Penn Ave. South, Suite 548, Minneapolis, MN 55431.)

The CP/M system is booted in a two-step process. The booting process illustrates the operation of the ATR8000 system, so let's go into it in detail.

First, turn the ATR8000 on. Any disk drives connected to the ATR8000 are restored to track 00, then stepped out five tracks. (We wondered why this was done until we found out that some disk drives can get the disk head caught behind the track 00 sensor. The five outward steps prevent this problem (an impressive "user helpful" feature). The drive's index pulses, from the index hole on the disk, are sensed and timed; if the index pulses indicate an rpm of 300, the drive is logged as a 5¼-inch drive. If the rpm is 360, the drive is logged as an 8-inch drive. Internal tables are set accordingly (for example, the single-density format command is told to place 18 sectors on a 5¼-inch track and to put 26 sectors on an 8-inch track; this boot-timing process determines which format is used).

The step rate of the drives is determined automatically at boot time, and the drives are run at the fastest rate at which they can be stepped. Because this rate varies widely between drives, automatic stepping timing is a real convenience; it makes the ATR8000 capable of using a wide range of drives without the user having to worry about step rates, settling times, and so forth, which vary so widely across the industry. If you have a drive only intermittently capable of running at high speed, however, you can force a slower default stepping speed on a particular drive by using the DDSYSGEN editor. (We had a problem with one of our 8-inch drives that has been around a long time; it could not always step at high speed, so we slowed down the stepping to the next available rate.)

Next, the ATR8000 settles down into Atari-emulation mode, in which it accepts normal Atari commands from the serial bus and executes them. For example, disk I/O requests are sent to the proper drive, printer requests are sent to the printer, and so on.

At this point, the ATR8000 is usable as an Atari disk drive. Next, let's boot CP/M.

Let's assume you have put the Autoterm-ADM 3A Emulator disk in the ATR8000's drive 1 and started up the Atari. Acting as an Atari disk drive, the ATR8000 reads in the emulator and sends the program to the Atari. The Atari then starts acting as a terminal, "watching" the serial bus for communications. At this point, the serial bus is turned around; the ATR8000 is the primary computer and the Atari is the terminal.

The ATR8000 is reset by the user via the back-panel Reset button, which sends it out of Atari disk-emulation mode. The ATR8000 displays the message ATRMON, which indicates that the system is running a small monitor, in ROM, in the ATR8000.

At this point, you're just about ready to run CP/M; remove the Autoterm-ADM 3A Emulator disk and insert any disk with the CP/M operating system into drive 1 (A). Next, type in B. This command initiates the boot

process from drive 1. In 2 or 3 seconds the familiar 60K CP/M 2.2 and A> messages appear on the Atari's screen.

If you are running with a terminal other than the Atari, the CP/M boot process is a single step; you put the CP/M system disk into drive 1, switch on the ATR8000, type in B, and boot directly. The difference is in using the ATR8000 to load the Atari's terminal program.

What is so impressive is the ease of this whole process. The ATR8000 determines drive size, density, sector size, and so forth, by itself, with no user intervention. You do not need to keep the system on a 5¼- or an 8-inch disk, nor do you need to permanently keep one kind of drive as A. Furthermore, programmers at SWP have allowed the use of 1024-byte sectors, which are internally deblocked to eight 128-byte sectors. The use of 1024-byte sectors is extremely efficient; in a 1024-byte disk format, most of the track is taken up with the data, not a number of sector headers and other non-data overhead. This format, by minimizing disk accesses,

The ATR8000 determines drive size, density, sector size, and so forth, by itself, with no user intervention.

speeds everything up. In a typical input or output operation, another disk access is not needed until all 1024 bytes are processed. This compares with eight disk accesses on a single-density, 128-byte-sector (standard CP/M) system.

Because of the lowered amount of sector header information, the 1024-byte-sector format is recommended. This format fits 180K bytes of data on a 5¼-inch disk and 674K bytes on an 8-inch disk, assuming double density. If you use double-sided drives, the capacity increases to 360K bytes on a 5¼-inch drive and 1.3 megabytes on an 8-inch drive.

From CP/M, many disk-track-layout formats are available, in either 5¼- or 8-inch disks:

- 128 bytes/sector, single density (the standard 8-inch disk format)
- 256 bytes/sector, double density (a common double-density format)
- 512 bytes/sector, double density (suitable for reading TRS-80 Model II 8-inch disks)
- 1024 bytes/sector, double density (the usual SWP format, allowing 674K bytes of storage on a single-sided 8-inch disk)

SWP's DDINIT program initializes a disk to any of these configurations, and the software automatically adjusts for the new sector sizes.

The ATR8000 can read disk formats of several manufac-

turers, including those of IBM, Kaypro, Osborne, and the Xerox 820. Configuration programs are available to read disks with nonstandard interleaving or sector size. We found these programs extremely useful; we had a library of Osborne disks, with their 90K-byte limit, and data spread across those disks that we wanted in one place. We copied about 30 Osborne disks down to three double-density 8-inch disks and had room to spare.

If you change disk density or sector size with a disk swap, a simple Control-C command will reset the ATR8000's internal tables, and upon the next disk access to the drive involved, the ATR8000 will reconfigure itself and the CP/M blocking/deblocking tables for the proper density and sector size.

We ran one rather unfair test of the ATR8000 just to see how far the software would go. We formatted a disk with half double-density and half single-density tracks on it and then started copying programs onto it. The system reached the track with the changed density; once the system "found" the new density areas on the disk, it reset the internal tables and continued writing. At this point, we gave up trying to find ways to beat the ATR8000.

Our ATR8000 system has two 8-inch Shugart 800 drives and one 5¼-inch Tandon TM-100-1 drive. Operation under CP/M and Atari DOS has been flawless. Any number of copy operations from 5¼- to 8-inch and vice versa, density changes, and strange disk formats have

operated with no problems. In other words, the ATR8000 disk firmware has been thoroughly debugged.

The CP/M software we've used with the ATR8000 includes Wordstar, Microsoft BASIC, Supercalc, and SMODEM37. All have performed without any problems. There is probably no CP/M system on the market that is easier to use. For instance, take the automatic drive configuration. When the ATR8000 is booted, it determines drive and sector size, density, and step rate automatically.

For most CP/M users, these things do not happen automatically. Most of them must be done by (usually) modifying the CP/M BIOS (basic input/output system), which involves editing and reassembling source code—no small task for a novice user. Generally, the user must configure the floppy controller-board software for drive step rate, size, number of tracks, and so on. The user must also configure CP/M for sector and disk size, setting up a number of tables for each new drive. Frankly, this is a miserable process and tedious even when you have been through it before; for a beginner, just understanding the CP/M parameter tables is nearly impossible.

But the ATR8000 does all of this automatically. We have changed drive configurations and densities many times and never once touched the BIOS. Because you can hook up almost any disk drive and use the drive without problems, the ATR8000 may be an ultimate CP/M system.

If you need a low-level disk analyzer, SWP offers Diskmon and supplies it to every CP/M customer. This sector-level disk editor is helpful for recovering data from bad disks and for fixing directories. SWP also supplies SMODEM37, a user-friendly telecommunications program configured for the Hayes Smartmodem and the ATR8000. (SMODEM37 is a public-domain program developed by the prolific Ward Christiansen and the CP/M User's Group.) We have used it for some time with CompuServe, The Source, and many bulletin boards and found it to be an excellent and friendly modem program. Such features as checksummed object-code transmission and reception, printer on/off, and a variety of data-transmission rates make it a powerful and useful tool.

The vendor documents all of these utilities in a well-written 70-page manual that also covers the parameters needed for the context editor and how to hook the system up to various disk drives. SWP also sends updates to its customers, and some errors in the manuals have been corrected. In general, the documentation is above average.

The 8088 Configuration

Internally, the ATR8000 is a standard 4-MHz Z80 system. A Mostek Z80 is the central processor, and 64K-bit or 16K-bit dynamic RAMs are used for memory. The other major chips include the standard Z80 CTC and the Western Digital 1797.

With the advent of the IBM Personal Computer (PC), the 8088 suddenly became a very popular processor. Because IBM is selling so many PCs, there is a great demand for 8088 software, and already many of the



Current Specials

IN STOCK NOW

IBM-PC

\$2995

Two 320 drives, 128k RAM, color graphics/monochrome card, monochrome monitor.

Call for prices on KayPro, Superbrain, Northstar, & other brands.

PRINTERS		MONITORS		MODEMS	
Tally 160L	'659	AMDEK 300A	'155	Hayes Smartmodem	'219
Okidata 92	'449	AMDEK Green	'149	Hayes 300/1200	'509
ID5 Prism 132	'1209	Zenith ZVM 121	'95	Hayes 1200B	'439
Gorilla Banana	'229	Zenith ZVM 123	'129	Anchor Mark VIII	'349
Gemini 10X	'329	BMC Green	'189	Anchor VI Internal, IBM	'192

All other brands at similar savings

GEMINI 15 printer, 100 cps, 15" carriage **\$359**

<p>KOALA PAD</p> <p>APPLE '99 IBM '109</p>	<p>ZENITH 122 Amber Monitor 800 Lines</p> <p>\$129</p>	<p>SANYO 555 Computer w/Wordstar, Spellstar, Infostar</p> <p>CALL</p>	<p>HERCULES GRAPHICS Card for IBM PC</p> <p>\$359</p>
---	--	---	---

HERE'S WHAT OUR CUSTOMERS SAY ... "full service attention at mail order prices. Informed, helpful, responsive." **Wes Gilbert, DATA I/O**

PACIFIC COMPUTERS ORDERS ONLY
13240 Northup Wy #4 - Bellevue, WA 98005 1-800-531-3133
Information: 206-641-7233

Prices reflect 3% cash discount • Bankcards • Sorry no COD • FOB Bellevue
All items currently in stock.

PICK UP WHERE IBM® LEAVES OFF.

Portable or desktop, you're way ahead when you pick up a **CORONA PC™**. Because we give you everything you've ever wanted in an IBM¹-compatible PC and more. For a great deal less.

COMPATIBLE AND MORE.

Our systems run all software that conforms to IBM PC programming standards. And the most popular software does.

We deliver twice the memory, with room for eight times as much.

We deliver a fast-access 320K floppy drive, a communication port and an improved IBM PC keyboard with indicator lights.

Our systems include high-resolution monitors (12" desktop, 9" portable) for crisper, cleaner displays, and both have built-in high-resolution graphics (640 x 325).

You get a complete system, ready to go to work.

MORE VERSATILITY.

With all the necessary features built into the main unit, the four expansion slots can be used for your special needs. For example, color or our optional 10MB hard disk.

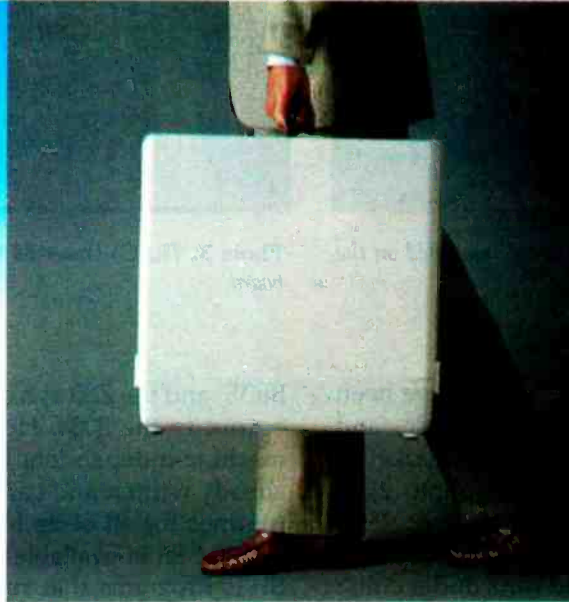

MORE SPEED.

Our RAM-disk software gives you temporary disk-type storage that works many times faster than disks.

PLUS SOFTWARE.

Our systems come with the operating system: MS-DOS². A programming language:

GW BASIC². A training course: PC Tutor.³ A professional word processor: MultiMate.⁴ Plus DOS utilities and demonstration programs. Or you can get the p-System⁵ from N.C.I. and write or run portable Pascal packages.

ALL FOR A GREAT DEAL LESS.

Even with all the extra features and performance, our systems still cost significantly less than the equivalent IBM PC.

Drop by your nearest **CORONA PC** dealer for a very convincing demonstration. Or contact us at 31324 Via Colinas, Westlake Village, CA 91361. (213) 991-1144 or (800) 621-6746 toll-free. Telex 658212 WSLK, in Europe 76066 CDS NL.

© Corona Data Systems 1983. 1. TM International Business Machines. 2. TM Microsoft. 3. TM Comprehensive Software Support. 4. TM Softword Systems. 5. TM University of California.

See us at Comdex Booth #310



CORONA™
data systems, inc.

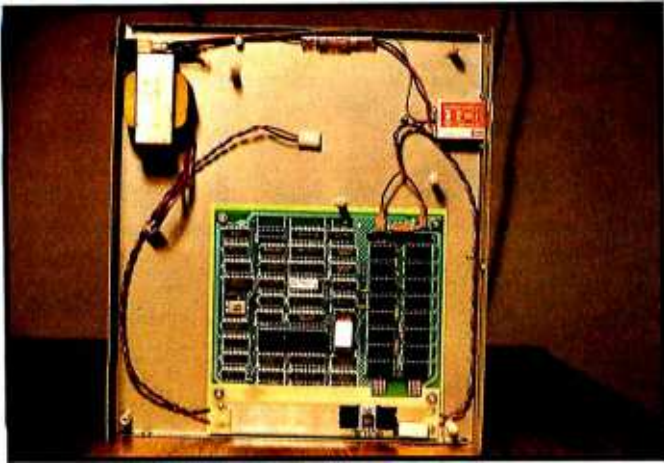

Photo 2: The Co-Power-88 main processor board, mounted on the ATR8000's bottom tray.

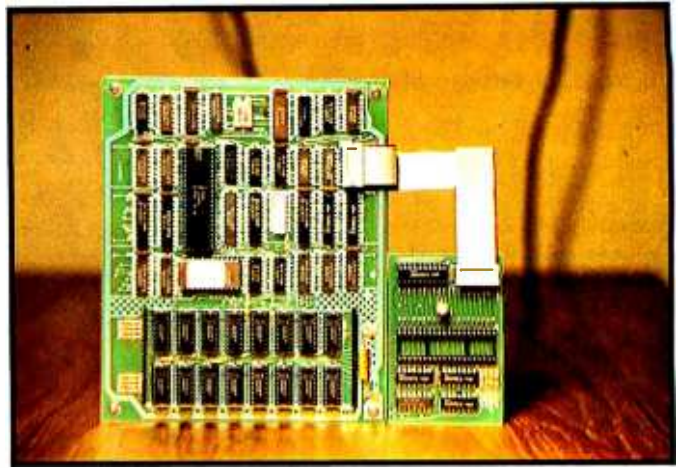

Photo 3: The Co-Power-88 main processor board and Z80 adapter board.

popular applications programs for CP/M-80 have been translated for the 8088 (Wordstar-86, Supercalc, and others). With this potentially large software market in mind, SWP developed the Co-Power-88 (photo 2), a stand-alone 8088 processor with either 128K or 256K bytes of memory, accessible through the ATR8000's own Z80. The 8088 is clocked at 5 MHz and runs under either MS-DOS from Microsoft or CP/M-86 from Digital Research.

The Co-Power-88, designed to provide Z80A-based CP/M 2.2 systems with the power of the 8088, plugs into the Z80's socket via a piggyback scheme. The Z80 is first removed, then an adapter (photo 3) is plugged into the Z80's socket and the Z80 is plugged into the adapter. The adapter gives the Z80 two new I/O ports, located at FE and FF hexadecimal, although the port locations are reconfigurable if those locations are already in use on your system. These two ports are then led via a short cable to the 8088 board; all communications between the 8088 and the outside world are through this cable.

This generic method of interfacing an 8088 to a Z80 can be applied not only to the ATR8000 but to many other Z80 systems. Given the number of users who will want to upgrade their Z80 systems to the 8088, this technique seems like an excellent way to go. SWP is planning on releasing the Co-Power-88 for a variety of Z80A-based CP/M machines in the near future and will probably sell a generic version for users wanting to install an 8088 themselves.

The CP/M-80 system runs normally with the Co-Power-88 installed. However, 120K or 250K bytes of Co-Power-88 RAM can emulate a disk drive, a very useful capability for spreadsheet manipulation, database sorting, and skimming through documents with Wordstar. This M-drive, as SWP refers to it, removes disk access delay time and greatly speeds up the CP/M system.

The Co-Power system is easy to boot. When "Z88 (return)" is typed, the 8088 seizes control of the user's CP/M system and boots off the main disk. The user's Z80

BIOS, and the Z80 as a controller, are used for input and output to the 8088. Hence the Co-Power-88 system is machine-independent because it uses the CP/M BIOS already written and containing the machine-dependent routines for all of its I/O functions.

CP/M-86 is available with the Co-Power-88 through SWP. Programs that run on the IBM PC should work with the Co-Power-88 if they don't rely on IBM-dependent features (direct ROM calls and so forth).

The Co-Power-88 is an excellent upgrade to CP/M-80 systems using a Z80 processor. It installs easily because it uses the CP/M routines already written. For users needing the large address space of the 8088 and who already have a CP/M-80 based system, the Co-Power-88 is well worth looking into.

Conclusion

The ATR8000 offers three levels of expansion. For the Atari, it provides a clean interface to disk drives, printers, and serial devices; for an Atari user or for any user with a terminal, it provides access to the CP/M marketplace's vast software supply and it offers the capability to access the growing 8088 software market.

The ATR8000 offers another form of expansion: future compatibility. The Atari's 6502 is an 8-bit processor in an increasingly 16-bit world. With the ATR8000, an Atari owner can begin to use CP/M-86, MS-DOS, and 16-bit 8088 software now.

A fine CP/M machine with extremely user-friendly disk interfacing, the ATR8000 is ideal for CP/M users who want to get their systems running without problems. It is a true turnkey system—one of the very few we have encountered. The ATR8000 closes the gap that has separated Atari owners from the rest of the software market. ■

Dave and Sandy Small (11314 Yucca Dr., Austin, TX 78759) are computer consultants. Both have degrees in computer science from Colorado State University.

The PC Saver™ Line Cord prevents costly computer errors.

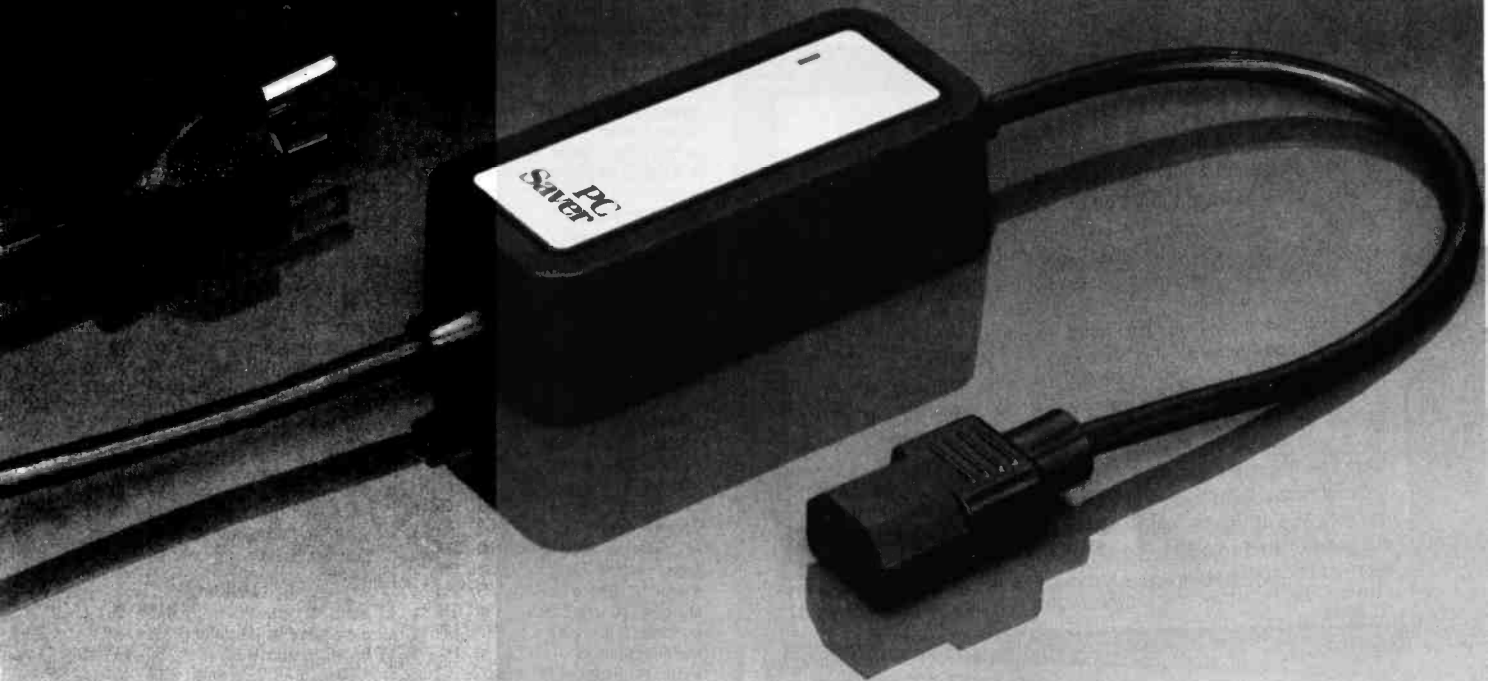

Surges, spikes and line noise cause computer errors.

The circuitry inside your personal computer and peripherals depend upon a clean supply of AC line voltage. Computers and peripherals are very susceptible to surges, spikes and line noise. These voltage anomalies are caused by ordinary activities such as the start and stop of elevators, operating home appliances, even switching lights on and off.

You may already be familiar with the results. Crashed software. Garbled files. Memory losses. Even damage to your computer's sensitive circuits.

Unique 2 way protection.

First, it filters the current from the wall outlet. Designed to IEEE specifications, the PC Saver Line Cord quickly clips surges and spikes to a safe 133 volts RMS/175 volts DC level and filters transverse and common mode noise with an 'L' type filter.

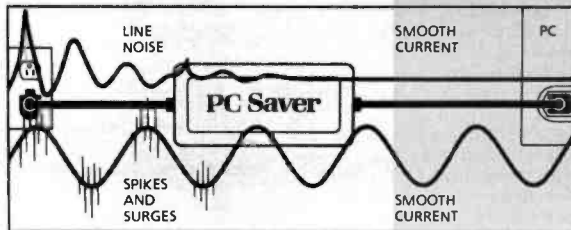

Second, the PC Saver Line Cord filters noise generated by peripherals within your system. For example, a printer and computer are connected to an outlet strip. Operating the printer generates noise which feeds back through the outlet strip into the computer causing software errors and possible hardware damage. With its protective circuitry the PC Saver Line Cord eliminates this problem.

Fits most personal computers.

The PC Saver Line Cord fits almost every make of personal computer, such as the IBM PC™ and XT™, all Apples™, Texas Instruments™, DEC™, WANG™, Compaq™, Victor™, Kaypro™, Osborne™ and many more. Simply replace your factory supplied power cord with the PC Saver and your system is assured maximum protection.

PC Saver Line Cord: outstanding value.

At only \$49.95, the PC Saver Line Cord gives you better performance than products at twice the price. Available at computer stores everywhere or direct from Kensington Microware Ltd. 919 Third Avenue, New York, NY 10022, (212) 486-7707, Tlx: 236200 KEN UR. For phone or mail orders please include \$2.50 shipping and handling. New York State residents add applicable sales tax. Visa and Mastercard accepted.



Circle 253 on inquiry card.

PC Saver was tested to the Institute of Electrical and Electronics Engineers (IEEE) specification 507 1980, Category A. Also available in 220/240 Volt model.

PC Saver—trademark of Kensington Microware Ltd.
© 1983 Kensington Microware Ltd.

The Universal Computer

ROMAR II—Runs Applesoft & CP/M!
6502 CPU for Applesoft, and Z-80 adapter card for CP/M 64K RAM, 72 keys in standard keyboard, 8 expansion slots accept standard APPLE cards. 80 W power supply w/fan, heavy duty construction. Will function perfectly with Apple-compatible disk drives and 3.3 DOS.
80 Col Card 589

Holiday Special \$495!!! LIST \$795



SPECIAL \$1.00 PACKAGES:

Buy a COLUMBIA VP portable at list and get a RITEMAN printer for \$1

IBM COMPATIBLE BOARDS

BUBBLE MEMORY CARD by Helix. A reliable, fast alternative to hard disk!!! Runs under MS/DOS 2.0. immediate availability

2 MB . \$999 4 MB . \$1499

AST RESEARCH:

PC-NET Starter Kit 2 Adaptive Boards, all needed cabling and software LIST \$1490 . . . \$ CALL

Additional Adapter Boards (1 needed per workstation) . . . LIST \$695
Mainframe Adapter Board: . . . \$ CALL

Direct Connect Modem: Auto-dial/receive, auto-BAUD clock, 1S + 1P, Game port . . . LIST \$695

MegaPlus: 64K-256K RAM Superdrive, Superpool Clock, 1P + 2S, Game port . . . \$ CALL

10-PLUS: 2S + 1P, Game port, clock . . . \$ CALL

PASOCOM: Absolutely BEST BUY:

265K RAM 1P + 1S, Game port, clock & calendar unbeatable value . . . \$369

QUADRAM: All boards available . . . \$ CALL
Quadlink . . . \$ CALL

PRINTERS



Mannesman-Talley MT-160L: HOT SELLER! . \$ CALL
MT-180L NEW up to 264 columns! . \$ CALL

GEMINI 10X from Star-Microtronics: All the features of EPSON-FT, plus backspace, continuous underline, List \$499 . . . \$ CALL!!!

GEMINI-15: similar but 15" carriage. Even better buy. List \$649 . . . ONLY \$ CALL!!!

Okidata Pacemark 350 cps . . . LIST \$2695 \$1999
Anadex WP-6000 . . . LIST \$2699 \$1995

IDS Microprint . . . \$ 919

Epson FX-80 . . . \$ CALL Epson RX-80 . . . \$ CALL

Okidata 92 . . . \$ CALL

RITEMAN Dot-Matrix Printer: Small enough to fit in your briefcase. 80/132 col., dot graphics, 120 CPS. List \$499 . . . \$329

Daisy-Wheel Printers:

DAISYWRITER 2000, 48K buffer . . . \$1099

TRANSTAR 130, emulates Diablo . . . \$ 699

TRANSTAR 315 color printer . . . \$ CALL

BROTHER HR-1 . . . \$ CALL

DYNAX HR-15, best buy . . . LIST \$99 \$ 449

QUME Sprint II . . . \$ CALL

DIABLO 620 . . . \$ 999

JUKI 6100 low cost/hi perfor. LIST \$99 \$ CALL

Silver-Reed EXP 550 . . . \$ 649

Smith Corona TPII . . . \$ CALL

Mannesman-Tally Sprint . . . LIST \$399 \$ CALL

PLOTTERS

Strobe Plotter . . . \$ CALL
Mannesman-Tally Pixy 3 . . . LIST 795 \$ 679

MODEMS

Hayes Smartmodem w/SmartCom . . . \$484

SmartCom II . . . \$ 79

Hayes 1200 B (F/IBM-PC) . . . \$449

US Robotics (similar to Hayes, but lower priced)

Autolink 1200 . . . \$399

Signalman MK12 Auto Send/Rec. 300/1200. BEST BUY . . . \$299

SPECIAL!

DYMAC ClipStrip: Only UL-Approved Surge Protector. Protect your investment!
LIST \$149 . . . ONLY \$109

OTHER COMPUTERS



NEC PC-8800: High flexibility & performance: Z-80 CPU w/ optional 8086 CPU, ROM BASIC, choice of 5 1/4" Floppies, dedicated graphics RAM . . . \$ CALL

16-bit card (8086) w/MS-DOS NEW List \$594 . . . \$ CALL
Hard Disk 5-15 MB List \$2295 . . . \$ CALL

Micro Decision by Morrow Designs

MD 11 NEW!

11 MB Hard Disk + one Floppy LIST \$2,795 . . . \$ CALL

MD-2 single-sided Floppies . . . \$972

MD-3 double-sided Floppies, Quest Bookkeeping . . . \$1245

Morrow Terminal or Liberty Terminal . . . \$545

INTERTEC: Superbrain QD: List \$2895 . . . \$2245

Televideo 803: All features of the well-known Televideo 802 (RS422 interface optional) + graphics + larger screen + free W/P & SpreadSheet = Unbeatable Buy!

LIST \$2495 . . . \$1989

Televideo 1603, 806, 816 Our prices are the lowest . . . \$ CALL

BASIS-108 Z-80 & 6502 CPU, high res. graphics . . . \$1989

Sanyo MBC-2000 8085 CPU, 2 Floppies 640KB . . . \$ CALL

NorthStar Advantage, w/16-bit upgrade . . . \$2499

PORTABLE COMPUTERS

PIED PIPER PORTABLE COMPUTER: . . . \$989

Televideo Portable: outstanding graphics, 8-bit, 96-160K RAM, 2 Floppies 737 KB, Mouse port, CP/M, GSX graphics software, WordProc, SpreadSheet LIST \$1499 . . . \$ CALL Available NOW



Kaypro 2, 4, 10 . . . \$ CALL

Zorba . . . \$ CALL

PORTABLE! 8088 & 8087 Processors

EAGLE Spirit XL—PC-compatible, 128K RAM, 10 MB hard disk + one floppy LIST \$4,795 . . . \$ CALL

TERMINALS

Hazeltine ESPRIT II . . . \$539
Hazeltine ESPRIT III . . . \$619
OUME OVT-108 . . . \$729
WYSE 100 . . . \$ CALL
WYSE 50 . . . \$ CALL

MONITORS

Dynax 12" Amber . . . \$135
Taxan RGB-1 . . . \$315
Taxan RGB-III hires . . . \$514
Zenith RGB hires . . . \$524
Princeton PGS hires . . . \$495
NEC 1203 RGB . . . \$610

BUY OF THE MONTH

BMC 80/20 by Okidata

Computer and printer for less than you'd pay for the computer alone!



Computer w/built-in Printer, direct-address graphics, opt. light-pen (incl. CP/M, BASIC, WordStar, SpellStar, MailMerge CalcStar)

This hottest-selling computer in Japan can now be yours at an unbelievably low price!!!

Monochrome model . . . List \$1995 \$1795

Color model . . . \$2995 \$2595

16-BIT COMPUTERS

COLUMBIA 1600 A BEST BUY:

Fully compatible with IBM-PC! Supports up to 4 users under MP/M-86 or Multi-user MS-DOS. \$3000 plus Free Software Nationwide service by Bell & Howell.



Columbia 1600-1 system w/amber monitor LIST \$3495 . . . \$ CALL

Columbia 1600-4 10 MB Winchester LIST \$5095 . . . \$ CALL

MP/M-86 Multi-user operating system LIST \$695 . . . \$ 595

Columbia VP Portable LIST \$2995 . . . \$ CALL

NOW YOU CAN LEASE A COLUMBIA 1600-1 FOR ONLY \$83/MO.!

CORONA-PC: Exceptional high-res.

display & graphics. MS-DOS, CP/M 86, GW-BASIC, GSX graphics, W/P & Spread Sheet. LIST \$2995 . . . \$ CALL

Corona-PC LIST \$2995 . . . \$ CALL

Corona Portable PC LIST \$2795 . . . \$ CALL

Televideo: LIST \$4495 . . . \$ CALL

Zenith 2-100 (Hard Disk Optional) . . . \$ CALL

FREE Lotus 1-2-3 . . . \$ CALL

NEC-APC: 8086, 8" Floppies, Hard Disk Option.

SPECIAL OFFER: CP/M-86, WordStar, SpellStar, Mail-Merge, Supercalc, dBASE-II, Millionaire game included FREE.

H02 Monochrome: LIST \$3448 . . . \$ CALL

H03 Color: LIST 4198 . . . \$ CALL

SANYO MBC-550

The first IBM-compatible computer under \$1,000!



Standard features: 8088 CPU, 128K RAM, 1 Floppy 160 KB, col- or graphics controller, printer port. **Software included:** BASIC, SpreadSheet, Word Processor. **1-year warranty!** Optional: MS-DOS for compatibility with most IBM software, 8087 Arithmetic Chip, 2nd Floppy & Hard Disk. **LIST price only \$995!!!** Deliveries start in September. This computer is already a hot seller and our first shipment has been completely sold out! . . . \$ CALL



DEC Rainbow-100:

Now w/MS-DOS, runs most IBM software . . . 2935
or lease . . . \$85/Mo.

EAGLE-PC: Many deluxe features (105 key keyboard), 8086 CPU for faster processing.

EAGLE-PC-E: 1 Floppy, LIST \$1995 . . . \$1555

EAGLE-PC-2: 2 Floppies, monitor, software . . . \$ CALL

LIST \$3495 . . . \$ CALL

EAGLE-PC-XL: 1 Floppy, 10 MB Hard Disk. LIST \$4495 . . . \$ CALL

BURROUGHS B-20

Most advanced 16-bit multi-user multi-tasking micro on the market. Beats many mini's, yet priced comparable to many 8-bit systems.



Extensive Burroughs & 3rd-party business software, outstanding word-processing, telecommunications & terminal emulation (All Burroughs software include training diskettes & "Help" screens).

All B-20 systems installed on your site. Nationwide Burroughs on-site service at extremely low cost. Dealer inquiries invited. Leasing available.

BURT-NEVADA (800) 845-5555

ORDERS: P.O. BOX 50029, HENDERSON, NV 89016

AK HI, NV (702) 458-0811 Circle 49 on inquiry card

Mo-Fri 7:00 AM-5:30 PM PST Sat 9:00 AM-3:00 PM PST

TERMS: Prices in this ad apply to prepaid orders only, reflect 5% cash discount off our regular sale prices. Excludes 1000 companies, Universities and Government only. 30 day net based on our regular (non-cash) price. This ad does not include all products. Prices subject to change. Absolutely no return on user or non-user items. Software refundable ONLY in UNOPENED original wrapping. 15 DAY EXCHANGE PRIVILEGE subject to 10% restocking. Add 3% for handling, shipping & insurance (\$3.95 minimum). Available items only. \$5.00 tax.

APPLE is a trademark of Apple Computer, Inc. IBM is trademark of International Business Machines, Inc.

Now you can buy IBM software at a convenient new location.



Introducing the ONE POINT Electronic Catalog.

Now you can get a complete listing and evaluation of *all* IBM compatible business software delivered electronically to your computer.

And you can buy this software at extremely low prices. 7 days a week, 24 hours a day.

It's called the ONE POINT Electronic Catalog and it takes all the hard parts out of buying software.

The catalog comes to you via your telephone modem and is updated daily. So you can search for programs, get evaluations and purchase software all with one phone call.

Each listing includes a description as well as evaluation comments from several sources. So you can be sure of buying the software best suited to your particular needs.

And since you buy directly from ITM, you pay far below retail prices.

Subscribing to the catalog costs only \$100. And an average search costs only about \$5.

So if you want to shop for software without ever leaving your hardware, call: (800) 334-3404 or write ITM, 2835 Mitchell Dr., Walnut Creek, CA 94598. Ask about our free demonstration.

ITMTM

See us at COMDEX Booth W974

The Hercules Graphics Card

This card connects directly to the display and provides high-resolution graphics for the IBM PC

by Tom Wadlow

When I bought an IBM Personal Computer (PC), I spent quite a bit of time comparing the merits of the monochrome display with those of the color display. One side of the debate asked: How can you have a home computer without some sort of graphics display? Look at all the flexibility you'd have, writing color-coded software and making graphs and charts. And what about games? The other side of the debate was, unfortunately, much more pragmatic: Are you going to be able to stare at color characters on the display all day?

Pragmatism won.

But now there's a product for people who want crisp, attractive text as well as graphics. Hercules Computer Technology's Graphics Card (see photo 1) directly replaces the IBM monochrome card; it plugs into a slot

in the IBM backplane and connects to the PC display (i.e., the green-phosphor video monitor). The card produces a display that is indistinguishable from that of the standard monochrome board. Twiddle a few bits, however, and the card provides a 720- by 348-point graphics display as well. In addition, the Hercules card has two displayable graphics pages. Because you can write into one page while displaying the other, some types of animation are possible.

The Hercules board looks and feels well constructed. It's a full-sized PC board that comes with an extra card guide. The board's connectors duplicate those of the IBM monochrome card—one for connection to the IBM monitor and one for the parallel printer interface. To use this board with a standard video monitor, you would prob-

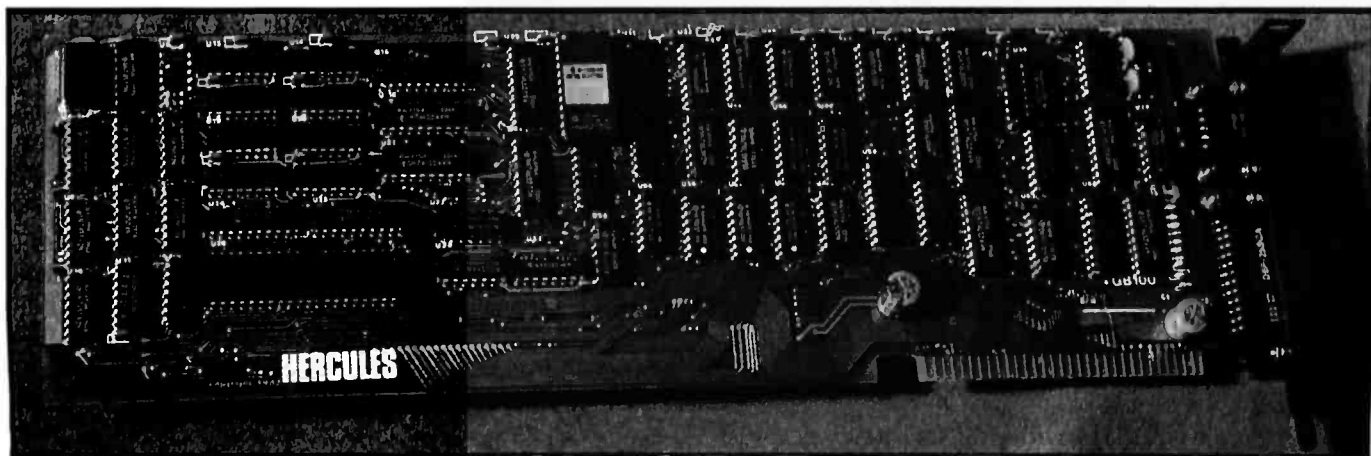

Photo 1: The Hercules Graphics Card plugs into a slot on the IBM PC's backplane, replacing IBM's monochrome card.

Command	Operation
GMODE	Enters graphics mode
TMODE	Enters text mode
CLRSCR	Clears the current graphics page
GPAGE	Sets the current graphics page for writing (either 0 or 1) but doesn't affect the display
LEVEL	Sets the intensity level for subsequent writing; 0 writes black (off), 1 writes white (on), 2 applies the exclusive-OR function to what is on the screen
DISP	Sets the currently displayed graphics page
PLOT	Writes one pixel to the screen
GETPT	Gets one pixel from the screen
MOVE	Sets an endpoint to be used for line drawing
DLINE	Draws a line from the point set by the last MOVE to the current point
BLKFIL	Fills a rectangle according to the currently set intensity
TEXT	Puts a character or characters on the screen
ARC	Draws a quarter circle
CIRCLE	Draws a complete circle
FILL	Fills in an irregular polygon

Table 1: *The graphics primitives supplied with the Hercules card.*

At a Glance

Name

Hercules Graphics Card

Use

Replaces the IBM monochrome display card; has both 80- by 25-character display and 720- by 348-point graphics display

Manufacturer

Hercules Computer Technology, 3200 Adeline St., Berkeley, CA 94703, (415) 799-9354

Size

Uses one slot on the IBM PC backplane

Features

Text display is indistinguishable from that of the IBM monochrome display; includes a printer port to allow replacement of the monochrome card

Hardware required

IBM monochrome video display; cannot be used in conjunction with a color display

Software

BASICA, in order to run HBASIC; can be used with high-level languages as well, although none is provided

Documentation

General description of hardware, low-level graphics interface routines, and BASIC

Price

\$499, includes Graph X and HBASIC software

ably need an adapter cable.

Replacing my monochrome board with the Hercules presented no problem because the operations manual contained explicit instructions. The Hercules card worked the first time, pretending to be the standard 80-by 25-character text display. With daily use, however, I have noticed an occasional failure to properly initialize on power-up; specifically, the cursor does not appear as it should, and the system does not boot. Each time this problem occurred, I solved it by turning off the system power switch, waiting a few seconds, and then turning the system back on.

I made working copies of the two Hercules disks so I could try out the graphics functions. A message on the disk envelope warns the user that only *one* backup copy is permitted, although this rule is not enforced by the software. It seems ridiculous to place such an unenforceable restriction on a software package, especially considering that the graphics functions are likely to be used in several ways on the same system. I'm sure that few people will endure the shuffling of floppy disks that's necessary to comply with this rule.

Graphics

The Hercules card provides a set of 15 graphics primitives, which can be called from BASIC, from assembly language, or from other high-level languages. Using

these primitives as a starting point, you can write sophisticated programs to manipulate a screen image. The functions supplied are listed in table 1.

The Graph X software manual, which describes the graphics operations, contains excellent examples of the assembly-language interfaces needed to call these functions from an assembler program. An object file can be used with the IBM linker to enable compiled languages to use Graph X. Graph X functions can be called from BASIC—both IBM's BASICA (the Advanced BASIC interpreter provided by IBM for the PC) and compiled BASIC—through a series of steps.

HBASIC

Probably the easiest way to start producing graphics with the Hercules card is using Hercules BASIC (HBASIC). When I first heard about HBASIC, I had visions of trying to keep track of which .BAS files were written for BASICA and which were written for HBASIC. My fears, however, were unfounded. The program called HBASIC is *not* a new BASIC. It loads BASICA and modifies it in memory (not on disk) to do graphics, but it is somewhat different. Because it is slightly slower than BASICA, timing loops must be recalculated. BASICA assumes an individual character size of 8 by 8 pixels, yet HBASIC assumes a matrix of 9 by 14 pixels. Many graphics commands intended for the IBM color/graphics

Text continued on page 352

Upsy-Daisy.

At \$649 TTX raises letter-quality daisywheel value to an all-time high.

Now there's a letter-quality daisywheel printer that even the most value-conscious customer will appreciate. The TTX-1014 Daisywheel.

Reliable and efficient, the TTX-1014's list of standard features make it a best buy in its class. Serial and parallel interface...standard. Interchangeable, 100-character ASC-II printwheel...standard. Pin- and friction-feed...both standard. Print speeds up to 140 words-per-minute, plus switch- and program selectable baud rate, pitch and line spacing.

All at a list price that's irresistible: \$649.

And if that's not enough, our new TTX family of compatible printwheels and ribbons give you even more quality for the money. Nine daisywheel typesyles. Single-strike and multi-strike ribbons. All offer you the kind of built-in TTX quality you'll want to put down on paper.

Find out more about the TTX-1014. And how we've "up-ed" the already high quality of our "daisy" with printwheels and ribbons. For full specifications and the TTX dealer nearest you, call the number below.

**Call TOLL-FREE
800-447-4700**



TTX
TELETEX™
COMMUNICATION CORPORATION

3420 East Third Avenue
Foster City, California 94404
415/341-1300 TX-466913

Circle 421 on inquiry card.

Listing 1: This IBM Macro Assembler program contains all the code needed to call any Graph X function. The program was used to generate a series of screens, from which some of the photos in this article were generated.

```
TITLE Hercules -- Exerciser for the Hercules Graphics Card
COMMENT *
    Written by Tom Wadlew
    *
video macro func ; Do BDOE Screen output function func
    mov ah,func
    int 10h
endm

gmode macro ; Enter graphics mode
    video 40h
endm

tmode macro ; Enter text mode
    video 41h
endm

clrscr macro ; Clear the screen
    video 42h
endm

gpage macro bufpage ; Change page to be written into
    mov al,bufpage ; (0 or 1) Doesn't affect display
    video 43h
endm

level macro i ; Set intensity level
    mov al,i ; 0 - black, 1 - white, 2 - XOR
    video 44h
endm

disp macro bufpage ; Set current display page
    mov al,bufpage ; (0 or 1)
    video 45h
endm

plot macro x,y ; sets, clears or xors a pixel
    mov di,x
    mov bp,y
    video 46h
endm

getpt macro x,y ; reads a pixel
    mov di,x
    mov bp,y
    video 47h
endm

move macro x,y ; set new endpoint
    mov di,x
    mov bp,y
    video 48h
endm

dline macro x,y ; draws from last endpoint to x,y
    mov di,x ; sets new endpoint at x,y
    mov bp,y
    video 49h
endm
```

Listing 1 continued on page 350

NEW FOR APPLE II AND IIe

WILDCARD™

MAKES BACK-UP COPIES OF PROTECTED SOFTWARE QUICKLY, EASILY, WITH JUST A PUSH OF A BUTTON.

New software locking schemes have rendered even the latest generation of copy programs virtually unusable. Locksmith™, Nibbles Away™ and other "Nibble copiers" require complicated parameter settings, much patience and great effort to use. More often than not, the results are disappointing. WILDCARD is different. Rather than copying disks track by track, WILDCARD ignores the disk and any copy protection encrypted on it. Instead, WILDCARD takes a snapshot of memory in your Apple® II.

Now you can make back-up copies of protected software with the push of a button.

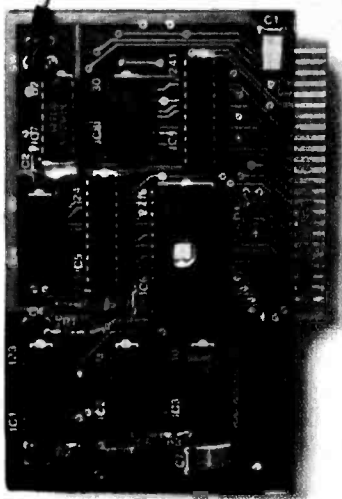

FEATURES

- Hardware copying device... push button operation.
- Copies 48K memory resident software, most 64K software.
- No programming experience or parameters necessary.
- Backs up DOS 3.2 and DOS 3.3 disks.
- Creates DOS 3.3 unprotected and autobooting disks.
- WILDCARD lives in any slot. Undetectable by software.
- Produces autobooting disk in 2 minutes.
- Copies are DOS 3.3 compatible.
- Copies become accessible for alterations.
- Simple, easy-to-use software included.

WILDCARD *Utility Disk 1* also included, featuring:

- Automatic program compression and BRUN file maker.
- Multiple programs can be placed on the same disk.
- Recreates basic files to load and save.
- Files can be placed on a hard disk...and more.

Software is not copy protected. System requirements: Apple II Plus with 64K and DOS 3.3 or Apple IIe. Franklin Ace also supported.

Wildcard does not operate with CP/M or other microprocessor based software.

Circle 164 on inquiry card.

WILDCARD **\$139.95**

Order direct from East Side Software Co., 344 E. 63 St., Suite 14-A, New York City 10021, 212-355-2860. Please include \$3.00 for shipping and handling. Orders outside continental U.S. please add \$10.00 for shipping and handling. Mail and phone orders may be charged to MasterCard and VISA. N.Y. State residents add sales tax. Dealer inquiries welcome.

IMPORTANT NOTICE: The WILDCARD is offered for the purpose of enabling you to make archival copies only. Under the Copyright Law you, as the owner of a copy of a computer program, are entitled to make a new copy for archival purposes only and the WILDCARD will enable you to do so. The WILDCARD is offered for no other purpose and you are not permitted to utilize it for any other use, other than that specified.

Apple and the Apple logo are registered trademarks of Apple Computer, Inc.—CP/M—trademark of Digital Research, Inc. Locksmith—trademark of Omega Microwave, Inc. Nibbles Away—trademark of Computer: applications.

Your troubles There's a *NewWord*

With word processing, you expect to become more efficient. But instead of producing letters and reports effortlessly, your word processing program frustrates you with its complicated manuals and ponderous operating procedures.

Your troubles are over. There's a new word for productivity—*NewWord*.

NewWord is remarkably advanced

NewWord is exceptionally powerful and versatile. It provides all the advanced editing and formatting capabilities that you need to quickly and easily create, correct and revise all your writings. *NewWord* not only does **more** than other word processing designs—it does each task faster, with fewer operations.

The proof of *NewWord's* powerful performance is in the printout. With *NewWord* you can deliver perfect documents every time.

NewWord's versatility includes **merge print**, which allows you to produce customized form letters and reports by combining standard and individualized text. Information stored on one disk or file can be transferred automatically to another, perhaps merged with financial reports and graphics. Using *NewWord*, you can merge mailing lists into form letters and print mailing labels.

You'd expect such an advanced feature only on the most expensive word processors, but merge print is built in *NewWord*.

NewWord retails for \$249.00—or about a third of the cost of the industry's leading word processing program and its merge print option.

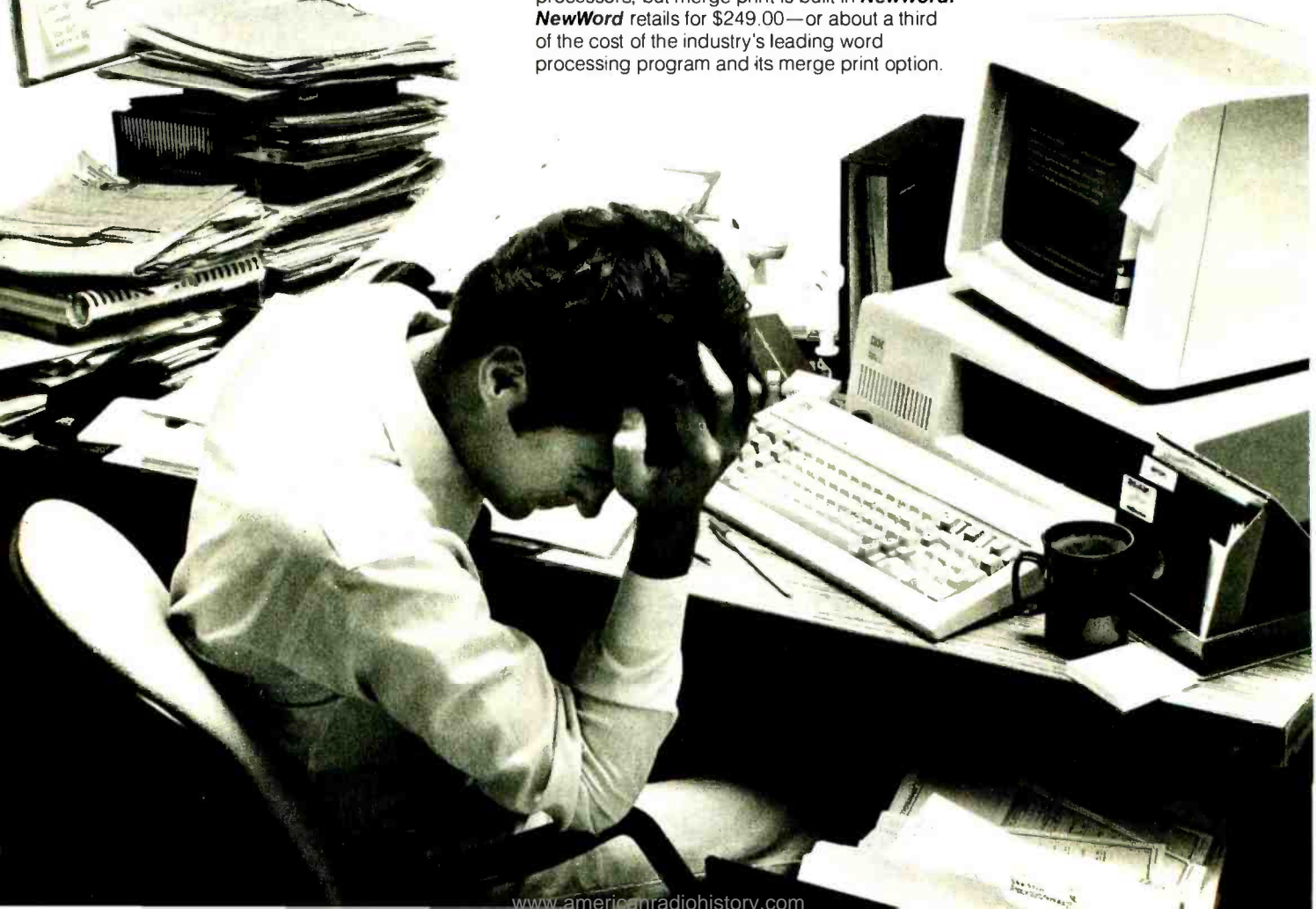
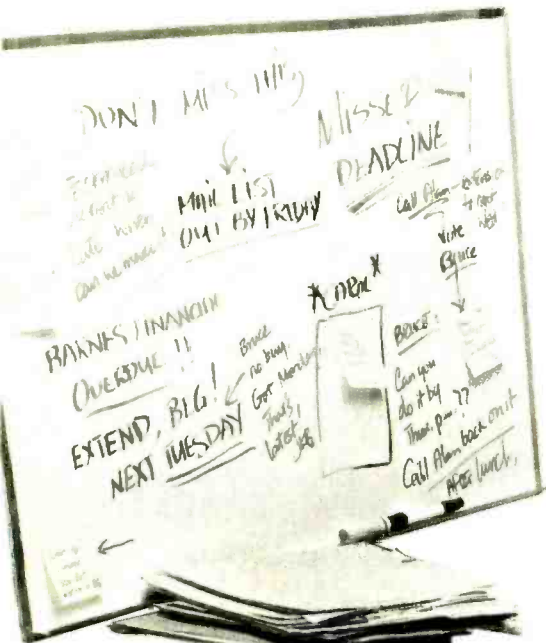

are over for efficiency

NewWord makes you productive right away

You can put **NewWord** to work immediately, without feeling awkward or confused. Anyone with WordStar® experience won't even have to read **NewWord's** manuals. WordStar® text files work with **NewWord**. Start writing, using the same commands as WordStar®. **NewWord's** high-powered performance and versatility will be immediately apparent.

New users will appreciate the highly readable manual and optional **novice NewWord**—a simplified, teach-yourself version featuring immediately useful functions. After **novice NewWord** you can begin to use **NewWord's** more advanced features without any trouble because **novice** teaches you how to use **NewWord**.

NewWord makes paperwork easy

Editing is easy and straightforward with **NewWord**. Single keystrokes perform primary functions, such as to insert, delete and move characters, words and sentences. **NewWord** obeys your instructions instantly, making corrections and revisions easy—like using the convenient "unerase" command when you change your mind. Or finding a specific page in the document.

Using **NewWord**, even large blocks of text are moved and repositioned easily, and just as quickly copied or deleted. With the Search-and-Replace function, words and phrases such as mis-spelling and titles can be changed throughout the document with a single command.

As you write, **NewWord** automatically arranges text to your preferred format. When you edit, **NewWord** reformats your document. You see on the screen exactly what you'll get on paper—including print options like boldfacing, underlining, etc.

You'll be pleased by how much less effort it takes to produce perfect, professional-looking documents—even for a first time user!

NewWord sets new performance standards

The best performance features of the most popular word processors have been refined, enhanced and improved in **NewWord**.

NewWord executes much faster because there are no overlays except the printer driver. System operations no longer slow down on your personal computer. Processing is uncomplicated, and rapid.

"Save and resume" command doesn't move the cursor to the beginning of the file, eliminating another frustration typical of the other program. "Living" ruler

lines automatically change margins and tab stops for you as you move around the document.

In non-document mode, indentation is automatic at your command and the file can invoke a specific tab size—examples of features that are useful with structured programming languages.

These are just some of **NewWord's** powers. Yet it's easier to use than the most sophisticated program available.

NewWord is simple to learn, easy to use

Select from a multiple choice "MENU" of functions, and interactive onscreen prompts lead you every step of the way. If you have a problem, **NewWord's** extensive "HELP" screens assist you—in plain English.

There are no complicated codes and command sequences to learn or memorize. Menus make **NewWord** the effortless, versatile writing tool you've been looking for.

When you get **NewWord**, you can count on getting to work right away. An installation guide sets you up in minutes. A tutorial starts you right into producing documents. And the **NewWord Encyclopedia** serves for handy reference.

NewWord Encyclopedia serves for handy reference.

Discover the NewWord in word processing

NewWord helps you improve paperwork efficiency, serving your every business/personal word processing need.

Discover how easy it is to take powerful and versatile word processing for granted. Your productivity will convince you. Discover **NewWord**.

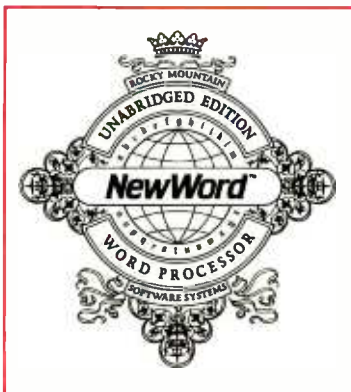

LIMITED TIME SPECIAL OFFER

Send us your word processing software and \$100.00 and we'll send you **NewWord**. Call us today, toll-free

800-832-2244

(In California, call 800-732-2311)

Before sending us your software, call to:

- confirm availability for your computer, terminal configuration and printer
- receive a return authorization number from us
- obtain shipping address for your trade-in software. (Send with your check, plus \$4.50 for shipping via UPS Surface. California residents add 6% or 6½% sales tax.)

This introductory offer expires **January 31, 1984**. Offer is limited to nationally advertised word processing software programs operable on user's presently owned computer. **NewWord** is available without trade-in for \$249.00

**Initial availability limited to selected CP/M-80 computers. Versions for additional CP/M-80 computers and IBM-PC, and compatibles available soon. Call to confirm availability for your computer, terminal, configuration, and printer.*



ROCKY MOUNTAIN SOFTWARE SYSTEMS
Business Microcomputers and Software

1280-C NEWELL AVENUE, SUITE 1001 • WALNUT CREEK, CALIFORNIA 94596 • (415) 680-8378

Specifications subject to change without notice. Some printing and display features may not be available in all configurations, subject to printer and terminal capabilities. WordStar is a registered trademark of MicroPro International, Inc. • CP/M is a registered trademark of Digital Research, Inc. • NewWord and NewStar are trademarks of NewStar, Inc.

Listing 1 continued:

```
blkfil  macro    x,y,w,h          ; fills a rectangle w,h whose lower left
        mov     di,x              ; corner is at x,y
        mov     bp,y
        mov     cx,w
        mov     bx,h
        video   4ah
        endm

putchr  macro    x,y,c          ; puts a character at x,y
        mov     di,x
        mov     bp,y
        mov     al,c
        video   4bh
        endm

arc      macro    x,y,r,q        ; Draws a quarter circle centered at x,y
        mov     di,x              ; radius r, in quadrant q  2  1
        mov     bp,y              ;                               3  4
        mov     bx,r
        mov     al,q
        video   4ch
        endm

circ    macro    x,y,r          ; Circle at x,y radius r
        mov     di,x
        mov     bp,y
        mov     bx,r
        video   4dh
        endm

fill    macro    x,y          ; Fill irregular shape where x,y is inside
        mov     di,x
        mov     bp,y
        video   4eh
        endm

wait    macro                    ; Wait for any key to be struck
        mov     ah,0
        int     16h
        endm

SSEG    SEGMENT STACK
        DW     32 DUP(?)
SSEG    ENDS

CSEG    SEGMENT
        ASSUME CS:CSEG

MAIN    PROC     FAR
        PUSH   DS          ; Save PC-DOS return information
        SUB    AX,AX
        PUSH   AX

; Setup
        gmode                    ; Enter graphics mode
        gpage   0            ; Select the graphics page to write into
        disp    0            ; Select the graphics page to be displayed
        clrscr                    ; Clear the page

; Fill entire screen to determine usable area
        fill    359,173
        wait                    ; Pause for measurement
        clrscr
```

Listing 1 continued on page 352

VISUAL presents ergonomic elegance and high performance in a low-cost terminal.

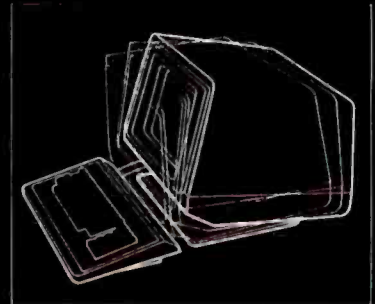

Tilt: 10° forward, 15° backward

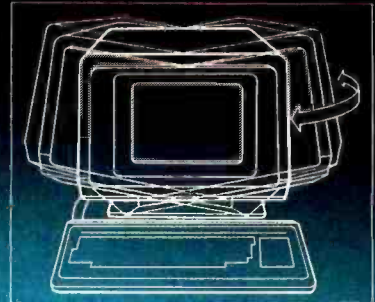

Swivel: 270°

VISUAL 50 and VISUAL 55 represent a new approach in low-cost terminals. Although they cost drastically less, they offer features you expect only from the high priced units.

For example, the enclosure is ergonomically designed in lightweight plastic and can easily be swiveled and tilted for maximum operator comfort. A detached keyboard, smooth scroll, large 7x9 dot matrix characters and non-glare screen are a few of the many human engineering features normally offered only on much higher priced terminals.

Another distinctive feature of the VISUAL 50 and VISUAL 55 is their emulation capability. Both terminals are code-for-code compatible with the Hazeltine Esprit™, ADDS Viewpoint™, Lear Siegler ADM-3A™ and DEC VT-52®. In addition, the VISUAL 55 offers emulations of the Hazeltine 1500 and VISUAL 210. Menu-driven set-up modes in non-volatile memory allow easy selection of terminal parameters.

And you're not limited to mere emulation. As the chart shows, the VISUAL 50 and 55 have features and versatility the older, less powerful low-cost terminals simply cannot match.

The VISUAL 55 extends the VISUAL 50 performance by adding 12 user-programmable function keys, extended editing features and selectable scrolling regions.

Both terminals are UL listed and exceed FCC Class A requirements and U.S. Government standards for X-ray emissions.

Call or write for full details.

FEATURE COMPARISON CHART

FEATURE	VISUAL 50/55	Hazeltine Esprit	ADDS Viewpoint	Lear Siegler ADM-5	TeleVideo® 910
Tilt and Swivel	YES	NO	NO	NO	NO
Detached Keyboard	YES	NO	YES	NO	NO
N-Key Rollover	YES	NO	YES	NO	NO
Audible Key Click	YES	YES	NO	NO	NO
Menu Set-Up Mode	YES	NO	NO	NO	NO
Status Line	YES	NO	NO	NO	NO
Full 5 Attribute Selection	YES	NO	NO	NO	YES
Smooth Scroll	YES	NO	NO	NO	NO
Line Drawing Character Set	YES	NO	NO	NO	NO
Block Mode	YES	YES	NO	NO	YES
Insert/Delete Line	YES	YES	NO	NO	YES
Bi-Directional Aux Port	YES	YES	NO	YES	NO
Columnar Tabbing	YES	YES	NO	NO	YES
Independent RCV/TX Rates	YES	NO	NO	NO	NO
Answerback User Programmable	YES	NO	NO	OPT.	NO

Service available in principal cities through Sorbus Service, Division of Management Assistance, Inc.

VISUAL

See for yourself

Visual Technology Incorporated
540 Main Street, Tewksbury, MA 01876
Telephone (617) 851-5000. Telex 951-539

```

; Draw a circle
  circ 359,173,100
  wait ; Pause for a photo

; Fill it
  fill 359,173 ; Fill the inside of the circle
  wait ; Pause for a photo

; Clear the screen and try something harder
  clrscr
  circ 359,173,100 ; Draw a circle like before
  circ 359,173,50 ; and then a smaller, concentric one
  wait ; Pause for a photo
  fill 270,173 ; Pick point inside and try to fill the donut
  wait ; Pause for a photo

; Draw a square around the circle
  move 254,68 ; Set the starting point
  dline 464,68 ; Draw a square 210 pixels on a side
  dline 464,278 ; centered around the center of the circle
  dline 254,278
  dline 254,68
  wait ; Pause for a photo

; Set to XOR mode and fill the circle
  level 2 ; Set the level to XOR-mode
  blkfil 254,278,210,210 ; Fill the square
  wait ; Pause for a photo

; Clear the screen and return to text mode
  clrscr
  tmode

  RET ; Return to PC-DOS
MAIN ENDP
CSEG ENDS

END

```

Text continued from page 344:

adapter work under HBASIC, though, and the HBASIC documentation provides a "cookbook" method of converting color BASICA programs to run under HBASIC.

Many of the Hercules card's features cannot be used from interpretive HBASIC, however. Linkages enable a program written in compiled BASIC to use the full set of Graph X routines, and there are easy ways to use Graph X from assembly-language programs and other compiled languages such as Pascal.

I found Graph X remarkably easy to use with the IBM assembler. Listing 1 is an IBM macro assembler program I wrote to generate some of the photographs in this article. The Graph X manual describes in detail the syntax for calling each function from assembly language, Pascal, and BASIC. My only complaint is that some of the examples are inconsistent. On page 13 of the Graph X manual is an example of drawing a circle (the comments on the right are mine).

```

MOV AH, 4DH Set the function to CIRCLE
(hexadecimal 4D)

```

```

MOV DI, X Set the x-location of the center
MOV BP, Y Set the y-location of the center
MOV BX, RADIUS Set the radius of the circle
INT 10H Call Graph X to draw the circle

```

Every example of individual functions uses a similar form, and the calling sequence is always the same: first, set the function code; second, initialize the registers; and finally, call Graph X.

However, when the time comes to give an example of an entire assembly-language program, the circle-drawing portion of that program is written as follows (the comments on the right are mine):

```

MOV BX, 120 Set the radius
MOV DI, 359 Set the x-location
MOV BP, 173 Set the y-location
MOV AH, 4DH Select the CIRCLE function
INT 10H Call Graph X to draw the circle

```

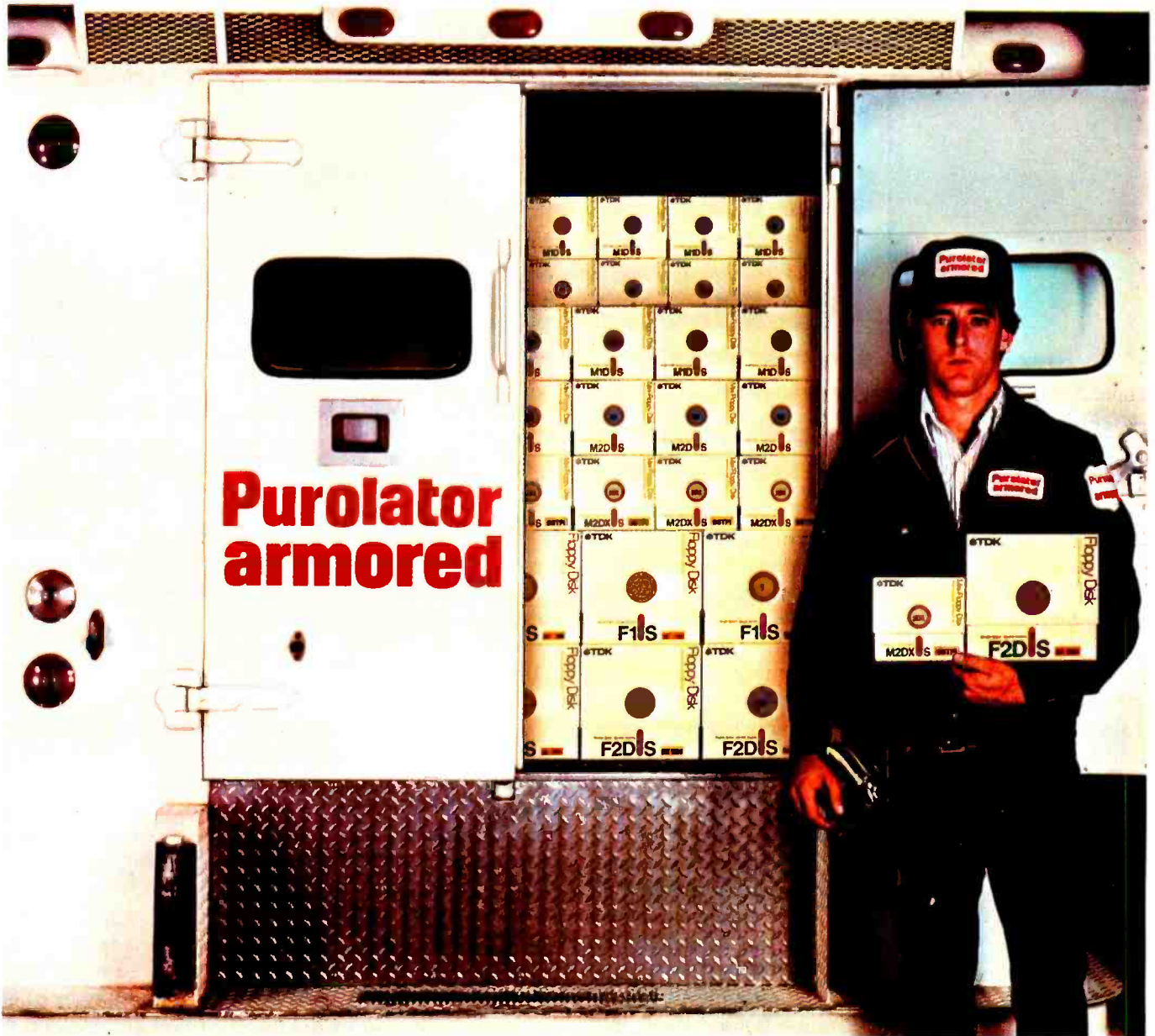

**Purolator
armored**

TDK Floppy Disks. Invaluable security for irreplaceable information.

Today, more and more companies are relying on convenient floppy disks to record, store and safeguard information. Irreplaceable information which is vital to their business interests. It is precisely the value placed on this information that makes the floppy disk an invaluable tool for storage and security. And this is where TDK floppy disks become invaluable to you. TDK floppy disks are guaranteed 100% error-free at the time of manufacture and certified for double-density encoding. Furthermore, each track of every TDK floppy disk is tested to exceed industry standards... including those of IBM, Shugart, ANSI, ECMA, ISO and JIS. Once you insert a quality TDK floppy disk into your computer system, you're guaranteed highly reliable, ultra smooth performance. This is due to TDK's proprietary disk-burnishing technique that provides optimum head-to-disk contact.

TDK floppy disks are available in 5¼ and 8-inch sizes in the most popular formats. Each disk comes in its own protective Tyvek-type envelope. For a copy of our brochure, "Some Straight Talk About Floppy Disks," write to: TDK Electronics Corp., Computer Products Marketing Dept., 12 Harbor Park Drive, Port Washington, NY 11050, or call 516-625-0100.



TDK
The heart of your system.

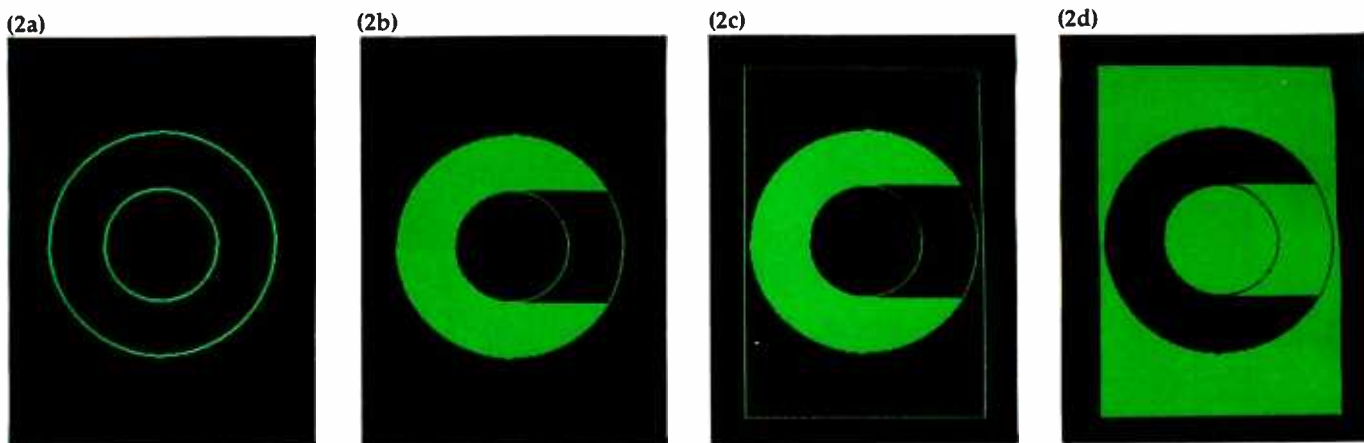

Photo 2: The concentric circles in 2a were produced with the CIRCLE function. Then, in 2b, FILL (the convex-polygon fill function) was applied. Next, in 2c, the card's line-drawing function produced the rectangle framing the figure. In 2d, the rectangle was colored in with BLKFIL, set at an intensity level of 2 (the XOR function).

Worse yet, the manual's only comment on those five lines of code was in the first line, simply "draw a circle." Consistency is very important in computer documentation, and I wish there were more in this set of manuals.

Despite the vagueness of the manuals, I experienced no difficulty producing a set of assembly-language and HBASIC programs to exercise the capabilities of the Hercules card. In the process, I found many usable features and three fairly important flaws. Most of the good features as well as the flaws are in the Graph X software and not in the Hercules board, so they can be corrected.

The manufacturer has provided two features, FILL and BLKFIL, that are indispensable in a graphics package. The first of these two features, an irregular-polygon fill (called a convex-polygon fill by the vendor), enables a programmer to select a point inside "an object with no interior holes and no peninsulas protruding into it." The interior of the polygon is filled by applying this function to the selected point, turning a hollow object into a solid one. Using FILL on an empty screen turns the entire screen green; using FILL on an object already filled erases the object entirely. Graph X performs this function with blinding speed. Photos 2a through 2d illustrate some of the capabilities of this software. The graphics were produced using the program in listing 1.

My only complaint about this feature concerns the definition of a convex polygon. There are plenty of algorithms to fill polygons with holes and peninsulas, and it's a shame that Hercules chose not to implement them. The vendor's convex-polygon fill can indeed be used to fill objects with holes, but those holes cast "shadows" that require more filling to repair them.

The other feature I especially like, BLKFIL, is used to fill rectangles in one of three ways. If the intensity value (set with the LEVEL primitive) is set at 0, the specified rectangle is erased. If intensity is set at 1, the rectangle is entirely filled in. If intensity is set at 2, the exclusive-OR (XOR) function alters the rectangle, as shown in photo 2d. I heartily approve of this feature. XOR is a useful graphics tool for preserving information; for exam-

ple, it enables you to move a cursor nondestructively over a display.

However, BLKFIL is as slow as molasses. I am willing, though unhappy, to accept this slow speed when using the XOR function but not when using BLKFIL ON (1) and BLKFILL OFF (0). No significant computation should be going on during those functions.

Another slight annoyance involves the aspect ratio, the ratio between the usable number of vertical and horizontal dots per inch. This ratio is important when you are trying to produce circles, for instance. The Hercules card provides an aspect ratio of 61/88, a rather unusual number that I expect resulted from trying to squeeze as many lines as possible onto the screen image. As the user's manual points out, this number can be approximated by 2/3, but a circle produced with an aspect ratio of 61/88 is measurably different from one produced with a ratio of 2/3. Nevertheless, most computers multiply by 61/88 as well as they do by 2/3 or 3/4. If you are working in a language such as FORTH, which is inherently integer-based, you may find this discrepancy frustrating. Listing 2, an HBASIC program that generates circles of various aspect ratios, was used to produce photo 3.

Hardware

I can offer very little criticism of the actual Hercules board because, with the exception of the occasional problem on power-up, it performs exactly as advertised. During switches between text and graphics modes, the screen gives a very distressing vertical bounce, which is harmless but potentially surprising the first time you see it. The switch between the two graphics pages, however, is as clean and glitch-free as you could possibly want.

A look at the documentation provided on the hardware reveals that an ambitious programmer could do many interesting things with the Hercules card. Mouse Systems has written a version of RasterOp that uses the Hercules; except for a brief demonstration at the 1983 West Coast Computer Faire, I haven't looked at it in detail. What I saw was very impressive, however.

\$299

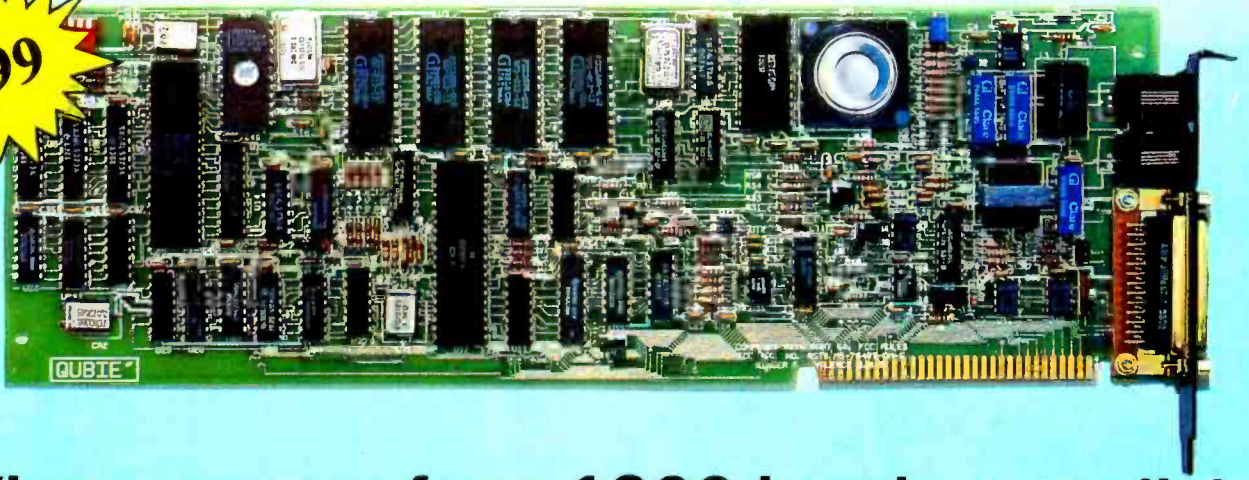

Why pay more for a 1200 baud, auto-dial, 212A Modem for your IBM PC?

Flip the pages. You see PC modem cards with fewer features advertised for as much as \$599. Up until now that's how much it cost to make a modem capable of transmitting at 120 characters per second (1200 baud). It doesn't take a computer to figure out the savings in phone line charges when you communicate four times faster than the 30 character per second modems (300 baud). Now you can have the solution to your communication needs at an unheard of price.

NOW COME THE SMART GUYS

You can imagine how precise the components had to be to convert tones over a phone line into characters. Precision equates to cost. With the advent of the mass market in personal computers the economics of scale drove the costs of manufacture down but did not effect the precision required. The technology used is called "analog filtering". It is the process of sending (modulating) and receiving (demodulating) tones with perfect pitch. A lot of adjusting, noise suppression, and a little magic is required. Real expensive. Some use lots of chips and filters (known as discrete components). The latest rage is LSI (Large Scale Integration) technology. Which is the same old analog stuff condensed onto fewer chips.

A NEW IDEA

We took a different approach. With the Qubie' PC modem card you can say goodbye to the fellow who delivers your ice because refrigeration has been invented. Through the use of four microprocessors (see picture) the tones are chopped up digitally and measured millions of times per second, eliminating the need for analog circuitry. Two microprocessors do the modulating, two the demodulating. The chips are programmed to emulate the 103 (30 characters per second) or 212 (210 characters per second) standards and determine the correct speed automatically. It's a proven technology that provides outstanding performance. Best of all, it's inexpensive and reliable.

NO CORNERS CUT

We included every feature you would want in a modem card. It plugs into your IBM PC or XT and occupies any one slot since it is just 6/10 of an inch thick. This card comes with its own asynchronous port. If you would like to use the async port for another peripheral when your modem is not in use, we will add a connector for just \$20. It's FCC registered for direct connection to your modular phone jack with the cable which is

included. There is a separate jack for your telephone or you can listen through the board's speaker. It operates in full or half duplex mode on Rotary dial lines (pulse dialing) or on tone lines (DTMF), or a combination of both. It will work in originate or auto-answer modes. A separate microprocessor, a Z8, controls all the functions.



LET'S TALK SOFTWARE

Our modem is 100% compatible with the Hayes software commands so you can use any of the popular communications packages like Cross-Talk, Transend, or PC Modem. We go one better than the competition. We include one of these popular programs with your modem, PC-TALK III. PC WORLD magazine referred to it as "the benchmark that other PC communications packages are measured against." It stores phone numbers, log-on information, handles setting the modems characteristics, saves to disk files, transmits from disk files, even binary files. And to make sure data is sent and received accurately, there is the XMODEM protocol which detects errors caused by poor line quality and retransmits the data.

WHY BUY FROM US

Because besides having the most advanced product on the market, we stand behind it and you. If at any time during the one year warranty period your modem should require service, we will fix or replace it within 48 hours. Notice also there are no hidden charges in our price. Nothing extra for credit cards or COD charges. We even pay UPS to deliver to you. If you still are

not convinced, and are ready to buy another brand of modem, ask them if their product can take our acid test.

THE ACID TEST

Qubie' gives you a 30 day satisfaction guarantee on your modem. If you are not completely satisfied we will refund the entire amount of your purchase including the postage to return it. If you can, get any of our competitors to give you the same guarantee. Buy any modem you like and return the one you don't like. We know which one you will keep.

WHY PAY MORE?

We don't have a clue. It's all here. A high quality, full featured, communications package at a price that used to be reserved for 300 baud modems. But if you decide to spend an extra \$200 or \$300, we would sure like to hear why. We have spent lots of time thinking about it, and frankly, we just can't come up with a reason.

TO ORDER BY MAIL SEND

- Your name and shipping address
- Daytime phone number
- California residents add 6% sales tax
- Company check or credit card number
With expiration date. (Personal checks take 15 days to clear)
- Specify single or double sided disk drive



TO ORDER BY PHONE

Call (805) 987-9741

PRICE:

\$299 includes 300/1200 Baud Direct-Connect modem card, PC-TALK III Software, cable to connect to modular phone jack, installation instructions and manual. 1 year limited warranty.

External async port connector \$20
Cable for Serial port to printer \$25

SHIPMENT

We pay UPS surface charges. UPS 2 day air service add \$5 extra. Credit card or bank check orders shipped next day.

QUBIE' DISTRIBUTING

Circle 361 on Inquiry card.

4809 Calle Alto
Camarillo, CA 93010
(805) 987-9741

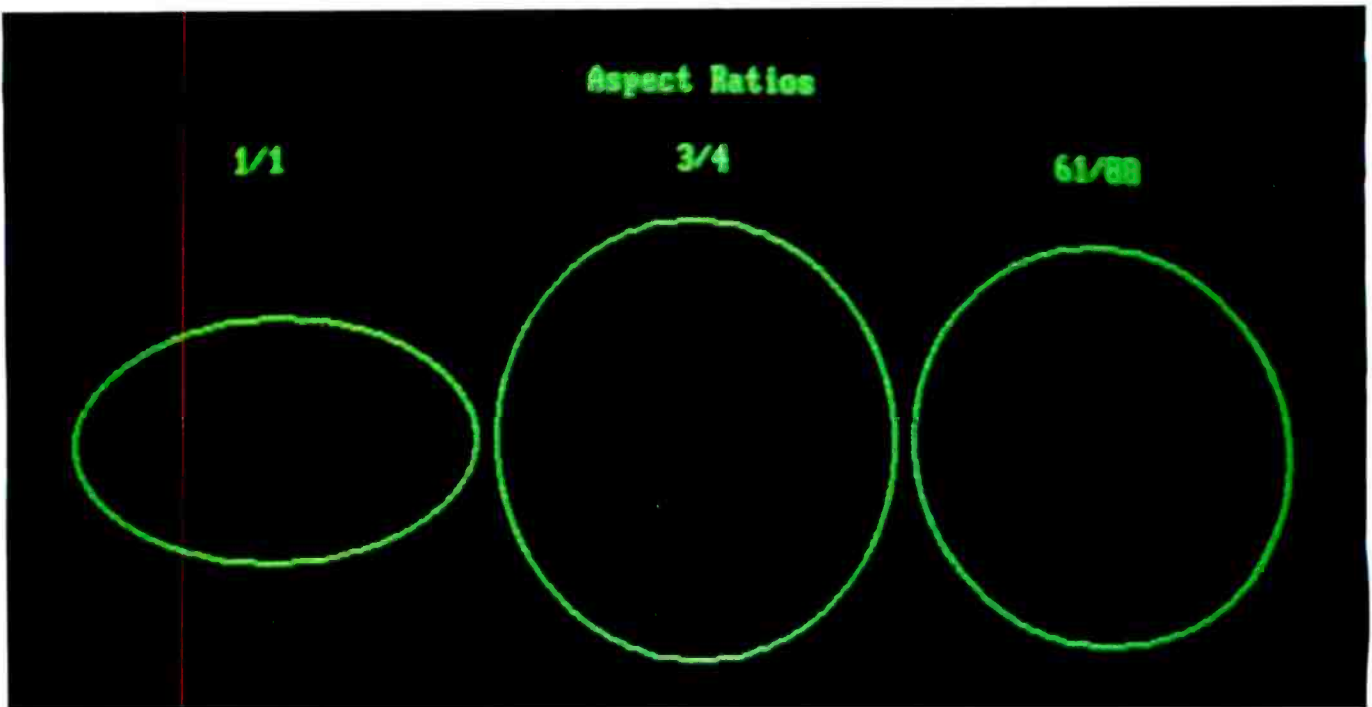

Photo 3: A comparison of aspect ratios generated with the program in listing 1.

Listing 2: This HBASIC program generates circles of various aspect ratios. It was used to produce photo 3.

```

10 REM ASPECT.BAS -- Demonstrates how an aspect ratio can affect a circle
15 REM Written by Tom Wadlow
20 CLS
30 CIRCLE(150,173),100
40 CIRCLE(360,173),100,,,,3/4
50 CIRCLE(570,173),100,,,,61/88
60 LOCATE 4,35:PRINT "Aspect Ratios";
70 LOCATE 6,15:PRINT "1/1";
80 LOCATE 6,40:PRINT "3/4";
90 LOCATE 6,62:PRINT "61/88";
100 LOCATE 21,15:PRINT "See the difference that 5/88 can make in a circle";
110 LOCATE 22,15:PRINT "The circle on the left (61/88) is correctly round";
120 REM Pause for a photo
130 LOCATE 1,1
140 INPUT " ",A$

```

The printer port on the graphics card has worked flawlessly with my Microprism 480. Hercules includes software that provides a graphics screen dump to the printer, but it works only with Epson printers equipped with Grafrax chips. Because I don't have an Epson, I couldn't test that feature. The screen dump works by replacing the built-in printer handler with a custom Hercules handler. You can do so by placing the commands INT10 and INT5E (for graphics and print handling, respectively) in your AUTOEXEC.BAT file to be executed on rebooting. Some packages, and specifically HBASIC, seem to replace the print handler themselves and thus are oblivious to preloading interrupt handlers.

Conclusion

Despite the flaws in its documentation and software, the Hercules Graphics Card is a fine product. The hard-

ware is well built and the architecture allows for much flexibility in constructing software. The Graph X package can provide users all the power they could want in terms of graphics primitives, and for those users whose tastes run in different directions, other companies are now coming out with more sophisticated software. In addition, some firms are modifying applications packages to use Hercules graphics. The Lotus 1-2-3 Information Manager is one such package. HBASIC is a good introduction to graphics, but people with sophisticated applications will probably want to work toward a compiled language in order to take full advantage of the Hercules Graphics Card. ■

Thomas A. Wadlow (POB 2755, Livermore, CA 94550) received a B.S.E.E. degree from Carnegie-Mellon University. He works as an engineer at the Lawrence Livermore National Laboratory.

Let the **ANGEL** do the waiting

It has been said that 30% of micro-computer users will eventually purchase a buffer. For business users, a buffer pays for itself in the time and money it saves the user not waiting for the print-out. The more you use your printer the more you need a buffer.

JAMMED PAGE RE-PRINTS



EASILY ACCESSIBLE SWITCHES

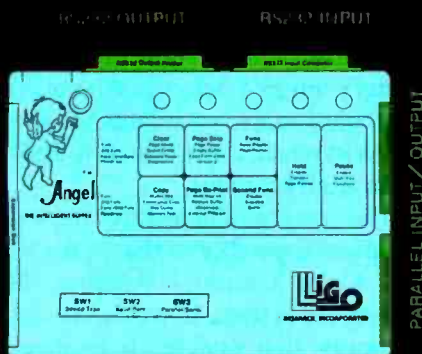

ANGEL HAS ALL INTERFACES

ANGEL. The Intelligent Buffer is the perfect mate for your system. It has both RS232 Serial and Centronics Parallel interface, and can convert from serial to parallel and parallel to serial. It is truly a universal buffer that is compatible with most microcomputer systems. This versatility means when you upgrade your system you can use the same ANGEL.

ANGEL passes data to the printer exactly as received from the computer and is independent of software — including graphics. The ANGEL also features an innovative page mode which carefully monitors the page break data during printing. Under the page mode you can reprint the last page, jammed pages, do page skip as well as page pause for single-sheet feeding.

ANGEL is an intelligent buffer with 12 additional functions that may be activated when you need them; pause, hold, copy, clear, self-test, page reprint, page skip, page pause, multi-copy, continuous copy, space compression, hex dump, etc.

ANGEL comes with 64K bytes of memory, ample for most applications. Additionally, you may activate the space compression mode which in many cases extends the buffer capacity to more than 128K.

ANGEL is designed for all types of users — even those without technical background. All switches, including baud rate selection and parallel / serial configurations are externally accessible. Installation is a matter of connecting cables, setting up DIP switches and power-on. Ligo Research makes available standard cables/adaptors for most popular computer/printers. Connection diagrams are also provided for users who want to make their own cables.



With such a good product available now, why wait for your printer to catch up? You can order the ANGEL from your dealer or call direct to 1-800-323-3304, TODAY!



396 E. 159th St., Harvey, IL 60426 • 1-800-323-3304, 1-312-331-8797 • Telex: 910 257-0850 LIGORSCH, HARV
In Canada: Computer Age, Ltd., P.O. Box 730, Nobleton, Ontario, LOG 1N0 • 1-416-859-0370

Ligo
RESEARCH, INCORPORATED

IBM Announces the PCjr

by Rich Malloy

After months of speculation and seemingly random rumors, the Entry Systems Division of IBM announced its most basic entry system, a home computer called the PCjr. The long-awaited "Peanut" features an 8088 microprocessor, a "detached" keyboard (linked via infrared light), two game cartridge slots, and compatibility with the IBM PC.

Two configurations will be offered. The basic or entry configuration has 64K bytes of RAM (expandable to 128K bytes), color graphics capability, internal slots for a single-disk drive and modem, and external connections for several peripherals, including a joystick, a light pen, serial devices, a parallel printer adapter, and an RGB (red, green, blue) display. The price of the base system is \$669.

In addition to the above, an enhanced system features 128K bytes of RAM (random-access read/write memory), a 5¼-inch, 360K-byte double-sided floppy-disk drive, enhanced graphics capability, and the ability to run many IBM PC programs. This configuration will cost \$1269.

Demonstrator units should be on display at authorized dealers during December, but deliveries are not scheduled to begin until sometime in the first quarter of 1984.

Perhaps the PCjr's most important feature is its compatibility with its bigger brother, the PC. The enhanced version of the PCjr uses a new version of PC-DOS, called version 2.1, which is available for \$65. This new version of PC-DOS is compatible with previous versions of PC-DOS, and thus many programs for the larger PC can run on the PCjr. However, this new version of PC-DOS apparently occupies a sizable amount of memory and thus limits the amount available to application

programs. Many IBM PC programs will not have enough memory available to run. Among the programs that do run are Easywriter (version 1.15), pfs:File (1.05), Multiplan (1.1), Visicalc (1.2), and IBM Logo. Peachtext runs but is not recommended.

The main circuit board of the PCjr has 72 chips, including an 8088 with the same clock speed (4.77 MHz) as that of the PC. Circuitry for the color graphics display, the serial interface, and the joystick ports is all on the main board, along with ROM chips and 64K bytes of RAM. Three expansion slots are available: one for a second bank of 64K bytes of RAM (\$140), one for a half-height disk drive (\$480), and one for a 300-bps (bits per second) internal modem (\$199). The slots are not interchangeable. An expansion bus connector is located on the right side of the machine. This is used to connect to a parallel printer adapter (\$99), which attaches to the side of the machine. The power supply is housed in a separate enclosure. There is no socket, by the way, for an 8087 arithmetic processor.

The detached keyboard has 62 keys as opposed to the IBM PC's 83 keys. A diamond-shaped cursor-key arrangement is present, but no numeric keypad or function keys are included. Instead, a function Shift key is available that transforms the numeric keys into function keys. The left Shift key and the Return key are in their normal, pre-PC places. The spacing of the keys seems somewhat different than that of a standard Selectric typewriter, however. A touch-typist's fingers will have a tendency to fall off the keys into the large spaces between them.

The most interesting thing about the keyboard is its infrared connection. The keyboard has its own power supply (four AA batteries) and can

communicate with the system unit as long as it is within 20 feet of it and in a direct line of sight of the computer's infrared detector. An optional keyboard cable is available for situations in which more than one system is in a given room.

The entry system features the same graphics capability as that of the IBM PC Color Graphics Adapter. The enhanced system, however, has extra memory that enables it to display more colors—for example, four colors in high-resolution mode (640 by 200 pixels). In addition, these four colors can be chosen from a palette of 16.

A number of peripherals and software packages were announced for the PCjr. These included joysticks (\$40) and a thermal printer (\$175). New software includes a cartridge-based version of BASIC that can access disk files and can use the enhanced graphics and sound capabilities of the PCjr. Other cartridge programs include several games (such as Crossfire) and educational programs. The game cartridges will sell for approximately \$35.

It is also interesting to note the similarity of the PCjr to the initial introduction of the PC. The first PC had a relatively limited memory (256K bytes maximum), limited storage capability (160K bytes per disk), and, of course, that controversial keyboard. In fact, rumors even circulated that these limitations were designed to limit competition with IBM's more expensive Display Writer and Data Master. Similarly, the PCjr has comparatively limited memory (128K bytes), limited storage (one disk drive), and yet another new keyboard. The PCjr will probably be a very strong contender in the home computer market. But these limitations will surely limit its competition with the PC—for the time being, anyway. ■

**MACROTECH INTRODUCES ADIT
THE I/O WITH A MIND OF ITS OWN.**

Take a load off your CPU.

Our new ADIT DMA I/O boards, used in conjunction with our complete line of dynamic memory boards, can offer you extremely efficient expansion of your S-100 system.

A Z80B microprocessor provides on-board intelligence. ADIT features up to 16 channels per slot, full software compatibility, multi-mode operations and will make all your user ports good to the last byte.

Write or phone us for complete information about how ADIT 16-channel intelligent DMA I/O boards and Macrotech modular memory boards will increase the speed and capabilities of your system.

The Macrotech family of modular products includes:

*MAX 256
MAX 512
MAX 768
MAX-M*

*MAX 384
MAX 640
MAX 896
128ST*

and

ADIT. The intelligent solution to S-100 I/O



MACROTECH INTERNATIONAL CORP., 20630 Lassen St., Chatsworth, CA 91311 (213) 700-1501

DEALER/DISTRIBUTORS: Priority One Electronics (800) 423-5922. (213) 709-5111 • Soft Machines (217) 351-7199 • IN ENGLAND: Fulcrum (Europe) (0621) 828-763

See us at Comdex booth W1078.

www.americanradiohistory.com

Circle 274 on inquiry card.

The Wang Professional Computer

Providing an easy-to-use word-processing program with sophisticated features, this 16-bit microcomputer runs MS-DOS 2.0

by Elaine Long

A year ago, Wang Laboratories entered the rapidly growing microcomputer arena with the Wang Professional Computer. The physical features of this 16-bit system are, to use a current industry buzzword, ergonomic—flexibly designed to suit limited space, neutral in color, and pleasant and easy to use.

The basic system, based on the Intel 8086 processor, provides an 8-MHz cycle speed, 128K bytes of memory (expandable to 640K bytes), a Centronics parallel-printer interface port, an RS-232C asynchronous serial interface, five expansion slots, a BASIC interpreter, built-in diagnostics, and 4-channel DMA (direct memory access) capability.

The Display

The separate monitor (see photo 1) has a pedestal base that allows you to vary the angle of the 12-inch, green-on-black, 25-line by 80-character (800 by 300 pixel) video display. An optional arm and desk clamp for the monitor provide even greater flexibility, allowing you to swing the monitor away from your working area when you don't need it. Characters are formed on an 8- by 10-pixel matrix, using the 96-character ASCII (American National Standard Code for Information Interchange) character set plus 128 additional foreign and graphics characters.

Character display attributes include boldface, inverse video, blinking, boldface underscore, reverse boldface underscore, subscript, and superscript.

The System's Keyboard

The detached keyboard pictured in photo 2 consists of 101 sculptured keys arranged in groupings with similar



Photo 2: The Wang's sculptured keyboard contains 101 sculptured keys, including 16 programmable function keys. Note the indicator lights, which can signal problems even when the display is not working.

functions. These groupings include a standard typewriter keypad, a 15-key numeric keypad, function keys for advanced operation and editing, 16 programmable special-function keys (used by Wang-supplied application programs and third-party and user-developed programs), 5 cursor-control keys, and a Help key. Knobs on the front of the monitor control display brightness. The Wang PC's display, which has an 800- by 300-pixel resolu-



Photo 1: In this configuration, the Wang Professional Computer rests on an optional stand (the PC Arm, \$150). A daisy-wheel printer (Model PC-PM010, approximately \$600) is on the left. Interestingly, the system unit, which houses two floppy-disk drives, can be placed either horizontally or vertically on a desk or it can be clamped to the side of a desk with the PC Clamp (which comes with the PC Arm).

tion, seems somewhat sharper than that of the IBM PC's monochrome monitor, which has a 720- by 350-pixel resolution. A bit-mapping scheme handles graphics. Five programmable LED (light-emitting diode) indicators on the keyboard are programmed to operate during power-on diagnostics, which takes about 30 seconds, indicating the beginning, end, and results of diagnostic tests at the start of each operation. All keyboard data is buffered; the 8086 processor is interrupted less than once every 10 milliseconds (ms). The keyboard also houses a 2-inch speaker for sound generation and thus provides audio and tactile feedback.

Two types of reaction are common to the audio-feedback feature of the Wang PC: some users love it, and others can't stand it. I found its very loud sound annoying. The feature is programmable, though, so you can reprogram the speaker to modify its volume and tone.

Disk Drives

A basic system comes with a 5¼-inch double-sided

double-density floppy-disk drive, which records 48 tracks per inch and can store 360K bytes of data. Although a great deal of software is written in a single-sided double-density format, it can still be used on the Wang PC because the computer's operating system, Microsoft's MS-DOS 2.0, enables it to also read single-sided double-density disks. You can also add a second disk drive or a 5¼-inch, 10-megabyte Winchester disk and controller. A system-diagnostics software disk comes as standard equipment.

Operating-System Features

Microsoft's MS-DOS has received much attention recently, not only because IBM chose it for its Personal Computer, but also because the test of time is revealing that this operating system stands up to the development needs of 16-bit applications. It is therefore safe to say that MS-DOS is emerging as a standard operating system. Wang enhanced MS-DOS for use on its computer.

Examples of utilities that Wang added to the operat-

At a Glance

Name

Wang Professional Computer

Manufacturer

Wang Laboratories Inc.
1 Industrial Ave.
Lowell, MA 01851
(617) 459-5000

Dimensions

Processor unit: 23.1 by 14.9 by 6.5 inches; 27.8 pounds
Video display: 11.8 by 13 by 10.8 inches; 14 pounds; angle of tilt with pedestal base: 15° back and 5° forward
Keyboard: 11.8 by 13 by 10.8 inches; 14 pounds; connected to the rear of the electronics unit by a telephone-cord-like coil

Computer

Intel 8086 16-bit microprocessor (8087 coprocessor is optional), 8-MHz system clock, 128K bytes of memory minimum and 640K bytes maximum; five expansion slots support memory enhancements and options; interfaces for disk control and video terminal control board are available; Centronics parallel port and RS-232C serial port come standard

Keyboard and Monitor

101-key detached keyboard with numeric keypad and 16 programmable special-function keys, including Help, Cancel, and Delete keys; 12-inch phosphor green-on-black display with 800- by 300-pixel resolution and 80-character by 24-line display format; 8- by 10-pixel/cell character display, 224-character set; tilt-and-swivel mount

Disk Storage

Provisions for removable- and fixed-disk storage housed in system; 5¼-inch double-sided double-density floppy disk: 360K bytes of storage, 48 tracks per inch, 250K-byte/sec data-transfer rate; single-sided double-density disks also read; additional 10-megabyte hard disk or floppy disk accommodated by expansion cabinet

Operating System

MS-DOS 2.0 permits dynamic file-space allocation, random and sequential file access, and automatic start-up; Wang-enhanced user interface enables menu mode or MS-DOS command mode of operation and provides user prompts; features include menu interface for systems utilities for file management, conversion aids, screen-formatting utilities, file-to-document conversion utilities, and program-development tools with menu-driven editor and on-line debugger

Software

MS BASIC interpreter included; BASIC compiler: \$295, MS Pascal: \$295, MS FORTRAN: \$354, MS COBOL: \$695, Asynchronous Communications: \$55, PC Word Processing: \$500, Business Graphics: \$300, Data Base: \$650, 2780/3780: \$200. Software Productivity Package (including Multiplan, Wang Word Processing, and Asynchronous Communications): \$650; remote Wangnet for VS Communications, VS Workstation Emulation, OIS Workstation Emulation, and Alliance Workstation Emulation: price not available; PC Notebook: \$200

Prices

Single floppy-disk system without monitor: \$2595
Single floppy-disk system with monitor: \$3265
Double floppy-disk system with monitor: \$3790
10-megabyte hard-disk, single floppy-disk system: \$5650

ing system include one for modification of communication parameters of the RS-232C serial port and utilities for text-to-document and document-to-text conversion. Others are Compare Data and Modify System Menu utilities. The operating system also supports four printer drivers: for the Wang PC-PM010 matrix printer, the NEC Spinwriter 3530, a general parallel printer, and a general serial printer.

In keeping with the goal of ease of use, the Wang PC, unlike the IBM PC, does not require users to learn the MS-DOS command structure. Instead, a user can perform all file functions on the Wang machine using standard English menu prompts. Photo 3 illustrates the operating-system utilities menu, and photo 4 shows an applications menu. The MS-DOS command-language mode is available, however, so that users familiar with that mode of operation can utilize it. Help screens are available to assist with nearly all selections within the operating system.

Word Processing

Wang Laboratories has set many standards for word processing, and the word-processing system designed for this computer approaches the same levels of sophistication and ease offered by the company's dedicated word processors. The Wang PC, however, is designed for use by people who have had no formal training in the use of data- or word-processing systems.

"It is our feeling," said a representative of Wang Laboratories, "that if the professional cannot learn to use the word-processing package within 30 minutes, he will never learn to use it." Through the extensive use of word-processing function keys and a hierarchical menu structure, Wang word-processing software has, to a large degree, achieved the company's goal and made the system simple to learn.

The word-processing screen is headed by a primary-status (or format) line that indicates the name of the document the operator is using as well as its page number and the line and location in the line where he is working (see photo 5). [Editor's Note: Photos 5 and 6 show menus of version 1.0 of Wang's word-processing package. Version 2.0, discussed in this review, provides enhanced features.] The format line controls the vertical line spacing, tab settings, and line length of all text following it. Along with standard single-, double-, and triple-spacing, you can format one-and-one-half-, half-, and quarter-spacing. Although the system can display only 80 characters across the screen, a horizontal-scroll feature lets you view and create documents with widths to 158 characters.

You can change the default format line fairly easily. You merely move the cursor to the home position, press the Format function key, make the necessary changes in the format mode, and then press the Execute key. The format line can be revised anywhere within a document, for such purposes as creating tables. The primary format, or any alternate format you have established, can then be recalled when needed.

Version 2.0 permits handling pagination either as you enter text by highlighting a suggested page break or at the end of the document's entry. For example, when text entry reaches line 55, enough text to fill a standard 8½-by 11-inch sheet of paper leaving adequate margins, the system sounds a tone and highlights the status line. You can then either enter a page break with the Page function key or continue text entry and set pagination when you're finished typing the document.

Using the function keys marked Previous and Next, you can scroll through a document screen by screen. When you move from one screen to the next, three lines of the previous screen's text appear at the top of the screen. A paging symbol signifies page separation. This logical method makes you aware of page breaks, although you are actually scrolling through screens rather than pages, and thus simulates the way you would page through a manuscript.

Global search and replace, a function incorporating both the search and the replace functions, requires that you position the cursor under the first character of the string you want to replace, hold down the Shift key, and press the Replace function key. While you move the cursor through the string you want replaced, its characters are highlighted. The screen then prompts, "Replace it?" and you have the option of performing an automatic global replace throughout the document or a selective replace.

I tested the speed of the automatic-replace function by entering a 200-word English-language document and copying it onto 10 screen pages, creating a 2000-word document. The last word on each page, the German word "Geschwindigkeit," I replaced with its English translation: speed. From the initial point of pushing the Shift and Replace keys to the replacement of the last occurrence of the word Geschwindigkeit, the procedure took 51 seconds. I then tested to see how quickly I could "page" through this same document. It took 32 seconds to scroll from page 1 to page 10.

The insert function is a bit unusual. When you press the Insert function key, all characters except the 29 immediately following the cursor disappear from the screen. Those 29 characters appear in the left-hand bottom of the screen while text is inserted. This movement may startle some first-time users, causing them to think that they've lost part of their text.

You can recall menus during text entry to select all the command functions and character attributes, including boldface, underscore, double underscore, subscript, and superscript. Photo 6 shows a menu displayed on a Wang PC monitor. You can use command functions and character-attribute automodes, however, without accessing those menus. The commands and automodes work well and are easy to use. Character attributes are displayed accurately on the screen, with boldface characters shown in reverse video.

The Wang word-processing program does not display right-hand justification, however, which might cause problems for some users. Instead, justification is handled



Photo 3: The menu of utility programs included in Wang's version of the MS-DOS operating system.

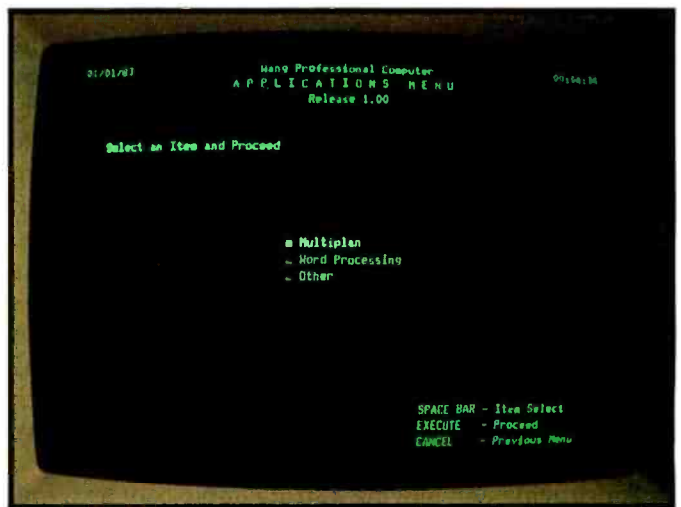

Photo 4: A menu of application programs in Wang's version of MS-DOS.

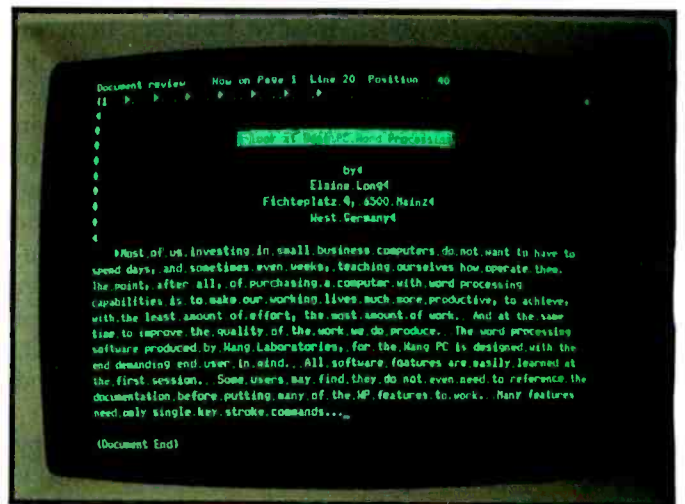

Photo 5: An example of text produced by Wang's word-processing program. The summary line and format line are at the top. Spaces are indicated with half-intensity periods.



Photo 6: A menu of commands for Wang's word-processing program.

during printing.

Another feature of the word-processing package, the glossary function, will be used extensively in offices by professionals who have much correspondence or prepare many documents. This function permits you to recall and insert, at any point in a document, an unlimited amount of standard text and editing formats. It is useful, for example, for often-used tables and forms. Learning how to use the glossary feature might take more time for a novice than learning any of the system's other word-processing features, but anyone who takes advantage of it will discover that preparing and using a glossary will help save time by eliminating much repetitive typing. The glossary is easily recalled with two keystrokes.

For copying and moving a string or block of text, four separate operations are available: copy, move, super copy, and super move. The copy and move functions affect text within one document and are handled with Copy and Move function keys. The super copy and super move functions, however, involve transfers between documents, which may be on the same disk or on different ones.

When you are finished with text entry or editing, you push Cancel, to which the screen responds "End of Edit?" If it is, you push Execute. Then a "rearranging" statement briefly appears on the screen, followed by the main word-processing menu. Executing the Print Document option brings you to the printing menu. After you've selected various printing options (number of originals, page length, margin setting, character set, pitch, justification, form type, and lines/inch) and pressed Execute, printing starts instantaneously.

Version 2.0 has a menu for document handling: copy doc., delete doc., and prepare new disk (format a disk). This menu is convenient to use and saves time, especially when the system is using only floppy disks. You do not have to go out of the word-processing program and back into the operating system to perform these operations.

Another feature of version 2.0 is a spelling checker with a 30,000-word dictionary that you can customize.

The software also performs an alphanumeric sort for a maximum of eight pages of 4000 characters each, sorting as many as four fields in one pass. Also available is a math function that performs multiplication, division, addition, and subtraction in columns and rows, providing totals, subtotals, grand totals, and verification of previously computed data. Because version 2.0 requires 128K bytes of memory, Wang Laboratories suggests that you start with 256K bytes of system memory.

Applications Software

Options include FORTRAN, Pascal, and COBOL compilers and a macroassembler. In addition, Multiplan, a financial planning and modeling package, has been licensed from Microsoft for use on the Wang PC. Also, Wang has recently released PC Notebook, a highly flexible database using an unstructured data format.

One of the first programs Wang Laboratories developed for the PC is communications software for asynchronous and synchronous communications, opening the way for Wang workstation emulations and remote Wangnet applications.

With the 3276 SNA/SDLC and 3270 BSC (Bisync) software packages, the Wang PC can function as a remote terminal, communicating with host mainframe computers and the IBM 3287 and 3284 printers. The packages permit the Wang PC to actively interact with many IBM mainframe systems, accessing host application programs or timesharing options, without changing the host application programs. Both of these emulation packages also support the IBM 3278 terminal keyboard.

Much third-party software is also available for the Wang PC. Peachtree Software Inc. has released a number of business packages. Among them are Inventory Management, Accounts Payable, Job Costing, Sales Invoicing, and Payroll programs. Available, too, is 1-2-3, a combination database, business graphics, and spreadsheet package from Lotus Development Corporation, as well as TK Solver, a mathematical-calculation package designed for financial planners, designers, and engineers. In the Software Connections program, Wang Laboratories has released an industry/applications-software cross-reference to aid in matching users' needs with available software.

This brings us to that big question of IBM PC/Wang PC software compatibility. Both systems use the same operating system, disk media, and microprocessor (the Wang PC uses the 8086; the IBM PC, the 8088). The contents, therefore, of any disks written by the IBM PC can be read by the Wang PC. And as long as an application program written for the IBM PC does not circumvent the I/O (input/output) facilities of the operating system, the Wang PC is fully compatible with the IBM PC.

But very rigorous market conditions have compelled some independent software companies to target applications software for use on a specific computer. Examples are those programs that were developed specifically for

Turbo Charge Your Apple[®] With Buffering!



If you use a printer now...

Bufferboard[™] For Apples and Printers

The Bufferboard is the original add-on buffer upgrade for existing interfaces. Easily installed, its memory power can store up to 20 pages of your Apple text data at a time. The Bufferboard accepts print data as fast as your Apple can send it. Then the Bufferboard transmits to your printer, while your computer races on to its next task.

The Bufferboard uses an available Apple slot and "Docks" onto most popular interfaces, including Epson, Apple and Orange Micro Grappler configurations. No external power supplies, no clumsy boxes and cables. It's the easiest and most economical way to add buffering.

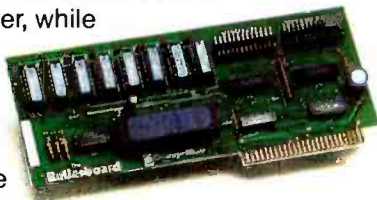

1400 N. LAKEVIEW AVE., ANAHEIM, CA 92807 U.S.A.
(714) 779-2772 TELEX: 183511CSMA

© Orange Micro, Inc., 1983

International Distributor Inquiries Invited.

If you're just adding a printer...

Buffered Grappler +[™]

The Buffered Grappler + is the most powerful Apple printer interface you can buy. All the memory features of the Bufferboard have been merged with the smartest interface available... the Grappler +. The Buffered Grappler + now gives you over 27 different built-in features. Buffer expansion capability allows up to 20 full pages of text memory. Exclusive new features give you special support of Ile 80 column text, screen dumps for Epson graphic aspect ratios, and support of the new Ile Double Hi Resolution Graphics.

Other features you'll be using in no time include Dual HiRes Graphics, Mixed Mode Screen Dumps, Enhanced Graphics, text formatting and much, much more. The New Buffered Grappler +. So much interface power you'll never need anything else.

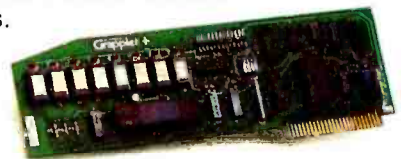

See us at Comdex booth #2581.

Apple is a registered trademark of Apple Computer, Inc.
Epson is a registered trademark of Epson America, Inc.

use on the IBM PC, taking advantage of machine-dependent capabilities. Techniques used in developing a machine-dependent software package include bypassing the operating system's I/O capabilities, the use of keyboard-specific function keys and display-specific attributes, and the use of machine-specific subroutines in the BIOS (basic input/output system), ROM (read-only memory), or PC-DOS. Therefore, not *all* application packages developed for the IBM PC will operate on the Wang PC without modification. But because the Wang PC and the IBM PC use the same type of operating system, microprocessor, and disk media, machine-dependent packages can be easily modified through the software source code. For those programs that do not

The documentation supplied with the Wang PC does not talk down to readers to the point of insulting them.

operate on the Wang PC, Wang Laboratories suggests that you request the software's vendor to modify them, because source code is generally not available to customers. And since Wang released the technical reference manual for the Wang PC, it has become a simple matter for a software developer to make such modifications.

System Expansion

The basic unit has five expansion slots. RAM (random-access read/write memory) is expandable to 640K bytes. If you install a CP/M emulation card, which has a Z80 microprocessor, the system can use applications software written for the CP/M-80 operating system. Two types of video cards can be used: the Wang monitor card (for Wang's monochrome monitor) or an industry-standard graphics card that supports any RGB (red-green-blue) monitor or NTSC (National Television System Committee) black-and-white or color television. The unit can house a 5¼-inch, 10-megabyte Winchester disk drive with controller card. The basic system also includes an industry-standard parallel port for connecting a printer and an RS-232C asynchronous serial port for terminal emulation and remote or internal communications.

When you use the Wang PC with the 3276 SNA/SDLC and 3270 BSC emulation software, you will need a multiport communications card, a modem cable, and an RS-232C/CCITT V.24 modem.

The system software sends the eighth bit of each byte to the printer to take advantage of the international character set and dot-addressable printers for graphics capabilities. Because it sends the eighth bit, however, it is not fully operable with all printers on the market. The four printer drivers within the operating system solve that problem to a large degree. The two general printer drivers, however, do not support *all* possible printer functions. I have been using the Epson FX-80 matrix printer, which, with the one exception of the

double-underscore function, fully supports the system's word-processing software. I would think, though, that manufacturers are rushing to make their printers compatible with as many systems as possible. Therefore, many other compatible printers are probably available now.

Documentation

The documentation supplied with the Wang PC does not suffer from the problems that much of the documentation written over the past few years experienced. It is not weighed down by an overabundance of user-friendliness, nor does it talk down to readers to the point of insulting them. Instead, *The Introductory Guide* is thorough and logically organized. It may, in fact, prove too thorough for some users. The manual is, however, written for everyone, covering the spectrum of required information from such basic material as how to insert a floppy disk to batch processing in the DOS command processor. As in all the documentation provided, illustrations, a table of contents, appendixes, and an index are supplied.

The BASIC Language Guide, provided with the system, is a straightforward manual designed for use by programmers familiar with standard BASIC programming. For the user who has the time, *The Word Processing Training Guide* covers all of the word-processing package's features. I found that an efficient way to quickly learn to use the package is to instead go through the *WP Reference Guide*. All of the system documentation comes in loose-leaf binders, making the insertion of updates and user notes convenient.

Prices

The basic Wang Professional Computer, Model PC 001, provides 128K bytes of memory, a 5¼-inch floppy-disk drive with 360K bytes of storage, the MS-DOS operating system, Interpretive BASIC, and a keyboard. It costs \$2595.

The Wang PC 002 includes those features plus a monochrome monitor and controller for \$3265. Adding a second drive to the PC 002 configuration produces the PC 003. This costs \$3790, comparing favorably with a similarly equipped IBM PC, which sells for \$3800.

These prices include diagnostics software and documentation but not applications software. For \$650, Wang sells a Software Productivity Package, which includes Multiplan, Wang Word Processing, and asynchronous-communications software. Wang also sells programming-language interpreters and compilers as well as many applications-software packages. A CP/M card costs \$600, and a 10-megabyte Winchester disk drive with a controller sells for \$2385.

Summary and Conclusions

The Wang PC system, based on 128K bytes of RAM, the 16-bit 8086 microprocessor, and MS-DOS 2.0, a 16-bit operating system, was designed to meet the rapidly growing hardware demands of a new generation of soft-

ZERO TO MULTIPLAN™ IN 5.2 MINUTES.

FINANCE OR ACCOUNTING WORKSHEETS FAST.

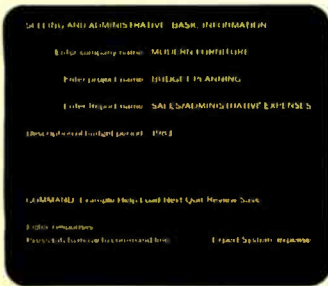

Gentlemen, start your computers.

Time: 0



Select budget intervals.

Time: 0.5

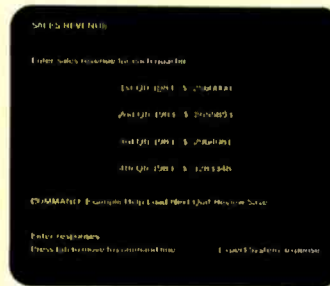

Enter sales revenue.

Time: 1.0



Enter selling expenses.

Time: 1.5

	1	2	3	4	5
BUDGET EXPERT SYSTEM - SALES AND ADMINISTRATIVE EXPENSES					
1 SALES REVENUE	2,500,000	2,500,000			
2 VARIABLE SELLING EXPENSES	250,000	250,000			
3 CONTRIBUTION	2,250,000	2,250,000			
4 OTHER	100,000	100,000			
5 TOTAL VARIABLE & OTHER	350,000	350,000			
6 CONTRIBUTION	1,900,000	1,900,000			
7 SALES AND ADMINISTRATIVE EXPENSES	200,000	200,000			
8 DEBIT	200,000	200,000			
9 CREDIT	200,000	200,000			
10 NET	1,700,000	1,700,000			

Your sales budget on the Multiplan electronic worksheet - in record time.

Time: 5.2

First, Microsoft created the Multiplan interactive electronic worksheet, to help you analyze your business problems and explore possible solutions. Without asking you to become a computer expert.

Now we've added the Multi-Tool™ budget and financial expert systems. They can help design

and build financial or accounting worksheets tailored to your specific needs. In minutes.

You won't have to worry about developing formulas or formatting screens to build your Multiplan worksheets. Because the expert systems literally do it for you.

For example, the Multi-Tool Budget expert system creates seven inter-related

Multiplan worksheets for a total budget planning and control environment.

What's more, each system is developed by experts: business professionals and leading authorities in finance and accounting.

You'll benefit from their knowledge immediately, through the powerful worksheets each Multi-Tool expert system builds for you. And with the sophisticated tutorial manuals that accompany each system. Each manual provides in-depth information about both the design of the worksheets and the areas of finance and accounting they cover.

The result: a tailored electronic worksheet that helps you make high quality decisions.

That's just what you'd expect from Microsoft. The people who let you concentrate on your business rather than on your computer.

Ask your computer dealer to let you test drive the new Multi-Tool expert systems. Better tools that help you put your business in first place.

THE MULTI-TOOL EXPERT SYSTEMS. A POWERFUL ADDITION TO THE MULTIPLAN ELECTRONIC WORKSHEET.

Available now:
The Multi-Tool Budget expert system.
The Multi-Tool Financial Statement expert system.

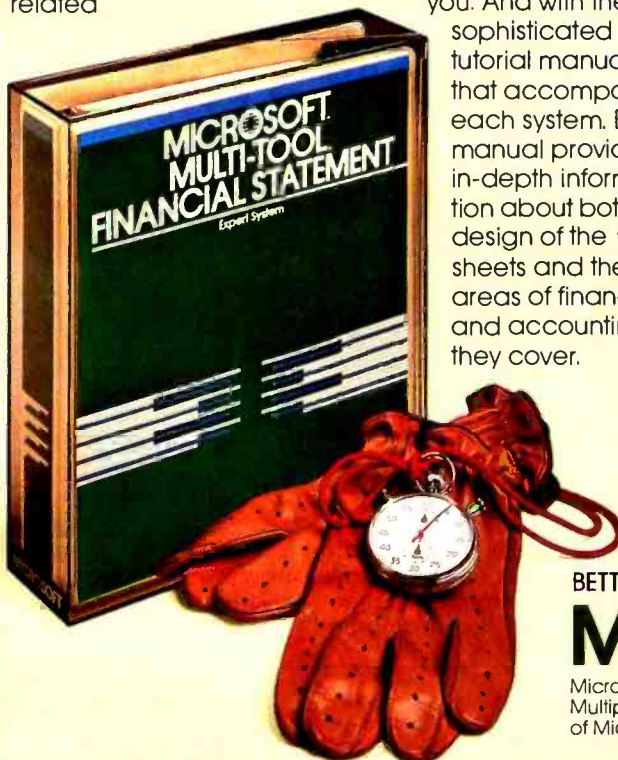

BETTER TOOLS FOR MICROCOMPUTERS

MICROSOFT™

Microsoft is a registered trademark, and Multi-Tool, Multiplan and the Microsoft logo are trademarks of Microsoft Corporation.

ware. For example, some users may think that a minimum requirement of 128K bytes for a word-processing application is excessive. Trends in software development, which provide new features (many approaching high-end dedicated word processors and typesetting systems) to less sophisticated users, however, will require at least this amount.

The system processor is powerful and fast. To test its speed, I ran the BASIC version of the Sieve of Eratosthenes prime-number program (see the January 1983 BYTE, page 286, listing 5) as a benchmark test. For 10 iterations of the Sieve program, the results were 940 seconds—less than half the time required for the IBM PC running Integer BASIC with an 8-bit bus at 4.77 MHz, according to the results published in the BYTE article. Speed is, of course, only one of many criteria to use when evaluating the performance of small systems. When considering soon-to-come hardware and user-friendly software developments, however, this factor takes on greater importance.

The Wang-developed word-processing program is superb. You would be hard-pressed to find a PC word-processing program that so successfully combines such ease of use with such sophisticated features.

Wang Laboratories designed the PC to adapt to all business and technical environments. The use of a nonstandard (read non-IBM) expansion-card format might prove a shortcoming, though. The availability of

the technical reference manual, however, should rectify that problem.

Moreover, the Professional Computer is designed to be incorporated into Wang systems. As more PC systems are used in large-business environments, interconnecting with mainframes will be a growing demand. Wang has addressed that requirement already.

In the first half of 1984, Wang plans to release a local interconnection option, a combination of hardware and software that will permit Wang PCs to run in a shared mode. Each repeater card will support as many as eight PCs, and repeaters will be able to interconnect via RG-62A coaxial cable. This option will thus allow a total of 24 PCs to be interconnected.

Wang Laboratories has also produced some high-quality applications software, and the company is actively encouraging development of third-party software, much of which is already on the market. Thus, the amount of software available for the Wang PC should grow steadily. ■

Photos 2 through 6 in this article are courtesy of Elphotec Computer Systems (Schiessgarten Str. 7, 6500, Mainz, West Germany).

Elaine Long (Fichteplatz 4, 6500, Mainz, West Germany) has a B.A. in Communications from the University of Delaware. She is an assistant editor at International Publications GmbH.

SATISFY YOUR DRIVES!

70 MAIN/FRAMES & DISK ENCLOSURES FROM \$100

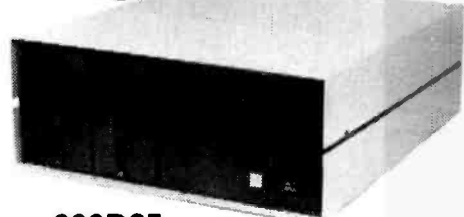

800D2F
5" Floppy Main/Frame
(10 cards) **\$392**

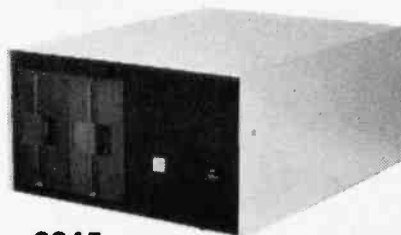

2215
5" Floppy Winchester
Main/Frame (7 cards) **\$380**

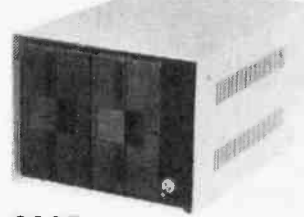
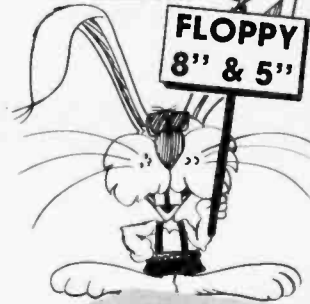

2905
5" Disk Enclosure **\$100**

32 Page
Free Fakt
Pakt Catalog

Write or call for our brochure which includes our application note: "Making micros, better than any ol' box computer"

NEGRAND

8620 Roosevelt Ave./Visalla, CA 93291
209/651-1203

We accept BankAmericard/Visa and MasterCard

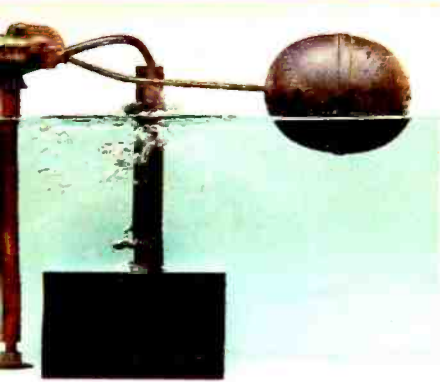

Six things you can do with your obsolete floppies.

Floppies were fine in their day. But they just don't make sense with the professional desktop computers of today.

What's the answer? The DMA 360 removable 5 1/4" Winchester. It's exactly the same size as a 5 1/4" half-height floppy drive – but that's where the similarity stops.

The DMA 360 gives you hard-disk reliability. Floppies don't.

The DMA 360 protects your data in a totally sealed cartridge. Floppies don't.

The DMA 360 packs 7.5 megabytes on a single ANSI-standard cartridge. Floppies don't. It takes up to 25 floppy disks to achieve an equal capacity.

The DMA 360 even has a lower cost-per-megabyte than a floppy. But it gives you so much more.

Like an average access time of 98 milliseconds. A transfer rate of 625 kilobytes per second.

And an error rate that's on par with the most reliable conventional Winchester disk drives.

There's no way you'd get that kind of performance from a floppy!

In fact, anything you can do with a floppy, you can do even better with a DMA 360. That's why we call it the floppy replacement.

For more information on what you can do with your obsolete floppies, write DMA Systems, 601 Pine Avenue, Goleta, CA 93117. Or call us at (805) 683-3811, Telex 658341.

Introducing the floppy replacement: DMA Systems' new half-height removable 5 1/4" Winchester.

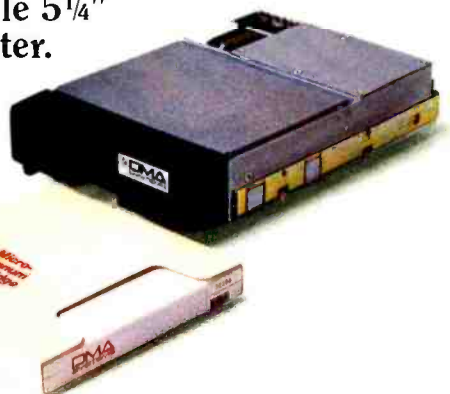

COMDEX/Fall '83

See us at Comdex booth number 166.

DMA SYSTEMS

The Removable Winchester Company.

Circle 156 on inquiry card.

NOW YOUR COMPUTER FITS THE ORIGINAL ARCADE HITS.

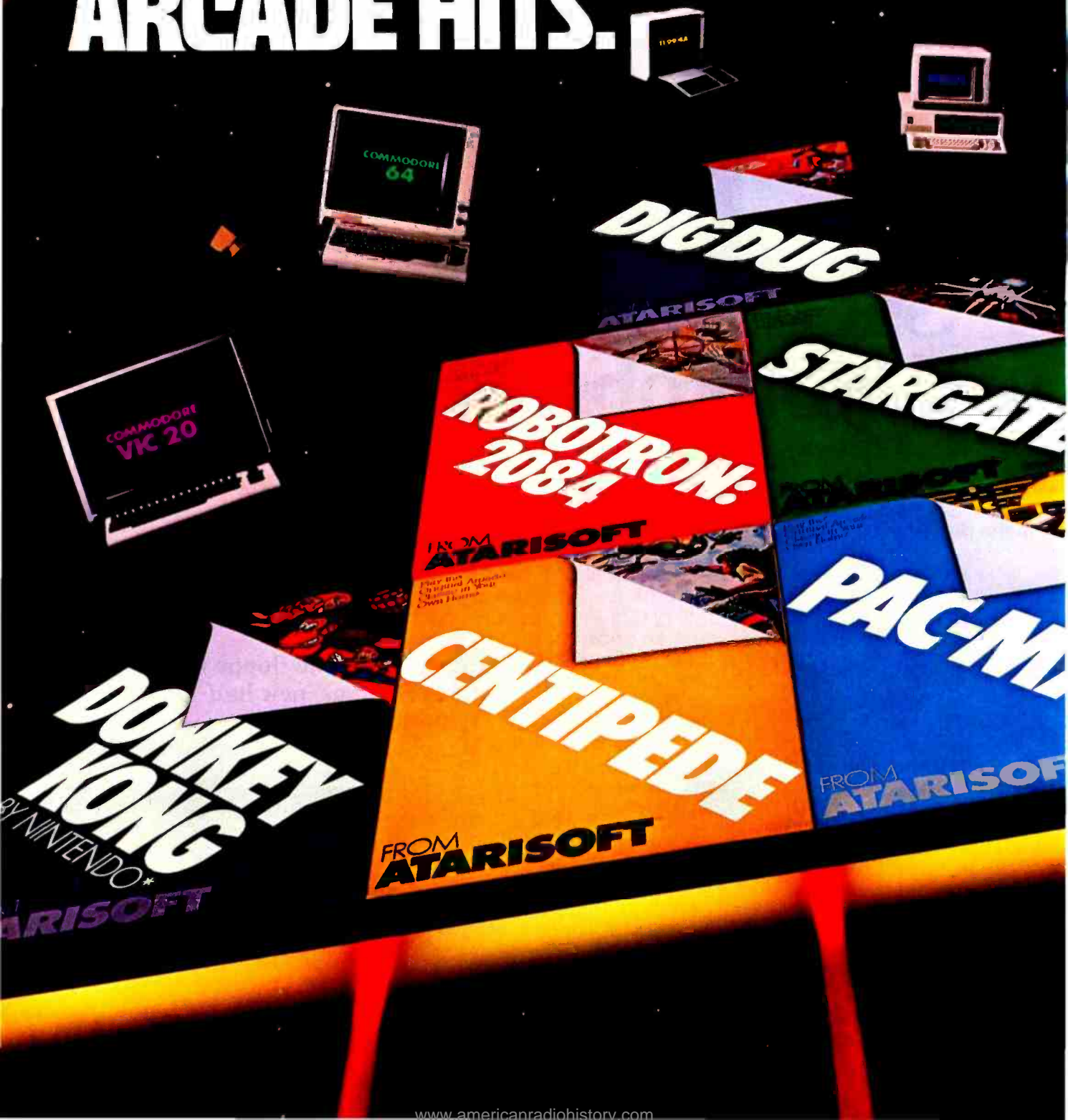

**DONKEY
KONG**
BY NINTENDO*
FROM ATARI

**ROBOTRON:
2084**
FROM ATARI
They Use
Controlled Armada
Ships in War
Over Home

CENTIPEDE
FROM ATARI

DIG DUG
ATARI

STARGATE

PAC-MAN
FROM ATARI

Now the excitement of original arcade graphics and sound effects comes home to your computer.

Introducing ATARISOFT.™ A new source for computer software.

If you own a Commodore VIC 20 or 64, a Texas Instruments 99/4A, an IBM or an Apple II, you can play the original arcade hits.

DONKEY KONG by Nintendo, CENTIPEDE,™ PAC-MAN, DEFENDER, ROBOTRON: 2084, STARGATE and DIG DUG. (On the TI 99/4A you can also play Protector II, Shamus, Picnic Paranoia and Super Storm.)

So, start playing the original hits on your computer.

Only from ATARISOFT.

Some games also available on ColecoVision and Intellivision.

ATARISOFT™

Now your computer fits
the arcade hits.

DONKEY KONG, Mario and NINTENDO are trademarks and © Nintendo 1981, 1983. PAC-MAN and characters are trademarks of Bally Midway Mfg. Co. sublicensed to Atari, Inc. by Namco-America, Inc. DEFENDER is a trademark of Williams Electronics, Inc., manufactured under license from Williams Electronics, Inc. ROBOTRON: 2084 is a trademark and © of Williams 1982, manufactured under license from Williams Electronics, Inc. STARGATE is a trademark and © of Williams 1981, manufactured under license from Williams Electronics, Inc. DIG DUG is created and designed by Namco Ltd. manufactured under license by Atari, Inc. Trade-marks and © Namco 1982. PROTECTOR II is a trademark of Synapse Software Corporation, manufactured under license by Atari, Inc. SHAMUS is a trademark of Synapse Software Corporation, manufactured under license by Atari, Inc. PICNIC PARANOIA is a trademark of Synapse Software Corporation, manufactured by Atari, Inc. SUPER STORM is engineered and designed by Synapse Software Corporation, manufactured under license by Atari, Inc. ATARISOFT™ products are manufactured by Atari, Inc. for use on the above referenced machines and are not made, licensed or approved by the manufacturers of these machines. COMMODORE 64, VIC 20, TEXAS INSTRUMENTS 99/4A, IBM, APPLE, COLECOVISION and INTELLIVISION are respectively trademarks of Commodore Electronics Limited, Texas Instruments, International Business Machines Corp., Apple Computer, Inc., Coleco Industries, Inc. and Mattel, Inc. A Warner Communications Company. ©1983 Atari, Inc. All rights reserved.

Complete this coupon and we'll keep you up to date on the newest hits from ATARISOFT.™

Name _____

Address _____

City _____

State _____

Zip _____

Telephone _____

PRODUCT OWNED: (Check one)

1 TI-99/4A

5 Commodore
Vic 20

2 IBM PC

6 Intellivision

3 Commodore 64

7 Apple II

4 ColecoVision

8 _____

Mail to:

Atari, Inc., P.O. Box 2943,
So. San Francisco, CA 94080.

ASM 2

Circle 36 on inquiry card.

In Search of the Most Amazing Thing

*An adventure game proves that the IBM PC isn't all business
(the game also runs on Apple, Atari, and Commodore 64 machines)*

by Elaine Holden

The advertisement reads: "Finally, aliens kids can reason with instead of destroy." Fulfilling that promise for children and adults accustomed to shoot-'em-up space games is a tall order. Intrigued but somewhat skeptical, I took the program home, plugged it into my IBM PC, and went on an adventure. And what an adventure!

In Search of the Most Amazing Thing was created by Tom Snyder Productions and is sold by Spinnaker Software. This educational adventure game encompasses an entire world called Porquatz. Half the world is very dull, but the other half, called the Darksome Mire, is covered

by a "near mist," filled with deadly mire crabs, fascinating tribes, unusual and varied terrain, and erratic winds.

The game offers you this world to explore in your quest for a hidden object, and its consideration to details is extensive. The graphics are delightful and beautifully done. Along with them are comments and hints given by various citizens of Porquatz. Some clues are merely helpful, others are lighthearted as well. I delight in this type of adventure after being subjected to grimly determined games with a do-or-die, blast-them-out-of-the-sky attitude. If you don't want to be fighting star wars for the rest of your life, this adventure is right on the money.

The Journey Begins

The game involves a nonviolent search for an object called the Most Amazing Thing, lost by Uncle Smoke Bailey many years ago. Uncle Smoke, wishing you to bring this Most Amazing Thing back to his home in Metallica (a city in the Darksome Mire), provides you with a B-liner, a combination hot-air balloon and dune buggy. You must fly through storms, drive over land covered with bogs, deal with aliens, and create music before finding the Most Amazing Thing. Uncle Smoke also gives you plenty of advice as well as a jet pack for short trips outside the B-liner.

Every player begins the game atop a cement island in the middle of the Darksome Mire, standing next to the B-liner and a trap door. I entered the door and took



Photo 1: Uncle Smoke's apartment. The chest next to Uncle contains treasures that can be auctioned off to the Metallicans.

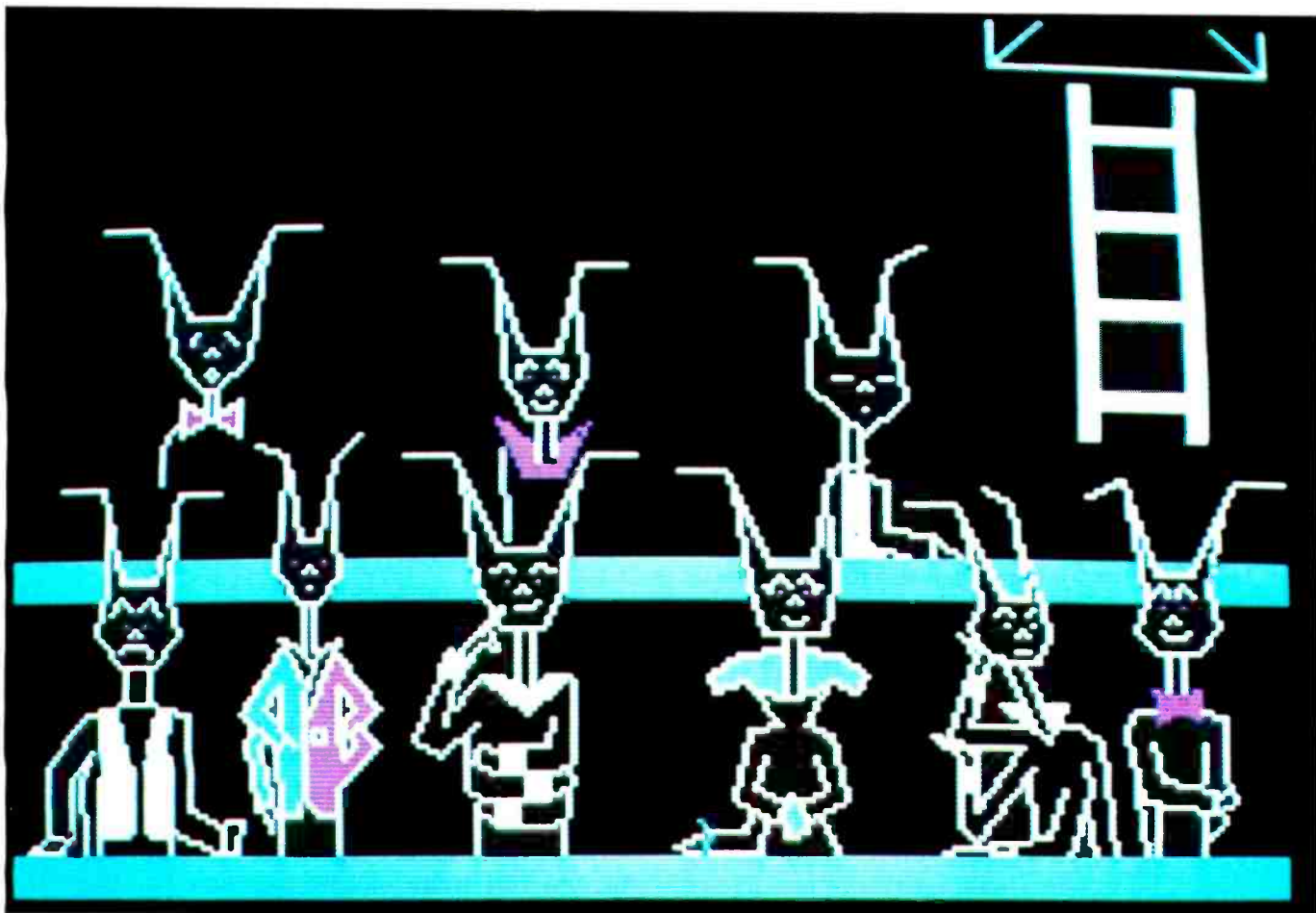

Photo 2: *The Metallican auction. The slippery folks pictured here can barter you out of treasures given to you by Uncle Smoke.*

a nearby elevator to the underground city of Metallica. The elevator allowed three stopping points: Uncle Smoke's apartment, the Galactic store, and the great Metallica auction. My first stop was the usual courtesy call to relatives in the neighborhood (see photo 1). Politeness paid off. Uncle Smoke gave me a clue to the whereabouts of the Most Amazing Thing and a petrified clam shell from Trellis Bog. Uncle suggested I sell the latter and keep notes of the clue. Bringing my relic to the auction (see photo 2), I proceeded to dicker with the Metallicans for the best price. (It took me a number of games to learn how to adjust my prices to realistic levels, and in the meantime those cagey fellows made off with several of my best treasures. The moral? Greed does not pay. Here's a hint: the auctioneer takes a single number from one to nine only.)

Eventually I accumulated sufficient chips for a trip to the Galactic Store. (All items and prices are listed in the instruction booklet as well as on the screen.) It is necessary to read the descriptions of items carefully. Some, such as the software packages Musix and Dicto, are necessary to communicate with the various cultures you will encounter and should be purchased. Others, such as the ultrasonic robot dog groomer, are luxury items only.

Inside the B-liner

Your first goal is to fully equip the B-liner (see photo 3) prior to takeoff. In order to maneuver, the machine needs navigation equipment, which must be purchased at the Galactic Store. You (the pilot) decide which meters to buy for outfitting the control panel (photo 4), then count your chips and begin purchasing software for the B-liner's on-board computer. And don't forget such packages as Musix and Dicto; surprisingly enough, several adults I know got into the game with a fully equipped flight-control panel and found themselves successfully flying over the Mire, but when they encountered aliens, they had no way to ask them clues or directions. (Conclusion: decision-making skills can be learned at all ages.)

After the B-liner is equipped, you are ready for take-off. While flying over the Darksome Mire, you must carefully consider wind direction. The winds come from different directions at various heights, necessitating moving the B-liner up or down until the proper direction is found.

Interspaced with huts and mire crabs are night rocks and popberry trees for fuel and food, respectively. To fuel the ship, I had to land the B-liner on one of these rocks, get out, jockey my jet pack to the drill platform,



Photo 3: The interior of the B-liner. Once in this compartment you can give various commands to operate the liner, leave, or communicate with different cultures.

and fuel up. Much the same procedure is required to eat (see photo 5), except that once I took the popberry off the tree, it often sank into the bog before I could navigate the jet pack down to it. Bitterly I watched a 12-year-old execute the maneuver perfectly and well within the time limit. Through perseverance, I managed to feed myself and then returned to the ship.

A Computer within a Computer

The software for the B-liner's computer is one of the most exciting parts of the game. The Map-H software, for example, locates every hut in the Mire. The Cults software contains facts about the people of each Mire culture, and Dicto translates important words and phrases used by all 25 cultures in the Darksome Mire. Musix is the software that shows you how to create songs, which are used for trading with the Mire cultures.

All cultures speak with their antennae. Dicto software shows the different shapes made to form words while also providing the corresponding tones. Six basic phrases are common to all cultures, but the symbols of each vary, according to the culture. Thus, the phrase "What is your quest?" can be expected from any culture, but the antenna patterns and tones vary.

Because each culture trades in Musix, you can make a song to trade with a culture in return for information. To do so, you draw any shape you want using the arrow keys, and when you finish, the picture and corresponding tones are played back, ready for trade. Cults software informs you as to the type of Musix the culture prefers.

World without End

Most adults experienced at playing computer games can complete this adventure in 10 to 12 hours. Two or more 10-year-olds (up to an entire class) working together can get through it in 20 to 30 hours. Lest you think the game can be shelved once you've found the

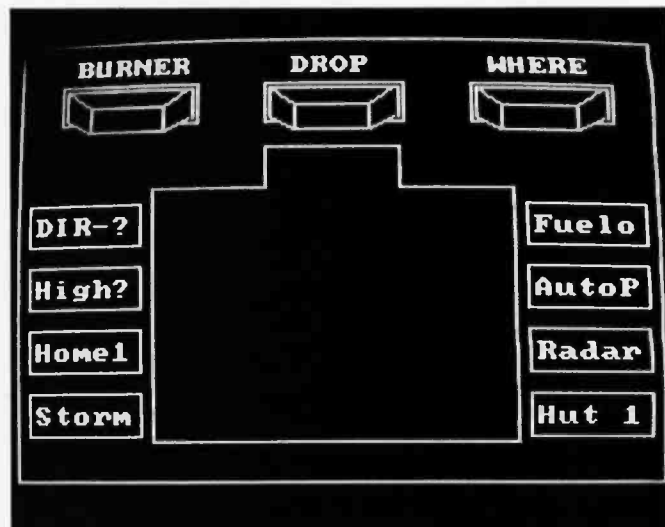

Photo 4: The flight-control panel of the B-liner.

Most Amazing Thing, tricky ol' Tom Snyder, creator of this highly enjoyable fantasy, has designed the program to change the location of the Most Amazing Thing every time the game is played. You can, of course, stop the game any time you wish and save your position so as to return later and carry on where you left off.

The adventures and experiences are richly entertaining and vary tremendously each time you play. The game convinces me that in an adventure violence is unnecessary to keep the imagination and intellect enthralled.

Adventure in the Classroom

In Search of the Most Amazing Thing should not be considered just an adventure game, however. The educational applications are numerous and, to a teacher, just as exciting.

One of the battles teachers fight every day is getting students to understand the value of note taking. To be able to instantly produce a historic date or obscure fact is not reason enough for most students to perform the exhaustive task of putting pen to paper.

Since this fact dawned on educators, they have been frantically trying to find relevant and interesting information that students will wish to retain. This program should provide the important motivation necessary for teaching note taking. Adventurers must recall, for example, all the advice from Uncle Smoke as well as information about the various cultures. Careful records must be kept on music preferences and antenna patterns. Organization of these notes for quick reference is critical.

Records of the amount of chips in your possession also prove very handy. Basic math is required when dealing with chips both during the auction and when trading with the cultures in the Mire. Players must further exercise their computational skills when evaluating meter readings and interpreting map coordinates.

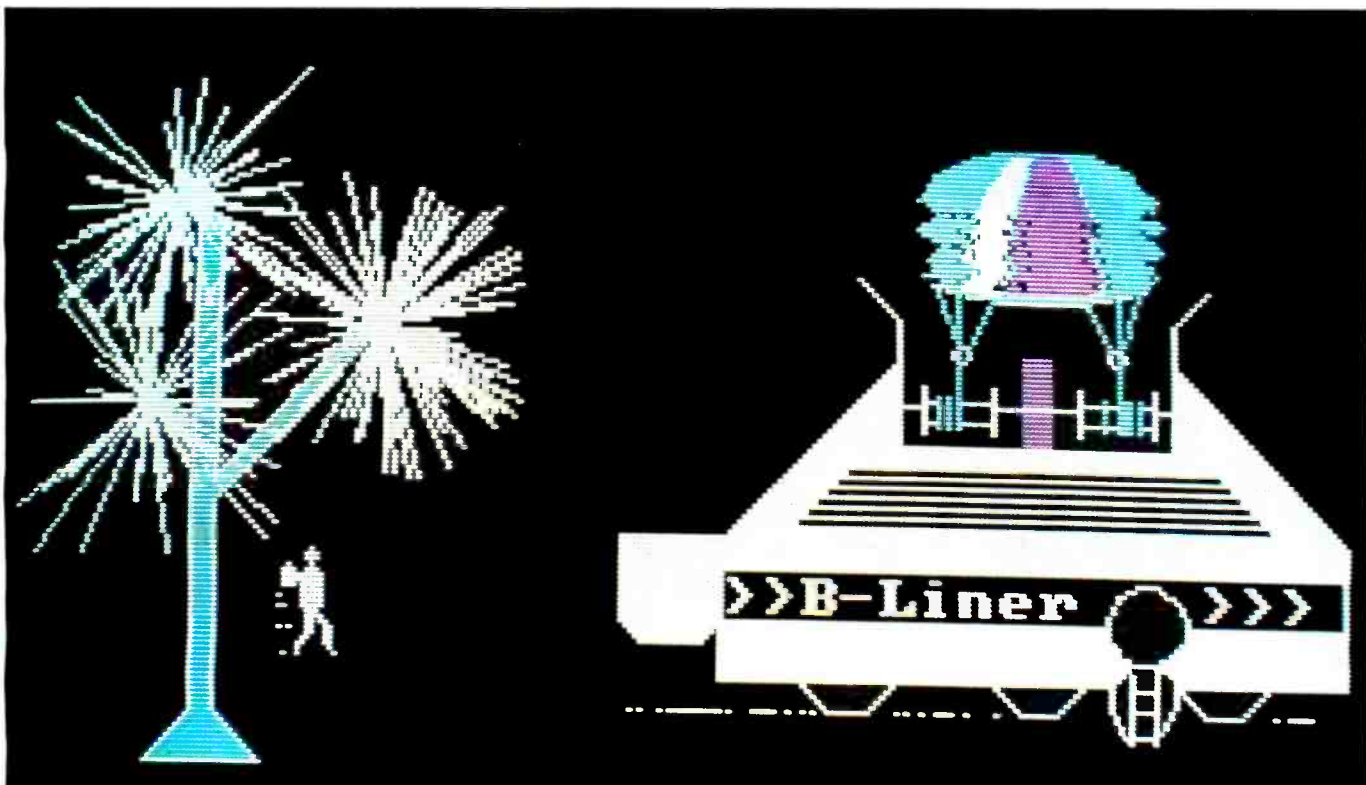

Photo 5: An adventurer (in jet pack) leaves the liner and flies to a popberry tree to eat. (Navigation takes talent; find a 12-year-old to show you how.)

Map-making and map-reading skills, essential to the study of any culture, are also an important part of this game. Often children do not recognize the value of maps because many school systems today do not have adequate geography programs. The world of *In Search of the Most Amazing Thing* may be one of the few places a child can painlessly learn the basic skills as well as the value of map reading.

Cultures are always associated with maps and travel. The game's 25 cultures prefer different types of music, speak different languages, and impart various pieces of advice. They also teach a valuable lesson. Underneath the dissimilar culture trappings, such as music and language, the cultures are in many ways the same.

Young people often don't get to see beyond the superficial differences between societies and seldom recognize the tremendous similarities of all people. Social-studies programs try to go beyond those differences; this game is another tool to help them succeed.

Throughout the adventure, decisions must be made. Good decision making is a learned skill; it isn't just randomly acquired. A simulation game, setting up decision-making situations, enables students to evaluate alternatives and make judgments. In real life, poor decisions can be costly or dangerous; in simulation games, students can get experience without undue punishment for errors.

In Search of the Most Amazing Thing also encourages reading by including a storybook. Players do not have to read the book to go on the adventure. Once you start adventuring, though, this book, written at about the

fifth-grade level, is a delightful addition to the program. The computer simulates the planet's environment, and the book complements it with details and background information.

Name Your System

The program runs on a 64K-byte IBM PC, a 48K-byte Apple, and a 48K-byte Atari. I have found that most features of the game are identical for all three microcomputers, but although the Atari has excellent sound qualities, it runs the slowest of the three. The Apple is second in speed, and the IBM PC is by far the fastest.

Map-making and map-reading skills are also an important part of this game.

It also has the capacity for a much wider variation in sounds. I would certainly recommend the game for use on any of these systems, but if you own an IBM PC and have been dutifully handling bookkeeping transactions, be advised: the IBM isn't just for business any more. The PC and the *Most Amazing Thing* seem to be made for each other. (Although a translation is now available for the Commodore 64, an overview of its performance is not included in this discussion.)

Summary

In Search of the Most Amazing Thing is an exciting adventure filled with interaction among cultures, harrowing balloon flights, and opportunities for creating

PERSONA

The Professional Small Business Computer



The Persona is a professional business computer at an affordable price. This versatile computer possesses all the features of more expensive personal computers but at a significantly lower price. Handsomely designed and easily expanded, the Persona offers a broad range of capabilities to meet today's business, education and entertainment requirements.

Standard Hardware

- 280A Processor
- 64K Ram Memory
- 2-180K Disk Drives
- 12 Inch Green Monitor
- Printer Interface (Parallel)
- Serial Communications Interface
- 4 Expansion Slots

Optional Hardware

- 360K Disk Drives
- 10MB Winchester
- 8086 (IBM Compatible) Processor with MS/DOS
- Additional 64K or 128K Ram
- High Resolution/Colour Graphics

Standard Software

- CP/M Operating System
- WordStar Word Processing
- CalcStar Electronic Spreadsheet
- Persona Communications Package

Optional Software

- MBASIC Programming Language
- InfoStar - Data Base Management
- MailMerge - Creates Mailing Labels
- SpellStar - English Spelling Checker
- Persona Professional Accounting
- Many More

Manufacturer's Suggested List Price - Only \$2,195.00

Sold At Participating **ComputerLand** Stores

OEM And Dealer Enquiries Welcome

For Further Information Contact: Mr. Ken Thomas,
V.P., Marketing

FROM:
NELMA DATA CORPORATION
5170A Timberlea Blvd.
Mississauga, Ontario,
Canada L4W 2S5
Tel: (416) 624-0334
Telex: 06-960121

**See us at COMDEX '83
Booth #7052.**

CP/M is a registered trademark of Digital Research Inc
WordStar CalcStar InfoStar SpellStar MailMerge are registered trademarks of MicroPro Corp
MBASIC is a registered trademark of Microsoft Inc

At a Glance

Name

In Search of the Most Amazing Thing

Type

A learning/adventure game

Manufacturer

Spinnaker Software Corporation
215 First St.
Cambridge, MA 02142
(617) 868-4700

Price

\$39.95

Format

5¼-inch floppy disk

Documentation

14-page instruction booklet, 76-page storybook, and a quick-reference card for your specific computer

Language

BASIC

Computer Needed

Apple II, II Plus, or IIe; Atari 800 or 1200, Commodore 64, or IBM Personal Computer

Audience

Adventurers, ages 10 to adult; teachers, especially in social studies and world cultures or those dealing with gifted and talented students

music, making judgments, and traveling over an entire world.

The graphics in the program are well designed and executed.

In addition to providing a colorful adventure, the game is a valuable educational tool. Successful players take notes, employ mathematical skills, and initiate social interactions.

An accompanying storybook rounds out the educational aspects of the program; it is nonthreatening, however, simply because its use is optional.

The program has wide appeal for ages 10 through adult. Educators can benefit from this program by involving an entire class in the adventure.

In Search of the Most Amazing Thing also clearly points out the versatility of the IBM PC as an educational tool, a recreational computer, and a business machine.

I highly recommend this game for the educational opportunities it provides as well as the exciting yet non-violent adventures. A player can be taught valuable skills through this program and have a terrific time as well. ■

Elaine Holden (22 Elm St., Peterborough, NH 03458) is supervisor of reading and language arts at the Merrimack School District, Merrimack, New Hampshire.



GIVE THE GIFT THAT MAKES YOUR APPLE SHINE.

This Christmas give PLATO® educational courseware and start your family on an exciting learning adventure.

Discover the difference quality courseware makes. Begin with the new PLATO Computer Concepts* series: The Computer Keyboard, Storage and Memory, Files and Editing, and Databases. Put these lessons into practice along with Keyboarding† and Computer Literacy to help your family really understand the computer.

Widen your child's world with these other PLATO lessons.

Grade school kids can have fun while they learn Basic Number

Facts, Whole Numbers, Decimals, and Fractions. For the teen-ager in your family there are PLATO lessons in Elementary Algebra‡, Physics-Elementary Mechanics, and Foreign Languages. All are part

of a growing library of quality educational programs.

Ask for PLATO at selected retail outlets.

PLATO courseware for micro-computers is available for the Apple II Plus and Apple IIe. Selected lessons are also available for the TI99/4A and Atari 800. For a free PLATO catalog: Call toll-free 800/233-3784. (In Calif., call 800/233-3785.) Or write Control Data Publishing Co., P.O. Box 261127, San Diego, CA 92126.



*Developed with Continuous Learning Corporation.

†Developed with Gregg/McGraw-Hill.

‡Developed with Courses by Computers, Inc.

Warranty available free from Control Data Publishing Co., 4455 Eastgate Mall, San Diego, CA 92121

Circle 120 on inquiry card.

PLATO
COMPUTER-BASED EDUCATION

GD
CONTROL DATA
PUBLISHING

maxell®

Floppy Discs

CALL NOW - TOLL FREE
1-800-328-DISC

Dealer inquiries invited. C.O.D.'s and charge cards accepted.

All orders shipped from stock, within 24 hours. Call toll FREE.



North Hills Corporation
3564 Rolling View Dr.
White Bear Lake, MN 55110
1-800-328-DISC
MN Call Collect 1-612-770-0485

QUALITY PRODUCTS FOR IBM PC

RAMS

4164 64K 200 nsec DRAMS \$5.25 ea.

4164 64K 150 nsec DRAMS ... \$CALL

CALL FOR QUANTITY PURCHASE!

DISK DRIVES

Slimline 320KB..... \$199

Teac 55B..... \$229

Shugart SA400L..... \$169

Shugart SA455B..... \$239

COMPLETE SYSTEM

The NEW TAVA PC 128K, 2-320 floppy disk drives, controller, video card, and monitor, runs IBM DOS 1.1, 2.0, and CP/M 86.

List Price...\$2395 OUR PRICE...\$1995

ROMAR II - Apple compatible computer, disk drive, Z card, controller and monitor
OUR PRICE...ONLY \$999

CALL FOR IBM PC AND OTHER PRODUCTS
ANI — 17752 SKYPARK CIRCLE, STE. 210
IRVINE, CA 92714
714/261-6226 • 714/261-6227

Circle 521 on inquiry card.



Scotch

DISKETTES

Call Toll-Free

1-800-328-DISC for prices and information. Dealer inquiries invited. C.O.D. and charge cards accepted.

All orders shipped from stock, within 24 hours. Call toll FREE



North Hills Corporation
3564 Rolling View Dr.
White Bear Lake, MN 55110
1-800-328-DISC
MN Call Collect 1-612-770-0485

If they can make it here, they'll make it anywhere.



When's the last time you saw "digging a well" or "installing bio-gas digesters" on someone's résumé? Working in the Peace Corps is not your average everyday job. But it sure has trained volunteers to cope with the unexpected—including any company's everyday problems, once the volunteers have come home.

Whatever it takes to be Peace Corps volunteers, it's a way of working that develops a resourcefulness and a degree of self-reliance that volunteers use long after they've come home. Anyplace they work. On any job they're given. And they all have a unique understanding of different cultures in developing countries.



Hire a former Peace Corps volunteer, and put that experience to work on your "toughest job." Call Peace Corps toll-free, 800-424-8580 (ext. 76) to tell them about job possibilities for returned volunteers. Or if you know of those who might like to volunteer, use the same phone number (ext. 93) to put their experience to work where it can do a world of good.

Peace Corps

The toughest job you'll ever love.

A Public Service of This Publication

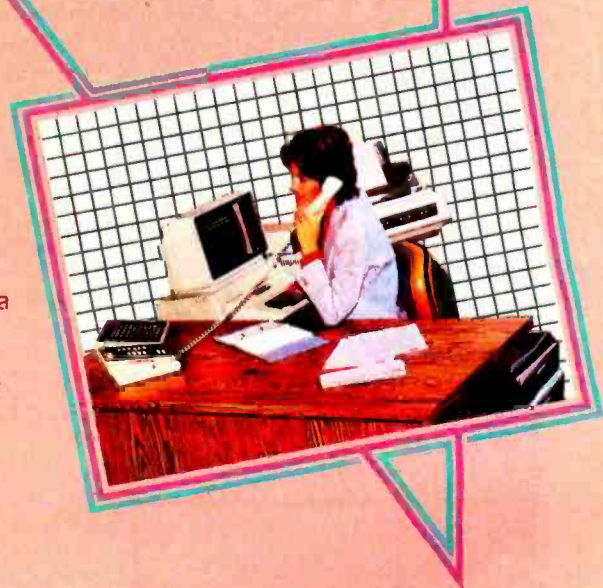

Be Well Connected In Business

Pro-Net™ System Professional Local Area Network

SWI announces office systems that let more people share more information than ever before.

In business, the more connections you have, the better. And now, SWI announces office system networking that electronically connects a variety of micro-computers through your host computer.

That means, everyone in your company who uses an APPLE IIe, FRANKLIN ACE or the IBM PERSONAL COMPUTER can share and have access to more information.

All kinds of information.

Like electronic mail, reports, word processing and even graphic images. Because now, SWI announces PRO-NET, PROFESSIONAL LOCAL AREA NETWORKING for the serious micro-business system, with multi-user operating systems for APPLE DOS, MS DOS, UCSD p SYSTEM and TURBODOS, combined with low cost high speed SATELLITE interface cards under \$300.00 per computer.

For instance, if you want to send charts, messages, share common data files, and system software, PRO-NET can retrieve and distribute those images as fast as 100 pages of text per second.

So if you want to make everyone in your organization more productive and maybe have a little fun with office communication, there has never been a better time to consider an SWI office communications system.

After all, even the impossible can be done with the right connections.

SWI INTERNATIONAL SYSTEMS™ Specialists in Networking For Microcomputers

See the PRO-NET SYSTEM at your local SWI INTERNATIONAL SYSTEMS dealer.
7741 East Gray Road, Suite 2 • Scottsdale, Arizona 85260-3496 • 602-998-3986 Telex: 467580

Circle 410 on Inquiry card.

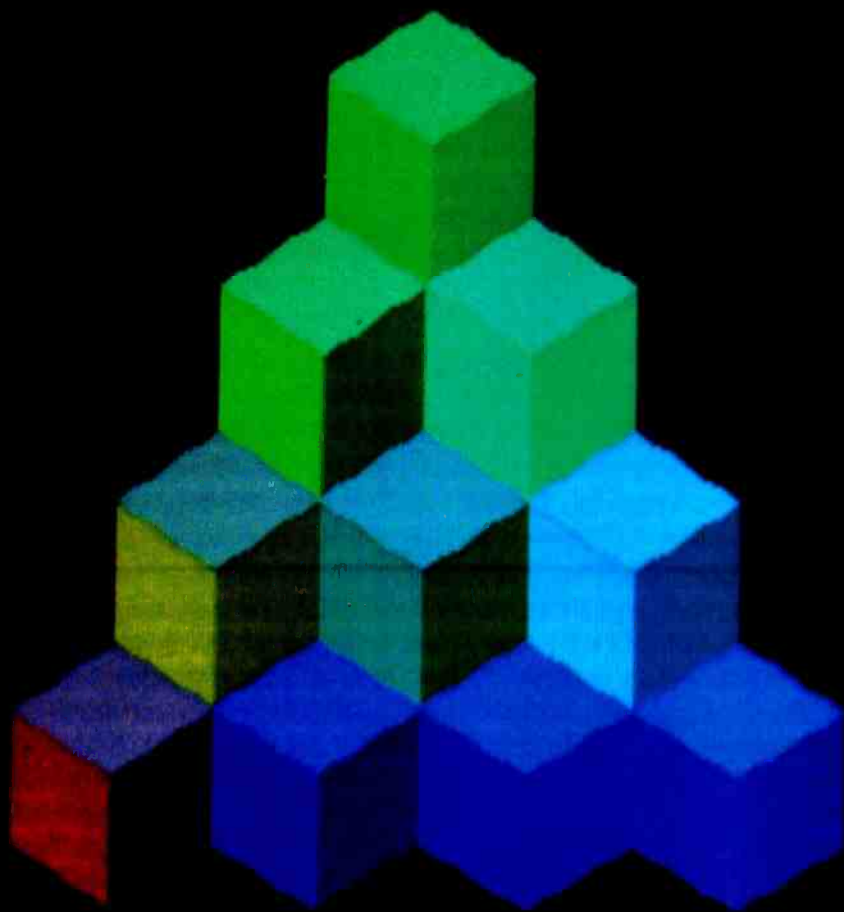

Color Graphics From Any Computer

*Full-color photography from a
black-and-white display*

by Frederick B. Essig

When many of us think about color graphics, we often think in terms of one of the popular computers that has built-in color graphics capabilities. Connected to a color TV or monitor, these machines indeed put on a dazzling color display. From games to computer-assisted design, color is a great enhancement for nearly all interactive or real-time computer applications.

Another use of color graphics, however, is the creation and subsequent transfer of graphic images to photographic film. Here we are more apt to be concerned with resolution and color quality (see photos 1, 2, and 3) than we are with interactive considerations. Specific applications of computer-to-film recording include preparation of transparencies for educational or business presentations (see photos 4 and 5), creation of serious works of art, and, if you have a great deal of patience, the making of animated films.

The process described here is not particularly easy to employ, at least not at first. The drawing and editing processes are tricky and can be tedious, and you must be prepared to spend some time fiddling with the camera, tripod, filters, and other equipment. But the quality of the final product is unquestionably superior to simple display photography; compared with other, non-computer means of preparing detailed graphics, the time involved is minimal. For owners of black-and-white computers, this is also a means of getting into color graphics with a small investment. All of the photos in this article were produced using this process.

Photographing a color TV screen or monitor has some serious limitations. You can, of course, simply set a camera in front of the display and snap the shutter. But pictures tend to be grainy, colors tend to bleed, and,

Photo 1: A simulated three-dimensional color triangle showing gradations of color and shading between red, green, and blue was created by a color-separation process on the black-and-white screen of an Osborne 1 portable computer.

with many microcomputers, you are restricted to a relatively few colors on the screen at one time. Subtle hues and realistic shading are not available. Of course, the more money you invest in equipment, the better your pictures can be because larger systems enable use of more colors and expensive RGB (red-green-blue) monitors minimize graininess and bleeding. The method I use, however, lets you create color pictures with the sharpness inherent in a good black-and-white monitor, with as many colors as you want in every picture. The method can be employed with virtually any personal computer on the market, using a black-and-white monitor or TV. All of the photos accompanying this article were made with an Osborne 1 computer and photographed from its built-in monitor.

The key to this process is color separation. Any color picture can be broken down into three monochrome images that later can be recombined to form the original color picture. In the early days of color photography, three black-and-white negatives were exposed simultaneously through red, green, and blue filters; these negatives were then used to make superimposed images on paper with cyan, magenta, and yellow dyes (the complementary colors of red, green, and blue). Modern color films consist of a sandwich of cyan, magenta, and yellow monochrome images. Televisions and monitors use a variation of this process: red, green, and blue images are received by the TV and cause red, green, and blue dots to light up on the screen. By varying the intensities of each of the three primary colors, a full range of colors is created.

Color-separation techniques are not new in computers. Sophisticated (and expensive) systems have been used for several years to produce very high-resolution pictures and films such as Disney's *Tron*. The computer separates a color image into three

Photo 2: "Fish and Coral" is an example of the artistic capabilities of the author and his process. This image was created without using the subtle shading shown in photo 1.

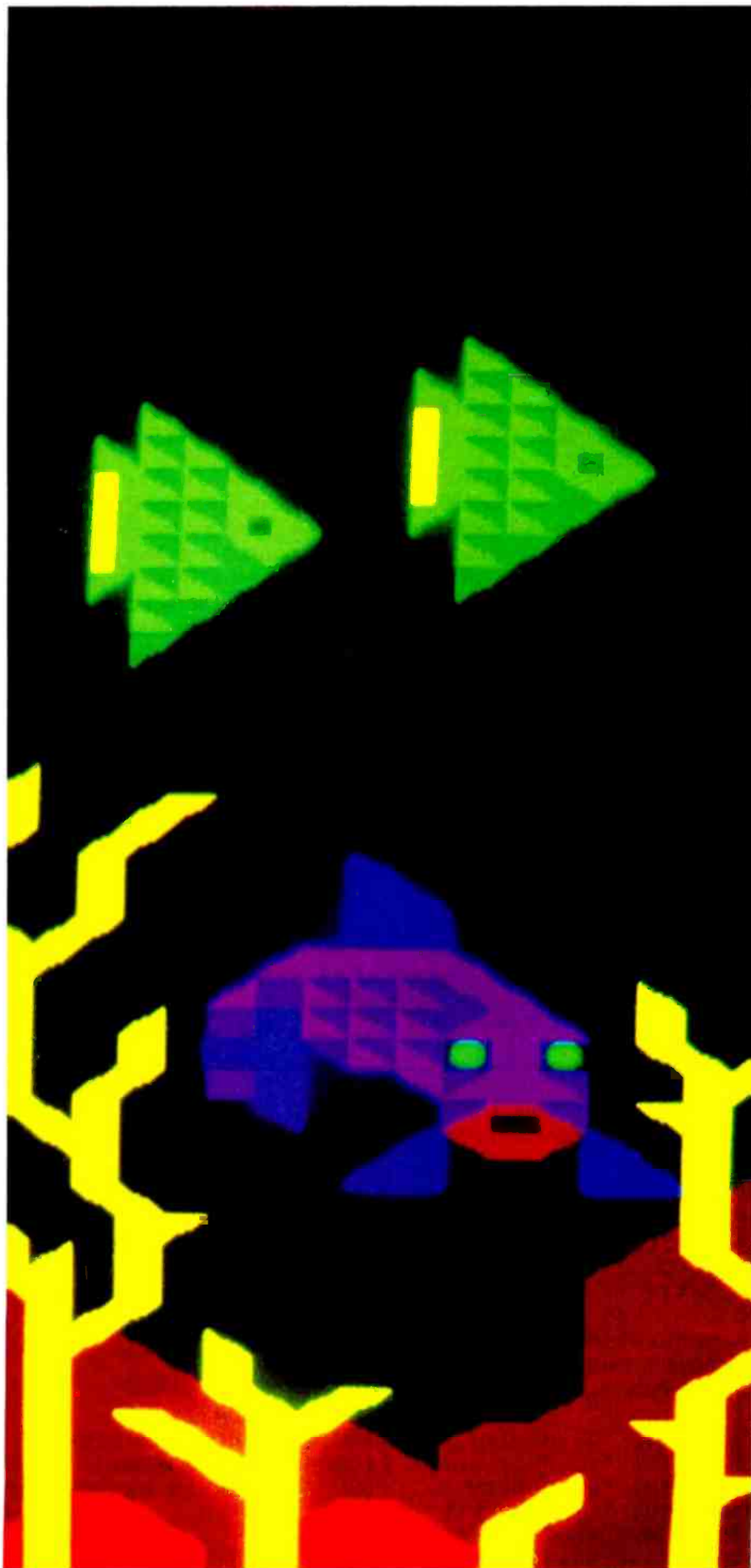

Using the Supercolor Program

1. Insert the MBASIC disk in drive A; insert the disk with the Supercolor program in drive B; if you're creating a new picture, be sure the disk in drive B has enough space (you can use as much as 24K bytes).

2. First menu: Choose whether you are creating a new picture, modifying an existing picture (disk or memory), or doing photography (disk or memory).

3. Provide a standard filename for a new or stored picture when prompted.

4. Choose the screen mode when prompted: mode one is screen one with only a rectangular symbol available; mode two is screen two only, full-character operation, black background only; mode three uses two screens, block character in screen one for background colors, full-character operation in screen two; mode four is full-character operation in both screens—use this for putting two characters in one pixel.

5. Enter a three-digit color code for background (000 in modes one and two) when asked.

6. Choose which screen to edit when asked; begin usually with screen two, which is the main picture screen.

7. Editing commands: # enters into lettering mode from graphics mode; esc returns to graphics mode; tab brings up the "color" prompt; enter a three-digit color code for characters to be drawn and then key **Return**. Press any letter key to choose a graphics symbol, according to the keyboard scheme in the Osborne users manual; use arrow keys to enter that character in the previously chosen color as many times as desired. ! saves characters on screen one instead of screen two; key % to return to screen two. Use the (key to see what is on screen one; use the) key to return to screen two. Push the space bar to move the cursor across the screen and to read colors recorded for each location; return to drawing mode by selecting a new character. The hyphen key enters delete mode; choose another character to return. + saves the picture to disk and returns to editing. Key esc to save and quit.

Note: Keep an eye on the "bytes =" prompt. If the number of free bytes approaches zero, save the picture to disk, restart the program, and reload from disk.

8. Photographing a picture: Use the "focus-grid" prompt to standardize the brightness of the screen with an exposure meter (e.g., adjust brightness so that the needles match at 1/15th second at f 3.5 for ISO 64 film); use the "preview" prompt to center the picture with the camera. When the "ready to photograph (red first-push return)" prompt appears, put a red filter over the camera lens, check the settings (try f11 for ISO 64 film), turn off the lights, key **Return**. At the end of six beeps, lock open the shutter.

When the last of the red picture disappears from the screen, put a green filter over the camera lens (the camera shutter is still open), key 0. When the green picture disappears, put a blue filter on the lens. After the blue picture, close the shutter and key **Return**. Cross your fingers and develop the film.

black-and-white images, each of which is then displayed separately on a very high-resolution black-and-white monitor and then combined photographically onto color film. Recently, Polaroid has introduced special photographic hardware that similarly makes high-resolution hard copy of color computer graphics.

The technique outlined here is an inexpensive, do-it-yourself application of color-separation photography for microcomputers. The only extra "hardware" you need, besides a camera, is a set of color-separation filters: Kodak wratten #29 (red), #61 (green), and #47B (blue). A genuine black-and-white display is needed; green or amber screens create serious problems with color balance. Listing 1 and this article should help you develop a program in BASIC that will run on your computer and let you create a picture containing up to 1000 different colors. The text box at left guides you through the actual display and photography processes.

A program to employ this technique consists of two parts. The first part is a drawing program that creates a color picture in the memory of the computer while simultaneously drawing a black-and-white approximation of that picture on the screen. The picture in memory will be saved as an x,y dimensioned array that contains a color code and character code (in low-resolution mode) for each pixel. The second part of the program (or a separate program) then

Text continued on page 392

Listing 1: The Supercolor program in MBASIC for the Osborne 1. A few items are machine-dependent; see the text for details.

```
10 GOTO 70
20 Y=INT((A-HOME)/128):X=A-HOME-Y*128
25 IF SCREEN=2 THEN K$(X,Y)=KL$:L$(X,Y)=T:RETURN
30 IF T=32 THEN C$(X,Y)=CB$ ELSE C$(X,Y)=KL$
40 BK$(X,Y)=T:RETURN
70 DIM C$(52,23),K$(52,23),L$(52,23),BK$(52,23)
80 HOME=61568!:REM *UPPER LEFT CORNER OF PICTURE AREA*
90 PRINT CHR$(26):PRINT "MENU"
100 PRINT "1. CREATE PICTURE"
110 PRINT "2. PHOTOGRAPH PICTURE FROM DISK"
120 PRINT "3. MODIFY EXISTING PICTURE FROM DISK"
130 PRINT "4. PHOTOGRAPH PICTURE FROM MEMORY"
140 PRINT "5. MODIFY EXISTING PICTURE IN MEMORY"
150 INPUT "TYPE NUMBER OF SELECTION";N
160 ON N GOTO 170,460,2100,630,2120
170 W=1:PRINT:INPUT "NAME OF NEW PICTURE";PICT$
```

Listing 1 continued on page 384

See us at
COMDEX[™]

DIMENSION. THE MOST POWERFUL, MOST COMPATIBLE PERSONAL COMPUTER YOU CAN BUY.

Introducing the capability the world has been waiting for. A single personal computer able to handle Apple,[®] IBM,[®] TRS-80,[®] UNIX[™] and CP/M[®] based software.

The Dimension 68000 Professional Personal Computer does it all. It actually contains the microprocessors found in all of today's popular personal computers. And a dramatic innovation creates the environment that these systems function merely by plugging in the software.

Add to this the incredible power of a 32 bit MC68000 microprocessor with up to 16 megabytes of random access memory.

Dimension. At about the same price as the IBM[®] PC, it's obviously the best value you can find. For more information ask your dealer or call us at (214) 630-2562 for the name of your nearest dealer.

dimension

A product of Micro Craft Corporation
4747 Irving Blvd., Suite 241
Dallas, Texas 75247. © 1983



Apple is a registered trademark of Apple Computer, Inc.; IBM is a registered trademark of International Business Machines Corporation; TRS-80 is a registered trademark of Radio Shack, a Tandy Corporation company; UNIX is a trademark of Bell Laboratories, Inc.; CP/M is a registered trademark of Digital Research Corporation.

www.americanradiohistory.com

Listing 1 continued:

```
180 PRINT "MODE MENU"
190 PRINT "1. BACKGROUND/PATTERN"
200 PRINT "2. FOREGROUND ONLY"
210 PRINT "3. FOREGROUND AND BACKGROUND"
220 PRINT "4. DOUBLE MODE"
230 INPUT "TYPE NUMBER OF CHOICE";MODE
240 PRINT CHR$(26):INPUT "SET BACKGROUND COLOR";CB$
245 PRINT"WAIT - INITIALIZING"
250 FOR Y=0 TO 22
260 FOR X=0 TO 51
270 IF MODE=1 THEN C$(X,Y)=CB$
272 IF MODE=2 THEN K$(X,Y)=CB$:L%(X,Y)=32
274 IF MODE=3 THEN C$(X,Y)=CB$:K$(X,Y)="":L%(X,Y)=32
276 IF MODE=4 THEN C$(X,Y)="000":K$(X,Y)="000":L%(X,Y)=32:BK%(X,Y)=32
290 NEXT X
300 NEXT Y
310 GOTO 2120
320 GOSUB 340
330 GOTO 90
340 OPEN "O",1,PICT$
350 PRINT #1, MODE;" "; CB$
360 FOR Y= 0 TO 22
370 FOR X=0 TO 51
380 IF MODE=1 THEN PRINT #1, C$(X,Y)
390 IF MODE=2 THEN PRINT #1, K$(X,Y);", ";L%(X,Y)
400 IF MODE=3 THEN PRINT #1, C$(X,Y);", ";K$(X,Y);", ";L%(X,Y)
410 IF MODE=4 THEN PRINT #1, C$(X,Y);", ";K$(X,Y);", ";L%(X,Y);", ";BK%(X,Y)
420 NEXT X
430 NEXT Y
440 CLOSE
450 RETURN
460 PRINT CHR$(26)
470 INPUT "NAME OF PICTURE TO PHOTOGRAPH";PICT$
480 GOSUB 500
490 GOTO 630
500 OPEN "I",1,PICT$
510 INPUT #1, MODE,CB$
515 PRINT CHR$(26); "LOADING LINE #"
520 FOR Y=0 TO 22
530 FOR X=0 TO 51
540 IF MODE=1 THEN INPUT #1, C$(X,Y)
550 IF MODE=2 THEN INPUT #1, K$(X,Y),L%(X,Y)
560 IF MODE=3 THEN INPUT #1,C$(X,Y),K$(X,Y),L%(X,Y)
570 IF MODE=4 THEN INPUT #1, C$(X,Y),K$(X,Y),L%(X,Y),BK%(X,Y)
590 NEXT X
595 PRINT Y;CHR$(30)
600 NEXT Y
610 CLOSE
620 RETURN
630 PRINT CHR$(26)
640 REM *FOCUS SCREEN*
650 INPUT " DO YOU WANT THE FOCUS GRID";GRD$
660 IF GRD$="Y" THEN 680 ELSE 770
680 FOR Y=0 TO 23
690 FOR X=0 TO 51
700 POKE HOME+X+Y*128,22
710 NEXT X
720 NEXT Y
730 X=25:Y=11:POKE HOME+X+128*Y,0
740 X=0:Y=0: POKE HOME+X+128*Y,0
750 X=51:Y=0:POKE HOME+X+128*Y,0
```

Listing 1 continued on page 386



LAST NIGHT WE EXCHANGED LETTERS WITH MOM, THEN HAD A PARTY FOR ELEVEN PEOPLE IN NINE DIFFERENT STATES AND ONLY HAD TO WASH ONE GLASS...

That's CompuServe, The Personal Communications Network For Every Computer Owner

And it doesn't matter what kind of computer you own. You'll use CompuServe's Electronic Mail system (we call it Email™) to compose, edit and send letters to friends or business associates. The system delivers any number of messages to other users anywhere in North America.

CompuServe's multi-channel CB simulator brings distant friends together and gets new friendships started. You can even use a scrambler if you have a secret you don't want to share. Special interest groups meet regularly to trade information on hardware, software and hobbies from photography to cooking and you can sell, swap and post personal notices on the bulletin board.

There's all this and much more on the CompuServe Information Service. All you need is a computer, a modem,

and CompuServe. CompuServe connects with almost any type or brand of personal computer or terminal and many communicating word processors. To receive an illustrated guide to CompuServe and learn how you can subscribe, contact or call:

CompuServe

Consumer Information Service, P. O. Box 20212
5000 Arlington Centre Blvd., Columbus, OH 43220
800-848-8199
In Ohio call 614-457-0802.

An H&R Block Company

Listing 1 continued:

```
760 INPUT QS
770 INPUT "DO YOU WANT TO PREVIEW PICTURE";PRV$
780 IF PRV$="Y" THEN GOSUB 2140 ELSE GOTO 810
800 INPUT "ANY CORRECTIONS";CORR$:IF CORR$="Y" THEN GOTO 2290
810 PRINT CHR$(26):INPUT "READY TO PHOTOGRAPH (RED FIRST-PUSH RETURN)";ANS$
820 PRINT CHR$(26)
830 FOR N=0 TO 5
840 PRINT CHR$(7)
850 FOR T=1 TO 1000:NEXT T
860 NEXT N
870 PRINT CHR$(26):POKE HOME,32
880 IF MODE=2 THEN 1080
890 IF MODE<4 THEN S=22
895 N=HOME
900 FOR Y=0 TO 22
910 FOR X=0 TO 51
930 IF MODE=4 THEN S=BK$(X,Y)
940 R=VAL(LEFT$(C$(X,Y),1))
950 IF R=0 THEN 965
960 POKE N,S
965 N=N+1
970 NEXT X
975 N=N+76
980 NEXT Y
990 FOR T=1 TO 9
995 N=HOME
1000 FOR Y=0 TO 22
1010 FOR X=0 TO 51
1030 IF T>=VAL(LEFT$(C$(X,Y),1)) THEN POKE N,32
1035 N=N+1
1040 NEXT X
1045 N=N+76
1050 NEXT Y
1060 NEXT T
1070 IF MODE=1 THEN 1250
1075 N=HOME
1080 FOR Y=0 TO 22
1090 FOR X=0 TO 51
1100 IF L$(X,Y)=32 THEN 1135
1110 IF VAL(LEFT$(K$(X,Y),1))=0 THEN 1135
1130 POKE N,L$(X,Y)
1135 N=N+1
1140 NEXT X
1145 N=N+76
1150 NEXT Y
1160 FOR T=1 TO 9
1165 N=HOME
1170 FOR Y=0 TO 22
1180 FOR X=0 TO 51
1200 IF T>=VAL(LEFT$(K$(X,Y),1)) THEN POKE N,32
1205 N=N+1
1210 NEXT X
1215 N=N+76
1220 NEXT Y
1230 NEXT T
1250 I$=INKEY$
1260 IF I$="" THEN GOTO 1280
1270 GOTO 1250
1280 IF MODE=2 THEN 1480
1290 IF MODE<4 THEN S=22
1295 N=HOME
```

Listing 1 continued on page 388

Extend your reach ...make the knowledge connection.



Use your personal computer to reach Knowledge Index and, in minutes, you can locate information leading to answers on money management, medical research, electronics, child behavior, current affairs, and more.

It's a service from Dialog, the world's leading online information retrieval service, used for over a decade by corporations, libraries and professionals. Now, the same information is available to you nights and weekends at special low rates.

More than 5 million references and abstracts from thousands of journals, books and reports. Plus sources of reviews of software, books, films, and consumer products. And unique databases like Microcomputer Index and International Software Database.

A one-time initiation fee of only \$35 gets you a password, self-instructional user manual and two free hours of Knowledge Index—a value of over \$50! One low cost—40¢/minute—covers it all. There is no monthly minimum—you pay only for the time you actually use.

So, use Knowledge Index to extend your reach. To sign up or receive more information, return the coupon.

Sign me up for Knowledge Index for a one-time initiation fee of \$35, and bill connect-time charges at the rate of 40¢/minute to the credit card listed below.*

Charge my Visa MasterCard American Express

Account Number: _____ Expiration Date: _____

Send more information

Signature: _____

Name (please print): _____

Address: _____

City: _____ State: _____ Zip: _____

Telephone: (_____) _____

*Send my user manual immediately and activate my password as soon as you receive and accept my signed contract.

3460 Hillview Avenue, Palo Alto, CA 94304.

800/528-6050 x 415.

B-12/83

KNOWLEDGE-INDEX

A Service of Lockheed Dialog

Circle 502 on inquiry card.

SAVE AT ELEK-TEK
TEXAS INSTRUMENTS

BA-2	33	TI-66	52
BA-35	22	PC-200	52
TI-35-8P	17	TI-5040-2	48
TI-MBA	30	TI-5130	60
BA-55	43	TI-5142-3	75
TI-55-2	33	TI-5218	130
TI-57	29	TI-LCD-Prog	50

HEWLETT-PACKARD
HP-75C 16K PORTABLE COMPUTER
\$719 Mfr. Sugg. 995



The battery powered portable computer which includes a built-in HP-IL interface, card reader, and time and appointment modes. Typewriter keyboard.

82164A HPIL/RS-232C Interface	235
82168A HPIL Acoustic Modem	395
82169A HPIL/HP1B Interface	315
82700A 8K Mem. Module	150

NEW HP-41CX
\$245

The great features of the 41CV

PLUS Built-in:

- Time Module Functions
- Extended Functions Module
- Enhanced Text (ASCII) FILE EDITOR

HP-41C	\$145
HP-41CV	200



Optical Wand	95
Card Reader	145
Printer	283
Quad R.A.M.(for HP41C)	60
Ext. Memory Module	60
Ext. Function Module	60
Time Module	60

	Mfr Sugg	Elek-Tek
HP-IL Loop Module	125	95
Digital Cassette Drive	450	335
Printer/Plotter(HP-IL)	450	335

SLIMLINE Shirt-pocket Styled
Power Packed Programmable
LCD PROBLEM SOLVERS

HP-10C Scientific (New)	\$54
HP-11C Scientific	70
HP-15C Scientific (New)	90
HP-12C Financial	90
HP-16C Programmer (New)	90
HP-97 Desktop Scientific	560

50%-60% off orig. mfr. suggested prices

HP-32E Scientific	32.50
HP-34C Scientific	50.00
HP-37E Financial	32.50

PERSONAL COMPUTATION DEALER

CALL TOLL FREE 800-621-1269
EXCEPT Illinois, Alaska, Hawaii

Corp. Accts. Invited. Min. Ord. \$15.00 Mastercard or Visa by mail or phone. Mail Cashier's Check, Mon. Ord. Pers. Check (2wks to dr). Add \$4.00 1st item (AK, HI, P.R., Canada add \$10.00 first item) \$1.00 ea. add'l ship. & handl. Shipments to IL address add 6% tax. Prices subj. to change. **WRITE for free catalog. 30 day return policy for defective replacements only. ALL ELEK-TEK MERCHANDISE IS BRAND NEW, FIRST QUALITY AND COMPLETE.**

ELEK-TEK, inc.
 6557 N. Lincoln Ave., Chicago, IL 60645
 (312) 631-7800 (312) 677-7860

Listing 1 continued:

```

1300 FOR Y=0 TO 22
1310 FOR X=0 TO 51
1330 IF MODE=4 THEN S=BK$(X,Y)
1340 G=VAL(MID$(C$(X,Y),2,1))
1350 IF G=0 THEN GOTO 1365
1360 POKE N,S
1365 N=N+1
1370 NEXT X
1375 N=N+76
1380 NEXT Y
1390 FOR T=1 TO 9
1395 N=HOME
1400 FOR Y=0 TO 22
1410 FOR X=0 TO 51
1430 IF T>=VAL(MID$(C$(X,Y),2,1)) THEN POKE N,32
1435 N=N+1
1440 NEXT X
1445 N=N+76
1450 NEXT Y
1460 NEXT T
1470 IF MODE=1 THEN 1650
1475 N=HOME
1480 FOR Y=0 TO 22
1490 FOR X=0 TO 51
1510 IF VAL(MID$(K$(X,Y),2,1))=0 THEN 1535
1530 POKE N,L$(X,Y)
1535 N=N+1
1540 NEXT X
1545 N=N+76
1550 NEXT Y
1560 FOR T=1 TO 9
1565 N=HOME
1570 FOR Y=0 TO 22
1580 FOR X=0 TO 51
1600 IF T=>VAL(MID$(K$(X,Y),2,1)) THEN POKE N,32
1605 N=N+1
1610 NEXT X
1615 N=N+76
1620 NEXT Y
1630 NEXT T
1650 I$=INKEY$
1660 IF I$="0" THEN GOTO 1680
1670 GOTO 1650
1680 IF MODE=2 THEN 1880
1690 IF MODE<4 THEN S=22
1695 N=HOME
1700 FOR Y=0 TO 22
1710 FOR X=0 TO 51
1730 IF MODE=4 THEN S=BK$(X,Y)
1740 B=VAL(RIGHT$(C$(X,Y),1))
1750 IF B=0 THEN 1770
1760 POKE N,S
1770 N=N+1: NEXT X
1775 N=N+76
1780 NEXT Y
1790 FOR T=1 TO 9
1795 N=HOME
1800 FOR Y=0 TO 22
1810 FOR X=0 TO 51
1830 IF T=VAL(RIGHT$(C$(X,Y),1)) THEN POKE N,32
1835 N=N+1
    
```

Listing 1 continued on page 390

KEY TRONIC POLISHES THE APPLE II* KEYBOARD



Eleven Function Keys
Streamline Multiple
Key Operations

Full Shifting Capability

Keys in Familiar
Typewriter Locations

Numeric Pad

10 Foot Cable
For Portability

Enhance your APPLE II* Computer System with a Key Tronic keyboard peripheral. This detached, low-profile keyboard is plug-compatible with the existing keyboard socket of the Apple II. It also features reliable microprocessor electronics, solid-state capacitance switches, and positive tactile feedback.

Special keyboard available for the handicapped — factory direct.

*Apple II is a registered trademark of Apple Computer, Inc.

Suggested Retail Price: \$298.00

To order Model KB-200 call Toll Free 1-800-262-6006 for the retailer closest to you. (7am-3pm Pacific Time)
Warranty information may be obtained, free of charge, by writing to the address below.

 **key tronic**

THE RESPONSIVE KEYBOARD COMPANY

DEPT. E1 • P. O. BOX 14687 • SPOKANE, WASHINGTON 99214 USA

RETAILERS: For the Distributor in your area, call Toll Free 1-800-262-6006 Dept. D (7am-3pm Pacific Time)

COME SEE US AT COMDEX, BOOTH #2979.

Listing 1 continued:

```
1840 NEXT X
1845 N=N+76
1850 NEXT Y
1860 NEXT T
1870 IF MODE=1 THEN 2040
1875 N=HOME
1880 FOR Y=0 TO 22
1890 FOR X=0 TO 51
1900 IF L$(X,Y)=32 THEN 1940
1910 IF VAL(RIGHT$(K$(X,Y),1))=0 THEN 1940
1930 POKE N,L$(X,Y)
1940 N=N+1:NEXT X
1945 N=N+76
1950 NEXT Y
1960 FOR T=1 TO 9
1965 N=HOME
1970 FOR Y=0 TO 22
1980 FOR X=0 TO 51
2000 IF T=VAL(RIGHT$(K$(X,Y),1)) THEN POKE N,32
2005 N=N+1
2010 NEXT X
2015 N=N+76
2020 NEXT Y
2030 NEXT T
2040 G$=INKEY$:IF INKEY$="" THEN 2040
2090 GOTO 90
2100 INPUT "NAME OF PICTURE TO MODIFY";PICT$
2110 GOSUB 500
2120 GOSUB 2140
2130 GOTO 2290
2140 INPUT"SHOW BACKGROUND(1) OR FOREGROUND(2)";SCREEN
2150 PRINT CHR$(26)
2160 FOR X=0 TO 51
2170 POKE HOME+X+128,42: POKE HOME+X+2816,42:NEXT X
2180 FOR Y=1 TO 21
2190 POKE HOME+Y*128,42: POKE HOME+Y*128+51,42:NEXT Y
2200 IF W=1 THEN 2280
2210 FOR Y=2 TO 21
2220 FOR X=1 TO 50
2230 N=HOME+X+128*Y
2240 IF SCREEN=1 THEN D=BK$(X,Y) ELSE D=L$(X,Y)
2250 POKE N,D
2260 NEXT X
2270 NEXT Y
2280 W=0: RETURN
2290 A=HOME+258
2300 POKE A,0
2305 PRINT "COLOR=";KL$;TAB(12) "BYTES=";FRE(0);
2307 PRINT TAB(30) "SYMBOLS"; TAB(44) "SCREEN=";SCREEN;CHR$(30)
2310 A$=INKEY$:IF LEN(A$)=0 THEN 2310
2320 IF A$=CHR$(12) THEN POKE A,T:GOSUB 20:A=A+1
2330 IF A$=CHR$(8) THEN POKE A,T:GOSUB 20:A=A-1
2340 IF A$=CHR$(11) THEN POKE A,T:GOSUB 20:A=A-128
2350 IF A$=CHR$(10) THEN POKE A,T:GOSUB 20:A=A+128
2360 IF A$="" THEN GOTO 2640
2365 IF A$="-" THEN T=32
2370 IF A$="+" THEN GOSUB 340
2380 IF A$=CHR$(9) THEN GOSUB 2490
2390 IF A$="!" THEN SCREEN=1:PRINT "COLOR=";KL$;
TAB(12) "PRINTING ALTERNATE SCREEN";CHR$(30)
2400 IF A$="#" THEN SCREEN=2:GOTO 2305
```

Listing 1 continued on page 392

LOW-COST RS-232 NETWORKING.

THE ANY-PORT-TO-ANY-PORT SMART SWITCH. \$895.

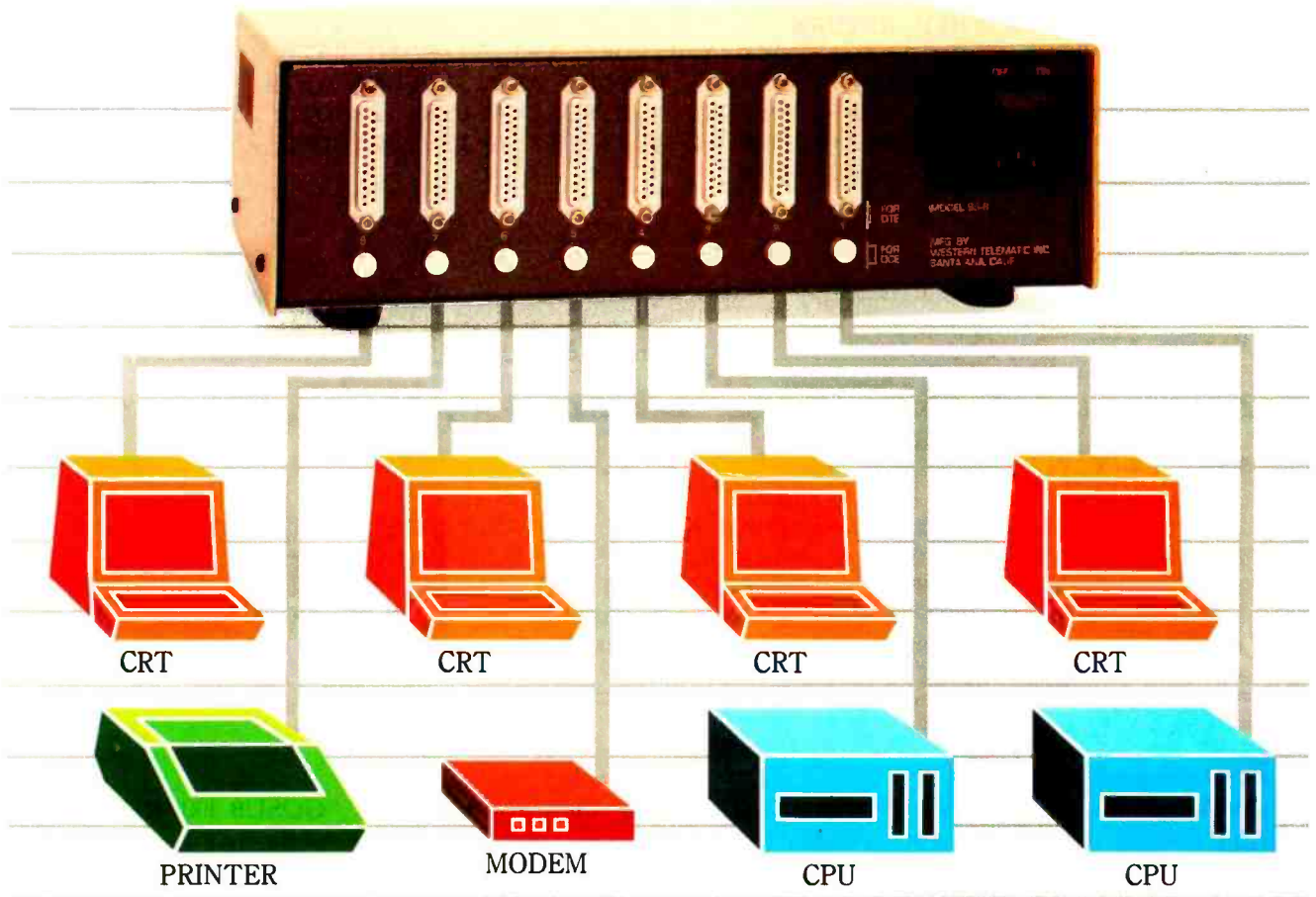

Here's an affordable way to switch up to eight RS-232 ports in any interconnection. Any port can select any other port, with up to four pairs of ports communicating at the same time. Push-buttons define each port as either DTE or DCE, for quick and easy installation.

The Smart Switch is controlled by simple user-friendly commands. A 2-character sequence lets you select a

port, determine status, and log-off. If the selected port is busy, it's smart enough to let you know when that port is available. What's more, it can optionally time-out connected ports not in use.

Use the Smart Switch to create your own low-cost network linking a number of terminals, printers or computers. Use it to give as many as seven users

access to a single I/O port on your computer, or six users access to two different computer systems. Or use it with any distributed computer environment.

To learn more about the SS-8 Smart Switch, call David Shumway toll-free at (800) 854-7226. In California call (714) 979-0363. Or write Western Telematic, Inc., 2435 South Anne Street, Santa Ana, California 92704. Or telex 467741.



wte western telematic inc.

See us at Comdex Booth #2112.

Listing 1 continued:

```
2410 IF A$="?" THEN T=127
2420 IF A$="(" THEN SCREEN=1:GOSUB 2150
2430 IF A$=")" THEN SCREEN=2:GOSUB 2150
2440 IF A$="#" THEN GOSUB 2510
2460 IF A$=CHR$(27) THEN GOTO 320:REM *PUSH ESC TO SAVE,QUIT*
2470 IF ASC(A$)>=64 THEN T=ASC(A$)-64
2480 GOTO 2300
2490 PRINT CHR$(27)+" ";CHR$(30):INPUT "COLOR=";KL$:
PRINT CHR$(27)+"(";CHR$(30)
2500 RETURN
2510 PRINT "        color=";KL$;"        LETTERING MODE";CHR$(30)
2520 B$=INKEY$:IF LEN(B$)=0 THEN 2520
2530 IF B$=CHR$(27) THEN RETURN
2540 IF B$=CHR$(8) THEN A=A-1:POKE A,0:POKE A+1,32:GOTO 2520
2550 IF B$=CHR$(12) THEN A=A+1:POKE A,0:POKE A-1,32:GOTO 2520
2560 IF B$=CHR$(11) THEN A=A-128:POKE A,0:POKE A+128,32:GOTO 2520
2570 IF B$=CHR$(10) THEN A=A+128:POKE A,0:POKE A-128,32:GOTO 2520
2580 IF B$=CHR$(9) THEN GOSUB 2490
2590 T=ASC(B$)
2600 POKE A,T
2610 GOSUB 20
2620 A=A+1:POKE A,0
2630 GOTO 2520
2640 PRINT "                                COLOR SCAN";CHR$(30)
2650 Y=INT((A-HOME)/128):X=A-HOME-Y*128
2660 PRINT "CØLØR=";K$(X,Y);TAB(15) "BACKGROUND =" ;C$(X,Y);
"                                ";CHR$(30)
2670 TEMP=L$(X,Y)
2680 J$=INKEY$:IF J$="" THEN 2680
2700 IF J$=CHR$(12) THEN A=A+1:POKE A,0:POKE A-1,TEMP:GOTO 2650
2710 IF J$=CHR$(8) THEN A=A-1:POKE A,0:POKE A+1,TEMP:GOTO 2650
2720 IF J$=CHR$(11) THEN A=A-128:POKE A,0:POKE A+128,TEMP:GOTO 2650
2730 IF J$=CHR$(10) THEN A=A+128:POKE A,0:POKE A-128,TEMP:GOTO 2650
2735 IF ASC(J$)>=64 THEN T=ASC(J$)-64:GOTO 2305
2736 IF J$="-" THEN T=32:GOTO 2305
2740 GOTO 2680
```

Text continued from page 382:

separates the picture into three black-and-white images, which represent the three primary colors, and displays them one at a time for the camera.

The critical element of the program is the color code, which consists of three digits, representing red, green, and blue color values. Each digit can vary from 0 to 9 and determines how long a pixel or character will be brightened on the screen. This coding gives 10 intensities for each of the primary colors, which can be combined to create a broad range of subtle hues and shading. For example, pure, brilliant red is represented by the code 900, and a dull, dark red is 100. The code 550 mixes equal quantities of red and green to create yellow, 640 and 730 results in two orange values, and so on.

The first part of the program creates the color picture. Actually, practically any picture-drawing or plotting program can be adapted for color. You need only a pair of subroutines to define a color for each pixel as you draw it. My drawing program sets up a number of drawing statements within an INKEY\$ loop. You choose a color, and all parts of the picture drawn subsequently will have that color until a different color is chosen. The three-digit color code in effect remains displayed at the top of the screen.

```
10 A$=INKEY$:if LEN(A$)=0
    THEN 10
20 }
30 } (drawing commands)
40 }
50 IF A$=CHR$(9) THEN
```

```
GOSUB 100:*REM CHR$(9)
is the TAB key*
100 INPUT "COLOR";KL$:PRINT
CHR$(30):RETURN
```

The second subroutine saves to memory both the color code and the character code for each point as it is entered:

```
20 Y=INT(A-HOME)/128):X=
A-HOME-Y*128
30 K$(X,Y)=KL$:L%(X,Y)=T:REM
*T' IS THE CHARACTER
CODE*
40 RETURN
```

(Note: HOME is the memory address of the upper left-hand corner of the video display. When adapting this program for computers other than Osborne, be sure to change the

THERE'S NOTHING EASIER UNDER THE SUN

Your personal
financial software
from Sundex

**IT'S EASY TO LEARN . . . EASY TO USE . . .
AND DURING OUR SUNDOWN PROMOTION . . .
INCREDIBLY EASY TO BUY!!**

**And, now pre-wrapped for you in SPECIAL
HOLIDAY GIFT PACKAGES.**

Sundex may be the only software you can confidently give as a gift. Not only do special promotional prices make it an **EXCEPTIONAL VALUE**, but "on screen instructions, a 'HELP' key, and manual written in 'plain English,' make these programs **EASY-TO-USE BY ANYONE INSTANTLY.**

Sundex programs can work alone or together to help you organize and manage your money:

CERTIFIED PERSONAL ACCOUNTANT™ — You're in control of your finances with the program that puts your financial status at your fingertips. Easily organize, analyze and manage your finances effectively. It even pays bills automatically!

CERTIFIED PERSONAL INVESTOR™ — Enjoy the ease and security of managing your investment portfolio on this program. It's designed for personal portfolio management, analysis, and tax form preparation.

PERSONAL PAYABLES™ — Have fun with the Sundex program that automatically pays all your bills from up to 10 different checking accounts and prints out your checks.

All these programs are now available for Apple II, Apple IIe, TI Professional, IBM P.C., Compaq, Eagle, Columbia and Franklin Computers.

The Sundex special prices last until February 5th. But, don't wait to buy. The prices go up every two weeks, so **THE SOONER YOU BUY THE LESS YOU PAY.** Ask your dealer to let you try this remarkable software. Then look for the colorful "Sundex Sundown" display to get this week's price on the programs you want for your family and friends . . . all holiday wrapped for you!

But hurry . . . you can still **SAVE UP TO 50%** if you act now.

Call 1-800-835-3243 today for the name of the Sundex dealer nearest you.

THERE'S NOTHING EASIER UNDER THE SUN

 **Sundex**

Sundex Software Corp.
3000 Pearl Street
Boulder, Colorado 80301

Dealer inquiries welcome:
1-800-835-2343.
Colorado: 303-440-3600



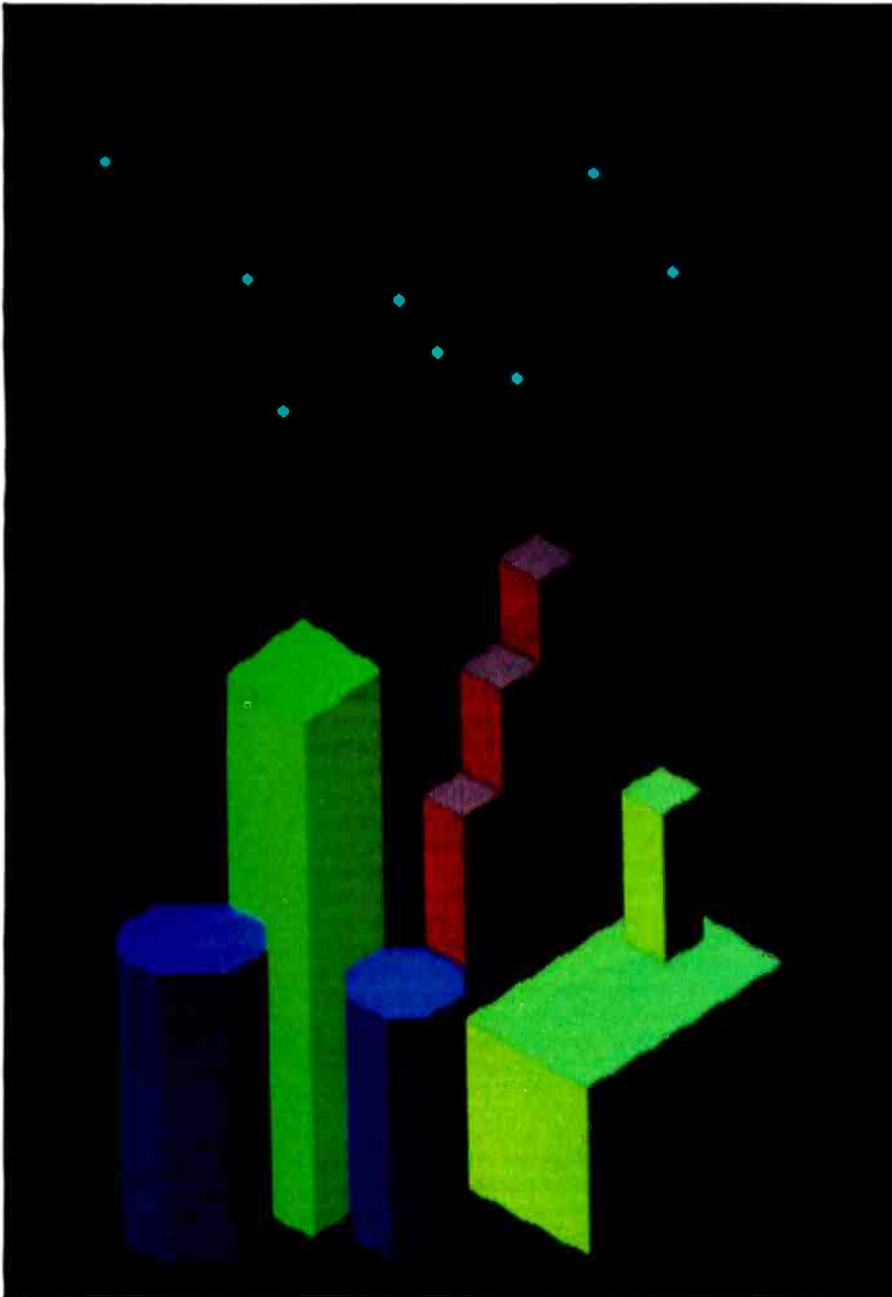

Photo 3: Low-resolution graphics are not a serious limitation for fine-art applications because of the double-screen mode and shading capabilities. These simulated three-dimensional structures are nothing more than juxtaposed parallelograms and other shapes with varying shades, drawn on alternate screens. Diagonal edges are formed where complementary right triangles on alternate screens share a diagonal series of pixels.

HOME value in line 80, viewable screen size in line 70, and maximum screen width, 128 on the Osborne, wherever mentioned.)

Once the picture has been created as a dimensioned array, you can save it in a disk file or display it for photographing. To photograph each of the three monochrome screens, first clear the screen and eliminate the cursor.

```
5 PRINT CHR$(26):POKE HOME,32
```

Then use the following routine to display the monochrome image for all red values in the picture (the left-most digit of color code).

```
5 N=HOME
10 FOR Y=0 TO 22: FOR X=0 TO 51
```

```
20 IF VAL(LEFT$(K$(X,Y),1))=0 THEN 40
30 POKE N, L%(X,Y)
40 N=N+1
50 NEXT X
55 N=N+76: REM *ON THE OSBORNE 52-COLUMN SCREEN THERE ARE 76 SPACES FROM THE END OF ONE LINE TO THE BEGINNING OF THE NEXT (52+76=128)*
60 NEXT Y
70 FOR T=1 TO 9
85 N=HOME
80 FOR Y=0 TO 22:
  FOR X=0 TO 51
90 IF T>=VAL(LEFT$(K$(X,Y),1)) THEN POKE N,32
100 N=N+1:NEXT X
110 N=N+76:NEXT Y
120 NEXT T
```

This routine is then repeated for the green and blue screens. Beginning with line 70, you go through the screen nine times. With the first pass, you delete all characters with red values of 1. On the second pass, you delete all characters with red values of 2, and so on, until the picture is completely blanked out. With this mechanism, you can mix 10 different intensity values within the same screen. Displaying and photographing all three screens in this manner takes 6-7 minutes in MBASIC.

Using Two Screens

When using low-resolution graphics characters, it is sometimes desirable to put two different characters of different colors in the same rectangular pixel. The diagonal edges of the blocks in photos 1 and 3 were done this way, filling each rectangle along the edge with two complementary right triangles of different colors. You must use two separate screens for each color, defining half of each block on one screen and the other half of the block on the other screen, switching back and forth between the screens while drawing the picture. Lettering must be white or a lighter version of the background color because it is "burned in" over the



ALL MINI DISKS COME ERROR FREE.

THE HARD PART IS MAKING SURE THEY STAY THAT WAY.

A disk is built with certain safeguards. That's why most disk makers offer guarantees that the product you receive comes to you error free.

We at Memtek Products are concerned that the minidisk remains error free. *Every* time you use it. After exposure to dust, cigarette smoke, fingerprints, even wear caused by your computer. And so, we have built safeguards around the disk, as well.

Memtek Products' latest innovation... acknowledgment of a real world beyond the laboratory.

The hub ring. Designed to prevent our minidisks from jamming in your machine. Rigid. Durable. Reinforced.

The coating. A critically-controlled coating of high-energy magnetic oxide particles that covers the disk's surface, which is then micro-polished to improve head to disk contact, preventing dropouts, lowering head abrasion.

The lubrication system. A constant lubricant protects both the disk surface and the drive head from wear.

The sleeve. Comes with a soft liner that protects the disk while gently cleaning the surface.

The guarantee.

We'll replace, free, any minidisk if it fails to accurately store and retrieve data due to a defect in materials or workmanship for up to 5 years from date of

purchase. Simply mail the disk back.

The Memtek lineup.

Premium, double and quad density minidisks as well as 10- and 15-minute computer cassettes and a 5 1/4" disk drive head cleaner.



WE PLAY FOR KEEPS™

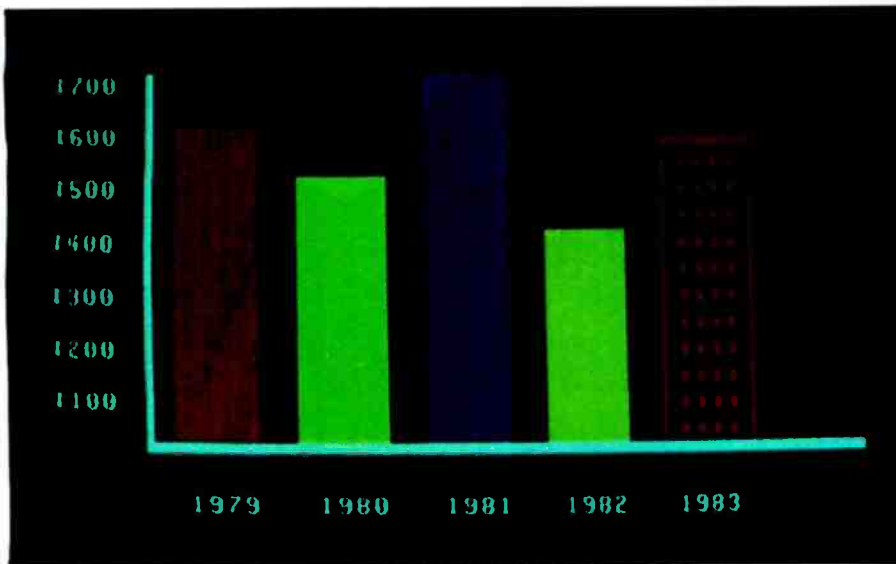

Photo 4: Snappy color slides for business or educational presentations can be made easily with "black-and-white" business systems and a set of color filters.

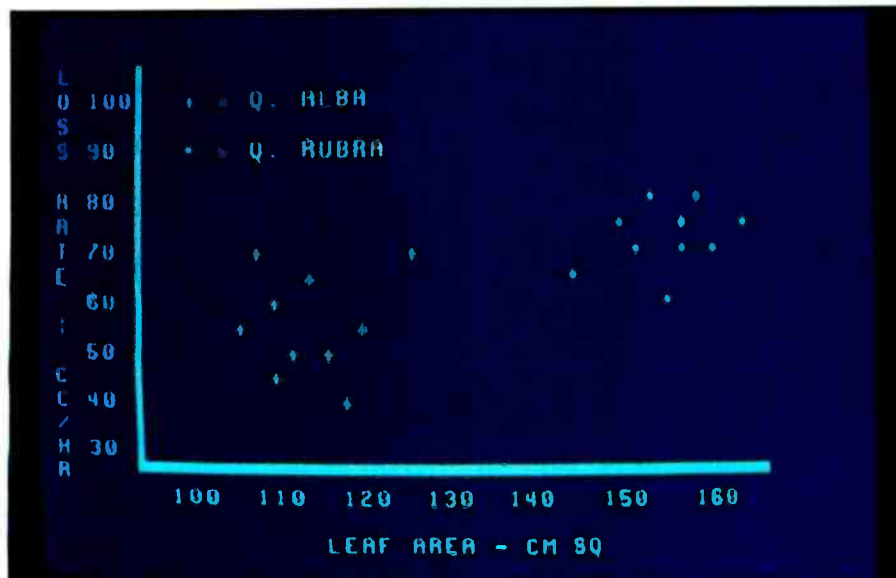

Photo 5: The popular white-on-blue graphics format usually produced with special film is done easily with a simple double exposure. First, a white screen is photographed through a blue filter, then white graphics on a black background are "burned in" with a second exposure. Any background color can be used with white or lightly colored lettering.

background (photo 5). Any color of lettering can be used on a black background.

Color Separation with Color Systems

You also can use this separation technique with a standard color computer and color monitor. The editing process is easier because you can see

on the monitor the colors you're using. However, the picture you save in memory can contain more color information than the picture you see on your monitor. You have to have two parallel color-selection mechanisms in your program. For example, an area that you color solid red on the monitor might include shading from dark red to light red in the picture be-

ing created in memory. You will see the latter only after you've photographed the picture. Be sure to switch to a black-and-white monitor for the photography.

Using High-Resolution Modes

The approach described in this article works fine with the Osborne's low-resolution graphics characters because of the relatively small number of memory locations required. The 52-by-22 display results in 1144 pixels that must be addressed on each screen, and each pixel requires 12 bytes to fully define three colors and character code in the two-screen mode, or about 13K bytes of RAM (random-access read/write memory). Typical high-resolution modes provide for about 320 by 200, or 64,000 pixels. There's no need for character codes or a two-screen mode with high-resolution systems, but 1000-color capability requires 3 bytes per pixel, or about 180K bytes of memory. With a 64K-byte machine like the Osborne, you would have to transfer the picture piecemeal to and from the disk.

The sheer number of pixels that must be selectively turned on and off for each of the three screens would mean a prolonged exposure time (I estimate at least 6-7 hours in MBASIC). Faster 16-bit or 32-bit processors and compiled programming help to reduce this problem. Computers that display a range of gray tones are ideal for this application, as each screen can be displayed and photographed in a few seconds, eliminating the need to scan the picture nine times for different intensity values. For everyone with "old-fashioned" 8-bit, 64K-byte-or-less computers, I suggest starting with low-resolution graphics. Perhaps you might want to take up the challenge of color separation with high-resolution graphics as your proficiency grows. ■

Frederick B. Essig holds a Ph.D. in botany. He is an associate professor in the Department of Biology at the University of South Florida, Tampa, FL 33620.

PRO-MODEM 1200



It's about time.

Time for your computer to make the telephone connection – with an intelligent, full 212A 300/1200 baud modem – with a real time clock/calendar – and with the capability to expand into a complete telecommunications system. It's time for PRO-MODEM 1200. Much more than just a phone modem.

When you're on-line, time is money. PRO-MODEM telecommunication systems help you save. By monitoring the duration and cost of your phone calls. And by sending and receiving messages, unattended, at preset times when the rates are lower. . . with or without your computer.

Compare the \$495 PRO-MODEM 1200 with any other modem on the market. For example, you'd have to buy both the Hayes Smartmodem 1200 plus their Chronograph for about \$950 to get a modem with time base.

PRO-MODEM 1200 is easy to use. A convenient "Help" command displays the Menu of operating command choices for quick reference whenever there's a question about what to do next. Extensive internal and remote self-diagnostics assure that the system is operating properly. Some of the other standard features include Auto Answer, Touch Tone and Pulse Dialing, and Programmable Intelligent Dialing.

PRO-MODEM does more. It lets you build a full telecommunications system with features like Auto Dialer, Incoming and Outgoing Message Buffering, Business/Personal Phone Directory, Programmable Operating Instructions, a 12-Character Alpha-Numeric Time and Message Display, and versatile PRO-COM Software. PRO-MODEM commands are Hayes compatible so you can use most existing telecommunications software without modification.

There's much more to the PRO-MODEM story. See your local dealer for complete details. He'll show you how to save time. And money.

Prometheus Products, Inc., 45277 Fremont Blvd., Fremont CA 94538, (415) 490-2370



PROMETHEUS

See it at Comdex booths H728 & H7442.

**NEW SOFTCARD IIe
AVAILABLE FOR THE APPLE IIe**



Microsoft SoftCard systems introduce your Apple to thousands of new programs.

More powerful Apples. When you plug a SoftCard™ system into the Apple® II, II Plus, or IIe, you're adding the ability to run thousands of CP/M®-80-based programs. Word processing, data-base management, analysis and forecasting programs—SoftCard gives your Apple access to thousands of software tools for use in your business or home.

Premium capabilities. Apple II or II Plus owners who want even more can add the Premium System. In addition to CP/M-80, it provides 80-column upper-and-lower case video and a 16K RAMCard. Apple IIe owners can have all this on a single card—the Premium SoftCard IIe.

Two computers in one. Any of these systems turns your Apple into two computers. One that runs Apple software and another that runs CP/M-80. Which means you'll double the utility of your computer.

Complete solutions. The SoftCard, Premium System, and Premium SoftCard IIe have everything you need. Easy-to-install circuit boards. The CP/M-80 operating system, Microsoft® BASIC. And the utilities you need to manage CP/M-80 files.

Why Microsoft? Microsoft was the first microcomputer

software manufacturer. The very first. Today, Microsoft software is running on well over a million computers, worldwide.

With a reputation for dependability and consistent product enhancement.

Ask your dealer. Ask about the superior application programs the SoftCard and Premium System make available to your Apple—high quality programs for almost every area of home, business and professional use. Then ask for a demonstration of the complete SoftCard, Premium System, or SoftCard IIe. And introduce your system to some of those thousands of new programs.

BETTER TOOLS FOR MICROCOMPUTERS

MICROSOFT™

MICROSOFT CORPORATION
10700 NORTHUP WAY
BELLEVUE, WASHINGTON 98004

Microsoft is a registered trademark, and SoftCard and the Microsoft logo are trademarks of Microsoft Corporation.

Mainframe to Micro: Adapting a Financial-Modeling Language

*A mainframe software company moving into
the microcomputer world must change more than its software*

by Greg Dunn

The era of the microcomputer is changing the character of computing. Images of Big Brother and the Pentagon have given way to Matthew Broderick innocently bringing the world to the brink using his home computer in the movie *WarGames*. Gone are the stories of huge programs created by highly trained teams of computer scientists in think tanks, replaced by reports of 20-year-old college dropouts making it big in video games (see the text box "When Worlds Collide: Social Aspects of the Move to Micros" on page 402).

The success of microcomputers guarantees the attention of big

business. Workers having microcomputers at home find it saves them labor in bookkeeping and word processing, provides games for fun and relaxation, and offers educational opportunities in self-paced tutorials on almost every subject. These people soon fit microcomputers into their office budgets. The compelling logic of distributed processing is making the microcomputer an integral part of the computing resource in companies all over the world. And, as the microcomputer moves into the office, software developers face new challenges in translating existing mainframe software to the microcomputer environment.

frame's central processor can access large amounts of both directly addressable and peripheral memory rapidly, and it has a data-word size that permits high precision even after repetitive recomputation.

The mainframe's resources permit number crunching on a large scale. However, handling input and output to users becomes a necessary evil, because any resource directed toward that activity steals from the resources used for computations or file access. While this also holds true for a microcomputer, one important difference changes the job of the software developer. The mainframe communicates with a remote CRT (cathode-ray tube) through a transmission line, limited, practically speaking, to a rate of 9600 bps (bits per second). A microcomputer talks to the screen at a memory-write rate of about 4.7 megabytes per second. Whenever the mainframe's central processor is occupied with I/O (input/output) to the user's terminal through this 9600-bps bottleneck, a lot of RAM (random-access read/write memory) as well as hard disks with rapid-access peripheral memory must wait. When the central processor paints menus or pictures on the user's video display, several megabytes stand idle—a high cost for user interface.

Compare this to a microcomputer, where the central processor can write to the screen as fast as it writes to memory and more rapidly than it can

**Issues Affecting the User
Directly and the Designer Indirectly**

- greatly enhanced visual display capabilities of the microcomputer
- increased "housekeeping" associated with the microcomputer
- limitations of job size
- greatly increased difficulty in obtaining direct product support from the software developer
- data security

**Issues Affecting the
Designer and Publisher Directly**

- product distribution channels
- product support demands
- organizational role, training, and personality profile for the typical user
- piracy

Table 1: *Some issues that distinguish microcomputer software from mainframe software and the groups affected.*

From the Developer's Viewpoint

A number of issues distinguish microcomputer software from mainframe software. Some primarily concern the software designer and publisher, while others also concern the user (see table 1). The designer must exploit the special opportunities provided by the microcomputer and minimize any negative consequences of its limitations.

Enhanced Display Capabilities

The mainframe computer's strength lies in its ability to do computations rapidly, to handle large quantities of data, to secure data by means of password protection schemes, and to let many users access a common data library simultaneously. A main-

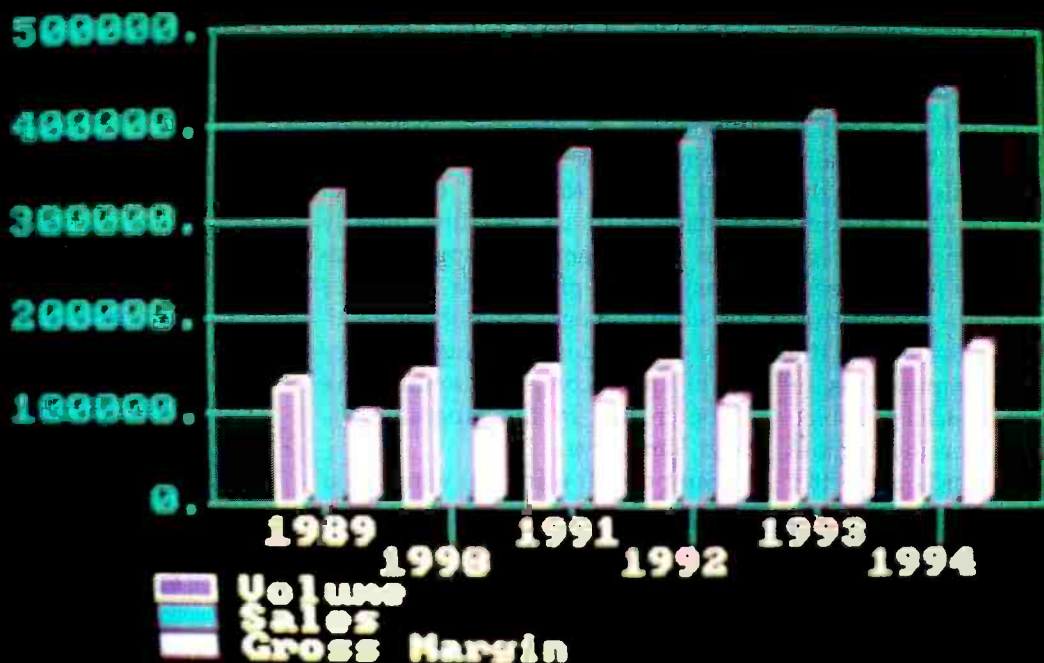

communicate with peripheral memory. Software developers can easily afford to use system resources to support elaborate user interfaces. And those interfaces make a world of difference in who uses the computer, and for what.

Mainframe software typically puts a high premium on abstract, symbolic thought. A user must not only know what he wants but also the command to execute the desired action. Mainframe tools are complex and typically require a substantial time investment for a user to acquire the skills necessary to do serious computation.

On a microcomputer, the programmer makes things easier for the user. Instead of terse symbolic word commands, the user gets "ring" menus or pictures. At any point in the program, users have options displayed on the screen. Even if you use a system only once every six months, you still can do useful work.

The 9600-bps Blues

The microcomputer has enabled us to do things that, while technically

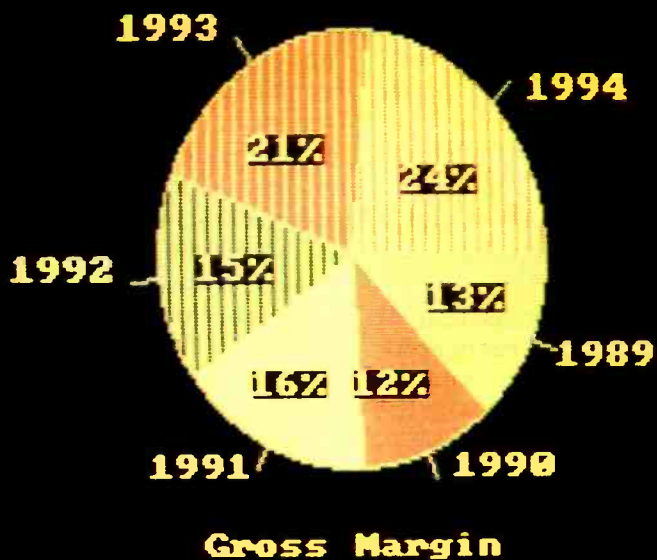

Standard color graphics with the IFPS/Personal package.

feasible on a mainframe, have not been practical because of resource constraints. For example, Execucom Inc. has adapted its mainframe financial-modeling package, Interactive Financial Planning System, or IFPS, to run on microcomputers. Van Van Cleve, a programmer for the IFPS/Personal project, says, "On a mainframe, there is a great disparity in the relative capacities for I/O and computation—and even more between disk-type I/O and user [CRT screen] I/O. On the mainframe you're running to the disk a lot faster than the data rate. As for computations, if you're doing 32 bits instead of 16 bits, you have a great improvement: more than 2-to-1. Bigger words are better for doing crunching operations, but not necessarily for things like strings and characters.

"The best I can get at my video display from a mainframe is a set of codes at 9600 bps. When you start getting more than 9600 bps, the reliability of the transmission line starts to go down. People do 19,200 bps now, but that's pretty special purpose and expensive. It's expensive to run high speed across distance. And you still can't even get close to the speed of communication between the central processor and memory.

"On the microcomputer you have a slow disk and a fast screen: a totally different environment. If we want to talk about [computational-bound] operations and normal I/O, you've got a much slower machine. But when you step into the I/O-intensive world of user interface, you have all the I/O capacity you need. It's not a burden the way it is on the mainframe."

The mainframe is at its best in operations in which the central processor communicates with memory or with the disk, rather than with the CRT. The microcomputer can talk to the screen as rapidly as it talks to memory. The screen is directly memory-mapped. With that method, complete information describing the current state of the screen remains present in memory. Could you design a mainframe that way?

"Yes, you could," says Van Cleve. "The problem is that, if you want to

write a mainframe program, you have to know the characteristics of every terminal that will be used to talk to it."

Because it never made sense to design a mainframe to optimize its screen I/O capabilities, the practical limitations of designing complex, screen-intensive user interfaces loom even larger than the theoretical limitations (those resulting directly from the transmission-speed limitations). Appropriate data structures for storing images are not automatically provided in the same way they are in a microcomputer, so they have to be created by the programmers. Says Van Cleve:

"Suppose I want to window a screen in the two systems. If I step into the IBM PC world, I can make a direct call to BIOS [basic input/output system] to scroll. I can scroll quickly to any designated area in the screen I want. If I want to simulate that in the mainframe, yes, I can do it. I can keep a screen image in an array, and I can manipulate it and then flash the results out the data-rate line. But I'm doing a lot of computation, I'm doing a lot of itty-bitty movement, and generating a number of different I/O calls. I can't do this all in one I/O call—fill a buffer full of a lot of things with carriage returns. In a mainframe environment I have to do it in a sequence of I/O calls. I can't control the screen directly. The best I can do is send it a bunch of ASCII [American National Standard Code for Information Interchange] characters that the mainframe then has to interpret in some kind of code to produce something: lines, charts, text, menus, whatever.

"On a microcomputer, on the other hand, you have the memory-map capability—you can write directly to the screen and produce an image at memory-loading speed, which is several orders of magnitude greater than 9600 bps. On a mainframe, I can't read back from my terminal in terms of user I/O. I write something to the screen: I have to remember what was there. On a microcomputer you can use the screen as a workspace. You can read back what you've written."

When Worlds Collide: Social Aspects of the Move to Micros

Mainframes and microcomputers have long inhabited separate spheres. When these worlds meet, the people involved in them must make some adjustments. Says Execucom's president, Jerry Wagner, "Mainframe people have a certain style, they have a certain mentality relative to thoroughness of documentation, specifications, all the things that go along with large-systems development. That kind of workstyle doesn't work well in the micro world. At least, it hasn't historically."

Many microcomputer owners take comfort in the thought that their entire system sits on a desk in front of them. For some, it removes feelings of intimidation they've had toward computers; for others, the joy is in the sense of having complete control of the resource. Wade Shaw of Execucom, who comes from a mainframe background, views microcomputers differently:

"I find it uncomfortable to think that the whole thing is sitting right there because I'm used to being on the other end of an organization. In a mainframe environment you have a group of people on the other end that are providing your service, and they buffer some aspects of the computer. To have to go in and put a cable on drives me bananas."

"I don't like to get my hands in the hardware. That's not my job. I've spent my time specializing in software design, and to ask me to actually go in there and change a card—that just blows me away. I feel it's a waste of my training."

Mark Wood at Execucom presents a view that may reconcile some of the differences between microcomputer enthusiasts who love to swap chips and solder connections and mainframe software specialists like Shaw: "It satisfies a basic human need to understand something completely, to form a gestalt of it."

"Look at this terminal that I work on here (which communicates with a remote Prime minicomputer). It has a wire that goes through the wall and when I'm sitting at the terminal I'm working with a tool, part of which is behind that wall. As a casual user, if I don't know about computers, hard disks, communications devices, front ends, packet networks, and whatever else, then there is no way I can

have a complete picture of the tool I'm using. All I know is, here's part of it, and there's something else behind that wall.

"The difference between this kind of user and somebody like Wade Shaw is: he already knows what's on the other end of that wire. He's got a master's degree in computer science. In his mind he has a picture of the complete tool. But for the casual user, it's different. He's using something he doesn't completely understand, and he knows somebody else has control of part of it."

Micro Myths

Developer Shaw talks about some of the myths surrounding microcomputers:

"There are a couple of curious notions surrounding microcomputers. One of them is that microcomputers are going to save the world from the big, bad, expensive mainframes and minicomputers. There's a bit of holiness in there, somehow—that it shouldn't cost that much to do computing, that it's everybody's intrinsic right.

"The other myth is that everybody's going to get rich off of their microcomputer—that every person is a budding computer entrepreneur just waiting to put his or her fingers on the keys and produce a masterpiece that's going to revolutionize the world and make him a millionaire overnight.

"Even though I think there's a lot of bunk in these notions, I enjoy them: at the very least, they're changing the image of programmers. For a long time, programmers have been regarded as clerks, because the first jobs that computers did were to replace clerical jobs. Now, with more people getting involved [in computing], the level of appreciation for what programmers do has been raised."

Microcomputer users' prejudices get into the act, though. Says Shaw, "There's a kind of disgust on the part of some of the younger programmers regarding computing in the mainframe and minicomputer marketplace. Some of the younger programmers make it clear that they really don't want to be involved with mainframes and minicomputers—they're not even curious. It's as though large computers are the past, and mainframe people and corporations aren't going to have any impact on the future. They just don't want to have anything to do with the mainframe world or the past. It's kind of unsettling, because it means they won't benefit from lessons already learned."

Will microcomputers bring computing to the executive's desk? Wagner doesn't think

so. "If, say, 5 percent of IFPS [Interactive Financial Planning System] users now are executives, that might increase to 10 percent with the IBM PC, but the number will never be significant. It's not a matter of ease of use, knowing computers, or of MBAs moving into management ranks. It's strictly a matter of time and culture. When you become an executive, it's not a part of the culture to use these kinds of tools.

"The time element closely associates with the cultural factor. To sit down at a terminal and write models, interrogate models, etc., is time-consuming. An executive can use his time much more effectively by working with a staff assistant who will do the model building, the interrogations, and so forth, for him.

"The key here is that the executive must be able to understand the work his assistant does for him on the computer."

Piracy

One software issue that is a much greater problem in the microcomputer market than in the mainframe market is the theft of goods. Software companies commonly estimate that from 25 to 50 percent of their potential revenue slips away to pirates. Why is the problem so much bigger in the microcomputer marketplace? I asked Sam Guckenheimer, Execucom's Product Manager for IFPS/Personal:

"It's harder to track," he said. "The mainframe world is very centralized. Your customer base is made up of a small number of installations and is, by contrast, quite easy to audit. Take a hot-selling machine like the VAX [minicomputer]. There may be 8000 VAXs installed now, something like that. Well, that's a fifth as many processors as IBM PCs are added into the work place every month. It's the difference in magnitude between ships in a harbor and people passing through a subway turnstile. You're talking about much greater dispersion. It's much more difficult to audit and control."

One possible solution Execucom has considered is a combination hardware/software protection scheme, using an encryption algorithm embedded within the software, and the same algorithm burned on a PROM (programmable read-only memory) installed in a device affixed to the keyboard. Other protection alternatives include tying the software to a particular processor by means of a serialized PROM (as Apple has done with its Lisa software) and the method most widely used for lower-priced software in the home market: scrambling

the information on the disk.

Of scrambling information, Sam Guckenheimer says: "Well, first, that means you can't copy it for backup. Second, you can't copy it over to a hard disk, and hard disks are starting to get used a lot. And third, it generally means that it takes much longer to boot and it tends to create difficulties in areas like operating-system compatibility. Look at all the software that was released for the IBM PC that doesn't work with MS-DOS 2.0 because protection games were played using memory areas subsequently required by the new operating system."

The protection scheme employing the serialized PROM involves the installation inside the computer of a PROM containing a unique serial number. Software publishers wishing to be protected by that serial number include it in their software, where it is checked against the hardware-resident number before the program will run. Thus a given piece of software is usable on only one machine. Guckenheimer's evaluation: "If you have a multiple-personal computer environment where machines get swapped for service, this solution dies instantly. Also, if people change offices and don't carry their machines with them, this system won't work."

No protection system will please everyone. "Users don't like software protection," Guckenheimer says. "It has, in fact, been recommended by a number of users that we go to multiuser licensing without protection. But then how do we really know how many copies are out there? How do the DP [data processing] departments we deal with know that, for the 100 they've distributed, there haven't been another 500 copies made? Copying a disk is generally a lot easier than getting budget approval."

Changing User Profile

As the character of the computer undergoes a dramatic change with the penetration of micros into the computer resource commonwealth, so does the profile of the typical user.

The new user is maybe someone who previously stayed away from the computer, feeling either that he "wasn't technical enough" to use it or that the investment of time in learning to use it would not be repaid by the benefits of using it. Some of these people have felt, probably correctly, that their need for the machine would be too intermittent to permit them to keep their skills current. The powerful and flexible user interface permitted by the micro-

computer is changing that picture. Says Guckenheimer, "It used to be that the people who worked with computers were always very analytical in their orientation. They would go through long descriptions of problems, meticulously laid out in advance on paper, and then enter them into the computer and solve them.

"Over the past few years software writers have directed more and more attention to making user interfaces flexible. The advent of microcomputers represents a tremendous leap forward in this process, so that now users are developing a different way of behaving with the computer. Instead of laying out their whole problem in advance, they'll sit down and start entering things almost from stream of consciousness. They don't necessarily have a clear definition of their problem when they start; they work it out as they describe it. It does away with, or makes much more cursory, the pencil and paper notes made beforehand. One of the reasons spreadsheets have caught on so well is that they lend themselves to putting in a few random numbers and then experimenting with their rela-

tionships until you get something that makes sense.

"I think that because of the microcomputer, there's a general shift in the way jobs are defined. The whole concept of the personal computer as a professional workstation implies that you break down some of the barriers of work specialization and that a given user may employ his computer for

Mainframe software writers have aimed at making user interfaces flexible.

a little bit of financial modeling, a little bit of word processing, some graphics, a database, communications, and project management. Before microcomputers, a company had, in the case of financial analysis, a person whose job was financial analysis and nothing else. Now, the capability of doing fairly sophisticated financial analysis is within reach of managers who don't have as much training and don't do financial

analysis as extensively. It means that more people will get involved in the process."

Customer Support

This is another area in which a major transformation must take place in shifting from mainframe to microcomputer. Introductory training delivered at the customer site and telephone hotline support are often included in the price of a mainframe software package, and training on advanced topics is available for a fee. Clearly, this sort of service is not feasible in the microcomputer market, where software is sold in large quantities, through distributors or computer stores, at comparatively low prices. Much of the training delivered in person to clients by mainframe software companies will have to be delivered through the computer for microcomputer software.

Product documentation must be thorough and understandable if a microcomputer product distributed through extremely high-volume channels is to stand on its own. If documentation is to become more helpful to the user, it will have to do

Business Scientific Data Plotting

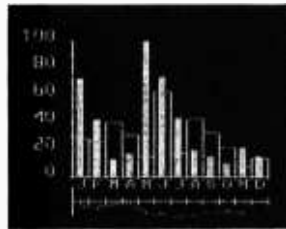

Softkit # 2

Data Plotting Software for Micros- This 232 pg book/disk package contains 18 programs in BASIC for processing and plotting data: Histograms, pie charts, log plots, regression, statistical analysis, curve fitting, barcharts, stock market charts, 3D views of surfaces, data management, applications to science, engineering and business.

Special features include writing text over graphics, automatic scaling and axis labeling, automatic replotting when data is changed.

Book contains program listing in Applesoft BASIC with theory, equations and full documentation. Disks contain same programs in Applesoft BASIC or IBMpc BASICA. Use the programs as-is or modify and combine for your own special applications.

Please send Book- \$30.50
 Applesoft Disk- \$19.95
 IBMpc BASICA Disk- \$19.95

Name _____
 Address _____
 City/State/Zip _____

check enclosed visa/mastercard

card no. _____ expiration date _____

call (617)934-0445 for faster delivery
 KERN PUBLICATIONS • P.O. Box 1029BN • Duxbury, MA 02332

Applied Statistics for Micros



Softkit # 7

Applied Statistics for Micros- This is a package of professional level statistics programs for use in business, science and engineering. Book contains program listings in BASIC alongside theory and documentation. Optional disk contains same programs in BASIC.

Book gives clear, easy-to-read tutorial on errors, statistical distributions, hypothesis tests, variance, covariance, regression, response surfaces and time series. 22 programs calculate normal, chi-square, t and F distributions; variance with randomized blocks, Latin squares, factorials, response surfaces. Hi-accuracy multi-linear regression program has data handling and transformation. Also programs for hypothesis testing, sorting and smoothing. Numerous practical applications.

Assumes no prior knowledge of statistics. Used as a text for years at a leading university.

Please send: Book- \$38
 IBMpc BASICA Disk- \$26 Applesoft Disk- \$26 CP/M86 Disk- \$26

Name _____
 Address _____
 City/State/Zip _____

check enclosed visa/mastercard

card no. _____ expiration date _____

call (617)934-0445 for faster delivery
 KERN PUBLICATIONS • P.O. Box 1029BN • Duxbury, MA 02332

so by being integrated as directly as possible within the product. As Guckenheimer says, "The concept of printed documentation is limiting. Documentation includes user prompts, help messages, interactive tutorials, and what-have-you. All of those tie together.

"Documentation is important, but it's often misunderstood. The most effective documentation is that which has to be read least. People often think of documentation as being effective when one can get a full description of what the software does from it. It's much better if the software explains itself."

What You Learn from a Mainframe Background

Kirk Jones explains why he thinks a company like Execucom, with a background in mainframe software development for large corporations, has an advantage in the big business market, even over companies with more experience in microcomputer software.

"We've learned from 10 years of experience how people solve corporate prob-

lems and what the information systems requirements are for solving corporate problems. We've learned how people integrate systems and models together, and what kind of support they have to have to solve corporate problems.

"What Visicorp knows how to do extremely well is solve the individual's business problems. But one of the problems

Maintainability is extremely important from a corporate point of view.

with a Visicalc-like product is the difficulty of maintaining the model. It is relatively tough to write a Visicalc model this month, not use it for six months, and then take that same application and run it again successfully, with new numbers, and still know what the numbers mean. Many Visicalc users find it easier to rewrite their spreadsheet after six months than to try to update the old one. One of the things

we've learned with IFPS is that maintainability is extremely important from a corporate point of view. The corporation can't afford to pay for that rebuilding."

Gary Greenfield, head of development for IFPS/Personal, concludes, "I think we're going to see a merging of what the mainframe software marketplace and the microcomputer marketplace have meant to their users. From the micro software marketplace, I think we will take lessons concerning the supportive user interface and the type of documentation and outline tutorials that users want. With microcomputer software relatively inexpensive compared to what we've been used to in the past, we've got to take a look at more cost-effective means of distributing our product: not just the software package, but the services associated with it, too.

"On the other hand, I think we can teach the microcomputer industry something about the type of professional training, consulting, and hotline service that corporate customers want from software vendors. We're going to see these marketplaces coming together."

Graphics for the IBMpc Apple II

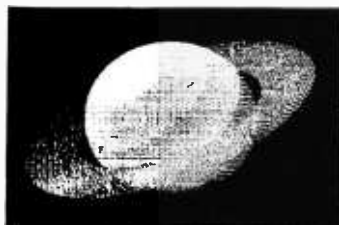

Softkits # 5,6

This is a spectacular collection of graphics programs for the IBMpc and the Apple II or Ie. It contains more than 60 programs in BASICA. They're listed beside theory and equations in a 280 page self-teaching guide. An optional program disk is available.

These programs will show you how to write your own 2D and 3D graphics software and they will give you many useful, ready-to-run graphics routines to incorporate in your own software.

Programs are menu driven and modular. They show how to use elementary graphics commands and do 2D and 3D translation, rotation, scaling, clipping, windowing, hidden line removal, shading, perspective, hi-speed animation, with applications to science, business, engineering and games. Adopted as a text in many leading universities. We know you will be pleased.

Please send:

- IBMpc Book- \$30.50 IBMpc BASICA Disk- \$21.50
 Apple Book- \$30.50 Applesoft Disk- \$21.50

Name _____

Address _____

City/State/Zip _____

- check enclosed visa/mastercard

card no. _____ expiration date _____

call (617)934-0445 for faster delivery

KERN PUBLICATIONS • P.O. Box 1029BN • Duxbury, MA 02332

Designer^{3D}

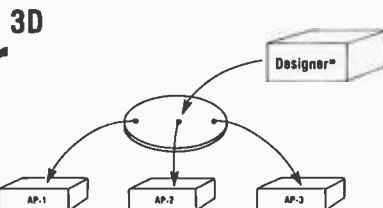

Softkit # 8

This is a professional 3 dimensional graphics design program. With Designer^{3D} you can interactively create 3D drawings on the screen, rotate in 3 dimensions, enlarge, view in perspective, store on disk, recall and update.

Run Designer^{3D} - a cursor appears on the screen with a set of 3 dimensional coordinate axes. Move the cursor around in 3 dimensions identifying node points, lines and points defining curves. Curves fit through points using a cubic spline algorithm. See your 3D picture being created on the screen. X,y,z coordinates are displayed as the cursor moves. Then enlarge, rotate, store your 3D picture on disk, recall and modify.

The picture stored on disk is a text file of node x,y,z coordinates and the lines and curves comprising the 3D object. Interface Designer^{3D} to other programs through this disk file. Use Designer^{3D} as a graphics pre-processor for your own applications software.

Designer^{3D} is supplied on disk in machine language with a user's manual. Perfect for CAD/CAM applications.

- Please send Apple Designer^{3D} - \$85
 IBMpc Designer^{3D} - \$85

Name _____

Address _____

City/State/Zip _____

- check enclosed visa/mastercard

card no. _____ expiration date _____

call (617)934-0445 for faster delivery

KERN PUBLICATIONS • P.O. Box 1029BN • Duxbury, MA 02332

SPECTACULAR OFFERS

wabash

6 YEAR WARRANTY

M11	5 1/4"	SINGLE SIDE SINGLE DENSITY	1.49*
M13	5 1/4"	SINGLE SIDE DOUBLE DENSITY	1.89*
M14	5 1/4"	DOUBLE SIDE DOUBLE DENSITY	2.79*
M16	5 1/4"	DOUBLE SIDE QUAD DENSITY	4.19*
F111	8"	SINGLE SIDE SINGLE DENSITY	1.89*
F1312	8"	SINGLE SIDE DOUBLE DENSITY	2.39*
F144	8"	DOUBLE SIDE DOUBLE DENSITY	2.99*

maxell

LIFETIME WARRANTY

MD1	5 1/4"	SINGLE SIDE DOUBLE DENSITY	2.09*
FD1-128	8"	SINGLE SIDE DOUBLE DENSITY	3.60*

BASF 2 YEAR WARRANTY	BASF LIFETIME WARRANTY
54968 5 1/4" ss,dd 1.79*	54974 5 1/4" ss,dd 2.19*
53428 8" ss,dd 1.89*	54998 8" ss,dd 2.29*

TDK LIFETIME WARRANTY	SENTINEL LIFETIME WARRANTY
2501 5 1/4" ss,dd 2.49*	5S-11 5 1/4" ss,dd 1.73*
2801 8" ss,dd 3.90*	8S-11 8" ss,dd 2.14*

WE ALSO STOCK AT FANTASTIC LOW PRICES



Floppies, Tape, Data Cartridges, Data Cassettes, and Disk Packs

* QUANTITY 100. SMALLER QUANTITIES ADD 5%

DISK DRIVE HEAD CLEANING KITS 5 1/4" = 15.95	C-10 CASSETTES Get 8 cassettes, and Cassette/8 Library Album 8.00
--	---

SNAP-IT POWER CENTER Turn one outlet into six! Power Surge Control RFI Filtration 15 Amp Circuit Breaker 59.95	LIBRARY CASES 8" Kas-sette/10 2.99 5 1/4" Mini Kas-sette/10 2.49
---	---

BOOK VALUES FULL SELECTION, DISCOUNT PRICES on hundreds of titles published by ALFRED, HAYDEN, DILITHIUM, SAMS, TAB, MCGRAW HILL and many others.	SOFTWARE AT FANTASTIC PRICES SAVE 25% OR MORE on thousands of software packages for all systems, including Business, Language, Engineering, Games, Graphics, Utility, and many more.
--	---

* Written purchase orders accepted from government agencies and well rated firms for net 30 day billing. • International orders accepted with a 15.00 surcharge for handling, plus shipping charges. • C.O.D. requires a 10% deposit. • We accept Visa, MasterCard, Money Orders, and Certified checks. • Checks require bank clearances. • All shipments F.O.B. San Diego. • Minimum shipping and handling 2.00, minimum order 10.00. • California residents add 6% sales tax. Prices and terms subject to change without notice. • All sales subject to availability, acceptance, and verification. • All sales are final. • Satisfaction guaranteed or full refund.

We also offer printer ribbons, printwheels, type elements, equipment covers, power consoles, paper supplies, storage and filing equipment, furniture and many other accessories for word and data processing systems. Write for our free catalog.

Orders Only
800-854-1555

Information
619-268-3537

Modern Hotline (Anytime)
619-268-4488
Exclusive Monthly Specials

ABC

DATA PRODUCTS

ITT TELEX 4992217
8868 CLAIREMONT MESA BLVD
SAN DIEGO, CALIFORNIA 92123

Housekeeping Problems

Kirk Jones worked only on mainframes before his assignment to Execucom's IFPS/Personal project. He makes this observation about microcomputers: "Personal computers are very unfriendly in the demands they make on the users for file backup and maintenance (*source management*, in traditional data-processing terms). They've put many of the problems that the mainframe world solved 20 years ago back in the user's lap. He is now responsible for backing up his floppy disks and for figuring out what to do when one of them goes bad. It's the user's problem when the disk can't be read, whereas in the mainframe world that is taken care of for you. There are people who do nothing but insulate the user from the hardware environment and the operating-system environment."

The same sort of phenomenon affects the software developer in a different way. Wade Shaw, a computer-language designer for Execucom, had these comments:

"One of the biggest problems that we've encountered with microcomputers has been control of the software source. You've written a program, you've fixed it up and think it's correct, and now you want to put it somewhere. So you put it on a floppy disk. Floppy disks tend to be somewhat unreliable, so you back it up on another floppy disk. Later, you make some changes in your master floppy disk. When somebody wants the program, you may hand him the wrong floppy disk.

"Or maybe you put the floppy disk onto the central system, the archival source system. Somebody takes that copy off, works on it, makes some changes to it, and doesn't tell you. Now you come back in, make some changes, and you overwrite his copy on the master. Pretty soon people start finding bugs they've already fixed, or they have to reenter enhancements they've already completed.

"Of course, this is always a problem when you have a lot of people working together, and it can be alleviated to a certain extent by careful planning and control of the source. But the

problem is aggravated by having a distributed computing facility as opposed to a centralized one."

Choices for Software Vendors

What microcomputer limitations have to be sidestepped or overcome to adapt software originally designed for a mainframe? Three important ones are utilization of memory, access time to the disk, and the speed of execution of floating-point arithmetic.

The first two limitations are almost inseparable, given the close functional resemblance of direct-access (RAM) and peripheral memory (floppy disk, RAM disk, or hard disk). An overlay structure, wherein sections of a program are swapped in and out of direct-access memory from disk as needed, allows the successful execution of a program too large to fit in RAM. Using this scheme, the programmer frees himself to write a program as large as he thinks his user has peripheral memory to accommodate. He is, however, subject to the constraint that no legal command given by the user ever requires a larger portion of the total program than will fit in the available RAM. He must also incorporate in his design the logic that decides what sections of the total code should be in RAM following a given user command.

What makes the overlay solution less than glorious are the delays the user must endure while waiting for code to be read in from the disk. How much time does he spend waiting? It depends on how fast new information can be obtained from the disk, how many distinct overlays have been built into the program (and therefore how often disk reads are required), and when the overlays must be swapped out during user interaction.

In practice, the second factor depends on the first, since the programmer must take it into account in designing his system.

The amount of time a user spends waiting depends mainly upon the technology available. Floppy-disk storage is slower but cheaper than hard-disk storage; hard-disk storage is slower but cheaper on a per-byte basis than RAM disk or direct-access

THE BUFFER DID IT.

Who Stole The 1500 Letters From The Computer?

Let's just say you've got to send a letter to 1500 different people. Would you like to spend 22.5 hours* or 60 seconds of computer time?

With a garden-variety buffer, the computer has to mix, merge and send 1500 addresses and 1500 letters to the buffer. Trouble is, most buffers only store about 32 letters. So after 32 letters, the computer's down until the printer's done. Altogether, you're talking 22.5 hours.

In the case of our new (not to mention amazing) ShuffleBuffer, computer time is 60 seconds flat. Just give

ShuffleBuffer one form letter and your address list, and it takes care of the mixing, the merging, and the printing. But that's not all ShuffleBuffer's stolen from the computer. Oh, no.

Who Changed and Rearranged The Facts?

Again, ShuffleBuffer's the culprit. You want to move paragraph #1 down where #3 is? Want to add a chart or picture? No problem. No mystery, either. Any buffer can give you FIFO, basic first-in, first-out printing. And some

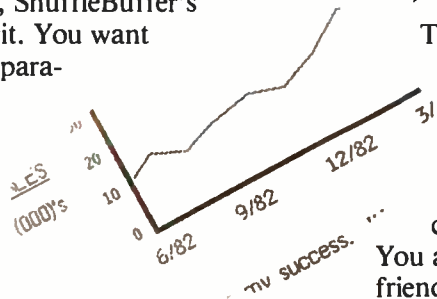

Mr. Harold Burns
P.O. Box 1111
Toledo, Ohio 48820

Dear Har...

buffers offer By-Pass; the ability to interrupt long jobs for short ones. But only ShuffleBuffer has what we call Random Access Printing — the brains to move stored information around on its way to the printer. Something only a computer could do before. Comes in especially handy if you do lots of printing. Or lengthy manuscripts. Or voluminous green and white spread sheets. And by the way, ShuffleBuffer does store up to 128K of information and gives you a By-Pass mode, too.

And Who Spilled The Beans 239 Times?

Most buffers can't tell the printer to duplicate. If they can, they only offer a start/stop switch, which means you're the one who has to count to 239. Turn your back on your buffer, and your printer might shoot out a room full of copies. ShuffleBuffer, however, *does* control quantity. Tell it the amount, and it counts the copies. By itself.

So, What's The Catch?

There isn't any. Sleuth around. You won't find another buffer that's as slick a character as this one.

You also won't find one that's friendly with any parallel or serial computer/printer combination. This is the world's only universal buffer.

With a brain.

Who Wants You To Catch A ShuffleBuffer In Action?

You guessed it. We do. Just go to your local computer dealer and ask him to show you a ShuffleBuffer at work. Or, you can call us at (215) 667-1713, and we'll clue you in on all the facts directly.

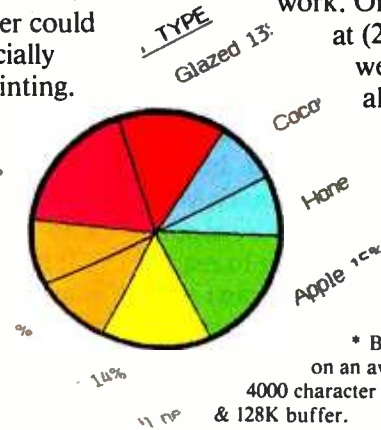

Now, keep it,
my doughboy
Love,
Glady

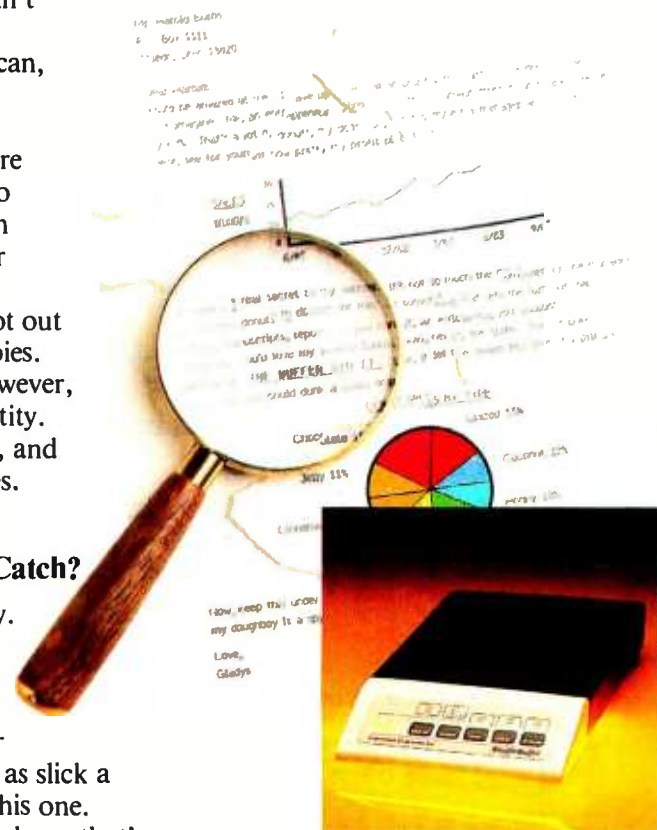

ShuffleBuffer
The Buffer with a Brain

Interactive Structures Inc.
146 Montgomery Avenue
Bala Cynwyd, PA 19004

memory mounted directly on the computer's motherboard. Therefore, like any other designer, the programmer must make some decisions about what equipment he thinks the user will be able and willing to obtain.

Shaw thinks that, above a certain reasonable minimum, the amount of memory available to the user is not necessarily the key factor in determining his ability to get the assistance he needs from the computer. "The problem with models is that they can always get bigger than your memory no matter how much you have. Even if you could buy an unlimited amount of memory, you'd still have a problem, because at some point your model is going to reach a size and complexity you can't work with effectively. I think that eventually the business analysts who do modeling will have to learn some of the same lessons programmers have, about structured design and modularization of models, the cost of maintaining code, and the importance of documenting it well."

The IFPS Example

As mentioned previously, Execucom markets a simulation-modeling language known as IFPS designed to run on a mainframe.

The company recently released IFPS/Personal, a smaller version of the mainframe package for the IBM PC and related microcomputers. Available initially only to corporate customers owning the mainframe package (with which IFPS/Personal communicates), the stand-alone microcomputer system will be released for the mass-distribution market early in 1984.

The Mainframe System

IFPS is an ultra-high-level simulation-modeling language. It runs on computers from the Wang VS series to the largest IBM and Cyber machines and on more than 25 different operating systems.

The modeling language itself is nonprocedural and English-like. The term "ultra-high-level" distinguishes it from high-level languages such as

COBOL, FORTRAN, and Pascal because IFPS is as far beyond these languages on the machine-language-to-spoken-word continuum as they are from assembly language. Users may order model statements almost arbitrarily, without regard to required computational sequence, as shown in listing 1. Internally, IFPS reorders statements so that no variable is computed before others on which it depends. The exception occurs when model statements describe a simultaneous equation. When this occurs, IFPS automatically employs an iterative numerical method to obtain the correct solution.

Interrogation facilities of the language include What If, Goal Seeking, Analyze, Sensitivity, and Impact. Most readers have some concept of a What If capability because some form of it is a feature of nearly every electronic spreadsheet on the market. In IFPS, What If is literally "what if" (see listing 2). In contrast to What Ifs in most spreadsheet packages, a What If in IFPS leaves the base case unaltered, so a user can do any num-

WHY PAY RETAIL ?

SANYO MONITORS

DM-2112 GREEN 12"	\$ 89
DM-2212 AMBER 12"	\$107
DM-8112 GREEN 12"	\$168
DM-8212 AMBER 12"	\$178
DMD6500 RGB 13"	\$346
AVM-196 RGB 19"	\$626
AVM-255 RGB 25"	\$787

ZENITH

Z-29 TERMINAL	\$676
ZVM-123 GREEN 12"	\$ 88
ZVM-122 AMBER 12"	\$113

STAR MICRONICS PRINTERS

GEMINI 10X	\$298
GEMINI 15X	\$428

PANASONIC

TR-120MIP GR. 12"	\$168
TR-120MOP AMB. 12"	\$185
CT-160 COL/EM 18"	\$289
DTD-1800G RGB 18"	\$325
DTD-1300G RGB 13"	\$388
KX-P1090 PRINTER	\$349
KX-P1160 PRINTER	\$1199
VP-6801A PLOTTER	\$1499

ZOOM MODEMS FOR APPLE

NETWORKER	\$115
NETMASTER	\$ 69
NETWORKER/NETMASTER	\$149

SILVER REED PRINTERS

580P/580S	\$432/\$467
550P/550S	\$648/\$675

CALL FOR \$ AMDEX, NBC...

TERMS: COD - FREIGHT COLLECT - CHARGE CARD
CUSTOMERS ADD 4% - \$1 PHONE CALL REBATE W/ORDER.

(301) 662-1317

**COMPUTER
WHOLESALEERS
of FREDERICK**

A DIVISION OF TESCO CORP.
1030 W. Patrick Street Frederick, MD 21701

NRZ DIGITAL DATA RECORDER



FEATURES:

- 4800 BAUD data rate (3" per second) 1 ERROR in 10⁸ BITS • RS-232 or TTL interface — NO EXTERNAL INTERFACE REQUIRED
- ASYNCHRONOUS COMMUNICATIONS STANDARD "HANDSHAKING" • SPEED STABILITY — LONG TERM ±.1% • COMPATIBLE with DC-3 • Works with CERTIFIED DATA or high quality FeO AUDIO TAPES • OPTIONS: 115v ac, 220v ac, 12v ac; Stand alone; Rack-mountable; 9600 BAUD; Buffered Version

The PD-1 SERIES DIGITAL DATA RECORDER continues to set new NRZ INDUSTRY STANDARDS. Its tachometer feedback LC stabilized motor circuit and heavy duty drive mechanism provide STABILITY, ACCURACY and RELIABILITY. You get LESS BIT DROP-OUT when capturing crucial information at HIGHER DATA TRANSFER RATES . . . at a MUCH LOWER COST. \$335.00

USED IN:

- PROCESS CONTROL • POINT-OF-SALE • TELEPHONE SWITCH LOGGING (Call Activity and Station Message Detail) • DIAGNOSTIC SUPPORT (local/remote) • HARD DISC BACKUP (for personal or small computer systems) • Many Other Applications

- An intelligent, buffered version of this device is also available.

TO ORDER, DIAL:
(201) 356-9200



Presenting the computer you will flip over.

Some computers have a vertical format for word processing. Still others offer a horizontal format for spread sheets.

The Corvus Concept™ gives you both. All in a single unit. By simply flipping the high resolution, bit-mapped screen.

Whole-page word processing and 13-column one-glance forecasting. No need for scrolling. And no need to constantly print out sample reports.

The Seybold Office Systems Report called it "The most impressive new desk-top computer" at the Hannover Fair. Byte Magazine has said "It will set the price/performance standard in its price class for some time to come."

Besides its dual orientation screen, the Concept has impressive memory

capacity with 256 kilobytes standard (expandable to 512 kilobytes).

And it's designed to grow with your needs. Every Concept has a built-in network interface that transforms it from a powerful stand-alone computer to a versatile, multi-function workstation on Corvus Omninet™ an interactive peripheral-sharing network.

Because it was an idea whose time had come, we called it the Corvus Concept. You'll call it a miracle.

Circle 123 on inquiry card.

♦♦
♦♦ **CORVUS SYSTEMS**

2029 O'Toole Avenue, San Jose, CA 95131
408/946-7700 TWX: 910-338-0226



YOURS FREE!

The essential new catalog of the business computer forms and supplies you need most!

It's quick • convenient • easy-to-use.

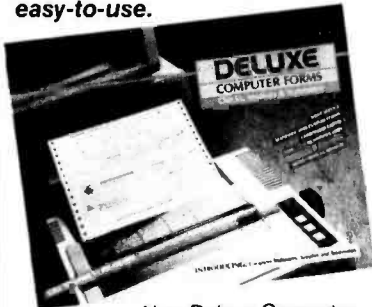

Now Deluxe Computer Forms, a division of Deluxe Check Printers, gives you the software-compatible checks, invoices, statements and word processing stationery you've been searching for. And accessories too.

And we can ship them all to you in as few as 3 working days!

Deluxe delivers your order in record time because we know how much you depend on it to make your office run smoothly. And we deliver it to your precise specifications. That means customization for your unique program needs, or personalization of any of our 200 standard forms for popular software programs. And you order only what you need—as few as 500 forms.

See what we've got to offer your business. Then see just how fast we can deliver it.

Send for your FREE catalog today!



YES. Rush me your complete, new catalog of computer forms and essentials.

My Name _____ Title _____

Company Name _____

Address _____

City _____ State _____ Zip _____

Phone (____) _____

Clip out and mail or call TOLL FREE:

1-800-328-0304

(In Minnesota, call 1-612-483-7300.)

7254

Listing 1: A model written for mainframe IFPS. The model statements may be ordered almost arbitrarily.

```

MODEL PRODBUD VERSION OF 07/14/83 15:43
100 COLUMNS 1-8
110 * QUARTERLY PRODUCTION BUDGET
120 *
130 * INVENTORY REQUIREMENTS
140 UNIT SALES = 200,350,350,500,500,400,450,400
150 BEGIN INV FINISHED GOODS = 200, PREVIOUS ENDING INV FINISHED GOODS
160 DESIRED END INV FINISHED GOODS = 30X * FUTURE UNIT SALES FOR 7, '
170 PREVIOUS
180 *
190 UNIT PRODUCTION = UNIT SALES + DESIRED END INV FINISHED GOODS - '
200 BEGIN INV FINISHED GOODS
210 *
220 ENDING INV FINISHED GOODS = BEGIN INV FINISHED GOODS + '
230 UNIT PRODUCTION - UNIT SALES
240 *
250 * MATERIAL REQUIREMENTS
260 COST OF MICRO CHIP BOARD = 200
270 COST OF CHASSIS PARTS = 60 FOR 4, 65
280 COST OF TERMINAL CHASSIS = 220
290 *
300 TOTAL COST MICRO CHIP BOARDS = COST OF MICRO CHIP BOARD * UNIT PRODUCTION
310 TOTAL COST CHASSIS PARTS = COST OF CHASSIS PARTS * UNIT PRODUCTION
320 TOTAL COST TERMINAL CHASSIS = COST OF TERMINAL CHASSIS * UNIT PRODUCTION
330 *
340 TOTAL COST MINICOMPUTER = SUM(TOTAL COST MICRO CHIP BOARDS THRU
TOTAL COST TERMINAL CHASSIS)
350 *
360 * LABOR REQUIREMENTS
370 TOTAL LABOR HOURS = LABOR HOURS PER UNIT * UNIT PRODUCTION
380 LABOR HOURS PER UNIT = 100
390 AVG LABOR RATE = 9.50 FOR 2, 10.80 FOR 3, 11.00
400 *
410 DIRECT LABOR = TOTAL LABOR HOURS * AVG LABOR RATE
    
```

Listing 2: The IFPS What If and Goal Seeking interrogation facilities.

```

INPUT: MODEL PRODBUD
READY FOR EDIT, LAST LINE IS 410
INPUT: SOLVE
ENTER SOLVE OPTIONS
INPUT: L340
    
```

***** WHAT IF CASE 1 *****

1 WHAT IF STATEMENT PROCESSED

	1	2	3	4	5	6	7	8
--	---	---	---	---	---	---	---	---

TOTAL COST MINIC	50400	168000	189600	240000	227950	201275	210975	194000
------------------	-------	--------	--------	--------	--------	--------	--------	--------

ENTER SOLVE OPTIONS

INPUT: GOAL SEEKING

GOAL SEEKING CASE 1

ENTER NAME OF VARIABLE(S) TO BE ADJUSTED TO ACHIEVE PERFORMANCE

INPUT: COST OF MICRO CHIP BOARD(1)

ENTER 1 COMPUTATIONAL STATEMENT(S) FOR PERFORMANCE

INPUT: TOTAL COST MINICOMPUTER(1)=54000

***** WHAT IF CASE 3 *****

1 WHAT IF STATEMENT PROCESSED

***** GOAL SEEKING CASE 1 *****

	1	2	3	4	5	6	7	8
--	---	---	---	---	---	---	---	---

COST OF MICRO CH	234.3	250	250	250	250	250	250	250
------------------	-------	-----	-----	-----	-----	-----	-----	-----

ber of tentative explorations without getting lost.

Goal Seeking allows the user to describe a goal—a specified value in a specified model column (usually representing a time period) for a specified model variable. The program then meets this goal, if it's feasible, by adjusting the value of some other specified model variable. For

example, a manufacturer running a model that describes the production of a new product might feel that the per-unit production cost of that product is too high. Using the Goal Seeking facility, the manufacturer can tell IFPS what the product should cost, and then let the program figure out the necessary raw-material cost or per-unit overhead. With this informa-

The latest software production solution from FORMASTER

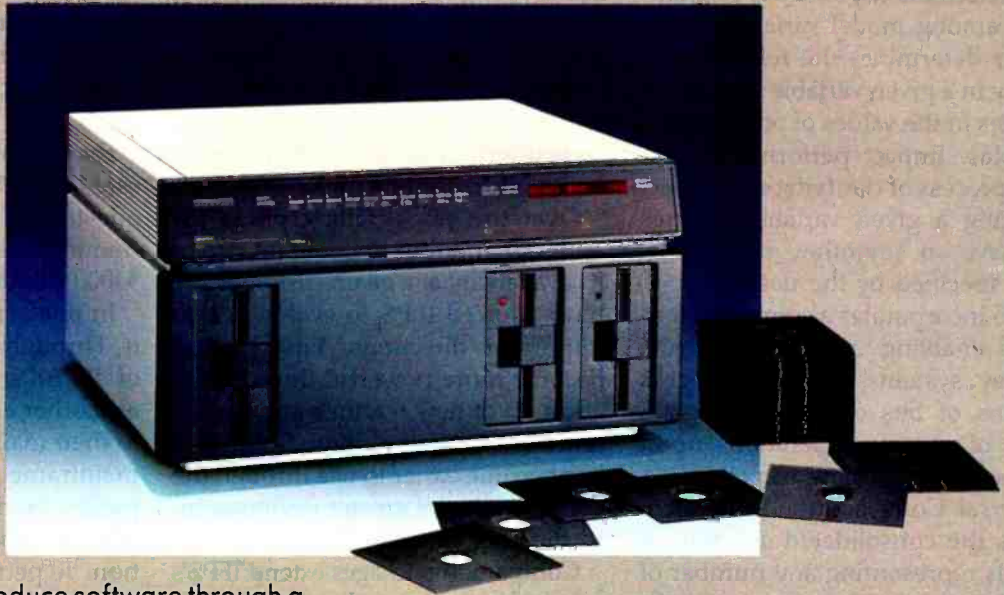

If you're trying to mass produce software through a time-consuming microcomputer operation...or think that high performance diskette duplication equipment is too expensive...you're looking at the solution. The FORMASTER™ Series Two.

The only intelligent, all-format duplicator with speed, copy accuracy, and low cost.

The same state of the art technology you find in FORMASTER Series One systems that are processing millions of diskettes around the world has been built into the Series Two. Features like the unique flexibility to intelligently write and verify all 5¼" or 3½" diskette formats, including complex GCR formats such as Apple, Commodore, and Victor.

The Series Two has the speed and copy accuracy to reduce your production costs. Up to 120 fully verified copies per hour. And you're assured of superior copy quality with bipolar bit-slice verification technology, self-checking memory and electronics, and time-proven operational software. You can even adjust production yields for different grades of media.

Best of all, it's extremely simple to use. With load-and-go Program Disks from FORMASTER's library of over 200 formats, it's like running an office copier.



The FORMASTER Series One intelligent diskette duplicator produces up to 326 fully verified copies per hour, with CopyLock™ piracy protection and copy serialization added automatically.

The right combination for piracy protection.

Like the Series One, the Series Two fills the hardware role in FORMASTER's unique CopyLock™ software protection process. The special CopyLock diskette signature simply cannot be reproduced by the end user's computer. Offered in both turn-key and custom versions for most popular computers, no other technology gives you the value-added security of CopyLock's combination hardware/software piracy protection, the most effective type of solution available today.



And if you need a larger-volume production solution...

The FORMASTER Series One product line now includes an integrated automatic loader with a new jam-proof design that handles up to 300 diskettes without operator attention.

These are just the latest solutions from FORMASTER to make software production easier—and more profitable. Call us at (408) 942-1771 and see how we can help you be successful in the software business.

FORMASTER

CORPORATION

1983 Concourse Dr., San Jose, CA 95131. (408) 942-1771. Telex 466462.

FORMASTER U.K. Corporation: Milton House, 172-184 Bath Road, Slough, Berks. SL1-3XE, England, Tel. (0753) 820981, Telex 925-859

The Leader in Software Production Technology

Reps wanted

See us at COMDEX/Fall, booth W373/375.

Circle 192 on inquiry card.

tion it may be clear that a higher production volume is needed, so the user can begin exploring the ramifications of the new production volume, using What If.

Analyze provides a stepwise trace back through model logic to help the user determine dependency relationships among model variables. Sensitivity determines the relative sensitivity in a given variable's values to changes in the values of other model variables. Impact performs the inverse process of clarifying what effect changing a given variable's values will have on any other model variables specified by the user.

IFPS incorporates a command language enabling users to construct turnkey systems that can process millions of bits of data through a series of complex operations upon the receipt of a single command. A Universal Consolidation subsystem allows the consolidated solution of models representing any number of individual entities (e.g., profit centers) at any number of organizational levels.

Mainframe IFPS offers sophisticated reporting facilities and provision for the two- and three-dimensional data files. It supports the storage of models and data files in compiled (binary) form and allows data encryption for security.

For special-purpose applications, mainframe IFPS is extensible, permitting users to link into the package their own FORTRAN functions and subroutines. Once linked, these routines may be called to operate upon model data as if they were intrinsic facilities of the language.

The maximum size of models in IFPS generally depends only upon the amount of memory a user has on his machine. Models as large as 8000 variables have been run. A typical IBM site running IFPS under the TSO time-sharing administrator reserves a full megabyte of virtual memory per normal user. Users running exceptionally large models are allocated more space.

Internally, mainframe IFPS is a combination FORTRAN/assembly-language program tens of thousands of lines long. To accommodate the

variations in local FORTRAN among its many different environments, IFPS's master source contains about twice as many FORTRAN lines as actually get shipped as the system for any given machine. It also contains routines in 12 different varieties of assembly language. To create a system for a given machine, Execucom's installation crew runs a code-selector program against that massive source, which throws out everything but the code directly relevant to the machine being addressed.

Over the years, falling prices for memory and the concomitant rise in its availability at a given customer site have allowed IFPS to evolve in two important directions. First, it has become more powerful through the addition of new features and the extension of existing ones. Second, it has become easier to use through the concentration of greater resources into the user interface.

Companion packages extend IFPS's capabilities in many directions. IFPS/Graphics provides full-color high-resolution graphics generation capabilities, including three-dimensional graphics, stackable bar charts, exploded pie charts, and all traditional forms of business graphics. IFPS/Dataspan provides for the conversion of reports produced by non-IFPS systems (such as databases and statistical-analysis packages) into datafiles suitable for use with IFPS. IFPS/Sentry provides for the creation of on-line "interviewers" who guide data-entry sessions by conversationally prompting the user for needed data. Entered data is checked against predefined specifications to minimize errors. IFPS/Optimum permits the solution of optimization problems formulated in the standard IFPS modeling language. The solution of integer, linear, and nonlinear problems is supported.

Several more interfaces are under development.

IFPS/Personal

The microcomputer version of IFPS, called IFPS/Personal, represents both a subset and a superset of the mainframe package. While it cannot handle models as large or computations

as complex as its mainframe counterpart, it retains the nonprocedural, English-like syntax. Like the mainframe system, it is a general-purpose simulation language not restricted to financial applications. IFPS/Personal runs on the IBM PC and compatibles, the Compaq, the TI Professional, and the Computer Device Dot. Execucom plans to extend its availability to all major microcomputers running MS-DOS.

For the microcomputer user interested in IFPS/Personal, an important question is: how much of this mainframe power can be packed into a \$4000 desktop computer?

In one sense, the answer is: all of it. Through a LINK command, users of IFPS/Personal can send models and other entities created on the PC to their mainframe for processing by mainframe IFPS or any of its companion products. Users can also have results shipped in the reverse direction. To perform operations available only on the mainframe, they can turn their PC into a remote terminal with the command HOST. This direct link between the microcomputer and mainframe versions of IFPS provides the user with the choice of a technology appropriate for his task. He can, for example, create and edit all of his models on his PC. Editing may account for fully half of the computer time logged by financial planners. This computer time will now cost essentially nothing beyond the relatively small cost of the microcomputer itself.

The IFPS/Personal user will be able to solve all but very large models directly on his personal computer, and he will be able to do most or all of his reporting and graphics. Only the tasks that require the power of the mainframe (such as the consolidation of giant, integrated modeling systems involving very large amounts of data) need be performed on a mainframe.

Although IFPS/Personal lacks some of the facilities of the mainframe version, it has some significant features its mainframe counterpart does not. In most cases these enhancements are suggested by and depend upon the unique hardware/operating sys-

Four Answers To Your S-100, Multi-User Problems.

Intercontinental Micro Systems makes everything you need for S-100 bus multi-user systems, networks or single user systems.

At a price that won't break your budget.

Quite simply, our single board computers, slaves, 256K memories and personality boards let you build a system *now*, not later. The hardware works, the software works,

and the prices are what you'd expect from a company that uses the most advanced design, software and production techniques to keep costs down.

What you won't expect is the almost awesome sophistication of Intercontinental Micro System's products.

So stop messing around with multiple sourc-

ing, hardware integration problems and software nightmares. Come to Intercontinental Micro and get it all — price, performance and delivery.

Read the specs, then call, write or circle the bingo number below. We'd be glad to send more information and help solve your S-100, multi-user system problems.

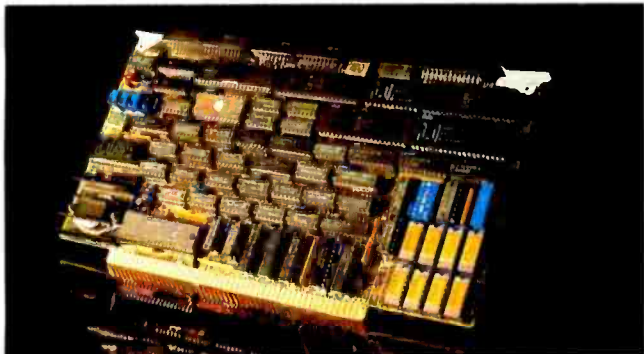

2 CPX-MX SLAVES.

□ IEEE 696.1/D2 S-100 compliance. □ Compatible with CPZ-48000 SBCP any Z-80A based CPU with extended address capability or 16 bit based CPUs complying with IEEE 696.1/D2 bus specification. □ Z-80B™ 6MHz (CPS-6X) or Z80A4MHz (CPS-4X) operation. □ Two synchronous (CPS-MS) or asynchronous (CPS-MA) serial I/O ports. □ TurboDOS™ & CP/NET™ compatible. □ Master confiscation of slave memory for diagnostic purposes. □ Two parallel I/O ports: eight data bits + 2 handshake lines per port. □ 64 Kbytes of onboard dynamic RAM. □ Master/slave memory-to-memory transfers under DMA control @ 571 Kbyte/sec transfer rate when used with CPZ-48000 SBCP □ Software selectable baud rates. □ Usable as an intelligent I/O processor in single user system.

1 CPZ-48000 SINGLE BOARD COMPUTER.

□ IEEE 696.1/D2 S-100 compliance. □ Z80A™ 4MHz Operation. □ Floppy disk controller (FDC). Single or double sided. Single or double density. 8" or 5 1/4" □ Two synchronous or asynchronous serial I/O channels (SIO). □ Two parallel I/O channels (PIO). □ Four channel DMA controller. □ 64K on board RAM. □ Memory management unit (MMU). Addresses up to 16 megabytes of system memory. □ Eight Vectored priority interrupts. □ Provisions for 2K or 4K onboard EPROM. □ Software selectable baud rates. □ IBM Bisync, HDLC, SDLC and other protocols. □ CP/M,™ MP/M,™ and TurboDOS™ operating systems available. □ Turbo-Disk™ implementation included.

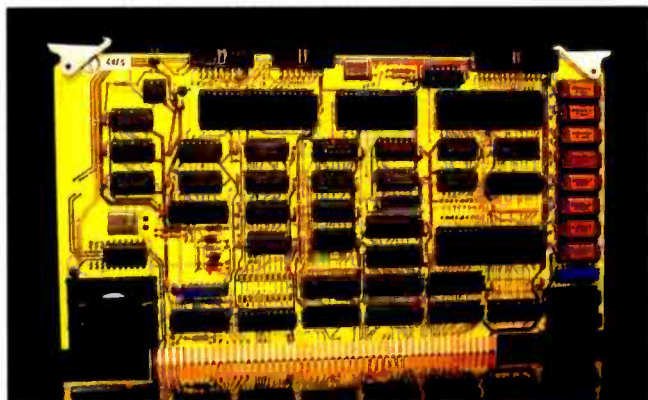

3 256KMB-100 256K MEMORY.

□ IEEE S-100 bus, spec 696.1/D2 compliance. The 256KMB-100 is compatible with most IEEE S-100 board products now on the market. □ Linear addressable to 2 megabytes. □ 225 nano-second access time, maximum. 160 nano-seconds, typical. □ 295 nano-second read-write time, minimum. □ Bank selectable 16K increments. □ I/O port address bank selection. □ Configures for phantom deselection. □ Parity error detection, visual and/or interrupts. □ Bank selection compatible with CROMIX,™ CP/M2.2,™ MP/M,™ Alpha Micro, and other major systems.

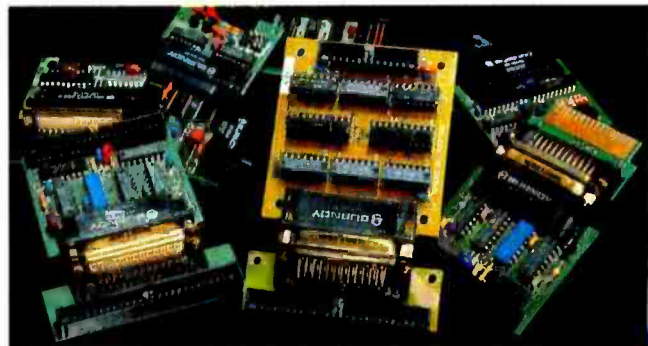

4 PERSONALITY BOARDS.

□ Centronics printer. □ 8 inch floppy disk. □ 5 1/4 inch floppy disk. □ RS232 serial communications. □ Synchronous/asynchronous modem. □ Priam smart/smart E hard disk. □ Long distance serial communication (2000 ft @ 9600 baud). □ Shugar Associates Systems Interface (SASI). □ Clock/calendar. □ Konan David, Jr.™ hard disk. □ Archive tape drive.



4015 Leaverton Court
Anaheim, CA 92807
(714) 630-0964
Telex: 678401-TAB-IRIN

Z80A & Z80B are trademarks of ZILOG Corp. • CP/M, MP/M & CP/NET are trademarks of Digital Research Corp. • TurboDOS is a trademark of Software 2000 Inc. CROMIX is a trademark of CROMEMCO Corp. • DAVID JR. is a trademark of KONAN Corp.

Circle 233 on inquiry card.



Photo 1: Ring-menu choices are displayed at the bottom of the screen.

tem facilities of the microcomputer environment.

Enhancements in IFPS/Personal

Ring-menu choices (see photo 1) replace typed commands throughout IFPS/Personal. Thus the user always has in view all or almost all of the currently available options. He need not search his memory or manual for the appropriate command word. Tapping the keyboard's space bar moves the user between choices: he uses the Enter key to select one. Single-stroke keyboard commands are also supported so that, as the user becomes familiar with the system through repeated use, the system can keep up with him.

A View mode gives Personal the capabilities of a spreadsheet package, including multiple windows and individually formattable columns. In addition, IFPS/Personal is a complete simulation-modeling language, providing model logic on the same screen with the spreadsheet-like solution matrix.

A full-screen editor supplants the line-oriented editor of the mainframe version. Facilities include block moves of text and several forms of an UNDO command. Color graphics are standard (see photos on page 401), as are user-definable function keys.

Like the mainframe version, IFPS/Personal supports many forms of model interrogation, nonprocedural solution of simultaneous equations, sophisticated reporting, command files, and recording of terminal sessions. It is even possible to create a command file automatically, simply by giving a command to record input and stepping through the desired operations.

What Got Left Out?

As a stand-alone package, IFPS/Personal lacks the following capabilities of mainframe IFPS:

- It cannot perform the complex, multimodel consolidation supported by the Universal Consolidation facility of mainframe IFPS that commonly supports applications involving more data than can be readily processed within the resources of a microcomputer.
- It has no capability for interfacing user-defined routines.
- It has links to the extension products Sentry, Dataspan, and Optimum and to external packages only through mainframe IFPS.
- Its command-file facilities are less powerful than those in the mainframe system.

• Binary storage of datafiles and models and data encryption are not supported.

• It cannot process models as large as those that mainframe IFPS can handle.

• It is computationally slower.

As memory and fast peripheral storage for microcomputers continue to become cheaper, many of these mainframe capabilities will be included in the microcomputer package.

So Who Needs Mainframes, Anyway?

According to Kirk Jones, who wrote the specifications for IFPS/Personal, a mainframe's strength "lies in its speed of computation, power in data management, and in the data security it can provide."

The mainframe computer is ideally suited as a central repository for large amounts of data. Because everything is in one place, security is easier to provide, at least from the point of view of the person with the master password to the machine. And, as Execucom's Competitive Analyst Mark Wood points out, "Even with the most powerful of today's micros, the 32-bit machines, it is still possible to formulate models and programs that only a mainframe can solve in a reasonable amount of time."

I asked Sam Guckenheimer, the IFPS/Personal Product Manager, what people who have IFPS in both versions would continue to do on the mainframe.

"They'll keep their corporate databases and model libraries there. Also, they'll do their big consolidation solutions there. Where you have geographic dispersion—in other words, where you have several offices accessing the same database—the mainframe is where you put all the components together. It is becoming a data library." ■

Gregory T. Dunn is a User Documentation Consultant at Execucom Systems Corp. He can be reached at 2513 Mountain View Dr., Austin, TX 78704.

Changing our ribbon is a snap.

Most printers make you fool with a messy ribbon.

But with Digital's Letterprinter 100, all you have to do is snap in one of our replacement cartridges.

You'll instantly get at least 5 million more characters' worth of ink.

Easy, isn't it?

The fact is, everything about the Letterprinter 100 is easy.

For example, with just a flick of a finger you can select

up to five different typefaces. Or let your

computer do it for you, automatically.

If you can't find a typeface you like,

we'll customize one for you.

Now why would the world's second

largest computer company go to

such lengths to make the

Letterprinter 100 so

accommodating?

Simply so it can spend more

time doing what you bought it

to do in the first place.

And that's printing crisp, clear

manuscripts and graphics. From letter-quality like you see here for word processing,

to high speed printing so you can get a draft

page in only 10 seconds.

The Letterprinter 100 works with any of

Digital's personal computers or video terminals. And it's a snap to use.

See the whole family of Digital's Printers, including the

daisy-wheel LQP02 and the low cost Personal Printer, the LA50.

For the distributor nearest you, call 1-800-DIGITAL, extension 700.

Or write Digital Equipment Corporation, Terminals Product Group,

2 Mt. Royal Avenue, UP01-5, Marlboro, MA 01752.

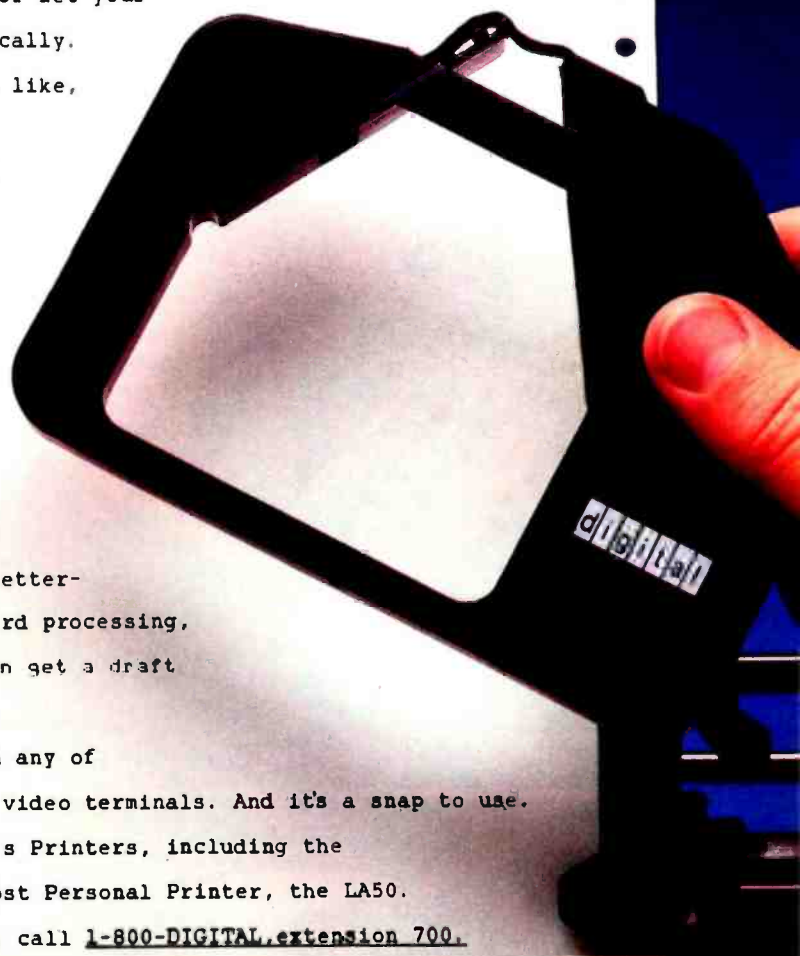

digital

...SORRY CHARLIE
FOR LEAVING YOU OUT!



FOR \$995 FEATURES INCLUDE: 8088 CPU
4.77 mhz
8K Bytes of EPROMS
OP/S, CP/M® 86
DOS 1.1 AND 2.0
64K of Memory expandable to 256K
One parallel and two serial I/O's
(50 to 9600 Baud)
Runs most of IBM PC's software
Five expansion slots
and detachable Keyboard.

EXPANSION CAPABILITY OPTIONS: 8087 High Speed
Co-processor, Four additional ports
Hard Disk Sub System in
5MB, 10MB, and 15MB
Color Graphics Card
Floppy Disk Controller
Disk Drives
and TAVA High Resolution Monitor
Multifunction TAVA memory card
3270 Emulator.

**CALL OR WRITE
FOR MORE DETAILS
OR SEND \$995+ TO:
TAVA CORPORATION
16861 Armstrong,
Irvine, California 92714
714/261-0200
Headquarters/Telex: 181667
Answer Back COMPDSHACK IRIN**

IBM® COMPATIBILITY FOR \$995

A Special Introductory Offer ††

TAVA PC

**WE THINK THE SMART COMPUTER
USER WANTS REAL VALUE WITH
IBM COMPATIBILITY!** Circle 416 on inquiry card.

The computer world is no longer strictly name brand conscious: IBM in 1983. ? in 1984. TAVA Corporation knows how to respond to consumer need! The TAVA PC is the low cost alternative to the industry's most popular products. Compatible with most of IBM's software, expandable, affordable, and soon to be available for the first time at Compushack franchises as well as other leading computer stores.



POKEing Around in the IBM PC

Part 2: Developing subroutines for BIOS interface and screen-display disk storage

by Hugh R. Howson

Part 1 of this two-part series introduced the concept of accessing the IBM Personal Computer's (PC's) BIOS (basic input/output system) from a BASIC program and summarized the PC's BIOS functions and central processor registers. Building on this background, this concluding part develops a general-purpose BIOS-interface subroutine that can transfer parameters from a BASIC program to the BIOS and can store BIOS results in memory. Then a subroutine is presented that can move data from one memory location to another using a machine-language MOV instruction. Finally, this article describes a subroutine that can store screen data on a disk. This second subroutine provides the file-handling facilities of DOS while avoiding the standard BASIC commands that can be cumbersome for operations involving large quantities of data.

A BIOS Interface Subroutine

We'll use the same approach in developing the general-purpose BIOS-interface subroutine that we used to develop the screen-scroll subroutine in Part 1. That is, at the sacrifice of

some programming elegance, I use the simplest conceptual approach to get a working program, relying as before on direct moves from the program to the registers. In addition, this general-purpose subroutine must be able to store results from registers into memory.

The first action of the subroutine is to store the current contents of the segment registers on a stack so that they can be restored at the end of the program. This step ensures that when control is returned to the BASIC program, that program can continue from the state it was in prior to the subroutine call. We did not need this step in the Part 1 program because that specific subroutine would not affect these register values. This general-purpose program, however, requires such a safeguard.

The operation codes that store these register values are each 1 byte, as listed below:

55 (BP register)
1E (DS register)
16 (SS register)
06 (ES register)

(Note that unless otherwise speci-

fied, all addresses and numerical instructions are given in hexadecimal.)

The effect of each of these instructions is to decrease the value of the stack pointer (SP) and then store the register value in the memory location pointed at by the SP. The SP normally points to the last item pushed onto the stack, which is referred to as the top of the stack.

Next, we provide for storing a segment address in the extra segment register (ES) by first loading 2 bytes into the AX register and then transferring them from AX to ES. The necessary instructions are

BB,00,00 (move to AX the values 00,00)
8E,C0 (move to ES from AX)

The 2-byte values 00 represent values that must be put into the program by the POKE command, prior to execution if the ES register address is required by the interrupt that calls the BIOS subroutine. The ES register is used only when defining a buffer address for a block of bytes to be either read in from or written out to a device such as a disk or a cassette.

The four accumulator registers, AX,

Build Your Own IBM-PC Compatible!

Here are the boards, assembly instructions and parts you need... plus full back-up service from Neronics!

Complete instructions show you how to build an IBM-PC compatible that can run ANY—not just "popular"—IBM-PC programs!

Motherboard functionally duplicates IBM-PC... features IBM-PC compatible BIOS ROM plus five empty sockets for ROMs of your choice. Sockets will accept IBM-PC PROMs or other PROMs.

Instructions include step-by-step procedure for transferring ROMs from a pc onto a floppy disk... which can then be mailed away for ROM duplication.

Board kits include printed circuit board, some hard-to-get parts, and detailed assembly instructions.

Complete kits include printed circuit boards, all parts, and detailed assembly instructions.

Manuals only, \$5.00 per kit.

IBM-PC Compatible 16-bit Motherboard with IBM compatible BIOS ROM— Board kit, \$89.95/ Complete kit, add \$140.00

IBM-PC Compatible Keyboard in cabinet (wired & tested), \$229.95

64k/256k Memory with serial port with DB-25 connector Board kit (64k), \$39.95/ Complete kit (64k), add \$134.00/ Each additional 64k block (to 256k), add \$75.00

Four Drive Disk Controller with hard disk SASI interface, parallel printer port, clock/calendar— Board kit, \$69.95/ Parts for Four Drive Disk Controller, add \$130.00/ Parts for Parallel Printer Port, add \$30.00/ Clock/Calendar, add \$45.00/ SASI Interface, add \$50.00/ All 4 functions wired and tested, \$329.95.

IBM-PC Compatible Color Board (for B&W)— Board kit with ROM, \$89.95/ Wired and tested, \$299.95.

Printer/Spooler Board with 64k buffer, clock calendar, parallel printer ports— Board kit with ROM, \$49.95

Modem Board, 300 BPS, direct connect/originate/auto-dial/auto answer plus 2 serial ports— Board kit with telephone company connectors, \$49.95

Power Supply Complete kit, \$179.95/ Extra power for hard disk option, add \$20.00

Cabinet for PC, steel with brushed aluminum front panel and simulated oak cover, \$199.95

5 1/4" Disk Drive, DSDD (wired & tested), \$269.95

10 Megabyte Hard Disk with controller & software (wired & tested), \$1295.50

Neronics offers complete service department to customers.

TERMINALS

(Terminals require ASCII keyboard and power supply.)

Power Transformer for either terminal, \$9.95

SmartVid Deluxe Terminal, 80 characters by 24 lines, microprocessor controlled with editing, reverse video and more— Board kit (includes board, character generator, video controller, 2k system ROM), \$99.95/ Complete kit, add \$100.00

FastVid Deluxe Terminal, 64 or 32 characters x 16 lines, baud rate to 19 kilobaud— Board kit (includes controller, character generator, and PROM), \$49.95/ Complete kit, add \$50.00

SPEECH

Electric Mouth Apple/5-100 Speech Board, with National NSC Digitaltalker speech chip— Apple/ 5-100 (Please check your choice.)/ Board kit (with Digitaltalker and 150 word vocabulary set), \$69.95/ Complete kit, add \$30.00/ 2nd Word Set (150 words), add \$39.95

SpeakEasy Universal Talking Board, operates with computers and terminals or in the stand-alone mode. Uses same power supply as terminals (see above). Board kit (includes VORTRAX speech chip and system ROM), \$89.95/ Complete kit, add \$60.00/ Cabinet, add \$15.00

S-100 DYNAMIC RAM BOARD

16k/64k RAM Board uses popular 4116 chips— Board kit (includes 8202 controller), \$69.95/ Complete kit (16k), add \$79.95/ Each additional 16k, add \$50.00

ELF II BEGINNER'S PAK

ELF II is a complete 256 byte, fully expandable learning computer with excellent documentation that explains hardware and software fundamentals. Learn to program in machine language! Learn the essence of how all computers operate and "think"! If you can afford to think about an IBM-PC or IBM-PC compatible, you can't afford not to have an ELF II beginner's pak! Complete kit, \$139.95

USE YOUR CREDIT CARD! CALL TOLL FREE 1-800-243-7428 (In Connecticut call 203-354-9375)

To order by mail, check boxes above for products you desire. Mail entire ad with remittance to:

Neronics R & D, Ltd.

333 Litchfield Road, New Milford, CT 06776

Total enclosed \$ _____ (Conn. res. add tax) Visa

MasterCard Acct. # _____

Exp Date _____ Signature _____

Print Name _____

Address _____

City _____

State _____ Zip _____

BX, CX, and DX, can now be loaded with the following instructions, which are the same as those introduced in Part 1:

B8,00,00 (AX register)
BB,00,00 (BX register)
B9,00,00 (CX register)
BA,00,00 (DX register)

Now we can call the BIOS interrupt with the data statement

CD,00

Prior to executing the subroutine, we must replace the interrupt number, 00 here, with the interrupt number identifying the BIOS function we wish to perform, as identified in table 2 of Part 1 (November, pages 123-124).

After the subroutine is over, we want to examine the contents of some of the registers, which may contain either status information or data as described in table 2 of Part 1. The registers of possible interest are AX, BX, CX, and DX. To retain these values we use for each register a 3-byte instruction consisting of an operation code, a low-address byte, and a high-address byte.

The operation code identifies the register whose value is to be moved, and the two address bytes specify the offset address in memory where the register value is to be stored. To keep our program self-contained, we store these values in the bytes immediately following the end of the program. Normally, the instruction we use assumes that the segment address is contained in the DS register. However, to prevent complications we use the CS register, which already contains the segment address of the start of the program. This override of the segment address is accomplished by preceding each instruction with

2E (use CS register for the next instruction)

The required instructions are:

2E,89,06,30,00 (move AX to memory offset 0030)

2E,89,1E,32,00 (move BX to

memory offset 0032)

2E,89,0E,34,00 (move CX to memory offset 0034)

2E,89,16,36,00 (move DX to memory offset 0036)

We determined these memory addresses by looking ahead to the end of the subroutine. The subroutine occupies offset positions decimal 0 to 47, so the register values can be stored starting at offset address decimal 48 or hexadecimal 30. Finally, we restore the register values from the stack with the instructions

07 (ES register value)

17 (SS register)

1F (DS register)

5D (BP register)

and issue the return statement to pass control back to the BASIC program, with the instruction

CB

The BASIC statements to load this subroutine into memory are provided in listing 1a. In listing 1b variables are assigned values equal to their offset positions in the program, thus providing self-documentation of the program and making it easier to use without having to recall any of the technical details. The PEEK and POKE statements that are implemented to retrieve or insert values can then use these variable names, as the following illustrates.

Disk Functions

To illustrate use of this subroutine, we will apply it to disk operations available in the BIOS. Typical actions we might want to perform include resetting the disk, reading the contents of one or more sectors of a track into memory at a specific buffer address, writing contents of a memory buffer onto one or more sectors of a track, and verifying data that has been written onto the disk.

Assuming that we will be using disk operations frequently in a program, we should now take the time

What did one computer say to the other?

Nothing much, until ASCOM came along.

With ASCOM™, personal computer communication has never been so easy. That's why Big 8 accounting firms and Fortune 500 companies use ASCOM. ASCOM is an interactive microcomputer telecommunications program for timesharing and data transfers. It is easy to use because it employs menus, simple commands and features on-line help facility.

A typical use of ASCOM is to access a data base to retrieve data for storage and analysis on your microcomputer. It can also be used to transmit program files to another machine running ASCOM or MODEM 7. This can be done locally through direct connection,

or over the telephone with a modem.

ASCOM works on IBM PC, MS-DOS, CP/M-86, CP/M-80, and TURBODOS compatible micros.



ASCOM Features:

- Works with modems or by direct connection from 110 to 19,200 baud.
- Transfers both text and program files between computers.
- Protocols synchronize large file transfers.
- Remote mode permits control of another micro running ASCOM.
- Auto processing with command files.
- Displays directories and files.

WESTICO 25 Van Zant Street
Norwalk, CT 06855
(203) 853-6880 • Telex 64-3788

Dial up our 24-Hour Computer Hotline for 300 baud modems: (203) 853-0816

Please send me an ASCOM program & documentation: \$175.00*

ASCOM documentation: \$30.00*

FREE: Catalog of over 300 programs.

C.O.D. Visa MasterCard

Card No. _____ Exp. _____

Model of Micro _____ 5¼" _____ 8" _____

Name _____

Company _____ Tel: _____

Address _____

City _____ St. _____ Zip _____

*Plus \$3.00 shipping and handling in North America. CT residents add 7½% sales tax). ASCOM is a trademark of Dynamic Microprocessor Associates. CP/M is a trademark of Digital Research © Copyright 1983 Westico, Inc.

WES-6.

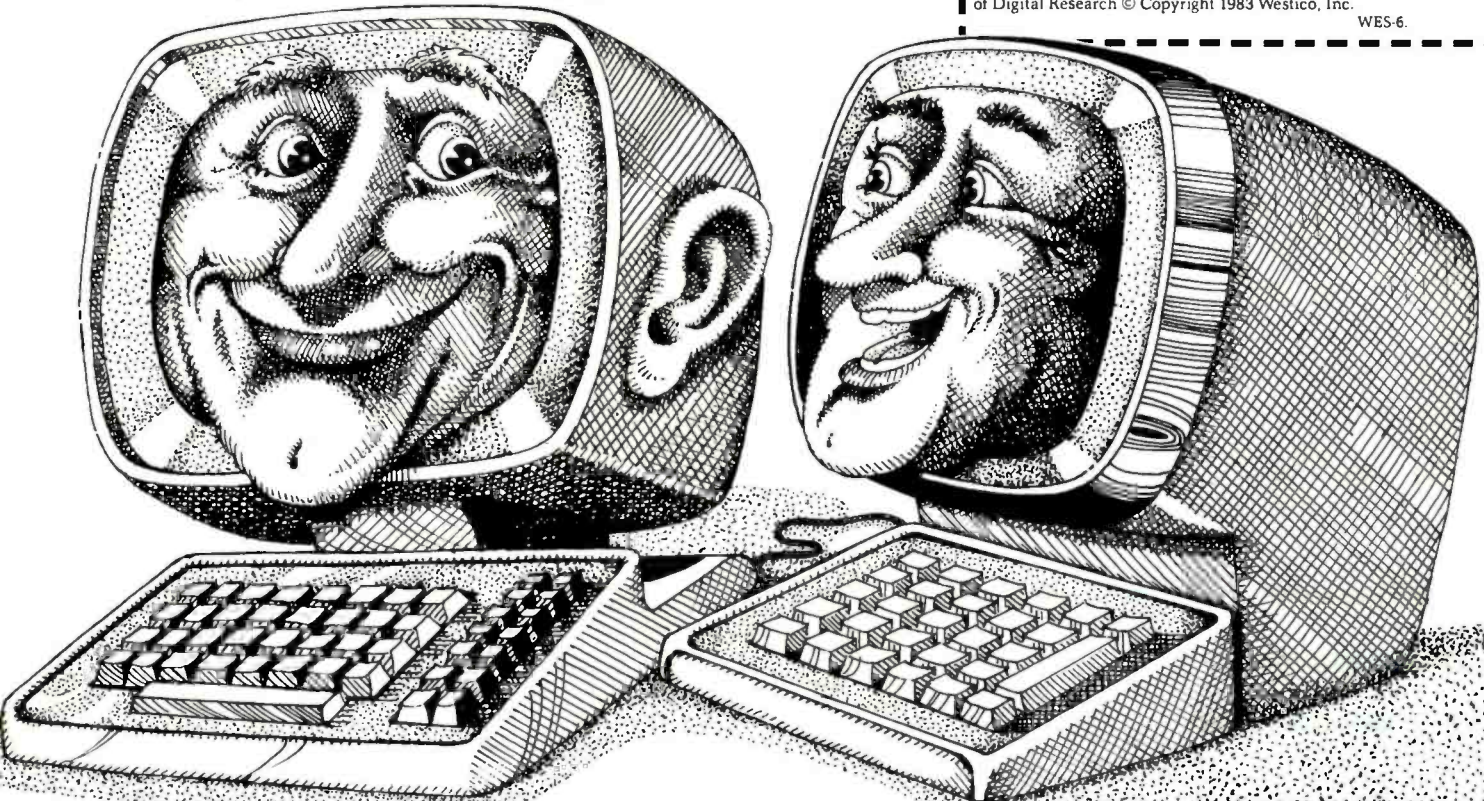

WESTICO
The Software Express Service

1st PLACE COMPUTER SYSTEMS

1-800-841-2748

1 IN LOW PRICES

COMPUTERS

ALDOS 580-10	\$3500
ALDOS 586-10	\$5498
ATARI	\$CALL
EAGLE	\$CALL
TELEVIDEO	
803	\$1769
1603	\$2019
TETETOTE I	\$1219
NORTHSTAR	
ADVANTAGE	\$2150

PRINTERS

B.M.C. BX80	\$319
BROTHER HRI	\$699
DAISYWRITER 48K	\$975
DATASOUTH	\$1155
GEMNI 10X	\$275
JUKI	\$499
OKIDATA	\$CALL
SMITHCORONA	\$499
CITOH	
8510	\$345
1550	\$599
F10-40C PS. \$1090	\$1499
F1055	\$1499
DIABLO	
620	\$875
630	\$1699
NEC	
3510	\$1364
7710	\$1899
3550	\$1705
2010	\$785

TERMINALS

ADDS VIEWPOINT A1	\$485
ALDOS II	\$789
TELEVIDEO 910	\$555
TELEVIDEO 925	\$699
TELEVIDEO 950	\$865
TELEVIDEO 970	\$975
VISUAL 50 GREEN	\$599

MONITORS

AMDEK 300G	\$130
AMDEK 300A	\$145
AMDEK 310A	\$209
AMDEK COLOR I	\$270
B.M.C. GREEN	\$85
B.M.C. COLOR	\$230
NEC JB1201	\$159
TAXON GREEN	\$129

DISK DRIVES

TANDON 100-2D	\$240
MICRO SCI A2	\$229
RANA 1000	\$375
RANA ELITE I	\$249
ATARI 1010	\$365

MODEMS

HAYS SMART MODEM	\$199
SMARTMODEM 1200	\$485
SMARTMODEM 1200 B	\$429
MICROMODEM II	\$263

**13422 N. CAVECREEK RD.
PHOENIX, AZ. 85022**

ORDER LINE: 1-800-841-2748
OTHER INFORMATION: 602-867-9897
CALL FOR OTHER LOW PRICED ITEMS

ALL PRICES SUBJECT TO CHANGE

Listing 1: The BIOS interface subroutine (a) and its position constants (b).

```

(1a)
10 '#####
20 '
30 '
40 '                                demonstration program to create BIOS interface
50 '
60 '
70 '#####
80 '
90 '
100 CLEAR , &HB000
110 DEFINT A-Z
120 SUBROUTINESEG=&HF00
130 GOSUB 1000
140 STOP
150 '
160 '
170 '#####
180 '
190 '
1000 '                                initialize BIOS subroutine
1010 '
1020 '
1030 DEF SEG = SUBROUTINESEG
1040 FOR I=0 TO 47
1050   READ J
1060   POKE I,J
1070 NEXT I
1080 '                                push BP, DS, SS, ES onto stack
1090 DATA &h55,&h1e,&h16,&h06
1100 '                                move 00,00 to AX
1110 DATA &hbB,&h00,&h00
1120 '                                and transfer to ES
1130 DATA &HBe,&hdB
1140 '                                move 00,00 to AX
1150 DATA &hbB,&h00,&h00
1160 '                                BX
1170 DATA &hbb,&h00,&h00
1180 '                                CX
1190 DATA &hb9,&h00,&h00
1200 '                                DX
1210 DATA &hba,&H00,&H00
1220 '                                call interrupt 00
1230 DATA &Hcd,&H00
1240 '                                move AX to memory
1250 DATA &h2e,&hb9,&h06,&h30,&h00
1260 '                                BX
1270 DATA &h2e,&hb9,&h1e,&h32,&h00
1280 '                                CX
1290 DATA &H2e,&hb9,&h0e,&h34,&h00
1300 '                                DX
1310 DATA &h2e,&hb9,&h16,&h36,&h00
1320 '                                restore ES, SS, DS, BP
1330 DATA &h07,&h17,&h1f,&h5d
1340 '                                return
  
```

Listing 1a continued on page 422

A flawless future is in sight with 3M diskettes.

When it comes to keeping track of precious data, predictable means reliable. Being able to count on every diskette, every time. At 3M, reliability is built into every diskette.

With 3M diskettes, your computer never forgets.

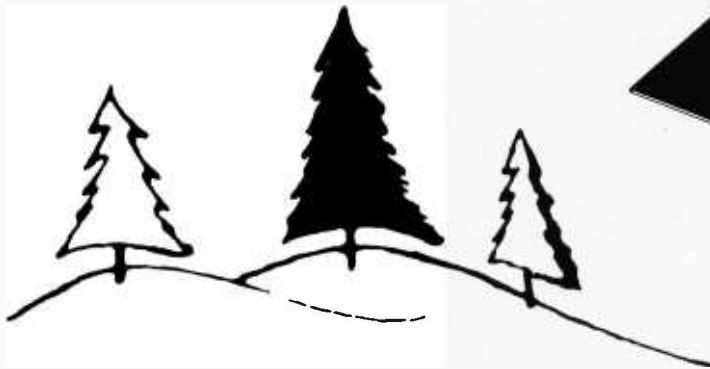
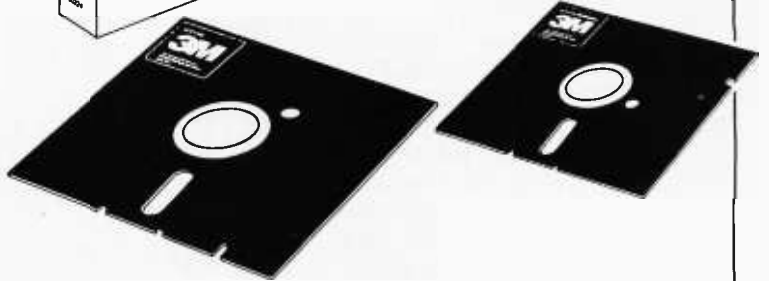
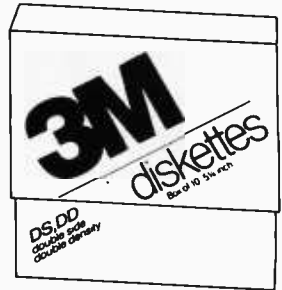

NORTH HILLS CORPORATION

Call Now Toll Free
1-800-328-DISC
New Lower Prices

Dealer Inquiries Invited — Finest Service — Shipped within 24 hrs.

maxell®

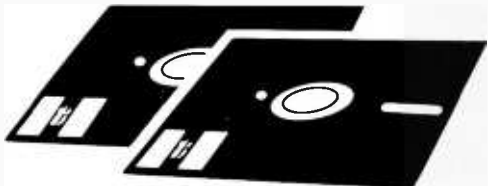

One floppy disk rises above all others. Maxell.

The Gold Standard.

A warranty as good as gold: backed for a lifetime.

Improve your memory.
Go on The Gold Standard.

maxell®

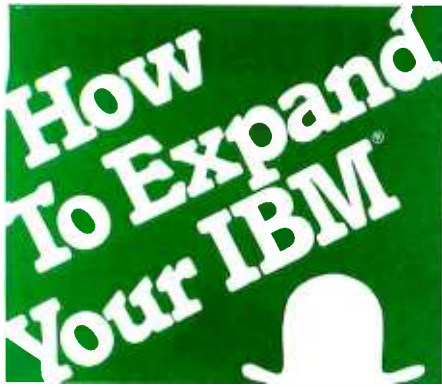

Exclusive six-function card expands workspace, increases speed, and boosts memory up to 576K.

The TITAN™ is the only expansion card that gives your IBM PC or XT both hard disk SASI interface and a parallel printer port. This advanced package also includes a pair of RS-232C serial ports, real-time clock/calendar with battery back-up, plus a choice of memory expansions. And everything slips into a single slot!

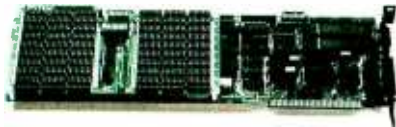

Pick a TITAN with parity-checked dynamic RAM from 64K to 576K. Each comes ready to run, complete with four super software selections. PSEUDO-DISK™ makes the RAM act like an exceptionally fast disk drive. PSEUDO-PRINT™ print spooler lets your computer calculate while the printer is running. WHATIME™ keeps track of date and time so you don't have to enter them at each system restart. HARDISK™ makes a 10MB Winchester addition plug-in easy.

Yes, it's a lot for one slot. And it's available now to add new utility to your IBM system.

Let us help you expand your IBM's productivity. For information on our multi-function boards and other Titan microcomputer products, see your computer dealer or contact: Titan Technologies, Inc., P.O. Box 8050, Ann Arbor, MI 48107; Telephone (313) 973-8422.

Sales and Marketing by The MARKETING RESOURCE GROUP, Costa Mesa, CA.



IBM PC and XT are registered trademarks of International Business Machines Corp. TITAN, PSEUDO-DISK, PSEUDO-PRINT, WHATIME, and HARDISK are trademarks of Titan Technologies, Inc.

Listing 1a continued:

```
1350 DATA &hcb
1360 '
1370 '
1380 '*****
```

(1b)

```
1390 '*****
1400 '
1410 '
1420 '           define position constants
1430 '
1440 '
1450 BIOSUB = 0
1460 ESHI   = 6
1470 ESLO   = 5
1480 AXHI   =11
1490 AXLO   =10
1500 BXHI   =14
1510 BXLO   =13
1520 CXHI   =17
1530 CXLO   =16
1540 DXHI   =20
1550 DXLO   =19
1560 INTERRUPT=22
1570 RTNAXHI =49
1580 RTNAXLO =48
1590 RTNBXHI =51
1600 RTNBXLO =50
1610 RTNCXHI =53
1620 RTNCXLO =52
1630 RTNDXHI =55
1640 RTNDXLO =54
1650 '
1660 '
1670 RETURN
1680 '
1690 '
1700 '*****
```

Text continued from page 418:

to redefine the position variables in terms of the disk function, as follows:

- ACTION = AXHI
- DRIVE = DXLO
- HEAD = DXHI
- TRACK = CXHI
- SECTOR = CXLO
- NUMBEROFSECTORS = AXLO
- BUFFERSEGMENTHI = ESHI
- BUFFERSEGMENTLO = ESLO
- BUFFEROFFSETHI = BXHI
- BUFFEROFFSETLO = BXLO
- STATUS = RTN-AXHI
- STATUSSECTORS = RTN-AXLO

We can then define the action codes, using the values given in table 2 of Part 1 for the disk function as follows:

- RESETDISK = 0
- READDISK = 2
- WRITEDISK = 3
- VERIFYDISK = 4

With these preliminary definitions completed, we can use the subroutines at any point in our program by using POKE to input the appropriate values, calling the subroutine, and by using PEEK on the status bytes to determine the status of the operation.



The Portable Printer with Everything!

VERSATILE — SPRINTER handles all your needs with ease. A built-in EasyLoad front sheet feeder for your letterhead . . . adjustable tractors for your pin fed paper . . . **plus** a straight through paper path for trouble free paper loading.

FULLY FUNCTIONAL — SPRINTER . . . the fastest 160 CPS dot matrix printer on the market today. SPRINTER gives you all the functions and features you need at the office, at home or on the go.

PORTABLE — New mobility for the modern professional. SPRINTER is a rugged and reliable printer that is suitable for traveling **without** sacrificing quality.

TRAVEL WITH THE BEST!

See the Sprinter at your local computer store, or call us for the dealer nearest you.

1 (800) 821-8848



Sheet Feed it . . .



DeskTop it . . .



Take it with you

See us at **COMDEX** booth 1336

Micro Peripherals, Inc.

4426 South Century Drive, Salt Lake City, UT 84107 • (801) 263-3081



Assume that we want to read data from a disk and store it in memory. First we must decide where in the memory space to place the data buffer. For a 128K-byte machine we might start the buffer at segment 1000, offset 0000. These values are entered into the subroutine with

```
DEF SEG = &H0F00
POKE BUFFERSEGMENTHI,
&H1000
POKE BUFFERSEGMENTLO,
&H0000
POKE BUFFEROFFSETHI,&H0000
POKE BUFFEROFFSETLO,&H0000
```

Let us say that the data is to be read from disk drive 0, head 0, track 38, starting at sector 1 and reading three contiguous sectors. This sequence is specified with

```
POKE ACTION, READDISK
POKE DRIVE, 0
POKE HEAD, 0
POKE TRACK, 38
                (or &H26)
POKE SECTOR, 1
POKE NUMBEROFSECTORS, 3
```

Finally, we need to specify the interrupt number, 13, for the disk function, call the subroutine, and retrieve the status results with

```
POKE INTERRUPT, &H13
CALL BIOSUB
DISKSTATUS = PEEK(STATUS)
SECTORSTATUS = PEEK(STATUS
                SECTORS)
```

These statements will initiate the reading of the disk, and the contents will be transferred to memory.

The BASIC program should first check that the disk status is zero, indicating a successful operation. If unsuccessful, the standard procedure is to reset the disk and reread, repeating this attempt up to three times. Once the data is in memory, it can be manipulated by the program using standard BASIC statements, starting with PEEK and POKE statements to examine individual bytes.

There are two limitations to note in the above procedure. First, it is not possible to read or write to a disk di-

rectly from a buffer defined in the screen-memory space. The screen-memory buffer-access timing is coordinated with the screen character-generator, which inhibits its use directly as a buffer for disk I/O (input/output). This limitation can be overcome easily by moving data between screen memory and regular memory, as we will illustrate later. Also, in the BIOS I use, the status report of the number of sectors actually written or read, which should be returned in the AL register, does not function, and the register has the value of zero whether or not the action was successful. This condition should not be a serious problem for most operations.

This subroutine can be used, unchanged, for any of the BIOS functions. Only use of the POKE statement to input the necessary parameter values to define the action desired is necessary. This subroutine is an efficient way to control the I/O devices from a BASIC program, and it may be a useful way for you to explore the BIOS routines yourself.

I originally developed this subroutine for a disk-utility program that can list the directory and the file-allocation table and examine or change any sector of a disk without being constrained by using DOS. This program was not difficult to develop, as it was possible to work entirely in BASIC once the preceding subroutine was developed.

In the previous subroutines we have used POKE to enter parameter values into the machine-language subroutine. It is also possible to pass values between the BASIC program and the subroutine as arguments of the CALL statement. This procedure makes the machine-language program slightly more complicated to develop but provides a more flexible interface between the main program and the subroutine. The use of arguments will be illustrated in the final program.

Moving Data within Memory

One use of a program to move data within memory is in screen applications. For example, for text or graphics applications you may wish to cre-

ate a working memory area that is larger than the screen memory. The screen then becomes a window that can be moved around to examine the various portions of the larger representation stored in memory. While this can be done within BASIC, using PEEK and POKE commands, the speed of the resulting program is too slow for most practical applications.

There is a machine-language instruction that directs the central processing unit to move data from a source address in memory to a destination address. The operation code is A4 if 1 byte is to be moved and A5 if a 2-byte word is to be moved. The source-offset address is specified by the contents of the source-index (SI) register in conjunction with the segment address contained in the data-segment (DS) register. The destination-offset address is taken from the destination-index (DI) register together with the segment address contained in the extra-segment (ES) register. As part of the MOV instruction, SI and DI are automatically incremented or decremented to point to the next memory locations. The direction of these automatic address changes is controlled by one of the status-register flags, appropriately named the direction flag. If this flag is set to the value 0, SI and DI will be incremented; if set to the value 1, those registers will be decremented.

This MOV instruction is particularly attractive because it may be preceded by a single-byte prefix that specifies that the MOV instruction is to be repeated continuously until the CX register has the value zero. This is referred to as the REP prefix, machine code F3. The REP instruction logic automatically decrements the CX register with each MOV instruction. Therefore, it provides a complete looping facility, and we need only load the number of bytes or words to be moved into the CX register, prior to the command, and the move will continue automatically until the specified amount of data is moved. We can now proceed to develop the subroutine.

The first step of our subroutine will be to store the current segment reg-

WILDCAT™

Looks Like an IBM™
Works Like an Apple™

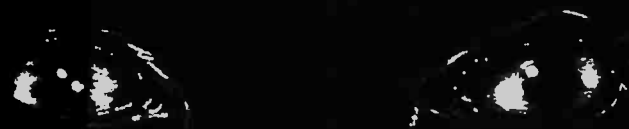

To a land where fruit and flowers reign supreme, comes the awesome power of the **Wildcat** to challenge their supremacy.

Wildcat is a sleek styled mobile computer designed for your vehicle, boat or aircraft. It looks like an IBM PC™ and is fully software compatible with the Apple II™ product line at a list price that would put a smile on the face of the most frugal computer buyer.

But price isn't everything. All those features that would cost you hundreds of dollars extra from our competitors, come standard with **Wildcat**. Let's compare some of these features:



	Apple IIe	Wildcat
Detachable keyboard	No	STD
Full numeric key pad	Option	STD
Full functions keys	No	41
Built in disk controller	No	STD
Parallel printer port	No	STD
RS 232 serial port	No	STD
Game port	1	2
RGB video out	Option	STD
Composite video	STD	STD
RF video for TV	Option	STD
CP/M	Option	STD
Hi Res graphics (6 color)	STD	STD
Low Res graphics (16 color)	STD	STD
64KB memory	STD	STD
Half high disk drives	No	STD
Converters for vehicles, boats, and aircraft	No	Option
Aluminum carrying case	No	Option
List price	\$1940*	\$1099.00*

For more information on the all new **Wildcat**, see your local computer dealer or call or write:



COMPUTER AND PERIPHERAL PRODUCTS

1530 S. Sinclair
Anaheim, CA 92806
(714) 978-9820

*Computer plus one disk drive

Warning: This equipment is exempt from compliance with FCC testing requirements pursuant to 47 CFR 15.301 (a) (1). Operation of this equipment in a residential area may cause interference.

IBM is the registered trademark of International Business Machines Corp.
Apple is the registered trademark of Apple Computer, Inc.
Apple II is the trademark of Apple Computer, Inc.

See us at Comdex Booth #3172.

HIGH PERFORMANCE

NOW AVAILABLE IN A THREE-SPEED

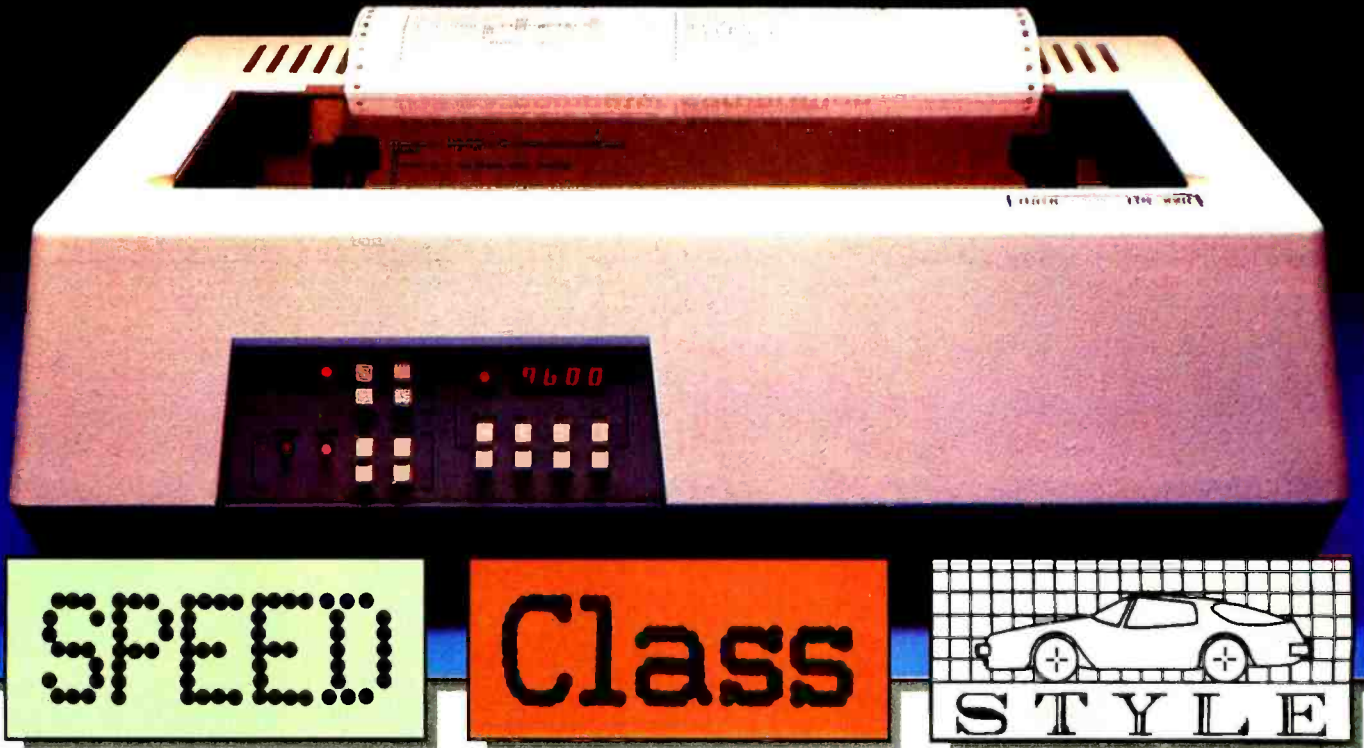

INTRODUCING THE NEW DS 220 MULTI-MODE MATRIX PRINTER

First there was the Datasouth DS180. The original high-performance printer. The printer that raised the standards of on-the-job performance to new heights. A tough act to follow.

And now, following in the same tradition, is the new Datasouth DS220. State-of-the-art performance, taken to higher levels. In a new 3-speed multimode form. Ready to run data, near letter quality and graphics output—in a single printer.

At data speed, the Datasouth DS220 leaves competitors in the dust. By using high speed tabbing to zip over blank spaces and true logic seeking to print the next available

character, the Datasouth DS220 charges through printed copy at speeds rivaling more expensive line printers.

At 40 CPS NLQ speed, the Datasouth DS220 creates near letter quality output with the kind of class that might make you wonder if it was produced by a daisy wheel printer. With its fine tuned 18 x 48 dot matrix, multiple fonts are produced with the precise clarity required for word processing applications.

And for graphics, the Datasouth DS220 adds high performance style to popular microcomputer applications programs through high resolution dot

addressable output. Sharp new details emerge from business charts and graphs, and engineering drawings.

And those are just its printing capabilities. Its fully instrumented dashboard allows push button programming of up to fifty features for forms control, communications and print style selection.

Best of all, the Datasouth DS220 costs much less than you might expect for a high performance three speed. Go to your nearest showroom and run a Datasouth DS220 through the gears. See how little it costs to own three high performance printers in one high performance package.

datasouth

H I G H P E R F O R M A N C E M A T R I X P R I N T E R S

AVAILABLE NATIONWIDE
THROUGH OUR NETWORK OF
SALES AND SERVICE DISTRIBUTORS

Datasouth Computer Corporation
Box 240947 · Charlotte, NC 28224
704/523-8500 · Telex 6843018 DASOU UW

ister values on the stack so that they may be restored prior to returning to the calling program. Because we will use only the DS and ES segment registers, we need to save only these. This is done with the following two instructions:

1E for the DS register
06 for the ES register

Let's assume we want to store the current contents of the screen, which begins at the source address B000:0000. The destination address of where we want to store the contents will be 1000:0000. The full screen contains 1920 words (24 rows by 80 columns, with 2 bytes for each character), or 780 words in hexadecimal. The addresses should be incremented because we will be storing the screen characters from top to bottom.

First we will move the addresses into the appropriate registers. Recall that it is necessary, when loading data into the segment registers, to load the value first into the AX register and then transfer it from the AX register to the desired segment register.

Therefore, the required instructions are as follows:

B8,00,B0 (load the source segment into AX)
8E,8D (transfer AX to DS)
BE,00,00 (load the source offset into SI)
B8,00,10 (load the destination segment into AX)
8E,C0 (transfer AX to ES)
BF,00,00 (load the destination offset into DI)
B9,80,07 (load CX with the word count)
FD (clear the direction flag)

We are now ready to issue the move instruction

F3,A5

Then we restore the registers and return to the calling program with

07,17,CB

The actual BASIC statements are il-

Listing 2: A subroutine that moves data within memory (a) and its position constants (b).

(2a)

```

680 '%%%%%%%%%%%%%%%%%%%%%%%%%%%%%%%%%%%%%%%%%%%%%%%%%%%%%%%%%%%%%%%%%%%%%%%%
690 '
700 '
710 '           "movesub" - machine language subroutine
720 '
730 '
740 DEF SEG=SUBROUTINESEG
750 FOR I=0 TO 26
760   READ J
770   POKE I,J
780 NEXT I
790 '           push DS, ES onto stack
800 DATA &h1e,&h06
810 '           load source seg address into AX
820 DATA &hb8,&h00,&hb0
830 '           and transfer to ES
840 DATA &h8e,&hd8
850 '           load source offset into SI
860 DATA &hbe,&h00,&h00
870 '           load destination seg address into AX
880 DATA &hb8,&h00,&h10
890 '           and transfer to DS
900 DATA &h8e,&hc0
910 '           load destination offset into DI
920 DATA &hb9,&h00,&h00
930 '           load word count into CX
940 DATA &hb9,&h80,&h07
950 '           set direction flag
960 DATA &hfc
970 '           move instruction
980 DATA &hf3,&ha5
990 '           "pop" (recover) register values from stack
1000 DATA &h07,&h1f
1010 '           return to calling program
1020 DATA &hcb
1030 '
1040 '
1050 '%%%%%%%%%%%%%%%%%%%%%%%%%%%%%%%%%%%%%%%%%%%%%%%%%%%%%%%%%%%%%%%%%%%%%%%%

```

(2b)

```

1050 '%%%%%%%%%%%%%%%%%%%%%%%%%%%%%%%%%%%%%%%%%%%%%%%%%%%%%%%%%%%%%%%%%%%%%%%%
1060 '
1070 '
1080 '           define position values for subroutine
1090 '
1100 '
1110 MOVESUB           = 0
1120 SOURCESEGH1     = 4
1130 SOURCESEGLD     = 3
1140 SOURCEOFFSETHI  = 9
1150 SOURCEOFFSETLO  = 8
1160 DESTINATIONSEGH1 =12
1170 DESTINATIONSEGLD =11
1180 DESTINATIONOFFSETHI=17

```

Listing 2b continued on page 428

Listing 2b continued:

```
1190 DESTINATIONOFFSETLO=16
1200 WORDCOUNTHI      =20
1210 WORDCOUNTLO    =19
1220 RETURN
1230 '
1240 '
1250 '#####'
```

illustrated in listing 2a. If we give the subroutine the name Movesub, then it can be executed at any time from the BASIC program with the statement

```
CALL MOVESUB
```

For ease of use, we have defined the position values as illustrated in listing 2b. Now if we want to change the parameters so that a second call to the subroutine will store new screen data in memory, adjacent to the first block of data, that is, starting at offset address 780, we would require the following BASIC statements:

```
DEF SEG=SUBROUTINESEG
POKE DESTINATIONOFFSET-
HI,07
POKE DESTINATIONOFFSET-
LO,80
POKE WORDCOUNTHI,07
POKE WORDCOUNTLO,80
CALL MOVESUB
```

and the move will be executed very quickly.

Interfacing with DOS

Earlier, we discussed the use of the BIOS disk functions to read or write data records directly onto disks. This approach can be useful for some applications, but it leaves the user with considerable responsibility for keeping track of what information is located where on the disk, checking that data is read and written correctly, taking corrective action if there are faulty sectors on the disk, and so on. These support facilities are all provided by DOS, so the final subroutine will demonstrate how to interface with DOS. This program is

not new but rather is an application of the Move subroutine developed earlier. One instance in which this program might be used is when we want to store the contents of the current screen display on a disk, or, conversely, retrieve a particular screen display that is stored on a disk.

To develop this application program, it is necessary to review the structure and role of the file-control block (FCB) used by a BASIC program to communicate with DOS. For each file that is opened in a BASIC program, an FCB is created in the main memory space to serve as the interface between the BASIC program and the DOS. The layout of this FCB is described in the IBM BASIC manual, chapter 4, as part of the discussion of the VARPTR (variable pointer) command. The BASIC statement

```
y = VARPTR(#file number)
```

assigns to the variable *y* the offset address of the first byte of the FCB for a file opened as the specified file number. This offset address can be used in conjunction with the segment address of the BASIC program to establish the absolute memory address of the start of the FCB.

It is not necessary to examine the detailed layout of the FCB as it is clearly described in the BASIC manual. The section that is of interest for our purpose is the data-buffer portion of the block. This buffer begins at byte-offset position 188. The length of this buffer's data field is defined when you first initiate the BASIC program with the /S:(buffer size) command. (The proper form of this command for the programs presented here is /S:512, yielding a

decimal 512-byte data-buffer size.) In normal BASIC operations on random files, the FIELD statement is used to point to this data buffer. Our objective in this subroutine is to bypass the FIELD statement, which can be too restrictive when we want to move relatively large amounts of data into and out of the buffer and across segment boundaries.

Given the accessibility of the FCB's data buffer, we can move data between the screen and the disk by using the Move subroutine developed above and assigning to it the address of the data buffer as either the source or destination address, depending on the direction in which we want to move data. The GET or PUT statements can be used to initiate the transfer of data between the buffer and the disk.

The VARPTR statement returns the address of the start of the FCB, and an increment of 188 gives the offset address of the first byte of the data buffer. However, we also require the segment address of the start of the BASIC workspace. This address is stored in reserved-memory locations 510-511 (*Technical Reference* manual, pages 3-22). Therefore, it will be necessary to extract this segment address using two PEEK statements.

This completes the technical information necessary for the DOS interface. The application will be illustrated in the last program.

Arguments of CALL

It will often be more practical to pass values to the machine-language subroutine as arguments of the CALL statement than to use POKE to input such values to the program as we have done in previous examples. To illustrate how this can be done we'll develop a program that transfers data between the screen and disk through DOS.

This complete program enables you to create an image on the screen and then save it on a disk or to have an image previously stored on a disk transferred to the screen. Function keys are used to control the actions of the program, which include clearing the screen, getting a screen image from a disk, transferring a screen

Introducing a sensible solution to the problems of dBASE II.™

	dBASE II	The Sensible Solution
Records Per File	65,535	999,999
Maximum Record Size	1,024 bytes	1,536 bytes
Fields Per Record	32	384
Key Fields Per File	7	10
Number of Files Simultaneously Accessible	2	10
Number of Screens Per Program	Limited by system memory	Limited only by system storage
Data Dictionary	No	Yes

We don't mean to debase dBASE II, but if you're looking for a data base manager that's long on features, dBASE II can come up a little short.

For instance, a single dBASE II record can only contain 32 fields. And when you need to share information between one file and another, you can only access two at a time.

So, as good as dBASE II is, its limitations can quickly paint you into an electronic corner.

And that's why we created *The Sensible Solution*.

Finally A sensational relational.

Along with all the usual things you expect from a data base manager, *The Sensible Solution* lets you handle the kind of tough assignments that dBASE II can't:

You can design data files with more than 300 variables. You can create reports using 10 different files at once. You can even set up file locking for multi-user computers.

Ready to get down to business.

A data base manager without ready-to-run application programs is hardly worth the disk it's copied on.

So, along with *The Sensible Solution*, you can also add *The Sensible Solution Bookkeeper™* or *Sensible Management™*, our complete one-entry accounting and management system.

They're both affordable. Business-tested. And supplied with source code so you can make your own modifications.

A sensible trial offer.

When you purchase *The Sensible Solution*, we'll send along a special trial disk that lets you create forms and enter a limited number of records. If, after 30 days, you're not satisfied, just return the unopened master system disk for a full refund.

So why not take us up on our trial offer? You've got nothing to lose.

Except the problems of dBASE II.

The Sensible Solution™

To order, write or call: O'Hanlon Computer Systems, 11058 Main Street, Bellevue, WA 98004 USA, Phone (206) 454-2261. Prices: *The Sensible Solution*—\$695, *Sensible Solution Bookkeeper*—\$495, *Sensible Management*—\$895. In Washington, add 7.9% state tax. VISA, Mastercard and dealer inquiries welcome.

dBASE II is a registered trademark of Ashton-Tate. Sensible Solution, Sensible Solution Bookkeeper and Sensible Solution Management are trademarks of O'Hanlon Computer Systems, Inc.

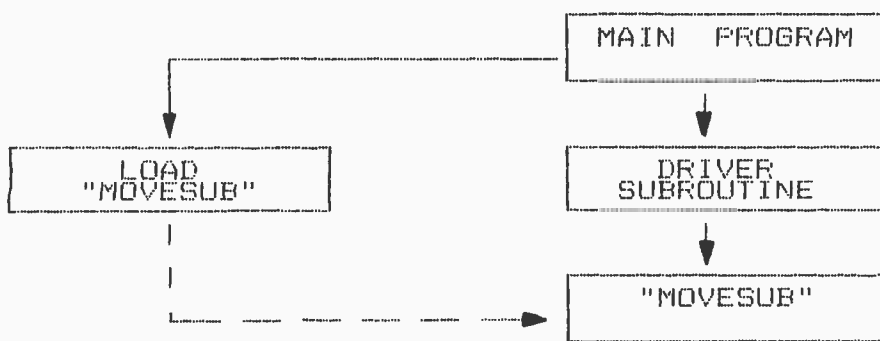

Figure 1: The structure of a program that moves data between a disk and the screen.

image to a disk, and stopping the program. The structure of the complete program is illustrated in figure 1.

The program starts by calling a subroutine to load the machine-language subroutine, a revised version of Movesub, into memory. The main program then executes the actions you have chosen. Whenever you wish to transfer data between a disk and the screen, the main program calls a driver subroutine to effect the transfer. The driver subroutine will use the Movesub routine as required. A listing of the main program is illustrated in listing 3a, and two of the supporting subroutines are illustrated in listing 3b.

The drive subroutines (listing 4) are responsible for transferring one complete screen image to, or from, the disk. As noted previously, the screen contains a total of 1920 words, or 3840 bytes. Because a sector of disk can store only 512 bytes of data, eight sectors will be required for each screen image. The driver subroutines are responsible for controlling this data

(1a)

1st argument	SOURCE SEGMENT
2nd argument	SOURCE OFFSET
3rd argument	DESTINATION SEGMENT
4th argument	DESTINATION OFFSET
5th argument	WORDCOUNT
CS register	RETURN ADDRESS
SP- PC register	

(1b)

1st argument	
2nd argument	
3rd argument	
4th argument	
5th argument	
CS register	
PC register	
DS register	
ES register	
SP- BP register	

Table 1: The stack at the time of a subroutine call (a) and an illustration of the effect of pushing register contents onto the stack (b).

De Smet C

PCDOS - CP/M-86 - MPM-86 - CCP/M-86

\$ 109

- OUTSTANDING PRICE/PERFORMANCE
"SIEVE" Benchmark
135 bytes compiled - 6144 bytes linked
65 sec. compile (disk) - 11.5 sec. run (10 iterations)
- FULL DEVELOPMENT PACKAGE
C Compiler, Assembler, Linker, Librarian and Full Screen Editor • Native 2.0 Support
- COMPLETE IMPLEMENTATION
FULL K & R - plus - STUDIO LIBRARY
Both 8087 and Software Floating Point

To order specify OS & DISK SIZE/FORMAT.
Calif. residents add 6% sales tax.

C WARE

970-4 West El Camino Sunnyvale, CA 94087

(408) 736-6905

PCDOS Trademark IBM - CP/M Trademark Digital Research

YES

NO

the sales clincher.

Use this helpful MuSYS NET/work 8816 Checklist to pyramid your profits.

When you're debating which multi-user micro to stock and sell, the answer is easy: Compare the leading makes head-to-head, feature for feature. The YES/NO data checklist below will help you and your customers choose today's best buy.

The facts:	MuSYS NET/work 8816	ALTOS 8000-10	TeleVideo™ 806/20	Micromation Mariner
Winchester formatted Mbytes (min/max)	16/102	10/20	15/30	20/40
Total RAM per user	128K	48K	64K	64K
User TPA	63.5K	48K	54K	62K
8- and/or 16-bit user processors	YES	NO	YES	NO
Perfect Software	YES	NO	NO	NO
Telecommunications Software	YES	NO	NO	NO
Operating system	Turbo-DOS™	MP/Mi™	Mmm-OST™	M/NET™



COGITATE

Specialists in Systems and Software

Call or write for complete information
Dealer inquiries invited • (313) 352-2345
24000 Telegraph Rd., Southfield, Michigan 48034

How Sweet it is!

only
\$1995⁰⁰

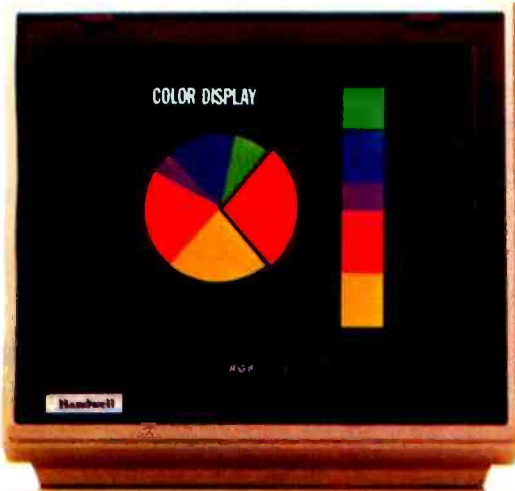

Monitor not included in price shown

Simulated Display

"What a feeling!" That's just how you'll feel knowing you've purchased an IBM-compatible Personal Computer with full color graphics capability at a price far, far below anyone else. Not only does the Handwell PC outperform everyone in price, but it comes loaded with standard features that some competitors don't even offer as options. Due to its eight expansion slots, you'll be able to upgrade your Handwell PC with many add-ons and options today and tomorrow, thus making it obsolescence-proof. When buying the Handwell PC, you will be able to take advantage of the enormous, off-the-shelf software library written for the IBM PC — thus accessing some of the finest user-friendly software available. All-in-all, the Handwell can, by combining quality, performance and unbelievable price, offer you a truly high-performance PC at substantial savings. So, stop and smell the roses along the way and see how sweet it is!



... a new breed of personal computer



STANDARD FEATURES: • Full Graphics capabilities (640 dots x 200 lines) • 128K Ram (expandable to 256K) • Two RS232 Serial Ports • One parallel printer port • Color Display Card • Fully detachable, IBM-compatible Keyboard • 8 Expansion Slots • One 5¼-inch Floppy Drive (327Kb-formatted) • MS-DOS Operating System (MS-DOS 2.0 and CP/M compatible) • 8088 Processor • Spooler (part of system memory, can be used as a printer buffer) • Real Time Clock and Calendar



4962 El Camino Real
 Los Altos, CA 94022
 415 962-9265

*IBM is a registered trademark of International Business Machines
 *CP/M is a registered trademark of Digital Research, Inc.
 *MS-DOS is a registered trademark of MicroSoft, Inc.

Dealer and OEM inquiries invited
For further information call
800-821-3628

flow and allocation of disk space. Note that the calls to Movesub have five arguments that represent source segment, source offset, destination segment, destination offset, and number of words to move.

The machine-language subroutine closely follows the method described in Appendix C of the IBM BASIC manual. When control is transferred to the machine-language program by the CALL statement, the memory addresses of the argument values are available in the stack pointed at by the SP. The stack also contains the code-segment address and program-counter address at the time of the call, to be used when control is returned to the calling program. The structure of the stack at this point is illustrated in table 1a.

The subroutine begins by storing register values DS, ES, and BP onto the stack with the resulting changes as illustrated in table 1b. The SP is copied into the base pointer (BP). We can then use the machine instruction

36,8B,5E,xx

which will copy into BX the 2 bytes stored at the memory location pointed at by BP plus the offset xx contained in the last byte of the instruction. By assigning the appropriate value to this offset, we can select whichever argument address we want from the stack, as illustrated by the repetitive use of this instruction in listing 5. Once the address of the argument is loaded into BX, the actual value can be transferred directly into the desired register as illustrated in the program.

The balance of the program is a repetition of the previous subroutine with the exception of the final statement, the return to the calling program. When arguments have been passed by the CALL statement, it is necessary to adjust the SP to bypass these arguments, effectively removing them from the stack. The adjustment to the pointer is two times the number of arguments, in this case 2 times 5 (or 10). This adjustment is made by using a different version of the return instruction, CA, followed by the adjustment, resulting in the

Text continued on page 438

Listing 3: The main program that transfers data between disk and screen (a) and its supporting subroutines (b).

```
(3a)
10 '#####
20 '
30 '          program to move data between screen & diskette
40 '          -illustration of call statement with arguments
60 '          call movesub (source segment, source offset,
70 '          dest. segment, dest. offset, wordcount)
80 '
90 '#####
100 '
110 '
120 DEFINT A-Z
130 CLEAR ,&HB000
140 SUBROUTINESEG%=&HF00
150 OPEN "B:SCREEN" AS #1 LEN=512
160 GOSUB 720          'initialize "movesub"
170 '
180 '
190 '          main program
200 '
210 '
220 CLS                'clear screen and initialize function keys
230 KEY OFF
240 KEY (1) ON
250 KEY (2) ON
260 KEY (9) ON
270 KEY (10) ON
280 ON KEY (1) GOSUB 490 'stop
290 ON KEY (2) GOSUB 620 'clear screen
300 ON KEY (9) GOSUB 1500 'disk to screen
310 ON KEY(10) GOSUB 1250 'screen to disk
320 '
330 '
340 LOCATE 25,1        'action control loop
350 BEEP
360 PRINT "Write on screen, or ENTER for next action"          ";
370 INPUT; "", 222$
380 LOCATE 25,1
390 BEEP
400 PRINT "F1-stop F2-clear screen F9-disk to screen F10-screen to disk";
      SPACE$(15);
410 GOTO 410          'wait for function key
420 STOP
430 '
440 '
450 '#####
(3b)
460 '#####
470 '
480 '          "stop" subroutine
490 CLOSE #1
500 KEY (1) OFF
510 KEY (2) OFF
520 KEY (9) OFF
530 KEY (10) OFF
```

Listing 3b continued on page 434

BASF QUALIMETRIC™ FLEXYDISKS.® A GUARANTEED LIFETIME OF OUTSTANDING PERFORMANCE.

BASF Qualimetric FlexyDisks feature a unique lifetime warranty, firm assurance that the vital information you enter on BASF FlexyDisks today will be secure and unchanged tomorrow. Key to this extraordinary warranted performance is the BASF Qualimetric standard... a totally new set of criteria against which all other magnetic media will be judged.*

You can count on BASF FlexyDisks because the Qualimetric standard reflects a continuing BASF commitment to perfection in magnetic media. One example is the unique two-piece liner in our FlexyDisk jacket. This BASF feature traps damaging debris away from the disk's surface and creates extra space in the head access area for optimum media-head alignment. The result is a guaranteed lifetime of outstanding performance.

For information security that bridges the gap between today and tomorrow, look for the distinctive BASF package with the Qualimetric seal. Call 800-343-4600 for the name of your nearest supplier.

Circle 43 on inquiry card.

*Contact BASF for warranty details.

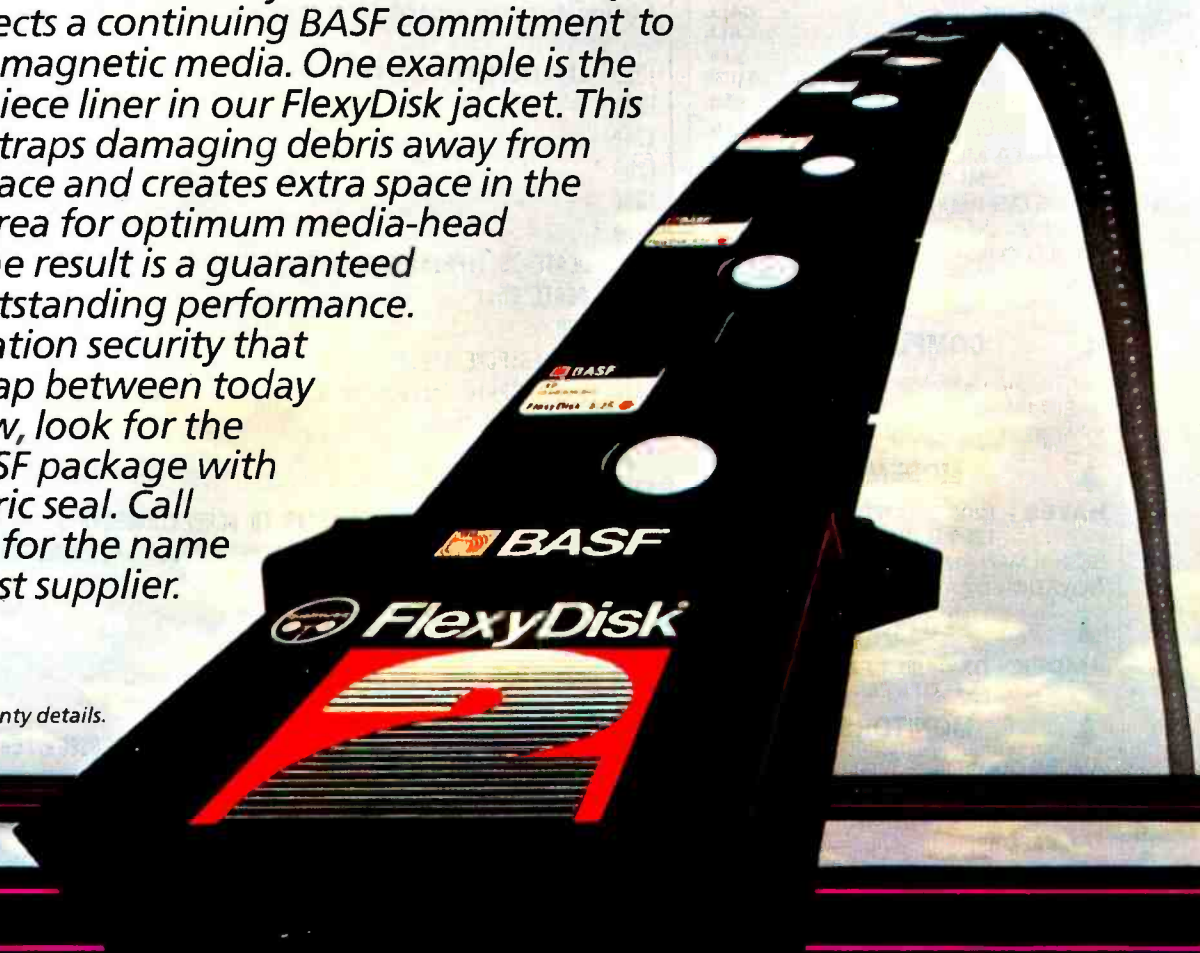

ENTER TOMORROW ON BASF TODAY.

© 1983 BASF Systems Corp., Bedford, MA



BASF

**!!!QUALITY PERIPHERALS!!!
FROM DIGITAL DIMENSIONS**

🎄 HOLIDAY SPECIALS 🎄

DAISYWRITER 2000, 48K.... \$1025
J-CAT MODEM \$125
"NEW" C. ITOH PROWRITER
HIGH SPEED 180 CPS.. CALL



**ALL MODELS, ACCESSORIES
AVAILABLE FOR BRANDS LISTED!**

**MULTIFUNCTION AND
EXPANSION BOARDS**

STB SUPER RIO™ 64K \$325
LNW BUSBOARD™ CALL
QUADRAM QUADLINK™ \$495
64K UPGRADE KITS \$58

PRINTERS

GEMINI 10X CALL
15X CALL
C. ITOH - PROWRITER I \$396
STARWRITER F-10 \$1086
RITEMAN INFORUNNER \$340
SILVER-REED EXP 500 P \$416
OKIDATA ML 92P \$428
ML 93P \$716
TRANSTAR T 315 \$477
IDS PRISM 132 w/COLOR \$1596
DIABLO 630-R-155 \$1876
NEC 3550 \$1807
"NEW" NEC 2050 \$952

COMPUTERS

COLUMBIA DESK TOP \$2795
BASIS 108 \$2095
FRANKLIN ACE PRO/DISK/COLOR.....\$1192

MODEMS

HAYES - 1200 SMARTMODEM.. \$509
1200 B IBM \$459
SIGNALMAN - MARK VI IBM \$189
NOVATION D-CAT \$169

PLOTTERS

AMDEK - DXY-100 4 PEN \$618
AMPLLOT 6 PEN AUTO.....\$1088

MONITORS

AMDEK COLOR I \$295
NEC JB 1201M GREEN \$156
GORILLA GREEN \$95
TAXAN RGB I \$302

SOFTWARE

CALL FOR: BUSINESS, EDUCATION,
 GRAPHICS, SYSTEM AND UTILITY,
 RECREATION AND WORD PROCESSING.

APPLE, IBM, TI, VIC 20, ATARI,
 COM'DR 64, TRS-80, CP/M.

MANY CURRENT PRICES DROPPING - CALL

Suite 123
 375 Hartford Trpk., Vernon, CT 06066

Info & Orders 203-872-8569
 Orders Only 1-800-243-5222
 Free Shipping on Prepaid Orders

MasterCard Visa Accepted - Add 2% to Total
 CT Residents Add 7.2% Sales Tax
 Prices Subject To Change Without Notice
 Send \$1.00 For Catalog

Listing 3b continued:

```
540 KEY ON
550 RETURN 420
560 '
570 '
580 '
590 '
600 '                                clear screen subroutine
610 '
620 '
630 CLS
640 RETURN 340
650 '
660 '
670 '
*****
```

Listing 4: Driver subroutines for disk-screen data transfers.

```
1220 '
1230 '
1240 '
1250 '                                "move screen to disk" - driver subroutine
1260 '
1270 '
1280 LOCATE 25,1:PRINT SPACE$(79);
1290 LOCATE 25,1
1300 BEEP
1310 DEF SEG:POKE 106,0
1320 INPUT;"F-10 screen to disk; enter screen image #:";SCREENIMAGE%
1330 SCREENOFFSET%=0
1340 WORDCOUNT%=256
1350 DEF SEG=SUBROUTINESEG%
1360 FOR RECORDNO%=SCREENIMAGE%*8 TO SCREENIMAGE%*8+6
1370 CALL MOVESUB%(SCREENSEG%,SCREENOFFSET%,FCBSEG%,FCB1DATAOFFSET%,
WORDCOUNT%)
1380 PUT #1,RECORDNO%
1390 SCREENOFFSET%=SCREENOFFSET%+512
1400 NEXT RECORDNO%
1410 WORDCOUNT%=(24*80-7*256)
1420 CALL MOVESUB%(SCREENSEG%,SCREENOFFSET%,FCBSEG%,FCB1DATAOFFSET%,
WORDCOUNT%)
1430 PUT #1, SCREENIMAGE%*8+7
1440 RETURN 340
1450 '
1460 '
1470 '
1480 '
1490 '
1500 '                                "move disk to screen" - driver subroutine
1510 '
1520 '
1530 LOCATE 25,1:PRINT SPACE$(79);
1540 LOCATE 25,1
1550 BEEP
1560 DEF SEG:POKE 106,0
1570 INPUT;"F-9 disk to screen; enter screen image #:";SCREENIMAGE%
```

Listing 4 continued on page 436

For your complete printer needs,

SILENT  SCRIBE™

The Affordable Professionals.



High quality correspondence, high-speed drafts and high-resolution graphics. Regardless of your business application, the Anadex line of Silent/Scribe printers places a solid, professional printer within reach of any business.

First of all, they've set new industry standards for quiet operation of impact printers – often operating unnoticed in the average office.

And the print quality of a Silent/Scribe is becoming the “just-as-good-as” benchmark other manufacturers are using when they describe print quality.

For operating ease, Silent/Scribe offers quick-in, quick-out long life ribbon cartridges that make ribbon changing a snap – no more dirty fingers from spool threading. And operator controls are up on top for easy use.

And connecting a Silent/Scribe to your computer is usually a matter of plug-it-in-and-print... including Apples, IBM PC's and virtually any other you can name.

Reliability? With a two year track record of over 99% reliability in operation, Silent/Scribe is tops in its field.

Anadex Silent/Scribe printers. They're fast, quiet, easy to use, and dependable.

We have one to fit your business.

And your bottom line.

Call 800 - 792-7779

In California Call 800 - 792-9992

 **Anadex**
©Copyright 1983. Anadex, Inc.

MADE IN
USA
FOR THE WORLD

Quietly going about your business.

ANADEX, INC. • 1001 Flynn Road (P.O. Box 6002) • Camarillo, California 93010 • Telephone: (805) 987-9660 • TWX 910-494-2761
U.S. Sales Offices: Irvine, California (714) 557-0457 • Schiller Park, Illinois (312) 671-1717 • Wakefield, Massachusetts (617) 245-9160
Hauppauge, New York, Phone: (516) 435-0222 • Atlanta, Georgia, Phone (404) 255-8006 • Austin, Texas, Phone: (512) 327-5250
ANADEX, LTD. • Weaver House, Station Road • Hook, Basingstoke, Hants RG27 9JY, England • Tel: Hook (025672) 3401 • Telex: 858762 ANADEX G
ANADEX GmbH • Behringstrasse 5 • 8752 Mainaschaff • Frankfurt, W. Germany • Tel: 011-49-06021-7225 • Telex: 4188347

Listing 4 continued:

```

1580 SCREENOFFSET%=0
1590 WORDCOUNT%=256
1600 DEF SEG=SUBROUTINESEG%
1610 FOR RECORDNO=SCREENIMAGE%#8 TO SCREENIMAGE%#8+6
1620   GET #1,RECORDNO
1630   CALL MOVESUB$(FCBSEG%,FCB1DATAOFFSET%,SCREENSEG%,SCREENOFFSET%,
        WORDCOUNT%)
1640   SCREENOFFSET%=SCREENOFFSET%+512
1650 NEXT RECORDNO
1660 WORDCOUNT%=(24#80-7#256)
1670 GET #1, SCREENIMAGE%#8+7
1680 CALL MOVESUB$(FCBSEG%,FCB1DATAOFFSET%,SCREENSEG%,SCREENOFFSET%,WORDCOUNT%)
1690 RETURN 340
1700 '
1710 '
1720 '*****

```

Listing 5: A subroutine with CALL arguments.

```

680 '*****
690 '
700 '
710 '           "movesub" - machine language subroutine
720 '           - call statement with arguments
730 '
740 DEF SEG=SUBROUTINESEG%
750 RESTORE B10
760 FOR I=0 TO 48
770   READ J
780   POKE I,J
790 NEXT I
800 '           push DS, ES, BP onto stack; move SP to BP
810 DATA &h1e,&h06,&h55,&h8b,&hec
820 '           load 1st argument address into BX
830 DATA &h36,&h8b,&h5e,&h12
840 '           and get value into DS
850 DATA &h36,&h8e,&h1f
860 '           load 2nd argument address into BX
870 DATA &h36,&h8b,&h5e,&h10
880 '           and get value into SI
890 DATA &h36,&h8b,&h37
900 '           load 3rd argument address into BX
910 DATA &h36,&h8b,&h5e,&h0e
920 '           and get value into ES
930 DATA &h36,&h8e,&h07
940 '           load 4th argument address into BX
950 DATA &h36,&h8b,&h5e,&h0c
960 '           and get value into DI
970 DATA &h36,&h8b,&h3f
980 '           load 5th argument address into BX
990 DATA &h36,&h8b,&h5e,&h0a
1000 '           and get value into CX
1010 DATA &h36,&h8b,&h0f
1020 '           set direction flag
1030 DATA &hfc
1040 '           move instruction

```

Listing 5 continued on page 438

To find out where we're showing off the P1350 printer, call one of these Toshiba distributors:

COMPU SHOP
1355 Glenville Drive
Richardson, TX 75081
(214) 783-1252

CYPRESS DISTRIBUTING CO., INC
1266 Lincoln Avenue
Suite 109
San Jose, CA 95125
(408) 297-9800

DIGITAL ENTRY SYSTEMS
27 Spruce Street
Waltham, MA 02154
(617) 899-6111

GENERAL BUSINESS COMPUTERS, INC.
2 North Olney Avenue
Cherry Hill, NJ 08003
(609) 424-8500

GENERAL MICROCOMPUTER
Georgetown Center
52303 Emmons Road #26
South Bend, IN 46637
(219) 277-4972

INTECH GROUP
Royal Commerce Center
2025 Royal Lane
Dallas, TX 75229
(214) 241-1717

KALTRONICS DISTRIBUTORS, INC.
702 Landwehr Rd.
Northbrook, IL 60062
(312) 291-1220

MICRO DISTRIBUTORS
11794 Parklawn Drive
Rockville, MD 20852
(301) 466-6450 or
(800) 636-6621

MICROAMERICA DISTRIBUTING CO
17103 Kingsview Avenue
Carson, CA 90746
(213) 327-6030

1050 Remington Road
Schaumburg, IL 60195
(312) 882-0095

366 Washington Street
Wellesley, MA 02181
(617) 431-7660

1461 Exchange Drive
Richardson, TX 75081
(214) 235-3616

MICROWARE DISTRIBUTORS, INC
20415 S.W. Blanton Avenue
Aloha, OR 97007
(503) 642-7679

MIDTEC ASSOCIATES
8363 Quivira Road
Lenexa, KN 66215
(913) 541-1711

MONROE DISTRIBUTING CO
2999 Payne Avenue
Cleveland, OH 44114
(216) 781-4600

PARAGON SALES, INC.
780 Charcot Avenue
San Jose, CA 95131
(408) 263-7955

PREMIER SOURCE DISTRIBUTING
1882 McGaw Avenue
Irvine, CA 92714
(714) 261-2011

STAR DATA, INC
4021 N. 30th Street, Suite 4
Phoenix, AZ 85016
(602) 955-9233

SYSPRINT, INC.
7777 S. Central Expressway, Suite 2A
Richardson, TX 75080
(214) 669-3666

TRANSALASKA DATA SYSTEMS, INC
200 Center Court
Anchorage, AK 99502
(907) 561-1776

...Or these Toshiba Regional Offices:

TOSHIBA AMERICA, INC.
177 Madison Avenue
Post Office Box 2331R
Morristown, NJ 07960
(201) 326-9777

TOSHIBA AMERICA, INC.
662 Office Parkway
The Colonnade Building
St. Louis, MO 63141
(314) 991-0751

TOSHIBA AMERICA, Inc.
2555 Cumberland Parkway, Suite 285
Atlanta, GA 30339
(404) 434-3891

TOSHIBA AMERICA, INC.
18017 Sky Park Circle
Suites P and Q
Irvine, CA 92714
(714) 250-0151

In Touch with Tomorrow

TOSHIBA

Circle 433 on Inquiry card.

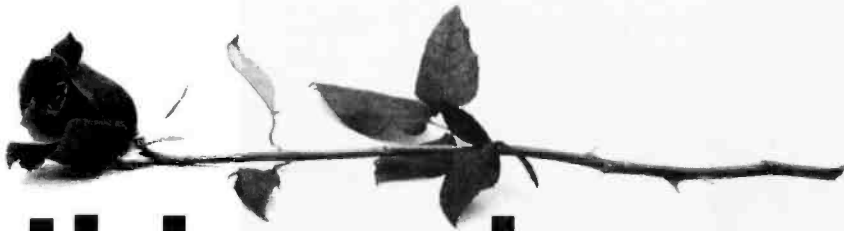

Nothing shows off your IBM PC™ like Toshiba's P1350 printer.

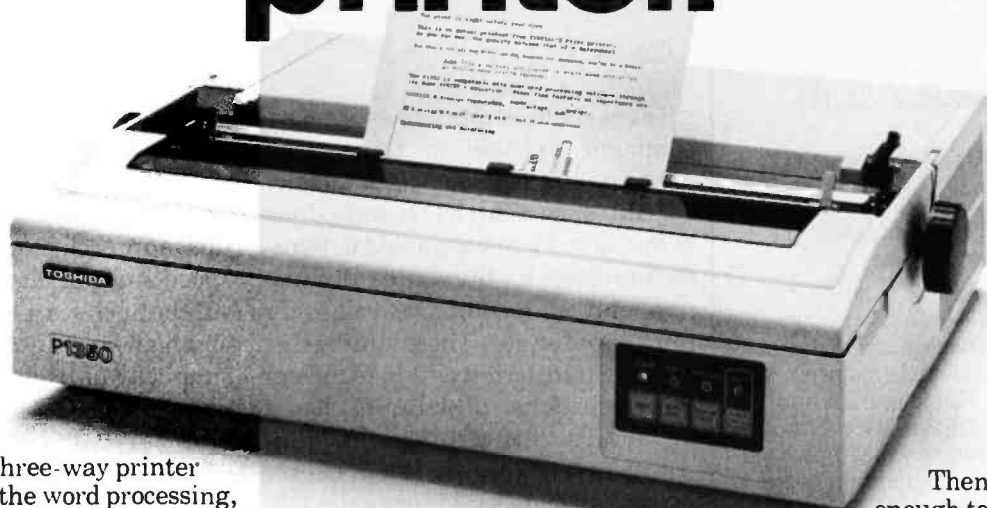

Now there's one three-way printer that fully equals the word processing, data and graphics capacity of your IBM PC: Toshiba's P1350.

But the P1350 is more than compatible with PC hardware. It will print programs like Lotus 1-2-3 data processing and graphics output with remarkable character definition.*

For even more flexibility, the Toshiba P1350 with Qume SPRINT 5 emulation handles all popular word processing programs. Under software command, the P1350 will print high-speed drafts or switch to letter-quality text and graphics.

The innovation behind this three-in-one flexibility is Toshiba's print head. Pin diameter has been reduced to just eight mils. And the number of

pins in the print head has been increased to 24.

The result is a superior 360 by 180 dot-per-inch density pattern in the text mode. Instead of spinning your wheels at 40 cps, the P1350 produces letter-quality printing at 100 cps. In its draft mode, Toshiba's P1350 can accelerate up to 192 cps.

When it comes to graphics, the P1350 really shows its stuff. Whatever your computer displays, Toshiba's P1350 prints. With astonishingly clear definition. And extra-fine reproduction that can only come from a print head capable of 200 million impressions and exclusive 180 by 180 dot-per-inch graphics density pattern.

Then, if that's not enough to pique your interest, the P1350 also

features three different fonts. Variable pitch. Subscripts, superscripts and underlining without the need of a second pass. A super-reliable, optional sheet feeder. And more.

So show off your IBM. OR ANY OTHER PERSONAL COMPUTER. With the superior quality and flexibility of Toshiba's spectacular P1350 printer.

Distributors on the adjacent list make it easy to find the P1350. Or get more information by calling, toll-free, 1-800-457-7777.

*IBM PC to P1350 graphics utilizes PaperScreen and color graphics adapter. IBM PC is a Trademark of International Business Machines. Lotus and 1-2-3 are Trademarks of Lotus Development Corporation. ©1983 Toshiba America, Inc.

In Touch with Tomorrow

TOSHIBA

See us at Comdex booth 5153.

Circle 434 on inquiry card.

Information Systems Division. TOSHIBA AMERICA, INC.

BYTE December 1983 437



More speed, more memory workspace from the people who lifted the 64K limit.

In 1981, we introduced our famous Saturn RAM card to boost the Apple's memory by 32K. Now, there are 64K and 128K versions for added power.

Increased RAM lets you run bigger programs, and our VisiCalc[®] expansion software provides a dramatic expansion of workspace memory. Also, the extra memory can work as a pseudo disk for instant access. (No more 20-second searches!) The Saturn RAM board is a super aid for advanced word processing, data base management, spread sheet, and accounting applications. And perfect with PASCAL, CP/M[™], and BASIC.



Use our easily installed cards in combination—and get a whopping 220K of VisiCalc workspace on the Apple IIe. Or sensational enhancements on Apple II+, Franklin, Basis and most Apple compatibles. We even have software that increases your Apple's memory in BASIC programming up to 4 megabytes!

This kind of performance requires sophisticated bank switching and supporting software that we originated, proved, and improved. Buy from the leader!

Let us help you expand your Apple's productivity. For information on our RAM boards and other Titan microcomputer products, see your computer dealer or contact: Titan Technologies, Inc., P.O. Box 8050, Ann Arbor, MI 48107; Telephone (313) 973-8422.

Sales and Marketing by The MARKETING RESOURCE GROUP, Costa Mesa, CA.



Apple is a registered trademark of Apple Computer, Inc. VisiCalc is a registered trademark of VisiCorp, Inc. CP/M is a registered trademark of Digital Research, Inc.

Listing 5 continued:

```

1050 DATA &hf3,&ha5
1060 ' "pop" (recover) register values from stack
1070 DATA &h5d,&h07,&h1f
1080 ' return with displacement value A(=2*# arguments)
1090 DATA &hca,&h0a,&h00
1100 '
1110 ' define constants
1120 '
1130 MOVESUB%=0
1140 SCREENSEG%=&HB000
1150 SCREENOFFSET%=&H0
1160 DEF SEG=&H0
1170 FCBSEG%=PEEK(&H511)*256+PEEK(&H510) 'BASIC segment address
1180 FCB1DATAOFFSET%=(VARPTR(#1)+188)
1190 RETURN
1200 '
1210 '
1220 '#####
    
```

Text continued from page 432:

complete instruction

CA,0A,00

There is one important cautionary comment to note in transferring memory addresses as arguments of a CALL statement, as we have done in this case. Here we wanted to transfer addresses for the source, destination, and word counts, as values for this subroutine. These addresses must be transferred as 2-byte integer representations. IBM BASIC has a peculiarity concerning the representation of integers. When integer variables are declared using the DEFINT statement at the start of a program, the variables represent integer values externally but, in fact, are stored in memory in 4, rather than 2, bytes. This representation cannot be used for these machine programs. Only when each integer variable is declared to be an integer by having the suffix "%" added will the representation in memory be in true 2-byte integer form. For this reason all of the variables, such as Source-seg%, include the necessary suffix.

Conclusion

The objective of this discussion of the use of POKEing in the IBM PC has been to illustrate several short, powerful machine-language subrou-

tines that can be incorporated into a BASIC program. These subroutines provided access to the facilities of the BIOS for peripheral device control and methods for moving data from one location to another in memory, particularly interfacing with DOS and disk storage. The advantages of this approach are to combine the speed and efficiency of machine-level subroutines for performing routine and high-volume operations with the simplicity of using BASIC for developing the logic for a specific application.

For those readers who have not had extensive contact with machine-language programs, I hope that these examples enable you to investigate the PC and its inner workings and provide a useful tool for the development of your own applications. ■

For Further Information

For further information on the machine and assembly language of the 8086 of the IBM PC, refer to *The 8086 Book* by Russell Rector and George Alexy (Berkeley, CA: Osborne/McGraw-Hill, 1980).

Hugh R. Howson, Ph.D., C.A., is on the faculty of Management at McGill University (1001 Sherbrooke St. W, Montreal, PQ, Canada H3A 1G5).

Become a dBASE II[®] expert without cracking a book.



dBASE II is, quite simply, the best-selling database management system (DBMS) made for any computer, ever. And with over 150,000 users so far, it's become the standard for managing data with a microcomputer.

Jump into dBASE II, disk-first.

The best way to learn to use dBASE II is to use dBASE II. Our on-disk tutorial is a hands-on interactive learning system that will get you up to speed on dBASE II, quickly and easily. Then you can use your new-found knowledge to create a full business information system that does exactly what you need done. A system that will handle today's problems, yet grow with you.



dBEST deal in town.

When you buy dBASE II, you'll be getting the most advanced information management tool available for your micro for only \$700 (suggested retail price). At the same time, you'll be getting the most advanced teaching tool (the dBASE II On-Disk Tutorial) for free.

For the name of your nearest dBASE II dealer, contact Ashton-Tate, 10150 West Jefferson Boulevard, Culver City, CA 90230, (800) 437-4329, ext. 212. In the U.K., call (0908) 568866.

ASHTON-TATE

See us at Comdex booth #3554 & #3654.

dBASE II is a registered trademark of Ashton-Tate.
©Ashton-Tate 1983



Only the Texas Instruments Professional Computer offers these 7 advantages that add up to more computer for your money.

If you're a smart business professional, you want a business computer that gives you the most productivity power for your dollar. For you, Texas Instruments has the answer: the TI Professional Computer. With seven obvious advantages that make buying TI make sense.

The Disk Storage Advantage.

The TI Professional Computer gives you standard 320K floppy disk storage. That's twice the standard data storage of the leading competitor.

The Function Key Advantage.

We give you 12 function keys that you can easily preprogram to make your work simpler and easier. The best the competition can do is 10 or fewer function keys.

The Keyboard Advantage.

Our standard touch-typing layout makes word processing as easy as sitting at a typewriter. The separate numeric and cursor control keypads let you isolate information and enter numbers for spreadsheets more quickly. And with our isolated edit/delete keys, you'll never have to

worry about accidentally erasing valuable data.

The Monitor Advantage.

Our monitor gives you 40-50% better resolution than the leading personal computers. Which means you get clearer displays that are easy on the eyes. And some of the sharpest graphics possible today.

The Software Advantage.

There's software available now for the TI Professional Computer that meets virtually every professional and small business need. And with our memory expansion board, you can use advanced integrated software like Lotus 1-2-3™ to help you do several kinds of work without changing programs.

The Expandability Advantage.

Our standard features like the floppy disk controller and printer support are built-in so they don't take up the valuable expansion slots you'll need for adding optional features like communications and up to ten megabytes of hard-disk storage. Which leads to one of our most exciting advantages...

The Future Enhancement Advantage.

No one wants to buy a personal computer that's already on the road to obsolescence. That's why we're developing exciting new features that you can easily add to your TI Professional Computer—like speech recognition. Imagine being able to say, "Spreadsheet, please" and having it appear instantly on your monitor. This and more will be available this fall.

One additional benefit makes the TI Professional Computer especially attractive — the price. Feature for feature, dollar for dollar, you'll get more computer for your money.

Get the business computer that puts these benefits to your advantage. Visit your TI authorized dealer or write: Texas Instruments Data Systems Group CA, Dept. 062BY, P. O. Box 402430, Dallas, TX 75240. Or call toll-free: 1-800-527-3500.



TEXAS INSTRUMENTS

Creating useful products
and services for you.

Hire performance.

Gifford gives you more.

When you go with Gifford, you get more than you ever thought possible from a multiuser computer system. Or a computer company. More productivity. More flexibility. More expandability. More speed. And more support.

It means *total performance* for every Gifford customer.

Gifford systems can run *both* 8 and 16-bit programs, giving you an incredible choice of over 5,000 CP/M[®] or MP/M[™] applications. And we developed this feature, so when we say it really works, it really does.

In addition, our systems can run popular single user programs, while giving you multiuser benefits such as the ability to share resources like printers and hard disks, plus advanced security features to protect sensitive information. And you can run true multiuser programs with features like file lockout, record lockout and shared data bases.

All Gifford systems use CompuPro's proven S-100 based products, making it easy to accommodate any

performance enhancements.

For example, expansion's a snap ... literally. Just snap in an expansion board, add a terminal, and you're ready to handle more. And since every system has twenty bus slots, there's plenty of power for everyone.

Gifford keeps on giving.

To make absolutely sure you get all the performance you hire, we support everything we sell. Should you ever need to call us, use our hotline to reach a knowledgeable representative.

And, if the problem can't be solved with words, it can be diagnosed via modem. If the problem is hardware related, we'll replace any defective CompuPro part within 24 hours *free* for two full years. Support continues with our two, three and five day hands-on seminars.

Meet our specs.

Just look at what our popular \$9990 three user system includes: 320K static RAM memory, two 8" DS/DD floppies, the Gifford F5-21

Winchester 21Mb drive, a CompuPro enclosure with IEEE 696/S-100 bus with 20 slots and nine I/O ports. Plus dBASEII[™], SuperCalc-86[™] and MP/M-86[™]

Other exclusive features include time accounting for users and projects, electronic mail, system scheduler, non-destructive memory test, MP/M II queue calls, and more. As well as expansion capabilities for up to six users.

Make the cut.

If you need our kind of performance, cut the coupon or give us a call. We'll send you a free brochure detailing our exclusive high performance features, our two year warranty, and the benefits of selecting an IEEE 696/S-100 bus-based system.

But if you don't need to hire us, there's only one possible reason. You already have.

Gifford Computer Systems is a Full Service CompuPro[®] Systems Center.



The powerful Gifford System 321 shown with optional GCS-80 terminals.

GIFFORD
COMPUTER SYSTEMS

1922 Republic Avenue, San Leandro, CA 94577
(415) 895-0798 A division of G&G Engineering
I'D LIKE THE WHOLE STORY.
Please send me your brochure.

Name _____ Title _____
Organization _____ M/S _____
Address _____
City _____ State _____ Zip _____
Phone _____
 Please have a representative call me. By P

GIFFORD COMPUTER SYSTEMS San Leandro, CA (415) 895-0798 San Francisco, CA (415) 391-4570 Los Angeles, CA (213) 477-3921
 Miami, FL (305) 665-9212 Houston, TX (713) 877-1212 Amherst, NY (716) 833-4758 Telex: 704521

Circle 199 on inquiry card.

www.americanradiohistory.com

The CMOS 6502

A new version of the 6502 microprocessor does more than save power—it includes powerful new instructions

by Steven Hendrix

Rockwell has introduced a CMOS (complementary metal-oxide semiconductor) version of the 6502 microprocessor that fills a number of gaps in the standard 6502's instruction set while offering the low power-consumption advantages of CMOS technology. Pin and software compatible with the standard 6502 chip, the CMOS version (designated the R65C02) promises to extend the range of applications that 6502-based packages can serve.

A mainstay of the personal-computer industry since the first Apple computer was produced, the standard 6502 microprocessor has a simple, straightforward instruction set and simple interfacing requirements. The instruction set at first appears to be restricted in comparison to other 8-bit processors such as the Z80, but, in practice, the simplicity of the instruction set often yields a shorter, faster program for common microprocessor applications. The instruction set does have restrictions on the use of certain addressing modes with some instructions and has several minor anomalies that are poorly documented.

In this article I will discuss some of the 6502's lesser-known deficiencies and the changes in the CMOS version that correct some of these problems. I will also review the CMOS version's instructions and added ad-

Several 6502 instructions don't behave as you might expect them to.

ressing modes, and finally I will describe some hardware interfacing considerations.

Quirks of the 6502

Several instructions on the 6502 do not behave as the documentation would have you believe. These irregularities rarely affect programs, which makes them more difficult to debug when they do enter into a program. The quirks discussed here pertain to the return-from-interrupt instruction, the branch-instruction timing, the absolute indirect-addressing mode, and bus cycles on certain index-addressing modes. The CMOS

version's design has not altered the return-from-interrupt and branch-instruction timing; therefore, the information presented on these topics pertains to both the standard and CMOS versions of the 6502. The CMOS version's design, however, has corrected the absolute indirect-addressing mode and bus-cycle anomalies.

RTI versus RTS

The RTI (return-from-interrupt) instruction appears functionally equivalent to the sequence PLP (pull status register from stack), RTS (return from subroutine). An interrupt is acknowledged at the end of an instruction, at which time the processor pushes the contents of the program counter on the stack, high byte followed by low byte, and then pushes the processor-status byte on the stack before jumping through the interrupt vector to the interrupt-handling routine.

The difference between the RTI instruction and the PLP, RTS sequence lies in the sequence in which the program counter is incremented. During a JSR (jump to subroutine), the value pushed on the stack is the address of

the third byte of the JSR instruction. Thus, the program counter is reloaded during an RTS instruction and then incremented before the attempt to fetch the next instruction. An interrupt pushes the address of the first byte of the next instruction to be executed, so the RTI instruction reloads the program counter and fetches the next instruction without first incrementing the program counter. This difference becomes especially important in writing software for tracing or single-stepping functions.

Branch-Instruction Timing

The branch-instruction timing problem lies not with the 6502, but rather with its documentation. The original data sheets specify the timing correctly, but several independent tutorials have incorrectly stated how long a branch instruction takes.

Unlike most other 6502 instructions, a branch instruction requires a variable number of clock cycles—from two to four, depending on the circumstances surrounding the

branch.

During the first clock cycle (bus cycle), the processor fetches the branch op code. The second cycle fetches the second byte of the instruction, which is the offset to be used if the branch is taken.

Several independent tutorials have confused 6502 branch-instruction timing considerations.

If the branch condition (flag set or cleared) is not met, the fetch for the next instruction occurs during the next clock cycle. If the branch is taken, the next cycle is used to add the offset to the low-order byte of the program counter. If there is a carry or borrow from this operation (considering the offset to be a signed value), a fourth clock cycle is used to update the high-order byte of the program counter.

The net result is that a branch that is not taken requires two clock cycles. A branch to a location within the same page requires three clock cycles, and only in the case of a branch that crosses a page boundary does the instruction require the full four cycles. Typical timing loops, especially for intervals under a millisecond or so, require close attention to these details of the branch-instruction timing.

Absolute Indirect Mode Wraparound

The absolute indirect-addressing mode works only with the JMP (jump) instruction. In normal use, it is a 3-byte instruction: the first byte contains the op code (6C)(all instructions and addresses are specified in hexadecimal); the second byte contains the low-order part of a memory address; and the third byte contains the high-order part of that address. The processor loads the byte at the referenced address into the low half of the program counter, and it loads the byte in the next higher memory location into the high half of the program counter. Thus, the instruction's effect is to jump to the location specified by the two bytes stored at the address given in the instruction.

A problem arises, however, when the jump destination is stored with the two bytes split between two memory pages (that is, if the second byte of the instruction is FF). The processor loads the referenced byte into the low half of the program counter and attempts to increment the address given in the instruction to load the high byte. However, it disregards the carry from the increment operation on the low byte of the address, with the result that the high byte of the program counter is loaded from the memory location 255 bytes prior to the referenced location.

In table 1 the JMP instructions illustrate this problem. The left-hand-column code operates correctly, loading the value A345 into the program counter. The right-hand-column code, however, does not correctly load the value A345 into the program. It does load the value 45, stored at location 02FF, into the program counter's low-order byte, but

Epson QX-10™ ?

Graphics?

Q PLOTTER

GRAPHIC POWER FOR THE EPSON QX-10™

with one key . . .

■ Draw Circles ■ Squares
■ Lines ■ Axis, etc.

also zooming and panning, multiple screens,
animation and much more . . .

Q Plotter also turns your Mbasic into a high powered
graphics basic.

introductory price **\$175.00**

To order call toll-free 1-800-824-7888 Operator 409
For technical information or dealer nearest you
Call (602) 747-0005 or Telex 709234

Metro Software Inc.

5648 E. Broadway Blvd., Dept. B, Tucson, Arizona 85711

QX-10 is a TM of Epson America • Mbasic is a TM of Microsoft

•NEW PRODUCTS•

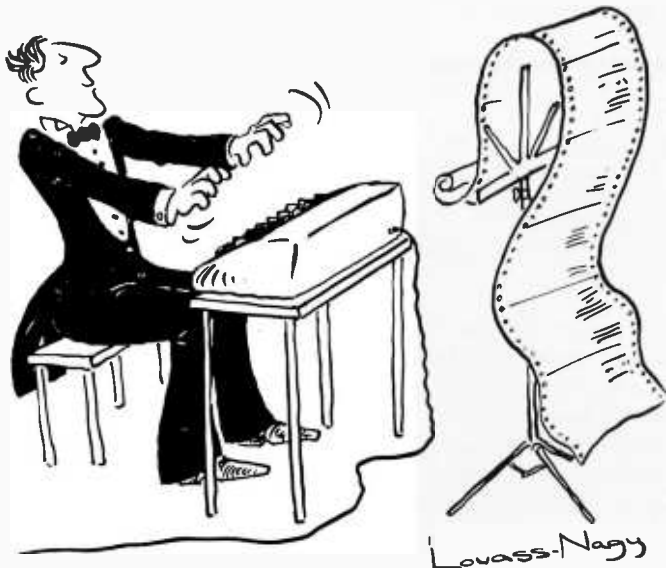

Before Johann Sebastian Bach developed a new method of tuning, you had to change instruments practically every time you wanted to change keys. Very difficult.

Before Avocet introduced its family of cross-assemblers, developing micro-processor software was much the same. You needed a separate development system for practically every type of processor. Very difficult and very expensive.

But with Avocet's cross-assemblers, a single computer can develop software for virtually any microprocessor! Does that put us in a league with Bach? You decide.

The Well-Tempered Cross-Assembler

Development Tools That Work

Avocet cross-assemblers are fast, reliable and user-proven in over 3 years of actual use. Ask NASA, IBM, XEROX or the hundreds of other organizations that use them. Every time you see a new microprocessor-based product, there's a good chance it was developed with Avocet cross-assemblers.

Avocet cross-assemblers are easy to use. They run on any computer with CP/M* and process assembly language for the most popular microprocessor families.

5 1/4" disk formats available at no extra cost include Osborne, Xerox, H-P, IBM PC, Kaypro, North Star, Zenith, Televideo, Otrona, DEC.

Turn Your Computer Into A Complete Development System

Of course, there's more. Avocet has the tools you need from start to finish to enter, assemble and test your software and finally cast it in EPROM:

Text Editor VEDIT -- full-screen text editor by CompuView. Makes source code entry a snap. Full-screen text editing, plus TECO-like macro facility for repetitive tasks. Pre-configured for over 40 terminals and personal computers as well as in user-configurable form.

CP/M-80 version \$150
 CP/M-86 or MDOS version \$195
 (when ordered with any Avocet product)

EPROM Programmer -- Model 7128 EPROM Programmer by Gtek programs most EPROMS without the need for personality modules. Self-contained power supply ... accepts ASCII commands and data from any computer through RS 232 serial interface. Cross-assembler hex object files can be down-loaded directly. Commands include verify and read, as well as partial programming.

PROM types supported: 2508, 2758, 2516, 2716, 2532, 2732, 2732A, 27C32, MCM8766, 2564, 2764, 27C64, 27128, 8748, 8741, 8749, 8742, 8751, 8755, plus Seeq and Xicor EEPROMS.

Avocet Cross-assembler	Target Microprocessor	CP/M-80 Version	•CP/M-86 IBM PC, MSDOS** Versions•
•XASMZ80	Z-80	\$200.00 each	\$250.00 each
•XASM85	8085		
XASM05	6805		
XASM09	6809		
XASM18	1802		
XASM48	8048/8041		
XASM51	8051		
XASM65	6502		
XASM68	6800/01		
XASMZ8	Z8		
XASMF8	F8/3870		
XASM400	COP400		
XASM75	NEC 7500		
Coming soon: XASM68K...68000		\$500.00	

(Upgrade kits will be available for new PROM types as they are introduced.)

Programmer \$389
 Options include:

- Software Driver Package --
- enhanced features, no installation required.
- CP/M-80 Version \$ 75
- IBM PC Version \$ 95
- RS 232 Cable \$ 30
- 8748 family socket adaptor ... \$ 98
- 8751 family socket adaptor ... \$174
- 8755 family socket adaptor ... \$135

- **G7228 Programmer by Gtek** -- baud to 2400 ... superfast, adaptive programming algorithms ... programs 2764 in one minute.

• Programmer \$499

- Ask us about Gang and PAL programmers.

- **HEXTRAN Universal HEX File Converter** -- Converts to and from Intel, Motorola, MOS Technology, Mostek, RCA, Fairchild, Tektronix, Texas Instruments and Binary formats.

• Converter, each version \$250

Call Us

If you're thinking about development systems, call us for some straight talk. If we don't have what you need, we'll help you find out who does. If you like, we'll even talk about Bach.

CALL TOLL FREE 1-800-448-8500
 (In the U.S. except Alaska and Hawaii)

VISA and Mastercard accepted. All popular disc formats now available -- please specify. Prices do not include shipping and handling -- call for exact quotes. OEM INQUIRIES INVITED.

*Trademark of Digital Research **Trademark of Microsoft



AVOCET SYSTEMS INC.

DEPT. 1283-B
 804 SOUTH STATE STREET
 DOVER, DELAWARE 19901
 302-734-0151 TELEX 467210

WANTED ECG DIAGNOSTIC PROGRAM

- Brief Form
- High Level Language
- To Run On Micro Or Minicomputer

Submit a one-page program description to:

ECG
21738 So. Avalon Blvd.
P.O. Box 145
Carson, CA 90746

All replies will be acknowledged.

A345 JMP (0200)	A345 JMP (02FF)
0200 45	0200 59
0201 A3	02FF 45
	0300 A3
Result: A345 → PC	Result: 5945 → PC

Table 1: Two sets of memory contents illustrating operation of the 6502 JMP instruction. The left-hand column of code operates as expected, but due to an instruction-set anomaly, the right-hand column's code yields an unexpected result because the program counter's desired high-order byte resides in a different page of memory than does the low-order byte.

rather than transferring to the next page of memory to obtain the high-order program-counter byte from location 0300, it incorrectly loads the value stored at location 0200 (59 in this case) into the program counter's high-order byte.

This anomaly can cause major problems when you attempt to develop general-purpose table-driven software. If the application program does not contain special code to insure that an indirect jump never references an address at the end of a page, unpredictable behavior that is difficult to trace can result. The R65C02 reportedly handles the absolute indirect-addressing mode correctly for all cases.

Spurious Bus-Read Cycles

A rare problem with I/O (input/output) devices can occur because of the nature of the 6502 bus. Two specific factors combine to cause this problem: all I/O is memory-mapped, and there is no such thing as an inactive bus cycle. In some cases, indexed instructions can lead to inadvertent accesses to I/O devices because of these two facts.

The 6502 treats memory and I/O ports alike, viewing both as memory. As a result, a system's decoding hardware causes I/O ports to appear at specific locations that look like part of the memory-address space to the 6502. A "read" bus cycle addressing a port acts as an "input" operation, and a "write" cycle acts as an

"output" operation.

The 6502 does not have separate pins for a "read" and a "write" signal, as do other processors such as the 8080 or the Z80. Instead, the R/W (read/write) signal is used to designate a "read" cycle if it is in a high state or a "write" cycle if it is in a low state. Timing is coordinated by the Phase 2 clock. If the read/write line is high when the Phase 2 clock is high, the device whose address appears on the address bus places data on the data bus. If the read/write line is low while the Phase 2 clock is high, the addressed device accepts data from the bus.

To show how indexed instructions can interfere with I/O devices, let's examine the bus cycles carried out to load the accumulator from an absolute address indexed by the X register. In standard 6502 mnemonics, this load instruction is LDA ADDR,X. This instruction takes four cycles unless the indexing crosses page boundaries, in which case it takes five. The latter is the troublemaker.

During the first cycle, the 6502 fetches the op code. The second and third cycles are used to fetch the low and high bytes of ADDR, respectively. If the indexing operation does not cross a page boundary, the sum of ADDR and X is placed on the address bus during the next cycle, and the A register is loaded from the data bus, finishing the instruction. If a page boundary is crossed, however, a partially formed address is placed on the bus during cycle four and the actual load happens in a fifth cycle. For normal memory access, the fifth cycle does no harm because it is a read cycle, resulting in memory placing data on the bus but no registers or memory being changed by it. (Even if the instruction is a store instruction, the cycle involving this partially formed address is a read cycle.)

Certain I/O devices, however, are affected by read operations. For instance, a spurious read from a 6850 ACIA (Asynchronous Communications Interface Adapter) could reset the "receive data register full" flag, so that a later operation would find that data was not available. Various other I/O devices such as parallel ports and

Buy Smartmodem 300 *right now*, and get this \$140 value FREE!

Subscription to **THE SOURCE**,
including User's Manual.
Value \$100*

One hour connect time.
Value \$20.75**

A comprehensive, hard-bound
handbook on communications.
Value \$19.95



Your computer's telephone

Hayes



Between Nov. 1-Jan. 15, you and your personal computer can make the big break. From isolated desktop computing. To the exciting world of telecomputing. With Hayes Smartmodem 300. The most popular 300 bps modem you can buy, for any computer with an RS-232C port. Let Smartmodem 300 connect you, via telephone lines, to computers, terminals and information services all across America. Including **THE SOURCESM AMERICA'S INFORMATION UTILITYSM**.

This offer takes you right to **THE SOURCE!** And you won't have to pay to join! The same day you purchase your Smartmodem, call **THE SOURCE** on their toll-free number. And you're already well on your way to getting on-line!

It frees up your time. This offer also entitles you to \$20.75 worth of connect time—at no charge. Use it as you please! Check the latest news and sports. Look up your flight schedule. View your stock portfolio. You name it. The time is yours! Sixty minutes

worth, or more, depending on the day and hour.

Giving you lots of connections. **THE SOURCE** has assembled the most comprehensive programs available on any system. For fun and practical applications. From games to commodity news. Electronic mail to teleconferencing. Discount shopping to abstracts of articles from business magazines.

And everything you need to know is right

there in your comprehensive, illustrated User's Manual. Included with your free membership to **THE SOURCE** during this special, limited time offer from Hayes.

Plus the last word on communications. Now here's a book that delivers what it promises! In Alfred Glossbrenner's best seller, **THE COMPLETE HANDBOOK OF PERSONAL COMPUTER COMMUNICATIONS**, you'll find a thorough, informative study of microcomputer communications. Worth every cent of the \$19.95 this hard-bound book sells for. And yours absolutely free!

If you act now! See your dealer soon. Buy Smartmodem 300, and get the best 300 bps modem around.

Plus a \$140 value FREE. Hayes Microcomputer Products, Inc. 5923 Peachtree Industrial Blvd., Norcross, Georgia 30092. 404/449-8791.



Hayes

Here's all you have to do:

1. When you purchase your Smartmodem 300, save your sales receipt and Hayes registration card (packed inside the box).
2. Pick up the phone and call **THE SOURCE**, on their toll-free number:
1-800-336-3366.

Tell **THE SOURCE** representative that you are participating in the special Hayes promotion, give the serial number of your Smartmodem (on the modem), and your credit card number (VISA, MasterCard, or American Express).† You will get your password to **THE SOURCE**, right on the spot!

3. Within a week you will receive an agreement from **THE SOURCE**, along with your New Member Kit. Sign the agreement, and return it within 10 days to **THE SOURCE**, along with your sales receipt for Smartmodem 300 and Hayes registration card. Remember, send no money. Your membership is free!
4. That's all it takes! Look for your User's Manual and free communications book within two weeks of receipt of the agreement, sales receipt and registration card.

†**THE SOURCE** requires a major credit card for billing of hourly connect time to individual members. Corporate members may apply for direct billing.

*Suggested retail price. **60 minutes or more connect time, depending on the day and hour. **THE SOURCE** and **AMERICA'S INFORMATION UTILITY** are service marks of Source Telecomputing Corporation, a subsidiary of The Reader's Digest Association, Inc. ©1983 Hayes Microcomputer Products, Inc.

counter/timers can also be affected by spurious reads. If the indexed address crosses a page boundary from the page in which the I/O device resides, the partially formed address placed on the bus during the fourth bus cycle can trip the I/O device. The R65C02 reportedly corrects this problem.

New Instructions

The R65C02 includes a number of new instructions, making it more powerful than the 6502. (The text box "An Assembler for the R65C02" on page 452 describes an assembler that supports the R65C02's extended instruction set.) Conditional branching based on the state of any bit in page 0, an unconditional short relative branch, stack operations for the X and Y registers, the ability to set or clear any individual bit in page 0, zeroing any byte in memory, and a "test and reset" or "test and set" memory bit instruction have been added.

The BBRx (branch on bit reset) in-

structions permit any bit in page 0 to be used as a flag. These are 3-byte instructions, with the op code in the first byte, the page-0 address of the byte containing the flag in the second byte, and the relative jump displacement in the third byte. Bits 6 through

The R65C02 includes a number of new instructions, making it more powerful than the standard 6502.

4 of the op code give (in binary) the number of the bit within the page-0 byte to be tested. The processor reads the byte from page 0, checks the bit designated by the op code, and continues normal program flow if the designated bit is a 1. If it is a 0, a normal signed relative short branch is executed, using the third byte of the instruction for the offset. The BBSx (branch on bit set) instructions do the

same thing except that they take the branch only if the referenced bit is set to 1.

Unconditional Short Branch

The unconditional short-branch instruction (BRA) eases writing of position-independent code and in some cases allows shorter code. With the 6502, a sequence such as SEC (set carry), BCS (branch if carry set) is sometimes necessary to cause an unconditional position-independent jump. Even that sequence requires 3 bytes, as does a normal absolute jump (JMP). The BRA instruction permits an unconditional, position-independent branch requiring only 2 bytes.

Four new stack-manipulation instructions have been added to act on the X and Y registers. In 6502 programs, the X and Y registers could be pushed only by transferring them first to the A register. Thus, the normal sequence for saving the registers for an interrupt routine went something like this: PHA (push the A

Dirty Power In
Ultra Quiet



KLEEN LINE
Power Out

Computer Protection

KLEEN LINE[®] CONDITIONER

Prevents:

- Computer Damage
- Lightning Spike Damage
- Brownout Interruptions
- Disruptive Line Noise
- Program Errors

Regulator • Filter • Suppressor

KLR-250A	250 Watt Load	\$291.95
KLR-250A-1S0	250 Watt Load; Patented Filter Isolated Sockets	\$346.95
KLR-500A	500 Watt Load	\$390.95
KLR-500A-1S0	500 Watt Load; Patented Filter Isolated Sockets	\$445.95

Shipping: \$12.75 Land; \$45.50 Air

Ask Your Local Dealer

ESP[®] Electronic Specialists, Inc.
171 South Main Street, Box 389, Natick, Massachusetts 01760

Toll Free Order Desk 1-800-225-4876
MasterCard, VISA, American Express

COMPETITIVE EDGE

P.O. Box 556
Plymouth, MI 48170

ORDERS 800-336-1410
LOCAL & INFO 313-451-0665

New Lower Prices on Compupro Components

RAM 22 256K A&T	\$1155	RAM 21 A&T	\$ 723	RAM 17 A&T	\$ 329
DISK 3 A&T	525	DISK 2 A&T	459	DISK 1 A&T	327
CPU 68K A&T	459	CPU 8086 A&T	495	CPU Z A&T	215
CPU 8085/8088 A&T	327	MDRIVE-H A&T	1355	SPU-Z	CALL
ENCLOSURE 2 D	611	ENCLOSURE 2 RACK			644
INTERFACER 4 A&T	297	INTERFACER 3-8 A&T			461
SYS SUPPORT 1 A&T	297	CPM-68K	242	CPM 2.2	119
CPM-86	198	CPM 8-16	297	MPM 8-16	660

Lomas Components

CPU 286 BOARD	\$1116	10MHZ 8086	\$ 520	8 MHZ 8086	\$ 420
HAZITALL 2P 2S	275	128K STATIC	725	128K DRAM	396
256K DRAM	636	LDP72	220	8 SERIAL	316
CP/M-86	195	MSDOS	225	MPM-86	525

Teletek Components

SYSTEMASTER	627	MEMORY DRIVE	747	CP/M 2.2	150
HD/CTC	596	4MHZ SBC1 64K	577	6MHZ SBC 64	799
PSIO 4S 2P	244	PSC RS422	94	MPM II	500
TURBODOS MULTI	695	MICRO MIKE'S MDZ/OS	MULTI		800

Competitive Edge Integrated Systems

LOMAS CPU 286, 128K STATIC, LDP72, HAZITALL, CP/M	\$4095
LOMAS CPU, 8086/8089, LDP72, 256K, HAZITALL, MP/M-86	3895
TELETEK SYSTEMASTER, Z80A, 64K 4 SLOT (2) 8" DSDD	2095
TELETEK SYSTEMASTER, Z80A, 64K 10 SLOT, 2-8" DSDD	2295
20 MEGABYTE HARD DISK FOR TELETEK W/HD/CTC	2095
6MHZ CPU Z, 1/O 4, 64K, DISK 1, CP/M 2.2	2795
6/8MHZ 8085/8088, 1/O 4, 64K, DISK 1, CP/M 2.2	2895
8MHZ 8086, 1/O 4, 128K, DISK 1, CP/M-86 SPELLBINDER	3595
8MHZ 68K, SPECIAL, 1/O 4, 128K, DISK 1, CP/M-68K	3395
10MHZ 8086, 256K, 1/O 4, SSI, DISK 1, MPM-86	4895
SEATTLE GAZELLE II 10MHZ 8086, 256K, 18 SLOT	4895

QUME 102 GREEN	\$539	QUME 102 AMBER	\$549	TV914	\$575
TELEVIDEO 924	699	TELEVIDEO 950	899	TV970	1075
VISUAL 50 GR	635	C ITOH 8510 P	385	8510 S	550
EPSON FX80	499	GORILLA BANANA	199	F10 40	1195
dBASE II	425	SUPERCALC 3	CALL	PASCALMT +	350

All prices subject to change. Compupro is a Goudbot Company. CP/M & MPM are registered trademarks or trademarks of Digital Research.

Four Reasons Why The Dysan Difference is Worth Paying For



1. 100% Surface Tested

Only Dysan provides fully usable diskette surfaces that are truly 100% error-free across the entire face of the diskette. An exclusive on-and-between the track testing procedure guarantees error-free performance regardless of temperature and humidity distortions or slight head misalignments.

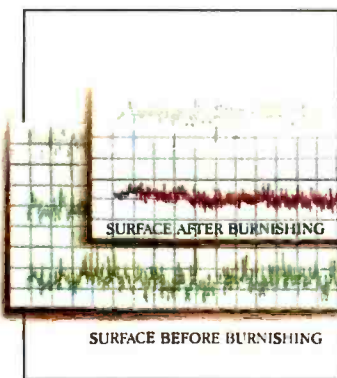

2. Advanced Burnishing Techniques

Dysan's advanced polishing methods create a smoother, more uniform diskette surface. This results in better signal quality on each track, less wear on drive heads and reliable access to data after millions of head passes.



3. DY¹⁰™ Lubricant

Dysan's proprietary DY¹⁰ lubricant complements the advanced burnishing process. Both maximize error-free performance while minimizing headwear. Optimal signal presence is maintained between the head and diskette surface during millions of write/read interfaces.

DY¹⁰ is a trademark of Dysan Corporation

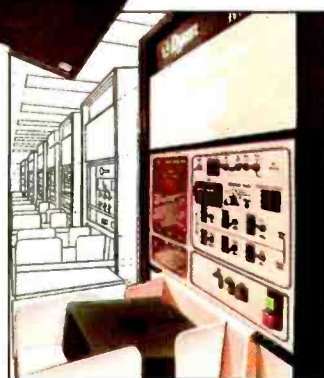

4. Auto-Load Certification

Dysan's unique quality control methods reflect technological leadership in designing, producing and testing precision magnetic media. Each diskette is unerringly certified by Dysan-built, automated and microprocessor controlled certifiers. Your system and data base will benefit from Dysan's diskette reliability and unsurpassed quality.

Select from a complete line of premium 8" and 5 1/4" diskettes, in single or double densities, certified on one or both sides.

Circle 162 on inquiry card.



Corporate Headquarters:
5201 Patrick Henry Drive
Santa Clara, CA 95050
(800) 551-9000

Frustration Insurance.

The Assembly Language Programming Series from Osborne/McGraw-Hill.



1) 6502 Assembly Language Programming
Leventhal Order #27-6 \$18.95
"The book that will probably get the reputation as being the 6502 Bible."
INTERFACE AGE

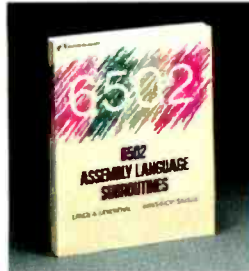

2) 6502 Assembly Language Subroutines
Leventhal, Saville Order #59-4 \$17.95
Over 50 ready-to-use subroutines.



3) Assembly Language Programming for the Apple II.
Mottola Order #51-9 \$15.95
Run programs hundreds of times faster and use less memory space than with programs written in BASIC.

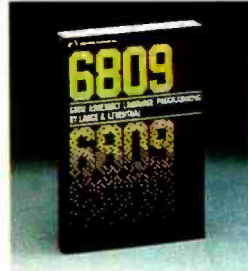

4) 6809 Assembly Language Programming
Leventhal Order #35-7 \$18.95
"Leventhal appears to have a formula for producing programming manuals. If so, it's a good formula. . . he has produced another clear and thorough manual for the serious programmer."
AMERICAN MATHEMATICAL MONTHLY



5) 6800 Assembly Language Programming
Leventhal Order #12-8 \$18.95
A complete reference to the 6800 instruction set and programming techniques.



6) 68000 Assembly Language Programming
Leventhal Order #62-4 \$18.95
Covers 68000 assembly language programming in the explicit detail needed to tap the full potential of this highly evolved microprocessor.



7) Z80[®] Assembly Language Programming
Leventhal Order #21-7 \$18.95
"There may never be a better book on the Z80 assembler than this one."
CREATIVE COMPUTING

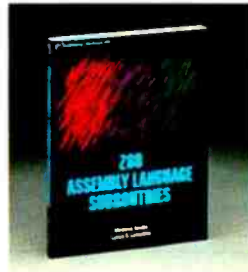

8) Z80[®] Assembly Language Subroutines
Leventhal, Saville Order #91-8 \$17.95
Over 50 useful subroutines to save you valuable programming time.



9) Z8000[®] Assembly Language Programming
Leventhal, Osborne, Collins Order #36-5 \$19.99
An excellent source reference for this powerful, 16-bit device. Filled with trouble-shooting hints and sample problems to guide the user to mastery of this "super chip."

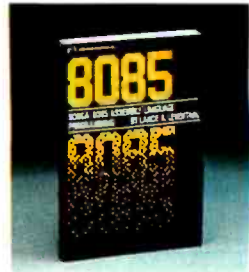

10) 8086A/8085 Assembly Language Programming
Leventhal Order #10-1 \$18.95
"... an excellent encyclopedia of assembly language programming."
BYTE

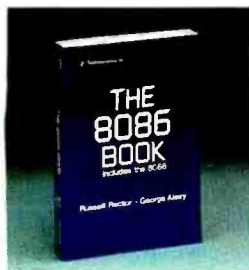

11) The 8086 Book
Rector, Alexy Order #29-2 \$16.99
"... far superior to any other book about the 8086."
DR. DOBBS JOURNAL

Before you hit the Frustration Key, reach for an Osborne/McGraw-Hill book.



By phone, call TOLL FREE: 800-227-2895. In California, call 800-772-4077. VISA and MasterCard accepted.

By Mail, complete the coupon below and mail to Osborne/McGraw-Hill, 2600 Tenth Street, Berkeley, CA 94710. All orders must be pre-paid. Check, money order, VISA and MasterCard accepted. Add shipping fees per item: \$0.75 4th Class, \$1.50 UPS, \$3.00 1st class/UPS Blue Label. California residents, add local tax.

Allow 4-6 weeks for delivery. Prices subject to change without notice.

Z80 and Z8000 are registered trademarks of Zilog Inc. ©1983 Osborne/McGraw-Hill

Osborne/McGraw-Hill

_____ Please send me a free catalog. Dept C-1

Name _____

Address _____

City _____

State _____ Zip _____

Indicate method of payment: _____ Check/Money Order
_____ VISA/Exp. date _____ MasterCard/Exp. date _____

Card # _____

Signature _____

QTY	ORDER #	PRICE

Tax _____
Shipping _____
TOTAL _____

register on the stack), TXA (transfer X to A), PHA, TYA (transfer Y to A), PHA. This sequence required extra time and memory and also made it difficult for a routine to save and restore all the registers and make use of a value passed to it in the A register. The four new instructions permit direct pushing and pulling of both the X and Y registers.

Set and Clear Page-0 Bits

Companions to the BBRx and BBSx instructions, the RMBx (reset-memory bit) and SMBx (set-memory bit) instructions permit setting and clearing single-bit flags in page 0 without affecting any internal processor registers accessible to the programmer. As before, bits 6 through 4 of the op code specify which bit is affected, and the second byte of the instruction specifies the page-0 location affected.

The new STZ (store zero) instruction permits zeroing an entire byte anywhere in memory without affecting processor registers. Four available addressing modes allow a 2-byte form for page-0 operations and a 3-byte form for general addresses, either of which may be indexed by the X register.

The TRB (test and reset bits) instruction is a composite of the 6502 BIT (bit test) and AND (logical and) instructions. The N (negative) flag is set to the value of bit 7 of the referenced memory location, and the V (overflow) flag is set to the value of bit 6. A logical AND is then performed between the referenced memory location and the A register, with the result stored into the memory location (A is unaffected), and the Z (zero) flag is changed to indicate the result of this operation (set if the result is 0, reset if it is nonzero). Note that, just as on the 6502, the N and V flags pertain to the value in memory *before* the AND operation takes place. The TSB (test and set bits) instruction is similar except that a logical OR is substituted for the logical AND operation.

Addressing Modes

In addition to totally new instructions, the R65C02 enables some exist-

ing addressing modes to be used with instructions that did not accept those modes on the original 6502. It also adds an entirely new addressing mode usable with a number of present instructions that should prove useful in making better use of the processor registers.

The 6502 has no simple indirect-addressing mode other than the JMP instruction. With no 16-bit registers to hold addresses, 6502 programs frequently keep addresses in page 0, especially when passing addresses to and from subroutines. However, the only way to use those addresses to

The R65C02 includes a simple indirect-addressing mode using a 2-byte address.

access the data to which they point is through the pre- or post-indexed indirect-addressing modes. Thus, a common sequence in programs consists of loading the Y register with 0, followed by an operation using the "indirect, indexed by Y" addressing mode. Not only does this sequence result in extra code requiring additional memory space and execution time, but it ties up the Y register, which might be better used in other ways.

The R65C02 corrects this deficiency by adding a simple indirect-addressing mode, which uses a 2-byte address stored in page 0. This addressing mode can be used with all the major accumulator instructions: ADC (add with carry), AND (logical and), CMP (compare memory with accumulator), EOR (logical exclusive-or), LDA (load accumulator from memory), ORA (logical inclusive-or), SBC (subtract with borrow), and STA (store accumulator to memory).

New Modes for BIT

The BIT (bit test) instruction of the 6502 is severely limited in addressing modes. This instruction accepts only two modes: absolute (direct) and 0 page. Because this instruction func-

tions as a logical AND except that the result is discarded, it is normally used to test flags. Most such tests would be most conveniently done with an immediate addressing mode, which is not permitted. Instead, 6502 programs must use a backward form of logic, loading the test mask using the immediate mode and then doing the test on the data directly from memory.

The R65C02 BIT instruction permits additional addressing modes—immediate, 0-page indexed, and absolute indexed. These added modes cover the vast majority of the situations in which this instruction would be used.

Increment and Decrement Accumulator

Arithmetic on the X and Y registers is not permitted by the 6502; neither is incrementing or decrementing the accumulator. Though such a need is rare, it does arise, and the lack of an accumulator-addressing mode for the increment and decrement instruction results in various kludges to get the desired result. Three alternate ways are commonly used. The most obvious is to use the ADC (add with carry) instruction to add an immediate value of 1. Because the 6502 does not provide a simple "add" instruction (without carry), this alternate method also requires a preceding CLC (clear carry) instruction, unless the state of the carry bit from prior operations is known. Alternatively, setting the carry bit followed by adding an immediate value of 0 accomplishes the same thing.

If the X or Y registers are not in use at the particular point in the program, it is possible to transfer the value from the A register to one of those registers and take advantage of the increment or decrement instructions for X and Y. A third method, most commonly used when the next step is to store the accumulator value in memory, is to store the A register value first and then increment it in memory, because the INC (increment) and DEC (decrement) instructions accept several different addressing modes for operations directly on data in memory.

**SAVE AT ELEK-TEK
ON PRINTERS**

**HUGE SAVINGS ON
ALL EPSON PRINTERS**

MX 80 FT MX 100
FX 80 FX 100

**CALL FOR SUPER
LOW PRICES**

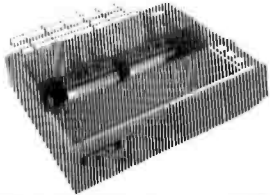

**EPSON RX-80
275.00**

8750 Ribbon Cartridges for Epson
80 Column Printers 4.00
8755 Ribbon Cartridges for Epson
132 Column Printers 7.00

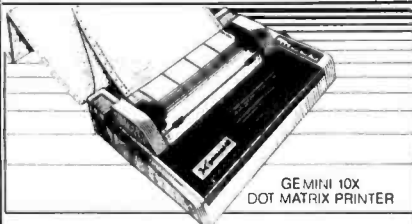

GEMINI 10X
DOT MATRIX PRINTER

**GEMINI 10X
\$275.00**

GEMINI 15

**15 in. wide carriage
\$399.00**

**NEW HIGH SPEED
DELTA 10 — call for price**

Gem O1 Ribbons for Gemini Printers - 6 for 15.00
12 for 24.00

Cables for Epson or Gemini

PA10A 10 ft. 36/36 pin standard parallel	30.00
IB-P10 10 ft. 36/25 pin parallel for IBM	32.00
PA6T 6 ft. 36/16 pin parallel for TI-99/4A	25.00
RS10A 10 ft. 25 pin standard RS-232(full loaded)	21.00
RS1Y RS-232 Y cable for TI-99/4A	35.00

**PRINTER INTERFACES
DISCOUNTED TOO!**

**LETTER QUALITY PRINTERS
\$500—\$1,550
TTX — COMREX — DIABLO**

**CALL TOLL FREE 800-621-1269
EXCEPT Illinois, Alaska, Hawaii**

Corp. Accts. Invited. Min Ord. \$15.00 Mastercard or Visa by mail or phone. Mail Cashier's Check, Money Ord., Pers. Check (2 wks to clrc) Add \$4.00 1st item. (AK, HI, P.R., Canada add \$10.00 first item) \$1.00 ea. add'l shpg. & handl. Shipments to IL address add 6% tax. Prices subj. to change. WRITE for free catalog. Return policy for defective on arrival replacements only; 90 day mfr. wty. ALL ELEK-TEK MERCHANDISE IS BRAND NEW, FIRST QUALITY AND COMPLETE.



ELEK-TEK inc.
6557 N. Lincoln Ave., Chicago IL 60645
(800) 621-1269 (312) 677-7660

The R65C02 eliminates all of this foolishness by allowing the accumulator-addressing mode to be used with the increment and decrement instructions, enabling them to operate on all three of the general-purpose registers.

Hardware Factors

The R65C02 has the electrical characteristics you would expect from the current generation of CMOS integrated circuits. Versions for speeds to 6 MHz will probably be available. Power consumption is low and varies with speed, as is normal for CMOS technology. With the clock stopped, 10 μ W power consumption is listed as maximum. Maximum power consumption in normal operation is listed as 4 mA (20 mW) per MHz, making battery-powered operation feasible when this chip is combined with the new CMOS memory chips.

Rockwell claims that the basic R65C02 version is pin and software compatible with the 6502. Another version, the R65C102, can generate all clock signals on-chip; it needs only an external TTL (transistor-transistor logic) level single-phase clock input (as does the 6502) or an external RC network or crystal. It also has a quadrature clock output, which is not provided by the 6502. This clock goes high in the middle of the phase-1 clock and returns low in the middle of the phase-2 clock.

The 6502 has not been commonly used in applications requiring multiple processors or direct-memory access, largely because it cannot float its address bus. Both the R65C102 and another version, the R65C112, have signals to permit bus sharing. The bus-enable (BE) signal permits an external device to cause the processor to float the address and data buses and the R/W signal, permitting access to the system buses. To prevent bus arbitration from interfering with read-modify-write instructions such as shifts and increments, a memory-lock (ML) output signal is provided to notify external devices that the processor cannot relinquish the bus until completion of the instruction. The R65C112 is designed to be used as a slave processor, re-

quiring a two-phase clock input that would be generated by the system master processor.

Summary

The CMOS version of the 6502 chip fills in a number of gaps in the 6502 instruction set in addition to adding the obvious advantages of CMOS technology. The characteristics of the new chip permit the 6502 to expand in both directions into areas that were previously impractical. Completely battery-powered systems are now feasible for small, dedicated applications. Additionally, the added bus control permits multiple-processor systems and sophisticated direct-memory-access schemes to be used with this processor.

Perhaps the most impressive feature of the CMOS version is complete compatibility with the 6502 specifications, permitting the enormous base of 6502-based hardware and software to be used with the newer processor. The R65C02 processor represents a step above the 6502 similar to the step from the 6800 to the 6502, without the accompanying compatibility problems. The current popularity of 6502-based personal computers provides a large market for new applications of this processor. ■

An Assembler for the R65C02

HEXASM is a full-feature resident assembler that supports the R65C02 microprocessor's extended instruction set. In addition to including such features as macros, conditional-assembly, and source-file-chaining functions, it can optionally be configured to either accept or reject constructs that are unique to the R65C02. HEXASM runs under HEXDOS on Ohio Scientific's OSI CIP and is available for \$38.50 from Hx Computer Products, Route 8, Box 81E, New Braunfels, TX 78130 or The 6502 Program Exchange, 2920 West Moana, Reno, NV 89509.

Steve Hendrix, an instructor pilot for the U.S. Air Force, has a B.S. in computer science and mathematics from the USAF Academy. He can be reached at Route 8, Box 81E, New Braunfels, TX 78130. His hobbies include computers and astronomy.

- CPM®
- IBM®
- APPLE®

DIRECT SOFTWARE™

- CPM®
- IBM®
- APPLE®

DISCOUNT DIGEST

TO ORDER CALL (415) 459-1282 • TOLL FREE (800) 533-3012 CA (800) 533-3011 USA

Direct Software™ Discount Prices Save \$\$ and Make Sense to Smart Buyers Who Know What They Want!!

DIRECT SOFTWARE™ MAKES PRIME PRODUCTS SO AFFORDABLE THAT THOSE IN-THE-KNOW WILL FIND IT UNWISE TO RESIST. OUR PRODUCTS ARE BACKED BY SUPPORT AND SERVICE, WITH SAME-DAY SHIPMENT ON MOST ORDERS, COMPARE OUR PRICES AND SAVE:

	List	Sale
ALPHA SOFTWARE		
Apple-IBM Connection	250	169
Data Base Manager	145	119
Data Base Manager II	295	269
Question	45	39
Typeface	125	79

	List	Sale
ANDERSON — BELL		
ABSTAT	395	319

	List	Sale
ASHTON-TATE		
dBASE II	700	398
Financial Planner	700	459
Friday	295	199

	List	Sale
ASPEN SOFTWARE		
Grammatik	75	56
Proof Reader	50	38

	List	Sale
A.T.I.		
Training WordStar	75	65
Training dBASE II	75	65
Training Multiplan	75	65

	List	Sale
CDEX		
MYB-Lotus 1-2-3	70	60
MYB-Visicalc	70	60

ACCOUNTING M.B.S.I.

	List	Sale
Account Payable	650	459
Account Receivable	650	459
Payroll	650	459
Order Entry -		
Inventory Control	650	459
General Ledger	650	459
Sales Analysis	325	229
RM Cobol		129

I.U.S.

	List	Sale
General Ledger	595	359
Account Receivable	595	359
Account Payable	595	359
Order Entry	595	359
Inventory Control	595	359

DIGITAL MARKETING

	List	Sale
Milestone	295	249
Datebook II	295	249
Footnote	129	109
Bibliography	125	109
Notebook	150	119
MICROLINK II	89	79

DIGITAL RESEARCH

	List	Sale
Concurrent CP/M 86	350	249
CB 80 Compiler	500	369
CBASIC	150	94
SID	75	63

FOX & GELLER

	List	Sale
Quickcode	295	180
dGraph	295	190
dUtil	99	58

GKE

	List	Sale
Condor 3	650	399
CROSSDATA	99	89

SPECIALS

	List	Sale
DBASE II + Quickcode	995	568
DBASE II + dUtil	799	449
DBASE II + DGraph	999	569
DBASE II + ABSTAT	1095	717
DBASE II + DBASE Window	949	599
DBASE II + WordStar	1195	629

WORDSTAR \$248 dBASE II \$398

MULTIPLAN \$179 LOTUS \$359

HUMANSOFT

	List	Sale
DBPlus	125	99

IUS

	List	Sale
Easy Filer	400	229
Easy Planner	250	179
Easy Writer II	250	199
Easy Speller	125	99
Easy Speller II	225	129

LEXISOFT

	List	Sale
Spellbinder	495	229

LIFETIME

	List	Sale
Volkswriter	195	125

LOTUS

	List	Sale
1-2-3	495	359

METASOFT

	List	Sale
Benchmark Word Processor	499	299
Benchmark Mail List	259	182

MICROPRO

	List	Sale
WordStar	495	248
WordStar/MailMerge	645	347
WordStar/SpellStar	645	347
Professional Pak	845	395
InfoStar	495	258
InfoStar + CP/M Card	495	339
WordStar + CP/M Card	495	339
MailMerge	250	129
SpellStar	250	128
CalcStar	145	88

MICROSOFT

	List	Sale
Multiplan	275	179
BASIC Interpreter	350	249
BASIC Compiler	395	285
Softcard	345	248
Flight Simulator	50	38

MICROSTUFF

	List	Sale
Crosstalk	195	117

OASIS

	List	Sale
The Word Plus	150	105
Punctuation & Style	150	99

PERFECT SOFTWARE

	List	Sale
Perfect Writer	489	265
Perfect Speller	289	159
Perfect Filer	589	249
Perfect Writer/Speller	695	359

SELECT Information Systems

	List	Sale
Select Word Processor	495	299

SORCIM

	List	Sale
SuperCalc I	195	129
SuperCalc II	295	169
SuperSpellguard	195	125

TYLOG

	List	Sale
DBase Window	249	199
dBase Door	149	129

VISICORP

	List	Sale
Visicalc	250	179

- Purchase orders accepted
- Prompt UPS service
- Dealer and institutional discounts
- Quantity discounts available
- Call for charges and return policy; Prices may change

Call today for our free catalog

TO ORDER CALL

(415) 459-1282



TOLL FREE

(800) 533-3012 CA (800) 533-3011 USA

850 College Ave., Suite #3
Kentfield, CA 94904

GREAT PRICES!

CHECK OUT ALL OUR INCREDIBLE

Looking for a great deal on business software?

800-SOFTWARE is hard to beat. You see, we became one of America's largest software marketers by offering great prices—and a lot more.

Here are some of the reasons to pick up the phone and pick up a bargain:

LOW DISCOUNT PRICES.

Our prices are fabulous! Generally 40-50% off suggested list price. How do we do it? By buying and selling in enormous volume. (All our programs are the very latest versions. And when "updates" appear, we'll get them for you, fast!)



FAST DELIVERY.

The key to our quick delivery is our giant inventory. We have what you want. Now. And we'll rush it to you like our business depends on it. (Because it does.)

FREE TECHNICAL SUPPORT 90 HOURS A WEEK!

That's right. We offer full technical support at no charge whatsoever, seven days a week.

That means if you have a question on

Sunday, at night, or during any of the 90 hours



we're open each week, you can get answers. Fast. (And remember, our technical product experts are not order-takers. Their only job is helping you get the

WordStar® \$269	dBase II™ \$439
MicroPro® Pro Pak \$389	4-Point Graphics™ \$129
ADVANCED LOGIC SYSTEMS™ Z-Card \$129 CP/M Card \$359 Smarterm II \$149 ALPHA™ Apple-IBM Connection \$150 Executive Package \$115 Database Manager II \$225 Type Faces \$ 95 Other Products CALL APPLIED SOFTWARE TECHNOLOGY™ VersaForm \$289 ASHTON-TATE™ dBASE II \$439 dBASE II User's Guide \$ 20 Friday! \$219 ASPEN™ Grammatik \$ 60 Random House Proofreader \$ 39 Random House Thesaurus \$119 ATI TRAINING™ Training Modules \$ 65 CENTRAL POINT SOFTWARE™ PC Copy II \$ 35 Copy II Plus \$ 35 CDEX™ Training Modules \$ 65 C.M.B. III ENTERPRISES™ WS-Patch & WS-Keys \$ 45 COMPUTING!™ Power! \$119 CONTINENTAL™ Home Accountant CALL DIGITAL RESEARCH™ Access Manager \$225 CBASIC \$109 CBASIC 86 CALL CB-80 Compiler \$379 CB-86 Compiler CALL Concurrent CP/M 86 \$259 CP/M 86 (IBM) \$ 49 Display Manager \$299 PASCAL/MT+ \$259 PASCAL/MT+86 CALL PERSONAL BASIC \$119 SPP CALL Other Products CALL FOX AND GELLER™ Quickcode \$229 dUtil \$ 75 dGraph \$229 HAYES™ SmartModem 1200 \$549 SmartModem 1200B (w/Smartcom) \$489	HERCULES™ Hercules Card \$409 HOWARDSON™ Tax Preparer CALL HUMANSOFT™ DBPlus \$ 95 IMSI™ 4-Point Graphics (IBM PC) \$129 Bisybase CALL Investment Manager CALL Accounting Series CALL IUS™ EasyWriter II \$229 EasySpeller II \$129 EasyWriter/Speller/Mailer CALL EasyWriter/Speller/Filter CALL EasyFiler \$249 Financial Management Series \$299/MOD Other Products & Specials CALL LEXISOFT™ SpellBinder \$269 LIFETREE SYSTEMS™ VolksWriter \$129 VolksWriter International \$155 VolksWriter Deluxe \$179 LOTUS™ 1/2/3 \$369 METASOFT™ Benchmark \$359 MICROLAB™ Tax Manager \$179 MICROPRO® WordStar \$269 WordStar/MailMerge \$369 Professional Pak (WS/MM/SS/SI) \$389 WordStar/InfoStar \$539 MailMerge \$139 InfoStar \$289 CalcStar \$129 DataStar \$179 SuperSort \$149 SpellStar \$139 ReportStar \$229 StarIndex \$129



GREAT SERVICE!

BUSINESS SOFTWARE PRICES:

SuperCalc 2™	\$169	Lotus 1-2-3™	\$369
Multiplan™	\$189	Perfect Writer	\$259
StarBurst Apple Packages and Other Products	\$139 CALL	PICKLES AND TROUT™ (CP/M for TRS) TRS-80 Model II, 16 & 12 Hard Disk	\$169 \$225
MICROSOFT® Basic Compiler	\$295	PROFESSIONAL SOFTWARE™ Word Plus PC	\$279
MBasic 80 Interpreter	\$275	Word Plus PC w/Boss	\$349
C Compiler	\$420	QUADRAM™ Quadboard (64K)	\$325
COBOL Compiler	\$549	Quadboard (256K)	\$489
Flight Simulator	\$ 45	Quadlink	\$559
Fortran	\$259	ROESOFT™ Pro Key	\$ 59
Fortran 80	\$349	SOFTWARE PUBLISHERS™ PFS File	\$ 95
Mouse	\$169	PFS File (IBM)	\$105
Multiplan™	\$189	PFS Report	\$ 95
Multi-Tool Expert Systems	CALL	PFS Graph	\$ 95
Pascal Compiler	\$259	SOFTWARE SYSTEMS™ Multimate	\$349
Premium Pack	\$509	SORCIM™ SuperCalc	\$129
Premium Softcard	\$495	SuperCalc 2	\$169
Ramcard	\$ 89	SpellGuard	\$129
Softcard™	\$259	SuperWriter	\$179
Other Products	CALL	VERTEX SYSTEMS™ Xeno Copy	\$ 75
MICROSTUF™ Crosstalk	\$119	VIDEX™ Enhancer II	\$119
MOUSE SYSTEMS™ PC Mouse	\$249	Videoterm	\$269
OASIS™ The Word Plus	\$129	Ultraterm	CALL
Punctuation and Style	\$109	VISICORP® VisiCalc®	\$189
ORGANIC™ Milestone	\$269	VisiCalc® IV	\$189
PBL CORPORATION™ Personal Investor	\$105	Advanced Visicalc®	\$269
PC DEMO™ Demo Disk	\$ 18	VisiTerm	\$ 85
PEACHTREE™ PeachText 5000	\$239	VisiDex	\$189
PERFECT SOFTWARE™ Perfect Writer	\$259	VisiFile	\$239
Perfect Speller	\$129	VisiSchedule	\$239
Perfect Writer/Speller	\$359	VisiTrend/Plot	\$239
Perfect Filer	\$279	VisiWord	\$279
Perfect Calc	\$169	VisiSpell	\$169
All Four Perfect Products	\$699	Other Products	CALL
PETER NORTON™ Norton Utilities	\$ 59	FLOPPY DISKETTES (Boxes of Ten)	
		MEMOREX™ 8" (SS/SD)	\$ 29
		8" (SS/DD)	\$ 30
		8" (DS/DD)	\$ 43
		5¼" (SS/DD)	\$ 30
		5¼" (DS/DD)	\$ 40
		MAXELL 8" (SS/DD)	\$ 42
		8" (DS/DD)	\$ 48
		5¼" (SS/DD)	\$ 32
		5¼" (DS/DD)	\$ 42
		Larger Quantities	CALL
		IN-HOUSE SPECIALS AND NEW PRODUCTS	CALL

They order from us because they know we're not running our business from a phone booth (we have over 30 full-time employees!). And that we fully guarantee every product we sell against defects. That's how we earned our membership in the respected Direct Mail/Marketing Association.

We've served thousands of satisfied customers. Now we'd like to serve you.



800-SOFTWARE IS READY TO SERVE YOU.



**TO ORDER CALL TOLL-FREE:
800-227-4587 or 415-644-3611**

Order Desk and Technical Support open:
6:30 a.m. - 9:00 p.m. Monday through Friday
10:00 a.m. - 4:00 p.m. Saturday and Sunday

800-SOFTWARE

940 Dwight Way Berkeley, CA 94710

- Purchase orders accepted. Please call in advance
- Prompt U.P.S. or Federal Express shipping.
- Overnight delivery available.
- Call for shipping charges, other low software prices or for a free catalog.
- Prices may change.
- International and national dealer requests welcome.
- Quantity discounts available.
- Call to inquire about our Corporate Sales Dept.



CA residents add sales tax.

© Copyright 800-SOFTWARE 1983

BYTE December 1983 455

RELIABILITY AND REPUTATION

When you buy from us, you're in good company. You see, some of our best customers are America's biggest corporations. Like IBM, Chevron, Hewlett-Packard, G.E., Price Waterhouse and Honeywell.

most out of the products we sell.)

Introductory
Offer

PASCAL

\$49.95

Standard Pascal for Your IBM PC, MS-DOS, CP/M 86, and CP/M 80 Computers

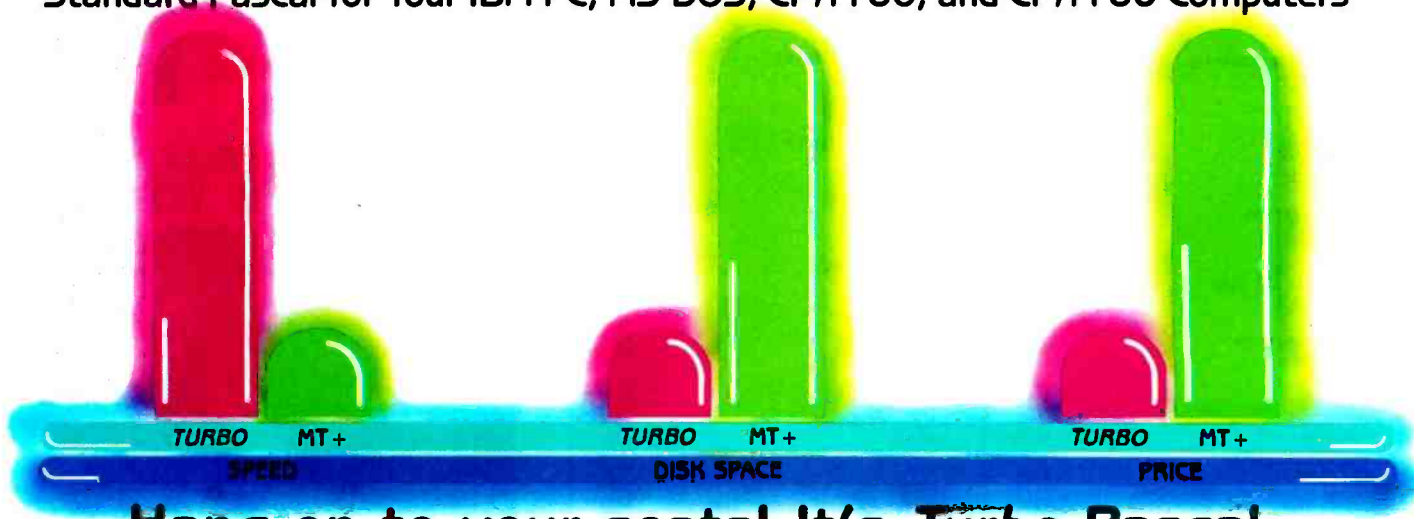

Hang on to your seats! It's *Turbo Pascal*.

	Turbo Pascal	JRT	MT+
8 & 16 bit	YES	NO	YES
Editor	YES	NO	NO
Generate Object Code	YES	NO	YES
Locates Run Time Errors Directly in Source Code	YES	NO	NO
Compilation Speed *	1 s.	46 s.	69 s. includes linking
Execution Speed *	6 s.	69 s.	8 s.
Disk Space	28K including editor	85K + editor	168K + editor
Price	\$49.95	\$39.95	\$595.00

There has never been a Pascal compiler this good with so many powerful features. We know what you've been waiting for: a true Pascal compiler that works fast, offers a full screen editor, and has a great price.

Turbo Pascal has it all. First, we've included a built-in, interactive full screen, Wordstar compatible editor; it not only lets you correct errors, but during program compilation the cursor even jumps *directly* to the error and waits for your correction. No kidding. Second, it takes only 28K of disk space, including the editor; and on your microcomputer you need all the space you can get. *Turbo Pascal* is

10 to 70 times faster during compilation, as well as execution than Digital Research's MT+ or JRT Pascal.

Hard to believe your good fortune on the price? Don't worry. We're Borland, and we produce only quality, state-of-the-art software. Companies such as Micro Pro, Morrow Computers, Access and others distribute our software products, so you can't go wrong.

Place your order today. And we'll ship your *Turbo Pascal* out fast. For VISA and MasterCard orders call toll free:

1-800-227-2400 X 968
IN CA: 1-800-772-2666 X 968

Benchmark data based on EightQueens in "Algorithms + Data Structures - Programs" by N. Wirth (Prentice-Hall, publisher). *Turbo Pascal* is a trademark of Borland International. MT+ is a trademark of MT MicroSystems. JRT Pascal is a product of JRT. Wordstar is a trademark of Micropro.

Dealer and Distributor Inquiries welcome.

Turbo Pascal \$49.95 + \$2.00 shipping per copy.

Check Money Order
VISA MasterCard
Card #: _____
Exp date: _____ Shipped UPS.

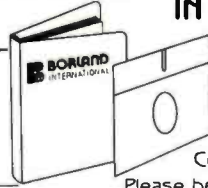

My system is: 8 bit 16 bit
Operating system: CP/M 80
CP/M 86 MS DOS PC DOS
Computer: _____ Disk Format: _____

Please be sure model number and format are correct.

NAME: _____
ADDRESS: _____
CITY/STATE/ZIP: _____
TELEPHONE: _____



Borland International
4807 Scotts Valley Drive
Scotts Valley, California 95066

California residents add 6 1/2% sales tax. Outside North America add \$15.00 for airmail, or \$5.00 for surface mail. Checks must be on a U.S. bank, and in U.S. dollars. Sorry, no C.O.D.

A Tiger Meets a Dragon

An examination of the mathematical properties of dragon curves and a program to print them on an IDS Paper Tiger printer

by Dan Rollins

Martin Gardner's "Mathematical Games" column in *Scientific American* (now Douglas Hofstadter's "Magical Themas" column) was a treasure chest of ideas for computer hobbyists. A few years ago Gardner described a computer-plotted example of a design he called a *dragon curve* (see figure 1). If you use your imagination you can see the resemblance to the classic oriental dragon—hence its name. Donald Knuth, mathematician and computer scientist, has done a great deal of work documenting the significance of the dragon-curve design and its relationship to number theory. Knuth was so impressed with the design that he reproduced it in ceramic tiles for the entryway of his home.

Fascinated by the beauty of dragon curves and intrigued by their binary nature, I wanted to create such designs to adorn my own walls. I wrote two programs for my TRS-80 Model I to output the design to my IDS Paper Tiger printer: a curve generator and a plotter emulator. In this article I will describe the theory of the dragon curve, methods of its construction, and its relationship to the broader generalized dragon design. I will also describe how to use TRS-80 disk memory to enhance the graphics potential of the IDS Paper Tiger,

enabling it to work like a plotter to fill an 8½- by 11-inch printer page with high-resolution figures.

Constructing the Dragon Curve

Dragons are designated by size, or *order*, of the dragon curve. There are several ways to construct these designs. The first two methods I describe will help you visualize the pro-

Folding the paper using any arbitrary sequence of directions will generate a line with the properties of a classical dragon curve.

cedure. The latter two are algorithms suitable for computer programming.

A way to define a dragon design geometrically is shown in figure 2. Start with a large right angle. This is an order-1 design. Erase part of the two line segments and replace each with smaller "folds" that intersect at right angles to create an order-2 design. To build larger dragon curves, follow the same procedure using the previously defined design. At each

step, replace n straight lines with n right angles to create an order- $n + 1$ dragon.

Another way to generate simple, low-order dragons is to fold and refold a narrow band of paper. This idea was the basis for physicist John E. Heighway's discovery of the dragon curve. Visualize a flat strip of cash-register tape—an order-0 dragon curve. Fold it once in the center, and you have an order-1 dragon. Bisecting the tape by folding it n times, always in the same direction, will create an order- n dragon curve (see figure 3). Because this operation will divide the paper into 2^n areas, an unfolded order- n tape will have $2^n - 1$ right-angle creases. (An old saw says that regardless of its thickness and length, no strip of paper can be folded more than seven times, but for this discussion, we will ignore this physical restriction.)

Now unfold the tape so that the creases form 90-degree angles. The unfolded tape will have a pattern of left and right turns that wind around in seemingly random directions. The dragon sequence is easier to describe when we designate a left turn as L, a right turn as R, and give the name S to the typographical string (the L,R sequence). If we choose L as the direction the tape bends on its first

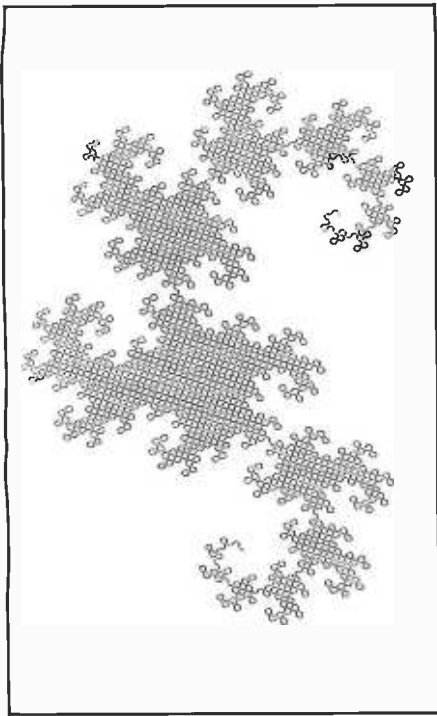

Figure 1: An order-12 classical dragon curve. This dragon curve was constructed on a TRS-80 Model I using the Gendrag program. It was printed on an IDS Paper Tiger, used with the Diskplot print routines as a plotting device.

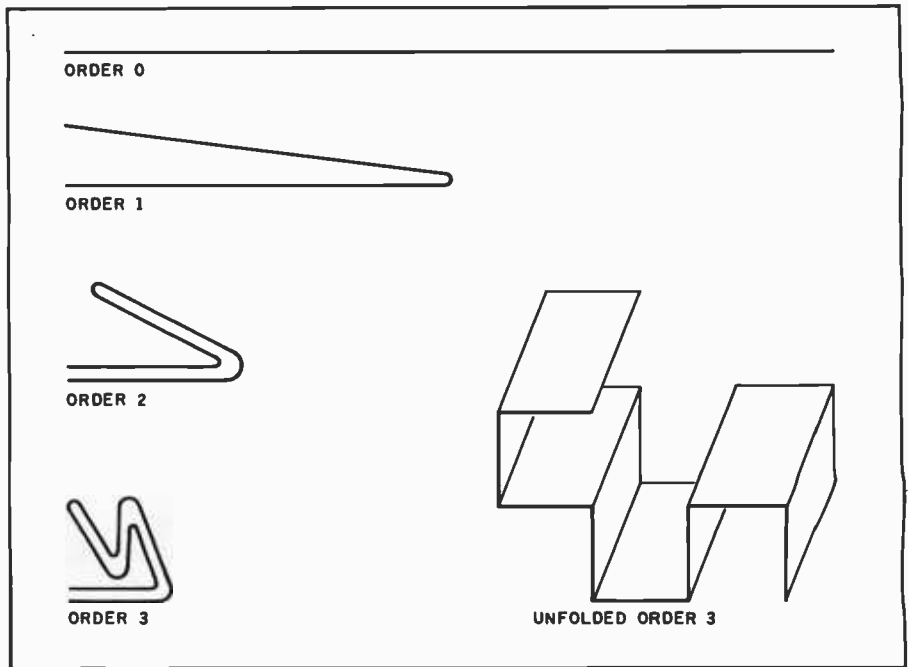

Figure 3: The paper-tape method of construction.

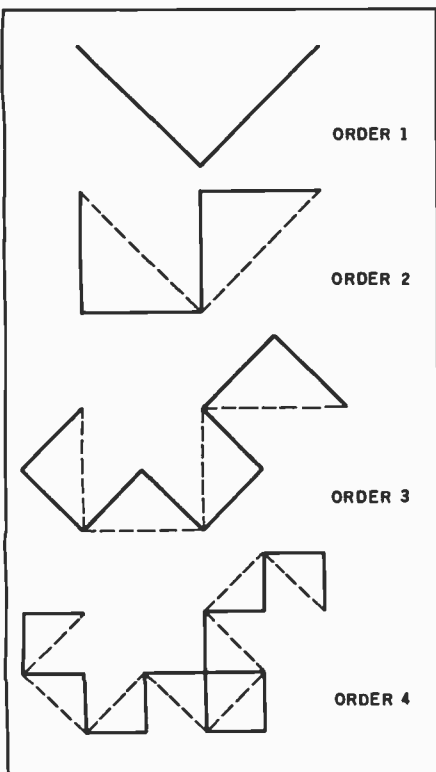

Figure 2: The geometric method of constructing dragon curves. Note that the side of dragon curve order- n becomes the hypotenuse of order- $n+1$.

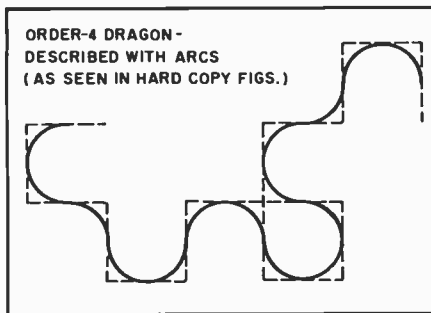

Figure 4: An order-4 dragon "rounded off" using (quadrant) arcs at every 90-degree angle. Compare to figure 1. The output of Diskplot uses this procedure.

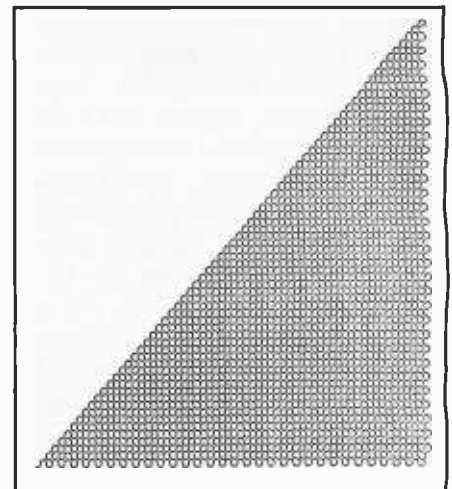

Figure 6: Folding the paper tape alternately left, then right, forms this isosceles dragon.

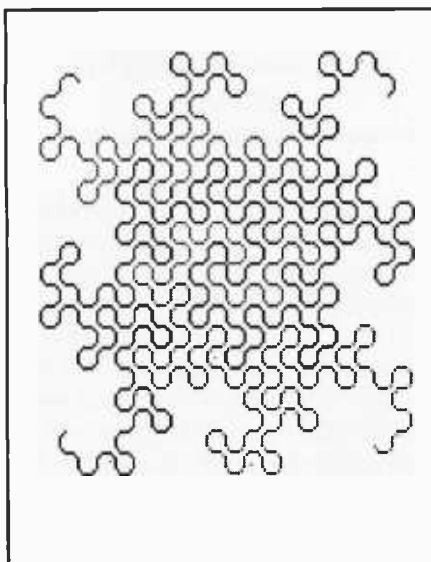

Figure 5: Four order-7 dragons placed "tail to tail."

fold, the lowest-order strings are described as follows:

S(1) = L
 S(2) = LLR
 S(3) = LLRLLRR
 S(4) = LLRLLRLLRRLRR

Building dragon sequences with a computer is a matter of manipulating the L,R strings. Notice that S(n+1) is a superset of sequence S(n). The emerging pattern can be extrapolated by either of the following recursive techniques:

Algorithm 1: To S(n), add an L. Then add the string obtained by inverting the center character of S(n); that is, if the center character is an R, make it an L and vice versa. Thus, because S(2) is LLR, S(3) is made up of LLR + L + LRR.

Algorithm 2: Add an L to S(n), then add the inverted and reversed sequence $\overline{S(n)}$. For example, because S(3) = LLRLLRR, its inverted form is RRLRLL. Rearranging these characters so that the last is first and the next to last is second, etc., creates the string LLRRLRR. So S(4) is S(3) + L + $\overline{S(3)}$ or LLRLLRR + L + LLRRLRR. The result is akin to placing two order-n dragons snout to snout, producing the order-n+1 dragon. Symbolically, this algorithm most closely resembles the folding of the cash-register tape and is the method used in listing 1, the BASIC dragon-generating program (Gendrag).

The dragon generated by either of these algorithms will have some interesting properties: the line representing any order dragon will never cross itself; any point along the tracing grid will be touched by at most two bends of the line, and no line segment will ever be traced twice. This is easiest to see when the corners of the bends are rounded (see figure 4).

Figure 5 illustrates a significant topographical property of dragon curves. That is, that an order-∞ design will cover exactly one-quarter of the infinite plane (OK, one-quarter of ∞ is ∞, but never mind that); four such dragons joined at their tails (see the center of figure 5) will fill the infinite plane without crossing one another.

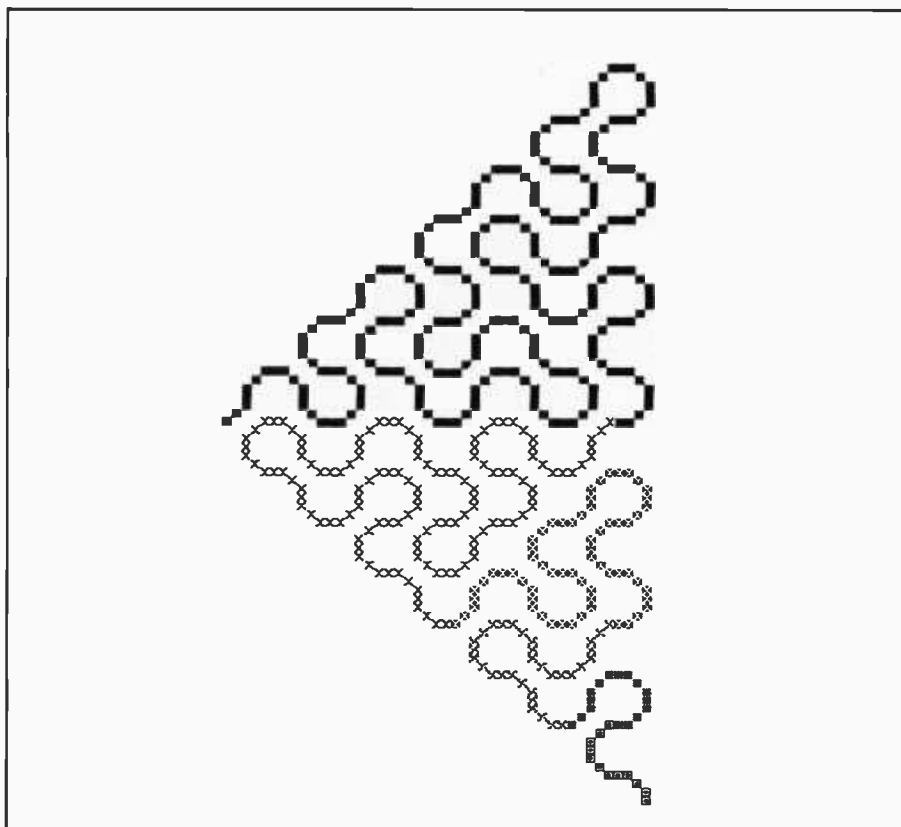

Figure 7: An illustration of the recursive nature of the isosceles dragon. Each triangle is made up of combinations of smaller triangles.

The Generalized Dragon Curve

Until now we've discussed only the "classical dragon curve," the figure drawn when the cash-register tape is always folded over to the left. It is easy to see that folding always to the right produces a mirror-image of the classical dragon (the "head" is the "tail" and vice versa). An alternating sequence of directions can also be used in the folding process. Figure 6 is a drawing of an order-12 "generalized dragon" when the first fold is to the left, the second to the right, the next to the left, etc. After the apparent randomness of the classical dragon, this one may come as a surprise. However, note the standard dragon features: the design will fill one-quarter of the plane, and it never crosses over itself. Figure 7 is an order-5 dragon with this LRLRL direction-reversal sequence. The recursive nature of this beast was illustrated by changing the dot pattern at each step of the inversion process.

Going one step further, it can be

proven that folding the paper using any arbitrary sequence of directions will generate a line with the same draconic properties. (See reference 2 for the elegant proof formulated by Davis and Knuth.) There are, of course, an infinite number of such combinations, some of them quite intriguing.

Given a direction-reversal sequence:

$$DRS = d_1 d_2 d_3 d_4 \dots d_n$$

the generalized dragon is constructed by the formula:

$$S(n) = S(1) + d_1 + \overline{S(1)} + S(2) + d_2 + \overline{S(2)} + \dots + S(n-1) + d_n + \overline{S(n-1)}$$

Figures 8 and 9 are dragon curves generated using the randomly selected direction-reversal sequences printed beneath each. These generalized dragon curves piqued my curiosity enough that I wrote a BASIC program to generate and draw

Listing 1: The program Gendragh, written in TRS-80 Disk BASIC.

```

5  ' **
6  ' **
7  ' **
8  ' **
9  ' **
10 ' **
11 ' **
12 ' **
13 ' **
14 ' **
15 ' **
16 ' **
17 ' **
18 ' **
19 ' **
20 ' **
21 ' **
22 ' **
23 ' **
24 ' **
25 ' **
26 ' **
27 ' **
28 ' **
29 ' **
30 ' **
31 ' **
32 ' **
33 ' **
34 ' **
35 ' **
36 ' **
37 ' **
38 D=D-D(J) :IF D<1 THEN D=4 ELSE IF D>4 THEN D=1
39 NEXT
40 XH=XH*(4+SC) :XL=XL*(4+SC) :YL=YL*(4+SC) :YH=YH*(4+SC)
41 XD=XH-XL :YD=YH-YL
42 IF YD>496 AND XD>496 THEN
43 PRINT USING"PLOT WON'T FIT! it's ### wide,### high";XD,YD
44 :INPUT"(DEFINE START OR (NEW DRAGON);QA$
45 :IF QA$="D" GOTO 300 ELSE IF QA$="N" THEN RUN ELSE 420
46 SX=(496-XD)/2-XL :SY=(P9-YD)/2-YL
47 IF XD>YD AND P9>496
48 THEN SD=2 :SX=(496-YD)/2+YH :SY=(P9-XD)/2-XL
49 ' **
50 ' ** follows code interprets the drason sequence,
51 ' ** Plottins the folds
52 ' **
53 X=X-SY :Y=SY :D=SD :CLS
54 FOR J=1 TO LAST
55 FOR K=1 TO SC
56 X=X+DX(D) :Y=Y+DY(D) :GOSUB 1500 '** Plot X,Y
57 NEXT
58 D=D
59 D=D-D(J) :IF D<1 THEN D=4 ELSE IF D>4 THEN D=1
60 FOR K=1 TO 2
61 X=X+DX(D1)+DX(D) :Y=Y+DY(D1)+DY(D) '** Plot X,Y
62 GOSUB 1500
63 NEXT
64 PRINT@ 196,USING "remains folds to Plot: ###";LAST-J
65 GOSUB 4000 '** close the file
66 GOSUB 5000 '** print the file
67 LPRINT
68 LPRINT TAB(34);"order ";N;" Drason Curve"
69 LPRINT TAB(30-L/2);"Direction Reversal Sequence: ";LR$
70 IF L=1 THEN LPRINT TAB(30)".....Classical Drason Curve"
71 CLS :PRINT :INPUT" Print the Same or a New curve (S/N)";A$
72 IF A$="N" THEN RUN ELSE IF A$<>"S" THEN 650
73 INPUT "Press <ENTER> when printer is ready";QA$ :GOTO 600
74
75
76
77
78
79
80
81
82
83
84
85
86
87
88
89
90
91
92
93
94
95
96
97
98
99
100
101
102
103
104
105
106
107
108
109
110
111
112
113
114
115
116
117
118
119
120
121
122
123
124
125
126
127
128
129
130
131
132
133
134
135
136
137
138
139
140
141
142
143
144
145
146
147
148
149
150
151
152
153
154
155
156
157
158
159
160
161
162
163
164
165
166
167
168
169
170
171
172
173
174
175
176
177
178
179
180
181
182
183
184
185
186
187
188
189
190
191
192
193
194
195
196
197
198
199
200
201
202
203
204
205
206
207
208
209
210
211
212
213
214
215
216
217
218
219
220
221
222
223
224
225
226
227
228
229
230
231
232
233
234
235
236
237
238
239
240
241
242
243
244
245
246
247
248
249
250
251
252
253
254
255
256
257
258
259
260
261
262
263
264
265
266
267
268
269
270
271
272
273
274
275
276
277
278
279
280
281
282
283
284
285
286
287
288
289
290
291
292
293
294
295
296
297
298
299
300
301
302
303
304
305
306
307
308
309
310
311
312
313
314
315
316
317
318
319
320
321
322
323
324
325
326
327
328
329
330
331
332
333
334
335
336
337
338
339
340
341
342
343
344
345
346
347
348
349
350
351
352
353
354
355
356
357
358
359
360
361
362
363
364
365
366
367
368
369
370
371
372
373
374
375
376
377
378
379
380
381
382
383
384
385
386
387
388
389
390
391
392
393
394
395
396
397
398
399
400
401
402
403
404
405
406
407
408
409
410
411
412
413
414
415
416
417
418
419
420
421
422
423
424
425
426
427
428
429
430
431
432
433
434
435
436
437
438
439
440
441
442
443
444
445
446
447
448
449
450
451
452
453
454
455
456
457
458
459
460
461
462
463
464
465
466
467
468
469
470
471
472
473
474
475
476
477
478
479
480
481
482
483
484
485
486
487
488
489
490
491
492
493
494
495
496
497
498
499
500
501
502
503
504
505
506
507
508
509
510
511
512
513
514
515
516
517
518
519
520
521
522
523
524
525
526
527
528
529
530
531
532
533
534
535
536
537
538
539
540
541
542
543
544
545
546
547
548
549
550
551
552
553
554
555
556
557
558
559
560
561
562
563
564
565
566
567
568
569
570
571
572
573
574
575
576
577
578
579
580
581
582
583
584
585
586
587
588
589
590
591
592
593
594
595
596
597
598
599
600
601
602
603
604
605
606
607
608
609
610
611
612
613
614
615
616
617
618
619
620
621
622
623
624
625
626
627
628
629
630
631
632
633
634
635
636
637
638
639
640
641
642
643
644
645
646
647
648
649
650
651
652
653
654
655
656
657
658
659
660
661
662
663
664
665
666
667
668
669
670
671
672
673
674
675
676
677
678
679
680
681
682
683
684
685
686
687
688
689
690
691
692
693
694
695
696
697
698
699
700
701
702
703
704
705
706
707
708
709
710
711
712
713
714
715
716
717
718
719
720
721
722
723
724
725
726
727
728
729
730
731
732
733
734
735
736
737
738
739
740
741
742
743
744
745
746
747
748
749
750
751
752
753
754
755
756
757
758
759
760
761
762
763
764
765
766
767
768
769
770
771
772
773
774
775
776
777
778
779
780
781
782
783
784
785
786
787
788
789
790
791
792
793
794
795
796
797
798
799
800
801
802
803
804
805
806
807
808
809
810
811
812
813
814
815
816
817
818
819
820
821
822
823
824
825
826
827
828
829
830
831
832
833
834
835
836
837
838
839
840
841
842
843
844
845
846
847
848
849
850
851
852
853
854
855
856
857
858
859
860
861
862
863
864
865
866
867
868
869
870
871
872
873
874
875
876
877
878
879
880
881
882
883
884
885
886
887
888
889
890
891
892
893
894
895
896
897
898
899
900
901
902
903
904
905
906
907
908
909
910
911
912
913
914
915
916
917
918
919
920
921
922
923
924
925
926
927
928
929
930
931
932
933
934
935
936
937
938
939
940
941
942
943
944
945
946
947
948
949
950
951
952
953
954
955
956
957
958
959
960
961
962
963
964
965
966
967
968
969
970
971
972
973
974
975
976
977
978
979
980
981
982
983
984
985
986
987
988
989
990
991
992
993
994
995
996
997
998
999

```

"It would take years at work to master the techniques we learn at the Wang Institute in three semesters."



The Wang Institute is an independent, non-profit graduate school which offers software professionals a unique opportunity to earn a Master's degree in software engineering.

"What makes the M.S.E. program so exciting? Many of the courses have never been presented before anywhere."

By combining formal academic methods with real-world industrial practices, the Wang Institute enables students to master software tools and techniques that can be applied

immediately in the workplace.

"The environment here isn't just conducive to learning, it makes not learning almost impossible."

Find out why some of the best software engineers in America are studying at the Wang Institute. Applications from part-time candidates are being accepted for January, 1984. Part-time students may take one course per semester.

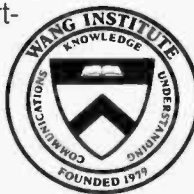

For application information, write or call: Janis Ackerman, Wang Institute of Graduate Studies, School of Information Technology, Tyng Road, Tyngsboro, MA 01879, (617) 649-9731.

Name _____

Address _____

Company _____

Tel. _____

Address _____

City _____ State _____ Zip _____

Yrs. of Software Development Exp. _____

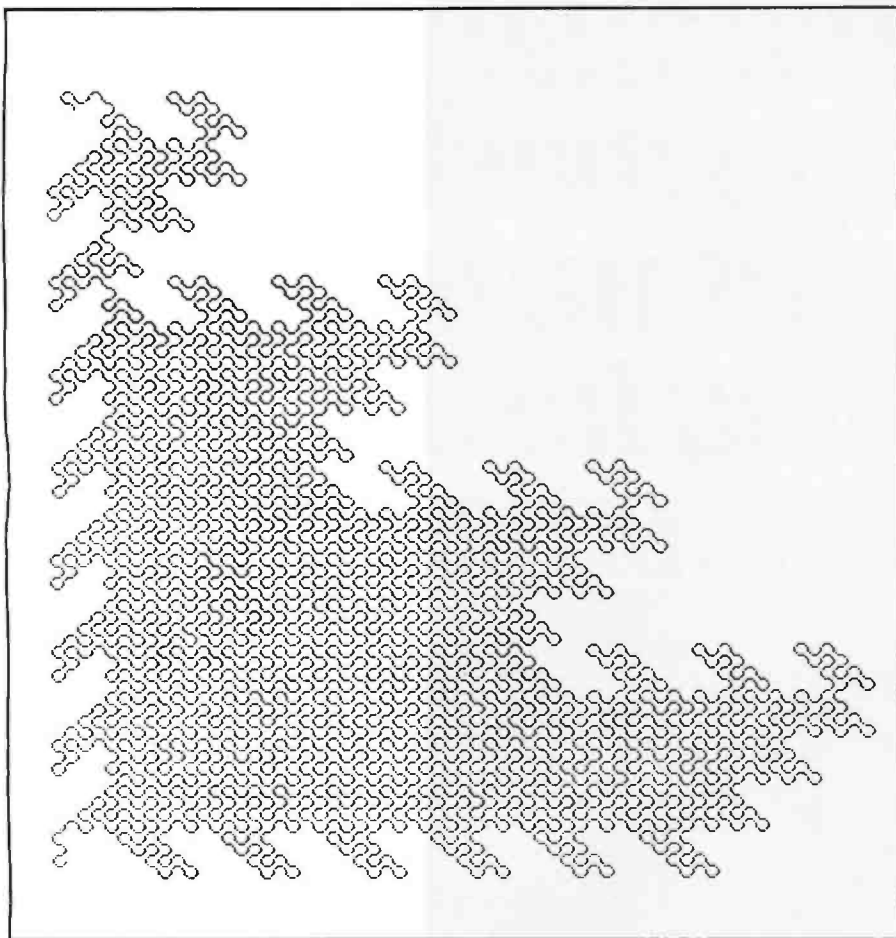

Figure 8: A nonclassical order-12 dragon, using the arbitrary sequence LRRRRLRRLR entitled "Four-Alarm Fire."

them. The program that builds the dragon sequence is relatively simple.

Computer Dragons

Listing 1 generates the dragon sequence and then interprets it as movement of an x,y pointer. The coordinate pairs generated may be used to draw on a video screen or move a pen around a plotter surface. I used this program in conjunction with the Diskplot routines (listing 2, described later) to produce the examples included with this article. Only a few minor modifications are needed to have the output sent to the TRS-80 Color Computer screen or another high-resolution device.

First the program asks for the order of the dragon to be drawn. You are then asked to input the direction-reversal sequence—the string of Ls and Rs mentioned earlier. Answering <G> generates random dragons such as those in figures 8 and 9.

Answering <ENTER> or <L> or <R> will generate a classical dragon curve. The SCALE? prompt determines the length of the line segments between the folds.

The dragon sequence is held in an integer array as a series of positive and negative 1s. Once this series has been generated, the program adds each successive value to a direction pointer that references a table holding the x,y offsets needed to move the "pen" in the desired direction. Figure 10 shows how this is accomplished. When the current direction is 1 (north) and the fold is to the left (counterclockwise), the direction pointer is adjusted to point to the west, the number-4 direction. Adding -1 to the current direction in this case will yield an underflow value of 0. Whenever underflow or overflow is indicated, the algorithm cycles the pointer to the correct value.

The line segments are drawn by re-

peatedly adding the x and y offsets found in the direction table to the current value of the x,y pointer and plotting the dot at the new location. The program doesn't actually draw a curve at each fold. Instead, a corner of the fold is simply chopped off by moving simultaneously in both the old and new directions.

To prevent the dragon from moving off the page, the program will automatically center the design before drawing it. This is done by making a "dry run" through the design, accumulating the high and low values of the x and y coordinates generated. When the dragon won't fit horizontally, it is rotated by initializing the starting direction differently and recalculating the starting x and y . This centering function is device dependent in that the page size (length and width) are those values used by the Diskplot plotter emulator.

TRS-80 Model I video resolution is only fine enough to display dragon curves of order 5 and below. After experimenting with the algorithm for a while, I began craving the 5000+ dots-per-square-inch resolution available on my Paper Tiger printer.

Tiger Graphics

The IDS Paper Tiger graphics option gives the user complete control over the placement of dots on a printed page. High-resolution graphics patterns are displayed by selectively energizing the print-needle pins as the print head moves across the page.

The printer enters graphics mode the first time it receives the ASCII (American National Standard Code for Information Interchange) control character ETX (hexadecimal 03). Thereafter it interprets characters as binary-dot patterns. The bits of the printed byte indicate the *fire/don't fire* decision for each of the seven pins of the print head. Bits 0-6, set in the output byte, energize the pins from top to bottom, respectively. Thus, a CHR\$(127) is printed as a vertical line of seven dots. To print the top and fourth dots, for example, send CHR\$(9)—setting bits 0 and 3.

To change modes or print a carriage

COMPUTER HUT™

COMPARE
OUR
SERVICE & PRICE!

SPECIAL OF THE MONTH

IBM-PC & XT
CALL FOR
PRICE

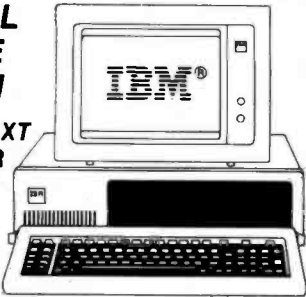

HARDWARE FOR IBM-PC DISK DRIVES

Tandon	
TM100-2 DS/DD	\$235
TM55-2	CALL
TM55-4	CALL
PANASONIC JA 551	\$239
SHUGART SA-455 half-high	\$239
TEAC FD-55B Slimline	\$259

MAYNARD ELECTRONICS	
Floppy Disk Controller	\$169
FDC w/Par. Port	\$219
FDC w/Ser Port	\$239

SANDSTAR SERIES

MK RESEARCH	
Ram 64K Exp. to 512K	\$199
Ram 64K Exp. to 512K + SP	\$229
Color Graphics for IBM-PC	CALL

QUADRAM	
Quadboard-PP, SP, C/C, Mem + s/w	
64K	\$285 256K \$449
Quad 512 + SP, Mem with s/w	
64K	\$249 512K \$639
Quadboard II-2SP, C/C, Mem + s/w	
64K	\$285 256K \$449
Quadcolor	CALL
Quadlink	\$499
MICROFAZER (print buffers) ..	CALL

AST RESEARCH	
MegaPlus II 4-Funct 64K + s/w	\$285
ComboPlus II 4-Funct 64K + s/w	\$285
6-Pack 5-Funct 64K + s/w	\$285
I/O Plus	\$135
OPTIONS FOR AST boards	\$45

HERCULES	
Hi Res Graphics 720 x 384, PP, + s/w	\$389

FREDRICKS ELECTRONICS	
COLORPLUS 640 x 200, 16-Color + s/w	\$369
BABY BLUE	CALL

HARD DISK - IBM-PC & XT

MOUNTAIN — External Syst.	
5MB	\$1650 10MB \$1925
15MB	\$2395 20MB \$2645
DAVONG	CALL
TALLGRASS	CALL

MONITORS

AMDEK	
Video 300G	\$139 300A
Video 310A	\$179
Color I	\$299 Color II ... \$439
Color II +	CALL
PGS	
HX12 Hi Res RGB monitor	\$509
SANYO	
	CALL

PRINTERS

EPSON	
FX80	CALL FX100... CALL
brother®	
HR1 A Par	\$699 Ser
HR-15 Par	\$489 Ser
DYNAX	
DX-15 Par	\$469 Ser
C-ITOH	
STARWRITER F-10 P or S	\$1149
PROWRITER 8510 P	\$399
PROWRITER 8510 S	\$579
PROWRITER2 1550 P	\$690
PROWRITER2 1550 S	\$749

star MICRONICS	
Gemini 10X	\$299 15X... CALL
Delta 10	\$519

OKIDATA	
82A	\$389 83A
84P	\$1049 84S
92P	\$459 92S
93P	\$779 93S

NEC	
3510	\$1485 7710
3515	\$1479 7715
3530	\$1575 7720
3550	\$1799 7730

TOSHIBA, IDS	
	CALL
SILVER-REED	
EXP 500 Par ..	\$429 Ser
EXP 550 Par ..	\$639 Ser

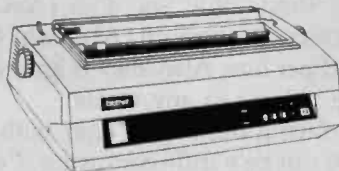

MODEMS

HAYES	
Micromodem II for Apple II	\$275
Micromodem II w/Term. prog.	\$319
Smartmodem 300	\$215
Smartmodem 1200	\$499
Smartmodem 1200B w/Smartcom II	\$439

NOVATION, US ROBOTICS CALL

ACCESSORIES

COMPUTERS

IBM Compatible

EAGLE	CALL
COLUMBIA	CALL
CORONA	CALL
DEC RAINBOW	CALL
EPSON	CALL

SOFTWARE FOR IBM-PC

LOTUS 123	\$355
Word Perfect \$319	WordStar CALL
DBase II	\$419 VisCalc
Multiplan	\$195



HARDWARE FOR APPLE

MICROTEK	
Dumpling-GX \$99	DMP-64
BAM-16	\$99 BAM-128
RV611-C	\$89

RH ELECTRONIC - Super Fan II ..	\$59
ORANGE MICRO Grappler + ..	\$129

CPM/CARD \$319 Z-CARD	
	\$135

PROMETHEUS	
Versacard	\$159
64K RAM	\$239

DISK DRIVES FOR APPLE

RANA Elite I	\$279
Elite II	\$449
MOUNTAIN - HARD DISKS	CALL

SURGE PROTECTORS

ANY PRODUCT NOT LISTED? CALL ASK ABOUT OUR REPAIR SERVICES

COMPUTER HUT ORDERS & INFORMATION ORDER-LINE ONLY
(603)889-0666 (800) 525-5012

OF NEW ENGLAND INC.
101 Elm St., Nashua, NH 03060

DEALER INQUIRIES INVITED

All products usually in stock for immediate shipment and carry full manufacturers' warranty. Price subject to change — this ad prepared two months in advance. You get the lowest price. We honor personal checks — allow 10 days to clear. COD up to \$200 add 3%. Visa, MasterCard add 3%. For shipping & insurance add 3% or \$5.00 min. for small items and \$8 min for monitors, printers, etc. APO & FPO orders add 12%. Include phone number. Call (603) 889-0666 for a return authorization number prior to returning any material.

Apple is a trademark of Apple Computers Inc. IBM is a trademark of IBM Corp.

Circle 102 on inquiry card.

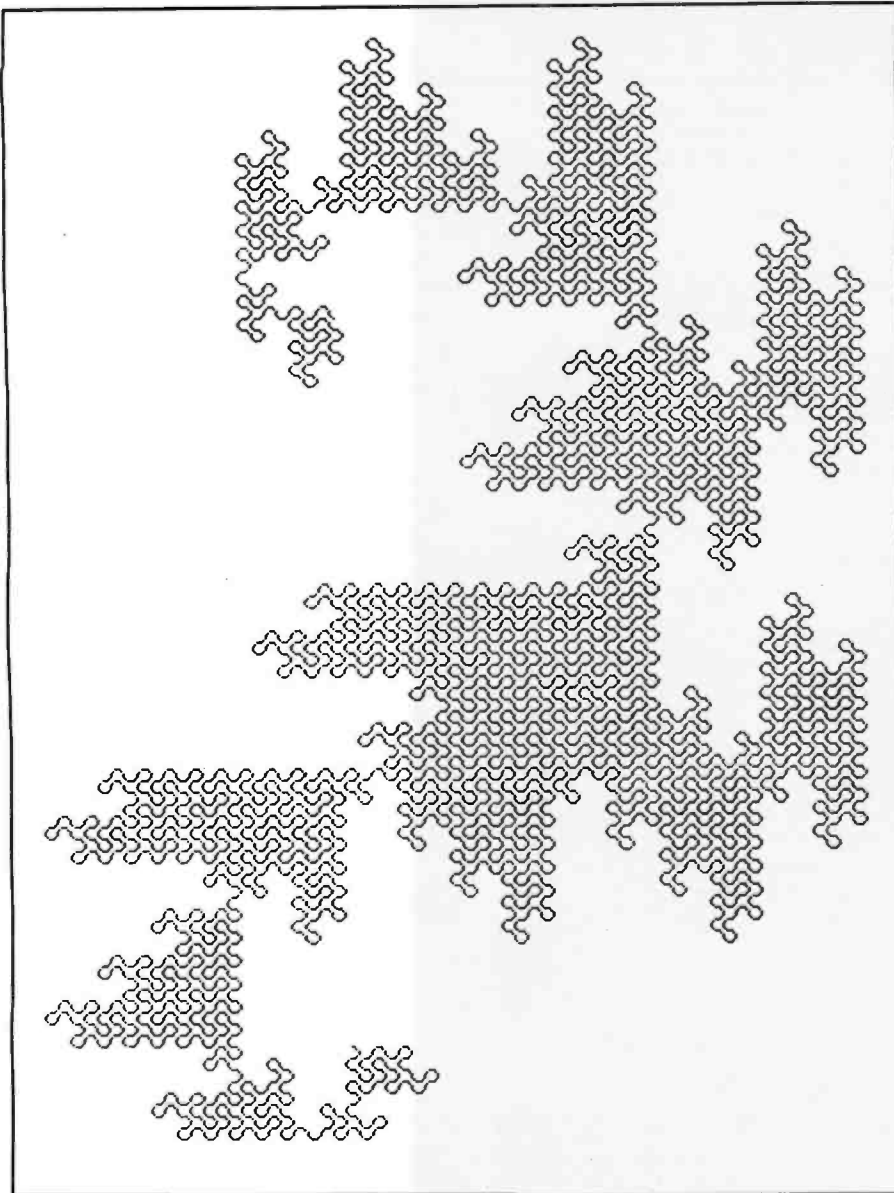

Figure 9: Nonclassical order-12 dragon (RLLRRRRRRRL) entitled "Squadron Formation."

return, the ETX code is used as an escape character. Once you enter the graphics mode, you must send a sequence of two codes for control actions. The first tells the printer to interpret the second as a control action. CHR\$(3); CHR\$(11), for example, forces a vertical tab (graphics linefeed and carriage return). The sequence CHR\$(3); CHR\$(2) exits graphics mode, forcing resumption of normal mode. To print the graphics character 3—firing the top and second pins—print the ETX twice: CHR\$(3); CHR\$(3).

While all seven dots may be printed, the vertical tab used in con-

tinuous scanning will move the print head down only six dots—resulting in the seventh dot being overwritten on the next pass. For all practical purposes, then, only six dots (ASCII characters 0 through 63) can be printed per line. Also, bit 7 is ignored by the printer in any mode.

Interfacing the Paper Tiger with a TRS-80 can be a trifle confusing. Certain codes that have had LPRINT performed on them while in graphics mode produce bizarre results. The problem lies in Radio Shack's LPRINT driver. The Level 2 BASIC firmware filters out some codes; it simply will not print them. Other

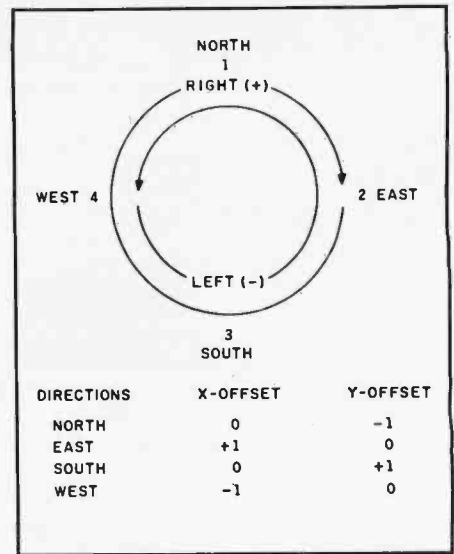

Figure 10: The "pen" is moved by adding offsets to an x,y pointer. The directions pointer is cycled according to the L,R sequence of the dragon.

characters are interpreted undesirably. The graphics data byte CHR\$(12), for example, is printed as a series of CHR\$(13) carriage returns, a "soft" formfeed. Any graphics LPRINT string that contains a CHR\$(12) will print a series of characters with the first, third, and fourth bits set—not quite what you had in mind.

My solution to this problem is to perform an OR on a value of 128 (80 hexadecimal) to each byte sent to the printer. This setting of bit 7 does not alter the way the graphics codes are printed and the LPRINT driver won't intercept or change such characters. Another method of solving this problem is to write your own printer driver.

My Paper Tiger, Model 440-G, lacks some of the options of the newer models: printing is unidirectional and there is no proportional spacing. The graphics feature, however, is compatible with all models that have graphics capabilities. Only three of the dot-spacing fonts (8.3, 10, and 12 characters per inch in normal mode) may be used for graphics output. The manual suggests that the 16.5-cpi font be avoided due to excessive print-head heat buildup. Also, graphics characters sent in this character density tend to not line up evenly.

The 12-characters-per-inch (cpi)

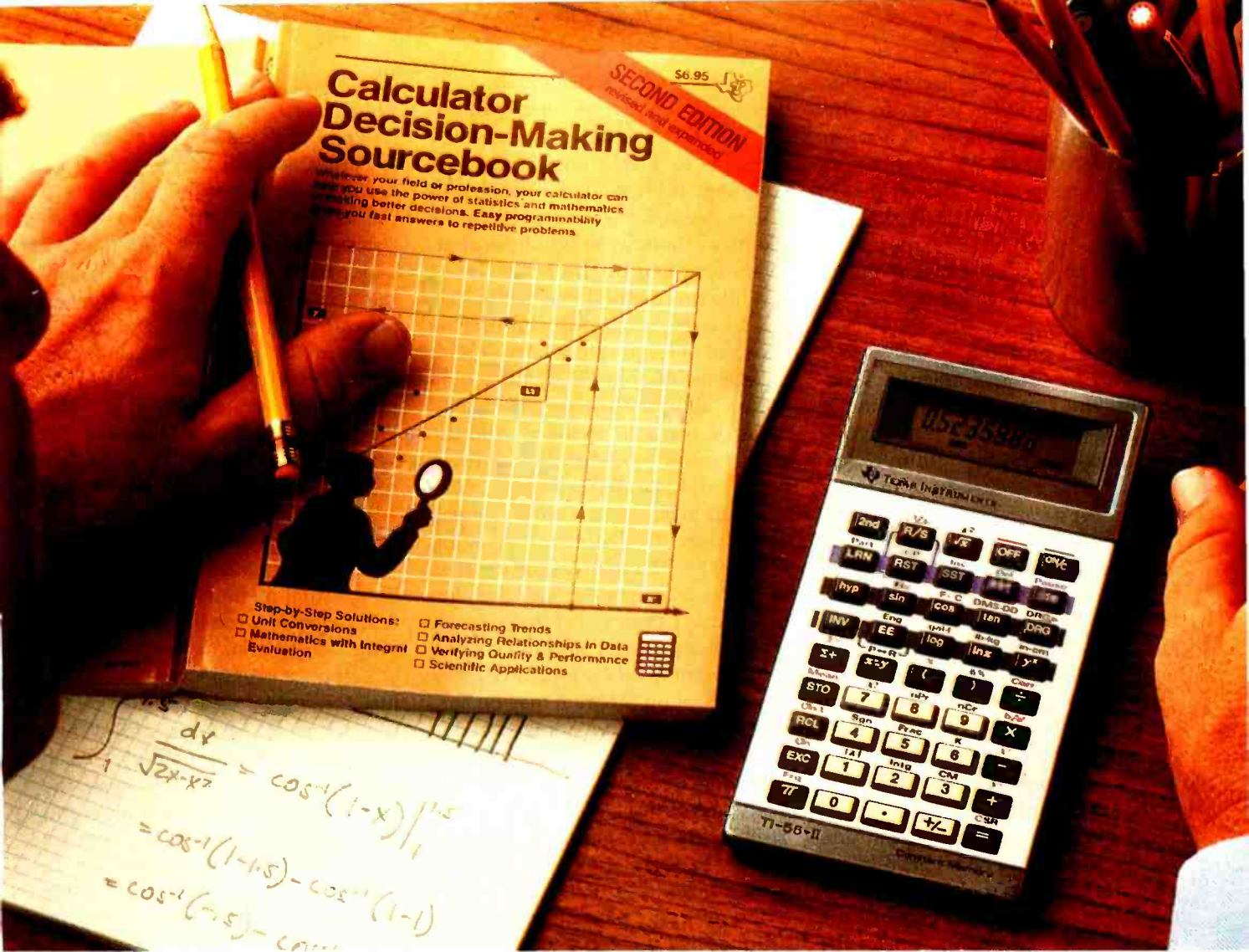

How the TI-55-II makes short work of long problems.

Whenever you can solve complex problems quickly and accurately, you're ahead of the game. And that's exactly what the TI-55-II does for you. By giving you 112 pre-programmed functions (like definite integrals), it allows you to take short cuts without losing accuracy. You'll accomplish a lot more in less time which means increased efficiency.

With our TI-55-II you can tackle problems you thought could only be solved with higher-priced programmables. You're not only getting the standard slide rule functions but also statistical

capabilities. This way you can work out linear regressions, permutations and combinations, just to name a few.

The TI-55-II also gives you enough programmability to eliminate a lot of repetitive key punching. Our Constant Memory™ keeps programs and data on tap, even when the calculator is turned off. So once you've entered a formula, you can simply put in the variables to get your solution. The Liquid Crystal Display shows your answers in standard, scientific or engineering notations — clearly and precisely.

We also help you get the most

out of your calculator with the Calculator Decision-Making Sourcebook. It gives you step-by-step examples of the best techniques used for solving mathematical, scientific and statistical problems. And we've included a special section on how to program your TI-55-II.

So next time you're facing another time-consuming problem, cut it down to size with the TI-55-II.



TEXAS INSTRUMENTS
 Creating useful products and services for you.

mode yields the best horizontal-to-vertical dot-spacing ratio. In this mode, 496 bytes can be printed across the page. A box 496 by 496 covers an area 7.7 inches wide by 6.9 inches high. The printer can print 120 lines on an 8½-by-11 sheet of paper. With a ½-inch border on each side, the effective resolution is 496 by 720.

A Plotter Emulator

Many printer manufacturers describe their product as having "graphics capability," but getting recognizable graphics from a dot-matrix printer is tricky. Programs written for generating video or plotter graphics invariably employ a two-dimensional coordinate system. That is, given a horizontal *x* ordinate and a vertical *y* ordinate, a video program will perform a SET on that position, making it visible. A plotter will perform a MOVE on a pen to the given coordinate from its last position, drawing a line as it goes. Neither action corresponds to what goes on in dot-matrix printing.

The graphics potential of your dot-matrix printer can be realized when a control program is used to emulate the actions of a plotter. Because the printer can't physically move the paper up and down under the print head, this action must be simulated by a program that writes to memory.

A simple version of such a program would create a two-dimensional in-

teger array, set each element to 0, then move an *x,y* "pointer" around the matrix setting the indicated elements to 1 as it goes. After this "plotting" is finished, a separate routine is needed to examine the array six lines at a time, to build the characters expected by the printer.

While this method may be the easiest to work with, it is enormously wasteful in terms of memory—an integer array of only 125 by 125 would occupy all of the approximately 32K bytes of available memory. And the print routine would be laborious. A more sophisticated program, one using all 16 bits of each array element, could store 256K dots (an array of, say, 500 by 500) again at the expense of processing time for both the plotting and printing routines. Also, when most of the computer's memory is preempted by a printer array, the application program may be hard pressed for its own storage needs.

The Paper Tiger can place over 350K dots on a page. I needed almost every one of these points to print the order-12 dragon seen in figure 1. To be able to access every potential dot on the page, I wrote Diskplot, a set of multipurpose plotting and printing routines that use disk storage interactively with memory—a virtual-memory plotting system.

The idea of virtual memory has been around about as long as disk drives have been interfaced with

computers. The concept is simple. While memory tends to be severely limited, there may be plenty of storage available on disk. A virtual-memory management system allocates to the user a block of RAM (random-access read/write memory) and a larger block of disk memory. When the user's program or data won't all fit into the RAM area, it is broken into segments or "pages." The page currently being accessed by the computer processor unit is held in RAM. When a different page is needed, the system saves the old page (invisibly to the user) and brings in the new one from the disk. The user may access memory as if the entire block was always in memory.

A virtual-memory operating system requires a translating or "mapping" algorithm to keep track of which page is in memory and to adjust the virtual addresses to reflect the actual RAM addresses. When only one page is in memory, this algorithm can be simple. However, the system becomes more complex (and more useful) when several pages are held in memory at the same time. In this case, the mapping algorithm should also have some sort of plan-ahead feature to anticipate which pages the user will need in future addressing.

The efficiency of the system is largely determined by the amount of time spent accessing the disk. The

EPROM PROGRAMMER & UV ERASER FOR THE 80's

S15 PROGRAMS OVER 300 DEVICE TYPES

MOS (8K - 256 K, SINGLE & 3 VOLTAGES) BIPOLAR PROMS, 40 PIN MICROS

- Stand Alone
- 256K Buffer (200 ns)
- Integrated keypad
- EPROM simulation
- Fast algorithm
- Power down sockets
- Temp compensated Ref. voltages
- 16 formats & 8 baud rates
- Auto-user friendly-mode



S15F \$995

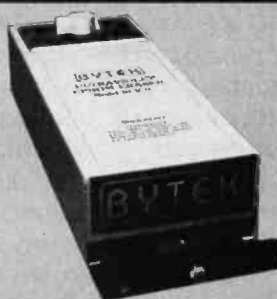

BUV-III \$66.50

- Heavy duty
- Safety switch
- UV indicator

BUV-IIB \$95.50

- Heavy duty
- Timer
- Safety switch
- 110/220 voltage

BYTEK
COMPUTER SYSTEMS
CORPORATION

OVER 26 FUNCTIONS

- Edit
- CRC Check
- Block Move
- Over Program
- Insert
- Delete
- 16 Diagnostic Functions
- And More!

(305) 994-3520

4089 S. Rogers Circle #7, Boca Raton, FL 33431

OTHER COMPLETE SYSTEMS

S15R (remote) \$695
S15P (4 key) \$795
S15B (bipolar) \$895
S15G (gang) \$1095

Computer's Choice.

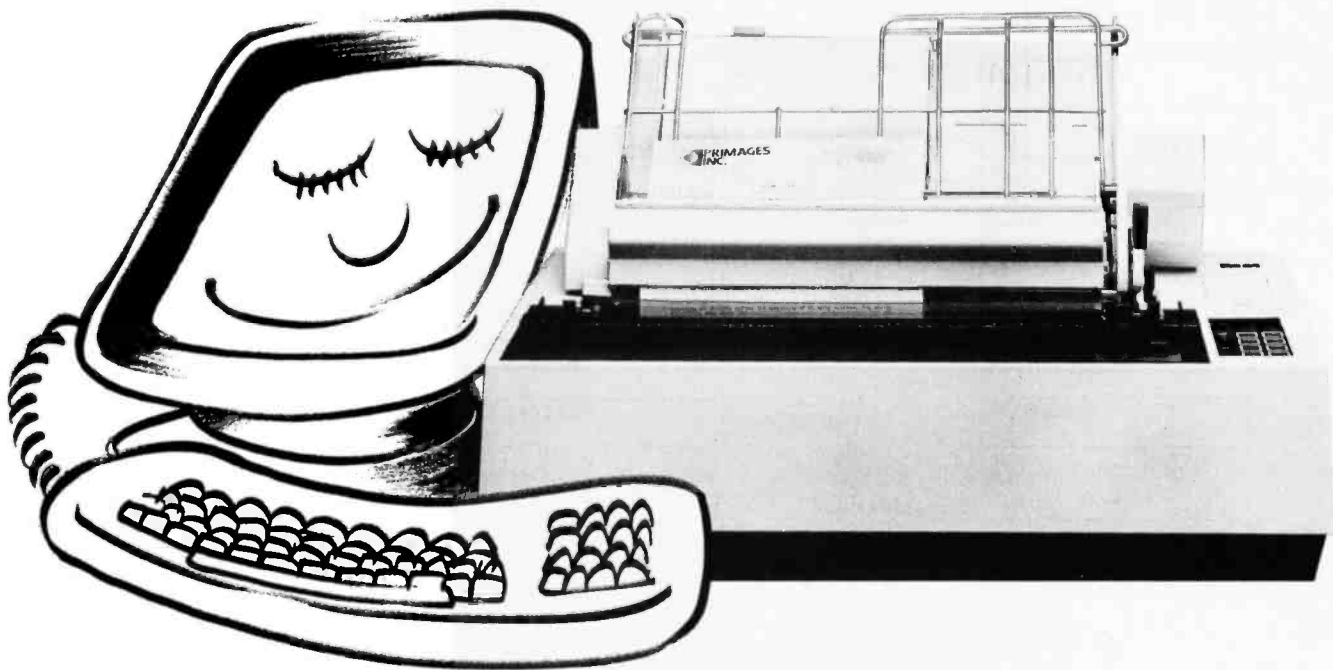

Primage I

Sooner or later, you'll probably want to use your business computer for word processing or data communications applications. And if you let your computer choose the best printer to provide letter quality printing at high production speeds, its first choice would be Primage I.

That's because when all the facts are entered, it's clear that the new Primage I gives you more for your money than any other daisy printer on the market—45 cps, heavy duty, letter quality printing, with an automatic sheet feeder, for under \$2,000.

The lower cost and higher performance are all made possible by a totally new control technology that allows simple, inherently more reliable stepping motors to run at much higher speeds. The design eliminates lots of parts that you find in other serial

printers. Parts you don't have to pay for and, just as important, parts you don't have to maintain. Primage I features simplified controls, easy paper feeding and a wide choice of fonts. It also comes with a unique 100-spoke daisy wheel that provides switch selectable multiple languages, and an easy access, easy set-up interface that connects to popular PC's without special cable fittings.

When you compare Primage I with top quality daisy printers and sheet feeders that cost up to 50% more, we're confident you'll make the same choice your computer would. So come into your computer dealer today for a first hand demonstration. Or contact us for detailed product literature. Primages Inc., 620 Johnson Ave., Bohemia, NY 11716 (516) 567-8200.

 **PRIMAGES
INC.**

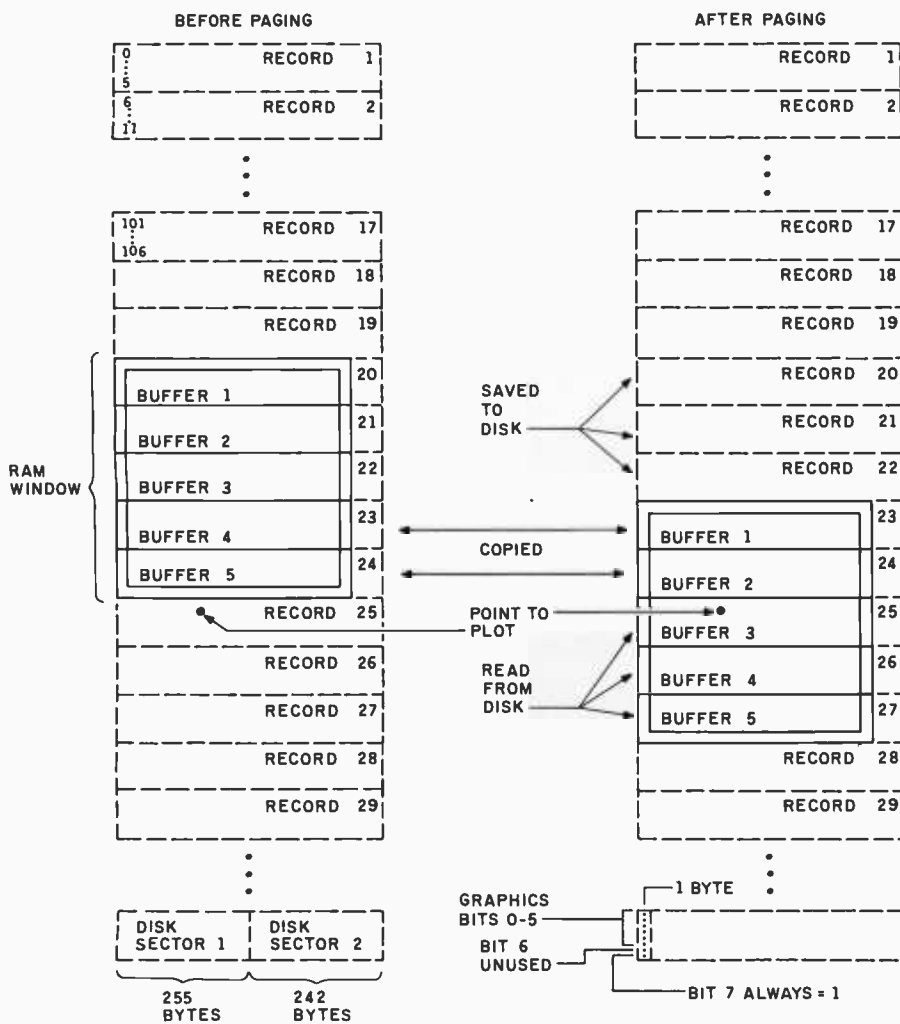

Figure 11: The virtual-memory mapping algorithm used in Diskplot. Records are moved in and out of RAM buffers. When the "pen" is directed off the page (point to plot in record 25, at left), part of a new page is scrolled into memory.

number of disk accesses may be limited by reading and writing a large number of pages, while the amount of time per access can be shortened by using a small number of pages. An optimum virtual-memory size will lie somewhere between all of main memory and a single disk buffer.

Radio Shack's (Microsoft) Disk BASIC includes all the tools necessary to implement these concepts on the TRS-80. Instead of packing bits into an integer array for later interpretation, I chose to build a random-access file to store the data on disk and use BASIC strings to hold the in-memory data. Standard GET and PUT commands scroll data in and out of memory, and no special VARPTR or POKE tricks are needed.

All data is stored as characters formatted for direct output to the printer. This method has both advantages and limitations. The main advantage is the speed of the printout. The disk sectors hold data that may be directly (with one exception) output to the printer. The printout routine is simple—read and perform an LPRINT on two sectors per output line. A pageful of graphics is output without waiting for BASIC to do a time-consuming conversion. The only exception occurs when an ETX data byte is encountered in the file. That byte must be printed twice. Typically the print head never halts its motion across the page. The graphics examples included with this article were each printed in less than two minutes.

As with many computer programs, the speed advantage is gained only at the expense of storage efficiency. Preformatting the data for printer output is inefficient in at least two ways. First, only 6 bits of any byte are seen by the printer, so 25 percent of each byte goes unused. Second, to stay compatible with TRSDOS, disk buffers must have an LRL (logical record length) of 255 bytes. (Theoretically, all 256 bytes are usable, but because the records are manipulated as strings and BASIC strings are only 255 characters long, the task becomes easier when the 256th byte is ignored.) Because a horizontal print line is 496 bytes wide, I use two 255-byte buffers for each. This means that 14 bytes at the end of the second disk buffer remain empty—another 3 percent loss of storage efficiency. If you use the NEWDOS80 or LDOS variable-length records, you can eliminate some of the waste.

Mapping Memory

Figure 11 illustrates the virtual-memory mapping algorithm I devised for Diskplot. Two random-access disk sectors contain the data for one printed line—six vertical (*y*) rows of 496 horizontal (*x*) columns. This 510-byte area is a buffer when it is in memory. The same two sectors are a record when they are on disk. For maximum flexibility, Diskplot allows a variable number of buffers.

The buffers are a "window" to the records stored on disk. This window is moved up and down within the file, according to the current position of the *x,y* pointer—the simulated plotter "pen."

The strategy for paging records in and out of the buffer area is as follows. Before any dot is plotted, the *y* ordinate is compared to the minimum and maximum *y* rows currently being held in buffers (the *x* ordinate need not be tested as all columns for a given *y* will be in memory). At some point the pen will be directed to move off the page—beyond the edge of the current viewing window. To accommodate the roving pen, the window is scrolled to a new position in the file, a position that places the pen at the center of

It's Simple. . . **CALL AND SAVE MONEY**

1-800-841-0860

**CONVENIENT
ORDER ENTRY
GA. INFO. 912-377-7120**

"Telemarketing Works For You"

Commodore

**CALL FOR BEST
PRICES ON
COMMODORE**

COMMODORE 64
VIC 1541 DISK DRIVE
VIC 1530 DATASETTE REC.
VIC 1525 GRAPHIC PRINTER
VIC 1520 COLOR PLOTTER
VIC 1600 VIC MODEM
VIC 1701 COLOR 14" MONITOR

COMMODORE 64 SOFTWARE
HESWARE SOFTWARE
WORDPRO PLUS 3

\$CALL

**TRS-80
COMPUTERS**

• PURE RADIO SHACK EQUIPMENT •

UP TO **20%** AND MORE

DISCOUNT

***** CALL FOR PRICES ***
ON COMPLETE LINE**

**IBM COMPATIBLES
YOUR CHOICE
EAGLE PC
COLUMBIA PC
CORONA PC
\$CALL**

**RB ROBOT
RB5X \$CALL
ARMATRON
ROBOT ARM
\$29**

**EPSON
PRINTERS**

FROM **\$CALL**

FX-80..... SAVE
RX-80..... SAVE
FX-100..... SAVE

**TRS-80 PRINTERS
COMPLETE LINE FROM \$199**

**SCM SMITH
CORONA**

**TP-1 DAISY
WHEEL
PRINTER
FROM \$CALL**

Star

**GEMINI
10X & 15
PRINTERS
FROM \$279**

**C. Itoh
\$CALL
Transtar
\$CALL**

**OKIDATA
PRINTERS**

FROM **\$CALL**
MICROLINE SERIES
•83A
•84P •92P •93P
PACEMARK 2350P

MODEMS

**Hayes
Novation**

\$CALL

**MONITORS
USI**

**TAXAN
\$CALL**

NOTICE

ALL PRODUCTS WE SELL ARE BRAND NEW AND COVERED BY THE MANUFACTURER'S SPECIFIC WARRANTIES. COPIES AVAILABLE UPON REQUEST. WE DO NOT SELL ANY USED, RECONDITIONED, FOREIGN OR INFERIOR MODIFIED EQUIPMENT. PRICES AND PRODUCTS SUBJECT TO CHANGE WITHOUT NOTICE.

**QUADRAM
CORPORATION**

GRAPPLER+

**FRANKLIN
Albert
COMPUTERS
\$CALL**

FREE

UPON REQUEST
•DISCOUNT PRICE LIST &
INFORMATION KIT
WRITE
MICRO MANAGEMENT SYSTEMS
TELEMARKET DEPT. # 1

**AST &
COLORPLUS
BOARDS
\$CALL**

**Verbatim
NEW
PRODUCTS
\$CALL**

Since 1978

- PIONEER IN DIRECT TO CONSUMER SALES OF MICRO COMPUTERS AND ELECTRONICS
- NAME BRAND PRODUCTS
- LARGE INVENTORIES
- NEXT DAY SHIPMENT ON MOST PRODUCTS



**Micro Management
Systems, Inc.**

2803 Thomasville Road East
Cairo, Georgia 31728
(912) 377-7120

**DISCOUNT
PRICES**



**BUY
DIRECT**

TELEMARKET DEPT. 1

the new page.

In figure 11, the user has chosen to use five buffers. The paging example begins with buffers 1 to 5 holding records 20 to 24. The calling program has directed the pen to write to record 25, which is not currently in memory. The window is moved down by first saving buffers 1, 2, and 3 to disk records 20, 21, and 22—scrolling these records out of the window. Then buffers 4 and 5 are copied to buffers 1 and 2. This action is the same as moving the higher numbered records to the lower numbered buffers; i.e., records 23 and 24 are placed into buffers 1 and 2. Finally, new records 25, 26, and 27 are read into buffers 3, 4, and 5—scrolling them into the window.

The top of the new page has been formed from the lower part of the old page. The bottom of the new page holds the data read from disk. The pen is then pointed to record 25 held in buffer 3, the center of the new page.

When widely separated *y* ordinates are sent consecutively to the subrou-

tine and there is no page overlap, all the buffers are saved, and new records are read into them.

In this manner, every disk access is to contiguous records, minimizing disk I/O (input/output) time. Furthermore, after paging, the pen is left pointing to the center of the window; its meandering course is likely to remain on the page for a maximum length of time.

This strategy is ideal for drawing dragon curves and other designs that seldom lift the pen from the paper. It becomes less efficient when the plotting program lifts the pen often to move to widely separated points. Knowing how the records and buffers are accessed will speed up the drawing of many designs; i.e., points along the same *y*-axis may have widely separated *x* ordinates without slowing the plotting. Even though Diskplot eliminates spurious disk writes (it doesn't resave a buffer that hasn't been altered while in memory), erratic motion along the *y*-axis is bound to increase disk I/O, slowing the "plotter" considerably.

Garbage Collection

Because Diskplot uses character-string buffers for dot storage, it spends time manipulating strings. Microsoft string-manipulation commands are flexible and extensive, but the BASIC garbage-collection process is, at times, irritating. A program that uses a lot of string space will eventually invoke this function, which locks up the keyboard and halts the running program while reorganizing the string-storage area. String sorts that create a TEMP\$ for each exchange are prime examples. The garbage collector is one reason such routines seem to take so long.

This problem has a little-known solution built into Disk BASIC. The "MID\$=" assignment function is used to replace a portion of a destination string with a portion of a source string. MID\$(DEST\$,5,2)=SRC\$ places the first two characters of SRC\$ into positions 5 and 6 of DEST\$. The last argument is optional with a default of moving the entire source string (or as much of it as will fit) into the specified positions of the

SAGETM
COMPUTER TECHNOLOGY

V

CHRISTMAS SPECIAL

Don't buy a toy this Christmas, Buy a SAGE
The fastest 16-bit microcomputer on the market

- UCSD p-System (others available)
- PASCAL compiler
- TIMBERLINE Spreadsheet
- WORD 7 Word processor
- 256 Kbytes of parity RAM (optional to 1 Mb)
- One 640K floppy drive
- IEEE-488 interface (GP-IB)
- Comprehensive documentation

VIMA HAS THE LOWEST COST PC, BUSINESS, SCIENTIFIC AND ENGINEERING - SINGLE AND MULTIUSER CONFIGURATIONS AVAILABLE.

A REAL COMPUTER FOR THE PRICE YOU'D PAY FOR AN ARCADE GAME!

EXAMPLE CONFIGURATIONS - INCLUDES SHIPPING

SAGE IV COMPUTER	SAGE IV
FREEDOM 100 TERMINAL	12 Mb HARD DISK
	1 Mb RAM
	2 TELEVIDEO 925
	OKIDATA uL 92
LIST: \$4,750	\$12,210
VIMA: \$3,495	\$ 8,995

Terms: MO, cashier check, bank wire. Personal checks - 2 weeks for processing. Major credit cards add 5% service charge. Ask about our educational discounts and business leasing plan.

INFORMATION: 608-221-4447 - Cost of call will be credited to your order. Orders:

VIMA INC. 1-800-368-3238 OPERATOR 6
P.O. BOX 6181 in VA, 1-800-542-2224
MADISON, WI 53716

FREE - \$200 VALUE

24 hour factory repair exchange for 1 year.

VIMA OFFERS FULL SUPPORT & SERVICE

WHEN _____

CO-SORTING

IT IS BETTER TO CO-SORT

CO-SORT IS DESIGNED TO RUN WITH YOUR CP/M PROGRAM SO THAT IT CAN RESPOND EASILY TO DYNAMIC REQUIREMENTS AND YOUR DEVELOPMENT IS EASY AND ACCURATE.

CO-SORT is a general-purpose high-speed sort/merge co-routine for all CP/M based applications. The routine is accessible from all languages, with any number of sources, variable or fixed length records, all data types and any number of keys in any direction. Best of all, your program won't have to stop to sort. In short, CO-SORT is the ultimate sort.

Priced at \$200, this program is well documented. For information, or to order, write INFORMATION RESOURCES, Box W, Manhasset, N.Y. 11030.

CP/M is a trademark of Digital Research.
CO-SORT is a trademark of Information Resources.

INFORMATION RESOURCES
BOX W, MANHASSET, NEW YORK 11030 (516) 365-7629

Satisfaction With True Mail Order Prices

With so many so-called Mail Order establishments using "toll free" lines, and grandiose advertising, how can you, the customer, expect to receive true mail order savings? We have done away with these expenses to offer comparable service passing on the savings to you. Our reputation for low prices and satisfaction is outstanding.

COLUMBIA DATA Personal Computer

Featuring:

- IBM PC Compatibility
- 16-bit 8088 Processor
- 8 Expansion Slots
- Two RS232 Serial Ports
- Centronics Printer Port
- Double Density Floppy Disk Controller
- 128K RAM Standard Memory

..... \$CALL

FRANKLIN ACE 1000 \$869.00

64K of memory, true upper and lowercase, color graphics capabilities, a typewriter-style keyboard, and a 12-key numeric pad, the ACE 1000 is powerful yet easy to use. What's more, the ACE 1000 is compatible with the 16,000 software programs written for Apple® computers.

PRINTERS

TRANSTAR or JUKI \$549.00

Okidata:	
Microline 92	\$ 499.00
Microline 93	\$ 915.00
C. Itoh:	
Prowriter I Parallel	\$ 369.00
Prowriter I Serial	\$ 489.00
Prowriter II Parallel	\$ 629.00
Prowriter II Serial	\$ 689.00
F-10 Starwriter	\$1150.00
F-10 Printmaster	\$CALL
Brother HRI:	\$ 775.00
Smith Corona TPI:	\$ 539.00
Star Micronics:	
Gemini 10X	Call for low prices!
Gemini 15	\$CALL
PICS Interface	\$ 87.50

MODEMS

Hayes:	
MicroModem IIe	
with Terminal Program	\$259.00
Hayes Smartmodem:	
300 Baud	\$199.00
1200 Baud	\$505.00
Novation:	
J-Cat	\$104.00
Applecat II	\$285.00
Smartcat 1200 Baud	\$440.00
U.S. Robotics:	
300 Baud	\$165.00
1200 Baud	\$459.00
Password	\$CALL

Send orders and inquiries to:

Computer Apparatus™

P.O. Box 414 • Wheatridge, Colorado 80034

Telephone Inquiries: (303) 759-9251

Monday thru Friday — 9:00 a.m. to 5:00 p.m. (Mountain Standard Time)

**We built our reputation on low prices
for the informed computer user.**

DISKETTES

Elephant:	
5 1/4" SS/DD	\$21.95
5 1/4" DS/DD	\$28.95
Verbatim:	
5 1/4" SS/DD	\$22.95
5 1/4" DS/DD	\$38.95
Dyan:	
5 1/4" SS/DD	\$29.95
5 1/4" DS/DD	\$38.95
Library Case 5 1/4"	\$ 1.75
*Kangaroo: (w/library case)	
5 1/4" SS/DD	\$21.35
5 1/4" DS/DD	\$28.95
Now available: The '6-pak'	
5 1/4" SS/DD	\$14.45
5 1/4" DS/DD	\$19.45
— 10 yr. Warranty —	

MONITORS

Amdek:	
Color I	\$295.00
Color II	\$489.00
300 G Green	\$145.00
300A Amber	\$155.00
310A Amber	\$175.00
Zenith: 12" Green	\$ 99.00
USI: 12" Amber	\$159.00
12" Green	\$155.00
*Taxan: Amber	\$139.00
PGS: RGB Monitor	\$CALL
BMC: 12" Green	\$ 95.00
NEC: 1203 Hi Res RGB	\$589.00

COMPUTER PRODUCTS FOR APPLE

MBI:	
VIP Graphics Card	\$ 109.00
Appltime Clock Card	\$ 75.00
Silicon Valley Systems:	
Final Analysis	\$ 149.00
Word Handler	\$ 115.00
Continental:	
Home Acct	\$ 48.00
On-Line:	
Screenwriter II Pro	\$ 139.00
Visicorp:	
Visidex	\$ 180.00
Visifiles	\$ 180.00
Visicalc	\$ 180.00
Visitrend/Plot	\$ 225.00
Stoneware:	
DB Master	\$ 154.00
DB Utility Pak	\$ 85.00
T & G Products:	
Joysticks	\$ 42.00
Select-a-Port	\$ 42.00
Game Paddles	\$ 28.00
Davong Hard Disks	
5 Megabytes	\$1359.00
10 Megabytes	\$1759.00
15 Megabytes	\$2159.00
Ram Cards	
Microsoft 16K	\$ 75.00
Generic 16K	\$ 60.00
Microsoft CP/M Z80 Card	\$ 269.00
80 Column Card:	
Videx w/softswitch	\$ 269.00

SOFTWARE

Wordstar	\$371.25
Mailmerge	\$187.50
Spellstar	\$187.50
Multiplan	\$206.25
MultiTool Word	\$296.25
MultiTool w/Mouse	\$371.25
Perfect Writer	\$206.25
Perfect Speller	\$129.75
Perfect Filer	\$247.50
LOTUS 1, 2, 3	\$371.25
P.C. Tutor	\$ 45.00
Home Accountant	\$112.50
C. Basic	\$150.00
Smart Com II	\$ 89.25
TIM III	\$371.25
PFS Report	\$ 93.75
PFS File	\$105.00
PFS Grape	\$105.00
PFS Write	\$105.00
Desktop Plan I	\$234.75
VisiCalc/256K	\$200.00
VisiWord w/Visispell	\$305.00

TANDOM DISK DRIVES Special

TM-100-2 DS/DD 320K Bytes	\$235.00
OR	
TM-55 320K Bytes Half Height	\$235.00

COMPUTER PRODUCTS IBM

The Ultimate Peripheral	
MONTE CARLO™ GT™ CARD 64K	\$CALL
\$45 per 64K upgrade	
Ask about the Quatro™ Card	
T & G Products:	
Joysticks	\$ 42.00
Game Paddles	\$ 28.00
Select A Port	\$ 42.00
BUSINESS	
Visicorp:	
Visidex	\$ 180.00
Visifiles	\$ 180.00
256K Visicalc	\$ 180.00
Visitrend/Plot	\$ 225.00
ENTERTAINMENT	
Inlocom:	
Zork I, II, III	\$ 26.50
Choplifter	\$ 26.50
Softflight Sym	\$ 38.00
QuadRam Quadboard	
64K	\$ 285.00
128K	\$ 330.00
192K	\$ 375.00
256K	\$ 415.00
Kraft Products:	
Joysticks	\$ 55.00
Game Paddle	\$ 29.00
Davong Hard Disks	
5 Megabyte	\$1359.00
10 Megabyte	\$1759.00
15 Megabyte	\$2159.00
Maynard Electronics	
Floppy Controllers w/Parallel	\$ 209.00
Floppy Controllers w/Serial	\$ 238.00

DELIVERIES: 2 - 4 weeks average.

PERSONAL CHECKS: Cashier's check and money order will receive shipping preference.

VISA & MASTERCARD: Add 4% to total.

CATALOG: Send for full pricing details.

Prices subject to change without notice.

SHIPPING: UPS add \$2.00 plus 3% of order total, or we calculate exact freight.

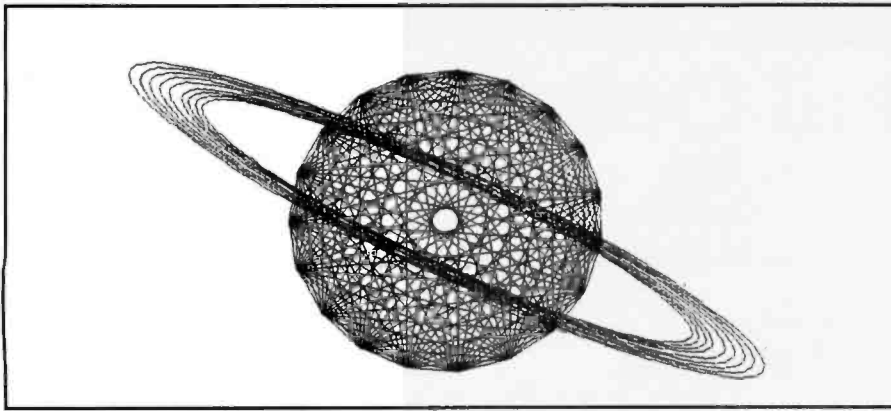

Figure 12: A 19-vertex n-gon overlaid by concentric ellipses. Drawn with Diskplot.

destination string. When DEST\$ and SRC\$ are the same length, invoking the function via

```
MID$(DEST$,1) = SRC$
```

replaces all characters of DEST\$ with the characters of SRC\$.

The effect is equivalent to the assignment: DEST\$=SRC\$, with the exception that no new string memory has been used. Consequently, garbage-collection time is minimized. For sorting strings of the same length, in place of the line

```
T$ = A$ : A$ = B$ : B$ = T$
```

use

```
MID$(T$,1) = A$ : MID$(A$,1) = B$
:MID$(B$,1) = T$
```

where T\$ has already been assigned with a length the same as A\$ and B\$. The time savings is dramatic! The virtual-memory system controlling Diskplot uses this method for moving data from the FIELDed disk buffer to the virtual-memory buffers, in copying buffers when the window is scrolled, and when turning on a bit in a string buffer. Therefore, even though much of 32K bytes of string memory is constantly being manipulated, garbage collection is never involved.

Using Diskplot

Diskplot was written to be used in a variety of plotting applications. The

subroutine package is a flexible alternative to expensive plotter hardware. Many plotter and high-resolution screen graphics programs can be easily converted for use with this program. Figure 12 was created by overlaying the output from Mike Higgins' plotter program (August 1981 BYTE, pages 414-416) with some elliptical circles that I devised. Only minor changes were needed for routing the output, via Diskplot, to my Paper Tiger.

Screen commands like PSET are implemented by assigning variables x and y with the desired coordinates and issuing a GOSUB to line 1500. LINE (or DRAW TO) commands are emulated with a GOSUB to 1000, preceded by assigning $x1,y1$ and $x2,y2$ with the start and end points of the line to be drawn.

Before running the application program, the string-storage area must be CLEARED and the initialization routine at line 3000 must be called. A series of inputs inquires about page length (the expected maximum y ordinate), the number of buffers desired, and the filename for the disk-plotter image file.

The calling program should perform a CLEAR on string space in proportion to the expected number of buffers. Each buffer requires 510 bytes of string memory. The dragon-curve generation program (listing 1) CLEARS enough memory for a 41-buffer window into the 120-record (48 gran) disk file. The number of buffers desired will depend on the applica-

tion program. It is usually best to CLEAR and buffer the maximum amount of available memory.

The initialization routine requests a filename for the plotter image. You are warned if the file already exists. If so, you may clear the file, select a different file, or use the file as a base for overlaying a new design. The overlay option is especially useful for graphing charts. You can generate a grid file by calling the LINE routine an appropriate number of times and then copying it to another file. Thereafter, overlay this file with new data points, lines, or curves. Consider the value of having, for instance, a clean score available for a program that sets notes onto sheet music.

The default filename is PLOT/RAF, which I use for the short-term file. After the design is finished, I save the file by copying with a different filename. My 40-track double-density drives can keep four files on one disk. I leave it to you to write a file-compression program. (Hints: most of the file remains filled with bytes of 80 (hexadecimal), and bytes 242 to 256 of the second sector of every record are unused.)

The routine starting at line 1000 draws a line from point $(x1,y1)$ to point $(x2,y2)$. Upon exit, $x1$ and $y1$ have been adjusted to $x2$ and $y2$. Subsequent calls need only redefine $x2$ and $y2$ to simulate a plotter DRAW TO command. This routine is adapted from Mike Higgins' algorithm (see reference 4). It is fast and efficient, requiring only integer variables. This routine determines the points between the two input coordinates and calls line 1500 to set each.

Lines 1500-1590 set the individual dot at the specified coordinates at x and y . This routine rejects any coordinates that would move the pen outside of the defined limits. It also handles the paging function of the virtual-operating system. Lines 1510 and 1520 constitute the "priming logic." These lines are executed only on the first call to the subroutine. They position the buffered "window" over the correct part of the file. When the Overwrite option is specified during initialization, the indicated records are read in for modification.

Make your best connection with Datec PAL Modems. The Datec PAL Series is your Personal Access Link to the world of remote computing. Now you have three new PALs.

New Datec PAL 103 Modem.

The PAL 103, 0-300 bps modem, has a built-in automatic dialer, a monitor speaker, and an industry standard command set. All at a very competitive price.

New Datec PAL 212 Modem.

The PAL 212, 300/1200 bps modem, includes all the features of the PAL 103, plus call progress messages. The PAL 212 detects and informs your computer of dial tone, busy signals, ringing, even voice band energy. For efficient unattended dialing.

New Datec PAL Plus Integral Modem.

The plug-in modem you've been waiting for. The PAL Plus is designed for use with the IBM PC, IBM XT, and COMPAQ portable, as well as other compatible



Datec
PAL 103
Modem



Datec
PAL 212
Modem



Datec
PAL Plus
Integral
Modem

Crosstalk
XVI
Software
and Manual



computers. We've added an extra, independent RS-232C port for connection to a serial printer or other peripherals to save you money. And here's the big Plus: with the PAL Plus, you get a copy of Crosstalk XVI, the premier communications software.

Our new PAL Series Modems cost less than similar modems. Because Datec uses the most advanced integrated circuits, we can build more reliable modems with fewer parts and pass the savings along to you.

Get more modem for less money. New Datec PAL Modems. Your Best Connection.

Special Note.

Datec designs special-purpose datacomm devices for unique industrial applications. Send us your problems, we'll send you the answers.

Datec, Datec PAL, and Your Best Connection are registered trademarks of Datec, Incorporated. IBM is a registered trademark of International Business Machines Corporation. COMPAQ is a registered trademark of COMPAQ Computer Corporation. Crosstalk XVI is a registered trademark of Microstuf, Inc.

DATEC®

Datec, Incorporated
200 Eastowne Drive, Suite 116
Chapel Hill, NC 27514
919-929-2135

See us at Booth No. 630, COMDEX Fall '83, Las Vegas Convention Center.

RYDEX

Remote Intelligence takes your computer from the screen out to the scene.



Who can blame you if you've only been using your computer as an efficient filing system. Up to now, getting it to physically do things for you, like regulate equipment or even just open the garage door, has been complex, troublesome and expensive.

Rydex has the intelligent solution!

The Rydex IC (Intelligent Controller) series transforms your PC into a powerful monitor and control tool, with capabilities ranging from relay activation to temperature monitoring, motor control and security/alarm system regulation. Control can be through

digital or analog channels, connected directly or by modem, with hundreds of IC units to a single

RS 232 serial port. Modular design means you can expand easily to virtually limitless remote control capacity.

Rydex ICs require no special computer knowledge or special software to use. All commands are accessible through Basic. IC systems are not difficult to install. Complete instructions come with the unit. Or if you have an especially complex application, our technical staff will be glad to assist.

And here's the final word on Rydex ICs. Affordability. Most systems can be installed for less than \$1,000.

RYDEX

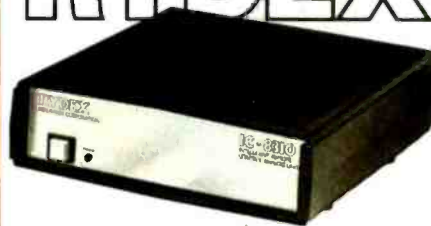

For more information on how Rydex ICs can put YOUR computer to work, call or fill in and mail coupon below to:

Rydex Industries Corporation, 200/4040 No. 3 Road, Richmond, B.C. V6X 2C2 (604) 278-6772.

NAME _____

COMPANY NAME _____

ADDRESS _____

ZIP/POSTAL _____ TEL. _____

Listing 2: The Diskplot plotter/print routines used to print the dragon curves in this article.

```

950 '**
960 '**
970 '**
980 '**
990 '**
1000 '**
1010 '**
1020 '**
1030 '**
1040 '**
1050 '**
1060 '**
1070 '**
1080 '**
1090 '**
1490 '**
1500 '**
1510 '**
1520 '**
1530 '**
1540 '**
1550 '**
1560 '**
1570 '**
1580 '**
1590 '**

DISKPL0T
Virtual memory plotting system for IDS Paper Tisers
.....by Ian Rollins

** MUST GOSUB 3000 to open file and initialize variables
** MUST GOSUB 4000 to flush buffers and close file

** GOSUB 1000 draws a line from (X1,Y1) to (X2,Y2)
** GOSUB 1500 sets a point at (X,Y)
** GOSUB 5000 prints the file

** system uses variables L1 to L8
** and variables beginning with P (see variables table)
*****

** this routine draws a line from (X1,Y1) to (X2,Y2)
** uses L1 - L8, X, Y
** leaves X1,Y1 and X,Y pointing to end of line X2,Y2
**
L1=X2-X1 :L2=Y2-Y1 :L3=0 :L4=1 :L5=1 :L6=0
L10 IF L1<0 THEN L5=-1 :L1=-L1
L20 IF L2<0 THEN L4=-1 :L2=-L2
L30 IF L2>L1 THEN L8=L1 :L1=L2 :L2=L8 :L3=L5 :L5=0 :L6=L4 :L4=0
L40 L7=INT(L1/2) :X=X1 :Y=Y1 :IF L1=0 GOSUB 1500 :RETURN
L50 FOR L8=1 TO L1
L60 GOSUB 1500
L70 X=X+L5 :Y=Y+L6 :L7=L7+L2
L80 IF L7>L1 THEN L7=L7-L1 :X=X+L3 :Y=Y+L4
L90 NEXT :X1=X2 :Y1=Y2 :RETURN
**
** this routine plots 1 dot at (X,Y)
** includes virtual memory paging logic
** ignores out of range coordinates
**
IF X<0 OR X>496 OR Y<0 OR Y>99
THEN PRINT@ 70,"Coordinate OUT OF RANGE!" ;CHR$(30) ;
:RETURN
1510 IF PZ=0 THEN PZ=1 :CLS :PRINT@ 18,"** Plotting **"
:P1=INT(Y/6)-P8 :IF P1<1 THEN P1=1
ELSE IF P1>P5 THEN P1=P5-P6 '** priming logic
1520 IF P0$="0" THEN P0$="" :GOSUB 2600 '** read for Overlay
1530 PZ=INT(Y/6) :P4=Y-P3*6 :P3=P3+1 :P7=P3-P1+1
1540 IF P7=P6+1 THEN GOSUB 2000
ELSE IF P7=0 THEN GOSUB 2100
ELSE IF P7<0 OR P7>P6+1 THEN GOSUB 2200
PH=0 :PL=X+1 :IF PL>255 THEN PH=1 :PL=PL-255
1560 PP=ASC(MID$(PB$(P7,PH),PL,1)) OR PD(P4)
1570 MID$(PB$(P7,PH),PL,1)=CHR$(PP) :PW(P7,PH)=1 '** set flag
1580 PRINT@ 70,USING P0$;X,Y,P3,P7,P4;
1590 RETURN

```

```

2990 '**
** Initialize file and virtual plotting system variables
** MUST call here FIRST, having CLEARED string space
**
3000 CLS :PRINTO 71,"Virtual Memory Plotter Emulator"
3010 DEFINT P,L :PRINT :PRINT
3020 X=0 :Y=0 :P3=0 :P1=0 :P7=0 :PH=0 :PL=0 :PP=0:** used often
3030 P6=31
:INPUT "Number of memory buffers (3-41, default=31)";P6
3040 P6=P6 OR 1:P8=INT(P6/2)+1:IF P6<3 OR P6>41 GOTO 3030
3050 DIM PB$(P6,1), PM(P6,1) '** buffers, write flags
3060 P9=720
:INPUT "Vertical Paste length in dots (default=720)";P9
3070 P5=INT(P9/6)+9 :PC$=STRING$(255,128) :PRINT
3080 PF$="PLOT/RAF"
:INPUT "Plotter-image filespec (default='PLOT/RAF')";PF$
3090 OPEN "R",1,PF$ :FIELD 1,255 AS PR$
3100 IF LOF(1)=0 THEN PS=1 :GOTO 3170
3110 PRINT"file: ";PF$ " already exists!!!"
3120 INPUT"(C) Clear,(O) Overlay or (D) use Different file";PQ$
3130 IF PQ$="C"
THEN PRINT"Are you sure you want to clear ";PF$;" (Y/N)";
:INPUT PQ$ :IF PQ$="Y" THEN CLOSE 1 :KILL PF$ :GOTO 3090
ELSE 3120
3140 IF PQ$="D" THEN CLOSE 1 :GOTO 3080
3150 IF PQ$<>"O" GOTO 3120
3160 IF LOF(1)<P5*2 THEN PS=LOF(1) ELSE 3220
3170 CLS :LSET PR$=PC$
3180 FOR PQ=PS TO P5*2
3190 PRINTO 0;"USING-Initializing file sector ##";PQ
PUT 1,PQ
3200
3210 NEXT
3220 FOR PQ=1 TO P6 :PB$(PQ,0)=PC$ :PB$(PQ,1)=PC$ :NEXT
3230 PUS="X=## Y=## Record=## Buffer=## Bit=#"
3240 PB(0)=1 :PB(1)=2 :PB(2)=4 :PB(3)=8 :PB(4)=16 :PB(5)=32
3250 CLS :PZ=0 :RETURN
3990 '**
** flush buffers and close file
** MUST call here LAST
**
4000 CLS :PRINT"Closing file: ";PF$
4010 GOSUB 2500 :CLOSE 1
4020 PRINT"file closed" :PRINT
4030 INPUT"Press <ENTER> to continue"; PQ$
4040 RETURN
4990 '**
** routine prints entire file to Paper Tiser
**
5000 CLS :PRINT"Print graphics file to Paper Tiser"
5010 PRINT :PRINT :PRINT"Ready Printer" :PRINT
5020 PRINT"input filespec (default = ";PF$;" )";
5030 INPUT PF$ :IF LEN(PF$)=0 GOTO 5020
5040 OPEN"R",1,PF$ :FIELD 1,255 AS PR$
5050 IF LOF(1)=0 THEN PRINT"NO SUCH FILE!"
:CLOSE 1 :KILL PF$ :GOTO 5020

```

```

5060 PE$=CHR$(131)
5070 LPRINT : LPRINT CHR$(158);PE$;
5080 LPRINT PE$;CHR$(139);
5090 FOR P2=1 TO LOF(1) STEP 2
5100 GET 1,P2 :PL=255 :GOSUB 5200
5110 GET 1,P2+1 :PL=242 :GOSUB 5200
5120 LPRINT PE$;CHR$(139);
5130 IF INKEY$=CHR$(31) THEN P2=LOF(1) '** <CLEAR> to abort
5140 NEXT :LPRINT PE$;CHR$(130);
5150 LPRINT :CLOSE 1
5160 RETURN
5170 '**
** prints first PL characters from PR$
** contains logic for embedded graphics ESC
**
5200 PJ=1
5210 PQ=INSTR(PJ,PR$,PE$)
5220 IF PQ=0 THEN LPRINT MID$(PR$,PJ,PL-PJ+1) :RETURN
5230 LPRINT MID$(PR$,PJ,PQ-PJ)PE$;PE$;
5240 PJ=PQ+1 :IF PJ<=PL THEN 5210 ELSE RETURN

```

```

10000 *****
** name
** function
*****
10010 '**
** P1
** P2
10020 '** P1
Physical file sector (used in GET and PUT)
**
10030 '** P3
current RECORD (Y/6)
**
10040 '** P4
current bit to set (Y mod 6)
**
10050 '** P5
highest RECORD on disk (P9/6)
**
10060 '** P6
total number of BUFFERS (is forced odd)
**
10070 '** P7
BUFFER currently being accessed
**
10080 '** P8
middle BUFFER (INT(P6/2)+1)
**
10090 '** P9
total vertical dots (maximum Y)
**
10100 '**
high or low string of BUFFER (1 or 0)
**
10110 '** PH
X offset within BUFFER string (1-255)
**
10120 '** PL
also length of string to LPRINT
**
10130 '** PP
current value of byte to alter
**
10140 '** PQ
temporary value, counter
**
10150 '** PJ
temporary value, counter
**
10160 '** PS
sector to start clearing file
**
10170 '** PZ
priming variable (=1 on first call to 1500)
**
10180 '** X
horizontal ordinate to plot
**
10190 '** Y
vertical ordinate to line to draw
**
10200 '** X1,Y1
starting point of line to draw
**
10210 '** X2,Y2
ending point of line to draw
**
10220 '**
**
10230 '** PB(n)
value to OR for setting dot n (0 is top)
**
10240 '** PM(n,1)
flag indicates that a BUFFER is updated
**
10250 '**
**

```

Professional Software for the Software Professional

DMA products operate on
the full range of
Z80, 8086, 8088 processors,
including the IBM-PC

Here's what you can do!

Application Creation

FORMULA II™

The Application Creator

The first and only Application Creator—a do-it-yourself concept for office automation. FORMULA II lets you define your files, forms, menus, and reports—FORMULA II then creates your program. FORMULA II includes a Database manager with an English Query language and a Form/Report Creator with word processing features.

Communications

ASCOM™

ASCOM™ is the most versatile asynchronous communication package for microcomputers on the market. It features interactive, menu-driven, and batch operations; supports auto-answer and auto-dial modems; includes most popular protocols; provides network simulation; and many other options. Xerox Corporation, NCR, Monroe Systems for Business, and the big 8 accounting firms use ASCOM™.

SYNC/COM™—A bisynchronous communication package that will be configurable for a variety of systems and includes a flexible interface to the operating system. 2780/3780/3270 protocols available on microcomputers with appropriate hardware.

TERMCOM™—A configurable terminal emulator allowing any personal computer to emulate most conversational and selected block mode terminals with asynchronous communications. Available December 1983.

Utilities

EM80/86™

This software emulator lets you use eight bit software on sixteen bit microcomputers without hardware modifications.

The 8086 O.S. Converter™

CP to MS—Permits execution of Digital Research's CP/M-86 programs under Microsoft's MSDOS (or PCDOS).

MS to CP—Permits execution of MSDOS programs under CP/M-86.

UT-86™

This package of user-friendly utilities for the IBM Personal Computer and similar systems includes copying, directory sorting, patching, and a general purpose file print utility.

Coming Soon

DMA."C"™—A "C" language compiler which will generate either Z80 or 8086 assembly language code. Due to a unique optimization routine which is based upon a functional "P-code" model, the efficiency of DMA."C" will far exceed that of existing compilers.



WE SPEAK YOUR LANGUAGE WE SPEAK YOUR LANGUAGE WE SPEAK YOUR LANGUAGE

DYNAMIC MICROPROCESSOR ASSOCIATES, INC.

545 FIFTH AVENUE, NY, NY 10017

Dealer Inquiries only • (212) 687-7115

Listing 2 continued:

```
10260 '** PB$(n,1) BUFFER storage strings (255 char. length) '**
10270 '** PC$ 255 graphical blanks ( CHR$(128) ) '**
10280 '** PE$ graphics escape CHR$(131) '**
10290 '** PF$ disk filename for plotter image '**
10300 '** PQ$ priming flag (= "0" for Overlay option) '**
10310 '** PR$ FIELDed strings (funnels all disk data) '**
10320 '** PU$ PRINT USING image for plotting data '**
10330 '** '**
10340 '** L1 Distance of long-axis '**
10350 '** L2 Distance of short-axis '**
10360 '** L3,4,5,6 horizontal and vertical steps (1,-1, or 0) '**
10370 '** L7 duty master (for determining ratio) '**
10380 '** L8 temporary value, long-axis counter '**
10390 '** '**
*****
```

If, upon entry, the specified x coordinate is out of range of the window buffers, line 1540 calls the subroutine for the required action, i.e., moving the window up or down with overlap or placing the window at an entirely different part of the file.

Line 1570 makes the actual modification to the indicated buffer, turning on the dot at the x,y coordinate. The correct buffer is selected, then an OR is performed on the current value of the x th byte of the buffer with a value that will fire the correct print-head pin upon output. Then, using the "MID\$=" assignment function, this combined value is placed back into the buffer. A flag is then set, indicating that the selected buffer has been altered.

Just as the initialization routine must be called before any plotting takes place, the CLOSE routine at line 4000 must be called when the design is finished. All the altered buffers at the ending window position are flushed out to the disk, and the file is properly closed.

Lines 5000 to 5240 constitute a stand-alone routine for printing a graphics file. An input prompts for a filename, indicating a default string of the last-used filename. The printer is set to 12 cpi (characters-per-inch) in graphics mode and the 2K-byte buffer is emptied. Then the file is read and two disk sectors are printed per physical printer line. The routine at 5200 does a scan of the print line to check for an ETX control character embedded in the file. When none exists, the entire line is printed unchanged. Otherwise the string is

printed up to the ETX, an ETX is printed twice, and the line is scanned again until the entire string has been output.

The top three lines of the video are reserved for Diskplot data display. The system keeps you informed of what's happening at all times. Every call to Diskplot prints the current x and y , the currently accessed buffer and record, and the bit being set in the current byte. Every time the disk is accessed, the buffer and record numbers are displayed. While displaying this data slows execution, it is a handy debugging device and lets you know that everything is running smoothly.

The final lines of listing 2 document the variables used by the Diskplot program. Notice that each variable in the dot-plotting routine begins with the letter P. All variables in the line-drawing routine begin with L. This makes it easier to interface the routines with a variety of application programs. Loops are indented and remarks indicate the logical subroutines and their functions.

The program may be speeded up by eliminating spaces and remarks and combining lines where feasible. You might also consider placing the often-called routines early in the program. All the variables are defined as integers and those most often used have been defined early to shorten the amount of time BASIC needs to look them up. Most of the duration of each call to Diskplot is in the calculations to determine the buffer number and the position within the buffer to be altered. So even though

the routines are disk-intensive, specifying a large number of buffers usually ensures that the program is not "I/O bound."

When no paging action is required, each dot takes about 0.24 seconds to plot. The duration of each call can be lowered to about 0.17 seconds by removing the PRINT USING command at line 1580. The order-12 example dragons each call the SET routine over 25,000 times. These designs take about 90 minutes for the plotting and printing phases. Because Diskplot uses standard BASIC commands, the routines could be compiled for a substantial time savings.

Summary

Just as the classical dragon curve is a special case of the generalized dragon curve, the generalized dragon curve might be considered the two-dimensional aspect of an even broader class of three-dimensional curves. Some interesting possibilities present themselves when the folds of the curve are at angles of other than 90 degrees.

The virtual-memory algorithms I've described work well with the dragon-curve program, but they can be inefficient in other applications. The line-drawing module could be improved by doing some preliminary paging, preparing the window in advance.

The Diskplot package has become a valuable addition to my subroutine library. The dragon curves that could only be drawn with this package make an impressive display. ■

References

1. Dameron, David. "Some Example Plots," February 1980 BYTE, page 140.
2. Davis, Chandler and Donald E. Knuth. "Number Representations and Dragon Curves," *Journal of Recreational Mathematics*, April 1970, page 66 and July 1970, page 133.
3. Gardner, Martin. "Mathematical Games," *Scientific American*, March 1967, page 124 and April 1967, page 118.
4. Higgins, Mike. "Fast Line-Drawing Technique," August 1981 BYTE, page 414.

Dan Rollins (134 Olive St., Glendale, CA 91206) is a freelance programmer and technical writer. He is currently writing a book entitled IBM-PC 8088 Macro Assembler Programming, soon to be published by Macmillan.

Send 2000 Letters Per Hour via Your Personal Computer

Delivered in 48 hours or sooner at 26 cents a piece.

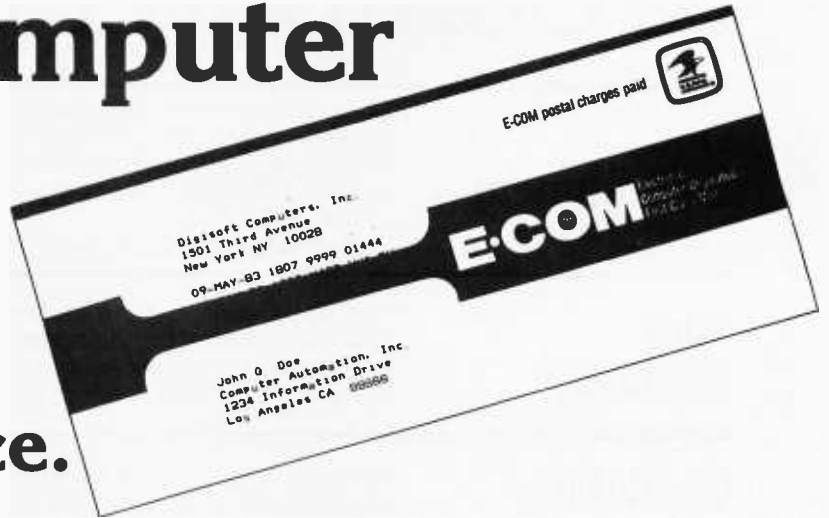

Presenting E-Com.

Last year the U.S. Postal Service quietly announced E-Com, enabling specially equipped personal computer users to bypass costly manual mail preparation, by

electronically submitting their messages and mailing lists directly to the Postal Service via modem.

This high speed computer originated mail arrives at its destination within 48 hours—often less—in an attention-grabbing blue E-Com envelope.

Announcing MAIL-COM. Only from Digisoft Computers.

MAIL-COM is powerful software you can use with your personal computer to access E-Com. With your personal computer, a modem and MAIL-COM you can send from 200 to 2000 letters per hour for just 26¢ each. Typed, addressed, folded, inserted, sealed and delivered. Complete.

MAIL-COM even eliminates the need to use your expensive letterheads and envelopes.

MAIL-COM is the only interactive software available for E-Com operation. It's easy to use. No special training is necessary. And since Digisoft Computers developed MAIL-COM in accordance with U.S. Postal Service specifications, users are guaranteed certification for

use upon purchase of MAIL-COM software.

MAIL-COM is the easiest and most economical way to do your mailings. And MAIL-COM is compatible with Database II™ and Wordstar™ if you are equipped with these programs. If you aren't, MAIL-COM includes a complete letter editor and address maintenance program of its own.

Each letter in your mailing can be identical or all can contain variable insertions. MAIL-COM operates all the features offered by E-Com.

Thousands of Uses.

If you have need for fast, economical mass mailing capabilities, MAIL-COM puts you and E-Com together.



Use it for new product announcements, invitations to press events, invoicing, fund

raising, collection, bulletins to your sales force, new business prospecting, reactivation of customers and much, much more. Every department in your company will have use for MAIL-COM.

Don't Delay

With MAIL-COM you could be saving time and money on fast, efficient E-Com letters. MAIL-COM software is available for the IBM PC, Victor, Alpha Micro,

CP/M, Apple CP/M and other formats. Order today. Call 212-734-3875, or mail the coupon below.

Digisoft

Digisoft Computers, Inc.
(212) 734-3875
Retail Dealer
Inquiries Invited

Digisoft Computers Inc.
Attn: MAIL-COM Marketing
1501 Third Avenue
New York, NY 10028

Yes! I want to eliminate the 6 costliest steps in preparing my organization's business mail. Please RUSH my MAIL-COM software to me immediately.

I'll need software for:

- IBM PC (\$195) CP/M (\$195)
 Victor (\$195) (specify disk format)
 Alpha Micro (\$495) Other (specify)
 Apple CP/M (\$235)

- My check or money order is enclosed (residents of New York State add sales tax).
 Charge my Visa or MasterCard.

Account No. _____ Exp. Date _____

Name _____

Address _____

City _____

State _____ Zip _____

Telephone(_____) _____

© 1983, Digisoft Computers, Inc.

ENGINEERS/COMPUTER SCIENTISTS

Software Development & Computer Graphics

Our Environment

General Electric's Research and Development Center—one of the world's leading laboratories linking basic research to applications—provides a challenging work environment in the software development area including:

- Distributed VAX 11's running VMS and UNIX operating systems; IBM 3083-B24.
- Rich language capabilities including C, Lisp, Pascal, Ada.

Your Challenge

You will be working at the leading edge of the new electronics and related information-based technologies. We have excellent career opportunities for experienced computer engineers/scientists in our Information Systems Application Services Group.

Candidate Profile

Positions require an MS or PhD in Computer Science/Engineering. Experience in VAX-VMS, UNIX or IBM-VM operating systems preferred.

The Opportunities

• Software Development Engineer

Assume a leadership role in developing software engineering tools and standards for an automated software environment, that includes

- Embedded systems and engineering work stations and
- Real-time microprocessor systems. You will need additional experience in software engineering principles and software development environments.

• Computer Graphics Engineer

Be an innovator in developing the algorithms and graphics software for a broad range of challenging R&D technology programs, working with

- Color frame buffers and cameras and
- High performance 3D vector refresh systems. You will need additional experience in device independent graphics and 2D/3D geometric algorithms.

Other Openings

Several attractive opportunities also exist for:

- **Information Systems Engineer**
- **IBM System Programmer**
- **Communications Systems Engineer**
- **Systems Security Engineer**
- **Quality Assurance Systems Engineer**

Contact

Investigate excellent salaries, benefits and growth prospects by sending your confidential resume to: Mr. Neff T. Dietrich, University Relations and Recruiting, Ref. 31M, General Electric Research and Development Center, P.O. Box 8, Schenectady, New York 12301. Only U.S. citizens or holders of U.S. Permanent Resident Visas will be considered.

The future is working at General Electric

GENERAL  **ELECTRIC**

An equal opportunity employer

A Computer-Algebra-Based Calculating System

By performing automatic unit conversion, this super-calculator saves time and effort and prevents common errors

by Stuart Edwards

Quick! What's the volume of the Earth in teaspoons? If you said 2.1931217×10^{26} teaspoons, you're right (assuming Earth is a sphere with a 3956-mile radius).

It's more likely, though, that you couldn't conveniently calculate that figure even with a microcomputer or calculator. Indeed, you would probably find any practical calculations involving extensive conversions of units similarly tedious.

To perform such calculations as those involved in determining the volume of the Earth in teaspoons, I use a system that employs a microcomputer and is based on the muSIMP/ muMATH package (from The Soft Warehouse). I call my configuration a super-calculator because it performs standard calculator functions (addition, subtraction, multiplication, division, and so on) and also carries units along algebraically in the calculation and expresses results in whatever units I want. I can pose a problem for the calculator giving at once all relevant information, including measured data values, the units in which the measurements are taken, the form of the mathematical expression to be used in the calculation, and the units in which the result is to be expressed. The system

then takes care of all details, including applying appropriate conversion factors and, more important, checking algebraically that the required units make sense in terms of the formula used and the units in which the quantities are entered.

The text box on page 484 shows input statements and answers for three sample problems.

How the Super-Calculator Works

Any computer algebra system, including the one I use, can work with undefined terms; that is, addition, subtraction, multiplication, division, and even exponentiation can be performed using variables that have no assigned numerical values. Consider, for example, the following super-calculator input and output statements:

```
? 3 (X + 2 X ^ 2) Y;  
@: 3 X Y + 6 X ^ 2 Y
```

The ? in the first line is a prompt. The rest of the line is the question "What is $3(X+2X^2)Y$?" terminated by a semicolon. The second line contains the result $(3XY+6X^2Y)$ determined by the system after applying the normal rules of algebra (in this case, distribution of the 3 and the Y over the sum within the paren-

theses); the @: combination signifies "the answer is."

Together, the two lines (one input and one output) constitute what I call a transaction—an element of interaction with the computer. This interaction consists of posing an algebraic problem and receiving the evaluated result. The time required for the system to respond depends on the complexity of the problem posed and on the speed of the computer. For simple transactions such as most of the ones presented in this article, a 3- or 4-second response for a Z80 running at 4 MHz is typical.

After completion of a transaction, the @ may be used to represent that transaction's result in a subsequent transaction. Thus, after completion of the above transaction, the next transaction might appear as follows:

```
? @ / X;  
@: 3 Y + 6 X Y
```

Here, @ / X means "the previous result divided by X"; @ represents the result of the last transaction, the X factor is divided into each term, and the new answer (or new @) is $3Y+6XY$.

Although it is not necessary to assign numerical values to variables,

such assignments can certainly be made, as the next four lines (two transactions) illustrate:

```
? X: 3;  
@: 3  
? 5 X^ 2;  
@: 45
```

The first transaction assigns the value 3 to X, and the second transaction shows the result of a numerical calculation with this new value substituted for X.

We may also assign non-numeric "values" to variables; values may be other undefined variables or even expressions involving undefined variables:

```
? X: THIS EXPRESSION;  
@: THIS EXPRESSION  
? (5 X)^ 2;  
@: 25 THIS^ 2 EXPRESSION^ 2
```

Here, the first transaction assigns the expression THIS EXPRESSION to X. (This expression must be read as THIS times EXPRESSION, because whenever two factors appear side by side with no intervening operator, multiplication is assumed, as in standard algebra.) The second transaction shows how the new value of X is substituted into an expression, followed by the distribution of the exponent 2 over the individual factors 5, THIS, and EXPRESSION. Because 5 is a number, 5^2 may be immediately evaluated as 25; the other factors, being undefined, cannot be squared and thus are left as $THIS^2$ and $EXPRESSION^2$.

This capability to assign to variables values that are expressions in terms of other variables is the key to the super-calculator. In my super-calculator configuration, for example, I allow the variable "second" to be an undefined unit of time, but a "minute" is defined in terms of the "second," as:

```
? minute: 60 second;  
@: 60 second
```

An "hour" may be defined in terms of the second:

```
? hour: 3600 second;  
@: 3600 second
```

or, because we have already defined minute:

```
? hour: 60 minute;  
@: 3600 second
```

The system has substituted the value of minute into the expression. The value of hour is now 3600 second, not 60 minute: when I make an assignment, it is the evaluated result ("3600 second") that is assigned, not the "raw" input expression ("60 minute").

Now when I use the word "minute" in my calculations, it is interpreted as "60 second," and "hour" is interpreted as "3600 second." Here are some other units of time:

```
? day: 24 hour;  
@: 86400 second  
? week: 7 day;  
@: 604800 second  
? year: 365.2422 day;  
@: 3.1556926 10^ 7 second  
? decade: 10 year;  
@: 3.1556926 10^ 8 second  
? century: 100 year;  
@: 3.1556926 10^ 9 second
```

In each case, the assigned value is the evaluated result in seconds, which is now my default standard unit of time. (Note that the numerical part of each answer, if it is very large, is expressed in scientific notation; this is what a regular scientific calculator would do. The same is true in the case of very small numbers.)

Similar considerations apply to units of length. I choose a standard unit in terms of which all lengths are defined, leaving this default standard unit as an undefined variable. If the standard is the meter, I enter the units of length as follows:

```
? centimeter: 1/100 meter;  
@: 0.01 meter  
? millimeter: 1/1000 meter;  
@: 0.001 meter  
? micrometer: 10^- 6 meter;  
@: 10^- 6 meter
```

```
? nanometer: 10^- 9 meter;  
@: 10^- 9 meter  
? kilometer: 1000 meter;  
@: 1000 meter  
? inch: 2.54 centimeter;  
@: 0.0254 meter  
? foot: 12 inch;  
@: 0.3048 meter  
? yard: 3 foot;  
@: 0.9144 meter  
? mile: 5280 foot;  
@: 1609.344 meter
```

Areas are handled as squared units of length because the usual rules of algebra apply. That is, when I multiply two lengths, I expect the result to be an area:

```
? (5 foot) (3 meter);  
@: 4.572 meter^ 2
```

To be consistent with the units of length, I use the square meter as my standard default unit of area. I also add a few more areas:

```
? are: 100 meter^ 2;  
@: 100 meter^ 2;  
? hectare: 100 are;  
@: 10000 meter^ 2  
? acre: 1/640 mile^ 2;  
@: 4046.8564224 meter^ 2
```

Similarly, volumes are by default expressed in cubic meters. Some extra units of volume are:

```
? USgallon: 3785.32 centimeter^ 3;  
@: 0.0037853 meter^ 3  
? IMPgallon: 4545.96 centimeter^ 3;  
@: 0.0045459 meter^ 3  
? quart: 1/4 USgallon;  
@: 9.4633 10^- 4 meter^ 3  
? pint: 1/2 quart;  
@: 4.73165 10^- 4 meter^ 3  
? cup: 1/2 pint;  
@: 2.365825 10^- 4 meter^ 3  
? fluidounce: 1/2 cup;  
@: 2.9572812 10^- 5 meter^ 3  
? tablespoon: 1/2 fluidounce;  
@: 1.4786406 10^- 5 meter^ 3  
? teaspoon: 1/3 tablespoon;  
@: 4.9288020 10^- 6 meter^ 3
```

Reserve the world in seconds.



Holidex II[®], the industry's first bi-modal reservation system, ensures that your room is waiting at over 1700 hotels in more than 50 countries. For reservations just call 800-HOLIDAY.

*A better
place to beSM*



The Super-Calculator in Action

The following sample problems and solutions illustrate operation of the super-calculator system.

Assuming the Earth is a sphere with a radius of 3956 miles, what is its volume in teaspoons?

Solution:

? $4 \pi / 3 (3956 \text{ mile})^3$ in teaspoon;
@: 2.1931217 10^{26} teaspoon

If you purchase 5 liters of gasoline and use it to drive 53 kilometers, what is your mileage in miles per gallon?

Solution:

? 53 kilometer / (5 liter) in mile / gallon;
@: 24.9321412 mile / gallon

According to Einstein's mass-energy relation, $E=mc^2$. What energy is released, in kilowatt years, by the complete conversion of 1 kilogram of mass?

Solution:

? $1 \text{ kg } c^2$ in kilo watt year;
@: 2848035.4213258 kilo watt year

super-calculator: as long as the units make sense in terms of the quantity being entered, the expression is accepted and automatically converted to standard units.

Unit Prefixes

To add to the repertoire of times and distances, I introduced prefixes. I had initially intended to put in such things as microseconds, nanometers, and kilometers, but that would have been cumbersome. I decided instead to make the prefixes separate quantities to which I assigned appropriate numerical values (1000 for "kilo," 1/1000000 for "micro," and so on. Now, to express a time in microseconds, I have:

? 1.23 micro second;
@: $1.23 \cdot 10^{-6}$ second

The prefix "micro" has been split from the root "second," and the implicit multiplication takes care of the conversion. The advantage of this method is that the prefixes are now available for all units in the system; I can work in nanoyards ("nano yard"), megaweeks ("mega week"), or any other such units. All 14 standard unit prefixes, from atto (10^{-18}) to tera (10^{12}), are entered, which yields a variety of length and time units and derived units for velocities or accelerations.

The "in" Operator

After defining all these units, I can enter expressions in whatever units are appropriate for the problem at hand. The manner in which the units are defined assures that times are converted to seconds, distances to meters, areas to square meters, volumes to cubic meters, and so forth. This is fine if I am content to have all results displayed in these units and want to perform complex calculations in a standard set of units such as the S.I. system or the centimeter-gram-second system.

Requiring such a standard puts us in a straitjacket—in the real world, not everything is standardized, and a calculator, to be useful, should be capable of expressing its results in the units I want.

Derived Units

By now I have an array of units and derived units that is quite extensive. By "derived units" I mean things like units of velocity (such as inches per second or kilometers per hour) or units of acceleration (such as feet per second squared). For instance, consider the number of ways to enter velocities. A velocity is nothing more than a distance divided by a time interval; because I have introduced 9 units of length and 8 units of time, there are 9×8 , or 72, derived units of velocity at my disposal. These include ordinary things like miles per hour:

? 55 mile / hour;
@: 24.5872 meter / second

and exotic things like yards per week:

? 1001 yard / week;
@: 0.0015134 meter / second

Any expression with a unit of length in the numerator and a unit of time in the denominator is an acceptable velocity and is converted automatically to meters per second.

I avoid plural forms such as "miles" or "seconds." Using only singular forms, I can enter new units without having to enter their plural forms. This method is a personal preference; other users may be happier defining all possible forms of a unit (i.e., pound, pounds, lb, lbs) so the terms can be used interchangeably.

Each time I add a new unit of length or time, my inventory of derived units expands; the size of the expansion depends on how many other units are already assigned. To get a sense of how far this concept can be taken, consider that I have available in my system 9 units of time (from seconds to centuries) and 17 units of length (from angstroms to parsecs); thus, there are 9×17 , or 153, ways of entering velocities. And there is nothing to prevent the addition of even more units of time or length.

Many derived units are formed by combining lengths and times, as in the case of units of acceleration. Again, any valid expression with one length unit in the numerator and the product of two time units in the denominator is a valid acceleration. This is the salient feature of the

THE ANSWER TO A WISHER WISHER

DISKETTES

Dysan SS/DD	31.00
Dysan DS/DD	42.95
Verbatim SS/DD	23.95
Verbatim DS/DD	39.00
Elephant SS/DD	22.95
Elephant DS/DD	29.00

DISKETTE STORAGE

5 1/4" Mini Plastic Case	1.95
5 1/4" Protector (50 Disk)	18.50
8" Protector (50 Disk)	20.50

MONITORS

NEC 12" Hi-Res Green	158.00
NEC 12" Econo Green	115.00
Sanyo 9" B/W	139.00
Sanyo 9" Green	149.00
Sanyo 12" Green	139.00
Sanyo 13" Color	399.00
USI 12" Amber (Gold)	159.00
Amdek Color I	326.00
Amdek Color II	469.00
Taxan Amber	139.00

PRINTERS

NEC 8023	473.00
NEC 7710	2399.00
Okidata Microliner 92	499.00
Okidata Microliner 93	873.00
Smith Corona TPI	545.00
Star Micronics Gemini 10X	CALL
Star Micronics Gemini 15	CALL

PRINTER BUFFERS

Microfazer 8K	129.00
Microbuffer 16K	209.00
Microbuffer 32K	224.00
Inline 32K	234.00

MODEMS

Novation AppleCat II	289.00
Novation 212 AppleCat	599.00
Novation 212 Add On	339.00
Novation J-Cat	115.00
Hayes Micromodem IIe w/Ter	259.00
Hayes Smartmodem	220.00
Hayes 1200B	468.00

DISK DRIVES

Micro Sci A40 W/O Cont	350.00
Micro Sci A40 W/Cont	429.00
Micro Sci A70 W/O Cont	488.00
Micro Sci A70 W/Cont	569.00
Rana Drive W/O Cont	339.00
Rana Drive W/Cont	409.00
Rana Disk Controller Card	95.00
Tandon TM-100-2	219.00
Tandon TM-55-2	219.00
Winchester 602	776.00
Winchester 603	873.00
Winchester 603E	971.00

HARDWARE

ABT Keypad (New)	98.00
M&R Superterm 80 x 24	248.00
M&R SuperMod RF Modulator	23.00
TG Game Paddles	26.50
TG Joysticks	39.00
TG Select A Port	39.00
Adam & Eve Game Paddles	26.50

Videx Keyboard Enhancer II	115.00
Videx Function Strip	69.00
Videx Soft Switch	27.50
MicroSoft Ram Card	79.00
MicroSoft Z-80 C/PM Card	244.00
MicroSoft Permium Pack	489.00

CALIFORNIA COMPUTER SYSTEMS

7710A Asyn.S. Interface	126.00
7712A Syn S. Interface	146.00
7721A P. Interface Std.	99.00

MOUNTAIN COMPUTERS, INC.

CPS Multi Function Card	130.50
Music System w/Software	309.00
ROM Plus w/Keyboard Filter	155.00

SOFTWARE

Magic Window	74.00
DBase II (Z-80 Card Req.)	424.00
Home Accountant	55.00
Easy Writer Pro	129.00
Easy Mailer Pro	107.00
Lisa 2.5	55.00
Screenwriter II	95.00
PFS Report	74.00
PFS Filing System	79.00
PFS Graph	79.00
Z-Term (Z-80 Card Req.)	79.00
Z-Term Pro (Z-80 Card Req.)	124.00
ACCII Express	65.00
ASCII Pro	90.00
Transend II	105.00
DB Master	154.00
DB Master Utility I or II	65.00
DB Master Graphic Process	69.00
SuperCalc	127.00
SuperCalc II	172.00

VISI CORP.

VisiPlot	155.00
VisiTerm	74.00
VisiTrend/Plot	219.00
VisiDex	184.00
VisiCalc	184.00
VisiLink	184.00

MICROPRO

Desk Top Plan II	184.00
Wordstar	257.00
Mailmerge	169.00
Spellstar	169.00
Calcstar	104.00
Datatar	195.00
Supersort	169.00

APPLE GAMES

Raster Blaster	20.50
Swashbuckler	23.00
Snack Attack	19.75
Deadline	32.75
Zork I or II	26.50
Pool 1.5	23.00
Frogger	23.00

MUSE SOFTWARE

Robot Wars	29.75
Three Mile Island	29.75
Castle Wolfenstein	19.75
A.B.M.	19.00

BRODERBUND

Bandits	24.00
Chop Lifter	24.00
Midnight Magic	24.75
Apple Panic	22.75
Galaxy Wars	19.25
Space Quarks	19.75

ON-LINE SYSTEMS

Frogger	24.00
Crossfire	24.00
Wizard & Princess	26.50
Missile Defense	19.75
Softporn Adventure	23.00
Threshold	28.75
Time Zone	65.00
Ultima II	39.00
Jaw Breaker	21.75
Sabotage	16.50
Cannon Ball Blitz	23.00

SIRIUS SOFTWARE

Speakers	22.75
Space Eggs	22.75
Gorgon	29.50
Bandits	23.00
Jellyfish	19.75
Fly Wars	19.75
Beer Run	19.75
Lemmings	19.75
Cyclods	19.75

MICRO SOFT

Typing Tutor II	19.75
Olympic Decathlon	24.95

EDU-WARE

Algebra	27.95
Compu-Read	21.95
S.A.T. Work Skill	34.00
Fractions	34.00

ANGEL's COMPUTER PRODUCTS, INC. (213) 891-5546

All products guaranteed to be new and free from defects in material and workmanship for 30 days.

MasterCard and Visa accepted on all orders at no extra charge.

\$3.00 for standard UPS shipping and handling on orders under 50 lbs., delivered in the continental U.S. COD up to \$300.00. Call for other shipping and handling on FPO, APO, foreign, and orders over 50 lbs. California residents add 6.5% sales tax.

Prices quoted are for stock on hand and subject to change without notice. Limited quantities on some items. No returns on software that has been opened.

Circle 24 on inquiry card.

Happy Holidays!

YOUR SATISFACTION IS OUR MAIN CONCERN

The "in" operator was created for flexibility. The "in" operator is an infix operator: a function named "in" receives one argument each on the left and on the right, much as do the arithmetic operators +, -, /. The argument on the left is the expression to be evaluated, and the one on the right is the set of units in which the result is to be expressed:

? 55 mile / hour in foot / second;
@: 80.6666666 foot / second

The "operator precedence" of "in" is lower than that of the arithmetic operators; in the example, "55 mile / hour" is the left argument, "foot / second" is the right argument.

The "in" operator does four things:

1. It evaluates the expression on the left, getting a result in standard units. "55 mile / hour" becomes "24.5872 meter / second" because meter and second are my standard units of length and time. This result is not displayed but is held internally in a temporary work area.
2. It evaluates the expression on the right, the required set of units, again obtaining its standard equivalent. "foot / second" becomes "0.3048 meter / second."
3. It algebraically divides the result from step 1 by the result from step 2. The common factors, meter and second, cancel out of the numerator and the denominator, leaving the dimensionless quantity 80.6666666 (i.e., 24.5872 / 0.3048).
4. It constructs a new expression consisting of the numeric result from step 3 multiplied by the unevaluated right argument, which gives "80.6666666 foot / second," the displayed result.

The definition of "in" is very general, enabling the use of complex expressions on the left and the right; physical constants can be used as units, as when I use "g":

? g: 32.174 foot / second ^ 2;
@: 9.8066352 meter / second ^ 2

to represent the standard acceleration due to gravity, as in the following transaction, which I'll call A:

? g 1/2 (5.32 second) ^ 2 in yard;
@: 151.7669029 yard

or as a unit of acceleration in the transaction that I'll call B:

? 60 mile / hour / (7 second) in g;
@: 0.3907325 g

In transaction A, I use g as a physical constant to compute the distance in yards an object would fall in 5.32 seconds (ignoring air resistance). In transaction B, I use this same g as a unit of acceleration, expressing the average acceleration of an automobile going from 0 to 60 miles per hour in 7 seconds.

The "in" operator never produces an algebraically incorrect result.

The "in" operator also protects against getting the wrong dimensions. Because the division in step 3 is done algebraically, the units would not cancel unless they are the same in the numerator and the denominator. In other words, the dimensions of the required units must be the same as those of the result. If this is not true—for example, if the required units are feet, but the expression yields a time interval in seconds—the units would not cancel out, and unexpected units would be introduced to force an algebraically correct answer. For example,

? 2500 mile / (450 mile / hour) in foot;
@: (65616.7979002 second / meter) foot

By introducing the extra "meter" in the denominator, the system is indicating there is a mismatch in dimensions. The answer returned in this case is a time, not a length, which is apparent because the result is not in the units requested.

By similar reasoning, if the result does appear in the required units, I can be reasonably sure the dimensions are being correctly manipulated. This does not always prevent me from using the wrong formula; however, it does provide an excellent check, especially when the algebra becomes too complex for the dimensions to be known intuitively. Something is wrong if I expect an acceleration for an answer but get a frequency instead; these algebraic techniques enable me to detect such errors immediately, regardless of the complexity of the computation.

If I realize I've made an error and want that result expressed in hours,

? @ in hour;
@: 5.5555555 hour

puts the expression right. The "in" operator never produces an algebraically incorrect result; even if I get the dimensions wrong, I can still recover easily, now that I know the result is a time and not a length.

Other Dimensions

Units of time and length are only the beginning. I also need mass (standard unit "gram"), electric charge ("coulomb"), magnetic flux ("weber"), and money ("USDollar"). For each dimension, I can add other nonstandard units. Mass can be expressed in pounds, slugs, tons, atomic mass units, carats, and ounces; electric charge can be expressed in units of the charge on an electron; magnetic flux can be expressed in maxwells; money can be expressed in cents, megabucks, or in other currencies such as yen or pounds sterling (provided I keep the exchange rates current).

Derived units can include a variety of energies (ergs, Btus, joules, kilowatt-hours, electron volts, horsepower-hours, foot-pounds); pressures (atmospheres, millimeters of mercury, pounds per square inch); forces (dynes, newtons); and so on. The total amount of memory available in the computer is the limiting factor; each new definition uses as much as 40 or 50 bytes of storage, depending on the length of its name

Don't ask us...

why we sell one of the most powerful software packages available for only \$250.

Ask our Competition!

Why they sell a Lot Less for more than \$600.

DataVu™ is a Fully Integrated User Friendly Information Management Facility written in assembly language. This package gives you four powerful features which allows you to write or develop your own user friendly application software.

Virtually all small businesses and professionals can take advantage of the following applications:

- Accounts Receivable
- Accounts Payable
- Time Billing
- Inventory Control
- Order Entry
- Payroll
- Word Processing
- Record Keeping
- General Ledger

```
PATIENT REGISTRATION RECORD
-----
Account Number: ..... Balance 30-60: .....00
Last Name: ..... Balance 60+ : .....00

Family Members:
Code First/Middle Name
-----
1 .....
2 .....
3 .....
4 .....

Address: .....
City: ..... State: ..... Zip: .....

Phone (0): .....
Home: ..... Data Registered: .....

Search for Account Number: .....
Search for Home Phone: .....
```

```
select account name balance where balance > 0
-----
1 Luxi-Disk Floppy F. 25.00
2 1003:Printer, Dot M. 75.00

Total number of records read: 2

select service fee from practice
-----
1 Office Visit 25.00
2 Physical 75.00
3 X-Ray 45.00
4 Consultation 25.00
5 Therapeutic Injection 80.00
6 Wellness 25.00
7 Throat Culture 25.00
8 Bone Test 25.00
9 Stool C & S 25.00
10 Office Surgery 95.00

Total number of records read: 10
```

```
MONTHLY SUMMARY REPORT -- ACCOUNT BALANCE
-----
```

ACCOUNT	NAME	(60+)	(30-60)	10-30	BAL. DUE
1001	Disk Floppy F.	25.00	.00	175.00	200.00
1002	Printer, Dot M.	40.00	.00	70.00	40.00
1003	Printer, Dot M.	.00	.00	65.00	65.00
1004	Riso, Granice G.	.00	.00	42.00	42.00
1005	Modem, Dial D.	.00	.00	88.00	88.00
TOTALS		65.00	.00	335.00	438.00

1 Automatic Screen Design (ASD)

This feature permits you to design multi-page forms that you wish to use for data entry and data viewing. You simply layout a screen mask and within seconds, without any programming, a data entry program can be generated in machine code and immediately executable. It supports function keys, wild card search, calculated fields, and many data types including signed numbers.

2 Relational Data Base Management

Having established data base through use of the ASD feature, you may use the Relational Data Base Management feature to manipulate and retrieve these data. You can load up to eight (8) data files at a time and use up to eight selection criteria to retrieve information. This feature provides 12 commands and utility programs to support activities like select, index, join, reformat, multi-key sort, and much, much more.

3 Report Generation

Reports generated from your data base that become routine and have enduring value may be specified by you in detailed format to the Report Generation feature. You can use it to retrieve information from up to eight (8) data files with simple statements. It can perform arithmetic operations and post calculated results to open file or existing data file.

4 Automatic Menu Generation

This feature permits you to design your own menus in which each option may invoke an executable program or a batch file. You simply layout the menu pages, and within seconds, without any programming, your menu program can be generated. There is no need to compile it because it is immediately executable. This feature allows you to construct user-friendly menu-driven application packages.

All This...
for only

\$250* complete

Available for CP/M-80, CP/M-86, MS-DOS, IBM PC, DEC Rainbow, Kaypro, NEC, Sanyo Heath 89/Z100, EPSON QX-10, Micro Decision, North Star, Osborne, Xerox, Apple II CP/M, Televideo, Superbrain, Eagle.

CP/M is a registered TM of Digital Research, Inc.

Thinkers Soft, Inc. P.O. Box 221, Garden City, NY 11530 (516) 294-8104

Introducing a new force in office automation.

The Lanier Business Processor.™

It can change from advanced word processor to personal computer to network terminal, as your company's needs change.

With its 16-bit capability, it's compatible with MS/DOS® software as well as CP/M®.

It can exchange information with an IBM Personal Computer just as easily as with an IBM mainframe computer.



With Lanier's exclusive One-Step,™ it's incredibly easy to use.

You can start with a single work station, then add to its capabilities, even link it to a bigger Lanier network.

CP/M® is a registered trademark of Digital Research, Inc.
MS/DOS® is a registered trademark of Micro Soft, Inc.

© 1983 Lanier Business Products, Inc.

488 BYTE December 1983

Amid the clamor of exaggerated office automation claims, we hesitate to add to the din. But here at last is a product that can do just about anything you ask of it.

It's the Lanier Business Processor, newest brainchild of the company that's been a driving force in office automation for over forty years. Built into it are decades of experience at helping businesses be more efficient, be more productive, and streamline, streamline, streamline.

The Lanier Business Processor does indeed do virtually everything. A word processor that excels as a personal computer. A personal computer that out-words processes even machines designed to do nothing else. A workstation that can be networked to other Lanier systems. And a modular business tool that you can add to, as your company's needs expand. You cannot outgrow it. It will never become obsolete.

You don't have to be an engineering genius to penetrate the secrets of the Business Processor, either. Thanks to Lanier's exclusive One Step™ system, it's incredibly easy to use. Within minutes you can take control. Your people waste less time becoming proficient. Non-typist executives, particularly, can reach advanced word processing skills in no time.

But revolutionary as our Business Processor is, expandable as it is, versatile as it is, what really sets it apart from the crowd is the depth of support we put behind it. Lanier offers you more real person-to-person help than any other company. We show you how to use our machines with your own documents. No canned pitch that never varies for us. We tailor each demonstration to the specific needs of the customer. You see *exactly* how the Business Processor can benefit *you*.

We train your people before the equipment arrives. We watch over the installation like hawks to make sure it goes smoothly. Once your system is installed, if you have questions, our response is to send a real person, not hand you an '800' number to call.

State-of-the-art technology coupled with genuine support make Lanier the force that it is. A force to be reckoned with in the world of office automation.

A force that could be pulling for *your* company.

If you'd like to see a demonstration of the remarkable Lanier Business Processor, simply send us this coupon, or call the Force at (800) 241-1706. Except in Alaska and Hawaii. In Georgia, call collect (404) 321-1244.



No other office automation company can match the kind of support our people give you every step of the way.

LANIER Business Products, Inc.
1700 Chantilly Drive N.E., Atlanta, GA 30324

Name _____ Title _____

Phone _____ Best time to call _____

Firm _____

Address _____ County _____

City _____ State _____ Zip _____

Nov. '83 Byte 4 76 B K3

THE LANIER FORCE

Products to make you more productive.

People to show you how.

and the complexity of the expression describing it. For example, the unit

? newton: kilo gram meter / second ^2;
@: 1000 gram meter / second ^2

takes 44 bytes to store.

To clarify the descriptions in this article, I have spelled out all units. In a practical system, abbreviations would be handy:

? kg: kilo gram;
@: 1000 gram

or

? ft: foot;
@: 0.3048 meter

Abbreviations can easily be defined, subject to the storage limitation. Synonyms can also be used:

? gallon: USgallon;
@: 0.0037853 meter ^3
? kilogram: kilo gram;
@: 1000 gram

Function Definitions

For formulas I want to use repeatedly, I can define functions, as in a programming language. For example, the expression representing the gravitational force acting between two masses, m_1 and m_2 , separated by a distance d , and acted upon by the universal gravitational constant G , is:

$$Gm_1m_2/d^2$$

To use this formula, I first need the constant G :

? G: 6.6732 10^-11 meter ^3 /
kilogram / second ^2;
@: 6.6732 10^-14 meter ^3 /
(gram second ^2)

and then a function definition:

? gravity (m1, m2, d): G m1 m2 /
d^2;
@: gravity

The function "gravity" has three parameters— m_1 , m_2 , and d —that are replaced by corresponding argument

values when the function is invoked. For instance,

? gravity (5.3 kilogram, 20 pound,
5 meter) in newton;
@: 1.2834098 10^-10 newton

expresses in newtons the gravitational attraction of two masses of 5.3 kilograms and 20 pounds at a distance of 5 meters. The arguments "5.3 kilogram," "20 pound," and "5 meter" are substituted in the function definition in place of the parameters "m1," "m2," and "d," respectively. The expression $G m_1 m_2 / d^2$ is then evaluated, and the result is returned to the point of invocation, where the "in" operator picks it up and converts it to newtons. Use of function definitions helps organize difficult problems and saves keystrokes.

Because most computer algebra systems use the LISP language or a variant, it is always possible to define more complicated functions involving loops, conditional tests, and similar operations; details, however, would vary from system to system. I added the one-line function definition described earlier to the muSIMP programming language specifically for this calculating system. A complete language itself, muSIMP embodies elegant modular and block-structured control constructs sufficient for many programming problems.

Temperature Scales

Temperature can be considered a physical dimension such as time or length. The standard unit I use is the Kelvin (K) degree. The other units are:

? Co: kelvin;
@: kelvin
? Fo: 5/9 kelvin;
@: 0.5555555 kelvin

These are units of temperature change, or relative temperature, and are not meant to be interpreted as temperatures on the Celsius (C) or Fahrenheit (F) scales. Relative temperature units are suitable for calculations involving specific heats.

Given the specific heat of water at constant pressure,

? specificheatH2O: 1 calorie / gram /
Co;
@: 4186 meter ^2 / (second ^2 gram
kelvin)

I can ask how much energy, in Btus, is required to raise 6 pounds of water by 30 F°, assuming the water does not change state:

? specificheatH2O 6 pound 30 Fo
in Btu;
@: 179.9749869 Btu

Bear in mind that the Fo in the first line does not refer to the F scale—I am referring to a temperature change, not a specific temperature. (Note: in these temperature transactions, the lowercase o represents the degree symbol.)

To work with actual temperatures in the various scales, I introduce two postfix operators, oF and oC. A postfix operator takes its argument on the left; if I enter

? waterboils: 212 oF;
@: 373:16 kelvin

the function named oF receives 212 as its argument, interprets it as an F temperature and converts it to K. The functions oF and oC are defined as:

? t oF: (5/9 (t - 32) + 273.16) kelvin;
@: oF
? t oC: (t + 273.16) kelvin;
@: oC

with t as the single parameter in each case.

That takes care of entering temperatures on C and F scales. To enter K temperature, I use "kelvin" because the K scale is an absolute scale that originates from a temperature of absolute zero and needs no conversion:

? nitrogenmelts: 77 kelvin;
@: 77 kelvin

Displaying K temperatures presents no problems. If I want to display temperatures on an F or a C

Statpro™

The most comprehensive statistics and graphics ever developed for and sophisticated database workstation the personal computer.

Years of research, development, and field testing have resulted in the most extensive statistics and graphics database program specifically designed for the personal computing environment. STATPRO™ provides the data analysis capabilities and flexibility previously available only on a large computer. Researchers, business professionals, and other data analysts will welcome the breadth yet simplicity of this program! STATPRO requires no previous computer experience, no special command language. Single keystrokes access all of the data manipulation, statistics, and graphics power of STATPRO.

STATPRO allows easy access to its extensive numerical data capabilities.

The strength of STATPRO is found in the functions of its user friendly, menu-driven database. You can easily learn to enter and edit, manipulate, transform, and print out data. STATPRO's searching capabilities allow these functions to be performed on all your data or a user defined subset of your data.

Statistics Modules Menu

- A) DESCRIPTION
- B) REGRESSION
- C) ANOVA
- D) TIME SERIES
- E) MULTIVAR

(ESC) Exit to Master Menu

Choice -> []

Transformations and over 400 conversions are available. You can place the results of these transformations into the same field or any other field in STATPRO's database.

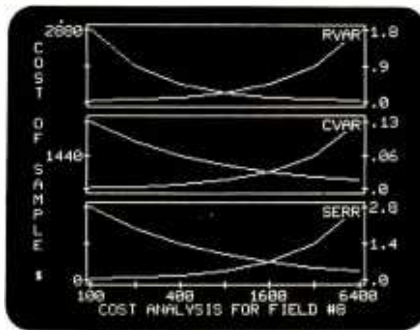

STATPRO offers a comprehensive collection of statistical procedures.

The statistics component of STATPRO contains a multitude of procedures, grouped into the following modules:

Descriptive: Contingency analysis, cross tabulation, normality tests; descriptive, comparative, range and non-parametric statistics.

Regression: Linear, non-linear, stepwise, and multiple regressions; residual analysis and statistical matrices.

Analysis of Variance: Single and nested classifications, two and three way equal and unequal sample size and non-parametric ANOVA.

Time Series: Moving averages, multi-stage least squares, fitted polynomials and trig functions, additive and multiply forecasting.

Multivariate: Principal components, factor, orthogonal factor, oblique factor, pair-weighted cluster, discriminant function, multiple contingency, and canonical correlation analysis.

STATPRO provides graphic representation of your data in minutes.

STATPRO graphics plot all the results of your STATPRO statistical analyses including scatter, triangle regression, and box plots; pie-

charts, histograms, and dendrograms. Further, with STATPRO you can custom edit with any of four character sets from the keyboard. You can also edit using paddles, joystick or special graphics commands. Mix text with data fields. Place multiple plots on each screen. Define your axis limits.

You can save your graphics on a disk for a multiple color "slide show" presentation, or print them out through a variety of compatible printers.

STATPRO documentation wraps up the package.

Although STATPRO software is essentially self-documenting, complete print documentation is provided. This includes a walk-through Introductory Tutorial, a Menu Chart, and a comprehensive User's Guide for each STATPRO component.

STATPRO currently runs on all versions of the Apple® II personal computers. It will be available for the IBM® PC in September.

To find out more about **Statpro: The Statistics and Graphics Database Workstation**, contact your local dealer; or

Call us toll-free at

800-322-2208

In Massachusetts call (617) 423-0420.

You can also call us toll-free for information on corporate purchase through our National Account Program.

 **Wadsworth Electronic Publishing Company**

Statler Office Building
20 Park Plaza, Boston, MA 02116

STATPRO is a trademark of Wadsworth Electronic Publishing Company. Apple is a registered trademark of Apple Computer, Inc. IBM is a registered trademark of International Business Machines, Corp.

scale, however, things get a bit trickier. I add logic to the "in" operator that handles the units of and oC separately. For example:

? nitrogenmelts in oF;
 @: -321.07 oF
 ? waterboils in oC;
 @: 100 oC

The oF and oC units on the right of an "in" cannot be mixed with any other units; they must stand alone as in the above transactions. This restriction does not hold for the units of relative temperature, Fo or Co, which may be combined with other units, as in:

? specificheatH2O in joule / kilogram / Co;
 @: 4186 joule / kilogram / Co

Combining temperature units enables me to ask, for example, what is the final F temperature of a ton of water, initially at 20° C, to which 10 million joules of heat energy are introduced:

? 20 oC + 10 ^ 7 joule / (1 ton) / specificheatH2O in oF;
 @: 72.7399951 oF

Plane and Solid Angles

I handle plane angles by introducing pi and using the radian as the standard unit:

? pi: 3.1415926;
 @: 3.1415926
 ? degree: pi/180 radian;
 @: 0.0174532 radian
 ? revolution: 360 degree;
 @: 6.2831852 radian

I want the normal trigonometric functions, which can be provided by programming them from the relevant Taylor series expansions. After the functions are properly defined, I have:

? sin (30 degree);
 @: 0.5
 ? cos (1/8 revolution);
 @: 0.7071067

The other functions are defined in terms of sin and cos:

? tan (angle): sin (angle) / cos (angle);
 @: tan
 ? sec (angle): 1 / cos (angle);
 @: sec
 ? csc (angle): 1 / sin (angle);
 @: csc
 ? cot (angle): 1 / tan (angle);
 @: cot

In these trigonometric functions, the argument must be a plane angle in radians, degrees, revolutions, or similar units. In some mathematical systems, angles are dimensionless quantities with no units. The definition of angle as the ratio of arc length to radius, which is the ratio of two lengths, suggests a simple dimensionless number. But for this system, I require that angles be entered in appropriate units, not as dimensionless quantities; however, trigonometric functions return results that are dimensionless numbers.

Having units of time and plane angle, I can use angular velocities. The moon's orbital period is 29.53 days, so its average angular velocity is

? omega: 1 revolution / (29.53 day);
 @: 2.4626499 10 ^ -6 radian / second

Taking the angular velocity as a constant (which it is, approximately), what fraction of the moon's face is illuminated, as viewed from Earth, 5 days after the new moon?

? (1 - cos (omega 5 day)) / 2;
 @: 0.2572515

I deal with solid angles in units of steradians or spheres. The standard is steradian, and sphere is defined as

? sphere: 4 pi steradian;
 @: 12.5663706 steradian

Mixing solid and plane angles enables me to define a function

? cone (theta): (1 - cos (theta)) 2 pi steradian;

@: cone

that computes the solid angle in a cone of half-angle theta. The argument must be in units of plane angle (because I am taking its cosine), and the returned value would be a solid angle in steradians. Then,

? cone (90 degree) in sphere;
 @: 0.5 sphere
 ? cone (1 radian);
 @: 2.8883658 steradian

Sexagesimal Notation

I find it convenient, especially when dealing with angles or times, to use base-60 (sexagesimal) notation. To enter a quantity such as 4 hours and 36 minutes, I might use the expression

? 4 hour + 36 minute;
 @: 16560 second

However, it would be simpler to enter this as

? 4:36 hour;
 @: 16560 second

The system recognizes that the colon, when between two numbers, is not an assignment or function definition but is a sexagesimal "radix point." The number on the right (in this case, 36) is divided by 60 and added to the number on the left (in this case, 4). The result is 4.6, which in the example is then multiplied by hour, resulting in 16560 seconds. I can take this one step further,

? 4:36:30 hour
 @: 16590 second

in which case I have entered hours, minutes, and seconds. I can do the same with angles.

? 15:22:09 degree;
 @: 0.2682426 radian
 ? sin (33:57:20 degree);
 @: 0.5585496

By appending the appropriate units, I can enter any quantity in sexagesimal notation.

A Most Convenient Marriage

The New Epson QX-10 and the QuCeS Hard Disk Storage System. Available Now at Your Local Epson Dealer.

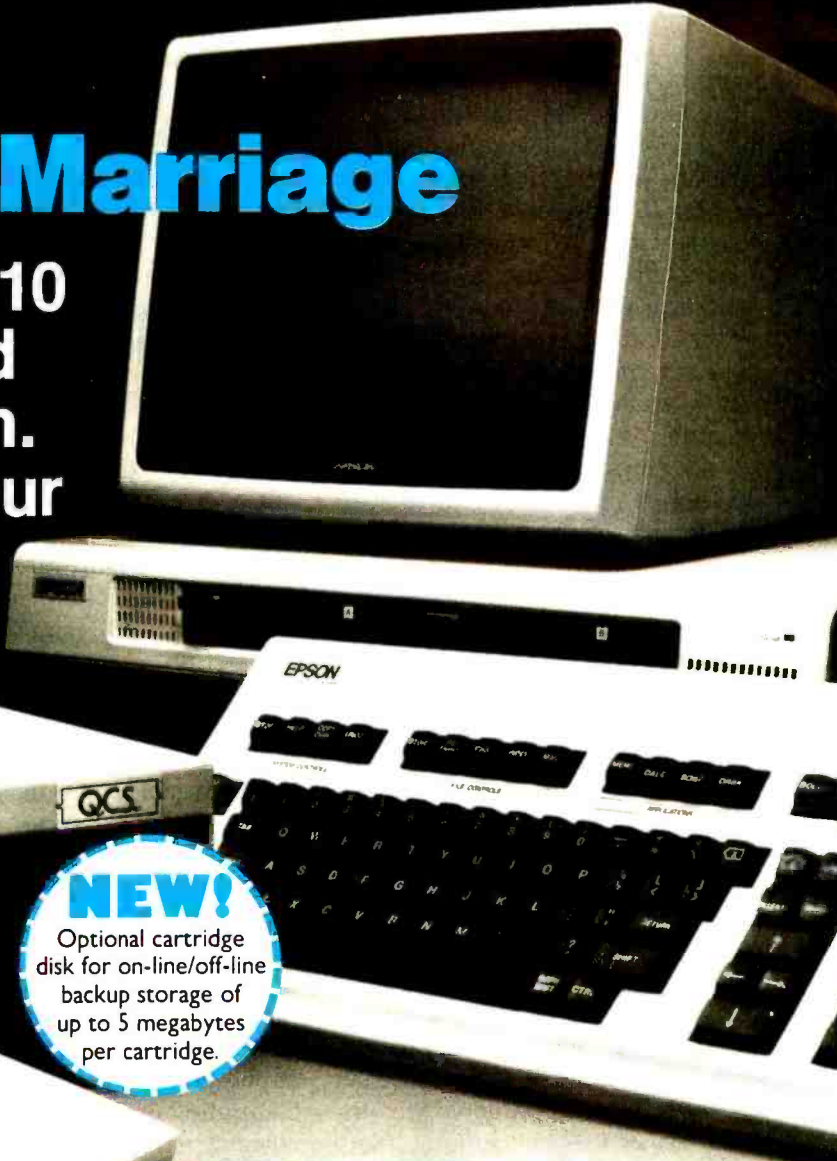

NEW!
Optional cartridge disk for on-line/off-line backup storage of up to 5 megabytes per cartridge.

Convenience is what the revolutionary QX-10 plain language microcomputer is all about. And now it's even more so. With 12 or 20 megabyte mass storage systems manufactured by QuCeS.

Now you can operate your new Epson QX-10 at peak performance with the QuCeS hard disk subsystem. A lot more memory. A lot more speed. And convenience. QuCeS mass storage systems are so reliable that Epson of America uses them in its own offices.

The new VALDOCS software system which runs the QX-10 is supplied by Epson. QuCeS furnishes the utilities such as Format, Back-up, and Test. Altogether an ideal marriage. It won't make your QX-10 any smarter; it'll just make it seem that way. And at a very low price.

Specifications	12 Megabyte	20 Megabyte
Storage Capacity— Unformatted Per Drive	12,749,184 Bytes	19,998,720 Bytes
Storage Capacity— Formatted Per Drive	10.0 MBytes	16.0 MBytes
Formatted Per Cylinder	32,768 Bytes	32,768 Bytes
Platters	2	2
Recording Heads	4	4
Cylinders	306	480
Data Tracks	1224	1920
Performance Specifications		
Rotational Rate	3600 rpm ± 1%	
Data Transfer Rate	5.0 Mbits per second ± 1%	
Access Time	8.33 milliseconds ± 1%	
Average Latency		
Seek Time		
Track-to-Track	3 milliseconds	3 milliseconds
Average	85 milliseconds	120 milliseconds
Maximum	205 milliseconds	310 milliseconds
Settling Time	15 milliseconds	
Physical Dimensions		
Height	5.3"	5.3"
Width	12.1"	12.1"
Depth	16.5"	16.5"
Environmental Specifications		
Operating Temperature	40°F to 95°F / 4.4°C to 35°C	
Non-Operating Temperature	32°F to 135°F / 0°C to 57.2°C	
Humidity (Non-Condensing)	8 to 80%	
Power Requirements		
Voltage	115V AC	
Power	75 Watts	
Q.C.S reserves the right to change specifications without notice or obligation.		



Quality Computer Services

Circle 362 on inquiry card.

3 Quces Drive, Metuchen, New Jersey 08840, (201) 548-2135, Toll free: (800) 631-5944
In Canada: ASAP Computer Products (416) 738-0500

See us at COMDEX/Fall '83, Las Vegas Convention Center, Las Vegas, Nevada, BOOTH #3255

Summary

A computer algebra system can speed scientific and engineering calculations by carrying units along algebraically and converting them as necessary. For each dimension under consideration, the user introduces a standard unit (seconds for time, meters for length, and so forth) and gives all conversion factors at the outset. At any time during the computation, you can introduce new units or physical constants in terms of the ones already defined. You can also introduce function definitions appropriate to the problem at hand, using them to save time and to help organize the work. The result of any computation can be expressed in standard units (the default) or in any units you want as long as the conversion factors have been introduced and the required units are appropriate in terms of the dimensions of the result. Although the super-calculator might be built around any computer algebra system, it is especially gratifying to have this capability in a personal computer for two reasons.

First, large computer algebra systems require large computers, which are not readily available to individuals or to small groups. Now that computer algebra is available for most popular microcomputers, the costs are low (total hardware and

software expenditures could be as little as \$2000), meaning that the kind of system I have described would be feasible for almost any engineering or scientific working group, indeed for almost any individual scientist or engineer. The capability to work in any units, without adding time or increasing difficulty, is a convincing argument for the use of such a system. If you consider the algebra system's capability to detect dimensional errors, the conventional scientific calculator begins to look clumsy by comparison.

Second, the hardware used—a Z80 system with 56K bytes of RAM (random-access read/write memory)—is not unusual; in the current technological environment, it's possible to imagine such a system reduced to the size of an 8½- by 11-inch notebook. Portable computers with typewriter keyboards, one- or two-line alphanumeric displays, and sufficient RAM can handle algebraic manipulations. Thus, we can look forward in the next few years to the availability of portable scientific calculators with the kind of algebraic capability I now have in my personal computer. The applications for such a device include computing miles per gallon, figuring current densities in amperes per square centimeter, and calculating the price of peanuts in dollars per kilogram. Each application has its

own characteristic units, constants and formulas, and each system could be configured by a user for specific problems.

In the past, computer algebra systems have been used for abstruse mathematical problems with formulas too cumbersome to be dealt with manually. (This is one reason most computer algebra is done on large machines.) Affordable computer algebra systems using personal computers and the techniques described in this article can improve the speed and certainty of calculations and will perhaps make the conventional scientific calculator obsolete in a few years. ■

Stuart Edwards is a software designer, consultant, and lecturer. He holds a Master's degree in computer science from the University of Hawaii.

Since submitting this article to BYTE several months ago, I have developed an advanced version of this system that includes a completely new algebra subsystem designed specifically for physical calculations. Write to me at 2993-B Koali Rd., Honolulu, HI 96826 if you are interested in obtaining a copy of the software.

Acknowledgments

Thanks to Dave Stoutemyer and Al Rich of The Soft Warehouse (POB 11174, Honolulu, HI 96828) for giving me a lot of help and encouragement on this project. Also thanks to Natalie Jung for her infectious enthusiasm.

a message to our subscribers

From time to time we make the BYTE subscriber list available to other companies who wish to send our subscribers material about their products. We take great care to screen these companies, choosing only those who are reputable, and whose products, services, or information we feel would be of interest to you. Direct mail is an efficient medium for presenting the latest personal computer goods and services to our subscribers.

Many BYTE subscribers appreciate this controlled use of our mailing list, and look forward to finding information of interest to them in the mail. Used are our subscribers' names and addresses only (no other information we may have is ever given).

While we believe the distribution of this information is of benefit to our subscribers, we firmly respect the wishes of any subscriber who does not want to receive such promotional literature. Should you wish to restrict the use of your name, simply send your request to the following address.

BYTE Publications Inc
Attn: Circulation Department
70 Main St
Peterborough NH
03458

Get the Message Express™. Not the runaround.



© 1983 Lanier Business Products, Inc.

With Lanier's Message Express, you won't be going around in circles trying to reach people who are trying to reach you.

You'll get all your messages, the first time. Because the Message Express records each call exactly as it was said. Then it's stored until you're ready to retrieve it.

It's direct. Private. And completely accurate. There are no lost messages. No missed messages. No confusion. And no telephone tag.

The Message Express was designed to link key executives in an office together. So you can keep in close contact with your co-workers at all times.

Get the Message Express. And get through.



I'd like more information on the Message Express.

Name _____

Title _____

Company _____ Phone _____

Business Address _____

City _____

County _____ State _____ Zip _____

Mail to Lanier Business Products, Inc.
1700 Chantilly Drive, N.E., Atlanta, GA 30324
Or call Lanier toll-free at (800) 241-1706. In Georgia,
(404) 321-1244, collect.

Nov. '83 Byte 176 UK3

LANIER

MOVE AHEAD AT THE SPEED OF SOUND **LANIER THOUGHT PROCESSING™**

Don't let paper messages give you the runaround. For a no-obligation demonstration of the Message Express™ circle 260.

2% plus 48 hours

For all the support you've shown us throughout the year, take 2% off your next purchase PLUS all products in stock will be shipped within 48 hours!!

Software for Apple

BANK STREET WRITER	\$ 48.00
SENSIBLE SPELLER	\$ 86.00
FORMAT II	\$112.50
WORD HANDLER	\$ 45.00
MAGIC WINDOW II	\$108.75
SCREENWRITER II	\$ 89.50
SCREENWRITER PROFESSIONAL	\$137.50
MASTER TYPE	\$ 30.00
COMPUTER SAT	\$ 36.75
FACE MAKER	\$ 25.50
TYPING TUTOR	\$ 17.50
HOME ACCOUNTANT	\$ 51.50
ASCII EXPRESS PRO	\$ 89.50
DATA CAPTURE 4.0	\$ 45.00
dBASE II	\$469.00
PFS GRAPH	\$ 86.00
PFS FILE	\$ 86.00
PFS REPORT	\$ 86.00
VISI CALC	\$187.50
VISI FILE	\$194.00
VISI PLOT	\$162.50
VISI TREND/PLOT	\$232.50
VISIDEX	\$194.00
DESKTOP PLAN II	\$244.00
DB MASTER	\$166.00
DB MASTER VER 4	\$254.00

Hardware for Apple

MBI VIP CARE	\$119.00
ORANGE MICRO GRAPPLER PLUS	\$119.00
16K BUFFERED GRAPPLER PLUS	\$179.00
ABT KEYBOARD	\$ 97.50
MICROSOFT Z-80 SOFT CARD	\$259.00
MICROSOFT RAM CARD	\$ 75.00
M & R SUP'R FAN	\$ 37.50
CPS MULTIFUNCTION BOARD	\$179.00
ROM PLUS W/KEYBOARD FILTER	\$ 45.00
CCS 7710-01 ASYNCHROMOUS INTERFACE	\$119.00

Games for Apple

ZORK I	\$27.50
WITNESS	\$34.50
FLIGHT SIMULATOR	\$42.00
SARGON II	\$44.00
CHESS 7.0	\$46.50
WIZARDY	\$37.50
EXODUS ULTIMA III	\$41.50
BAG OF TRICKS	\$30.00

Accessories for Apple

T & G SELECT A PORT	\$41.50
T & G JOYSTICKS W/TOGGLE	\$45.00
T & G GAME PADDLES	\$27.50
ADAM AND EVE GAME PADDLES	\$27.50
KENSINGTON SYSTEM SAVER	\$75.00

Software for IBM

WORDSTAR	\$371.25
MAILMERGE	\$187.50
SPELLSTAR	\$187.50
MULTIPLAN	\$199.00
MULTITOOl WORD	\$296.25
MULTITOOl W/MOUSE	\$371.25
PERFECT WRITER	\$199.00
PERFECT SPELLER	\$123.75
PERFECT FILER	\$247.50
LOTUS 1-2-3	\$371.25
P.C. TUTOR	\$ 44.00
HOME ACCOUNTANT	\$112.50
C. BASIC	\$149.00
SMART COM II	\$ 89.25
TIM III	\$371.25
PFS REPORT	\$ 99.00
PFS FILE	\$ 99.00
PFS GRAPH	\$ 99.00
PFS WRITE	\$105.00
DESKTOP PLAN I	\$243.75
VISICALC/256K	\$198.00
VISIWORD W/VISISPELL	\$298.00

IBM Hardware

MONTECARLO QUARTO	\$284.00
MONTECARLO GT	\$295.00
VERSAWRITER GRAPHICS TABLET	\$262.50
QUADBOARD 512T	\$211.25
QUADBOARD 256K	\$482.50
MICROFAZER 16P	\$153.56
MICROFAZER 16S	\$178.75
MICROFAZER IN LINE 64S	\$268.12
MICROFAZER IN LINE 32P	\$182.81
U. S. ROBOTICS PASSWORD	\$342.00

Accessories

KRAFT JOYSTICK	\$ 52.00
KRAFT PADDLE	\$ 37.50
MOUSE	\$146.00
T & G JOYSTICK	\$ 52.00
T & G TRACKBALL	\$ 52.00
T & G GAME PADDLES	\$ 35.00

Kangaroo Disk Special

Buy 10 get 1 FREE
\$30.95

Diskettes

DYSAN: TOP QUALITY	
5 1/4" SS/DD (BOX OF 10)	\$34.00
5 1/4" DS/DD (BDX OF 10)	\$39.00
VERBATIM:	
5 1/4" SS/DD (BOX OF 10)	\$23.95
5 1/4" DS/DD (BOX OF 10)	\$43.95
ELEPHANT DISKETTES:	
5 1/4" SS/DD (BOX OF 10)	\$22.95
5 1/4" DS/DD (BOX OF 10)	\$29.95
LIBRARY CASES	\$ 1.75
FLIP AND FILES	\$18.75

Columbia 1600-1 Data Product Personal Computer

FEATURING:
DOUBLE DENSITY FLOPPY DISK CONTROLLER
128K RAM STANDARD MEMORY
2-320 DS/DD DISK DRIVES
IBM PC COMPATIBILITY
16-BIT 8088 PROCESSOR
8 EXPANSION SLOTS
TWO RS232 SERIAL PORTS
CENTRONICS PRINTER PORT



Super 3000 Software Pack Includes:

HOME ACCOUNTANT PLUS
PERFECT WRITER (WORD PROCESSING)
PERFECT SPELLER (SPELLING CHECKER)
PERFECT CALC (ELECTRONIC SPREADSHEET)
PERFECT FILER (DATA BASE MANAGER)

PERFECT SOFTWARE CUSTOMER SUPPORT HOTLINE
FAST GRAPHS (COLOR GRAPHICS REPORT GENERATOR)
SPACE COMMANDERS (COLOR GRAPHICS GAME)
AND MUCH MORE!
Call For Pricing And Information On The Extensive Software Standard With The Computer!

Fan Fold Paper

Prices FOB SP	
9 1/2 x 11 20 lb. WHITE	
3000 ST	\$29.00
14 7/8 x 11 20 lb. WHITE	
3000 ST	\$39.00

RAM Special

4164 Dynamic \$6.00 ea.
We can supply the quality & price Dealers and Manufacturers need.

Surge Protectors Insulators

PEACH	\$ 75.25
LIME	\$ 67.00
ORANGE	\$105.00
LEMON	\$ 46.50
KENSINGTON SYSTEM SAVER	
Your choice	
110V or 220V	\$ 75.00

Riteman Printers

Briefcase Size Printers for Portable Computers
SCALL

Printers

C-ITOH PRINTERS:	
PROWRITER I	
PARALLEL	\$ 379.00
PROWRITER I SERIAL	\$ 499.00
PROWRITER II	
PARALLEL	\$ 649.00
PROWRITER II SERIAL	\$ 699.00
OKIDATA:	
MICROLINE 92: 160 CPS BIDIRECTIONAL WITH 40 CPS CORRESPONDENCE, 80 COLUMN	\$ 472.00
MICROLINE 93: 160 CPS BIDIRECTIONAL WITH 40 CPS CORRESPONDENCE, 132 COLUMN	\$ 899.00
PACEMARK 2350: 350 CPS BIDIRECTIONAL/2 COLOR PRINTING, 136 COLUMN.	
PARALLEL	\$2099.00
SERIAL	\$2199.00
PACEMARK 2410:	
PARALLEL	\$2399.00
SERIAL	\$2499.00
IDS PRISM:	
132 COLOR	\$1495.00
SMITH-CORONA:	
TP-I PARALLEL OR SERIAL	\$ 549.00
STAR MICRONICS:	
NEW GEMINI 10X, IMPROVED THROUGHOUT 120 CPS.	
PARALLEL	SCALL
JUKI:	
L/Q 18 CPS. PARALLEL	SCALL

New

Columbia VP

- 128K Standard
 - 2 DS/DD Drives
 - 9" Green Monitor or Amber
 - IBM Compatible
 - Super 3000 Software Pack
- And MUCH, MUCH MORE

.....\$CALL

Modems

- D. C. HAYES:
- SMARTMODEM 300 BAUD \$209.00
 - SMARTMODEM 1200 BAUD \$525.00
 - SMARTMODEM 1200B \$475.00
 - SMARTCOM II \$ 85.00

- MICROMODEM IIe
W/TERM PACKAGE \$CALL

- NOVATION:
- J/CAT RS232 DIRECT CONNECT \$119.00
 - SMART CAT 1200 BAUD \$455.00
 - APPLECAT II (APPLE) \$289.00

- U. S. ROBOTICS:
- 2 YEAR WARRANTY 300 BAUD \$179.00
 - 1200 BAUD \$479.00
 - PASSWORD \$CALL

New

COMPAQ Portable

- Expandable 256K
- 2 DS/DD Drives
- 9" Green Monitor
- IBM Compatible

..... \$CALL

Hercules Graphics Cards Plantronics Color Graphics Card

..... \$CALL

IBM Compatible Disk Drives

Maynard Electronics
Floppy Disk Controller for IBM PC
WITH PARALLEL PORT \$179.00
WITH SERIAL PORT \$209.00

Shugart Half Height Drive

FOR YOUR IBM \$235.00

Tandon Drive Special

- DS/DD 320K BYTES TM-100-2 \$229.00
- DS/DD 32K BYTES TM-55-2 \$229.00

Disk Drives

- 4th DIMENSION W/CDNTROLLER CARD .. \$279.00
- W/O CONTROLLER CARD \$245.00
- RANA DISK DRIVES ELITE I 40 TRACK \$265.00

Siemans Disk Drives

- DS/DD 320K BYTES OF STORAGE \$245.00

Davong Hard Drives Internal or External

- 5 MEGABYTES \$CALL
- 10 MEGABYTES \$CALL
- 15 MEGABYTES \$CALL
- 20 MEGABYTES \$CALL

IBM® Personal Computers



IBM W/2 TANDON 100-2 DS/DD DISK DRIVES, CONTROLLER CARD, 64K, AMDEK COLOR I, KANGAROO DISKS, LOTUS 1, 2, 3.
ALL FOR \$3333.33

Monitors

- | | | |
|---------------------------|--|--|
| AMDEK: | NEC: | |
| COLOR I \$299.00 | 1201 GREEN \$159.00 | |
| COLOR II \$499.99 | 1212 COLOR COMPOSITE \$299.00 | |
| 300G GREEN \$145.00 | 1215 RGB HI-RES COLOR \$599.00 | |
| 300A AMBER \$159.00 | ZENITH: | |
| | ZVM-121 17 MHZ \$109.00 | |
| | TAXAN: | |
| | AMBER \$145.00 | |
| | PRINCETON GRAPHICS: | |
| | OUTSTANDING COLOR FDR IBM \$499.00 | |

New

Amdek Monitors

- Color I Plus
- Color II Plus

.....\$CALL

You Can Call Us Now

We're open 7 days a week

1 (800) 255-4659 1 (213) 716-1812

Customer Service (213) 716-1824

2% does not apply to specials, offer good through December 24, 1983



THE COMPUTER-LINE™

"Committed to bringing computers within the reach of all Americans"

Now

in Los Angeles 21054 Sherman Way • Canoga Park (In Warner Center) • (213) 716-1812

In Denver 1136 South Colorado Blvd. • Denver • (303) 758-8261

Circle 112 on Inquiry card.

TERMS All prices reflect a 2.9% cash discount. All goods acknowledged faulty on receipt by the customer will be repaired or replaced at our discretion. Customers must call for an RMA number before returning any goods. This facilitates our quick attendance to faulty goods. We reserve the right to repair or return to the manufacturer for repair all goods becoming faulty within the specified warranty period. Any goods (hardware or software) returned for restocking are subject to a 15% restocking fee at our discretion. The charge for cancellation of orders is 20% at our discretion. No returns on software. We accept no responsibility for any false claims made by manufacturers. Prices quoted for stock on hand and subject to change without notice. Specialists in APO and international deliveries. Please add 3% (minimum \$3.00) for shipping. APO add to all prices 5% for shipping (minimum \$5.00). We will calculate exact freight. Please allow a minimum of 2 weeks plus mail time (if an order is mailed in) for receipt of all UPS delivered goods. All goods (other than APO or international) delivered UPS ground.

AN ACCOMPLISHED PERFORMER AT AN ENTRY LEVEL PRICE.

BMC



BMC now offers you a dot matrix printer that delivers sophisticated features margin to margin. The BX-80 prints bi-directional in 40, 80, 71, or 142 columns in normal, double width or compressed text. And you can mix these in any line or print. You can also do superscript as well as superb graphics in character or bit image. And the BX-80 does all this with a changeable print head that delivers up to 30 million characters, with true descenders. The BX-80 gives you an integrated friction feed with built in sprocket tractor that adjusts to fit any size paper up to 10 inches in width.

Other features such as programmable line spacing, strobe pulse synchronization and TTL level technology are part of the BMC tradition of performance and reliability at an affordable price.

See us at Comdex Booth 242

Circle #481 for dealer inquiries. Circle #482 for end-user inquiries.



Setting the Standard in Performance and Price

CALIFORNIA

16830 S. Avalon Blvd., Carson, CA 90746

Telex: 664258 BMC GDNA

Phone: (213) 515-6005

NEW YORK

450 Barell Ave., Carlstadt, NJ 07074

Phone: (201) 939-7079

TOLL FREE: 1 (800) 752-5002

User to User

Conducted by Jerry Pournelle

From Pascal to Modula-2

Dear Jerry,

In "The Debate Goes On . . ." (August, page 312), you refer to a Modula-2 program that can translate programs from Pascal into Modula-2. I am very interested in a program such as this as we are switching the language used at our installation from Pascal to Modula-2.

Could you tell me how I could get a copy of this program? Thank you.

Dan Stanger

**Howard Brandston Lighting Design Inc.
141 West 24th St.
New York, NY 10011**

Alas, I was premature in believing the Pascal-to-Modula program was available. It wouldn't be hard to write, and I'm certain one will be done Real Soon Now.

My apologies for raising your hopes. I'll report on the program as soon as I have one that works. . . . Jerry

Dear Jerry,

You have mentioned several times Niklaus Wirth's new book *Programming in Modula-2*. I have tried to find it in the local bookstores (big bookstores, of course), but each of them said they needed the ISBN number. I checked your articles and also the article, "Modula-2," (April, page 385) for the number. Unfortunately, it was never mentioned. I suppose you have that book. Could you please send me the ISBN number? I think you are about my last hope for finding the book within this year.

Danny Backx

Grootreesdijk 124

B 2460 Kasterlee

Belgium

There is a second, corrected edition: the ISBN number is 0-387-12206-0. . . . Jerry

Dear Jerry,

I have been fascinated by your comments on Modula-2 and the Sage. I bought Niklaus Wirth's book and have given it a fast first reading. I have visited a Sage dealer in Manhattan and seen his 1-megabyte RAM, 20-megabyte disk model running three terminals. I have written letters to both Sage and Volition (no replies as yet). Now I am hoping that you might put me in contact with some

serious users of the Sage/Modula-2 system.

I am trying to evaluate the system for custom accounting and engineering systems that might be constructed from modules that I (and others) would first have to develop. I have been doing this using Osbornes and Victors with dBASE II for local customers. The Osborne's small disk-storage space (even with double density) has always required me to stop the system short of what it might be. The Victor has not been the same problem; however, dBASE II has provided its own rack of difficulties that must be continually dealt with. Although, as advertised, dBASE II has cut application-development time to less than 25 percent when compared to Microsoft BASIC and less than 60 percent when compared to Pascal/M, it is miserable as a language and littered with bugs that Ashton-Tate has demonstrated no interest in fixing. Full-blown COBOL seems too unwieldy for me. The concept of Modula-2 is very appealing, even though I realize that I must develop my own DBMS language before I can use it. That is, unless you have heard of one that will run the Sage and would be better than developing my own.

When I was in Champaign/Urbana, I saw the documentation on a microcomputer-based DBMS called Knowledge Man. It was a DBMS language more elegant than dBASE II and without the constraints. The University of Illinois Information Services had it. No one had yet run it seriously (it is designed for the IBM PC with 256K bytes). Have you heard of or seen it?

Ben Smith

POB 80582

Fairbanks, AK 99708

I first saw dBASE II, then yclept Vulcan, in about 1979. It had the most miserable documentation I've ever seen. One of the users at Cal Tech's Jet Propulsion Laboratories volunteered to write a tutorial introduction to it on her own time. Ashton-Tate bought the program, changed the documents somewhat, and marketed it skillfully. For several years dBASE II was about the best database program available for microcomputer users.

Alas, the program hasn't really kept up. Modern microcomputers are capable of much more than they were when Vulcan was writ-

ten, but dBASE II has improved hardly at all.

I'm not familiar with Knowledge Man. Within a year I expect to see some really good database programs written in Modula-2 for the new generation microcomputers.

. . . **Jerry**

Vector Review Requested

Dear Jerry,

I would like to address a couple of issues mentioned in "Interstellar Drives, Osborne Accessories, DEDICATE/32, and Death Valley" (July, page 323).

As for an appropriate namer for your Compupro mainframe, why not try "Manny" on for size? I realize it may not be elaborate, but it works.

Something I would like to see would be a review of Vector Graphic equipment and software. In the first column of yours that I read, you mentioned that you had heard of Vector's program editor, Scope. I use it quite a bit since I own an older Vector system and do some programming in dBASE II (which has a lousy editor). For someone that does some programming but does not need macros and features found on EMACS and other large systems, it's a good package. Besides that, it's free with the system. The Vector-designed software, especially Execuplan II, its spreadsheet package, is pretty good compared to some others I've seen. I've sold a number of different hardware-software combinations, and the Vector systems have been the easiest to sell, even though they are somewhat more expensive.

Randy Golden

POB 2397

Kilgore, TX 75662

I tried "Manny" but the machine didn't like it. We try to cater to his whims . . .

Some years ago I strongly recommended Vector Graphic equipment, but that was two generations of microcomputers ago; I'm no longer familiar with Vector's hardware or software, and indeed seldom hear much about it. It's my impression that Scope was excellent in its day, but better editors are available now. I don't know whether they'd work with your equipment; my friend Owen Davies, a senior editor at Omni magazine, had a Vector system with a nonstandard operating system and couldn't use foreign programs with it. He finally replaced it. . . . Jerry

From an Ex Ex-Mon User

Dear Jerry,

I note with interest your description of the Ex-Mon monitor adapter for the Osborne 1 in "Interstellar Drives, Osborne Accessories, DEDICATE/32, and Death Valley" (July, page 323). I feel strongly this device should not be recommended.

I purchased the Ex-Mon in November, when I bought my Osborne 1. Within two weeks (of very delicate handling), the device failed. My monitor screen went blank, the 5-inch screen continued to function (indicating that the computer had not failed), and I trundled my machine back to the computer store.

The setup was under warranty. The store replaced my Ex-Mon device, and told me it had had problems with these in the past, particularly when owners had manipulated the Ex-Mon while the computer was turned on. Apparently this can destroy the device.

I used my next Ex-Mon with complete satisfaction, adding an extra length of cable between monitor and computer so I could plug in the monitor without

touching the Ex-Mon adapter. My new one caused no problems, but in retrospect this may be because I hooked up the external monitor only once or twice in the last six months.

The end of the dream came a week ago. I set up a computer station in my home office and plugged in the monitor. The computer and monitor worked well. I rearranged the wiring, unplugging the monitor in mid-cable to do so. When I plugged it back in, the monitor died; that is, the adapter died. Apparently it is more fragile than I thought.

I went back to the store. "Yes," the manager said, "we've had five or six of those that have self-destructed." That seems a lot for a small town such as Napa. I have no information regarding the failure rate of the Ex-Mon, but it seems to be high.

My computer store says another company makes such a device. If I can find out who it is, I will write you that information. If you find out who it is, please put a note in your column.

Dan McMahon
4590 Dry Creek Rd.
Napa, CA 94558

Alas, I have had several other letters with similar complaints. Our unit has worked for about a year with no trouble, but I confess we don't use it continuously because we have a regular Osborne large screen as well.

I'd be glad to try a similar product from another company, but at the moment I don't know who makes them. Perhaps the Osborne User Group would know. . . . Jerry

99/4A Notes

Dear Jerry,

Thanks for kicking TI in "Interstellar Drives, Osborne Accessories, DEDICATE/32, and Death Valley" (July, page 323). Like you, I owned one of their calculators—the SR-56—with 100-step programming and always thought highly of it and TI.

The difference between the calculators and the 99/4A turns on the observation that we could make the calculators do everything they could. Not so with the 99/4A, yet it seems not surprising from the perhaps mistaken viewpoint that the 99 is really a ROMed-up version of the TI 990 computer system.

If the 99/4A is really just part of that series with a clumsy BASIC-GROM system, it seems imperative that these third-party software people get hacking on a chip-replacement set for the operating system. There are three reasons:

First, it looks like an inexpensive concurrent computer is right on the shelves (the 99/4A is \$70 at local stores). Second, it seems to be the most direct approach to both the third-party licensing and hobbyist problems with GROM/GPL. By replacing GROM and the OS with a relocatable OS monitor, TI might just have to back down. (A software-interrupt driven 9900 is very attractive and it's right there to be taken.) And, more personally, as a newcomer to owning a computer, I resent being sold a system with a resident GROM.

Anyway, here are some books that point to better things:

For an explanation about why the 99/4A is really a 990 and, interestingly, a floppy-disk control program, use *Microprocessors/Microcomputers/System Design* published by McGraw-Hill.

For a glimpse of a concurrent 990 (and therefore, 99/4A) as well as what might be a description of where GROM came from, read chapter 5: "Component Software" from *Software Development* (TI #MPA29).

What's more than just a word processor, is also the Random House Electronic Thesaurus™

PeachText 5000™, the complete personal productivity system, offers five complete applications in a single package. PeachText™ word processor is one of the best in the industry and the Random House Electronic Thesaurus gives you instant access to more than 4,400 indexed words and 26,000 synonyms.

PeachText 5000™

Available on the IBM Personal Computer™ and compatibles, plus the Epson QX-10™, the Victor 9000™ and soon the NCR DECISION MATE V™

For a tutorial with software and hardware theory and explanation, read *Fundamentals of Microcomputer Design* (TI #MPB30A) and *16-Bit Microprocessor Systems*, published by McGraw-Hill.

I bought these books to augment TI's Editor/Assembler manual. For learning assembly language they've been a great help. However, it'll take real expertise to do anything about the 99/4A. I hope that the right people will get working. It'll be a while before my 99/4A deserves a name; I'm jealous.

Frederick Hawkins
1020 North 6th St.
Allentown, PA 18102

We've yet to get a TI 99/4A, although I intend to buy one so that I can include at least a few words about it in upcoming books and columns. You obviously know a great deal more about the TI machines than I do; I wouldn't have the faintest idea of how to replace the operating system, and I don't advise anyone to try it.

However, if there's anyone out there who's both mad enough and expert enough to accomplish this, I'd love to hear from him.

Thanks for the tip on books. (See Jerry's article, "The User Looks at Books," on page 519.) I haven't seen those yet; given the explosion in computer books, it's nearly impossible to keep up. . . . Jerry

Simplifying Structure

Dear Jerry,

Structure, structure, and more structure. There is no such thing as a structured programming language, just structured programmers.

I see no use in a language that won't let you do something that needs to be done, just for some arbitrary rule of structure. I'd rather see a language that cooperates with the programmer in the solution of a problem and leaves structure and organization to the programmer instead of a language that fights the programmer if he or she tries to use the language any way other than the way it was written.

Example: I specialize in taking applications programs that run nicely on a big expensive mainframe and trimming them down to run on a small mini. I want a language that will cooperate, not give me more of a problem.

Of course, the programmer must develop certain techniques to self-structure his code, or, as you point out, the program

cannot be maintained. My point is, it should be the programmer who structures his or her code and the language to execute it, not the other way around. A programmer's style evolves, as do his or her skills.

M. W. Cocke
246 West Upsal St.
Philadelphia, PA 19119

Certainly programming style evolves; I was just working on my old Star Trek game and I discovered a number of horrors I'd put in it.

The question of language limitations is important. Marvin Minsky of MIT decries Pascal because it is, as he says, a voluntarily worn straitjacket. It prevents you from doing certain things in the most convenient way. The payoff is that later you will have a much better chance of remembering exactly how you did what. More to the point, someone else will have a fighting chance of understanding what you did.

I once saw Minsky write a Turing Machine simulator in APL. It was a single line of about 80 characters of code. In APL, a single character can stand for "Invert this matrix" or something equally complex. There was no

chance that Minsky or anyone else would ever be able to modify that program.

If all your programs are for your own use and will never be maintained or modified by someone else; if you can guarantee that you will not abandon the programming language for a new one, but will stay familiar with it; and if you'll never want to incorporate elements of old programs into new ones you're writing, then you should probably use the most flexible language possible.

I'm not overly pleased with many of Pascal's limits myself, and I admit that I do most of my programming in CB-80 because Pascal's peculiarities tend to infuriate me. However, since we're switching to Modula-2 here at Chaos Manor, a lot of the Pascal debate has become moot.

Do recall that my columns are largely oriented toward the user. I'm always pleased when a professional programmer finds something to like. . . . Jerry

A New Warranty

Dear Jerry,

This letter involves the dreaded software licensing agreement. You have had

What's more than just an electronic thesaurus, is also Spelling Proofreader.

PeachText 5000™, the complete personal productivity system, offers five complete applications in a single package. With its standard 20,000 word dictionary, Spelling Proofreader can check a 10,000 word document for errors in less than two minutes. You can also add words to create specialized dictionaries.

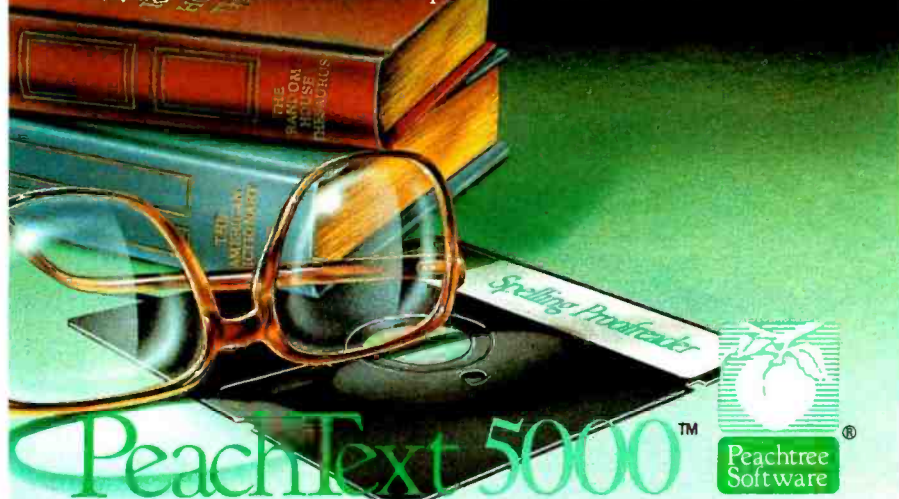

Available on the IBM Personal Computer™ and compatibles, plus the Epson QX-10™ the Victor 9000™ and soon the NCR DECISION MATE V™

occasion to get upset about the nonsense that is usually contained in these things, and so have I. This led me to have a little fun with them, as seen in the "Viewpoint" column that I wrote for the February 28, 1983, issue of *Infoworld*. My hope was that people would start enclosing copies of this warranty with their payments to software companies. It didn't happen, but life goes on.

Dave Wilson
635 Wellsbury Way
Palo Alto, CA 94306

For those who didn't see it, Mr. Wilson's hilarious "warranty" of the check accompanying payment for software included such terms as "This check is valid for 30 days. Should the paper it is printed on disintegrate, you be sure to let me know" and "This check is provided 'As Is' without warranty, either express or implied, including, but not limited to, the implied warranties of financial value or liquidity. The entire risk that this check can be cashed, or even that it is drawn on a bank that actually exists on the planet Earth is assumed by you. Should the check prove defective, you—not I—assume the entire cost of all necessary, but fruitless, efforts at reimbursement."

I too regret that the micro community didn't adopt his "implied warranty" which, naturally, became effective when the check was cashed. . . . Jerry

Two for Public-Domain Pascal

Dear Jerry,

You asked for information in "Epson QX-10, Zenith Z-29, CP/M-68K, and More" (August, page 434) on how to get the public-domain version of UCSD Pascal running on a system using a Compupro Disk 1 controller. Unfortunately, I have been having problems getting Version IV.0 UCSD p-System from Softech Microsystems running using the Disk 1. If the two versions are similar enough I may be able to use information about the public version to get the commercial version running. Let me define my problem.

The computer I have been working on has a Z80 processor, 64K RAM, a Compupro Disk 1 single-density/double-density disk controller, and two 8-inch disk drives. The operating system is CP/M 2.2, which uses the Compupro-supplied GBBIOS with changes only in the con-

sole and printer routines.

First I tried to use the PASBOOT program to boot up the CP/M-adaptable system. Since the p-System disks were single density, it was necessary to recalibrate the drives before trying to read the secondary booter, which refused to be read anyway.

Next I obtained a working p-System disk from another computer. I changed the PASBOOT program to include disk routines from the Compupro-supplied GBBOOT program. I also modified the GBBIOS to do only single-density reads and to run below CP/M at B800 hexadecimal. The attempt to boot was partially successful and the secondary booter was read in, but an error, "Can't find SYSTEM. PASCAL," occurred. Since the same disk will boot up on its own with other computers, I assume that this file is present. The interleave and skew values I used are correct for this disk. There were also no errors occurring during the BIOS disk routines.

I wrote both Compupro and Softech Microsystems and was told that the problem is a nonstandard BIOS and that I will have to use the full-adaptable system.

If you receive or already have information on getting either version of Pascal running, I would appreciate it greatly if you would send it to me. I would especially like to receive a working SBIOS for use with the Disk 1.

Dwight Irving
Chemistry Department
University of Idaho
Moscow, ID 83843

Alas, your problems are typical of others reported to me. All I can say is that there is a version of public-domain UCSD Pascal running at Cornell University; but so far, no one has shown me how to get it operating on my machine. I keep hoping. . . . Jerry

Dear Jerry,

If you successfully get the public-domain UCSD p-System up on your Compupro, will other users like me be able to do so? In other words, will somebody please document the installation so the rest of us can install it also?

I am the service manager of a small computer dealership (Apple, DEC, Osborne, Victor, and add-ons). I have grown accustomed to the Apple version of UCSD/p and recognize the value of its transportability. I have seen the Sage in action and would like our store to carry it (no floor plan for it yet, or we would

What's more than just a spelling proofreader, is also PeachCalc[®] electronic spreadsheet.

PeachText 5000[™], the complete personal productivity system, offers five complete applications in a single package. PeachCalc provides a large electronic spreadsheet with up to 254 rows and 63 columns suitable for text, numbers and formulas.

PeachText 5000[™]

Available on the IBM Personal Computer[™] and compatibles, plus the Epson QX-10[™], the Victor 9000[™] and soon the NCR DECISION MATE V[™].

Peachtree Software[®]

have it now), which would mean more exposure to UCSD/p. Both Victor and Osborne have versions of the p-System up and running. This means that my job will soon involve answering questions about the p-System, and I would like to give customers the right answers from my experience. I am also rather fond of Pascal.

It was my intention to buy the general version of the UCSD p-System from a vendor in San Diego, try to hook onto the CBIOS of C/PM-816, and see what happened. If there is an easily installed, public-domain version of the p-System, I am very interested, even to the point of getting it, installing it, and making the installed version for Compupro 816 public. I had not even heard of a public version until your mention in the August User's Column.

Ed Karns
Executron Systems
628 East Washington St.
Petaluma, CA 94952

I really know no more than that a Cornell University professor told me there was an S-100-bus version of UCSD Pascal and that it was legally available.

A number of people I respect are fond of UCSD Pascal and its operating system. As I've mentioned before, Carl Helmers, former editorial director of BYTE, has five Apple computers running UCSD Pascal; he's so fond of them that his personalized automobile license plate reads "P CODE."

If I learn anything more, I promise I'll feature it in the column. . . . Jerry

What's the Next Bus?

Dear Jerry,

The S-100 bus has served long and well, but as you well know the day will soon be upon us when 32-bit microprocessors are relatively inexpensive and multimegabyte RAMs are within the reach of homebrews without having to sell the furniture. It is useless to pooh-pooh the idea with comments like, "What will one do with all that power and memory," as the ideas and applications will rise to the challenge. (You only have to think back a few years when 16K became available for a micro.) Given the limitations of the S-100, where are the hackers going to migrate?

I am not asking for a specific answer but thought that this subject would be appropriate for discussion reviewing the

merits and disadvantages of the Multibus, Versabus, VME, IEEE-896, "Futurebus," et al.

I am already thinking about the VME, and from what I have read, I think that this may be the best. Obviously, my thinking is irrelevant, as I would have to follow the manufacturer's offerings.

Justin Farnsworth
65, rue Chauveau
92200 Neuilly
France

I agree that the question is more than interesting. I don't have an answer. My friend and associate Tony Pietsch developed a project known as the PI Buss, which he claims has advantages over all the others, but I don't know who would develop and market it.

Perhaps some other readers will have more information. . . . Jerry

Three Busy Bees

Dear Jerry,

You have said several times that you hope the computer market is never fully sewn up by large companies. I wonder if

I might trouble you for an opinion for a "garage company"? I daresay that our situation is, if not unique, then far from ordinary. We keep getting kicked out of the garage by our parents. If that seems like a rather unusual company, allow me to explain.

The company is B, B & B Electronics (1 Jill Dr., Carnegie, PA 15106), named for the three of us foolish enough to propose a company. We do not legally exist as a company and two of us are still minors. This didn't stop us from pursuing computer design over the last three and a half years. Before we graduated from high school last spring, we succeeded in getting our first micro running without any formal training and without assistance beyond the kindly loan by U.S. Steel of a ROM-burner. In recent months we have redesigned our machine, and it is now a self-contained, if jury-rigged, affair that no longer requires an external terminal. We are sufficiently happy with what we now have to refer to it as our "prototype," even though we have no way of producing or marketing it.

While we iron out a few minor bugs, we are casting about for ideas to add a

What's more than just PeachCalc[®] electronic spreadsheet, is also List Manager.

PeachText 5000™ the complete personal productivity system, offers five complete applications in a single package. List Manager is a simple data base manager and list-file organizer. It gives you complete control over mailing lists, labels, files and other reference aids.

PeachText 5000™ Peachtree Software[®]

Available on the IBM Personal Computer™ and compatibles, plus the Epson QX-10™, the Victor 9000™ and soon the NCR DECISION MATE V™.

(1a)

FRONT VIEW

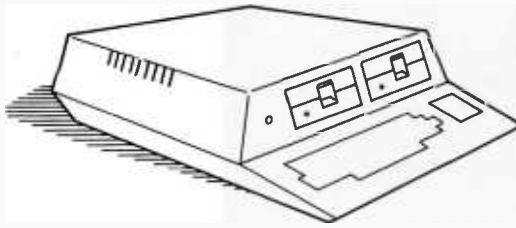

(1b)

SIDE VIEW

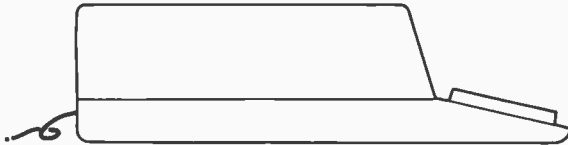

(1c)

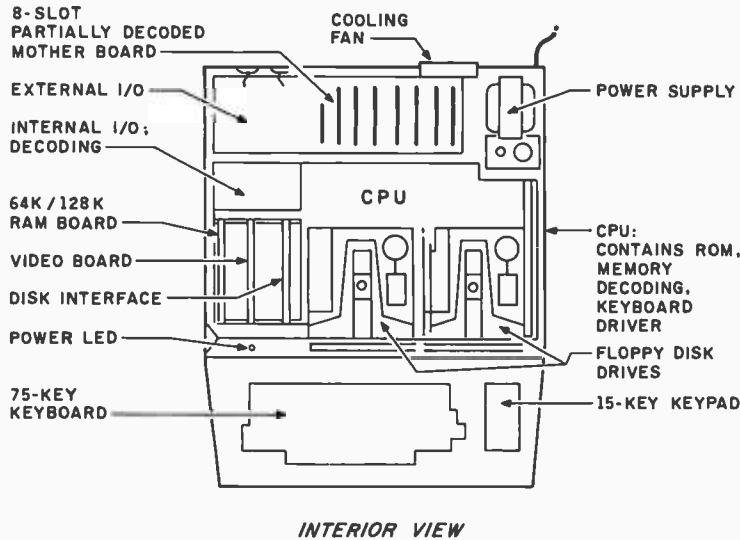

Figure 1: The proposed production model of the BBB-1.

- 1a: The front view showing dual floppy-disk drives.
- 1b: The side view showing relative proportions.
- 1c: The interior view of the homebrew computer.

special touch to our machine that might interest somebody in the design. Meanwhile, we've had a great deal of fun and learned quite a bit in the process. People who congratulate us are never turned away, and advice offered is accepted with open minds (even if we do promptly discard it). With this in mind, do you have any suggestions or criticisms to offer us?

In the optimistic days, before it was demonstrated to us that building a computer was impossible, Bob Barker (not the one on TV, but the first B in our company) and I agreed to send you one of our first production models (see figure 1).

The system we have now is a Z80-based microcomputer with 64K or 128K of dynamic RAM, 16K of ROM, and 2K of video RAM. We have a 90-key keyboard (see figure 2) on the drawing board shown with the proposed key layout, meaning it's what we want, but can we find keycap manufacturers who have the proper legends? You may recognize the layout as being drawn almost directly from the H-19, of which the three of us are fond. We can actually use any key layout by reprogramming the keyboard encoder; at present we have a stock Jameco keyboard on the prototype.

The video screen is currently 25 lines of 64 characters, which will change to 80 characters if we ever get around to buying a faster crystal. The display is generated by the MC6845 video-display chip found in the TRS-80 Model II/12/16. (By the way, did you know it's possible to pro-

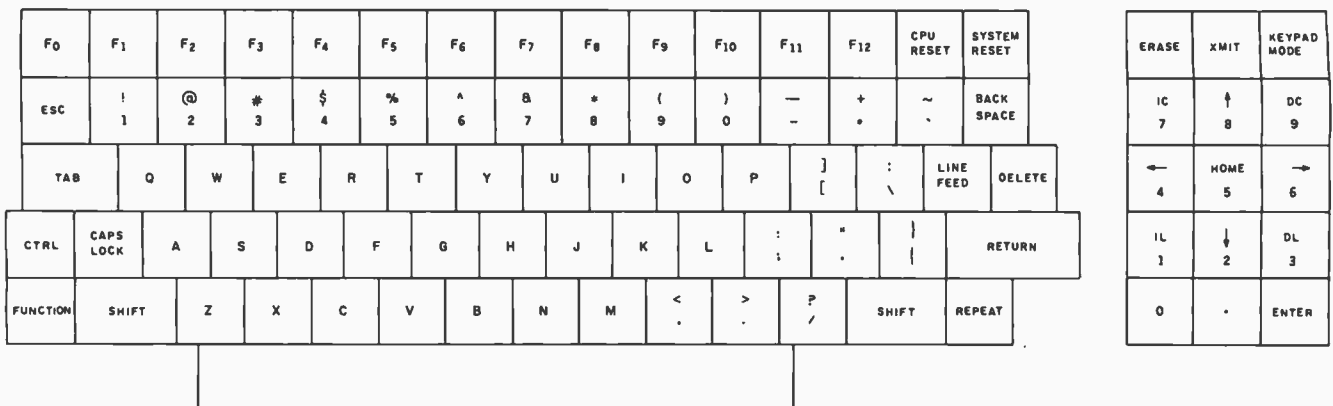

Figure 2: The keyboard of the BBB-1.

gram a Model II/12/16 to burn out its own monitor?) The 128-character set is produced by an 8 by 8 matrix copied largely from the character set of the Ohio Scientific Superboard II of days gone by, plus their reverse video complements. The ways in which we revise the video section depend on whether the machine will be intended for use on TV sets or not.

Something else not yet worked out is disk storage, but Bob is working on it. He also modified the memory decoding and bank switching to allow CP/M Plus; he and Roger Brockenbrough (the third B) have agreed that implementing such a system and developing a CBIOS will be my job. (They make me do all the software; I wrote a BASIC interpreter, machine monitor, and a cassette-operating system.)

The software is in ROM at present: a tiny BASIC I'm almost afraid to admit having written, a monitor hardly above the OSI CIP stage, and the I/O support routines. On initialization, these programs all bank-switch themselves nicely into RAM so the user never sees the ROM. This transfer, with the Z80 block-move instructions, is too fast to even notice on reset.

Since the summer has gone while we worked and we are out of high school, things are starting to wind down for our grand and glorious ideas. By the time we get out of college, however, our knowledge will no doubt be out of date. We predict our current design to be laughably outdated within a year or two at the most.

Please do not criticize our lack of Microsoft BASIC. Last December we wrote a respectful letter to Microsoft asking if we could possibly license any existing BASIC at all, to which they never responded. I then wrote my own, which I hope I never have to do again: it's murder! Also, my end product is only marginally more developed than the tiny BASIC found built into some processor chips (such as the Z8671). Rest assured that we would never even think of marketing any product with my current BASIC 1.3 in it.

Mark Bereit
343 Rockfield Rd.
Pittsburgh, PA 15243

I'm impressed. I doubt you chaps will have any problems finding suitable positions in the computer world.

The days of fortunes made through new full-blown computer designs built in a garage for a few hundred dollars are, alas, just about over. Wozniak and Jobs (Apple) and David Jackson

(Altos) obviously had the right ideas—but they were also supremely lucky in their timing.

There are still openings for after-market equipment for popular machines like the Commodore 64, Atari, IBM PC, and such, and a very good market exists for IEE-696 (S-100) boards that do new and different things. Most successful garage companies, though, will probably involve software. . . . Jerry

Languages of Choice

Dear Jerry,

I am an engineer and not a computer scientist. As an engineer, I am interested in using and writing programs that solve problems, not programs that are works of art. These tend to be much larger than your typical one-run on a microcomputer, generally running from 1000 to 20,000 lines of code. In addition, they may handle amounts of data up to 100,000 numbers or more in an iterative fashion. I have to be concerned with cost to my client, so speed and the charges are important, especially since computer charges may be 10 to 50 percent of some of the studies that my company does. As computers be-

come more powerful, we will find more problems to use that extra power. Currently, certain studies that we would like to do are not economical and would require a 10-fold drop in computer charges before we can consider them.

Now, engineers use FORTRAN (that language hated by you and computer scientists) not to spite anyone and not because of tradition, but because it has two major advantages besides speed of execution. The first is *portability*. When programs are written to closely adhere to the ANSI 66 (or 77) standards for FORTRAN, it is easy to move programs from computer to computer. For example, a team of two engineers moved a 50,000-plus-lines civil-engineering program from a Honeywell (36-bit word) to a Harris 500 (24-bit word) in about four hours of editing and compiling. I have worked with programs written by research organizations for computers other than the one I use, yet I only have to change 4 to 10 lines (clearly identified in documentation) out of 10 to 20,000 lines of code—and then have it compile and run correctly the first time. We have had a 3000-line program (written by our company's engineers) on

What's more than . . . PeachText 5000™ the complete personal productivity system, offers five complete applications in a single package—PeachText™ word processor, Random House Electronic Thesaurus™, Spelling Proofreader, PeachCalc™ electronic spreadsheet and List Manager.

PeachText 5000 is available on the IBM Personal Computer™ and compatibles, plus the Epson QX-10™, the Victor 9000™ and will soon be released on the NCR DECISION MATE V™.

Manufacturer's Suggested Retail Price

\$395

prices may vary

The IBM Personal Computer is a trademark of International Business Machines Corp. • Epson QX-10 is a trademark of Epson America, Inc. • Victor is a trademark of Victor Technologies, Inc. • The NCR DECISION MATE V is a trademark of the NCR Corporation. • Random House Electronic Thesaurus is a trademark of Random House, Inc.

Peachtree Software **Unmistakably Peachtree**

five different computers and compilers in the last year and a half—and it can typically be brought up in less than 2 hours. How many of your favorite languages are available on as broad a range of computers and capable of this degree of portability?

The second major reason is *dynamic dimensioning of arrays*. First, subroutines can receive arrays of any size and shape.

```
SUBROUTINE (ARRAY, M,N)
DIMENSION ARRAY (M,N)
```

Granted, this can lead to errors in the hands of the careless, but it also allows a powerful library of standard subroutines to be built up (for example, the IBM Scientific Subroutines Package in the public domain), compiled, and then kept in a library. These subroutines are source-compatible with any ANSI standard FORTRAN compiler, thus reducing the amount of work that the user must do.

Also, multiple arrays can be allocated out of a large pool vector after a few parameters are entered for the problem. Since these parameters can change from run to run (thus changing the size of the arrays), the use of a pool means that we do not have to edit and recompile the program every time certain parameters change—as they constantly do in engineering. Before I implemented this feature to a program, we had to recompile one program once a month (a 4- to 6-hour job)—now it is once a year, when we add a new feature to the program.

I know that subscript checking is non-existent in standard FORTRAN and its string-handling capabilities are abysmal, but I can live with this more so than I could with the array limitations and non-portability that you are finding in Pascal. Currently, the only language that might possibly replace FORTRAN is C, and only if enough companies accept the de facto Bell-standard version.

I also know of your dislike of Microsoft BASIC on microcomputers, but its dynamic arrays and flexible Chain (which lets a program modify itself) allow it to be used in ways simply not possible with CBASIC or any other BASIC. I do not know of any other version of BASIC or any other language on 8-bit microcomputers that will allow me to do what I can do in my POL/PS. (See Mark Finger's three-part article, "Problem Oriented Language," in *BYTE*, December 1982, January and February 1983.) I noted the problems of unreadable code and line numbers per

line, but instead of abandoning the language, I wrote a series of utilities that allows me to have relatively readable code with comments yet do development more easily than with a compiled language. These programs have been released to the public domain (under the typical public-domain copyright limitations—that is, not for resale for more than a small copying charge). I will still furnish them for the \$30 indicated.

I envy those versions of BASIC that have local variables in their subroutines, but CBASIC is best used in business-type applications where the general data structure and size are known beforehand. In technical areas, the dynamic arrays and self-modifying features (to incorporate a user-defined equation, for example) are more important.

Mark Finger
2439 Overlook Circle
Lawrence, KS 66044

I don't hate FORTRAN. When I was a graduate student, we had to program the IBM 650 in machine language, and we would have sold our chances for graduation for FORTRAN.

However, I still don't recommend FORTRAN as a language microcomputer users ought to learn. Its portability is commendable but applies largely to mini and mainframe computers; microcomputers have the usual problems of disk-format compatibility and disk file structures to add to the confusion. And the array problem in Pascal is certainly severe; I've cursed it often enough myself.

However, most computer users will begin with interpreted BASIC. When they grow weary of that, they look for a compiled language. I simply would not recommend that their first choice be FORTRAN.

Those who already know FORTRAN from larger machines are often disappointed when they discover the limits of most microcomputer implementations but are usually able to adjust. That's fine for them. FORTRAN is likely to be the language of choice for many special applications, too.

Your impression of compiled CBASIC (CB-80) is incorrect. CB-80 permits dynamic arrays, has an excellent library manager for precompiled code segments, and has chaining at least as good as Microsoft's MBASIC.

I remain unrepentant: FORTRAN is not what I'd recommend microcomputer users learn when they tire of BASIC. Go out and learn Modula-2. That's the wave of the micro future.

Where in the world did you learn to lump me in with the computer scientists? . . . Jerry

Software Before Hardware

Dear Jerry,

In regard to your statement in "Zenith-100, Epson QX-10, Software Licensing, and the Software Piracy Problem" (June, page 411): "The one thing you won't persuade me of is that you've much chance of handling the records of 100,000 policy holders on any kind of microcomputer I'm going to see in the next few years."

Sorry, Jerry, but Advanced Management Systems Limited (a New Zealand company) has developed a complete package of software for the DEC LSI-11/23 microcomputer, including operating system, compilers, editor, database system, etc., that will support up to 40 terminals on a 256K-byte DEC LSI-11/23.

We call this package AMPS (Advanced Management Programming System) and believe it has more advanced features than most mini and mainframe systems. The first application for this software was for Royal Insurance, which has over 100,000 policy covers on its New Zealand head-office computer. Royal has one LSI-11/23 computer in each of its six main branches.

In case you consider the LSI-11/23 to be a minicomputer rather than a micro (although DEC calls it a micro), it is worth mentioning that we intend making a version of the software for the 68000, and I am confident it will be able to support a hundred terminals.

It is my contention that virtually all manufacturer-supplied software is grossly inefficient and wastes 90 percent or more of the computer's power. This has been demonstrated by developing an on-line system on an IBM 370/135 that runs over two hundred terminals, as well as by the AMPS software on the LSI-11/23. In each case, the manufacturer's software will support only about one-tenth this number of terminals.

The days of the big mainframe computers are numbered, as Intel, Motorola, and National Semiconductor bring out chips with more and more power. Existing software available on 16- and 32-bit microcomputers is generally inefficient also. With good software, machines like the 68000, the DEC 11-J, the 80286, and the NS-32 series will totally collapse the computer market, as they can economically cover the whole range of products from single-user micros to superminis and medium-sized mainframes. For larger systems, the most economical solution will be to use multiprocessor versions of the

TIC TOC WE'VE GOT THE CLOCK

Enhance the performance of your IBM® PC or XT with RAM +3, a new multifunction board from Seattle Computer. It combines the most needed functions for your PC on a single card. This leaves the PC's other expansion slots open for your future needs. Here's what you get:

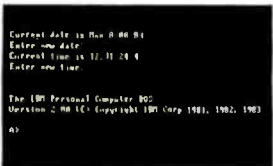

Lithium Powered Clock The RAM +3 clock/calendar eliminates the need to manually input the date and time each time you power up. And the inexpensive lithium battery ensures that the clock keeps accurate time even when the power is off.

RS-232 Serial Port It's an easy way to connect letter quality printers, modems and other peripherals to your IBM. It's compatible with IBM's Asynchronous Communications Adapter and can be selected as either COM1 or COM2. No translation software is required.

Parallel Printer Port Designed to operate most parallel printers, it is functionally identical to and completely compatible with the IBM Printer Adapter.

Memory Options To increase the memory capacity of your IBM, there are five RAM +3 memory options: 0k, 64k, 128k, 192k, and 256k. The memory expansion boards are socketed and expandable in 64k increments to 256k. For users who do not need to increase the memory of their PC but want the clock and added port capabilities, a no memory, unsocketed RAM +3 is also available.

FLASH DISK™ and FLASH PRINT™ To dramatically improve your PC's throughput, FLASH DISK lets you designate as much as 576k of RAM as a disk drive. And with FLASH PRINT, you can compute and print simultaneously. FLASH PRINT is a user definable buffer that lets you select, in 1k increments, as much as 63k of memory as a buffer. Your printer can run at its maximum speed while you continue to compute.

RAM +3 is Available and Affordable Seattle Computer RAM +3 boards are available through a nationwide network of retail outlets including ComputerLand stores. For the location of the outlet nearest you call toll free:

1-800-426-8936.

RAM +3 prices start at \$210.00*

*(Unsocketed, no memory version;
\$395 for the expandable 64k version)

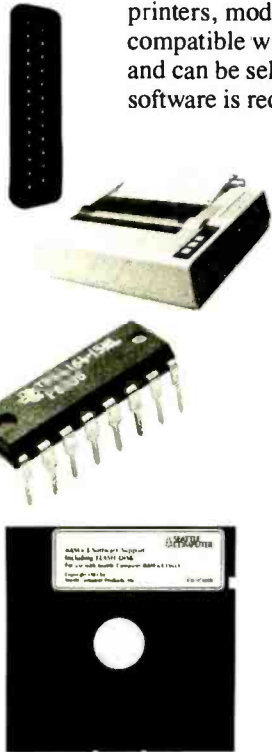
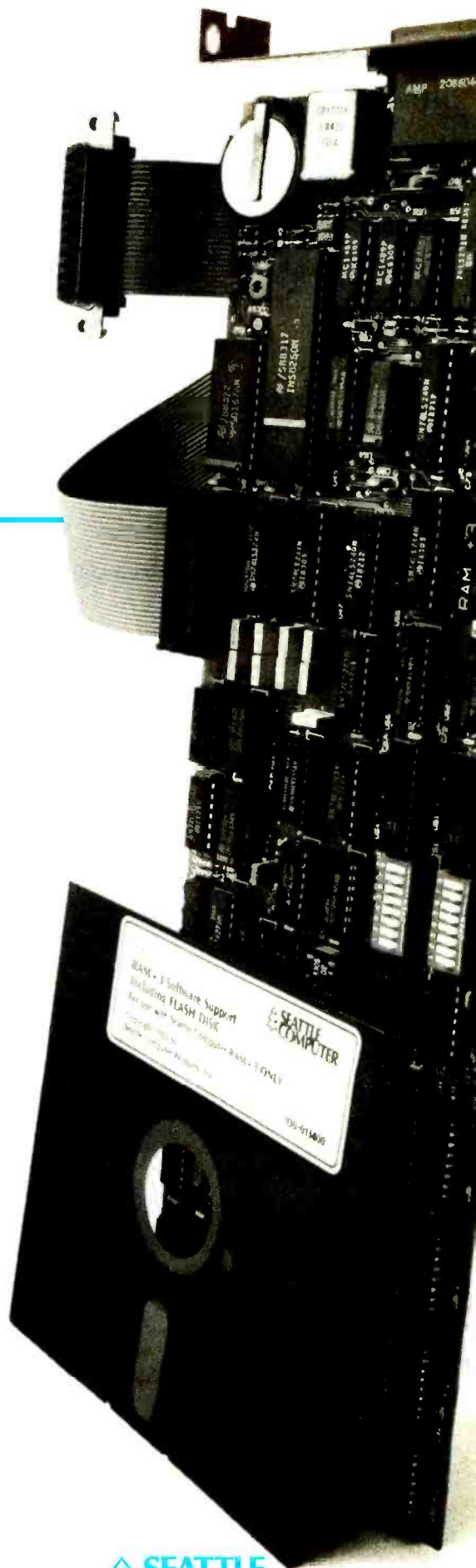

RAM +3 Software Support
Including FLASH DISK
For use with Seattle Computer RAM +3 ONLY
Copyright © 1983 by Seattle Computer Products, Inc.
100-01400



Seattle Computer Products, Inc.,
1114 Industry Drive, Seattle, WA 98188

BYTE December 1983 507

®IBM is a registered trademark of International Business Machines Corporation
Circle 381 on inquiry card.

same machines.

The real changes will only occur, however, when computer users learn to choose their software and then get some hardware that works with it, rather than the other way around. The prime-number benchmarks published by BYTE amply demonstrate that the variation in application-execution speed using different compilers for a given machine varies by a factor of 1 to 1000, which far exceeds any hardware price/performance variations. Programmer productivity also varies by a factor of more than 1 to 10 on different software, again indicating that the software should be chosen before the hardware.

R. Tomes

Advanced Management Systems Limited
11 Huron St., POB 33-726
Takapuna, New Zealand

Of course I consider the LSI-11/23 a mini-computer, and so would just about anyone else.

However, I agree that I was rash in my statement; the Sage IV with hard disk can already manage 100,000 policy records, and I'm rewriting my "Minimum Data Base" to

allow it to do much the same thing (although I've no need for that many records!).

I can't recall why I ever said a silly thing like that. I wrote it in December 1982 (the pipeline was much longer then; it's down to a couple of months now), but alas, I knew better then. Perhaps I can plead too much Christmas cheer? Stay well. . . . Jerry

For Your Information

Dear Jerry,

In addition to the deficiencies of Superfile, which you have already mentioned in "Terminal Solutions, Manual Madness, BASIC Bits, and Info Helpers" (April, page 324), there is one more I have never seen reference to in print: the program does not prevent one giving a file an illegal name.

Some months ago I was called to the rescue of a friend who was having problems: "I used the Superfile utilities program to rename a file, and I can see the new name in the directory, but when I try to do anything with the file, the computer can't find it." It took only a moment to see what had happened: my friend had spec-

ified the new name as "MAIL LIST" (including the space), and Superfile had accepted this, although the final "T" had then been dropped, producing a file named "MAIL LIS" (still with a space). Any subsequent attempt to read, print, rename, or even erase the file then simply resulted in the message "MAIL?" or "NO FILE," since CP/M saw the space as marking the end of the filename and was looking for a file called "MAIL." Since we did not have DU (disk utility) or any similar program on a disk of the right format, the only thing I could think of was to make sure all the other files on the disk had a file type in their names, do "ERA *" to get rid of this otherwise inaccessible file (fortunately it was the index file rather than one of the input files), then run Superfile again on the original files.

You might like to make your readers (and FYI Inc., if it doesn't already know) aware of this additional problem.

Alan Beagley
322 Birdwood Terrace
Toowong, Queensland
4066, Australia

I wonder how many other programs there



**Board
for S-100 Bus**

**256K/1MEG Byte
Dynamic Ram
Model 256KM**

features: 256K using 64K chips \$759.00

- 256K/1 mega Byte using 64K or 256K DRAMS
- 8/16b Data
- 24b Address
- Parity per Byte
- 175 nsec Access Time
- will run Z80/Z8000 to 6 mhz, 8086, 80186, 68000 to 8mhz without wait states
- transparant refresh, unlimited DMA.

FLOPPY DISK CONTROLLER Model FDC1 \$395

- features: • Single or Double density, sides, in any combination of up to four 8" or 5.25" drives.
- Digital phase locked loop.
- DMA data transfer with cross 64K boundaries, 24B address, DMA arbitration.
- Monitor/boot EPROM accomodating two different processors.
- CPM Bios programs.
- Serial port to 19.2K baud.

Z80B CPU BOARD Model Z80 CPU \$325

- features: • 2, 4 or 6 mhz clock.
- 22 bit Address by Memory Mapping in 16K blocks.
- 2 or 4Kbyte EPROM (not supplied) with Phantom generation.
- Jump on Reset
- Provision to run two different CPU's on the same bus, such model 80186 CPU.

80186 CPU BOARD Model 80186 CPU \$595

- features: • Intel 80186 Based.
- Executes 8086 codes plus 10 additional.
- Built in DMA channels, timers, interrupt controller.
- Interface to Numeric Data Processor, 8087.
- 8 or 16 bit data transfer, with 4 or 8 mhz clock.
- Provision to run 2 different CPU's on the bus, such as our M:Z80 CPU.

Board Sets: Z80 CPU, 256KM, FDC1, and CP/M 3.0
plus manual \$1390.

*CP/M is a registered trademark of Digital Research, Inc.

Delivery is within 3 to 5 working days. MC, Visa or COD orders accepted. (Add 6% for COD orders.) Shipping Extra. Illinois residents add 5 1/4% sales tax.

O.E.M. & DEALER PRICE AVAILABLE

S.C. DIGITAL, INC.

1240 N. Highland Ave., Suite #4 • P.O. Box 906, Aurora, Illinois 60507
Phone: (312) 897-7749

And then
there
were none.



The list of already extinct animals grows . . . the great auk, the Texas gray wolf, the Badlands bighorn, the sea mink, the passenger pigeon . . .

What happens if civilization continues to slowly choke out wildlife species by species?

Man cannot live on a planet unfit for animals.

Join an organization that's doing something about preserving our endangered species. Get involved. Write the National Wildlife Federation, Department 105, 1412 16th Street, NW, Washington, DC 20036.



It's not too late.

COMPUTER WAREHOUSE

CALL TOLL FREE **1-800-528-1054**

QUADRAM

Quadlink	\$449
Quadboard 64K	\$249
Quadboard 256K	\$389
Quadboard II 64K	\$249
Quadboard II 256K	\$389
Microfazer (ME16) 16K	\$129
Microfazer (ME32) 32K	\$149
Microfazer (MSS16) 16K	\$149
Microfazer (MSS32) 32K	\$179

PRINTERS

C-Itoh

F-10 Parallel or Serial	\$935
55 CPS Serial or Parallel	\$1319
8510 Parallel (Prowriter)	\$339
8510SP (Prowriter SP)	\$559

Computer International

Daisywriter 2000 w/48K	\$999
------------------------	-------

Comrex

CR-2	\$449
------	-------

Datasouth

DS180	\$1155
-------	--------

Diablo

620 RO	\$850
630 RO	\$1699
630 ECS/IBM	\$2075

DTC

380Z	\$1080
------	--------

Inforunner

Riteman	\$329
---------	-------

IDS

Microprism 480	\$480
Prism 80	\$1160
Prism 80 Color	\$1345
Prism 132	\$1310
Prism 132 Color	\$1500

Juki

6100	Call
------	------

Epson

All models	Call
------------	------

NEC

PC-8023A	\$385
PC-8025	\$669
3510	\$1365
3550	\$1710
7710	\$1900
2010	\$785
2015	\$785
2050	\$910

Okidata

82A	\$355
83A	\$550
84P	\$975
84S	\$1060
92	\$420
93	\$700
2350P	\$2020
2410P	\$2299

Olivetti

PRAXIS 41 (w/interface)	\$539
2300 INKJET	\$319

Qume

1140 w/interface	\$1369
------------------	--------

Silver Reed

EXP550P	\$879
EXP550S	Call
EXP500	\$389

Star Micronics

Gemini-10X	Call
Gemini-15X	Call
Delta 10	Call

Tally

MT 180L w/Tractors	Call
MT 180L w/Tractors	Call
Spirit 80	Call

Toshiba

P1350	\$1445
1350P Serial or Parallel	\$1445

Transtar

120P	\$449
120S	\$489
130P	\$669
130S	\$709
140S	\$1179
T315	\$449

SPECIAL OF THE MONTH
SANYO*EPSON SYSTEMS

DUAL DRIVE SYSTEM \$1495

SANYO MBC-555 • SANYO CRT-36 HI-RES GREEN MONITOR
EPSON RX-80 WordStar • CalcStar

• Mailmerge • InfoStar • Spell Star
• Easywriter • MS-DOS • Sanyo Basic
Above with Sanyo CRT-70 Color Monitor **\$1939**

SINGLE DRIVE SYSTEM \$1175

SANYO MBC-550 • SANYO CRT-36 HI-RES GREEN MONITOR • EPSON RX-80
WordStar • CalcStar • Easywriter
• MS-DOS • Sanyo Basic
Above with Sanyo CRT-70 Color Monitor **\$1629**

DISKETTES

Rana

Elite 1	\$245
Elite 2	\$380
Elite 3	\$490
Controller (w/Drive only)	\$75
1000 (For Atari)	\$269

TRAK

PI-1	\$199
ATD-2	\$375

VIEW TERMINALS

ADDS

A-1 Green	\$480
A-2 Green	\$490
Viewpoint 80	\$619

Altos

Smart II	Call
----------	------

Hazeltine

Esprit I	\$485
Esprit II	\$540
Esprit III	\$735

Qume

QVT 102 Green	\$535
QVT 102 Amber	\$550
QVT 103 Green	\$840
QVT 103 Amber	\$850

Televideo

910+	\$539
914	\$539
924	\$669
925	\$689
950	\$889
970	\$969

Wyse

Wyse 50	\$489
Wyse 100	\$680
Wyse 300	\$1020

Visual

Visual 50 Green	\$619
Visual 55 Green	\$709

Zenith

Z-29	\$629
------	-------

DISK DRIVES

Maxell

MD-1 (Qty. 100)	\$230
-----------------	-------

Scotch

744-0 (Qty. 100)	\$200
------------------	-------

Elephant

S/S S/D (Qty. 100)	\$155
--------------------	-------

MONITORS

Amdek

Video 300	\$130
Video 300A	\$145
Color I	\$270
Color I Plus	\$275

BMC

12" Green	\$85
12" Color	\$195

NEC

JB 1201	\$155
JB 1280	\$115

Taxan

12" Amber	\$125
-----------	-------

Zenith

12" Green Screen	\$95
12" Amber Screen	\$120

COMPUTERS

Altos

Series 5-80-2	\$1949
5-80-10 W/MPM	\$3525
5-86-10	Call

Atari

600XL	\$149
800XL	\$248

Columbia

Single Drive System	\$2325
Dual Drive System	\$2665

Corona

Hyperion	Call
----------	------

Northstar

Advantage	\$2160
Advantage w/5MB	\$3345
Advantage w/15MB	\$4315

Pied Piper

Communicator I Portable, Z-80, 64K Ram, Full sized keyboard, Slimline 5 1/4 Disk Drive with 1M Byte of storage, Monitor output, Perfect Word, Perfect Calc, Perfect Speller, Perfect Filer, CPM, 90-day nationwide warranty... **\$965**

Sanyo

MBC-550 System	\$1175
MBC-555 System	\$1495

Televideo Systems

802 H	\$4210
803	\$1815
1803	\$2150
806/20	\$4775
800 A (user station)	\$ 999
Teleport	Call

MODEMS

Hayes

Smartmodem	\$199
Smartmodem 1200	\$485
Smartmodem 1200B	\$430
Micromodem IIe	\$235



2222 E. Indian School Rd. • Phoenix, Arizona 85016
Order Line: 1-800-528-1054
Order Processing & Other Information: 602-954-6109

Store Hours: Tue-Fri 10-5:30 Saturday 9-1 Order Line Hours: Mon-Fri 10-5:30 Saturday 9-1

Prices reflect 3% to 5% cash discount. Product shipped in factory cartons with manufacturer's warranty. Please add \$8.00 per order for shipping. Prices & availability subject to change without notice. Send cashier's check or money order...all other checks will delay shipping two weeks.

are that allow illegal filenames? Microsoft BASIC will allow you to give a lowercase filename; that can't be accessed, renamed, or erased from within CP/M, but at least BASIC can get at it. It's simple enough to write a function that will check to see if a filename is legal, but alas, many programmers don't do that. It's especially important to check this when your program has utilities that allow renaming a file.

DU, Spat, and other such programs will allow recovery from such errors. They're available from Workman and Associates of Pasadena, California, or the CP/M user group. . . . Jerry

Software Disasters

Dear Jerry,

I am writing this to give you a little ammunition, I hope, to try to get something done about the terrible situation regarding software for microcomputers that has developed just in the past year, as far as I know. I am referring to the several licensing absurdities you have written about recently, and other concerns. First, the usual absence of clear statements regarding exactly what other software and peripherals a given program will work with. Second, the (illegal) disavowal or disclaimer of responsibility to correct bugs, even if they render the program totally unrunnable. And third, the refusal to publish or otherwise release source code that is required for other companies to create or update their own products that were designed to run with the first-mentioned software.

Since March I have paid \$450 or more for software, all of which was advertised in BYTE, none of which I can use. I have to blame myself somewhat for lacking the patience in all cases to ascertain what a given program will do and run with. But then, I don't have the time to do very much of this, and waiting for gaudy and optimistically worded advertising brochures to be sent on my request is very often an exercise in futility.

I suggest several solutions. First, the legal solution would require that every piece of software sold commercially have explicit statements about what environment it will run under and also state the known environments that it will not run under, given the context under which it was bought. Second, the computerized bulletin-board systems that are now common throughout the country could be used to spread information about specific

products to point out those programs with bugs or those that will not run with whatever. Third, BYTE could maintain a file of comments on commercial software products that it could sell, for a nominal profit, without necessarily claiming accuracy for the specific comments.

Mark A. Melton
5329 Rex Ave.
San Diego, CA 92105

The problem is important, and it won't just go away. However, I don't believe that what we need is additional regulations or laws; the result of that would be to stifle the computer industry. In particular, regulations keep the small entrepreneur from entering the market at all, since he can't afford the lawyers and contract-compliance officers to deal with a highly regulatory environment. We could use some common sense all around: buyers, distributors, publishers, and advertisers.

Alas, the fact that a product is advertised in BYTE, or any other magazine, is no guarantee that it works—or indeed that it will be delivered on time. Magazines operate under severe restraints; they can't refuse advertisements without being prepared to do some heavy legal slugging. As long as the advertiser pays the bills, and isn't under some kind of court judgment, it's very hard for a magazine to turn down an ad. I know for a fact that the BYTE editorial people would prefer that certain advertisers would get mad and go away, so we wouldn't have to answer all the angry mail we get about the products.

Incidentally, I have never, in the years I have written for BYTE, had any interference from the editorial staff regarding the opinions I express, regardless of whether I'm discussing a heavy advertiser or three lads and lassies working in a garage. The only suggestions I've ever been given have been "I think the readers might like to see more about" certain machines.

Let me drive it home: "Advertised in BYTE" does not imply the approval of BYTE's editors, staff, or columnists.

Some principles: first, if something sounds too good to be true, it probably is. If it's not, independent reviewers will tell you soon enough. If you can't wait for the reviews, you may be lucky, but you may also be stung.

Second, there are distributors—certain stores, selected mail-order software houses, some systems consultants—with a reputation for honest dealing, including full refunds if the customer isn't satisfied. Those outfits simply cannot operate on the same markup as the heavy discounters do. If you plan to buy an unfamiliar product, or a product that's not known to work on your system, then you'd

probably do better to pay a higher price and deal with someone you know. If you don't know who the good guys are, it's not too hard to find out; the word gets around.

I agree there's a problem; indeed, it's one reason I write this column. I like these little machines, and I don't like to see anyone get stung. . . . Jerry

Abnormal Warranty

Dear Jerry,

Those absurd software disclaimers that you detest can now be found on hardware: last week, I purchased a joystick for a video game. One model had "2-year warranty" in bold letters on the box. I chose that one. After I arrived home, I read the warranty and encountered one of the silliest and most meaningless disclaimers yet: "This warranty applies only if your joystick is used in a normal fashion, prescribed by the instructions for your video-game console. It is void if the joystick is abused, tampered with, used unreasonably, or fails as a result of normal wear."

If it doesn't cover failure "as a result of normal wear," what does it cover? First they say that the warranty applies only if the product is used in a "normal fashion," and then they disclaim that statement. I am beginning to appreciate Digital Research's disclaimers. At least they are unambiguous.

Robert Swirsky
412 Arbuckle Ave.
Cedarhurst, NY 11516

Alas, the age of chivalry is dead. We have entered the age of sophisters, calculators, economists, and lawyers, and the glory of America is extinguished. . . (with some apologies to Edmund Burke). . . . Jerry

No Insults Intended

Dear Jerry,

I have been reading your column for several years. I was extremely insulted by a comment in "Zenith Z-100, Epson QX-10, Software Licensing, and the Software Piracy Problem" (June, page 411): Snapshot's "easy to install: a 16-year-old did ours. . . ." I'm 16 years old and know my way through electronics and my Apple. There are many BYTE readers in my age group, and many of my friends are also computer nuts. Something is very wrong

PC PEACOCK™ Brings Living Color to Your IBM PC™

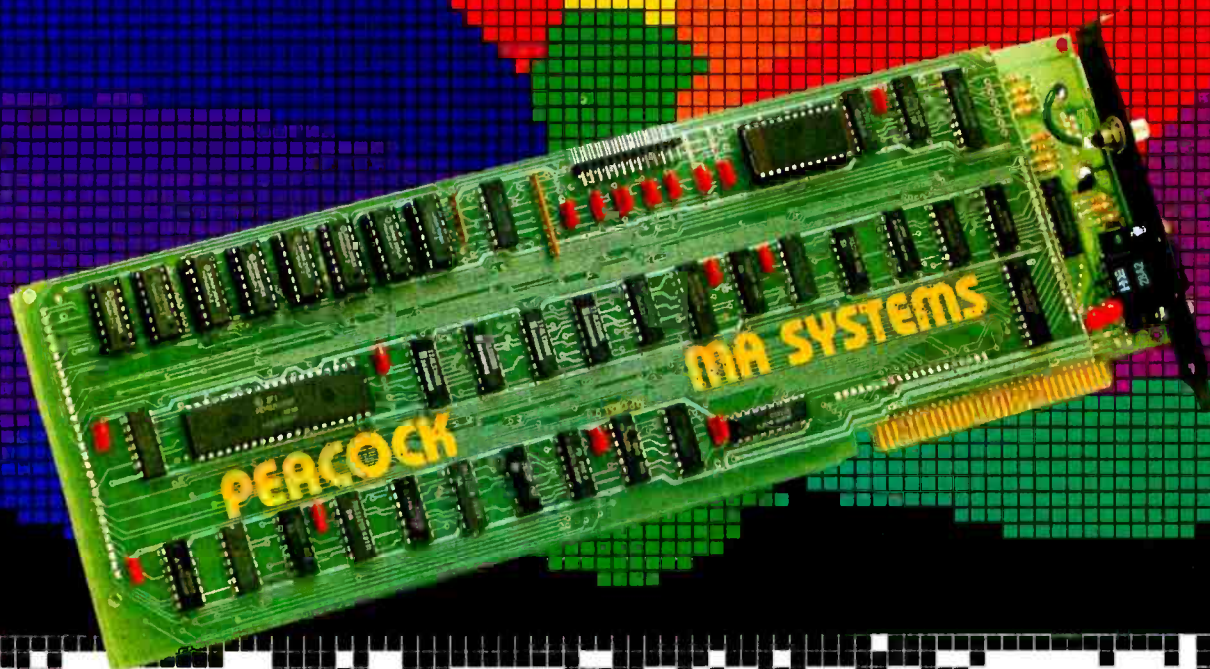

Computing is dull in black and white. But it doesn't have to be. PC PEACOCK brings the excitement of color to your IBM computer. Pictures, charts and graphs "come alive" in multicolor brilliance. PC PEACOCK works with all color and monochrome displays to produce crisp, detailed images. You'll see your favorite programs in the splendor of color. PC PEACOCK is fully compatible with all software for your IBM PC — including the wide variety of graphics programs. The medium resolution multicolor mode and high resolution monochrome mode enhance your display capabilities for business, educational and home applications.

And PC PEACOCK is convenient. The optional parallel port allows you to connect a printer to your computer without wasting an additional expansion slot. Connections for all displays (RGB, composite, monochrome and televisions) are included. PC PEACOCK is designed to provide years of error-free performance and is backed with an outstanding TWO YEAR warranty. So bring living color to your IBM PC, with the PC PEACOCK Color Graphics Adapter. The PC PEACOCK is available now at your local IBM dealer. For more information on all of MA System's IBM and Apple products, please call or write.

IBM PC is a trademark of International Business Machines Corp
PC PEACOCK is a trademark of MA Systems, Inc

MA SYSTEMS

An Enconl Company

2015 O'Toole Ave., San Jose, CA 95131

(408) 943-0596

See us at
COMDEX/Fall '83

November 28-December 2, 1983

Sahara Hotel
Las Vegas, Nevada

Booth No. S9316

Circle 492 on inquiry card.
www.americanradiohistory.com

if the standard for ease of installation is whether a 16-year-old can do it. I built a digital music synthesizer and interfaced it to my Apple. You may say in your report of the West Coast Computer Faire (June, page 306) about the Hero robot that your kit-building days are long gone, but mine aren't.

Adam Dershowitz
2 Tudor City
New York, NY 10017

Without intending insult, may I suggest you're not an entirely representative 16-year-old? One must have a few milestones in making comparisons, lest we all flounder in a sea of relative concepts. In another place I mentioned that Osborne Starter-Pack could be used by Boy Scouts; surely no one believes I intended to insult the BSA? . . . Jerry

Dear Jerry,

I am embarrassed for both you and Volition systems. Please do not refer to competent software engineers as "hackers" in print again. Had you not made it clear in the first paragraph of your article ("Ulterior Motives, Lobo, Buying Your First Computer, JRT Update," May, page 298) that you were using an unusual meaning for the word "hacker," I might have concluded that Volition sold untested, undocumented products.

There is a subtlety in the meaning of the term "hacker" that has not been properly communicated to you (for the definitive explanation of what a hacker is, I refer you to *Psychology of Computer Programming* by G. M. Weinberg). A hacker is not only talented; he is also undisciplined. He is addicted, not to the field of software development as a serious profession, but to the implementation of code (and coding is a surprisingly small part of professional software development).

The hacker makes programs that work; this does not mean he writes programs that are good. Two examples of the difference between working and good programs are: a good program is well documented (hackers don't document) and a good program has been tested and proved to work with all kinds of erroneous entries (hacker programs tend to fail catastrophically if you give them bad data).

To put it another way: if you want a pretty painting or a fast-paced video game, get an artist or a hacker. But if you want a solid bridge or a powerful Modula-2 compiler, get a mechanical

engineer or a software engineer.

I've made my point, but let me give you an analogy in the realm of science fiction: suppose you were a not-yet-famous author, and a distinguished reviewer referred to you in a distinguished publication as an "amusing writer of sci-fi." This is roughly comparable to Volition being reviewed by Jerry Pournelle in BYTE as a "nice bunch of hackers."

Marc Stiegler
132 Laurel Way #2B
Herndon, VA 22070

Alas, despite your embarrassment, there is no universal agreement on what is meant by a computer "hacker." I assure you that very highly professional programmers often refer to themselves as hackers and do so with some pride. Weinberg's is but one of a number of attempts to define this elusive word.

Moreover, there may be times when what one wants is a hacker even in your sense of the word. A well-known and wealthy writer, having become enamored of my first computer (Ezekial, RIP), decided that he could do much better. He went off to get a contract for a book about using computers. With the advance, he engaged a firm of consulting engineers to build him a system. He gave them few-to-no financial restrictions, and at last count he not only didn't have a working computer, he was forced to use his typewriter to write his computer book. (Sometimes it may be better to have it Wednesday than perfect.) In any event, let me assure you that the troops at Volition are thoroughly professional, and I intended no insult to them.

Your final paragraph refers to Harlan Ellison's well-known campaign to extirpate the term "sci-fi." It's true that use of the phrase marks one as unfamiliar with the customs of organized science-fiction fandom, and indeed some writers do resent it; but most of us take it in stride. As for my tales, I hope they're found entertaining, although not all are intended to be amusing. . . . Jerry

CP/M vs. TRSDOS

Dear Jerry,

Some general thoughts on CP/M: I use the TRSDOS operating system that came with my Model II about two years ago. The first thing I noticed was the 'DIR' command—TRSDOS is much better. Another difference is its printer interface. CP/M could learn from the TRSDOS 'FORMS' command. You can still use the printer, but not as conveniently. If you forget to turn on the printer, CP/M hangs

up. TRSDOS gives you the 'Printer Not Ready' prompt. For disk files, TRSDOS could find a file no matter what disk drive it was on; CP/M requires that you specify the drive in your command. Also, if you accidentally call out a disk drive with no disk in it, CP/M hangs up, requiring a reboot. TRSDOS simply tells you 'Disk Drive Not Ready.'

I have more to learn about CP/M, but from here, it does not stack up to TRSDOS. If there is any significant speed difference, it hasn't affected me yet. I don't see why Radio Shack doesn't capitalize on its excellent operating system and expand its available software.

Bruce M. Beatty
1218-B Tom Hunter Rd.
Charlotte, NC 28213

The fault, alas, is not in your CP/M but in your CBIOS. (Customized Basic Input/Output System is the software that tells CP/M what kind of computer it's working with.) We've had recovery from "Drive Not Ready" since we began using CP/M 1.4. For those with Z80 systems, there's also ZCPR, a replacement for the Command Processor in CP/M; this has the "search all disks for file" feature you like, plus a number of others. (ZCPR is public domain; there's a lot of documentation. It's available from Workman and Associates, or through one or another of the CP/M user clubs.) Finally, there's CP/M Plus, which is just gaining popularity; it has many features the older CP/M didn't.

The TRSDOS you see is greatly changed from the early versions which so exasperated TRS-80 Model I users. Even with fixes, there was never a version of TRSDOS that I preferred to CP/M, if for no other reason than that, for better or worse, CP/M became the de facto standard for the micro world and made for widespread distribution of programs—and thus heavy investment in program construction and documentation.

I'll even hazard the prediction that one or another form of CP/M (probably Concurrent CP/M-86) will continue to be the de facto standard as the micro world grows up. . . . Jerry

IBM's Keyboard Best

Dear Jerry,

There is one bit of criticism that I must share. I own an IBM Personal Computer, with the IBM keyboard. I like the IBM keyboard. It has great feel and is a pleasure to use. I realize that it is not a standard keyboard (what is a standard keyboard?), but the time necessary to use

Lyc0 Computer Marketing & Consultants

TO ORDER

TOLL FREE 800-233-8760

CALL US

In PA 1-717-327-1824

**TEXAS INSTRUMENT
DRIVE \$255.00**

**for ATARI
COMPUTERS**

PERCOM

**13 inch
COLOR TV**
(with 1 yr. warranty)
\$199.95

**CORDLESS
TELEPHONES**
(up to 700 ft. range)
from ... \$69.75

AT88S1 \$299.00
AT88S2 \$535.00
AT88SIPD \$CALL\$
RFD40SI \$399.00
RFD40S2 \$689.00
RDF44SI \$489.00
AT88 DOUBLER BOARD \$139.00

MODEMS
NOVATION CAT \$144.75
D-CAT \$155.75
J-CAT \$114.75
MICROBIT \$159.75

SANYO
PR555 \$CALL\$
MBC 1000 \$1299

BLANK DISKETTES

ELEPHANT

Single Side SD (10) \$17.75
Single Side DD (10) \$21.75
Double Side DD (10) \$26.75

WABASH

Single Side SD (10) \$19.75
Single Side DD (10) \$23.75
Double Side DD (10) \$32.75

CERTRON CASSETTES

CC-10 12 for \$15.99
CC-20 12 for \$17.99

INNOVATIVE CONCEPTS

Disk Storage (holds 10) \$4.95
Disk Storage (holds 15) \$9.95
Disk Storage (holds 50) \$26.95
ROM Storage (holds 10) \$19.75

MONITORS

Amdek Color I \$275.00
Amdek 300 Green \$149.00
Amdek 300 Amber \$149.00
GORILLA GREEN \$88.00

SAVE

on these
in-stock

PRINTERS

CITOH
GORILLA GX100 \$185.00
PROWRITER 8510 ... \$339.00
PROWRITER II \$659.00
8600B \$1025.00
STARWRITER \$1099.00
PRINTMASTER \$1499.00

GEMINI 10X . \$269.00
PROWRITER . \$339.00
NEC 8023.... \$369.00

EPSON
RX-80 \$SAVES
RX80FT ON
FX80 In-Stock
FX100 EPSON
MX80FT PRINTERS
MX100 \$CALL\$

OKIDATA
80 \$SAVES
82A CALL for
83A LOWEST
84 PRICES
92 on these
93 IN-Stock
PACEMARK 2350 PRINTERS
PACEMARK 2410 \$SAVES

LETTER QUALITY

SMITH CORONA TPI \$459.00
SANYO 5500 \$649.00
DIABLO 630 \$1719.00

STAR MICRONICS

GEMINI 10X \$269.00
GEMINI 15X \$CALL\$
DELTA 10 \$479.00
GEMINI 15 DISC... \$BLOW OUTS

CARDCO

5 Slot Expansion 64 \$54.00
Universal Cass. Int. \$29.75
Printer Utility \$19.75
6 Slot Expansion \$79.95
3 Slot Expansion \$24.95
Vic 20/64 Printer Int. \$59.95

HES 64

64Forth R \$55.75
Hesmon R \$29.75
Turtle Graphics R \$49.75
Heswriter R \$38.75
Gridrunner R \$29.75
Attack of Mut Cam R. \$34.75
Turtle Tutor R \$29.75

SPINNAKER 64

KinderComp \$21.75
Story Machine \$23.75
Face Maker \$23.75
Snooper Trooper \$29.75
Delta Drawing \$34.75
Shamus II c/d \$24.95

commodore

PARKER 20
Frogger (ROM) \$33.75
QBert (ROM) \$33.75
Tutankham (rom) \$33.75

PARKER BROTHERS

Super Cobra R \$33.75
Astro Chase R \$33.75
Frogger R \$33.75
QBert R \$33.75
Popeye R \$33.75
Risk R \$42.75

SSI

Battle of Shilo C/D \$26.75
Tigers in the Snow C/D \$26.75
Battle for Normandy C/D \$26.75
Knights of the Desert C/D \$26.75
Cosmic Balance C/D \$26.75

BUSINESS

Visicalc \$159.75
Letter Perfect \$89.75
Letter Perfect \$89.75
Data Perfect \$89.75
Text Wizard \$49.75
Spell Wizard \$64.75
File Manager \$69.75
Home File Mgr \$69.75
Bookkeeper \$119.75
C.R.I.S \$199.75
Home Accountant \$59.75
Bank Street W \$49.75

SPINNAKER

Story Machine R \$26.75
Face Maker R \$24.75
Kinderomp R \$20.75
Fraction Fever R \$24.75
Delta Drawing R \$26.75

HES

Gridrunner R \$27.75
Sword Point D \$24.75
BRODERBUND
AE D \$24.75
Apple Panic D \$23.75
Chopflifer ROM \$32.75

600XL \$\$\$\$\$149.00
800 XL... \$CALL\$

1025 Printer \$399.00
1020 Color Printer \$245.00
1027 Printer \$299.00
1010 Recorder \$75.00
410 Recorder \$75.00
810 Disk Drive \$399.00
1050 Disk Drive \$335.00

ATARI
Computers for people.
© 1981 ATARI INC.

BIG 5

Miner 2049

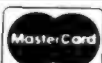

TO ORDER



CALL TOLL FREE
800-233-8760

In PA 1-717-327-1824

or send order to
Lyc0 Computer
P.O. Box 5088
Jersey Shore, PA 17740

POLICY

In-stock items shipped within 24 hours of order. Personal checks require four weeks clearance before shipping. No deposit on C.O.D. orders. Free shipping on prepaid cash orders within the continental U.S. PA residents add sales tax. All products subject to availability and price change. Advertised prices show 4% discount offered for cash, add 4% for Master Card or Visa. DEALER INQUIRIES INVITED.

it is well worth the effort. I have yet to work with a keyboard that did not require some adaptation by the user (Televideo and DEC keyboards require a tremendous amount of user flexibility).

Scott Wentzka

9875 Northwest 16th St.
Coral Springs, FL 33065

You are not alone in defending the IBM PC keyboard. It's obvious that my dislike of the keyboard hasn't precisely ruined IBM's sales: I'm still waiting for the PC I ordered months ago!

I remain unrepentant, though: the IBM Selectric Typewriter was the standard keyboard for most of the potential computer users in the world. True, those who never learned touch-typing can adjust to most anything, but why did IBM have to make things complicated for those of us who'd already learned the Selectric? Fortunately, it's now possible to reprogram the whole keyboard, so that one needs only a source of keytops to customize properly; the issue is rapidly becoming moot. . . . Jerry

Bootstrap Solution

Dear Jerry,

This is in response to comments in your July User's Column about moving programs from one computer to another.

I am writing this on an Epson QX-10, which we have had for about three months. One reason we decided on the QX-10 was that, even if Valdocs did not work out, we would still have access to the great body of CP/M programs. Unfortunately, we found out that we were wrong because no other programs were available on Epson-format disks.

It is very little help to be able to transfer programs from machine to machine because I have no other CP/M machine, nor do I have CP/M programs. In fact, it is the CP/M programs I wish to obtain.

Of course, it is likely that I could find someone locally who also has a CP/M machine. If that person also has the standard 8-inch CP/M disks, I could send away for the CPMUG disks, then copy those programs to the Epson. If, however, the other person does not have the standard 8-inch CP/M disks, we are both back to where I started.

What is really needed is a way for a new CP/M user to access the various computerized bulletin-board systems (CBBS) that have CP/M software. Naturally, if the user had the MODEM7 program, access by modem would be fairly easy. Unfor-

tunately, MODEM7 is itself a CP/M program, which the new CP/M user will not have.

Therefore, what is really needed is: a "bootstrap" program, a tiny program that is easily implemented on a bare-bones machine, which will download a full-blown CP/M loader program from a CBBS that uses the bootstrap protocol. The bootstrap itself should be made extremely simple for easiest implementation (it may be used once per system, then never used again). It should be described in multiple languages; BASIC would probably be easiest, although some CP/M systems may not have BASIC, so the bootstrap should also be available as an assembly-language listing. The bootstrap format could be quite slow, since it should allow BASIC implementation and it would only be used once.

The existence of such a program would not, of course, solve all of the problems involved in getting access to CP/M public-domain software. First-time users may have to be inducted into the mysteries of assembly language, but achieving a working program can be done without understanding, if the program has been fully developed and the process of entering the program is described explicitly. In addition, the various concepts of ports, modems, and RS-232C connections and cables would have to be addressed. Also, there would be the little matter of phone numbers for the appropriate CBBS. But this information can be transferred on paper, in a book or an article, and would allow new CP/M users access to public-domain software.

This approach could be more help to the new CP/M user than *The Transporter*.

Terry Ritter

2609 Choctaw Trail
Austin, TX 78745

The Transporter (reviewed in July, page 323) was designed to solve the problem of getting the first program—such as MODEM7—across to new machines.

A second problem involves ethics and good sense. A number of people have been kind enough to write some excellent CP/M programs and put them in the public domain—which is to say, to give them away. Having done that, they naturally feel little obligation to support the programs or transfer them to new machines and formats.

On the other hand, when someone does take the trouble to improve program documentation and transfer public-domain programs to new formats, that person is sometimes at-

tacked as a pirate or thief for charging for this service. Usually the attack comes from some outsider, but once in a while it will come from the original program author. This leaves little incentive for anyone to collect public-domain software, test it, and distribute it on new formats.

Incidentally, much of what you describe already exists on one or another public computer bulletin-board system. Finding out which ones have what takes a fair amount of work, of course, and the connect time for transferring long files can be lengthy. As an example, ZCPR, the improved Z80 Command Processor for CP/M, takes up about 15 disks and many hours to transfer by telephone.

If anyone has—or wants to write—the programs you described, I'll be pleased to review them. In the meantime, I talked Barry Workman into putting up a number of his CP/M utilities into Epson QX-10 format so I could use them; he sells them at reasonable prices. Many, but not all, are public domain. . . . Jerry

Jerry Pournelle welcomes readers' comments and opinions. Send a self-addressed envelope to Jerry Pournelle, c/o BYTE Publications, POB 372, Hancock, NH 03449. Please put your address on the letter as well as on the envelope. Due to the high volume of letters, Jerry cannot guarantee a personal reply.

BYTE's Bugs

Line Change

Dean Brown of Alderwood Manor, Washington, spotted a bug in James Folts's "Cross-Reference Utility for IBM PC BASIC Programs" (August, page 378). The program will work properly with programs having 5-digit line numbers if line 6050 is changed from

```
LABEL$(LABEL.NUMBER) = SPACE$(5)
```

to

```
LABEL$(LABEL.NUMBER) = SPACE$(6)
```

Brown explains, "This change is necessary because the STR\$(val) function used in line 6060 prefixes positive numbers with a blank, thus requiring the field length to be one greater than the length of the line number to be displayed." ■

\$150 CHRISTMAS BONUS

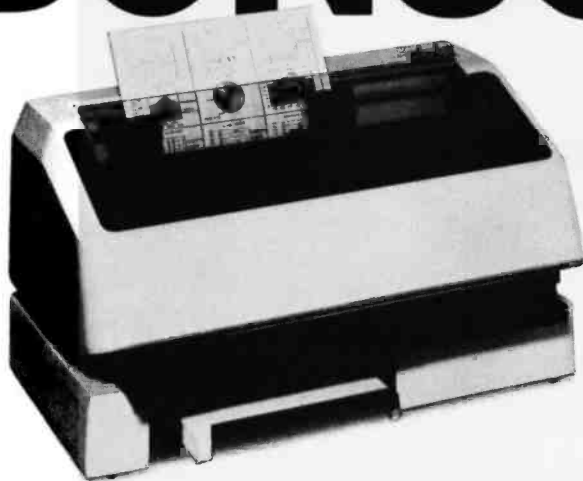

Dataproducts wants to put some green back into your holidays. So, when you buy our P Series color printer and autosheet feeder, help yourself to \$100 worth of anything you want at the store of purchase. And that's just the beginning. Buying our full color P Series printer and autosheet feeder also entitles you to another holiday surprise. Our EP2 Program, absolutely free! It allows the user to make his Dataproducts printer perform like the IBM graphics printer or the Epson MX80, at your command. It's a \$50 value that's yours for a smile.

Why are we giving away so much? It's our way of introducing you to the versatile P Series color printer and autosheet feeder. The P Series translates information into brilliant full color charts, graphs and texts. It delivers a full page of text quality print in nothing flat while its feeder automatically prevents loading hassles. And the P Series uses printer or plain paper and fills every appropriate line with crisp, sharp copy, even if it has to hyphenate.

Priced at \$499, the autosheet feeder eliminates the need for manually fed paper, and has the ability to print any report, in large quantities, on standard 8½" paper. The autosheet feeder holds up to 250 sheets of 15 lb. or 200 sheets of 20 lb. 8½" wide paper, including bond, offset and coated paper. And it works on the P Series color printer's existing power source, requires no special programming or controls, and is completely transparent to host software.

Just take this ad with you to your nearest participating computer store and ask to see our P Series Printer. It's the full color printer that'll put some green back into your holidays. For the name of your nearest participating dealer, call 1-800-258-1386.

P Dataproducts



SOMEWHERE, OUT THERE, A BEST-SELLING PROGRAM

WHERE IS IT?

Wherever it is, we want it. Maybe, just maybe, we're searching for your program, but we'll never find it unless you call us.

It has to be good, though. Because we're the Software Guild™, an organization devoted to finding the very best microcomputer programs for packaging and distribution under the Softsmith™ label. Hundreds of titles have already been licensed to the Softsmith library. But they're only the beginning. Our goal is to have the best program in major categories on every

popular machine. Of course, we can't do it without you.

If you're a program author or publisher, The Software Guild offers some distinct professional and monetary advantages.

First, you devote your time to what you do best: programming. You can leave the manufacturing, packaging, documentation, distribution and customer service to us.

Second, our revolutionary retail merchandising system will put your program before the public through the normal computer and software stores, plus record outlets, department stores, book shops, and more places where software has never before been available.

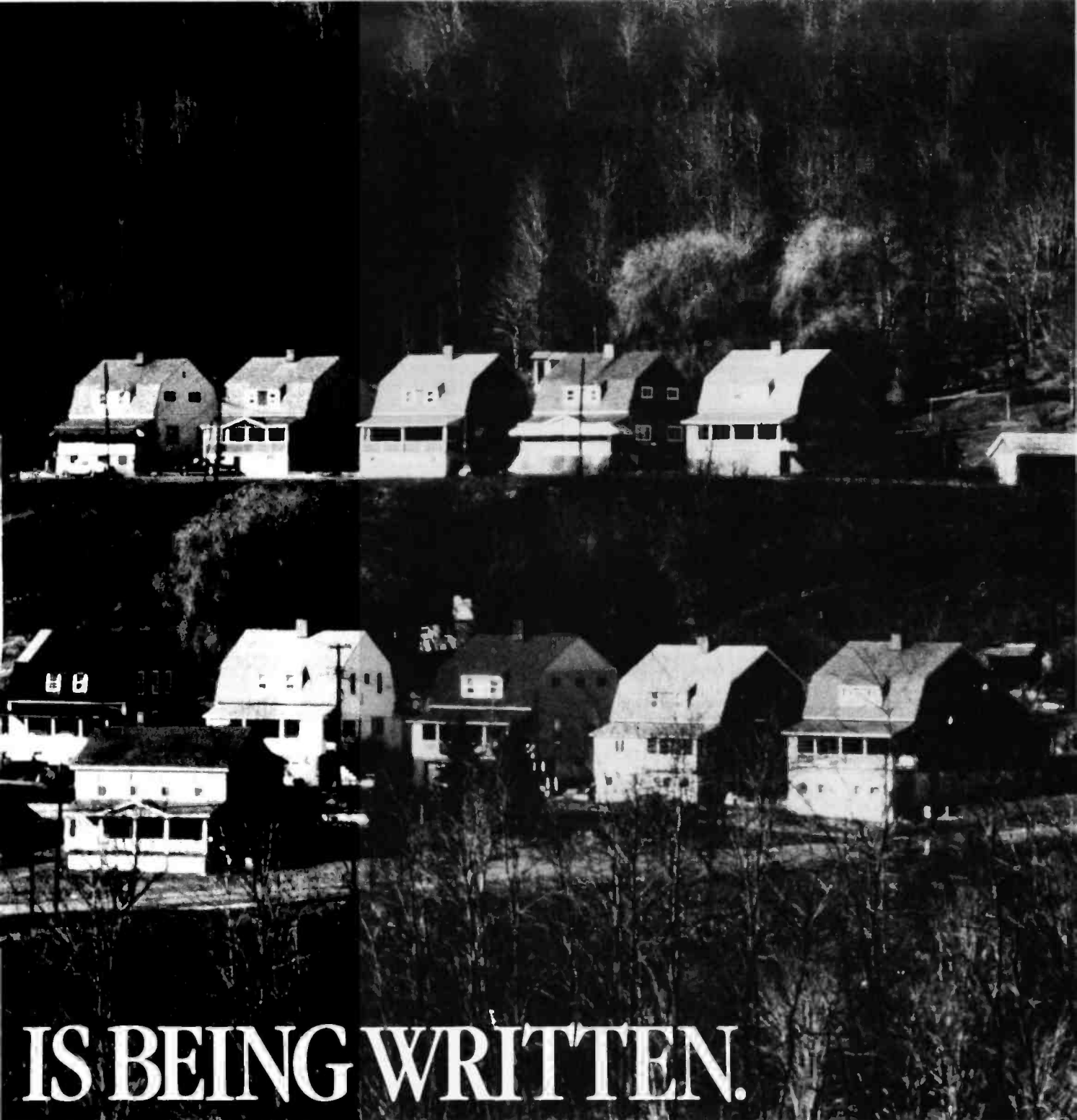

IS BEING WRITTEN.

Third, is royalties. Wider distribution means more substantial royalties. And, your Software Guild royalties start to accrue when the dealer makes his purchase in quantity, so you aren't left waiting while money trickles in.

Fourth is flexibility. We do not insist on the exclusive rights to your program. You can deal with other publishers and distributors, or market your program yourself, while it is in Softsmith distribution.

We know you're out there, working and dreaming, and we want to help make your dream come true. Our full staff of professional evaluators are waiting to review your best-seller.

**So call us, wherever you are.
Contact Regina Roberts at (415) 487-5200.**

**Or write:
The Software Guild
2935 Whipple Rd.
Union City, CA 94587**



The Software Guild™
(415)487-5200

Before Buying an IBM Personal Computer ...

Take a close look at the new **Sanyo MBC 550 and MBC 555 Computers — The IBM-PC Look Alike, Work Alike That Cost Only One Third As Much.**

Because they use the MS/DOS operating system, the de-facto standard for IBM-PC compatibility, over 80% of the IBM software runs without modification. Because of the long list of exceptional features below, **The Sanyo MBC 500 and MBC 555 are the only responsible alternatives to the unreasonably high cost of the IBM-PC.**



Exceptional Features Standard on the MBC 550

- Powerful 16 bit 8088 CPU
- The same CPU as used in the IBM-PC
- 128K User Memory (Expandable to 256K)
- 160K Single Disk Drive
- High-Quality, Full Featured, Low Profile Detached Keyboard
- Full 80 Column Display with Color Graphics
- A must for Spread Sheets & Word Processing
- MS/DOS Operating System Included
- Sanyo BASIC Included
- Centronics (parallel) Printer Port
- Speaker • Joystick Port
- Diagnostics
- Includes: Calc Star Spread Sheet, Word Star and EZ Writer One Word Processing Software

Special Software Enhancement

With the purchase of a MBC 555 Dual Drive Computer, your free software package is enhanced by the addition of your choice of SmartPacks:

SmartPack 1

- Mailmerge
- Spellstar
- Infostar

SmartPack 2

- Easy Filer
- Easy Planner
- Easy Mailer

Special System Packages

Single Drive Computer with Monitor and Printer

- MBC 550 Computer with 128K memory
- 12" Green Monitor
- Epson RX-80 Printer

Your Cost
\$1,399⁹⁵

Dual Drive 256K System with Monitor and Printer

- MBC 555 Computer with 256K memory
- 12" Green Monitor
- Epson RX-80 Printer

Your Cost
\$1,999⁹⁵

Accessories & Upgrades

Accessories & Upgrades	Your Cost
FDD 1655 Second 160K Disk Drive	399.95
MBC 64K 64K Memory Expansion	120.00
MBC 128K 128K Memory Expansion	240.00
MBC 232 RS-232C Serial Interface	100.00
MBC 8MHD 8MB Winchester Hard Disk	2,495.00

ROMAR II ONLY
\$499⁹⁵



64K-DUAL PROCESSOR
INCLUDES CP/M

THE ONLY APPLE II COMPATIBLE COMPUTER APPROVED FOR IMPORT BY U. S. CUSTOMS

Texas Instruments Home Computer

\$99⁹⁵ * TI 99/4A including the \$50 TI rebate (you pay us \$149.95)

The only 16K COLOR computer under \$100-16 bit-FAST!

Purchase of TI-99/4A includes One Year Full Warranty & 2 1/2 hrs class from TI—also New TI-Hot Line phone number.

FREE with the purchase of any of these TI packages, either Word Processor, MultiPlan or LOGD (one only!)

- Package one:
- PHP 1250 Disk drive
 - PHP 1200 Disk controller card
 - PHP 1200 Peripheral box
 - PHP 1260 32K expansion card
 - Sugg. retail: \$1199.00 Your cost: \$429.95
- Package two:
- PHP 1250 Disk drive
 - PHP 1240 Disk controller card
 - PHP 1200 Peripheral box
 - PHP 1260 32K expansion card
 - Sugg. retail: \$999.00 Your cost: \$319.95
- Package three:
- TI 99/4A Computer
 - PHP 1250 Disk drive
 - PHP 1240 Disk controller card
 - PHP 1200 Peripheral expansion box
 - PHP 1260 32K expansion card
 - Sugg. retail: \$1499.00 Your cost: \$529.95* (after TI \$50.00 rebate-you pay us \$579.95)

- Package four:
- TI 99/4A Computer
 - PHP 1250 Disk drive
 - PHP 1240 Disk controller card
 - PHP 1200 Peripheral expansion box
 - PHP 1260 32K expansion card
 - Sugg. retail: \$1799.00 Your cost: \$649.95* (after TI \$50.00 rebate-you pay us \$699.95)

- Package five:
- TI 99/4A Computer
 - PHP 1250 Disk drive
 - PHP 1240 Disk controller card
 - PHP 1200 Peripheral expansion box
 - PHP 1260 32K expansion card
 - PHP 2500 Printer (Epson 80)
 - Sugg. retail: \$1799.00 Your cost: \$949.00* (after TI \$50.00 rebate-you pay us \$999.95)

- Package six:
- TI 99/4A Computer
 - PHP 1250 Disk drive
 - PHP 1240 Disk controller card
 - PHP 1200 Peripheral expansion box
 - PHP 1260 32K expansion card
 - PHP 4100 Color monitor
 - Sugg. retail: \$1699.00 Your cost: \$879.95* (after TI \$50.00 rebate-you pay us \$929.95)

HEWLETT PACKARD

HP-75C Computer \$699.95

8K module 164.95
7470A opt 003 print/plotter 1199.00
Call for math pack, surveying pac, text formatter & VisiCalc for HP-75C

- HP-10C Scientific calc 59.95
- HP-11C Scientific calc 76.90
- HP-12C Financial calc 99.95
- HP-15C Scientific calc 99.95
- HP-16C Prog. sci. calc 99.95
- HP-97 Prog. sci. w/print 595.00
- HP-41C Prog. calculator 148.95
- HP-41CV Prog. calculator 218.95
- Optical wand 104.95
- Printer for 41CV 298.95
- Cad reader for 41CV 159.95
- HP 82163A Video interface 258.95
- HP II systems on hand 104.95
- II interface module 378.95
- Digital cassette drive 378.95
- Thermal plotter/printer 64.95
- Extended function mem. mod 64.95
- Extended memory module 64.95
- Time module 64.95
- Memory module for 41C/41CV 24.95
- Quad memory module for 41C 85.00

COMMODORE 64

Commodore 1701 Color Monitor 14" screen-big screen, high quality-direct connect to 64 & VIC-20 Your LOW Cost: \$269.95



Commodore 1525E Printer Quality dot matrix, direct connect to Com. 64 & VIC-20. No interface necessary. Your LOW Cost: \$269.95

Commodore Datasette Includes interface & cable, for use with Com. 64 & VIC-20. Your Cost: \$69.95

Commodore 1541 Disk Drive High quality at low cost, direct connect to Com. 64 & VIC-20. Your LOW Cost: \$299.95

Commodore C1600 Modem The best deal in the country for a modem-Your LOW Cost: \$69.95

Commodore Software Package (30 programs) only \$12.95 with the purchase of one of these packages:

COMMODORE 64 \$189⁹⁵
COMMODORE 64 Computer—only \$189.95*
*when purchased with any of these three packages.

- COMMODORE 64 \$189.95 with the purchase of
- 1 1541 Disk Drive \$299.95
 - 1 1525E Printer \$289.95
 - ALL FOR \$779.85

- COMMODORE 64 \$189.95 with the purchase of
- 1 1541 Disk Drive \$299.95
 - 1 1701 14" color monitor \$269.95
 - ALL FOR \$769.85

- COMMODORE 64 \$189.95 with the purchase of
- 1 1541 Disk Drive \$299.95
 - 1 1526 Fast printer-includes IFC/cable direct connect to 64 ALL FOR \$839.95

NEW Impact Dot Matrix Printer by "Fidelity" direct connect to VIC 20/Com. 64. 30 cps ribbon cartridge, inc. adapter. Uses 2 1/4" plain paper tape—does graphics! Y/C: \$99.95 (90 day warranty)

- DATA 20 Accessories
- 2.80 card For Commodore 64 \$269.95
 - 80 column card For Commodore 64 169.95
 - 40 column card For VIC 20 99.95
 - 40 column card w/8K mem built-in for VIC-20 139.95
 - Video Pack 64K For VIC-20 329.95

*FREE with the purchase of each of the above I/I products—Word Master/word processing software, Mailing List software & Telecommunications software.

FRANKLIN

FRANKLIN ACE 1000 — APPLE COMPATIBLE! 64K with many more features than Apple Upper/lower case, typewriter-style keyboard, VisiCalc keys. Built-in fan, 12-key numeric pad & much more!

SPECIAL PACKAGE:

- ACE 1000 computer (64K of RAM)
- Disk drive w/controller
- 80 column card
- Ace Calc - spread sheet
- Ace Writer - word processing software
- 12" green monitor
- Epson printer or Star Gemini 10X (Dot matrix printer, current model)
- \$100 worth of software for Apple (retail \$)
- Sugg. retail: \$2895.00 Y/C: \$1699.00

Package Two: Same as Special Package, but with second Vista Disk Drive-Y/C: \$1898.00

- Package Three: Same as One & Two, but with letter quality printer, instead of dot matrix:
- w/Diablo 620 2629.00
 - w/SCM TP 1 2238.00
 - w/Olivetti Praxis 41 2069.00
 - w/Brother 50 2069.00
 - w/C. Itoh F 10 2749.00

DUAL DISK PACKAGE

- Romar II - 64K
 - Dual Processor Computer
 - Vista Controller Card
 - 2 Vista Disk Drives
- YOUR COST ONLY
\$999⁹⁵

DISK MONITOR, 80 COLUMN SYSTEM

- Romar II - 64K
 - Dual Processor Computer
 - Vista Controller Card
 - Single Vista Disk Drive
 - 80 Column Display Card
 - 12" Green Monitor
- YOUR COST ONLY
\$999⁹⁵

DISK MONITOR, 80 COLUMN SYSTEM W/PRINTER

- Romar II - 64K
 - Dual Processor Computer
 - Vista Controller Card
 - Single Vista Disk Drive
 - 80 Column Display Card
 - 12" Green Monitor
 - RX80 or Gemini 10X Printer
- YOUR COST
\$1289⁹⁵

DRIVE MONITOR, 80 COLUMN SYSTEM WITH LETTER QUALITY PRINTER

- Romar II - 64K
 - Dual Processor Computer
 - Vista Controller Card
 - Single Vista Disk Drive
 - 80 Column Display Card
 - 12" Green Monitor
 - Letter Quality Printer
- YOUR COST
\$1589⁹⁵

FRANKLIN ACE 1200 with 128K RAM total dual processors—Two computers in one! 64K Apple compatible w/6502 processor 64K CP/M 2.80-B processor inc. CP/M 2.2 and other features include: color, serial & parallel IFC's, upper & lower case, etc.

Package ACE 1200 dual processor, total 128K

- Disk drive w/controller
 - Disk drive II only
 - 40/80 column card
 - Dual IFC board, parallel/serial
 - Word Star software
 - Mail Merge software
 - Ace Calc - spread sheet
 - Welcome diskette
 - 12" green monitor
- Sugg. Retail: **\$3650.00**
Y/C: **\$1799.95**

Package Two: Same as Package One with one Epson printer or Star Gemini 10X

Sugg. retail: \$4100 Y/C: \$2189.00

Same as Package One plus:

- Letter Quality printer:
- w/Diablo 620 2879.00
 - w/SCM TP 1 2479.00
 - w/Olivetti Praxis 41 2299.00
 - 5 language typewriter w/Brother 50 2259.00
 - w/C. Itoh F10 2999.00
 - w/Silver-Reed EX43 2299.00
- and many more, please inquire
Opt'l interfaces & cables

OLYMPIC SALES COMPANY

P.O. Box 74545 216 S. Oxford Ave. Los Angeles, CA 90004
Phone (213) 739-1130 Cable "OLYRAV" LSA Telex: 67 34 77

SPECIAL OFFER TO ACCREDITED SCHOOLS—on Commodore Executive 64, SANYO MBC 550, & Franklin ACE 1000 & 1200—Buy 10 systems—GET 1 FREE! CALL for details & eligibility!

Order Desks: 7:00 AM to 7:00 PM Mon thru Sat—TOLL-FREE: (out of CA) 800-421-8045 (in CA) 800-252-2153 TELEX: 67 34 77 CABLE: "OLYRAV" LSA
Goods subject to availability; this ad supersedes all previous ads; FOB our warehouse; prices subject to change without notice; not responsible for typographical errors; all orders subject to verification; minimum shipping & handling: \$5.95. Send for our catalog—\$2 domestic, \$5.95 foreign. Some of the goods not available all stores Call first to be sure!



The User Looks at Books

The best and the worst books on CP/M, Pascal, C, and Ada

by Jerry Pournelle

When I first got started using microcomputers, back in the dark ages of the 70s, there was a simple solution to the computer-book problem: you bought every book on microcomputers as soon as it was published. You wouldn't go bankrupt, even though the books were overpriced, because there weren't very many.

I used to include book reviews in the User's Column. Now there's no room, but we get a lot of letters asking for more book reviews. Meanwhile, four cubic feet of unreviewed books lie scattered on shelves throughout Chaos Manor. I've therefore struck a deal with BYTE: I'll do an occasional special roundup on books.

CP/M Books

The CP/M manuals put out by Digital Research are notoriously poor. This particularly upset my late mad friend. "First they translated them into Swahili," he said. "But what made me really mad was when they encrypted the translation." Digital has since made great strides toward reforming its document foundry; however, for many years the company simply couldn't produce a readable document. The result was a spate of books to teach you how to use CP/M.

One of the earliest of these was *The CP/M Handbook with MP/M* by Rodney Zaks. It's still readable, and much better than the Digital manuals; Zaks's book can serve quite well as an introduction for beginners just learning to use the CP/M operating sys-

tem. It spends rather too much time on ED, the nearly unusable text editor that comes free with CP/M, and rather too little time discussing the difference between logical and physical devices, but all in all it gets the basic job done.

Another good introduction that begins at a very low level is Thom Hogan's *Osborne CP/M User Guide*. Like the Zaks book, Hogan assumes the reader begins with no knowledge beyond the ability to turn the computer on. Both explain what disks are and the difference between disk storage and memory. I find that I prefer Hogan's organization and style to Zaks's, but I'm not sure which is best for beginners.

Alas, both of these books suffer from the same defect: they become more obscure just as they get interesting. For example, it's possible under CP/M to have your computer run a series of programs on startup. Zeke II, the machine I'm writing this on, goes through memory checks, displays disk directories, and formats the "memory disk," after which it calls in the text editor; all this happens automatically on reset. Both Zaks and Hogan tell you how to make your machines do that, but it sure would be difficult without another source of information. You can puzzle out how from their text, but you'll curse the author before you're done.

The Hogan book is more complete, and if you're willing to learn something about CP/M it will teach you more; the Zaks book is a better "cookbook" for just getting the job done.

If you're really interested in learning about CP/M, Jack D. Dennon's *CP/M Revealed* is your best bet after you've done the introductory work. Dennon's organization is rather poor. He begins with baby talk but quickly gives advanced material. For all that, his book is unique and invaluable for those willing to invest the time in understanding it. You'd do well to buy Hogan's book at the same time you get Dennon's, though; you'll need both.

CP/M Revealed assumes you want to know something about assembly-language programming, at least enough to be able to write and assemble simple programs. It thus starts you with simple programs, such as Hello, and quickly goes on from there. Before the book is done, you've been shown how to merge files, assemble them, do random-access file management, make BDOS (basic disk operating system) calls, and even recover erased files. These are all valuable exercises. However, you have to do the work; there's not much point in getting Dennon's book just to read. I sure wish someone would put out a disk with Dennon's programs already typed in, so that you merely need to assemble them.

Finally, there's Mark Dahmke's *Microcomputer Operating Systems*. This is an advanced book about small computers in general, rather than a book about CP/M. If you're interested in what's going on in your machine and why programmers tend to do things in certain ways, this book is enlightening. Like the Dennon book though, it's not required reading.

Whatever you get, though, get a copy of the *CP/M Diskguide* by Curtis Ingraham. This is one of a series of small-format handbooks put out by Osborne/McGraw-Hill, and it's an excellent ready reference. It won't teach you anything you didn't know, but that's not its purpose. What it does do is list just about every useful command CP/M recognizes. Along with the commands, the book gives a terse but accurate description of what each command does. I find I use it all the time, since I tend to forget the precise format for the various options you can give STAT and PIP, and I sure don't remember the memory map for my system. All that and more is in this useful little book.

Another very useful tool is *The User's Guide to CP/M Systems and Software*, and no, I didn't write it. Given the way people trademark things, I wouldn't be surprised to find someone trying to trademark "User"; fair warning, I got here first.

The *User's Guide* is somewhere between a magazine and a book. It looks like a magazine and is sold in issues, both in stores and by subscriptions, but the contents are more book-like. A great deal of the *User's Guide* is written by Tony Bove and Cheryl Rhodes; they have the knack of explaining CP/M programs very well indeed.

The *User's Guide* seems to have grown out of *Datacast*, which was a Jim Warren publication edited by Bove and Rhodes; it, too, had a lot of easy-to-understand instructions and shared their propensity for classical artwork on the covers.

A typical *User's Guide* contains articles on how to use Wordstar and Supercalc, overviews of particular implementations and installations of Wordstar, and a general article on CP/M. Naturally, each issue is different. So far I haven't found one that wasn't worth more than what it costs. Recommended.

Pascal Books

There are about a zillion books on Pascal. I can't possibly review them all, and I'm sure to leave out someone's favorite. Apologies in advance.

One book I do *not* recommend is

David Heiserman's *Pascal*, published by Tab Books. If you have a TRS-80 with cassette and no disks, and through some misguided chance you've acquired Supersoft Tiny Pascal, the book may be useful; but if you don't, it isn't. I really cannot recommend that you spend much time with Tiny Pascal anyway, and systems without disk drives belong in the dark ages. Trying to learn a language using a cassette is a sure-fire way to get discouraged and give it up as a bad job.

Heiserman's book suffers from the generic problems of all Tab books: sloppy editing, tiny margins, un-aesthetic print and layout, and all-around carelessness. As an example, he states:

```
WRITE('HELLO', 'THERE', '.  
HOW ARE YOU?');
```

with the expectation that it will print "HELLO THERE. HOW ARE YOU?" but of course it won't, for there is no space between HELLO and THERE. Trivial but infuriating slop like this seems characteristic of just about every Tab book I've seen.

Slightly better is Ronald Anderson's *From BASIC to Pascal*, but it, too, suffers from the Tab syndrome, and the examples are reproduced from a dot-matrix printer; they're very hard to read. The book purports to tell BASIC programmers how to switch over to Pascal, but I'd hate to have to rely on it as my guide.

Another book I don't recommend is Kenneth Bowles's *Microcomputing Problem Solving Using Pascal*, which is the standard textbook at UCSD—possibly because the professor who teaches Pascal is named Kenneth Bowles. I've attempted to read this book, and it's impossibly opaque. It's also done in typewriter script, making it physically as well as intellectually difficult to read.

Two more I can't say I care much for: Rodney Zaks's *Introduction to Pascal* and *A Primer on Pascal* by Richard Conway, David Gries, and E. Carl Zimmerman. Zaks's book isn't all that bad, and it does go into some pretty complicated concepts before it's done; it is certainly more pleasant

to read than the book by Conway et al. You could live with Zaks, and if there's nothing better conveniently at hand, you could learn the language from it; certainly I'd prefer it to the *Primer* or either of the Tab books. There are, however, better introductory texts.

The book I learned with is Peter Grogono's *Programming in Pascal*. It begins at elementary levels and goes into progressively more complex subjects. I very much like his Pascal style and program layout, and his discussion of records and event rings is the best I've seen in any book. It's not really a beginning text, but if you're familiar with programming in general, Grogono's book is very good for those who want to learn Pascal as an additional language. However, there's no mention of CP/M or microcomputers. Grogono can teach generic Pascal, but you'll still need a guide to your particular implementation.

Our current favorite beginner's text is *A First Course in Computer Programming Using Pascal* by Andrew M. Keller. This book isn't complete in that there's not an adequate discussion of records and pointers, but this book and Grogono's combined can teach you to write practical programs without too many tears. (On price alone, the Zaks book may be the way to go: one book instead of two. However, I don't think Zaks's is as good an introduction as Keller's, and isn't as complete on complex issues as Grogono.)

For Apple users there's Elliot B. Koffman's *Pascal—A Problem Solving Approach*, which is intended as a collegiate-level text and goes up to relatively complicated programs. Not as general as the Keller/Grogono combination, it is adequate for learning a lot about UCSD Pascal, and some may prefer Koffman's style. There are a lot of examples and problems, with answers in the back of the book. For reasons I don't understand, this book, like many Pascal textbooks, gives program examples all in uppercase. This encourages what is, in my judgment, bad programming style. I think programs are much more readable if uppercase is used for reserved words, such as BEGIN and END, and

Now your computer can say anything and say it well. Introducing the Votrax Personal Speech System.

Quite articulate.

The unlimited vocabulary Votrax Personal Speech System is the most sophisticated, low cost voice synthesizer available today. Its highly articulate text-to-speech translator lets your computer properly pronounce conversational words at least 95% of the time.

For all those unusual words and proper names, you can define an exception word table and store your own translations. And remember, the entirely self-contained Votrax PS System gets your computer talking without using any valuable computer memory.

Built-in versatility.

Much more than just a voice output device, the Votrax PS System lets you mix either speech and sound effects or speech and music. A programmable master clock and 255 programmable frequencies give you unmatched control of speech and sound effects.

The Votrax PS System offers user expandable ROM for custom applications, user downloadable software capability and sound effects subroutines for easy user programming. Its programmable speech rate provides more natural rhythm, while 16 programmable amplitude levels give you greater control of word emphasis.

Actual size: 12.2" x 4.5" x 2.6"

Friendly to humans.

Designed to look like a printer to your computer, the Votrax PS System is extremely easy to use. It can be used in tandem with your printer without an additional interface card. Both serial and parallel ports come standard, allowing you to connect the Votrax PS System to virtually any computer. Speech, music and sound effects are only a PRINT statement away.

“Listen here”

What to say after “Hello”.

Businesses will appreciate spoken data transmission, narration of graphic displays and unmanned, oral product demonstrations. Spoken verification of data input will make computers much easier for the blind to use. School children can receive comprehensive

Votrax®

The Votrax Personal Speech System is covered by a limited warranty.

Write Votrax for a free copy.

500 Stephenson Highway, Troy, MI 48084

computer instruction with voice textbooks as well as spoken drills and testing. And then, late at night, you can make those adventure games explode.

A quick list.

- Highly articulate Votrax text-to-speech translator.
- 255 programmable frequencies for speech/sound effects.
- 16 amplitude levels.
- Simultaneous speech and sound effects or speech and music.
- 8 octave, 3 note music synthesis.
- Serial and parallel interface standard.
 - User programmable master clock.
 - User defined exception word table.
 - User programmable speech rate, amplitude and inflection.
 - User expandable ROM for custom applications.
 - User downloadable software capability.
 - 3,500 character input buffer: sub-divisible for a printer buffer.
- Internal speaker and external speaker jack.
- Real time clock and 8 user defined alarms.
- Oral power up and error prompting.
- X-on/X-off and RTS-CTS handshaking.
- Programmable Baud settings (75-9600).
- Interrupt driven Z-80 microprocessor.
- Parallel/Serial interconnect modes.
- Proper number string translation: the number “154” is pronounced “one hundred fifty four”.

To order, see your local computer retailer or call toll-free

1-800-521-1350

Michigan residents, please call (313) 588-0341. MasterCard, VISA or personal check accepted. The price is \$395 plus \$4 for delivery. Educational discount available. Add sales tax in Michigan and California.

© VOTRAX 1982

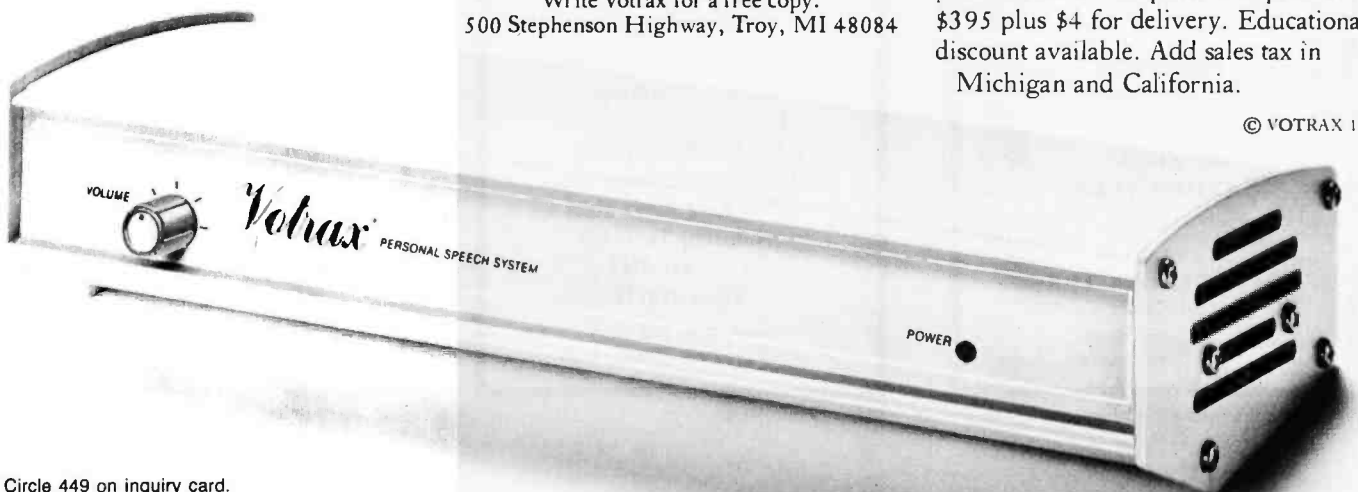

Circle 449 on inquiry card.

most of the program is written in lowercase letters.

One book I've liked a lot was *Doing Business with Pascal* by Richard and Douglas Hergert. It's not a beginner's book, but it would do as a follow-up after Keller, and it offers a great number of practical business programs. Any small business owner faced with writing programs, or trying to understand programs written for the business, would do well to read this book. It's mostly for UCSD Pascal, but the authors admit there are other implementations. At least it's micro-oriented.

Another, perhaps even better, is *Pascal Programs for Business* by Tom Swan. This book has chapters on word processing as well as business subjects. There are a lot of interesting programs; I can't testify that they'll work, but they look good to me, and they're well structured. Kernighan and Plauger have repeatedly stated that one of the best ways to learn programming is to read well-designed programs; Swan offers that opportunity. Some are so interesting that I intend to key them in Real Soon Now.

The Osborne/McGraw-Hill people have translated their two books, *Practical BASIC Programs* and *Some Common BASIC Programs*, into Pascal and put them out as, unsurprisingly, *Practical Pascal Programs* and *Some Common Pascal Programs*. You cannot use

them as simple cookbooks because, alas, Pascal implementations differ a lot on how they do input/output and file management. Different machines and implementations require non-trivial modifications of the programs given in the books, and if you don't know something about the Pascal implementation you're using, you'll never get these programs to run on your machine.

On the other hand, provided you know something of Pascal, there are some really practical programs in these books. When I needed a matrix inverter, I found it in *Common*, and I've used the Bayesian decision-analysis program from *Practical*. I warn you again, you need to know what you're doing; these books make little concession to readers not familiar with their subject matter; there's no explanation of what matrix inversion means, and darned little about Bayes's theory of inductive reasoning. However, if you do know what you're doing, having these programs as models can sure save you a lot of time.

Finally, there's *Software Tools in Pascal* by Brian W. Kernighan and P. J. Plauger. Their original *Software Tools* (FORTRAN and RATFOR) used to be required reading for anyone seriously studying software engineering. This is a translation of their classic work into Pascal.

Kernighan and Plauger present an amazing variety of programs, many of which "cascade," in that later programs call in earlier ones as sub-programs. Their "software tools" have thus become famous. It isn't so much the programs themselves; there are now better programs to do the jobs, such as text editing, that those programs were supposed to accomplish. The value of the books and programs is in teaching, by example, just what structured programming is all about.

Alas, *Software Tools in Pascal* was written for Pascal implementations running on machines a good bit larger than any BYTE readers are likely to have at home. It takes a lot of translation to get the "tools" running on a microcomputer. Unless you actually experiment with the programs, though, a good bit of the value of the book is lost.

I found that out some time ago and set my son Alex to doing something about it. The result was his own book and program disk. Using Pascal/M from Sorcim and Pascal MT+ from Digital Research as the two implementations of choice, he translated the introductory building blocks of *Software Tools* so that they will now run on most microcomputers. The disk comes with considerable documentation, including the best exposition of what Pascal error messages

300 BAUD	MODEMS	1200 BAUD
SIGNALMAN. . . Free hour on 'SOURCE'		
300 BAUD direct connect \$ 69		
300 BAUD AUTO DIAL/ANS \$119		
300/1200 AUTO DIAL/ANS \$319		
US ROBOTICS. . . 300/1200 . . . MODEMS		
'Hayes Compatible'		
'Password' with cables, spkr \$339		
'Auto 212' dxle \$419		
DOT MATRIX	PRINTERS	LETTER QUALITY
GEMINI 10x 120 cps graphics \$289		
PROWRITER 120 cps hi density \$319		
JUKI daisy wheel 18 cps \$565		
DAISYWRITER c/o 40 cps \$999		
CPM	COMPUTERS	IBM
Eagle II	HARD DISKS	Columbia P.C.
10 MB . \$1295	23 MB . \$1995	40 MB . \$2495
Televideo	\$CALLS	Eagle P.C.
IMAGE COMPUTERS		
P.O. Box 1164, Cardiff, CA 92007		
CALL TO ORDER:		
619 436-7669		VISA/MC
619 436-8317		ADD 3%

Circle 223 on inquiry card.



**Best Prices On
TRS-80 Computers**

Our 6th year of discounts
Ed or Joe McManus
Fgt. Prepaid. Save Tax.
Toll Free 800-231-3680

Marymac Industries, Inc.
22511 Katy Fwy., Katy
(Houston) Tx 77450
1-713-392-0747
Telex 774132

See us in the Wall Street
Journal every Tues., Wed., Thurs.

Circle 276 on inquiry card.

RTL

**Relocatable
Threaded
Language** **\$150**

RTL is a new language which retains the speed and extensibility of Forth but adds many additional advantages as a result of its more structured dictionary. Names, code, and variables are all stored in separate areas for easy generation of headerless, romable code. All code is relocatable. RTL supports local variables, multitasking, redirected I/O, and even allows definitions to be changed retroactively. All source code is included. Versions are currently available or under development for 68000, 6809, 8080, 280, 8086, 8088, and 6502.

RTL Programming Aids
10844 Deerwood SE
Lowell, MI 49331
(616) 897-5672

Circle 369 on Inquiry card.

The personal, portable daisywheel printer.

Only \$599.

For the first time, your letter-quality printer can be used almost anywhere! Bring the new Transtar 120 with you to work, to school, and home again! Conveniently weighing in at less than 19 pounds, it generates unrivaled print quality and is the size of a standard briefcase. The new 120 is so light, so small, that you can take it with you!

Remarkably, the new \$599 Transtar 120 is "plug and go" compatible with the best-selling word processing programs. Just plug the 120 into your personal computer and watch this precision printer purr along at 14 cps Shannon text speed producing superscript, subscript, underlining and a true boldface. Even using letterhead is now a breeze with the 120's automatic single sheet loading!

Don't worry about durability: it's a tough little machine. It joins the highly reliable family of Transtar printers with a failure rate that's the envy of the industry: less than 1%. Should your 120 ever need repair, a nationwide network of authorized service centers stands ready for speedy repair on your six-month end-user warranty.

Just think of it: everything you want in a letter-quality printer...anywhere you want it. Only \$599.

Transtar

P.O. Box C-96975, Bellevue, Washington 98009

Circle 437 on inquiry card.

mean and what is likely to have caused the error, that I have seen yet in any of these texts.

If you want to learn Pascal, you could do worse than make a package deal: MT+ Compiler; three books: Keller, Grogono, and the Kernighan and Plauger; and Alexander Pournelle's *A Primer on Pascal for CP/M Systems*.

C Language Books

There aren't so many books on the C language yet, but given time I'm sure there will be. A good way to find out if you will like C is to read the August 1983 issue of *BYTE*.

Not long ago, the only way to learn C was from Brian W. Kernighan and Dennis M. Ritchie, *The C Programming Language*. Now there are better introductory books, but Kernighan and Ritchie is still the standard, and since Kernighan was the principal author of the C language, he can speak with some authority when he writes about it.

The book is a bit terse. It definitely assumes you know something about

computers and programming. It was also written under the assumption that you're working with a system using the Unix operating system. On the other hand, there's a good tutorial guide that is invaluable provided you can make the proper changes so that the tutorial programs can run under your particular implementation.

You can learn the C language without getting Kernighan and Ritchie, but that's doing it the hard way. You're also working too hard if you make it the *only* book on C that you buy.

Two better introductory books are Thomas Plum's *Learning to Program in C* and Jack Purdum's *C Programming Guide*. I'd rate Plum's book slightly better for beginners, but if you already know something about programming, Purdum's is more complete and often gives comparisons of how BASIC and C would handle the same problem. You don't need both.

Ada Books

Despite some disagreement from a few readers, I continue in my belief

that learning Ada is the best long-term job insurance a programmer can have. Ada is, of course, the new language to be supported by the Department of Defense (DOD). It's full of bells and whistles and special features; its major strength is that, like Modula II, it is designed to allow co-processing, which is to say, to let computers do more than one part of a task at the same time.

There's a very good history of Ada in *Software Engineering with Ada* by Grady Booch. This is, at first, an infuriating book; it addresses important questions, such as the crisis in software, in terms that I had a negative response to. If that happens to you, ignore it, and read on. Booch has a lot to say, and it's important. Indeed, as his book title indicates, the book is as much about software engineering, and a philosophy of software design, as it is about the Ada language. Part of the book is really heavy slogging; I found myself reading some pages more than once. Like me, Booch has strong opinions, and I guarantee he'll irritate some readers.

BYTE Back issues for sale

	1976	1977	1978	1979	1980	1981	1982	1983
Jan.				\$2.75	\$3.25	\$3.25		\$3.70
Feb.			\$2.75	\$2.75	\$3.25	\$3.25	\$3.70	\$3.70
March			\$2.75	\$2.75	\$3.25	\$3.25	\$3.70	\$3.70
April			\$2.75	\$2.75	\$3.25	\$3.25	\$3.70	\$3.70
May		\$2.00	\$2.75	\$2.75	\$3.25	\$3.25	\$3.70	\$3.70
June		\$2.00	\$2.75	\$2.75	\$3.25	\$3.25	\$3.70	\$3.70

	1976	1977	1978	1979	1980	1981	1982	1983
July	\$2.00	\$2.00	\$2.75	\$2.75	\$3.25	\$3.25	\$3.70	\$4.25
Aug.		\$2.00	\$2.75	\$2.75		\$3.25	\$3.70	\$4.25
Sept.		\$2.75	\$2.75	\$2.75	\$3.25		\$3.70	\$4.25
Oct.			\$2.75	\$2.75	\$3.25	\$3.25	\$3.70	\$4.25
Nov.				\$3.25		\$3.25	\$3.70	\$4.25
Dec.		\$2.75	\$2.75	\$3.25	\$3.25	\$3.25	\$3.70	

Circle and send requests with payment to:
BYTE Back Issues
P.O. Box 328
Hancock, NH 03449

Please allow 4 weeks for domestic delivery and 8 weeks for foreign delivery.

name _____
 address _____
 city _____
 state _____ zip _____

The above prices include postage in the US. Please add \$.50 per copy for Canada and Mexico; and \$2.00 per copy to foreign countries.

Check enclosed

Payments from foreign countries must be made in US funds payable at a US bank.

VISA Master Card
 Card # _____ Exp. _____

Signature _____

Compilers From Whitesmiths, Ltd. Are Earning Top Grades.

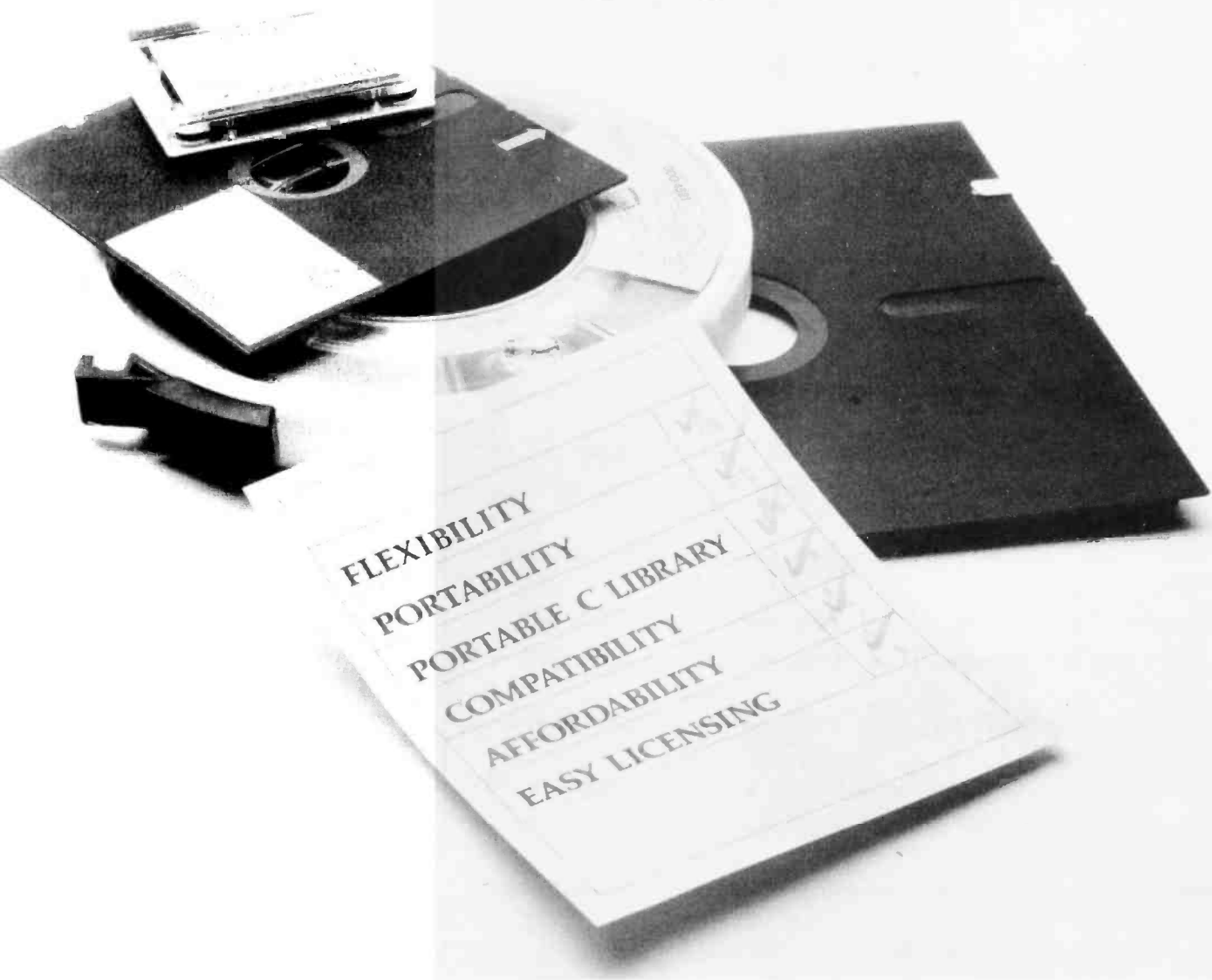

For users of PDP-11, VAX, MC68000, 8080, or 8086 CPUs, Whitesmiths' C Compilers are quite a step above average.

COMPILERS FROM WHITESMITHS, LTD. OFFER:

- **THE HIGHEST PORTABILITY** through recompiling and relinking between all the DEC products, the 8080, the 8088 (8086), and the 68000.
- **FIELD-PROVEN RELIABILITY.**
- **EASE OF APPLICATION DEVELOPMENT.**

The Whitesmiths field-proven Pascal and C Compiler (with cross support option) is portable, compatible and reliable. The compilers are not only portable, but also compatible with most of the popular operating systems and machine architectures. The C Compiler is a FULL IMPLEMENTATION OF KERNIGHAN & RITCHIE'S

C LANGUAGE STANDARD. Pascal conforms to the ISO Standard Level 0. Portability is achieved as a result of an identical preprocessor, parser, and C Portable Library for each compiler. (The C Portable Library contains string manipulation functions and extensive I/O formatting support.) The reliability of the compilers is a product of the portability.

Software application developers achieve ease of development through simply having the ability to recompile and relink to numerous machine architectures. The ability to develop on numerous hardware configurations also provides **INCREASED REVENUE AND PROFIT!**

The C Compilers are \$550. Each Cross Support is an additional \$550. Pascal and C Compilers are \$700; Cross Support is an additional \$700. The Authorization Seal provides ease of licensing. By simply affixing the Authorization Seal to the exterior of your box you have licensed your software with Whitesmiths, Ltd. No license to sign!

To find out how you can make our compilers work for you, write for the PROFIT BUILDER'S CHECKLIST at: Whitesmiths, Ltd.
97 Lowell Road, Concord, MA 01742 (617) 369-8499
Telex: 951708 SOFTWARE CNCM



Whitesmiths, Ltd.

UNIX is a trademark of Bell Laboratories; PDP-11 and VAX are trademarks of Digital Equipment Corporation; MC68000 is a trademark of Motorola Inc. Distributors: Australia, Fawcett Pty. Ltd., P.O.B. 224, Thanesville, NSW 2220 (612) 570 6100; Japan, Advanced Data Controls Corp., Chiyoda-ku, Tokyo (03) 263-0383; United Kingdom, Real Time Systems, Douglas, Isle of Man 0624 833403.

Books Reviewed

Anderson, Ronald W. *From BASIC to Pascal* (Blue Ridge Summit, PA: Tab Books, 1982).

Booch, Grady. *Software Engineering with Ada* (Menlo Park, CA: Benjamin/Cummings Publishing Co., 1983).

Bove, Tony and Cheryl Rhodes, eds. *User's Guide to CP/M Systems and Software* (Stanford, CA: TUG Inc.(POB 3050)).

Bowles, Kenneth L. *Microcomputing: Problem Solving Using Pascal* (New York: Springer-Verlag, 1977).

Conway, Richard, David Gries, and E. Carl Zimmerman. *A Primer on Pascal*, 3rd ed. (Cambridge, MA: Winthrop Publishers, 1976).

Dahmke, Mark. *Microcomputer Operating Systems* (Peterborough, NH: BYTE Books, 1982).

Davidson, Greg. *Practical Pascal Programs* (Berkeley, CA: Osborne/McGraw-Hill, 1982).

Dennon, Jack D. *CP/M Revealed* (Rochelle Park, NJ: Hayden Publishing Corp., 1982).

Gehani, Narain. *Ada: An Advanced Introduction* (Englewood Cliffs, NJ: Prentice-Hall, 1983).

Grogono, Peter. *Programming in Pascal*, revised ed. (Reading, MA: Addison-Wesley, 1980).

Heiserman, David L. *Pascal* (Blue Ridge Summit, PA: Tab Books, 1980).

Hergert, Richard and Douglas Hergert. *Doing Business with Pascal* (Berkeley, CA: Sybex, 1983).

Hogan, Thom. *Osborne CP/M User Guide*, 2nd ed. (Berkeley, CA: Osborne/McGraw-Hill, 1982).

Ingraham, Curtis A. *CP/M Diskguide* (Berkeley, CA: Osborne/McGraw-Hill, 1983).

Keller, Arthur M. *A First Course in Computer Programming Using Pascal* (New York: McGraw-Hill, 1983).

Kernighan, Brian W. and P. J. Plauger. *Software Tools* (Reading, MA: Addison-Wesley, 1976).

Kernighan, Brian W. and P. J. Plauger. *Software Tools in Pascal* (Reading, MA: Addison-Wesley, 1981).

Kernighan, Brian W. and Dennis M. Ritchie. *The C Programming Language* (Englewood Cliffs, NJ: Prentice-Hall, 1978).

Koffman, Elliot B. *Pascal—A Problem Solving Approach* (Reading, MA: Addison-Wesley Microbooks Popular Series, 1982).

Plum, Thomas. *Learning to Program in C* (Cardiff, NJ: Plum Hall Inc., 1983).

Poole, Lon, Mary Borchers, and Greg Davidson. *Some Common Pascal Programs* (Berkeley, CA: Osborne/McGraw-Hill, 1982).

Pournelle, Alexander. *A Primer on Pascal for CP/M Systems* (Pasadena, CA: Workman and Associates (112 Marion Ave.), 1982).

Purdum, Jack. *C Programming Guide* (Indianapolis, IN: Que Corporation, 1983).

Pyle, I. C. *The Ada Programming Language* (Englewood Cliffs, NJ: Prentice-Hall, 1981).

Zaks, Rodnay. *The CP/M Handbook with MP/M* (Berkeley, CA: Sybex, 1982).

Zaks, Rodnay. *Introduction to Pascal (Including UCSD Pascal)* (Berkeley, CA: Sybex, 1981).

No matter: it's worth the effort.

I have no opinion on the worth of the book as an Ada handbook, because I don't know enough about the language. Booch is an Ada enthusiast and presents an awful lot about the language; I think I could write an Ada program using Booch as my only reference, although I'm glad I don't have to. The real value, though, is in explaining why Ada does things in the way it does. I have no hesitation in recommending this book to anyone seriously interested in understanding Ada.

If you know how to program and just want to learn Ada, I can recommend *Ada—An Advanced Introduction* by Narain Gehani. This is a much more traditional book than Booch's. It doesn't go into the Ada "philosophy" much, but it has many more examples of Ada programs and how to write them. If I were required to write an Ada program quickly, I'd far prefer Gehani to Booch. On the other hand, if I were serious about learning Ada, I'd get both. Recommended.

The Ada Programming Language, by I. C. Pyle, used to be the only Ada book; alas, that was about all it had going for it. The book is dense, convoluted in style, and printed in a less-than-pleasing typeface. It also contains erroneous examples. In Pyle's defense, at the time he wrote the book there was no Ada compiler for him to work with, and the DOD publications he had to use as sources were only slightly more comprehensible than Linear B. In any event, it is a book whose time has passed.

The Tidal Wave

There's no shortage of computer books now. My publishing friends tell me computer books are the most popular nonfiction line in the industry. They also say the *real* tidal wave will arrive in 1984.

At best, there's ample information; the challenge will be to sort the gold from the dross. I'll try to do that in future reviews. ■

Jerry Pournelle is a former aerospace engineer and current science-fiction writer who loves to play with computers.

MERRY CHRISTMAS, DARLING!



He asked for a new shirt and tie he'd seen at Bloomingdale's. What he really wanted was more profile in the office.

She asked for a new executive organizer — and promised that this time she'd use it. What she really wanted was a way to succeed.

They gave each other ARIS, the Action Resource Information System. And they each got what they really wanted.

Now Ted's performance is really getting noticed. ARIS organizes his needs, manages his priorities, keeps track of his busy schedule. ARIS eases his work load by placing his calls, outlining his reports, and updating his client records-automatically. And, the built-in word processor has all the features he wants. Ted's getting more work done, faster, more effectively. With ARIS, Ted achieves the real management results he needs.

Susan threw out her old organizer. ARIS prints her action lists, confirms her meetings, even updates her pocket diary. She loves the simplicity of a single program managing her work and her computer. ARIS reveals the true value of total software integration. Now when Susan changes her database, the right information appears instantly in her client files, in her correspondence — everywhere she needs it. ARIS deals with the big issues and the little details, so Susan can focus on her goals.

His performance excels. She's on her way to success. And, with increased effectiveness, they have more time for each other. Thanks to ARIS.

Now. What do you want for Christmas?

esc  EXCEL
SYSTEMS CORPORATION

655 Redwood Highway • Suite 311 • Mill Valley, CA 94941

Ask your Dealer to demonstrate the entire EXCEL SYSTEMS line for you.

Sooner or later, an Eagle has to leave
its nest.



IBM and Selectric are registered TMs of IBM Corp.

Introducing the Eagle Spirit[®] XL. The easy-to-use, professional portable.



Sooner or later, you have to leave your office. And when you do, you need a computer that can go out the door without sacrificing power or capabilities.

A portable computer like the Eagle Spirit XL.

It's highly IBM[®]-compatible, so you can choose from hundreds of software and hardware products designed for the IBM-PC—even graphics and games.

And you can store several of your favorite programs right on a single disk, thanks to Eagle Spirit's 10 Megabyte hard disk memory. Making your business as portable as your computer.

Power? The Eagle Spirit XL is as powerful as a lot of desktops, including the IBM-XT. There's memory to 640K, letting you run even the largest spreadsheets with memory to spare. Plus three ports (two serial and one parallel) that connect you to the world of printers, plotters, mice and modems.

Best of all, you can add ease-of-use features unique to Eagle: like our FlexMenu[®] that calls up a program with just two keystrokes. Or FlexKey[®], designed to simplify popular software packages such as WordStar[®], VisiCalc[®], SuperCalc III[®] and Lotus 1-2-3[®].

With extras like built-in graphics, a familiar Selectric[®]-type keyboard, even a non-glare screen. And it comes as a complete package for one easy-to-take price. Backed by a warranty second to none.

The Eagle Spirit XL. From the people who make the broadest range of IBM-compatible computers.

Ask your computer dealer about the new addition to the Eagle PC series. We've made it easier. And now, we've made it portable.

EAGLE
COMPUTER

Eagle makes it easier.

For the Eagle dealer nearest you, phone
800-538-8157, Ext. 938.
In California, 800-672-3470, Ext. 938.

Software Received

Apple

Apple Cider Spider, an arcade-type game. As a spider, you must get back to your web in the rafters of the apple cider factory. Avoid rolling apples, slicers, crushers, bottlers, and cappers. With luck and timing, you can race the clock to make it home. For II, II Plus, and IIe; floppy disk, \$34.95. Sierra On-Line Inc., Sierra On-Line Building, Coarsegold, CA 93614.

The Apple Family Sing-along Christmas Disk, a disk of Christmas carols. This multivoice, four-part harmony of 16 Christmas carols is complete with words and lasts one-half hour. Handy for Christmas parties, office parties, or family gatherings. For II, II Plus, and III; floppy disk, \$24.50. Solutions Software, PO Drawer 72289, Roselle, IL 60172.

Bermuda Race, a sailing simulation of the blue-water race from Newport, Rhode Island, to Bermuda. One or two players can chart progress as you sail 635 miles of the open Atlantic. Race against those who set the Bermuda Race record with the help of nautical interactive tutorials. For the II; floppy disk, \$29.95. Howard W. Sams & Co., 4300 West 62nd St., Indianapolis, IN 46268.

Compiled Customer/Client Processor, a tailored database program designed to provide storage and manipulation of essential information concerning firms and individuals you do business with. Five of the 14 information fields are user defined. This program can search for records using five user-specified criteria, and it can print records and mailing labels. For the II Plus;

floppy disk, \$59.95. Proflo Software, POB 7115, Murray, UT 84107.

The DT Hunting Trainer/Simulator, a hunting-simulation program designed to accurately depict field conditions and bullet trajectories. Sharpen your hunting skills and judgment by taking into account wind, slope, range, target, and your own ability. For II Plus and IIe; floppy disk, \$29.50. Datatech Software Systems Inc., 19312 East Eldorado Dr., Aurora, CO 80013.

The Einstein Compiler, a BASIC compiler that automatically translates Applesoft BASIC programs into Apple machine language. Compiled programs execute several times faster than uncompiled code and the compiler enables the integrated compilation and execution of multi-module programs. It provides debugging tools and offers mechanisms for program security. For II Plus and IIe; floppy disk, \$129. The Einstein Corp., 11340 West Olympic Blvd., Los Angeles, CA 90064.

Gruds In Space, an illustrated adventure game in which you must deliver a rare fuel to a ship stranded on Pluto. You will be teleporting to other planets to solve many puzzles. If you can deliver the fuel on time, you win one million dollars from President Fred. For II, II Plus, and IIe; floppy disk, \$39.95. Sirius Software Inc., 10364 Rockingham Dr., Sacramento, CA 95827.

Homework Helper, Elementary Mathematics, an educational program that shows you the answers to mathematics problems and displays the extras you need to 'show your work.' Addition

shows carries; subtraction shows borrows; multiplication shows intermediate products; and division shows long-division results up to the first three digits. For II Plus and IIe; floppy disk, \$24.95. Colorado Cypher-netics Inc., 3550 Arapahoe #4, Boulder, CO 80302.

The Last Diary, a personal scheduling program. This record-keeping system is similar to the book form with a page for every day. Each day contains three comment lines. You can manipulate data for taxes or sales; print a day, week, month, or year; or search to find any string or character. For II Plus and IIe; floppy disk, \$49.95. Proflo Software (see address above).

Memory Jogger, a perpetual-reminder program. Never forget another birthday, bill, engagement, or project deadline. This program serves as a flexible appointment-and-event calendar and time-management system. Features include one-time entry for recurring events, rapid search over all fields, and events listed chronologically or alphabetically. For II Plus and IIe; floppy disk, \$29.95. Craftsbury Software Inc., 1623 Montague St. NW, Washington, DC 20011.

Monte Carlo Simulations, a general-purpose statistical simulation and analysis tool that contains two processes: a statistical-analysis process to match a set of raw data to a standard probability distribution, and the simulation process that generates random numbers based on an assumed probability distribution. For the II; floppy disk, \$60. Actuarial Micro Software, 3915 A Valley Court, Winston-Salem, NC 27106.

Natural Family Planning Personal Charting Program, a fertility-charting program. Daily charts display each cycle with temperature and pH signs plotted in graphs as well as text. A statistical analysis of charted cycles displays cycle length, peak day, and the post-ovulatory phase. For the II; floppy disk, \$39.50. Family Life Software, 1401 South 11th Ave., St. Cloud, MN 56301.

Pen-Pal, a word-processing program that uses your computer's full capabilities to type, edit, store, and print large amounts of information. You can write a letter with a few commands or produce a thesis complete with tables. For II and IIe; floppy disk, \$59.95. Howard W. Sams & Co. (see address above).

The Quest, an adventure game. As King Galt's newest advisor, you must accompany his champion fighter, Gorn, on a quest to rid the kingdom of a vengeful dragon. Refresh your water supply and refer to your map of more than 200 locations in high-resolution graphics. For the II; floppy disk, \$19.95. Penguin Software, 830 4th Ave., Geneva, IL 60134.

Ramdisk IIe, a utility program for Apple IIe computers with extended 80-column cards. It has 25 screens of menu-driven documentation and supports double high-resolution graphics. Ramdisk IIe can be modified and copied. For the IIe; floppy disk, \$19.95. Precision Software, 6514 North Fresno St., Milwaukee, WI 53224.

Sammy Lightfoot, an arcade-type game. This little acrobat with a fancy hairdo craves the spotlight under the Big

MicroAge®

**"THEIR ENTHUSIASM ABOUT OUR GROWTH
IN ALASKA WAS CONTAGIOUS...IN LESS
THAN TWO YEARS WE'VE EXPANDED INTO
FOUR COMPUTER STORES!"**

"MicroAge's enthusiasm was catching! The same can do energy that started MicroAge during the pioneering days of microcomputing is now a matter of company policy."

"Plus, MicroAge helped us get key product lines for Alaska!"

"We're believers in MicroAge. Their industry knowledge and insight into recent product developments has given us the flexibility to think and react before our competition does. We started with 4 people in a single store in 1981...now we have 4 stores and 26 people."

"At MicroAge, they speak our language...success!"



Jay Wisthoff
MicroAge Franchisee

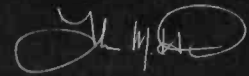

Tom Hunter
MicroAge Franchisee

To build your own professional computer sales organization with MicroAge, write to:

MicroAge®
COMPUTER STORES
"The Solution Store"®

1457 West Alameda • Tempe, Arizona 85282
(602) 968-3168



MicroAge franchisees Jay Wisthoff and Tom Hunter shown with Televideo products.

Circle 283 on inquiry card.

Software Received

Top. He now faces the toughest challenge of his career: an audition that requires perfect timing on the trampolines and courage to swing across the trapeze with fire at his feet. Grinning pumpkins and pounding hammers are out to smash Sammy's dream. For II, II Plus, and IIe; floppy disk, \$37.79. Sierra On-Line Inc. (see address above).

Speedstat 2, a statistical-analysis program that provides an easy means for getting edited or raw data in and out of the system in the form of printed statistical reports or reusable data. For the II; floppy disk, \$299. Softcorp International, 229 Huber Village Blvd., Westerville, OH 43081.

Stellar 7, a strategy arcade-type game in which you are in command of the Agrav Unit, Raven. You must reach

the Arcturan star system and destroy the Supreme Overlord of the Empire, the infamous Gir Draxon. If you survive the onslaught of Arcturan forces on seven star systems, a Warplink will appear and transport you to the next star system. For II, II Plus, and IIe; floppy disk, \$34.95. Software Entertainment Co., 537 Willamette St., Eugene, OR 97401.

Wine Connoisseur, a cellar-inventory program that also files your tasting notes on flavors, aromas, vintages, and regions. This program enables you to pick the appropriate wines for meals using screen prompts and multifield search. For II Plus and IIe; floppy disk, \$39.95. Craftsby Software Inc. (see address above).

Wings Out of Shadow, an arcade-type game based on a

science-fiction story by Fred Saberhagen. You command a spaceship that must fight four levels of a fleet of Berserkers: Bridge Game, Maze Game, Flight Deck, and Last Battle in which you must eliminate all Berserkers or distract them until the *Hope* escapes. For the II Plus; floppy disk, \$34.95. Jim Baen Inc., 8 West 36th St., New York, NY 10018.

The Witness, an interactive-whodunit game. As a chief police detective during the 1930s, you must solve your toughest case to date: a sordid family affair that could put everyone from the heir-ess to the butler in jail. See if you can untangle the knot of motives and alibis and solve the case in less than 12 hours. For the II; floppy disk, \$49.95. Infocom Inc., 55 Wheeler St., Cambridge, MA 02138.

Zaxxon, an air-battle simulation game. As the pilot of a fighter spacecraft, you must destroy a deadly armored robot by skillfully maneuvering to attack enemy installations and fuel tanks. Avoid the enemy's barrage of missiles and gunfire as you scale walls and navigate through force fields in the three-dimensional battlefield. For II, II Plus, and IIe; floppy disk, \$39.95. Datasoft Inc., 9421 Winnetka Ave., Chatsworth, CA 91311-9969.

Atari

Astro Chase, an arcade-type game. As an ace space soldier you must save Earth from destruction by eliminating mines that threaten humanity. Avoid attacks from a variety of enemy fighters trying to distract you. For 400/800 and 1200; cartridge,

C LANGUAGE PROGRAMING

From Plum Hall...the experts in C training

• C
Programming
Guidelines
Thomas Plum

• Learning to
Program in
C
Thomas Plum

Learning to Program in C 372 pp., 7 1/2" x 10". Price \$25.00

A practical, step-by-step guide for everyone acquainted with computers who wants to master this powerful "implementer's" language. Inside, you will learn how to write portable programs for the full spectrum of processors, micro, mini and mainframe

C Programming Guidelines 70 pp., 7 1/2" x 10". Price \$25.00

A compilation of standards for consistent style and usage of C language. Arranged in manual page format for easy reference, it presents time-tested rules for program readability and portability.

PLUM HALL

1 Spruce Av, Cardiff NJ 08032

Please send me:

The experts in C and Unix™ language training.
Phone orders: 609-927-3770

information on C and Unix Training Seminars
copies of Learning to Program in C @ \$25.00/copy
copies of C Programming Guidelines @ \$25.00/copy

NJ residents add 6% sales tax, overseas, contact Prentice-Hall International.

NAME _____

COMPANY _____

ADDRESS _____

CITY/STATE/ZIP _____

Check

American Express

Master Card

Visa

CARD # _____

EXP. DATE _____ / _____ / _____

Signature _____

Unix is a trademark of Bell Laboratory

FREE C LANGUAGE POCKET GUIDE!

A handy C language programming pocket guide is yours free when you order either (or both) of the manuals above. A full 14 pages of valuable C language information!

programmers

READ THIS...

NOW, I KNOW I CAN MAKE BIG MONEY WRITING AND SELLING MY PROGRAMS. THIS BOOK TOLD ME WHAT TO WRITE — WHO TO SELL IT TO — THOUSANDS OF NAMES, ADDRESSES, IDEAS, GUIDELINES. "SOFTWARE WRITER'S MARKET" IS A FANTASTIC BOOK!



- * WHO TO SELL YOUR PROGRAMS TO
- * THOUSANDS OF COMPANY NAMES AND ADDRESSES, WITH DETAILED LISTINGS SHOWING:
 - (1) WHAT PROGRAMS PUBLISHERS ARE LOOKING FOR
 - (2) HOW THEY WANT YOU TO SUBMIT YOUR PROGRAM
 - (3) HOW MUCH THEY PAY — AND WHEN!
- * 100 CATEGORIES — FROM "ACCOUNTS RECEIVABLE" TO "GAMES" TO "VIDEO CONTROL" PROGRAMS
- * HOW TO WRITE CLEAR DOCUMENTATION
- * DEBUGGING TECHNIQUES

Enclose check or money order for \$19.95 (No C.O.D.'s) to:

IPF Publications
146 Country Club Lane
Pomona, NY 10970
(914) 354-5585

Reserve Your Copy Today!

Name

Address

City..... State..... Zip.....



Exporting Services

We Are Buyer's Agent for Overseas Dealers and Distributors

- Lowest prices, immediate quotations, prompt delivery.
- Access to all major hardware and software manufacturers.
- All professional services provided: Licensing, Export Documentation, and Follow-through.

**24-Hour Response as Close as Your Telex
TELEX 470851**

American Buying and Export Services
1036 Country Club Drive, Moraga, CA 94556
(415) 376-7600

Software Received

\$40. Parker Brothers, 50 Dunham Rd., Beverly, MA 01915.

Beneath Apple Manor, a fantasy game simulation. You play the role of an adventurer, exploring a multilevel underground maze of corridors, rooms, and secret passages to kill monsters and find treasures. Increase your skills in each level with colorful high-resolution graphics. For the 800; floppy disk, \$29.95. Quality Software, Suite 105, 6660 Reseda Blvd., Reseda, CA 91335.

DOS-MOD, a modification and enhancement program. Atari DOS 2.05 now includes full use of the screen, one-line commands, command-file capability, options to control wild-card file operations, and a reliable memory/disk swapping facility. For the 400/800; floppy disk, \$35. Eclipse, 1058 Marigold Court, Sunnyvale, CA 94086.

Excalibur, a medieval simulation game. Based on the legend of King Arthur, you must govern a nation wisely using economics, diplomacy, magic, military strategy, even the loyalties of friends and enemies. An Atari joystick controller is required. For the 400/800; floppy disk, \$29.95. Atari Program Exchange, 1265 Borregas Ave., POB 427, Sunnyvale, CA 94086.

Fathom, a subterranean rescue-mission game. You must locate three pieces of Neptune's trident to free his mermaid daughter from her underwater prison. You can switch from a dolphin form to a seagull to search both sea and sky for the missing pieces. Learn to make magical stars and starfish to help you in your mission. For the 2600; cartridge, \$29.95. Imagic, 981 University Ave., Los Gatos, CA 95030.

Kaboom, an arcade-type game. You are after the Mad Bomber, a scowling convict who roams the rooftops dropping bombs with lighted fuses. As you maneuver water buckets to try to catch the falling bombs, you are accompanied by the music of the 1812 Overture. For 400/800 and 1200; cartridge, \$34.95. Activision Inc., 2350 Bayshore Frontage Rd., Mountain View, CA 94043.

Moon Shuttle, an arcade-type game. As the pilot of a Moon Shuttle flight, you repeatedly encounter unexpected dangers as you blast your way through asteroids and bomb launchers while the enemy skillfully dodges your sights. For 400/800 and 1200; floppy disk and cassette, \$29.95. Datasoft Inc., 9421 Winnetka Ave., Chatsworth, CA 91311-9969.

Moonsweeper, an arcade-type adventure. You must reach and rescue miners stranded on hostile moons in an outerspace quadrant. Avoid a deadly photon torch, space bullet showers, and Aurora flare activity at lethal levels. Land on as many moons as you can while you rescue the miners. For the 2600; cartridge, \$30. Imagic (see address above).

Murder on the Zinderneuf, an adventure mystery game in which you pick one of eight detectives and try to solve the mystery of the Zinderneuf blimp before it lands. If you fail, someone will get away with murder. The mystery changes with each different detective. For 400/800 and 1200; floppy disk, \$40. Electronic Arts, 2755 Campus Dr., San Mateo, CA 94403.

The Official Frogger, an arcade-game adaptation. You are a frog with seven lives who must get home safely.

PROGRAMMING IN C ? BE SURE YOU GET ALL THE PHACT'S !

base your C programming on
PHACT-dbrm
a multi-keyed (I S A M)
Data Base Record Manager.

PHACT-dbrm
is an easy to use library of C callable functions for manipulation of records in a database, plus high level database manipulation tools.

PHACT-dbrm
supports: data dictionary; 5 datatypes; variable length records; full database security; database locking, data portability; ".h" file creation and much much more!

PHACT-dbrm
runs on: all UNIX systems • IDRIS and UNIX look-alikes • MSDOS • CP/M

PHACT-rql (Relational Query Language) **PHACT-rg**
(Report Generator) and **PHACT-rsg** (Relational Screen Generator)
under development.

PHACT-dbrm
is priced between \$250-\$950. (Source available)



To get all the PHACT's call DAVID GRAHAM at
PHACT ASSOCIATES Ltd • 212 • 420-1512
231 EAST 11 STREET • NEW YORK • NY 10003

COMPUShACK

PRICES AND AVAILABILITY SUBJECT TO CHANGE WITHOUT NOTICE
 ALL RETURNED MERCHANDISE SUBJECT TO A 20% RESTOCKING FEE.
 ADD 10% FOR NET TERMS
 PRICES GOOD IN U.S. ONLY.
 PRICES REFLECTED IN THIS SECTION ARE LOWER THAN FRANCHISE STORES.

WE TEST EVERY COMPUTER SYSTEM BEFORE WE SHIP IT!

AST RESEARCH

IO Plus-Parallel & Serial Port, Clock Calendar W/Bat. back-up, Superdrive, Superspool **\$199.00**
 Combo Plus—256K, Parallel & Serial Port, Clock Calendar W/Bat. back-up, Superdrive, Superspool **\$499.00**
 Mega Plus—512K, Parallel & Serial Port, Clock Calendar W/Bat. back-up **\$999.00**

QUADRAM

Quad Board - 256K, Parallel Port, Serial I/O Clock Calendar with battery backup **\$599.00**
 512K Ram with Serial I/O **\$799.00**

HERCULES GRAPHICS CARD

This card gives you 720x350 graphics **\$499.00**
BIG BLUE **\$479.00**

MAYNARD SANDSTAR SERIES

Multifunction Card **\$95.00**
 Floppy Disk Controller **\$225.00**
 Memory Card **\$189.00**

MONITORS

AMDEK
 300A **\$199.00** I **\$349.00**
 300G **\$169.00** II **\$699.00**
 310A **\$199.00** III **\$399.00**
 IV **\$1199.00**

NEC

JB 1201M **\$169.00** JC 1203 **\$755.00**
 JC 1212M **\$335.00** JB 1260 **\$139.00**

PRINCETON GRAPHICS SYSTEMS

High Res. Color **\$499**

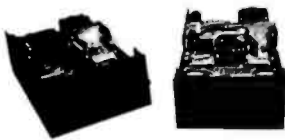

FLOPPY DISK DRIVES

SHUGART
 SA400 SS/SD **\$169.00**

TANDON

TM-100-2 DS/DD **CALL**
 TM-848-1 SS/DD **\$349**
 TM-848-2 DS/DD **\$399**

SIEMENS

FDD 100-5 **\$159.00**

DISK DRIVES

For IBM PC
 Tandon 100-2 **CALL**
 Slimline 320KB **\$229.00**

PRINTERS

BROTHER *brother*
 HR-1 A parallel **\$769.00**
 HR-1 A serial **\$869.00**
 DX-15 **\$599.00**
 Tractor feed option **\$135.00**



IBM

Special of the Month!

IBM PC® COMPLETE LINE

IBM PC

64K, Two 320KB Disk Drives, Floppy Disk Controller, Video Card and High Res Monitor **\$2599.00**



SPECIAL OF THE MONTH!!

TAVA PC

Desk Top IBM PC® Compatible Computer, 128K Ram, Two 320KB Disk Drives, Floppy Disk Controller, Color Graphics Card, One parallel Port, Two serial Ports, High Res Monitor. System runs DOS 1.1; 2.0, and CP/M86® **\$1995.00**

LOTUS 1-2-3 SOFTWARE **\$459**

HARD DISK SYSTEMS FOR IBM

HARD DISK SYSTEM FOR IBM PC

256K IBM PC, 360KB Disk Drive, FDC, 10 MB Hard Disk w/controller, Cabinet controller & software, Color Card, Monitor **\$3999.00**

PRINTERS

OKIDATA

82A **\$429.00**
 83A **\$699.00**
 84AP parallel **\$999.00**
 84AS serial **\$1099.00**
 92A **\$525.00**
 93A **\$899.00**

SILVER REED

Printer **\$699.00**

DAISY WHEEL PRINTERS BY DIABLO

Model 620
 132 Column/20CPS **\$899.00**
Model 630
 API/40 CPS Letter Quality **\$1499.00**
Model 630
 ECS/API-40CPS
 Multi-Lingual **\$1899.00**

Dalsywriter Dalsywheel

Printer **\$1175.00**

Epson FX-80 **CALL**

Epson FX-100 **CALL**

NEC SPINWRITER

NEC



7710-1 **\$2095** 3510 **\$1495**
 7715-1 **\$2295** 3515 **\$1495**
 7730-1 **\$2095** 3530 **\$1695**
 7720-1 **\$2695** 3550 **\$1995**
 7725-1 **\$2695** PC8023A **\$ 595**

APPLE IIe



Computer System Controller, Two Disk Drives, Monitor **\$1699**

OTHER PRODUCTS FOR APPLE

Special of the Month!



\$199

TAVA CORP. DATA DRIVE

100% Compatible Disk drive for APPLE II+ and APPLE IIe. Runs DOS, CPM®, Pascal software.

SLIMLINE DRIVE **\$269.00**

HAYES MICROCOMPUTER PRODUCTS

Micromodem 300 baud **\$299.95**
 Smartmodem 1200 baud **\$529.95**

COMPUShACK

THE UNIQUE FRANCHISING CONCEPT WITH THE FOLLOWING FEATURES:

PRIVATE LABEL PRODUCTS WITH NO ROYALTIES, DISCOUNT PRICES, FULL SERVICE & SUPPORT, COURTESY AND MORE.

Circle 95 on inquiry card.

(714) 261-1000

FRANCHISE INQUIRIES WELCOME

14861 ARMSTRONG, IRVINE, CA 92714
 HEADQUARTERS/TELEX: 181667-ANSWER BACK: COMPSHACK IRIN

*IBM is a registered trademark of IBM Corporation
 *APPLE is a registered trademark of Apple Computers, Inc.
 *CP/M and CP/M86 are registered trademarks of Digital Research, Inc.

PRODUCTS AND PRICES NOT AVAILABLE AT ALL STORES

ALL FLOPPIES REPAIRED QUICKLY AT LOW COST

CALL FOR STORE LOCATION

You must cross the freeway while cars, trucks, and bulldozers are traveling at various speeds. After you try to jump across the freeway to the safety barrier, you must navigate the river by leaping on logs and jumping on turtles' backs. For the 2600; cassette, \$18. Starpath Corp., 2005 De la Cruz Blvd., Santa Clara, CA 95050.

Operation Whirlwind, a WWII strategy game. You command a reinforced infantry battalion. Your job is to infiltrate enemy lines, destroying any resistance you encounter. The computer's forces harass you as you try to seize the city and hold it against counterattack in a limited amount of time. For 400/800 and 1200; floppy disk, \$39.95. Broderbund Software Inc., 1938 Fourth St., San Rafael, CA 94901.

Orc Attack, a medieval-battle game. Save the castle from an Orc attack by hurling rocks and boiling oil from the parapet. Watch out for the sorcerer that is lurking in the background waiting to cast evil spells. For 400/800 and 1200; cartridge, \$39.95. Thorn Emi Home Video, 1370 Avenue of the Americas, New York, NY 10019.

O'Riley's Mine, an underground adventure game. As Timothy O'Riley, you must travel down through your mine to capture buried treasures and return home safely to the top of the mine shaft. Avoid hungry river monsters and drowning in the rushing water. Use your dynamite carefully to destroy the monsters without destroying yourself. For 400/800 and 1200; floppy disk and cassette, \$29.95. Datasoft Inc. (see address above).

Q Bert, an arcade-type game in which you hop Q Bert down a pyramid of cubes

that change color with each successful landing. All the cubes must be changed to the same color before the player can move on to the next, more hectic round of play. For 400/800 and 1200; cartridge, \$40. Parker Brothers (see address above).

Rabbit Transit, a fast-action arcade-type game. As a rabbit, you must get through the mysterious meadow and the land of ledges before you can start a family. Avoid meadow meanies who try to prevent you from reaching the turtle that will carry you down the river. For the 2600; cassette, \$18. Starpath Corp. (see address above).

Super Cobra, a high-altitude arcade-type game where realistic missiles explode around you. The enemy base can be reached only by helicopter and the pilot must execute hairpin aerial maneuvers through a constantly changing terrain of mazes, caves, and cities with tall buildings, while under attack by missiles, meteors, tanks, and flying saucers. For the 400/800; cartridge, \$40. Parker Brothers (see address above).

Wavy Navy, an arcade-type game. You pilot a PT boat being tossed by 30-foot waves while surrounded by enemy bombers and kamikaze fighters that appear on the horizon backed up by helicopters with blazing machine guns. For 400/800 and 1200; floppy disk, \$34.95. Sirius Software Inc., 10364 Rockingham Dr., Sacramento, CA 95827.

The Witness, an interactive-whodunit game (see description under Apple). Infocom Inc., 55 Wheeler St., Cambridge, MA 02138.

Worms, a two-dimensional grid game. You are in control of electronic-light lines that

geometrically resemble worms. They capture territories by laying trails from dot to dot. You can choose from five worms with varying capacities. For the 400/800 and 1200; floppy disk, \$35. Electronic Arts (see address above).

XBASIC, a machine-language program to expand the power of Atari BASIC by adding 30 new functions that include string arrays, multi-color characters, player-missile graphics, and more. For the 400/800; floppy disk, \$29.95. Superware, 2028 Kingshouse Rd., Silver Spring, MD 20904.

CP/M

ACPs, a series of Access Control Programs that interfaces with CP/M 2.2, reserving system-access for authorized users. Access to a system's resources (data and program files, peripheral equipment) is also user-specific. Handles log-on/off from multiple direct-cabled and dial-up terminals and includes a manual. Floppy disk, \$150. Grover Software, POB 34216, Bethesda, MD 20817.

The Champion, a complete CP/M 2.2 accounting package written in dBASE II that includes general ledger and financial statements, accounts payable and purchase order, inventory, payroll, and accounts receivable with order entry and point of sale. This program eliminates the need for batching or sorting data and features a help function and automatic recovery in the event of a crash. Floppy disk, \$195. Data Base Research Corp., Suite 155, 66 South Van Gordon St., Lakewood, CO 80228.

Grafprn, a utility program that lets you print high-res-

olution graphics files on dot-matrix printers. It calculates all the dots on the line between the endpoints and passes this information to the printer (rasterization). This program is limited to Tektronix Plot 10 graphics information. Floppy disk, \$29.95. Micromaster Computer Consultants, 20877 Southwest Winema Dr., Tualatin, OR 97062.

Home Word Processing Service, a start-up kit. This program shows you how to start up a small word-processing service. It includes sample marketing, operating, and start-up plans, a manual, and a collection of pamphlets on such topics as legalities. Floppy disk, \$29.95. South Bay Word Processing, Suite 290, 1558 Oro Vista Rd., San Diego, CA 92154.

Starburst, a systems-building and database management tool for the nonprogrammer that unites Micropro programs or links other software programs to perform ordinary office tasks. This program lets you build and create the menus you need. Floppy disk, \$195. Micropro International Corp., 33 San Pablo Ave., San Rafael, CA 94903.

Commodore

Arcadia Mania, a fast-action arcade-type game in which you shoot nineteen waves of menacing aliens that are all out to get you. Try to kill as many as possible with your limited supply of ammunition. The more you hit, the higher your score. For the 64; floppy disk, \$24.95. Perseus Programming, 9311 Avery Rd., Broadview Heights, OH 44147.

David's Midnight Magic, a fast-action electronic-pinball game. See how high your

Buy Hardware/Software at Wholesale, And Save On Software Rentals, As A NETWORK™ Member Only!

Save hundreds of dollars when you buy DIRECT from America's Number 1 Computer Buying Service at just 8% above DEALER WHOLESALE PRICES, plus shipping.

Members receive The Personal Computer NETWORK's Giant Catalog featuring thousands of products and the lowest prices on the widest selection of computer software and hardware in the nation!

RENT BEFORE YOU BUY—Members are eligible to join The NETWORK's Business and Game Software Rental Libraries for a much smaller fee than other software rental services. And The NETWORK's rental charges are far less—just 20%-25% of the Member WHOLESALE PRICE!

Join The NETWORK today for as low as \$8 for one year (or \$15 for two years) and receive all these exclusive, money-saving benefits:

- 1. REAL BUYING CLOUT**—Buy at just 8% above DEALER WHOLESALE PRICES, plus shipping. (On credit card orders there is a 3% service charge.)
- 2. CONVENIENT SHOP-AT-HOME CATALOG**
- 3. KNOWLEDGEABLE SERVICE CONSULTANTS**
- 4. FULLY INSURED FAST HOME DELIVERY**
- 5. OPTIONAL BUSINESS SOFTWARE RENTAL LIBRARY**—Members join for just \$30 per year in addition to the basic membership fee. Rent business software at just 20%-25% of The NETWORK's low prices for a 7-day period (plus a 3-day grace period for return shipping). 100% of your rental fee applies towards purchase.
- 6. OPTIONAL GAME SOFTWARE RENTAL LIBRARY**—Members join for just \$10 per year in addition to the basic membership fee. All the same conditions apply as for benefit five.
- 7. SPECIAL SAVINGS BULLETINS**—Save even more on limited-quantity merchandise!
- 8. DISCOUNT COMPUTER BOOK LIBRARY**—Save up to 50%!
- 9. MEMBERSHIP SATISFACTION GUARANTEE**—If you are not satisfied, notify us within 30 days to receive a 100% money-back refund.
- 10. PRODUCT SATISFACTION GUARANTEE**—If you are not satisfied with any hardware, return it within 15 days for a 100% money-back refund.

All items subject to availability. Prices subject to change without notice.
Copyright ©1983, PC NETWORK INC.

Low prices, fast home delivery and two software rental libraries are only the beginning! The NETWORK is your source for everything from memory chips to mainframes—and it's all just 8% above wholesale, plus shipping.

HARDWARE

Monitors (color and monochrome)
Printers
Complete Systems
Disk Drives (full/half height, add-on/add-in)
Multi-Function Boards
Graphics Boards
Modems
Local Area Networks
Memory Chips (all speeds available)
S-100 Components

SOFTWARE (rent or buy!)

Business	Scientific
Recreational	Data Bases
Compilers	Educational
Word Processors	Graphics
Utilities	CP/M-MS/DOS

SUPPLIES & ACCESSORIES

Blank Diskettes (all formats)
Paper Stock
Ribbons
Print Wheels
Cables
And More!

Choose hardware and software from hundreds of manufacturers, including:

- | | |
|--------------------|-----------------------|
| • Altos | • MicroPro |
| • Amdek | • Microsoft |
| • Apparat | • Morrow |
| • AST | • Motorola |
| • Ashton-Tate | • NEC |
| • Atari | • Northstar |
| • CDC | • Okidata |
| • Coleco | • Peach Tree |
| • Columbia | • Princeton |
| • Commodore | • Quadram |
| • Corona | • Sanyo |
| • Cromemco | • Sierra On-Line |
| • DEC | • Software Publishing |
| • Digital Research | • Softword |
| • Eagle | • Tandon |
| • Epson | • Tecmar |
| • Franklin | • Texas Instruments |
| • Hayes | • Toshiba |
| • IBM | • Visicorp |
| • IUS | • Zenith |
| • Lotus | |

SAVE ON UPGRADES!

NETWORK SPECIAL

Disk Drive	Retail	Wholesale
Two Tandon TM 50-2 Half Height DS/DD	\$574/ pair	\$350/ pair*
64K Chips	Retail \$11 each	Wholesale \$5.10 ea.*

*NETWORK Members pay just 8% over the wholesale price, plus shipping.

SPECIAL V.I.P. MEMBERSHIPS

Available at \$15 per year or \$25 for two years. V.I.P. Members receive additional benefits:

- 1. BOTH SOFTWARE RENTAL LIBRARIES FOR \$35** in addition to the V.I.P. membership fee.
- 2. EXTENDED 10-DAY SOFTWARE RENTAL PRIVILEGES** (plus 3 days for return shipping).
- 3. ADVANCE NOTIFICATION OF SPECIAL SAVINGS BULLETINS.**

CALL TOLL FREE

1-800-621-S-A-V-E

In Illinois call (312) 372-4488

Your Membership Validation Number: Y999
You can validate your membership number and, if you wish, place your first money-saving order over the phone by using your VISA, MASTERCARD or AMERICAN EXPRESS. Our knowledgeable service consultants are on duty Mon-Fri 8 AM to 7 PM. Sat 9 AM to 5 PM CST.



Call now...Join the PC NETWORK and start saving today!

THE NETWORK • MEMBERSHIP APPLICATION

YES! Please enroll me as a member in The NETWORK™ and rush my catalog featuring thousands of computer hardware and software products, all at just 8% above DEALER WHOLESALE PRICES. I will also receive all the other exclusive, money-saving services available to Members.

I am under no obligation to buy anything. My complete satisfaction is guaranteed.

Please check (✓) all boxes that apply:

Basic Membership

- One-year membership for \$8
 Two-year membership for \$15 (SAVE \$1)
 Business Software Rental Library for \$30 add'l. per year—members only
 Games Software Rental Library for \$10 add'l. per year—members only

Special V.I.P. Membership

919

- One-year membership for \$15
 Two-year membership for \$25 (SAVE \$5)
 BOTH Business and Game Software Rental Libraries for \$35 add'l. per year—V.I.P. members only
 Bill my credit card: VISA
 MasterCard American Express
 Account Number: _____ Exp. Date: _____/_____/_____
 mo. year

Check or money order enclosed for \$ _____

Name _____

Address _____ Apt. No. _____

City _____ State _____ ZIP _____

Telephone (_____) _____

My computer(s) is: IBM PC Apple II TRS-80

Atari Commodore Other _____

Signature _____ (Signature required to validate membership)

Software Received

score goes using dual-flipper controls, bumper action, roll-overs, and multiple-ball play, accompanied by all the sounds and lights of the classic arcade-pinball machine. Jostle the machine too much, though, and the game will tilt. For the 64; floppy disk, \$34.95. Broderbund Software Inc., 1938 Fourth St., San Rafael, CA 94901.

Disk Duplicator, a machine-language program that provides a fast and convenient way to back up disks in as few as four exchanges. This system copies all programs, sequential files, user files, relative files, and more. For the 64; floppy disk, \$14.95. H & H Enterprises, 5056 North 41st St., Milwaukee, WI 53209.

Disk Retriever, a machine-language program that provides a method to recover accidentally scratched programs and data files. This system can restore all programs, sequential files, user files, and relative files to their original status, provided that no prior information has been saved on that disk. For the 64; floppy disk, \$9.95. H & H Enterprises (see address above).

Fourth Encounter, an arcade-type game. Hostile aliens are determined to overrun your planet and enslave the inhabitants. As waves of aliens swoop from the sky attacking you, you shoot lethal laser bolts to eliminate them. For the VIC-20; cartridge, \$39.95. Thorn Emi Home Video, 1370 Avenue of the Americas, New York, NY 10019.

Jumpman, a multilevel arcade-type game. You are trained as the government's top-secret bomb defuser. With seven lives, you maneuver your way around obstacles to save Jupiter, which has been sabotaged with

bombs throughout its thirty levels. You must defuse the bombs and restore the communications systems. For the 64; floppy disk, \$39.95. Epyx/Automated Simulations, 1043 Kiel Court, Sunnyvale, CA 94086.

Typetest, a typing-speed testing program. Select how many words you'd like in your test and the program randomly selects that amount of words, lets you type them, and tells you how fast you typed them. For the 64; cassette, \$11.95. Scott LeDoux, 67 Bridle Rd., POB 383, Billerica, MA 01821.

IBM Personal Computer

Beneath Apple Manor, a fantasy game simulation (see description under Atari). Floppy disk, \$29.95. Quality Software, Suite 105, 6660 Reseda Blvd., Reseda, CA 91335.

The Bottom Line Strategist, an econometric forecasting tool that uses graphics to track and analyze financial and marketing strategies. With little programming knowledge, you can see the viability of a project in a tabular or graphical display. You set parameters with ample help via keys. Floppy disk, \$400. Ashton-Tate, 10150 West Jefferson Blvd., Culver City, CA 90230.

Cache/Q, a software-accelerator package. This sophisticated RAM-caching technique lets you buffer data from mass storage into main memory. Changes in the buffered material are automatically written through to mass storage, thereby affording complete protection for the data. The result is faster-running application programs that are easy to use. Floppy disk, \$225. Techne

QUALITY PARTS AT DISCOUNT PRICES!

SUB-MINIATURE D TYPE CONNECTOR
SOLDER TYPE SUB-MINIATURE CONNECTORS USED FOR COMPUTER HOOK UPS

DB-15 PLUG	\$2.75
DB-15 SOCKET	\$4.00
DB-15 HOOD	\$1.50
DB-25 PLUG	\$2.75
DB-25 SOCKET	\$3.50
DB-25 HOOD	\$1.25

KEY ASSEMBLY 5 KEY

CONTAINS 5 SINGLE-POLE NORMALLY OPEN SWITCHES. MEASURES 3 1/2" LONG.

6 KEY

CONTAINS 6 SINGLE-POLE NORMALLY OPEN SWITCHES. MEASURES 4 1/2" LONG.

SOLID STATE RELAYS 2 AMP

MOTOROLA #MP 120D2 RATED CONTROL - 3.6-6VDC LOAD - 120VAC 2 AMPS 1 T.L. COMPATIBLE. SIZE: 1 1/2" x 1/2" x 1" HIGH
\$3.50 EACH 10 FOR \$32.00

10 AMP

TELEDYNE P/N 615-1 CONTROL: 3-32 VDC LOAD: 10 AMP 140 VAC
\$9.50 EACH

WIRE 15 CONDUCTOR
COLOR CODE D 24 GA STRANDED GRAY JACKET
25 FEET \$12.00 100 FEET \$37.50

BCD DIP SWITCH
10 POSITION ROTARY SCREWDRIVER ADJUST. FITS 6 PIN DIP
\$1.85 EACH

FREE! FREE! FREE! SEND FOR **NEW LARGER 48 PAGE CATALOG**

MINIATURE TOGGLE SWITCHES ALL ARE RATED 5 AMPS @ 125 VAC

S.P.D.T. (on-on) P.C. STYLE. NON-THREADED BUSHING 75¢ EACH 10 FOR \$7.00	S.P.D.T. (on-on) SOLDER LUG TERMINALS \$1.00 EACH 10 FOR \$9.00 100 FOR \$80.00	S.P.D.T. (on-off-on) SOLDER LUG TERMINALS \$1.00 EACH 10 FOR \$9.00 100 FOR \$80.00
S.P.D.T. (on-off-on) NON-THREADED BUSHING P.C. STYLE 75¢ EACH 10 FOR \$7.00	S.P.D.T. (on-on) P.C. LUGS. THREADED BUSHING \$1.00 EACH 10 FOR \$9.00 100 FOR \$80.00	D.P.D.T. (on-on) SOLDER LUG TERMINALS \$2.00 EACH 10 FOR \$19.00 100 FOR \$180.00

POWER SUPPLY
REGULATED FULLY ADJUSTABLE 5 VDC AT 3 AMPS
\$18.50 EACH

EDGE CONNECTORS
22/44 22/44 GOLD PLATED CONTACTS
\$2.00 EACH 10 FOR \$18.00

28/56 28/56 GOLD PLATED CONTACTS 156 CONTACT SPACING
\$2.50 EACH 10 FOR \$22.00

50/100 MICRO PLASTIC #MP-0125-50-DS-1 STANDARD 5-100 CONNECTOR 125" SPACING. GOLD PLATED P.C. MOUNT
\$3.75 EACH 10 FOR \$35.00

ALL ELECTRONICS CORP.
905 S. VERMONT • P.O. BOX 20406 • LOS ANGELES, CA 90006
TOLL FREE ORDERS • 1-800-826-5432
(IN CALIFORNIA: 1-800-258-6666)
AK, HI, OR INFORMATION • (213) 380-8000

- QUANTITIES LIMITED
- MINIMUM ORDER \$10.00
- USA \$2.50 SHIPPING
- NG C O D
- FOREIGN ORDERS INCLUDE SUFFICIENT SHIPPING
- CALIF RES ADD 6 1/2%

PUT "THE TOUCH" ON YOUR APPLE®

"SOFT-TOUCH"™

Now get high resolution touch screen capabilities for your Apple® IIe or Apple® II+ with CTA's Soft-Touch™ bezel and interface. It attaches easily to any Apple® Monitor III and comes with all the hardware and software you need to install and operate it. Use CTA's Soft-Touch™ as a training device or to replace joysticks or keyboard game commands. Use it for spreadsheet programs, too. Ask your Apple® dealer for CTA's Soft-Touch™ — and put the touch on your Apple®!

Dealer Inquiries welcome

CTA

Computer Technology Associates
New Products Division
1704 Moon, N.E.
Albuquerque, New Mexico 87112
(505) 298-0942
TWX 910 989 1157

Apple® is a registered trademark of Apple® Computer, Inc. Soft-Touch is a trademark of Computer Technology Associates.

COHERENT™ IS SUPERIOR TO UNIX* AND IT'S AVAILABLE TODAY ON THE IBM PC.

Mark Williams Company hasn't just taken a mini-computer operating system, like UNIX, and ported it to the PC. We wrote COHERENT ourselves. We were able to bring UNIX capability to the PC with the PC in mind, making it the most efficient personal computer work station available at an unbelievable price.

For the first time you get a multi-user, multitasking operating system on your IBM PC. Because COHERENT is UNIX-compatible, UNIX software will run on the PC under COHERENT.

The software system includes a C-compiler and over 100 utilities, all for \$500. Similar environments cost thousands more.

COHERENT on the IBM PC requires a hard disk and 256K memory. It's available on the IBM XT, and Tecmar, Davong and Corvus hard disks.

Available now. For additional information, call or write,

Mark Williams Company
1430 West Wrightwood, Chicago, Illinois 60614
312/472-6659



Software Received

Software Corp., Suite 210, 3685 Mt. Diablo Blvd., Lafayette, CA 94549.

Chip Wars, an interactive barnyard game for all ages. The chickens have flown the coop and are laying eggs all over the cow pasture. Farmer Dave must race against time to get all those chickens and eggs back to the henhouse while avoiding a prize-winning bull. Floppy disk, \$29.95. Accupipe Corp., 222 West Lancaster Ave., Paoli, PA 19301.

Happy Alligator, an alphabet-teaching program designed for 3- to 6-year-old children. When the child enters the correct letter on the keyboard, the program draws a fun picture on the color monitor. Adult supervision needed only to change disks. Floppy disk, \$29.95. Happy Alligator Co., 274

Cabot Court, Fishkill, NY 12524.

Instat, a general-purpose instant-statistics program. Features include complex contingency tables, histograms, means and standard deviations, and regression and comparison of means. Because P-values are computed automatically, looking up in tables is not required. Produces output on any printer. Floppy disk, \$85. Statistical Consulting Services, 517 East Lodge Dr., Tempe, AZ 85283.

J-Bird, an arcade-type game. You are the J-Bird who must change the color of your world composed of a three-dimensional pyramid of colored cubes. You change cubes' colors by hopping onto a cube and marking it as your territory. Avoid the cartoon critters, a sly snake, a

crafty cat, and Hob and Nob, two pesty characters who change your cubes back to the original color. Floppy disk, \$36.95. Orion Software, POB 2488, Auburn, AL 36831.

Know Your Client, a utility program that lets you keep track of information about your clients. You can enter and instantly recall information such as employees in a company that you plan to visit, when to follow up calls, find clients who have common factors, print labels, and more. Floppy disk, \$92.95. Execuware, Suite 300, 7415 Pineville-Matthews Rd., Box 10, Charlotte, NC 28226.

Meteor Math II, an educational math-adventure game. The pilot must destroy meteors to prevent Earth's destruction by solving math problems. Select the math

mode (addition, subtraction, multiplication, division) and other options on a preflight checklist. Floppy disk, \$44.95. Brauer Computer Support, Education Division, POB 86634, San Diego, CA 92138.

Oil Barons, a strategy game for one to eight players. You become a Texas Wildcatter and must amass more wealth than other players. A colorful game board helps players map and analyze land holdings. The computer keeps score and handles the banking, freeing players for optimal strategies. Floppy disk, \$53.33. Epyx/Automated Simulations, 1043 Kiel Court, Sunnyvale, CA 94086.

Realfast 1, a utility program that links compiled IBM FORTRAN code to the high-speed mathematics of the 8087 Numerical Data Pro-

CompuPro

8 and/or 16 Bits.

At **CompuPro**, we know it isn't enough to make the best computer system around — expert planning, custom configuration, tailored software and swift service are just as vital to our customers. That's why we carefully select and train each of our **Full Service CompuPro System Centers** to provide a complete solutions package for your high-performance computing needs. So for your business, scientific and industrial applications, turn to the professionals listed below. Think of them as your computer consultants — not just retailers.

ALABAMA

Birmingham
Cost Plus Computers
(205) 879-5976

ARIZONA

Scottsdale
S-100
(800) 528-3138

CALIFORNIA

Bakersfield
Creative Computing Services
(805) 835-1118

Berkeley

American Computers & Engineers
(415) 849-0177
Track Computer Center
(415) 845-6366

Burlingame

Mentzer Computer Systems
(415) 340-9363

Canyon Country

Creative Computing Services
(805) 251-9877

Chatsworth

Priority One Electronics
(213) 709-6789

Hayward

Best Computers Hayward
(415) 886-4732

Irvine

Priority One Electronics
(714) 660-1411

Los Angeles

American Computers & Engineers
(213) 477-6751

Gifford Computer Systems
(213) 477-3921

Mountain View

ACC
(415) 969-4969

Oakland

Track Computer Center
(415) 444-8725

Pacific Palisades

System Interface Consultants
(213) 454-2100

Pasadena

Omni Unlimited
(213) 795-6664

Petaluma

Advanced Information Mgmt.
(707) 763-7283

Pleasanton

Best Computers Stoneridge
(415) 463-2233

©1983 CompuPro

cessor. It accelerates formatted input/outputs and mathematical operations. Floppy disk, \$120. Geostat Systems International Inc., POB 1193, Golden, CO 80402.

Styx, an arcade-type game. The bewitching Styx is holding a vast expanse of your playing field. You must venture into its territory to stake your claim. Your stronghold grows as you force the re-treating Styx into the corner. Floppy disk, \$39.95. Windmill Software Inc., 2209 Leominster Dr., Burlington, Ontario L7P 3W8, Canada.

Venture, a financial-planning and analysis system. Financial analysts, strategic planners, capital budget analysts, and others in business can use this program to model, analyze, evaluate, and report on a business from an opera-

tional point of view. Floppy disk, \$495. Weiss Associates Inc., 127 Michael Dr., Red Bank, NJ 07701.

TRS-80

Multiple Access Program (MAP), a utility program. You can search large data or text files in seconds. Enter information in any format you choose: words, phrases, sentences, paragraphs, or fixed fields and MAP will index every item three or more characters long. For Models II and III; floppy disk, \$195. Softshell, POB 18522, Baltimore, MD 21237.

Psiconn, a strategy and concentration game. Try to take over the 600 positions of the board while skipping a barrier that will appear after every 10 positions. When you take one of seven bonuses, a

barrier disappears. For the Color Computer; cassette, \$23.95. The Software Factory, 7014 Southwest 46th St., Miami, FL 33155.

Rainbow's Corner, a collection of five learning games and two math utilities. Enliven a child's imagination and expand creativity by letting them hunt for a pot of gold in a deserted castle, decode messages at the control panel of an alien space ship, or pilot a Blue Mite. For the Color Computer; cassette, \$19.95. John Boesch & Co., 2901 Mirante, Richmond, CA 94803.

Texas Instruments

Cosmic Cruise, an arcade-type game. Travel through space while avoiding planets, asteroids, and attacking aliens. Capture rebel out-

posts to refuel and rearm. Your saucer's console warns you of impending danger. For the 99/4A; cassette, \$11.95. JW Software, 814 West Main, Urbana, IL 61801.

The Dow-4 Gazelle Instrument Flight Simulator, a flying simulation of a private, four-seater, single-engine, instrument-equipped airplane. Beginners learn to take off, land, and use the radio; seasoned pilots refresh skills such as stall recovery and steep turns. In this game, if you crash you are rescued. For the 99/4A; cassette, \$30. John Dow, 6360 Caton, Pittsburgh, PA 15217.

Run the Rapids, an arcade-type game. Navigate your raft through winding, white-water river. Avoid protruding rocks, dangerous fish, and drifting logs. Pick up floating treasures to score points. For

Spoken Here...

SACRAMENTO

Logic Systems
(916) 971-3133

SAN FRANCISCO

Gifford Computer Systems
(415) 391-4570

SAN LEANDRO

Gifford Computer Systems
(415) 895-0798

SAN RAFAEL

Computer House
(415) 453-0865

SANTA BARBARA

Data Bank
(805) 962-8489

SANTA MARIA

Data Bank
(805) 922-1333

SANTA ROSA

Matrix Computers
(707) 542-0571

SUNNYVALE

Pragmatic Designs Inc.
(408) 736-8670

COLORADO

Rocky Mountain Microsystems, Inc.
(303) 232-4545

FLORIDA

Brandon/Tampa

Micro Computer Technology
(813) 685-7659

Ft. Walton Beach

Softech, Inc.
(904) 244-0445

Satellite Beach

Binary Magic, Inc.
(305) 777-7080

HAWAII

Kahului Maui

Capacity Plus Computers
(808) 877-3496

ILLINOIS

Athens

Computers Plus
(217) 636-8491

La Grange Park

Small Business Systems Inc.
(312) 579-3311

Skokie

Lillipute Computer Mart Inc.
(312) 674-1383

INDIANA

Terre Haute

General Software Inc.
(812) 234-9421

MARYLAND

Bethesda

JR Systems
(301) 657-3598

MASSACHUSETTS

Boston

New England Electronic Exch.
(617) 491-3000

Chestnut Hill

Key Micro Systems
(617) 738-7306

(Please turn the page)

CompuPro®

A GODBOUT COMPANY

3506 Breakwater Court, Hayward, CA 94545

©1983 CompuPro

Software Received

the 99/4A; cassette, \$11.95. JW Software (see address above).

ZX81/T/S 1000

Lab-rat, a maze game. Find your way through a mind-boggling maze with only a compass and radar to guide you. As you proceed through the maze in as few moves as possible, your current position will be displayed in three-dimensional perspective. Cassette, \$7.50. Event Horizon Software, 2345 Northfield, Trenton, MI 48183.

Master-Minds, a scientific-deduction game. You must break a 4-digit secret code in less than 15 attempts in order to win. Your computer responds with a few cryptic

clues. Cassette, \$7.50. Event Horizon Software (see address above).

Stor-a-lot, an address-file and mailing-list system. This program, which stores 90 addresses, has full editing, search, and alphabetizing features. Data may be output to the screen or printer. Cassette, \$7.50. Event Horizon Software (see address above).

Other Computers

Airport, an air-traffic simulation. This action game tests your skill as an air-traffic controller. Flight plans, landings, take-offs, or transits are all radioed to you. Guide 26 aircraft safely and you win. But violate FAA rules with a "near miss" and you're fired.

For the Heath/Zenith operating systems and the Osborne 1; floppy disk, \$19.95. The Software Toolworks, Suite 1118, 15233 Ventura Blvd., Sherman Oaks, CA 91403.

Pen-Pal, a word-processing program (see description under Apple). For the Franklin Ace; floppy disk, \$59.95. Howard W. Sams & Co., 4300 West 62nd St., Indianapolis, IN 46268. ■

This is a list of software packages that have been received by BYTE Publications during the past month. The list is correct to the best of our knowledge, but it is not meant to be a full description of the product or the forms in which the product is available. In particular, some packages may be sold for several machines or in both cassette and floppy-disk format; the product listed here is the version received by BYTE Publications.

This is an all-inclusive list that makes no comment on the quality or usefulness of the software listed. We regret that we cannot review every software package we receive. Instead, this list is meant to be a monthly acknowledgment of these packages and the companies that sent them. All software received is considered to be on loan to BYTE and is returned to the manufacturer after a set period of time. Companies sending software packages should be sure to include the list price of the packages and (where appropriate) the alternate forms in which they are available.

...And Here.

NEW YORK

Amherst
Gifford Computer Systems
(716) 833-4758

Deer Park
Datapro Systems Inc.
(516) 595-1311

Staten Island
John D. Owens Assoc.
(212) 448-6283

NORTH CAROLINA

Greensboro
General Semantics Computers
(919) 378-1500

OREGON

Portland
Microwest Computer Products
(503) 238-6274

PENNSYLVANIA

Philadelphia
Information Network Systems
(215) 364-8220

RHODE ISLAND

Coventry
Key Micro Systems
(401) 828-7270

TEXAS

Austin
CPA Systems Inc.
(512) 458-9281

Dallas
Dator Systems
(214) 521-0915

Houston
Gifford Computer Systems
(713) 877-1212

Seguin
CPA Systems, Inc.
(512) 379-0660

VIRGINIA

Woodbridge
ONETCO
(703) 590-5464

WISCONSIN

Greenfield
Byte Shop of Milwaukee
(414) 281-7004

Madison
Beam International
(608) 255-2325

CANADA

Vancouver, B.C.
Dynacomp Business Computers Ltd.
(604) 872-7737

Coquitlam, B.C.
CSC System Center Ltd.
(604) 941-0622

THE PHILIPPINES

Quezon City
Corona International Inc.
78-34-71

UNITED KINGDOM

Swansea
Comcen Technology Ltd.
(0792) 796000

CompuPro®

A GODBOUT COMPANY

3506 Breakwater Court, Hayward, CA 94545

©1983 CompuPro

It's True — We Did It!

We have met or have beaten most advertised prices.

Don't be foolish. Buy Direct!



EAGLE

OUR PC FLYS

IBM Compatible

Simply a better PC. All models available for immediate delivery

Call Lowest \$



Mannesmann Tally

- Standard — 7 x 9 160 CPS
- NLO — 40 x 18 40 CPS
- 2K Buffer and Tractor Standard

160 L 80 col. Call **Best Seller**

180 L 132 col. Call **Best Seller**



IDS

- Proportional Spacing
- 8 Character Styles
- 200 CPS Bi Directional
- Color Optional
- Sheet Feed • Graphics
- 3.4K Buffer

Prism 80

Prism 132 and Micro Prism \$ Call



Red Hot Special!

Novation J-CAT

- 300 BPS Modem
- Originate/Auto Answer

Sizzling **\$84⁹⁵**

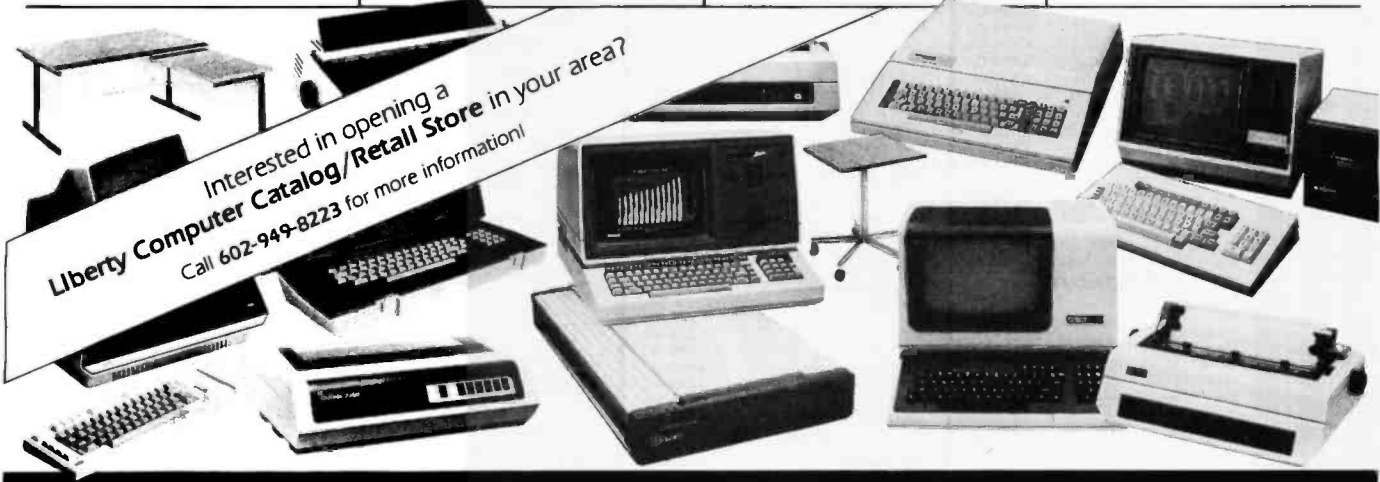

Interested in opening a
Liberty Computer Catalog/Retail Store in your area?
Call 602-949-8223 for more information!

ALTOS
ZENITH
TELEVIDEO
SANYO
USI
TRANSTAR

FRANKLIN
HAYES
NOVATION
VDS
EAGLE
RITEMAN

OMNITEC
VENTEL
AMDEK
BMC
MICOM
DATASOUTH

TAXAN
DIABLO
NEC
EPSON
U.S. ROBOTICS
PRINTEK

OKIDATA
OSBORNE
COMREX
DAISYWRITER
JUKI
STAR

GTC
ADDS
DEC
C. ITOH
SILVER-REED
MANY OTHERS

For Price Quotes and Ordering Call:

1-800-328-8905

For Technical Information and
Arizona Orders, Call:
602-949-8218

For Shipping and Order Status Information,
Call: 602-990-7556

LIBERTY
GROUP, INCORPORATED

4221 Winfield Scott Plaza • Scottsdale, Az 85251



Everything in
computer related
products:

- Computers
- Modems
- Printers
- Software
- Monitors
- Terminals
- Accessories
- Paper
- Ribbons
- Diskettes
- Office Furniture

Prices listed reflect a cash discount and are subject to change without notice. We welcome Certified and Cashiers Checks, Bank Wires and Money Orders. C.O.D.s are shipped with a minimum C.O.D. charge. Allow 3-7 days for personal checks to clear. Product is subject to availability. Equipment is in factory sealed boxes with manufacturer's warranty. There will be a re-stocking charge for returned merchandise. Call first for an RMA number. Software not warranted for suitability. No return of Software which has been opened. Add 2% for shipping & handling charges (minimum \$2.50). All equipment shipped F.O.B. Scottsdale, Az 85251.

Circle 263 on inquiry card.

COMPUTER MAIL ORDER



TERMINALS

910	\$559.00
912	\$689.00
920	\$739.00
925	\$719.00
950	\$929.00
970	\$1069.00

COMPUTERS

800A	\$1099.00
802	\$2699.00
803	\$1949.00
802H	\$4695.00
806/20	\$4999.00
816/40	\$9199.00
1602	\$3399.00
1603	CALL

MODEMS

HAYES

Smart	\$219.00
Smart 1200 (1200 Baud)	\$509.00
Chronograph	\$199.00
Micromodem 100	\$309.00
Micromodem II	\$279.00
Micromodem II (with term)	\$299.00
Smart Com II	\$99.00
Smart 1200B	\$469.00

NOVATION

J-Cat	\$119.00
Cat	\$144.00
D-Cat	\$159.00
103 Smart Cat	\$189.00
Apple Cat II	\$279.00
103/212 Smart Cat	\$439.00
212 Apple Cat II	\$609.00
Apple Cat II 212 Upgrade	\$309.00

ANCHOR

Mark I (RS-232)	\$79.00
Mark II (Atari)	\$79.00
Mark III (T-199)	\$109.00
Mark IV (CBM-PET)	\$125.00
Mark V (Osborne)	\$95.00
Mark VI (IBM-PC)	\$179.00
Mark VII (Auto Ans/Auto Dial)	\$119.00
Mark VIII	\$269.00
TRS-80 Color Computer	\$99.00
9 Volt Power Supply	\$9.00

ZENITH

ZT1 Terminal	\$369.00
--------------	----------



IIE-1	\$1369.00
IIE-2	\$1649.00
IIE-3	\$2399.00
IIE-4	\$3199.00
PC-E	\$1579.00
PC-1	\$2399.00
PC-2	\$2799.00
PC-XL	\$3599.00
1620	\$3599.00
1630	\$5499.00
1640	\$6499.00
Cyma Software	CALL

MONITORS

AMDEK

300G	\$149.00
300A	\$159.00
310A	\$169.00
Color I	\$279.00
Color II	\$399.00
Color III	\$349.00
Color IV	\$999.00

USI

Pl 1 9" G	\$99.00
Pl 2 12" G	\$119.00
Pl 3 12" A	\$149.00
Pl 4 9" A	\$139.00
1400 Color	\$299.00

ZENITH

ZVM 122A	\$109.00
ZVM 123G	\$99.00

BMC

12" Green	\$85.00
9191 AU 13" Color	\$249.00

TAXAN

12 N Green	\$129.00
12 A Amber	\$139.00
12 RGB I	\$299.00

NEC

JB 1260	\$119.00
JB 1201	\$149.00
JB 1205	\$169.00
JC 1215	\$299.00
JC 1216	\$429.00
JC 1203	\$469.00

GORILLA

12" Amber	\$95.00
12" Green	\$89.00



NEC 3560 Printer... \$1799
PERCOM/TANDON

DRIVES

5 1/4" 320K Floppy	\$249.00
5 Meg Hard w/Controller	\$1399.00
10 Meg Hard w/Controller	\$1699.00
15 Meg Hard w/Controller	\$2095.00
20 Meg Hard w/Controller	\$2399.00

AMDEK

310A Amber Monitor	\$169.00
OXY 100 Plotter	\$599.00
Color II	\$399.00

AST RESEARCH, INC.

Six Pak Plus...from	\$279.00
Combo Plus II...from	\$279.00
Mega Plus...from	\$309.00
I/O Plus II...from	\$139.00

QUADRAM

Quadlink	\$549.00
Quadboard...as low as	\$309.00
Quad 512 Plus...as low as	\$259.00
Quadcolor...as low as	\$219.00
Chronograph	\$89.00
Parallel Interface Board	\$89.00
64K RAM Chips Kit	\$69.00

MICRO PRO

Word Star/Mail Merge	\$369.00
InfoStar	\$299.00
Spell Star	\$159.00
CallStar	\$159.00

MICROSTUF

Crosstalk	\$129.00
-----------	----------

MICROSOFT

Multipan	\$179.00
----------	----------

ASHTON-TATE

D-Base II	\$419.00
-----------	----------

IUS

EasyWriter II	\$219.00
EasySpeller	\$119.00
EasyFiler	\$239.00

CONTINENTAL SOFTWARE

1st Class Mail/Form Letter	\$79.00
The Home Accountant Plus	\$99.00

SYNAPSE

File Manager	\$89.00
--------------	---------

LOTUS

123	\$329.00
-----	----------

PFS

File	APPLE	IBM
Report	\$79.00	\$89.00
Graph	\$79.00	\$89.00
Write	n/a	\$89.00

KRAFT

IBM Joystick	\$55.00
IBM Paddles	\$39.00

PROFESSIONAL SOFTWARE

PC Plus Word Processing	\$299.00
-------------------------	----------

KOALA

Koala Pad	\$85.00
Apple	\$95.00
IBM	\$75.00
Atari	\$75.00
CBM 64	\$75.00

PAPER SUPPLIES

1or2" Address Labels(Tract.Feed)	\$9.95
15" Report Paper(Tract.Feed)	\$24.95
8 1/2" Blnk Wht Paper(Tract.Feed)	\$19.95



MBC-550PC	CALL
MBC-555PC	CALL
MBC 1100	\$1599.00
MBC 1150	\$2099.00
MBC 1200	\$1999.00
MBC 1250	\$2399.00
FDD 3200-320K Drive	\$399.00
FDD 6400-64K Drive	\$499.00
PR 5500 Printer	\$699.00

PRINTERS

EPSON

MX80 FT. MX100. RX80.	CALL
FX80. FX100	CALL

OKIDATA

82. 83. 84. 92. 93.	CALL
---------------------	------

STAR

Delta 10	\$559.00
Gemini 10X	\$299.00
Gemini P15	\$449.00
Serial Board	\$75.00

SMITH CORONA

TP-2	\$469.00
Tractor Feed	\$119.00

C.ITOH

Gorilla	\$209.00
Prowriter 8510P	\$379.00
Prowriter 1550P	\$689.00
Starwriter F10-40P	\$1149.00
Printmaster F10-55P	\$1549.00
Tractor Feed	\$199.00

DAISYWRITER

2000 Letter Quality	\$1049.00
2500...NEW	CALL
Tractor Feed	\$109.00

DIABLO

620	\$949.00
630	\$1749.00

IOS

Call for ALL Configurations on
IDS PRISM PRINTERS.

NEC

8023 AN	\$399.00
8025	\$729.00
3510	\$1449.00
3530	\$1499.00
3550	\$1799.00
7710/7730	\$1949.00

BMC

401 Letter Quality	\$699.00
BX-80 Dot Matr.	\$259.00

COMREX

Comwriter II Parallel Printer	\$549.00
-------------------------------	----------

MANNSEMAN TALLY

Spirit 80	\$319.00
MT-160L	\$589.00
MT-180L	\$829.00

TRANSTAR

TRANSTAR	CALL
TOSHIBA	CALL

CABLES & CONNECTIONS

Atari to Parallel	\$29.00
Atari to Serial	\$29.00
Apple to Parallel	\$69.00
Apple to Parallel/Graphics	\$99.00
Apple to Serial	\$89.00
IBM to Parallel	\$35.00
IBM to Serial	\$29.00
Parallel to Parallel	\$29.00
Serial to Serial	\$29.00
Grappier Plus	\$129.00
PKASO	\$139.00
Atari to Modem Cable	\$29.00
CBM 64 to IEEE Board	\$79.00
Apple 80 Column Card	\$159.00
CBM Pet to Parallel	\$99.00
CBM Pet to Serial	\$89.00



HP 75	\$749.00
HP 41C	\$149.00
HP 41CV	\$209.00
HP 41CX	\$259.00
HP 10C	\$52.00
HP 11C	\$69.00
HP 12C	\$92.00
HP 15C	\$92.00
HP 16C	\$92.00

For HP 41/41CV

HPIL Module	\$99.00
HPIL Cassette or Printer	\$359.00
Card Reader	\$144.00
Extended Functions Module	\$64.00
Time Module	\$64.00

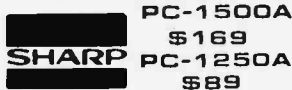

PC-1500A

\$169

PC-1250A

\$89

POCKET COMPUTERS

CE-125 Printer/Cass. Int.	\$129.00
CE-150 Color Print./Cass. Int.	\$172.00
CE-155 8K RAM	\$94.00
CE-161 16K RAM	\$135.00
CE-500 RDM Library	each \$39.00

Texas Instruments

TI-40	\$209
-------	-------

CALL FOR PRICING ON

TIMEX SINCLAIR 1000

16K Memory	\$44.95
2040 Printer	\$99.95
Vu-Calc	\$17.95
Mindware Printer	\$99.00

= WEST = = CANADA = = EAST =

1-800-648-3311

1-800-268-4559

1-800-233-8950

In NV call (702)588-5654, Dept. 1201
P.O. Box 6689, Stateline, NV 89449
Order Status #: 588-5654

In Toronto call (416)828-0866, Dept. 1201
2505 Dunwin Ct., Unit 1B,
Mississauga, Ontario, Canada L5L1T1
Order Status #: 828-0866

In PA call (717)327-9575, Dept. 1201
477 E. Third St. Williamsport, PA 17701
Order Status #: 327-9576

No risk, no deposit on C.O.D. orders. Pre-paid orders receive free shipping within the UPS Continental United States with no waiting period for certified checks or money orders. Add 3% (minimum \$5.00) shipping and handling on all C.O.D. and credit card orders. Larger shipments may require additional charges. NV and PA residents add sales tax. All items subject to availability and price change. We stock manufacturer's and third party software for most all computers on the market. Call today for our new catalog.

COMPUTER MAIL ORDER



FRANKLIN
COLOR COMPUTERS
 ACE 1000, ACE 1200, ACE 1200 OMS,
 ACE 1100 PRO PACK, ACE 1000, ACE
 10 Drive & Controller, 80 Column Card,
 ACECalc & ACEWriter..... CALL
APPLE IIe STARTER PACK
 64K Apple IIe, Disk Drive and Controller,
 80 Column Card & Monitor III...
COMPLETE \$1599.00

MICRO-SCI
Apple & Franklin
 A2 \$219.00
 A4D \$299.00
 A70 \$319.00
 C2 Controller \$79.00
 C47 Controller \$89.00

RANA
 Elite I (Apple/Franklin) \$279.00
 Elite II (Apple/Franklin) \$319.00
 Elite III (Apple/Franklin) \$569.00

VISICORP
FOR APPLE, IBM & FRANKLIN
 Visidex \$189.00
 Visifile \$189.00
 Visiplot \$159.00
 Visiterm \$89.00
 Visitrend/Plot \$229.00
 VisiSchedule \$229.00
 Desktop Plan \$189.00
 Visicac 4 (IBM) \$169.00
 Visicac Advanced IIe \$309.00
 Stretch Calc \$89.00
 Visicorp prices for IBM may vary slightly.

LJK
 Letter Perfect Apple \$109.00
 Data Perfect Apple \$75.00

AXLON
 Apple/Franklin 128K Ram \$299.00
 Apple/Franklin Ram Disk \$729.00

MPC
 Bubdisk (128K Non Volatile) \$649.00

WICO
 Joystick \$21.95
 Famous Red Ball \$23.95
 Power Grip \$21.95
 Three-Way Deluxe \$22.95
 Atari/VIC Trackball \$34.95
 Apple Trackball \$59.95

KRAFT
 Atari Single Fire \$13.00
 Atari Switch Hitter \$16.00
 Apple Joystick \$44.00
 Apple Paddles \$39.00

Commodore



CBM 8032
\$599
CBM64...\$219
VIC 20.....\$89

CALL ON

Executive 64 Portable
 152D Color Printer/Plotter \$169.00
 1525 80 Column Printer \$219.00
 1530 Datasette \$69.00
 1541 Single Disk Drive \$249.00
 1600 VIC Modem \$59.00
 1650 AD/AA Modem \$89.00
 1702 14" Color Monitor \$249.00
 Pet 64 \$569.00
 Pet 4032 \$599.00
 CBM 8032 \$599.00
 Super Pet \$999.00
 B128-80 \$769.00
 2031 \$299.00
 8050 \$949.00
 8250 \$1199.00
 9060 \$1999.00
 9090 \$2199.00
 4023 \$379.00
 6400 \$1399.00
 64K Upgrade \$269.00
 Spell Master \$149.00
 Z-Ram \$549.00
 Silicon Office \$749.00
 The Manager \$209.00
 Soft Rom \$129.00
 Jinsam CALL
 CalcResult 64 \$139.00
 CodeWriter 64 \$75.00
 VisiCalc \$169.00

PROFESSIONAL SOFTWARE

Word Pro 2 Plus \$159.00
 Word Pro 3 Plus \$189.00
 Word Pro 4 Plus \$279.00
 Word Pro 5 Plus \$279.00
 InfoPro \$179.00
 Administrator \$399.00
 Power \$79.00
 Word Pro 64 Plus \$65.00

CARDCO for VIC 20/64

Light Pen \$32.00
 Cassette Interface \$29.00
 Parallel Printer Interface \$69.00
 3 Slot Expans. Interface (20) \$32.00
 6 Slot Expans. Interface (20) \$79.00

HOME COMPUTERS



ATARI 600XL.....\$149
ATARI 800XL.....\$269
ATARI 1200XL.....CALL
ATARI 400.....CALL
ATARI 800.....CALL

1010 Program Recorder \$74.00
 1020 40 Col. Printer/Plotter \$249.00
 1025 80 Col. Printer \$449.00
 1027 Letter Quality Printer \$299.00
 1050 Disk Drive \$379.00
 1030 Direct Connect Modem CALL
 CX30 Paddles \$12.00
 CX40 Joystick \$8.00
 CX42 Remote Joystick CALL
 CX77 Touch Tablet \$69.00
 CX80 Trak Ball \$49.00
 CX85 Keypad \$105.00
 CX418 Home Manager \$69.00
 CX488 Communicator II \$229.00
 KX7098 Atari Accountant \$209.00
 KX7101 Entertainer \$69.00
 KX7102 Arcade Champ \$75.00

ALIEN
 Atari Voice Box \$119.00
 Apple Voice Box \$149.00

MEMORY BOARDS
 Axlon 32K Ram \$59.00
 Axlon 48K Ram \$99.00
 Axlon 128K Ram \$299.00
 Intec 32K Board \$59.00
 Intec 48K Board \$85.00
 Intec 64K Board (400 only) \$99.00
 Intec Real Time Clock \$39.00

DISK & CART HOLDERS
 Filp-n-File 10 \$4.00
 Filp-n-File 50 \$19.00
 Filp-n-File 400/800 Cart \$19.00

PERCOM
 AT 88-S1 \$329.00
 AT 88-A2 \$269.00
 AT 88-S2 \$569.00
 AT 88-S1 PD \$469.00
 AT 88-DDA \$145.00
 RFD 40-S1 \$449.00
 RFD 40-A1 \$279.00
 RFD 40-S2 \$729.00
 RFD 44-S1 \$539.00
 RFD 44-S2 \$869.00
 TX 99-S1 (Texas Inst.) \$279.00
RANA
 1000 Atari Disk Drive \$319.00
TRAX
 AT-D2 CALL

FLOPPY DISKS
MAXELL
 MD-1 \$29.00
 MD-2 \$39.00
 FD-1(8") \$40.00
 FD-2(8") DS DDI \$50.00
ELEPHANT
 5 1/4" SS SD \$18.50
 5 1/4" SS DD \$24.95
 5 1/4" DS DD \$29.95
VERBATUM
 5 1/4" SS DD \$26.00
 5 1/4" DS DD \$36.00
HEAD
 Disk Head Cleaner \$14.95

C.M.O. TOP 80

APPLE/FRANKLIN
 1. Choplifter \$27.00
 2. Bank Street Writer \$55.00
 3. PFS: File \$89.00
 4. Visicalc \$179.00
 5. Home Accountant \$55.00
 6. Zaxxon \$29.00
 7. Most Amazing Thing \$28.00
 8. Visifile \$189.00
 9. Fathoms 40 \$19.00
 10. Deadline \$35.00
 11. PFS: Report \$89.00
 12. Zork III \$29.00
 13. Frogger \$24.00
 14. Facemaker \$24.00
 15. Snooper Troops #1 \$32.00
 16. Delta Drawing \$35.00
 17. Castle Wolfenstine \$24.00
 18. Wayout \$29.00
 19. Canyon Climber \$19.00
 20. Bandits \$26.00

CBM 64
 1. Word Pro 64 \$65.00
 2. Jumpman \$29.00
 3. Gorf (20/64) \$14.95
 4. Microspec Data Base 64 \$69.00
 5. Logo 64 \$39.00
 6. Microspec Gen. Ledger 64 \$79.00
 7. Zork III \$29.00
 8. Frogger (64) \$23.00
 9. Quick Brown Fox (20/64) \$49.00
 10. Shamus \$29.00
 11. Deadline \$29.00
 12. Assembler 64 \$14.95
 13. Zork II \$29.00
 14. 3-D Man \$14.00
 15. Protector \$32.00
 16. Starcross \$29.00
 17. Easy Mail 64 \$14.95
 18. Grave Robber \$11.00
 19. Wall Street \$19.00
 20. Trash Man \$32.00

ATARI
 1. Donkey Kong \$39.00
 2. Zaxxon \$29.00
 3. E.T. Phone Home \$39.00
 4. Miner 2049er \$35.00
 5. Dig Dug \$33.00
 6. Choplifter \$29.00
 7. Donkey Kong, Jr \$39.00
 8. Canyon Climber \$25.00
 9. Snooper Troops #2 \$34.00
 10. Word Wizard \$59.00
 11. Picnic Paranola \$34.00
 12. Jumpman \$29.00
 13. Shamus \$34.00
 14. Letter Perfect \$109.00
 15. File Manager 800 \$69.00
 16. Preppie \$24.00
 17. Astro Chase \$25.00
 18. Blade/Black Hole \$27.00
 19. Pac Man \$33.00
 20. Baja Buggies \$25.00

21. Crush, Crumble & Chomp \$24.00
 22. Wayout \$27.00
 23. Zork II \$29.00
 24. Visicalc \$159.00
 25. Atari Writer \$49.00
 26. Three Little Pigs \$25.00
 27. Upper Reaches of Apshei \$16.00
 28. Starbowl Football \$24.95
 29. Dreils \$26.00
 30. Protector \$34.00
 31. Frogger \$25.00
 32. Lunar Leeper \$24.00
 33. Wizard of Wor \$34.00
 34. Kindercomp \$21.00
 35. Moon Shuttle \$22.00
 36. Home Accountant \$55.00
 37. Temple of Apshei \$29.00
 38. Spell Wizard \$39.00
 39. Nautilus \$26.00
 40. O'Riley's Mine \$22.00

= WEST = = CANADA = = EAST =

1-800-648-3311 1-800-268-4559 1-800-233-8950

In NV call (702)588-5654, Dept. 1201
 P.O. Box 6689, Steline, NV 89449
 Order Status #: 588-5654

In Toronto call (416)828-0866, Dept. 1201
 2505 Dunwin Ct., Unit 1B,
 Mississauga, Ontario, Canada L5L1T1
 Order Status #: 828-0866

In PA call (717)327-9575, Dept. 1201
 477 E. Third St. Williamsport, PA 17701
 Order Status #: 327-9576

CANADIAN ORDERS: All prices are subject to shipping, tax and currency exchange fluctuations. Call for exact pricing in Canada.
INTERNATIONAL ORDERS: All shipments outside the Continental United States must be pre-paid by certified check only. Include 3% (minimum \$5.00) shipping and handling. **EDUCATIONAL DISCOUNTS:** Additional discounts are available to qualified Educational Institutions.
APO & FPO: Add 3% (minimum \$5.00) shipping and handling.

Circle 104 on inquiry card.

Clubs and Newsletters

Update for Human Services

People who work in the health and human services can subscribe to a newsletter, *Healthcare Microcomputing Network*, that intends to introduce improvements in micro-computer usage to healthcare facilities. Subscribers are linked with other health-related corporations through both the publication and *Network's* on-line database service with emphasis on current specialized news about the microcomputer industry. The *Network* is published monthly by Cronin and Associates of Minneapolis, Minnesota. For further details, contact *Healthcare Microcomputing Network*, Suite 520, 6600 France Ave. S, Minneapolis, MN 55435, (612) 926-5827.

And Logo Goes On

The *National Logo Exchange (NLX)* is a monthly newsletter that provides practical ideas and tips for teachers who use the Logo language in their classrooms. The newsletter provides a forum for sharing Logo ideas, techniques, and philosophies. Articles are written by classroom teachers and professional educators to provide up-to-date reviews of recent Logo versions and resources. Subscriptions are \$25 a year in the U.S., Canada, and Mexico, and \$30 elsewhere. Contact the *National Logo Exchange*, POB 5341, Charlottesville, VA 22905.

Bi-monthly Explorations

Owners of the Explorer-85 computer and S-100 bus can join a users group that produces a newsletter every two

months called *Explorations*. New issues as well as back issues are available for \$1 each. For details, contact Leroy W. Marshall, 808 Vassar Lane, Schaumburg, IL 60193, (312) 980-8980.

Pascal for Advanced Placement

A free newsletter is designed to share beneficial ideas for those who teach Advanced Placement Computer Science (APCS), which uses only Pascal. The *APCS Newsletter* will be produced monthly and will raise such issues as software in the classroom, teaching ideas, and materials for teaching introductory Pascal. Those interested are encouraged to send their name, address, and hardware description to Tim Corica, *APCS Newsletter*, The Peddie School, Hightstown, NJ 08520.

Computer Group Has Good News

The Christian Computer Users Association (CCUA) serves as a clearinghouse for information on software and systems of interest to Christian churches. It produces the quarterly *CCUA News*, operates a software exchange, and runs the computer-based Good News Information Service. A one-year membership costs \$15. For more information, contact Douglas Vos, Christian Computer Users Association, 1145 Alexander St. SE, Grand Rapids, MI 49507, (616) 241-0368.

Timex/Sinclair in the Finger Lakes

A group for users of Timex/Sinclair computers is forming

in the Finger Lakes region of New York state between Rochester and Syracuse. Anyone interested can send inquiries to Mark Tepper, 67 North Main St., Geneva, NY 14456.

Schools Use Microcomputers

The Center for Social Organization of Schools of the Johns Hopkins University of Baltimore, Maryland, prepares and distributes a newsletter entitled *School Uses of Microcomputers*. These reports from a national survey include charts on the percentage of teachers who are computerists, how many schools have computers, and the amount of use they receive during the day. It includes tables on the uses of drills and applications of micro-computers in elementary and secondary schools. For further information, contact Dr. Henry Jay Becker, Center for Social Organization of Schools, Johns Hopkins University, 3505 North Charles St., Baltimore, MD 21218.

Participants Welcome

People who are interested in joining a 68000-software users group that is forming in southern California are encouraged to contact Carl Cagan, 211 North El Camino Real, Suite 101C, Encinitas, CA 92024, (619) 942-0744.

Connect With Micro Decision Users

The Connecticut Micro Decision Users Group (CMDUG) of Orange, Connecticut, meets on the second Wednesday of every month for anyone interested

in the Micro Decision computer. A subscription to the group's quarterly *CMDUG Newsletter* is included with membership. The fee is \$12 per year. For details such as locations and times of meetings, contact Dave Mintie, CMDUG, 226 Boston Post Rd., Orange, CT 06477.

Color Computers In Philadelphia

A section of the Philadelphia Area Computer Society (PACS) is called the Color Computer Users Group. It meets on the third Saturday of the month at 10 a.m. in the Science Building of LaSalle College. Further information is available from Arnold Weiss, Apt. 1626, Kennedy House, 1901 J. F. Kennedy Blvd., Philadelphia, PA 19103.

Louisiana IBM PC Users Group

The NW Louisiana IBM Personal Computer Users Group meets on the third Tuesday of each month at 7 p.m. For further information on the club's activities, contact Harry Friedman, NW Louisiana IBM Personal Computer Users Group, 945 Dudley Dr., Shreveport, LA 71104.

For Friendly Folks

Folklore is a quarterly publication circulated to all subscribers and members of FOLK. Designed for Friends of LISP/Logo Kids (FOLK), it contains articles, columns, and code that relate to the expanding field of artificial intelligence. The group has a hotline and a bulletin-board system. Membership is \$15 a year for students and senior citizens, \$25 for a regular

membership, and \$100 for companies or institutions. A subscription to *Folklore* alone is \$7.50. For details, contact FOLK, Friends of LISP/Logo Kids, 254 Laguna Honda Blvd., San Francisco, CA 94116.

Group for the TI 99/4A

The International 99/4A Users Group (IUG) is seeking members and people interested in the TI 99/4A. The group produces a bimonthly newsletter called *4A Forum*. Submissions to the newsletter are welcome. The annual membership fee is \$5. For details, contact Jim Robinson, International Users Group (IUG), 1778 Hays Dr., Louisville, CO 80027.

Osborne Group In Chicago

Chicago's First Osborne Group (CFOG) meets regularly and produces a monthly newsletter entitled PIP (Peripheral Interchange Program) that includes interviews, an events calendar, software reviews, and articles. Contributions to the newsletter are welcome. The club provides a bulletin-board service to members, and membership is open to anyone for \$20 annually. Contact CFOG, Rob Troxel, POB 943, Libertyville, IL 60048, (312) 356-6889.

Meet with Antelope

The Antelope Valley Commodore User Group meets

on the first Saturday of every month. For further details, contact Jim Haner, Antelope Valley Commodore User Group, POB 4436, Lancaster, CA 93539, (805) 942-2626.

HBO In Canada for the Atari

The Hamilton, Burlington, Oakville (HBO) Atari User Group meets on the third Wednesday of each month at the Port Nelson United Church Hall, 3132 South Drive, Burlington, Ontario. A newsletter is produced that contains details about meetings, book reviews, and club business. Membership fees are \$25 annually for individuals and \$35 for a family. If you wish to attend a meeting a \$4 fee will be charged. For information, contact William Morris, 67 Moxley Dr., Hamilton, Ontario L8T 3Y8, Canada, (416) 388-3552.

New Delhi Enthusiasts

A home computer users club, the ZX Club, meets twice a month in New Delhi, India, to exchange the news and solve problems encountered by users of the ZX81. Owners and users of any home computer are welcome, however. The members of the club have developed a music program for the ZX81. For further details, contact ZX Club, h-35 d Saket, New Delhi 110 017, India. ■

If you would like BYTE readers to know about your club or newsletter send the details accompanied by no more than one newsletter to Clubs and Newsletters, BYTE Publications, POB 372, Hancock, NH 03449. Overseas groups are encouraged to participate. Please allow at least three months for your announcement to appear.

Give Personal BASIC™ a try. And win Hawaii!

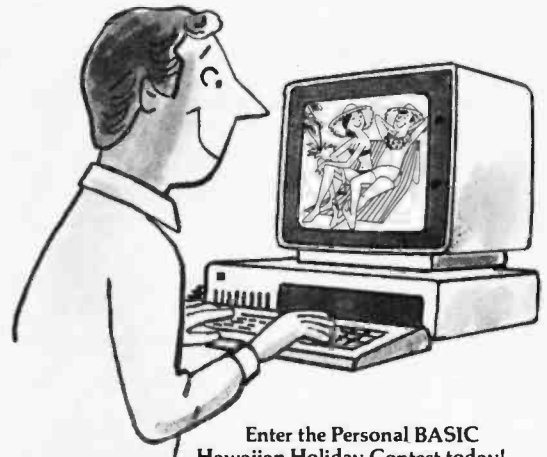

Enter the Personal BASIC Hawaiian Holiday Contest today!

Because you might become the winner of a trip to Hawaii for two—featuring airfare, hotel accommodations, a rental car and \$500 spending money.

Other prizes include a \$500 shopping spree and five \$100 shopping sprees—to be spent in those stores where the winners purchased Personal BASIC, the world's easiest-to-learn BASIC language.

Call toll free for the participating dealer nearest you: (800) 227-1617, ext. 420. In California call: (800) 772-3545, ext. 420.

But hurry, contest ends January 31, 1984.



The Digital Research logo and products are either trademarks or registered trademarks of Digital Research Inc. ©1983 Digital Research Inc.

COMPUTER T SHIRTS!



Software Fashion
P.O. Box 9861, Wethersfield,
CT 06109—0861, or call Linda
to order **1 (800) 223-1796**. NY
residents call **1 (212) 371-1900**.



c. (User Friendly)



d. (PC Compatible)

Hey Linda, I know a good thing when I see it. Send me _____ computer shirts as indicated below. I'm enclosing \$_____ of \$9.00 plus \$2.25 postage and handling for each shirt. (CT residents add 7½% sales tax). Allow 4-6 weeks for delivery. Please print clearly.

MC Visa Check/M.O. card # _____ exp. date _____

Name _____

Address _____

City, State, Zip _____

Qty.	Color (Black/White)	Size (S,M,L,XL)	Style (a,b,c,d)

B

WHY YOU SHOULD RECOMMEND A KAYPRO EVEN IF YOU DIDN'T BUY ONE YOURSELF

If you're happy with the computer you now own, we're happy for you. Because we both know what you went through to buy it.

More than likely, it was a long year's education that sent you into a complex maze of trial and error. You spent a lot of time asking questions in computer stores. More time hunting for answers in computer books. Even more time investigating all the hardware, let alone software options you had to consider.

It was a hard way to get what you needed. A year that earned you an honorary degree in computer engineering and the status of a computer buff.

But just between us buffs, would you recommend a year like that to a friend?

FOR THE FIRST-TIME BUYER, KAYPRO IS A GODSEND.

We think the 'hard way' is the wrong way to have to buy a computer. After all, a business person shouldn't be required to make de-

isions better left to an engineer.

Trying to find compatible interfaces and software packages alone would drive most people up the wall (remember?).

So, we've taken a different

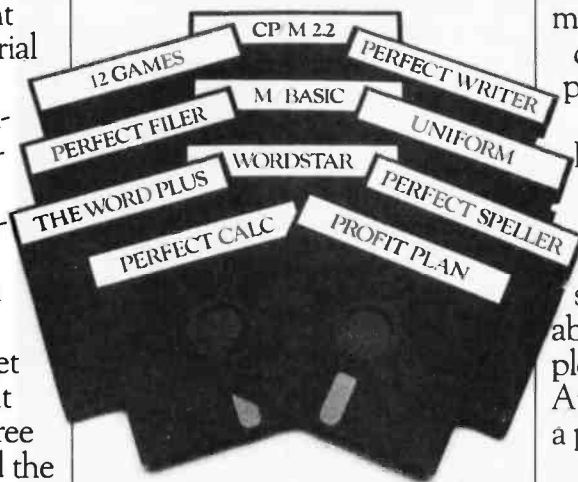

approach to making and selling our Kaypro II. Rather than a starter system, with options you buy piece for piece, it's designed with all the integrated hardware and software it needs to be fully functional.

Off the shelf, Kaypro II is completely ready for business. We think that's what the first-time buyer really needs.

IT'S A COMPLETELY INTEGRATED SYSTEM.

Since we don't consider a monitor, disk drives, interfaces or

other hardware as optional extras, all Kaypro's hardware comes complete in an integrated system. Except, of course, for a printer. As you know, some people don't need one. And those who do must decide whether they need dot matrix or letter quality printing.

What's complete on a Kaypro II?

64K RAM, Z-80 micro-processor. A 9" green screen monitor. Dual disk drives, the same used by IBM. A detachable keyboard that's more complete than you'll find on the latest Apple. Built-in interfaces for both a printer and communications.

In other words, all the hardware you'd recommend to a first-time buyer. In one complete package.

IT COMES COMPLETE WITH SOFTWARE.

While businesses can be very different, the fact is that 95% of all business needs can be fulfilled by a series of three business applications programs. Word Processing/Spelling, Data Base Management and Financial Spreadsheets.

It's the software that's optional with other computers.

But it too comes complete with a Kaypro.

And with its CP/M operating system, Kaypro II is capable of running thousands of other business programs, to fill more specialized needs.

IT SELLS FOR \$1595, COMPLETE.

People are bound to ask you how much they should spend on a computer. There is, of course, an obvious answer: as little as possible and still get a serious business system, complete with all the functions they need.

At \$1595, Kaypro II is the least expensive serious business system we know of on the market today.

There are basic starter systems advertised for less. But their optional hardware and software can double or triple their basic price. So they can end up costing \$2000-\$3000 more than a Kaypro.

A good example is an Apple IIe. With a hardware configuration comparable to Kaypro II's, complete with comparable software, it lists for an average price of \$4400. \$2805 more than a Kaypro.

IT OFFERS MORE MEMORY FOR THE MONEY.

Since disk drive memory capacity is always a concern, once again the idea is to get the most for the money. With two disk drives, Kaypro II gives you 400K for \$1595. With equivalent hardware, an IBM gives you 320K for about \$2800. And Apple IIe gives you 286K for about \$2400.

So once again, Kaypro II delivers.

IT HAS POWER TO SPARE FOR WHAT MOST BUSINESSES NEED.

The more you love computers, the more tempting it is to recommend a 16-bit vs. 8-bit

machine. You know that 16-bit systems are a little faster and have more power to run longer programs.

However, 16-biters are far more expensive than the 8-bit variety. And, unfortunately, have only a handful of business applications software packages that really take advantage of them.

SPECIFICATIONS	
Microprocessor	Perfect Filer
Z-80	Perfect Calc
Operating System	spreadsheet
CP/M 2.2	Wordstar word processing
User Memory	The Word Plus
64K	Profit Plan
Disk Drives:	spreadsheet
2 drives, 400K, unformatted	M-Basic
Interfaces	12 Games
1 Serial	Uniform - allows computer to 'read' and 'write'
1 Parallel	Keyboard
Keyboard	TRS-80, Osborne, Xerox disks
Detached, 63-key with numeric keypad	Dimensions
Software included:	Height: 8 inches
Perfect Writer	Width: 18 inches
word processing	Depth: 15½ inches
Perfect Speller	Weight: 26 lbs. (portable)

Considering the real needs and budget limitations of most small businesses, why suggest a company limo when a good company car will do?

Since 75% of all micros sold today are 8-bit systems, it's indicative of their capacity to take care of business. We'd stick with a Kaypro II.

IT CAN PAY FOR ITSELF FASTER THAN MORE EXPENSIVE COMPUTERS.

Every business person wants a computer to pay for itself in increased productivity.

And the faster the better. Perhaps on this count alone, Kaypro II is worth recommending.

As a fully functional business system for \$1595, Kaypro can win the payout race hands down.

IT'S BECOME A LEADING SELLER THANKS TO COMPUTER BUFFS, LIKE YOU.

In fact, Kaypro II is one of the best sellers in the \$1000-\$5000 price range. And it got there largely because of the enthusiastic word of mouth, and word of press, of computer enthusiasts. Many of whom, after building their own systems, bought a Kaypro II as their second computer.

So you certainly won't be alone if you recommend Kaypro II to anyone shopping for a first computer.

Or look at it this way. Once you tell people about the complete business computer for \$1595, they'll probably stop bugging you with a lot of questions.

They may even forget to ask why you didn't buy a Kaypro II for yourself.

Just between us buffs, we can't recommend a good answer for that.

CALL 800-447-4700 FOR THE DEALER NEAREST YOU.

Circle 249 on inquiry card.

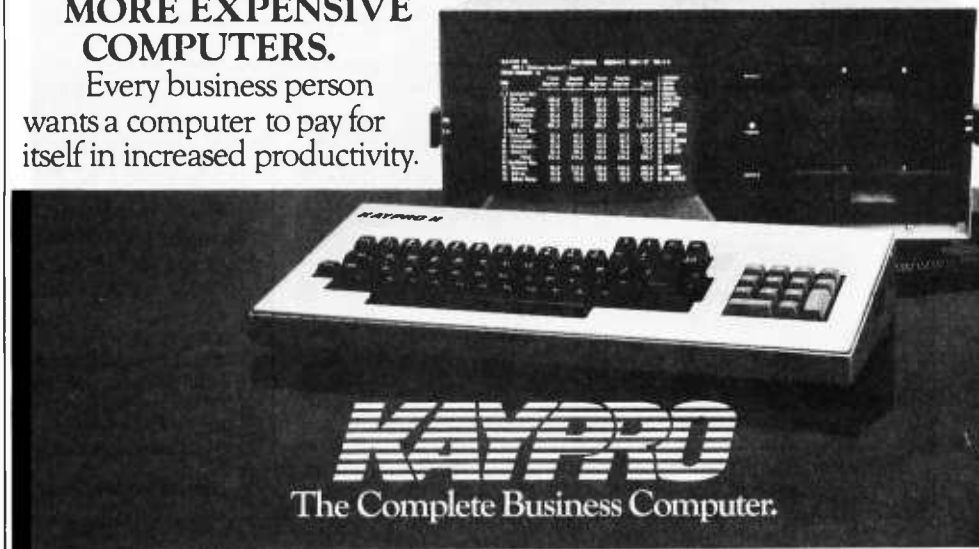

Books Received

The ABZ's of Word Processing for Executives and Professionals, Robert M. Segal and Susan B. Kelley. New York: Stravon Educational Press, 1983; 64 pages, 21.5 by 28 cm, softcover, ISBN 0-87396-097-1, \$10.95.

Applesoft Language, 2nd ed. Brian D. Blackwood and George H. Blackwood. Indianapolis, IN: Howard W. Sams & Co., 1983; 280 pages, 15 by 23 cm, softcover, ISBN 0-672-22073-3, \$13.95.

Astrology: A Look into the Future, Sam D. Roberts. Holzkirchen, West Germany: Ing. W. Hofacker GmbH, 1982; 140 pages, 13 by 20.5 cm, softcover, ISBN 3-88963-171-1, \$9.95.

BASIC By Design, Andrew Kitchen. Englewood Cliffs, NJ: Prentice-Hall, 1983; 514 pages, 17.5 by 23.5 cm, softcover, ISBN 0-13-060269-8, \$18.95.

BASICally Speaking—A Young Person's Introduction to Computing, Frances Lieberman Cohen. Englewood Cliffs, NJ: Prentice-Hall, 1983; 144 pages, 21.5 by 27.8 cm, softcover, ISBN 0-8359-0333-9, \$12.95.

The Blue Book for the Apple Computer, 3rd ed. Chicago, IL: WIDL Video Publications, 1983; 850 pages, 21 by 27.5 cm, softcover, ISBN 684-17927-X, \$24.95.

Byting Back, Rick Gears. Solana Beach, CA: Valleyware Publishing, 1983; 104 pages, 21.5 by 13.5 cm, softcover, ISBN none, \$3.95.

Computers and Data Processing: Introduction with Basic, 3rd ed. Keith Carver. New York: John Wiley & Sons, 1983; 544 pages, 17.5 by 25.3 cm, softcover, ISBN 0-471-09834-5, \$19.95.

The Computer Careers Handbook, Connie Winkler. New York: Arco Publishing Inc., 1983; 160 pages, 20 by 26 cm, softcover, ISBN 0-668-05530-8, \$7.95.

Computers for Small Business, Gary Bencar. Santa Barbara, CA: La Cumbre Publishing Co., 1983; 158 pages, 13.5 by 21.5 cm, softcover, ISBN 0-935222-05-7, \$9.95.

Computer Graphics and Reporting Financial Data, Irwin M. Jarett. New York: John Wiley & Sons, 1983; 376 pages, 22 by 29 cm, hardcover, ISBN 0-471-86761-6, \$49.95.

Computer Programs for Electronic Analysis and Design, Dimitri S. Bugnolo. Reston, VA: Reston Publishing Co., 1983; 272 pages, 17.5 by 23.3 cm, softcover, ISBN 0-8359-0874-7, \$16.95.

Computer Programs for Machine Design, Robert J. Wenzel. Indianapolis, IN: Howard W. Sams & Co.,

1982; 276 pages, 21 by 27.5 cm, softcover, ISBN 0-672-21960-3, \$21.95.

The Data Factory, Edward G. Roeske. New York: Yourdon Press, 1983; 104 pages, 15.5 by 22.5 cm, softcover, ISBN 0-917072-34-0, \$17.

The Directory of Office Information Systems, 2nd ed. Association of Information Systems Professionals. New York: Information Clearing House, 1983; 310 pages, 21.5 by 28 cm, softcover, ISBN 931634-02-4, \$34.95.

The Easy Guide to Your Apple II, Joseph Kascmer. Berkeley, CA: Sybex, 1983; 160 pages, 14 by 21 cm, softcover, ISBN 0-89588-122-5, \$9.95.

8088 Assembler Language Programming: The IBM PC, David C. Willen and Jeffrey I. Krantz. Indianapolis, IN: Howard W. Sams & Co., 1983; 240 pages, 20.5 by 23.5 cm, softcover, ISBN 0-672-22024-5, \$15.95.

Encyclopedia of Computer Terms, Douglas Downing. Woodbury, NY: Barron's Educational Series Inc., 1983; 160 pages, 13.5 by 20.5 cm, softcover, ISBN 0-8120-2519-9, \$6.95.

Fancy Programming in Applesoft, Gabriel Cuellar. Reston, VA: Reston Publishing Co., 1983; 272 pages, 15 by 23 cm, softcover, ISBN 0-8359-1856-4, \$14.95.

The Foolproof Guide to SCRIPSIT Wordprocessing, Jeff Berner. Berkeley, CA: Sybex, 1983; 208 pages, 18 by 23 cm, softcover, ISBN 0-89588-098-9, \$11.95.

How to Buy a Business Computer and Get It Right the First Time, Edward M. Cross. Reston, VA: Reston Publishing Co., 1983; 224 pages, 17.5 by 23.5 cm, softcover, ISBN 0-8359-2922-1, \$14.95.

The Illustrated CP/M-Wordstar Dictionary, Russell A. Stultz. Englewood Cliffs, NJ: Prentice-Hall, 1983; 272 pages, 15 by 22.5 cm, softcover, ISBN 0-13-450528-X, \$14.95.

Learning Simulation Techniques on a Microcomputer, Pat Macaluso. Blue Ridge Summit, PA: Tab Books, 1983; 154 pages, 13 by 21 cm, softcover, ISBN 0-8306-1535-0, \$10.95.

Microcomputer Controlled Toys & Games & How They Work, Van Waterford. Blue Ridge Summit, PA: Tab Books, 1983; 240 pages, 13 by 21 cm, softcover, ISBN 0-8306-1407-9, \$9.95.

Microcomputer Graphics, Donald Hearn and M. Pauline Baker. Englewood Cliffs, NJ: Prentice-Hall, 1983; 320 pages, 18.5 by 24.5 cm, hardcover, ISBN 0-13-580670-4, \$24.95.

Microcomputers in Large Organizations, Thomas

BYTE COVERS

The prints shown at left are beautiful Collector Edition Byte Covers, strictly limited to 750 prints each, and signed and numbered by the artist, Robert Tinney. Each print is 18 in. x 22 in., and is accompanied by its own Certificate of Authenticity. To order, use the coupon below. Visa and MasterCard orders may call 1-504-272-7266.



Through the Trap Door
March 1979—\$35



Breaking the Sound Barrier
September 1977—\$35

Please send _____ **Through the Trap Door** prints (\$35), _____ **Breaking the Sound Barrier** prints (\$35), or _____ sets of both prints (\$55). I have included \$3 per order shipping and handling (\$8 overseas).

I have enclosed check or money order

Visa MasterCard

Card No. _____
Expires: _____
Name: _____
Address: _____
City: _____
State: _____ Zip: _____

Robert Tinney Graphics • 1864 N. Pamela Dr. • Baton Rouge, LA 70815

William Madron. Englewood Cliffs, NJ: Prentice-Hall, 1983; 192 pages, 17.3 by 23.3 cm, softcover, ISBN 0-13-580787-5, \$12.95.

Microcomputers on the Farm, Jack O. Beasley. Indianapolis, IN: Howard W. Sams & Co., 1983; 208 pages, 13.5 by 21.5 cm, softcover, ISBN 0-672-22011-3, \$14.95.

Minute Manual for Apple Writer II, Jim Pirisino. Columbia, MD: Minuteware, 1983; 100 pages, 14 by 21 cm, softcover, ISBN none, \$7.95.

The Official Silicon Valley Guy Handbook, Patty Bell and Doug Myrland. New York: Avon Books, 1983; 128 pages, 13.5 by 20.5 cm, softcover, ISBN 0-380-84392-7, \$3.95.

Powers of Ten, Philip Morrison and Phylis Morrison and the Office of Charles and Ray Eames. New York: Scientific American Books Inc., 1983; 176 pages, 22 by 24 cm, hardcover, ISBN 0-7167-1409-4, \$29.95.

The Pre-computer Book, F.A. Wilson. London, England: Bernard Babani Ltd., 1983; 96 pages, 17.8 by 11 cm, softcover, ISBN 0-85934-090-2, £1.95.

Science and Engineering Programs for the Timex/Sinclair 1000, Cass Lewart. New York: Micro Text/McGraw-Hill, 1983; 120 pages, 15 by 23 cm, softcover, ISBN 0-07-037444-9, \$13.95.

Simplified Guide to Small Computers for Business, Daniel R. McGlynn. New York: John Wiley & Sons, 1983; 256 pages, 17.5 by 25 cm, softcover, ISBN 0-471-86853-1, \$14.95.

6502 Systems Programming, Thomas G. Windeknecht. Boston, MA: Little, Brown and Company, 1983; 256 pages, 17.8 by 23.5 cm, softcover, ISBN 0-316-94563-3, \$14.50.

Skarbak Software Directory, 3rd ed. Anna and Joe Skarbak. St. Louis, MO: Skarbak

Corp. Inc., 1982; 448 pages, 13.5 by 21 cm, softcover, ISBN none, \$14.95.

Soul of CP/M, Mitchell Waite and Robert Lafore. Indianapolis, IN: Howard W. Sams & Co., 1983; 400 pages, 18.5 by 23 cm, softcover, ISBN 0-672-22030-X, \$18.95.

TRS-80 Color Computer Interfacing With Experiments, Andrew C. Staugaard Jr. Indianapolis, IN: Howard W. Sams & Co., 1983; 206 pages, 13.5 by 21.5 cm, softcover, ISBN 0-672-21893-3, \$14.95.

Using & Programming the TI-99/4A, Frederick Holtz. Blue Ridge Summit, PA: Tab Books, 1983; 224 pages, 19.5 by 23.5 cm, softcover, ISBN 0-

8306-0620-3, \$9.95.

Using COBOL in an MP/M System, Neil C. Gelb, CDP. Indianapolis, IN: Howard W. Sams & Co., 1983; 112 pages, 13.5 by 21.5 cm, softcover, ISBN 0-672-21936-0, \$12.95.

VAX-11 Assembly Language Programming, Sara Baase. Englewood Cliffs, NJ: Prentice-Hall, 1983; 416 pages, 18.5 by 24.5 cm, hardcover, ISBN 0-13-940957-2, \$26.95.

Z80 Assembly Language Subroutines, Lance A. Leventhal and Winthrop Saville. Berkeley, CA: Osborne/McGraw-Hill, 1983; 497 pages, 18.5 by 23.5 cm, softcover, ISBN 0-931988-91-8, \$15.95. ■

This is a list of books received at BYTE Publications during this past month. Although the list is not meant to be exhaustive, its purpose is to acquaint BYTE readers with recently published titles in computer science and related fields. We regret that we cannot review or comment on all the books we receive; instead, this list is meant to be a monthly acknowledgment of these books and the publishers who sent them.



COMPLETE DIRECTORY ASSISTANCE FOR YOUR COMPUTER.

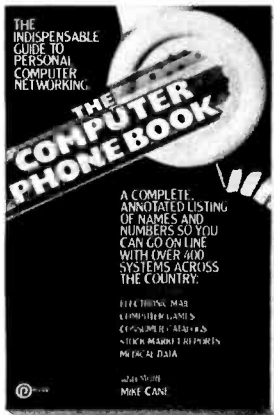

Think of *The Computer Phone Book* as the Yellow Pages to keep by your modem. It's the only annotated directory of all on-line data bases that tells personal computer users all about computer networking.

You can connect with over 400 systems nationwide. Call a business consultant in L.A., buy a suit in Chicago or check Wall Street's latest stock report.

To get all the listed numbers, (even the unlisted) look for *The Computer Phone Book* in stores everywhere, or fill out the coupon. And get a great connection anywhere, anytime.

New American Library, P.O. Box 999, Bergenfield, N.J. 07621

Please send me _____ copies of (Z5446) **The Computer Phone Book™** at \$9.95 each (\$12.50 in Canada), plus \$1.50 postage and handling per order. I enclose check money order (no COD's or cash), or charge Visa MasterCard.

Card # _____ Exp. Date _____

Signature _____

Name _____

Address _____

City _____ State _____ Zip _____



Allow a minimum of four weeks for delivery. This offer, prices and numbers, are subject to change without notice. Offer expires June 30, 1984.



For complete selection of software and accessories for the IBM/PC and compatible computers.

ORYX SYSTEMS

QUALITY DISCOUNTS

APPLE/ FRANKLIN

ASHTON-TATE	
d-Base II	\$ 399
ASPEN SOFTWARE	
Grammarik	\$ 60
Proofreader	42
BEAGLE BROS.	
Apple Mechanic	\$ 22
DOS Boss	17
Utility City	22
BRODERBUND	
Bank Street Writer	\$ 55
General Ledger w/AP	305
Payroll	275
CDEX	
*Visicalc Training	\$ 45
CHARLES MANN	
Class Scheduling	299
CONTINENTAL SOFTWARE	
Home Accountant	\$ 55
DOW JONES	
Market Analyzer	\$ 245
Market Manager	219
Microscope	569

LOGO CORNER

Krell Logo	\$ 75
Abelson Book	15
Terrapin Logo w/full documentation	115

HAYDEN	
Prewriter	\$ 108
HOWARD SOFTWARE	
Tax Preparer	\$ Call
LINK SYSTEMS	
Datafax	\$ Call
Datalink	79
MICROPRO	
Wordstar (Special)	\$ 375
(w/CP/M Card, 7 col. 64K)	
Infostar (Includes CP/M, 70 col., 64K) ..	375
Pra Pak (WS/MM/SS/Index) ..	499
MICROSOFT	
Cobol-80	\$ 499
Fortran-80	145
TASC Compiler	125
A.L.D.S.	99
Multiplan (DOS)	169
OMEGA	
Locksmith	\$ 69
Inspector	47
Watson	44
PEACHTREE (CP/M)	
Peachpak 40 G/L/A/R	\$ 237
A/P (Special)	

Series 40	
G/L, A/R, A/P ea.	195
Inventory	225
Series 9	
Peachcalc	279
Telecommunications	279
PENGUIN SOFTWARE	
Complete Graphics	\$ 53
Graphics Magician	45
Complete Graphics/Apple Tablet	86
Special Effects	50
SOFTECH	
Basic Compilers Runtime	\$ 169
Softtech	94
UCSD p-system set	469
Xeno file	39
SOFTWARE PUBLISHING	
PFS: File	\$ 94
PFS: Graph	94
PFS: Report	94
SUPERSOFT	
Basic Tutor	\$ 579
Fortran	299
SYSTEMS PLUS (Z80 req.)	
Landlord	\$ 375
VISICORP	
Visicalc (II or IIE)	\$ 179
Visischedule	225

CP/M SOFTWARE

COMPVIEW	
*V-Edit 8080 Z80, IBM/PC	\$ 130
*V-Edit CP/M 86, MS DOS	160
DIGITAL RESEARCH	
*Pascal MT + W/SPP	\$ 389
MAC	85
SID (8080 Debugger)	68
ZSID (Z80) Debugger	90
CP/M 2.2	140
C Basic 2	110
PL/1-80	375
INFOCOM	
*Deadline	\$ 49
*Storcross	39
*Suspended	49
*Zork, I, II, III teach)	39
Planet Fall	49
LEXISOFT	
*Spellbinder	\$ 275
MARK OF THE UNICORN	
*Final Word	\$ 229

d-BASE II CORNER

Ashton-Tate	
d-Base II	\$ Call
Bottom Line Strategist	269
FPL	475
Friday	225
Human Soft	
d-Base Plus	\$ 99
Fox & Geller	
Quick Code	\$ 199
D Util	60
Software Banc	
d-Base II User's Guide: w/ d-Base II Purchase	\$ 15
w/o d-Base Purchase	20
Anderson-Bell	
Abstot	\$ 349
Tylog Systems	
d-Base Window	\$ 199

*All above available on PC-DOS

MICROPRO	
*WordStar	\$ Call
*InfoStar	275
*Pro-Pack (WS/MM/SS Index)	\$ Call
All others	\$ Call

MICROSOFT	
Basic 80	\$ 249
Basic Compiler	289
Fortran 80	330
Cobol 80	499
Macro 80	150
MuMath/MuSimp	194
MuLisp/MuStar	156
*Multiplan	175

MICROSTUF	
*Crosstalk	\$ 135

ORGANIC SOFTWARE	
*Datebook	\$ 229
*Milestone	229

PICKLES & TROUT	
CP/M for TRS-II	\$ 180

PRO/TEM SOFTWARE	
*Footnote	\$ 105

REVASCO	
Z80 Disassembler	\$ 85

SORCIM	
*Supercalc II	\$ 179
Superwriter (w/Speller & Mailer) ..	179

SELECT	
Select Word Processor	\$ 356

PEACHTREE CORNER

▶ PeachPak 4 (G/L, A/P, AR)	\$ 237
▶ General Ledger / Accounts Payable / Accounts Receivable / Sales Invoicing / Inventory Control / Receipt Pay Payroll	Each 399
▶ PeachText	160
▶ PeachText w/ Random House Thesaurus	195
▶ Spelling Proofreader	95
▶ PeachCalc	90
▶ Job Cost System	399
▶ Client Posting & Accounting	399
▶ Graphics Language	275
▶ Business Graphic System	199

NORTHWEST ANALYTICAL	
*Statpak	\$ 365

OASIS	
The Word Plus	\$ 120
Punctuation and Style	99

STAR SOFTWARE SYSTEM	
G/L, A/R, A/P or Pay	\$ 349
*Legal Time, Billing	845
*Property Mgmt.	845

Formats

All prices below are for 8" standard. Other formats are available. Some formats subject to Download fee and require minimum 2 weeks for delivery. Please inquire.

SUPERSOFT	
*Diagnostic II	\$ 89
Disk Doctor	75
*Fortran 4	299
Basic 8086	225
C Cross Assembler	400
*ScotchPad	219
T MAKER III	
	220

IBM / PC

Please see CP/M listing. All products with a * in front are also made for PC/DOS and are priced the same unless otherwise specified.

ALPHA SOFTWARE	
Data Base Mgr. II	\$ 195
Mailing List	72
Executive Pkg.	105
Type Faces	99
Question	35
Apple-IBM Connection	130

CENTRAL POINT	
Copy II PC	\$ 34

CONDOR III	
w/Training	\$ 445

CONTINENTAL	
Home Accountant	\$ 99

DIGITAL RESEARCH	
Concurrent CP/M 86	\$ 225
CP/M-86	50
Cobol 86	499
Pascal MT + 86 (MS DOS)	375
SPP 86	130
SID 86	113
C Basic 86	135

DOW JONES	
Market Analyzer	\$ 245
Market Manager	219

ECO-SOFT	
Microstat	\$ 230

FINANCIER	
Tax Series	105
Personal	\$ 119

GRAPHIC SOFTWARE	
Super Chartman II	\$ 299
Super Chartman IV	199
Both (above)	350

LEXISOFT	
SpellBinder	\$ 259

LIFETREE	
Volkswriter	\$ 135

LOTUS 123	
	\$ Call

MICROPRO	
(All)	\$ Call

PEACHTREE	
Please see listing under CP/M.	

SUPERSOFT

C Compiler 8086	150
Star Edit	180
Disk Edit	75
Basic Compiler	225
Fortran IV PC/DOS	
or 8086	299
8087 Support	40
Diagnostics II	89
Optimizer	149
Personal Data Base	99
Investment Tax Pac	160
Scratch Pad	219

SYSTEMS PLUS

Landlord (prop mgmt)	\$ 375
Runtime Basic	
(req d for above)	45
T-Maker III	\$ 220

... and many more!

**APPLE/
FRANKLIN
BOARDS**

ALS CP/M Card	\$ 299
ALS Smartem	249
ALS Z-Card II	142
ABT Keyboard	99
Axlon Ramdisk 128K	299
Bit 3 Dual	
Comm-plus	209
CCS 7710	
Asynch Serial	119
Central Point Alaska	105
East Side Wild Card	110
Microsoft 16K Ramcard	72
Microsoft Softcard	245
Microsoft Softcard +	429
Microsoft Premium	
Softcard (IIE)	397
Micratek Printer I/F	75
Micratek Dumping 16	195
Micratek Dumping-GX	119
Mountain A-D/A	279
Mountain Music	
System w/Software	299
PCP 4 MHz Appli-	
Card + 88 Card	599
PCP 88 Card 16 Bit	
+ 64K	475
Prometheus Versacard	159
Prometheus Graphite	
Card	99
SSM AISO Serial I/F	
w/cable	129
SSM AIO-2 Serial	
Parallel	179
Street Echo II Speech	
Synthesizer I/F	129
Tymac Parallel I/F	
w/cable	79
Videx Display	
Enhancer	109
Videx Display	
Enhancer II	129
Videx Func. Strip	69

Videx Videoterm	
VT-600	235
Videx Ultraterm	299
Wesper 16K Ram Card	69

**IBM/PC
BOARDS**

AST RESEARCH

ComboPlus 64K Clock/	
Calendar, Serial &	
Parallel, I/F, Expand-	
able to 256K	\$ 287
MegaPlus 64K, Clock/	
Calendar, Serial Port,	
Expandable to 512K	
w/Megapak	269

Extra ports available
for Megaplus and I/O
Plus II includes Game,
Parallel & Serial

Parallel & Serial	40
-------------------	----

Megapak 256K upgrade
for Megaplus

+ Call	
--------	--

I/O Plus II Clock/Calendar
and Serial Port

+ Call	115
--------	-----

BYAD DS-II	\$ 599
------------	--------

MAYNARD ELECTRONICS

Floppy Drive	
Controller	\$ 165
Floppy Drive Control-	
ler w/Parallel Port	229
w/Serial Port	249
Sandstar Mem. Card	
- 3 modules cap.	194
Sandstar Multifunction	
Card - 6 modules cap.	93
Sandstar Modules	\$ Call

QUADRAM

Quadboard 64K, Clock/	
Calendar, Serial &	
Parallel Ports,	
Software	\$ 296
Microlazer Stock Printer	
Buffer (expandable to 512K)	
▶ Parallel/Parallel 8K	145
▶ Parallel/Parallel 64K	188
▶ Serial/Parallel 8K	170
▶ Serial/Serial 8K	170
Quadlink 64K Memory,	
Game Port allows	
Apple Software to	
to an IBM/PC	\$ Call
TECMAR Products	\$ Call

DISPLAY CARD CORNER

Hercules Graphics Board	\$ 399
Orchid Monochrome Graphic Adapter	432
Plantronics Colorplus	389
USI Display Card (color/monochrome)	\$ Call
Amdek MAI Card	\$ Call
Tecmar Graphic Master	\$ Call

XEDEX/MICROLOG

Baby Blue	\$ 475
-----------	--------

TALL TREE

512K JRAM Mem.	
Board	\$ 699

MONITORS

Amdek Video 300A	
Amber	\$ 180
Amdek RGB	425
NEC 12" Hi-Res Green	187
Sanyo 12" Hi-Res	
Green	199
USI Hi-Res 12" Amber	169
NEC JB-1260 Green	119
PGS RGB Color	\$ Call
NEC JC 1203 RGB	560
Quadram	
Quadrachrome	\$ Call
Taxan 12" Amber	149
Taxan 12" Green	136
Taxan 12" Med. RGB	323
Taxan 12" High RGB	512
Taxan RGB	
Cable for PC	17

TELECOMMUNICATIONS CORNER
★ ★ ★ SPECIAL ★ ★ ★

Hayes Smartmodem 12000/Hayes Smartcom II Software	
AST I/O Plus II Clock Calendar and Serial Port	\$ 695
Above w/Smartmodem 300	415
Hayes Smartmodem 1200 & Smartcom II Software	579

MODEMS

Novation	
Apple-Cat II	\$ 269
Hayes Micromodem II	299
Anchor Mark I	84
Anchor Mark VII	129
Hayes	
Smartmodem 300	\$ 205
Smartmodem 1200	499
Hayes Chronograph	189
Novation 212	
Auto Cut	585

US Robotics Auto-

Dial (full auto	
answer 300/1200)	459
US Robotics Auto-	
Link (auto answer	
300/1200)	410
US Robotics Password	395

DISK DRIVES

Tandon TM-55-2	\$ 275
Tandon TM-100-2	240
Davong DSI-501 Hard	\$ Call
Davong DSI-512 Hard	\$ Call
Davong DSI-519 Hard	\$ Call
Corona 5 MB Hard	1,395
Corona 10 MB Hard	1,795
CDC 1800	270
Corvus	\$ Call
Tall Grass	\$ Call
Vista Solo 143K	\$ 259
Vista Solo & Controller	329
Want Slim Line	
& Controller	299
Want Dual Slim	
Line & Controller	529

DISKETTES

3M 5" DS, DD, Box	\$ 40
BASF 5" DS, DD, Box	37
Maxell 5" DS, DD,	
MD2, Box	40
Verbatim 5"	
DS, DD, Box	35
Ultra Magnetics 5"	
DS, DD, Bonus Box	
(12 Diskettes)	35

PLOTTERS

Enter P100 Sweet P	
Apple/Franklin,	
IBM/PC	\$ 599
Strobe M100 Plotter	
w/ I/F Apple/Franklin	499
Strobe M100 Plotter	
(RS 232)	539
Panasonic Digital	
Plotter	\$ Call

MISC.

Chalk Board	\$ Call
Kaala Technologies	
Graphic Tablet	\$ 99
Symtec Light Pen	
IBM/PC	140
Symtec Light Pen	
Apple/Franklin	200
TG Joystick IBM/PC	49
TG Joystick	
Apple/Franklin	46
Verso VersaWriter	
Tablet IBM/PC,	
Apple/Franklin	235
Wico Analog Joystick	59
Wico Apple Adapter	18
Wico IBM/PC	
I/F Card	52
Keytronic Keyboard	
IBM/PC	219
Keytronic Keyboard	
Apple/Franklin	249
Curtis PC Products	\$ Call
Electronic Protection	
Series	\$ Call

CP/M is a registered trademark of Digital Research. IBM and the IBM logo are registered trademarks of International Business Machines. Apple and the Apple logo are registered trademarks of the Apple Computer Company. Franklin and the Franklin logo are trademarks of the Franklin Computer Company.

Please:

- ▶ Wisconsin residents add 5% for sales tax.
- ▶ Add \$3.50 for shipping per software and light items. For multiple and other items, call.
- ▶ Foreign — add 15% handling & shipping for prepayment. (Int'l money order.)
- ▶ Prices are subject to change without notice.
- ▶ All items subject to availability.

Store prices are strictly retail.

We welcome:

- ▶ COD (Add \$2.00 per shipment. Cash or certified check required.)
- ▶ Visa, MasterCharge & American Express. (Add 4%.)
- ▶ Checks. (Allow 1-2 weeks for clearing.)

Working Hours:
Mon. - Thurs. 8:30 - 5:30 • Fri. 8:30 - 6:30
Sat. 10:00 - 2:00 • Central Time

ORYX SYSTEMS, INC.
425 First St. • P.O. Box 1961
Wausau, WI 54401

For technical information and
in Wisconsin: 715-848-1374

Int'l Telex: 260181
ORYX SYS WAU

ORDER TOLL FREE OUTSIDE WISCONSIN 1-800-826-1589



Ask BYTE

Conducted by Steve Ciarcia

(1a)

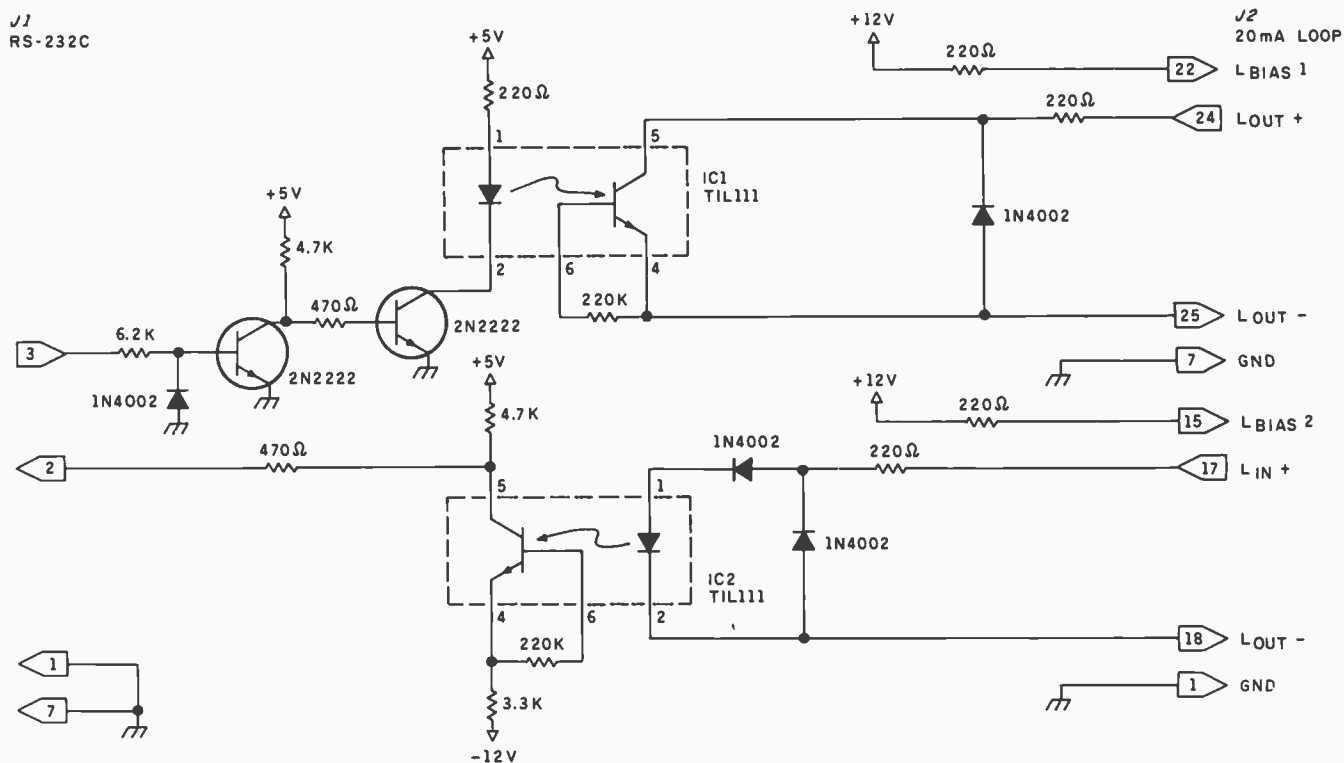
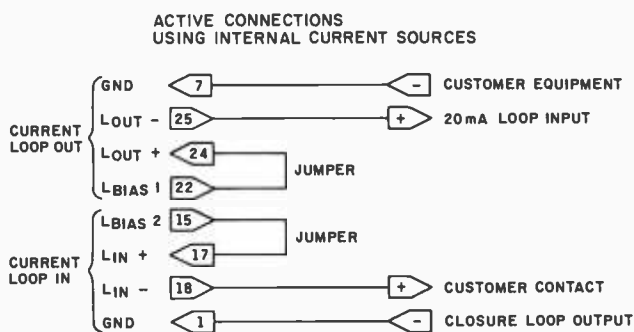
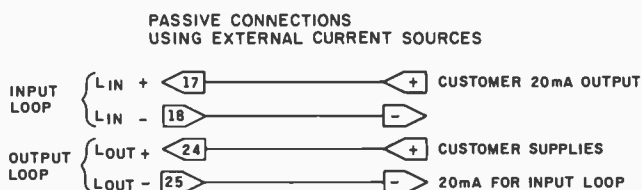

Figure 1: Figure 1a shows the computer serial output to 20-mA loop conversion. Figure 1b shows the active connections for use with internal current sources. Figure 1c shows the passive connections for use with external current sources.

(1b)



(1c)



Apple-Teletype Connections

Dear Steve,

Can you direct me to an article that shows how to connect an Apple II Plus to a Teletype Model 33ASR terminal? Because I already have an 8251A USART (universal synchronous/asynchronous receiver/transmitter), I'd prefer to use one if possible.

Specifically, I need to know details about addressing and how to print out program listings and results. My application involves punch tapes for machine tools. Thanks for your help.

Dave Madalozzo
Tarboro, NC

The simple schematic diagram and connection drawings shown in figure 1

convert the serial output of a computer to a 20-mA loop suitable for driving Teletype machines. The circuit features optoisolators to avoid any chance of an electrical failure in the Model 33ASR damaging the computer. I assume that you have the serial port because several cards for the Apple that provide this feature are available. A printed-circuit board with the components of figure 1 is available from The Micromint (561 Willow Ave., Cedarhurst, NY 11516, (800) 645-3479; in New York, (516) 374-6793). For a more detailed analysis of RS-232C and current-loop interfacing, see "The Current-Loop Interface" portion (page 170) of "Welcome to the Standards Jungle" by Ian H. Witten (BYTE, February 1983, page 146). . . . Steve

Introducing the new RX-80.

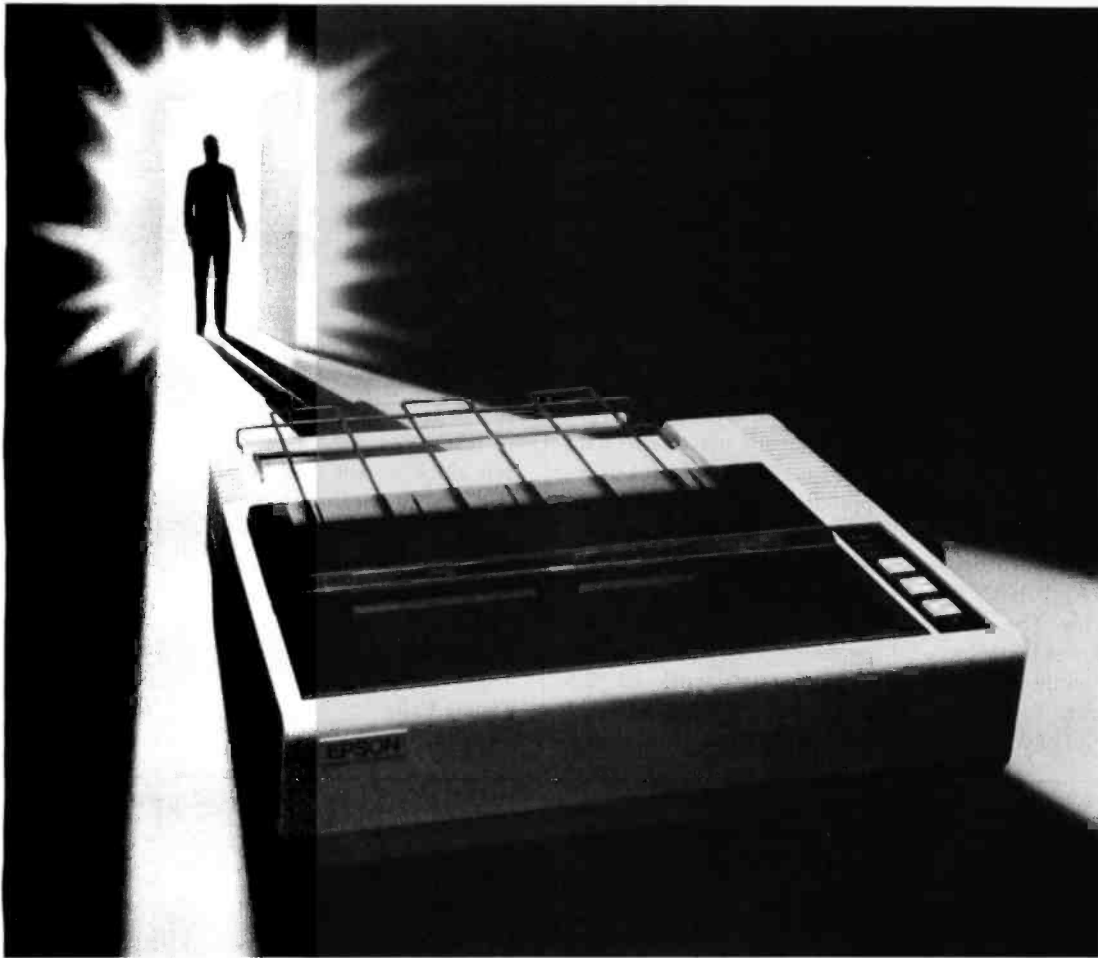

A printer this good
could only come from one company.

Epson.

Take a look at the new Epson RX-80 with a critical eye and you'll know what we mean. Epson printers are put together with manufacturing tolerances in the micron range. And meticulously checked for quality — one at a time.

Our reliability rate is approaching perfection. Which means you'll probably never — ever — have a problem with your RX-80.

A real Epson for only \$299.

For a limited time, you can get the RX-80 for only \$299. But just because we made it affordable doesn't mean we've left off the goodies. You get 128 different typestyles with a resolution so sharp you have to look twice to make sure it's dot matrix. You get bidirectional printing, logic seeking, and a speed of

100 characters per second. And you even get programmable forms control, graphics, and a special Quiet Mode to keep the noise down.

This is your printer.

No matter what computer you own — or will own — do yourself a favor and make sure your printer is an Epson RX-80.

We build them to be the finest printers on earth. No matter how small the price.

Number one. **EPSON**
And built like it. EPSON AMERICA, INC.

3415 Kashiwa Street, Torrance, CA 90505

Please call (800) 421-5426 for the dealer nearest you. In California (213) 539-9140

Real-Time Solution

Dear Steve,

I attempted to interface the MM58167A real-time-clock chip to my Ferguson Big Board computer as described in your article "Everyone Can Know The Real Time" (BYTE, May 1982, page 34). The circuit worked the first time on power-up. Satisfied, I put the interface aside and went on to other things.

After several months, I decided to reconnect the interface; that's when I began experiencing the same problem that Mr. Edward Beighe (Ask BYTE, April 1983, page 465) was having. The seconds counter was stuck on hexadecimal FF while the other counters seemed to be working correctly. Thinking I had

blown the chip, I purchased another one—with data sheets. The second chip produced the same erroneous results.

Over the period of time that I had not used the real-time clock, I had made several changes to my Big Board, one of which was increasing the clock rate from 2.5 MHz to 3.5 MHz. The data sheets for the MM58167A state that the maximum time from ready strobe inactive to data valid is 800 ns, which I interpreted to mean that it could take 800 ns before data is ready. I changed my board back to 2.5 MHz and both clock chips worked! After repeatedly verifying that the clock would work at 2.5 MHz but not 3.5 MHz, I made an addition to the orig-

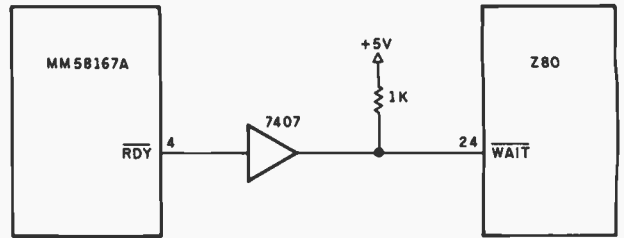

Figure 2: A remedy for real-time clock-timing problems on higher-speed systems.

inal clock circuit (see figure 2). The circuit has worked perfectly at 3.5 MHz ever since.

I hope this helps Mr. Beighe and others with timing problems.

Ronnie Kelly
Chicago, IL

Thank you very much for your solution to Mr. Beighe's problem. He did not mention how he was driving the chip, but 800 ns is a relatively long access time, and wait states should be employed with faster clock rates. Your solution is simple and correct. . . . Steve

**CMOS
Microprocessor**

Dear Steve,

Last month I bought an Epson HX-20 notebook-sized computer. Epson advertises that the HX-20 has two CMOS 6301 microprocessors. I've never heard of a 6301 and no one I asked seems to know either. Can you give me the facts? Thanks.

Brad Kulp
Landover Hills, MD

The 6301 microprocessor used in the Epson HX-20 is a CMOS version of the Motorola 6801 microprocessor. CMOS (complementary metal-oxide semiconductor) chips are used throughout the computer to keep the power consumption at a low level.

A product description of the Epson HX-20, by Gregg Williams, appeared in the April 1982 BYTE on page 104. It was an introductory review but it describes many of the features of the unit. . . . Steve

IMSAI Manuals

Dear Steve,

I recently bought an IMSAI system with serial I/O, revision 3, circa 1976, with twin Intel 8251 USARTs (universal synchronous/asynchronous receiver/transmitter). The manual is missing, and IMSAI, alas, is no longer among us. With a little help from my friends, there was no problem tracing the modem signals on the PCB. The "old-timer" is now plugged in and working, but I still would like a copy of the manual.

Is there some place where I can buy manuals for vintage products?

Gisle Hannemyr
Tromso, Norway

Microsystems magazine features advertisements by a company that has taken over the line of IMSAI computers. It should be able to furnish the documentation that you require. Write or call IMSAI Computer Division, Fischer-Freitas Corporation, 910 81st

Ave., Bldg. 14, Oakland, CA 94621, (415) 635-7615. . . . Steve

Modem Musings

Dear Steve,

As a computer technician, I know how much time and energy go into your projects. I appreciate the work you are doing very much.

I am writing to you on two subjects. The first is the ECM-103 modem (BYTE, March 1983, page 26):

1. The RS-232C interface in it has no control signals such as RTS (request to send) and CTS (clear to send). How does communication take place?
2. How do I add ring detection?
3. Where can I get a DAA (data-access arrangement), and what should I expect to pay?
4. Can I just connect the telephone interface to the base of a regular telephone?

5. I would like to be able to auto-dial by sending ASCII (American National Standard Code for Information Interchange) strings to the modem. I thought about using an 8085 processor because of its built-in serial port. Do you have any suggestions?

I have an H-89 with the serial port on a wire-wrap board and will put this circuit on the same board, so I have a lot of flexibility in what I do.

The second subject concerns future projects. I would like to see a 68000-based system with DMA (direct memory access), math processor, priority interrupt, hard- and soft-disk controllers, and everything else one could want. It would also be able to use a 32-bit databus version of the 68000 when they become cost-effective. I also would like to see it use the Motorola Versabus and Unix. Maybe it could have an 8-bit processor to handle the I/O. In fact, I would like to have seen this

There's a side to the Wang PC that IBM would like you to ignore.

Maybe what puts the Wang Professional Computer ahead of the IBM PC is what's behind it.

Because at the back of the Wang PC is a series of system interfaces that can tie you into total office automation now. Integral links that let you access not only other Wang equipment, but even most popular databases and mainframes, including IBM.

The Wang Professional Computer also offers a variety of telecommunications options that can access everything from the Dow Jones News/Retrieval® service to electronic mail. And by simply adding word processing software, the Wang PC turns into the easiest-to-use word processor on the market.

Face to face, the Wang PC is superior to the IBM PC in speed, compatibility and ease-of-use.

Back to back, there's no comparison.



For a demonstration of the Wang Professional Computer, call 1-800-225-9264. Or send this coupon to: Wang Laboratories, Inc., Business Executive Center, One Industrial Avenue, Lowell, MA 01851.

Name _____		
Title _____		
Company _____		
Address _____		
City _____	State _____	Zip _____
Telephone (____) _____		BY3

WANG

The Office Automation
Computer People.

instead of the MPX-16. I think we have enough IBM PC clones.

Again, thank you for your efforts.

Bob Iacullo
Doylestown, PA

The ECM-103 and other modems use two sets of tones and operate in a full-duplex mode. Because this method allows the simultaneous transmission and reception of data, no handshaking signals (RTS and CTS) are needed.

The circuit shown in figure 3 provides a simple means of ring detection. The article

from which this circuit was taken appeared in the February 20, 1975 issue of Electronics. It is titled "Optically coupled ringer doesn't load phone line." In it, William D. Kraengel Jr. illustrates a simple way to capture a high-voltage signal and safely convert it to TTL or CMOS levels. While this circuit drives an oscillator, it could just as easily toggle a counter and trip on a preset number of rings.

A DAA can be obtained from your local telephone company or any of several manufacturers. They must be

FCC-certified and vary in price. I have seen some as low as \$50 in quantities of 10,000. Single quantities must be quoted. One source for a DAA is Cermetek Microelectronics Inc., 1308 Borregas Ave., Sunnyvale, CA 94086. The telephone interface can be connected to the base of a regular telephone.

Many articles have been published on auto-dialing. If yours is a Touch Tone system, see my article on page 42 of the December 1981 BYTE. "Build a Touch Tone Decoder for Remote Control" gives information on an en-

coder circuit. Such a circuit can be driven from a parallel port (or serial port, through a UART). If it is a pulse-dialing (rotary) telephone system, the pulses can easily be generated in software.

At the time that I designed the MPX-16, there was considerably more hardware and software information available for the 8088 processor. With the introduction of the IBM PC, a plethora of accessory boards was flooding the market and it seemed unnecessary to "reinvent the wheel." . . . Steve

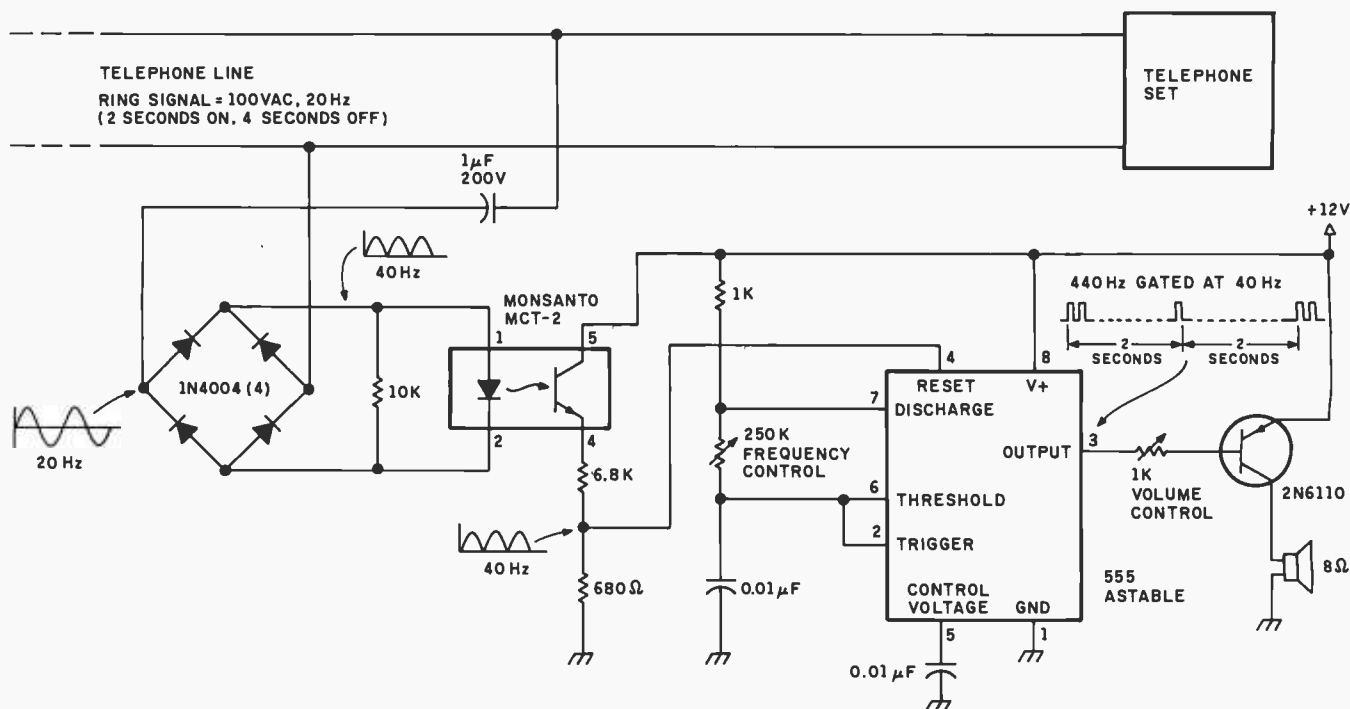

Figure 3: The ring-detection circuit is useful for detection of high-voltage signals and conversion to common logic levels.

High-Speed Communications

Dear Steve,

I read your June 1983 BYTE article (page 35) "Use ADPCM for Highly Intelligible Speech Synthesis" with great interest. I'm particularly interested in the possibility of developing a method of

transmitting not only high-quality voice signals through a 32-kbps (thousand bits per second) digital channel, but also high-speed (9600-bps) modem traffic.

"The Return of TELPAK," printed in the March 1983 issue of Telecommunications magazine (authored by Ivan Riley of Aydin Monitor Sys-

tems), claims that although 32-kbps ADPCM is capable of handling 4800-bps modems, it cannot pass 9600-bps traffic (CCITT V.29). The same article claims that a technique referred to as VQL (variable quantization level) encoding is capable of 9600-bps transmission.

I would appreciate any in-

formation you may have or to which you can refer me that deals with VQL or the general topic of systems designed to pass analog voice and modems through 32-kbps communications links.
Christopher Paul
Bayport, NY

The August 1983 issue of Sys-



THERE'S NO OTHER COPIER ON EARTH LIKE IT.

The Minolta Beta 450Z has features no copier ever had before.

Like auto magnification. Which allows the 450Z, with its automatic document feeder, to take a stack of different size originals and automatically reduce or enlarge them to uniform size copies.

If you simply want to make copies of that stack of originals, the 450Z will automatically select the correct paper size for each one.

The 450Z has a unique variable magnification zooming lens that gives you a virtually limitless range of copy sizes. From almost 50% larger than the original to 50% smaller.

If you don't need reduction, enlargement or auto magnification, ask your dealer about the Beta 450 (without the Z).

Both make copies that are out of this world.

**Call your Minolta dealer for a demonstration.
Look in the Yellow Pages under the Minolta
trademark. Or call toll free 800-526-5256.
In New Jersey call 201-342-6707.**



Please have my dealer contact me for a demonstration of the new Minolta Beta 450Z.

Please send me more information.

Name _____

Title _____

Company _____

Address _____

City _____ State _____

Zip _____ Telephone _____

Mail to Minolta Corporation
Business Equipment Division
101 Williams Drive
Ramsey, N.J. 07446.



PMN-11

© 1983 Minolta Corporation

tems and Software, devoted to combining voice and data communications, features a special report on that subject. In addition, many advertisements feature devices that handle both voice and data transmissions.

The magazine can be obtained from Hayden Publishing Company Inc., 50 Essex St., Rochelle Park, NJ 07662. Subscriptions are offered free of charge to qualified subscribers, and single issues can be obtained at \$4 each. . . .Steve

Ukrainian Word Processing

Dear Steve,

In addition to doing word processing in English, I am looking for a computer with which I could do word processing in Ukrainian as well. I wrote to you since my problem with foreign-language character generation might best be solved through hardware. While there are software programs for various character generators, I still haven't found one with which it is possible to do word processing. C. Kenneth Fan, for example, had an article, "An IBM Character Generator," in the January 1983 *Creative Computing*. His program requires at least 96K bytes of ROM for work space—whereas this space is also used by some of the more powerful word-processing programs.

I plan to get a microcomputer in the near future, and I want to know if there is a computer on the market that supports foreign-language character sets. Ukrainian uses the Cyrillic alphabet, so I need a complete character set and not just accents and a few special characters. Do you know of any monitor with a user-definable character set? The Epson QX-10 changes its character set from normal to bold or italic; I sup-

pose that this is done through an alternate character generator. Wouldn't it be possible to do the same thing with another alphabet?

I already have an Olympia ES105 KRO electronic typewriter with a general-purpose interface that can be set for either serial or parallel operation. I also have a Russian print wheel that I am going to convert to Ukrainian.

Please let me know which computer you think would be easiest to work with. If you have any suggestions or ideas, I would appreciate your advice.

Thank you.
(Rev.) Maxim M. Kobasuk
Glen Cove, NY

The Victor 9000 computer has a software-generated character set that is loaded when the system is first initialized. Utilities are available for creating characters interactively and for installing them in an operating system. This feature will allow you to create whatever character set you desire. Since it is a one-for-one substitution, it should not affect the word-processing program.

Apple II, Atari, and other computers with graphics capability can create alternate character sets in software but must be patched into your existing word-processing program in order to be effective for screen display.

Additional information on the Victor 9000 can be obtained from Victor Business Products, 3900 North Rockwell St., Chicago, IL 60618. . . .Steve

Macro Micro Display

Dear Steve,

I am looking for a means of either projecting a black-and-white video-display image using rear-screen projection or implementing a light-dis-

play system similar to those used in stadium scoreboards. I would like to interface my IBM PC to the system to provide real-time display information at conferences and conventions.

Requirements for the system include character heights of not less than 6 inches, a maximum cost of \$500, and high visibility in a well-lit environment. Any suggestions? Thank you.

Bert Whittier
Melrose, MA

Electrohome Electronics manufactures a projection TV monitor that can be driven by any microcomputer. This would seem to be the simplest solution to your problem; however, I prefer not to quote its cost. Call or write them for additional information at Electrohome (U.S.A.) Limited, 182 Wales Ave., Tonawanda, NY 14150, (716) 694-3332. . . .Steve

Atari Parallel Interface

Dear Steve,

I've heard rumors that a printer interface can be built for Atari personal computers by using the number 3 and 4 controller jacks, and that a company is producing such a product. So far, however, I have been unable to locate any such company.

Do you have a schematic or know of anyone who is familiar with such an interface? I assume the interface is serial, but is a parallel interface possible using the controller ports? Thanks.

Ron M. Yoakem
Bainbridge, OH

Macrotronics makes a product that will enable the Atari 400 or 800 to drive a parallel printer through the front controller connector, without the need for the Atari 850 or a similar interface.

A short driver program directs all LPRINT commands to the parallel-printer interface. It is compatible with BASIC, DOS, and ASSEMBLER/DEBUG. The address is Macrotronics Inc., 1125 North Golden State Blvd., Turlock, CA 95380, (209) 667-2888. . . .Steve

Math Language

Dear Steve,

I am having trouble finding a microcomputer language that handles complex arithmetic. As I am currently changing systems, the available languages will have some effect on what I purchase. I'd appreciate any help you can provide.

Stuart Sands
Berkeley, CA

FORTRAN IV has a COMPLEX function, but it is not implemented on microcomputer versions. I have been told by a professional programmer that the mainframe implementation is so slow that he writes his own routines; it is not very difficult. All that is necessary is to compute the real and imaginary parts separately, and then add them. This may be the easiest solution to your search. . . .Steve

Scope Your Data

Dear Steve,

How can I determine the data rate, parity, and stop-bit characteristics being transmitted by a computer over an RS-232C port by examining these signals on an oscilloscope?

Chuck Gollnick
Pullman, WA

Determining the data rate of a data signal by using an oscilloscope is very easy. Send a series of characters with lots of "ones" in its binary code. The question mark (?) is hexadecimal

Last year our fire protection systems kept the heat off a lot of business owners.

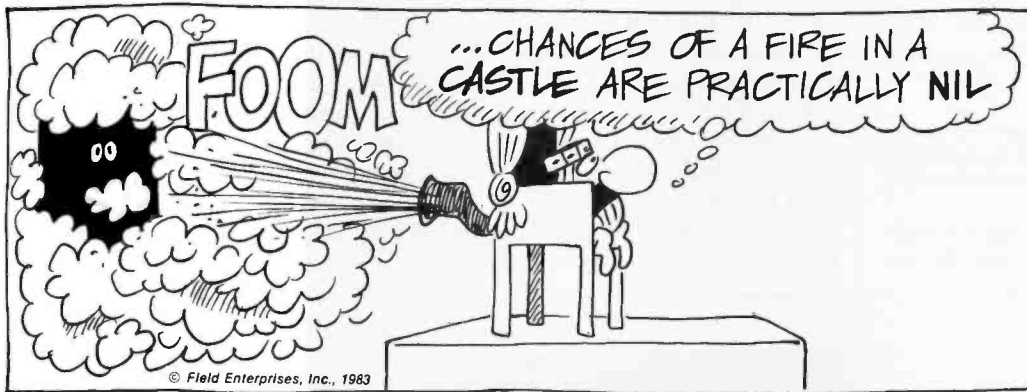

It's sheer wizardry the way Fenwal's suppression systems spot fire and snuff it out instantly. Our systems use the fastest way known of stopping fire, Halon 1301. It's perfectly clean and people-safe. That keeps downtime to an absolute minimum.

We've been building and perfecting our systems for more than 20 years. There are thousands installed around the world. Because Fenwal manufactures all its own major system components, you get a system with components built to work together and backed by single source responsibility.

Plus the attention of a *local* factory trained wizard who's knowledgeable in cost efficient system configuration.

Whatever you want to protect—valuable documents, computer rooms, communication centers, control rooms, switching rooms, anything at all that you can't afford to be without—we can do the job.

For the name of your local Fenwal wizard, look in the Yellow Pages under "Fire Protection," or contact the Castle at (617) 881-2000.

FENWAL®

Fenwal Incorporated,
Ashland, MA 01721.
A Division of Kidde, Inc.

Ask BYTE

ASCII code 7F (01111111) and makes a good choice. Set the sweep rate on the scope so that these "one" pulses are stable and note the number of time-base divisions between any two adjacent pulses on the scope screen. The result should be in the "1 bit in so many milliseconds" range for typical transmission rates. The inverse of this value is the data rate.

Determining the parity and stop-bit characteristics is more difficult since the waveform is not steady. A storage scope would be necessary for such a measurement.

A hardware latch to hold one data word for inspection and a software routine are other methods of determining parity and stop bits. . . .Steve

Big Board Speaks

Dear Steve,

I am assembling a custom Z80 system for use by my

wife who suffers from a paralyzed palate and can no longer speak. She will be able to communicate with me by typing and, by using a modem, will be able to contact me at my office, where I have a microcomputer and modem available. In order to become thoroughly familiar with the hardware (and to save a little money), I plan to assemble a kit. I have chosen the Ferguson Big Board for the main board. I need advice about which disk drives to use, as all my experience has been on large, main-frame timesharing systems.

The Big Board kit has an on-board Western Digital 1771 disk controller, and the documentation calls for a "Shugart Series 800 compatible" drive. The recording format is single-density IBM 3740. I do not have ready access to literature covering these specifications. I would

be very grateful if you could tell me where I can find the necessary information to guide me in purchasing a suitable pair of drives at a reasonable price. Are double-sided drives practical in this application?

I read with great personal interest your two articles in BYTE (September and October 1982) on the voice simulator and plan to make this my first project once the basic system is running.

Walter Brouillette
Jamesville, NY

The Shugart 801 disk drive is a perfect companion for the Ferguson Big Board or virtually any system that uses the Western Digital 1771 controller. It is an extremely popular drive and is sold by nearly all mail-order computer stores. They are available as a bare drive or in a cabinet with power supply and cables. See the back pages of

BYTE for advertisements.

For your application, I think a single-sided drive is adequate (and cheaper). The amount of data that can be stored on an 8-inch disk in IBM 3740 format is a quarter megabyte. . . .Steve

Scratch-built 68000

Dear Steve,

I am trying to build a 68000-based computer from scrap parts, but I need to find a board that I can stuff. The only boards that I have found have either too little memory (I would like at least 128K bytes) or a cassette interface (I want a floppy-disk interface). Is there a kit available from you or anyone else that would fit my needs? Also, could you tell me whether anyone makes a 68000 board for the S-100 bus? Thank you.

Philip Lawrence
Austin, TX

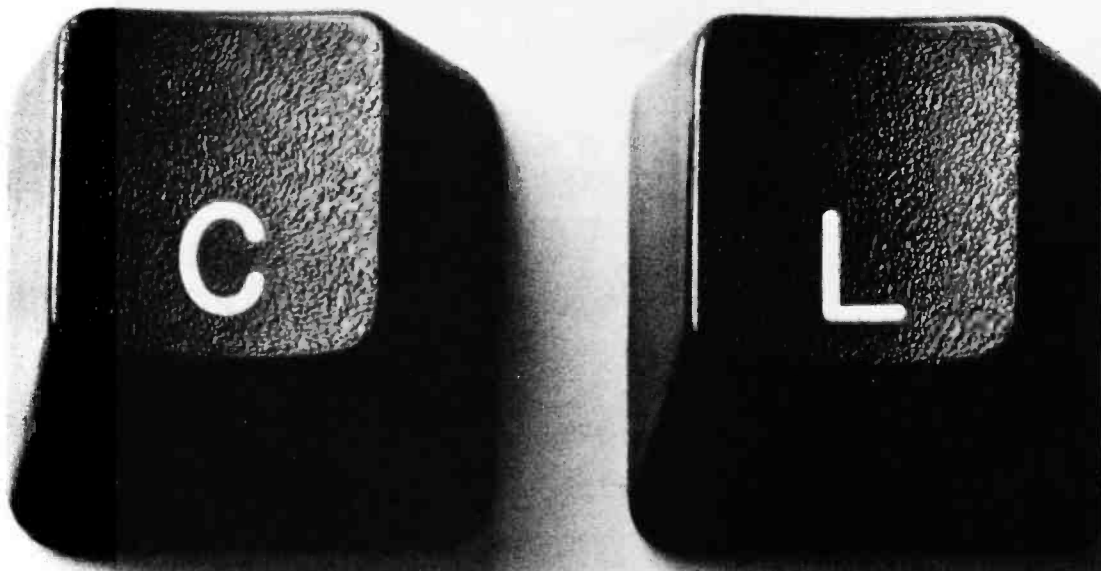

The best career move you can make is to

It's free. It's confidential.

Today's technical career market changes fast.

But now there's a way to keep up with it. This new key to career opportunity is your personal computer. And the cost is nothing but a phone call.

Just call CLEO. That stands for Computer Listings

of Employment Opportunities.

CLEO responds to your commands. You specify what job categories, companies, or geographic locations interest you. CLEO calls up the appropriate ads right on your screen. At every step, you're guided by explicit online instructions.

Daily updates keep CLEO job listings current.

Educational Microcomputer Systems manufactures a 68000-based single-board computer that may be of interest to you. While it contains only 20K bytes of on-board RAM, it does have two memory-expansion buses that allow up to 256K bytes. It has two serial ports, a 16-bit parallel port, and is software-compatible with the Motorola MEX68KDM board. A bare board and documentation are available for \$99.95 from Educational Microcomputer Systems, POB 16115, Irvine, CA 92713-6115, (714) 553-0133. In addition, a recent ad in Computer Shopper disclosed a 68000-based processor bare board, Multibus-compatible, with documentation, for \$69.99. It is available from Unicorn Electronics, 10010 Canoga Ave., Unit B-8, Chatsworth, CA 91311, (213) 341-8833. Also, Digicom Research Corporation sells a dual-processor system for the S-100 bus. It is based on the

16-bit MC68000 and the 8-bit Z80 central processing units and features software switching between them. Further information can be obtained from Digicom Research Corporation, Terrace Hill, Ithaca, NY 14850. . . . Steve

Biblical Word Processing

Dear Steve,

I have an IBM PC and will be purchasing mass-storage equipment as soon as I know what I want to purchase. My need at this point is a program that will permit me to enter thousands of pages of text and then search that text for occurrences of a given word or phrase.

I have approximately 1200 sermons that average 30 pages of text each. Eventually, I want to put all of these in storage. I realize I will need approximately 100

megabytes to accomplish this. Each of these sermons will be named and dated. I would like to be able to put them into the computer in random order but be able to retrieve them in chronological order. After some (or all) of the sermons are in storage, I want to be able to ask the computer to search all (or a designated portion) of the sermons for every occurrence of a certain word or phrase. When an occurrence of the word or phrase is located, I want to be able to preview the context of that word or phrase (with scrolling capability) and then permit either a printout of a chosen portion of the text or an advance to the next occurrence. I would also want to be able to call up any given sermon by name and be able to preview it (again with the printout option). Can you give me any help? Thank

you very much.
Donald Derksen
Keystone, SD

Your need to search and retrieve multipage sermons is entirely feasible with your IBM PC. A hard-disk system will be needed, and the software can be as simple as a word processor with "find and replace" capability. Your sermons can be entered as text in pages as they would normally be typed, so that titles, phrases, or any word can be found. The program would have to be compatible with the hard disk.

Unfortunately, I am not aware of such a program. Similar programs do exist and may be adaptable for your use. For example, The Word Processor has the entire King James version of the bible on floppy disks with the ability to search on any word, character, or phrase, with display and print capability. Perhaps the disks can be replaced

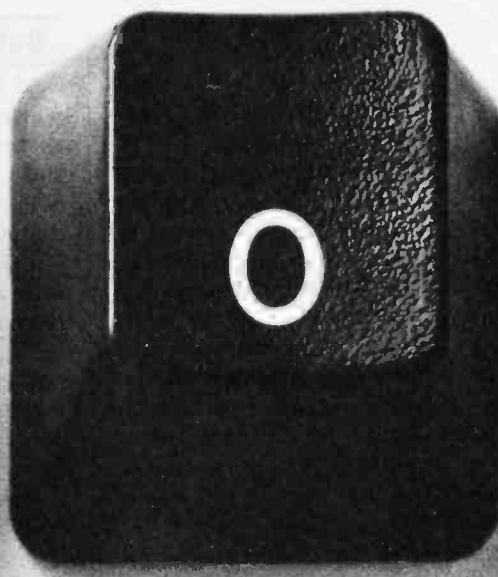

the keyboard of your personal computer.

You can even apply for positions right from your own terminal. For a detailed job search, or just an idea of what's available, CLEO is waiting for your call today. With today's opportunities.

**CLEO access: (415) 482-1550 (408) 294-2000
(213) 618-8800 (714) 476-8800 (619) 224-8800**

Circle 72 on inquiry card.

300 BAUD, full duplex, standard ASCII code.
Access assistance: (213) 618-1525

CLEO

Computer Listings of Employment Opportunities

An electronic publishing activity of The Copley Press, Inc.

Recruitment advertisers—
call (213) 618-0200 collect
to find out how you can
place your ad on CLEO.

with your sermons. The address is Bible Research Systems, 8804 Wildridge Dr., Austin, TX 78759, (512) 346-2181. Other word-processing programs may have the capabilities that you require. One worth checking is Readware, POB 680-A, West Redding, CT 06896, (203) 431-3521.

I think the biggest obstacle to completing your project is the entering of 36,000 pages of text into your computer system. At 5 minutes per page, there is more than 3000 hours of typing required. That's seventy-five 40-hour weeks! . . .Steve

More on Modems

Dear Steve,

In regard to your article "Build the ECM-103, an Originate/Answer Modem" (BYTE, March 1983, page 26), the information on modems is invaluable to me. I would like to know if you could reference other publications concerning modems. Thank you.

Christopher J. Rizzo
Staten Island, NY

An excellent article on modems appeared in the November and December 1982 issues of Popular Computing. The November article, "Modems: Hooking Your Computer to the World" by Stan Miastkowski (page 88), provides a complete description of the terms commonly used with modems and explains the differences between modems. The December article (page 111) describes various software packages that are available. All of your questions should be answered with this information. . . .Steve

Synthesizing Sounds

Dear Steve,

I recently built the sound-generating circuit you described in the July 1982

BYTE, "Add Programmable Sound Effects to Your Computer," page 60. I've had a good time with the programs you presented and even wrote a program to produce a siren sound.

Now I'm interested in knowing more about sound synthesis and things I can do with the SN76489A circuit. Can you recommend any books or other sources of information on sound synthesis or electronic sound effects?

John W. Macrae
Maysville, KY

A two-part article in the December 1980 and January 1981 issues of Microcomputing entitled "Computer Music the Easy Way" by Steve Marum describes an S-100 interface to a Texas Instruments SN76489A Programmable Sound Generator chip and software to create a sophisticated music editor. This editor will translate music into the digital data necessary for the SN76489A. Back issues can be obtained from Microcomputing, 80 Pine St., Peterborough, NH 03458.

An excellent book on sound synthesis is Musical Applications of Microprocessors by Hal Chamberlain, published by Hayden Book Company Inc., Rochelle Park, NJ. It covers digital microprocessor sound and music synthesis and includes a lot of background information. Some parts get rather technical, but it will serve as an excellent reference for this subject. . . .Steve

Light-Pen Connections

Dear Steve,

It's easy to build an inexpensive light pen (\$1.50) for Atari, VIC-20, or Commodore 64 computers by using

a resistor and a photo-transistor. The hard part is finding a DE9 connector to hook it up to the computer—unless you cannibalize a broken joystick. Where can I find a source of new DE9s? Thank you.

Matt Blais
Westtown, PA

A search through the back pages of a recent issue of BYTE revealed at least two sources for the DE9 connectors that are used on the Commodore 64 and VIC-20 computers. They are Jameco Electronics, 1355 Shoreway Rd., Belmont, CA 94002, (415) 592-8097 and California Digital, POB 3097B, Torrance, CA 90503, (800) 421-5041.

They are listed along with the RS-232C connectors. The DE9 is simply a 9-pin version of the more popular 25-pin "standard" RS-232C connectors. . . .Steve

Data-Bank Catalog

Dear Steve,

I would like to know about all the data banks available, and I understand that there is a book published that has compiled this information. Thanks for your help.

Michael G. McElroy
Norman, OK

An excellent list of data banks appears in The Creative Apple, edited by Pelczarski and Tate and published by Creative Computing Press, Morristown, NJ 07960. . . .Steve

Too Many Queens

Dear Steve,

My computer teacher posed an interesting problem to me. He said that there are 12 setups on a chessboard where eight queens could be

placed in such a way that none of the queens threatened each other. The problem is to try to find these setups by representing a chessboard by an 8 by 8 matrix. While the algorithm is fairly simple, using eight nested loops to put all eight queens through every permutation, I find it difficult to implement in Commodore BASIC for my home computer. (The computer in school is a PDP-11 with a Pascal compiler.) I am interested in trying it on my computer and seeing how many hours it takes to find the solutions. (I assume it would take hours, because it took several minutes on the PDP-11.) Any help would be appreciated.

David Alexander
East Meadow, NY

An article that appeared in the October 1978 BYTE, "Solving the Eight Queens Problem" by Terry Smith (page 122), describes another approach to this problem. The program presented should run in Commodore BASIC, but I do not know how long it will "crunch" before all solutions are printed. He mentions that "there are 92 solutions of which 23 are discrete." . . .Steve ■

In "Ask BYTE," Steve Ciarcia answers questions on any area of microcomputing. The most representative questions received each month will be answered and published. Do you have a nagging problem? Send your inquiry to:
Ask BYTE
c/o Steve Ciarcia
POB 582
Glastonbury, CT
06033

If you are a subscriber to The Source, chat with Steve [TCE317] directly. Due to the high volume of inquiries, personal replies cannot be given. Be sure to include "Ask BYTE" in the address.

How the American Express® Corporate Card can help small businesses in a big way.



Created exclusively for company use, our Corporate Card can help you conduct business the American Express way. More efficiently. With greater control. Strictly first class.

Regardless of the nature or size of your company, our Corporate Card can help you mind your own business better and easier.

By putting all your travel and entertainment spending on a separate company account, you'll have the answers (and receipts) should any tax questions arise.

The Corporate Card can also improve company cash flow. And simplify business travel management. Reduce cash advances, as well as costly administration and paperwork.

In addition, you'll have access to the personal service of over 180 American Express small business account specialists.

Hundreds of thousands of small businesses already use the Corporate Card. If you'd like to join them, simply fill out the coupon or call toll-free 1-800-528-AMEX.*

A.M. Busquet, V.P.
American Express
Travel Management Services
P.O. Box 13821, Phoenix, Arizona 85002

I'd like to find out how the American Express® Corporate Card can benefit my company.

Name _____
 Company _____
 Title _____
 Address _____
 City _____ State _____ Zip _____
 Phone _____ No. of Travelers _____

242-00-0059-80

American Express® Travel Management Services



Print & distribute 187 customer status reports.

Run off 17 confidential booklets for B. of D. meeting.

Get out 1300 internal newsletters for all employees.

Run General Use 14" paper.

Run price lists. Yellow paper.

Need direct mail for sales blitz.

United Charities letter for employees. Use logo & Pres. Sig.

Charts for sales meetings. Ask Bob for number.

If you can live without o 90 days of this, we'll tak



The 2700 Electronic Printer.

You might think an offer like that would be a risky thing for us. But you'd be wrong. Because almost everyone who tries our 2700 distributed electronic printers finds they really can't bear to part with them. They're just too efficient and too economical to give up.

You see, since they're very small and very quiet, you can put them exactly where they're most convenient for the people who need them.

And, since they function as high speed printers as well as letter-quality printers, you save money right off

the bat. (Our 2700s can actually print out at up to 12 pages per minute and still give you an impressive print-shop look.)

But those are only a few of the reasons hundreds of companies in dozens of different industries have tried them and kept them.

They also appreciate the fact that the 2700 comes with service available in more than 100 cities across the country.

And that in 1982 it won the Printer of the Year award from Datek Information Services, publishers of the 1983 PRINTOUT annual.

XEROX

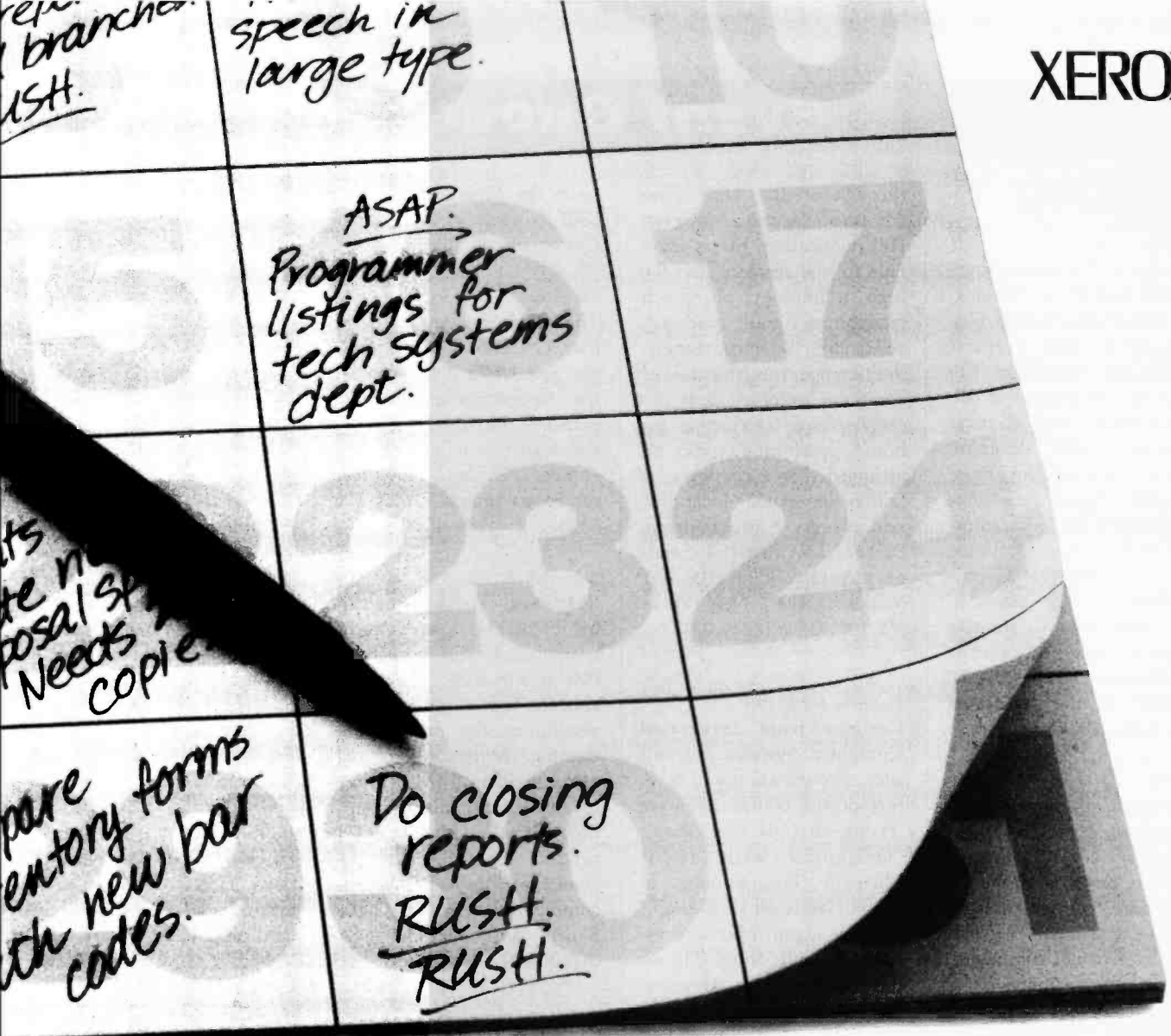

ur Xerox 2700 after e it back.

So, if you still feel we're running a risk with our offer, please feel free to take advantage of us.*

To arrange for a nearby demonstration, just call Xerox Printing Systems Division, toll-free, at 1 (800) 556-1234, Ext. 95. In California, 1 (800) 441-2345, Ext. 95. Or send in our coupon.

Then, simply have our local sales office qualify you under our order qualification procedure and you'll have your very own 2700 to use for at least 90 days.

We say at least only because we know you'll keep it a lot longer than that.

And probably order more.

You caught my interest. Tell me where I can see a demonstration and how I can qualify for your special 90-day offer on the Xerox 2700.

Name/Title _____

Company _____

Street _____ City _____

State _____ Zip _____ Phone () _____

Mail to: Keith Davidson, Xerox Printing Systems Division, 880 Apollo Street, El Segundo, CA 90245. PMN-11-83

*This offer is only available through our standard lease plans. It expires on December 31, 1983.

Event Queue

December 1983

December

Courses in Continuing Engineering Education, Washington, DC, and San Diego, CA. Two of the five available courses are "Intelligent Robots: The Integration of Microcomputer and Robotic Technology" and "Programming in the C and Unix Environment." Course fees range from \$695 to \$875. For information on dates, locations, and fees, contact George Harrison, George Washington University, Continuing Engineering Education, Washington, DC 20052, (800) 424-9773; in the District of Columbia, (202) 676-6106.

December

Seminars for Professional Development, various sites throughout the U.S. Datapro Research Corporation offers more than 35 professional development seminars in such areas as personal computers, data communications, systems and software, and office automation. Complete outlines and schedules are available from Datapro Research Corp., 1805 Underwood Blvd., Delran, NJ 08075, (800) 257-9406; in New Jersey, (609) 764-0100.

December-January 1984

Courses from Q. E. D. Information Sciences, various sites throughout the U.S. Scheduled courses include "Systems Analysis Workshop," "Data Security and Design," "Cost-Benefit Analysis," and "Project Management and Control." Address inquiries to Q. E. D. Information Sciences Inc., Q. E. D. Plaza, POB 181, Wellesley, MA 02181, (800) 343-4848; in Massachusetts, (617) 237-5656.

December-January 1984

Intensive Seminars for Professionals, various sites

throughout the U.S. *Electronics* magazine, a McGraw-Hill publication, offers seminars in management and the high technology of speech recognition and synthesis, controlling electromagnetic interference, fundamentals of computer graphics, and microprocessor interfacing. In-house presentations can be arranged. For a catalog outlining seminars, locations, and fees, contact Irene Parker, McGraw-Hill Seminar Center, Suite 603, 331 Madison Ave., New York, NY 10017, (212) 687-0243.

December-March 1984

Courses from Integrated Computer Systems, various sites throughout the U.S. A few of the course titles are "Hands-on Unix Workshop," "Designing with 16-bit Micros," "Programming in C—A Hands-on Workshop," and "Hands-on Microprocessor Troubleshooting." The fee for most of the courses is \$895. For information, contact Ruth Dordick, Integrated Computer Systems, 6305 Arizona Place, Los Angeles, CA 90045, (213) 450-2060.

December-August 1984

Conferences and Expositions from the Society of Manufacturing Engineers, various sites throughout the U.S. and around the world. More than 25 conferences and expositions are scheduled. For a calendar, contact the Public Relations Department, Society of Manufacturing Engineers, One SME Dr., POB 930, Dearborn, MI 48121, (313) 271-0777.

December 10-12

Computerized Writing Workshops, Gainesville, FL. This workshop is limited to eight writers who are interested in breaking into the word-processing field. For details,

write the Press Association, 5305 Northwest 57th Lane, Gainesville, FL 32606.

December 12

The IBM System/36 Seminar, Orlando, FL. This seminar provides a discussion on the capabilities and performance of the IBM System/36. For registration and details, contact DGC Inc., 1450 Preston Forest Square, Dallas, TX 75230, (214) 991-4044.

December 12

Software Workshops in MMSFORTH, Boston metropolitan area. This workshop, "Metaforth and Other Advanced Topics," is a public version of the professional training Miller Microcomputer Services (MMS) offers to client companies in support of the MMSFORTH product line. Details are available from Miller Microcomputer Services, 61 Lake Shore Rd., Natick, MA 01760, (617) 653-6136.

December 12-14

An Introduction to Small Computers for Business Applications, Hamilton Hotel, Schaumburg, IL. This conference and hardware demonstration will provide an introduction and review of small computers and microprocessors with an emphasis on what they are, what their terminology is, and what operating systems and software packages are available. Program materials are included in the \$350 fee. For details, contact Bob Mattis, Information Systems Division, EECI Inc., POB 241, Glen Ellyn, IL 60137, (312) 790-0010.

December 12-15

Conference on Human Factors in Computing Systems—CHI '83, Boston, MA. Papers, sessions, and tutorials will focus on system usability.

The sponsor of this event is the special interest group on Computers and Human Interaction (CHI) of the Association for Computing Machinery (ACM). Further information is available from Raoul N. Smith, GTE Laboratories, 40 Sylvan Rd., Waltham, MA 02254, (617) 466-4044 or 890-8460.

December 13-15

Automatic Testing and Test Instrumentation '83, Metrople Hotel, Brighton, England. This exhibition and conference covers all aspects of test systems. For details, contact Network Events Ltd., Printers Mews, Market Hill, Buckingham, MK18 1JX, England; tel: (028 0) 815226; Telex: 83111.

December 14-15

Hi Tech Update '83, Delta Ottawa Hotel, Ottawa, Ontario, Canada. An annual update on state-of-the-art high technologies. Contact Marg Coll, 1138 Sherman Dr., Ottawa, Ontario K2C 2M4, Canada, (613) 225-4229.

December 15-16

Personal Computer Local Networks, San Francisco, CA. This is the final program in the four-part Architecture Technology Corporation 1983 Forum Series. This program will bring together manufacturers and users of local-network schemes to exchange information in an informal setting. The format includes presentations, panel discussions, and a technological summary. The fee is \$395. For further information, contact the Architecture Technology Corp., POB 24344, Minneapolis, MN 55424, (612) 935-2035.

December 27-30

Modern Language Association Convention, Sheraton Centre, New York, NY.

The Micromint Collection

Micromint. Supporting the varied projects that appear in Steve Ciarcia's monthly article in BYTE magazine, "Ciarcia's Circuit Cellar." Offering a wide range of computers and peripherals supporting the needs of the hobbyist as well as worldwide corporate clients.

MPX-16 MICROCOMPUTER IBM PC COMPATIBLE



The MPX-16 is Steve Ciarcia's most ambitious project to date. The computer runs all application software written for the IBM PC and is IBM PC bus compatible. Can be used with video monitor & IBM keyboard with optional adapter.

Buy the MPX-16 in the form that best meets your budget. As a bare board, as a wave-soldered board that contains all components less the IC's, as an assembled and tested circuit board or as a complete system.

As featured on the cover of "BYTE" magazine. Also featured in "Ciarcia's Circuit Cellar" November, December 1982 & January 1983.

- Runs all application programs written for the IBM PC (simply boot up the system and slip in a disk formatted for the IBM PC).
- IBM PC bus compatible + 9 expansion slots.
- Intel 8088 16-bit microprocessor.
- Optional Intel 8087 math coprocessor.
- 256K bytes on-board memory.
- Up to one megabyte of system memory.
- Up to 64K bytes of system ROM/EPROM.
- Two RS-232C serial I/O ports.
- Three parallel I/O ports.
- Disk controller for 5 1/4" or 8" drives.
- Sixteen levels of vectored interrupts.

- MPX-16 Microcomputer circuit board assembled w/64K RAM, CP/M-86 or PC-DOS BIOS \$1,200.
- MPX-16 as above with 256K RAM 1,395.
- MPX-16 Semi-Kit (wave soldered circuit board w/all components) less IC's 595.
- Complete kit of IC's w/256K RAM 595.
- MPX-16 Unpopulated (bare) pc board 300.
- CP/M-86 Operating System 80.
- MPX-16 Switching Power Supply Including cable harness for 2 disk drives 300.
- MPX-16 Technical Reference Manual 50.
- MPX-16 Metal Enclosure with cutouts for two 5 1/4" full height drives 300.
- Tandon TM 100-2 double density drive 300.
- IBM PC Keyboard Interface Adapter 100.
- Serial terminal cable 35.
- Parallel printer cable 35.

Shipping and handling additional on MPX-16 orders.

Z8 BASIC SYSTEM CONTROLLER NEW!!!

Replaces Z8 Basic Computer Controller



As featured in Ciarcia's Circuit Cellar, BYTE magazine, July & August 1981.

- Uses Zilog Z8671 single chip microcomputer.
- On board tiny BASIC interpreter.
- 2 parallel ports plus serial I/O port.
- Just connect a CRT terminal and write control programs in BASIC.
- 2K bytes of RAM, up to 4K bytes of ROM.
- Baud rates 110-9600 BPS.
- Data and address buses available for 124K memory and I/O expansion.
- Consumes only 1.5 watts at +5, +12 & -12.
- Cross Assemblers for various computers.
- BCC11 Assembled & Tested \$149.

New Low Price

IBM PC is a trademark of International Business Machines, Inc.
CP/M86 is a trademark of Digital Research Inc.
MS-DOS is a trademark of Microsoft Inc.
Z8 is a trademark of Zilog Inc.

Z8 MEMORY, I/O EXPANSION, CASSETTE INTERFACE

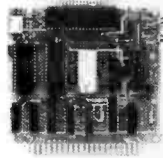

- Add up to 8K of memory plus 3 parallel ports.
- Cassette Interface—300 baud K.C. Standard.
- BCC03 w/4K Assembled & Tested \$149.

Z8 ANALOG TO DIGITAL CONVERTER NEW!!!

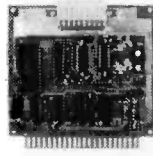

- Uses Analog Devices 7581 8 channel 8 bit IC.
- Adds Process Control capability to the Z8.
- 1090 samples per second.
- BCC13 Assembled & Tested \$140.

Z8 EPROM PROGRAMMER

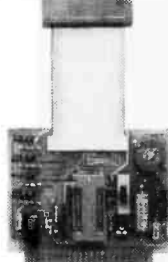

- Transfer BASIC or Assembly Language application programs from RAM to 2716 or 2732 EPROM.
- Requires Z8 Expansion Board for operation.
- BCC07 Assembled & Tested \$145.

Z8 SERIAL EXPANSION BOARD

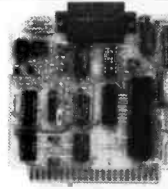

- Adds additional RS 232C and opto-isolated 20 ma current loop serial port to the Z8.
- Runs at 75 to 19,200 baud in all protocols.
- BCC08 Assembled & Tested \$160.

Z8 16K MEMORY EXPANSION BOARD NEW!!!

- Add 16K of additional memory, RAM or EPROM, to your Z8 System Controller in any multiple.
- Uses 2016, 6116, 2716 or 2732 memory types.
- BCC14 w/8K Assembled & Tested \$120.

Z8 FIVE SLOT MOTHER BOARD



- MB02 Assembled & Tested \$69.

Z8 CROSS ASSEMBLERS

- From Allen Ashley
- TRS-80 Model I or III \$75.
- CP/M 2.2 8" or Northstar 5 1/4" 150.
- From Micro Resources
- CP/M 2.2 8" or APPLE 5 1/4" 75.

SPEECH SYNTHESIZERS

MICROVOX TEXT-TO-SPEECH SYNTHESIZER



As featured in Ciarcia's Circuit Cellar BYTE Magazine September, October 1982.

- Microvox is a second generation professional voice quality text-to-speech synthesizer that is easily interfaced to any computer, modem, RS-232C serial or parallel output device and provides speech of unbelievable clarity.
- Unlimited vocabulary.
- 64 programmable inflection levels.
- 6K text-to-speech algorithm.
- Full ASCII character set recognition and echo.
- RS232C and parallel output.
- 1000 character buffer, 3000 optional.
- Adjustable baud rates (75-9600).
- Spelling output mode.
- 7 octave music and sound effects.
- On board audio amplifier & power supply.
- X-On/X-Off handshaking.
- MV01 Assembled with 1K buffer \$299.
- MV02 Complete Kit with 1K buffer 219.
- Add \$15.00 for 3K buffer option.

SWEET-TALKER VOICE SYNTHESIZER

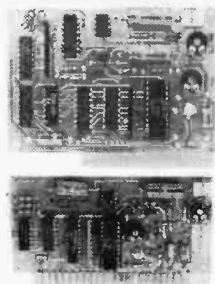

As featured in Ciarcia's Circuit Cellar BYTE Magazine, September 1981

- The Sweet-Talker Voice Synthesizer allows you to add speech of unlimited vocabulary to your Apple II or any computer with a parallel printer port at very low cost.
- Utilizes Votrax SC-01A speech synthesizer.
- Unlimited vocabulary.
- Text-to-Speech Algorithm on disk for Apple II.
- Contains 64 phonemes accessed by 6-bit code.
- Four levels of programmable inflection.
- On board audio amplifier & volume control.
- ST02 Apple II plug-in, Assembled & Tested with Text-to-Speech Algorithm on 3.3 disk . \$99.
- NEW LOW PRICE!!!
- ST01 Parallel Port Version, Assembled 99.

New Low Price

VOTRAX SC-01A PHONETIC SPEECH SYNTHESIZER

The SC-01A Speech Synthesizer is a completely self-contained solid state device that phonetically synthesizes continuous speech of unlimited vocabulary. Used in Microvox and Sweet-Talker.

- SC01A Quantity 1-99 \$44. ea.
- 100 + 32. ea.
- 1000 + 24. ea.

E-Z COLOR GRAPHICS INTERFACE

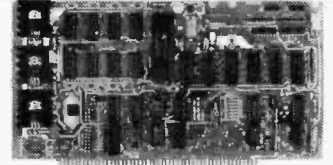

As featured in Ciarcia's Circuit Cellar BYTE Magazine, August 1982

- Add color graphics, animation & 3-D effects to your S-100, TRS-80 Model I and III & Apple II at low cost. The Super Editor software package includes a pattern editor, sprite editor, slide show, and demo scenes all in BASIC. Can be used with Color Monitor or TV set and rf modulator.
- Resolution—256 X 192 Pixels.
- 16 colors including Black & Transparent.
- 16K Bytes on board I/O mapped video memory.
- Advanced TI TMS9918A Color Video Processor.
- 32 SPRITES facilitates 3-D effect.
- Composite Video output.
- Krell & Terrapin have LOGO software packages to support the E-Z Color Boards.

- Apple II E-Z Color plug-in board with Super Editor on 3.3 disk.
- EZ01 Assembled & Tested \$119.
- EZ02 Complete Kit 105.
- NEW!! S-100 E-Z Color Graphics board with sound generator, Atari type joy stick interface, plus MBasic CP/M Super Editor Software on 8" disk.
- EZ04 Assembled & Tested \$289.
- TRS-80 Model I or Model III E-Z Color w/ Super Editor software, power supply and enclosure.
- Assembled & Tested \$249.
- Complete Kit 219.

300 BAUD ANSWER/ORIGINATE MODEM KIT NEW!!!

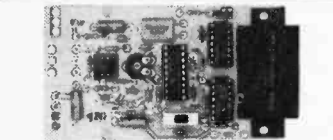

As featured in Ciarcia's Circuit Cellar BYTE Magazine, March 1983

- The newest item to Micromint's growing list of products is this 300 Baud Modem. It is crystal controlled, uses the TI TMS 99532 IC, contains just 25 parts and can be used with an acoustic coupler or in a direct connect mode.
- MD04 Complete Kit \$60.
- MD05 Transformer for Direct Connect Mode 9.
- AC01 Acoustic Coupler Kit \$20.

TRIPLE VOLTAGE POWER SUPPLIES

- +5v @ 300 ma. +/- 12v @ 25 ma.
- UPS01 Assembled & Tested \$35.
- UPS02 Complete Kit 27.
- +5v @ 1 Amp. + 12v @ .5 Amp. - 12v @ 50 ma.
- UPS03 Assembled & Tested 60.
- UPS04 Complete Kit 50.

MICROMINT INC. 561 Willow Avenue, Cedarhurst, NY 11516

To Order: Call Toll Free 1-800-645-3479
For Information Call: 1-516-374-6793
Call: Monday-Friday, 9-5 PM

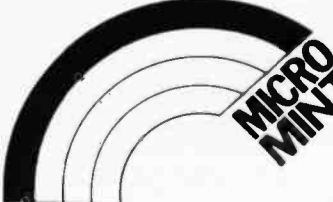

Event Queue

Among the highlights of this convention is a large technology exhibit. Full details are available from the Modern Language Association of America, 62 Fifth Ave., New York, NY 10011, (212) 741-5587.

January 1984

January-February

Fundamentals of Finance and Accounting Using a Microcomputer, various sites throughout the U.S. This three-day seminar is sponsored by the Data Processing Institute of the New York University School of Continuing Education. It will cover microcomputer applications for effective decision making and controlling business requirements. Previous computer knowledge is not required. The fee for the course is \$695. For specific dates and locations, contact the NYU School of Continuing Education Seminar Center, 575 Madison Ave., New York, NY 10022, (212) 748-5094.

January 2-6

Microcomputer Applications for Executives and Professionals: An Introductory Hands-on Approach, Lime-tree Beach Hotel, St. Thomas, Virgin Islands. Applications, word processing, spreadsheets, data management, and integrated software packages are a few of the topics to be presented at this seminar. Depending on enrollment, one or two people will share IBM Personal Computers using Lotus's 1-2-3 spreadsheet and other selected software. For further details, contact Dave Olson, Computer Workshops and Seminars Inc., 6th floor, 1701 Arch St., Philadelphia, PA 19103, (215) 496-0323.

January 4-6

Seventeenth Hawaii International Conference on System Sciences, Honolulu, HI. This conference is devoted to advances in information and system sciences with emphasis on medical-information processing, decision-support systems, and office automation. For information, contact Emily Yano Jorgensen, Center for Executive Development, College of Business Administration, University of Hawaii, 2404 Maile Way C-202, Honolulu, HI 96822, (808) 948-7396.

January 4-8

The Third American Society of Computers in Medicine and Dentistry Conference, Sheraton Waikiki Hotel, Waikiki, HI. The intention of this forum is to promote the clinical uses of microcomputers in medical, dental, and veterinary practices. The co-sponsor of this event is the Ohio State University Department of Anesthesia. For further details, contact Arlene Rogers, American Society of Computers in Medicine and Dentistry, POB 21483, Upper Arlington, OH 43221, (614) 421-8487.

January 8-11

Retail Directions '84, New York Hilton and Sheraton Centre Hotels, New York, NY. The 73rd annual convention and exposition sponsored by the National Retail Merchants Association (NRMA) will feature new developments in retail store technology, business systems, marketing techniques, and sales-promotion tools. Admission is free to bona fide members of the retail industry. For details, contact Dan Soskin, NRMA Enterprises, 100 West 31st St., New York, NY 10001, (212) 244-8780.

January 8-14

CADRE '84 Conference and Teachers Institute, San Jose,

CA. Computers in Art and Design, Research and Education (CADRE) is a forum that brings together leaders, thinkers, and computerists from all walks of life to explore the impact of computers on the arts. The Teachers Institute begins on January 11. Its fee is \$100. Registration for the conference is \$200 or \$250 on site. For details, contact CADRE '84 Conference, Department of Art, San Jose State University, Washington Square, San Jose, CA 95192, (408) 277-2555.

January 9-13

Technology Opportunity Conference, Houston, TX. This conference focuses on the convergence of optical-storage, videodisk, and computer technologies. For full details, contact Technology Opportunity Conference, POB 14817, San Francisco, CA 94114, (415) 626-1133.

January 14-15

The Fourth Annual Computer Fair, Northland Mall, Sterling, IL. This event is sponsored by the Sauk Valley Computer Club. For details, contact Vinus Williams, Rt. 1, Milledgeville, IL 61051, (815) 625-8585 days.

January 16-17

MOS Analog/Digital Interface Circuit Design for VLSI Systems, San Francisco Airport Hilton Hotel, San Francisco, CA. This short course will emphasize applicable design techniques for very large-scale integration systems. Course notes are included in the \$450 fee. For a brochure, contact Continuing Education in Engineering, University of California Extension, 2223 Fulton St., Berkeley, CA 94720, (415) 642-4151.

January 17-19

Mini/Micro-Southeast and Southcon/84 High Technology Electronics Exhibition and

Convention, Orange County Convention/Civic Center, Orlando, FL. Mini/Micro, designed for the original equipment manufacturing community, explores peripherals, processors, data communications, and software. A few of the topics to be addressed at Southcon/84 are artificial intelligence, computer-aided design, and factory automation. For details on these concurrent events, contact Electronic Conventions Inc., 8110 Airport Blvd., Los Angeles, CA 90045, (213) 772-2965.

January 17-20

Uniform, Washington Hilton, Washington, DC. This conference and exposition is designed for and by users of Unix-based systems. For details, contact Mark Weber, Professional Exposition Management Co. Inc., Suite 205, 2400 East Devon Ave., Des Plaines, IL 60018, (800) 323-5155; in Illinois, (312) 299-3131.

January 18-23

Commtext International and NAVA/ICIA '84 Convention, Dallas Convention Center, Dallas, TX. This communications and information technologies exposition highlights the latest developments in audio-visual, video, and microcomputer products for many communication needs. The concurrent convention is sponsored by the National Audio Visual Association/International Communications Industries Association (NAVA/ICIA). For information, contact Robert Milko, NAVA, 3150 Spring St., Fairfax, VA 22031, (703) 273-7200.

January 23-25

Teaching Math with Microcomputers, Hacienda Resort Hotel, Las Vegas, NV. This seminar, sponsored by the National Council of Teachers of Mathematics (NCTM), is designed to inform educators

AVIS RAPID RETURN.SM IT'S FAST. IT'S EASY. AND NO ONE HAS ANYTHING LIKE IT!



© 1983 Avis Rent A Car System, Inc. AvisSM

IT GIVES YOU A RECORD OF YOUR CHARGES IN WELL UNDER A MINUTE.

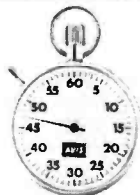

See how fast you can return your car.

You'll never have to go to the rental counter again to return your car and get a record of your rental expense. Because we give you something no one else can. Avis Rapid Return.SM The first—and only—fully automated, self-service car return system



"I get a copy of my expenses without waiting at the rental counter!"

in car rental history!

And Rapid Return is as easy to use as your pocket calculator. Just punch in your car number, mileage and gas gauge reading. In well under a minute it not only completes your car return; it also gives you a copy of your rental charges.

And since you get your charges so quickly you'll be able to complete your expense account quickly, too.

NO LINES. NO WAITING. NO COMPETITION.

The simple fact is that the competition just isn't fast enough to beat Rapid Return. And it's been proving itself at some of the busiest airports and downtown locations for the past several months.

As a result, whenever you run to use new Rapid Return, you won't run into a line to slow you down. And all you need to use Rapid Return is an Avis or another major credit card.

So if you want to return your car and get a copy of your rental charges the fastest way possible, there's just one place to go, Avis. Because only Avis offers the technological leadership that delivers state of the art services like Rapid Return. It's designed to make car renting faster and easier than ever for you.



It's easy to use as your pocket calculator!



Avis features GM cars. Chevrolet Caprice Classic.



TRYING HARDER MAKES AVIS SECOND TO NONE.SM

For reservations and information, call 1-800-331-1212. Or your travel consultant.

Rapid Return available at many major airports and downtown locations for charge customers who require no modification of their charges.

Event Queue

in elementary, intermediate, and secondary schools about using microcomputers effectively in mathematics education. For details, contact NCTM Seminar Series, 1906 Association Dr., Reston, VA 22091, (703) 620-9840.

January 24-26

Advanced Semiconductor Equipment Exposition (ASEE) and Technical Conference, Convention Center, San Jose, CA. Five sessions designed as a broad-based program focus on the manufacturing aspect of the semiconductor industry. For details, contact Joyce Estill, Cartledge & Associates Inc., Suite 205, 4030 Moorpark Ave., San Jose, CA 95117, (408) 554-6644.

January 25-27

The Business Telecommunications Exposition, Stadium Club, Giants Stadium, East Rutherford, NJ. This exposition is designed for managers in the fields of telecommunications, facsimile communications, and communications in voice, video, and data. Other topics to be covered are office automation, word processing, and purchasing. Registration is required for admittance to the exposition. Contact Michael Houston, The Exposition Group Inc., 9128 Columbia Ave., North Bergen, NJ 07047, (201) 662-1318.

January 27-29

Resource '84, Shamrock Hilton Hotel, Houston, TX. This computer exposition is dedicated to users in the medical, dental, legal, and accounting professions who need to buy a new system or want to upgrade existing systems. Telecommunications information and software applicable to home and office uses will be displayed. Admission is free for physicians, dentists, attorneys, and accountants; all others pay \$2.50. Entrance to any or

all of the seminars is \$10. For details, contact Joyce Fadem, Professional Resources Inc., POB 740433, Houston, TX 77274.

January 31-February 3

The Sixth Annual Communication Networks 1984 Conference and Exposition, Washington Convention Center, Washington, DC. Voice and telecommunications, electronic mail, data processing, and communications are a few of the products and services to be displayed at this event. Registration information is available from Louise Myerow, POB 880, Framingham, MA 01701, (800) 225-4698; in Massachusetts, (617) 879-0700.

February 1984

February 2-4

The Third Annual SCS Multiconference, Bahia Hotel, Mission Bay, San Diego, CA. This conference, sponsored by the Society for Computer Simulation (SCS), is composed of four conferences: Modeling and Simulation on Microcomputers, Simulation in Health Care Delivery Systems, Aerospace Simulation, and Simulation in Strongly Typed Languages, Ada, Pascal, Simula. For details, contact Gloria Rico, SCS, POB 2228, La Jolla, CA 92038, (619) 459-3888.

February 7-9

Florida Agribusiness Computer Conference and Trade Show, Civic Center, Lakeland, FL. This conference will demonstrate how computers can be used as decision-making tools for managers in agribusiness. The sponsor of this second annual farm computer conference is the University of Florida's Institute

of Food and Agricultural Sciences (IFAS). For details, contact IFAS Director of Conferences, 1041 McCarty Hall, University of Florida, Gainesville, FL 32611, (904) 392-5930.

February 13-16

Kuwait Info '84, International Exhibition Center, Kuwait City, Kuwait. Exhibits in this third annual event will encompass a broad range of information businesses, including data processing, word processing, communications, office automation, micrographics, security systems, and environmental control systems. Information is available from Carol Purdey, Intermarket Network Corp., Suite 203, 1110 Vermont Ave. NW, Washington, DC 20005, (202) 822-0127.

February 13-16

ACM Computer Science Conference, Franklin Plaza Hotel, Philadelphia, PA. This conference is sponsored by the Association for Computing Machinery (ACM) and the computer science departments of many universities. For details about the Twelfth Annual Employment Register, which is a highlight of the conference, contact the ACM Computer Science Employment Register, Department of Computer Science, University of Pittsburgh, Pittsburgh, PA 15260. For details about the ACM Computer Science Conference, contact the Association for Computing Machinery, 1133 Avenue of the Americas, New York, NY 10036, (212) 265-6300.

February 20-22

1984 Office Automation Conference (OAC '84), Los Angeles Convention Center, Los Angeles, CA. The fifth annual OAC, sponsored by the American Federation of Information Processing Soci-

eties (AFIPS), will feature five tracks oriented toward the interests of managers and administrators; technology managers and planners; analysts, consultants, and implementors; product designers and developers; and users of the automated office. For information, contact AFIPS Inc., 1815 North Lynn St., Arlington, VA 22209, (703) 558-3617.

February 20-23

APAC '84, Inter-Continental Hotel, Riyadh, Saudi Arabia. Arabian Productivity Advancement Using Computers/Graphics (APAC) is the first international conference and exposition on computer graphics to be held in Saudi Arabia. Industry and government representatives from Middle Eastern and Western nations will attend. For information, contact APAC '84 Conference Director, World Computer Graphics Association Inc., Suite 399, 2033 M St. NW, Washington, DC 20036, (202) 775-9556.

February 21-23

Softcon, Superdome, New Orleans, LA. This international software conference and trade fair is designed for retailers, independent sales organizations, consultants, government agencies, educational institutions, and professional software developers. Registration is \$15. For further information, contact Northeast Expositions, 822 Boylston St., Chestnut Hill, MA 02167, (800) 841-7000; in Massachusetts, (617) 739-2000.

February 22-28

Imprinta 84, Fairgrounds, Dusseldorf, West Germany. This international congress and exhibition will feature techniques and services in print communication and its alternatives. For details, contact Dusseldorf Trade Shows, 500 Fifth Ave., New York, NY 10110, (212) 840-7744. ■

Rutishauser

The Feeder World of Quality

Portrait and landscape forms – Models for most letter quality printers – With or without interfaces – Electronically or mechanically controlled – No operator adjustments required – No reverse platen motion required – High precision registration – UL-recognitions – Multi-part forms – No paper cassettes – Field proven – Envelope attachment – Any paper size up to 12" x 15" – Clip-on mounting – Complete control of paper and its pathway to print-mechanism! – Lightweight – The Single Bin Cut Sheet Feeder most in use – Swiss-made quality

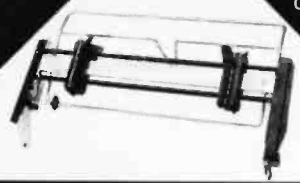

RT 200
Bi-directional Forms-Tractor. For precise continuous form feeding.

RT 200

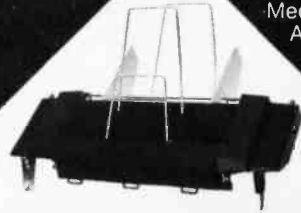

RS 700
Mechanical Sheet Feeder. Automatic feeder with mechanical control mechanism. No electronics required. Driven forward by printer platen.

RS 700

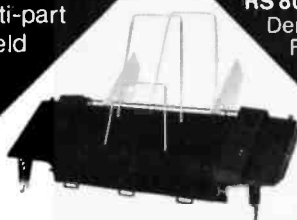

RS 800
Demand Sheet Feeder. Feeds sheets on command from an external interface. Compatible with RS 950.

RS 800

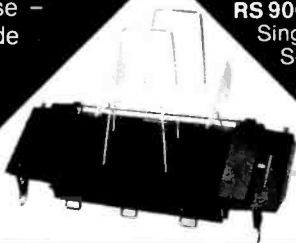

RS 900
Single Bin Sheet Feeder. Self-controlled automatic feeder with internal electronics for universal application. The most widely used single bin feeder in the world.

RS 900

Rutishauser Products are available for a wide variety of popular types of Letter Quality Printers.

AES · Anadex · Binder · Brother · Centronics · Daisy Systems ·

RS 950/RS 1950 Double Bin Sheet Feeder.
Feeds sheets from either of two supply bins upon command from an external interface. Direct control by printer electronics. OEM supplied interface or custom interface available for selected printers.



RS 950

Diablo · Data-Royal · Dataproducts · Facit · Fujitsu · HPI · IBM-System 6 · Mannesmann Tally · NEC · Olympia · Qume · Ricoh · T.A. · Santic · SCM · TEC/C. Itoh · Toshiba · Walther · Wang · Xerox

Maybe you didn't know we offer such a large Family of Devices!

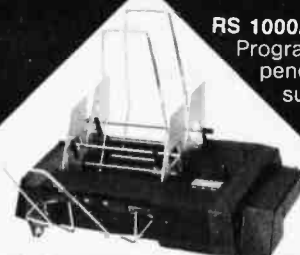

RS 1000/RS 1100
Programmable Double Bin Sheet Feeder. Independent self-controlled feeding from two supply bins, with or without external electronic commands. Several modes of operation including user programmable sheet selection and programmed platen motion sheet selection. Feeds sheets up to 12" wide.

RS 1000

RF 400 Front Feed Device.
Programmed insertion of single or multipart forms for precisely registered applications – pre-printed forms, ledger cards, etc.

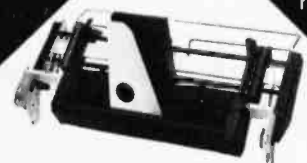

RF 400

Rutishauser

Rutishauser Data AG, Rhynerstrasse 9, 8712 Stäfa, Switzerland
Tel. (01) 926 43 00, Tx. 875171 ruti ch
Rutishauser of America, Inc., 9677 Wendell Road, Dallas, TX 75243, U.S.A.,
Tel. (214) 3439154, Tx. 730609 ruti dal – a subsidiary of Rutishauser Data AG
Circle 496 on Inquiry card.

What's New?

HOLIDAY COMPUTING



Collector Plate Shows Santa Computing

A limited edition collector plate called Santa's Computer is available from American Artists. The plate, executed in a fashion similar to the late Norman Rockwell, depicts Santa at a computer console entering requests from good children as his faithful elves scurry about sorting letters and preparing lists for his calculations.

This 8½-inch fine china plate was created by Scott

Gustafson, a Chicago-based illustrator. Gustafson has illustrated a number of publications and children's books and has worked as an artist for the Saturday Evening Post. The issue price for this collectible is \$29.50. For more information, contact American Artists, Fourth Floor, 225 West Hubbard, Chicago, IL 60610, (312) 828-0555.

Circle 603 on inquiry card.

Tab-feed Greeting Cards

Seasonal greeting cards with continuous tab feed and clean-edge perforations have been introduced by Compucards. The inside of the card is blank so that you can print your personal holiday greetings. Complementary envelopes are provided.

Presently, Compucards offers a choice of Christmas cards. The first

features Mrs. Claus adjusting her husband's scarf; the second depicts four jolly revelers arriving in their horse-drawn sleigh. Both cards are rendered in red and black inks. A package of 20 cards with envelopes is \$9.95. For details, contact Compucards, POB 894, Stone Mountain, GA 30086.

Computer Board Game for Children

Computer Caper is a computer-literacy board game for children ages 4 to 8. It comes with stickers and a computer riddle book. To win, you must be the first player to move your computer chip from Input Island to Printout Pass. Two to four players can participate. Computer Caper is available for \$10, postage paid, from Holiday Games Inc., 5501 West North Ave., Milwaukee, WI 53208, (414) 444-1060.

Circle 607 on inquiry card.

Home Learning Entertainment System

Chalk Board's Powerpad, a touch-sensitive input device, and Leonardo's Library of software packages form an integrated learning/entertainment system. The Powerpad is a 17-by 20-inch hard plastic case housing a 12-by 12-inch touch-sensitive tablet that effectively replaces your computer keyboard. Powerpad uses a form of membrane-switch technology that has thousands of digital switches that register multiple points of contact simultaneously.

A Mylar overlay that fits the Powerpad work area is supplied with each package in Leonardo's Library. The overlay, when used with its accompanying cartridge or disk software, works with the Powerpad to provide a range of interactive applications, such as an artist's canvas or a piano keyboard. Six subject

areas make up Leonardo's Library: language arts, mathematics, music, science, social studies, and visual arts. A Logo package and a programming kit are among the programs offered.

The Powerpad and Leonardo's Library run on such home computers as the Apple II, II Plus, and IIe, Atari 400/800, Commodore VIC-20 and 64, and the IBM PC and PC/XT. Powerpad costs \$99.95. Software packages range from \$24.95 to \$49.95. For further information, contact Chalk Board Inc., 3772 Pleasantdale Rd., Atlanta, GA 30340, (800) 241-3989; in Georgia, (404) 496-0101.

Circle 604 on inquiry card.

Computer Widow T-Shirts

Purple-on-lavender T-shirts and nightshirts bearing the lament "Computer Widow" are available from JMK Computer Services. T-shirts cost \$7.95, plus \$1.25 shipping. The nightshirts are \$12.95, with \$1.50 postage. Contact JMK Computer Services, POB 1672, West Caldwell, NJ 07007, (201) 227-3348.

Circle 602 on inquiry card.

Low-cost Robot Beeps and Barrels Along

Rhino Robots' Scorpion is a compact, software-programmable robot that makes noises as it trundles along your floor.

What's New?

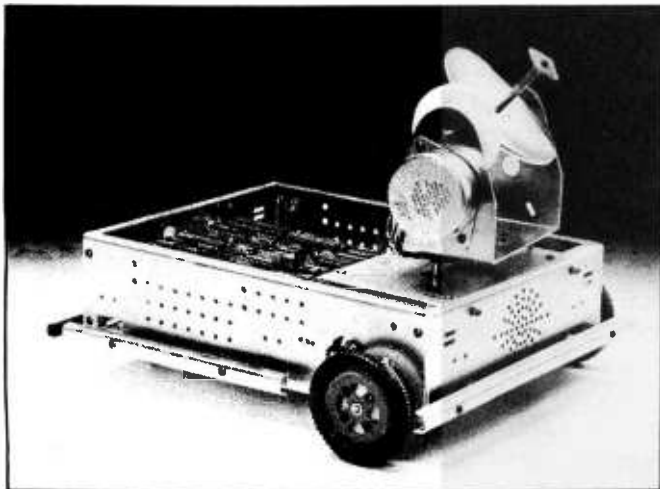

Scorpion's base measures 9 by 12 inches and resembles NASA's Lunar Landing Module. With it, you can devise your own artificial-intelligence experiments while spending less than \$700.

Scorpion is equipped with a 6502 microprocessor, an 8K-byte EPROM, 2K bytes of RAM, and two 6522 interface chips that provide 32 I/O lines and four programmable timers, two of which can be event counters. Its eight microswitches discern obstacles in its path and provide the means for avoiding those obstacles when retracing a preset path. A two-axis optical scanner with a resolution of 1.5 degrees of scan per step recognizes pat-

terns over a 300-degree span in both vertical and horizontal planes. Visual patterns can be displayed on your computer's video monitor. Additional hardware includes sensing bumpers, a speaker, two ground tracks, two "eyes," and four motors, two of which are drive wheels.

Scorpion works with any computer with an RS-232C interface. It operates from a 12-V DC power supply. Shipped in kit form with complete assembly and programming instructions, Scorpion costs \$660. For more information, contact Rhino Robots Inc., POB 4010, Champaign, IL 61820, (217) 352-8485. Circle 601 on inquiry card.

Bumper Sticker for Hackers

Surprise the computer hacker in your life with the "I Love My Computer" bumper sticker from International Computer Products. Printed on a durable white plastic base, this bumper sticker features the customary red heart to express affection. As an

added attraction, a pair of red lips replaces the "o" in "Computer." For each copy, send \$1.50, plus \$0.20 shipping, to International Computer Products, 346 North Western Ave., Los Angeles, CA 90004. Circle 600 on inquiry card.

Computer Tie

Tie-One-On is marketing a holiday gift for those hard-to-buy-for males: the computer tie. Woven into this navy blue tie are the words bit, byte, floppy, hard, RAM, ROM, micro, and mini. The tie is made of a silk/polyester blend and is available for \$15.95, postage paid, from Tie-One-On Inc., POB 40225, Philadelphia, PA 19106, (215) 625-2855.

Circle 605 on inquiry card.



SYSTEMS

NS16032-based Megamicro Runs Unity

The Megamicro LMC-16032, a 32-bit, virtual-memory microcomputer based on National Semiconductor's NS16032 microprocessor and running under Human Computing Resources' Toronto Unity operating system, has been introduced by the Logical Microcomputer Company. The LMC-16032, which operates on the IEEE-796 (Multibus) standard, provides demand-paged address and data space of up to 16 megabytes for each of its 32 possible users. It can perform 161,000 double-precision, 64-bit floating-point multiplications per second. The LMC-16032 can handle 16 hard-disk drives for a total memory capacity of more than 1600 megabytes.

In its basic configuration, the LMC-16032 comes with virtual memory, floating-point hardware, 512K bytes of parity check-

ing RAM, eight serial RS-232C ports, an intelligent disk controller, and a 20-megabyte Winchester hard-disk drive. Toronto Unity, an implementation of Berkeley's 4.1 enhancement of Bell Laboratories' Unix operating system, serves as the DOS, and C and FORTRAN compilers are supplied. Fully assembled and tested, the basic system costs \$15,000. An enclosure and all manuals, cables, and power supplies are provided.

Such optional hardware as error-correcting RAM, additional serial and parallel ports, and 16-, 20-, and 40-megabyte hard-disk drives can be ordered. Optional languages include Pascal, PL/I, COBOL, Ada, and LISP. For further information, contact the Logical Microcomputer Co., 140 South Dearborn St., Chicago, IL 60603, (312) 580-0250.

Circle 617 on inquiry card.

What's New?



Computer-aided Drafting System for Architects

Bausch & Lomb has introduced a computer-aided drafting system for architects. Called Prodraft, this system has a 15-inch high-resolution (1024 by 800) raster-graphics display and an MC68000 processor. A menu tablet lets the operator quickly select repetitive figures and functions, and the 6.7-megabyte Winchester hard-disk drive is accompanied by a single-sheet, A-to-D size plotter. Special menus include residential, commercial, light com-

mercial, and renovation packages.

An Architectural Drafting Library composed of more than 100 predrawn figures and symbols is available. Prior computer experience is not required because Prodraft comes with a training manual and videotaped instructions. Prodraft sells for \$29,995. Contact Bausch & Lomb, Interactive Graphics, POB 14547, Austin, TX 78761, (512) 837-8952.

Circle 609 on inquiry card.

Single-board Computer Is CP/M-compatible

The single-board EQ-4 from Insight Enterprises is compatible with CP/M 2.2 and 3.0. It has virtual memory-mapping circuitry that lets the Z80A central processor and the DMA controller directly access 128K bytes of RAM, 2K bytes of EPROM, and 4K bytes of video memory in 8K-byte blocks.

Interfaces incorporated into the EQ-4 include SASI, four serial RS-232C chan-

nels with independently programmable data rates ranging from 110 to 76,800 bps, a Centronics parallel printer, and floppy-disk ports. The floppy-disk controllers can handle single- and double-density 5¼- and 8-inch drives simultaneously. CTC, DART, and PIO peripheral controllers are standard. The parallel keyboard input accommodates 7- or 8-bit ASCII-encoded boards with

jumper-selectable active high and low strobes. Horizontal and vertical sync signals and composite video output compose EQ-4's video features. Standard Microsystems' 8002 video-display attributes controller provides the EQ-4 with an on-chip character generator, 128 characters in a 7- by 11-dot matrix, and character-oriented, wide- and thin-line graphics. Attributes supported for each character are reverse video, character blank, blink, underline, and strike-through.

The single-unit price for the EQ-4 is \$750, which includes CBIOS, utilities, and source codes. Complete specifications are available from Insight Enterprises Corp., Suite 12, 373 North Western Ave., Los Angeles, CA 90004, (213) 461-3262.

Circle 613 on inquiry card.

Line of Micros Marketed at Compushack Stores

A line of IBM PC-compatible computers from Tava Corporation is sold at Compushack stores.

The Tava PC features 64K bytes of RAM, five PC-compatible expansion slots, a parallel printer interface, two serial ports, and a keyboard. The RAM is expandable to 256K bytes, and up to nine expansion slots are possible. It costs \$995.

The portable Tava PC 1 is an enhanced version of the Tava PC, offering identical memory, expansion,

and interface capabilities. Enhancements include dual slim-line 320K-byte 5¼-inch floppy-disk drives and a 9-inch display. The PC 1 retails for \$1995.

The Tava Executive PC (base price, \$2995) has built-in network capabilities that can accommodate 16 terminals. Standard hardware includes 256K bytes of RAM, 640K bytes of dual floppy-disk storage, a parallel printer port, and a serial interface. RAM is expandable to 512K bytes.

For complete details, contact your local Compushack outlet or Compushack, Tava Corp., 16861 Armstrong, Irvine, CA 92714, (714) 261-1000.

Circle 616 on inquiry card.

Color Computer Uses 6809E

The Bestcom GTX-1000 color computer, based on the 6809E microprocessor, can be attached to a home color television. The basic GTX-1000 comes with 16K bytes of RAM, 16K bytes of ROM, a built-in modem connector, one cassette and two joystick interface ports, and an RS-232C port. An optional expansion unit has provisions for a parallel printer, additional memory, and floppy- or Winchester-disk drive controllers. The standard operating system is Microsoft Extended BASIC. Contact Graphtek Corp., 2959 West Fairmount Ave., Phoenix, AZ 85017, (602) 277-7434.

Circle 612 on inquiry card.

What's New?



Portable Computer Has Built-in State Analyzers

Omnilogic has unveiled Omni II, a portable CP/M-compatible computer with built-in timing and state logic analyzer capabilities. The 27-pound, software-intensive Omni II can collect 1000 data samples on each of its 16 channels or, as an option, 330 samples per channel on up to 48 channels. For software analysis, up to 16 channels of data recognition are available. All test parameters and data can be stored on a CP/M-based floppy-disk format for additional off-line analysis. Any display can be dumped to a printer.

Omni II's hardware specifications include a Z80 microprocessor, 64K bytes of memory, two double-density 5¼-inch floppy-disk drives, a 9-inch green-phosphor monitor, and RS-232C and Centronics-type parallel ports. It's supplied with such general-purpose software as CP/M-80, Perfect Writer, Perfect Speller, Perfect Filer, Perfect Calc,

Profitplan, and S-BASIC.

The Omni II is priced at \$3950. Contact Omnilogic Inc., POB 87, Renton, WA 98057, (800) 228-6664; in Washington state, (206) 271-2000.

Circle 610 on inquiry card.

Low-cost Computer Offers High-price Features

Memotech Corporation is marketing a low-cost Z80-based computer called the MTX-512. Standard hardware includes 64K bytes of RAM, 16K bytes of dedicated video RAM, real-time clock, 256- by 192-pixel high-resolution graphics, 40-column text, 16 colors, and user-definable graphics abilities. I/O ports for a Centronics-type parallel printer and two game-controllers are provided along with separate television and video monitor ports, a game cartridge port, an uncommitted port, and a 2400-bps cassette interface. Three voices, high-

fidelity output, and a white-noise generator make up the MTX-512's sound capabilities. Its 79-key keyboard has separate numeric and cursor-control pads as well as function keys. Oxford BASIC and an assembler/disassembler are embedded in 16K bytes of ROM.

Network interfacing, up to 512K bytes of RAM, an

80-column video board, dual RS-232C ports, and 5¼- and 8-inch floppy-disk drives with CP/M are offered as options. Pascal and FORTH are available as add-on ROM packs. The suggested retail price for the MTX-512 is \$595. For further information, contact Memotech Corp., 7550 West Yale Ave., Denver, CO 80227, (303) 986-1516.

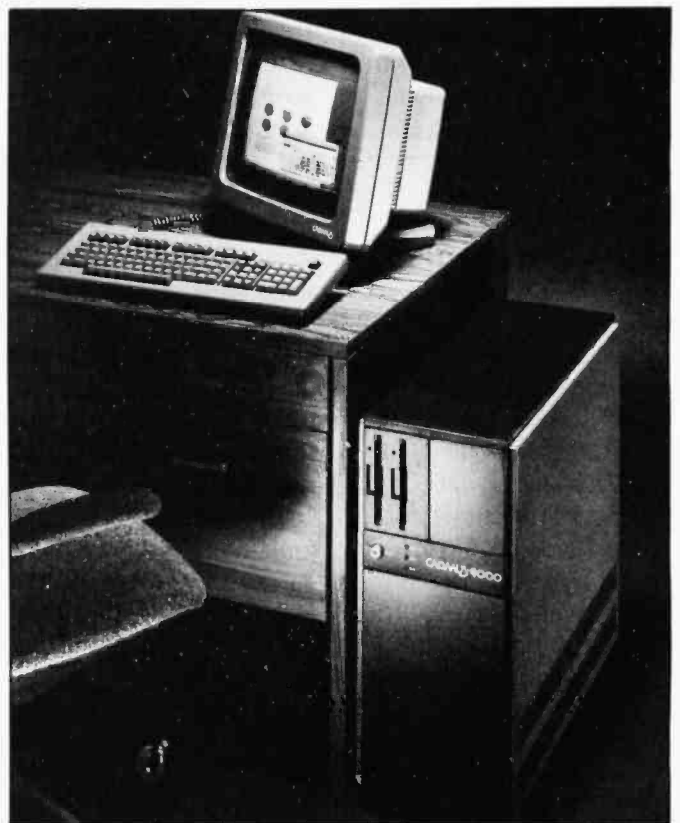

Fiber Optics Link Multiusers in Unix Environment

The Cadmus 9000 family of microcomputers uses a 50-megabit-per-second fiber-optic link to support 64 graphics workstations or more than 100 terminals in a distributed Unix environment. Features of

the Cadmus 9790 Advanced Function Workstation include a 10-MHz MC68000 microprocessor, one-half megabyte of main memory (expandable to 4 megabytes), and a bit-mapped graphics

What's New?

controller with a 1024- by 800-pixel display area. An adjustable 17-inch monochrome video monitor, a mouse interface, detachable keyboard, a 65-mega-byte Winchester hard-disk drive, a streaming tape cartridge for storage backup, and an optional local-area-network interface make this multiuser Unix-based system unique.

For complete technical specifications, purchasing details, and shipping information, contact Cadmus Computer Systems, 600 Suffolk St., Lowell, MA 01852, (617) 453-2899. Circle 608 on inquiry card.

High-speed Board for STD Bus

Techno has announced a high-speed 6502-based single-board computer for STD-bus applications. The CPU-100 has a built-in RS-232C serial interface for direct terminal/printer connection and room for up to 8K bytes of memory. Two user-defined I/O ports, two interval timers, serial-to-parallel and parallel-to-serial shift registers, and two bidirectional 8-bit data ports with control lines are included. The CPU-100 can function as the central processing unit of a multiboard system with memory expansion to 65K bytes.

A 2K-byte monitor and mathematics package are available. Contact Techno Inc., 14 Crandall Ave., Pompton Lakes, NJ 07442, (201) 839-0740. Circle 611 on inquiry card.



16-bit Computer for Business or Personal Use

A 16-bit business/personal computer has been announced by Sunicom Inc. The basic System 330 has an 8088 microprocessor, 128K bytes of RAM, three on-board expansion slots, and a full-function 93-key ASCII keyboard. The low-profile keyboard offers a standard alphanumeric typewriter format that's augmented with 10 numeric keys, 14 editing keys, and eight double-function keys. The System 330 supports CP/M-86, MS-DOS, Pascal, FORTRAN, COBOL, and BASIC. It costs \$1795.

A choice of mass-storage options is offered: single or dual 160K-byte 5¼-inch floppy-disk drives, 8-inch drives, dual 720K-byte floppy disks, and 8- or 16-megabyte hard disks. Color and monochrome display screens are available. An expansion box providing six additional slots can be obtained. Also available is a linked software package that interconnects five subsystems: word processing, database

management, financial planning, communications, and accounting. At the heart of this software is a system manager that permits data from one application to be extracted and inserted in another.

The System 330A, outfitted with a single 160K-byte floppy-disk drive, MS-DOS, and an eight-color monitor, costs \$2695. With dual disk drives and color monitor, the 330B is \$3195. A pair of 720K-byte floppy-disk drives comes with the \$3625 System 330E. The proprietary linked software is \$540. The expansion unit ranges from \$510 to \$3495, depending on optional capabilities. For further information, contact Sunicom Inc., 17862 East 17th St., Tustin, CA 92680, (714) 730-6061. Circle 614 on inquiry card.

Dual Floppy Drives In Single Case

Digital Equipment Corporation asserts that its

Rainbow 100+ is the first machine from a major vendor to offer 256k-bit memory technology. The 100+ is also said to be the first computer to carry a Winchester hard-disk and twin floppy-disk drives in a single enclosure.

Employing both the 8-bit Z80A and the 16-bit 8088 microprocessors, the Rainbow 100+ comes with 10 megabytes of Winchester storage, 800K bytes of dual floppy-disk storage, serial synchronous and asynchronous communications, memory-mapped video, full international character support, built-in terminal emulator, and a serial RS-232C/RS-423 printer port. Its 128K bytes of RAM is expandable up to 896K bytes. Diagnostics and a computer-based instruction course are supplied. The basic Rainbow 100+ costs \$5475, including documentation. An operating-system kit that includes CP/M-86/80 version 2.0 and MS-DOS version 2.05 can be purchased for \$250.

Digital offers a choice of white, green, or amber monochrome display monitors. Each 12-inch monitor offers 80- or 120-column displays, bit-mapped graphics, and high-definition characters. The monitors cost \$325.

For entering data, Digital markets a low-profile keyboard for \$245. Featuring a sculptured key array, the 105-key keyboard is divided into four areas: traditional typing, editing, numeric, and special function.

Options include RAM

What's New?

memory extensions, high-resolution graphics, complete technical documentation, and a line of printers. Digital Equipment Corporation maintains its corporate headquarters in Maynard, MA 01754. Circle 619 on inquiry card.

Tabletop Computer

Creative Micro Systems' 9687 computer is available in a variety of setups. This tabletop machine offers 14 internal card slots, Winchester hard-disk capacities ranging as high as 50 megabytes, and up to 1 megabyte of floppy-disk storage. It can be ordered with 10 serial ports and as much as 1 megabyte of RAM.

The basic 9687 features a 2-MHz M6809 microprocessor, 64K bytes of static RAM, two serial ports, two parallel ports, one double-density double-sided 650K-byte floppy-disk drive, a 20-megabyte Winchester hard-disk drive, and the OS-9 operating system. It costs \$5995; quantity discounts are offered. For full details, contact Creative Micro Systems, 3822 Ceritos Ave., Los Alamitos, CA 90720, (213) 493-2484.

Circle 618 on inquiry card.

Tax Manager for Accountants

Samuel Klein and Company, certified public accountants, has configured an integrated tax-manage-

ment system designed to help accountants manage their tax practices. The Tax Manager comprises a portable computer with a self-contained 10-megabyte hard-disk drive, a dot-matrix printer, and a host of accounting software. When equipped with a modem, it can communicate with on-line services. The base price is \$4995.

System software represents the foundation of the Tax Manager. A key program, called Tenforty, gives you a single-screen model of IRS Form 1040 so that you can plan taxes for the years 1981 through 1987 in a matter of seconds. For review, you can print out the tax plan. A word processor and spelling checker help you generate IRS and everyday correspondence, instruction letters for tax returns, and mailing labels. An electronic spreadsheet provides the means for creating complex financial models, budgets, and projections. Tax Manager's relational database gives you control over filing requirements, staffing, and status reports. Financial-analysis ratios, Bardahl test computations, and interest schedules can be computed. Other capabilities include general ledger, accounts payable/receivable, and payroll.

Additional software packages are offered. More information is available from Samuel Klein and Co., MAS Software Services Division, 1180 Raymond Blvd., Newark, NJ 07102, (201) 624-6100. Circle 615 on inquiry card.

SOFTWARE

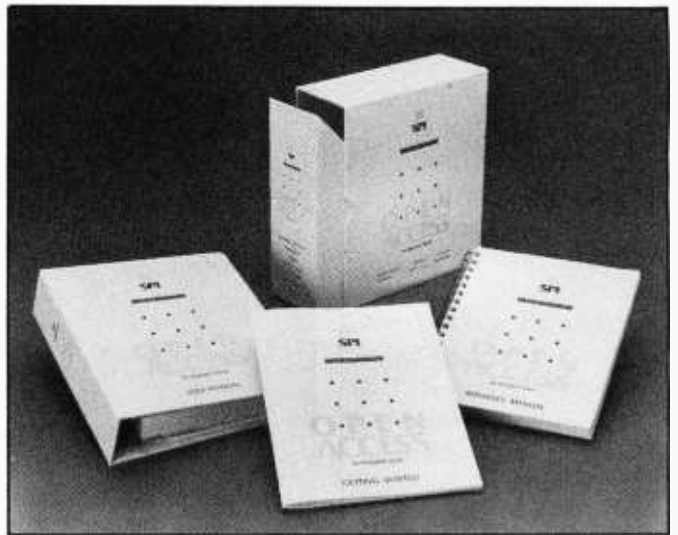

Business Package Includes Spreadsheet, Graphics Module, Word Processor

Open Access from Software Products International serves as an all-in-one "super program" that's capable of handling the prime tasks of a business manager. Included in this package are an electronic spreadsheet, a three-dimensional color graphics module, a word processor, an appointment scheduler, and a communications module, all of which are centered around a database manager that accesses all input data. Open Access also offers pop-up windows that let you view different forms of information simultaneously without going through menus or command sequences.

Open Access is designed for the IBM Personal Computer, its compatibles, the DEC Rainbow, and desktop computers from Texas Instruments, NCR, and Wang. It costs \$595. For more information, contact Software Products International, 10343 Roselle St.,

San Diego, CA 92121, (619) 450-1526.

Circle 636 on inquiry card.

Business Tool Can Be Run by Novices

Novices and experts can use Sofstar's Business Planning Tool to create budgets, forecasts, and business plans in familiar income-statement and balance-sheet formats. Accounts are defined by positioning the IBM Personal Computer's cursor at the desired location and entering an account name. Accounts must fall within one of the following categories: income, expense, assets, or liabilities and equity.

The Business Planning Tool features a 12-month window that presents a range of possibilities based on assumptions contained in account descriptions. A graph screen is used to display a horizontal bar graph of an account. All data or

What's New?

individual components of an account can be displayed or edited. Editing of constants and seasonal variations is provided. The Business Planning Tool does not require programming commands or special symbols. All formatting is completely automatic. Another feature is the ability to write complex, preformatted spreadsheets that can be used with Visicorp's Visicalc.

The Business Planning Tool runs on 128K-byte IBM Personal Computers with one disk drive. It costs \$195 and is manufactured by Sofstar Inc., 13935 U.S. Highway #1, Juno Beach, FL 33408, (305) 627-5511. Circle 620 on inquiry card.

Utility Programs with the Inside Track

The Inside Track is a collection of utility programs for the IBM Personal Computer from Data Base Decisions. This package comprises 61 programs that provide you with assembly-language-assisted speed by means of subroutines that can be called from interpretive BASIC or from a compiled language. These subroutines perform such functions as read and write files as fast as DOS, display data on screen four to 10 times faster than the BASIC PRINT statement, copy memory from one location to another, and copy-protect disks. Certain programs let you reverse a block of memory for use as a program scratchpad or limit the memory used by

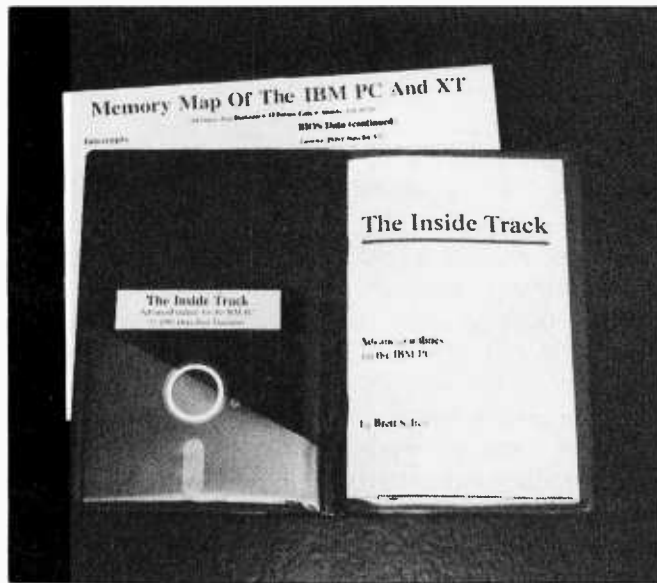

compiled BASIC programs to eliminate reloading of COMMAND.COM and to allow concurrent program loading. Other programs handle such chores as dynamically scheduling up to four programs from within a program.

The Inside Track requires a 64K-byte IBM PC with PC-DOS, a disk drive, and an 80-column monitor.

Most of the programs run with any version of PC-DOS; however, a few programs require DOS 2.0, in which case 128K bytes of memory is necessary. This package is available factory-direct for \$45, plus \$2.50 shipping, from Data Base Decisions, 14 Bonnie Ln., Atlanta, GA 30328, (404) 256-3860.

Circle 635 on inquiry card.

Cash and Time-Management Programs Aid Professionals

American Software Application Programs has announced five cash-control and time-management programs designed for professionals: Due Process for attorneys, Net Worth for CPAs, the Blue Print for architects, the Spec Sheet for engineers, and the Guide Line for consultants. Each program provides complete client accounting with 18 different statement formats, comprehensive management reports, appointment scheduling, and

letter writing with name and address merge capabilities. Also provided is a utility program that repairs files and indexes, splits files onto several disks, merges files when upgrading to a hard-disk drive, and backs up files for historical records.

These programs run on CP/M and CP/M-86 systems. They come with documentation designed for first-time users. Free dealer and end-user support is provided over toll-free telephone lines. Each program

retails for \$995; demonstration kits are available for \$70. For more information, contact American Software Application Programs, Suite 270, 100 East Thousand Oaks Blvd., Thousand Oaks, CA 91360, (800) 252-2727; in California, (805) 496-5329. Circle 626 on inquiry card.

Machine-Independent Operating System

S1 is a general-purpose, machine- and processor-independent operating system from Multi Solutions. Distinctive characteristics include building-block construction, machine-language implementation, system facilities for applications, networking facilities, real-time operation, file-system compatibility, and window management. Up to 256 processors can be simultaneously supported with any task running on the central processor. It offers conventional command processors, menus, and prompts; extensive graphic support; windowing and bit-mapping; and bit-mapped printer/plotter and terminal support.

S1 is portable to a variety of systems, including 32-bit machines. It can read and write files to and from CP/M, MP/M II, MS-DOS, Unix, Xenix, p-System, Flex, and other operating systems. It presently is running on Z80, 68000, and 8080/8085 computers. Languages available include C, FORTRAN, and Pascal.

Prices for a precon-

What's New?

figured S1 package begin at \$200. OEM and system houses inquiries are welcome. For a brochure outlining this product, contact Multi Solutions Inc., 660 Whitehead Rd., Lawrenceville, NJ 08648, (609) 695-1337.

Circle 623 on inquiry card.

Write Your Own Programs at Home

Dynatech Microsoftware's Home File Writer enables Commodore 64 and Atari 800 and XL series users to write a variety of applications programs for everyday use. Possible applications include household inventory, recipe files, medical and health records, mailing lists, and tax information. This self-prompting program lets you enter the screen format and calculations onto your monitor in plain English. It then translates your information into a form that will work on the computer. Home File Writer rejects improper or illegal input and gives you another opportunity to enter your data correctly. Once your application program is written, Home File Writer can be removed, which minimizes hardware overhead. Its operation is totally transparent.

Home File Writer is supplied with documentation. It costs \$69.95. For more details, contact Dynatech Microsoftware Inc., 7847 North Caldwell Ave., Niles, IL 60648, (800) 621-4109; in Illinois, (312) 470-0700. Circle 625 on inquiry card.

By a Factor of Two

Two encryption systems based on the National Bureau of Standards Data Encryption Standard have been developed by Prime Factors.

U-Psypher is a file-oriented, interactive program for full-file encryption on computers that run CP/M, MP/M, and MS-DOS. Descrypt/MS is a DES assembler source code for 8080, 8085, Zilog Z80, 8086, and 8088 microprocessors. Both encryptors can be integrated into real-time systems. Implementations, module sizes, and throughput requirements are user-specifiable. U-Psypher costs \$99; Descrypt/MS with source code DES is \$1500. Contact Prime Factors, 6529 Telegraph Ave., Oakland, CA 94609, (415) 654-5090.

Circle 624 on inquiry card.

Lobo Chats to the Max

Compu-Talk, an assembly-language program, turns the Lobo Max-80 computer into a talking computer. With Compu-Talk, the Lobo can interactively communicate with Votrax's Type'N'Talk or Personal Speech System. This program provides spelled speech, identification of uppercase and lowercase characters, key-stroke echo, and audible feed of program control keys. The voice can be switched on or off at any time, and it can be set to spell out acronyms. It speaks and reads the line

and column number on which the cursor is located, provides page and line review, and vocalizes special characters.

Compu-Talk requires one 5¼-inch disk drive, Type'N'Talk, a connector cable, and the LDOS operating system. A version is available for Radio Shack TRS-80 Models I, II, III, IV, 12, and 16. Compu-Talk costs \$129.95. A complete package containing the program, interface cable, and Type'N'Talk is available for \$429.85. The documentation alone is \$20. Contact Compu-Talk Systems, POB 28355, Columbus, OH 43228, (614) 279-8271.

Circle 632 on inquiry card.

Drafting Training Program

A computer-aided drafting program for training high school and college students, GRID can produce, store, retrieve, and edit two- and three-dimensional drawings. Entirely menu-driven, GRID (Graphics Instruction Device) runs on Hewlett-Packard HP-85, -86, and -87 desktop computers.

Features of the program include single-keystroke commands, English-language instructions, and the ability to plot drawings on the video display and three-dimensional data in either orthographic, isometric, or cabinet views. A graphics editor lets students see results of an editing command as it's entered, and GRID's single-step

mode lets you watch a drawing develop one line at a time. It has the ability to step backward through your drawing command, erasing lines as it goes. Drawing commands include points, arc, circle, polygon, and step/repeat.

With a digitizer module, GRID costs \$495, including manual. It's available in 3½- and 5¼-inch floppy-disk formats. Contact Responsive Logic, 156 Donald St., Oregon City, OR 97045, (503) 655-4980.

Circle 622 on inquiry card.

Burroughs Emulation for Personal Computers

Intercomputer Communications Corporation's Intercom 100 software allows such personal computers as Corona, Columbia, Eagle, Compaq, and IBM to emulate a Burroughs MT983/TD830 online terminal. It simultaneously supports up to five addresses: four for concurrent operator dialogues and bidirectional file transfers and one for background printing. This program offers a plain-English configuration and menus that are clear enough for nontechnical users.

Intercom 100 comes on a 5¼-inch floppy disk. Each copy costs \$99. For further information, contact Intercomputer Communications Corp., Suite 2A, 3195 Linwood Ave., Cincinnati, OH 45208, (513) 321-3199.

Circle 634 on inquiry card.

What's New?

Visicalc IV Features Graphics, Data Management, and User-Defined Commands

Visicorp has announced the availability of Visicalc IV for the IBM PC and XT. This program integrates all the features of standard Visicalc and extends them with graphics, sorting, spreadsheet management, and a capability for user-defined commands, known as Keysaver. Visicalc IV's new graphics commands let you convert spreadsheet data into a graphical format instantly. "What-if" analyses can be created with a single keystroke that calls up one or more of the eight integral graphics options. Complex or special graphs can be stored on disk and later quickly retrieved with a single keystroke. Graphs can be printed in standard or large size, normal or reverse image, and normal or sideways. Available graphs include area, bar, dot, pie, scatter, line, and such sophisticated graphs as high, low, closed, and stacked and comparative bar. Both monochrome and color graphics are supported.

Visicalc IV's high-speed sorting and rearranging capabilities treat your spreadsheets as if they were a database. This allows you to generate ad hoc reports as well as standard financial models. Sorting can be performed on rows or subsets of rows; columns can be rearranged with a few keystrokes.

The Keysaver feature lets you store a series of Visicalc commands and operations under any key, including function keys. A

single file can accommodate as many as 66 user commands. Defining a keystroke sequence is said to be a simple operation because the software continually tracks the last 75 characters typed. At any time, you can recall these keystrokes, define them as a command, and assign them to a function key, or you can modify the sequence if desired.

Visicalc IV is available from Visicorp dealers nationwide. The suggested retail price is \$250. Visicorp is headquartered at 2895 Zanker Rd., San Jose, CA 95134, (408) 946-9000. Circle 638 on inquiry card.

Technical Analysis Tools Bundled In Single Program

A number of analysis tools are packed into the Technical Investor from Savant Corporation. This program contains three types of moving averages, five different volume indicators, regressions, point and figure charts, speed resistance lines, relative strength plots, and oscillator functions. Automatic routines let you define the charts you want. Up to four chart windows can be displayed simultaneously, and each window is independently controllable. If your IBM PC or Compaq computer is equipped with a smart modem, communications with either the Dow Jones News/Retrieval or the Warner Computer

Systems database can be achieved with a press of a button. You can also mix the types and amounts of data in disk storage.

The Technical Investor requires 128K bytes of memory, dual double-sided double-density disk drives, and a color graphics card. A dot-graphics printer and a modem are strongly recommended. The list price is \$395, which includes a manual with instructions for novices and details for experienced users. Complete information is available from Savant Corp., POB 440278, Houston, TX 77244, (800) 231-9900; in Texas, (713) 556-8363. Circle 627 on inquiry card.

Teacher Authoring System Is Easy to Use

TAS, Teacher Authoring System, is a menu-driven program that's designed to adapt to any classroom curriculum. Running on the Radio Shack TRS-80 Models III and IV, TAS combines an authoring program with presentation, student records, and file-maintenance programs so that even teachers without programming experience can use it to create computerized lessons. With this program, teachers can write up to 10 pages of text and design graphics to highlight material, store pages temporarily for later recall, add up to 50 questions to reference any one of five review pages, print master lists of questions and answers, and adjust a lesson's format for each student.

This two-module system

comes with an instructor disk (with backup) for the development and maintenance of lessons and student records and a student disk with the presentation program and a sample lesson. The user manual contains a tutorial section that describes the lesson development process and a reference section. It requires 48K bytes of memory and a disk drive. The retail price is \$149.95. Complete information is available from Teach Yourself By Computer Software, 2128 West Jefferson Rd., Pittsford, NY 14534, (716) 424-5453. Circle 630 on inquiry card.

Magicbind Upgrades Word Processors

Magicbind is a file-merging program with advanced features for users of Wordstar, Magic Wand, and other CP/M-based text editors that generate ASCII files. At any time with Magicbind, you can insert data items into the main body of a document, merge two or more files into a single document, select records based on special classification codes, verify data-file accuracy by examining the number of fields in each record and the number of digits in a field, print mailing labels, and automatically number chapters, paragraphs, articles, and listed items. Magicbind maintains separate page- and record-number counters, which facilitates selective printing of multipage documents. In addition, it provides more

What's New?

than 60 print-formatting capabilities, including bold-face, underline, superscript, subscript, accenting, automatic footnoting, and proportional, nonproportional, justified, and nonjustified printing.

Magicbind requires 48K bytes of RAM and a Diablo 630/1650-compatible printer or a NEC Spinwriter. It costs \$250. The print-formatting program, called Magicprint, can be purchased separately for \$195. For full details, contact Computer Editype Systems, 509 Cathedral Parkway 10A, New York, NY 10025, (212) 222-8148. Circle 670 on inquiry card.

Business Package for Model 100

Businesspak+, a set of six cassette-based business programs for the Radio Shack Model 100, has been introduced by the Portable Computer Support Group. The complete package, including manual, costs \$89.95.

For word processing, Write+ lets you set margins, right-justify type, and print multiple copies. It has more than 36 features, and it supports both serial and parallel printers. A planning tool and minispreadsheet, Exps+ provides 18 columns with up to 18 entries each. This spreadsheet can give you totals for each day and category. Names of rows and columns can be changed, and replication across columns, cumulative totals, and automatic growth or



decline rate projection are offered. All its mathematics functions are built in.

For printing out bar, line, and pie graphs of any Exps+ report, there's Graph+. This program shows the percents on pie charts and the values on other charts, and it works with the DMP-100 and other dot-matrix printers. Put+ lets you list information in an organized manner. It features prompts and

the ability to rapidly create addresses or schedule items. Sort+ lets you alphabetically or numerically sort any list compiled with Put+. Telex+ allows you to send mailgram messages over telephone lines.

For full details, contact Portable Computer Support Group, 11035 Harry Hines Blvd., #207, Dallas, TX 75229, (212) 351-0564. Circle 631 on inquiry card.

Word Processor for Eagles

Muse Word Processing from Marc Software International, which offers an advanced scientific typing feature with 13 levels of super/subscripts, is available for the Eagle PC and 1600 Series computers. Special character sets are supported on the Eagle so that Greek and mathe-

matics characters can be displayed on the video screen. This package provides the processing required to coordinate the key that is struck on the keyboard with the on-screen character and with the character that is printed. Standard features include a spelling checker,

mailing-list processor, abbreviation glossary, column functions, automatic hyphenation, and advanced document-selection capability. Muse offers a recovery system that saves a document when your computer crashes and an encryption feature that provides password security.

The Muse Word Processor runs on 256K-byte Eagles supporting a hard disk and DOS 1.1 or 2.0. The single-copy price is \$595; multiple discounts are offered. The manufacturer provides full technical support and general information by means of a hot-line service. Contact Marc Software International Inc., Suite 200, 260 Sheridan Ave., Palo Alto, CA 94306, (415) 326-1971.

Circle 629 on inquiry card.

Music Learning System

Simply Music is a product for learning music on the Alphasyntauri Computer Music System. This software is designed to enhance the way music is heard, played, and learned. It offers three displays that show live keyboard playing and pre-recorded pieces in action: Grand Staff, Keyboard Picture, and Color Bar/Octave. Grand Staff displays bass and treble notes on-screen and, as you play the keyboard, notes and chords are shown on the staff. With Keyboard Picture, the keyboard is depicted in a top-down view on your monitor with each

What's New?

key labeled with its letter name. Individual notes are assigned a color and a position on your screen and each octave has its own row with the Color Bar/Octave display. As notes are played, the color bars light up, showing their relative position within the octave. Song parts can be switched off, lowered in volume, or revoiced for different instruments. Other features include key transposition and speed control.

Simply Music is available for both four- and five-octave Alphasyntauri Music Systems. It costs \$199. Complementary courseware packages are offered. A complete Simply Music courseware package, including a four-octave synthesizer, costs \$1495. For more details, contact Syntauri Corp., Suite 112, 4962 El Camino Real, Los Altos, CA 94022, (415) 966-1273.

Circle 637 on inquiry card.

control panel, operating much like a joystick, provides control over the image. With the control panel, users can access material at speeds of up to 600 words per minute.

The Model DP-10 works with the Apple II, II Plus, and IIe. The base price is

\$2495. A similar unit for the IBM PC will be announced during the first quarter of 1984. Full details are available from Visualtek Inc., 1610 26th St., Santa Monica, CA 90404, (213) 829-6841.

Circle 651 on inquiry card.

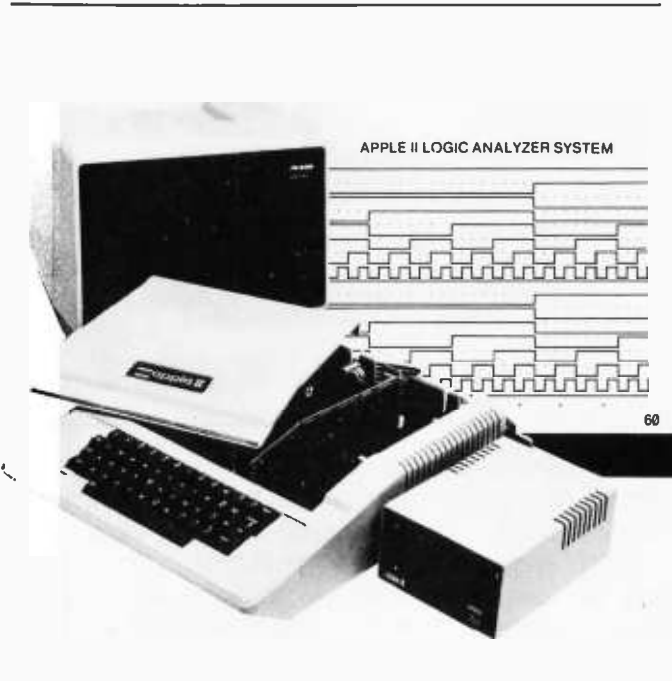

System Converts Apple II into Logic Analyzer

Total Logic Corporation has announced the availability of a hardware and software system that converts the Apple II into a sophisticated logic analyzer. The LA-100 offers such capabilities as a 16-bit-wide data path, 1024-word memory, qualified clock inputs, a 16-bit trigger word that allows data collection to begin or end on the trigger with or without a programmable delay, and the ability to display data either as bits or as a timing-like graphics display. The LA-100 also lets you use your Apple's disk subsystem for both storing and

recalling data and instrument setups.

The LA-100 system is made up of a plug-in card, connector cable, and software. It costs \$795, including a comprehensive users manual. It can be ordered factory-direct from Total Logic Corp., Suite 110, 343 West Drake, Fort Collins, CO 80526, (303) 226-5980.

Circle 649 on inquiry card.

Triple Apple Execution Speed

Titan Technologies' Accelerator II is said to more

than triple the execution speed of virtually all Apple II and II Plus programs. When attached to any Apple slot, this 6502-based card creates parallel operations: the Apple's main board handles video output while the Accelerator II duplicates the Apple's 48K bytes of memory. In addition, this card supplies the Apple with a built-in language card.

The Accelerator II is hardware compatible with most standard Apple peripherals. All peripherals, however, are not able to run at faster speeds (e.g., disk drives and modems). To compensate for this, switches are provided to decrease the speed for individual devices. The Accelerator II has a suggested retail price of \$599. For more information, contact Titan Technologies, 310 West Ann St., Ann Arbor, MI 48104, (313) 662-8542. Circle 640 on inquiry card.

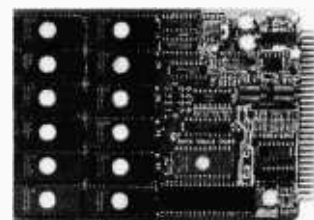

36 Seconds of Preprogrammed Speech

Voice-Alive can be pre-programmed for up to 36 seconds of speech. This speech-synthesizer board is said to provide tape-recorder-quality speech, complete with inflections and emotions. A self-contained unit, Voice-Alive comes with a

PERIPHERALS

Device Enlarges Displays for Visually Impaired

The Model DP-10 from Visualtek is a plug-in device that aids the visually impaired by automatically enlarging the characters displayed on Apple monitors. This device magnifies characters from 2 to 16 times their original size without operator intervention or special programming. Since the DP-10 enlarges characters up to 5 inches high, only a portion of the original display can be seen at one time. To fix this, a user

What's New?

1-watt audio amplifier and up to 12 ROMs for vocabulary. Standard features include programmed time delays of up to one hour, a 56-pin edge connector, and eight inputs for initiating separate messages or words. Inputs can be activated by TTL signals or by shorting them through ground contacts. Lookup tables for each input activate single or multiple messages, repeat a single message, or activate multiple messages interspersed with pauses. Voice-Alive can be activated by microprocessor signals or by simple switch closures. It measures 4½ by 6½ inches.

A single Voice-Alive costs between \$350 and \$750, depending on memory requirements. For orders of one to five units, a vocabulary set-up charge of \$250 is applied. Custom vocabularies, such as a foreign language, are available. For particulars, contact Datavoice Corp., Suite 1900, 2 North LaSalle St., Chicago, IL 60602, (312) 327-8488.

Circle 643 on inquiry card.

Module Accepts 32K of Static Memory

The processor-independent 5006A STD bus memory module can accommodate up to 32K bytes of static memory. This module will accept 6116-type RAMs, type 2716 EPROMs, MOS ROMs, and 5-volt pin-compatible EEPROMs. Different types of static memories can be intermixed without

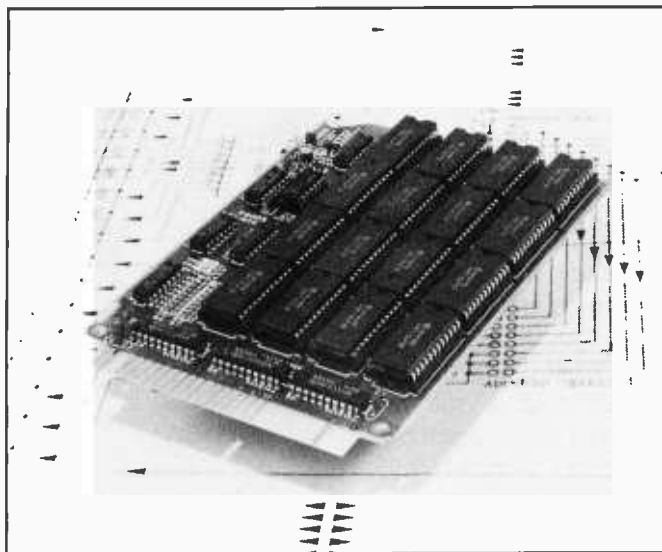

module reconfiguration, and unused sockets are automatically disabled. With 6116 series RAMs, access times of 100, 120, and 150 ns are possible. A single 5-volt power supply is required.

The 5006A memory

module is available in populated and depopulated versions for \$250 and \$99, respectively. Contact STD Microsystems, 399 Sherman Ave., Palo Alto, CA 94306, (415) 327-6800.

Circle 650 on inquiry card.

Analog I/O Board Commodore Compatible

The Model 24/8 Analog I/O board expands Commodore VIC-20s and 64s with eight channels of A/D and eight channels of D/A. The A/D converter is 12 bits wide, and its fast acquisition time (100 μ s) makes it suitable for data acquisition. The Model 24/8's on-board RAM permits high sample rates and block moves of data to the host computer. The 8-bit D/A channels are suitable for most control applications.

The Model 24/8 can serve as a stand-alone controller or its control loop can be closed with the Commodore for user supervision and interaction. Its sample rate, chan-

nel selection, and operating modes are under your control through supplied software.

The Model 24/8 costs approximately \$295. Kits may be available during the first quarter of 1984. For full specifications, write to Applied Electronics Consultants, POB 349, Clemson, SC 29633.

Circle 648 on inquiry card.

Finger Print Your Printers

Finger Print lets users of IBM PC and Epson printers select a variety of print functions by merely tapping the printer's panel

buttons, eliminating the need for special control characters. Among its 10 special print functions are perforation skip-over, left margin indent, buffer clear, and compressed, double-wide, and emphasized characters. No soldering is required.

Finger Print is supplied with operating instructions and control panel reference labels. It costs \$59.95. Contact Dresselhaus Computer Products, 837 East Alosta Ave., Glendora, CA 91740, (213) 914-5831.

Circle 644 on inquiry card.



Communications Manager Is Z80 Computer

Babytalk is an intelligent communications-management interface for the IBM PC and Texas Instruments Professional Computer. Babytalk, produced by Microlog, is a self-contained Z80-based micro-

What's New?

computer that provides a terminal emulator, a smart modem, a print spooler, 64K bytes of dynamic RAM, CP/M-80 compatibility, and automatic time/date. It emulates such protocols as 3270 bisync and 3270 SNA, and 3780 batch/bisync as well as a variety of asynchronous terminals, including DEC VT-100 and IBM 3101. Its on-board modem offers 300-, 600-, and 1200-bps operation and auto-dial and auto-answer. This direct-connect modem supports Bell 103/202 and CCITT V.21/V.23 protocols. For print spooling, Babytalk has both serial and parallel ports. Other features include a utility that lets you define function keys with multistroke sequences up to 80 characters long.

Babytalk costs \$895. For more information, contact Microlog Inc., 222 Route 59, Suffern, NY 10901, (914) 368-0353.

Circle 642 on inquiry card.



Colorful Speech Introduced

Spectrum Projects has introduced a low-cost voice-synthesizer for the Radio Shack TRS-80 Color Computer. Built around the Votrax SC01 phoneme synthesizer, the Voice Pak

has an unlimited vocabulary, automatic inflection, four programmable pitch levels, and the ability to produce a full sentence from a single line of BASIC. It's equipped with a voice editor that can create an unlimited number of words and sound effects.

The Voice Pak ROMpak is supplied with a users manual and a software cassette. Fully assembled and tested, it costs \$69.95, plus \$3 per order for shipping and handling. Voice Pak is available directly from Spectrum Projects, 93-15 86th Dr., Woodhaven, NY 11421, (212) 441-2807.

Circle 641 on inquiry card.

PUBLICATIONS

Round Table's Gathering

Computer Business is a monthly publication containing abstracts of articles published in business, financial, and computing magazines. Produced by Round Table Associates, the contents explore what's new and significant in computer and communications publications. Topics are arranged under the categories of mainframes, mini- and microcomputers, software, peripherals, data communications, office automation, consumers, electronics, and more. Back issues are \$15. Contact Round Table Associates, POB 45923, Los Angeles, CA 90045, (213) 649-2846.

Circle 659 on inquiry card.

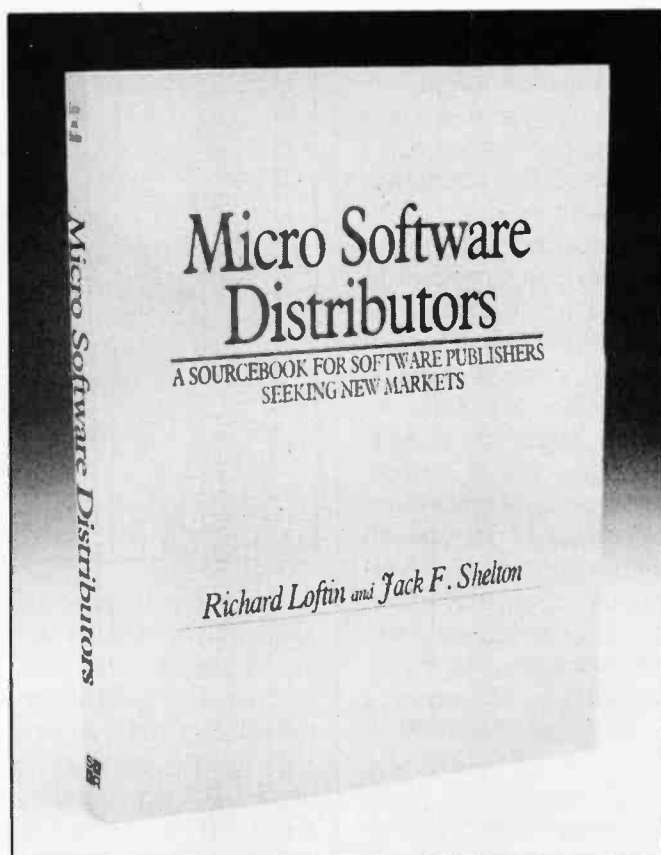

Directory Focuses on Distributors of Microcomputer Software

A directory that focuses on the microcomputer-software middleman, *Micro Software Distributors: A Sourcebook for Publishers Seeking New Markets*, contains profiles of more than 150 companies that purchase or license software for quantity resale. Each company is described in terms of the software it seeks, what it pays, the marketing rights it obtains, to whom it sells, and the support it provides. Explanations about submitting proposals are included. The directory, which costs \$95, covers hardware and software manufacturers, book publishers, retailers, and other organizations seeking programs for resale. Contact

Software Research Co., POB 9524, Drawer C, Washington, DC 20016, (202) 364-8700.

Circle 654 on inquiry card.

By and for Lisa Users

Signal is a free newsletter produced by the Semaphore Corporation for users of Apple's Lisa. Its entire format is created using only the Lisa. Subscriptions are free to users who submit the serial numbers of their Lisas. Other readers can subscribe to Signal for \$10 for 10 issues; \$20 outside of North America. Contact Signal, 207 Granada Dr., Aptos, CA 95003.

Circle 656 on inquiry card.

What's New?

Japan's News from Satellite

Satellite Systems Engineering of Bethesda, Maryland, produces a bi-weekly newsletter that is a source of news and information about telecommunications in Japan. It covers such subjects as technological advances, new products, joint ventures, computers, legislative and administrative actions, and people. The Japan Telecommunications News costs \$325 annually. If you subscribe before 1984, you'll receive a discount. Contact Satellite Systems Engineering Inc., Japan Telecommunications News, Suite 520E, 7315 Wisconsin Ave., Bethesda, MD 20814. Circle 655 on inquiry card.

Vector Electronic Offers Catalog

Almost 1000 electronic packaging, breadboarding, and prototyping items are described in Vector Electronic Company's 68-page catalog. One-third of the catalog covers micro-computer prototyping boards for the VME, S-100, Multi-, and STD-bus systems. Other systems include the IBM PC, Exorcisor, Apple II, DEC, and TI 980. Another section of the catalog covers a large variety of card racks and cases with a cross-index between card size and case-model number. Contact Vector Electronic Co., 12460 Gladstone Ave., Sylmar, CA 91342, (213) 365-9661. Circle 658 on inquiry card.



For Apple Software In Education

A directory about current educational software programs produced for the Apple II is organized by subject, contains a master index, and provides a publisher-information section. The 1983-84 Swift's Educational Software Directory—Apple II Edition reflects this year's increase in software listings with an enhanced format for entries. The price is \$18.95. Contact Sterling Swift Publishing Co., 7901 South IH-35, Austin, TX 78744, (512) 282-6840. Circle 662 on inquiry card.

Free Telex Book

Telex Communications from Your Personal Computer, Word Processor, or Terminal, a 20-page free booklet from RCA Communications Inc., describes how to register for the Telex service, the telephone interface and signaling protocol required, how to send a Telex message in real time or store and forward, and

how to receive incoming Telex messages through real time or an RCA Data-bank. It includes sample formats as well. For de-

tails, contact RCA Communications Inc., 60 Broad St., New York, NY 10004, (212) 806-7736. Circle 663 on inquiry card.

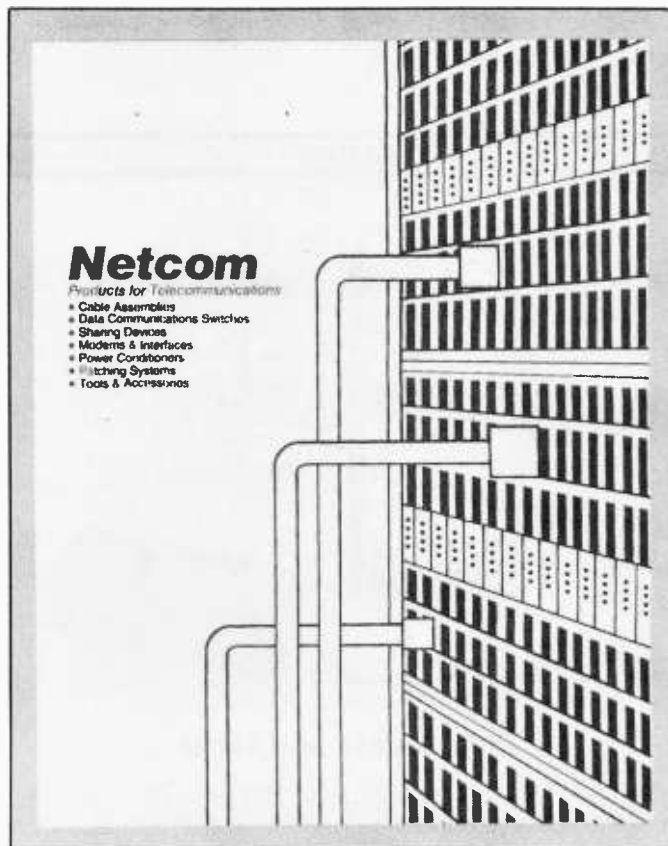

Products for Telecommunications

A free 12-page catalog is available from Netcom, manufacturers of telecommunications equipment and accessories. The catalog includes information on cable assemblies, data-communications switches, sharing devices, modems and interfaces, power conditioners, patching systems, and other tools needed in telecommunications. The company's product line includes a full range of AC power-line conditioning equipment,

filters, and voltage regulators, and services such as system design, installation, and testing. For a catalog, contact Netcom, 79 Hazel St., Glen Cove, NY 11542, (516) 671-8811. Circle 653 on inquiry card.

For Your 64

What's? for the 64 is a resource guide of new products for the Commodore 64 computer. Over

What's New?

100 pages include information about programs, software, peripherals, interfaces, book titles, magazines, and user groups that cater to the Commodore 64. It includes a directory of sources that focus on operating needs encountered by owners. The

book includes a magazine-article bibliography of literature and written programs. The guide sells for \$15. Contact What's? for the 64, 3494 Chickasaw Circle, Lake Worth, FL 33463.

Circle 661 on inquiry card.

CHIPS

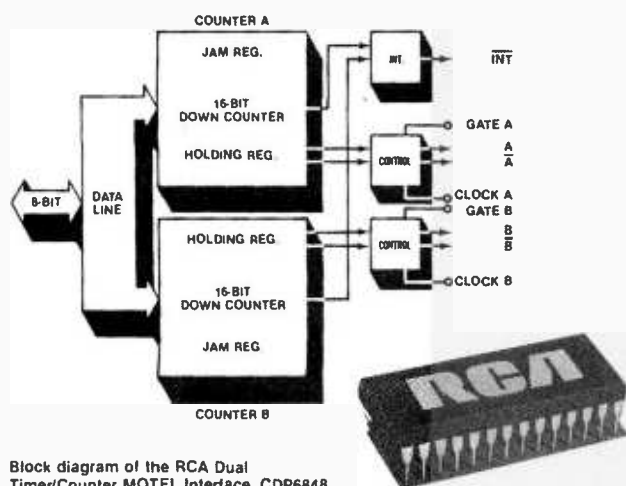

Block diagram of the RCA Dual Timer/Counter MOTEL Interface, CDP6848.

Chip Counts and Times

A CMOS dual counter/timer chip is compatible with general-purpose and multiplexed address and data buses of popular microprocessors. The CDP6848 is a CMOS peripheral device capable of operating on the Motorola-Intel (MOTEL) microprocessor bus in five modes. The chip accepts separate read and write signals or a common read/write signal with a data strobe. Counters and registers can be addressed in memory directly by such microprocessors as RCA CMOS CDP6805, 8048, 8049, 8051, and NSC 800. Contact RCA/Solid State Division, POB 3200,

Somerville, NJ 08876, (800) 526-2177; in New Jersey, (201) 685-6423. Circle 667 on inquiry card.

4-bit Smart LCD Driver/Controller

A CMOS 4-bit, single-chip LCD controller/driver called the μ PD7514 can drive either three or four backplanes in triplexed or quadruplexed modes or two backplanes in biplexed mode. It offers low power consumption and operates from a single +5-V power supply. Other features include four vectored interrupts (two internal and two ex-

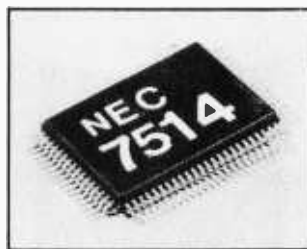

ternal) and two standby modes. Its instruction set consists of 97 instructions. The μ PD7514 is available in an 80-pin flat-pack configuration. It costs \$8.95 for large-quantity orders and is available from NEC Electronics USA Inc., One Natick Executive Park, Natick, MA 01760, (617) 655-8833.

Circle 668 on inquiry card.

Low-Power Quad Comparator

The LP339 consists of four independent voltage comparators in a single chip designed to draw only 60 microamperes of total current. Each comparator operates over a common-mode voltage range. The LP339 is designed to interface with the CMOS logic family. It includes sensing at ground potential, a pin-out identical to the LM339, and high-output sink-current capability. It is protected against reverse voltages and will operate from single- or split-power supplies. Characteristics include a low-input biasing current and a low-input offset voltage. The cost per unit is 72 cents in quantities of 100 or more. Contact National Semiconductor Corp., 2900 Semiconductor Dr., MS

1925, Santa Clara, CA 95051, (408) 721-5856.

Circle 666 on inquiry card.

RMS-to-DC Converter

The AD637 is a root-mean-square to DC converter that offers accuracy and wide bandwidth with 0.02 percent nonlinearity. Operating from DC to 8MHz with a maximum of ± 0.5 mV fixed offset and ± 0.2 percent of reading total unadjusted error, a single external capacitor sets low-corner frequency and determines low-frequency accuracy, ripple level, response speed, and settling time. The AD637 computes the true root-mean-square value of complex AC waveforms and operates with ± 3 -V to ± 18 -V supplies. An on-chip buffer amplifier provides typical 5-V/ μ s slew rate, maximum ± 2 mV input offset, and maximum 5nA bias current. It is packaged in a 14-pin ceramic package. In quantities of 100 or more, the AD637 is priced from \$13. Contact Analog Devices, Rt. 1, POB 280, Norwood, MA 02062.

Circle 664 on inquiry card.

Write Controller/Head Driver

A tunnel-erase floppy-disk controller with erase delays, the MC3471P from Motorola is a write controller/head driver integrated circuit designed to provide the entire interface between the write-data and head-control signals

What's New?

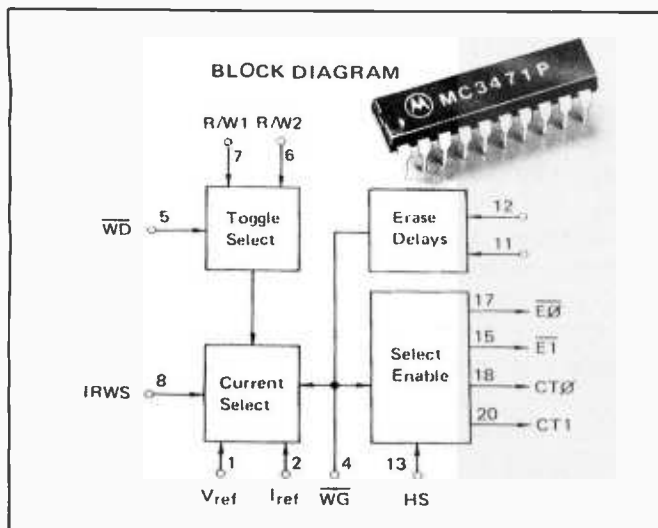

and the heads (write and erase) for either tunnel- or straddle-erase floppy-disk systems. It combines all write functions formerly accomplished using separate building blocks or discrete transistors.

Means for selecting a range of write currents and for head selection during both read and write operations are provided.

Provision is also made for adjusting degauss period, inner-outer track compensation, and the delay from write gate to erase turn-on and turn-off. In quantities of 100 or more, the MC3471P is \$4.25. Contact Motorola Semiconductor Products Inc., POB 20912, Phoenix, AZ 85036, (602) 897-3826.

Circle 665 on inquiry card.



text out sideways in blocks of 18 lines.

Optionally, Transam offers a parallel interface and a battery-powered acoustic coupler for the HX-20. The interface lets you connect the HX-20 to an external parallel printer and print data when the serial port is taken up with an acoustic coupler or cable.

ITE+ costs \$50, plus VAT (value-added tax). The parallel interface is \$85, plus VAT. Contact Transam Microsystems Ltd., 59/61 Theobald's Rd., London WC1X 8SF, England; tel: 01-405 5240/2113; Telex: 24224 (Ref. 1422).

Circle 675 on inquiry card.

FOREIGN

80 Columns for the HX-20

An intelligent terminal emulator with an 80-column printout capability, ITE+ has been developed by Transam for installation into the main body of the HX-20 or the expansion unit. The machine-code program in ROM allows the HX-20 to be linked to a larger computer and to act as a device for entering and receiving data. This communications link may be made via cable or telephone line.

ITE+ can be used for

editing text to be transmitted or for reviewing messages already received. Text, once prepared, can be saved to a file, transmitted, or printed. The editor uses the HX-20's virtual screen and scrolls left and right for a full line length. For viewing and correcting data, you can display a single line of text by using 4 lines of 20 columns for a total of 80 lines of displayed text. ITE+ has the ability to print a full 80-column line. It does this by printing the

Three New Cards

Three add-on cards from Rade Systems Ltd. plug into the company's Z80-based single-board computers. The first card, featuring a 10-MHz 8086 processor card, has 128K bytes of on-board memory, expandable to 1 megabyte, which can be added to an optional 8087 coprocessor. The second card is a 512 by 512 graphics card with a high-speed plot rate to a maximum of 1.5 million pixels per second, in either 8 colors plus cursor or a 16-gray scale. The third card, soon to be available, is a 10-MHz 16032 processor card with 128K bytes of

on-board expandable memory in 256K-byte increments. Both the 16082 memory-management chip and the 16081 floating-point processor are available on-board as optional devices. Contact Rade Systems Ltd., 290a High Rd., Willesden, NW10 2EU England; tel: 01-451 4414/5/6.

Circle 674 on inquiry card.

Five Versions of the Big Buffer

The Big Buffer hardware spooler for parallel printers increases system speed. Its I/O ports are Centronics-

What's New?

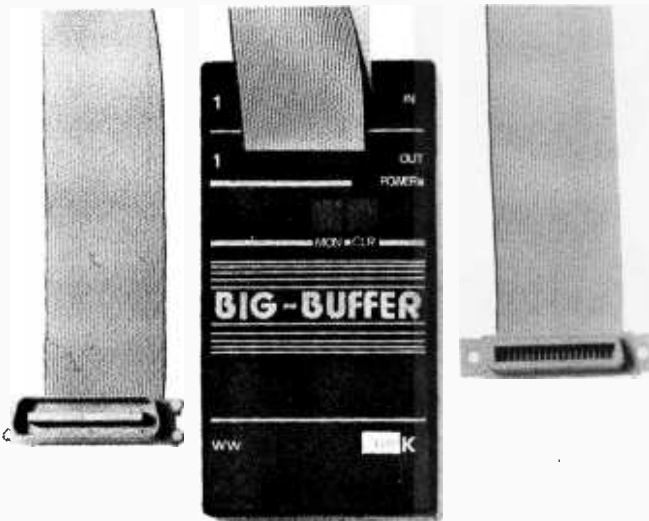

compatible. Five versions with memory capacities ranging from 8K to 120K bytes are available. The spooler features a reset key that clears the buffer contents and a monitor mode in which each character sent from the computer is printed in hexadecimal and ASCII codes, making it possible to inspect all codes that are sent from the computer to the

printer. An optional 110-V AC, 60-Hz power supply costs \$30. Prices range in U.S. funds from \$170 for the 8K-byte version to \$363 for the 120K-byte version. Dealer inquiries are welcome. Contact Mikrocomputertechnik, Winchenbachstr. 3a, POB 201 605, D-5600 Wuppertal 2, West Germany; tel: 0202/510444. Circle 673 on inquiry card.



Apples for All

Technical Aids & Systems for the Handicapped (TASH) has developed a Mod Keyboard System that allows disabled per-

sons to operate an Apple II Plus with standard software. Words, phrases, and standard characters are displayed on the key-

board. Up to 14 displays of time-saving words, phrases, and commands are displayed by the keyboard; additional displays, words, and phrases can be customized. Users can create and edit text or messages up to 500 characters long. Color and audio are available together; black-and-white disables audio feedback. The Mod Keyboard System includes a Commodore VIC-20, a direct-scan cartridge, monitor, ability switch, and user manual. Although it contains a VIC, the system can be used with an Apple II Plus and multiplex circuit board and a compatible printer. Prices vary depending on features. For details, contact TASH Inc., c/o Sunnybrook Medical Centre, 2075 Bayview Ave., Toronto, Ontario M4N 3M5, Canada, (416) 486-3569. Circle 669 on inquiry card.

Magnum Portable Features Pop-up Display

The Dulmont Magnum portable computer features a pop-up, eight-line by 80-character LCD. Standard hardware includes the 16-bit Intel 80186 microprocessor, 128K bytes of ROM, two serial ports, one parallel port, a real-time clock, and a bus expansion socket. The Magnum can be equipped with up to 256K bytes of battery-backed CMOS RAM and an additional 128K bytes of ROM. It has a full-size

QWERTY keyboard with user-definable function keys and a power-save circuit that shuts down the central processor when it's been idle. A word processor, a spreadsheet, a planner/diary, and BASIC-86 are supplied in ROM. The operating system is MS-DOS. Its approximate size is 12 by 11 by 2 inches (305 by 280 by 51 mm). It weighs about 8 pounds (3.5 kg).

The Dulmont Magnum costs less than \$2500 [Australian dollars]. For full information, contact Dulmont Electronic Systems, POB 1668, Hornsby Northgate, New South Wales 2077, Australia; tel: (02) 477 6444; Telex: AA74936 DULMON.

Circle 672 on inquiry card.

Bubble Memories Have Password Security

Ecosea Technologies has unveiled a line of magnetic bubble-memory cards for the IBM PC and PC XT. Two versions are available: the PDIB128, which provides 128K bytes of non-volatile storage, and the PDIB384, a 384K-byte card. Either card resides in a single IBM slot, using only two I/O lines. Hardware-based password security is a key feature of these non-volatile memories. Once you create a password, you can use it to lock up the computer, the bubble memory, or both. No method of bypassing or illegally reading the password is said to exist.

What's New?

Ecosea's bubble memories operate as a standard DOS 2.0-type device. They are compatible with all DOS software and do not require any patching of system files. DMA and interrupts are supported but not required. Comprehensive diagnostic software, utilities, and installation and operator manuals are

provided. The PDIB128 and the PDIB384 cost \$995 and \$1995 (Canadian funds), respectively. For more information, contact Ecosea Technologies Corp., Unit 13, 465 King St. E, Toronto, Ontario M5A 1L5, Canada, (416) 366-1000.

Circle 671 on inquiry card.

levels of difficulty are offered: Neophyte, Moderate, and Idiot Savant. A unique feature of Bombs Over Manhattan is its Someone's Coming mode, which is a tiny word processor that can be accessed during any point in the game. The word processor lets you write, edit, print, and store documents up to 66 lines long.

Bombs Over Manhattan runs on 64K-byte IBM Personal Computers with PC-DOS, a color graphics card, and a double-sided double-density 320K-byte floppy-disk drive. A joystick is optional. The suggested retail price is \$29.95. Dealer inquiries are welcome. For more information, contact Tamalpais Software, POB 02338, Portland, OR 97202, (503) 232-0021.

Circle 689 on inquiry card.

bytes of memory and the Extended BASIC module. It's available on cassette or floppy disk for \$19.95 from the Extended Software Co., 11987 Cedar Creek Dr., Cincinnati, OH 45240, (513) 825-6645.

Circle 688 on inquiry card.

GAMES

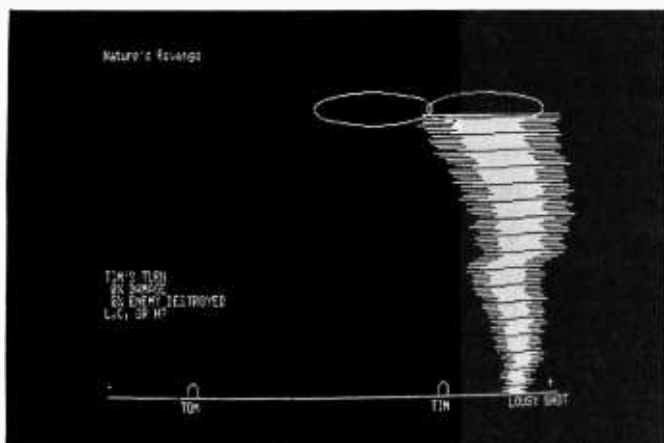

Trio of Games for Televidéos

Fun & Games Software markets a three-pack of games for Televideo 803 and Teletote computer users. The three high-resolution graphics games are Nature's Revenge, Cannon Shoot, and Lunar Module. Each features animated displays depicting the actions

and movements for all phases of the game.

The 803 Games-Pak costs \$46.50. It can be ordered directly from Fun & Games Software, 3333 East Redlands, Fresno, CA 93726, (209) 226-1918.

Circle 683 on inquiry card.

Here's One for Woody Allen

Bombs Over Manhattan is a strategic defense game from Tamalpais Software. The object of the game is to defend your city from enemy attack and accrue enough points to allow peace talks to begin. When peace is achieved, you can reconstruct damaged por-

tions of your city and move on to the next level of play. Points are scored by intercepting bombs and missiles. If you lose, your city is consumed to the refrain of "We'll Meet Again." Your city can be one of nine major American cities or one of your own design. Three

Devilish Game for TI-99/4A

Diablo, designed for the TI-99/4A computer, consists of two tracks on each of 116 movable panels for a total of 232 tracks. Players must arrange the twisted tracks to keep a moving ball on a continuous path. Each section of track is removed from play after it has been negotiated. Diablo becomes increasingly difficult as less and less track is available to support the advancing ball. This graphics game can be operated by joysticks or through keyboard control. Sound effects add to the fun.

Diablo requires 16K

Three-dimensional Game for Apple

Cubit, an arcade-type game for Apple computers, uses a three-dimensional pyramid made up of cubes as its playing field. The object is to change the color of all the cubes by hopping from one to another. You must avoid bouncing balls, snakes, and gremlins. Your safety rests upon a set of transport disks and a magic star.

Cubit features four levels of difficulty, each of which is divided into four rounds of play. It's playable with either a joystick or keyboard on 48K-byte Apples running DOS 3.3. The suggested retail price is \$39.95. Dealer and distributor inquiries are invited. Cubit is produced by Micromax Systems Inc., 6868 Nancy Ridge Dr., San Diego, CA 92121, (619) 457-3131.

Circle 682 on inquiry card.

Computerized Coloring Book Has 25 Hi-Res Pictures

Versa Computing's Color Me is a computerized coloring book suitable for children ages 3 to 12. It's composed of 25 high-resolution pictures of varying degrees of difficulty. Each

What's New?

Color Me picture is sprinkled with objects and animals familiar to children and has a large, uppercase title to help reinforce word and subject recognition. Children use paddles or joysticks to choose colors from the more than 30 available and to select program options. Color Me pictures can be used over and over again.

Color Me comes on floppy disk for Apple II Plus/IIe and IBM Personal Computers and on cassette for the Radio Shack TRS-80 Color Computer. The retail price is \$29.95. Contact Versa Computing Inc., Suite 104, 3541 Old Conejo Rd., Newbury Park, CA 91320, (805) 498-1956.

Circle 684 on inquiry card.

MISCELLANEOUS

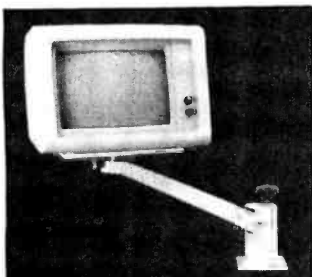

Adjustable Arm Lifts Monitors Up and Away

Lintek's Monitor Mover is an adjustable mechanical arm that holds most computer displays up and off your desk. This system is made of a heavy-duty desk clamp, a 360-degree swivel base, a 15-inch vertically adjustable arm, and a CRT mounting tray. The tray swivels and can be tilted up to 15 degrees. Each Monitor Mover features

steel construction and an off-white urethane finish.

Optional extended monitor cables and two additional styles of desk mounts are available. The list price is \$129.95. For details, contact Lintek Inc., POB 8056, Grand Rapids, MI 49508. Circle 694 on inquiry card.

Coin Vending Control System for Libraries

XCP's fully automated vending control systems allow library patrons to use microcomputers without staff supervision to control time and usage. Two versions of the Microvend Computer Usage Control System are available: the 3300T and the 5500T. The Model 3300T accepts quarters and tokens; it does not make change. The 5500T accepts nickels, dimes, and quarters. It also accumulates coins until the correct amount is deposited and makes change.

Both systems can be adjusted to provide 1 to 25 minutes of equipment usage. A cumulative time capability allows unlimited equipment time; each time the correct vend price is deposited, another time unit is added. An override key allows free computer usage by staff members. Other features include an accounting meter, a shut-off warning signal, lighted coin-deposit indicator, and multivending capabilities. Installation is simple: plug the computer's CRT power cord into the Microvend control box, close and lock the door, and plug the

computer and Microvend into a wall socket.

An annual rental without a purchase option or a 36-month lease term with a 20 percent purchase op-

tion are available. For full contractual information, contact XCP Inc., 8 West Main St., Dryden, NY 13053, (607) 844-9143. Circle 695 on inquiry card.

State Analyzer Can Be Carried into Field

The Micro Tracer state analyzer offers a 1K-byte trace buffer, pattern-recognition logic, and formatted serial output in a box weighing less than 5 pounds. Plug-in personality modules interpret processor codes, and an 18-inch ribbon cable with a 40-pin clip to place over the microprocessor sets up the Micro Tracer. Data is captured by either a 16-bit trap address keyboard or by a separate trigger probe that connects to any logic-level signal in the system. Data can be displayed or printed in sequential processor cycles or disassembled and presented in assembly mnemonics. Micro Tracer can display data one cycle at a time on a front panel LED.

Micro Tracer's base price is \$995. Personality modules are available for Z80/Z80A and 8085/8085A microprocessors; other

modules are under development. Additional modules cost \$200 each. For full details, contact Spywood Systems, POB 794, Holliston, MA 01746. Circle 691 on inquiry card.

Visicalc Wall Chart Guides Users

A two-color, 18- by 25-inch wall chart graphically depicting all Visicalc commands is available from Crest Software. Key-stroke combinations with explanations, editing key combinations, operators, and math functions are all covered. A Superscript wall chart for the Radio Shack TRS-80 Model III is also available.

Each wall chart costs \$4, plus \$2 shipping. They can be ordered from Crest Software, 2132 Crestview Dr., Durango, CO 81301, (303) 247-9518.

Circle 690 on inquiry card.

Where Do New Products Items Come From?

The information printed in the new products pages of BYTE is obtained from "new product" or "press release" copy sent by the promoters of new products. If in our judgment the information might be of interest to the personal computing experimenters and homebrewers who read BYTE, we print it in some form. We openly solicit releases and photos from manufacturers and suppliers to this marketplace. The information is printed more or less as a first-in first-out queue, subject to occasional priority modifications. While we would not knowingly print untrue or inaccurate data, or data from unreliable companies, our capacity to evaluate the products and companies appearing in the "What's New?" feature is necessarily limited. We therefore cannot be responsible for product quality or company performance.

CHANNEL SYSTEM CORP

The Channel Connecting You And Computers

APPLE-SOFTWARE

	LIST	SALE
APPLIED SOFTWARE TECHNOLOGY		
Versa Form	389.00	259.00
Qbase	189.00	139.00
Templates PO/INV @	49.95	39.00
ML/CRJ/EJ @	39.95	33.00
ASHTON-TATE™		
dBase II	700.00	395.00
BPI Systems™		
GL/AP/AR/INV/PR @	395.00	295.00
BRODERBUND™		
A.E.	34.95	25.00
CENTRAL POINT SOFTWARE		
Copy II Plus	39.95	32.00
CONTINENTAL SOFTWARE™		
Home Accountant	74.95	49.00
FCM	99.95	68.00
DOW JONES SOFTWARE™		
Market Analyzer™	350.00	279.00
FOX & GELLER™		
Quick Code	295.00	195.00
dGraph	295.00	195.00
dUtil	99.00	69.00
Quick Screen	149.00	119.00
INFOCOM™		
Deadline	49.95	34.00
Zork I/II/III @	39.95	27.00
MICROPRO®		
Infostar	495.00	299.00
MICROSOFT®		
Multiplan™	275.00	179.00
MUSE®		
Supertext Home Office	99.00	73.00
PERFECT SOFTWARE™		
Perfect Writer	495.00	219.00
SIERRA ON-LINE SYSTEMS		
Frogger	34.95	25.00
SILICON VALLEY SYSTEMS		
Word Handler	59.95	39.00
List Handler	49.95	35.00
SOFTWARE PUBLISHING CORP.™		
PFS File	125.00	85.00
SPINNAKER™		
Educational Software	UP TO 30% OFF	
VISICORP™		
Visicalc	250.00	169.00
Other Products	UP TO 34% OFF	

APPLE-HARDWARE

	LIST	SALE
CENTRAL POINT SOFTWARE		
Alaska Card™	129.95	99.00
EPS		
Keyboard w/Basic Prom	399.95	319.00
Basic Prom @	32.95	29.00
GIBSON LABS		
LPS Hi/Res Light Pen	349.00	279.00
HAYES MICROCOMPUTER PRODUCTS®		
Miromodem II w/SC I	329.00	249.00
Smartmodem 1200 RS232	699.00	499.00
KENSINGTON®		
System Fan Saver	89.95	69.00
KRAFT		
Paddles	49.95	39.00
Joystick	64.95	49.00
KOALA™		
Graphic Tablet	124.95	95.00
MICRO SCI		
A2 Drive w/o controller	345.00	249.00
A2 Drive w/controller	445.00	325.00
MICROSOFT®		
Softcard	345.00	219.00
Premium Softcard	495.00	369.00
NOVATION		
212 Apple Cat II	725.00	599.00
Smartcat 103/212	595.00	469.00
Maxifone	1150.00	999.00
ORANGE MICRO™		
Buffered Grappler + 16K	239.00	185.00
PRACTICAL PERIPHERALS		
Microbuffer II + 16K	259.00	199.00
SSM		
Modem Card w/source	325.00	259.00
Transmodem 1200	695.00	499.00
VIOEX		
Ultraterm	379.00	279.00
Other Products	UP TO 27% OFF	
IBM PC SOFTWARE		
APPLIED SOFTWARE TECHNOLOGY		
VersaForm	389.00	259.00
Qbase	189.00	139.00
Templates PO/INV @	49.95	39.00
ML/CRJ/EJ @	39.95	33.00
ASHTON-TATE™		
dBase	700.00	395.00

	LIST	SALE
CENTRAL POINT SOFTWARE		
Copy II PC	39.95	32.00
CONTINENTAL SOFTWARE™		
Home Accountant	150.00	89.00
FCM	124.95	79.00
DIGITAL RESEARCH™		
CP/M 86	60.00	45.00
Concurrent CP/M 86	350.00	235.00
DOW JONES SOFTWARE™		
Market Analyzer	350.00	279.00
FOX & GELLER		
Quick Code	295.00	195.00
dGraph	295.00	195.00
dUtil	99.00	69.00
INFOCOM™		
Deadline	49.95	34.00
Zork I/II/III @	39.95	27.00
MICROSOFT®		
Multiplan	275.00	179.00
Multi-Tool word w/Mouse	495.00	349.00
PEACHTREE SOFTWARE™		
Peachtex 5000	395.00	239.00
PERFECT SOFTWARE™		
Perfect Writer	495.00	219.00
SIERRA ON-LINE SYSTEMS		
Frogger	34.95	25.00
SOFTWARE PUBLISHING CORP.™		
PFS: File	140.00	95.00
SPINNAKER™		
Educational Softwares	UP TO 30% OFF	
VISICORP™		
Visicalc	250.00	169.00
Other Products	UP TO 34% OFF	
IBM HARDWARE		
HAYES MICROCOMPUTER PRODUCTS®		
Smartmodem 1200B	599.00	479.00
Smartmodem 1200 (RS232)	699.00	499.00
KRAFT		
Paddles	49.95	39.00
Joystick	69.95	49.00
KOALA™		
Graphic Tablet	150.00	115.00
MICROSOFT®		
Mouse	195.00	149.00
NOVATION		
Smartcat 103/212 (RS232)	595.00	469.00
Maxifone (RS232)	1150.00	999.00

	LIST	SALE
QUADRAM		
Quadlink	680.00	579.00
Quadboard 64K	395.00	285.00
Quadboard II 64K	395.00	285.00
MONITORS		
AMDEK		
Color 1 + LO/RES	399.00	339.00
Video 300		
12" HI/RES Green	179.00	157.00
Video 300A 12" Amber	199.00	159.00
NEC		
12" HI/RES Green	285.00	159.00
12" LO/RES Color	399.00	379.00
12" HI/RES Color (PC)	699.00	599.00
PRINTERS		
OKIDATA		
ML-82A	549.00	419.00
ML-83A	899.00	719.00
ML-84P	1395.00	1049.00
ML-84S	1495.00	1129.00
ML-92P	699.00	529.00
ML-93P	1249.00	939.00
ML-92S	799.00	599.00
ML-93S	1349.00	1019.00
DISKETTES		
DYSAN®		
5 1/4" SS/SD		32.00
5 1/4" SS/DD (plastic box)		37.00
5 1/4" DS/DD (plastic box)		43.00
IBM®		
5 1/4" SS/DD		29.90
5 1/4" DS/DD		39.90
MAXELL®		
5 1/4" SS/DD		28.90
5 1/4" OS/DD		41.90
TDK®		
5 1/4" SS/DD		39.00
5 1/4" OS/DD		47.00
ACCESSORIES		
AMARAY		
5 1/4" Disk Bank (white)	7.50	6.50
5 1/4" Disk Bank (smoke)	7.50	6.50
5 1/4" Disk Bank System	29.95	25.00
INNOVATIVE CONCEPTS		
5 1/4" Flip-N-File	29.95	25.00

National: 1-800-821-4381

Calif: 1-800-421-3245 • Local: (805) 683-3006 / 683-1779



5788 Dawson St., Goleta, CA 93117 HOURS: ORDER DESK 8-6:30 Mon-Sat. Store Mon.-Fri. 9-6:30 - Sat. 9-5

TERMS Add 3% for shipping & handling. \$3.00 minimum UPS next day delivery for items in stock. Add 6% for CA. Sales Tax Add 2% to total for Visa & Master Charge. All sales final for software, accessories & diskettes. Defective Hardware, Monitors, Printers returns must be within 10 working days of purchase accompanied by RMA # for exchange only. Apple is the Registered Trademark of Apple Computer Inc. IBM is the Registered Trademark of International Business Machines Corp.

Two New Office Products from IBM

by Rich Malloy

Practically every major computer company has tried either to imitate the IBM Personal Computer or to design peripherals for it. And now even IBM has jumped on the bandwagon. By IBM, we mean of course not the small Entry Systems Group in Boca Raton, Florida, which produces the popular PC, but the large Information Systems Group, which produces those large systems that are almost synonymous with the IBM logo. Recently, amid a flurry of rumors about the new Peanut or PC Junior, the Information Systems Division announced two significant products based on the PC: a desktop System/370 and a new version of the IBM 3270 display terminal that features concurrent processing and windows.

The IBM Personal Computer XT/370

As its name implies, this new enhancement of the IBM PC XT is designed to emulate the legendary IBM System/370 mainframe. According to IBM, it should run many of the same programs that run on the large machines in the System/370 VM/CMS (Virtual Machine/Conversational Monitor System) family. In addition, the machine has the capability to function as an IBM 3277 display terminal connected to a host computer. And it is still functional as a PC.

The cost for the complete XT/370 system with 10 megabytes of disk storage is \$8995. (A 20-megabyte system will cost \$11,690.) An upgrade kit for an XT will cost \$3790. You will also need, however, a new software package (called VM/PC), which costs \$1000, and a monitor and adapter board for each of these hardware configurations. Thus, for about \$10,700, you can have the equivalent of a small System 370 on your desk.

The XT/370 (which, following a tradition of hard-to-remember 4-digit names, is officially called the 5160 Model 588) consists of a standard XT plus three additional boards. One is a new terminal-emulation board that emulates the IBM 3277 display terminal. The second contains 512K bytes of memory. The third contains a set of coprocessor chips.

The three processors on this board were all produced by IBM in association with Intel and Motorola. The first is based on the Intel 8087 and handles floating-point arithmetic. The remaining two are based on the Motorola MC 68000. One of these can directly execute 72 of the instructions used by the 370. The second can emulate 45 of the 370's other instructions. A few remaining instructions that refer specifically to the 370 have not been emulated.

The VM/PC (Virtual Machine/Personal Computer) software runs under PC-DOS version 2.0 and enables the XT to function as a single-user virtual machine with 480K bytes of real memory and up to 4 megabytes of virtual memory.

As for performance, the XT/370 is hindered by the relatively slow speed (compared to mainframes) of its disk drive. But within this constraint, IBM claims that for commercial applications the XT/370 is about half as fast as an entry-level IBM 4300 system. For scientific applications, the XT/370 should be twice as fast, thanks to the 8087 chip.

The XT/370 should run several popular compilers without any alterations. These include OS/VS COBOL, VS FORTRAN, and Pascal/VS. These programs, along with customer application programs, can be downloaded from a host 370 system. Special reduced monthly charges will be assessed by IBM for 370 software used on the XT/370.

This new system should be available during the second quarter of 1984. Don't look for it in your local Computerland store, however. IBM plans to offer it only to large customers through its National Accounts Division, at least for the time being. One wonders if, a few months down the road, Amdahl and Prime will offer similar products at reduced prices.

The IBM 3270 Personal Computer

This second product from the Information Systems Group combines a standard IBM PC with an IBM 3270 display terminal. The noteworthy feature of this system is its capability to access up to four

programs running concurrently on one or more host computers, along with a PC-DOS application program and two "notebook" data areas. Also, a new high-resolution monitor is available for this system.

The 3270-PC has 256K bytes of memory, with options available for up to 640K bytes. A 122-key keyboard includes all of the keys of both a regular PC and a 3270 terminal.

The color monitor (called the 5272—another four-digit name) features eight colors with a very high resolution, equal to that of the PC's monochrome monitor. An antiglare screen is also provided, but bit-mapped graphics are not. It seems a safe bet that a graphics adapter board will soon be available for this monitor and that it will be the new color monitor for the PC. The price for this new display is \$995.

The 3270-PC Control Program, which runs under PC-DOS 2.0, allows you to access up to seven programs: four on a host computer through the 3270 link, two "notebook" data-storage areas, and a PC-DOS application program. You can define a number of windows through which you can monitor any of these programs. You can define the size, color, and position of any of these windows.

The Notebook data-storage areas let you transfer data from host programs to PC-DOS programs and vice versa. The size limit for each area is about 4000 bytes, and you can easily edit the contents of the notebooks. For example, you can run Lotus's 1-2-3, select part of the results for transfer to a Notebook area, add some descriptive labels, and then transfer the Notebook contents to a host computer's electronic-mail program.

The cost for a 3270-PC system with 256K bytes of RAM is \$4290. Additional requirements include the 3270-PC Control Program (\$300) and a monitor plus adapter board. It should be available from IBM's National Accounts Division in the first quarter of 1984. ■

Rich Malloy is BYTE's product-review editor.

ORDER WITH CONFIDENCE

from one of the nation's largest
consumer electronic parts distributors!

DISK DRIVE

Slim disk drive for Apple II® computer. New in a box.

LOWEST PRICE EVER!

A sturdy cabinet and 3' cable are included. Runs on Apple controller or our optional controller.

ORDER NO. 83-APL-DD-1 **\$229.95**

CONTROLLER CARD

For two disk drives.

ORDER NO. 83-APL-CTL-1 **\$49.95**

IBM COMPATIBLE JOYSTICK

Heavy duty all metal. Featuring ultra linear pots, self centering, dual fine center adjustments. The finest industrial/commercial joystick available.

ORDER NO. 83-IB-XY-23 **\$44.95**

APPLE® COMPATIBLE JOYSTICK

With double trigger feature. (Four total) light weight, linear pots.

ORDER NO. 83-APL-XY-9

APPLE® COMPATIBLE JOYSTICK

Cord terminated with 16 Pin plug. Our most popular joystick.

ORDER NO. 83-APL-XY-10 **\$16.50**

REPLACEMENT KEYBOARD FOR APPLE II®



Heavy duty — error free switches. Switchable N key rollover, last key repeat. Upper/lower case capability. Alpha lock, cable included.

ORDER NO. 83-APL-KB-7 **\$79.95**

SELF CENTERING APPLE® COMPATIBLE JOYSTICK

With double trigger feature. (Four total) light weight, linear pots.

ORDER NO. 83-APL-XY-18 **\$29.95**

ARCADE TYPE JOYSTICK

For Atari, Commodore, Texas Instruments, Sears. Heavy duty leaf switches.

ORDER NO. 83-ATR-JY-1 **\$15.00**

RF MODULATORS



Use your TV as a monitor. Converts video signals into RF. Hooks up to Apple with no modifications. FCC listed. Two versions: With sound and without sound.

ORDER NO. 83-VM42 Without Sound **\$16.00**

ORDER NO. 83-CRM-320 With Sound **\$21.95**

5A APPLE II® COMPATIBLE REPLACEMENT POWER SUPPLY



Full 2A more than the original power supply. Heavy duty. 110/220V operation. Mounts directly into Apple II case. AC cord included.

ORDER NO. 83-APL-PS-51 **\$79.95**

5A POWER SUPPLY With BUILT-IN COOLING FAN

NEW!

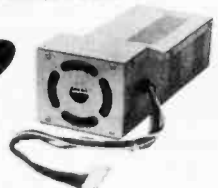

Newly patented Apple II® compatible 5A power supply. Fits completely into Apple II case. Eliminates the need for external cooling fan.

ORDER NO. 83-APL-PS-53 **\$89.95**

DATA SPEC™ SUPER CABLES

Fully shielded — shock proof — low loss. 25 Conductor RS232 cable assembly with 100% alluminox shield. Special underhood molding and shielding.

The best cables currently made!

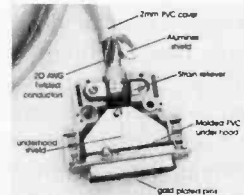

ORDER NO.	LENGTH	PLUG/JACK	PRICE
83-MRS232MM-3	3'	Male/Male	\$24.95
83-MRS232MM-5	5'	Male/Male	27.95
83-MRS232MM-10	10'	Male/Male	29.95
83-MRS232MM-25	25'	Male/Male	37.95
83-MRS232MF-3	3'	Male/Female	25.95
83-MRS232MF-5	5'	Male/Female	28.95
83-MRS232MF-10	10'	Male/Female	30.95
83-MRS232MF-25	25'	Male/Female	38.95

SOLDER TYPE 25 PIN "D" (RS232) CONNECTOR



ORDER NO.		1-11	12-49
83-DB25M	Solder Type Male	\$2.25	\$2.00
83-DB25F	Solder Type Female	2.90	2.60
83-DH25H	Hood with hardware	1.30	1.20

RF CABLES



RCA to RCA. Connects computer to monitor, etc.

ORDER NO.		PRICE
83-BRR-3	3'	\$1.95
83-BRR-6	6'	2.50
83-BRR-12	12'	4.50

Please Note: ORA Electronics products are intended to be sold to persons with a working knowledge of electronics and computing. If you do not have such knowledge, please visit your local dealer for products and information.



MINIMUM ORDER \$25.00. VISA, MASTER CARD accepted. No surcharges. Exact UPS charges will be added. PREPAID: Certified checks and money orders, send exact amount. No shipping, handling or insurance charges in the continental USA. PERSONAL CHECKS: add 5% shipping charges, allow 3 weeks to clear. INTERNATIONAL BUYERS: US currency and 20% extra for shipping. CA Residents, add sales tax. OEM DEALERS: send for special prices on your company letterhead.

NO PURCHASE ORDERS OR OPEN ACCOUNTS—NO EXCEPTIONS.



"OUR SERVICE MAKES THE DIFFERENCE"

To order, call TOLL FREE: **(800)423-5336**

Calif. TOLL FREE: **(800)382-3663**

Local: **(213)701-5848**

Telex 181011 ORA PARTS NTGE

18215 PARTHENIA STREET, NORTHRIDGE, CA 91325

Book Reviews

Electronically Speaking: Computer Speech Generation

John P. Cater
Howard W. Sams & Co.
Indianapolis, IN: 1982
232 pages
softcover, \$14.95

Reviewed by
Joseph A. Scott

Most technical books tend to be written for people who already know the fundamentals of a particular field but who need to broaden their expertise. Other technical books offer a cursory treatment designed for people who want a general idea of a certain field without the details. Both alternatives are unsatisfactory for the novice who is genuinely interested in developing a particular skill or expertise but who has no previous knowledge. *Electronically Speaking* addresses itself to just such a reader.

Cater's book is written for "the neophyte to speech synthesis." It assumes the reader has some knowledge of computer operation, a modicum about computer architecture and electronic circuits, and an awareness of the ways a computer can interface with the world. Both the neophyte and a more advanced student of speech synthesis now have a ready source of information about a variety of products currently available to generate computer speech as well as a baker's dozen of circuits for speech-synthesis applications that you can build yourself.

The heart of the book lies in the sixth chapter. Here Cater details three major technologies in artificial-speech production: waveform encoding for speech reconstruction, the analog-formant-frequency synthesis

method, and LPC and PARCOR synthesizers. Visual and verbal analogies and examples, block diagrams, flowcharts, and skeleton schematics enhance the neophyte's understanding. Chapter 6 also compares the technologies in terms of quality and understandability of the produced speech, cost, and memory requirements.

Chapter 7 reviews 16 speech-synthesis peripherals for small computers ranging from Centigram Corporation's Cindy (formerly called LISA) to Texas Instruments' Speak & Spell. Each peripheral is categorized by the type of speech-generating technology it uses, and the author compares each in terms of its theory of operation, vocabulary, storage capability, and cost. The chapter includes photographs of a few synthesizers, some of the internal hardware, block diagrams of the operating systems, and relatively complete or skeletonized schematics. It includes three summary charts for each type of synthesizer and compares the models in such areas as size, speech capability, computer type used, and cost. Although the author points out that some incomplete descriptions are due to the proprietary nature of some of this information, that is to be expected in a new field. This caveat does not detract from the chapter's value. This chapter is informative for people who are either contemplating adding speech to a computer or who want to be able to intelligently discuss the state of the art in speech synthesis.

While chapters 6 and 7 delineate the state of the art in voice synthesis in terms of how it is achieved and what is available, two other chapters discuss the historical development of speech-mak-

ing devices and the potential of synthesizers today. The chapter on history provides a brief but fascinating discussion of early speech-making devices that range from von Kempelen and Wheatstone's talking bellows to the Voder synthesizer displayed in 1939 at the World's Fair.

The last chapter offers a potpourri of uses for voice synthesizers for home and commercial applications. Here those of a more practical bent may be somewhat disappointed because the uses suggested are currently met adequately and inexpensively by bells and alarms.

But several intriguing questions must be answered before artificial speech can become a part of mainstream technology. Cater addresses both the equipment end and the less tangible aspects of communication humans take for granted. This additional dimension is found in a couple of chapters that discuss human speech. One chapter focuses on the physical, physiological, and neurological mechanisms of speech production. This chapter is a useful reference point to understanding the standards against which artificial speech will be compared. It also provides an awareness of the complexity of human communication that must somehow be replicated by a mechanical or electronic system.

A chapter on linguistics provides a look at the characteristics of what sounds are produced, classifies the sounds produced in speech and used in English, and describes how they are produced. Three tables in this chapter provide handy information for the new user of speech synthesizers. The tables list the most frequently used speech sounds and spoken words in the English

language and the relative power of a selection of speech sounds. This informs the novice who is developing a vocabulary of the words he will need and the sounds he has to perfect to make synthesized speech more understandable.

Finally, mention must be made of a chapter that raises questions and makes suggestions about a topic rarely mentioned in technical books. Cater devotes a chapter to what he calls the "etiquette of computer speech." He raises the issue of how humans will react in a world where not only people but things talk and where the things are not adept at responding to social signals that say "shut up." Cater makes us aware of subtler aspects of human communication that presently lack parallels in talking computers. For instance, humans usually tell each other non-verbally when they are about to speak and then await recognition. To do otherwise begs being labeled something ranging from aggressive to boorish. Unless our talking computers are programmed to similar good manners, we may find ourselves in the midst of an armada of aggressive, boorish appliances.

I wish the author had included a discussion of some of the considerations and problems associated with installing a speech synthesizer on a personal computer, Murphy's Law being what it is. And I could have used some guidance on how to improve a synthesizer's diction, elocution, or what have you. Perhaps these concerns are so vast that they could fill another volume. ■

Joseph A. Scott (6 Mione Way, Chico, CA 95926) is a psychology professor at California State University in Chico.

CHECK SUNTRONICS NEW LOW PRICES

TOLL FREE
(ORDERS ONLY)

1-800-421-5775

Calif. orders and all info call 213-644-1149

Apple Compatible Products

General Products

General Products- cont.

S-100 Products



AFDC-1 Floppy Disk Drive Controller **\$79.95**
Runs DOS 3.3 with any standard Shugart compatible 5 1/4" disk drive. (2 drives each card)



ASCII KEYBOARD A&T **\$69.00**
Plug in compatible with Apple II, has shift-lock, underscore, | and back slash characters.

BMC DISK DRIVE AND CONTROLLER for APPLE II
BAL500 Disk Drive 5 1/4" SS/DD 249.00
100% Apple II compatible 69.00
Controller for above

APPLE Connector 50 pin 3.50

Apple Prototype Board.

Double Sided glass with gold plated Apple and General Purpose terminals. Contains matrix of 17 x 63 solder plated donuts on .15" x .1" spacing. Great for 14, 16, and 24 pin IC's. **SUN-722** 7.95

Apprate PROM Blaster 119.00
"ALS" 80 Column Card 159.00
"ALS" Z-CARD (Z80 CPU) 149.00
API Apple Parallel Printer interface card. Centronics Compatible 445.00

Mitsubishi Disk Drives, 5 1/4" and 8" Slim
5 1/4" Thin DSDD 40 Track 310.00
8" Thin DSDD 80 Track 450.00

DISKETTE SALE

5 1/4" Diskettes	10 up	100 up
SS/DD (100% certified)	1.75	1.55
DS/DD (100% certified)	2.50	2.30

Video Monitors

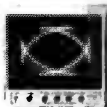

SAMWOO GREEN 9" 18MHz \$115.00
SAMWOO AMBER 9" 18MHz 119.00
SAMWOO GREEN 12" 18MHz 124.00
SAMWOO AMBER 12" 18MHz 127.00
Composite video I/O. 750 lines resolution. 75/10K ohm impedance.



BMC 13" COLOR monitor for your home computer/video game display. Offers 350 x 350 resolution with 400 dots at the center. **9191U 13" Color** 229.00

BMC 13" RGB COLOR monitor offers state of the art RGB for the IBM PC with 690 x 240 resolution and latest in TTL level technology. **9191MU 13" RGB Color** 445.00

Note: Please add \$10.00 shipping and handling for the video monitors and printers.

BMC PRINTERS



BX-80 dot matrix printer with 80 cps, 9 x 7 print head. Quiet, reliable and priced for entry level end-user. **\$259.00**

PB401 16 cps letter quality bi-directional daisy wheel printer. 132 cpl with cassette type ribbon 731.00

BMC PB101 16 cps letter quality bi-directional daisy wheel printer. 132 characters per line with cassette type ribbon. 2K buffer and opt tractor feed. Available in serial and parallel. 718.00

EPROM & RAM SUPER SALE

P/N	Description	8 24	25up
2716	(450nS)	3.95	3.95
2732	(450nS)	4.40	4.40
2532	(450nS)	4.40	4.10
2764	(28 pin)	5.95	5.95
2714L-2	(200nS)	1.62	1.62
4164	(in stock)	Call	Call
6116P-3	(150nS)	6.10	5.75

Mother Boards & Card Cages

SLOTS	Base Bd	KIT	A & T	w/CAGE
6	\$12.00	\$37.00	\$52.00	\$77.00
8	16.00	48.00	73.00	108.00
12	22.00	68.00	103.00	143.00

10MHz, No termination. Includes power indicator and wiring for muffin fan. Uses OK connector for solderless installation and removal of power & reset lines.



64KSM A&T without RAM **\$155.00**
64KSM A&T w/64k RAM (32-6116's) 339.00
S-100 Board Uses 6MHz 6116's. 1/2A max. power, Bank Select plus Extended Addressing allow for multi-memory board set-up. 4 independent 16K Blocks make easy use with multi-user systems. Any 2K RAM may be replaced by 2716 EPROM.

SBC-880 Z80A CPU, A&T \$169.00
SBC-880 Z80A CPU, Kit 149.00
4MHz Z80A CPU boards with Serial/Parallel Ports.

UFDC-1 Floppy Controller, A&T 245.00
UFDC-1 Floppy Controller, Kit 225.00
The UFDC-1 Floppy Controller uses the WD1795 chip which runs either and/or 8" 5 1/4" Disk Drives.

CLOCK CALENDAR A&T 115.00
CLOCK CALENDAR Kit 95.00
This S-100 Clock Calendar Board has 4 interrupts, Time, Day of Week and Battery Backup.

S-100 Edge Connector 100 pin 3.95

S-100 Prototype Board



Double Sided glass with gold plated, numbered S-100 terminals. Matrix of 25 x 78 solder plated donuts on .15" x .1" spacing. Locations for headers and regulators. Great for 14, 16, and 24 pin IC's. **SUN-721** 12.95



SUNTRONICS CO., INC.
12621 Crenshaw Blvd., Hawthorne, CA 90250

STORE HOURS: MON.-FRI. 9:00am to 6:00pm SATURDAY 10:00am to 5:00pm

Mail Order—Min. Order \$10. Visa or MasterCard (please include expiration date). Add \$2.00 (shipping and handling) for first 3 pounds plus .50 for each additional pound to your order. CA residents add Calif. sales tax.

MAJOR EXPANSION AT MINOR EXPENSE

Why pay more for top quality peripherals and accessories when our prices are consistently among the lowest anywhere? Expand your system and shrink your cost. We invite you to compare prices, then call us.

MICROSOFT	SALE PRICE
For IBM PC	
9913 64K card	\$235.81
0113 128K card	353.71
0213 192K card	471.50
0313 256K card	589.53
9938 64K system card	266.13
0338 256K system card	425.99
9937 mouse	131.38
0013 64K ram chips	117.90
For Apple II, II+, IIe	
2304 softcard system	232.44
2312 softcard system plus	423.50
2313 ramcard	67.33
2223 multiplan el. wrksheet	185.28
9804 softcard prem. system	468.25
2348 prem. softcard IIe	333.50

MODEMS	SALE PRICE
01 HAYES stack chronograph	\$194.77
02 HAYES stack smartmodem	225.40
03 HAYES smartmodem 1200	551.25
04 NOVATION cat	159.25
05 NOVATION dcat	175.17
06 NOVATION autocat	638.22
07 NOVATION jcat	118.64
08 NOVATION smartcat 103/212	473.76
09 NOVATION smartcat 103	198.30

VIDEX	SALE PRICE
UL-00 ultraterm	\$273.92
VT-500 videoterm 50.Hz	201.64
VT-501 videoterm 50.Hz softswitch	224.55
VT-502 videoterm 50.Hz softswitch inver	230.55
VT-600 videoterm 60.Hz	201.64
VT-601 videoterm 60.Hz softswitch	223.32
VT-602 videoterm 60.Hz softswitch inver	230.55
VT-SPA000 switchplate	13.73
PS-000 paral, ser. I/O card	165.50
ENH-000 Enhancer II	107.70
ENH-FS-000 Function Strip	28.19
ENH-FS-001 Enhancer II, Function Strip	129.37

DYNSAN DISKETTES	SALE PRICE
104/1 5.25" .ss.sd	\$31.85
104/1D 5.25" .ss.sd	33.68
104/2D 5.25" .ds.dd	39.81
3740/1 8" .ss.sd	33.07
3740/1D 8" .ss.dd	41.03
3740/2 8" .ds.sd	41.03
3740/2D 8" .ds.dd	47.77
boxes of 10 each	

MISC. ITEMS	SALE PRICE
644-0100 lemon surge protector	\$45.33
644-0110 orange surge protector	111.42
644-0120 lime surge protector	71.27
7654 system saver (APPLE)	66.15

ORDERS ONLY
IN CAL. 800-858-4810 800-821-6662

COMMERCIAL BUSINESS SUPPLY
2858 S. ROBERTSON BLVD. LOS ANGELES, CA 90034



INFORMATION
(213) 559-0596

Phone orders accepted on Visa and MasterCard only. Add 3% for credit card use. California residents add 6.5% sales tax. No C.O.D. Actual shipping and handling charge added to all orders. Prepaid orders as follows: Money orders or cashier's check—merchandise shipped upon receipt. Personal checks must clear before shipping. 20% restocking fee. Prices and availability subject to change.

Book Reviews

Mastering CP/M

Alan R. Miller
Sybex Inc., Berkeley, CA:
1983
400 pages, \$25

Reviewed by
Bruce R. Evans

At last, someone has written a book for those of us who hanker to get into the guts of CP/M but lack the perseverance to get through Digital Research's obtuse manuals. Oh, there are lots of introductory books that start with "This is a disk. There's a hole in the middle of it. Insert it into the drive as in the photo." However, a lot of us passed that phase years ago. We want to modify our disk-operating systems to run modems, printers, and even hard disks. Until now, nobody seemed interested in us.

Sybex Inc. and Alan R. Miller have come to our rescue. Miller starts with an overview of the layout and location of the CP/M operating system. He quickly goes through the standard acronyms—CCP, TPA, IOBYTE, and the like. Miller deftly puts these rather vague concepts into perspective. He then does the same with the built-in commands and transient programs such as Pip, Stat, and Mac, Digital Research's macro assembler. Emphasis is solely on assembly-language utilities. Before you know it, Miller has covered what most other authors spend a book on and you are doing things like writing an assembly-language program to let you restart a crashed program.

Chapter 2 is worth the price of the entire book. Although I am proficient in assembly-language programming, I have never quite been

able to understand how to modify the low-level BIOS (basic input/output system). I doubt I am alone. And unless you already know how to do it, the CP/M manuals are hopeless at explaining this procedure. Most other CP/M books don't even attempt this. Alan Miller makes it easy; his method is ingenious. As he explains the procedure, he has you go through all the steps without actually changing your BIOS. Then you save the unmodified BIOS, load it back onto the system tracks, and try to run it. If you followed all the steps, it will go just fine. However, if it doesn't, you know that you messed up the steps rather than the new driver routines you wrote.

In chapter 3 the author actually has you add new drivers to your BIOS. Again, Miller does the unusual. He assumes that anyone using this book will be proficient enough to write his own bare-bones routines. Therefore, Miller concentrates on adding bells and whistles to our programs. Instead of a simple printer driver, he shows you how to write printer-control and status-checking subroutines, how to use the IOBYTE to stream your output, and, finally, how to create a memory cache to direct your output to a disk file. If you're getting the idea by now that the software in this book is as valuable as the instruction, you're right.

Next, Miller starts to build a macro library. These subroutines are used repeatedly in assembly-language programming—for 16-bit arithmetic, screen control, disk manipulation, and more. Rather than rewrite these with every program, the programmer saves them on disk and then instructs his assembler to add them during as-

sembly of his program. Unfortunately, ASM, the assembler that comes with CP/M, doesn't have the capability to use these. You must be using CP/M's Mac assembler to benefit from this section. If you're not, you'll quickly see why you need it to do any serious programming.

The next four chapters lead you through the intricacies of the high-level BDOS (basic disk-operating system) for both disk and nondisk uses. Again, you learn by writing yet more utility programs and macros. If you follow this through, you'll have written 24 macros and 15 complete programs. You'll have a disk full of utility programs and the knowledge to use them.

Now that you are proficient with BDOS, Miller leads you through the disk directory. You read not just the abbreviated form that the DIR command gives, you get all the nuts and bolts of the system including memory maps and disk parameters. Although CP/M is a fairly efficient system, it can be improved upon. By this point in the book, you're prepared to try to do just that.

Miller finishes with the mandatory listing of 8080 and

Z80 mnemonics. Again, he can't stand to be conventional. His listings are followed by details of both instruction sets. Although it's definitely not a course in assembly-language programming for beginners, this book is also an excellent reference manual for advanced programmers. Again, Miller shows his knowledge of 8080 and Z80 programming by pointing out the similarities and the traps present.

Alan Miller has written a book aimed at the experienced programmer that will explain the ins and outs of the CP/M disk-operating system. By leading the reader by the hand without insulting him, by building up a macro library that will extend the raw CP/M system, and by demonstrating an intimate knowledge of the subtleties of CP/M, Miller's book is a worthy replacement for Digital Research's documentation. If I sound enthusiastic about this book, it's because I am. ■

Bruce R. Evans (16 Marwin Rd., Pickering, Ontario L1V 2N7, Canada) is a family physician and an experienced CP/M user.

BYTE's Bugs

Line Change

Dean Brown of Alderwood Manor, Washington, spotted a bug in James Folts's IBM PC BASIC cross-reference utility (August, pages 378-384). The program will work properly with programs having 5-digit line numbers if line 6050 is changed from

```
6050 LABEL$(LABEL.NUMBER) = SPACES$(5)
```

to

```
6050 LABEL$(LABEL.NUMBER) = SPACES$(6)
```

Brown explains, "The change is necessary because the STR\$(val) function used in line 6060 prefixes positive numbers with a blank, thus requiring the field length to be one greater than the length of the line number to be displayed." ■

★ ★ ★ The GRAY MARKET



We don't play games

Lowest Prices Anwhere! Here is why:

1. Low Advertising Budget
2. Large Volume Buying
3. No Support
4. No Repair Service

Our advertising budget is kept low, we sell in large volume and you benefit by getting the best prices anywhere. You may use **Visa, MasterCard, American Express** or prepay (cashier's check or money order).

We carry so many products that we are unable to list them all. However, call us for your specific needs. We have listed examples of some of our products and prices. Believe it or not, all our products are priced the same.

**ALL PRODUCTS ARE NEW
IN SEALED CONTAINERS**

**IF YOU WANT THE LOWEST
AND BEST PRICES CALL US
(213) 557-3934**

COMPUTERS		MONITORS		IBM PERIPHERALS	
ALLOS	SCALL	AMDEK COLOR I	SCALL	RAM CARDS	SCALL
VIC 20	SCALL	NEC	SCALL	QUADRAM	SCALL
COLOMBIA	SCALL	ZENITH	SCALL	RAYTRONICS	SCALL
CORONA	SCALL	SANYO	SCALL	AST	SCALL
NORTH STAR	SCALL	TAXAN	SCALL	COLOR MONITORS	SCALL
FRANKLIN	SCALL	USI	SCALL	10 MEGA BYTE HA	SCALL
DEC RAINBOW	SCALL	COMREX	SCALL	GRAPHICS CARDS	SCALL
TELEVIDEO	SCALL	GORILLA	SCALL	DISC DRIVES	SCALL
SANYO	SCALL	MODEMS	SCALL	MODEMS	SCALL
TENAS INSTRUMENT	SCALL	HAYES 300 BAUD	SCALL	COMMADOR 64 - VIC 20	SCALL
ZENITH	SCALL	NOVATIONS	SCALL	PERIPHERALS	SCALL
PIED PIPER	SCALL	SIGNALMAN	SCALL	DIS DRIVES	SCALL
ZORBA	SCALL	TERMINALS	SCALL	MONITORS	SCALL
PRINTERS - DOT MATRIXES		TELEVIDEO 925	SCALL	INTERFACES	SCALL
EPSON FX-80	\$519.00	QUME	SCALL	CARDCO	SCALL
OKIDATA 92A	\$429.00	ZENITH	SCALL	THE CONNECTION	SCALL
STAR MICRONICS	SCALL	AMPEX DIALOG	SCALL	SOFTWARE	SCALL
C. ITHO	SCALL	TERMIFLEX	SCALL	PAPER CLIP-	SCALL
PROWRITER	SCALL	DISC DRIVES	SCALL	DATA 20	SCALL
IDS	SCALL	SHUGART	SCALL	WORD PLUS	SCALL
DATASOUTH	SCALL	TANDON	SCALL	EXPANSION BOARD	SCALL
ANADEX	SCALL	SIEMANS	SCALL	PLOTTERS	SCALL
NEC	SCALL	REMX	SCALL	HEWLETT PACKARD	SCALL
TOSHIBA	SCALL	RANA	SCALL	BAUSCH & LOMB	SCALL
RITEMAN	SCALL	COMMADOR 64 DRI	SCALL	AMDEX	SCALL
MANNSMAN TALLY	SCALL	APPLE PERIPHERALS	SCALL	BMC	SCALL
OLIVETTE	SCALL	GRAPPLER PLUS	\$115.00	STROBE	SCALL
RIKO	SCALL	MICROTEK	SCALL	HARD DISC DRIVES	SCALL
LETTER QUALITY		OTHER PARALLEL	SCALL	SWITCH BOXES	SCALL
BROTHER HR-1	\$59.00	INTERFACES	SCALL	ACCESSORIES	SCALL
DYNAX DX-15	\$449.00	SERIAL INTERFAC	SCALL	DUST COVERS	\$7.95
COMREX	SCALL	80 COLUMN CARDS	SCALL	PRINT WHEELS	SCALL
NEC	SCALL	CPM CARDS	SCALL	RIBBONS	SCALL
DIABLO	SCALL	16K RAM CARDS	SCALL	DISKETTE CASES	SCALL
QUME	SCALL	LANGUAGE CARDS	SCALL	SURGE PROTECTOR	SCALL
C. ITHO	SCALL	APPLE DISK DRIV	SCALL	DISKETTES DS/DD	\$28.95
STARWRITER	SCALL	BUFFERS	SCALL	10 ea.	
SILVER REED	SCALL	COMPLETE STOCK OF	SCALL		
JUKI	SCALL	CABLES	SCALL		

SUNNY LOW LOW COST POWER SUPPLIES (LINEAR & SWITCHING) FOR S-100, DISK DRIVES

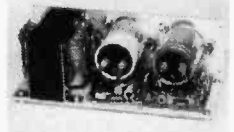
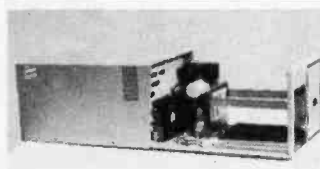

S-100 & DISK POWER SUPPLIES:

ITEM	IDEAL FOR	+5V OVP	-5V	+24V(OR +12V)	+8V	±16V	SIZE W x D x H	PRICE
S ₃	12 SLOT & 2 FLOPPY (1 Floppy & 1 Hard Disk)	5A	1A	5-7A PEAK	13A	3A	10" x 6" x 5"	105.95
S ₄	6 SLOT & 2 FLOPPY	4A	1A	4-5A PEAK	8A	3A	8 3/8" x 5" x 4 3/4"	95.95

DISK POWER SUPPLIES:

ITEM	IDEAL FOR	+5V OVP	-5V	+24V (or +12V)	+8V Unreg.	±12V	SIZE W x D x H	PRICE
R ₀	2 x 8" SLIMLINE	2.5A		2.5A - 5A Peak			5" x 4" x 4"	51.95
R ₁	2 x 8" or 2 x 5 1/4" DISK	4A	1A	3A - 5A Peak	2A		8" x 4" x 3 3/4"	56.95
R ₂	3 x 8" (or 5 1/4") FLOPPY	6A	1A	6A - 8A Peak			10" x 4 7/8" x 3 3/4"	71.95
R ₃	or 1x Floppy & 1x Hard	6A	1A	6A - 8A Peak		1A	9" x 6 1/4" x 4 3/8"	98.95

AC & DC POWER CABLES WITH CONNECTOR FOR 2 DRIVES 8.00

S-100 POWER SUPPLY KITS (OPEN FRAME WITH BASE PLATE, 3 HRS. ASSY. TIME)

ITEM	(IDEAL FOR)	+8V	-8V	+16V	-16V	+28V	SIZE: WxDxH	PRICE
KIT 1	15 CARDS	15A	---	2.5A	2.5A	---	12" x 5" x 4 7/8"	54.95
KIT 2	20 CARDS	25A	---	3A	3A	---	12" x 5" x 4 7/8"	61.95
KIT 3	DISK SYSTEM	15A	1A	3A	3A	5A	13 1/2" x 5" x 4 7/8"	69.95

SHIPPING FOR EA. PWR SUPPLY: \$5.50 IN CALIF.; \$8.00 IN OTHER STATES; \$18.00 IN CANADA. FOR EA. TRANSFORMER: \$5.00 IN ALL STATES; \$12.00 IN CANADA. CALIF. RESIDENTS ADD 6.5% SALES TAX.

DEALER INQUIRIES INVITED

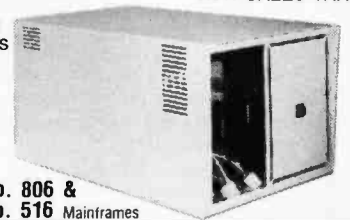

No. 806 & No. 516 Mainframes

6 SLOT MAINFRAME ASSY. & TESTED ONLY \$399.95 + SHIPPING \$18.00

EACH MAINFRAME (ITEM NO. 806 OR 516) CONTAINS: EMI FILTER • FUSE HOLDER • AC POWER CORD • POWER SWITCH & INDICATOR • RESET SWITCH • 4 1/2" COOLING FAN • S-100 BUS 6 SLOT CARD CAGE • (110/220 VAC, 50/60 Hz.) POWER SUPPLY FOR DISK DRIVES & S-100 SLOTS • 2 EA. DC POWER CABLES WITH CONNECTOR AND MOUNTING HARDWARE FOR DISK DRIVES • 9 EA. CUT-OUTS; 7 FOR DB25 CONNECTOR, 1 FOR 50 PIN CONNECTOR & 1 FOR CENTRONICS • CUSTOM FINISH & LOGO-LESS • COMPACT SIZE • LIGHTWEIGHT, 28 LBS. ITEM #806 FOR 2 EA. 8" THINLINE FLOPPY (TANDON TM848-1 & 848-2 OR EQUIV.), OR ONE HARD DISK, POWER SUPPLY: +8V/8A, ±16V/3A, +5V/5A OVP, -5V/1A & 24V/5A. SIZE: 12"(W) x 19.5"(D) x 9.8"(H). ITEM #516 FOR 2 EA. 5 1/4" FLOPPY (TANDON TM-100 - 1, 2, 3, 4 OR EQUIV.), OR ONE 5 1/4" FLOPPY & ONE 5 1/4" WINCHESTER HARD DISK (TANDON TM 600-2, 3 OR EQUIV.), POWER SUPPLY: +8V/8A, ±16V/3A OVP, +5V/6A OVP, +12V/6A, 8A PEAK. SIZE: 13.75"(W) x 19.5"(D) x 7"(H).

MAILING ADDRESS:
P.O. BOX 4296
TORRANCE, CA 90510
TELEX: 182558

SUNNY INTERNATIONAL
(TRANSFORMERS MANUFACTURER)
(213) 328-2425 MON-SAT 9-6

SHIPPING ADDRESS:
22129 1/2 S. VERMONT AVE
TORRANCE, CA 90502



**ATTENTION BIG BOARD USERS!
WHY USE OUTDATED TECHNOLOGY?**

**INSIGHT ENTERPRISES
IS NOW DELIVERING A NEW
STATE-OF-THE-ART CP/M Z80-A
SINGLE BOARD COMPUTER**

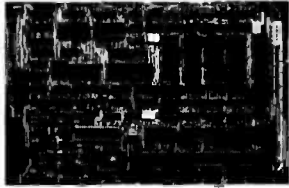

On board video • 128K of Dynamic RAM and 4K of STATIC (video memory) • DMA • SASI (hard disk interface) • Floppy disk controller (4 drives any combination of 5-1/4" or 8") • 4 serial ports • Full Centronics Printer port • Expansion bus • wide line and thin line graphics • Extended track buffer • Printer buffer • Fully interrupt driven • Parallel or Serial keyboard • Compact Size • (8x14 inches)

\$750.00 Single quantity OEM pricing 2-4 weeks delivery \$10.00 shipping

INSIGHT ENTERPRISES CORPORATION
373 N. Western Ave., Suite 12 Los Angeles, CA 90004 (213) 461-3262
Dealers OEM, International inquiries welcome
MANUFACTURING LICENSES ARE AVAILABLE WORLDWIDE UPON REQUEST

Circle 229 on inquiry card.

APPLEWARE, INC.

The Apple Users Group
Software Library Bonanza
At truly affordable prices!



For the first time enjoy your Apple to its fullest capacity using specially packed disks with over 60 outstanding programs each. [not available from any other source]

Each packed disk includes an extensive variety of interesting, useful and entertaining programs indispensable to all computerists! Each mixed category packed disk includes:

BUSINESS • EDUCATIONAL • DATA BASE • GAMES UTILITIES • SCIENCE • MUSIC • GRAPHICS • FINANCE
Library Disks I, II and III are mixed categories. Dedicated disks are:

• GAMES • UTILITIES • GRAPHICS • INTEGER • SCIENCE & TECHNOLOGY. Each packed disk is available for only \$59.95 each.

WHY PAY MORE?

Order direct from this ad and **Save up to \$150.** Buy Library Disks I, II and III and get a special bonus disk **FREE** over 260 programs for \$179.95 + \$3 shipping. For the best value, receive all 9 disks featuring over 600 of our best programs for **only 65¢ each** for a package price of only \$369. Postage Paid!

NEW! Business • Professional • Executive Package (enabling you to bring your business to its highest level of efficiency) also available. Circle Readers Service Card for our complete catalog.

For Orders Only Call now
TOLL FREE: 1-800-327-8664
Florida: 1-305-987-8665



Compatible with II, II+, IIe, IIx, IIcx, and Franklin Ace (For 3.3 DOS)

Circle 29 on inquiry card.

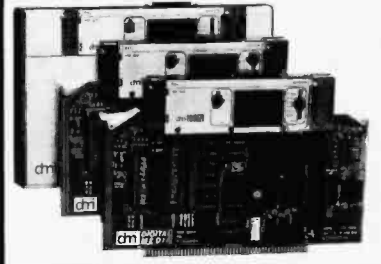

**NEW GENERATION OF
INTELLIGENT PAL/EPROM
PROGRAMMERS - FOR THE
NEW BREED OF ENGINEERS**

• 20 AND 24 PIN PALs • 27 AND 25 EPROMs • ROM EMULATION

DIGITAL MEDIA
3178 GIBRALTAR AVENUE
COSTA MESA, CA 92626
(714) 751-1373

Circle 146 on inquiry card.

**EXCLUSIVE - FREE
MANUFACTURER'S WARRANTY**

• Prices are the lowest available.

Model	Qty. 1	Qty. 2-10
FDD100-8	\$225	\$200
FDD200-8	\$275	\$250

*Additional quantity discounts available. With the FDD-200-8, you buy twice the storage capacity at a nominal cost increase.

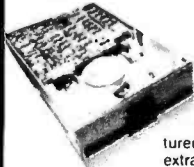

**Shugart-
Compatible Drives**

FDD100-8
FDD200-8

• No other company can offer the manufacturer's 90-day warranty at no extra charge.

- All warranty work is accomplished at the manufacturer's factory authorized service center.
- We ship from existing inventory.

Visa/Mastercharge

H&M Disk Drive Services

689 L South State College Blvd., Fullerton, CA 92631
(714) 526-1992/Call Collect Mail Order. Add \$7 Shipping. California residents add 6% sales tax

Circle 207 on inquiry card.

**Now, Interconnect Any
Two RS232 Devices**

American
Made

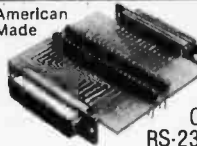

**WIRING
ADAPTER**
\$24.95

Connects any two RS-232 devices in any pattern. Temporary or permanent. Comes complete with ten plug-in jumper wires. Wiring Adapter just \$24.95 plus \$1.75 for postage and handling, (IL res. add 5% sales tax); we accept MC, Visa, and Purchase Orders from rated firms. Get FREE illustrated catalog of interface and monitoring equipment.



B&B electronics

P.O. Box 475 B • Mendota, IL 61342
Phone: (815) 539-5827

Circle 40 on inquiry card.

**FLOPPY
DISK-DRIVE
REPAIR**

Command Services exclusively repairs **Tandon** and **Shugart** disk drives. We are affordable, fast and experienced.

For service, call toll free:
1-800-782-5500
In New York State call:
1-800-323-1800

Command Services Corporation

7143 Henry Clay Blvd.
Liverpool, New York 13088
315-457-1432

Circle 78 on inquiry card.

SOURCE SOFTWARE

Professional-quality, CP/M compatible Z80 assembler accepts standard Zilog mnemonics as well as 19 pseudo-ops, prints a sorted symbol table, and can read from multiple input files. Modular structure allows easy revision as a cross-assembler

Complete source listing with detailed tutorial on theory of assemblers is contained in a 200-page manual. Professional techniques fully explained include Radix 40, binary search, expression processing by recursive descent, etc. Source code also available on a standard format 8" SSSD disk.

Manual with listing \$25
Manual and 8" disk \$50

(foreign orders add \$3 surface, \$10 airmail)

King Software
PO Box 208
Red Bank, N.J. 07701
(201) 530-7245

NJ residents please add 6% sales tax

Circle 257 on inquiry card.

**GLOUCESTER
COMPUTER**

PQ/64, all features of Promqueen less mimic mode. Software enhanced to include EPROM QC utilities, RS-232 communication, printouts, 28 pin ZIF socket.

Reads, edits runs and programs all 5 volt 2500 and 2700 series EPROMs plus variety of EEPROMs all without personality modules. Commodore C-64 host computer. Inquire about the mimic mode capability in our VIC Promqueen. **\$299.00**

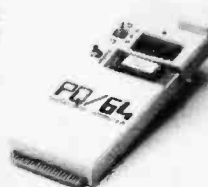

ROM Packs Industrial quality circuit cards are socketed, solder masked, fully bypassed, and include a ground plane for low noise operation. Includes 1 EPROM, 8K & 16K models for VIC-20 and C-64. Specify 2732 or 2764 EPROM type. Molded plastic case. **\$39.00**

GLOUCESTER COMPUTER
1 Blackburn Center, Gloucester, MA 01930 617-283-7719

Circle 201 on inquiry card.

**ANALOG ↔ DIGITAL
DIGITAL ↔ ANALOG**

CONVERSION MODULES

**SOFTWARE
GAIN CONTROL**

high accuracy amplifier	programmable gain instrumentation amplifier	custom board test \$100	2 to 15 kHz
conversion time from 1 to 1024	12 bit sample and hold amplifier	high accuracy amplifier	programmable gain instrumentation amplifier
8 channel differential amplifier	programmable gain instrumentation amplifier	conversion time from 1 to 1024	12 bit sample and hold amplifier
high accuracy amplifier	programmable gain instrumentation amplifier	conversion time from 1 to 1024	12 bit sample and hold amplifier
high accuracy amplifier	programmable gain instrumentation amplifier	conversion time from 1 to 1024	12 bit sample and hold amplifier
high accuracy amplifier	programmable gain instrumentation amplifier	conversion time from 1 to 1024	12 bit sample and hold amplifier
high accuracy amplifier	programmable gain instrumentation amplifier	conversion time from 1 to 1024	12 bit sample and hold amplifier
high accuracy amplifier	programmable gain instrumentation amplifier	conversion time from 1 to 1024	12 bit sample and hold amplifier
high accuracy amplifier	programmable gain instrumentation amplifier	conversion time from 1 to 1024	12 bit sample and hold amplifier
high accuracy amplifier	programmable gain instrumentation amplifier	conversion time from 1 to 1024	12 bit sample and hold amplifier

For additional details about the AD-100-4 and other fine California Data Corporation 100% individually tested, high reliability products, circle the reader service card number below or for faster response write or call us.

**CALIFORNIA DATA
CORPORATION**
3475 Old Conejo Road, Suite C-10
Newbury Park, CA 91320
(805) 498-3651

Circle 60 on inquiry card.

MICROMAIL™



IBM PC-COMplete SYSTEM VERY SPECIAL PRICE

64K, Two 320KB Disk Drives, Floppy Disk Controller
Video Card and High Res Monitor **\$2590**

SPECIAL OF THE MONTH!!

IBM PC W/64K, 360KB Disk Drive, FDC, Color Graphics
Card, Monitor, 10MB Hard Disk W/Controller, Cable,
Software, Matrix printer, Cable, all for only .. **\$3990**

TAVA PC

Desk Top IBM PC® Compatible Computer, 128K Ram,
Two 320KB Disk Drives, Floppy Disk Controller, Color
Graphics Card, One parallel Port, Two serial Ports,
High Res Monitor. System runs DOS 1.1; 2.0, and
CP/M86® **\$1995**

DISK DRIVES FOR IBM PC

Tandon 100-2 **\$240**
Slimline DS/DD 320KB **\$250**

MONITORS

AMDEK

300A \$190.00	I \$340.00
300G \$160.00	II \$690.00
310A \$190.00	III \$390.00
IV \$1190.00	

NEC

JB 1201M \$160.00	JC 1203 \$750.00
JC 1212M \$330.00	JB 1260 \$130.00

PRINCETON GRAPHICS SYSTEMS

Hi-Res Color **\$490**

PRINTERS

C-ITOH

GX-100 \$240	1550 \$690
8510 \$460	F-10 \$1290
F-10 \$1690	

DAISYWRITER 2000 **CALL**

OKIDATA

82A \$440	84A \$975
83A \$690	92A \$575
93A \$970	

EPSON

FX-80 **CALL**

SILVER REED

Printer **\$690**

BROTHER

HR-1 **\$750**
DX-15 **\$490**

SMITH CORONA

TP-1 **\$520**

STAR MICRONICS

Gemini 10 **CALL**
Gemini 15 **CALL**

NEC SPINWRITER

7710-1 \$2050	3510 \$1450
7715-1 \$2200	3515 \$1450
7720-1 \$2500	3530 \$1650
7725-1 \$2500	3550 \$1950
7730-1 \$2050	PC8023A \$550

HARD DISKS FOR APPLE AND IBM

..... **CALL**

MEMORY BOARDS

MONTE CARLO **CALL**

TECMAR **CALL**

AST

10 Plus. Five function Card **\$199**
Combo Plus. 4 function card. Fully pop. 256K **\$450**
Mega Plus. Fully pop. 512K **\$990**

AST SIXPAK 384K **CALL**

QUADRAM

Quad Card. Fully pop. 256K **\$450**

QUADLINK **CALL**

BIG BLUE **\$470**

HERCULES Graphics Card **\$490**

MAYNARD SANDSTAR SERIES

FDC 5 1/4 & 8" **\$220**

Multifunction Card **\$90**

Memory Card **\$180**

DISK DRIVE FOR APPLE

Slimline, or Standard **\$190**

APPLE IIe

Computer System, Controller, Two Disk Drives,
Monitor **\$1590**

MICROMAIL

631 E. First St., Tustin, CA 92680

PRICES AND AVAILABILITY SUBJECT TO CHANGE WITHOUT NOTICE

(714) 838-9100

APPLE is a trademark of Apple Computers, Inc.
IBM is a trademark of IBM Corp.
CP/M86 is a trademark of Digital Research, Inc.

MEMOREX FLEXIBLE DISCS

WE WILL NOT BE UNDER-SOLD! Call Free (800)235-4137 for prices and information. Dealer inquiries invited and C.O.D.'s accepted.

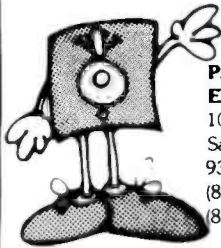

PACIFIC EXCHANGES
100 Foothill Blvd.
San Luis Obispo, CA
93401. In Cal. call
(800)592-5935 or
(805)543-1037

Circle 334 on inquiry card.

wabash®

Flexible Diskettes

6 Year Warranty - 100% Certified
DELIVERED PRICES

5 1/4" \$160 each SINGLE SIDE SINGLE DENSITY 48 TPI W/HUB RING Packed 10 per Soft Pack	BULK SSSD \$140 each 100/Case White Envelope W/HUB RING
5 1/4" \$189 each SINGLE SIDE DOUBLE DENSITY 48 TPI W/HUB RING Packed 10 per Soft Pack	BULK SSD \$170 each 100/Case White Envelope W/HUB RING
5 1/4" \$275 each DOUBLE SIDE DOUBLE DENSITY 48 TPI W/HUB RING Packed 10 per Soft Pack	BULK DSDD \$244 each 100/Case White Envelope W/HUB RING

Free shipping in continental USA. Call for quantity discounts. We accept money orders, certified checks, VISA and MasterCard. Personal checks accepted, but take two weeks to clear bank. N.D. add 4%.



Software Services™
1326 - 25th St. S., Suite D
 Fargo, ND 58103
1-800-634-2248

Circle 398 on inquiry card.

APPLE INSTRUMENT INTERFACE (DATA LOGGER)

- Converts your Apple into a Chart Recorder
- Analog input: 0-10mV, 0-100mV 0-IV 0.024% precision
- Chromatography, spectrophotometry pH, temperature etc. measurements
- Data storage, plotting, integration
- Menu driven
- All hardware and software included for introductory price of \$375.00

SCIENTIFIC COMPUTER INTERFACING
23585 Timothy Ct
Elkhart, IN 46514
(219) 262-1691

Circle 501 on inquiry card.

HOBBY ROBOT-X™

More SpecDroids™
from SPECTRON INSTRUMENT

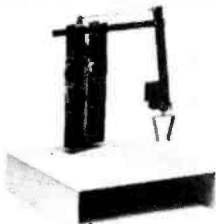

ROBOT IV..... KIT \$250
A traditional style robot arm. 3 axis with grip and wrist rotation. It compliments our ROBOT I by introducing motion in three dimensions with parts gripping and handling. It doesn't have the drawing and vision ability of our ROBOT I. Great for stacking sugar cubes, or for transferring to your coffee. With software for learn mode using VIC 20/64 and joystick. Includes 2 and 4 finger grippers. Optional vision and on module.

VISION SYSTEMS See Oct. and Nov. ad in BYTE.

VISION 1 PANORAMIC SCAN VISION KIT.....\$100

Many other vision systems. Ask for catalog.

SPECTRON INSTRUMENT
1342 W. Cedar Ave. Denver, CO 80223
Telephone (303) 744-7088



Circle 400 on inquiry card.

HOOKING IN

1984 EDITION - THE UNDERGROUND
COMPUTER BULLETIN BOARD WORKBOOK AND GUIDE

FIRST TIME BETWEEN TWO COVERS

No matter what type of computer you own, this book will get you on-line TODAY!
Complete information on computer bulletin board systems including:

- What they are (and what's happening).
- Kinds of information available.
- Public domain systems.
- Free software (and how to get yours).
- Blitz course in telecomputing.
- Buyer's guide to modems.

Over 400 verified listings. Periodically Updated. On-line Logbook. Electronic Mail Address Book. \$14.95 P.P. Make checks payable to:

Computer Food Press
Div. of Coltrane & Beach
31754 Foxfield Dr.
Westlake Village, CA 91361



Voice Orders—(213) 838-7716 Modern Orders—(213) 558-9033

HOOK IN NOW!!
SPECIAL OFFICE

When ordering, refer to this AD and receive your FIRST UPDATE FREE!

Circle 477 on inquiry card.

TYPED

of looking for reliable
Source of Supply?

RUN DOWN
from Looking???

NERVOUS
about

QUALITY??

**DISKETTES +
RIBBONS +
ACCESSORIES**



Call Bob Kelly Now...

Kelly Computer Supplies
1811 Carl St. • St. Paul, MN 55113
Toll Free... 800-447-2929
MN Res. Call Collect... 612/644-9030

MAXELL - DISKETTES

Circle 250 on inquiry card.

HOFACKER

Books • Software • Hardware Add-Ons • for your ATARI 600XL/800 XL, Commodore 64, VIC-20, Sinclair, Times, Apple II, Osborne/OSI

BOOKS for ATARI 400/500XL/800XL 1200XL
ATARI BASIC - Learning by Using
An excellent book for the beginner. Many short programs and learning exercises. All important features of the ATARI computers are described. Includes drawings, special sounds, keys, paddles, joystick, specialized screen routines, graphics, sound applications, peek, poke and special stuff.
Order No. 184 \$7.95
Small Business Software for all ATARI computers.
SUPERMAIL (500 addresses on 1 disk) Completely written in FORTH. Comes on auto-load disk. No carriage, no DOS, no FORTH language required.
Order No. 7312 \$49.00
SUPERINVENTORY (1000 items p/disk) Completely written in FORTH. Same as above. (Disk only)
Order No. 7200 \$49.00
BUSIPACK-1 (written in FORTH). Complete order entry, inventory, mailing and invoicing. (Disk only)
Order No. 7313 \$98.00
ATCASW
Convert your ATARI 800 into a powerful cash register. (Disk only)
Order No. 7303 \$49.95
Inventory program in BASIC
Order No. 7201 (CI) \$29.95
Order No. 7200 (OI) \$39.95
Mailing List in BASIC
Order No. 7212 (CI) \$19.95
Order No. 7211 (OI) \$24.95
Inventory control in BASIC
Order No. 7214 (CI) \$19.95
Order No. 7215 (OI) \$24.95
Dealer and Distributor inquiries are invited.
ELCOMP PUBLISHING, INC.
53 Research Lane
Pomona, CA 91768
Phone: (714) 622-8314, Telex: 20 81 91

Circle 167 on inquiry card.

SEE OUR CATALOG FOR 8" DISKETTES

SAVE UP TO 50%
5 1/4" DISKETTES



	\$/10	\$/50	\$/100
wabash			
SSDD (M1344-11X)	21.00	102.50	199.00
DSDD (M1444-11X)	29.00	142.50	279.00
DSDD-96TPI (M1564-11X)	43.00	209.00	410.00
control data			
SSDD (CDC1242-00)	22.00	106.00	210.00
DSDD (CDC1244-00)	30.50	147.00	290.00
3M scotch			
SSDD (3M 744-D-0)	22.00	109.00	213.00
DSDD (3M 745-D-0)	31.00	150.00	295.00
DSDD-96TPI (3M-747-0)	45.00	212.00	399.00
verbatim			
SSDD (VDS55-01)	25.20	124.00	245.00
DSDD (VDS50-01)	36.50	180.00	355.00
DSDD-96TPI (VDS57-01)	45.80	226.00	448.00
maxell			
SSDD (MAX-1M-1M)	26.50	130.00	255.00
DSDD (MAX-1M-2-DM)	38.00	185.00	360.00
DSDD-96TPI (M2-D3M)	43.00	210.00	410.00
dysan			
SSDD (DYS 104-1D)	35.00	172.00	340.00
DSDD (DYS 104-2D)	41.50	200.00	395.00
DSDD-96TPI (DYS 204-2D)	48.00	240.00	475.00

CALL TOLL FREE 800-824-7888

VISA, M.C., C.O.D. ORDERS ONLY OPERATOR 906

Creativity Unlimited 7 DAYS A WEEK

CHECKS, M.O., VISA, M.C. 1741 SARATOGA AVE., #201
- ADD \$2.00 SHIP/ORDER SAN JOSE, CA 95129
CA RESIDENTS ADD (408) 252-4210
6% SALES TAX (Outside USA: add 16% for shipping)
M-F, 8:00 AM TO 5:00 PM
SURCHARGE ON ORDERS SHIPPED OUTSIDE USA FOR NEXT DAY RESPONSE
FREE CATALOG

DEALER INQUIRIES INVITED

Circle 126 on inquiry card.

Attn: IBM P.C. USERS!

PeachText 5000™

PeachText 5000 has arrived. A complete personal productivity system for word processing, financial modeling and simple data-management. All at one price.

PeachText 5000 is available for a select list of microcomputers: The IBM Personal Computer™, the COMPAQ Portable Computer™, the Texas Instruments P.C.™, the Zenith Z-100™, and the Eagle P.C.™. Free 90 support from Peachtree S/W.

only \$275.00

- EDUWARE S/W available
- Terms: Visa, M.C. or C.O.D.
- Dealer Inquiries Invited

COMPU-MEDIA SOFTWARE, INC.
159 Main St. S.I.N.Y. 10307

CALL TOLL FREE 1-800-248-2418
In N.Y. State 212-967-1700



Circle 459 on inquiry card.

"THE ORIGINAL BIG BOARD"
OEM - INDUSTRIAL - BUSINESS - SCIENTIFIC
SINGLE BOARD COMPUTER KIT!
Z-80 CPU! 64K RAM!
 (DO NOT CONFUSE WITH ANY OF OUR FLATTERING IMITATORS!)

NEW!

NEW LOWER PRICES

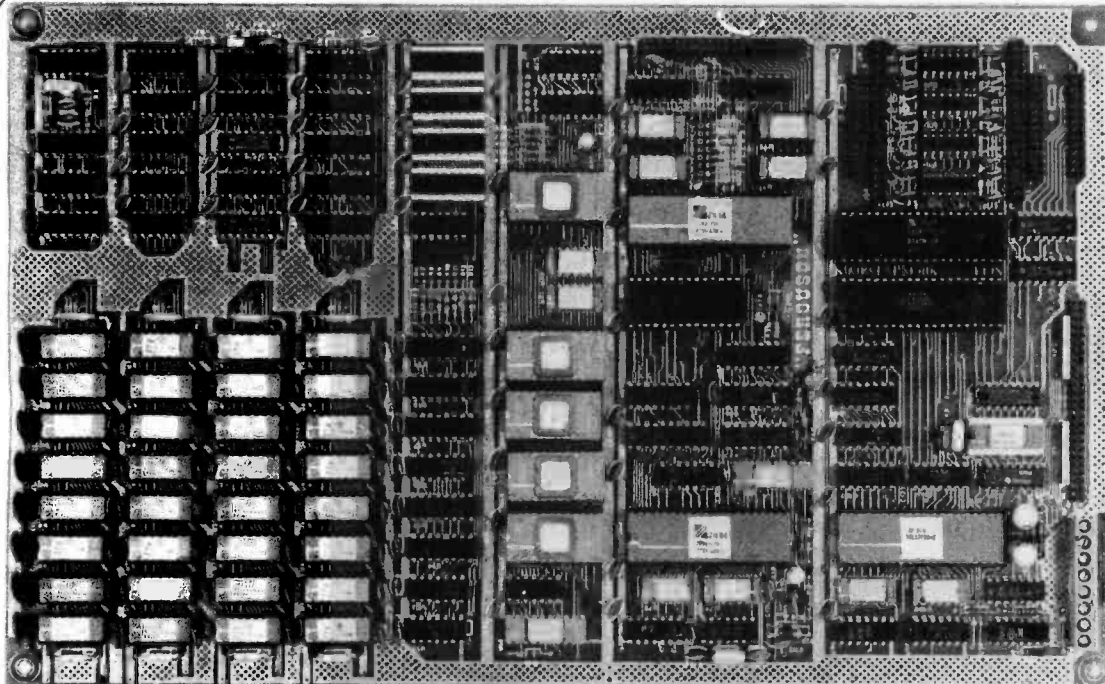

PARTIALLY ASSEMBLED KITS
 For All Sockets Installed
 And Soldered Add \$50.
 (Not For Blank PCB)

WANT MORE INFO?
 Full Documentation and
 Schematics — \$5.

THE BIG BOARD PROJECT: With thousands sold worldwide and over two years of field experience, the Big Board may just be one of the most reliable single board computers available today. This is the same design that was licensed by Xerox Corp. as the basis for their 820 computer.

The Big Board gives you the right mix of most needed computing features all on one board. The Big Board was designed from scratch to run the latest version of CP/M*. Just imagine all the off-the-shelf software that can be run on the Big Board without any modifications needed.

\$279.00 (64K KIT BASIC I/O)

SIZE: 8 1/2 x 13 3/4 IN.
 SAME AS AN 8 IN. DRIVE.
 REQUIRES: +5V @ 3 AMPS
 + - 12V @ .5 AMPS.

FULLY SOCKETED! FEATURES: (Remember, all this on one board!)

64K RAM
 Uses industry standard 4116 RAM's. All 64K is available to the user, our VIDEO and EPROM sections do not make holes in system RAM. Also, very special care was taken in the RAM array PC layout to eliminate potential noise and glitches.

Z-80 CPU
 Running at 2.5 MHZ. Handles all 4116 RAM refresh and supports Mode 2 INTERRUPTS. Fully buffered and runs 8080 software.

SERIAL I/O (OPTIONAL)
 Full 2 channels using the Z80 SIO and the SMC 8116 Baud Rate Generator. FULL RS232! For synchronous or asynchronous communication. In synchronous mode, the clocks can be transmitted or received by a modem. Both channels can be set up for either data-communication or data-terminals. Supports mode 2 Int. Price for all parts and connectors: \$39.95

BASIC I/O
 Consists of separate parallel port (Z80 PIO) for use with an ASCII encoded keyboard for input. Output would be on the 80 x 24 Video Display.

BLANK PC BOARD — \$99.95
 The blank Big Board PC Board comes complete with full documentation (including schematics), the character ROM, the PFM 3.3 MONITOR ROM, and a diskette with the source of our BIOS, BOOT, and PFM 3.3 MONITOR.

24 x 80 CHARACTER VIDEO
 With a crisp, flicker-free display that looks extremely sharp even on small monitors. Hardware scroll and full cursor control. Composite video or split video and sync. Character set is supplied on a 2716 style ROM, making customized fonts easy. Sync pulses can be any desired length or polarity. Video may be inverted or true. 5 x 7 Matrix - Upper & Lower Case.

FLOPPY DISC CONTROLLER
 Uses WD1771 controller chip with a TTL Data Separator for enhanced reliability. IBM 3740 compatible. Supports up to four 8 inch disc drives. Directly compatible with standard Shugart drives such as the SA800 or SA801. Drives can be configured for remote AC off-on. Runs CP/M* 2.2.

TWO PORT PARALLEL I/O (OPTIONAL)
 Uses Z-80 PIO. Full 16 bits, fully buffered, bi-directional. Uses selectable hand shake polarity. Set of all parts and connectors for parallel I/O: \$19.95

REAL TIME CLOCK (OPTIONAL)
 Uses Z-80 CTC. Can be configured as a Counter on Real Time Clock. Set of all parts: \$9.95

CP/M* 2.2 FOR BIG BOARD
 The popular CP/M* D.O.S. to run on Big Board is available for \$139.00.

DOUBLE DENSITY ADAPTER BOARD — \$149.95 (A&T)
 Requires no cuts or MODS to an existing Big Board. Gives up to 670K storage on a single sided 8 in. diskette. With software to patch your CP/M* 2.2.

PFM 3.3 2K SYSTEM MONITOR
 The real power of the Big Board lies in its PFM 3.3 on board monitor. PFM commands include: Dump Memory, Boot CP/M*, Copy, Examine, Fill Memory, Test Memory, Go To, Read and Write I/O Ports, Disc Read (Drive, Track, Sector), and Search PFM occupies one of the four 2716 EPROM locations provided. Z-80 is a Trademark of Zilog.

Digital Research Computers
 (OF TEXAS)
 P.O. BOX 461565 • GARLAND, TEXAS 75046 • (214) 271-3538

TERMS: Shipments will be made approximately 3 to 6 weeks after we receive your order. VISA, MC, cash accepted. We will accept COD's (for the Big Board only) with a \$75 deposit. Balance UPS COD. Add \$4.00 shipping.
 USA AND CANADA ONLY

**FOR YOUR APPLE,
RADIO SHACK,
IBM PC,
OSBORNE ETC.**



DISKETTES-5 1/4 IN.
3M MEMOREX
SSDD \$2.10 Ea./50 \$2.10 Ea./100
DSDD \$2.85 Ea./50 \$2.85 Ea./100

HARD DISC SUBSYSTEMS
5MB 10MB 15MB
APPLE \$1,250 \$1,500 \$1,700
IBM \$1,300 \$1,550 \$1,750

PRINTERS
FACIT 4510 P AND S \$450 Ea.
PROWRITER 8510 P \$395 Ea.
PROWRITER 1550 P \$695 Ea.
TRANSTAR 315 \$515 Ea.

We carry Daisy Wheel Printers, Floppy Disc Drives, Monitors, Terminals, Expansion Boards, Software, Ribbons, Printwheels, Etc.

Met-Chem



Met-Chem International Corporation
2911 Dixwell Avenue, Hamden, Conn. 06518
Phone: (203) 248-3212 or 1-800-638-2436

Circle 279 on inquiry card.

GARDEN OF EDEN



COMPUTERS
16485 Magnolia
Westminster, CA 92683



(714) 841-4994

***CREDIT ORDERS ONLY OUTSIDE CA*
800-762-3227**

PLEASE HAVE CREDIT CARD READY

HAYES 1200 BD
SMTMODEM 469.95
MICROMODEM //e (NEW) 269.95
OKIDATA 92 439.95
GEMINI 10X 279.95
SOURCE SUBSCRIPTION... 49.95
ADV. VISICALC //e 239.95
PFS: FILE, WRITE, RPT.,
GRAPH EACH 79.95

BUFFERED GRAPPLER+... 169.95
RANA ELITE I 239.95
RANA ELITE II 379.95
RANA ELITE III 479.95

CALL, WRITE, OR STOP IN FOR YOUR
FREE 42 PAGE PRICE LIST

F.O.B. WESTMINSTER, ADD 2% P.O./PLASTIC

Circle 197 on inquiry card.

TeleCOMM™ — A Complete Versatile, User-friendly & Telecommunicating ELECTRONIC MAIL

TeleVideo®, CP/M®, MP/M™, TurboDOS™ based Computers.
TeleCOMM provides you with the most efficient and cost-effective means of communicating between you and your branch office. Coworkers, friends or family via a local area network or nationwide telephone link.

- Multi-User Computers
- Password Protected Transactions
- Broadcasting and Forwarding
- Totally Menu-driven Functions
- Versatile Printing
- Save and Delete Letters
- Assembler Language
- E-COM Access
- Unlimited Users
- Send Letters/Messages/Programs
- Full Screen Editing
- Date: Month/Day/Year
- Automatic Prompt for Incoming Mail
- Attractive Video Attributes (TeleVideo)

Listed Price: \$495 Special Introductory Price: \$250

TeleWORD™ — WORD PROCESSOR

- CP/M Based & Modern Interfaced
- Built-in Operating System Commands
- Password Protected Transactions
- Page/Document Format
- Clipboard Processing
- Document Assembly and Merge
- Unlimited Undo Commands
- Screen Editing
- Prompt for Incoming Electronic Mail
- Multi-tasking (Concurrent Printing)
- Fully Menu-driven Functions
- Horizontal and Vertical Scroll
- Justifications and Indentations
- Calculator Mode
- Mailing List & Label/Envelope Printing
- Block Move and Delete

Special Introductory Price: \$95

TurboDOS™ — Free Consulting & Demo. Customized Drivers. Multuser: \$495

TeleHOST™ — Allows your terminal/computer to communicate with other computers/E-COM via telephone links. Price: \$95

TeleLIST™ — Mailing List Program. Prints Labels. Price: \$75

International Computers & Telecommunications, Inc.
932 Hungerford Drive, 16-B, Rockville, MD 20850
(301) 251-0062

Circle 230 on inquiry card.

4164 RAM

64K X 1 200 NS

SET 8/\$35.00

SET 9/\$39.00

100 \$3.95 Each
1,000 \$3.85 Each
5,000 \$3.75 Each
10,000 \$3.50 Each

Digital Deli

2632 W. Baseline
Mesa, AZ 85202
Attn: RAM DEPT.

(602) 831-5064

Circle 142 on inquiry card.

EXPRESS YOURSELF!

With beautiful silk-screened T-shirts & hats made just for **COMPUTER ENTHUSIASTS**

SHIRTS are hi-quality, U.S.-made & hand screened with your choice of:

COMPUTER JOCK COMPUTING HIGH-TECH HUMAN
SIZES BRANDED
(S2 athletic grey) (S4 navy) (S5 orange)

HATS are high-quality, mesh-back sport caps imprinted with your choice of:

PERSONAL COMPUTER COMPUTER JOCK ACTION POTENTIAL
(H1) (H2) (H3)

SPECIAL PRICE: \$7.00 each shirt or hat! Order a few for you, family & friends. Great gift!!! Child size, too!!!

HIS'N'HERS SPECIAL: Set of two burgundy shirts: one says "HARDWARE", other says "SOFTWARE". Only \$12/pair! (state sizes)

TO ORDER: SHIRTS come in S, M, L, & XL, or L Child. HATS come in Red or Blue. Send name, address, shirt size/hat color and imprint for each item. Add \$1/order (\$4 outside US) for P+H and mail to:

Make checks (US\$) ACTION POTENTIAL Dept. BY1 payable to: P. O. Box 069 Clayton, DE 19703

Satisfaction guaranteed or money back. Offer ends 1/31/84. Allow 3-7 weeks delivery.

Circle 10 on Inquiry card.

INFO PROBE

A Powerful Data Base Program for Scientific and Commercial Research



WITH GRAPHS AND STATISTICS INTERACTIVE, NO PROGRAMMING

\$445 For IBM-PC, CPM, RT11, TSX, VAX with money back guarantee

\$9. Full Featured Demo on Disc

Centre Computer Consultants
Box 739, State College, PA 16801
PHONE 814/237-4535

Circle 64 on inquiry card.

TDK
The heart of your system.

Dealer Inquiries invited

5 1/4" Soft Sector Box/10
M10-S 1 side/dbl dens. \$27.50
M20-S 2 sides/dbl dens. \$39.50
M20-X-S 2 side/quad 96 tpl. \$44.50

8" Soft Sector
F1-S 1 side/sgl or dbl dens. \$38.30
F20-S 2 side/dbl dens. \$44.50

Checks-VISA-MC-C.O.D./Add \$2 Shipping Call or write for our complete list.

LYBEN COMPUTER SYSTEMS

27204 Harper Ave., St. Clair Shores, MI 48081
Phone: (313) 777-7780

SAVE 50% ON TDK DISKETTES

Circle 271 on inquiry card.

PROMPT DELIVERY! AND TRY TO BEAT THESE IC PRICES:

DYNAMIC RAM		
64K	200 ns	\$ 5.65
64K	150 ns	5.95
64K	120 ns	6.27
16K	200 ns	1.56
EPROM		
27128	300 ns	\$19.20
2764	250 ns	5.99
2732	450 ns	4.25
2716	450 ns	3.60
2532	450 ns	4.75
STATIC RAM		
6264P-15	150 ns	\$38.00
6116P-3	150 ns	5.62
6117P-3	150 ns	4.20

MasterCard VISA or UPS CASH COD Factory New, Prime Parts MICROPROCESSORS UNLIMITED
24,000 South Peoria Ave BEGGS, OK, 74421 (918) 267-4961

Prices subject to change. Please expect higher prices on some parts due to world wide shortages. Call for volume prices. Subject to available quantities. Shipping & Insurance extra. Cash discount prices shown. Federal Express Standard Air - \$5.99. Orders received by 5 PM CST will be delivered to you by the next morning.

Circle 296 on inquiry card.

The INTELLIGENT GRAPHICS TERMINAL

All of this on a single S-100 board

- Full 512 color mapping palette
- TTL/analog RGB color or 8 level grey
- 680x480 4 color and/or 340x480 16 color
- Transparencies, overlays, multiple pages
- 8086, EPROM, 128K RAM expandable on-card
- Full editing terminal/graphics firmware
- Text throughput is greater than 2000 cps
- 10 windows, individually scrollable
- Programmable terminal formats to 113x40
- 64K x 64K virtual screen graphics with clipping and scale
- Drawn/filled circle, pie, arc, polygon
- Complex fill patterns and line styles

Low introductory prices: Assembled and tested \$895. Partial kit \$295.

Available soon: Fully integrated expansion card adds speech, sound effects, serial and parallel ports, and time-of-day clock.

Advanced Graphics Engineering
P.O. Box 3403, Reston, VA 22090
(703) 435-8110

Circle 14 on inquiry card.

FORMULA INTERNATIONAL INC.

12603 Crenshaw Blvd., Dept. B, Hawthorne, CA 90250

For information (213) 973-1921 • Orders Only (outside Calif.) (800) 672-8758



pinecom™

Pioneer of Low Cost Apple* Compatible Computer

No Copyright Infringements!

Compare These Features with Our Competitors:

- Powerful Utility Program (100% Apple Compatible)
- 68-Key Upper & Lower Case Keyboard with Numeric Keypad
- 25 Pre-programmed Function Keys
- 2 Speed Auto Repeat Function
- 64K User Memory—expandable to 192K
- 5A Switching Power Supply (110/220VAC)
- All ICs Are Socketed for Easy Service
- Nation-wide Dealer Network for Convenient Technical Support



**Now
with New
Improved
Keyboard
and 64K RAM
\$499⁰⁰**

And best of all, the price Assembled and Tested is just.



pinecom™ DP-64

- Dual Processor (6502 and Z80A)
- Detached Keyboard
- 64K RAM Expandable to 192K
- 25 Function Key Keyboard
- Auto Repeat Keys w/Upper/lower Case
- 2 Slim Disk Drives (optional)
- 100% Apple II Compatible
- 40/80 Column Display (optional)
- Runs Both Apple Soft and CP/M Software

Model DP-64 Fully Assembled ... **\$625⁰⁰**



AP-II COMPUTER A&T

Apple Look Alike
48K User Memory
Supports Upper & Lower Case
100% Apple II* Compatible

\$445⁰⁰

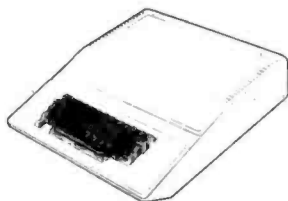

AP-II MOTHERBOARD

Apple II + * Compatible
48K Memory Space
8 Expansion Slots

Bare Board **\$69.95 ea.**
Assembled & Tested ... **\$295.00 ea.**

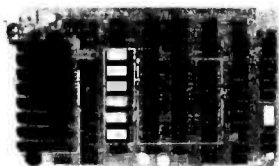

PRINTER by BMC

Parallel Interface (Centronics
Compatible) Standard
Microprocessor Electronics
80cps Bidirectional with Logic Seeking
96 Character ASCII
Adjustable Sprocket and Friction Feed

Model BX-80 **\$265⁰⁰**

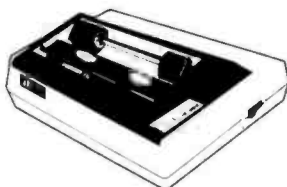

MICRO-II COMPUTER

100% Apple Compatible • No Copyright Problems!

Model I 48K RAM **\$475⁰⁰**

Model II 64K RAM **\$499⁰⁰**

Model III 64K RAM w/Dual CPU ... **\$545⁰⁰**
(6502 for Applesoft & Z80A for CP/M)

All above models are standard with Numeric Keypad, Function Keys, Auto Repeat Keys, Upper/lower Case Function, Fully Assembled and Tested.

PERIPHERALS

Autoterm 80-Col. w/Softswitch **\$99.95**
80-Column Card **99.95**
80-Column for Apple II* **49.95**
Z80 CP/M Card (no software) **99.95**
16K RAM Card **49.95**
Parallel Printer Interface **85.00**
Buffer for Printer Interface (16-64K) **85.00**
Serial Printer Interface Card w/Adj. Baud **85.00**
Disk Controller **65.00**
Disk Controller DOS 3.2/3.3 Auto Select. **75.00**
EPROM Writer Card (2716/2732/2764) ... **75.00**

**★ SEND ★
ONE DOLLAR
FOR OUR
DETAILED
CATALOG**

SEND ONE DOLLAR
FOR OUR DETAIL CATALOG

Inside California
Outside Calif. (incl. Mexico & Canada)
Overseas

Shipping & Handling Charges
Under \$50.00 Over \$50.00
Purchase Purchase
10% 5%
15% 10%
25% 20%

Minimum Order \$10.00/Calif. Residents
add 6.5% Sales Tax. Phone Orders Accepted
on VISA or MC ONLY. NO C.O.D.'s. Prices sub-
ject to change without notice.



**STORE HOURS
MON-FRI-10-7
SAT-10-6**

Circle #193 for dealer inquiries. Circle #194 for all others. *Apple and Apple II are the trademark of APPLE COMPUTERS, INC.

ZAM CONSULTANTS

SILVER STATE LIQ.

NEW & USED CPUs APPLE 11-E WITH 80 COLUMN CARD 64-K MEM 1 DISK.

NEW \$1,595
2nd DISK \$300
GEMINI 10 PRINTER \$355

ALL NEW EQUIPMENT



We carry many used CPUs & Peripherals. Visa & Master Card OK. Allow 3 wk. for personal check to clear.

CALL: (702) 294-0920
(702) 871-6565

Circle 463 on inquiry card.

Daisy Wheel Printer

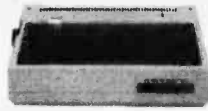

- 12/14 CPS
- 10/12/15 Pitch
- Parallel Interface

\$395

- Dynax DX-15 Daisy Wheel 13 cps ... \$CALL
- Silver Reed EXP 550 Daisy Wheel ... \$595
- Brother HR-1 Daisy Wheel 16 cps ... \$645
- Daisywriter 2000 w/48K ... \$1095
- C. Itoh F-10 40 cps ... \$1195
- Qume Sprint 11 Daisy Wheel 40 cps ... \$1395

MICRO MART

8764 Complex Dr., San Diego, CA 92123
(619) 268-0169

Circle 288 on Inquiry card.

PERIPHERALS FOR APPLE AND IBM(PC)

ONE YEAR WARRANTY ON ALL ITEMS
ALL PRODUCTS BUILT IN U.S.A.

	EACH	P.C.B.
APPLE/SHUGART DRIVE (5 1/4")	\$179	
DISK CONTROLLER (DOS 3.2-3.3)	59	\$ 19
80 COLUMN CARD (VIDEX EQUIVALENT)	139	29
80 COLUMN WITH 64K RAM (FOR 11e ONLY)	129	28
GRAPHIC PRINTER INTERFACE WITH 16K TO 64K BUFFER AND GRAPHICS	179	29
QUAD CARD (4 FUNCTIONS) (PARALLEL SERIAL BSR. CLOCK) (PRINTER GRAPHICS ROM)	159	33
Z80 SOFTCARD (MICROSOFT EQUIVALENT)	99	29
IBM(PC) BARE MOTHER BOARD		175
GEMINI 10X	289	
SILVER REED 500	459	
5 1/4" FLOPPY DRIVE ENCLOSURE	17	

COLORADO COMPUTER PERIPHERALS
THE P.C.B. COMPANY
R.R. 6, BOX 7-D GOLDEN, CO 80403
(303) 278-7172

Circle 76 on inquiry card.

LOOK at these prices!

AMDEK Color I ... \$289; Video 300 Green ... \$150
INTRAACTIVE Pkaso Card ... \$135; IDS Prism ... \$155
VIDEX Ultraterm ... \$289; Videoterm w/swch ... \$230
GRAPPLER + ... \$120; bufferboard (16K) ... \$125
HAYES:
MICROMODEM II ... \$255, w/Term. Prog. ... \$290
SMARTMODEM 300 ... \$219; 1200 ... \$489
SMARTMODEM 1200B w/Smartcom II ... \$455
EASTSIDE Wildcard ... \$105
SATURN Titan Combo Card 64K ... \$500
VISTA Floppy Drive 5 1/4" w/Contr. Card ... \$325
TYMAC Parallel Printer Card ... \$ 88
RANA Elite I ... \$280; II ... \$444; Contr. Card ... \$100

We Carry Ribbons & Diskettes @ Super Prices!

Payment: Money Order, Cashier's Check, Bank Wire:
Personal Checks—Allow 2 weeks clearance. C.O.D.s:
Cash/Certified Checks only. N.Y. Res.: Add 8 1/4% S.T.

Add \$5 shipping on all orders.
Please include phone number

Call or Write for Additional Specials.

MICRO MYSTIQUE

73-20 183rd St., Flushing, N.Y. 11366
(212) 454-6190

Circle 290 on inquiry card.

BIG STEPPER

Stepping-Motor Driver Box
Control Motion With Any Computer

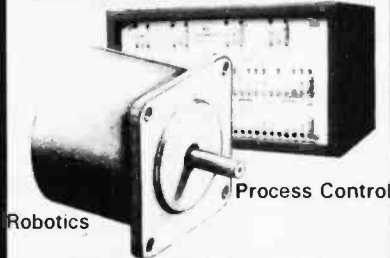

Robotics Process Control

HOOKUP AND GO!

Provides all required power

Drives 4 motors at up to 5 amps per winding
while sensing 8 limit switch inputs

PARALLEL "BIG STEPPER" ... \$450
SERIAL "SMART STEPPER" (RS232) ... \$850
STEPPING-MOTOR TIPS COOKBOOK ... \$8

Includes 3-D positioning program

Centre Computer Consultants (814) 237-4535
P.O. Box 739 State College, PA 16801

Circle 65 on inquiry card.

Dealer Inquiries

Disks 'n Things

Wabash

Low Low Prices!

maxell

213-706-8602
Pre-Paid Ship. C.O.D., MC, Visa
Credit For Direct Dial Call With \$50 Order

Disks 'n Things
5505 Softwind Way
Agoura Hills, CA 91301

Circle 151 on inquiry card.

SUPER PRICE SAVER

Apple 2E System \$1495.
IBM PC System 2595.
Dynax 449.
Gemini 10X 269.
Okidata 92/93 449./829.
NEC 8023 399.
NEC 3550 1895.
Amdex 300/310 135./167.
PI 3 148.
Rana I 259.
Tandon TM 100-2 249.
Teac Slim 5 1/2 Ile 249.
Panasonic Slim 5 1/4 IBM 249.
Anchor Mark XII 300-1200 289.
Hayes 1200/1200B 479./489.
Koala Ile 79.
Wesper IPI/BPO 69./159.
Quadram 64K 269.
Software 30% OFF CALL

Computer Price Club

16783 Beach Blvd., Huntington Beach, CA 92647

714-841-6160

Circle 107 on inquiry card.

This thing is weird...This thing is weird...This thing is weird...

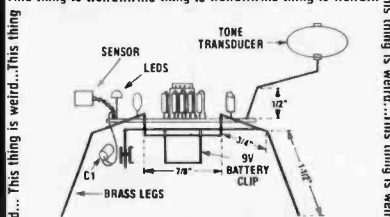

LIMIK

electronic bugs

Lim-ik (Lim 'iki n. 1. The generic term for a harmless species of electronic bugs. 2. A unique line of educational kits which teach you fundamentals in Op Amp design. 3. Interactive toys that make great 'pets' for your inquisitive children.

SA LIMIK — Sound Activated LIMIK responds to acoustical pressure waves, emits a cricket-like sound upon activation (kit)

PA LIMIK — Proximity Activated LIMIK responds to the presence of human beings, animals, or any other statically charged bodies that are moving. Sounds emitted are similar to a tree frog or a Cicada. Has an effective range of 5 to 20 feet, depending on environmental factors, such as temperature and humidity (kit)

To order, call (804) 740-8380 or send check or money order to MK Enterprises, 8911 Norwick Rd., Richmond, VA, 23228. Please include \$2.25 for shipping and handling. Va residents add 4% sales tax. We also make a line of unusual security sensors (Twilight, Infrared & Proximity) which can interface to your computer over 2 wires. Ask about our flyer

This thing is weird...This thing is weird...This thing is weird...

MEMOREX

SAVE 50% ON DATA RELIABLE DISCS

Dealer Inquiries Invited

5 1/4" Specify Soft	Box/10
3481 1 side/dbl dens.....	\$22.30
3491 2 sides/dbl dens.....	\$30.70
3504 1 side/quad 96 tpi.....	\$30.00
3501 2 sides/quad 96 tpi.....	\$39.30

8" Specify Soft or 32 Sector	
3062 1 side/sgl dens.....	\$22.10
3090 1 side/dbl dens.....	\$28.90
3102 2 sides/dbl dens.....	\$33.80

Checks-VISA-MC-C.O.D./Add \$2 Shipping
Call or write for our discount catalog.

LYBEN COMPUTER SYSTEMS
27204 Harper Ave., St. Clair Shores, MI 48081
Phone: (313) 777-7780

CERTIFIED 100% ERROR-FREE

Circle 272 on inquiry card.

DISPLAYED VIDEO IS DRIVING DOWN PRICES ON DISKS! FREE SHIPPING!

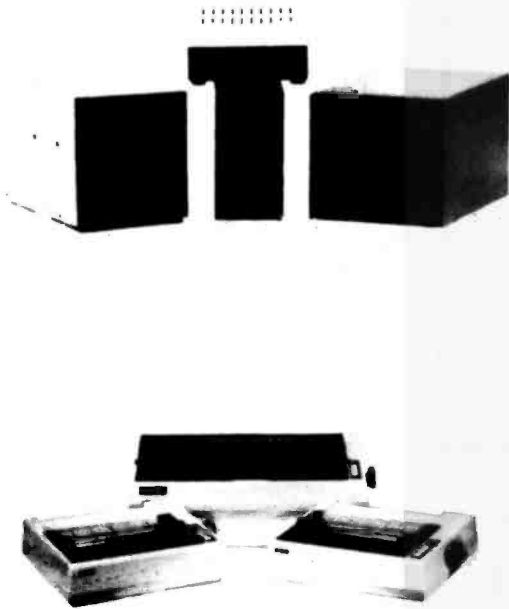

TEC'S NEW HALF-HIGH 40 TRACK DISK DRIVE W/CASE & POWER SUPPLY AT AN INCREDIBLE LOW PRICE! \$195.00!!!!

NEW! TRUE HALF HEIGHT DRIVES! 1 5/8 INCH NOT 2 INCH OR 2 7/16 INCH! DIRECT DRIVE! NO DRIVE BELT! 3MS TRACK TO TRACK!

- TEAC's New Slimline 40 Track w/case & power supply **\$235.00**
- Tandon 40 Track TM-100-1 w/case & power supply **\$220.00**
(DOUBLE SIDED 40 TRACK DRIVES ADD \$75.00)
- Shugart New Slimline Double Sided 40 Track w/case & P.S. **\$299.00**
- Shugart New Slimline Double Sided 80 Track w/case & P.S. **\$379.00**
- Tandon Single Sided Slimline 8" Disk Drive w/dual case & P.S. **\$545.00**
- Tandon Double Sided Slimline 8" Disk Drive w/dual case & P.S. **\$625.00**
- Two Drive 5 1/4" Cable (FOR MOST COMPUTERS) **\$23.99**
(WITH GOLD PLATED CONNECTORS)
- DV's Color Computer 1st Drive Only **\$389.00**
ONE YEAR WARRANTY ON TEAC & SHUGART DRIVES/180 DAYS ON TEC & TANDON
- Hayes Smart Modem 300 Baud..... **\$225.00** 1200 Baud..... **\$525.00**
- Model I Double Density Board **\$89.00**
- DV's Line Filter W/Surge Supression **\$45.00**
- Diskette File Box "Holds 70 Diskettes" **\$29.95**

PRINTER PRICES

- MX80 FT w/Graphtrax Plus. **\$459.00** Gemini 10 **\$349.00**
- MX100 w/Graphtrax Plus. **\$659.00** Gemini 15 **\$479.00**
- RX80 w/Graphtrax Plus. . . **\$389.00** Citoth Prowriter 8510. . . **\$395.00**
- FX80 w/Graphtrax Plus. . . **\$569.00** Starwriter F10. . . **\$1169.00**
- FX100 w/Graphtrax Plus. . . **\$779.00** Smith Corona TP1. . . **\$595.00**
- Printer Cable 10' long w/gold plated connectors starting at. . . **\$25.99**

DV'S EXCLUSIVE "YOU CANT LOSE" SIX MONTH WARRANTY!

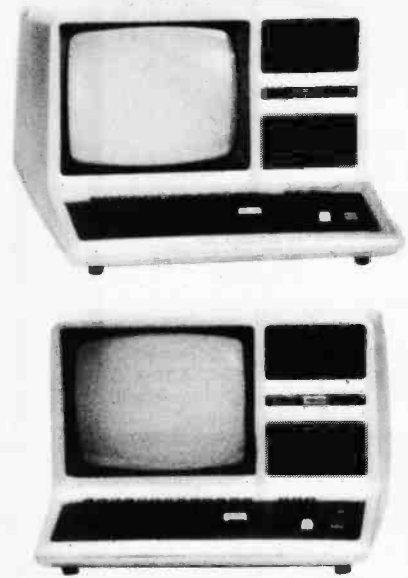

"NO YOU'RE NOT SEEING THINGS, THAT'S FOUR INTERNAL DRIVES IN A MODEL 4, WITH UP TO 4 MEG, DISK STORAGE AVAILABLE NOW!"

DV IS DRIVING DOWN PRICES ON DISK!

DISPLAYED VIDEO is now offering TRS-80' MODEL 4 with TANDON/TEC/TEAC disk drives, one of the most reliable disk drive systems on the market, for **INCREDIBLY** low prices.

- MODEL 4 with 64K dual 40 track double density disk drives, complete system with TRSDOS 6.0 and 1 BOX OF DISKETTES
PLUG IT IN AND GO \$1599.00/128K...\$1679.00
- MODEL 4 with 64K dual 40/40 track double density disk drives, complete systems with TRSDOS 6.0 and 1 BOX OF DISKETTES
PLUG IT IN AND GO \$1899.00/128K...\$1979.00
- MODEL 4 with 64K dual 80 track double density disk drives, complete systems with TRSDOS 6.0 and 1 BOX OF DISKETTES
PLUG IT IN AND GO \$1899.00/128K...\$1979.00
- MODEL 4 with 64K dual 80/80 track double density disk drives, complete systems with TRSDOS 6.0 and 1 BOX OF DISKETTES
PLUG IT IN AND GO \$2199.00/128K...\$2279.00
- MODEL 4 with 64K four 40 track double density internal disk drives, complete systems with TRSDOS 6.0 and 1 BOX OF DISKETTES
PLUG IT IN AND GO \$2299.00/128K...\$2379.00
- MODEL 4 with 64K four internal drives of any configuration available to achieve up to 4 meg of disk storage. **CALL**
- MODEL III/4 Internal Two Drive Kit: Includes controller board, dual drive mounting bracket, dual power supply, all hardware cable; and connectors (gold plated) & TEC Drive. **\$399.00**
- 4 DRIVE KIT MINUS DRIVE. **\$349.00**
- MODEL 100 8K. **\$679.00** 24K. **\$839.00**
- DV'S MODEL I DOUBLE DENSITY BOARDS. **\$89.00**

WE CARRY TRS-80, IBM, LNW, EPSON & FRANKLIN COMPUTERS

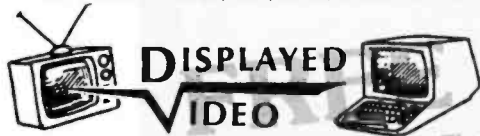

**IMMEDIATE DELIVERY
DV'S SIX MONTH
PARTS AND LABOR WARRANTY**

Visit our retail location at:
**111 Marshall Street
Litchfield, MI 49252
(313) 426-5086
(313) 482-4424
(517) 542-3280
(517) 542-3939
(517) 542-3947**

Authorized Dealership at:
111 Marshall Street, Litchfield, Michigan 49252 P142
To Order, Call (313) 426-5086; (313) 482-4424; (517) 542-3280
(517) 542-3939; (517) 542-3947
OR WRITE:

Displayed Video, 111 Marshall St., Litchfield, MI 49252

Circle 154 on inquiry card.

*TRS-80 is a trademark of the Tandy Corporation

Prices subject to change without notice.

Scorpion

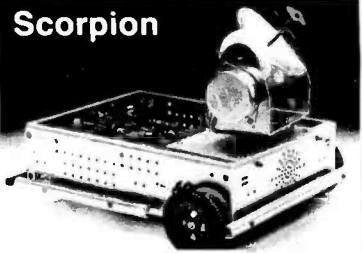

- 8K ROM
- 4 motors
- speaker
- ground scanner
- 2K RAM
- optical scanners
- 2 eyes
- control from any RS-232C interface

\$660.00 10% Rebate til 1/1/84
Manual only \$20 prepaid

RHINO
ROBOTS

P.O. Box 4010
2502 S. Neil
Champaign, IL
61820

Circle 368 on inquiry card.

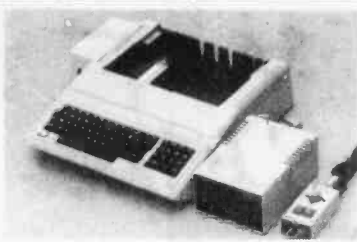

APPLE COMPATIBLE

Disk Drive \$150.00 ea.
Controller Card \$35.00 ea.
Computer Case \$55.00 ea.
Keyboard \$70.00 ea.
(Numeric and Function Keys)
Switching Power Supply .. \$49.50 ea.
Joystick (Heavy Duty) . . . \$17.50 ea.
Slim Fan \$25.00 ea.

Prices for dealers in quantities of 25 or more.
End Users Inquiries welcomed.

ELECTRADE CO. (408) 946-2541
780 Trimble Rd. Suite 605
San Jose, CA 95131

Circle 168 on inquiry card.

Radio Shack TRS-80™ Computers

At Guaranteed Savings

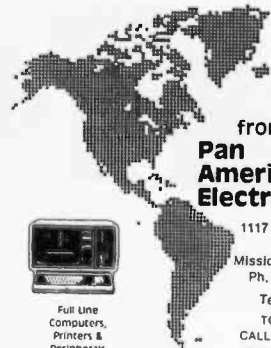

from
**Pan
American
Electronics**

1117 Conway Ave.
Dept. B
Mission, Texas 78572
Ph. 512/581-2766

Telex 767339
TO ORDER
CALL TOLL FREE
800-531-7466

Full Line
Computers,
Printers &
Peripherals

Circle 335 on Inquiry card.

GET FULLY VALIDATED
ADA* ON YOUR S-100
PERSONAL
COMPUTER
NOW!



Digicomp's
DELPHI-100

dual processor
system hosts the first validated
Ada for a microcomputer. Turn
your S-100 system into a work-
station for Ada training and
system programming.

CALL 1-800-457-6000
(NYS: 607-273-5900)
OR WRITE TO US TODAY.



Digicomp Research

Terrace Hill, Ithaca, NY 14850 607 273-5900

*ADA IS A REGISTERED TRADEMARK OF U.S. DoD (AJPO)

Circle 140 on inquiry card.

SL-MICRO

STATISTICAL LANGUAGE
for MICROCOMPUTERS

features

VALUE and VAR LABELS
DATA TRANSFORMATION
FREQUENCIES CROSSTABS
PEARSON CORR REGRESSION
CONDESCRIPTIVE

Only \$250. Manual \$15
Available for IBM PC, CP/M
or MS-DOS. Many Formats.

QSC BOX 23056
LANSING, MI 48909
PHONE (517) 641-4428

Circle 363 on inquiry card.

PASCAL ↔ DOS 3.3

NEW HIGH PERFORMANCE
UTILITY FOR APPLES®

TRANSFER TEXT, CODE AND DATA
FILES IN BOTH DIRECTIONS BETWEEN
DOS 3.3 AND UCSD® PASCAL

VIEW EITHER DIRECTORY (CATALOG)

FAST CONVERSION OF TEXT FILES

FAST TRANSFERS OF ALL FILES

SEND DOMESTIC
\$39.95 SHIPPING INCLUDED

INCLUDES DOCUMENTATION

PASDOS

LINNTON ELECTRONIC SYSTEMS
P.O. BOX 17612
PORTLAND, ORE 97217
503 286 0459

6801 Test Bed & Programmer

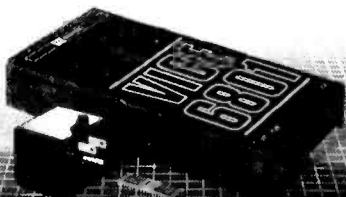

Virtual In-Circuit Emulator (VICE)
develops single-chip microcomputer
programs for the 6801/68701 and
programs on-board EPROM. A cost
and time effective way to program
the 6801/68701 for \$695.

WINTEK

Wintek Corp.
1804 South Street
Lafayette, IN 47904
317-742-8428

Circle 458 on inquiry card.

BIG SAVINGS Apple Compatible Closeouts

- Cooling Fan \$49
- 16K Ram Card 39
- Case 45
- Keyboard & Cable 69
- Mother Board 199
- Power Supply 59
- Disk Drive 195

CAL-COM

1109 BRIARWOOD
ANAHEIM, CA 92805
714-635-0768

Circle 59 on inquiry card.

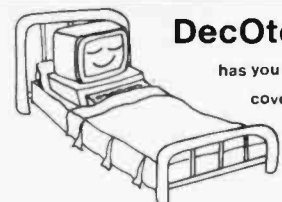

DecOtec™

has you
covered

DecOtec™ tailored covers extend the
life of your equipment by protecting
against dust, dirt, glitches and bugs.
Our covers can be tailored to fit ALL
equipment.

Write or call for free brochures and
estimates.

Dealer/OEM volume inquiries invited

DECOTECH™



P.O. Box 24449 Dept. B • Dayton, Ohio 45424
(513) 236-9923

Circle 137 on inquiry card.

Hewlett Packard

Write or call for prices.



SPECIALS on INTEGRATED CIRCUITS

6502	7.45	10/ 6.95	50/ 6.55	100/ 6.15
6502A/6512A	8.40	10/ 7.95	50/ 7.35	100/ 6.90
6520 PIA	5.15	10/ 4.90	50/ 4.45	100/ 4.15
6522 VIA	6.45	10/ 6.10	50/ 5.75	100/ 5.45
6532	7.90	10/ 7.40	50/ 7.00	100/ 6.60
2114-L200		2.45	25/ 2.30	100/ 2.15
2716 EPROM		4.45	5/ 4.20	10/ 3.95
2532 EPROM		5.90	5/ 5.75	10/ 5.45
6116 2Kx8 CMOS RAM		6.45	5/ 6.20	10/ 5.95
4116 RAM				8 for 14
4164 RAM				6.50
Zero Insertion Force 24 pin Socket (Scanbe)				2.00

Anchor Automation Signalman Modems

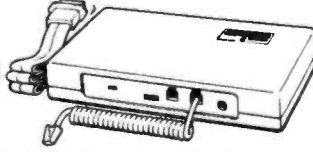

FREE SOURCE MEMBERSHIP WITH SIGNALMAN
All Signalman Modems are Direct Connect, and include cables to connect to your computer and to the telephone. Signalman Modems provide the best price-performance values.

Dealer and OEM inquiries invited

Volksmodem	(79)	59
RS232 or Atari Cable for Volksmodem		9
Mark VII for IBM Personal Computer	(279)	179
Mark VII Auto Dial/Auto Answer	(159)	99
Mark XII Smart Model 1200/300	(399)	299
DC HAYES Smartmodem		219
DC Hayes Smartmodem 1200/300		529

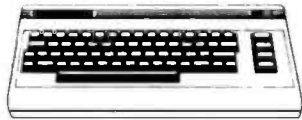

PROM QUEEN for VIC	170
Apple Emulator for Commodore 64	Call
STAT Statistics Package for C64	95
Solid Oak 2 Level Stand for C64 or VIC	29
C64/VIC Switch (networking)	125
BACKUP VI.O tape copier for C64 or VIC	20
CARDBOARD/6 Motherboard - VIC	64
CARDBOARD/5 Motherboard - C64	56
CARD PRINT G Printer Int. with Graphics	72
CARD PRINT B Printer Interface—C64/VIC	40
CARDBOARD/3s Motherboard - VIC	22
CARDCO C64/VIC Calculator Keypad	32
CARDRAM/16 RAM Expansion - VIC	44
Complete CAROCO Line in stock	
CIE and VIE IEEE Interfaces in stock	
MSO SuperDrive for C64 or IEEE	365
MAE Assembler for C64	50

APPLE—FRANKLIN ITEMS

KRAFT Apple Joystick	40
Kraft Apple Paddle Pair	30
SPINNAKER Software in stock	
Broderbund Software in stock	
16K RAM Card for Apple	59
Multiplan—Microsoft	185
Solid Oak 2 Level Stand for Apple	29
Serial Card for Apple	99
MCP RAM/80 column card for IIe (AP/TXT)	139
Z80 Softcard and CP/M (Microsoft)	235
RANA Elite I with Controller	389
Parallel Printer Interface/Cable	69
Microtek Interfaces in stock	
Apple Dumping with 16K Buffer	160
Grappler + Interface	129
Kraft Products for Apple in stock	
DC Hayes Micromodem II	299
PFS: File	95
PFS: Report	95
Videx 80 Column Card	209
Hayden Software for Apple 20% OFF	
Apple Blue Book	19

Commodore

See us for Personal, Business, and Educational requirements. Educational Discounts available.

PETSCAN I \$245 base price

Allows you to connect up to 30 CBM/PET Computers to shared disk drives and printers. Completely transparent to the user. Perfect for schools or multiple word processing configurations. Base configuration supports 2 computers. Additional computer hookups \$100 each.

COMPACT/STCP \$115

Intelligent Terminal Package for PET, CBM, C64
Includes ACIA Hardware / STCP Software

VIC/C64 Switch—Networking 125

Allows 8 computers to share drive and printer.

SCREENMAKER 80Column Adapter for C 64 145

Provides big screen capability for business applications.

GENESIS Computer Corp

VICController (for C64 as well) 50

combine with BSR modules for home or business control

COMSENSE Remote Sensing Adapter for C64 or VIC 35

COM VOICE Synthesizer for C64 or VIC 139

includes software for text to speech, pitch, etc.

COM CLOCK Real Time Clock with battery backup 45

VIC 20 Products and Software in stock

Thorn EMI Software	UMI Software
ABACUS Software	HES Software
16K RAM for VIC	64 Vanilla Pilot
	27

VICTORY Software for VIC and C 64

Street Sweepers (VIC)	12	Kongo Kong (VIC)	16
Night Rider (VIC)	11	Cosmic Debris (VIC)	12
Annihilator	16	Adventure Pack I	16
Adventure Pack II	16	Metamorphosis	11
Educational Pack I	11	Trek	12
Strategy Pack I	16	Grave Robbers	12

PAPER CLIP Word Processor 109

ORACLE Data Base from Batteries Included 125

Super BusCard from Batteries Included 179

Commodore 64 Programmers Reference Guide 16

MicroChess for C64—8 levels of play 19

excellent graphics and color

SPINNAKER Software C64, Apple, IBM, Atari 11

Compute!'s First Book of PET/CBM 125

C64 or VIC SWITCH 78

POWER ROM Utilities for PET/CBM 85

WordPro 3+/64 with Spellmaster 279

WordPro 4+ - 8032,disk, printer

SPELLMASTER spelling checker for WordPro 189

VISICALC for PET, ATARI, or Apple 40

PET-TRAX PET to Epson Graphics Software 40

SM-KIT enhanced PET/CBM ROM Utilities 35

Programmers Toolkit - PET ROM Utilities 135

Calc Result Advanced—C64 65

EASY CALC for C64 36

PET Spacemaker II ROM Switch 49

COPYWRITER Word Processor for C64 40

2 Meter PET to IEEE or IEEE to IEEE Cable 8

Dust Cover for PET, CBM, 4040, or 8050

CmC Interfaces (ADA1800, ADA1450, SADI in stock)

Programming the PET/CBM (Compute!)—R West 20

Compute! First Book of VIC 11

OMNICALC (HES) 79

HES MODEM with Software 65

HES Software and Hardware in stock

UMI products in stock

FlexFile for PET/CBM/ C64 \$110

Database, Report Writer with calculations, Mailing Lists.

FORTH for PET/C64 full FIG model—Cargill/Riley \$50

Metacompiler for FORTH for independent object code 30

KMMM PASCAL IV.1 for PET/C64 99

EARL for PET/CBM Disk-based ASSEMBLER 65

Super Graphics — BASIC Language Extensions 45

Fast machine language graphics routines for PET/CBM

RAM/ROM for PET/CBM 4K \$75 8K \$90

Commodore Public Domain Software for C64 75

DISK SPECIALS



Scotch (3M) 5" ss/dd	10/ 2.20	50/ 2.00	100/ 1.95
Scotch (3M) 5" ds/dd	10/ 3.05	50/ 2.80	100/ 2.75
Scotch (3M) 8" ss/ss	10/ 2.30	50/ 2.10	100/ 2.06
Scotch (3M) 8" ss/dd	10/ 2.85	50/ 2.70	100/ 2.65

We stock VERBATIM DISKS

Write for Dealer and OEM prices.

Sentinel 5" ss/dd	10/ 1.90	50/ 1.85	100/ 1.80
Sentinel 5" ds/dd	10/ 2.55	50/ 2.50	100/ 2.45

We stock Dyan disks

Wabash 5" ss/ss	10/ 1.60	50/ 1.55	100/ 1.45
Wabash 5" ss/dd	10/ 1.90	50/ 1.85	100/ 1.75
Wabash 8" ss/ss	10/ 2.00	50/ 1.95	100/ 1.85

We stock MAXELL DISKS

Write for dealer and OEM prices.

Disk Storage Pages	10 for \$5	Hub Rings 50 for \$6
Disk Library Cases	8"—3.00	5"—2.25
Head Cleaning Kits	11	

CASSETTE TAPES—AGFA PE-611 PREMIUM

C-10	10/ .61	50/ .58	100/ .50
C-30	10/ .85	50/ .82	100/ .70

DATASHIELD BACKUP POWER SOURCE \$265

Battery back up Uninterruptible Power Supply with surge and noise filtering. The answer to your power problems.

MultiPlan—IBM or Apple 185

Quadboard for IBM available

Peachtext 5000 Software Package 219

PFS Software for IBM and Apple in stock

VOTRAX Personal Speech System 280

BMC 9191 Color Monitor 229

BMC 12A 12" Green Monitor 85

Dynax (Brother) DX-15 Daisy Wheel Printer 469

Itoh Prowriter Parallel Printer 379

Panasonic 1090 Printer with Correspondence Mode

Daisywriter 2000 with 48K buffer 1050

Gemini 10X 299

EPSON, Dkidata, other printers in stock

USI CompuMDD 4 R F Modulator 29

We Stock AMOEK Monitors

Amdek DXY-100 Plotter 590

A P Products 15% OFF

Watanabe Intelligent Plotter 990 6-pen 1290

BROOKS 6 Outlet Surge Suppressor/Noise Filter 54

Electrohome 1302-2 13" Hi-res RGB Monitor 335

Panasonic 12" Monitor (20 MHz) with audio 139

Synertek SYM-1 Microcomputer 189

ALL BOOK and SOFTWARE PRICES DISCOUNTED

USI Video Monitors—Green or AMBER 20 MHz hi-res.

Dealer and OEM inquiries invited



ZVM-122A	109	ZVM-123G	99
ZVM-131	300	ZVM-135	510
HERO 1 Robot (factory assembled)			2145
Z29 Terminal (DEC and ADM compatible)			680
ZT-10 Intel. Terminal with Serial Port			340
Z100 16-bit/8-bit Systems			CALL

We stock entire Zenith line.



WE STOCK ENTIRE LINE—write for prices.

SPINNAKER and Broderbund Software in Stock

215-822-7727
252 Bethlehem Pike
Colmar, PA 18915

A B Computers

WRITE FOR CATALOG. Add \$1.50 per order for United Parcel. We pay balance of UPS surface shipping charges on all prepaid orders (add extra for mail, APO/FPO, air). Prices include cash discount. Regular prices slightly higher. Prices subject to change.

SUPER-FAST! Z80 DISASSEMBLER \$69.95

Uses Zilog Mnemonics, allows user defined labels, strings, and data spaces. Source or listing-type output with Xref to any device. Available for Z80 CP/M or TRS-80.

SLR Systems
200 Homewood Drive
Butler, PA 16001
(412) 282-0864

Add \$2.00 shipping. Specify format required. Check, money order, VISA, Master Card, C.O.D. PA residents add 6% sales tax. Dealer Inquiries Invited. CP/M, TRS-80 TM of Digital Research, Tandy Corp.

Circle 389 on inquiry card.

wabash®

When it comes to
Flexible Disks, nobody
does it better than
Wabash.

MasterCard, Visa Accepted.
Call Free: (800) 235-4137



PACIFIC EXCHANGES
100 Foothill Blvd
San Luis Obispo, CA
93401 (In Cal call
(805) 543-1037)

Circle 334 on inquiry card.

SINGLE-CHIP MICROCOMPUTER BOARDS & KITS

- 8048/8049/8050/8748
- 8035/8039/8040/8749
- 8031/8051/8751
- 6511Q/6500/11/12/13
- 6501Q/6541Q

Boards from \$24.95
Kits from \$55.95

TECH STAR LABORATORY
Suite 504, R&B Corp. Park
1701 N Greenville Ave.
Richardson, TX 75081

Circle 419 on inquiry card.

PROGRAMMABLE COMMUNICATIONS TRANSLATOR

THE PCT-100 IS A CONFIGURABLE IN-LINE RS-232 PROTOCOL AND DATA TRANSLATOR. THE PCT-100 CAN PROVIDE:

- TERMINAL OR PRINTER EMULATION
- DEC OR IBM SYSTEM COMPATIBILITY
- MACRO-FUNCTION KEYS
- "TYPE-AHEAD" AND DATA BUFFERING
- BAUD RATE CONVERSION
- HANDSHAKE PROTOCOL TRANSLATION (E.G. CTS/RTS, XON/XOFF)

THE PCT-100 IS CONFIGURED USING A BUILT-IN COMMUNICATIONS TRANSLATION LANGUAGE. PROGRAMS CAN BE EASILY ENTERED & EDITED FROM ANY ASCII DEVICE.

PCT-100-PCB (PCB ONLY).....\$ 289
PCT-100-ASM (PCB w/ CASE)..\$ 339
PCT-512-MOD (POWER SUPPLY)..\$ 59



MSI



METHOD SYSTEMS INCORPORATED
19751 SOUTH LAKESHORE BOULEVARD
EUCLID, OHIO 44119
(216) 531-0404

Circle 280 on inquiry card.

SMAL/80

SMAL/80	Assembler
HL=M (PTR);	LHLD PTR
DE=9;	LXI D,9
HL=HL+DE;	DAD D
IF A=L EQUAL	CMP L
THEN	JNZ L1
A=A-14	SUI 14
ELSE	JMP L2
A=L;	L1: MOV A,L
M (BC)=A;	L2: STAX B

New! Z-80 version (runs on 8080's): \$175. 8080 version only: \$150. Macro-processor only: \$75. Available on CP/M disks. Add \$4 for shipping. Complete tutorial text: "Structured Microprocessor Programming" (Publ; Yourdon Press) \$20 plus \$2 shipping. Send for your free button and literature or try the Ultimate Demo: SMAL/80 is Guaranteed!

Chromod Associates,
1030 Park Ave., Hoboken, N. J. 07030
Telephone: (201) 653-7615

Circle 69 on inquiry card.

Now... You Can Monitor 7 Most Important RS-232 Interface Lines



Made in America

RS-232-INTERFACE TESTER

connects in series with any RS-232 interface. LED's clearly display status of 7 functions: transmit data, receive data, request to send, clear to send, data set ready, carrier detect, data terminal ready. Requires no power; may be left in permanently. Satisfaction guaranteed. ORDER NOW! Only \$39.95 plus \$1.75 for postage and handling. (IL res. add 5% sales tax); we accept MC, Visa. FREE: Illustrated catalog of problem detecting equipment. Phone 815/539-5827. Make checks payable to:

B & B electronics
Box 475 B, MENDOTA, IL 61342

Circle 41 on inquiry card.



SAVE MORE THAN EVER ON 3M Scotch DISKETTES!

\$1.95 ea. 5 1/4" SSDD (744) Qty. 20
\$2.70 ea. 5 1/4" DSDD (745) Qty. 20

5 1/4" SSDD—96TPI (746)\$2.89 ea.
5 1/4" DSDD—96TPI (747)\$3.95 ea.
(Specify soft, 10 or 16 sector.)

8" SSDD (740)\$2.07 ea.
8" SSDD (741)\$2.54 ea.
8" DSDD (743)\$3.30 ea.
(Specify soft or 32 sector.)

Lifetime Warranty!
3M HEAD CLEANING KITS\$23.00

Save even more on quantity orders!
Minimum Order: 20 diskettes. Add \$3.00 shipping per 200 diskettes. C.O.D. charge \$1.65 additional.
Visa • MasterCard • Checks

For fast service, call
DISK WORLD!
Nationwide: 1-800-621-6827
In Illinois: 312-944-2788

Suite 4806 • 30 E. Huron Street • Chicago, Illinois 60611

Authorized Distributor
Information Processing Products



Circle 152 on inquiry card.

COMPUTER INTERFACES



Convert your electronic typewriter to a letter-quality computer printer! Available for Olivetti Praxis 30,35, 40, & 41 and Adler/Royal 1005, 1010, 1011/5005, 5010, 5011.

- Centronics parallel or RS-232C serial
- Easily installs inside typewriter
- Compatible with most computers
- Cable assemblies available
- Prices start at only \$149.

Selectone

28301 Industrial Blvd.
Hayward, CA 94545

CALL TOLL FREE
800-227-0376
800-421-5389 (In CA)

Circle 384 on inquiry card.

DataStar™ and your Fortran

HAVE THE BEST OF BOTH WORLDS—DataStar's powerful data input, sorting, and editing, and your Fortran programs to perform sophisticated data processing. With DSUBS, simple subroutine calls are all that are needed to read, write, and update DataStar data and index files.

SUPER DEAL: UTILITY package that includes numerous string processing, terminal control, CP/M BDOS and BIOS calls, character and number I/O, etc., and the DSUBS package, along with programming examples and thorough documentation, all for \$99.

Random Access, Inc.
P.O. Box 2094
Bloomington, IN 47402
(812) 339-5854



DataStar is a trademark of MicroPro Int.
CP/M is a trademark of Digital Research.

Circle 367 on inquiry card.

7400

7400	19	74125	39
7401	22	74126	44
7402	22	74128	59
7403	22	74132	69
7404	22	74136	75
7405	23	74139	95
7406	2.35	74141	79
7407	2.35	74142	2.95
7408	26	74143	2.95
7409	23	74144	2.95
7410	22	74145	62
7411	29	74147	1.95
7412	29	74148	1.20
7413	39	74150	1.09
7414	59	74151	67
7416	29	74152	67
7417	29	74153	67
7420	22	74154	1.19
7421	35	74155	78
7422	29	74156	78
7423	29	74157	69
7425	29	74158	1.65
7426	29	74159	2.49
7427	25	74160	88
7429	45	74161	88
7430	23	74162	89
7432	29	74163	87
7437	25	74164	87
7438	29	74165	87
7439	29	74166	1.20
7440	19	74167	1.95
7441	79	74170	1.69
7442	57	74172	4.75
7443	95	74173	79
7444	95	74174	89
7445	79	74175	85
7448	79	74176	75
7447	65	74177	75
7448	79	74179	1.34
7450	19	74180	75
7451	19	74181	1.75
7453	19	74182	75
7454	19	74184	2.25
7459	25	74185	2.25
7460	23	74186	9.95
7470	29	74188	3.90
7472	29	74190	1.15
7473	34	74191	1.15
7474	34	74192	85
7475	38	74193	85
7476	34	74194	85
7479	4.60	74195	68
7480	49	74196	85
7482	95	74197	85
7483	55	74198	1.39
7485	65	74199	1.39
7486	35	74221	1.19
7489	1.75	74251	95
7490	39	74273	1.05
7491	57	74276	1.89
7492	45	74279	75
7493	45	74283	1.40
7494	69	74284	3.90
7495	65	74285	3.90
7496	69	74290	1.25
7497	2.90	74298	95
74100	2.90	74305	68
74107	32	74366	68
74109	37	74367	68
74116	1.95	74368	68
74121	29	74390	1.45
74122	39	74393	1.90
74123	59	74490	1.90

74LS00

74LS00	26	74LS162	1.05
74LS01	26	74LS163	1.05
74LS02	28	74LS164	1.19
74LS03	28	74LS165	89
74LS04	35	74LS166	2.48
74LS05	28	74LS168	1.15
74LS08	28	74LS169	1.15
74LS09	35	74LS170	1.99
74LS10	28	74LS173	89
74LS11	39	74LS174	89
74LS12	33	74LS175	89
74LS13	47	74LS181	2.20
74LS14	95	74LS190	1.15
74LS15	35	74LS191	1.15
74LS20	26	74LS192	98
74LS21	33	74LS193	98
74LS22	33	74LS194	1.15
74LS26	33	74LS195	95
74LS27	33	74LS196	89
74LS28	33	74LS197	89
74LS30	26	74LS221	1.15
74LS32	33	74LS240	1.69
74LS33	55	74LS242	1.69
74LS37	45	74LS243	1.69
74LS38	39	74LS244	1.49
74LS40	26	74LS245	2.20
74LS42	79	74LS247	1.10
74LS47	79	74LS248	1.10
74LS48	95	74LS249	1.19
74LS51	26	74LS251	1.40
74LS54	29	74LS253	1.40
74LS55	29	74LS257	85
74LS73	45	74LS258	98
74LS74	42	74LS259	2.95
74LS75	59	74LS260	65
74LS76	45	74LS261	2.49
74LS78	45	74LS266	59
74LS83A	79	74LS273	1.75
74LS85	1.19	74LS275	4.40
74LS86	45	74LS279	59
74LS90	57	74LS283	99
74LS92	75	74LS290	99
74LS93	75	74LS293	99
74LS95	88	74LS295	1.10
74LS96	98	74LS298	1.19
74LS107	45	74LS324	1.75
74LS109	45	74LS347	1.95
74LS113	43	74LS348	1.95
74LS114	43	74LS352	1.19
74LS122	55	74LS363	1.19
74LS129	1.19	74LS363	1.19
74LS134	1.35	74LS365	69
74LS125	89	74LS366	69
74LS126	52	74LS367	69
74LS132	79	74LS368	69
74LS136	49	74LS373	1.89
74LS138	85	74LS374	1.89
74LS139	85	74LS375	69
74LS145	1.25	74LS377	95
74LS148	1.49	74LS385	1.95
74LS151	79	74LS386	65
74LS153	79	74LS390	1.95
74LS154	1.70	74LS393	1.95
74LS155	1.19	74LS395	1.70
74LS156	99	74LS399	2.35
74LS157	85	74LS424	2.95
74LS158	75	74LS568	1.75
74LS160	1.05	74LS567	2.29
74LS161	1.15	74LS378	1.95
74LS133	65	74LS379	1.95
74LS241	1.69	74LS381	2.95
74LS280	2.90	74LS640	2.95
74LS299	2.00	74LS645	2.95
74LS339	1.95	74LS690	1.50

Tel: 1-(800)-821-3628

74S00

74S00	39
74S02	43
74S03	45
74S04	52
74S05	52
74S08	49
74S09	49
74S10	42
74S11	42
74S15	42
74S20	42
74S22	42
74S30	42
74S32	49
74S38	1.19
74S40	49
74S51	42
74S64	46
74S65	46
74S74	69
74S86	72
74S112	72
74S113	72
74S114	72
74S124	3.69
74S133	54
74S134	66
74S135	1.15
74S136	1.69
74S138	1.29
74S139	1.29
74S140	73
74S151	1.29
74S153	1.29
74S158	1.29
74S160	2.70
74S174	1.49
74S175	1.49
74S188	2.69
74S194	1.89
74S195	1.89
74S196	1.89
74S240	2.75
74S241	2.75
74S242	2.99
74S243	2.99
74S244	2.99
74S251	1.35
74S253	1.35
74S257	1.29
74S258	1.29
74S260	7.75
74S280	2.79
74S287	2.99
74S288	2.55
74S373	3.10
74S374	3.10
74S387	2.75
74S471	7.95
74S472	7.95
74S473	7.95
74S474	9.95
74S475	9.95
74S570	5.75
74S571	5.75
74S572	8.95
74S573	8.95
74S940	2.90
74S941	2.90
74S132	2.15
74S161	2.95
74S163	3.15
74S181	2.15
74S189	2.95
74S225	7.75
74S283	4.15
74S289	3.95

LINEAR

LM301CN	35
LM304H	1.98
LM305H	1.89
LM306H	3.25
LM307CN	.29
LM308CN	.98
LM309K	1.49
LM310CN	1.25
LM311D/CN	.89
LM312H	1.75
LM317T	1.70
LM318CN	1.49
LM319N/H	1.25
LM320K-XX*	1.35
LM320T-XX*	1.39
LM320H-XX*	1.25
LM323K	4.95
LM324N	.95
LM337K	5.95
LM338K	6.95
LM339N	.95
LM340K-XX*	1.75
LM340T-XX*	1.25
LM340H-XX*	1.25
LM344H	1.95
LM348N	1.20
LM350K	5.60
LM358CN	.98
LM360N	1.49
LM372N	1.95
LM376N	3.75
LM377N	1.25
LM380CN/N	2.75
LM381N	1.79
LM383T	1.95
LM386N	1.25
LM387N	1.40

16 RAM CARD

Compatible with:
DOS 3.3 CP M.
Visicalc PASCAL
1 YR WARRANTY
\$39.95

**MULTIFUNCTION BOARD
WITH MEMORY, I/O
CLOCK
FOR IBM P/C
CALL FOR LOWEST PRICE**

**SPEEDY EPROM
PROGRAMMER
FOR APPLE II
PROGRAMMING**

2716, 2732, 2764, 27128,
2532, 2564
IN 30 SECONDS \$99.00

**Apple II/IIIe
Compatible \$175.00
Disk Drive**

**CONTROLLER
CARD \$44.95**

**SUPER COOLING
FANS FOR APPLE
WITH SURG**

\$39.50

**IBM MEMORY
EXPANSION KIT**

**IBM 64K \$52.95
(9 Pcs 64K RAM)**

**High Quality
Diskettes**

5 1/4" SS/SD 15/Box
5 1/4" SS/DD 17/Box
5 1/4" DS/DD 27/Box

**80 Column Dot Matrix
Printer**

**CP-80 by C.T.I.
80 cps parallel interface
graphics printing compatible
with EPSON MX80FT**

SALE PRICE \$299.00

TERMS: For shipping include \$2 for UPS Ground or \$3 for UPS Blue Label Air. Items over 5 pounds require additional shipping charges. \$10 minimum order.

1-(800) 821-3628

DIP SWITCHES

4 Position	85
5 Position	90
6 Position	90
7 Position	90
8 Position	95

SOUND CHIPS

76177	2.95
76189	8.95
AY3-8910	9.95
AY3-8912	12.95
MC3340	1.49

MOS PROMS

2708	3.95
2758	5.95
2716	3.95
2732	5.95
TMS2516	7.95
TMS2716	7.95
TMS2532	4.95
2732	4.95
2732-250	8.95
2732-200	11.95
2764	8.95
2764-250	10.95
2764-200	16.95
TMS2564	12.95
MC68764	39.95
27128	25.95

Z80 SERIES

8000 SERIES

8200 SERIES

6800 SERIES

**CALL FOR
PRICE**

S-RAM

2101	1.95
5101	3.95
2111	2.49
2112	2.99
2114	8.95
2114-25	8.10
2114L-1	8.12
2114L-3	8.13
2114L-2	8.13
2147	4.95
HM6116-1	4.75
HM6116-3	4.95
HM6116-2	8.95
HM6116LP-4	5.95
HM6116LP-3	6.95
HM6116LP-2	10.95

Miscellaneous

6502	4.95
68000	49.95
8748	24.95
8255-5	5.95
82S123	2.55
82S129	2.99
82S131	3.99
93422	8.95
93L422	9.95
93425	3.95

5¼" DISK DRIVES

- ★ **TANDON: TM 100-1**
Single Sided, 40 TRK/Side
Single or Double Density **\$17900**
Free Shipping
- ★ **TANDON: TM 100-2**
Double Sided, 40 TRK/Side
Single or Double Density **\$23900**
Free Shipping
- ★ **CDC: 9409**
Double Sided, 40 TRK/Side
Single or Double Density **\$23900**
Free Shipping
- ★ **SHUGART: SA 455**
Half Height, Double Sided, 40
TRK/Side Single or Double Density **\$229**
Free Shipping

Order Toll Free

1-800-531-5475 (Outside Of Texas)

(512) 250-1489 (In Texas)

Texas Residents Add 5% Sales Tax.

CompuAdd Corp.

13010 Research Blvd., Suite 101
Austin, Texas 78750

Circle 88 on Inquiry card.

TIRED

of looking for reliable
Source of Supply?

RUN DOWN

from Looking???

NERVOUS

about
QUALITY??

DISKETTES + RIBBONS + ACCESSORIES

Call Bob Kelly Now...

Kelly Computer Supplies

1811 Carl St. • St. Paul, MN 55113

Toll Free . . . 800 - 447 - 2929

MN Res. Call Collect. . . 612/644-9030

3M SCOTCH DISKETTES



Circle 251 on Inquiry card.

TDK

flexible disks

Call Free (800)235-4137
for prices and information.
Dealer inquiries invited.
C.O.D. and charge cards
accepted.



**PACIFIC
EXCHANGES**
100 Foothill Blvd.
San Luis Obispo, CA
93401 (In Cal. call
(805) 543-1037.)

Circle 334 on Inquiry card.

NEW!

SMITH-CORONA
Memory Correct III Messenger
Printer & Typewriter

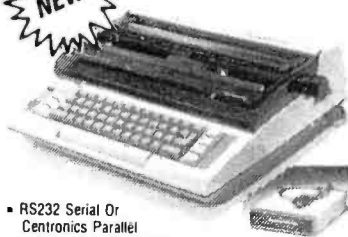

- RS232 Serial Or
Centronics Parallel
- Multiple Pitch 10, 12, 15

Order Toll Free:
Free Shipping

\$579

1-800-531-5475 (Outside Of Texas)
(512) 250-1489 (In Texas)

CompuAdd Corp.

13010 Research Blvd., Suite 101
Austin, Texas 78750

Circle 89 on inquiry card.

Apple

Compatible Drives

\$195

Includes:

- 40 TRK, 163 K Drive
- Cabinet & Cable
- Free Shipping
- 6 Month Warranty

Order Toll Free:
Free Shipping

1-800-531-5475 (Outside Of Texas)
(512) 250-1489 (In Texas)

CompuAdd Corp.

13010 Research Blvd., Suite 101
Austin, Texas 78750

Circle 90 on Inquiry card.

POWER PROTECTION FOR YOUR SYSTEM



The Datasaver™ AC Power Backup fits
most desktop and portable microcom-
puter systems. Call Cuesta Systems, Inc.
at (805) 541-4160 for product informa-
tion and application literature.
VISA/Mastercard orders.

INSTANT POWER

Circle 128 on inquiry card.

Best Prices On Quality Printers!

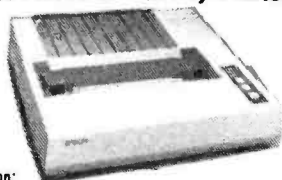

Epson:
RX 80 **Call**
RX 80 FT **Call**
FX 80 **Call**
FX 100 **Call**

Star-Micronica:
Gemini-10X **\$299**
Gemini-15 **\$439**

Order Toll Free: Free Shipping

1-800-531-5475 (Outside Of Texas)
(512) 250-1489 (In Texas)

CompuAdd Corp.

13010 Research Blvd., Suite 101
Austin, Texas 78750

Circle 91 on Inquiry card.

Electronic Circuit Analysis

- AC and DC analysis
- Very fast, optimized machine language
- Worst case, sensitivity analysis
- Sweep component values
- 64 Nodes
- Compare circuits
- Log or linear sweep
- Full file handling
- Full editing, error trapping
- Frequency response, magnitude and phase
- Complete manual with examples
- Transmission lines
- Complex y parameters
- Available for CP/M, MSDOS, TRSDOS
- Price - \$150.00

Tatum Labs

P.O. Box 698

Sandy Hook, CT 06482

(203) 426-2184

Circle 415 on Inquiry card.

MEMORY FOR IBM PC-XT



64K — \$159.95
320K — \$319.95
384K — \$359.95
512K — \$439.95

- Uses 64K Drums
- Gold Fingers — Solder Mask
- Addressing On Any 64K Block
- No Parity

Add 6% sales tax in California. Add
\$2.00 for shipping. Add \$2.00 for C.O.D.
Send check or money order to:

IN SYNC

5738 Commerce Blvd.
Rhonert Park, CA 94928
(707) 585-2793

Circle 224 on Inquiry card.

MEGA-BOARD™

new!

Ideal for

- **COMPUTERISTS**
- **OEM MANUFACTURERS**
- **DEVELOPMENT LABS**
- **UNIVERSITIES**
- **INDUSTRIAL APPLICATIONS**

THE ULTIMATE OEM/PC COMPATIBLE SINGLE BOARD COMPUTER

FULL IBM - PC* COMPATIBILITY!

DEALERS AND OEM MANUFACTURERS QUANTITY DISCOUNTS AVAILABLE

Standard Key-board Interface
(Full PC compatible)

Hardware Reset
(Overcomes reset flaw in PC)

Eight Compatible I/O Interface Connectors
(Full PC compatible)
(compatible with all IBM-PC* plug-in cards)

Power Connector
(Full IBM* pinout compatible)

Special J1 Interface
(Allows horizontal mounting of compatible expansion cards for easy bus expansion and custom configuring) (Board has 62 pin gold plated compatible connector)

8088 Processor
(Same as PC)

8087 Numeric Processor
(Same as PC)

Extended ROM Capability
(Runs all compatible PC ROMS) (Jumper programmable to accommodate all popular 8K, 16K, 32K and 64K ROM chips and NEW EE ROMS! VPP power pin available for EP ROM burning!) (External VPP voltage required)

Peripheral Support Circuits
(Same as PC)

Configuration Switches
(Same as PC)

Board Size
10.5 inch X 13.5 inch

Speaker/Audio Port
(Same as PC)

Wire Wrap Area
To facilitate special custom applications!

Full Mega-Byte Ram Capacity! On board!
(With parity)
 256K Bytes using 64K chips
 1 Mega Bytes using 256K chips

ONLY!
\$9995
Evaluation Board Kit

MEGA-BOARD™ Evaluation Board Kit!
(Blank board with full assembly instructions and parts list.)

Includes highest quality PC board with gold plating, silk screen, solder mask

- MEGA-BOARD™** with full assembly instructions \$99.95
- USERS MANUAL** with theory of operation, schematics, block diagram, application notes \$19.95
- MEGA-BIOS™** fully compatible MS-DOS/PC-DOS BIOS \$29.95

ORDER NOW!!!
SATISFACTION GUARANTEED!
10-day money back guarantee if not completely satisfied.

DTC™ DISPLAY TELECOMMUNICATIONS CORPORATION

4100 SPRING VALLEY ROAD
SUITE 400
DALLAS, TX 75234
(214) 991-1644

TERMS: Shipment made 2 to 5 weeks from receipt of order. VISA, MC, money order, Company check accepted. COD'S require \$25 deposit. Balance UPS COD. Please add \$2.00 shipping and handling per order.

*IBM and IBM PC are trademarks of International Business Machines

©1983 Display Telecommunications Corporation

Smith-Corona TP-1 Daisy Wheel Printer

only \$399⁰⁰

UNBELIEVABLE!

- fully-formed characters
- serial or parallel interface
- compatible with most micro-computers
- choice of 10 or 12 CPI models

Also for your TP-1 letter quality printer—the **Smith-Corona Tractor Feed**

\$129⁰⁰

- Adjustable tractor widths
- For continuous forms
- Quick, easy removal

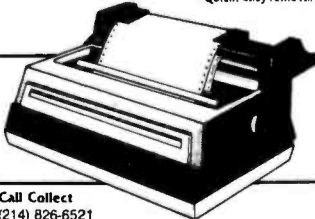

Call Collect
(214) 826-6521

FIGURE-LOGIC BUSINESS EQUIPMENT, INC.
6408 Gaston Avenue / Dallas, Texas 75214

Circle 188 on Inquiry card.

CONVERSE WITH YOUR COMPUTER

AT LAST! A FULL IMPLEMENTATION of the original ELIZA program is now available to run on your microcomputer!

Created at MIT in 1966, ELIZA has become the world's most celebrated artificial intelligence demonstration program. ELIZA is a non-directive psychotherapist who analyzes each statement as you type it in and then responds with her own comment or Question—and her remarks are often amazingly appropriate!

Designed to run on a large mainframe, ELIZA has never before been available to personal computer users except in greatly stripped down versions lacking the sophistication which made the original program so fascinating.

Now, our new microcomputer version possessing the FULL power and range of expression of the original is being offered at the introductory price of only \$25. And if you want to find out how she does it: teach her to do more! We will include the complete SOURCE PROGRAM for only \$20 additional.

Order your copy of ELIZA today and you'll never again wonder how to respond when you hear someone say, "Okay, let's see what this computer of yours can actually do!"

ELIZA IS AVAILABLE IN THE FOLLOWING FORMATS:

1. 5 1/4 inch disk for the 48K Apple II, II Plus, IIe or III \$25 for Protected Version—\$45 for Applesoft Source Version
2. 5 1/4 inch disk for the 84K IBM Personal Computer \$25 for Protected Version—\$45 for IBM Disk BASIC Source Version
3. 5 1/4 inch disk or tape cassette for the Commodore 64 (specify which) \$25 for Protected Version—\$45 for C-64 BASIC Source Version
4. Standard 8 inch single density disk for all CP/M based computers \$25 for ELIZA.COM—\$45 with Microsoft BASIC-80 Source
5. 5 1/4 inch disk for most CP/M based computers (specify computer) \$25 for ELIZA.COM—\$45 with Microsoft BASIC-80 Source

Please add \$2.00 shipping and handling to all orders (California residents please add 6% sales tax)

ARTIFICIAL INTELLIGENCE RESEARCH GROUP

921 North La Jolla Avenue, Dept. B
Los Angeles, CA 90046
(213) 656-7386 (213) 654-2214
MC, VISA and checks accepted



Circle 32 on Inquiry card.

**ALSO
RS232C**



Dot Matrix Printer Interfaces with Apple II
Featuring an Apple II@-compatible parallel interface, Addmaster Corporation has produced a new dot matrix printer, Model 170. The interface includes a Centronics-type handshake and DB-25 interface connector, Baudot, and day—and time clock. The Model 170 provides 18 or 21 characters per line, 6 lines per inch print density, on standard 2 1/2" adding machine tape. Designed to use with personal computers, Model 170 will produce hard and carbonless copies of programs, data or results. Write Addmaster Corporation, 416 Junipero Serra Dr., San Gabriel, CA 91776 or call 213/285-1121.

Circle 11 on Inquiry card.



Solve your disc problems, buy 100% surface tested Dysan diskettes. All orders shipped from stock, within 24 hours. Call toll FREE (800) 235-4137 for prices and information. Visa and Master Card accepted.



PACIFIC EXCHANGES
100 Foothill Blvd.
San Luis Obispo, CA
93401. (In Cal. call
(805) 543-1037.)

Circle 334 on Inquiry card.

LOOK!

SYSTEMS

Dec Rainbow 100	\$3345
CompuPro 816A	3927
MD2 w/terminal	1442

LTR QLTYPRIINTER

Daisywriter 2000	\$1042
Nec 3550	1065
Qume Sprint 11/40	1335
Juki	-call-

DOT MATRIX PRINTERS

C. Itoh 8510 AP	\$386
Epson FX, MX, RX	-call-
Okidata 92	442
Gemini 10, 15	-call-

1800 HOBBIELANE,
SANTA ROSA,
CA 95407



Prices Subject To
Change Without
Notice

(707) 544-5304

VISA • MASTERCARD

Circle 454 on Inquiry card.

**Tektronix 40XX
Terminal Emulation**

**EMU-TEK™ IS NOW AVAILABLE FOR
IBM PC, XT, AND MOST COMPATIBLES**

- Access powerful mainframe graphics using:
 - PLOT 10 (trademark of TEKTRONIX, Inc.)
 - DISPLA (registered trademark of ISSCO)
 - DARC (available from QUESTEL, Inc.)
 - and most similar packages and services.
- Upgrade with complete software compatibility.
- Increase versatility with options such as:
 - High resolution board support
 - Local pen-plotter support
 - Hard copy on matrix printer
 - Advanced communications program features
 - Other terminal emulations, including:
 - VT100 (trademark Digital Equipment Corp.)
 - RETRO-GRAPHICS (trademark Digital Engineering, Inc.)

• **30 DAY NO-RISK TRIAL PRIVILEGE.**

10801 Dale St./P.O. Box 615
Stanton, CA 90680
FTG DATA SYSTEMS (714) 995-3900
FTG will soon become PC INNOVATIONS

Circle 185 on Inquiry card.

**FAST
Factory
Floppy Disc
Drive
Repair**

Specialists in the repair of:

Shugart
Tandon
PerSci

PERSci, INC.



12624 Daphne Avenue
Hawthorne, CA 90250
(213) 777-7536
TWX 910-321-4448

Circle 344 on Inquiry card.

**C LANGUAGE
PROGRAMMERS**

**c-systems
C COMPILER
c-window™**

The complete c language source level program testing and debugging tool.

- Single step by c source line.
- Set breakpoints at line numbers.
- Display and alter variables by symbol name, using c expression syntax.
- No more printf or assembler level debugging!

c-window™ is a support package for the **c-systems C COMPILER** for 8086/8088 based systems.

Contact:

c-systems Fullerton, CA 92634
P.O. Box 3253 714-637-5362

TM c-systems

Circle 57 on Inquiry card.

S-100 EPROM PROGRAMMER

EPROM-32

- High quality S-100 board meets or exceeds IEEE-696.
- Programs 1K through 32K (byte) EPROMs.
- Textool zero-insertion-force programming socket.
- EPROM is programmed through I/O ports and can be verified through I/O ports or located in memory space for verification.
- Programming voltage generated on-board.
- Personality Modules simplify adaptation of board to different EPROM types:

PM-1—2508, 2758	PM-3—2732, 2732A	PM-6—68764
2516, 2716	PM-4—2564	PM-8—27128
PM-2—2532	PM-5—2764	
- CP/M-compatible control software includes commands for programming, verification, disk I/O and editing.

\$269.95*
(A & T)

**MicroDynamics
Corporation**

6363 Poplar Ave • Suite 105
Memphis, TN 38119

ORDER DESK:
1-800-237-8400 ext 440
Technical Inquiries:
901-682-4054

*Price includes EPROM-32, documentation and two Personality Modules (specify). Additional Modules—\$7.95. Control software on 8" SSD diskette—\$9.95. UPS ground—\$2.00. UPS air—\$4.00. COD—\$1.50. foreign add \$15.00. TN add 6% sales tax. VISA and MASTERCARD welcome.

Circle 292 on Inquiry card.

**TOLL-FREE
ORDERING:
800-222-8686**

CCT CUSTOM COMPUTER TECHNOLOGY

1 CRAFTSMAN COURT — BOX 4160 — SEDONA, ARIZONA 86340

**FOR TECHNICAL SUPPORT/
SERVICE / IN ARIZONA:
602-282-6299**

Purchase your Hardware and Software directly from an OEM/Systems Integrator. Take advantage of our buying power! We stock a full line of Board Level Components, Software, and Peripherals. Call for your needs. We'll give you the Lowest Prices, and the Technical Support and Know-How we are quickly becoming well-known for. Satisfied Customers Nationwide! The Nations's Custom Systems House for Business, Education and Science. Call for a system quote.

• FOREMOST QUALITY • ADVANCED SUPPORT • REASONABLE COST •

OF PRIME INTEREST

Our prime interest at CCT is **service and support**. We build and sell hundreds of systems per year to the serious computer market. We rigidly adhere to our strict policy of reliable machines, and reliable people behind them. We feel the CompuPro product line to be the state-of-the-art of the computer industry.

THE CCT EXCLUSIVE WARRANTY

With any system we build, we provide, in writing, an unconditional 12 month **direct** warranty on the entire system, including mainframe, boards, drives, power supplies, cabling and peripherals! We offer guaranteed 24 hour in-house repair and/or replacement with just a toll-free phone call. We can offer this, since we are so sure of our level of quality and reliability. It's great to know that in the event of a problem, you're not out of business waiting on service turnaround. We deliver!

Our various OEM contracts with all the manufacturers of the components we integrate, allow us this unprecedented flexibility. No factory O.K.'s necessary — just get it running — **NOW!**

- Wyse 100 terminal - 14" Green ... **\$699**
 - WS Prom Option - Installed ... **\$50**
 - Mitsubishi 8" DSDD drives, full or half height. Set-up FREE OF CHARGE ... **\$449**
 - Okidata 82 ... **\$389 / 83 ... \$619**
 - 84 ... **\$1029 / 92 ... \$469 / 93 ... \$779**
 - Ashton-Tate dBASE II 8" or MD ... **\$299**
 - Supercalc 86 - for CP/M 86 & MP/M ... **\$99**
 - Visual Terminals in stock ... **Call**
 - Lear Siegler ADM 20 ... **\$499**
 - Freedom 50 ... **\$499 / 100-\$549**
 - Hays Modem-**\$259** • Diablo 620-**\$1029**
- We carry a full line of software in all available formats at discount prices.

TECH TIP CORNER

dBASE II USERS - CUSTOM TERMINAL KEYS! Implement your arrow keys; emulate Wordstar edit commands - send an SASE with \$2.00 - (ATTN: TTC). Tell us your arrow key codes. We'll return easy, detailed instructions to change almost anything. It's beautiful — Pat...



**PROFESSIONAL LEVEL BUSINESS SYSTEMS
STATE-OF-THE-ART QUALITY, PERFORMANCE, RELIABILITY**

CCT ANNOUNCES: OUR OWN IN-HOUSE ENGINEERED CUSTOM COMPUPRO SYSTEMS

CCT-1 — ENTRY LEVEL S-100 BUSINESS SYSTEM

- Enclosure 2-Desk-20 Slot Mainframe •
- CPU 8085/88 - 6Mhz 8085/8Mhz 8088 •
- Disk 1 - DMA Floppy Disk Controller •
- RAM 16 - 64K Static RAM - 12 Mhz •
- Interfacer 4 - 3 Serial/2 Parallel I/O •
- CCT 2.4 Dual 8" Mitsubishi DSDD Drive System - 2.4 Megabytes •
- CP/M 80 - 2.2 LD/M - CCT Modified •
- All Cabling, Complete CCT Assembly, Testing, and Minimum 20 Hour Burn-in •

**INTRODUCTORY PRICE:
\$3,399**

RUNS ALL STANDARD 8" CP/M SOFTWARE - INCLUDES OUR EXCLUSIVE 12 MONTH DIRECT WARRANTY

CP/M MP/M NOTE: Each copy we furnish is CCT modified for the target system. M-Drive/H and hard disk drivers are furnished, and the BIOS optimized for the fastest disk step rate, as well as terminal and printer compatibility.

★ ★ CCT-2 — THE FASTEST MICROCOMPUTER IN THE WORLD!! ★ ★

- Enclosure 2-Desk •
- CPU 8086 - 10Mhz •
- 128K - 16 Bit Memory •
- Interfacer 3-8 •
- 90K Baud Parallel Terminal Board •
- Disk 1 •
- CP/M 86 - CCT Modified •
- All Cabling, Complete CCT Assembly, Testing, & Minimum 20 Hour Burn-in •
- 78 Key Professional Ergonomic Keyboard •
- High Resolution Amber Monitor. •
- CCT 2.4 Dual DSDD Drive System •

**INTRODUCTORY PRICE:
\$6,799**

RUNS ALL CP/M 86 SOFTWARE - ULTRA FAST - INCLUDES 12 MONTH DIRECT WARRANTY

★ ★ CCT-3 — 10Mhz 68K System similar to above, with 128K RAM \$6,699 ★ ★

We are the largest in the custom configuration of complete state-of-the-art S-100 systems, at package pricing, with integration, burn-in and programming. We custom build CompuPro systems / hard disk systems for business applications. Call for CompuPro literature, CCT system configuration data and technical information. We can save you money!

★ SUPER PRICES ★ COMPUPRO COMPONENTS ★ IN STOCK ★

- SYSTEM SPECIALS — ALL CCT A&T, BURNED IN:**
- 816A-**\$4299** • 816B-**\$4999** • 816C-**\$6499**
 - M-Drive CP/M - Blowout-**\$39** • Disk 1w/CP/M-**\$449** • M-Drive/H-512K-**\$1149**
 - CPU 8085/88-**\$319** • CPU 8086/87-**\$579/10Mhz-\$659** • CPU 68K-**\$519/10Mhz-\$639** • CPU-Z-**\$249**
 - CPU 286-**\$1249/10Mhz-\$1359** • Disk 1-**\$369** • Disk 2-**\$599** • Disk 3-**\$599**
 - RAM 17 (12Mhz)-**\$329** • RAM 16 (12Mhz)-**\$359** • RAM 21 (128K)-**\$779** • RAM 22 (256K)-**\$1399**
 - Interfacer 1 - **\$229** • Interfacer 2-**\$249** • Interfacer 3-5-**\$399/3-8-\$459** • Interfacer 4-**\$349**
 - System Support 1-**\$299** • Enclosure 2-Desk-**\$599/Rack-\$649** • 20 Slot Motherboard-**\$210**
 - CP/M 80-**\$99** • CP/M 86-**\$150** • MP/M 8-16-**\$699** • CP/M 68K-**\$279** • UNIX - SOON
 - 86 Upgrade Kit: Consists of CP/M 86, 64K Ram, System Support 1, Cable - **\$749**
- Call for CSC Boards — New Releases — Operating System Mods/Updates**

★ PRICE BREAKTHROUGH ★

Hard Disk Subsystems

CCT/Fujitsu 5 1/4" subsystem, includes Disk 3, custom enclosure & power supply, all cabling, A&T, formatted, burned-in. Ready for any CompuPro or similar S-100 system:
CCT-5 (5.5 Meg)-**\$1599**
CCT-10 (11 Meg)-**\$1899** / CCT-20 (22 Meg)-**\$2299**

? ? HARD DISK DECISIONS ? ?

Hard/Floppy Combinations

An exclusive CCT innovation. CCT/Fujitsu/Mitsubishi ultra-system: 5 1/4" hard disk next to a 1.2 Meg. DSDD 8" floppy. Includes Disk 3, custom horizontal enclosure and power supply, all cabling, A&T, formatted, burned-in. Will stand alone in any CompuPro system:
CCT-5/1-**\$2099** CCT-10/1-**\$2399** CCT-20/1-**\$2799**

★ NEW DISK 3 1/4" HD SYSTEMS ★

2.4 Megabyte Floppy Systems

CCT/Mitsubishi 2.4 Megabyte Dual DSDD 8" system. Includes custom horizontal enclosure, all cabling, A&T, burned-in. This is the fastest system available: **\$1149**
With stacked half-height drives: **\$1175**

All Systems Carry Our Exclusive 12 Month Warranty.

Prices & availability subject to change. All products new, and carry full manufacturer's warranties. Call for catalog. Free technical help to anyone. We can configure boards & software for your system. Plug-in and go. Arizona Residents add sales tax. CompuPro® Trademark — W.J. Godbout; CP/M® MP/M® Trademarks — Digital Research

**STUFF YOUR STOCKINGS
WITH 3M SCOTCH
BRAND DISKETTES**

FROM
MY Supplier, inc.



WE HAVE ALL YOUR COMPUTER
SUPPLY NEEDS

- Diskettes Storage Equipment
- Ribbons, Printwheels & Binders
- And Now...Color Coder Plus



C.O.D.



SO EASY TO ORDER
CALL TOLL FREE
800-448-4016
IN CA 800-556-6786

MY Supplier, inc.

COMPUTER & WORD PROCESSING SUPPLIES
348 N. MOORPARK ROAD
THOUSAND OAKS, CA 91360

Circle 308 on Inquiry card.

Serial ◀■■■■■■▶ Parallel



PRINTERS!
PLOTTERS!
PUNCHES!
ROBOTS!

**Convert What You Have
To What You Want!**

- * RS232 Serial
- * 8 Baud Rates
- * Latched Outputs
- * Centronics Parallel
- * Handshake Signals
- * Compact 3 1/2 x 4 1/2 x 1 1/2

No longer will your peripheral choices be limited by the type of port you have available! Our new High Performance 700 Series Converters provide the missing link. Based on the latest in CMOS technology, these units feature full baud rate selection to 19.2K, with handshake signals to maximize transfer efficiency. Detailed documentation allows simplified installation. Order the Model 770 (SerPar) or Model 775 (ParSer) Today!

only **\$89.95**
Connector Option \$10.00
CA Residents 8% tax
UPS Shipping \$3.00

1501-B Pine Street
Post Office Box 2233
Oxnard, California 93000
CALL (805) 487-1865 or 487-1866
For FAST Delivery

Circle 175 on Inquiry card.



\$9.95

FOR USE WITH MOST MICRO COMPUTERS

APPLE · ATARI · COMMODORE · TEXAS INSTRUMENTS · TRS-80 ...

PAYMENT ENCLOSED \$_____ * Add \$1.00 per order for postage and handling. Outside USA add \$2.50 per unit ordered; send US funds only Visa MasterCard

P.O. BOX 7008
ROSEVILLE, MI 48305
1-800-732-0614



Michigan Residents Add 4%

Printer Cables

- Parallel —
- ALTOS \$35.00*
- ATTACHE \$35.00*
- ATARI \$35.00*
- CENTRONICS \$35.00*
- COLUMBIA \$35.00*
- EAGLE \$35.00*
- IBM-PC \$35.00*
- KAYPRO \$35.00*
- OSBORNE \$35.00*
- SANYO \$35.00*
- TI-99 \$35.00*

FREE SHIPPING

FREE SHIPPING

— SERIAL —

ATTACHE COM.
RS232 (DB25P)
(9 conductor 1-8, 20)

CABLES UNLIMITED
4030 Wabaska Dr.
San Diego, CA 92107
619-222-3366

*CA Residents Add 6% Sales Tax (\$2.40)

Circle 461 on Inquiry card.

**SUPER-FAST!
Z80**

Relocating Macro
ASSEMBLER
\$169.95

Directly generates COM, HEX, or REL files. Flexible REL format allows external bytes and words with complete math operations on them (Microsoft format optional). Features Zlog mnemonics with nested macros, conditionals and include files. Unique one-pass design generates compact Intermediate code which is then processed to resolve forward references, yielding tremendous time savings. Complete listing, symbol table and cross-reference output may be sent to any device. The perfect tool for assembly language programming. Linker included. Manual only — \$30. For Z80 CP/M and TRS-80.

S L R Systems

1822 NORTH MAIN ST. • BUTLER, PA 16001 • (412) 282-0854
Shipping \$3 U.S. others \$7 PA • 6% Check, MD, VISA, M.C. C.O.D.
Most formats available. Dealer and OEM inquiries invited.
Z80 CP/M TRS-80 TMs of Zilog Digital Research, Tandy Corp.

Circle 390 on Inquiry card.

**ZENTH/Heath
Users**

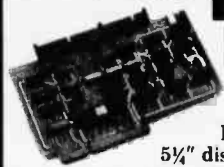

Double Your
5 1/4" disk storage
capacity without adding a drive.

Get twice as much from your H88 or H89 microcomputer. Our FDC-880H floppy disk controller, in conjunction with your 5 1/4" drives, for example, expands memory capacity from 256 bytes to 512 bytes per sector.

And it handles single and double-sided, single and double-density, 8" and 5 1/4" drives — simultaneously.



Control Data Recording Systems Inc.
7210 Clairmont Mesa Blvd., San Diego, CA 92111
(619) 560-1272

Circle 82 on Inquiry card.

**Verbatim
flexible disks**

Call Free (800) 235-4137 for prices and information. Dealer inquiries invited. C.O.D. and charge cards accepted.

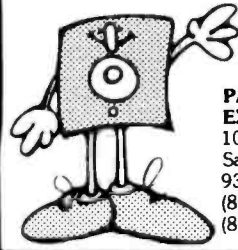

PACIFIC EXCHANGES
100 Foothill Blvd.
San Luis Obispo, CA 93401. In Cal call (800) 592-5935 or (805) 543-1037.

Circle 334 on Inquiry card.

When it comes to quality software for microsystems, DYNACOMP delivers:

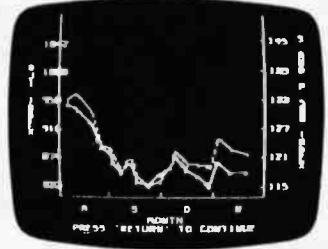

STOCK MASTER (APPLE): \$59.95
The Systems ... Apple Atari Canon Commodore
CompuStar CP/M Franklin HZ-100
IBM PC Kaypro Morrow NEC North Star
Osborne SuperBrain Timex TRS-80

The Software ...
ADVENTURE BUSINESS CARD GAMES EDUCATION
ENGINEERING GAMES HOME FINANCE INVESTING
LANGUAGES SCIENCE TAX PLANNING UTILITIES

Name brand diskettes: \$19.95/10 (85, 80 w/hub ring). Includes FREE plastic storage box. Add \$2.00 shipping.

CALL OR WRITE FOR A FREE CATALOG
DYNACOMP, INC.
1427 Monroe Avenue, Rochester, N.Y. 14618
Telephone: (716) 442-8960

Circle 160 on Inquiry card.

The Statistician

CPM IBM-PC
TRS-DOS XENIX

- Multiple Regression
- Stepwise
- Ridge
- All Subsets
- Backward Elimination
- Time Series Analysis
- Descriptive Statistics
- Transformations
- Survey Research
- Nonparametrics
- XY Plots
- ANOVA
- Random Samples
- Data Base
- Search & sort
- Hypothesis tests

Please call TOLL FREE
1-800-334-0854 (Ext. 814)



for more information
or write:
Quant Systems
Box 628
Charleston, SC 29402
VISA/MC Accepted

Circle 359 on Inquiry card.

WE'RE GROWING



OUR SALTIER DEAL

TRADE YOUR 5 1/4" DRIVE

SGL SIDE/DBL DEN FOR DBL SIDE/
DBL DEN DRIVE \$75.00 ALLOWANCE

DBL SIDE/DBL DEN FOR 2 EA
1/2 HGT DBL SIDE/DBL DEN DRIVES
\$175.00 ALLOWANCE

IBM ACCESSORIES

AST	
Six Pak Plus (Serial/Par/CLK 64K Expands to 384K) . . .	299.00
Meg-A-Plus (Serial/CLK/64K Expands to 256K) . . .	299.00
Meg-A-Pak (Expands Meg-A-Plus to 512K) . . .	299.00
I/O Plus (SP) . . .	149.00
PC-Net (with Shared User Software) . . .	556.00
PC-Net Starter Kit . . .	1,192.00
AST-5251 (Allows connection of IBM PC to System 340038) . . .	626.50

MANY OTHER OPTIONS AVAILABLE.

ASHTON-TATE

D-Base II . . .	400.00
Bottom Line Strategist . . .	279.00
Financial Planner . . .	499.00
Friday . . .	189.00

DOW JONES

Dow Jones Invest/Evaluator . . .	125.00
----------------------------------	--------

D.C. HAYES

Smartmodem 1200B-Smartcom 2 software Included . . .	429.00
Smartcom 2-Telecomputive for 300/1200 on disk . . .	89.00

LOTUS DEVELOPMENT

Lotus 1-2-3 (on disk) . . .	369.00
-----------------------------	--------

KRAFT

Joy Stick . . .	47.50
Paddle (pair) . . .	37.00

KEYTRONICS

Enhance your PC-with a superior keyboard . . .	210.00
--	--------

MAYNARD

Floppy Controller . . .	155.00
Floppy Controller (Serial) . . .	225.00
Floppy Controller (PAR) . . .	205.00

SANDSTAR

Sandstar MOD-FDC (for 5 1/4" or 8" drives) . . .	200.00
Parallel MOD . . .	60.00
Serial-MOD . . .	79.00
Clock Calendar MOD . . .	69.00
Game Adapter MOD . . .	49.00

Sandstar Multi-Function Bd (Holds up to 6 modular add-ons) . . .	82.00
---	-------

PLANTRONICS COLOR PLUS

Color + Color Display Card (16 colors) . . .	495.00
--	--------

PRINCETON GRAPHICS

PGS HX12-Hi-Res Color, The Best . . .	475.00
---------------------------------------	--------

QUADRAM

Quadlink—Allows Apple Software to be used in IBM PC HAS 64K Ram-Game Port Display Gen-Disk Intf. w/software . . .	520.00
Quadboard 2—64K Ram (expands to 256K) 2 Ser Port CLK and software . . .	289.00
Quadboard — 64K (expands to 256K) Par and Serial Port CLK and software . . .	289.00
Quad 512 — 64 Ram (expands to 512K) Serial Port and software . . .	259.00
Quadchrome — Color Monitor . . .	489.00
Tilt Table . . .	40.00
Chronograph Clk/Calendar BD. . .	79.00

SHUGART DISK DRIVES

SA455L-1/2 HGT 320 K DS/DD w/BRKTS . . .	239.00 ea.
	440.00 for 2 ea.

TANDON DISK DRIVES

TM100-2A 320K DS/DD . . .	225.00
TM55-2 1/2 HGT 320 K DS/DD w/BRKTS . . .	249.00 ea.
	440.00 for 2

APPLE/FRANKLIN ACCESSORIES

ALS

CPM 3.0 Card . . .	289.00
Z-Card II . . .	139.00

ASHTON-TATE

D-Base II . . .	400.00
-----------------	--------

ALSTAR

RF Modulator . . .	19.00
--------------------	-------

DOW JONES

Dow Jones Invest/Evaluator . . .	125.00
----------------------------------	--------

GENERIC

Z-80 Card (Emulates Micro-Soft) . . .	99.00
80 Col. Video (Videx Compatible) . . .	99.00
80 Col. Video w/Soft Switch . . .	125.00
Joy Stick . . .	20.00
E-Prom Writer . . .	79.00
Pararell Interface . . .	49.00
Pararell Interface w/Graphics . . .	65.00
16K Ram Card . . .	40.00
RF Modulator . . .	13.00

HAYES

Micro-Modem II . . .	259.00
Micro-Model II w/terminal package . . .	279.00

KENSINGTON

System Saver/Fan & Surge Pro . . .	75.00
------------------------------------	-------

KOALA TECH

Koala Gr/Tablet w/Software . . .	99.00
----------------------------------	-------

KRAFT

Joystick for II E . . .	44.00
-------------------------	-------

LOTUS DEVELOPMENT

Executive Briefing System . . .	139.00
---------------------------------	--------

MICRO-MAX

View Max 80 (80 Col for II +) . . .	139.00
View Max 80E (80 Col w/64K Memory Exp to 128K) . . .	129.00

MICROTEK

Dumpling 64K/Interface and Graphics 64K Buffer . . .	235.00
Dumpling GX-P/Par Interface Card and Cable . . .	99.00
Parallel Interface Board (RV611C) . . .	61.00
BAM 16 (16K Add-on Memory) . . .	45.00

NOVATION

Apple Cat II w/software . . .	269.00
212 Apple Cat . . .	625.00
Handset . . .	29.00

ORANGE MICRO

Grappler X & Graphics Interface . . .	121.00
Grappler + 16K Buffer (Exp. and 5 to 64K) . . .	179.00

PRINCETON GRAPHICS

Interface Card allows use of HX12 Color Monitor . . .	156.00
---	--------

QUADRAM

RAM 80—80 Col 64K card . . .	119.00
APIC—Par Intf. card . . .	60.00
APIC/G—Par Intf. w/Graphics . . .	65.00
CPI—8' Cable (APIC to Cen. Printer) . . .	34.00
APIC III—Par Printer Intf. for Apple w/8' Cable . . .	95.00

TG PRODUCTS

Joy Stick—For Apple II + . . .	38.00
Paddles . . .	29.00
Selecta Port . . .	38.00

VIDEX

Ultraterm . . .	289.00
Videterm . . .	249.00

VISTA

A800 Floppy Controller for 8" Drives . . .	300.00
A-800-1 Cable . . .	27.00

ATARI

KRAFT

Joy Stick . . .	15.00
-----------------	-------

PERCOM

AT 88 SS/DD Disk Drive w/Printer Port . . .	499.00
---	--------

RANA

Rana 1000—SS/DD Disk Drive . . .	379.00
----------------------------------	--------

TRAK

AT-D2 SS/DD Disk Drive . . .	379.00
------------------------------	--------

COMMODORE

STAR

Star Gemini Interface to VIC 20 + CMD 64 . . .	65.00
--	-------

DOW JONES

Dow Jones Invest/Evaluator . . .	125.00
----------------------------------	--------

KRAFT

Joy Stick . . .	15.00
-----------------	-------

KOALA

Koala GR/Tablet w/software (specify VIC20 or CMD64) . . .	99.00
---	-------

KAPRO II — IV

Sprinter K (5MHZ Speed-up) . . .	99.00
----------------------------------	-------

K-Clock (Batt Backup Clk/Cab) . . .	99.50
-------------------------------------	-------

Vidoe Output BD-(allows use of video monitor) . . .	125.00
---	--------

Kaypro II Upgrade Disk Drives (DS/DD) . . .	239.00
---	--------

(Trade In Allowance \$75 for SS/DD Drive)

TI-PROFESSIONAL

Lotus 1-2-3 . . .	369.00
-------------------	--------

QUADRAM

TI-64 64K Ram Card . . .	206.00
--------------------------	--------

TI-92 192K Ram Card . . .	319.00
---------------------------	--------

**IBM UP-GRADE
KIT**
INCLUDES 9 EA. 4164-
200NS FOR EXPANSION
ON ALL IBM
PRODUCTS WITH
PARITY
\$55.00/per set

TOLL FREE

1-800-545-2633

CONTINENTAL U.S.

Circle 204 on inquiry card.

**The Great Salt Lake
Computer Company, Inc.**

1-801-363-3314

www.americanradiohistory.com

Retail Sales

123 East 200 South
Salt Lake City, Utah 84111

Retail Hours

Monday-Friday 10 AM to 6 PM
Saturday 10 AM to 5 PM

OUR CUSTOMERS ARE

MINIMUM SHIPPING \$3.00 - NO SURCHARGE ON VISA/MASTERCARD

TOLL FREE 1-800-545-2633 - Continental U.S.

DISK DRIVES

SHUGART	
5 1/4" SA400 (35 TR) 160K	150.00
5 1/4" SA400L (40 TR) 190 K	189.00
5 1/4" SA455L (40 TR) 320 K 1/2 HGT	235.00
8" SA801R(SS/DD) 600 K	359.00
8" SA851R(DS/DD) 1.2 MG	479.00
QUME	
5 1/4" 142 (40TR) 320 K 1/2 HGT	239.00
8" DT8 (842)	490.00
MITSUBISHI	
5 1/4" M-4853 1/2 size	410.00
96 TPI same as TM 100-4	
M-2894-63(SS/DD) 220V	449.00
8" M-2896-63	399.00
Thinline 8" DS/DD 1.2 MG	
8" M-2894-63 (110V)	389.00
STD 8" DS/DD 1.2 MG	

AC SURGE ELIMINATORS

Grizzly (200W) uninterruptible power system + surge protection	750.00
Grizzly (500W) uninterruptible power system + surge protection	1,802.00
Hawk AC power monitor w/surge protection	160.41
Lemon (6AC outlets-3 prong)	44.00
Lime (5-3 prong pwr cord w/on-off switch)	69.00
Orange-AC surge + EMI filter (6 outlets)	95.00
Peach (3 outlets)	69.00

DATA CABLES

8"DSC 88-25KT-for 2-8" drvs w/skt. conn.	20.00
5 1/4" DSC55-25KT-for 1-5 1/4" drvs w/skt. conn.	20.00
RS232MM-5' (male to male)	19.00
IBM to PAR	32.00
Osborne to PAR	32.00
Kaypro to PAR	32.00
OKI-Data Serial	24.00

E-PROM ERASERS

QUV-T8/1H (hobby)	49.95
QUV-T8/2I (Industrial version)	68.95
QUV-T8/2P (w/timer & safety switch)	97.50

CDC

5 1/4" 9409-DS/DD	259.00
TANDON	
5 1/4" TM100-1 SS/DD 160K	150.00
5 1/4" TM100-2A FOR IBM-PC	225.00
DS/DD (320 K)	
TM101-4 (96 TPI Quad Den)	339.00
8" TM848-2 (DS/DD) 1.2 MG	400.00
SIEMAN'S	
8" FD100-8 (SS/DD) 110V (801 R)	169.00
8" FD100-8 (SS/DD) 220V (Compatible)	199.00
MPI	
5 1/4" B-51 40TR SS/DD 180 K	145.00

CONNECTORS

RS232 Connectors	
SOLDER TYPE	
DB25P	2.50
DB25S	3.00
DB25 Hood	1.00
S-100 Connectors	10 for 25.00
DE9P	2.00

DISK DRIVE CABINETS

8" CABINETS

8" DDC88V28 w/PS vertical for 2-8" drives	269.00
8" DDC88T-1 w/PS vertical-for 2 or 4-8" thinline drives	269.00
8" DDC88T-2 w/PS vertical for 2 8" thinline drives	200.00
8" DDC8H w/PS horizontal for 1 ea. 8" drive	249.00
8" DDC8V w/PS vertical for 1 8" drive	249.00
8" DDC88H w/PS horizontal for 2-8" drives	269.00

5 1/4" CABINETS

5 1/4" DDC5H w/PS horizontal-for 1-5 1/4" drive	55.00
5 1/4" DDC5V w/PS vertical-for 1 ea. 5 1/4" drive	65.00
5 1/4" DDC55V w/PS vertical-for 2-5 1/4" drives	85.00

DISK SUB ASSEMBLY

OUR BEST BUY'S

8" SUB ASSEMBLY	
DDS + O 2EA SS/DD Siemens FD100-8 Drives w/Cabinet	595.00
DDS + 2 EA DS/DD Mitsubishi M2894-63 w/cabinet	1,075.00
DDS + 4 EA DS/DD 8" Thinline Drives w/Cabinet	1,150.00
Specify—Vertical or Horizontal Cabinet	
5 1/4" SUB ASSEMBLY	
DDS + 5 1EA SS/DD Disk Drive	200.00
DDS + 6 2EA SS/DD Disk Drive	369.00

MODEMS

★ Hayes Smart 300	199.00
★ Hayes Smart 1200	499.00
Multi-Tech MT 212 AD (1200/300)	499.00
Novation J-Cat 300	119.00
U.S. Robotics 212A Auto Dial	469.00
★ U.S. Robotics (300/1200)	375.00

DISKETTES

5 1/4" Soft Sector SS/DD	18.00/10
FOR APPLE, ETC.	
5 1/4" Soft Sector DS/DD	24.00/10
FOR IBM PC & PARTNERS	
FOR QTY OF 100 (15% DISCOUNT)	

DISKETTE STORAGE

AA-5 1/4" (Holds 82 Disks)	17.00
AA-8 (Holds 82 Disks)	26.00
Smoked Plexiglass Disk Tubs	
LIBRARY CASES	
CAS-5 1/4" Colors Available; color burst assl.	2.50
CAS-8" beige, black, blue, red, gray	3.00
Color Burst (Pack of 5)	12.00
FLIP "N" FILE	
Flip "N" File 25-5 1/4" (holds 25) w/lock	21.00
50-5 1/4" (holds 50) w/lock	27.95
Flip "N" File "Original-5" (holds 50)	21.00
Flip "N" File "Original 8" (holds 50)	29.95

DISKETTES

Disquettes are 3m media/processed, packaged and cprilled by CENTECH. Lifetime warranty—5 colors in each pkg. (Red, Yellow, Blue, Green, Brown)

5 1/4" Sgl side/dbl den	22.00/10
5 1/4" Dbl side/dbl den	29.00/10
5 1/4" 10 sector	24.00/10
5 1/4" 16 sector	24.00/10
8" Sgl side/dbl den	30.00/10
8" Dbl side/dbl den	40.00/10

VIDEO DISPLAY MONITORS

AMBER

Dynax AM121 (20 MHZ) Hi-Res/80 Col/12"	139.00
USI PI-4 (20 MHZ) Hi-Res/80 Col/9"	139.00
USI PI-3 (20 MHZ) Hi-Res/80 Col/12"	149.00
★ Zenith ZM122 (18 MHZ) Hi-Res/80 Col/12"	119.00

COLOR

Amdek I-12" Composite (For Apple)	260.00
Amdek II-12" RGB (For IBM-PC) w/audio	469.00
Amdek I + Composite w/audio	289.00
BMC 9191-12" Composite (For Apple)	255.00
Princeton HX-12 RGB (For IBM-PC)	475.00
Sakata SC-100-13" Composite (For All)	260.00
Sakata SC-200-RGB (For All)	489.00

GREEN

BMC 12AU (15 MHZ) 80 Col/12"	80.00
Dynax GM 120 (20 MHZ) Hi-Res/80 Col/12"	129.00
Sanyo DM 2112 (15 MHZ) 64 Col/12"	80.00
Sakata SC-1000 (18 MHZ) 80 Col/12"	119.00
USI PI-1 (20 MHZ) Hi-Res/9"	129.00
USI PI-2 (20 MHZ) Hi-Res/12"	139.00

S-100 PRODUCTS

CARD CAGES/MOTHER BOARDS

*IEEE-696-No termination required w/card bare card

Slots	Bare Bd	A + T	cage	cage
4	15.00	40.00	60.00	20.00
6	20.00	48.00	70.00	22.00
8	25.00	69.00	100.00	31.00
12	30.00	99.00	140.00	41.00
18	40.00	150.00	200.00	50.00
22	60.00	185.00	—	75.00

All card cages will accommodate a 4" fan Add \$20.00 for 1 fan-Add \$30.00 for 2 fans

CLOCK/CALENDAR

S-100*Time in hrs., min., sec. AM/PM or Military Format+Date in Mo., Day, Yr., Day of Week & Leap Year recognition+4 hard interrupts (1024 Hz, 1 Hz, 1 min, 1 hr)+On board battery (w/ll last 14 mos. w/no power on)

QTC-CCS-BB (S-100)	45.00
QTC-CCS-A (A + T) for S-100	95.00

MAINFRAMES

For 2 Standard 8" Drives

MF + DD6 (6 slot M/B)	575.00
MF + DD8 (8 slot M/B)	625.00
MF + DD12 (12 slot M/B)	675.00

For 2 Thinline 8" Drives

IMF + DD6F	350.00
------------	--------

For 2-5 1/4" Disk Drives

MF + MD12 (12 slot M/B)	560.00
-------------------------	--------

Standard Plain Front

MF + 12 (12 slot M/B)	499.00
MF + 22 (22 slot M/B)	550.00

All mainframes except IMF + DD6F have EMI filter, 2 AC outlets, 15 ea. DB25, 2 ea. 50 pin, 2 ea. 34 pin, 1 ea. Centronic cutouts, power supply for 8" MF (-5V1A1 + 5V6A1 + 8V16A1 ± 16V3A1 + 24V6A)

SIERRA DATA

SDS-SBC-100-Z80 (4mhz) master 2 serial 2 par/floppy controller/64k ram	\$655.00
SDS-SBC-100S4mhz slave/2 serial 2 par/64k ram	\$565.00
SDS-ZSIO/4-4 serial port I/O bd	\$250.00
SDS-MUX-RS232 multiplexer bd	\$235.00
SDS-HDI-M-Hard disk bd for micropolls	\$129.00
SDS-CPM/B105-cp/m for SBC100 w/BIOS	\$150.00
SDS-Turbodos-Multi-user for master & slaves	\$645.00

CPU/MEM/I/O

QTC-SBC 2/4 BB (SBC880)	\$50.00
QTC-SBC 2/4 A A + T (SBC880)	\$265.00
QTC-Z + 80 BB (BIG Z)	\$28.00
DYNAMIC (64K/256K or 1 MEG)	
QTC-EXP + III Bare Bd. (CT256)	\$75.00
QTC-EXP + III 64K A + T (CT256)	\$375.00
QTC-I/O + BB 2 SER 2 PAR A + T	\$75.00
QTC-I/O + A + T	\$300.00
QTC-ADA ADA Converter A + T	\$400.00
QTC-Dual GPIB-488 IEEE 488 Interface bd.	\$795.00
Interfacer 2	249.00
Interfacer 3	515.00
Interfacer 4	314.00
System Support I	308.00
Active Terminator	65.00
Enclosure 2 (Desk)	725.00
Enclosure 2 (Rack MT)	775.00
CPU-Z	228.00
M-Drive H	1,229.00
6 Slot MB	125.00
12 Slot MB	155.00
CPU 68K	510.00

COMPUPRO

20 Slot MB	225.00
CPU 8085/88	349.00
CPU 8086/8087	550.00
Disk I	399.00
CPM 2.2 for Disk I	150.00
Disk II	610.00
Ram 16-64K	325.00
Ram 17-64K	299.00
Ram 21-128K	650.00
Interfacer 1	198.00

COMPUTIME/QT BARE BOARD SET

PN-2048 Best Bare Board Set Available

QTC-SBC 2/4 CPU (SBC 880)	
QTC-EXP + III 256K (CT256) Memory bd./ Expandable to 1MG	
QTC-FDC 5/8 Floppy disk controller	

Bare Board Set \$150.00

- 1) Includes manuals & assembly instructions
- 2) Parts available
- 3) Monitor & B10S available. Add \$30.00.



CUSTOMER SERVICE

JOHN PIZZELLO

1-801-363-3317

Circle 205 on inquiry card.

The Great Salt Lake
Computer Company, Inc.

1-801-363-3314

www.americanradiohistory.com

Retail Sales

123 East 200 South
Salt Lake City, Utah 84111

Retail Hours

Monday-Friday 10 AM to 6 PM
Saturday 10 AM to 5 PM

OUR PRIORITY ONE

CALIFORNIA RESIDENTS SAVE 6% SALES TAX

3 YEARS (1976) EXPERIENCE IN COMPUTER MAIL ORDER BUSINESS

PRINTERS

ALPHACOM

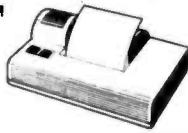

- 40 or 80 COL.
- 80 CPS
- FULL CHARACTER SETS
- GRAPHICS
- LIGHT WT. 4 TO 6 LBS.
- FRICTION FEED

ALPHACOM 42 (40 col) 101.00
ALPHACOM 81 (80 col) 149.00

INTERFACE for ATARI, COMMODORE,
and TI 39.00
40 COL. PAPER (per roll) 2.80
80 COL. PAPER (per roll) 4.50

BMC

PB101 16CPS, 2K Buffer, Par 649.00
PB104 Silver Reed Look-Alike 599.00

BROTHER

HR-1A 17CPS Daisywheel 3K Buff 575.00
HR-1A 17 CPS Daisywheel 3K Buff 589.00

CENTRONICS

351P—200CPS, Par 100 CPS CORR. 1,795.00
6085P—600CPS, Par w/cabinet 6,500.00
6085S—600CPS, Serial w/cabinet 7,000.00
6085IBM—600CPS w/cabinet 7,500.00
358 3 or 4 Automatic cut sheet feeder 695.00

COMREX

CR-2 12 CPS, 5K Buffer 499.00

DATA-SOUTH

DS 180 180CPS/Serial or Par/Tactor 1,400.00

DAISYWRIER

Daisywriter 2000-48K Buffer/20T040CPS LTR/Par 1,050.00
Daisywriter Cable 40.00

DIABLO

620 (25CPS/Serial) 820.00
630 (40CPS/Multi-IF) 1,790.00
630 ECS/IBM 2,100.00

DYNAX

Dynax-15 Par-13CPS Daisy Wheel
2 color PTG-3K buff 475.00
Dyanx 15 Serial-13CPS Daisy Wheel 525.00

C, ITOH

Pro-writer I (8510A) Par 120 CPS 350.00
Pro-writer I (8510A) Serial 120 CPS 529.00
Pro-writer II Parallel-15" 669.00
8600 (180CPS) Par or Serial 18 PIN 90 CPS LTR 1,099.00
F-10 40CPS/Diablo/Par or Serial 1,149.00
F-10 55CPS/Diablo/Par or Serial 1,425.00

GENERAL ELECTRIC

Demand Document Printers
3400—400CPS Serial/Tactor to 60 100 CPS CORR. 2,175.00
3404—400CPS Serial/Tactor 100CPS CORR. 2,459.00

MANNESMAN-TALLY

Splrit 80CPS Par 10" 330.00
160L (160CPS-40CPS LTR 10") 589.00
180L (160CPS-40CPS LTR 15") 829.00

MPI

MPI-Portable Sprinter/160CPS/IBM Port/4K Buff. up to
64K 100 CPS CORR. Keybd avlb. 795.00
MPI-99G (9") Par 499.00
MPI 150 BI (15") Par 2K Buff w/Graphics 675.00
MPI 150 AI (15") Par 4K Buff w/Graphics 799.00
MPI 150 AI (15") Par 16K Buff w/Graphics 899.00

NEC

NEC2010 20CPS Serial Daisywheel 950.00
NEC2015 20CPS Diablo Comp Daisywheel 950.00
NEC2030 20CPS Par Daisywheel 950.00
NEC2050 20CPS for IBM Daisywheel 1,050.00
NEC3510 35CPS Par Daisywheel 1,595.00
NEC3550 35CPS IBM 1,850.00
NEC7710 55CPS Serial Daisywheel 1,995.00
NEC7715 55CPS Diablo Comp Daisywheel 1,995.00
NEC8023A 100CPS-Par-Graphics-10" 389.00
NEC8025A 100CPS Par Graphics 15" 699.00
Serial Card 139.00

OKI-DATA

2350—350CPS 2 color tractor 2,195.00
2410P 350CPS 2 color tractor 2,495.00
Microline 82A (SER & PAR-120CPS 10") 379.00
Microline 83A (SER & PAR-120CPS 15") 629.00
Microline 92 (PAR-160CPS-LTR-10") 489.00
Microline 93 (PAR-160CPS-LTR-15") 799.00
Microline 84P (PAR-200CPS-LTR-15") 969.00
Microline 84S (SER-200CPS-LTR-15") 1,059.00

STAR MICRONICS

Gemini 10X NEW VERSION (PAR-120CPS-10") CALL
Gemini 15X (PAR-120CPS-15") CALL
Gemini 15 (PAR-100CPS-15") 399.00
Gemini Delta 10 (Par-160CPS-10" 8K buffer serial) CALL

SILVER REED

EXP 550P-17CPS Daisy Wheel-PAR 670.00
EXP 550S-17CPS Daisy Wheel-Serial 690.00

TOSHIBA

P-1350 (192CPS-120CPS/LTR PAR or Serial) 1,499.00

TRANSTAR

120 P 14CPS Par Diablo Comp. 479.00
315 Color Printer 500CPS Par 489.00

PRINTER ACCESSORIES

DIABLO

Diablo 620-Uni-Direct Tractor 110.00
Diablo 620-Sheet Feeder 720.00
Diablo 630-Bi-Direct Tractor 275.00
Diablo 630-Tractor Sound Cover 29.00
Diablo 630-SGL Sheet Feeder 775.00

JUKI-6100

Serial Interface 55.00
Bi-Dir Tractor 120.00
Uni-Dir Tractor 90.00

MANNESMAN-TALLY

Factory Quick Tear 230.00
Auto Front Feed 1,150.00

NEC

Thimbles 15.00
Vertical Tractor 219.00
Horizontal 152.00
Bi-Dir. Tractor 330.00
Cut Sheet Feeder 1,100.00

OKI-DATA

84 Cut Sheet Feeder 515.00
82/92 Tractor 55.00
Serial Intf. w/2K Buffer (For 82A) 125.00
Serial Intf. w/2K Buffer (For 92 & 93) 110.00
Okigraph I 82A or 83A Graphics ROM 40.00
Okigraph II 82A or 83A Disk for Apple 55.00

STAR-MICRONICS

Serial Intf. Bd 70.00
Serial Intf. Bd w/2K Buffer 120.00
Commodore 64 Intf. Bd. 72.00

TOSHIBA

P-1350 Cut Sheet Feeder 800.00
P-1350 Bi-Dir. Tractor 210.00

APPLE DISK DRIVES

Vista Solo (35TR) 199.00
Micro-Sci A-2 (35TR) 225.00
Micro-Sci A-40 (40TR) 269.00
Micro-Sci A-70 (Quad) 329.00
Micro-Sci Controller 70.00
Rana Elite I 249.00
Rana Elite II 399.00
Rana Elite III 509.00
Rana Controller 85.00
Super 5 "THINLINE" ½ size 163K 40TR 209.00

SYSTEMS

APPLE/FRANKLIN

Apple II E Starter—Includes CPU 1 F.D. Monitor and
Stand 1,525.00
Franklin 1000 w/color 799.00
Franklin 1200 Starter includes CPU 2 F.D. 80 col 1,625.00
Franklin 1200 OMS includes CPU-2 F.D. and bundled
software 1,825.00

IBM*PC TYPES

COLUMBIA (1600-1) 16 bit 128K Ram 2 ea.
320K Disk Drive-2 SER, 1 PAR, Key Bd. 8 slots,
Display Cd., bundled software 2,775.00
IBM P.C. 16 bit 64K Ram 2 ea. 320 K Disk Drive,
Princeton HG12X-Color Card 3,395.00
EAGLE PC-2 16 bit 128K Ram 2 ea. 320K Disk
Drive 12" Green (HH-Res) bundled software
EAGLE PORTABLE 16 bit 128K Ram 1 F.D./10 MG HD/Green
Screen MS-DOS 210 bundled software 4,000.00

KAYPRO

Kaypro II w/bundled software 1,475.00
Kaypro 4 w/bundled software 1,875.00
Kaypro 10 w/bundled software 2,695.00
Sprinter K (5MHz Speed-up) 99.00
K-Clock (Batt Backup Clk/Cal) 99.50
Video Output BD (allows use of video monitor) 125.00
Kaypro II Upgrade Disk Drives (DS/DD) 239.00
(Trade-In Allowance \$75 for SS/DD Drive)

MOLECULAR SYSTEMS

Micro 10-8 16 bit (8086) CPU 1 ea. 8" F.D.—1 ea. 10
MB HD—64K Ram expands to 256K up to 8 users
w/additional application processors—
CP/M and CP/M 86 5,200.00
Micro 15-8 16 bit (8086) CPU 1 ea. 8" F.D.—1 ea. 15
MB HD—64K Ram expands to 256K up to 8 users
w/additional application processors—
CP/M and CP/M 86 6,600.00
AP 8001—ASYNC/9600 BPS Application Processor 589.00
AP 8003—ASYNC/19,200 BPS Application Processor 839.00
AP 8011—SYNC/50K BPS 1,079.00

NEC

PC8201A-Portable 2.4 MHz CPU 16K Ram/Expands to
64K-32K RAM LCD Display—Keybd (67 key-5 function)
Modem, Serial and Par Port-FD and Cassette
Interface—Uses 4 AA Batt—bundled software 660.00

PC8201A-90—N1 Cad Pak 16.00
PC8221A—Portable Printer 149.00
PC8271A-02—AC Adapter 15.00

S-100

Compupro 816A 4,125.00
Compupro 816B 5,495.00
Compupro 816C 6,995.00

TELEVIDEO

TS-801 4 MHZ CPU-64K 2 ea. 360K F.D.—
Graphics 12" green 1,900.00
TS-1603 5 MHZ CPU-128K 2 ea. 360K F.D.—
Graphics 12" Green CP/M 2,400.00
Teletote 1 4 MHZ CPU 64K 1 ea. F.D. 9" Amber
detach KYBD Par/Ser mouse port CP/M 1,350.00
Teletote 2 4 MHZ CPU 64K 2 ea. F.D. 9" Amber
detach KYBD Par/Ser mouse port CP/M 1,895.00

TERMINALS

ADDS

Viewpoint-A1 (White) 509.00
Viewpoint-A2 (Green) 539.00
Viewpoint-3A + (Green) 509.00
Viewpoint 60-Same as Televideo 925 715.00
Viewpoint 90-Same as Televideo 950 (132 Col) 925.00
Viewpoint Color 995.00

QUME

QVT-102 80 Col. Green (910 comp) 549.00
QVT-102 80 Col. Amber 560.00
QVT-103 80/132 Col. Green 865.00
QVT-103 80/132 Col. Amber 895.00
QVT-108 80/132 Col. Amber (925 Corp.) 715.00

TELEVIDEO

TV910 529.00
TV910 + 565.00
TV925 w/2nd page memory 715.00
TV950 w/2nd, 3rd, 4th page memory 925.00
TV970 1,019.00
RG1000/TV60 Graphics Upgrade for 925/950 1,100.00

WYSE

WYSE-100 725.00
WYSE-300 (Color) 1,125.00

TOLL FREE

1-800-545-2633

CONTINENTAL U.S.

Circle 205 on inquiry card.

The Great Salt Lake
Computer Company, Inc.

1-801-363-3314

www.americanradiohistory.com

Mail Orders
P.O. Box 3150
Salt Lake City, Utah 84110

Mail Orders
Monday-Friday 8 AM to 6 PM
(sometimes much later)
Saturday 10 AM to 5 PM

*IBM PC Compatible

PC PIPELINE

Low, direct prices • Fast, direct service

2532-450	\$425
2716-450	320
2732-450	399
2764-250	615
*4164-150P	510
*4164-200	489
6116-P3	460
6116-LP-3	499

Add \$2.95 shipping to all orders. 2.6% for credit card orders
 OEM • Quantity discounts available • P.O.s on approval • C.O.D. OK • Credit cards • FL residents add 5% tax • All new, no surplus, no seconds (Prices subject to change.)

4920 Cypress St., Suite 100,
Tampa, FL 33607

In FL, and for info., call 813-875-0299
FOR ORDERS ONLY, 800-237-8910
 8 AM-5 PM EST



Circle 184 on inquiry card.

PRO-1

PROFESSIONAL PROTOTYPING BOARD FOR YOUR APPLE®

ALL I.C. PINS LETTERED BY COLUMN AND NUMBERED BY ROW
 ACCEPTS ALL STANDARD I.C. SOCKETS
 ACCEPTS UP TO 52 (118 PIN) SOCKETS
 NUMBERED INPUT & OUTPUT PINS



\$29.95

NEW
 Also Available for
 IBM® - P.C.
\$39.95

- VCC & GND Pins Conveniently Available
- ±12V & -5V also Provided for Convenient Use
- Accepts all Standard I.D.S. Connectors (110V CTR)
- Gold-plated Edge Connector
- Provisions for Filtering on Air Power Supplies
- Premium Quality Black Fiberglass

Hollywood Hardware, Inc.
 8842 Valjean Ave.
 Van Nuys, CA 91408
 (813) 888-1204

* 1983 - HOLLYWOOD HARDWARE, INC. APPLE IS A REGISTERED TRADEMARK OF APPLE COMPUTER, INC. IBM IS A REGISTERED TRADEMARK OF INTERNATIONAL BUSINESS MACHINES



Circle 215 on inquiry card.

TIRED

of looking for reliable Source of Supply?

RUN DOWN

from Looking???

NERVOUS

about QUALITY???

DISKETTES + RIBBONS + ACCESSORIES



Call Bob Kelly Now. . .
Kelly Computer Supplies
 1811 Carl St. • St. Paul, MN 55113
 Toll Free . . . 800 - 447 - 2929
 MN Res. Call Collect. . . 612/644-9030

VERBATIM - DISKETTES

Circle 252 on inquiry card.

Boulder Logical Testing, Inc. is now offering a new EPROM Programmer FOR \$245.00



- Microprocessor based
- Programs 2716, 2732, 2732A and 2532 EPROMS
- Zero Insertion Force (ZIF) sockets are standard
- 25 or 22 volt programming voltage option
- Copy from EPROM to EPROM automatically
- RS 232 interface with selectable baud rates
- Thorough user documentation includes example software drivers for popular computer systems, including Apple®, IBM PC®, and CP/M®
- Command set can be used from host computer or terminal
- Comes complete with power supply

To order, or for more information write:
Boulder Logical Testing, Inc.
 PO Box 902, Boulder, CO 80306
 (303) 494-8196

Check, Money Order, MC/VISA only. Price includes shipping & documentation. CO residents include state sales tax.
 *Apple is trademark of Apple Inc. IBM PC is trademark of IBM. CP/M is trademark of Digital Research.

Circle 52 on inquiry card.

RIBBONS CARTRIDGES AND SPOOLS

	PRICE PER RIBBON	PRICE PER DOZEN
Anadex 9500	13.50	147.00
Commodore Pet 8023	7.00	81.00
C. Itoh Prowriter	5.95	68.40
C. Itoh Starwriter F-10	4.75	54.00
Data South DS-180	6.50	75.00
Epson MX-70/80	5.25	60.00
Epson MX-100	9.95	108.00
Epson MX-100 Reload	6.50	72.00
Gemini - 10	2.50	27.00
IDS Microprism ~ 480	6.00	69.00
IDS Paper Tiger 460/560	7.50	87.00
IDS Prism	8.00	93.00
Okidata - 80, 82 & 83	2.50	27.00
Okidata - 84	5.00	57.00

TO ORDER CALL (313) 569-3218 or
 WRITE FOR OUR CATALOG
DWIGHT COMPANY, INC.
 15565 NORTHLAND DRIVE
 WEST TOWER SUITE 804
 SOUTHFIELD, MICHIGAN 48075

Circle 159 on inquiry card.

IBM PC, APPLE, etc. . .

SHARING AND SWITCHING PROBLEMS? GILTRONIX HAS THE SOLUTION!

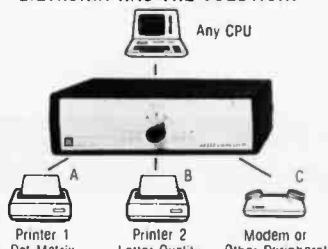

Any CPU

Printer 1 Dot Matrix Printer 2 Letter Quality Modem or Other Peripheral

MANUAL UNITS 2-6 Ports Selecto-Switch OR AUTOMATIC UNITS 2-7 Ports Auto-Switch

Serial (RS 232)/Parallel (Centronics)

LOW COST ADD-ONS FROM THE MAIN MANUFACTURER



3780 Fabian Way, Palo Alto, CA 94303
 (415) 493-1300

Circle 200 on inquiry card.

DISKETTES

3M Scotch® BRAND

AT SUPER LOW PRICES WE WILL SHIP YOUR ORDER WITHIN 24 HOURS AND WE PAY THE SHIPPING CHARGES



COD ACCEPTED
 DEALER INQUIRIES INVITED

CALL TOLL FREE
800 922-8193

IN CALIFORNIA
800 468-1068

TAYCO
 Tayco Business Forms
 Computer Supplies
 Post Office Box 605
 Newbury Park, CA 91320



Circle 417 on inquiry card.

Scotch® Diskettes

Rely on Scotch® diskettes to keep your valuable data safe. Dependable Scotch diskettes are tested and guaranteed error-free. The low abrasivity saves your read/write heads. They're compatible with most diskette drives.



(800)235-4137



DEALER INQUIRIES INVITED

PACIFIC EXCHANGES
 1141 Fremont Blvd.
 San Luis Obispo, CA
 93401 In Cal call
 (805)542-5445 or
 (805)544-1117



Circle 334 on inquiry card.

TeleVideo DEALERS

- Fast Dump/Restore over 800k per disk \$80
- Type Ahead with Print Screen 64 Character Type Ahead Buffer \$80
- 3270 & 2780/3780 Biscync Communications from Phone 1 & Batech \$700 & \$300
- TurboDOS for TeleVideo Start at \$225
- BIOS & Formatting for 802H use all 20 MB \$150
- B™ Disk Drive for 802 Computer Drive & Software \$1,100
- RM Cobol™ for TurboDOS Full System \$525
 Run Time \$175
- Standby Power System 200VA-400VA-800VA As low as \$363

RM/COBOL is a registered trademark of Ryan-McFarland Corp.
 CP/M® is registered trademark of Digital Research, Inc.
 TurboDOS is a registered trademark of Software 2000, Inc.

PLUS OTHER GOOD TELEVIDEO STUFF!

COGITATE, Inc.

SPECIALISTS IN UNIQUE TELEVIDEO SOFTWARE
 24000 Telegraph Road, Southfield, MI 48034
 (313) 352-2345
 VISA/MASTER CARD Accepted

Circle 75 on inquiry card.

JADE Computer Products

OKIDATA—MICROLINE 92 & 93

160 CPS, true correspondence quality printing, full graphics. IBM PC compatible (optional), handles single sheet as well as fan-fold paper, professional design construction and quality

PRM-43092	Oki 92 parallel List 699.00	_____	\$439.95
PRM-43093	Oki 93 parallel List 1199.00	_____	\$795.95
PRA-43181	2K serial board	_____	\$115.00
PRA-43086	IBM PC ROMS for 92	_____	\$49.95
PRA-43087	IBM PC ROMS for 93	_____	\$49.95
PRA-43080	Extra ribbon (2)	_____	\$9.95
PRA-43088	Tractor for Oki 92	_____	\$54.95

MICROLINE 82, 83, & 84

120 CPS (82, 83) 200 CPS (84), industry standard printers, serial and parallel interfaces, true lower case descenders, handles single-sheet as well as fan fold

PRM-43082	Oki 82 List Price 599.95	_____	\$379.95
PRM-43083	Oki 83 w/ FREE! tractor	_____	\$825.95
PRM-43084	Oki 84 parallel List \$1399.00	_____	\$925.00
PRM-43085	Oki 84 serial List 1499.00	_____	\$995.00
PRA-43081	2K serial board	_____	\$159.95
PRA-43080	Extra ribbons 82/92, 83/93	_____	\$9.95
PRA-43088	Tractor for Oki 82	_____	\$54.95
PRA-43180	Ribbons 83, 84, 93	_____	\$9.95

EPSON PRINTERS

Save at Least 150.00!!

CALL US FOR THE BEST DEAL ON THE WORLD'S BEST SELLING LINE OF PRINTERS!

EPSON RX-80	100 CPS w/tractor, graphics	
PRM-29082	A 499.00 Value, Save 200.00	— \$299.95
EPSON RX-80FT	100 CPS with FREE graphics	
PRM-29084	Friction & tractor feed	— SAVE \$150.00
EPSON MX-80FT	80 CPS with FREE graphics	
PRM-28082	Friction & tractor feed	— SAVE \$150.00
EPSON MX-100	100 CPS 15" platten	
PRM-28100	Friction & tractor	— SAVE \$150.00
EPSON FX-80	160 CPS with FREE graphics	
PRM-29080	Friction & tractor feed	— SAVE \$150.00
EPSON FX-100	160 CPS 15" platten	
PRM-29100	Friction & tractor feed	— SAVE \$150.00

GEMINI 10X & 15X

Star Micronics—up to 120 CPS, full graphics, friction and tractor feed, Epson FX-80 compatible

PRM-66010	Gemini 10X	_____	SAVE \$150.00
PRM-66015	Gemini 15X	_____	SAVE \$150.00
PRA-66200	Serial board, G-10, G-15	_____	\$89.00
PRA-66202	Serial board, G-10X, G-15X	_____	\$55.00
PRA-66206	10X, 15X 4K serial	_____	\$109.00

NEW! DELTA 10

160 CPS, up to 16K buffer, serial and parallel interfaces, graphics friction and tractor, FX-80 compatible
PRM-66120 _____ Save \$150.00

COMREX CR-II

Best buy in letter quality printers. NEW! from Comrex! full featured letter quality printer, FREE! 5K buffer, logic seeking bi-directional printing, boldface, proportional spacing, double-strike, backspace, underline, true super script and sub script, drop in daisy wheel cartridge

PRD-11101	CR-II parallel	_____	\$495.00
PRD-11102	CR-II serial	_____	\$589.95
PRA-11100	Tractor option	_____	\$99.95
PRA-99700	Cut sheet feeder	_____	\$189.95
PRA-11115	Keyboard option	_____	\$179.95

SILVER REED EXP-550

Economical daisy wheel printer with 200 words per minute (18 CPS), full 15-inch platen, Diablo 630 protocol, 10, 12, 15 pitch or proportional printing. Very quiet, very reliable, a bargain in the under \$1000, letter quality printer market

PRD-52001	Parallel, List 895.00	_____	\$669.00
PRD-52002	Serial, List 995.00	_____	\$775.00
PRA-52000	Tractor, List 159.95	_____	\$129.00

DISK DRIVE For APPLE

Totally Apple compatible, 143,360 bytes per drive on DOS 3.3 full one year factory warranty, half-track capability, reads all Apple software, plugs right into Apple controller as second drive, DOS 3.3, 3.2.1 Pascal, & CP/M compatible

MSM-431010	Standard Disk II size	_____	\$199.00
MSM-431030	Controller only	_____	\$60.00

HALF-HEIGHT DRIVE For APPLE

Totally Apple compatible. Works with all Apple software and controllers. Faster and quieter than most other drives, yet only half the size!

MSM-581010	Half-height	_____	\$199.95
------------	-------------	-------	----------

SUPER DISKETTE SPECIAL!

We bought out a major manufacturer's overstock, and we are passing the savings on to you! Single sided double density, package of ten FREE plastic case

MMD-5120103	Apple diskettes	_____	\$18.95
-------------	-----------------	-------	---------

CP/M 3.0 CARD For APPLE—ALS

The most powerful card available for your Apple! 6 MHz, Z-80B, additional 64K RAM, CP/M 3.0 plus, 100% CP/M 2.2 compatibility, C Basic, CP/M graphics, 300% faster than any other CP/M for Apple
CPX-62810A ALS CP/M card _____ \$299.00

Z CARD For APPLE—ALS

Two computers in one, Z-80 and 6502, more than doubles the power and potential of your Apple, includes Z-80 CPU card, CP/M 2.2 and complete manual set, Pascal compatible, one year warranty
CPX-62800A A & T with CP/M 2.2 _____ \$139.00

80 COLUMN CARD

80 column x 24 line video card for Apple II addressable 25th status line, normal/inverse or high/low video, 128 ASCII characters, upper and lower case, 7 x 9 dot matrix with true descenders, CP/M, Pascal and Fortran compatible, 40/80 Hz, 40/60 column selection from keyboard. Best 80 column card!

IOV-2450A	Viewmax 80	_____	\$139.95
IOV-2455A	Visicalc/Easywriter Preboot	_____	\$24.95

16K RAM CARD For APPLE II

Expand your Apple II 64K, use as language card, full one year warranty. Why spend \$175.00?

MEX-16700A	Save over 115.00	_____	\$49.95
------------	------------------	-------	---------

PRINTER CARD & CABLE

For Apple. Standard centronics parallel interface for Epson, Okidata, C. Itoh, Gemini, NEC, Comrex, etc. Includes printer cable and supports graphics

IOV-2100A	Printer card & cable	_____	\$49.95
-----------	----------------------	-------	---------

FAN/POWER CENTER For APPLE

Cooling fan for your overheated Apple II, II+, or IIe; also includes power switch and two switched outlets with voltage protection circuitry

SYA-1520A	Apple fan	_____	\$59.95
-----------	-----------	-------	---------

NEW! MICROMODEM IIe HAYES

The standard in direct-connect, plug-in modem cards for Apple, 110-300 baud. Includes FREE Smartcom I
IOM-2000A Micromodem IIe _____ \$239.95

KOALA PAD—KOALA TECH.

A touch sensitive pad that functions like a joystick or mouse, allowing you to move the cursor around the screen with the touch of a finger. Complete with software

SYA-1518A	Koala Pad	_____	\$99.95
-----------	-----------	-------	---------

GRAPPLER PLUS—Orange Micro

The ultimate parallel printer graphics interface card with many new features, now at a new low price!

IOV-2300A	Grappler Plus	_____	\$119.95
-----------	---------------	-------	----------

BUFFERED GRAPPLER PLUS

Combines the flexibility of the Grappler + with the convenience of the Bufferboard, all on a single board
IDP-2320A Buffered Grappler+ _____ \$175.00

BUFFERBOARD—Orange Micro

Add up to 20 pages of text output buffering to your existing Grappler + board

IOV-2310A	Bufferboard	_____	\$135.00
-----------	-------------	-------	----------

ASIO—SSM/TRANSEND

RS232 serial I/O board for Apple, works with printers or modems, 110 to 9600 baud, DOS, CP/M and Pascal compatible

IOI-2052A	ASIO	_____	\$119.95
-----------	------	-------	----------

DUAL 8-inch DISK DRIVES

Up to 2 Megabytes for your Apple, two double density 8 inch slimline disk drives, cabinet, power supply, cable, controller, and software. Compatible with DOS, CP/M, Pascal, and IBM 3740 formats

1 MEGABYTE SUB SYSTEM	_____	\$1195.00
2 MEGABYTE SUB SYSTEM	_____	\$1395.00

Better than USI, Better than Amdek!

BEST MONITORS AVAILABLE!

Ultra-high resolution, up to 22 MHz, 1000 lines per inch, amber or green phosphor. FREE! tilt and swivel base, US manufacturer

VDM-881220	12" green 22 MHz	_____	\$149.95
VDM-881210	12" amber 22 MHz	_____	\$149.95
VDM-880920	9" green 18 MHz	_____	\$139.95
VDM-880910	9" amber 18 MHz	_____	\$139.95

12-inch GREEN—ZENITH

15 MHz, 40 or 80 column			
VDM-201201	12" green	_____	\$94.95

MICROFAZER—QUADRAM

The Microfazer stand-alone printer buffers are available in any configuration of serial or parallel input, with serial or parallel output. All are expandable up to 64K of memory (about 30 pages of 8 1/2 x 11 text); the parallel-to-parallel version is expandable to 512K Copy and pause feature included

Parallel/Parallel	
IOP-26008	8K List 169.00 _____ \$139.95
IOP-26032	32K List 225.00 _____ \$184.95
IOP-26128	128K List 445.00 _____ \$269.95

Serial/Parallel	
IOP-27008	8K List 199.00 _____ \$189.95

Serial/Serial	
IOP-28008	8K List 199.00 _____ \$169.95
IOP-28032	32K List 220.00 _____ \$199.95

Parallel/Serial	
IDP-29008	8K List 199.00 _____ \$169.95

MICROBUFFER PRACTICAL PERIPHERALS, INC

Stand-alone Microbuffers	
IOP-2500A	Parallel, 32K _____ \$249.95
IOP-2510A	Parallel, 64K _____ \$299.95
IOP-2520A	Serial, 32K _____ \$249.95
IOP-2530A	Serial, 64K _____ \$299.95

Microbuffers for Apple II	
IOP-2560A	Parallel, 16K _____ \$199.95
IOP-2570A	Parallel, 32K _____ \$249.95
IOP-2580A	Serial, 16K _____ \$199.95
IOP-2590A	Serial, 32K _____ \$249.95

Microbuffers for Epson Printers	
IOP-2540A	Parallel, 16K _____ \$139.95
IOP-2550A	Serial, 8K _____ \$139.95

PLACE ORDERS TOLL FREE!

Continental USA
(800) 421-5500

Inside California
(800) 262-1710

Los Angeles Area
(213) 973-7707

JADE Computer Products

S-100 BOARDS ON SALE!

SBC-200 SD SYSTEMS

4 MHz Z-80A CPU with serial and parallel I/O
CPU-30200A A & T \$298.95

THE BIG Z—JADE

2 or 4 MHz switchable Z-80 CPU board with serial I/O
CPU-30200B Bare board w/manual \$35.00
CPU-30201K Kit w/manual \$179.95
CPU-30201A A & T \$199.00

SBC 300 SD SYSTEMS

Self-contained S-100 Z80 microcomputer, 4/6 MHz
CPC-30304A SBC 300, 4 MHz, A & T \$619.95
CPU-30306A SBC 300, 6 MHz, A & T \$689.95

CPU-Z COMPUPRO

2 or 4 MHz Z80A CPU, 24 bit addressing
CPU-30500A 2/4 MHz A & T \$279.95
CPU-30500C 3/6 MHz CSC \$347.95

8085/8088 COMPUPRO

Both 8 and 16 bit CPUs standard 8 bit S-100 bus
CPU-20510A 6 MHz A & T \$389.95
CPU-20510C 6/8 MHz CSC \$497.95

SINGLE BOARD COMPUTER NEW! ADC SUPER SIX

First 6 MHz S-100 single board computer to support banked CP/M 3.0 featuring 128K RAM, 6 MHz Z-80B, DMA cont, DART, PIO, CTC, double-density disk controller, up to 4K of Eprom. IEEE 696 compatible. 6 MHz super slave boards also available for networks
CPC-30860A 64K super six \$749.95
CPC-30862A 128K super six \$799.95
SFC-52502000F CP/M 3.0 for super six \$349.95
SFC-55622000F Turbo-DOS single user \$249.95

64K STATIC RAM—JADE

Uses new 2K x 8 static RAMs, fully supports IEEE 696
MEM-99152B Bare board \$49.95
MEM-99152K Kit less RAM \$89.95
MEM-32152K 32K kit \$169.00
MEM-56152K 56K kit \$225.00
MEM-64152K 64K kit \$265.00
Assembled & Tested add \$30.00

EXPANDORAM III

High density memory board, 64K, 128K or 256K
MEM-65064A 64K \$398.95
MEM-65128A 128K \$464.95
MEM-65192A 192K \$524.95
MEM-65256A 256K \$589.95

EXPANDORAM IV—SD SYSTEMS

Up to 1024K using 256K RAM chips, parity
MEM-66256 ExpandoRAM IV w/parity \$975.95
MEM-67256 ExpandoRAM IV w/EDC \$1675.95

DOUBLE D—JADE COMPUTER

High reliability, double density disk controller
IOD-1200B Bare board & hdwr man \$59.95
IOD-1200K Kit w/hdwr & stwr man \$299.95
IOD-1200A A & T w/hdwr & stwr man \$325.00
SFC-59002001F CP/M 2.2 with Double D \$99.95

VERSAFLOPPY II—SD SYSTEMS

Double density disk controller for 5 1/4" and 8"
IOD-1160A A & T with PROM \$344.95
SFC-55009047F CP/M 3.0 with VF-II \$80.00

VERSAFLOPPY II 696

Fully compatible with IEEE 696 standards
IOD-1170A Versafloppy II/696 A & T \$349.95
SFC-55009157F 8" banked CP/M 3.0 **\$75.00
SFC-55009157M 5 1/4" banked CP/M 3.0 **\$75.00
SFC-55009159F 8" unbanked CP/M 3.0 **\$75.00
SFC-55009159M 5 1/4" unbanked CP/M 3.0 **\$75.00
**Price is \$75.00 if ordered with Versafloppy II
The price if ordered separately is \$199.95

VERSAFLOPPY III—SD SYSTEMS

Winchester and floppy controller in a single board!
IOD-1180A Versafloppy III A & T \$759.95
SFC-55009257F 8" banked CP/M 3.0 **\$129.00
SFC-55009257M 5 1/4" banked CP/M 3.0 **\$129.00
SFC-55009259F 8" unbanked CP/M 3.0 **\$129.00
SFC-55009259M 5 1/4" unbanked CP/M 3.0 **\$129.00
*Configured for SBC 300
**Price is \$129.00 if ordered with Versafloppy III.
The price is \$199.95 if ordered separately

I/O-4 SSM MICROCOMPUTER

Two serial I/O ports plus two parallel I/O ports
IOI-1010A A & T \$245.00

INTERFACER 4 COMPUPRO

Three serial, one parallel, one centronics parallel
IOI-1840A A & T \$389.95
IOI-1840C CSC \$495.00

I/O-8 SD SYSTEMS

Full compliance with IEEE 696 standards
IOI-1510A 8 Async ports \$589.95
IOI-1520A 4 Sync/4 Async \$669.95

THE BUS PROBE

Best selling inexpensive S-100 diagnostic analyzer
TSX-200B Bare board \$59.95
TSX-200K Kit \$179.95
TSX-200A A & T \$199.95

ISO BUS—JADE COMPUTER

Silent, simple and on SALE! A better motherboard
6 Slot (5 1/4" x 8 1/2") 19 MHz
MBS-061B Bare board \$22.95
MBS-061K Kit \$39.95
MBS-061A A & T \$49.95
12 Slot (9 1/4" x 8 1/2") 10 MHz
MBS-121B Bare board \$34.95
MBS-121K Kit \$69.95
MBS-121A A & T \$89.95
18 Slot (14 1/2" x 8 1/2") 6MHz
MBS-181B Bare board \$54.95
MBS-181K Kit \$99.95
MBS-181A A & T \$139.95

8 inch DISK DRIVES

SIEMENS FDD 100-8 Single sided, double density
MSF-201120 \$179.00 ea 2 for \$175.00 ea
SHUGART SA 801R Single sided, double density
MSF-10801R \$355.00 ea 2 for \$349.00 ea
SHUGART SA-851R Double sided, double density
MSF-10851R \$459.00 ea 2 for \$455.00 ea
QUME DT-8 Double sided, double density
MSF-750080 \$479.00 ea 2 for \$459.00 ea
TANDON TM 848-1 SS DD thin-line
MSF-558481 \$369.00 ea 2 for \$359.00 ea
TANDON TM 848-2 DS DD thin-line
MSF-558482 \$439.00 ea 2 for \$435.00 ea
NEC FD1165 DS DD thin-line
MSF-851165 \$450.00 ea 2 for \$440.00 ea
NEC FD1164 SS DD thin-line
MSF-851164 \$360.00 ea 2 for \$350.00 ea

DISK SUB-SYSTEMS JADE

Handsome metal cabinet with proportionally balanced air flow system, rugged dual drive power cable kit, power switch, line cord, fuse holder, cooling fan, nevrmar rubber feet, all necessary hardware to mount two 8-inch disk drives, power supply, and fan. does not include signal cable
Dual 8" Sub-Assembly Cabinet
END-000420 Bare cabinet \$49.95
END-000421 Cabinet kit \$199.95
END-000431 A & T \$249.95

8" Sub-Systems—Single Sided, Double Density
END-000423 Kit w/2 Siemens FD100-8Ds \$579.00
END-000424 A & T w/2 Siemens FD100-8Ds \$595.00
END-000433 Kit w/2 Shugart SA-801Rs \$939.00
END-000434 A & T w/2 Shugart SA-801Rs \$969.00

8" Sub-Systems—Double Sided, Double Density
END-000426 Kit w/2 Qume DT-8s \$1229.00
END-000427 A & T w/2 Qume DT-8s \$1249.00
END-000436 Kit w/2 Shugart SA-851 Rs \$1199.00
END-000437 A & T w/2 Shugart SA-851 Rs \$1219.00

DUAL SLIMLINE SUB-SYSTEMS

Dual 8-inch Slimline Cabinet
END-000820 Bare cabinet \$59.95
END-000822 A & T w/o drives \$164.95

Dual 8-inch Slimline Sub-systems
END-000843 Kit w/2 SS DD drives \$869.00
END-000844 A & T w/2 SS DD drives \$879.00
END-000845 Kit w/2 DS DD drives \$1060.00
END-000846 A & T w/2 DS DD drives \$1099.00

DISK DRIVE POWER SUPPLY

Sufficient current to power up to three 8" drives
PSD-206A List Price 149.00 \$89.95

PB-1 SSM MICROCOMPUTER

2708, 2716 EPROM board with on-board programmer
MEM-99510A A & T w/manual \$219.00

PROM-100 SD SYSTEMS

2708, 2716, 2732 EPROM programmer with software
MEM-99520A A & T with software \$219.95

ULTRA-VIOLET EPROM ERASERS

Inexpensive erasers for industry or home
XME-3100 Spectronics w/o timer \$69.50
XME-3101 Spectronics with timer \$94.95
XME-3200 Logical Devices \$49.95

Satisfying Your Personal And Professional Computer Needs Since 1975

We accept cash, checks, credit cards, or purchase orders from qualified firms and institutions.
Minimum prepaid order \$15.00 California residents add 6 1/2% tax. Export customers outside the US or Canada please add 10% to all prices. Prices and availability subject to change without notice. Shipping and handling charges via UPS Ground 50¢/lb. UPS Air \$1.00/lb. minimum charge \$3.00 Prices quoted are for pre-paid orders only

JADE Computer Products 4901 West Rosecrans Avenue, Hawthorne, California 90250

DISK DRIVES & MODEMS

Save

ACCESSORIES FOR IBM PC

5 1/4 inch DISK DRIVES

TANDON TM 100-1 SS DD 48 TPI	
MSM-551001	\$225.00 ea 2 for \$195.00 ea
SHUGART SA 400L SS DD 48 TPI	
MSM-104000	\$209.00 ea 2 for \$199.95 ea
TANDON TM 100-2 DS DD 48 TPI	
MSM-551002	\$229.00 ea 2 for \$225.00 ea
MPI B52 DS DD 48 TPI can be substituted for CDC	
MSM-155200	\$275.00 ea 2 for \$270.00 ea
MPI B51 SS DD 48 TPI	
MSM-155100	\$209.00 ea 2 for \$199.00 ea
MPI B91 Single sided. Quad Density 96 TPI	
MSM-155300	\$285.00 ea 2 for \$275.00 ea
MPI B92 Double sided Quad density 96 TPI	
MSM-155400	\$400.00 ea 2 for \$390.00 ea

5 1/4" CABINETS/POWER SUPPLY

END-000216 Single cab w/power supply	\$69.95
END-000226 Dual cab w/power supply	\$85.00

SMARTMODEM—HAYES

Sophisticated direct-connect auto-answer/auto-dial modem. touch tone or pulse dialing. RS232C interface programmable

IOM-5500A Smartmodem 1200	\$475.00
IOM-5550A 1200B for IBM PC	\$399.95
IOM-5400A Smartmodem 300	\$199.00
IOM-1500A Hayes Cronograph	\$199.00
IOM-1100A Micromodem 100	\$349.00
IOM-2000A Micromodem IIe	\$259.00

1200 BAUD SMART CAT NOVIATION

103/212 Smart Cat and 103 Smart Cat, 1200 and 300 baud, built-in dialer, auto re-dial if busy, auto answer/disconnect, direct connect, LED readout displays mode analog/digital loopback self tests, usable with multi-line phones

IOM-5241A 300 Baud 103 Smart Cat	\$229.95
IOM-5251A 1200 Baud 212/103 Smart Cat	\$549.95

J-CAT MODEM—NOVIATION

1/5 the size of ordinary modems. Bell 103, manual or auto-answer, automatic answer/originate, direct connect, built-in self-test, two LEDs and audio beeps provide status information

IOM-5261A Novation J-Cat	\$119.00
--------------------------	----------

SMART BUY IN MODEMS SIGNALMAN

Direct connect, low cost, high quality, and state-of-the-art features. Includes FREE! subscription to the Source

MARK I Universal 300 baud, automatic originate/answer selection, RS232C	
IOM-5600A 300b RS-232	\$79.95

MARK VI 300 Baud for IBM PC, auto-answer, auto-dial, plug-in modem board with full communications software included FREE!	
IOM-5630A 300 Baud IBM card	\$159.95

MARK VII Universal 300 baud, auto-answer, auto-dial RS-232 modem	
IOM-5610A Deluxe RS-232 300b	\$149.95

NEW! MARK XII New Universal 1200 Baud auto-answer, auto-dial modem with all the popular features of the Hayes Smartmodem 1200	
IOM-5620A 1200B deluxe modem	\$399.95

SIX PAK PLUS—AST

Up to 384K RAM, clock calendar with battery back up, serial port, parallel printer port, game port, super drive and super spool software included FREE!

MEX-38064A 64K C.S.P	\$289.95
MEX-38256A 256K C.S.P	\$489.95
For Game Port Option Add	\$39.95

MEGA PLUS—AST

Up to 512K RAM, clock calendar with battery back up, 2 serial ports, parallel printer port, game port, super drive and superspool software included FREE!

MEX-51064A 64K C, 1 serial	\$269.95
MEX-51000S Second serial port option	\$39.95
MEX-51000P Printer port option	\$39.95
MEX-51000G Game port option	\$39.95
For Each Additional 64K RAM Add	\$49.95

I/O PLUS II—AST

Up to 2 serial ports, parallel printer port, game port, clock calendar with battery back up, super drive and superspool software included FREE!

IOI-7500A Clock & 1 serial port	\$129.95
IOI-7500P Printer port option	\$39.95
IOI-7500S Second serial port option	\$39.95
IOI-7500G Game port option	\$39.95

SYSTEM CARD—MICROSOFT

From the authors of MS-DOS—up to 256K RAM, serial port, parallel printer port, clock calendar, plus RAM drive disk emulation, print spooler, time utilities, and terminal emulation software. DOS 1.1 or 2.0 compatible

MEX-16064A 64K system card	\$279.95
MEX-16256A 256K system card	\$429.95

QUADBOARD I—QUADRAM

Up to 256K RAM, serial port, parallel printer port, clock calendar, RAM disk and printer spooler software

MEX-41064A 64K Quadboard	\$279.95
MEX-41256A 256K Quadboard	\$399.95

QUADLINK—QUADRAM

Allows IBM PC to run Apple software. Includes interface card and software to allow your IBM PC to run both Apple DOS and PC DOS

CPX-50500A Quadlink	\$495.00
---------------------	----------

THE BEST SOFTWARE For IBM PC

We have taken the top rated programs and reduced the price making them a super value

LOTUS 1 2 3 Best spreadsheet	
SFP-24001020M Lotus 123 (1A)	\$329.95
DBASE II Best Data base	
SFP-11210100M Ashton-Tate DBASE II	\$429.95
WORDSTAR Best word processor	
SFP-13600100M MicroPro Wordstar	\$299.95
PROPACK Wordstar/Mail/Spell/Starindex	
SFP-13600900M MicroPro's best	\$394.95
VISIFILE Best Data base, Index	
SFP-14101080M Visicorp Visifile	\$199.95
CROSTALK Best communications package	
SFP-53770100M MicroStuff Crosstalk	\$129.95
MULTIPLAN Best selling spreadsheet	
SFP-162010100 Microsoft Multiplan	\$179.95
FLIGHT SIMULATOR Best Flight Simulator	\$39.95
SFP-332010100 Microsoft Flight Simulator	\$39.95

NOW! BETTER THAN EPSON

OkiData's new plug-n-play ROMS for Oki printers are fully IBM PC compatible! All ASCII characters, full graphics, complete Epson emulation, plus near letter quality printing not available with Epson

PRA-43086 Plug-n-play for 92	\$49.95
PRA-43087 Plug-n-play for 93	\$49.95
WCA-2536A IBM PC to Oki or Epson cable	\$32.95

HI-RES COLOR MONITORS

Only the best Quadchrome or Princeton HX-12, 690 x 480 resolution, 16 brilliant colors, special 31mm dot-pitch tube, includes FREE! cable

VDC-241301 Quadram Quadchrome	\$539.95
VDC-241401 Princeton Graphics HX-12	\$549.95

NEC or AMDEK, popular RGB monitors for IBM

VDC-652000 NEC JC 1203 RGB	\$599.95
VDC-801320 Amdek Color II	\$439.95

HERCULES GRAPHIC CARD

Two pages of ultra-high resolution text and graphics 720 x 348, compatible with Lotus 123, Visicalc, dBase II, etc. Includes parallel printer port

IOV-5010A Hercules Graphic Card	\$359.95
---------------------------------	----------

PLANTRONICS COLOR PLUS

Up to 16 colors, 80 characters, biplanar technology, includes parallel printer port

IOV-6010A Plantronics Color Plus	\$379.95
----------------------------------	----------

QUADCOLOR I & II

Quadcolor I delivers standard IBM PC color and graphics, add Quadcolor II and hi-resolution (640 x 200) color graphics are possible

IOV-4010A Quadcolor I basic board	\$234.95
IOV-4020A Quadcolor II add on	\$229.95

64K RAM UPGRADE For IBM PC

High speed RAM upgrade kit with parity (error detection) and one year warranty

MEX-64100K 64K kit for IBM PC	\$49.95
-------------------------------	---------

320K DISK DRIVES

Tandon TM-100-2 double-sided, double-density 320K disk drive. Original equipment drive on IBM PC

MSM-551002 Full size Tandon	\$224.95
MSM-991004 Half-height 320K drive	\$199.95

DISKETTES For IBM PC

High quality 320K double-sided, double-density diskettes, certified to be absolutely error free. Box of ten, warranted for one year

MMD-5220104 With FREE! plastic box	\$24.95
MMD-5220101 Verbatim Datalife	\$34.95

THE BEST MOUSE

From Mouse Systems. Optical mouse with no moving parts—nothing to wear out, includes software and is compatible with all major software packages

SYX-14100A Mouse Systems mouse	\$249.95
--------------------------------	----------

MICROSOFT MOUSE

Mechanical mouse from the folks that wrote your PC's operating system. Includes software and cables

SYX-16100A Microsoft mouse	\$149.95
----------------------------	----------

Place Orders Toll Free!

Continental U.S.A.
(800) 421-5500

Inside California
(800) 262-1710

Los Angeles Area
(213) 973-7707

Circle 242 on Inquiry card.

BYTE December 1983 623

OK, so you're dreaming of a Computer



HAVE WE GOT A DREAM

Let us prove to you that Christmas can be

APPLE

ALLEN MUNCHIES	15.95
ASCII EXPRESS PRO	89.95
BILETOAD	29.95
BOOKKEEPER III	69.95
BPT GENERAL ACCOUNTING	294.95
C BASIC (REQ. Z-80)	119.95
CONTEXT CONNECTOR	129.95
CRYPTO CUBE	29.95
D.B. MASTER 4.0	239.95
DATAPAX	179.95
DATASAR (REQ. Z-80)	195.95
DIAMOND MIND	29.95
DBASE II (REQ. Z-80)	449.95
EINSTEIN COMPILER	99.95
EXECUTIVE SECRETARY	179.95
FRIDAY	199.95
GRAPHIC SOLUTION	119.95
GRAPHTRIX 1.3	54.95
GRUDS IN SPACE	27.95
HI-RES SECRETS	99.95
HOME ACCOUNTANT	54.95
INFOSTAR (REQ. Z-80)	319.95
JUMPMAN	34.95
KAREL THE ROBOT	179.95
KEN USTON'S PRO BLACKJACK	54.95
MAGIC WINDOW II	99.95
MASTER PLANNER (REQ Z80)	229.95
MAZE CRAZE CONSTRUCT. SET	29.95
MILESTONE (REQ. Z-80)	199.95
MILLIONAIRE	44.95
MULTIPLAN	189.95
ORCA/M	79.95
PF8: REPORT	99.95
PIE: SPELLER COMMUNICATION	64.95
PIE WRITER 2.2	119.95
PINBALL CONSTRUCTION SET	29.95
POOYAN	24.95
PROGRAMMING AIDS	64.95
FRONTO DOS	21.95
Q-BASE	139.95
QEAUTRON	34.95
QUICK CODE (REQ. Z-80)	199.95
REPORTSTAR (REQ. Z-80)	239.95
ROOTS/M (REQ. Z-80)	134.95
S.A.M.	79.95
SCRAPER CAPER	34.95
SENSIBLE SPELLER	84.95
SPEED READ +	49.95
SPELLSTAR (REQ. Z-80)	164.95
STAR MAZE	29.95
SUPERCALC (REQ. Z-80)	189.95
SUPER-TEXT PRO 40/80	69.95
SYSTEM II EX TURNING PT	1099.95
TAX PREPARER	159.95
TERRAPIN LOGO	104.95
ULTIMA I	29.95
VERSIFORM	259.95
VISICALC ENHANCED //e	179.95
WITNESS	29.95
WIZWARE MICROZINE	29.95
WIZWARE SQUARE PAIRS	29.95
WIZWARE TURTLE TRACKS	29.95
WORD ATTACK!	39.95
WORDSTAR	249.95
ZENITH	29.95

ATARI

ACTION	- CART	69.95
ARCADE MACHINE	- DISK	44.95
ATLANTIS	- CART	29.95
BAJA BUGGIES	- DISK	27.95
BANK STREET WRITER	- DISK	34.95
BLUEPRINT	- CART	34.95
BUG OFF!	- DISK	24.95
CAPTURE THE FLAG	- DISK	44.95
CHOPFLIFTER	- CART	34.95
COMPUTER WAR	- CART	29.95
DELTA MUSIC	- CART	29.95
DELTA DRAWING	- CART	29.95
DIAMOND MINE	- CART	34.95
DISKEY	- DISK	39.95
DISKSCAN	- DISK	29.95
DISK WORKSHOP	- DISK	27.95
DOMINO MAN	- CART	34.95
EAGLES	- DISK	29.95
FILE FAX	- DISK	99.95
FINANCIAL WIZARD	- DISK	39.95
GRAPHICS MAGICIAN	- DISK	44.95
GRUDS IN SPACE	- DISK	29.95
HOME ACCOUNTANT	- DISK	64.95
JOURNEY TO PLANETS	- CART	34.95
JUMPMAN	- DISK	29.95
JUMPMAN JR.	- CART	29.95
MR. COOL	- CART	29.95
MADEN FOOTBALL	- CART	34.95
MEMORY TRAINER	- DISK	64.95
MILLIONAIRE	- DISK	44.95
MINER 2049ef	- CART	37.95
MOUNTAIN KING	- CART	34.95
OMEGA RACE	- CART	34.95
OZZY OZONE	- DISK	29.95
PINBALL	- DISK	24.95
PITSTOP	- CART	29.95
POGOMAN	- DISK	29.95
PREPPIE	- DISK	24.95
QUASIMODO	- DISK	27.95
RACK 'EM UP	- CART	34.95
RALLY SPEEDWAY	- CART	39.95
RENDERVOUS	- DISK	29.95
RIVER QUEST	- DISK	27.95
ROM'S REVENGE	- DISK	34.95
S.A.M.	- DISK	44.95
SATAN'S HOLLOW	- CART	34.95
SCRAPER CAPER	- CART	37.95
SEA DRAGON	- DISK	27.95
SOLAR FOX	- CART	34.95
STAR BOWL FOOTBALL	- DISK	24.95
STRATOS	- DISK	19.95
SWORD POINT	- DISK	27.95
SYN-FILE+	- DISK	74.95
TAX ADVANTAGE	- DISK	44.95
TELENGARD	- DISK	24.95
TELETARI	- DISK	29.95
TEXT/SPELL WIZARD	- DISK	64.95
TIME RUNNER	- DISK	21.95
TRUST	- DISK	27.95
TYCOON	- DISK	44.95
WING WAR	- CART	29.95
WINGS	- CART	34.95
WIZWARE MICROZINE	- DISK	29.95
WIZWARE TURTLE TRKS	- DISK	29.95
ZAXXON	- DISK	29.95

CBM-64

BANK STREET WRITER	DISK	57.95
CALC RESULT ADV.	DISK	119.95
CASTLE WOLFENSTEIN	DISK	24.95
CAVE OF WORD WIZARD	DISK	19.95
CHECKERS	DISK	54.95
CHESS	DISK	54.95
CHOPLIFTER	CART	34.95
COMPUTER BASEBALL	DISK	29.95
CROSSFIRE	DISK	24.95
CYBORG	DISK	24.95
DAVID'S MID. MAGIC	DISK	27.95
DELTA MUSIC	CART	29.95
DISKEY	DISK	39.95
DIAMOND MINE	CART	29.95
DRAGONRIDER OF PERN	DISK	29.95
DRELAB	CART	27.95
DUNZHIN	DISK	24.95
EAGLES	DISK	29.95
ELECTRONIC CHECKBK	DISK	19.95
FIREONE	DISK	27.95
FORT APOCALYSE	DISK	27.95
FROGGER	DISK	27.95
GENERAL LEDGER	DISK	79.95
GENESIS	DISK	24.95
GRUDS IN SPACE	DISK	29.95
HESMON	CART	29.95
HESWRITER 64	CART	34.95
HOME ACCOUNTANT	DISK	59.95
INSTA-CALC	DISK	39.95
INSTA-MAIL	DISK	27.95
INSTA-SPEED COMPILR	DISK	79.95
INSTA-WRITER	DISK	44.95
JAWBREAKER	DISK	24.95
JOURNEY TO PLANETS	CART	29.95
JUICE	CART	29.95
JUMPMAN	DISK	29.95
KINDERCOMP	CART	24.95
KNIGHTS OF DESERT	CASS	29.95
MEMORY TRAINER	DISK	47.95
MICRO-ADDITION	DISK	34.95
MR. COOL	CART	29.95
OMNICALC	DISK	74.95
PAINT WIZARD	DISK	37.95
PIPES	CART	29.95
PITSTOP	CART	29.95
PHARON'S CURSE	DISK	24.95
POOYAN	DISK	24.95
QUICK BROWN FOX	CART	47.95
RACK 'EM UP	CART	29.95
ROM'S REVENGE	DISK	34.95
SAVE NEW YORK	CART	29.95
SCRIPT 64	DISK	79.95
SEA DRAGON	DISK	27.95
SEAWINDER	DISK	27.95
SPEED READER II	DISK	54.95
SPITBALL	CART	29.95
STARFIRE	DISK	27.95
STORY MACHINE	CART	29.95
SUICIDE STRIKE	DISK	27.95
TELENGARD	CASS	17.95
TIME RUNNER	DISK	24.95
TYPING TUTOR + WORD	DISK	19.95
VANILLA PILOT	DISK	17.95
ZAXXON	DISK	29.95
ZORK I	DISK	29.95

IBM

ANSWER	189.95
CBASIC COMPILER (CP/M86)	249.95
THE CREATOR	229.95
CROSSTALK XVI	149.95
D.B. MASTER	139.95
DARK CRYSTAL	27.95
DATA CAPTURE	99.95
DATA DESIGN	169.95
DATAPAX	199.95
DELTA DRAWING	39.95
DBASE II MS-DOS/CP/M86	429.95
EASY SPELLER II MS-DOS	169.95
EINSTEIN WRITER	209.95
EZ MAILER II	129.95
FCM	99.95
FILE FAX	129.95
FILE MANAGER +	79.95
FLIGHT SIMULATOR	39.95
FORTRAN COMPILER MS-DOS	249.95
FRIDAY (MS-DOS)	199.95
HOME ACCOUNTANT PLUS	49.95
INFOSTAR	349.95
THE LEDGER	339.95
LETTERFORM 1000 2.0	69.95
LOGIC CALC	139.95
LOGIC QUEST III	389.95
LOW! I	199.95
MAILMERGE	179.95
MILESTONE (CP/M 86)	199.95
MINER 2049	34.95
MULTIMATE	299.95
MULTIPLAN	189.95
MULTI-TOOL WORD W/MOUSE	339.95
PEACHTEXT 5000 (MS/DOS)	249.95
PERFECT WRITER	189.95
PERSONAL INVESTOR 1.1	139.95
PERSONAL PEARL	199.95
PF8: REPORT	94.95
PIE: SPELLER	64.95
PIE WRITER	139.95
PRO CALC	249.95
PROFESSOR DOS	44.95
Q-BASE	139.95
QUICK-CODE MS-DOS/CP/M86	199.95
REPORT STAR	249.95
SCRAPER CAPER	34.95
SELECT WORD PROCESS SYS	279.95
SMARTCOM II	89.95
SPELLGUARD	149.95
SPELLSTAR	179.95
STARBURST	129.95
SUPERCALC II	199.95
SUPERWRITER 1.10	199.95
SUPER-TEXT PROFESSIONAL	79.95
T/MAKER III	199.95
T.I.M. III	349.95
TYCOON	44.95
ULTIMA II	54.95
VERSIFORM	259.95
VISICALC 256K	179.95
VISIFILE	239.95
VISITREND/PLOT	239.95
VISIWORD/VISISPELL	279.95
WIZARD	39.95
WORDSTAR	349.95

Remember - Apple Country Ltd. will try to meet o

For technical assistance, order status and California calls (619) 765-0239
Apple Country, Ltd., P.O. Box 1099, 2602 Washington St., Julian, Calif. 92036

Terms: We accept American Express. No extra charge for Visa/MasterCard, Cashier's Check, personal check (allow 2 weeks to clear) Shipping & Handling: 5% (\$5 min.); APO FPO Alaska Hawaii & Monitors 5% (\$10 min.) Foreign orders 15% (\$15 min.) All items are new with manufacturer's warranty. Prices are subject to availability & change without notice. Purchase order must include check. California residents add 6% sales tax. Send \$1 (good toward first purchase) for new fall catalog

Apple Country, Ltd. is a **DISCOUNT MAIL ORDER HOUSE** for the micro computer industry and is a California corporation not affiliated with Apple Computer Inc. Apple is a trademark of Apple Computer Inc.

Circle 28 on Inquiry card.

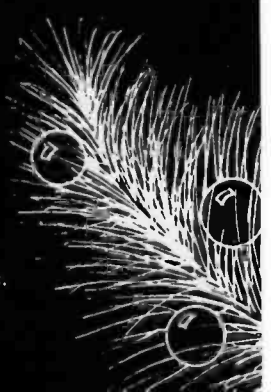

Christmas-
FOR YOU!
fun and affordable

Apple Country Ltd.
has your number for
ROCK BOTTOM PRICES!
1-800-222-2602

MONITORS

AMDEK COLOR I PLUS	294.95
AMDEK COLOR II PLUS	424.95
AMDEK COLOR III	369.95
AMDEK COLOR IV	749.95
AMDEK VIDEO 300 (GREEN)	134.95
AMDEK VIDEO 300 (AMBER)	144.95
AMDEK VIDEO 310 (AMBER)	164.95
BMC 12AU 12" GREEN	89.95
BMC AU9191U 13" COLOR	299.95
BMC 1401 13" RGB COLOR	349.95
BMC AU9191MU 13" RGB IBM	629.95
COMMODORE COLOR MONITOR	269.95
COMREX 13" COLOR W/SOUND	269.95
COMREX 12" HI-RES AMBER	134.95
COMREX 12" HI-RES GREEN	129.95
COMREX 12" HI-RES LT GRN	129.95
COMREX 13" RGB COLOR	269.95
ELECTROHOME 9" GREEN	129.95
ELECTROHOME 12" GREEN	144.95
ELECTROHOME 13" RGB IBM	379.95
ELECTROHOME 13" RGB COLOR	359.95
GORILLA 12" GREEN	89.95
NEC 12" GREEN SCREEN	154.95
NEC 12" ECONO GREEN	109.95
NEC 12" LO-RES COLOR	289.95
NEC 12" AMBER SCREEN	164.95
NEC 12" COLOR - IBM	479.95
PRINCETON GRAPHICS HK-12	489.95
SAKATA 13" COLOR	264.95
SAKATA 13" RGB COLOR	499.95
SAKATA SUPER RGB MONITOR	679.95
SAKATA 12" GREEN	104.95
TAXAN 12" GREEN	124.95
TAXAN 12" AMBER	129.95
TAXAN RGB VISION I	294.95
TAXAN RGB VISION III	439.95
ZENITH 12" AMBER	119.95
ZENITH 12" GREEN	99.95
ZENITH RGB COLOR MONITOR	389.95
USI 9" AMBER MONITOR	129.95
USI 9" GREEN MONITOR	119.95
USI 12" AMBER	149.95
USI 12" GREEN MONITOR	139.95
USI 14" LO-RES COLOR	289.95

MODEMS

ANCHOR MARK I (RS-232)	79.95
ANCHOR MARK II (ATARI)	79.95
ANCHOR MARK III (TI99/4A)	99.95
ANCHOR MARK V (OSBORNE)	94.95
ANCHOR MARK VI (IBM PC)	199.95
ANCHOR MARK VII (RS-232)	109.95
ANCHOR MARK XII (RS-232)	279.95
NOVATION J-CAT	104.95
NOVATION 212 AUTO CAT	579.95
SMARTCAT 212 (1200 BAUD)	429.95
SMARTMODEM 300 BAUD	194.95
SMARTMODEM 1200 BAUD	484.95
SMARTMODEM 1200B - IBM	449.95
US ROBOTICS AUTODIAL 212	449.95

PRINTERS

ANADEX DP-9501A	1029.95
ANADEX DP-9625A	1339.95
ANADEX DP-9620A	1129.95
ANADEX WP-6000	2199.95
ANADEX DP-6500TR 500CPS	2329.95
CENTRONICS 352DP	1999.95
C.ITOH A10 DAISY WHEEL	539.95
C.ITOH 8510SP	569.95
COMREX CR-I DAISY WHEEL	629.95
COMREX CR-II DAISY WHEEL	469.95
DAISEYWRITER 2000	1129.95
DIABLO 630R155	1784.95
EPSON FX-80 W/TRACTOR	LOW!!
EPSON FX-100 F/T	LOW!!
EPSON MX-80 F/T	LOW!!
EPSON MX-100 F/T	LOW!!
EPSON RX-80	LOW!!
EPSON RX-90 F/T	LOW!!
GEMINI 10X	LOW!!
GEMINI 15X	LOW!!
GORILLA BANANA PRINTER	189.95
IDS MICROPRISM	479.95
IDS PRISM 132	1299.95
IDS PRISM 132C - COLOR	1499.95
JUKI 6100 PRINTER (P)	549.95
MANNESMANN TALLY MT160L	599.95
MANNESMANN TALLY MT180L	799.95
MANNESMANN TALLY MT1802	1499.95
NEC 3550 SPINWRITER-IBM	1754.95
NEC 8025 120 CPS 136 COL	719.95
OKIDATA MICROLINE-IBM	299.95
OKIDATA PACEMARK 2350S	1999.95
OKIDATA PACEMARK 2350S	2199.95
OKIDATA PACEMARK 2410P	2329.95
OKIDATA PACEMARK 2410S	2499.95
OKIDATA 82A W/GRAPHICS	379.95
OKIDATA 83A W/GRAPHICS	579.95
OKIDATA 84P	1049.95
OKIDATA 84S	1129.95
OKIDATA 92P	449.95
OKIDATA 93P	729.95
OKIDATA 93S	829.95
PRINTMASTER (DAISY)	1549.95
TOSHIBA P-1350 LP	1579.95
PROWRITER I PRINTER	344.95
PROWRITER II PRINTER	619.95
C ITOH 8600BP	979.95
QUME SPRINT 11/40+	1399.95
SANYO PR5500 DAISY WHEEL	659.95
SILVER-REED 550 DAISY	699.95
STAR DELTA-10 160CPS	LOW!!
STARWRITER DAISY WHEEL	1099.95
TRANSTAR 315 COLOR	449.95
TRANSTAR 120P 14CPS	464.95
TRANSTAR 130P 18CPS	699.95
TRANSTAR 140S 40CPS	1229.95
EPSON SERIAL (RS-232)	134.95
GRAPFITI CARD	84.95
GRAPPLER +	119.95
MICROBUFFER II 16K	144.95
PKASO INTERFACE	129.95
WIZARD BPO 16K	129.95
WIZARD SOB 16K	179.95

OTHER PRINTERS AVAILABLE

COMPUTERS

COMMODORE 64	LOW!!
COMMODORE 1541 DRIVE	LOW!!
IBM PC	LOW!!
COLUMBIA VP PORTABLE	2349.95
COLUMBIA COMPLETE SYS.	2649.95
IBM-PC COMPATIBLE SYSTEM	
128K, 2-DS/DD DRIVES, KEYBOARD	
AND COMPLETE SOFTWARE PACKAGE	
CORVUS CONCEPT MC68000	3199
256K, 8" FLOPPY DRIVE	
COMPLETE SOFTWARE PACKAGE	
BI-DIRECTIONAL 8-1/2X11 SCREEN	
CORVUS CONCEPT 512K	\$3599
EAGLE PC II 128K SYSTEM	2649.95
ANGLE SPIRIT XL	3649.95
PORTABLE 128K RAM EXPANDABLE	
TO 640K RAM ON BOARD, 1 320K	
FLOPPY 10 MEGABYTE HARD DISK,	
IBM COMPATIBLE KEYBOARD,	
MONOCHROME MONITOR, 2 SERIAL &	
1 PARALLEL PORT, MS DOS 2.0,	
GW BASIC, CP/M 86	
KAYPRO II	1449.95
LEADING EDGE	
IBM COMPATIBLE COMPUTER	
8088 MPC 7.16 Mhz	
7 EXPANSION SLOTS, BUILT IN	
CLOCK, PARALLEL AND SERIAL	
PORTS, 128K RAM, MONITOR,	
WORD PROCESSING SOFTWARE.	
CALL FOR LOW PRICE!	
NEC APC-H01	\$2049
NEC APC-H02	\$2549
NEC APC-H03	\$3049
SANYO MBC 550 SYSTEM	769.95
SANYO WBC-1000	1529.95
TELEVIDEO 16-BIT DESKTOP	
128K 8088 5MHZ DUAL 360K DRIVES	
INCLUDES CP/M \$3499.95	
TELEVIDEO 910 TERMINAL	549.95
TELEVIDEO 925 TERMINAL	789.95
TELEVIDEO 970 TERMINAL	1199.95
ZENITH Z-120 ALL-IN-ONE	
BUILT-IN GREEN SCREEN	
DUAL DRIVES SPECIAL \$2999.95	
APPLE //e NOW AVAILABLE	
PLEASE CALL FOR OUR LOW PRICE	
FRANKLIN ACE 1000 W/COLOR LOW!!	
FRANKLIN ACE 1200 SYSTEM LOW!!	
DISKETTES	
ELEPHANT DISKETTES SS/SD	16.95
ELEPHANT DISKETTES SS/DD	19.95
ELEPHANT DISKETTES DS/DD	25.95

APPLE

ALS CP/M CARD	299.95
AMDEK AMDISK 3" DISK DR	239.95
APPLE-CAT II	264.95
APPLE DUMPLING GX	119.95
4TH DIMENSION DRIVE+CTRL	289.95
4TH DIMENSION DRIVE-ONLY	199.95
HAYES MICROMODEM IIe	249.95
KENSINGTON SYSTEM SAVER	64.95
KOALA GR/TABLET W/SFTWR	99.95
LAZER MICROSYSTEM DRIVE	189.95
MICRO-SCI A2 DRIVE ONLY	239.95
MICRO-SCI A2 W/CTRL-CARD	299.95
MOUNTAIN MUSIC SYSTEM	289.95
MOUNTAIN ROM WRITER	134.95
PREMIUM SOFTCARD IIe	334.95
QUADRAM 64K80C0L CRD IIe	124.95
RANA ELITE I W/CTRL-CARD	349.95
RANA ELITE II W/CTRL	499.95
RANA ELITE III W/CTRL	649.95
SOUNDCHASER MUSIC SYSTEM	619.95
SOFTCARD (2-80 CARD)	234.95
SWEET P PLOTTER	459.95
TG JOYSTICK W/TOGGLE IIe	49.95
TRANSMODEM 1200	499.95
WICO APPLE MOUSE	124.95

IBM

KOALA PAD TOUCH TABLET	99.95
KRAFT JOYSTICK	54.95
MICROSOFT SYSTEMCRD 256K	449.95
MICROSOFT MOUSE	134.95
MOUSE SYSTEMS PC MOUSE	224.95
QUADLINK APPLE EMULATOR	489.95
QUADRAM QUADBOARD I 64K	289.95
QUADRAM QUADCOLOR I	229.95
QUADRAM QUADCHROME MON	524.95
QUADRAM QUADSREEN MON	1549.95
RANA DS/DD DISK DRIVE	259.95
STB SUPER I/O MULTIFUNCT	169.95
TG JOYSTICK W/TOGGLE	49.95
TRANSEND P.C. MODEM 1200	399.95
VERSAWRITER GRAPH TABLET	239.95
WIZARD SPOOLER P/S 16K	239.95

CBM-64 WARE

CARDBOARD/5 5 SLOT EXPAN.	54.95
CARDKEY/1	32.95
DATA20 Z80 VIDEOPAK	224.95
HES MODEM I	64.95
KOALA GRAPH TABLET W/SFT	79.95
VIC/64 SWITCH	119.95

MERRY
CHRISTMAS
PEGGY

BEAT any advertised price - Call us today!

1-800-222-2602



California Digital

Post Office Box 3097 B • Torrance, California 90503

★ FREE ★

Plastic library case supplied with all diskettes purchased from California Digital

\$19.95

Manufactured for California Digital by one of the most respected producers of magnetic media. Each diskette is double density at 40 tracks. To insure extended media life all diskettes are manufactured with a reinforced hub.

Each box of 25 diskettes is supplied with a free plastic library case.
5 1/4 sector CAL-501. Ten sector CAL-510.
Also Available Double sided soft sector diskettes for use with the IBM/PC CAL-551 \$24.95



5 1/4" DISKETTES WITH LIBRARY CASE

\$26.50

Your Choice
SCOTCH MEMOREX VERBATIM

Single Side Double Density

Soft Sector 10 Sector 16 Sector

SCOTCH	744D-0	744D-10	744D-16	26.50
MEMOREX	3481	3483	3485	26.50
VERBATIM	525-01	525-10	NA	26.50
MAXELL	MD1	MH1-10	MH1-16	26.50
DYSAN	104/10	107/10	NA	45.00

Double Side Double Density

SCOTCH	745-0	745-10	745-16	39.00
VERBATIM	550-01	550-10	NA	42.50
MAXELL	MD2-D	MH2-10D	MH2-16D	45.00
DYSAN	104/2D	107/2D	NA	49.50
DYSAN 96	204/2D	NA	NA	59.50

EIGHT INCH DISKETTES

Single Side Single Density		Single Side Double Density		
SCOTCH	740-0	29.50	SCOTCH 741-0	39.00
MEMOREX	3060	29.50	MEMOREX 3090	35.00
DYSAN	3740/1	39.50	DYSAN 3740/D	57.50
Thirty Two Sector				
SCOTCH	740-32	29.50	SCOTCH 743-0	47.50
File A File B - store 50 pages INC-525 18.95		File A File B - store 50 pages INC-800 27.95		
File A File B - store 50 pages INC-800 27.95		Scotch head clean kit 5 1/4 8 MM-CMS 24.95		
Plastic library cases 5 1/4 8 SRW 15 2.95		MEMOREX 3114		39.50
		DYSAN 3740/2D		65.00

23" COMPOSITE MONITOR \$159

Ideal monitor for classroom demonstrations.

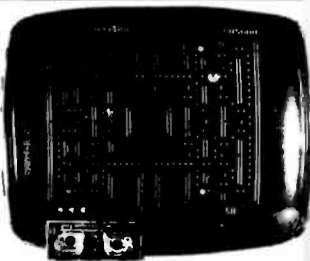

Ever try gathering a classroom of students around a 12" monitor? Here is your opportunity to purchase a 23" high resolution monitor at a reasonable price. These units accept standard composite video signals generated by most personal computers including the Apple and IBM. Attach it your computer and in second you are shooting down Kingpins in wide screen video. MOT-BW23 35 lbs. Monitors are spare home and for safety should be enclosed. Wood grained enclosure for an additional \$35.00 additional. ENC23 15 lbs.



SPECIAL

Shugart 410

\$129

These Shugart 410 5 1/4" disk drives are all factory fresh 1983 production, recently purchased from the Four Phase Division of the Motorola Corporation.

These disk drives are single sided 80 track (96 TPI) suitable for use with the Radio Shack Model 1 and Model 3. Or any other application that can support an 80 track second drive such as the IBM/PC. The 4 1/2" full height and functionally the same as the Tandon TM 100-3. Complete with power connector and installation manual.

When these Shugart 410's are liquidated the price will revert to our regular price of \$249. SHU-SA410

MEMORY

16K DYNAMIC 2732 EPROM

1.95 4.95
4116 150ns. 450ns.

64K DYNAMIC 16K STATIC
5.95 4.95
4164 150ns. 6116 200ns.

2764 EPROM SALE \$5.95

DYNAMIC MEMORY

4027 4K dynamic 250ns	ICM-4027250	1.99	1.85	1.75
4116 150ns 16K	ICM-4116150	1.75	1.65	1.45
4116 200ns 16K	ICM-4116200	1.75	1.65	1.45
4164 150ns 64K 128 refresh	ICM-4164150	5.95	5.35	4.97
41256 150ns 256K	ICM-41256150	Available Mar-84		
DP409 dynamic control	ICM-409	39.00	35.00	29.00

STATIC MEMORY

21102 200ns 1K static	ICM-2110200	1.49	1.29	1.15
21102 450ns 1K static	ICM-21102450	1.29	1.15	.99
2112 450ns 2K static	ICM-2112450	2.29	2.85	2.75
2114 300ns 1K x 4	ICM-2114300	1.95	1.85	1.75
3014TMS 450ns 4K x 1	ICM-4044500	3.49	3.29	2.99
5257 300ns 4K x 1	ICM-5257300	2.50	2.25	1.99
6116 Pa 200ns 2K x 8	ICM-6116200	4.50	4.65	4.15
6116 P3 150ns 2K x 8	ICM-6116150	4.75	4.65	4.35
6167 2167 109ns 16K x 120 pin	ICM-6167100	7.95	7.50	7.90

EPROMS

2708 450ns 1K x 8	ICE-2708	4.95	4.75	4.55
2716 450ns 2K x 8	ICE-2716	4.50	4.25	3.97
2716 450ns 2K x 8	ICE-2716T	4.75	4.50	4.25
2732 150ns 4K x 8	ICE-2732	4.50	3.75	3.55
2732 350ns 4K x 8	ICE-273250	6.50	6.00	7.60
2532 450ns 4K x 8	ICE-2532	10.50	9.90	9.50
2764 350ns 8K x 8	ICE-2764	5.95	5.65	5.35
27128 350ns 16K x 8	ICE-27128	18.95	17.75	16.35
2817 EEROM 2K x 8	ICE-2817	45.00	39.00	36.50

CONNECTORS



S-100 Gold

GOLD S-100 EDGE CARD CONNECTORS		DB25P	
catalog	each 10-99 100+	catalog	each 10-99 100+
1ms34 811 250 CNE-IM5	2.95 2.50 2.19	DB25P male	CND-9P 1.60 1.40 1.30
Bullfinch HiRel CNE-H100	4.19 3.05 3.47	DB25P female	CND-9F 1.60 1.35 1.30
S-100 Wire W CNE-W10 3.95 3.50 3.19		DB15P male	CND-15P 2.25 2.10 2.90
Altair 1401 CNE-100A 4.95 4.50 4.19		DB15S female	CND-15S 2.25 2.10 2.90
.140" CENTER EDGE CARD CONNECTORS			
22744 Eyelet CNE-44E	2.50 2.15 1.95	DB25 hood	CND25H 1.35 1.15 .77
43772 Motor CNE-72S	6.60 6.15 5.75	DB25S female	CND-25S 2.55 2.75 1.95
36/72 D.C. BAL. CNE-72S	5.95 5.50 5.19	DC37S female	CND-37S 5.95 5.75 5.50
Other connectors available upon request.			
RIBBON CONNECTORS			
DB25P male	CND-25P 5.85 5.25 4.15	DISK DRIVE POWER CONNECTORS	
DB25S female	CND-25S 5.95 5.59 4.90	8 5 pin D.C.	CNP-8DC 1.95 1.29 .89
57-30360 male	CNC-36P 7.95 6.75 5.90	8 3 AC S/S	CNP-3SS 1.69 1.09 .69
20 pin edge	CND-20S 7.95 6.75 5.90	8 3 AC D.C.	CNP-3DS 1.69 1.09 .69
20 pin edge	CNI-DE20 4.35 3.50 2.80	5 pin D.C.	CNP-5DC 1.79 1.19 .79
20 pin socket	CNI-D20 2.75 1.85 1.60	5 pin D.C. except	CNP-5DP 2.59 1.99 1.59
26 pin edge	CNI-DE26 4.85 3.50 2.70	AMPHENOL / CENTRONICS TYPE	
26 pin socket	CNI-D26 3.50 2.40 2.15	57-30360 36P	CND-36P 7.95 6.35 4.90
34 pin edge	CNI-DE34 4.95 4.50 3.50	IEEE488 C.C.	CND-24P 7.95 6.35 4.90
34 pin socket	CNI-D34 4.50 3.95 3.15	IBM/PC	
50 pin edge	CNI-DE50 5.95 5.60 4.90		
50 pin socket	CNI-D50 4.95 4.60 3.80		

BLOWOUT SALE

\$169



California Digital has recently participated in the purchase of several thousand Siemens FDD 100-8 floppy disk drives. These units are electronically and physically similar to that of the Shugart 801R. All units are new and shipped in factory sealed boxes. Manual and power connectors supplied free upon request. Your choice 115 Volt, 60 Hz, or 230 Volt, 50Hz.

REMEX DOUBLE SIDED \$219

California Digital has just purchased a large quantity of Remex RFD-4000 Eight Inch double sided disk drives. Remex is the only double sided disk drive that has a double gimbal mounted head assembly that guarantees lower head tracking. This drive is mechanically solid. Remex has always been known for producing premiere products for the floppy disk market. The Remex company is a subsidiary of the Ex-cell-o Corporation, a Fortune 500 Company.

Eight Inch Single Sided Drives

	One	Two	Ten
SHUGART 801R	385	375	365
SHUGART 810 Half Height	385	375	365
SIEMENS FDD 100-8	169	169	159
TANDON 848E-1 Half Height	369	359	349

Eight Inch Double Sided Drives

SHUGART SA851R	495	485	475
SHUGART 860 Half Height	485	475	459
QUME 842 "QUME TRACK 8"	459	459	449
TANDON 848E-2 Half Height	459	447	465
REMEX RFD-4000	219	219	209
MITSUBISHI M2894-63	379	375	369
MITSUBISHI M2896-63 Half Ht.	459	449	409

Five Inch Single Sided Drives

SHUGART SA400L	235	229	225
SHUGART SA410 96TPI/80 Trk.	129	119	call
SHUGART SA200 3/4 Height	159	149	139
TANDON TM100-1	189	179	175

Five Inch Double Sided Drives

SHUGART SA450	319	309	299
SHUGART SA455 Half Height	259	249	239
SHUGART SA465 Half Ht. 96TPI	289	279	269
TANDON TM50-2 Half Height	215	209	199
TANDON TM55-4 half Ht. 96TPI	329	319	309
TANDON 100-2	279	269	259
TANDON 101-4 96TPI 80 Track	369	355	350
MITSUBISHI 4851 Half Height	259	249	245
MITSUBISHI 4853 1/2 Ht. 96TPI	339	329	319
MITSUBISHI 4854 1/2 Ht., 8" elec.	465	449	439
QUME 142 Half Height	239	229	219
TEAC FD-55B Half Height	299	289	275

Five Inch Winchester Hard Disks Drives

SHUGART 612	13 M/Bytes	895	865	825
SHUGART 706	6 M/Byte, Half Ht	795	775	755
SHUGART 712	13 M/Byte, 1/2 Ht.	895	865	825
SEAGATE 506	6 M/Byte	495	475	455
TANDON 5D3	19 M/Byte	895	875	855

Upon request, all drives are supplied with power connectors and manual

ENCLOSURES

California Digital manufactures an assortment of stock and custom disk drive enclosures. If the volume is justified we will custom design an enclosure for your application. The following stock disk drive enclosures are available. All include power supplies the 8" enclosures are supplied with exhaust fans.

Horizontal mount two 8" full height drives	\$275.00	Horizontal mount one full height or two half height 8" disk drives	\$239.00
Vertical mount two full height 8" disk drives	\$299.00	Vertical mount two full height 5 1/4" disk drives	\$139.00

TOLL FREE ORDER LINE
(800) 421-5041
TECHNICAL & CALIFORNIA
(213) 643-9001

Shipping: First five pounds \$3.00, each additional pound \$ 5.50. Foreign orders: 10% shipping, excess will be refunded. California residents add 6 1/2% sales tax. • COD's discouraged. Open accounts extended to state supported educational institutions and companies with a strong "Dun & Bradstreet" rating. Retail location 15608 Inglewood Avenue, Lawndale 90260.

CALIFORNIA DIGITAL

Post Office Box 3097 B • Torrance, California 90503

LIBERTY FREEDOM 50 \$475 FREE

The Liberty Freedom 50 terminal features detachable selective bi-directional printing, superspeed, subsecond function keys, 15 graphic symbols, and DIP switch selectable character set for 2 foreign languages. The 12 inch slotted non-stare green phosphor screen displays 24 rows by 80 characters in 792 matrix with line descenders. Self-test and 25th data display row also included. Switch selectable baud rates from 110-119,200 baud. Screen attributes do not use display memory, allowing operator to display all 1920 characters. Emulates 5 popular CRT terminals for easy software configuration. Switch selectable between 115 and 230 volt. We have never seen a terminal with all these features for the incredibly low price of only \$475. LIB-F50 40 lbs.

DIABLO \$879

Word Processing Printer



Now from the originator of the daisy wheel printer, the Diablo 820. Print speeds to 24 char/sec. Selectable bi-directional printing, superspeed, subsecond function keys and more. Plus standard RS-232C interfacing. Communication speeds to 1200 baud with a 1500 character print buffer. Software programmable adjustable horizontal tabs makes report formatting easy. Over 20 different print wheels are currently available. The 820 automatically selects the print spacing for 10, 12, 15 character print wheels. On site service available worldwide. DBL-620 50 lbs.

PRINTERS \$289



Star Gemini-10X 120 char/sec. 4K buffer. Star Gemini-15 100 char./sec. 15 paper. Star Gemini Data 10 160 Char./sec. Star Coder 80FT fiction & tractor. Toshiba P1350 192 char./sec. letter quality. On-data BSA serial & parallel I/O. Paper. Oxdada 92A parallel interface. 160 char./sec. Oxdada B3A & parallel 15 paper. Oxdada B1A & parallel 15 paper. Oxdada 2350 150 char/sec. Epson Fx80 10 160 char/sec. with graphics. Epson MX100 with graphics. 15 paper. NEC8023A parallel 9" paper, graphics. Anadex 9501A high speed with graphics. Anadex 9600A 200 char/sec. par 18 serial. Quantix 7030 correspondence quality 180 char/sec. Corolla low cost dot matrix printer. Pioneer 8510 parallel 9" paper. Pioneer II parallel 15 paper, graphics. Datapoints B-400 3, 3 band printer 600 LPM. Plastipon P330 high speed printer 300 lines per minute. Printonix P600 ultra high speed 600 lines per minute. Mannesmann Tally 160L serial & par 160 char/sec.

MATRIX PRINTERS

STR-G10X	289.00
STR-G15	383.00
STR-D10	433.00
VST-C80FT	229.00
TOS-1350	1469.00
OKI-32A	273.00
OKI-92A	475.00
OKI-92A	619.00
OKI-92A	1024.00
OKI-2350	1995.00
EPSON-FX80	575.00
EPSON-MX100	645.00
NEC-6023A	389.00
ADX-9501A	1099.00
ADX-9600A	1189.00
QTA-7030	1585.00
PRO-7500	189.00
PRO-8510	343.00
PRO-2P	689.00
DPS-8600	6985.00
PTX-9200	4292.00
PTX-9600	5795.00
MAN-160L	559.00

WORD PROCESSING PRINTERS

NEC7710 55 char/sec. serial interface.	NEC-7710	1939.00
NEC7730 55 char/sec. par interface	NEC-7730	1939.00
NEC3550 popular printer designed for the IBM/PC	NEC-3550	1799.00
NEC4050 designed for IBM PC-20 char/sec. dot 11	NEC-4050	995.00
Silver Reed EXP500 14 char/sec. par interface	SRO-EXP500	459.00
Silver Reed EXP500 17 Char/sec. serial	SRD-EXP500	659.00
Dialo 630 40 char/sec. serial	DBL-630	879.00
Dialo 620 proportional spacing hor & vert. lat. 20 cps	DBL-620	879.00
Jan 6100 18 char/sec. graphic mode	JUK-6100	539.00
Brother H91A dot matrix parallel interface	BTH-H91P	695.00
Brother H91A serial interface	BTH-H91S	779.00
StarWriter F10 serial 40 char/sec.	PRO-F10S	1125.00
StarWriter F10 parallel 40 char/sec.	PRO-F10P	1225.00
Comrex CR1 word processing printer, serial int.	CRX-CR1S	729.00
Comrex CR2 5K buffer, proportional spacing par I	CRX-CR2P	495.00

MONITORS

BMC 124 green phosphor 15 MHz composite video	BMC-12A	79.00
BMC 12 high resolution 20MHz	BMC-12EN	134.00
Zenith ZVM123 Amber Phosphor 12" 40/80 column switch	ZTH-123	119.00
Zenith ZVM123 green phosphor 12" 40/80 column switch	ZTH-123G	105.00
NEC JB1201 green phosphor 18 MHz composite video	NEC-JB1201	169.00
NEC JB1260 commercial grade composite	NEC-JB1260	129.00
Amibit 1201 green phosphor 18 MHz composite video	AMIB-1201	169.00
Motrola 23 open frame flat white composite video	MOT-BW23	159.00
Motrola 23 open frame requires hor sync & power	MOT-BW23	69.00
Conrac 8 open frame requires hor sync & 12v supply	CON-W89	59.00
Conrac 8 open frame requires hor sync & 12v supply	CON-W89	59.00
BMC 9191 19" color composite video with sound	BMC-9191	249.00
BMC 9191M RGB designed for use with the IBM computer	BMC-9191M	499.00
NEC JC1200M RGB color monitor	NEC-JC1201	699.00
NEC JC1201 color composite	NEC-JC1201	339.00
Zenith ZVM134 RGB color suitable for IBM PC	ZTH-Z134	379.00
Comrex color composite monitor	COM-6650	669.00
Amibit 1341 composite video	AMIB-1340	329.00

MODEMS

DIRECT CONNECT \$69

Hayes Smart Modem 1200 baud, auto answer, auto dial	HYS-121AD	474.95
Hayes 1200 for use with the IBM/PC, 1200 baud	HYS-1200B	440.00
Hayes Smartmodem 300 baud only, auto answer, auto dial	HYS-300A	279.00
Hayes Micromodem II, 1024 Apple direct connect	HYS-MA2	319.00
Hayes Micromodem 100, S-100 auto answer, auto dial	HYS-100	319.00
U.S. Robotics 2124 300 1000 baud	USR-CR1832	189.00
Hayes Chromatoprint, line & auto	USR-212A	249.00
Universal Data 1031P, line power, answer & originate	UDS-1031P	169.00
Universal Data 1031PA, Auto answer	UDS-1031PA	219.00
Universal Data 202, 1200 baud, half duplex only	UDS-202P	219.00
Universal Data 212, P, for 1200 baud duplex, line power	UDS-212P	359.00
Navigation 4 Call direct connect, auto answer	NAV-C4	115.00
Navigation Call, acoustic connect	NAV-C4C	159.00
Navigation SmartCall 1031 auto answer, auto dial	NAV-SC103	215.00
Navigation SmartCall 1031-212, 1200 baud auto dial	NAV-SC212	529.00
Signman Mark 1, direct connect with terminal cable	SGL-MK1	69.00

FREE

Your Choice
Second Drive or Monitor

SANYO IBM COMPATIBLE

\$995

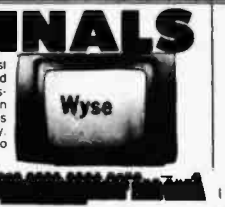

The Wyse 100 features die cast aluminum case, 102 key keyboard and non-glare 26 line green phosphor video display. Split screen both horizontal and vertical makes the WY-100 unusually user friendly. This unique terminal is perfect to enhance any business system.

APPLE \$699

Apple II/e, 64K computer only
Apple II/e starter kit, monitor, disk, 80 col. card.
Advanced Business Tech. 13 Key Pad
Calif. Computer 7710A Sync. Serial Interface
Calif. Computer 7710B same but for modem
Calif. Computer 7714A 12K PROM module
Calif. Computer 7720A parallel interface
Calif. Computer 7724A Calendar/clock modular
Calif. Computer 7729A Centronics interface
Calif. Computer 7740A programmable timer
California Digital 16K card for standard Apple II
Hayes Microcom II for Apple II
Kensington Micro. System saver I/n
Microsoft Software with CP/M, Z-80
Mountain Computer "The Clock"
Mountain Computer AD/DA 16 input, 8bit
Mountain Computer ROM Plus with keybit filter
Mountain Computer ROM writer/socket
Orange Micro "GRAFFLER" parallel interface
Sorrenio Value 8 controller double side D/D.
TEAC 5 1/4" disk drive for Apple II
Vista Vision 80, 80 column card for std. Apple II
Vista 8" disk controller double side D/D.

LIB-F50	475.00
VSL-40	919.00
VSL-300	650.00
VSL-3304C	925.00
APX-0125A	675.00
WVS-50	595.00
WVS-100	795.00
WVS-300	1159.00
TVI-50P	575.00
TVI-925	759.00
TVI-950	250.00
TVI-970	495.00
ZTH-229	7095.00

APL-2E	\$989
APT-2E5K	1459
ABT-13B	109
CCS-7710	125
CCS-7710B	125
CCS-7714	99
CCS-7720	99
CCS-7724	99
CCS-7729	99
CCS-7740	99
CAL-A16	39
HYS-MM2	279
HYS-MM3	135
MSF-SFTCD	239
MTN-TCLK	225
MTN-ADA	269
MTN-RMF	169
MTN-TMS	195
OMS-G2	139
SWAZ23	135
TEA-A2	269
VSA-VIS80	289
VSA-A800	489

ASCII KEYBOARD \$49



California Digital has purchased over 3000 of these microprocessors. Keyboards from the General Dynamics Corporation 93 ASCII encoded Hall effect switches includes 8 function keys and 14 key numeric cluster make this keyboard an excellent value at only \$49. MIC-93GD 5 lbs.
We also have available a matching General Dynamics serial terminal panel. STD
Non-encoded Hytek 58 key metal contact keyboard, HIK-58 \$24.95. Matching 15 key numeric cluster \$9.95. HIK-15 Both only \$29.95. HIK-58/15.
Not pictured. 49 key eight bit modified Hollerith coded Microswitch Hall effect keyboard. REMOVED from punch card equipment. \$14.95. DIT-KB49 ASCII encoder available.



Sanyo Electronics has just released the long awaited IBM/PC look-a-like, the MBC-550. This is a complete microcomputer that includes 128K/byte of memory, a 5 1/4" 160K/byte disk drive upgradeable to 320K/byte drives. Also includes both color composite and RGB graphics interface, low profile keyboard, and parallel printer port. Extensive software such as Sanyo Basic, disk utilities, Wordstar word processing software, Calcstar spreadsheet & Easy Writer I. MS-DOS is supplied with the Sanyo computer. Most programs written for the IBM/PC will operate on the MBC-550.
Along with all this California Digital offers "FREE" your choice of either a second disk drive, or a high resolution green or amber screen monitor. All at the super low price of only \$995.
We are currently experiencing an initial shortage of this computer. Please place your orders early. The MBC-550 will be shipped on a first ordered basis.

256 KILOBYTE MEMORY BOARD \$495



The California Digital 256K RAM board represents an outstanding value in S-100 memory technology. Priced slightly above earlier generation 64K dynamic ram boards it gives you these additional features: 256K of memory with parity. Plenty of room for expansion to any of the interrupt lines. A status port. ERROR LED, or IEEE-686 "ERROR signal. 24 or 16 bit addressing with memory management.
The board is very recent in design using the National Semiconductor DP-8402 RAM Controller chip. Split termination networks are used on all address lines. CAS line, and RAS lines emitting the least traces of ringing. The board uses two separate voltage regulators. One for the DRAMs and one for the interface logic increasing the noise immunity of the ram array. Typical power dissipation is 8 watts.
Documentation includes theory of operation, configuration guide, a schematic, and application notes on the use of the memory management options. CAL-256K 2 Lbs.

S-100 BOARDS

16 BIT MICROPROCESSORS		
Octagon CPU 8088/280, & controller	DCT-88280	795.00
Goobout 8088/8087 microproc. 16 bit	GBT-8687	495.00
Goobout CPU processor 8085/8088, 8/16	GBT-8588	359.00
SINGLE BOARD COMPUTERS		
Insight ED-4, 128K, 4 serial port S-100	INS-ED4	595.00
Advanced Digital, Fobby & FAX	AND-280	750.00
Telexis System master, 765 floppy, 84K	TEL-SM1	895.00
Telexis FDC-1 single board, no memory	TEL-FDC1	675.00
8 BIT MICROPROCESSORS		
Goobout 280, 24 bit extended add.	GBT-280	250.00
California Computer 280 microprocessor	CCS-280	275.00
Tarbel 280 with two RS232 ports	TAR-280	339.00
FLOPPY DISK CONTROLLERS		
Goobout Disk I, double density.	GBT-DISK1	395.00
California Computer 2424 with CPU	CCS-2422	339.00
Morrow Disk Jockey II with CPM 2.2	MOS-DJ2	350.00
Morrow Disk Jockey II with CPM, sgk. Den.	MOS-DJ1	225.00
Tarbel Electronics double density	TAR-DK2	415.00
Tarbel Electronics single density	TAR-DK1	279.00
Fulcrum OMA DmDisk, 1/10 to hard disk	FCM-D01	389.00
CPM OPERATING SYSTEM		
Digital Research CP/M 3.0, 8" soft den.	DR-CpM30	249.00
Digital Research CP/M 2.2 for Disk I	GBT-CpM22	199.00
Goobout CP/M86 for 8088 and 8086	GBT-CM86	265.00
Tarbel Electronics CP/M 2.2	TAR-CM22	199.00
HARD DISK CONTROLLERS		
Octagon hard disk controller with EIC	OCT-HD1	475.00
Goobout Disk 2, 8" & 14" hard disk	GBT-DISK2	569.00
Goobout Disk 3, for 3 1/2" Winchester	GBT-DISK3	Nov.
Tarbel Electronics controller for 8 1/4" Win	GBT-SM85	495.00
Western Digital new WD-1001 (incl S-100)	WDI-1001	495.00
EPROM BOARDS		
Inner Access EPROM Bd. programs 27128 IAC-P1	IAC-P1	465.00
Digital Research PROM board, 32K	DGR-P32	119.00
STATIC MEMORY BOARDS		
Goobout Ram 16, 64K, 16 bit data trans	GBT-R16	459.00
Goobout Ram 17, 64K 8 bit 24 address	GBT-R17	359.00
Goobout Ram 21, 128K byte 8/16 transfer	GBT-R21	859.00
Fulcrum OmmRam 8/16 transfer bus	FCM-8/16	395.00
California Computer 2116, 8 bit only	CCS-2116	249.00
DYNAMIC MEMORY BOARDS		
California Digital 256K expand to 1 Meg	CAL-D256	290.00
California Comp. 256K, 84K bank select	CCS-256	295.00
INTERFACE BOARDS		
Goobout interface I, 2 serial ports	GBT-I33A	239.00
Goobout interface II, 1 serial 3 port ports	GBT-I35A	269.00
Goobout interface III, with 3 serial ports	GBT-I37A	495.00
Goobout interface III, with 1 serial ports	GBT-I38A	585.00
Goobout interface IV, 3 serial, 2 parallel	GBT-I87A	329.00
California Computer 2710, 4 serial ports	CCS-2710	279.00
Goobout Computer 2712, 2 serial, 2 par	GBT-2712	279.00
California Computer 2720, 4 port par I	CCS-2720	219.00
California Computer 2830, 8 port serial	CCS-2830	425.00
Morrow Designs Multibus, 3 1/2P	MDS-MTL1	319.00
SPECIAL FUNCTION BOARDS		
Hayes S-100 Microcom. 300 baud.	HYS-M100	325.00
Goobout clock/calendar, battery	OIC-CG100	139.00
Goobout System support board, AK EPROM	GBT-SYS1	350.00
Goobout System support board, 9511 math	GBT-SYS11	539.00
Dual Systems 4 channel 12 bit D/A conv.	DSC-DM12	619.00
Dual System 12 bit resolution, 32 ch. A/D	DSC-AM12	629.00
Mullins Opto-Isolator, controls 8 ch.	MUL-IOB1	129.00
Mullins encoder board with logic & probe	MUL-16L	79.00
I/O Technology wire wrap prototype	IOI-WI100	49.00
Artec Electronics wire wrap prototype	ART-WW100	25.00
Artec Electronics general purpose solder	ART-GP100	25.00
MAINFRAMES & MOTHER BOARDS		
Eclipse Data, stainless, 22 slot	EDP-100	665.00
Goobout Enclosure 2, 20 slots	GBT-ME20	675.00
California Computer 2200, 12 slot	CCS-2200	419.00
California Digital 18 slot mother board	CAL-MB18	35.00
Goobout 12 slot mother board assembled	GBT-MB12	149.00

CP/M SOFTWARE

AdaSoft CP/M	ADA-445C	395.00
D-Base II	ASH-015C	429.00
Wordstar	MPR-187C	309.00
Mailmerge	MPR-392C	169.00
Spellstar	MPR-429C	169.00
Multiplan	MSF-483C	189.00
Macro 80	MSF-187C	139.00
Supersoft	MPR-309C	149.00
MAC	DGR-401C	85.00
CP/M 3.0	DGR-410C	249.00
Despool	DGR-367C	45.00
Pascal Plus	DGR-004C	429.00
CP/M 86	DGR-186C	239.00
CP/M II	DGR-208C	379.00

Additional Software available for Apple, IBM/PC and Atari. Please telephone for price and availability.

TOLL FREE ORDER LINE

(800) 421-5041
TECHNICAL & CALIFORNIA
(213) 643-9001

Shipping: First five pounds \$3.00, each additional pound \$.50
Foreign orders: 10% shipping, excess will be refunded.
California residents add 6 1/2% sales tax. COD is discouraged.
Open accounts extended to state supported educational institutions and companies with a strong Dun & Bradstreet rating.
Retail location: 15608 Inglewood Avenue, Lawndale 90260.

VIDEO DISPLAYS

look for low cost— high quality video displays

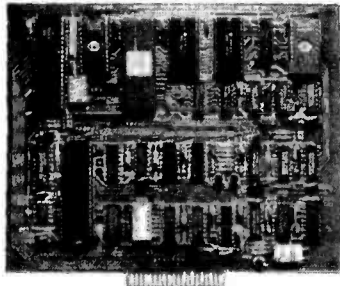

VIDEO TERMINAL BOARD. This is a complete stand alone Video Terminal board. All that is needed besides this board is a parallel ASCII keyboard, standard NTSC monitor, and a power supply. It displays 80 columns by 25 lines of UPPER and lower case characters. Data is transferred by RS232 at rates of 110 to 9600 baud

—switch selectable. Complete source listing is included in the documentation. Both the CRT program and the character generator are in 2716 EPROMS to allow easy modification to your needs. This board uses a 6502 microprocessor and a 6845 crt controller. The serial input port is interrupt driven. Assembled and tested part number 82-018A \$199.95. The bare board with the crystal and EPROMS, part number 82-018B \$89.95

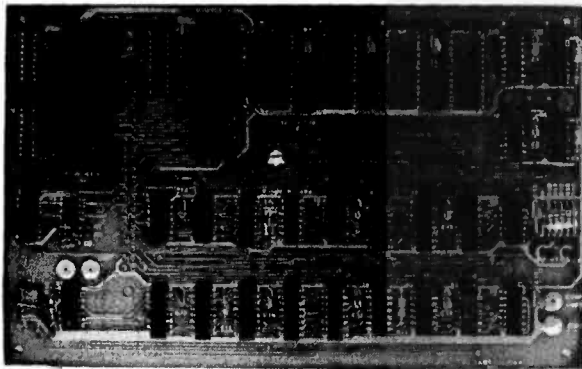

MINI VIDEO. This board can be used to add a video display to your aim or other computer. It can also, with the addition of a parallel keyboard, 5V power supply, and video monitor, run Tom Pittman's Tiny Basic. The display format is 40 columns by 24 lines. This board has two parallel ports (6522), a 6502 MPU 4K RAM, 2 or 4K EPROM. The assembled video board without EPROMS, part number 82-140A \$149.95. The Tiny Basic EPROM \$39.95. The character generator EPROM \$19.95. The parallel Input EPROM \$19.95.

To order: Send check or money order. Add 6.5% tax in California. Add 5% shipping for orders less than \$100 or 3% for orders over \$100 or 10% outside U.S.A. Phone orders: We accept Visa or MC. Add \$2.00 for C.O.D. Will Call Hours 9am to 4pm.

JOHN BELL ENGINEERING, INC.



1014 CENTER ST.
SAN CARLOS, CA. 94070
(415) 592-8411

PERIPHERALS FOR THE IBM PC

look for low cost— high quality inter- faces for the IBM PC

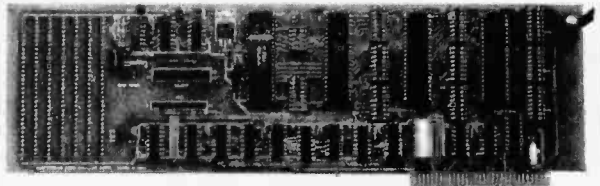

UNIVERSAL I/O. The Universal I/O board has 16 eight bit analog inputs with a voltage range of 0 to 5 volts. It also has 9 eight bit parallel I/O ports. It has interrupt circuitry, Timer clock 32768 Hz. to 512 sec., prototyping area, and LED for power. Part number 83-064A \$299.95

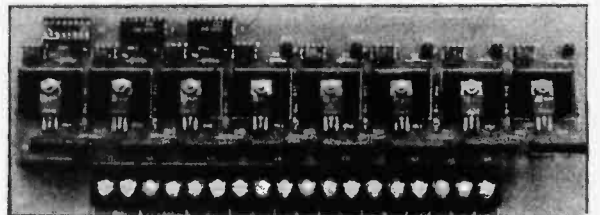

120 VAC CONTROL. This board has eight optically isolated triac switches. Each switch can control 200 watts. It connects via a 16 pin ribbon cable to a parallel output port. Screw terminals are provided for 120 vac connection. Part number 82-332. \$119.95.

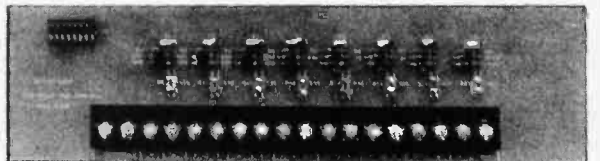

INPUT PROTECTOR. This board protects the inputs of the ANALOG input or PARALLEL input ports. There are 4.7K pullups, diodes and caps for each line. It connects via a 16 pin ribbon cable. Screw terminals are provided for connection. Part number 82-334. \$89.95.

To order: Send check or money order. Add 6.5% tax in California. Add 5% shipping for orders less than \$100 or 3% for orders over \$100 or 10% outside U.S.A. Phone orders: We accept Visa or MC. Add \$2.00 for C.O.D. Will Call Hours 9am to 4pm.

JOHN BELL ENGINEERING, INC.



1014 CENTER ST.
SAN CARLOS, CA. 94070
(415) 592-8411

PERIPHERALS FOR THE APPLE II

look for low cost— high quality inter- faces for the APPLE II

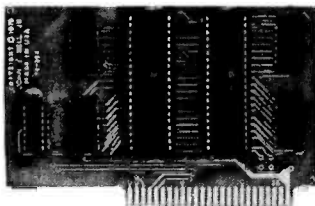

6522 APPLE II INTERFACE. This interface plugs directly into slot 1 through 7 in the APPLE II or the APPLE IIe. It provides four 8 bit bi-directional I/O ports, four 16 bit timer/counters, and handshaking. Four 16 pin dip sockets provide easy

connections to peripheral devices. This board is also used to run the JBE EPROM Programmer. Order part # 79-295A asm. \$69.95 or # 79-295B bare board \$29.95

EPROM PROGRAMMER.

Programs 5 volt 2716's, 2516's, and 2532's. It interfaces to the 6522 interface with 4 ribbon cables. A Textool zero insertion force socket is used for the EPROM. Complete documentation for reading and writing. Cables available separately. Order part # 80-244A asm. \$49.95 or # 80-244B bare board \$29.95 and set of 4 cables 2 ft. long \$17.00

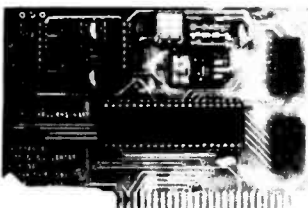
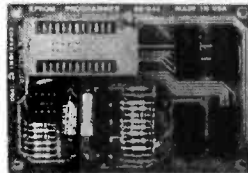

A-D CONVERTER.

16 Channel A-D plugs into your APPLE II or APPLE IIe. The 16 inputs are high impedance, 0 to 5 volt range, 8 bit resolution. Conversion time is less than 100 us per channel. Two 16 pin dip sockets are used for input. Order part # 81-132A asm. \$89.95 or # 81-132B bare board \$29.95

SPEECH SYNTHESIZER.

This board uses the VOTRAX SC-01 Phoneme Synthesizer chip. The on board audio amp connects directly to an 8 ohm speaker. A disk with a text to speech program is included. Order part #81-088 \$129.95

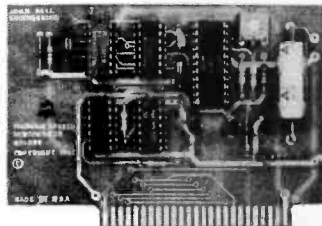

To order: Send check or money order. Add 6.5% tax in California. Add 5% shipping for orders less than \$100 or 3% for orders over \$100 or 10% outside U.S.A. Phone orders: We accept Visa or MC. Add \$2.00 for C.O.D. Will Call Hours 9am to 4pm.

JOHN BELL ENGINEERING, INC.



1014 CENTER ST.
SAN CARLOS, CA. 94070
(415) 592-8411

INDUSTRIAL CONTROL PRODUCTS

look for low cost— high quality indus- trial computers

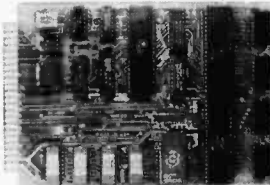

SLIM MICROCOMPUTER. This 6502 based 4.5" x 6.5" computer has the same 44 pin bus as the AIM computer. It has 2K RAM, 2K or 4K EPROM, and four 8 bit parallel I/O ports (two 6522's). The clock is 1 MHz crystal controlled and has power on reset. This board was

designed for control and is ideal for personal and OEM use. This computer can be expanded with the peripherals listed below. Order part # 81-260A asm. \$199.95 or #81-260B bare board \$39.95

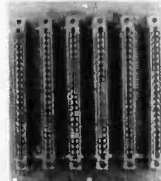

SIX SLOT MOTHER BOARD.

This board has 6 44 pin edge connectors connected in parallel. The card spacing is .750". It will mount in VECTOR card cages. Order part # 81-320A asm. \$99.95 or # 81-320B bare board \$49.95.

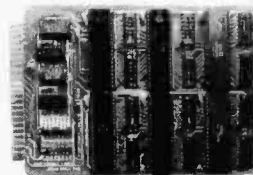

12 PORT PARALLEL I/O.

This board has six 6522 VIA's. This is a total of 96 I/O lines. Each of the 12 8 bit ports also has 2 handshake lines. Order part # 82-036A asm. \$169.95 or # 82-036B bare board \$49.95

RAM EPROM MEMORY (32K).

This board has 16 24 pin sockets that will accept 2716 EPROM's or 6116 RAM's to total 32K bytes. The memory is mapped from 0 to 7FFF. The first 2K (0-7FF) can be disabled with a jumper to allow for the 2K of RAM on the SLIM computer. Order part # 81-330A asm. w/o memory \$99.95 or # 81-330B bare board \$49.95



ANALOG I/O INTERFACE. This board has 16 analog inputs and 2 analog outputs. The inputs are 8 bit (256 steps), 0-5 volt, high impedance with a conversion time of 200us per channel. The outputs are R-2R ladders (R = 15K) driven between 0 and 5 volts and are 8 bit (256 steps) also. Order part # 81-292A asm. \$199.95 or #81-292B bare board \$49.95

To order: Send check or money order. Add 6.5% tax in California. Add 5% shipping for orders less than \$100 or 3% for orders over \$100 or 10% outside U.S.A. Phone orders: We accept Visa or MC. Add \$2.00 for C.O.D. Will Call Hours 9am to 4pm.

JOHN BELL ENGINEERING, INC.



1014 CENTER ST.
SAN CARLOS, CA. 94070
(415) 592-8411

MICROPROCESSOR COMPONENTS

Table with columns: Part No., Pins, Price, Part No., Pins, Price, Part No., Pins, Price. Lists various microprocessor chips like SN74720, SN74721, etc.

MICROPROCESSOR CHIPS table listing various microprocessors such as 80C10, 80C11, 80C12, etc.

DYNAMIC RAMS table listing various dynamic random access memory chips like 1103, 40B27, 4116N-2, etc.

DT1050 - Applications: Teaching aids, appliances, clocks, automotive, telecommunications, language translations, etc. DT1057 - Expands the DT1050 vocabulary from 137 to over 260 words.

74LS table listing various 74LS series logic chips like 74LS00, 74LS01, 74LS02, etc.

Z80, Z80A, Z80B, Z8000 SERIES table listing Zilog Z80 series microprocessors.

STATIC RAMS table listing various static random access memory chips like 2101, 2102, 2103, etc.

DT1050 DigitalTalk™ \$34.95 ea. MMS54104 Processor Chip \$14.95 ea. DT1057 - Expands the DT1050 vocabulary from 137 to over 260 words. Includes 2 ROMs and sprockets. Part No. DT1057 \$24.95 ea.

74S/PROMS table listing various 74S and PROM chips like 74S00, 74S01, 74S02, etc.

6800/68000 SERIES table listing Motorola 6800 and 68000 series microprocessors.

PROMS/EPROMS table listing various programmable read-only memory chips like 1702A, 2708, 2716, etc.

INTEGRAL table listing various integrated circuits from the INTEL family like 74AS10, 74ALS10, etc.

CA-LINEAR table listing various CA-linear chips like CA3130E, CA3130F, etc.

8080A SERIES table listing Intel 8080 series microprocessors.

DISK CONTROLLERS table listing various disk controller chips like INS1771-1, FD1791, etc.

30009 1983 INTEGRAL Data Book (356p) \$9.95 NEW PRODUCT! 74HC High Speed CMOS table listing various 74HC series logic chips.

CD-CMOS table listing various CD-CMOS chips like CD4000, CD4001, etc.

SPECIAL FUNCTION table listing various special function chips like CD0205CN, CD0206CN, etc.

DATA ACQUISITION table listing various data acquisition chips like BC10, MC3470P, etc.

30012 1982 NATIONAL PAL Data Book (176p) \$5.95 table listing various PAL chips like PAL10H, PAL12H, etc.

CD-CMOS table listing various CD-CMOS chips like CD4000, CD4001, etc.

LOW PROFILE (TIN) SOCKETS table listing various low profile sockets like 8 pin LP, 14 pin LP, etc.

SOLDERLESS STANDARD (TIN) table listing various solderless standard sockets like 14 pin ST, 16 pin ST, etc.

WIRE WRAP SOCKETS (GOLD) LEVEL #3 table listing various wire wrap sockets like 8 pin WW, 14 pin WW, etc.

SOLDERABLE (GOLD) STANDARD table listing various solderable standard sockets like 8 pin SG, 14 pin SG, etc.

WIRE WRAP SOCKETS (GOLD) LEVEL #3 table listing various wire wrap sockets like 8 pin WW, 14 pin WW, etc.

LINEAR table listing various linear chips like LM723M, LM733M, etc.

\$10.00 Minimum Order - U.S. Funds Only table listing shipping and ordering information.

Prices Subject to Change table listing pricing and shipping information.

30003 1982 Nat. Linear Data Book (192p) \$11.95 table listing various linear chips from the 1982 National Linear Data Book.

MasterCard ameco VISA ELECTRONICS 1355 SHOREWAY ROAD, BELMONT, CA 94002 1283 PHONE ORDERS WELCOME - (415) 592-8097 Telex: 176043

VOICE SYNTHESIZER FOR APPLE AND COMMODORE

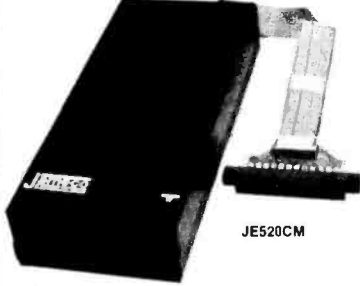

JES20CM

Over 250 word vocabulary affixes allow the formation of more than 500 words • Built-in amplifier, speaker, volume control, and audio jack • Recreates a clear, natural male voice • Plug-in user ready with documentation and sample software • Case size: 7 1/4" L x 3 1/4" W x 1-3/8" H

APPLICATIONS:

- Security Warning
- Teaching
- Instrumentation
- Telecommunication
- Handicap Aid
- Games

The JES20 VOICE SYNTHESIZER will plug right into your computer and allow you to enhance almost any application. Utilizing National Semiconductor's DIGITALSPEECH™ Speech Processor IC (with four custom memory chips), the JES20 compresses natural speech into digital memory, including the original inflections and emphases. The result is an extremely clear, natural vocalization.

Part No.	Description	Price
JES20CM	For Commodore 64 & VIC-20	\$114.95
JES20AP	For Apple II, II+, and IIe	\$149.95

Micro-Logic Corp. MICRO-CHARTS



- Fully decoded data • Instant access • 2-sided, totally comprehensive • Compact 8 1/2" x 11" durable credit card plastic • Perfect for programmers & engineers
 - Clear & concise tables for full instruction set, disassembly, ASCII, base conversion, effect of flags, compare vs jump, interrupt structure, prout, cycle times, diagrams, bug notes, & much more.
- | PART NO. | REFERENCE | PRICE |
|----------|------------------------|--------|
| ML-Z80 | Z80 CPU | \$5.95 |
| ML-8080A | 8080A/8085A | \$5.95 |
| ML-6502 | 6502 (65XX) | \$5.95 |
| ML-8048 | 8048, Relatives | \$5.95 |
| ML-7400 | 5400/7400 TTL Pin-Outs | \$5.95 |

BOOKS

- | | | |
|--------|--|---------|
| 30001 | National CMOS Data Book (1981) (640 pages) 74C, CD4000, and A/D Converters | \$6.95 |
| 30003 | National Linear Data Book (1982) (1376 pages) LM, LF, ADC, DAC, LH Series | \$11.95 |
| 30006 | National Memory Data Book (1980) (484 pages) RAMs, ROMs, PROMs, EPROMs Series | \$6.95 |
| 30009 | Intersil Data Book (1983) (1356 pages) Complete Line | \$9.95 |
| 30010 | National Audio/Radio Handbook (1980) (240 pages) Pre-Amps, AM, FM & FM Stereo, Power Amps | \$5.95 |
| 30012 | National PAL Data Book (1982) (176 pages) Application Notes, Linear Briefs, etc. | \$5.95 |
| 30013 | Zilog Data Book (1983) (641 pages) Microprocessors and Support Chips | \$7.95 |
| 210830 | Intel Memory Components Handbook (1983) (798 pages) Contains all Application Notes, Article Reprints, Data Sheets, and other design information on Intel's RAMs, EPROMs, EPROMs & Bubble Memories. | \$14.95 |
| 210844 | Intel Microprocessor & Peripheral Handbook (1983) (1027 pages) Contains Data Sheets on all of Intel's Microprocessors and Peripherals. | \$14.95 |

4-Digit Fluorescent Alarm Clock Kit

• Bright 4 digit 0.5" high display • 10 minute snooze alarm • AM/PM Indicator

The JE750 Alarm Clock Kit is a versatile 12-hour digital clock with 24-hour alarm. The clock has a bright 0.5" high blue-green fluorescent display. The 24-hour alarm allows the user to disable the alarm and immediately re-enable the alarm to activate 24 hours later. The kit includes all documentation, components, case and wall transformer. Size: 6.5" L x 3 1/4" W x 1 1/2" H.

JE750 Alarm Clock Kit \$29.95

Jameco Digital Thermometer Kit

Dual sensors — switch controls for indoor/outdoor or dual monitoring — can be extended to 500 feet. Continuous LED 8" H display. Range: -40°F to 199°F, -40°C to 100°C. Accuracy: ±1° Fahrenheit/0.5°Celsius. Simulated walnut case. AC wall adapter included. Size: 6 1/2" L x 3 1/4" W x 1 1/2" H.

JE300 \$39.95

Universal Computer Keyboard Enclosures

- DTE Bank Desk-Top Enclosures are designed for easy modification. High strength epoxy modified end panels in mocha brown finish. Sliding rear-bottom panel for service component access. Top/bottom panels: 080" thick alum. anodize type 1200 finish (gold tint color) for best paint adhesion after modification. Vented top & bottom panels for cooling efficiency. Rigid construction provides unlimited applications. Assembly instructions included.
- | | | |
|--------|---------------------|---------|
| DTE-8 | Panel Width 7.5" | \$24.95 |
| DTE-11 | Panel Width 10.3" | \$27.95 |
| DTE-14 | Panel Width 13.5" | \$29.95 |
| DTE-20 | Panel Width 19.25" | \$34.95 |
| DTE-22 | Panel Width 21.375" | \$39.95 |

CARD-EDGE CONNECTOR

Mates with double sided 1/16" PC board with contact fingers on one side

Part No.	No. of Contacts	1-9	10-99	100+
C26	26	2.49	2.38	2.05
C38	38	3.29	2.95	2.58
C40	40	3.59	3.29	2.89
C50	50	4.39	3.95	3.35

SOLDER TRANSITION CONNECTORS FOR PERMANENT TERMINATION TO PRINTED CIRCUIT BOARDS

Part No.	No. of Contacts	1-9	10-99	100+
S120	20	1.15	99	89
S126	26	1.25	1.15	99
S124	24	1.09	1.15	1.15
S140	40	1.49	1.55	1.35
S150	50	1.89	1.69	1.45

36-Pin CENTRONICS RIBBON CONNECTORS 24-Pin IEEE488

Part No.	No. of Contacts/Style	1-9	10-99	100+
CR14M	14 Male	6.39	5.49	4.49
CR14F	14 Female	6.19	5.29	4.29
CR24M	24 Male	7.95	6.95	5.95
CR24F	24 Female	7.69	6.79	5.75
CR36M	36 Male	9.99	7.99	6.49
CR36F	36 Female	8.75	7.59	7.15

28AWG FLAT GREY CABLE

Part No.	No. of Contacts/Connectors	Wire Type	Price Per Foot
171-9	9	28AWG Flat Stranded	.18
171-14	14	28AWG Flat Stranded	.25
171-15	15	28AWG Flat Stranded	.27
171-18	18	28AWG Flat Stranded	.36
171-20	20	28AWG Flat Stranded	.36
171-24	24	28AWG Flat Stranded	.45
171-25	25	28AWG Flat Stranded	.47
171-26	26	28AWG Flat Stranded	.47
171-34	34	28AWG Flat Stranded	.65
171-36	36	28AWG Flat Stranded	.67
171-37	37	28AWG Flat Stranded	.68
171-40	40	28AWG Flat Stranded	.75
171-50	50	28AWG Flat Stranded	.89

ACCESSORIES FOR APPLE COMPUTERS

Numeric/Auxiliary Keypad for APPLE IIe*

The JE614 is a new, updated numeric/auxiliary keypad for the APPLE IIe. It offers the flexibility of a 10 keypad and the convenience of 22 directly accessible functions. Screen manipulating functions make word processing a snap and cursor controls make the keypad ideal for "VisiCalc" users. The JE614 keypad is housed in a durable metal enclosure and is color-coordinated with your APPLE IIe computer. Operation of the keypad can begin within minutes upon unboxing. Special functions include Home, Clear, Done, End of Screen, Scroll Up, Scroll Down, Tab, Delete, Left, Right, Up, and Down. Each key has auto-repeat.

JE614 Assembled and Tested \$89.95

Switching Power Supply for APPLE II, II+ and IIe*

• Can drive four floppy disk drives and up to eight expansion cards • Short circuit and overload protection • Fits inside Apple computer • Fully regulated • 5V @ 500 mA, 12V @ 3A, 50V @ 100 mA • Apple type plug in power cord included • Size: 7 1/2" L x 3 1/2" W x 1 1/2" H • Weight: 2 lbs.

Part No. KHP4007 \$79.95

POWER SUPPLY +5VDC @ 7.5 AMP, 12VDC @ 1.5 AMP SWITCHING

Input: 115VAC, 50-60Hz @ 2 amp/230VAC, 50Hz @ 1.5 amp. Fan volt./power supply select switches (115/230VAC), Output: 5VDC @ 7.5 amp, 12VDC @ 1.5 amp. 8 R. blk. pow. cord. 11W @ 13W @ 2 1/2" L x 3 1/4" W x 1 1/2" H.

Part No. PS94VDS \$39.95 each

POWER SUPPLY 4-Channel Switching - Apple Compatible

Microprocessor, mini-computer, terminal, medical equipment and process control applications. Input: 90-130VAC 47-440Hz. Output: +5VDC @ 1A, -5VDC @ 1A, -12VDC @ 1A. Line reg. ±0.2%, Reg. 100mV @ 1.0 amp. Load reg. ±1%. Overcurrent protection. Reg. 50 mA output. Part No. FCS-604A \$69.95 each

SOCKET CONNECTORS

Part No.	No. of Contacts/Connectors	1-9	10-99	100+
S20	20	1.30	1.25	1.09
S26	26	1.69	1.49	1.35
S34	34	2.09	1.79	1.59
S40	40	2.29	2.09	1.79
S50	50	2.99	2.39	2.09
S60	60	3.39	2.95	2.59

MALE CONNECTOR

Mates with Socket Connector 10" x 10"

Part No.	No. of Contacts/Connectors	1-9	10-99	100+
M20	20	4.09	3.65	3.19
M26	26	4.49	3.95	3.49
M34	34	4.85	4.49	3.99
M40	40	5.49	4.89	4.29
M50	50	6.49	5.75	4.95

D-SUB CONNECTORS

Part No.	No. of Contacts/Style	1-9	10-99	100+
CD59P	9 Male	2.95	2.85	2.29
CD85S	5 Female	3.39	3.09	2.69
CD415P	15 Male	4.95	3.55	3.09
CD415S	15 Female	4.79	4.19	3.69
CD229P	25 Male	5.49	4.19	4.25
CD215S	25 Female	5.95	5.49	4.65
CD237P	37 Male	7.79	6.95	6.09
CD237S	37 Female	8.95	7.95	6.95

CUSTOM ASSEMBLIES

Use the part numbers from the connectors and cable to order your own custom assembled cables.

EXAMPLE: If you desire a 25 foot cable with a male "Centronics" connector on one end, and a female "Centronics" connector on the other end, you would order:

15-50 (CENTRONS) = 1.75 (CENTRONS) \$18.44
65 = 25 (25 foot long cable) = \$18.25
7.00 (25 foot charge on all custom cables) = \$7.00

Please specify "CUSTOM" after the part no. to ensure your order will be lined correctly. (Important: Please specify cable in FEET, not inches!)

ALL CUSTOM ASSEMBLIES MUST BE PREPAID BEFORE ASSEMBLY. THERE ARE NO RETURNS ON CUSTOM CABLE ASSEMBLIES. \$7.00 SET-UP CHARGE (PER STYLE) ON ALL CUSTOM CABLES.

Extended 80 Column/64K RAM Card for APPLE IIe*

Now you can double the memory capacity and get an 80 column display format for your APPLE IIe computer at an affordable price. Just mate the JE84 card into your APPLE IIe and expand your display to 80 characters per line. Perfect for word processing. The JE84 also features built-in battery backup to prevent UV exposure. Compact — only 9.00" x 3.70" x 2.80". Completes with holding tray for 8 chips.

Board: High density board design assures 64K bytes of RAM and a 2 1/2" x 4 1/2" board. Fully tested to assure proper operation.

Uses word processing — displays 1000 more characters per screen • Extra memory allows running of extremely large programs • Ultra High Resolution Graphics (when software available)

JE84 Assembled and Tested \$149.95

Cooling Fan for APPLE II, II+ and IIe*

• Fits on the side of APPLE II, II+, and IIe enclosures • Eliminates overheating problems, slowing, booting, freezing, and operation failure • Computer protected from fan surface as power switch for fan control • Includes fan speed control

Part No. APF-1 \$49.95

IBM MEMORY EXPANSION KIT

Most of the popular memory boards allow you to add an additional 64K, 128K, 192K, or 256K. The IBM64K Kit will populate these boards in 64K byte increments. The kit is simple to install — just insert the nine 64K RAM chips in the provided sockets and set the two groups of switches. Directions are included.

IBM64K (Nine 200ns 64K RAMs) \$49.95

EXPAND YOUR MEMORY

TRS-80 to 16K, 32K, or 48K

- **Model 1 = From 4K to 16K Requires (1) One Kit
- Model 3 = From 4K to 48K Requires (3) Three Kits
- Color = From 4K to 16K Requires (1) One Kit

**Model 1 equipped with Expansion Board up to 48K Two Kits Required — One Kit Required for each 16K of Expansion

TRS-16K3 *200ns for Color & Model III \$12.95
TRS-16K4 *250ns for Model I \$10.95

TRS-80 Color 32K or 64K Conversion Kit

Easy to install kit comes complete with 8 ea. 4164-2 (200ns) 64K dynamic RAMs & conversion documentation. Converts TRS-80 color computer with B circuit boards, & all new color computers to 32K. Minor modifications of 32K memory will allow the use of all the 64K of the dynamic RAM providing you have a FLEX DOS operating system.

TRS-64K2 \$44.95

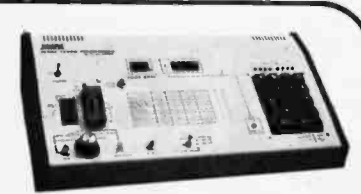

JE664 EPROM PROGRAMMER

8K to 64K EPROMS — 24 AND 28 PIN PACKAGES

- Programs, validates, and checks for properly erased EPROMs • Emulates PROMs or EPROMs • RS232C Computer Interface for adding program loading • Loads data into RAM by keyboard • Changes data in RAM by keyboard • Loads RAM from an EPROM • Compares EPROMs for content differences • Copies EPROMs • Power Input: 115VAC, 60Hz, ~10W power consumption • Enclosure: Color-coordinated, light tan panels w/molded mocha brown and pieces • Size: 15-5/8" L x 8 1/2" x 3 1/4" W x 5 1/4" H.

JE664-A EPROM Programmer \$995.00
 Assembled & Tested (Includes JMI6A Module)

JE665 — RS232C INTERFACE OPTION

The JE665 RS232C Interface Option implements computer access to the JE664's RAM. Sample software written in BASIC provided for TRS-80® Model I, Level II Computer. Baud rate: 9600. Word length: 8 bits - odd parity. Stop bits: 2. Option may be applied to other computers. The JE665 can be interfaced to any computer with an RS232C port. Information is also provided for interfacing to any CP/M system with an RS232C port.

JE664-ARS EPROM Programmer w/JE665 Option \$1195.00
 Assembled and Tested (Includes JMI6A Module)

PIN	EPROM	EPROM MANUFACTURER	PRICE
JM08A	2708	AMT, Motorola, National, Intel, TI (25V)	\$14.95
JM16A	2716, TMS2716	Intel, Motorola, National, NEC, TI, (25V)	\$14.95
JM32A	TMS2716	Motorola, TI (+5, -5, +12)	\$14.95
JM16B	2716	Motorola, TI (25V)	\$14.95
JM27A	2732	AMI, Fujitsu, NEC, Hitachi, Intel (25V)	\$14.95
JM32C	2732A (21V)	Fujitsu, Intel (21V)	\$14.95
JM48A	MC68B764	Motorola (21V)	\$14.95
JM48B	2764	Intel (21V)	\$14.95
JM48C	TMS2764	TI (21V)	\$14.95
JM64D	HN482764G-4	Hitachi (21V)	\$14.95

UV-EPROM Eraser

8 Chips — 51 Minutes

1 Chip — 37 Minutes

Erasee 2708, 2716, 2732, 2764, 2516, 2532, 2564. Erases up to 8 chips within 51 minutes (1 chip in 37 minutes). Maintains constant exposure distance of one inch. Special conductive foam liner eliminates static build-up. Built-in safety lock to prevent UV exposure. Compact — only 9.00" x 3.70" x 2.80". Completes with holding tray for 8 chips.

DE-4 UV-EPROM Eraser \$79.95

UVS-11EL Replacement Bulb \$16.95

5 1/4" APPLE™ COMPATIBLE DISK DRIVE

- Uses Shugart SA390 mechanics • 143K formatted storage • 35 tracks — compatible with Apple controller • Complete with connector and cable — just plug into your disk controller card • Size: 7 1/4" L x 3 1/4" W x 8-9/16" D • Weight: 4 lb.

Part No. ADD-514 \$195.95

8" FLOPPY DISK DRIVE

FDD100-8 \$169.95 ea.

The FDD100-8 8" Floppy Disk Drive (Industry Standard) features single or double density. Recording mode: FM single, MFM double density. Transfer rate: 250K bits/sec. single density; 500K bits/sec. double density. The FDD100-8 is designed to work with the single-sided soft sectorized IBM Diskette I, or no. disk cartridge. Power: 115VAC @ 50-60Hz, +24VDC @ 1.5 amp max., +5VDC @ 1.2 amp max. Until as pictured above does not include case, power supply, or cabinet. Size: 8.25" W x 14 1/4" L x 4 5/8" H. Weighs 12 lbs. incl. 50-pg. manual.

Part No. FDD100-8 \$169.95 ea.

IBM MEMORY EXPANSION KIT

SAVE HUNDREDS OF \$\$\$ BY UPGRADING MEMORY BOARDS YOURSELF!

Most of the popular memory boards allow you to add an additional 64K, 128K, 192K, or 256K. The IBM64K Kit will populate these boards in 64K byte increments. The kit is simple to install — just insert the nine 64K RAM chips in the provided sockets and set the two groups of switches. Directions are included.

IBM64K (Nine 200ns 64K RAMs) \$49.95

EXPAND YOUR MEMORY

TRS-80 to 16K, 32K, or 48K

- **Model 1 = From 4K to 16K Requires (1) One Kit
- Model 3 = From 4K to 48K Requires (3) Three Kits
- Color = From 4K to 16K Requires (1) One Kit

**Model 1 equipped with Expansion Board up to 48K Two Kits Required — One Kit Required for each 16K of Expansion

TRS-16K3 *200ns for Color & Model III \$12.95
TRS-16K4 *250ns for Model I \$10.95

TRS-80 Color 32K or 64K Conversion Kit

Easy to install kit comes complete with 8 ea. 4164-2 (200ns) 64K dynamic RAMs & conversion documentation. Converts TRS-80 color computer with B circuit boards, & all new color computers to 32K. Minor modifications of 32K memory will allow the use of all the 64K of the dynamic RAM providing you have a FLEX DOS operating system.

TRS-64K2 \$44.95

Do Kay

COMPUTER
PRODUCTS,
Inc.

ORDER TOLL FREE

(800)

538-8800

(CALIFORNIA RESIDENTS)

(800)

848-8008



TERMS: For shipping include \$2.00 for UPS Ground or \$3.00 for UPS Blue Air. \$10.00 minimum order. Bay Area and Los Angeles Counties add 6½% Sales Tax, other California residents add 6% Sales Tax. We reserve the right to limit quantities and substitute manufacturer. Prices subject to change without notice.

VISIT OUR RETAIL STORE

2100 De La Cruz Blvd.
Santa Clara, CA 95050
(408) 988-0697

Do Kay

STATIC RAMS

2101	256 x 4 (450ns)	1.90
5101	256 x 4 (450ns) (cmos)	3.90
2102-1	1024 x 1 (450ns)	.88
2102L-4	1024 x 1 (450ns) (LP)	.98
2102L-2	1024 x 1 (250ns) (LP)	1.45
2111	256 x 4 (450ns)	2.45
2112	256 x 4 (450ns)	2.95
2114	1024 x 4 (450ns)	8/9.90
2114-25	1024 x 4 (250ns)	8/9.95
2114L-4	1024 x 4 (450ns) (LP)	8/11.95
2114L-3	1024 x 4 (300ns) (LP)	8/12.45
2114L-2	1024 x 4 (200ns) (LP)	8/12.95
2147	4096 x 1 (55ns)	4.90
TMS4044-4	4096 x 1 (450ns)	3.45
TMS4044-3	4096 x 1 (300ns)	3.95
TMS4044-2	4096 x 1 (200ns)	4.45
MK4118	1024 x 8 (250ns)	9.90
TMM2016-200	2048 x 8 (200ns)	4.10
TMM2016-150	2048 x 8 (150ns)	4.90
TMM2016-100	2048 x 8 (100ns)	6.10
HMB6116-4	2048 x 8 (200ns) (cmos)	4.70
HMB6116-3	2048 x 8 (150ns) (cmos)	4.90
HMB6116-2	2048 x 8 (120ns) (cmos)	8.90
HMB6116LP-4	2048 x 8 (200ns) (cmos) (LP)	6.90
HMB6116LP-3	2048 x 8 (150ns) (cmos) (LP)	6.90
HMB6116LP-2	2048 x 8 (120ns) (cmos) (LP)	9.95
Z-6132	4096 x 8 (300ns) (Total)	33.95

LP = Low Power Qstat = Quasi-Static

DYNAMIC RAMS

TMS4027	4096 x 1 (250ns)	1.95
UPD411	4096 x 1 (300ns)	2.95
MMS280	4096 x 1 (300ns)	2.95
MK4108	8192 x 1 (200ns)	1.90
MMS298	8192 x 1 (250ns)	1.80
4116-300	16384 x 1 (300ns)	8/10.75
4116-250	16384 x 1 (250ns)	8/10.95
4116-200	16384 x 1 (200ns)	8/11.95
4116-150	16384 x 1 (150ns)	8/13.95
4116-120	16384 x 1 (120ns)	8/28.95
2118	16384 x 1 (150ns) (5v)	4.90
4164-200	65536 x 1 (200ns) (5v)	6.90
4164-150	65536 x 1 (150ns) (5v)	6.90

5V = single 5 volt supply

EPROMS

1702	256 x 8 (1us)	4.45
2708	1024 x 8 (450ns)	3.90
2758	1024 x 8 (450ns) (5v)	5.90
2716	2048 x 8 (450ns) (5v)	3.90
2716-1	2048 x 8 (350ns) (5v)	5.90
TMS2516	2048 x 8 (450ns) (5v)	5.45
TMS2716	2048 x 8 (450ns) (5v)	7.90
TMS2532	4096 x 8 (450ns) (5v)	5.90
2732	4096 x 8 (450ns) (5v)	4.90
2732-250	4096 x 8 (250ns) (5v)	8.90
2732-200	4096 x 8 (200ns) (5v)	10.95
2784	8192 x 8 (450ns) (5v)	9.90
2784-250	8192 x 8 (250ns) (5v)	13.95
2784-200	8192 x 8 (200ns) (5v)	23.95
TMS2564	8192 x 8 (450ns) (5v)	16.95
MC68764	8192 x 8 (450ns) (5v) (24 pin)	38.95
27128	16384 x 8 call	Call

5v = Single 5 Volt Supply

74LS00

74LS00	.23	74LS173	.68
74LS01	.24	74LS174	.54
74LS02	.24	74LS175	.54
74LS03	.24	74LS181	2.10
74LS04	.23	74LS189	8.90
74LS05	.24	74LS190	.88
74LS06	.27	74LS191	.88
74LS09	.28	74LS192	.78
74LS10	.24	74LS193	.78
74LS11	.34	74LS194	.68
74LS12	.34	74LS195	.68
74LS13	.44	74LS196	.78
74LS14	.58	74LS197	.78
74LS15	.34	74LS221	.88
74LS20	.24	74LS240	.94
74LS21	.28	74LS241	.98
74LS22	.24	74LS242	.98
74LS26	.28	74LS243	.98
74LS27	.28	74LS244	1.25
74LS28	.34	74LS245	1.45
74LS30	.24	74LS247	.74
74LS32	.28	74LS248	.98
74LS33	.54	74LS249	.98
74LS37	.34	74LS251	.58
74LS38	.34	74LS253	.58
74LS40	.24	74LS257	.58
74LS42	.48	74LS258	.58
74LS47	.74	74LS259	2.70
74LS48	.74	74LS260	.58
74LS49	.74	74LS266	.54
74LS51	.24	74LS273	1.45
74LS54	.28	74LS275	3.30
74LS55	.28	74LS279	.48
74LS63	1.20	74LS280	1.95
74LS73	.38	74LS283	.68
74LS74	.34	74LS290	.88
74LS75	.38	74LS293	.88
74LS76	.38	74LS295	.98
74LS78	.48	74LS298	.88
74LS83	.59	74LS299	1.70
74LS85	.68	74LS323	3.45
74LS88	.38	74LS324	1.70
74LS90	.54	74LS352	1.25
74LS91	.88	74LS353	1.25

74LS92	.54	74LS363	1.30
74LS93	.54	74LS364	1.90
74LS95	.74	74LS365	.48
74LS96	.88	74LS366	.48
74LS107	.38	74LS367	.44
74LS109	.38	74LS368	.44
74LS112	.38	74LS373	1.35
74LS113	.38	74LS374	1.35
74LS114	.38	74LS377	1.35
74LS122	.44	74LS378	1.13
74LS123	.78	74LS379	1.30
74LS124	2.85	74LS385	1.85
74LS125	.48	74LS386	.44
74LS126	.48	74LS390	1.15
74LS132	.58	74LS393	1.15
74LS133	.58	74LS395	1.15
74LS136	.38	74LS399	1.45
74LS137	.98	74LS424	2.90
74LS138	.54	74LS447	.38
74LS139	.54	74LS490	1.90
74LS145	1.15	74LS624	3.95
74LS147	2.45	74LS640	2.15
74LS148	1.30	74LS645	2.15
74LS151	.54	74LS668	1.85
74LS153	.54	74LS669	1.85
74LS154	1.85	74LS670	1.45
74LS155	.68	74LS674	9.80
74LS156	.68	74LS682	3.15
74LS157	.64	74LS683	3.15
74LS158	.58	74LS684	3.15
74LS160	.68	74LS685	3.15
74LS161	.64	74LS688	2.35
74LS162	.68	74LS689	3.15
74LS163	.64	74LS783	23.95
74LS164	.68	81LS95	1.45
74LS165	.94	81LS96	1.45
74LS166	1.90	81LS97	1.45
74LS168	1.70	81LS98	1.45
74LS169	1.70	25LS2521	2.75
74LS170	1.45	25LS2569	4.20

6500 1MHZ

6502	4.90
6504	6.90
6505	8.90
6507	9.90
6520	4.30
6522	7.90
6532	9.90
6545	21.50
6551	10.85

2 MHZ

6502A	6.90
6522A	9.90
6532A	10.95
6545A	26.95
6551A	10.95

3 MHZ

6502B	13.95
-------	-------

6800

68000	58.95
6800	3.90
6802	7.90
6808	12.90
6809E	16.95
6809	10.95
6810	2.90
6820	4.30
6821	3.20
6840	13.95
6843	11.95
6844	33.95
6845	24.95
6847	13.95
6847	10.95
6850	3.20
6852	15.70
6860	9.90
6862	10.95
6875	6.90
6880	2.20
6883	21.95
68047	23.95
68488	18.95

6800 1MHZ

68B00	9.95
68B02	21.25
68B09E	28.95
68B09	28.95
68B10	6.90
68B21	6.90
68B45	18.95
68B50	5.90

8000

8035	5.90
8039	8.90
INS-8060	16.95
INS-8073	23.95
8080	3.90
8085	5.90
8085A-2	10.95
8088	28.95
8087	CALL
8088	38.95
8089	88.95
8155	6.90
8155-2	7.90
8158	8.90
8185	28.95
8185-2	38.95
8741	38.95
8748	23.95
8755	23.95

8200

8202	23.95
8203	38.95
8205	3.45
8212	1.75
8214	3.80
8216	1.70
8224	2.20
8226	1.75
8228	3.45
8237	18.95
8237-5	20.95
8238	4.45
8243	4.40
8250	9.95
8251	4.45
8253	6.90
8253-5	7.90
8255	4.45
8255-5	5.20
8257	7.90
8257-5	8.90
8259	6.85
8259-5	7.45
8271	38.95
8272	38.95
8275	28.95
8279	8.90
8279-5	9.00
8272	6.45
8283	6.45
8284	5.45
8286	6.45
8287	6.45
8288	24.00
8289	48.95

Z-80

2.5 Mhz

Z80-CPU	3.90
Z80-CTC	4.45
Z80-DART	9.95
Z80-DMA	13.95
Z80-PIO	4.45
Z80-SIO/0	15.95
Z80-SIO/1	15.95
Z80-SIO/2	15.95
Z80-SIO/9	15.95

4.0 Mhz

Z80A-CPU	4.90
Z80A-CTC	4.90
Z80A-DART	10.95
Z80A-DMA	15.95
Z80A-PIO	4.90
Z80A-SIO/0	15.95
Z80A-SIO/1	15.95
Z80A-SIO/2	15.95
Z80A-SIO/9	15.95

6.0 Mhz

Z80B-CPU	12.95
Z80B-CTC	12.95
Z80B-PIO	12.95
Z80B-DART	18.95

ZILOG

Z6132	33.95
Z8671	38.95

DISC CONTROLLERS

1771	15.95
1791	23.95
1793	25.95
1795	48.95
1797	48.95
2791	53.95
2793	53.95
2795	58.95
2797	58.95
6843	33.95
8272	38.95
UPD785	38.95
MB8876	28.95
MB8877	33.95
1691	16.95
2143	17.95

UARTS

AY3-1014	6.90
AY5-1013	3.90
AY3-1015	6.90
PT-1472	3.90
TR1602	3.90
2350	9.90
2651	8.90
TM56011	5.90
IM6402	7.90
IM6403	8.90
INS8250	9.95

INTERFACE

8T26	1.54
8T28	1.84
8T95	.88
8T98	.88
8T97	.88
8T98	.88
DM8131	2.90
DP8304	2.24
DS8835	1.94
DS8838	.98

VOLTAGE REGULATORS

7805T	.74	7905T	.84
78M05C	.34	7908T	.84
7808T	.74	7912T	.84
7812T	.74	7915T	.84
7815T	.74	7924T	.84
7824T	.74	7905K	1.44
7805K	1.34	7912K	1.44
7812K	1.34	7915K	1.44
7815K	1.34	7924K	1.44
7824K	1.34	79L05	.78
78L05	.88	79L12	.78
78L12	.68	79L15	.78
78L15	.68	LM323K	4.90
78H05K	9.90	UA78540	1.90
78H12K	9.90		

C,T = TO-220 K = TO-3 L = TO-92

DIP SWITCHES

4 POSITION	.84
5 POSITION	.89
6 POSITION	.89
7 POSITION	.94
8 POSITION	.94

IC SOCKETS

	1-99	100
8 pin ST	.12	.10
14 pin ST	.14	.11
16 pin ST	.16	.12
18 pin ST	.19	.17
20 pin ST	.28	.26
22 pin ST	.29	.26
24 pin ST	.29	.26
28 pin ST	.39	.31
40 pin ST	.48	.38
64 pin ST	4.20	call

ST = SOLDERTAIL

8 pin WW	.58	.48
14 pin WW	.68	.51
16 pin WW	.68	.57
18 pin WW	.98	.89
20 pin WW	1.04	.97
22 pin WW	1.34	1.23
24 pin WW	1.44	1.30
28 pin WW	1.64	1.44
40 pin WW	1.94	1.75

WW = WIREWRAP

16 pin ZIF	6.70	call
24 pin ZIF	9.90	call
28 pin ZIF	9.95	call

ZIF = TEXTTOOL (Zero Insertion Force)

CRYSTALS

32.768khz	1.90
1.0 mhz	4.90
1.8432	4.90
2.0	3.90
2.097152	3.90
2.4576	3.90
3.2768	3.90
3.579535	3.90
4.0	3.90
5.0	3.90
5.0688	3.90
5.185	3.90
5.7143	3.90
6.0	3.90
6.144	3.90
6.5536	3.90
8.0	3.90
10.0	3.90
10.738635	3.90
14.31818	3.90
15.0	3.90
16.0	3.90
17.430	3.90
18.0	3.90
18.432	3.90
20.0	3.90
22.1184	3.90
32.0	3.90

RESISTORS

1/4 WATT 5% CARBON FILM ALL STANDARD VALUES FROM 1 OHM TO 10 MEG OHM

50 PCS	1.25
100 PCS	2.00
1000 PCS	15.00

APPLE ACCESSORIES

80 Column Card	129.95
16 K Card	42.50
Fan	38.95
Power Supply	84.95
RF Mod	24.95
Joy Stick (Apple II)	29.95
Paddles Apple	9.95
Z80 Card	129.95
SCRG Switch-A-Slot	19.95
Paddle Adapple	24.95
Extend-A Slot	19.95
Disk Drive	224.95
Controller Card	69.95

5 1/4" DISKETTES

ATHANA OR NASHUA

SSSD	18.95
SSDD	22.95
DSDD	27.95

PERISOFT

ACCESSORIES FOR APPLE II & IIe
ALL WITH 1 YEAR WARRANTY BY

PRINTERLINK CENTRONICS PARALLEL INTERFACE

- Simple to use — No configuring required
- Use with any centronics printer — EPSON, OKIDATA, etc.

- Includes Cable & Manual

\$58⁰⁰

MESSENGER SERIAL INTERFACE

- Connects to any RS-232 serial device
- 8 switch selectable drivers for printers, terminals and modems
- Includes Cable & Manual

\$98⁰⁰

TIMELINK REAL TIME CLOCK

- Applications in file management, word processing, communications, etc.
- Exclusive Alarm Clock feature
- Battery recharges automatically

\$83⁰⁰

NEW BUFFERLINK ADD-ON PRINTER BUFFER

- No more waiting for printed output
- Connects easily to any parallel interface
- Expandable from 16K to 64K

\$138⁰⁰ (16K)

The Flip Sort™

The new Flip Sort™ has all the fine qualities of the original Flip Sort™, with some added benefits. Along with a new design, capacity has increased 50%, to hold 75 diskettes and the price is more reasonable than ever. \$19.95 ea.



The Flip Sort Plus™

The Flip Sort Plus™ adds new dimensions to storage. Designed with similar elegant lines as the original Flip Sort™, in a transparent smoked acrylic. The Flip Sort Plus™ has a storage capacity of over 100 diskettes and has all the outstanding features you have come to expect from the flip sort Family. 24.95 each

Do Kay

2100 De La Cruz Blvd.
Santa Clara, CA 95050

Computer Components THE WORLDS' LARGEST



Christmas Specials

Sanyo Computer

- IBM Compatible
- Introductory Offer

\$920

BMC Monitor

- Model 12AUW
- 80 col.
- 12" Green Screen

\$79

Daisy Writer Printer

- Model 2000
- 48K Buffer

\$1199

Star Micronics Gemini 10X Printer

- 120 cps
- 6 month warranty

**We will beat all
Competitors' Prices**

CDC Disk Drive

- Dbl. Side/Dbl. Density
- IBM Compatible

\$249

Circle 81 on inquiry card.

Micro Sci Disk Drive

- Fully Apple Compatible

\$209

Apple IIE 80 Column Card

- Made by Apple

\$49

Microtek

- 16K Card
- 2 year warranty

\$49

Aston Tate

- D Base II
- IBM Compatible

\$389

Hayes Micro Modem

- Fully compatible
w/IIE or II+
- w/Terminal Package

\$259

Wesper Micro

- Graphics Interface
- Apple & Grappler
Compatible

\$69

Hard Disk for PC

5MB	\$1350
10MB	1550
15MB	2150

8" Disk Drive

- Siemens FDD 100-8
- Shugart Compatible
- Sgl. Side/Dbl. Density

1 for **\$169**

2 for **\$159** ea.

Printer Paper

- 500 Sheets
- 18 Bond

\$9.95

**We accept all P.O.'s from Universities
CALL 800-847-1718**

We Offer More Than ^{Just} Low Prices!!!



Unlimited is becoming MAIL ORDER HOUSE!



Christmas Specials

Apple IIE Starter

- Apple II Monitor
- 1 Drive w/Controller
- 80 column card

\$1495

Apple IIE Starter

- Same as Above except
- w/MicroSci Drive
- BMC Monitor

\$1395

Franklin Starter System

- Ace 1000
- 1 Drive w/Controller
- Green 12" Monitor

\$1150

Franklin Ace 1200 Office Management System

- 2 Drives
- Ace calc. & Ace writer

\$1895

5 1/4" Diskettes

- Sgl. Side/Dbl. Density
- 5 year warranty
- Reinforced hub

1 for **\$18**

100 for **\$160**

Circle 81 on Inquiry card.

Tandon for IBM

- TM 100-2
- Dbl. Side/Dbl. Density

\$225

64K Memory Upgrade for IBM

- Prime Parts
- 200 ns

9 for **\$54**

IBM PC

- 64K
- 2, Half Height Drives
- Color Card & Green Monitor

\$2595

Quadram Quadlink

- Turns IBM into Apple

\$499

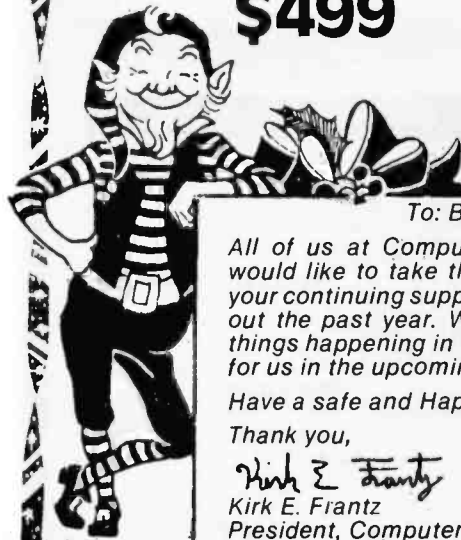

IBM Monochrome Monitor

\$339

Plantronics

- Color Board for PC
- Parallel Port
- Software Included
- Hi-Res

\$499

Plug 'n Play

- Eprom for Okidata
- Makes it PC Compatible

\$99

AST Research Six Pack +

- Par. Ser. Ports
- Real Time Clock
- 64K Exp. to 384K

\$299



To: Byte Readers

All of us at Computer Components Unlimited would like to take the time to say "thanks" for your continuing support of our company throughout the past year. We have some very exciting things happening in the next few months. Watch for us in the upcoming issues of Byte Magazine.

Have a safe and Happy Holiday.

Thank you,

Kirk E. Frantz

Kirk E. Frantz

President, Computer Components Unlimited

Computer Components Unlimited

800-847-1718

OUTSIDE CALIFORNIA

RETAIL STORE:

11976 Aviation Blvd.
Inglewood, CA 90304

MAIL ORDER:

P.O. Box 1936
Hawthorne, CA 90250

www.americanradiohistory.com

**This Ad Supersedes All Others
(213) 643-5188**

All merchandise new. We accept MC, visa, wire Transfer, COD Call, Certified Check, P.O. s from qualified firms, APO accepted. Shipping Minimum \$4.50 first 5 pounds Tax: California Res. Only add 6% sales tax.

Prices Subject to Change

**Mon.—Fri. 8 a.m. to 6 p.m.
Sat. & Sun. 10 a.m. to 5 p.m.**



MORE SPECIALS FROM HOLIDAY SAVINGS 20%

PRINTERS

C. ITOH

Gorilla-Banana, 50 cps	\$ 194
Prowriter 8510, 120 cps	349
Prowriter II 1550 (15")	649
Prowriter I Serial	499
Prowriter II Serial	695
Starwriter F-10, 40 pu	1129
8600BP, 180 cps	999
Printmaster F-10-55	1405

Epson

RX-80 (120 cps)	Call
MX-80FT (80 cps)	Call
Fx-80 (160 cps)	Call
Fx-100 (15" Carriage)	Call

NEC

PC8023A (100 cps)	\$ 399
PC8025 (15" Carriage)	699

Okidata

Microline 92P (160 cps)	\$ 439
Microline 92S (160 cps)	599
Microline 93P (160 cps, 15")	779
Microline 93S (160 cps, 15")	899
Microline 82A (Par. & Serial)	379
Microline 83A (15" Carriage)	599
Microline 84P (200 cps)	949
Microline 84S (200 cps)	999

Star Micronics

Gemini 10X (120 cps)	\$ 294
Gemini 15 (100 cps)	339
Gemini 15X	489
Delta 10	449

Letter Quality

Brother Hr I	\$ 599
Comrex II	499
Juki	499
Dynax DX-15	479

Daisywriter

2000 w/Buffer	\$1199
---------------	--------

Call For All Printers

PRINTER ACCESSORIES

Orange Micro

Grappler +	\$ 119
Grappler + w/16K exp. to 64K	179

Apple Par. Card

Card & Cable	\$ 49
--------------	-------

Microtek

Dumpling GX	\$ 99
Dumpling w/ 16K exp. to 64K	149
Additional 16K for	15

Wesper Micro

Full Graphics Interface Card	\$ 79
------------------------------	-------

Cables

IBM to Printer	\$ 29
Kaypro to Printer	29
Osborne to Printer	29

Okidata Options

Tractor for 82 & 92	\$ 59
2K Serial Buffer	119

Star Options

Serial Interface	\$ 60
------------------	-------

Epson Options

Buffer w/Serial	\$ 119
-----------------	--------

DISK DRIVES FOR APPLE & FRANKLIN

Super 5

Sup-5 1 1/2 Height Controller	\$ 209
	69

Rana Systems

Elite I	\$ 250
Elite II	400
Elite III (Quad Density) Controller (controls 4 drives)	500
	90

Quentin Research

Apple Mate Controller	\$ 219
	60

Micro Sci

A-2 Controller	\$ 209
	70

Mountain Computer

5 meg handisk	\$1795
---------------	--------

MODEMS

Hayes Micro Computer

300 Baud Smart Modem	\$ 209
1200 Baud Smart Modem	499
Micro Modem w/software	259
1200 Baud w/smart com for PC	409
Chronograph	229

Novation

J-Cat 300 Baud	\$ 109
Apple Cat II	249

5 1/4" & 8" DISK DRIVES

Shugart

SA400, Sgl/DBI	\$ 160
SA455, 1/2 Height	225
SA801R Sgl/DBI	355
SA851R Dbl/DBI	475

Tandon

TM 100-1, 160K	\$ 160
TM 100-2, 320K	235
TM 101-4 (quad)	299
TMTM 848-1 Sgl/DBI Den	359
TM 848-2 Dbl/DBI Den	435

Mitsubishi

2894 Dbl/DBI 8"	\$ 399
-----------------	--------

Siemens

FDD 100-8, Sgl/DBI	\$ 159
--------------------	--------

CDC

9409T, 320K	\$ 249
-------------	--------

Circle 82 on Inquiry card.

IBM PC ACCESSORIES

Ast Research

IO +	\$ 119
Combo +	259
Six Pack +	279
Mega +	279
Mega Pack	279

Quadram

Quad Link	\$ 475
Color Graphics Card	245
Quadchrome Color Monitor	475

Tandon

320K Disk Drive	\$ 235
-----------------	--------

Panasonic

Slimline Drive, 320K	\$ 205
----------------------	--------

CDC

320K Disk Drive	\$ 249
-----------------	--------

64K Upgrade

each 64K	\$ 59
----------	-------

Paradise Systems

Multi Display Card	\$ 399
--------------------	--------

Plantronics

Multi Display Card	\$ 399
--------------------	--------

PC Cable

Printer Cable (6 ft)	\$ 29
----------------------	-------

APPLE, FRANKLIN Accessories

Advanced Logic Systems

CPM 3.0 Card (6 MHz)	\$ 299
Z Card	139
CPM Card + Super Calc.	499

Astar

RF Modulator	\$ 18.
Fan	39
Hi-quality Joystick	29

Gibson

Light pen	\$ 239
-----------	--------

Micro Max

80 col. for II+ or Franklin, Inverse Char. Soft switch, Videx Compatible	\$ 139
80 col. for IIE w/64K exp. 128K	139

Kensington

System Saver	\$ 79
--------------	-------

Micro Soft

Softcard w/cpm	\$ 239
16 K Card	69
Premium Pack	499

California Computer Systems

Serial interface card	\$ 129
-----------------------	--------

TG Products

Joystick	\$ 44
Paddles	34
Selectaport	39

Kraft

Joystick	\$ 49
----------	-------

Micro Tek

Bam 16K card	\$ 59
--------------	-------

We accept all P.O.'s from Universities
CALL 800-847-1718

We Offer More Than ^{Just} Low Prices!!!



Computer Components Unlimited TO 40% OFF LIST PRICE

PERSONAL / PORTABLE SYSTEMS

Franklin	
Ace 1000 w/64K	Call
Ace 1100	Call
Ace 1200 w/Drive	Call
Ace Pro Pack	\$1149
Franklin Ace Drive	299

Apple Computer	
IIe w/64K	\$1090
IIe Starter System	1525
Apple Drive	319
Apple IIe 80 col. card	49

IBM	
PC 64K, Keyboard, 1 Drive	\$1995
PC 64K, Keyboard, 2 Drives	2245
XT Hard Disk Drive, 128K	4995
PC Monochrome Card	335
PC Color Card	275
PC Monochrome Monitor	335

Kaypro	
Kaypro II	\$1495
Kaypro 4	1950
Kaypro 10	2595

Columbia	
1600-1, 2 Dbl. Drives, Color Card, Keyboard	\$2795

Eagle	
Call for pricing	
Televideo	

Teletote I	\$1395
Teletote II	1695
TS 803	1900
TS 1603	2450

Compupro	
816A	\$4095
Call for Compupro Board Pricing	

Sanyo	
MBC-555	\$ 975
MBC-1000	1395

STM Computers	
Pied Piper I	\$ 995

LOW PRICED Hi Quality DISKETTES

Computer Components	
5 1/4" Disks	
Sgl Side/Dbl Density	\$18 a box
Dbl Side/Dbl Density	27 a box

8" Disks	
Sgl Side/Sgl Density	\$19 a box
Dbl Side/Dbl Density	29 a box
All Disks come w/Reinforced Hub, 5 yr warranty and not bulk packed.	

Filptubs	
Smoked Plexiglass Diskette File Holds 70	\$ 19
Call for all brands of Disks.	

TERMINALS

Qume	
102, 80 col. Green	\$ 539
102AM	549
103, 80/132	749

Adds	
Viewpoint 3A +	\$ 570

Televideo	
925	\$ 719
950	919

DISK DRIVE CABINETS

5 1/4" Cabinets	
Single Cab. w/ power supply	\$ 49
Dual Cab. w/ power supply	85

8" Cabinets	
Single Cab. w/ fan & power supply	\$ 209
Dual Cab. w/ fan & power supply	259

HOT CIRCUITS

Watch Computer Components to expand in this area. Call for all volume requirements.

TTL	
74L & 244	\$1.39

Dynamic Rams	
TMS 4027	\$1.99
UPD 411	3.00
4116-200 ns	1.59
4164-200 ns	5.95
4164-150 ns	6.95

Static Rams	
2114L-2	\$1.69
6116-4 200 ns	4.65

Eproms	
1702	\$4.40
2708	3.80
2716	7.50
2732	4.80
2764	6.00

VIDEO DISPLAY MONITORS

USI	
PI 1 (9" Green HiRes)	\$ 119
PI 2 (12" Green HiRes)	139
PI 3 (12" Amber HiRes)	149
PI 4 (9" Amber HiRes)	129

BMC	
12 AUW (12" Green)	\$ 79
9191 Color Composite	249
12 EUN (20MHZ HiRes)	129

Zenith	
ZVM122 (Green)	\$ 99
ZVM123 (Amber)	129

Gorilla	
HiRes Green	\$ 89
HiRes Amber	99

Amdek	
Color I Composite Color	\$ 329
Color II RGB	419
300A	159
310A	179
300G	149

Princeton Graphics	
PGS HX12	\$ 479

Happy
Holidays



Circle 82 on inquiry card.

Computer Components Unlimited

800-847-1718
OUTSIDE CALIFORNIA

RETAIL STORE:
11976 Aviation Blvd.
Inglewood, CA 90304

MAIL ORDER:
P.O. Box 1936
Hawthorne, CA 90250

**This Ad Supersedes All Others
(213) 643-5188**

All merchandise new. We accept MC, Visa, Wire Transfer, COD Call, Certified Check, P.O.'s from qualified firms, APO accepted. Shipping: Minimum \$4.50 first 5 pounds. Tax: California Res. Only add 6 1/2% sales tax.

Prices Subject to Change

**Mon.—Fri. 8 a.m. to 6 p.m.
Sat. & Sun. 10 a.m. to 5 p.m.**

ADVANCED COMPUTER PRODUCTS



HARDWARE

IBM PC COMBO CARD MEMORY PLUS AT LOW PRICES!

Now! "Multicard" expandable from 64-256K with

(1) PARALLEL (1) SERIAL
(1) CLOCK/CALENDAR

COEX 64 SPC with 64K **\$229⁰⁰**
COEX 256 SPC with 256K **\$399⁰⁰**

Item	List	ACP
AST Megaplus™ Card	395	279
P/N MG064 (64K, S, C)		
•Comboplus™ Card	395	279
P/N MC-064SPC (64K, S, P, C)		
•PC I/O Plus™ Card	165	115
P/N IO (C, S)		
•"SIX PACK"™		
P/N SP064SPC (64K, S, P, C)	299	
COEX Extender Card	40	29
Prototype Card	69	35
HERCULES Hercules Graphic Card	379	
MOUSE SYSTEMS Mouse for IBM	269	
MICROSOFT Mouse plus Multitool Word	Call	
MAR 6 Slot Expansion Chassis for IBMPCXT or Eagle etc	439	
ORCHID Hi-Res Graphics Adaptor	395	
PERSYST Spectrum (64-256K)	319	
P/N SP64 (64K, Ck, S, P)		
PLANTRONICS Color plus™ Card	469	
QUADRAM Quadboard (64-256K)	395	279
P/N Q64, 64K w/4 functions		
QuadLink Apple Card	580	525
Quadboard 64K	100	
Microfazer Print Buffer MP-64	488	
RIXON PC212A Modem I/O	596	449
BSM Transmodem 1200	479	
USI Multidisplay Card	299	
VISTA "Multicard"™ (exp. 64-256K)		
P/N V-064 (64K, Ck, S, P)	395	229
P/N V-256 (256K, Ck, S, P)	695	399
•"Maxicard"™ (up to 576K)		
P/N V-576-64K	249	
P/N V-576-576K	729	
•"PC Master"™ (10 I/O)	495	329
•"PC Extender"™ (up to 10 I/O)	249	199
•"Diskmaster"™	299	199
•ThinLine Dual Floppy	2100	999
•V1200 6.25in Cartridge Drive		

S-100 64K "CMOS" RAMCARD

Unbelievable Price!

\$299⁰⁰

Assembled and Tested

- ACP has sold over 1000 of these IEEE compatible, low-priced, high-reliability 64K Static RAM Cards.
- Single 5-Volt operation.

PRINTERS

COEX 80FT/80cps	\$299	\$199
DYNAX Daisywheel		525
SILVER REED EXP500 132 Column		649
STAR MICRONICS - HEWI Gemini 10X 120cps	399	319
Gemini 15 15"	599	399
EPSON FX80	699	549
FX100	895	749
BROTHER HP-1 BMC	1195	895
DAISYWRIITER	1495	1295
TTX Daisywheel		549
NEC Sprinter 3550		1875
IBM PC to Parallel Cable	60	39

MONITORS

AMDEK CORP 300 Green 12"	\$199	\$155
310 Amber 12"	210	175
IBM Mono Extension Cable	399	339
Color II Composite/Hilachi	899	695
Color II RGB Hi-Res		695
DMC 12" Green	129	89
PRINCETON GRAPHICS RGB IBM Lookalike	700	545

DISKETTES

DYSAN 5 1/4" SS SD	10-555	538
DYSAN 5 1/4" DD	10-65	48
IBM 5 1/4" SS SD	10-60	43
IBM 5 1/4" SS DD	10-65	47
VERBATIM 525-01 SS	10-45	23
VERBATIM 550-01 DS	10-55	34
MAXELL MD1 SS	10-50	29
MAXELL MD2 DS	10-60	39
Flip Storage Box 5 1/4" (80 disks)		19
BULK SPECIAL SS	10-25	19
With Sleeve and Box	100-195	149

MORE IBM GOODIES

COMPUABLE Keyboard & Drive Covers (set)	\$19
CURTIS PC Pedestal	\$80 84
PGS or Quadchrome Adaptor Vertical PC System Stand	10 20
IBM Mono Extension Cable	50 44
Keyboard Ext. Cable (3-9')	34
EPO PROTECTION DEVICES The Lemon (Surge Protector)	43
The Peach (Surge Protector)	68
The Orange (with EMVRFI)	122
The Line	78
INTEL 8087 IC	199
KOALA PAD	99
KRAFT Joystick IBM	70 40
RAM EXPANSION 16K Memory Board (16 IC's)	19
64K Memory Exp. (8 IC's)	50

TIME SHARE SERVICES

COMPUERVE Subscription	\$40
SOURCE Subscription	75

MODEMS

HAYES Smartmodem 300	\$210
PC Modem Software 1.3 (above)	48
Smartmodem 1200	525
PC Software 1.4C (above)	78
Smartmodem 1200B	445
Smartcom II	78
Smartmodem to IBM Cable	25

APPLE™ COMPATIBLE DISK CONTROLLER

Only **\$49⁹⁵**

Apple Printer Interface

w/Apple to Epson Cable **\$49⁹⁵**

Apple IIe Compatible 80 Column Card w/64K

\$99⁹⁵

APPLE COOLING FAN

with Surge Suppression **\$49⁹⁵**

APPLE COMPATIBLE POWER SUPPLY

+ 5V @ 5A
+ 12V @ 3A
- 12V @ 25A
- 5V @ 25A **\$79⁹⁵**

APPLE COMPATIBLE JOY STICK

only **\$15⁹⁵**

Vista Computer Company

VISTA V1200 6.2 Cartridge Drive w/Controller

Apple or IBM Compatible **\$999⁹⁵**

Please Specify with Order

VISTA "SOLO" Apple II/IIe Compatible Disk Drive

Totally compatible to Apple Drives. **Only \$199⁹⁵**

Controller **\$49.95**
Just plug in and run.

Apple II 16K RAM CARD

Compatible with Z80 Softcard™, PASCAL CP/M™

Full 1 year Warranty, Top Quality by COEX

NEW LOW ACP PRICE **\$49⁹⁵**

Also from COEX, NEW EPSON Parallel Interface for Apple. **\$49.95**

VISTA A800 8" Disk Controller

for Apple **\$299⁹⁵**

VISTA "DISKMASTER" IBM Compatible

3", 5", 8" and V1200 Compatible **\$199⁹⁵**

apple computer Authorized Dealer

Item	LIST	ACP
Apple IIe w/64K	\$1395.00	\$1195.00
Apple IIe System	1995.00	1695.00
Apple IIe System w/Ext Text	2195.00	1895.00
Disk II w/Controller	545.00	449.00
Disk II w/ Controller	395.00	359.00
Monitor III Green	249.00	169.00
Super Serial Card	195.00	169.00
Parallel Interface Card	185.00	139.00
80 Column Text Card	125.00	
Extended 80 Column Text	295.00	249.00
Dot Matrix Printer	695.00	529.00

*Apple Products Available In-Store Only!

MORE HARDWARE

Item	LIST	ACP
MICROSOFT Z80 Softcard	\$395.00	\$249.00
16K Ramcard	195.00	89.00
SSM ACP-II 4 Function Serial/Parallel	225.00	179.00
EASTSIDE Wildcard Apple II	149.00	115.00
KENSINGTON System Saver	89.95	69.00
KEYBOARD COMPANY Numerical Keyboard	149.95	124.95
Apple II Joystick	49.95	44.50
Apple II Hand Controllers	29.95	25.95
KRAFT Joystick		49.00
Hand Controller		40.00
MPC 128K Bubble Memory	875.00	699.00
PROMETHEUS VERSAcad Four-in-1	199.00	166.00
VISTA COMPUTER CO. 8000 B Disk Control	379.95	299.00
Quartet Disk Drive 5 1/4"	849.00	799.00
Solo Disk Drive w/Contr	299.00	249.00
Solo Drive w/o Contr	249.00	199.00
Vista 5 1/4" Disk Contr	92.00	49.00
Typehead Buffer	49.95	35.00
VIDEX Videoterm 80x24 Card	345.00	279.00
Keyboard Enhancer II	149.00	129.00
Soft Switch	35.00	30.00
Function Strip Keys	79.00	68.00
PRACTICAL PERIPHERALS 16K MicroBuffer	259.00	220.00
32K MicroBuffer	299.00	253.00
Snapshot Option	149.00	109.00
VOTRAX Type nTalk Speech Personal System	249.00	219.00
395.00	339.00	
VYNET Apple II Voice Syn.	385.00	349.00
Apple II Telephone I/O	295.00	249.00
SCOTT INSTRUMENTS Voice Recogn'n VET80	799.00	675.00
COEX 16K RAM Card	99.00	49.95
Parallel Disk Drive Cable	99.00	79.95
Apple Protocard	29.00	19.95
Apple Extendercard	29.00	19.95
Apple IIe EXT RAM Card	199.00	99.95
CARDVUS ORANGE MICRO The Grappler I/O (Plus)	175.00	139.00
The Bufferboard	175.00	139.00
SATURIN SYSTEMS 32K RAM Card	219.00	179.00
128K RAM Card	499.00	439.00
STREET ECHO II	149.00	129.00
LEGEND 64KC II/III	327.00	269.00
128KC II/III	599.00	499.00
1638C 16K Static MICRO/PRO Woodstar w/CP/M	499	415
MOUNTAIN COMPUTER MCS Multifunction	239.00	169.00
Misc System	395.00	335.00
A/D plus D/A	350.00	299.00
ROM Plus	155.00	129.00
M&R ENTERPRISES Sup/term 80x24 Card	395.00	269.00
Sup/Mod II	69.00	49.00
Sup/Mod V (IBM)	69.00	49.00
ALS The CP/M Plus Z80 Card	399.00	329.00
Smartterm 80x24 Card	349.00	279.00
The Synnergizer Package	699.00	549.00

Apple Compatible Software

SAVE UP TO 40%

BUSINESS ASCII Exprs. Prot.	99
Screen Writer	\$129
BD Master	155
Zoom Graphics	32
Visicalc™ 3.3	185
Utility City	22
Visplot	159
Locksmith 4.0	90
PFS, File II	115
Nobbies Away II	49
PFS, File III	155
GAMES	26
Visitand/Visplot	25
Choptier	39
PFS, Graph II	115
Frogger	24
PFS, Graph III	155
Wizardry	39
Multipan	199
Snack Attack	24
Verisform	278
Cannonball Blitz	26
Wordstar	299
King Diamonds	25
dBASE II	439
Zork I	29
Supercalc	169
Zork II	29
PFS, Report II	95
Sieracross	25
PFS, Report III	118
Serpentine	25
Acct Plus Q/L	299
Star Blazer	25
GL, A/P, A/R	599
Deadline	39
Above+Inventory	799
Tubeway	29
Magic Window	115
Flight Simulator	25
HOME Space Vikings	43
Home Accountant	59
Sargon II	29
Transend I	78
Spillies Simulator	29
Transend II	119
Apple Panic	22
Vialterm	89
Olympic Decath	23

Apple™ Apple Trademark of Apple Computer
IBM™ IBM Trademark of International Business Machines

DOT MATRIX PRINTER

COEX 80-FT

- ✓ 9x7 Dot Matrix 80 CPS, Bi-Directional Printing
- ✓ 2K Buffered Memory
- ✓ 80, 96, 132 Columns, Graphics and Block Printing
- ✓ Selectable Char Pitch, Line Spacing and Feed

COEX Interface Card to Apple **\$49.95**

\$199⁰⁰

ACP HAS DISK DRIVES

APPLE II™ COMPATIBLE Thin Line Drive

\$249⁰⁰

TANDON 100-2 PC Compatible • Double Sided

\$289⁰⁰

TOSHIBA Half-High PC Compatible • Double Sided

\$249⁰⁰

OTHER DRIVES WE STOCK

TANDON 848-2 ThinLine	\$479.00	SHUGART 801R	\$399.00
TEAC F055B	299.00	SHUGART 860 ThinLine	479.00
PASCASION C155 (PC Comp)	259.00	SHUGART SA400	210.00
MPI 852	279.00	SEAGATE ST506 (6MB Win.)	599.00

TOLL FREE **800-854-8230**

TWX **910-595-1565**

Mail Order: P.O. Box 17329 Irvine, CA 92713
Retail: 13108 E. Edinger, Santa Ana, CA 92705
(714) 558-8813
542 W. Trimble, San Jose, CA 95131
(408) 946-7010



If You're Thinking IBM PC™, READ THIS!

COEX Combocard II

- ★ 64K to 256K RAM
- ★ ASYNC Serial Port
- ★ Clock/Calendar w/NiCad Backup
- ★ Parallel Printer Port
- ★ RAMDisk Software
- ★ Spooler Software

64K only **\$229⁰⁰**

256K only **\$399⁰⁰**

Zero "K" Version Available Only \$199.00

PLUS! . . .with Purchase of either Memory card above

SUPERCALC™ only **\$89.00** (195.00 value)
Disk Emulator **FREE**
Print Spooler **FREE**

ACP PC "FEATURE OF THE MONTH"

1. **DISKMASTER™**. Disk Controller for IBM PC or XT adds both 5 1/4" and 8" floppy drives. Complete with Software. Same card can also handle the Amlyn 6.2 Mb Cartridge Add-on Subsystem \$299 **\$199**
2. **VISTA 1200 with DISKMASTER™** \$999
3. **M&R "SUPR EXTENDER™"**. IBM PC & XT Expansion Chassis with (6) Slots, Power Supply and Fan. Your price!! only \$439.00. You cannot afford to live without one.

DISK DRIVES

TANDON 100-2

PC Compatible • Double Sided
\$289⁰⁰

TOSHIBA 1/2 High
 PC Compatible • Double Sided
\$249⁰⁰



Other Models Also Available

Circle 12 on inquiry card.

MAIL ORDER: P.O. Box 17329 Irvine, CA 92713
Retail: 1310 E. Edinger, Santa Ana, CA 92705
(714) 558-8813
 542 W. Trimble, San Jose, CA 95131
(408) 946-7010

TOLL FREE
800-854-8230
 TWX
910-595-1565

LOW COST MEMORY — AVAILABLE NOW!

SEND FOR YOUR FREE 1983 CATALOG!

HARDWARE

	List	ACP
AST Megaplus™ Card	395	\$279
P/N MG064 (64K, S, C)		
Combolplus™ Card	395	279
P/N MC-064SPC (64K, S, P, C)		
PC I/O Plus II™ Card	165	115
P/N I/O (C, S)		
"SIX PACK"		
P/N SP064SPC (64K, S, P, C)	299	
COEX Extender Card	40	28
Prototype Card	69	35
HERCULES Hercules Graphic Card	359	
MOUSE SYSTEMS Mouse for IBM	269	
MICROSOFT Mouse plus Multitool Word	Call	
ORCHID Hi-Res Graphics Adaptor	395	339
PERSYS Spectrum (64-256K)		
P/N SP64 (64K, Ck, S, P)	318	
PLANTRONICS Color plus™ Card	399	
QUADRAM Quadboard (64-256K)		
P/N Q64, 64K w/4 functions	395	279
QuadLink Apple Card	680	525
Quadboard 64K		279
Microfazer Print Buffer MP-64		190
Quadchrome (Hires, RGB)		488
RIXON PC212A Modem I/O	596	448
SSM Transmodem 1200		479
USI Multidisplay Card		299
VISTA "Multicard™" (exp. 64-256K)		
P/N V-064 (64K, Ck, S, P)	395	229
P/N V-256 (256K, Ck, S, P)	695	399
"Mastercard™" (up to 576K)		
P/N V-576-64K	249	728
P/N V-576-576K		328
"PC Master" (10 I/O)	495	328
"PC Extender" (up to 10 I/O)	249	199
"Diskmaster"	299	199
"8" Thinline Dual Floppy	Call	
"V1200 6.2Mb Cartridge Drive		999

PRINTERS

COEX 80FT/80cps	\$299	\$199
DYNAX Daisywheel		525
SILVER REED EXP500 132 Column		649
STAR MICRONICS - NEW!		
Gemini 10X 120cps	399	319
Gemini 15 15"		599 469
EPSON FX80	699	549
FX100	895	749
BROTHER HR-1/BMC	1195	895
DAISYWHEEL TTX Daisywheel	1495	1295
NEC Spinwriter 3550		549 1875
IBM PC to Parallel Cable	60	39

MONITORS

AMDEK CORP 300 Green 12"	\$199	\$155
310 Amber 12"		175
Color I Composite/Hitachi	399	339
Color II RGB Hi-Res	899	695
BMC 12" Green	129	89
PRINCETON GRAPHICS RGB IBM Lookalike	700	545

DISKETTES

DYSAN 5 1/4" SS SD	10/\$55	\$38
DYSAN 5 1/4" DS SD	10/65	48
IBM 5 1/4" SS SD	10/60	43
IBM 5 1/4" SS DO	10/65	47
VERBATIM 525-01 SS	10/45	23
VERBATIM 550-01 DS	10/55	34
MAXELL M01 SS	10/50	29
MAXELL M02 OS	10/60	39
Flop Storage Box 5 1/4" (80 disks)		19
BULK SPECIAL SS	10/25	19
With Sleeve and Box	100/195	149

MORE IBM GOODIES

COMPUCABLE Keyboard & Drive Covers (set)	\$19	
CURTIS PC Pedestal	\$80	64
PGS or Quadchrome Adaptor		10
Vertical PC System Stand		20
IBM Mono Extension Cable	50	44
Keyboard Ext. Cable (3-9')		34
EPO PROTECTION DEVICES The Lemon (Surge Protector)		43
The Poach (Surge Protector)		68
The Orange (with EMI/RFI)		122
The Limo		76
INTEL 8087 IC		199
KOALA PAD		99
KRAFT Joystick IBM	70	40
RAM EXPANSION 16K Motherboard (16 IC's)		19
64K Memory Exp. (9 IC's)		50

TIME SHARE SERVICES

COMPUSERVE Subscription	\$40	
SOURCE Subscription		75

MODEMS

HAYES Smartmodem 300	\$210	
PC Modem Software 1.3 (above)		49
Smartmodem 1200		525
PC Software 1.4C (above)		79
Smartmodem 1200B		445
Smartcom II		79
Smartmodem to IBM Cable		25

SOFTWARE

dBASE II
\$399⁰⁰

Condor
\$389⁰⁰

SuperCalc
\$99⁰⁰

SuperCalc 2
\$179⁰⁰

Multiplan
\$189⁰⁰

Wordstar
\$299⁰⁰

Lotus 1-2-3
Call!

T. K. Solver!
Call!

Flight Simulator
\$45⁰⁰

Context MBA
Call!

Computer Inovations
C86C Compiler
\$369⁰⁰

Copy II Plus
\$32⁰⁰

Visiword
\$289⁰⁰

Digital Research
 Pascal MT + 86 \$295.00
 Concurrent CP/M 86 260.00
 CBASIC 86 149.00

Plus More Great Software Values In Our 1983 Catalog!
Send For Your Copy NOW.

TERMS: NO. Cashier's Check, Bank Wire. Personal checks allow 2 weeks for processing. Include Drivers License and credit card #s. Visa, AMEX, CB add 3% service charge. Add 3% shipping & handling or \$2.50, whichever is greater. Add 10% for foreign orders or US Parcel Post include Telephone number. NO CODs. Prices subject to change without notice. Some items subject to prior sale. We reserve the right to substitute manufacturer. Retail prices may vary. We are not an authorized IBM dealer. IBM™ trademark of International Business Machines.

64K MEMORY + P.S.C. \$229.00

**Six
Solid Reasons
You Should
Buy From
Priority One
Electronics**

1

Quick Delivery. We appreciate that speed of delivery is of primary concern to you. And, we share that concern. We are organized for and committed to shipping orders within 24 hours. Our order pulling day begins before 6:00 am, with crews working until after midnight to process every order as quickly as possible. Not only will your order arrive promptly, it will also be correct. Our triple check quality procedures is your guarantee that your order will be right — the first time.

2

Before sales support. Our knowledgeable sales representatives are available to answer your questions about the products we sell. They have the latest price and availability information at their fingertips from our 100 user Alpha Micro Computer System. Our manufacturers and in-house engineering staff hold regular training seminars to keep our sales staff abreast of the latest information in our rapidly evolving marketplace.

3

After sales support. It has been said that "a mail order distributor cannot support their customers from a distance". If this is a rule, then **WE ARE THE EXCEPTION.** We are often able to offer better support than the local dealer who must thinly spread his limited technical resources across all the products he sells. Because of our size and large customer base, we are able to maintain a staff of engineers and technicians who specialize in specific areas to better serve you.

4

Product and Pricing.

We are proud of the products we sell. Our new product evaluation procedures approve less than 10% of the products offered to us. We are selective, because you deserve it. And yet, we carry the broadest line of quality computer products and accessories. And we stock them in depth. Our multi-million dollar inventory is testimony to our commitment to rapid delivery. Our unequalled purchasing power allows us to continually offer the most competitive prices, while maintaining the financial strength necessary to insure the professional support you expect from us.

5

Largest and Fastest Growing. This year Inc Magazine has named us "the 31st fastest growing, privately held, company in the entire United States." Making us number one in our field. We thank you for making this possible. We strive daily to earn your continued patronage. Even we make a mistake now and then. And when we do, our courteous Customer Service Department is only a phone call away. Our strength has allowed us and our customers to weather the storm of "P O Box Operations" that proliferate within this industry. These fly-by-night companies, are here today with a lower price, but are gone tomorrow, leaving their customers high and dry.

6

New Catalog. Our new, 104 page, full color Winter '83/Spring '84 Engineering Selection Guide is hot off the press. This publication has become the Bible of Our Industry because of the wide variety of products, and the comprehensive technical information included. As an added bonus, if you act now and **place your order before December 31, 1983, you can save up to an additional 10% off our already discounted catalog prices.** If you or an associate have not yet received your copy, call our toll-free number, and one will be mailed today.

1

PRIORITY ONE ELECTRONICS

9161 Deering Ave., Chatsworth, CA 91311

(800) 423-5922

(213) 709-5111

WIREMASTER

Whip your wire wrap and PC layout problems with **WIREMASTER**

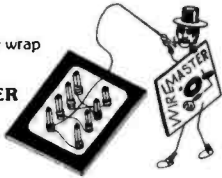

WIREMASTER is a software tool for design, layout, and assembly of hardware. Your schematic is fed to **WIREMASTER**, which produces network maps, cross-references, wire and parts lists, and debug checklists. **CHANGEMASTER** keeps track of fixes and updates. **PLOTBOARD** and **PRINTBOARD** give pictures of the layout. Post-processors for wirewrap machines available. Runs on **CP/M, MSDOS, UNIX, and VMS**. \$195.

AFTERTHOUGHT ENGINEERING 7266 Courtney Dr., San Diego, CA 92111, (619) 279-2868.

Circle 508 on Inquiry card.

"CONTROL YOUR WORLD" WITH YOUR VIC-20

With simple circuits using low cost parts and our program supplied on cassette tape, we'll show you how to use your **COMMODORE VIC-20** for:

- Digital Thermometers
- Digital Clock
- Burglar Alarm - 2 Zone, Time Controlled
- Fire Alarm - 2 Zone, Time Controlled
- Dusk to Dawn Lighting with Photo Cell
- Furnace and Air Cond., Clock and Thermostat
- Clock Controlled Appliance Switches

Simple program variations in basic can operate lights, motors, furnaces, machines, heat pumps, radios, sound systems, test equipment, swimming pools, garden watering, and more.

Your video screen will display simultaneously:
 • Two Digital Temperatures • Digital Time • Two Analog Inputs • Five Input Ports Status • Eight Output Ports Status.

GET A LOW COST EDUCATION IN COMPUTER CONTROL. ORDER YOUR CASSETTE AND INSTRUCTION BOOK NOW! \$39.90 PRICE INCLUDES POSTAGE.

Terms: MASTER CARD/VISA

The Continental Press, Inc., Elizabethtown, PA 17022
 Toll free: 800-233-0759 Collect in PA: (717) 367-1836

Circle 509 on Inquiry card.

Protect your computer from high voltage power surge

SURGEFREE
 NOW AVAILABLE IN 10 SOCKETS

\$79.95

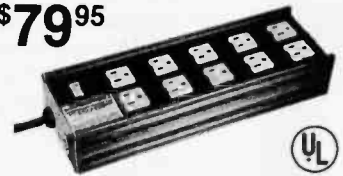

CHECK AMERICAN EXPRESS CARTE BLANCHE

XXXXXXXXXXXXXXXXXXXX

EXPIRATION DATE: _____

NAME: _____

ADDRESS: _____

CITY: _____ STATE: _____ ZIP: _____

MAIL TO: **Computronix Corporation**
 BOX 1425
 MELVILLE, N.Y. 11747

Circle 512 on Inquiry card.

DATA SWITCH FOR IBM PC PRINTER INTERFACE

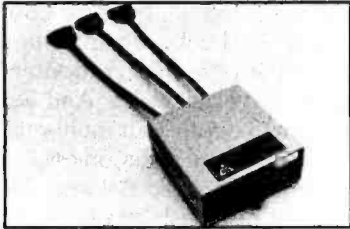

Model 1220 Bi Directional Data Switch with 3-3ft. data cables gives an IBM PC user 2 Centronics Interfaces to connect a draft printer & letter quality printer to his Parallel Interface. A toggle switch on the front panel selects the desired printer. Runs at any speed. Built in data cables, save money. Supplied assembled and tested. \$179.00. Available from your local computer dealer or

Terminal Data Corp.

11878 Coakley Circle, Rockville, MD
 (301) 881-7655

Circle 507 on Inquiry card.

12 Bit A/D Converter

Professional data conversion for your Apple® computer at a new low price of \$299.95

Compare with any competitive product at twice the price!

- 16 channels of analog input
- Full 12 bit data accuracy (1 part in 4096)
- No programming needed — Convert any channel direct from Basic
- Complete accessory software on disk
 - Including high-speed access handler
 - "Demo-Scope" multichannel waveform display
 - Plain English discussion and example tutorial



- Applications include:
 - Security
 - Control
 - Laboratory data acquisition
 - Voice analysis
 - Energy control

8842 VALJEAN AVE.
 VAN NUYS, CA. 91406
 (213) 989-1204

© 1982 Hollywood Hardware Inc.
 "Apple" is a Registered Trademark of Apple Computer, Inc.

Circle 510 on Inquiry card.

APPLE® -PROM EPROM BURNER CARD

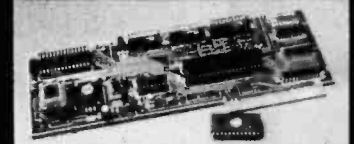

All menu-driven software is provided along with a complete user's manual. All commands are self-prompting, there are no personality modules required and all voltages are on-board card.

BURNS EPROMS FEATURES

2708 2532 2732 *Auto erase verify
 2716 2516 2764 *Auto burn verify
 2732A 2564 *Partial burn capacity

only **149.95** *Low Insertion force socket

Now Available **APPLE® -PROM Console Unit!**
Computer Technology Associates

CTA New Products Division
 1704 Moon, N.E.
 Albuquerque, N.M. 87112
 (505) 298-0942

Specifications subject to change without notice.
 Apple is a registered trademark of Apple Computer, Inc.
 VISA / MC / AE Accepted

Circle 513 on Inquiry card.



THE FULL-FEATURED KEYBOARD EXPANDER
 Redefine any key to send a string of characters. **MagiKey™** does more ...

- * automates application software, integrates function or cursor keys
- * "help" menus displayed at any time
- * built-in batch processing more powerful than SUBMIT or XSUB
- * strings can redefine keys, pause for fill-the-blanks keyboard input, or contain nested key definitions
- * invisible to system and software
- * for any 8080-8085-Z80-CP/M 2.2, no system or software modifications

\$100

8" SSSD, Kaypro 5 1/4" - Inquire about other 5 1/4" formats
 check, VISA, MC add 6% tax in CA

PRO microSystems
 16609 Sagewood Lane
 Poway, California 92064
 (619) 693-1022

CP/M (tm) Digital Research

Circle 508 on Inquiry card.



LC NETWORK LINE FILTER

Model C-519-L1 EMI/RFI filter protects against high energy transients... varistor clamps higher voltages to safe levels... Max Rating: 15 A, 125 VAC, 1875 Watts continuous duty... \$97.50.

J. W. MILLER
DIVISION/Bell Industries
 19070 Reyes Ave., Rancho Dominguez, CA 90224
 (213) 537-5200

Circle 511 on Inquiry card.

SAVE ON CONTINUOUS BLANK LETTERHEAD WITH CLEAN-EDGE-PERF

500/Pkg.	9 1/2 x 11	20 lb.	8.50/Pkg.
2800/Ctn.	9 1/2 x 11	20 lb.	34.95/Ctn.

SAVE ON CUSTOM PRINTED CONTINUOUS STATIONERY WITH CLEAN-EDGE-PERF

PAPER	WT.	1M	3M	5M
White Bond	20	85.00	54.00	32.00
25% White Rag	20	105.00	80.00	39.00
Classic Laid White	24	115.00	88.00	45.00
Classic Laid Ivory	24	115.00	88.00	45.00

Size: 9 1/2 x 11 - Detached To: 8 1/2 x 11

SEND IN YOUR COPY OF LETTERHEAD. WE WILL MATCH INK AS CLOSE AS POSSIBLE. TWO COLOR ADD 35.00/FLAT

ENCLOSE CHECK OR MONEY ORDER. NO C.O.D.'S. ALLOW 3 WEEKS. FASTER DELIVER WITH M/C, VISA PHONE ORDERS. ILLINOIS RESIDENCE ADD 5 1/4% SALES TAX.

ALL PRICES ARE DELIVERED!
COMPUTER PAPER PEOPLE
 P.O. BOX 381 • WINFIELD, ILL 60190
 (312) 665-7601

Circle 514 on Inquiry card.

IBM PC 256K 2X 320 KB DS/DD DISK DRIVES FLOPPY DISK CONTROLLER

ALL FOR \$2599

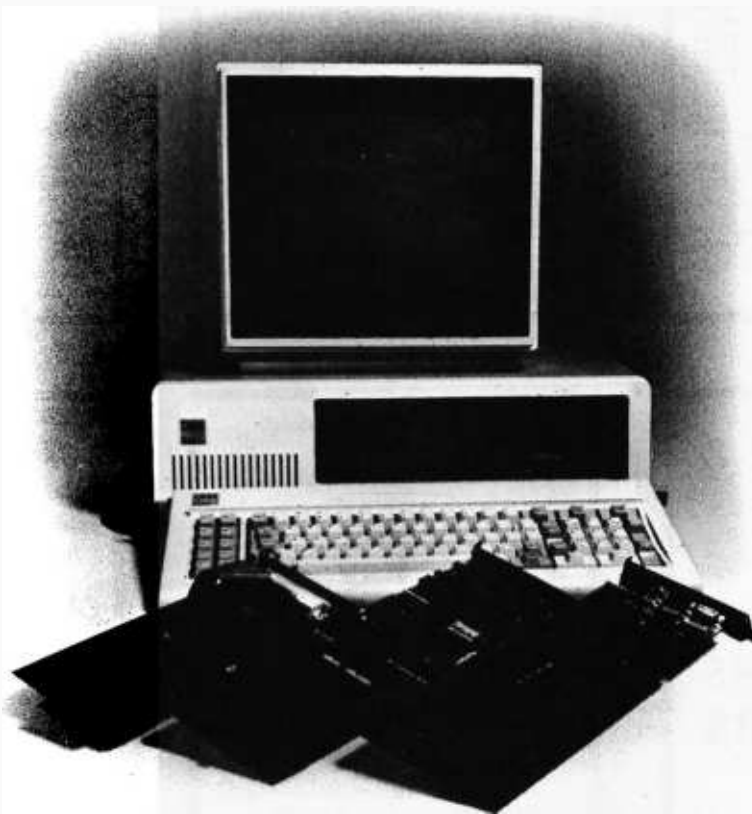

**Call for prices on
System Configurations.**

**IBM PC256K COLOR GRAPHICS BOARD FLOPPY DRIVE CONTROLLER
WITH PARALLEL PORT 360KB DS/DD DISK DRIVE, PRINTER, CABLE
DOS 2.0, 10MB HARD DISK SUBSYSTEM INCLUDES CABLE,
CONTROLLER, POWER SUPPLY, CABINET, SOFTWARE**

DISK DRIVES FOR IBM PC

Double Sided/Double Density 320KB **\$225**

HARD DISK FOR IBM PC

5MB **\$1399** 10MB **\$1599** 15MB **\$2199**

MEMORY BOARDS

AST MULTIFUNCTION **\$299**

AST I/O PLUS **\$199**

QUADRAM 256K MULTIFUNCTION... **\$399**

HERCULES CARD **\$499**

QCS BIG BLUE CARD..... **\$479**

HAYES

SMARTMODEM 300 BAUD **\$239**

SMARTMODEM 1200 BAUD **\$559**

MONITORS

PGS COLOR MONITOR HX-12 **\$499**

AMDEK, NEC MONITORS AVAILABLE . **CALL**

APPLE IIe STARTER SYSTEM **\$1599**

DISK DRIVE FOR APPLE II & IIe . . . **\$219**

PRINTERS

BROTHER HR-1 **\$750** HR-15..... **\$499**

OKIDATA 82A. **\$499** 83A **\$699**

84A **\$999** 93A **\$959**

GEMINI 10 ... **\$359** 15 **\$529**

NEC 3510 .. **\$1499** 3550 **\$1899**

7710 **\$2075**

EPSON RX80 . **\$379** FX80 **\$599**

MX80 **\$449** MX100 **\$649**

HAYES SMARTMODEM 300 BAUD ... \$239

HAYES SMARTMODEM 1200 BAUD .. \$559

VISICALC ... **\$199** MULTIPLAN .. **\$199**

LOTUS 1-2-3.. **\$359** WORDSTAR .. **\$329**

SUPER CALC II **\$199** MAILMERGE.. **\$179**

WORD PERFECT **\$349** EASY WRITER **\$129**

TAVA PC

Desk Top, IBM PC Compatible Computer, Runs

DOS 1.1, 2.0, CP/M86 **\$1025**

COMPUTER POST INC.

22102 CLARENDON ST. STE. #1

WOODLAND HILLS, CA 91367

(213) 999-1041

CALL FOR FREE PRICE SHEET.

PRICES SUBJECT TO CHAGE WITHOUT NOTICE.

SHIPPING AND HANDLING EXTRA

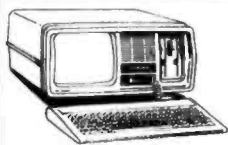

CORONA \$2395

- 2 Dr. 320K ea.
- 128K RAM
- software

Your choice of **DESKTOP** or **PORTABLE**

- NEC 8201A note book computer \$677
- IBM-PC 64K, 2 Drs, color graphics ... \$2499
- COLUMBIA 2 Drs, Kybd, software ... \$2495
- EAGLE-PC 2 Drs, Mon, 128K, software \$2495
- SANYO-550 IBM Compatible, 128K ... \$899
- FRANKLIN Ace 1200 OMS package ... \$1699
- FRANKLIN Ace 1000 Pro package ... \$1199
- SIGMA DESG 10MB expsn chassis ... \$1799
- DATAMAC 10 MB Internal (IBM-PC) ... \$1499
- EPSON FX-100 the best of Epson ... \$739
- Delta 10 better than FX-80 call
- DYNAX DX-15 letter quality, 16 cps ... \$429
- SILVER REED EXP-550 20 cps, 16" wide \$599
- OKI 92 160 cps DP, 40 cps correspondn \$475
- OKI 84 200 cps DP, 50 cps correspondn \$948

—Call for other items not listed—

MICROLAND

Add 3% for MC/VISA
COD 15% deposit
(ship same day order)

5223 Beechnut
Houston, TX 77096
(713) 668-4695

Circle 317 on inquiry card.

AFFORDABLE & RELIABLE

EPROM PROGRAMMERS & UV ERASERS

See our ad on Page 14

LOGICAL DEVICES, INC

Circle 266 on inquiry card.

CHIPS & DALE

THE INFLATION FIGHTERS!

4116	200ns	8/812.00	
4116	150ns	8/813.75	
2114L	300ns	8/812.00	
2114L	200ns	8/813.00	
4164	200ns	\$5.50 each	
4164	150ns	\$5.95 each	
6116	150ns	\$5.20 each	
6116	200ns	\$4.85 each	
6116LP	150ns	\$5.85 each	
1791	Disk Controller	\$20.00 each	
1771	Disk Controller	\$16.75 each	
Z80A-Z80ACTC		\$3.50 each	
Z80A P10		\$4.00 each	
8251A		\$4.00 each	
8255		\$4.25 each	
2716-1	5V 350ns	8/84.25	\$5.00 each
2716	5V 450ns		\$3.35 each
2732	5V 450ns		\$3.85 each
2532	5V 450ns	8/84.25	\$5.00 each
2764	5V 300ns 28 pin		\$5.95 each
2564	5V		CALL
8087			CALL
68000			CALL

Allow up to 3 wks. for personal checks to clear. Please include phone number. Prices subject to change without notice. Shipping & Handling for Chips \$3.50, FOB Bellevue, WA, for all else. Washington state residents add 7.9% Sales Tax.

CHIPS & DALE 1-206-451-9770
10655 N.E. 4th St., Suite 400
Bellevue, WA 98004

Circle 67 on inquiry card.

FREE

We will meet any legitimate advertised price in this issue of BYTE on any computer, terminal or printer we stock and ship it free (48 states) via UPS. Closeouts and items not stocked are excluded.

Call, or, you may order by including the other ad, or its page no., and your certified check or money order. Insurance, if you wish it, is 50¢ per \$100 extra.

All items factory sealed & warranted. Sorry no credit cards, personal or company checks. 10% deposit on CODs.

CIRCLE READER SERVICE CARD FOR DISCOUNT BULLETIN



H. L. WHITAKER Co.
7603 Firestone Bl.
Downey, CA 90241
(213) 566-3556

Authorized dealer: Columbia, Diablo, Eagle, ITOH, Morrow, NEC, North Star, Qume, Seiko, Silver-Reed, Teletideo and other major brands.

Circle 92 on inquiry card.

ONE KEY WORD PROCESSING on your **TELEVIDEO™** with **WORDSTAR™** and . . .

OVER
\$60 SOLD!



\$99.95

Mastercard
Visa

- Nu Key™ Automates the 36 most commonly used word processing functions
- Reduces learning time while increasing operator speed
- For beginners and Wordstar experts
- Comes complete with 14 new matching keycaps

For your TELEVIDEO™ 880, T5-800, T5-800A, and T5 802
PLEASE SEND WORDSTAR SERIAL NUMBER TO:

Business Solutions, Inc.
91 W. Long Lake Rd., Suite 9
Bloomfield Hills, MI 48013
(313) 540-3360

COMPANY OF DIGITAL RESEARCH: TELEVIDEO & TELESOLUTIONS™
OF TELEVIDEO: WORDSTAR™ OF MICROPRO INTERNATIONAL
NUKEY & KWIC KEY™ OF BUSINESS SOLUTIONS, INC.

Circle 54 on inquiry card.

COMPUTER SUPPLIES FOR ALL MAKES & MODELS

DISKETTES

5 1/4" S/S S/D \$1.80
MIN. ORDER 50

RIBBONS

NEC 3500 \$6.44
(NON-FLIP CARTRIDGE)

EPSON \$4.64
MX70/MX80

EPSON \$7.84
MX100
MIN. ORDER 6

LABELS • CONTINUOUS FORMS

CALL TOLL FREE 1-800-248-2418

IN N.Y. STATE (212) 967-1700

TERMS—VISA, MC OR COD

DEALER INQUIRIES INVITED

WORLDWIDE COMPUTER SUPPLIES
159 MAIN ST., S.I., N.Y. 10307

Circle 460 on inquiry card.

LSI C COMPILER for 8080/8085/Z80

New version of the compiler is
available now!

The object code is **COMPACT**
and is **FASTEST** in current C compilers.

Our "Sieve" program runs in
8.0 seconds (standard)

and 6.2 seconds (optimized)

(See January 1983 BYTE, pp 283-326)

price: \$500 (FOB Japan)

for pamphlet write:
P.O. Box 508 STA. CRUZ
CA. USA 95062

for further information contact:

LSI JAPAN CO., LTD.

2-24-9 YOYOGI SHIBUYA-KU TOKYO (151) JAPAN
PHONE (03) 379-2427

Circle 270 on inquiry card.

CompuPro

Lowest prices on CompuPro boards
CALL FOR QUOTE

CUSTOM SOLUTIONS
are our specialty.

**BUSINESS & PROFESSIONAL
Hardware & Software Experts**

★ NOW AVAILABLE ★
COMPUPRO-10 Multi-User 8/16 System
Mention this ad for a 10% DISCOUNT
off any system

ONETCO
OFFICE NETWORKS CORPORATION

(703) 690-3312

14057 Jeff. Davis Hwy.
Woodbridge, VA 22191

FULL SERVICE SYSTEM CENTER

Circle 324 on inquiry card.

Maxell Floppy Disks

The Mini-Disks
with maximum quality.



Dealer inquiries
invited. C.O.D.'s
accepted. Call
FREE (800) 235-4137.



PACIFIC EXCHANGES
100 Foothill Blvd., San Luis
San Luis Obispo, CA 93401.
In Cal call (800) 592-5935 or
(805) 543-1037.

Circle 334 on inquiry card.

KENSINGTON MICROWARE



SYSTEM SAVER

- Surge Suppression
- Dual Outlet
- U.L. Listed
- Fits Apple Stand

\$65

QUADRAM

APIC (APPLE III PARALLEL)	129.99
IPIC (IBM PARALLEL)	89.99
ERAM 80 column 64K II-E	SCALL
MICROFAZER	SCALL
QUADBOARD I or II (64K)	279.99
QUADCOLOR I	234.99
QUADCOLOR II	209.99
QUAD 512+ (64K)	249.99
QUADCHROME MONITOR	499.99

**QUADLINK
479.99**

MICROSOFT

A.L.D.S.	75.99
APPLESOFT COMPILER	116.99
BASIC COMPILER	259.99
COBOL COMPILER	559.99
DECATHLON (APPLE)	22.99
FLIGHT SIMULATOR (IBM)	34.99
MOUSE (IBM)	129.99
MULTITOOL BUDGET	109.99
SOFTCARD II+	215.99
SOFTCARD PREMIUM (Ile)	359.99
TYPING TUTOR II	18.99
64K IBM SYSTEMCARD	295.99

**MULTIPLAN
165.99**

als

CP/M 3.0

279.99

Dispatcher 99.99

SMARTTERM II, or
Z-CARD II

129.99

DTC

380 Z
LETTER QUALITY
DAISY WHEEL PRINTER

- 48K Buffer **999.99**
- 32 CPS
- Graphics
- 10, 12, 15 Pitch
- Proportional spacing

Sheet Feeder	599.99
Tractors	129.99
Cable (Please Specify)	49.99

SPINNAKER

DELTA DRAWING	32.99
FACEMAKER	21.99
HEY DIDDLE DIDDLE	19.99
KINDERCOMP	19.99
MOST AMAZING THING	26.99
RHYMES AND RIDDLES	19.99
SNOOPER TROOPS I	27.99
SNOOPER TROOPS 2	27.99
STORY MACHINE	21.99

XMAS SPECIAL
1 of each **214.99**

APPLE SOFTWARE

BPI (GLAP, AR, PAY, INV)	299.99
BRODERBUND Arcade Machine	44.99
Bank Street Writer	52.99
David's Midnite Magic	26.99
Loderunner	26.99
CENTRAL POINT Copy II+	25.99
CORVUS	SCALL
OATAMOST Aztec	29.99
Swashbuckler	26.99
Kids & APPLE. VIC. COMM ea	14.99
DATASOFT Canyon Climber	17.99
Zaxxon	29.99
DLM Alien Addition	Sch-37.99, H-27.99
Alligator Mix	Sch-37.99, H-27.99
Demoition Division	Sch-37.99, H-27.99
Dragon Mix	Sch-37.99, H-27.99
Meteor Multiplication	Sch-37.99, H-27.99
Minus Mission	Sch-37.99, H-27.99
Spelling Wiz or Verb Viper	37.99
Word Invasion or Word Man	37.99
Word Master or Word Radar	37.99
EDUFIN Friendly Flip Flip	23.99
EPYX Crush Crumble Chomp	22.99
GRAPH 'n CALC	149.99
HAYDEN Piewriter	129.99
Sargon II	26.99
INCREDIBLE JACK	129.99
JDR-AND Secret Agent	21.99
KENSINGTON Formatt II	26.99
LAS Crossword Magic	39.99
LEARNING CO Bumble Games	29.99
Bumble Plot	29.99
Gertrudes Puzzle	32.99
Gertrudes Secret	32.99
Juggles Rainbow	22.99
Magic Spell	26.99
Mountain Parade	26.99
Rockey's Boots	37.99
LIGHTNING Mastertype	29.99
MICROLAB Highrise	22.99
Miner 20-49er	29.99
Death in the Caribbean	26.99
Data Factory	229.99
ODESTA CHESS	53.99
Checkers	37.99
Odin	37.99
PEACHTREE	SCALL
PENGIN Graphics Magician	44.99
SIERRA ON LINE Frogger	24.99
Screenwriter II	89.99
Screenwriter PRO	149.99
Ultima II	44.99
Camionball Blitz	26.99
General Manager	169.99
Dark Crystal	29.99
SOFTWARE DIMENSIONS ACCT-II	SCALL
STATE OF THE ART	SCALL
SUBLOGIC Pinball	26.99
ULTRASOFT Serpents Star	29.99
Mick of the Sun	29.99
VISICORP	SCALL

APPLE HARDWARE

CDP 16K RAM CARD	39.99
Printer Card & Cable	39.99
Fan w/surge, 2 Outlets	39.99
DAN PAYMAR Lower Case I (rev 1-6)	25.99
Lower Case 2 (rev 7)	19.99
DARK STAR Snapshot II	99.99
EASTSIDE Wildcard	119.99
FOURTH DIMENSION Drive	219.99
HAYES Micromodem II	254.99
HDME Repeat Key	19.99
KOALA PAD	89.99
KRAFT Joystick	44.99
KRAFT Paddles	31.99
LEGENO 128K Ram	359.99
MICRO-SCI Drive	219.99
MOUNTAIN CPS Card	159.99
Rampus+ 32K	159.99
NOVATION Appecat II	269.99
Appecat Upgrade 1200 Baud	309.99
DRANGE MICRO Grappier+	119.99
Bufferboard	119.99
Buffered Grappier+	179.99
PAADLE ADAPPLE	24.99
SATURN 128K Ram	379.99
Accelerator II	444.99
Neptune 64K	199.99

ACCESSORIES

3 Ring Disk Sheets (10)	7.99
Printer Stand Small	24.99
Printer Stand Large	29.99
Fingerprint (FOR EPS0N)	44.99
64 KCHIPS (9x4 164-200ns)	79.99
16K CHIPS (8x4 116-200ns)	9.99
LIBRARY CASE	1.99
Flip 'n File (ORIGINAL)	17.99
Flip 'n File 25 Locktray	17.99
Flip 'n File 5D Locktray	27.99
Power Strip w/surge	17.99
HAYES 300 Baud Smartmodem	199.99
1200 Baud Smartmodem	474.99
NOVATION J CAT	104.99
NOVATION 103/121 AUTOCAT	429.99
NOVATION 103 SMARTCAT	169.99
NOVATION INFONE MAXI	869.99
NOVATION EXPANSION MOO	29.99
PAGEMATE BOOK HOLDER	17.99
RIBBONS-MX100 or FX 100	7.99
MX80, MX80/II, FX80, FX80/II	4.49
OKIATA OR GEMINI	2.99
BROTHER, DTC	1.99

IBM

1/2 Height DS/DD DRIVE	229.99
ALPHA Data Base MAR II	169.99
Apple-IBM Connection	129.99
Executive Package	115.99
Typefaces	79.99
ARMONK Executive Suite	27.99
ASHTON TATE dBase II	SCALL
Encyclopedia	59.99
Friday	SCALL
AST Boards	SCALL
BRODERBUND Apple Panic	21.99
Serpentine	26.99
CENTRAL POINT Copy II PC	25.99
OATAMOST Space Strike	21.99
Pig Pen	21.99
Real Estate Inv Prog	69.99
Write On	69.99
EDUWARE Algebra I	29.99
Prisoner II	29.99
EPYX Crush Crumble Chomp	22.99
Jabbertalky	22.99
Oh Barons	74.99
Star Warrior	22.99
Temple of Apsahai	29.99
Upper Reaches or Curse of Ra	14.99
GRAPH N CALC	149.99
HAYDEN Piewriter	129.99
HAYES 1200B Modem	439.99
KENSINGTON PC Saver	SCALL
KRAFT Paddles	34.99
LIFETREE Volkswriter	119.99
LIGHTNING Mastertype	36.99
LOTUS 1-2-3	SCALL
MICROLAB Highrise	22.99
Death in the Caribbean	25.99
Miner 20-49er	29.99
MOUNTAIN Hard disk	SCALL
NORTON Utilities	59.99
PC CRAWYON	49.99
PC TUTOR	47.99
PERFECT SOFTWARE	SCALL
POOL 1.5	27.99
PLANTRONICS ColorPlus	369.99
SIERRA ON-LINE Frogger	26.99
CrossFire, Lunar Leap, Mouskattakin	22.99
Golf Challenge	19.99
Ulysses & Golden Fleece	29.99
SIR-TECH Wizardry	44.99
SUBLOGIC Pinball	29.99
TMAKER	169.99
TG Joystick	44.99
TITAN 64K Board	499.99
VISICORP Visicalc or Visidex	164.99
VisiFile, Trend/Plot, Schedule ea	199.99
VisiLink	SCALL
Visi-ort	SCALL
VisiSpell	179.99
Visiword	269.99

SORCIM

**SUPERCALC
SUPER SPELLGUARD
119.99 ea.**

**SUPERWRITER
SUPERCALC 2
167.99 ea.**

APPLE, IBM & CP/M VERSIONS

Videx

APPLE WRITER PRE-BOOT	14.99
CHARACTER ROMS	24.99
ENHANCER II	99.99
FUNCTION STRIP	34.99
HARDSWITCH	16.99
MICROMODEM CHIP	24.99
PSIO	169.99
SOFTSWITCH	25.99
ULTRATERM	249.99
ULTRATERM PRE-BOOTS	SCALL
VIDEOTERM W/S/S + INV	219.99
VISICALC PRE-BOOT	39.99

VIDEOTERM 199.99

EDUWARE

ALGEBRA I, II, or III	27.99
COMPUMATH	34.99
COMPUREAD	21.99
COMPUSPELL	21.99
DECIMALS 3.0	33.99
FRACTIONS 3.0	33.99
PERCEPTION GAMES	19.99
PRISONER II	23.99
PSAT WORD ATTACK	33.99
RENDEZVOUS	27.99
SAT WORD ATTACK	33.99
SPELLING BEE GAMES	27.99
SPELLING/READING PRIMER	27.99
STATISTICS	21.99

INFOCOM

DEADLINE	32.99
PLANETFALL	ea
SUSPENDED WITNESS	
STARCROSS	
ZORK I	24.99
ZORK II	ea
ZORK III	ea

APPLE, IBM, & CP/M VERSIONS
CP/M VERSIONS \$5.00 MORE

MONITORS

PRINCETON RGB HX-12	489.99
DUADCHROME RGB HX-12	499.99
TAXAN RGB-I or III	SCALL
TAXAN 12" Green 18hm	119.99
USI PI 1 9" Green 20hm	116.99
USI PI 2 12" Green 20hm	119.99
USI PI 3 12" Amber 20hm	146.99
USI PI 4 9" Amber 20hm	136.99
USI 1400C Color Composite	288.99
OSBORNE Monitor Cable	SCALL
T1 Monitor Cable	SCALL
RCA 6" Male-Male	3.99
11e to Princeton card/cable	139.99
TAXAN 12" Amber 18hm	124.99

MicroPro

CALCSTAR	89.99
DATASTAR	179.99
MAILMERGE	139.99
REPORTSTAR	199.99
SPELLSTAR	139.99
STARINDEX	109.99
SPERSORT	139.99
WORDSTAR PRO	389.99

INFOSTAR \$CALL
WORDSTAR FOR
SPECIAL
PRICING

Continental

APPLE SOFTWARE 1983 BOOK	9.99
ATARI SOFTWARE 1983 BOOK	9.99
APPLE GRAPHICS BOOK	14.99
CPA (GL, AP, AR, PA) ea	149.99
FCM/FL 1st CLASS MAIL (AP)	61.99
FCM/FL 1st CLASS MAIL (IBM)	71.99
HOME ACCOUNTANT+ (IBM)	84.99
HOME ACC'T+ (KAYPRO, OSBORNE)	59.99
HOME ACCOUNTANT+ (TI PRO)	119.99
PROPERTY MANAGEMENT	299.99
TAX ADVANTAGE	39.99
ULTRAFIL (IBM)	SCALL
HOME ACCOUNTANT	
• Apple	44.99
• Atari	
• Commodore	

DISKETTES

DYSAN 5" SS/DD (10)	31.99
DYSAN 5" SS/DD (100)	299.99
MAXELL 5" SS/DD (10)	27.99
MAXELL 5" SS/DD (100)	259.99
MAXELL 5" DS/DD (10)	37.99
MAXELL 5" DS/DD (100)	359.99
VERBATIM 5" SS/DD (10)	24.99
VERBATIM 5" SS/DD (100)	229.99
VERBATIM 5" DS/DD (10)	36.99
VERBATIM 5" DS/DD (100)	349.99

Dysan

double-sided, double density
Box of 10 Case of 100
38.99 369.99

PRINTERS

C-10H PROWRITER	SCALL
EPSON (ALL MODELS)	SCALL
OKIATA 82A	384.99
OKIATA 83A	629.99
OKIATA 84P	969.99
OKIATA 92	489.99
OKIATA 93	859.99
STAR GEMINI 10X	SCALL
STAR GEMINI 15X	SCALL
STAR DELTA	SCALL
SMITH CDORONA TP2	499.99
TRANSTAR	SCALL

RIBBONS IN STOCK FOR MOST MODELS



COMPUTER DISCOUNT PRODUCTS

MAIL & PHONE ORDERS
860 S. Winchester Bl
San Jose, CA 95128
(408) 985-0400

860 S. Winchester Bl
San Jose, CA 95128
(408) 985-0401

1230 Market St.
San Francisco, CA 94102
(415) 626-2244

HOURS: MON-FRI 8AM-7PM SAT-SUN-HOL 10AM-5PM (S.F. STORE OPENS 10AM EVERY DAY)

- No Charge For Credit Cards
- Prices Subject To Change
- Software Sales Are Final
- Min. \$4.00 Shipping Charge
- Purchase Orders Call First



U.S. MICRO SALES

★ MADE IN USA ★ BUY FACTORY DIRECT ★

DISK DRIVE SPECIALS We've Lowered Our Prices



Offering A Complete Selection And THE LOWEST PRICES IN BYTE!

8" Shugart 801R SS/DD - The Industry Standard	\$355.00
8" Shugart 851R Double Sided 1.2 Meg - The Old Reliable	457.00
8" Qume Datalrak-8 DS/DD "THE BEST" of the floppys	479.00
8" Mitsubishi Full Height Double Sided 1 Year Parts + Labor	445.00
8" Mitsubishi Thinline DS/DD 1 Year P+L Direct Drive	465.00
8" Tandon 848-1 Slimline SS/DD 600K BYTES D.C. Motor	355.00
8" Tandon 848-2 Slimline Double Sided 1.2 Meg. D.C. Motor	475.00
8" Siemens 100-8 SS/DD ON SALE NOW!!! But How Long?	169.00
5 1/4" Mitsubishi Full height 96T.P.I. DS/DD 750K M4852	295.00
5 1/4" Mitsubishi Slimline 96T.P.I. DS/DD 750K M4853	315.00
5 1/4" Qume 142 Slimline DS/DD	375.00
5 1/4" Tandon TM-100-2 I.B.M. PC Add-on! DS/DD 48 T.P.I.	259.00
5 1/4" Tandon TM 100-4 DS/DD 96T.P.I. 750K	369.00

★ WINCHESTER HARD DISKS ★

-----CHRISTMAS SPECIAL-----

5 1/4" Miniscribe Hard Disk

*5 Meg \$589 *10 Meg \$749

8" Quantum 20" Megabyte Winchester - Two Platters	1895.00
8" Quantum 40" Meg Four Platter - Most Popular	2395.00
8" Quantum 85" Megabyte - Special Order on this Monster!	2895.00
8" IDMEGA 10- Meg* Removeable Disk Drive with SCSI Controlled Interface Board. Runs up to four drives	1895.00
8" IDMEGA 10 Meg* Cartridge Drive - No Control Interface	895.00
8" 10 Meg* Removeable Cartridge Media #M-2000-51	50.00

★LAST MINUTE SPECIAL!!! Buy any Winchester hard disk drive above and get a Western Digital hard disk interface board AT COST! ONLY 295.00!

*Total storage space after formatting.



California
Computer
Systems

YEAR END CHRISTMAS SALE SAVE \$61.00

New CCS2068 64K Dynamic Memory

• 65,536 bytes of Dynamic RAM • Z-80/8080, S-100 compatible • Port bank/16 levels of 64K = system memory of 1024K • Independently addressed in 16K blocks • 200ns access and data lines • Hysteresis drivers and receivers for high noise immunity and minimal bus loading effects. Part #B-5000-50 ONLY \$299.00

YEAR END SYSTEM SALE

- 2300A Mainframe
- 2066 64K Memory
- 2810 Z-80A CPU
- All AC/DC & Data Cables
- 2422 Disk Controller
- CP/M Operating System
- 2719 2-Port. RS-232 Serial
- 8-bit Parallel I/O

A powerful package at ONLY \$1495.00

CCS CALSTAR SYSTEM

Now available and with FREE SOFTWARE: • Perfect Writer • Perfect Calc • Perfect Speller and • Perfect Filer.

This powerful single box system includes: • Z-80 with 128K of RAM expandable to 256K • A networking interface • SASI hard disk interface to add-on a Winchester • CP/M 3.0 operating system • One parallel and two serial ports • Reads and writes the IBM 3740 format (compatible with XOR) AND • Two double-sided double-density 8" floppy drives for 2.4 Megabytes of formatted storage AND • Will run two or more 8" or 5 1/4" floppys. Part #S-1500-05

ON SALE NOW

Regular ~~\$3295.00~~ - Our Price Only \$2695.00

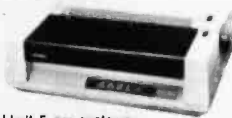

FOR XMAS ONLY \$450.00

Limit 5 per customer

XOR-500 DAISYWHEEL PRINTER

A letter-quality daisy-wheel printer at an unheard of wholesale price! This 20 cps workhorse features a daisy-wheel compatible with QUME's products. Full 132 column format with 256 character buffer, serial AND parallel interfacing (standard), 8 level automatic impression control - original and 3 copies. The \$450.00 price is not a misprint. High reliability and quality performance sums-up the XOR-500 Daisy-wheel Printer.

XOR-500 TERMINAL SLASHED! Cut another \$50 Only \$445.00



That's right! A 700.00 terminal for \$445.00, a special Christmas deal for our customers.

Features: ★Screen tilt ★Detached keyboard ★9 cursor control keys ★5 function keys ★7 screen attributes ★25th status line ★50-19.2 Kbaud ★Column plus field tab ★AND MORE
★All these features with a full 6 month warranty makes this terminal the best buy on the market.

CHRISTMAS SAVINGS!



\$395

HELD OVER

ON THE ORIGINAL S-100 MOD

For engineers, hobbyists, and anyone who wants to save a bundle, the S1-MOD is the answer. Full regulated power to run up to four floppy disks coupled with a mammoth S-100 power supply and 12 slot bus, makes the S1-MOD an exceptional computer base. Single board design means no wiring from the power supply to the motherboard. This eliminates all ground loop problems associated with other brands of mainframes who are forced to use termination. The S1-MOD is being offered this month with a matching S-100-12 cabinet. Fan cooled, fused, with reset and keylock the cabinet is also enamel painted and silk screened. Four A.C. outlets are provided for peripheral hookup and plenty of cutouts available for RS-232, centronics + others. Our regular \$225.00 price for the S1-MOD and 250.00 price for our 12 slot cabinet is being SLASHED!

SPECIFICATIONS:

Regulated Unregulated
+5V @ 5A +8V @ 30A
+24V @ 3A +16V @ 6A
-5V @ 1A -16V @ 6A

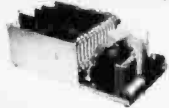

SAVE OVER \$100

Don't settle for those cheap 6 slot imitations you've seen elsewhere in this mag. OWN THE BEST! XOR S-1 MOD and S-100-12 Cabinet \$395.00!

DUAL DRIVE SUBSYSTEMS



HORIZONTAL OR VERTICAL

Fully Assembled and Tested Units

ONE YEAR P+L WARRANTY

On Shugart and Mitsubishi Subsystems

w/two Mitsubishi DS/DD Assem. + Tested 2.4 Meg	\$1170.00
w/two Shugart 801R SS/DD Assem. + Tested 1.2 Meg	975.00
w/two Shugart 851R DS/DD Assem. + Tested 2.4 Meg	1225.00
w/two Siemens 120-8 SS/DD Assem. + Tested 1.2 Meg	675.00
w/two Qume DT-8 DS/DD Assem. + Tested 2.4 Meg	1250.00
Cabinet Assem. & Tested w/Power Supply and Accs.	235.00
Cabinet Top and Bottom with Mounting Hardware	Only 69.50
All cabinets A & T and subsystems include all AC/DC wiring and 50 pin data cable except the horizontal model which includes the Internal 50 pin cable and requires an external 50 pin cable part #C-6000-01	\$ 25.00
5 1/4" Subsystems - Cabinet - Power Supply - Drives - Cables	
w/two 48TPI SS/DD includes all cables Assem. + Tested	495.00
w/two 48TPI DS/DD includes all cables Assem. + Tested	595.00
w/two 96TPI DS/DD includes all cables Assem. + Tested	695.00

CUSTOMER SERVICE HOTLINE 1 - (714) 898-5525

DO YOU
NEED AN

IBM-PC 16-BIT COMPUTER

TO PROCESS
YOUR DATA?

COMPLETE SYSTEM

ONLY

\$1795

Model XPC with
MS/DOS features:

★64K memory ★Green

CRT ★2 floppy drives for a

total of 750K storage ★Multi-

function keyboard (this is one part

of the system that's NOT like IBM's, it's better) ★Fully

expandable memory On-Board to 256K PLUS 5 expansion

slots (all IBM compatible) ★2 serial, one parallel port

★Optional EPROM to 32K ★Optional Hard Disk add-on

★Optional floppy add-on ★Optional 8087 math co-

processor ★All available through U.S. Micro Sales and

YES it's all fully IBM compatible ★MS/DOS standard,

CP/M-86 operating system available at only \$65.00

THE XPC

A New Model PC by XOR

So close to the IBM PC you'll have to look twice. Due to the thousands of requests we've been receiving by phone, mail and visitors, we've responded by getting XOR to design this fantastic 16-bit IBM duplicate. We're offering a ONE YEAR warranty (vs. 90 days). Need more information? Order the manual for \$5.00 (plus shipping). This low price includes drives, controllers, monitor, power supply, etc. About the keyboard... If you've ever seen or used the IBM PC keyboard, you'll understand why we HAD to come up with something better - and we did! As a matter of fact, for those of you who own an IBM PC - it's time to take a hammer to that keyboard and call Toll Free to pick-up one of our compatible replacement keyboards at only \$239.00

BASIC COMPUTER

ONLY

\$995

The Features:

★64K RAM memory

★Expandable to 256K

★Full monitor PROM

★IBM PC compatibility

★Multi-function key-

board and cable

★Runs MS/DOS and CP/M-86 (not included) ★Power

Supply +5V @ 10 Amp, +12V @ 6 Amp, -12V @ 1 Amp

★EPROM expandable on-board to 32K ★5 expansion slots

with room for 4 more

INCLUDES: ★8 level interrupt ★2 serial and one parallel

port ★3 timer channels ★4 DMA channels ★Reset port

★Speaker port ★and MORE!

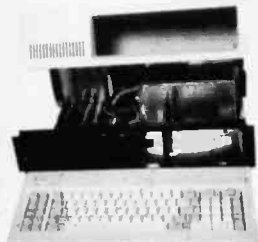



TWO Locations to Serve You

ORDER TOLL FREE

★ EAST ★

★ WEST ★

800-435-9357

800-854-8174

In Ill. (815) 485-4002

In Calif. (714) 898-1492

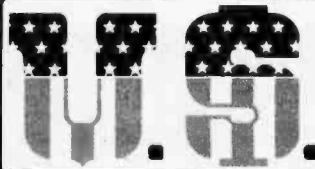

MICRO SALES

★ MADE IN USA ★ BUY FACTORY DIRECT ★

★ EAST ★ 11 Edison Drive, New Lenox, Illinois 60451

★ WEST ★ 15392 Assembly Lane, Huntington Beach, CA 92649

TERMS: We accept VISA/MC, prepay, check or money order. Please allow personal checks two weeks to clear before shipment. 15.00 handling charge on all orders under \$50.00, 15% restocking fee. All orders shipped via UPS unless otherwise specified. All UPS C.O.D. orders over \$100.00 require a Cashiers Check. Our products carry a full ONE YEAR Parts and Labor Warranty excluding drives, printers and terminals which carry the full OEM factory warranty. PRICES SUBJECT TO CHANGE WITHOUT NOTICE.

CUSTOM COMPUTER SYSTEMS by XOR

Why do companies like I.B.M. Corp., Atari Corp., Mattel Elec., Kennedy Space Center, Edwards A.F.B., Motorola Corp., Raytheon, and Pacific Technology buy product by mail from us? Maybe it's our full 1 year parts and labor warranty on all XOR O.E.M. products. It could be our state of the art technology, or even the factory direct sales and service. We think it's our custom computer systems with over 1000 possible configurations. If you don't see it advertised, call us today, chances are we CAN custom build the system YOU need.

★ MICRO MANAGERS: POWERFUL, PORTABLE, AND AFFORDABLE ★



Don't be fooled by the system's small portable size. A full 64K of memory with an industry standard S-100 bus. Includes CP/M 2.2 and many utilities on two disks. Add on a hard disk when you need more storage. The software and hardware that comes with each 5 1/4" system, is ready to run a pair of 8" single or double sided floppies. Just plug in the 50 pin data cable to the system - many other configurations are available.

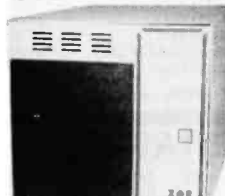

Inexpensive but powerful, small enough for portability, these mini hard disk systems have a special XOR interface to the S-100 bus that leaves an S-100 slot open for expandability. Choose from 5, 10, and 16 megabyte sizes (6.5, 12, + 20 megabyte unformatted.) Includes CP/M operating system. One year parts and labor warranty. Includes software and controller for 8" floppies.

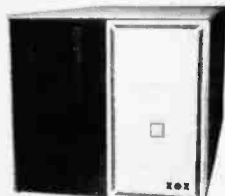

Our most popular computer features a 4 slot S-100 bus and 8" industry standard format. Reads and writes the IBM 3740 format as well as any byte size sector. Expandable? Yes, add a hard disk or cartridge subsystem when your data base grows. You've probably seen some "look-a-like" S-100 4-slot systems lately, but they just don't measure up the XOR 8" Micro Manager

5 1/4" Z-80A 64K CP/M System

- ★ Dual Floppy 375K SS/DD 40 Track #S-1000-86 \$1445.00
- ★ Dual Floppy 750K DS/DD 40 Track #S-1000-87 \$1595.00
- ★ Dual Floppy 1.5 Meg DS/DD 80 Track #S-1000-88 \$1645.00
- ★ System Chassis (No boards, drives, CP/M) #S-1000-84 \$ 425.00

5 1/4" Hard Disk with 1/2 Height Floppies

- ★ 5 Meg Hard Disk w/375 Floppy #S-1000-81 \$2195.00
- ★ 5 Meg Hard Disk w/750K Floppy #S-1000-90 \$2345.00
- ★ 10 Meg Hard Disk w/2 1.5M Floppy #S-1000-92 \$2795.00
- ★ 16 Meg Hard Disk w/2 1.5M Floppy #S-1000-93 \$2895.00

2.4 Meg DS/DD 8" CP/M System

- ★ System w/Dual SS/DD 1.2 Meg #S-1000-40 \$1795.00
- ★ System w/Dual DS/DD 2.4 Meg #S-1000-39 \$1995.00
- ★ System w/NO Drives (Includes CP/M) #S-1000-71 \$1195.00
- ★ System Chassis (No boards, drives, CP/M) #S-1000-70 \$ 395.00

★ THE BASIC PROFESSIONAL FLOPPY, HARD DISK AND TAPE BACKUP ★



2.4 Meg DS/DD 64K Z-80A CP/M System

This "Industry Standard" computer features a 12 slot motherboard, 30 amp power supply, 2 serial RS-232 ports, centronics parallel port and CP/M software. The XOR disk controller included, will read and write the I.B.M. 3740 format (8" CP/M standard) as well as R/W single on double sided, single or double density, and any byte/size sector. One year parts and labor on the complete system. #S-1000-36 \$2345.00

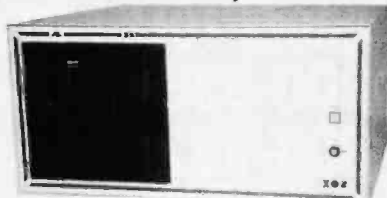

20 Meg Winchester w/2.4 Meg Floppies

For the serious professional this system features the famous S-100-12 cabinet with XOR's S1-M00 12-slot motherboard. The Quantum hard disk has two 10 Meg platters (A and B). One platter can be "backed-up" on another. 2/DS/DD 1.2 floppies are used for software entry, copies, and back-up. One year parts and labor. #S-1000-63 \$5275.00

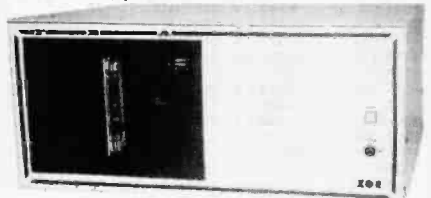

20M H.D. with 17M Tape and 1.2M Floppy

Backup your priceless data on this full 17 megabyte tape drive and be able to pip files between any of the three peripherals for total versatility. Bot CP/M from hard disk or floppy, change tapes for archival storage. Reads and writes the IBM 3740 Format (8" CP/M standard). #S-1000-69 \$6390.00
Above system 40 megabyte hard disk #S-1000-82 \$7240.00

A word on Special Orders and Configuring the System you need:

We've built and shipped hundreds of Custom Computers that we have never advertised but, have been able to build to the customer specifications. Examples: A 10 port hard disk system set-up to poll micro-wave devices; a Micro Manager interfaced to an X-Ray machine; a 7-User system with six of the users at satellite stations via phone line modem communication throughout the United States. So whatever configuration you need; 4 floppies, 4 hard disks, 10 serial ports, etc., call us Toll Free and talk to our Engineering Sales Crew and let us quote a price and delivery date that will satisfy your needs.

★ THE OFFICE MASTERS! REMOVABLE CARTRIDGE DISK SYSTEMS ★

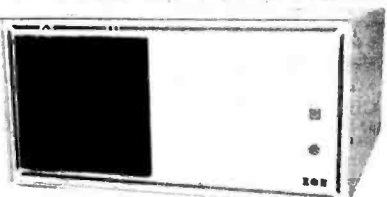

10 Meg Cartridge Disk And 1.2 Meg Floppy

An office system at an almost unbelievable price when you consider the bundle of applications software that comes with the system. Ten megabytes of formatted storage on a removable cartridge disk allows unlimited storage space with extra 10 Meg cartridges available at \$50.00 each. With the speed and reliability of a hard disk and removability of a floppy this office master is the choice. #S-1000-74 \$3695.00

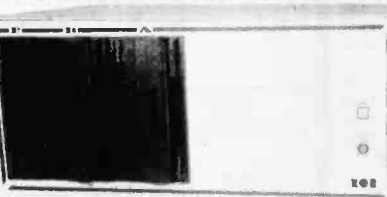

TWO 10 Meg Removable and DS/DD Floppy

Designed to be our #1 seller and no one else makes anything like it. A true state-of-the-art system with virtually no-limit to storage capacities in 10 Meg removable cartridges. Backup problems? Get high speed backup from cartridge to cartridge, ten megabytes worth, in 6 minutes! HINT: We don't use "PIP." Future technology here today. #S-100-76 \$4595.00

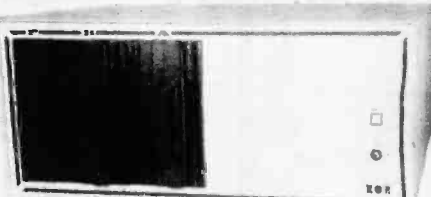

4 User Cartridge Disk System

Four users and two 10 megabyte removable cartridge disks may be just what you want to automate your office or small business, with all the software packages you'll ever need. A multi-user version of the system at left, these users can be up to 100 feet away from each other. Most any terminal will work with the user ports. #S-1000-80 \$5825.00

★ THE BUSINESS PROFESSIONALS: HARD DISK MULTI-USER SYSTEMS ★



2 User Hard Disk System

A twenty meg hard disk (2 platter) with a DS/DD 1.2 Meg floppy disk makes this a perfect system for a small business. Two user allows dual access to the system files with each station up to 100 feet apart! Includes above software. Full one year parts and labor. #S-1000-61 \$5495.00

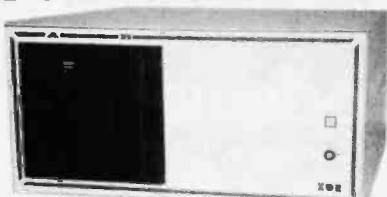

40 Meg Hard Disk 4 User System

A must for a growing business! Two DS/DD floppies (2.4 Meg) for data backup and copy with a 4 platter 40 Meg hard disk four user capability to automate the whole front office. You can even designate a 10 Meg platter to each user! Same warranty as all our products - (configurable from 2 to 7 users) #S-1000-60 \$7295

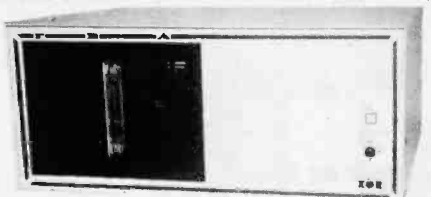

7 User 85 Meg w/17 Meg Backup

Now it's available, the automated business system to run even those large companies! 7 separate users tied into one professional host system. If 85 Meg isn't enough, we can put together as much as three hundred and forty megabytes! Full 17 Meg tape backup insures archival storage of valuable data #S-1000-98 \$9595.00

Circle 441 on inquiry card.

4164

64K DYNAMIC
200 NS

\$595

TMM2016

2KX8 STATIC
200 NS

\$415

STATIC RAMS

2101	256 x 4 (450ns)	1.95
5101	256 x 4 (450ns) (cmos)	3.95
2102-1	1024 x 1 (450ns)	.89
2102L-4	1024 x 1 (450ns) (LP)	.99
2102L-2	1024 x 1 (250ns) (LP)	1.49
2111	256 x 4 (450ns)	2.49
2112	256 x 4 (450ns)	2.99
2114	1024 x 4 (450ns)	8/9.95
2114-25	1024 x 4 (250ns)	8/10.95
2114L-4	1024 x 4 (450ns) (LP)	8/12.95
2114L-3	1024 x 4 (300ns) (LP)	8/13.45
2114L-2	1024 x 4 (200ns) (LP)	8/13.95
TC5514	1024 x 4 (650ns) (cmos)	2.49
TC5516	2048 x 8 (250ns) (cmos)	9.95
2147	4096 x 1 (55ns)	4.95
TMS4044-4	4096 x 1 (450ns)	3.49
TMS4044-3	4096 x 1 (300ns)	3.99
TMS4044-2	4096 x 1 (200ns)	4.49
MK4118	1024 x 8 (250ns)	9.95
TMM2016-200	2048 x 8 (200ns)	4.15
TMM2016-150	2048 x 8 (150ns)	4.95
TMM2016-100	2048 x 8 (100ns)	6.15
HM6116-4	2048 x 8 (200ns) (cmos)	4.75
HM6116-3	2048 x 8 (150ns) (cmos)	4.95
HM6116-2	2048 x 8 (120ns) (cmos)	8.95
HM6116LP-4	2048 x 8 (200ns) (cmos)(LP)	5.95
HM6116LP-3	2048 x 8 (150ns) (cmos)(LP)	6.95
HM6116LP-2	2048 x 8 (120ns) (cmos)(LP)	10.95
Z-6132	4096 x 8 (300ns) (Qstat)	34.95
HM6264	8192 x 8 (150ns) (cmos)	49.95

LP = Low Power Qstat = Quasi-Static

EPROMS

1702	256 x 8 (1us)	4.50
2708	1024 x 8 (450ns)	3.95
2758	1024 x 8 (450ns) (5v)	5.95
2716	2048 x 8 (450ns) (5v)	3.95
2716-1	2048 x 8 (350ns) (5v)	5.95
TMS2516	2048 x 8 (450ns) (5v)	5.50
TMS2716	2048 x 8 (450ns)	7.95
TMS2532	4096 x 8 (450ns) (5v)	5.95
2732	4096 x 8 (450ns) (5v)	4.95
2732-250	4096 x 8 (250ns) (5v)	8.95
2732-200	4096 x 8 (200ns) (5v)	11.95
2732A-4	4096 x 8 (450ns) (5v) (21vPGM)	6.95
2732A	4096 x 8 (250ns) (5v) (21vPGM)	9.95
2732A-2	4096 x 8 (200ns) (5v) (21vPGM)	13.95
2764	8192 x 8 (450ns) (5v)	9.95
2764-250	8192 x 8 (250ns) (5v)	14.95
2764-200	8192 x 8 (200ns) (5v)	24.95
MCS2564	8192 x 8 (450ns) (5v)	17.95
MC68764	8192 x 8 (450ns) (5v) (24 pin)	39.95
27128	16384x8 (300ns) (5v)	29.95

5v = Single 5 Volt Supply 21vPGM = Program at 21 Volts

CRYSTALS

32.768 khz	1.95
1.0 mhz	4.95
1.8432	4.95
2.0	3.95
2.097152	3.95
2.4576	3.95
3.2768	3.95
3.579545	3.95
4.0	3.95
5.0	3.95
5.0688	3.95
5.185	3.95
5.7143	3.95
6.0	3.95
6.144	3.95
6.5536	3.95
8.0	3.95
10.0	3.95
10.738635	3.95
14.31818	3.95
15.0	3.95
16.0	3.95
17.430	3.95
18.0	3.95
18.432	3.95
20.0	3.95
22.1184	3.95
32.0	3.95

74LS00

74LS00	.24	74LS173	.69
74LS01	.25	74LS174	.55
74LS02	.25	74LS175	.55
74LS03	.25	74LS181	2.15
74LS04	.24	74LS189	8.95
74LS05	.25	74LS190	.89
74LS08	.28	74LS191	.89
74LS09	.29	74LS192	.79
74LS10	.25	74LS193	.79
74LS11	.35	74LS194	.89
74LS12	.35	74LS195	.69
74LS13	.45	74LS196	.79
74LS14	.59	74LS197	.79
74LS15	.35	74LS241	.89
74LS20	.25	74LS240	.95
74LS21	.29	74LS249	.99
74LS22	.25	74LS242	.99
74LS26	.29	74LS243	.99
74LS27	.29	74LS244	1.29
74LS28	.35	74LS245	1.49
74LS30	.25	74LS247	.75
74LS32	.29	74LS248	.99
74LS33	.55	74LS249	.99
74LS37	.35	74LS251	.59
74LS38	.35	74LS253	.59
74LS40	.25	74LS257	.59
74LS42	.49	74LS258	.59
74LS47	.75	74LS259	.75
74LS48	.75	74LS260	.59
74LS49	.75	74LS266	.55
74LS51	.25	74LS273	1.49
74LS54	.29	74LS275	3.35
74LS55	.29	74LS279	.49
74LS63	1.25	74LS280	1.98
74LS73	.39	74LS283	.89
74LS74	.35	74LS290	.89
74LS75	.39	74LS293	.89
74LS76	.39	74LS295	.99
74LS78	.49	74LS298	.89
74LS83	.60	74LS299	1.75
74LS85	.69	74LS323	3.50
74LS86	.39	74LS324	1.75
74LS90	.55	74LS352	1.29
74LS91	.89	74LS353	1.29
74LS92	.55	74LS363	1.35
74LS93	.55	74LS364	1.95
74LS95	.75	74LS365	.49
74LS96	.89	74LS366	.49
74LS107	.39	74LS367	.45
74LS109	.39	74LS368	.45
74LS112	.39	74LS373	1.39
74LS113	.39	74LS374	1.39
74LS114	.39	74LS375	.95
74LS122	.45	74LS377	1.39
74LS123	.79	74LS378	1.18
74LS124	2.90	74LS379	1.35
74LS125	.48	74LS385	3.90
74LS126	.49	74LS388	.45
74LS132	.59	74LS390	1.19
74LS133	.59	74LS393	1.19
74LS136	.39	74LS395	1.19
74LS137	.99	74LS399	1.49
74LS138	.55	74LS424	2.95
74LS139	.55	74LS447	.95
74LS145	1.20	74LS490	1.95
74LS147	2.49	74LS624	3.99
74LS148	1.35	74LS640	2.20
74LS151	.55	74LS645	2.20
74LS153	.55	74LS668	1.69
74LS154	1.90	74LS669	1.89
74LS155	.69	74LS870	1.49
74LS156	.89	74LS674	14.95
74LS157	.65	74LS682	3.20
74LS158	.59	74LS683	3.20
74LS160	.89	74LS684	3.20
74LS161	.65	74LS685	3.20
74LS162	.69	74LS688	2.40
74LS163	.65	74LS689	3.20
74LS164	.69	81LS95	1.49
74LS165	.95	81LS96	1.49
74LS166	1.95	81LS97	1.49
74LS168	1.75	81LS98	1.49
74LS169	1.75	25LS2521	2.80
74LS170	1.49	25LS2569	4.25

EPROM ERASERS

	Timer	Capacity Chip	Intensity (uW/Cm ²)	
PE-14		9	8,000	83.00
PE-14T	X	9	8,000	119.00
PE-24T	X	12	9,600	175.00
PL-265T	X	30	9,600	255.00
PR-125T	X	25	17,000	349.00
PR-320T	X	42	17,000	595.00

UARTS

AY3-1014	6.95
AY5-1013	3.95
AY3-1015	6.95
PT1472	9.95
TR1602	3.95
2350	9.95
2651	8.95
IM6402	7.95
IM6403	8.95
INS8250	10.95

GENERATORS

BIT-RATE

MC14411	11.95
BR1941	11.95
4702	12.95
COM5016	16.95
COM8118	10.95
MM5307	10.95
74LS109	.39
74LS112	.39
74LS113	.39
74LS114	.39
74LS122	.45
74LS123	.79
74LS124	2.90
74LS125	.48
74LS126	.49
74LS132	.59
74LS133	.59
74LS136	.39
74LS137	.99
74LS138	.55
74LS139	.55
74LS145	1.20
74LS147	2.49
74LS148	1.35
74LS151	.55
74LS153	.55
74LS154	1.90
74LS155	.69
74LS156	.89
74LS157	.65
74LS158	.59
74LS160	.89
74LS161	.65
74LS162	.69
74LS163	.65
74LS164	.69
74LS165	.95
74LS166	1.95
74LS168	1.75
74LS169	1.75
74LS170	1.49

MISC.

UPD7201	29.95
UMS99532	29.95
TLN2003	2.49
3242	7.95
3341	4.95
MC3470	4.95
MC3480	9.00
11C90	13.95
95H90	7.95
2513-001 UP	9.95
2513-002 LOW	9.95

CLOCK CIRCUITS

MM5314	4.95
MM5369	3.95
MM5375	4.95
MM58167	12.95
MM58174	11.95
MSM5832	3.95

KEYBOARD CHIPS

AY5-2376	11.95
AY5-3600	11.95
AY5-3600 PRO	11.95

DYNAMIC RAMS

TMS4027	4096 x 1 (250ns)	1.99
UPD411	4096 x 1 (300ns)	3.00
MM5280	4096 x 1 (300ns)	3.00
MK4108	8192 x 1 (200ns)	1.95
MM5298	8192 x 1 (250ns)	1.85
4118-300	16384 x 1 (300ns)	8/11.75
4118-250	16384 x 1 (250ns)	8/11.95
4118-200	16384 x 1 (200ns)	8/12.95
4118-150	16384 x 1 (150ns)	8/14.95
4118-120	16384 x 1 (120ns)	8/29.95
2118	16384 x 1 (150ns) (5v)	4.95
MK4332	32768 x 1 (200ns)	9.95
4164-200	65536 x 1 (200ns) (5v)	5.95
4164-150	65536 x 1 (150ns) (5v)	6.95
MCM8665	65536 x 1 (200ns) (5v)	8.95
TMS4184-15	65536 x 1 (150ns) (5v)	8.95

5V = single 5 volt supply

ORDER TOLL FREE

800-538-5000

800-662-6279

(CALIFORNIA RESIDENTS)

6800

68000	59.95
6800	3.95
6802	7.95
6803	19.95
6808	13.90
6809E	19.95
6809	11.95
6810	2.95
6820	4.35
6821	3.25
6828	14.95
6840	12.95
6843	34.95
6844	25.95
6845	14.95
6847	11.95
6850	3.25
6852	5.75
6860	9.95
6875	6.95
6880	2.25
6883	22.95
68047	24.95
68488	19.95

6800 = 1MHZ

68B00	10.95
68B02	22.25
68B09E	29.95
68B09	29.95
68B10	6.95
68B21	6.95
68B40	19.95
68B45	19.95
68B50	5.95

68B00 = 2 MHZ

8200

8202	24.95
8203	39.95
8205	3.50
8212	1.80
8214	3.85
8216	1.75
8224	2.25
8226	1.80
8228	3.49
8237	19.95
8237-5	21.95
8238	4.49
8243	4.45
8250	10.95
8251	4.49
8253	6.95
8253-5	7.95
8255	4.49
8255-5	5.25
8257	7.95
8257-5	8.95
8259	6.90
8259-5	7.50
8271	79.95
8272	39.95
8275	29.95
8279	8.95
8279-5	10.00
8282	6.50
8283	6.50
8284	5.50
8286	6.50
8287	6.50
82	

2114 450 NS 8/\$995

2114 250 NS 8/\$1095

CMOS

Table of CMOS components with columns for part numbers and prices.

• Computer managed inventory — virtually no back orders!
• Very competitive prices!
• Friendly staff!
• Fast service — most orders shipped within 24 hours!

RCA

Table of RCA components with columns for part numbers and prices.

TI

Table of TI components with columns for part numbers and prices.

BI FET

Table of BI FET components with columns for part numbers and prices.

LINEAR

Table of LINEAR components with columns for part numbers and prices.

VOLTAGE REGULATORS

Table of VOLTAGE REGULATORS components with columns for part numbers and prices.

74S00

Table of 74S00 components with columns for part numbers and prices.



DATA ACQUISITION

Table of DATA ACQUISITION components with columns for part numbers and prices.

C, T = TO-220 K = TO-3
L = TO-92

INTERSIL

Table of INTERSIL components with columns for part numbers and prices.

EXAR

Table of EXAR components with columns for part numbers and prices.

INTERFACE

Table of INTERFACE components with columns for part numbers and prices.

CONNECTORS

Table of CONNECTORS components with columns for part numbers and prices.

7400

Table of 7400 components with columns for part numbers and prices.

9000 SERIES

Table of 9000 SERIES components with columns for part numbers and prices.

ORDER TOLL FREE

800-538-5000

800-662-6279

(CALIFORNIA RESIDENTS)

CALL US FOR VOLUME QUOTES

ALL MERCHANDISE
100% GUARANTEED

© Copyright 1983 JDR Microdevices

2732 32K EPROM **\$495**

2764 64K EPROM **\$995**

SPECTACULAR FALL SAVINGS!
(QUANTITIES LIMITED!)

RF MODULATOR (ASTEC UM1082)

- * PRESET TO CHANNEL 3
- * USE TO BUILD TV-COMPUTER INTERFACE
- * +5 VOLT OPERATION

NOW ONLY \$695

POWER SUPPLIES IDEAL FOR HOBBYIST, BENCHWORK AND DO-IT-YOURSELFERS!
90-DAY WARRANTY!
NEW AND UNUSED!!

ASTEC AA11190

- * QUAD OUTPUT SWITCHING DESIGN AS USED IN APPLE III
- * +5 @ 4A; -5 @ .25A
- * +12 @ 2.5A; -12 @ .30A; 15.5"x4.5"x2"

NOW ONLY \$5990

SIGMA INSTRUMENTS

Model 2PC2241

- * DESIGNED FOR DEC EQUIPMENT
- * FUSE PROTECTED * LINEAR DESIGN
- * AUXILIARY AC OUTLET
- * +5 @ 4A; -15V @ 1.5A; 12.25"x4"x4.75"

NOW ONLY \$1995

ORDER 800-538-5000
TOLL FREE 800-662-6279
(CALIFORNIA RESIDENTS)

CAPACITORS

TANTALUM

	6V	10V	15V	20V	25V	35V	50V
.22uf						.40	
.27						.40	
.33						.40	.45
.47				.35		.50	
.68						.45	.50
1.0		.40	.40	.45	.45		
1.5				.45	.50	.60	
1.8						.75	
2.2	.35	.40	.45			.65	.85
2.7	.40	.45				.90	
3.3	.45	.50	.55	.80	.65	.90	
3.9	.45						
4.7	.45	.55	.60	.65	.85	.90	
6.8		.70	.75				
8.2						1.00	
10	.55	.65	.80	.85	.90	1.00	
12	.65	.85	.90				
15	.75	.85	.90				
18		1.25					
22	1.00	1.35					
27		2.25					
39	1.50						
47	1.35						
58	1.75						
100		3.25					
270	3.75						

DISC

	50V	.05	470	50V	.05
22	50V	.05	560	50V	.05
25	50V	.05	680	50V	.05
27	50V	.05	820	50V	.05
33	50V	.05	.001uf	50V	.05
47	50V	.05	.0015	50V	.05
56	50V	.05	.0022	50V	.05
68	50V	.05	.005	50V	.05
82	50V	.05	.01	50V	.07
100	50V	.05	.02	50V	.01
220	50V	.05	.05	50V	.01
330	50V	.05	.1	12V	.11
			.1	50V	.12

MONOLITHIC

.1uf-mono 50V .18 .47uf-mono 50V .25

ELECTROLYTIC

RADIAL			AXIAL		
.47uf	50V	.14	1uf	50V	.14
1	25V	.14	4.7	16V	.14
2.2	35V	.15	10	16V	.14
4.7	50V	.15	10	50V	.18
10	50V	.15	22	16V	.14
47	35V	.18	47	50V	.20
100	16V	.18	100	15V	.20
220	35V	.20	100	35V	.25
470	25V	.30	150	25V	.25
2200	18V	.80	220	25V	.30
			330	16V	.40
			500	16V	.42
			1000	16V	.80
			1500	16V	.70
			6000	16V	.85

COMPUTER GRADE

28,000uf 30V 3.85

OPTO-ISOLATORS

4N26	1.00	MCA-7	4.25
4N27	1.10	MCA-255	1.75
4N28	.69	IL-1	1.25
4N33	1.75	ILA-30	1.25
4N35	1.25	ILQ-74	2.75
4N37	1.25	H11C5	1.25
MCT-2	1.00	TIL-111	1.00
MCT-6	1.50	TIL-113	1.75

FEDERAL EXPRESS SERVICES AVAILABLE

TRANSISTORS

2N918	.50	MPS3706	.15
MPS918	.25	2N3772	1.85
2N2102	.75	2N3903	.25
2N2218	.50	2N3904	.10
2N2218A	.50	2N3906	.10
2N2219	.50	2N4122	.25
2N2219A	.50	2N4123	.25
2N2222	.25	2N4249	.25
PN2222	.10	2N4304	.75
MPS2369	.25	2N4401	.25
2N2484	.25	2N4402	.25
2N2905	.50	2N4403	.25
2N2907	.25	2N4857	1.00
PN2907	.125	PN4916	.25
2N3055	.79	2N5086	.25
3055T	.69	PN5129	.25
2N3393	.30	PN5139	.25
2N3414	.25	2N5209	.25
2N3563	.40	2N6028	.35
2N3565	.40	2N6043	1.75
PN3565	.25	2N6045	1.75
MPS3638	.25	MPS-A05	.25
MPS3640	.25	MPS-A06	.25
PN3643	.25	MPS-A55	.25
PN3644	.25	TIP29	.65
MPS3704	.15	TIP31	.75
		TIP32	.79

IC SOCKETS

	1-99	100
8 pin ST	.13	.11
14 pin ST	.15	.12
16 pin ST	.17	.13
18 pin ST	.20	.18
20 pin ST	.29	.27
22 pin ST	.30	.27
24 pin ST	.30	.27
28 pin ST	.40	.32
40 pin ST	.49	.39
64 pin ST	4.25	call
ST = SOLDERTAIL		
8 pin WW	.59	.49
14 pin WW	.69	.52
16 pin WW	.69	.58
18 pin WW	.99	.90
20 pin WW	1.09	.98
22 pin WW	1.39	1.28
24 pin WW	1.49	1.35
28 pin WW	1.69	1.49
40 pin WW	1.99	1.80
WW = WIREWRAP		
16 pin ZIF	6.75	call
24 pin ZIF	9.95	call
28 pin ZIF	10.95	call
ZIF = TEXT TOOL (Zero Insertion Force)		



LED LAMPS

	1-99	100-up
Jumbo Red	.10	.09
Jumbo Green	.18	.15
Jumbo Yellow	.18	.15

DIODES

1N751	5.1 volt zener	.25
1N759	12.0 volt zener	.25
1N4148	(1N914) switching	25/1.00
1N4004	400PIV rectifier	10/1.00
KBP02	200PIV 1.5amp bridge	.45
KBP04	400PIV 1.5amp bridge	.55
VM48	Dip-Bridge	.35

MUFFIN FANS NEW UN-USED

4.68" Square	14.95
3.125" Square	14.95

HEAT SINKS

TO-3 style	.95
TO-220 style	.35

SWITCHES

SPDT mini-toggle	1.25
DPDT mini-toggle	1.50
SPST mini-pushbutton	.39

DIP SWITCHES

4 POSITION	.85
5 POSITION	.90
6 POSITION	.90
7 POSITION	.95
8 POSITION	.95

RESISTORS

1/4 WATT 5% CARBON FILM ALL STANDARD VALUES FROM 1 OHM TO 10 MEG OHM	
50 PCS. SAME VALUE	.025
100 PCS. SAME VALUE	.02
1000 PCS. SAME VALUE	.015

BYPASS CAPS

.01 UF DISC	100/6.00
.1 UF DISC	100/8.00
.1 UF MONOLITHIC	100/15.00

LED DISPLAYS

HP 5082-7760	.6"	CC	1.29
MAN 72	.3"	CA	.99
MAN 74	.3"	CC	.99
FND-357 (359)	.375"	CC	1.25
FND-500 (503)	.5"	CC	1.49
FND-507 (510)	.5"	CA	1.49

VISIT OUR RETAIL STORE

HOURS: M-W-F, 9-5 T-Th., 9-9 Sat. 10-3

PLEASE USE YOUR CUSTOMER NUMBER WHEN ORDERING

TERMS: Minimum order \$10. For shipping and handling include \$2.50 for UPS Ground and \$3.50 for UPS Air. Orders over 1 lb. and foreign orders may require additional shipping charges — please contact our sales department for the amount. CA residents must include 6% sales tax, Bay Area and LA residents include 6.75%. Prices subject to change without notice. We are not responsible for typographical errors. We reserve the right to limit quantities and to substitute manufacturer. All merchandise subject to prior sale.

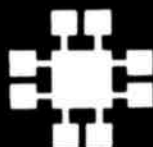

JDR Microdevices

1224 S. Bascom Avenue
San Jose, CA 95128

800-538-5000 • 800-662-6279 (CA)
(408) 995-5430 • Telex 171-110

© Copyright 1983 JDR Microdevices

2716

16K EPROMS

\$395

EACH

2732

32K EPROMS

\$495

EACH

MICROCOMPUTER HARDWARE HANDBOOK FROM ELCOMP — \$14.95

Over 800 pages of manufacturers data sheets on most commonly used IC's.

Includes:

- * TTL — 74/74LS and 74F
- * CMOS
- * Voltage Regulators
- * Memory — RAM, ROM, EPROM
- * CPU's — 6800, 6500, Z80, 8080, 8085, 8086/8
- * MPU support & interface — 6800, 6500, Z80, 8200, etc.

BEST SELLING BOOKS

OSBORNE/MC GRAW-HILL

- Apple II User's Guide 16.95
- CRT Controller's Handbook 9.95
- 68000 Assembly Language Programming 16.99
- CBASIC User Guide 15.00

SYBEX

- Your First Computer 6.95
- The CP/M Handbook 14.95
- The PASCAL Handbook 18.95
- Microprocessor interfacing Techniques 17.95

TRANSFORMERS

FRAME STYLE

- 12.6VAC 2amp 4.95
- 12.6VAC CT 2amp 5.95
- 12.6VAC CT 4amp 7.95
- 12.6VAC CT 8amp 10.95
- 25.2VAC CT 2amp 7.95

PLUG CASE STYLE

- 12VAC 250ma 3.95
- 12VAC 500ma 4.95
- 12VAC 1amp 5.95
- 12VAC 2amp 6.95

DC ADAPTER

- 6, 9, 12 VDC selectable with universal adapter 8.95

NOTE: Please include sufficient amount for shipping on above items.

DISK DRIVES TANDON

TM100-1 5¼" (FOR IBM) SS/DD 229.00

TM100-2 5¼" (FOR IBM) DS/DD 259.00

SHUGART

SA 400L 5¼" (40 TRACK) SS/DD 199.95

SA 400 5¼" (35 TRACK) SS/DD 189.95

PERTEC

FD-200 5¼" SS/DD 179.95

FD-250 5¼" DS/DD 199.95

MPI

MP-52 5¼" (FOR IBM) DS/DD 249.00

NOTE: Please include sufficient amount for shipping on above items.

8" DRIVE SALE

FD100-8 \$189

SHUGART 801 EQUIVALENT
SS/DD 10 FOR \$175 EA.

FD200-8 \$239

SHUGART 851 EQUIVALENT
DS/DD 10 FOR \$220 EA.

CABINETS FOR 5¼" DISK DRIVES

CABINET #1 \$29.95

- * DIMENSIONS 8½ x 5½ x 3½"
- * COLOR MATCHES APPLE
- * FITS STANDARD 5¼" DRIVES, INCL. SHUGART
- * INCLUDES MOUNTING HARDWARE AND FEET

CABINET #2 \$79.00

- * COMPLETE WITH POWER SUPPLY, SWITCH, LINE CORD, FUSE & STANDARD POWER CONNECTOR
- * DIMENSIONS: 11½ x 5¾ x 3½"
- * +5V @ 1 AMP, +12V @ 1.5 AMP
- * FITS STANDARD 5¼" DRIVES
- * PLEASE SPECIFY GRAY OR TAN

NOTE: Please include sufficient amount for shipping on above items.

EDGE-CARD CONNECTORS

- S-100 ST 3.95
- S-100 WW 4.95
- 72 pin ST 6.95
- 72 pin WW 7.95
- 50 pin ST 4.95
- 44 pin ST 2.95
- 44 pin WW 4.95
- 44 pin SE 3.95



DIP CONNECTORS

DESCRIPTION	HIGH RELIABILITY TOOLED ST IC SOCKETS	COMPONENT CARRIERS (DIP HEADERS)	RIBBON CABLE DIP PLUGS (IDC)
ORDER BY	AUGATxx-ST	ICCxx	IDPxx
CONTACTS 8	.99	.65	
14	.99	.75	1.45
16	.99	.85	1.65
18	1.69	1.00	
20	1.89	1.25	
22	1.89	1.25	
24	1.99	1.35	2.50
28	2.49	1.50	
40	2.99	2.10	4.15

For order instructions see "IDC Connectors" below.

WE GOOFED!

Due to overwhelming demand, we are SOLD OUT of SA-460 disk drives. We apologize and thank you for your understanding.

CENTRONICS

- IDCEN36 Ribbon Cable 36 Pin Male 8.95
- CEN36 Solder Cup 36 Pin Male 7.95

RIBBON CABLE

CONTACTS	SINGLE COLOR		COLOR CODED	
	1'	10'	1'	10'
10	.50	4.40	.83	7.30
16	.55	4.80	1.00	8.80
20	.65	5.70	1.25	11.00
25	.75	6.60	1.32	11.60
26	.75	6.60	1.32	11.60
34	.98	8.60	1.65	14.50
40	1.32	11.60	1.92	16.80
50	1.38	12.10	2.50	22.00

D-SUBMINIATURE

DESCRIPTION	SOLDER CUP		RIGHT ANGLE PC SOLDER		IDC RIBBON CABLE		HOODS	
	MALE	FEMALE	MALE	FEMALE	MALE	FEMALE	BLACK	GREY
ORDER BY	DBxxP	DBxxS	DBxxPR	DBxxSR	IDBxxP	IDBxxS	HOOD-B	HOOD
CONTACTS 9	2.08	2.66	1.65	2.18	3.37	3.69	—	1.60
15	2.69	3.63	2.20	3.03	4.70	5.13	—	1.60
25	2.50	3.25	3.00	4.42	6.23	6.84	1.25	1.25
37	4.80	7.11	4.83	6.19	9.22	10.08	—	2.95
50	6.06	9.24	—	—	—	—	—	3.50

For order instructions see "IDC Connectors" below.

MOUNTING HARDWARE 1.00

IDC CONNECTORS

DESCRIPTION	SOLDER HEADER	RIGHT ANGLE SOLDER HEADER	WW HEADER	RIGHT ANGLE WW HEADER	RIBBON HEADER SOCKET	RIBBON HEADER	RIBBON EDGE CARD
ORDER BY	IDHxxS	IDHxxSR	IDHxxW	IDHxxWR	IDSxx	IDMxx	IDExx
CONTACTS 10	.82	.85	1.86	2.05	1.15	—	2.25
20	1.29	1.35	2.98	3.28	1.86	5.50	2.36
26	1.68	1.76	3.84	4.22	2.43	6.25	2.65
34	2.20	2.31	4.50	4.45	3.15	7.00	3.25
40	2.58	2.72	5.28	4.80	3.73	7.50	3.80
50	3.24	3.39	6.63	7.30	4.65	8.50	4.74

ORDERING INSTRUCTIONS: Insert the number of contacts in the position marked "xx" of the "order by" part number listed. Example: A 10 pin right angle solder style header would be IDH10SR.

FOR APPLE COMPUTER USERS

JDR PRODUCTS

JDR HALF-HEIGHT DISK DRIVE

- ★ 35 Track w/Apple Controller
 - ★ 40 Track Controller and DOS
- Available (Call for Price) **NEW \$239⁹⁵**

JDR 16K RAM CARD FOR APPLE II+

- ★ 2 YEAR WARRANTY
 - Kit with Instructions \$40.95
 - Bare PC Card \$14.95
- \$44⁹⁵**

JDR COOLING FAN CLEARANCE SALE!

- ★ With Surge Protection
 - ★ Quantities Are Limited!
- \$49⁹⁵**

800-538-5000

800-662-6279
(CALIFORNIA RESIDENTS)

OTHER ACCESSORIES FOR APPLE II

THUNDERCLOCK \$129.95

- ★ Real-Time Clock Calendar ★ Software Included
- ★ Mountain Software Compatible
- ★ BSR Control Options Available

KRAFT JOYSTICK \$49.95

"The Choice of Professionals"

MICROMAX

VIEWMAX-80 NOW ONLY \$159⁹⁵

- ★ 80 Column Card for Apple II+
- ★ Video Soft Switch
- ★ Inverse Video ★ 2 Year Warranty

VIEWMAX-80e NEW \$129⁹⁵

- ★ 80 Column Card for Apple IIe
- ★ 64K RAM Expandable to 128K
- 64K RAM Upgrade **\$47.60**

GRAPHMAX \$129⁹⁵

- ★ Hi Resolution Graphics
- ★ Printer Card
- ★ Centronics Parallel Interface

Graphmax with Color & Zoom Options \$149.95

Z-MAX \$139⁹⁵

- ★ Z-80 Card for Apple II+
- ★ Use to Run CPM Programs

MA SYSTEMS

FD-35 DISK DRIVE \$229.95

- ★ Shugart Mechanism — Made in U.S.A.

★ Direct Replacement for Apple Disk II ★ 1 Year Warranty CONTROLLER CARD \$69.95

- ★ One Year Warranty

APPLE COMPATIBLE POWER SUPPLY

- ★ Use To Power Apple-Type Systems

- ★ +5V @ 5A +12V @ 3A
- ★ -5V @ .5A -12V @ .5A

- ★ Instructions Included

\$79⁹⁵



ALL

MERCHANDISE

100%

GUARANTEED

PERISOFT PRINTERLINK

- ★ Low Cost Centronics Parallel Interface with Cable and Manual **\$59⁰⁰**

MESSENGER

- ★ Serial Interface
- Connects Virtually Any Serial Device
- ★ Includes Cable **\$99⁰⁰**

TIMELINK

- ★ Real-Time Clock
- Calendar with Alarm Feature **\$84⁰⁰**

ALL WITH ONE YEAR WARRANTY

MONITORS

MONOCHROME

BMC BM 12AUW GREEN 12" NEW \$89.95

NEC JB1201M - 20 MHZ GREEN \$169.00

ZENITH ZVM-121 - 15 MHZ GREEN \$99.00

TAXAN 18 MHZ AMBER \$139.00

COLOR

BMC BM-AU9191U COMPOSITE 13" \$279.00

AMDEK COLOR I - COMPOSITE \$335.00

NO C.O.D. ORDERS PLEASE

5 1/4" DISKETTES

VERBATIM DATALIFE

SS/DD SOFT SECTOR 29.95

SS/DD 10 SECTOR HARD 29.95

NASHUA

SS/SD SOFT SECTOR WITH HUB RING \$19⁹⁵

Ask about our full line of Nashua diskettes **BEST BUY**

VISIT OUR RETAIL STORE

HOURS: M-W-F, 9-5 T-Th., 9-9 Sat. 10-3

PLEASE USE YOUR CUSTOMER NUMBER WHEN ORDERING

TERMS: Minimum order \$10. For shipping and handling include \$2.50 for UPS Ground and \$3.50 for UPS Air. Orders over 1 lb. and foreign orders may require additional shipping charges — please contact our sales department for the amount. CA residents must include 6% sales tax. Bay Area and LA residents include 6 1/2%. Prices subject to change without notice. We are not responsible for typographical errors. We reserve the right to limit quantities and to substitute manufacturer. All merchandise subject to prior sale.

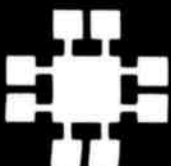

JDR Microdevices

1224 S. Bascom Ave. • San Jose, CA 95128

(408) 995-5430 • Telex 171-110

Unclassified Ads

NEEDED: Nonprofit performing-arts foundation seeks tax-deductible donations of portable computer with or without printer, typewriters, and TI-compatible printer to aid us in mailings, finances, and fund raising. Hugh Appert, American Dance Foundation Inc., 2291 Broadway, New York, NY 10024. (212) 799-5445.

WANTED: Nonprofit group of volunteer professionals devoted to rehabilitation research and community service for persons with hearing or vision impairments needs TI 99/4A, cassette, RS-232C interface and modem, VIC-20s with datasets, VICModem, two green monitors, and IEEE-488- or RS-232C-compatible dot-matrix printer. Will pay shipping. Donations are fully tax exempt. J. Whitlock, New England Institute of Applied Biophysics, 59 North Ashland St., Worcester, MA 01609. (617) 798-8707.

WANTED: Elwyn Institute is a nonprofit rehabilitation center seeking a distributor for new ribbon cartridges that are assembled, tested, and manufactured by handicapped people. We also welcome tax-exempt donations of word-processing equipment. Alvin Synhor, Elwyn Institute, 5001 Lancaster Ave., Philadelphia, PA 19131. (215) 477-9100.

WANTED: A donation of any micro- or minicomputer for an educational cause. Will accept computer books, computer audio/visual materials, video player/recorder plus compatible color TV. Also, will buy: Apple II or Ite and Europlus 48K microcomputer with drives, controllers (with or without), a 12-inch green screen, a 16K RAM card, Z80 CP/M card, 80-column matrix printer, and more. Iendekai Muzorewa, POB FM156, Famaona, Bulawayo, Zimbabwe, Africa, tel: 34916 Bulawayo.

WANTED: Student [micro]electronics class needs your discarded or unwanted computers, systems, printers, or parts for educational use. Jim Seals, 1819 North Semoran Blvd., Orlando, FL 32807.

WANTED: Two nonprofit organizations, a church-youth group and school FTA, need a new or slightly used TI 99/4A-compatible printer with cords. Donations are tax deductible. Brian Neidig, 2105 Old Coupland Rd., Taylor, TX 76754.

WANTED: Christian church seeks donation of personal computer for church-accounting purposes. Gifts are tax deductible. Rev. Feeser or Nate Solem, Grace Lutheran Church, 2101 Harrison St., Kingman, AZ 86401. (602) 753-3068.

WANTED: The Solebury Student Computer Club is interested in trading Apple-compatible software. Please send your list of software. The Solebury Student Computer Club, Phillips Mill Rd., New Hope, PA 18938.

WANTED: College student needs programs of a scientific or mathematical nature for the Apple II, II Plus, and IIe, especially in chemistry and physics. If you send a disk, I will return it with utility programs. Ell Rotenberg, 1203 Magee Ave., Philadelphia, PA 19111.

WANTED: High school student would appreciate a donated computer for programming and experimentation purposes. Karl Smolenski, 2924 R. 54a, Penn Yan, NY 14527.

WANTED: High school student needs computer or spare parts to make one. Also, any computer books. Norm Guertin, 281 Grafton St., Worcester, MA 01604.

FOR SALE: Back issues of BYTE from January 1980 to December 1982, except January 1982. Good condition: all for \$100, postage paid anywhere in the continental US. Send cashier's check or money order. Phil Busch, 790 Northeast Wharton Dr., Grants Pass, OR 97526. (503) 474-1354.

FOR TRADE: Entire sheet of POKEs and PEEKs along with collection of programs for exchange with TRS-80 Color Computer users. Send list of all programs to swap with mine, also any information that may be passed on. Stephen Inoue, 4194 Tambor Rd., San Diego, CA 92124. (619) 571-1412.

WANTED: One copy of BYTE Vol. 1, No. 5, January 1976, to make set complete. W.A. Winshall, 3 Ferndale Rd., Weston, MA 02193. (617) 235-5360.

FOR SALE: North Star Horizon, 5 users, 352K RAM, 5 1/4-inch disk drive, 338K, ten I/O serial ports, Z80A CPU, 14-inch hard disk IBM MB HDOS, CP/M, TSSC, HBASIC, Cost over \$12,000, sell \$5750 or near offer. The Armchair Sailor Bookstore, Lee's Wharf, Newport, RI 02840, (401) 847-4252.

FOR SALE: Winchester Tallgrass double-disk drive, 12 plus 12 megabyte tape backup, almost new, considerably below market price. Also, Cyma Dental Receivable program to sell or trade for new Softward. Judith D. Sutterfield, 1800 Alamo Ave., Colorado Springs, CO 80907.

FOR SALE: Modified TRS-80 Model I Level II, 16K computer, includes cassette, stringy floppy, wafers with programs for both business and games; TRS-80 Line Printer; and custom-built table. Entire system to go, worth over \$1100, asking \$800. Joel Minchinton, 107 South 2nd St., Wahpeton, ND 58075. (701) 642-1326.

WANTED: High school student would like donated Apple computer equipment, cards, peripherals, anything unwanted. I will gladly pay all postage. Chris Faigle, 3001 River Hills Terrace, Midlothian, VA 23113, (804) 794-8903.

FOR SALE: Seven Compupro 16K static memory boards; four Compupro 8K static memory boards; two MITS 4K static memory boards; two MITS ROM BASIC; two MITS floppy-disk controllers; 2 MITS 8080 CPU boards; one MITS turnkey module; and two MITS cassette adapters. Also, Western Digital WD1000-85: \$375 and SOROC IO 120, CRT, good condition: \$350. David E. Boston, POB 518, Cedarville, OH 45314. (513) 766-5198.

FOR SALE: Micro Term ACT-IVa: \$275. Sanyo 15-inch black-and-white video monitor: \$150. Zenith Z-19A terminal: \$470. Sinclair ZX81: \$28. DEC MSVII-DD [64K-byte Q-bus dual-height RAM board]: \$250. DEC DLVIIJ [Q-bus 4-serial line board] with cables: \$320. Vadic 3400 modem, 1200 bits per second, full duplex: \$395. All perfect. R. Thornton, (516) 686-7890 or 626-3919.

FOR SALE: Apple II Plus 48K, keyboard replaced. Hefty power supply: \$900 or offer. Without power supply and case: \$625. Mark Carroll, 1550 Beverly Place, Berkeley, CA 94706, (415) 525-7608 or 658-6719.

FOR SALE: Four new Apple II- and IIe-compatible disk drives (that include half-tracking, CP/M, Pascal, DOS 3.3 and 3.2: \$225 each or \$880 for all. Also, Atari cartridges: Indy 500 [\$25] and Speedway II [\$9], Peter Doty, 4813 Northwest 19th Place, Gainesville, FL 32605. (904) 376-0542.

FOR SALE: North Star Horizon 32K with two OD disk drives, Wordsmith word-processing system [40-line by 85-column screen], detached WP keyboard, and software: \$2150. Also, Diabio 1650 printer: \$2000. All in perfect condition. Bob Renegar, 23 Brookside Rd., Wallingford, PA 19086. (215) 566-4097.

FOR SALE: Motorola 6800 system with SOROC IO-120 terminal, SwTPC motherboard, MP-A2 processor board, two 8K and one 4K static memory boards, 16K static memory unpopulated, cassette interface, PROM burner MP-R and software, MPT Timer, two serial and two parallel interface boards, Editor/Assembler, 4K and 8K BASIC, software on ROM and cassette, manuals: \$1395. Will ship. Ray Romeu, 2530 Parkway St., Ft. Myers, FL 33901. (813) 936-5459.

FOR SALE: Cardco Universal Cassette interface for VIC-20 and C-64. In excellent condition: asking \$35 or best offer. For sale: VIC-20 hardware and cassettes. Will pay shipping. I want to form a VIC-20 users club in the Rochester area. Eduardo Fernandez, 185 Parkside Ave., Rochester, NY 14609. (716) 482-0643.

WANTED: SOL computer modifications: 80- by 24-inch screen module, Z80 module 4 MHz, dual-personality module, and schematic diagram of the IMSAI AP-44 printer. Kjell Ovarstrom, Lejonets Gata 352, 13660 Handen, Sweden.

FOR SALE: 8080 Editor, Assembler, Monitor in 3 volumes with hex and octal listing and full discussion of their use: \$15. 101 Basic Computer Games by Ahl: \$6. Basic Software Library, vol. 1: \$12. \$30 for all, postpaid. Also OST and Ham Radio. R. Mendelson, 27 Somerset Place, Murray Hill, NJ 07974.

FOR SALE: North Star Horizon with two DD disk drives, 56k floating-point board, and Godbout Graphics board. Hazeltine 1500 VDT with 24 by 80 characters. Texas Instruments 810 dot-matrix printer, RS-232C serial interface, 150 cps, 3600 bits per second, tractor feed, and stand. Excellent condition: asking \$800 for computer, \$300 for terminal, and \$700 for printer or make an offer for all. Eddy Stappaerts, 6716 El Rodeo Rd., Rancho Palos Verdes, CA 90272. (213) 377-1682.

FOR SALE: Shugart SA 801R 8-inch SSD disk drives. All are brand new, still factory-sealed in original cartons. Will sell for \$199 each or two for \$350. You pay shipping. Greg Olson, POB 908, Newport, WA 99156, (509) 447-5963 evenings and weekends.

FOR SALE: 64K memory board for the Atari 400/800, brand new with guarantee, complete: \$85. Ben Katz, 9062 Veronica Dr., Huntington Beach, CA 92646. (714) 968-2780.

FOR SALE: Partially disassembled Harris data terminal (IBM Selectric mechanism, correspondence code, integral modem board, telephone cradle) with IBM and terminal manuals: \$125. XITEK SCT-100 [5-100 bus] video board with manual and RF converter: \$35 FOB. Richard J. Willis, 10325 Camlino Cuervo #168, San Diego, CA 92108.

FOR SALE: Two printers: Micro Peripherals KP-40 with 44 columns, three 7/8-inch rolls of paper, dot-matrix mechanism and interface: assembled and like new: \$75 or best offer. Centronics 737 7 by 9 dot-matrix, six type styles, slightly used condition: \$250 or best offer. Thomas Kryst, Rt. 5 Box 209, Rolla, MO 65401.

FOR SALE: Ohio Scientific C3D with 52K bytes main memory, Ampex DB0 CRT terminal and Anadex 9501 printer. Disk storage is 1/4 megabyte floppy, 7 megabyte disk: \$5000. Eille Miller, Pine Tree Legal Assistance, 146 Middle St., Portland, ME 04101. (207) 774-8211.

LEGAL NOTICE

U.S. POSTAL SERVICE STATEMENT OF OWNERSHIP, MANAGEMENT AND CIRCULATION (Required by 39 U.S.C. 3685)

- Title of publication: **BYTE**.
- Date of filing: **October 1, 1983**.
- Frequency of issue: **monthly**.
- Number of issues published annually: **12**.
- Annual Subscription Price: **\$21.00**.
- Complete mailing address of known office of publication: **70 Main Street, Peterborough, NH 03458**.
- Complete mailing address of the headquarters or general business offices of the publishers: **1221 Avenue of the Americas, New York, NY 10020**.

8. Full names and complete mailing address of publisher, editor, and managing editor: **Publisher, Gene W. Simpson, 70 Main Street, Peterborough, NH 03458; Editor, Lawrence J. Curran, 70 Main Street, Peterborough, NH 03458; Managing Editor, Pamela Clark, 70 Main Street, Peterborough, NH 03458.**

9. Owner: **The owner is McGraw-Hill, Inc., 1221 Avenue of the Americas, New York, NY 10020. Stockholders holding 1 percent or more of stock are: Donald C. McGraw, Jr.; Harold W. McGraw, Jr.; John L. McGraw; William H. McGraw; June M. McBroom; Elizabeth McGraw Webster; all in care of McGraw-Hill, Inc., 1221 Avenue of the Americas, New York, NY 10020; Cede & Co. c/o Chase Manhattan Bank, N.A. 1211 Avenue of the Americas, New York, NY 10036; DuPont Pension c/o Wilmington Trust Company, Rodney Square North, Wilmington, DE 19890; Ohio Public Employees Retirement System, 277 East Town Street, Columbus, OH 43215.**

10. Known bondholders, mortgagees, and other security holders owning or holding 1 percent or more of total amount of bonds, mortgages or other securities: **None.**

11. Not applicable.

12. Extent and nature of circulation:

	Average No. Copies Each Issue During Preceding 12 Months	Actual No. Copies of Single Issue Published Nearest to Filing Date
A. Total No. Copies	418,833	473,500
B. Paid Circulation		
1. Sales through dealers and carriers, street vendors and counter sales	119,624	181,875
2. Paid Subscription	266,805	282,506
C. Total Paid Circulation	386,429	464,381
D. Free distribution by mail, carrier or other means samples, complimentary, and other free copies	5,165	2,095
E. Total distribution	391,594	466,476
F. Copies not distributed		
1. Office use, left over, unaccounted, spoiled after printing	6,130	7,024
2. Return from news agents	21,109	None to date
G. Total	418,833	473,500

11. I certify that the statements made by me above are correct and complete.

BYTE

Gene W. Simpson, Publisher

UNCLASSIFIED POLICY: Readers who have computer equipment to buy, sell, or trade or who are requesting or giving advice may send a notice to BYTE for inclusion in the Unclassified Ads section. To be considered for publication, an advertisement must be noncommercial (individuals or bona fide computer clubs only), typed double-spaced on plain white paper, contain 75 words or fewer, and include complete name and address. This service is free of charge; notices are printed once only as space permits. Your confirmation of placement is appearance in an issue of BYTE as we engage in no correspondence. Please allow at least three months for your ad to appear. Send your notices to Unclassified Ads, BYTE/McGraw-Hill, POB 372, Hancock, NH 03449.

Unclassified Ads

WANTED: High school student with PET 2001 wants working or broken PETs. I will pay postage. Eric Ryott, 162 Redwood Dr., Richmond, KY 40475, (606) 623-2207.

FOR SALE: Heath H-11 processor with 32K-byte memory, H-27 dual floppy-disk drive, two serial interface ports, and H-19 CRT. Includes all documentation and FORTRAN/BASIC operating software: \$4000 or best offer. T.A. Homan, 7741 Stanley Mill Dr., Centerville, OH 45459, (513) 434-3896.

FOR SALE: RCA VIP with 4K, Simple and Super sound boards, ASCII keyboard, Tiny BASIC, homemade color board, 5 volt, 1A power supply, 3 years, of Viper, and cassettes with over 60 games and programs. With manuals and documentation: requires video monitor and cassette recorder. Over \$550 value, selling for \$390. Nathan Gopen, 168 Pond St., Sharon, MA 02067, (617) 784-2771.

FOR SALE: Expansion interface for use with the TRS-80 Model I. I am also interested in 40-track disk drives for use with same. Brad Karp, 8101 Hawthorne Lane, Elkins Park, PA 19117, (215) 379-0667 evenings.

FOR SALE: Heath/Zenith Z-90 with 16K expansion RAM; Z-47 8-inch DSDD drives; H-25 high-speed printer with software: \$6500 or best offer. Tim Olson, (701) 774-3684.

FOR SALE: Integral Data Systems Micropism Model 480, 1K-byte buffer, parallel/serial I/O, programmable, graphics, near letter quality, draft speed modes of 5, 6, 8.4, 10, 12, and 16.8 cpi plus other features. Like new with cable and paper: \$450. Rich Reis, 711 Copley Lane, Silver Spring, MD 20904, (301) 384-0540.

WANTED: Radio Shack or LNW expansion interface for TRS-80 Model I. Joe Dashiell, 501 Fairfax Rd. #623, Blacksburg, VA 24060, (703) 552-8408.

FOR SALE: TRS-80/S-100. Complete S-100 HUH 8100 bus converter fully loaded, DTE/DCE RS-232C serial, current loop, and parallel I/O, 16K RAM and six S-100 slots. In finished wood case with 8-amp power supply and cooling fan: \$600 value, asking \$450. Also, two Godbout EconoRAM 8K S-100 at \$65 each. Jade Terminator/Extender: \$50. Jade Double-D disk-controller kit: \$225. Penny Whistle 103 acoustic modem: \$50. Will accept reasonable offer. Jens Hansen, (904) 968-0126.

FOR SALE: Three Digital Group machines. Two have TVC64, four parallel and serial ports, keyboard, monitor, and cabinets. One has DG Z80A CPU, 58K, and two drives. Other has R. & W. Z80A CPU, 64K, new motherboards, and two 8-inch DDSS disk drives. Third has DG Z80A CPU, 64K, TVC64, four parallel and serial ports, keyboard, monitor, and two 8-inch DDSS disk drives. Send SASE for list and prices. H. Wood, 2002 Rookwood Rd., Silver Spring, MD 20910, (301) 589-4171.

FOR SALE: HP B2905B Printer. 80-cps impact printer with five type options and graphics. HPIB (IEEE 488) interface, with 2m HPIB cable. New in June '83; \$885 retail. \$440 or best offer; UPS COD. Also, HPIB cables in different lengths and functional: \$30 each (\$80-100 retail). Tom von Alten, 9250 Landmark, Boise, ID 83704, (208) 322-7804.

WANTED: Italian-speaking microcomputer fans to exchange ideas and programs for the TI 99/4A home computer. Roy Moglia, 5137 Burlington Ave. N, St. Petersburg, FL 33710.

WANTED: Need to communicate with Morrow Designs Micro Decision users about its good and bad points. Howard Burns, 1265 North Diamond Bar Blvd., Diamond Bar, CA 91765, (714) 594-9259 evenings.

FOR SALE: Seria Data Sciences Z-80 SBC with CP/M 2.2 mounted in XOR 4-slot mainframe with two 8-inch Tandem thinline SSDD drives. Limited use: \$1500. D. I. Lawry, POB 1157, Corrales, NM 87048, (505) 898-5245.

FOR SALE: OSI CIP Model II with 8K RAM/ROM, 600 bits per second, cassette interface, Joysticks, and software. Documented. Original cost over \$600; all for \$275 or will trade for Apple II-compatible drive with DOS and controller. Lorenz Huelserbergen, 1908 Alabama St., Lawrence, KS 66044.

It May Come as No Surprise

The Circuit Cellar's creator, Steve Ciarcia, has won first place and the \$100 bonus in September's roundup with the first part of "Build the Micro D-Cam Solid-State Video Camera," entitled "The IS32 Optic RAM and the Micro D-Cam Hardware." Second place goes to our illustrious commentator, Jerry Pournelle, for "The Next Five Years in Microcomputers." And along with winning the \$50 prize for second place, Dr. Pournelle walks off with third place for his User's Column about "Eagles, Text Editors, New Compilers, and Much More." In fourth place, readers chose BYTE technical editor Stanley Wszola for "How to Choose a Portable." And fifth-place winners are the authors of the trilogy entitled "Inside CMOS Technology," Martin B. Pawloski, Tony Moroyan, and Joe Altnether. Congratulations to all these authors.

Correspondence

Address all editorial correspondence to the editor at BYTE, POB 372, Hancock, NH 03449. Unacceptable manuscripts will be returned if accompanied by sufficient first-class postage. Not responsible for lost manuscripts or photos. Opinions expressed by the authors are not necessarily those of BYTE. Entire contents copyright © 1983 by BYTE Publications Inc. All rights reserved. Where necessary, permission is granted by the copyright owner for libraries and others registered with the Copyright Clearance Center (CCC) to photocopy any article herein for the flat fee of \$1.50 per copy of the article or any part thereof. Correspondence and payment should be sent directly to the CCC, 21 Congress St., Salem, MA 01970. Specify ISSN 0360-5280/83. \$1.50. Copying done for other than personal or internal reference use without the permission of McGraw-Hill is prohibited. Requests for special permission or bulk orders should be addressed to the publisher, BYTE® is available in microform from University Microfilms International, 300 North Zeeb Rd., Dept. PR, Ann Arbor, MI 48106 USA or 18 Bedford Row, Dept. PR, London WC1R 4EJ England.

BOMB BYTE's Ongoing Monitor Box

Article #	Page	Article	Author(s)
1	36	Keep Power-Line Pollution Out of Your Computer	Ciarcia
2	48	BYTE West Coast: Microsoft Windows	Lemmons
3	59	User's Column: Buddy, Can You Spare a Door Latch?	Pournelle
4	103	An Introduction to Integrated Software	Chang
5	113	Presentation and Form in User-Interface Architecture	Carroll
6	127	Why Is Software So Hard to Use?	Edwards, Sam
7	143	Walt Disney and User-Oriented Software	Heckel
8	155	Making Life Easier for Professional and Novice Programmers	Pope, Kates, Fineberg, Dean, Nicholson
9	161	Simplify, Simplify, Simplify	Vandor
10	177	Integrating Voice in the Office World	Brown
11	189	The Starburst User Interface	Houston
12	199	The Complete Information-Management System	Warfield, White
13	210	The Allegory of Software	Andrews
14	218	The New Interface Technology	Herbach, Katz, Landau
15	234	Trackball-Interfacing Techniques for Microprocessors	Clanton
16	247	The User Interface: Two Approaches	Haas
17	263	The Future of Metaphor in Man-Computer Systems	Small, Small
18	286	The Texas Instruments Professional Computer	Wadlow
19	329	The ATR8000	Long
20	343	The Hercules Graphics Card	Holden
21	360	The Wang Professional Computer	Essig
22	372	In Search of the Most Amazing Thing	Dunn
23	380	Color Graphics from Any Computer	Howson
24	400	Mainframe to Micro: Adapting a Financial-Modeling Language	Hendrix
25	417	POKEing Around in the IBM PC, Part 2: Developing Subroutines for BIOS Interface and Screen-Display Disk Storage	Rollins
26	443	The CMOS 6502	Edwards, Stuart
27	457	A Tiger Meets a Dragon	Pournelle
28	481	A Computer-Algebra-Based Calculating System	
29	519	The User Looks at Books	

Reader Service

Inquiry No.	Page No.	Inquiry No.	Page No.	Inquiry No.	Page No.	Inquiry No.	Page No.
3	1ST.PLACE SYSTEMS 420	495	COMPLEX SYSTEMS INC. 275	164	EAST SIDE SOFTWARE 347	*	LANGLEY ST. CLAIR 198
1	1 SUPERWAREHOUSE 202	87	COMPONENTS EXPRESS 192	165	EASTERN ENTERPRISES 172	259	LANIER BUSN.PROD. 488, 489
4	800 SOFTWARE 454, 455	459	COMPU-MEDIA SOFT. 602	167	ELCOMP 602	260	LANIER BUSN.PROD. 495
6	A.S.T. RESEARCH 279	88	COMPUADD 612	519	ELECTRADE 280	262	LEADING EDGE PROD CIII
7	AB COMPUTERS 609	89	COMPUADD 612	168	ELECTRADE 608	263	LIBERTY GROUP INC. 543
8	ABC DATA PRODUCTS 406	90	COMPUADD 612	169	ELECTRONIC PROTECTION DEV. 31	264	LIGO RESEARCH INC. 357
9	ACTION COMPUTER 95	91	COMPUADD 612	170	ELECTRONIC PROTECTION DEV. 33	*	LINNTON ELECTRONIC SYS. 608
10	ACTION POTENTIAL 604	93	COMPUPRO 149	171	ELECTRONIC SPECIALISTS 448	265	LOGICAL DEVICES 14
11	ADDMASTER CORP. 614	*	COMPUPRO 540, 541, 542	172	ELEK-TEK 388	266	LOGICAL DEVICES 644
12	ADV. COMP. PROD. 638, 639	94	COMPUSERVE 385	488	ELEK-TEK 452	267	LOGICAL MICROCOMPUTER 188
14	ADV. DIGITAL CORP. 147	95	COMPUSHACK 535	173	ELLIS COMPUTING INC. 69	268	LOMAS DATA PRODUCTS 246
15	ADV.GRAPHIC ENGINEERING 604	96	COMPUTER ACCESSORIES 291	174	ELLIS COMPUTING INC. 331	269	LOTUS DEVELOPMENT 317
15	ADV. LOGIC SYSTEMS 307	97	COMPUTER APPARATUS 471	*	EMPIRICAL RESEARCH GROUP 122	270	LSI JAPAN CO. 844
16	ADV. SYS. CONCEPTS 68	98	COMPUTER CHANNEL 164	175	ENGINEERING SPECIALTIES 616	271	LYBEN COMP. SYS. 604
506	AFTERTHOUGHT 642	99	COMPUTER DISCOUNT PROD. 645	176	ENTER COMPUTER 46, 47	272	LYBEN COMP. SYS. 606
*	ALF PRODUCTS, INC. 318	483	COMPUTER EDITYPE 85	*	EPSON AMERICA 70, 71	273	LYCO COMPUTER 513
18	ALL ELECTRONICS CORP. 538	477	COMPUTER FOOD PRESS 602	179	EPSON AMERICA 555	492	MA SYSTEMS 511
521	ALPHA NUMERIC 378	101	COMPUTER FURN. & ACCESS. 207	181	EXCEL 148	274	MACROTECH INT'L 359
20	ALPHA OMEGA COMPUTER 146	102	COMPUTER HUT OF N.E. 463	182	EXCEL 527	275	MANX SOFTWARE SYS. 62
26	AM MICRO 268	103	COMPUTER INNOVATIONS 106	183	EXPOTEK 324	518	MARITIME SOFTWARE 280
*	AMDEX CORP. 63	104	COMPUTER MAIL ORDER 544, 545	184	EXXON OFFICE SYSTEMS 620	276	MARYMAC INDUSTRIES 522
21	AMER. BUYING & EXPORT 534	514	COMPUTER PAPER PEOPLE 642	185	F.T.G DATA SYS. 614	277	MAYNARD ELECTRONICS 97
22	AMER. SQUARE COMP. 83	*	COMPUTER PLUS 73	186	FALCO DATA PROD. 142	278	MC TOY COMPANY 45
23	AMERICAN EXPRESS CO. 565	106	COMPUTER POST INC. 643	187	FENWAL PROTECTION SYS. 561	*	MC/P APPLICATIONS 333
23	ANADEX 435	107	COMPUTER PRICE CLUB 606	188	FIGURE-LOGIC BUS. EQUIP. 614	*	MCGRW-HILL INC. 304, 305
24	ANGEL'S COMPUTER 485	111	COMPUTER TECHNOLOGY 538	189	FLAGSTAFF ENGINEERING 226	279	MEMOEX MEDIA PROD. 241
25	APPARAT INC. 311	513	COMPUTER TECHNOLOGY 642	190	FLIP-IT 306	280	MET CHEM INT'L CORP. 604
27	APPLE COMPUTER INC. CII, 1	*	COMPUTER WAREHOUSE 509	191	FLOPPY DISK SERV. INC. 157	281	METHOD SYS. INC. 610
28	APPLE COUNTRY LTD. 624, 625	112	COMPUTERLINE INT'L-A 496, 497	192	FORMASTER CORP. 411	282	MEFJ COMPUTERS 444
29	APPLEWARE INC. 600	113	COMPUTERLINE INT'L-B 298	193	FORMULA INT'L 605	282	MEJ ENTERPRISES INC. 222
30	APPLIED SOFTWARE TECH. 323	114	COMPUTERS AND MORE 134	194	FORMULA INT'L 605	284	MICRO CRAFT CORP. 383
31	ARKTRONICS CORP. 79	115	COMPUTERS WHOLESAL 325	195	FOX & GELLER INC. 102	286	MICRO FOCUS 216, 217
32	ARTIFICIAL INT'L. RESEARCH 614	512	COMPUTRONIX CORP. 642	196	FUJITSU PROFESS. MICROSYS. 315	287	MICRO MANAGEMENT SYS. 469
34	ASHTON-TATE 145	116	COMPUPVIEW PROD. INC. 56, 57	197	GARDEN OF EDEN COMPUTERS 604	288	MICRO MART 606
35	ASHTON-TATE 439	117	CONCORDE PERIPHERAL SYS. 294	198	GENERAL ELECTRIC R&D 480	289	MICRO MINT 569
36	ATARI SOFT 370, 371	118	CONCORDE PERIPHERAL SYS. 294	198	GENERAL TECHNOLOGY 85	290	MICRO MYSTIQUE 606
*	AT&T CONSUMER PROD. 309	119	CONDOR COMP. CORP. 303	199	GILFORD COMP. SYS. 442	291	MICRO-TAX 169
38	AVIS RENT-A-CAR 571	83	CONROY-LAPOINTE 186, 187	200	GILLTRONIX, INC. 620	283	MICROAGE COMP.STORES INC. 531
39	AVOCET 445	84	CONROY-LAPOINTE 186, 187	201	GLOUCESTER COMP.CO.INC. 600	497	MICROCOMPUTER SYSTEMS 64
40	B&B ELECTR. 600	85	CONROY-LAPOINTE 186, 187	350	GRAY MARKET, THE 599	292	MICRODYNAMICS 614
41	B&B ELECTR. 610	509	CONTINENTAL PRESS 642	202	GREAT LAKES COMPUTER 151	293	MICROHOUSE 215
42	BAHR TECHNOLOGY 30	120	CONTROL DATA CORP. 377	204	GREAT SALT LAKE COMP. 617	317	MICROLAND 644
43	BASF SYSTEMS 433	121	CONTROL ELECTR. INC. 316	205	GREAT SALT LAKE COMP. 618, 619	294	MICROMAIL 601
44	BAY TECHNICAL ASSOC. 12	122	CORONA DATA SYS. 337	206	GTEK INC. 214	296	MICROPROCESSORS UNLTD. 604
45	BELL, JOHN ENGR 628	123	CORVUS SYS. INC. 409	*	H&E COMPUTRONICS 107	*	MICROSOFT CORP. 88, 89
46	BELL, JOHN ENGR 628	124	COSMOS 165	207	H&M DISK DRIVE SERVICES 600	*	MICROSOFT CORP. 367
47	BELL, JOHN ENGR 629	125	CREATIVITY LOGIC 78	493	HANDWELL CORP. 431	*	MICROSOFT CORP. 399
48	BELL, JOHN ENGR. 629	126	CREATIVITY UNLTD. 602	210	HANDWELL CORP. 611	297	MICROTECH EXPORTS 276
49	BHRT 340, 341	127	CROMEMCO 5	211	HAYDEN SOFTWARE 269	298	MICROWARE 224
481	BMC USA, INC. 498	128	CUESTA SYSTEMS 612	212	HAYES MICROCOMP.PROD. 139	299	MICROXPRESS 278
482	BMC USA, INC. 498	129	CUMANA 18	213	HAYES MICROCOMP.PROD. 447	300	MID-AMERICA WHOLESALERS 270
*	BORLAND, LTD. 456	130	CUSTOM COMP.TECH. 615	214	HOLIDAY INNS, INC. 483	511	MILLER, J. W. 642
51	BOTTOM LINE, THE 262	131	DATA ACQUISITIONS SYS. 98, 99	215	HOLLYWOOD HARDWARE 620	301	MINI MICRO MART 80, 81
52	BOULDER LOGICAL TESTING 620	132	DATA STORAGE SOLUTIONS 195	510	HOLLYWOOD HARDWARE 642	302	MINI MICRO MART 87
53	BROWN DISC MANUFACTURING 176	133	DATABASE RESEARCH 179	216	HOUSTON INSTRUMENTS 193	303	MINOLTA CORP. 559
*	BURDICK CO 446	134	DATAPRODUCTS 515	217	HUMAN DESIGNED SYSTEMS 231	*	MK ENTERPRISES 606
54	BUSINESS SOLUTIONS 644	135	DATASOURCE SYS.MRKTG. 76	218	HUMAN SOFT 91	304	MORROW 271
*	BYTE PUBL. INC. 494	504	DATASOUTH COMPUTER CORP. 266	219	I.T.M. 342	305	MOUNTAIN VIEW PRESS 93
*	BYTE BACK ISSUES 524	505	DATASOUTH COMPUTER CORP. 426	220	IBM CORP. 28, 29	306	MPI 423
55	BYTEK COMP. SYS. CORP. 466	136	DATEC, INC. 473	223	IMAGE COMP. PROD. 522	*	MPS DISTRIBUTORS 208, 209
56	BYTEWRITER 26	137	DECOTEC 608	224	IN-SYNC 612	307	MTI SYSTEMS CORP. 222
*	C WARE 430	*	DELUXE COMP. FORMS 410	225	INCOMM 194	*	MUSYS CORP. 255
57	C-SYSTEMS 614	138	DENNISON KYBE CORP. 293	227	INFOCOM 152, 153	308	MY SUPPLIER, INC. 616
58	C.S.D. INC. 150	502	DIALOG 387	228	INFORMATION RESOURCES 470	310	NEC HOME ELECTR.USA 326, 327
461	CABLES UNLTD. 616	139	DIAMOND SFTW.SUPPLY 228	229	INSIGHT ENTERPRISES 600	312	NEC INFORMATION SYS. 131
59	CAL-COM SERVICES 608	140	DIGICOMP RESRCH CORP 608	230	INT'L COMP.&TELECOMM.INC. 604	313	NELMA DATA 376
*	CALIF. DIGITAL 626, 627	141	DIGISOFT COMPUTERS 479	231	INTEGRAND 368	*	NETRONICS 418
60	CALIF. DATA CORP. 600	142	DIGITAL DELI 604	232	INTERACTIVE STRUCT. 407	315	NETWORK CONSULTING INC. 229
*	CALIF. MICRO COMP. 316	143	DIGITAL DIMENSIONS 434	233	INTERCONTN.MICRO SYS. 413	316	NETWORK CONSULTING INC. 319
515	CARRYCASE 280	*	DIGITAL EQUIPMENT CORP. 109, 110, 111	234	INTERDATA SYSTEMS INC. 67	484	NEW AMERICAN LIBRARY 551
62	CDR SYSTEMS 616	144	DIGITAL EQUIPMENT CORP. 415	479	INTERFACE INC. 240	*	NORTH HILLS CORP. 378
*	CENTENNIAL COMP. PROD. 259	145	DIGITAL MARKETING 274	480	INTERFACE INC. 240	*	NORTH HILLS CORP. 421
64	CENTRE COMP.CONSTNTS. 604	146	DIGITAL MEDIA 600	236	INTERTEC DATA SYS. 13	318	NORTH STAR COMPUTERS 265
65	CENTRE COMP.CONSTNTS. 606	147	DIGITAL RESEARCH 232, 233	237	IPF 533	319	NORTHWEST DIGITAL SYS. 32
489	CHANNEL SYS 593	148	DIGITAL RESEARCH 547	238	IQ TECHNOLOGIES 299	320	NOVATION, INC. 174, 175
66	CHESSSELL-ROBOCOM CORP. 94	148	DIGITAL RESEARCH COMP. 603	240	J.C. SYSTEMS 129	321	O'HANLON COMP. SYS. 429
67	CHIPS & DALE 644	*	DIRECT SOFTWARE 453	241	JADE COMP.PROD. 621	322	OCOCO 68
68	CHRISLIN IND. INC. 253	149	DISCOUNT SOFTWARE 267	242	JADE COMP.PROD. 622, 623	323	OCTAGON COMP SYS 140, 141
69	CHROMOD ASSOC. 610	150	DISCWASHER COMP. ACCESS. 301	243	JAMECO ELECTR. 105	324	OFFICE NETWORKS CORP. 644
72	CLEO 562, 563	151	DISKS 'N THINGS 606	244	JAMECO ELECTR. 630, 631	239	OLDEN 44
73	CMC, INT'L 24	152	DISKWORLD 610	244	JDR MICRODEVICES INC. 648, 649	325	OLIVETTI AND C.SPA 65
74	COGITATE 430	153	DISPLAY TELECOMMNTNS. 613	245	JDR MICRODEVICES INC. 650, 651	326	OLYMPIC SALES 518
75	COGITATE 620	154	DISPLAYED VIDEO 607	246	JDR MICRODEVICES INC. 652	328	OMNISOFT 257
76	COLORADO COMP. PERIPH. 606	155	DMA 477	247	JUKI INDUSTRY OF AMERICA 201	*	ORA ELECTRONICS 595
77	COLUMBIA DATA PROD. 121	156	DMA SYSTEMS 369	248	KADAK PRODUCTS B2	329	ORANGE MICRO 227
78	COMMAND SERVICES CORP. 600	157	DOKAY COMP. PROD. INC. 632, 633	249	KAYPRO 548, 549	330	ORANGE MICRO 272, 273
79	COMMERCIAL BUSINESS SYS. 597	158	DOW JONES SOFTWARE 9	250	KELLY COMP.SUPPLIES 602	331	ORANGE MICRO 365
80	COMMUNICATIONS ELECTR. 196, 197	159	DWIGHT CO., INC. 620	251	KELLY COMP.SUPPLIES 612	332	ORYX SYSTEMS 552, 553
81	COMP. COMPNTS. UNLTD. 634, 635	160	DYNACOMP 616	252	KELLY COMP.SUPPLIES 620	333	OSBORNE/MCGRW-HILL 450
82	COMP. COMPNTS. UNLTD. 636, 637	161	DYNACOMP 616	253	KENSINGTON MICROWARE 339	*	PACIFIC COMPUTERS 336
487	COMP.WHOLESALERS OF FREDERICK 408	162	DYNAX, INC. 167	254	KERN PUBLICATIONS 404, 405	334	PACIFIC EXCHANGES 602, 610, 612, 614, 616, 620, 644
*	COMPAQ COMPUTER CORP. 10, 11	162	DYSAN CORP. 449	255	KEYTRONICS CORP. 389	498	PACIFIC INFOTECH 108
86	COMPETITIVE EDGE 448	222	EAGLE COMPUTER 528, 529	256	KING SOFTWARE 600	335	PAN AMERICAN ELEC. INC. 608
		163	EAGLE SOFTWARE 162	258	LABORATORY MICROSYS. 82	494	PANASONIC IND CO. 90
						336	PASCOT 74
						503	PC NETWORK 537
						337	PC WARE INC. 312, 313
						339	PEACHTREE SOFTWARE 500
						340	PEACHTREE SOFTWARE 501
						341	PEACHTREE SOFTWARE 502
						342	PEACHTREE SOFTWARE 503
						343	PEACHTREE SOFTWARE 505
						499	PEGASUS DATA 408
						344	PER SCI INC. 614
						*	PERCOM DATA 19, 21
						485	PHACT ASSOC. 534
						345	PHONE I, INC. 86

To get further information on the products advertised in BYTE, fill out the reader service card with your name and address. Then circle the appropriate numbers for the advertisers you select from the list. Add a 20-cent stamp to the card, then drop it in the mail. Not only do you gain information, but our advertisers are encouraged to use the marketplace provided by BYTE. This helps us bring you a bigger BYTE. The index is provided as an additional service by the publisher, who assumes no liability for errors or omissions. *Correspond directly with company.

Reader Service

Inquiry No.	Page No.	Inquiry No.	Page No.	Inquiry No.	Page No.	Inquiry No.	Page No.
486	PLUM HALL 532	378	SAGE COMP. TECH. 173	409	SUPERSOFT 77	439	TSK ELECTR. CORP. 133
346	PRACTICAL PERIPH. 123, 124, 125	379	SAKATA 249	410	SWI INT'L 379	441	U.S. MICRO SALES 646, 647
500	PRACTICAL PERIPH. 332	501	SCIENTIFIC COMPUTER 602	411	SYNETIX 20	440	U.S. ROBOTICS 130
348	PRIMAGES INC. 467		SCOTTSDALE SYSTEMS 117	412	SYNETIX 328	442	UNIPRESS SOFTWARE INC. 334
347	PRINCETON GRAPHIC SYS. 296, 297	380	SEATTLE COMP. PRODS. 60	413	SYSTEM VISION CORP. 160	443	UNIVERSAL DATA SYS 58
348	PRINTEK 295	381	SEATTLE COMP. PRODS. 507	414	TALLGRASS TECH. 61	444	VERBATIM CORP. 183
349	PRINTER STORE, THE 116	382	SEEQUA COMP. CORP. 6	415	TATUM LABS 612	445	VIDEX 15
351	PRIORITY ONE 640, 641	383	SEKON COMPUTER 160	416	TAVA CORP. 416	446	VIMA 470
508	PRO MICROSYSTEMS 642	384	SELECTONE CORP. COMP. PROD. 610	417	TAYCO BUSINESS FORMS 620	447	VISUAL TECH, INC. 351
352	PROF. SOFTWARE PROD. 154	385	SEMI DISK SYSTEM 137	427	TDI SYS. INC. 266	520	VLM COMPUTER 280
353	PROGRAMMERS SOFTWARE EX. 306	386	SGL HOMALITE 120	418	TDK ELECTRONICS 353	448	VOICE MACHINE COMMUN. 321
353	PROGRAMMING INT'L 260, 261	387	SHARP ELECTRONICS 289	419	TECH STAR LABORATORY 610	449	VOTRAX 521
353	PROGRAMMING INT'L 284, 285	366	SIEMENS COMM. SYS. INC. 34, 35		TEKTRONIX INC. 223	450	VR DATA 115
356	PROMETHEUS PRODUCTS 397		SILICON SPECIALTIES 104	420	TELETEK ENTERPRISES, INC. 55	451	W.T.I. COMP. & PERIPH. PROD. 425
357	PURCHASING AGENT, THE 136	389	SLR SYSTEMS 610	421	TELETEK COMMUNICATIONS 345	452	WADSWORTH ELECTR. PUB. CO. 491
358	QUADRAM CORP. 22, 23	390	SLR SYSTEMS 616	507	TERMINAL DATA 642	453	WANG ELECTR. PUB. INC. 138
359	QUANT SYSTEMS 616	391	SOFTLINE CORP. 66	422	TERRAPIN INC. 230		WANG INSTITUTE 461
360	QUASAR DATA PROD. INC. 171	392	SOFTQUEST 118	423	TEXAS COMP. SYS. 243		WANG LABS INC. 557
361	QUBIE DISTRIBUTING 355	393	SOFTWARE AUTOMATION 225	424	TEXAS INSTRUMENTS 184		WAREHOUSE SOFTWARE 128
362	QUCES 493	394	SOFTWARE BANC 244, 245		TEXAS INSTRUMENTS 440, 441, 465	454	WCB COMPUTERS 614
363	QUESTIONNAIRE SERVICE CO. 608	396	SOFTWARE BANC DEALER SERV. 119	425	THINKERS SOFT INC. 487	455	WESTERN TELEOMATIC 391
475	RADIO SHACK CIV	397	SOFTWARE FASHION 547	426	THREE M COMPANY 112		WESTICO INC. 419
365	RANA SYSTEMS 25		SOFTWARE GUILD 516, 517	428	TIMEX COMPUTER 281	92	WHITAKER, H.L. 644
388	RANA SYSTEMS 27	398	SOFTWARE SERVICES 602	429	TINNEY, ROBERT GRAPHICS 398	456	WHITESMITHS LTD 525
367	RANDOM ACCESS INC. 610	490	SOFTWARE SOLUTION 205		TINNEY, ROBERT GRAPHICS 550	457	WILLIAMS, MARK CO. 539
368	RHINO ROBOTS INC. 608		SORCIM 16, 17	430	TITAN TECHNOLOGY 422	458	WINTEK CORP. 608
	ROCKY MOUNTAIN MICRO INC. 283	400	SPECTRON INSTRUMENTS 602	431	TITAN TECHNOLOGY 438	460	WORLDWIDE COMP. SUPPLIES 644
	ROCKY MT. SOFT. SYS. 348, 349	401	SPSS 277	432	TOPOZ, INC. 221	517	WRITING CONSULTANTS 280
516	ROGERS LAB 280	402	STAR MICRONICS 126	433	TOSHIBA AMERICA INC. 436	462	XEROX PRINTING SYSTEMS 566, 567
369	RTL PROGRAMMING AIDS 522	403	STARBUCK DATA CO. 204	434	TOSHIBA AMERICA INC. 437	463	ZAM CONSULTANTS 606
496	RUTISHAUSER 573	404	STM CORP 163	435	TRANSACTION STORAGE SYS. 135		
370	RYDEX INDUSTRIES CORP. 474	405	SUNDEX 393	436	TRANSTAR 185		
371	S C DIGITAL 508	406	SUNNY INT'L. 599	437	TRANSTAR 523		
372	S-100 DIV. 696 CORP. 92	407	SUNTRONICS 597	438	TRISTAR DATA SYS. 162		
377	SAFWARE 192	408	SUPERSOFT 75		TRONIX 616		

*Correspond directly with company.

BYTE ADVERTISING SALES STAFF:

J. Peter Huestis, Advertising Sales Manager, 70 Main Street, Peterborough, N.H. 03458 Tel (603) 924-9281

NEW ENGLAND

ME, NH, VT, MA, RI
Paul McPherson, Jr. (617) 262-1160
McGraw-Hill Publications
607 Boylston Street
Boston, MA 02116

ATLANTIC

NJ (NORTH), NY, NYC, CT
Eugene Duncan (212) 512-2096
McGraw-Hill Publications
1221 Avenue of the Americas—39th Floor
New York, NY 10020

Dick McGurk (212) 512-3588

McGraw-Hill Publications
1221 Avenue of the Americas—39th Floor
New York, NY 10020

EAST

PA (EAST), NJ (SOUTH), MD, VA, W.VA, DE, D.C.
Daniel Ferro (215) 496-3833
McGraw-Hill Publications
Three Parkway
Philadelphia, PA 19102

SOUTHEAST

NC, SC, GA, FL, AL, TN
Maggie McClelland (404) 252-0626
McGraw-Hill Publications
4170 Ashford Dunwoody Road—Suite 420
Atlanta, GA 30319

MIDWEST

IL, MO, KS, IA, ND, SD, MN, WI, NB
Jack Anderson (312) 751-3740
McGraw-Hill Publications
Blair Building
645 N. Michigan Ave.
Chicago, IL 60611

GREAT LAKES, OHIO REGION

MI, OH, PA (ALLEGHENY), KY, IN, EASTERN CANADA
Dennis Riley (313) 352-9760
McGraw-Hill Publications
4000 Town Center—Suite 770
Southfield, MI 48075

SOUTHWEST, ROCKY MOUNTAIN

UT, CO, WY, OK, TX, AR, MS, LA
Alan Morris (214) 458-2400
McGraw-Hill Publications
Prestonwood Tower—Suite 907
5151 Beltline
Dallas, TX 75240

SOUTH PACIFIC

Southern CAN, AZ, NIM, LAS VEGAS
Page Goodrich (714) 557-6292
McGraw-Hill Publications
3301 Red Hill Ave
Building #1, Suite 222
Costa Mesa, CA 92626

Karen Niles (213) 480-5243, 487-1160

McGraw-Hill Publications
3333 Wilshire Boulevard #407
Los Angeles, CA 90010

NORTH PACIFIC

HI, WA, OR, ID, MT, NORTHERN CALIF, NV
(EXCEPT LAS VEGAS), W. CANADA
David Jern (415) 362-4600
McGraw-Hill Publications
425 Battery St.
San Francisco, CA 94111

Bill McAfee (415) 964-0624

McGraw-Hill Publications
1000 Elwell Court—Suite 225
Palo Alto, CA 94303

WEST COAST SURPLUS AND RETAIL

ACCOUNTS
Tom Harvey (805) 964-8577
3463 State St.—Suite 256
Santa Barbara, CA 93105

Post Card Mailings

National
Bradley Browne (603) 924-6166
BYTE Publications
70 Main Street
Peterborough, NH 03458

Seavex, Ltd.
Room 102, Yu Yuet Lal Bldg.
43-55 Wyndham St. Central
Hong Kong

Paul Ishii
McGraw-Hill Publications
Overseas Corp.
Room 1528
Kasumigaseki Bldg.
3-2-5 Kasumigaseki, Chiyoda-Ku
Tokyo 100, Japan

Mr. Arthur Scheffer
McGraw-Hill Publishing Co.
34 Dover St.
London W1X 3RA
England
01 493 1451

Mr. Emilio Zerboni
McGraw-Hill Publishing Co.
Via Flavio Baracchini 1
20123 Milan, Italy
86 90 656

Seavex Ltd.
05-49/50 Tanglin Shopping Center
19 Tanglin Rd. Singapore 1024
Republic of Singapore

International Advertising Sales Representatives:

Mr. Hans Csokor
Publmedia
Reinsnerstrasse 61
A-1037 Vienna, Austria

Mrs. Gurit Gepner
McGraw-Hill Publishing Co.
115 Yosephthal St.
Bat Yam, Israel
866 561 321 39

Mr. Fritz Krusebecker
McGraw-Hill Publishing Co.
Liebigstrasse 27C
D-6000 Frankfurt/Main 1
West Germany
72 01 81

Mrs. Maria Sarmento
Pedro Teixeira 8, Off. 320
Iberia Mart 1
Madrid 4, Spain
45 52 891

Mr. Andrew Karnig
Andrew Karnig & Associates
Kungsholmsgatan 10
112 27 Stockholm, Sweden
08 51 68 70

Mr. Michael Sales
McGraw-Hill Publishing Co.
17 rue Georges Bizet
F 75116 Paris
France
720 33 42

History will record as a profound irony
that the most powerful word processing package
ever created for the IBM® Personal Computer
can be worked with two fingers.



It was created by Leading Edge®,
specifically to take advantage of the
power of the IBM PC, plus the sim-
plicity that all that power ought to
be able to give you—but didn't.

Until now, you could go for the
simplicity, and end up with a some-
what glorified typewriter. Or you
could go for the power, and go nuts
performing dozens of commands to
do even the simplest things.

But with Leading Edge Word
Processing™ you get both.

You don't have to start with an
ounce of understanding about word
processing.

You don't even have to be a terrific
typist. (Matter of fact, the worse you
type, the more the help.)

So come along:

Hunt and peck your way into the future.



Leading Edge Products Inc., Headquarters and Retail Division, 225 Turnpike Street, Canton, Mass. 02021 (800) 343-6833 (617) 828-8150

*IBM is a registered trademark of International Business Machines Corporation.

Circle 262 on inquiry card.

www.americanradiohistory.com

Radio Shack's TRS-80® Model 100— A Big Gift That Comes in a Small Package



America's First Pre-Programmed, Ready-to-Run Truly Portable Computer!

The Micro Executive Workstation™. The TRS-80 Model 100 is one present that can be used by *any* executive—*anywhere!* This is a true portable computer that works on batteries or optional AC adapter. It's small enough to fit easily in a briefcase, yet powerful enough to serve as a desktop microcomputer. And it requires no "extras" to get started.

Ready to Use. Turn on Model 100 and five built-in management programs—plus your own files—are instantly listed on its eight-line by 40-character liquid crystal display. The full-size typewriter keyboard and the powerful editing functions of Model 100's personal word processing program make it a breeze to jot down notes or write letters and reports. Model 100 also works as an appointment calendar, address book, phone directory, plus a

telephone auto-dialer. You can even write your own BASIC programs.

A Portable Terminal. With Model 100's communications program and built-in auto-dial modem, you can access national information services, such as CompuServe® and Dow Jones News/Retrieval®. Or connect Model 100 directly to another computer—micro, mini or mainframe—using the RS-232C interface. Model 100 also includes a parallel printer port and a cassette tape interface.

Available Nationwide. You don't have to go out of your way to buy this gift! You can get the 8K Model 100 (Cat. No. 26-3801, \$799) or the 24K Model 100 (26-3802, \$999) at any Radio Shack Computer Center, participating store or dealer near you.

Radio Shack®

The biggest name in little computers®

A DIVISION OF TANDY CORPORATION

Prices apply at participating Radio Shack stores and dealers. CompuServe is a registered trademark of CompuServe, Inc. Dow Jones News/Retrieval is a registered trademark of Dow Jones & Co., Inc.

Circle 475 on inquiry card.
www.americanradiohistory.com