

# BYTE®

MAY 1982 Vol. 7, No. 5

\$2.95 in USA

\$3.50 in Canada/£1.85 in U.K.

A McGraw-Hill Publication

the small systems journal



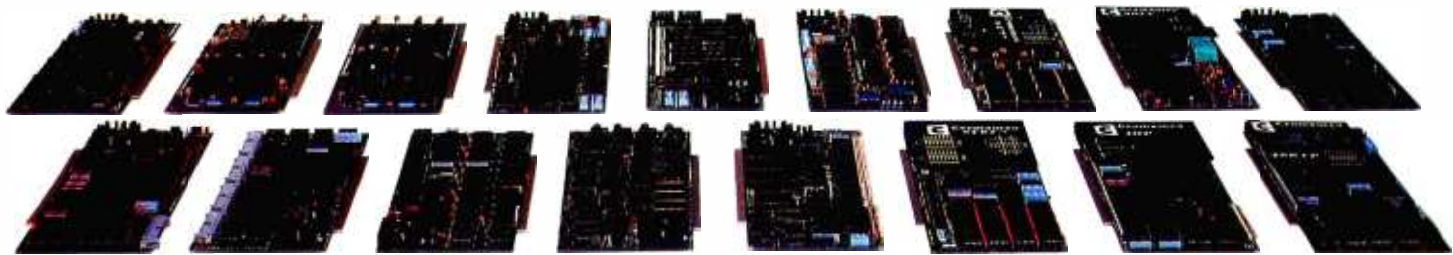
JAPANESE COMPUTERS



# A new small computer that won't limit you tomorrow



New Cromemco System One shown with our high-capability terminal and printer.



**Expandability**



Here's a low-priced computer that won't run out of memory capacity or expandability halfway through your project.

Typically, computer usage tends to grow, requiring more capability, more memory, more storage. Without a lot of capability and expandability, your computer can be obsolete from the start.

The new System One is a real building-block machine. It has capability and expandability by the carload.

Look at these features:

- **Z80-A processor**
- **64K of RAM**
- **780K of disk storage**
- **CRT and printer interfaces**
- **Eight S-100 card slots, allowing expansion with**
  - color graphics
  - additional memory
  - additional interfaces for telecommunications, data acquisition, etc.
- **Small size**

### **GENEROUS DISK STORAGE**

The 780K of disk storage in the System One Model CS-1 is much greater than what is typically available in small computers. But here, too, you have a choice since a second version, Model CS-1H, has a 5" Winchester drive that gives you **5 megabytes** of disk storage.

### **MULTI-USER, MULTI-TASKING CAPABILITY**

Believe it or not, this new computer even offers multi-user capability when used with our advanced CROMIX\* operating system option. Not only does this outstanding O/S support multiple users on this computer but does so with powerful features like multi-

ple directories, file protection and record level lock. CROMIX lets you run multiple jobs as well.

In addition to our highly-acclaimed CROMIX, there is our CDOS\*. This is an enhanced CP/M† type system designed for single-user applications. CP/M and a wealth of CP/M-compatible software are also available for the new System One through third-party vendors.

### **COLOR GRAPHICS/WORD PROCESSING**

This small computer even gives you the option of outstanding high-resolution color graphics with our Model SDI interface and two-port RAM cards.

Then there's our tremendously wide range of Cromemco software including packages for word processing, business, and much more, all usable with the new System One.

### **ANTI-OBSOLESCENCE/LOW-PRICED**

As you can see, the new One offers you a lot of performance. It's obviously designed with anti-obsolescence in mind.

What's more, it's priced at only \$3,995. That's considerably less than many machines with much less capability. And it's not that much more than many machines that have little or nothing in the way of expandability.

Physically, the One is small — 7" high. And it's all-metal in construction. It's only 14 1/8" wide, ideal for desk top use. A rack mount-option is also available.

### **CONTACT YOUR REP NOW**

Get all the details on this important building-block computer. Get in touch with your Cromemco rep now. He'll show you how the new System One can grow with your task.

\*CROMIX and CDOS are trademarks of Cromemco Inc.

†CP/M is a trademark of Digital Research

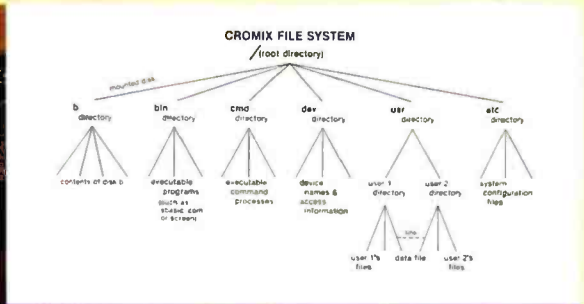


**Cromemco**™  
i n c o r p o r a t e d

280 BERNARDO AVE., MOUNTAIN VIEW, CA 94040 • (415) 964-7400  
Tomorrow's computers today

Circle 126 on inquiry card.





# CROMIX\* — Cromemco's outstanding UNIX† — like operating system

CROMIX is just the kind of major development you've come to expect from Cromemco. After all, we're already well-known for the most respected software in the microcomputer field.

And now we've come up with the industry's first UNIX-lookalike for microcomputers. It's a tried and proven operating system. It's available on both 5" and 8" diskettes for Cromemco systems with 128K or more of memory.

Here are just some of the features you get in this powerful Cromemco system:

- Multi-user and multi-tasking capability
- Hierarchical directories
- Completely compatible file, device, and interprocess I/O
- Extensive subsystem support

## FILE SYSTEM

One of the important features of our CROMIX is its file system comprised of hierarchical directories. It's a tree structure of three types of files: data files,

\*CROMIX is a trademark of Cromemco, Inc.  
†UNIX is a trademark of Bell Telephone Laboratories

directories, and device files. File, device, and interprocess I/O are compatible among these file types (input and output may be redirected interchangeably from and to any source or destination).

The tree structure allows different directories to be maintained for different users or functions with no chance of conflict.

## PROTECTED FILES

Because of the hierarchical structure of the file system, CROMIX maintains separate ownership of every file and directory. All files can thus be protected from access by other users of the system. In fact, each file is protected by **four separate access privileges** in each of the three user categories.

## TREMENDOUS ADDRESS SPACE, FAST ACCESS

The flexible file system and generalized disk structure of CROMIX give a disk address space in excess of one gigabyte per volume — file size is limited only by available disk capacity.

Speed of access to disk files has also been optimized. Average access speeds far surpass any yet implemented on microcomputers.

## 'C' COMPILER AVAILABLE, TOO

Cromemco offers a wide range of languages that operate under CROMIX. These include a high-level command process language and extensive subsystem support such as COBOL, FORTRAN IV, RATFOR, LISP, and 32K and 16K BASICS.

There is even our highly-acclaimed 'C' compiler which allows a programmer fingertip access to CROMIX system calls.

## THE STANDARD O-S FOR THE FUTURE

The power and breadth of its features make CROMIX the standard for the next generation of microcomputer operating systems.

And yet it is available for a surprisingly low \$595.

The thing to do is to get all this capability working for you now. Get in touch with your Cromemco rep today.



**Cromemco**™  
i n c o r p o r a t e d

280 BERNARDO AVE., MOUNTAIN VIEW, CA 94040 • (415) 964-7400

Tomorrow's computers today

Circle 127 on inquiry card.



## Features

**34 Everyone Can Know the Real Time** by Steve Ciarcia / Technological advances have made real-time clocks simple and inexpensive.

**60 Six Personal Computers from Japan** by Christopher P. Kocher and Michael Keith / A comparative review of the BMC i800, Canon CX-1, Hitachi MB-6890, NEC PC-8001A, Fujitsu FM-8, and Systems Formulate Corporation Bubcom80.

**106 Japan Update** by Mark Haas / The semiannual Consumer Electronics Show is on its way to becoming a showcase for new computer products.

**114 The Machines Behind the Machines** by Phil Lemmons / Several Japanese companies, both large and small, have their eyes on the American market.

**118 The Japanese Manufacturers—How Successful Will They Be?** by Tod Zipnick / How they fare depends largely on their ability to meet the needs of the American marketplace.

**140 Japan Maps Computer Domination** by Tom Manuel / Ten-year R&D effort aims to leapfrog U.S. technology.

**148 The Atari Tutorial, Part 9: Even More Colors!** by Kathleen Pitta and Lane Winner / Television artifacts and the new GTIA chip allow even more colors to be displayed on Atari computers.

**162 Ports of Entry and Soft Breezes for the Color Computer and Model III** by William Barden Jr. / A S10 anemometer and other remote-sensing projects using the cassette interface.

**202 The Input/Output Primer, Part 4: The BCD and Serial Interfaces** by Steve Leibson / A look at one of the least understood interfaces—the RS-232C—and one of the first instrument interfaces.

**226 The User's Column: Supercalc, Spelling Programs, BASIC Compilers, and Home-Grown Accounting** by Jerry Pournelle / A critical computer user surveys new programs, including one of his own.

**274 More Maze Building** by Thomas Edward Neldner / A Pascal program to generate mazes efficiently on a printer.

**318 TRS-80 BASIC Program Hang-ups: The Reasons and Some Solutions** by Glenn Tesler / Understand and eliminate those mysterious crashes on your TRS-80 Model I.

**334 Anatomy and Development of a Batch-Processing System** by Gene Walters / A software system that lets your computer run a series of programs without your intervention.

**426 CHEDIT: A Graphics-Character Editor** by Jerry N. Sweet / Define your own character set for Apple Pascal.

**446 Give Your Apple a Voice: A Speech-Development System Using the Radio Shack Speech Synthesizer** by John Blankenship / How to make your Apple II talk.

**465 Programming PERT In BASIC** by Steven Zimmerman and Leo M. Conrad / A method for planning complex activities where no precedents exist.

**479 CP/M, Your Time Has Come: A Real-Time Clock for the Most Popular Microcomputer Operating System** by J. L. Calaway and B. Hill / All the hardware and software you need to get time-of-day printouts whenever you like.

## Reviews

**224** Alien Typhoon by Walt Latocha

**246** PU1 for Microcomputers by John A. Lehman

**252** Apple II 80-Column Video Boards, Five Popular Units by John E. Howland

**266** More Apple 80-Column Boards by Gregg Williams

**286** Colne Robotics Armdroid, The Small-Systems Robot by Steven W. Leininger

**296** Super FORTH Isn't by Gregg Williams

## Nucleus

**6** Editorial: Japan and the "64K" Question

**14** Letters

**20, 307** BYTE's Bits

**22** BYTE Comment: Copyrights, Computers, and the Betamax Case

**300, 302, 304** Book Reviews: Fifty BASIC Exercises; Programmer's Guide to the 1802; TRS-80 Color Computer Technical Reference Manual

**300** BYTE's Bugs

**308** Programming Quizzes: Structured Strings in BASIC

**388** BYTELINES

**398** Ask BYTE

**408** Event Queue

**457** Technical Forum: Hierarchical Interrupts

**460** Books Received

**462** Clubs and Newsletters

**463** Software Received

**494** What's New?

**542** BOMB, BOMB Results

**542** Unclassified Ads

**543** Reader Service



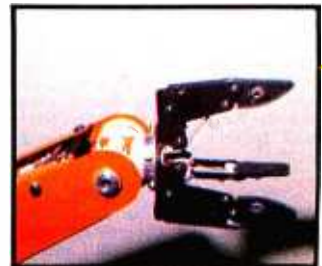
Page 60



Page 106



Page 114



Page 286





Editor in Chief

**Christopher Morgan**

**Managing Editor**

Mark Haas

**Technical Editors**

Gregg Williams, Senior Editor;  
Richard S. Shuford; Curtis P. Feigel;  
George Stewart; Arthur Little;  
Stanley Wszola; Steve Garcia; Mark Dahmke  
Philip Lemmons; Allan Lundell, Consulting  
Editors; Jon Swanson, Drafting Editor

**Copy Editors**

Beverly Cronin, Chief; Faith Hanson;  
Warren Williamson; Anthony J. Lockwood;  
Ann Graves; Hilary Selby Polk;  
Elizabeth Kepner; Margaret Cook,  
Junior Copy Editor

**Assistants**

Faith Ferry; Debe Wheeler;  
Beverly Jackson

**Production**

David R. Anderson, Assoc. Director;  
Patrice Scribner; Damian Henriques;  
Jan Muller; Virginia Reardon;  
Sherry McCarthy, Chief Typographer;  
Debi Fredericks; Donna Sweeney;  
Valerie Horn; Jonathan M. Graves,  
Creative Consultant

**Advertising**

Thomas Harvey, Director; Marion Carlson;  
Rob Hannings; Deborah Porter;  
Vicki Reynolds; Cathy A. R. Drew;  
Jacqueline Earnshaw, Reader Service  
Coordinator; Wai Chiu Li, Advertising/  
Production Coordinator; Linda J. Sweeney

**Circulation**

Gregory Spitzfaden, Manager;  
Andrew Jackson, Asst. Manager;  
Agnes E. Perry; Barbara Varnum;  
Louise Menegus; Pinky Krulis;  
Sheila A. Bamford  
James Bingham, Dealer Sales;  
Deborah J. Cadwell, Asst.  
Linda Ryan

**Controller's Office**

Daniel Rodrigues, Controller;  
Mary E. Fluhr, Acct. & D/P Mgr.; Karen  
Burgess; Jeanne Cilley; Linda Fluhr;  
Vicki Bennett

**Traffic**

N. Scott Gagnon; Scott Jackson,  
Kathleen Reckart

**Receptionist**

Jeanann Waters

**Publishers**

Virginia Londoner; Gordon R. Williamson;  
John E. Hayes, Associate Publisher;  
Cheryl A. Hurd; Michele P. Verville, Publisher's  
Assistants;

Officers of McGraw-Hill Publications Company: Paul F. McPherson, President; Executive Vice Presidents: Daniel A. McMillan, III, Gene W. Simpson; Senior Vice President-Editorial: Ralph R. Schulz; Vice Presidents: Kemp Anderson, Business Systems Development; Harry L. Brown, Special Markets; Robert B. Doll, Circulation; James E. Hackett, Controller; Eric B. Herr, Planning and Development; H. John Sweger, Jr., Marketing.

Officers of the Corporation: Harold W. McGraw Jr., Chairman and Chief Executive Officer; Joseph L. Dionne, President and Chief Operating Officer; Robert N. Landes, Senior Vice President and Secretary; Ralph J. Webb, Treasurer.



## In This Issue

The Japanese entered the American personal computer market in earnest this year, and as one might expect, their products come standard with a host of "extras" at a price competitive with current American designs. This month we look closely at several Japanese personal computers—some that are already on the market, some that are on the horizon, and some that may never be sold in this country. Six machines, from Hitachi, BMC (Oki), Fujitsu, Canon, Systems Formulate, and NEC, are featured on the cover (photographed by Paul Avis; Pauline Elkin, stylist). For reviews of these computers see "Six Personal Computers from Japan" by Christopher P. Kocher and Michael Keith. Phil Lemmons discusses the companies responsible for these computers in "The Machines Behind the Machines." For a brief introduction to three new Japanese computers that were shown at the recent Consumer Electronics Show in Las Vegas see "Japan Update" by Mark Haas.

Steve Garcia tells you how you can build a real-time clock simply and inexpensively. Steve Leibson continues the Input/Output Primer with Part 4, in which he describes BCD and serial interfaces. Part 9 of the Atari Tutorial is on colors, and William Barden Jr. talks about ports of entry for the Color Computer and Model III.

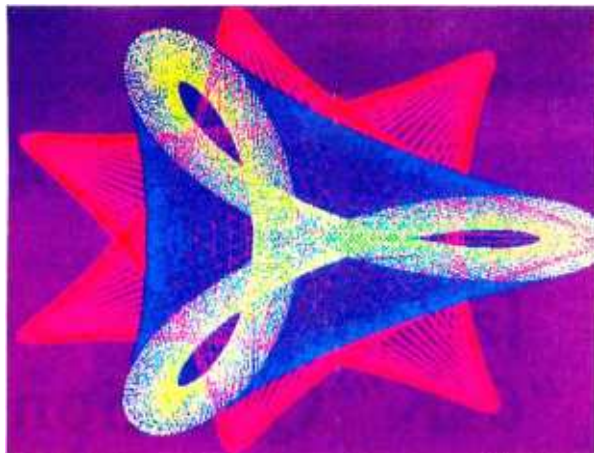
BYTE is published monthly by BYTE Publications Inc. 70 Main St. Peterborough NH 03458, phone (603) 924-9281, a wholly-owned subsidiary of McGraw-Hill, Inc. Address subscriptions, change of address, USPS Form 3579, and fulfillment questions to BYTE Subscriptions, POB 590, Martinsville NJ 08836. Second class postage paid at Waseca, Minnesota 56093 - USPS Publication No. 528890 (ISSN 0360-5280). Canadian second class registration number 9321. Subscriptions are \$19 for one year, \$34 for two years, and \$49 for three years in the USA and its possessions. In Canada and Mexico, \$21 for one year, \$38 for two years, \$55 for three years. \$43 for one year air delivery to Europe. \$35 surface delivery elsewhere. Air delivery to selected areas at additional rates upon request. Single copy price is \$2.95 in the USA and its possessions, \$3.50 in Canada and Mexico, \$4.50 in Europe, and \$5.00 elsewhere. Foreign subscriptions and sales should be remitted in United States funds drawn on a US bank. Printed in United States of America.

Address all editorial correspondence to the editor at BYTE, POB 372, Hancock NH 03449. Unacceptable manuscripts will be returned if accompanied by sufficient first class postage. Not responsible for lost manuscripts or photos. Opinions expressed by the authors are not necessarily those of BYTE. Entire contents copyright © 1982 by BYTE Publications Inc. All rights reserved. Where necessary, permission is granted by the copyright owner for libraries and others registered with the Copyright Clearance Center (CCC) to photocopy any article herein for the base fee of \$1.00 per copy of the article or item plus 25 cents per page. Payment should be sent directly to the CCC, 21 Congress St. Salem MA 01970. Copying done for other than personal or internal reference use without the permission of McGraw-Hill is prohibited. Requests for special permission or bulk orders should be addressed to the publisher.

BYTE® is available in microform from University Microfilms International, 300 N Zeeb Rd. Dept PR, Ann Arbor MI 48106 USA or 18 Bedford Row, Dept PR, London WC1R 4EJ England.

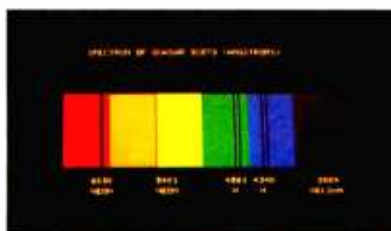


Office hours: Mon-Thur 8:30 AM - 4:30 PM, Friday 8:30 AM - Noon, Eastern Time



"...stands well above other S-100 graphics displays in its price and performance range."

BYTE, Product Review



"...better monochromatic display..."

ELECTRONIC DESIGN,  
1981 Technology Forecast

# MICROANGELO

**HIGH RESOLUTION GRAPHICS SINGLE BOARD COMPUTER**  
512 x 480 resolution black and white and vivid color displays

RS-170 composite or direct drive output

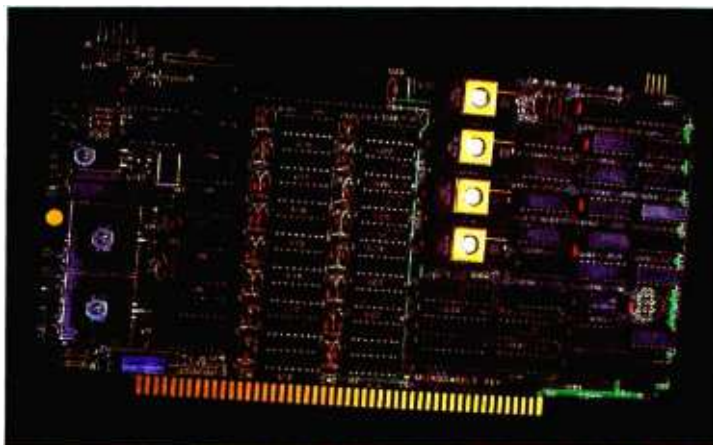
Local or external sync generation

4 Mhz Z80 microprocessor

60 hertz real-time clock

8 level interrupt tie-in

IEEE S100 bus compatible



Light pen interface

Time multiplexed refresh

4K resident Screenware™ Pak I operating system

32K RAM isolated from host address space

High speed communications over parallel bus ports

## Screenware™ Pak I

A 4K byte operating system resident in PROM on MicroAngelo™. Pak I emulates an 85 character by 40 line graphics terminal and provides over 40 graphics commands. Provisions exist for user defined character sets and directly callable user extensions to Screenware™ Pak I.

## Screenware™ Pak II

An optional software superset of Pak I which adds circle generation, polygon flood, programmable split screen for separate graphics and terminal I/O, relative coordinates, faster vector and character plotting, a macro facility, full UCSD Pascal compatibility, and more.

## And now...COLOR!!

The new MicroAngelo™ Palette board treats from 2 to 8 MicroAngelos as "bit planes" at a full 512 x 480 resolution. Up to 256 colors may be chosen from 16.8 million through the programmable color lookup table. Overlays, bit plane precedence, fade-in, fade-out, gray levels, blinking bit plane, and a highly visual color editor are standard.

**Ask about our multibus and RS-232 versions.**

# SCION

Circle 370 on inquiry card.

12310 Pinecrest Road • Reston, VA 22091 • (703) 476-6100 • TWX: 710-833-0684



**syn · op · sis**, n. 1. a brief compendium of comments giving an overview of the whole subject.

2. a central index to the CP/M files on all your disks.

**YOUR FILE CONTENTS  
AT A GLANCE!**

**SOFTWARE.LET  
/DISK#23**

1 January 1982  
Ellen J. Potter: pb  
Digital Marketing Corp.  
Order for Synopsis

SYNOPSIS™ automatically maintains a central index with the file name, disk I.D., plus four user-defined lines of comments about any CP/M file, (i.e. date, writer, addressee, and subject.)

When editing a document file, just enter the four lines as non-printing comments at the top of your text. SYNOPSIS automatically reads the comments into the index. Nondocument files can also be cataloged in the index.

You can search the index for words or phrases in one or more fields. SYNOPSIS displays each full entry found.

The price is \$125. SYNOPSIS requires CP/M 2.x or MP/M, WordStar, Spellbinder or Magic Wand and 48K RAM. Formats: 8", NorthStar DD, Micropolis Mod II, Superbrain 3.0, Apple II with CP/M, 5¼" Xerox and 8" Xerox.

SOFTWARE  
SOFTWARE  
**DIGITAL MARKETING**  
DIGITAL MARKETING™



**DIGITAL MARKETING CORPORATION**

2670 CHERRY LANE • WALNUT CREEK • CA • 94596  
(415) 938-2880 • Telex 17-1852 (DIGMKTG WNCK)  
Dealer Inquiries Invited

A Product Of

**PRO/TEM**

140 TEV SOFTWARE

Trademarks: Synopsis - Pro/Tem Software - CP/M, MP/M - Digital Research - WordStar - MicroPro Int'l - Spellbinder - Lexisoft - Magic Wand - Peachtree Software.

## Editorial

# Japan and the "64K" Question

by Chris Morgan, Editor in Chief

Last May, Senior Editor Gregg Williams and I went to Tokyo to prepare for this special issue featuring the new Japanese personal computers. "Will the Japanese take over?" we asked ourselves during our ten-day whirlwind tour of major Japanese electronics firms. That was the 64K question. The answer is "There is no answer."

One can draw parallels to other consumer markets in which the Japanese have become dominant, but those comparisons would be risky. For one, U.S. companies offered no real competition to the Japanese when the latter swept in to blitz the car, camera, and audio markets. But the situation is fundamentally different in the computer field. The vast majority of technical computer innovations have come from American research-and-development labs—till today, at least. But now the Japanese are aggressively entering the R&D field. Therein lies the danger (or the opportunity, depending on your point of view).

The question of whether the Japanese will take over or not is, in a sense, moot. By one definition they already have. Lift the lid on almost any personal computer and you'll see scores of Japanese-made components: resistors, capacitors, and ICs (especially memories, a field where the Japanese dominate the world market). Often a majority of the components are made in Japan. Yet in another sense the Japanese must fight an uphill battle against the creativity of American computer companies.

The other big "if" in the picture is the U.S. government's position on Japanese imports in general. The Japanese are all too aware that a major change in import duties or quotas could quickly cut them off from the world's most lucrative consumer-electronics and computer market.

What will their strategy be? I see a two-pronged approach: (1) form joint ventures with American companies so the Japanese will have access to the U.S.'s vaunted software experience, and (2) complete the development of the recently announced "Japanese master plan for a fifth-generation computer system" with a massive R&D push. I'll describe both approaches in detail. First, the joint-venture strategy.

### Japanese-American Joint Ventures

The Japanese are weakest in software development; their track record has been uneven. They've developed some of the best video-game software in the business (e.g., Space Invaders and Pac-Man), but their business software has been virtually nonexistent. One reason for this is the radically different way the Japanese conduct business, a direct function, in turn, of the complexity of written Japanese. The Japanese use three different character sets containing a myriad of symbols. A conventionally designed Japanese typewriter would be almost a contradiction in terms. To my knowledge there are no typewriters

# PERCOM

## YOU GET MORE OUT OF PERCOM DISK SYSTEMS.

# EXPECT IT!

At Percom, our business is making disk storage systems for microcomputers — something we've been doing right, since 1977.

From the design of rock-solid drive controller circuitry to quality controls that include 100% life testing of every drive shipped, you can expect to get more out of Percom Disk Systems.

And Percom provides you with comprehensive after-sales service from our wholly owned, fully independent customer service center.

### WINCHESTER 10-MEGABYTE DISK STORAGE SYSTEMS

Enormous storage capacity plus high speed. Percom 5¼ inch hard disk systems are 40 times faster than single-density floppy mini-disks, 20 times faster than double-density units.

Systems include a smart, four-drive controller featuring state-of-the-art data encoding and separation, adaptable industry-standard disk interfacing. Versions for the Apple II, Atari,



### FLOPPY MINI-DISK STORAGE SYSTEMS

40 or 80-track drives, single or dual-head, floppy or non-floppy — all double-density rated. Available in 1, 2 and 3-drive add-on units, 1 and 2-drive internal units, with full documentation and software support. Add-on drives from \$399, complete systems from \$459.95.

To learn more about quality Percom disk storage systems, mail the coupon today. Or, call toll-free 1-800-527-1222.

**YES... I'd like to know more about Percom disk systems. Please rush me information.**

Send to: PERCOM DATA COMPANY, INC. Dept BD1  
11220 Pagemill Road, Dallas TX 75243

name \_\_\_\_\_

street \_\_\_\_\_

city \_\_\_\_\_ state \_\_\_\_\_ zip \_\_\_\_\_

phone number \_\_\_\_\_

I'm interested in floppy disk storage for my...  
TRS-80  Mdl I  Mdl II  CC  IBM PC  
 H/Z-89  H-8  AIM/KIM/SYM  System-50

I'm interested in hard disk storage for my...  
 IBM PC  TRS-80 Mdl III  Apple II  Atari  H/Z-89

Other computer? \_\_\_\_\_  
( floppy disk or  hard disk?)



## THE DRIVE PEOPLE

11220 Pagemill Road • Dallas TX • 75243 • (214) 340-7081

PRICES AND SPECIFICATIONS SUBJECT TO CHANGE WITHOUT NOTICE.  
\*TRS-80 is a trademark of Tandy Radio Shack Corporation which has no relationship to Percom Data Company, Inc.  
© 1981 Percom Data Company, Inc.



# Pascal/Z

## NEW 4.0

### SYMBOLIC DEBUGGER

This fourth generation version of our reliable, Z-80 native code compiler adds the two features professionals ask for:

- ◆ **InterPest™**—an interactive *symbolic Pascal debugger* that allows easy error detection.
- ◆ **Overlays**—that allow larger programs to run in limited memory.

### A compiler for Professional programmers

Pascal/Z is a true Pascal. It closely follows the Jensen and Wirth standard with a minimum of extensions designed to aid the serious program developer in producing extremely compact, bug-free code that runs FAST.

Pascal/Z generates Z-80 native code that is ROMable and Re-entrant. Permits separate compilation, direct file access, external routines and includes a relocating macro assembler and Microsoft compatible linker. And code written for Pascal/Z is fully compatible with I-PAS 8000, our new native code Pascal compiler for Z-8000, to guarantee graceful migration to 16 bit operation.

### Get "The FACTS about Pascal"

Confused about which Pascal to buy? Pseudo-code... Native code... M, MT or Z? Compare the *unbiased* benchmarks in our new booklet. **Don't buy a Pascal compiler until you've read it.**

Call us for a free copy:

**800-847-2088**

(outside NYS)

**or 607-257-0190**

And ask your local full-service computer dealer about our Pascal/Z demo package.



**InterSystems™**  
Ithaca Intersystems Inc.

**Micros for bigger ideas.**

Ithaca Intersystems Inc.

1650 Hanshaw Rd • Ithaca, NY 14850 • TWX 510 255-4346

U.K. Distributor:

**Ithaca Intersystems (U.K.) Ltd.**

Coleridge Road London N8 8ED Phone: 01-341 2447 Telex: 299568

### Editorial

that can type Japanese characters. (Significant progress is being made, however, in the display of Japanese characters on video screens. At last year's Tokyo Microcomputer Show, several computer terminals were shown for the first time displaying all three Japanese character sets: kanji, katakana, and hiragana.) Japanese secretaries write all business correspondence—what there is of it—in longhand because most negotiations are conducted verbally. As a result, the Japanese lack an intuitive understanding of American office procedures and are hampered in their ability to design good word-processing software.

To remedy this situation, many Japanese computer companies are obtaining licenses from U.S. companies to use software such as CP/M, Microsoft BASIC, and Visicalc on Japanese computers, and they are forming joint ventures with American companies, such as the Fujitsu/TRW connection. This type of alliance helps cloud the issue of import restrictions, because the U.S. companies could rightly claim that actions against a Japanese partner would hurt the American partner too. Japanese companies are also building, or planning to build, production plants in America. Japanese electronics companies are sometimes more adventuresome than their American counterparts. In the videodisc field (which we'll be covering in detail next month), despite IBM's and MCA's withdrawal from the laserdisc market, Pioneer is planning to build an American videodisc production plant. Pioneer deserves high praise for backing the best videodisc format and not letting it die. It's unfortunate that RCA and Sears are continuing to promote the inferior Selectavision system.

### The "Master Plan"

Of potentially greatest significance in Japan's computer fortunes is the ten-year plan for national computer policy announced last fall by the Japanese Information Processing Development Center (JIPDEC), whereby Japanese computer companies would jointly develop a grandiose fifth-generation computer system on several different levels, relying on sophisticated artificial-intelligence research into natural languages and graphics. (See Tom Manuel's article, "Japan Maps Computer Domination," page 140.) This may sound like a major threat, but as Tod Zipnick says (page 118), in many cases Japanese computers are designed for the Japanese market. One of the biggest technological problems the Japanese face today is that their written language is virtually unusable for fostering computer literacy. (All the Japanese software we saw was written mostly in BASIC with Japanese REM statements. The REM statements were written in a phonetic, Roman form of kanji that the Japanese use with some reluctance because it is considered aesthetically inferior to true kanji. Quite simply, there is no practical alternative if the Japanese wish to do any meaningful programming. The fact is that every high-level language

Circle 219 on inquiry card.

Circle 220 on inquiry card. ➔

# Ithaca 525/800™

A computer system so advanced, the technology you'll need later is already here. And waiting.



The Ithaca 525/800 gives you the ability to address an almost unlimited number of applications in business, scientific, and educational environments.

Its state-of-the-art hardware gives you a single or multi-user 8-bit system in one machine that handles 5 $\frac{1}{4}$ " or 8" floppy and hard disks.

It has a processor that's 50% faster than conventional systems. A unique Cache CP/M® - MP/M® system that's typically 500% faster. That's right, 500%. And up to 1 Mbyte of memory.

It has add-on capacity built-in now, ready to expand when you're ready. There are no hidden costs to pay for later. Everything you need comes with the

Ithaca 525/800. In fact, it could be the only system you'll ever need.

It's simply the finest price/performance Z-80® based system available. And it's here now, waiting for your call.

**800-247-2088**

In New York State  
(607) 257-0190

**Ithaca**  
Computer Systems™

*We think as fast as you do.*

1650 Hanshaw Road, P.O. Box 91  
Ithaca, NY 14850  
TWX: 510-255-4346

® CP/M and MP/M Digital Research, Inc.    ® Z-80 Zilog, Inc.    ™ Ithaca 525/800 Ithaca InterSystems, Inc.



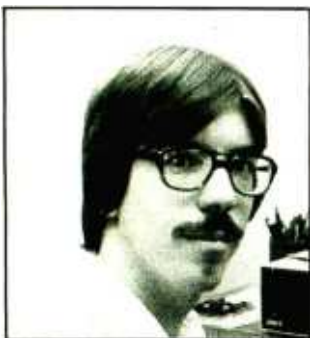
presently in existence uses some form of the English-based ASCII character set.) And the Japanese (like the Chinese, who face a similar problem) must become as computer-literate as the rest of the world to survive in the coming computer age. Their preoccupation with overcoming the computer-language barrier will necessarily temper their aggressive ways for a while. Nonetheless, I have a great deal of respect for their ability to get up to speed quickly.

I welcome the Japanese into the "international computer sweepstakes." Only when we begin to think on a more global than national scale will we see that the so-called "Japanese threat" is really more of an "international promise."

\* \* \*

### A Note About Our Hardware Reviewers

This month we review six Japanese computers in "Six Personal Computers from Japan" (page 60) cowritten by Michael Keith and Christopher Kocher. Both men work in advanced computer science research in the southern New Jersey area and wrote the NEC PC-8001 review that appeared in the January 1981 BYTE (page 72). Producing these six comprehensive reviews was a major undertaking, and we thought BYTE readers would enjoy learning a little bit about their backgrounds.



Michael Keith



Chris Kocher

Michael Keith is 26 years old and has a BS degree in electrical engineering from the New Jersey Institute of Technology and an MS in electrical engineering from Stanford University. He owns an Apple II computer. Among other things, he uses it in his spare time to manage the finances of his church. His other pursuits include playing the piano, reading, and juggling.

Thirty-four-year-old Chris Kocher has a BA in chemistry and an MS in systems engineering, both from the University of Pennsylvania. He is, in his own words, "slowly making my way toward a PhD in systems engineering." His hobbies include collecting books (over 2000 so far) and cross-country skiing. ■

# CompuView

## New! CP/M-86 For IBM PERSONAL COMPUTER

The first available implementation of CP/M-86 for the IBM Personal Computer has the features needed to run the full range of CP/M-86 application programs. Included are serial and parallel printer support, a 'smart' screen driver which can emulate most popular CRT terminals, and double density 193K/drive disk capacity. The Tecmar, Inc. Winchester hard disk & other peripherals are also supported.

Innovative features include built in horizontal scrolling and screen line editing which lets the user extensively edit or re-enter any line on the screen for CP/M and application programs. Besides editing the line being typed in, the cursor may be moved to any line on the screen, and the line edited by overtyping or inserting and deleting characters. Typing the 'Return' key will then send the line, as it appears on the screen, to CP/M. While common on mainframe systems, this screen line editing is new to CP/M and greatly reduces the amount of retyping necessary due to mistyped or repeated commands.

CompuView CP/M-86 for IBM Personal Computer. . . \$325  
VEDIT-86 with above purchase. . . . . \$100

### 8086 Software

- VEDIT full screen editor for CP/M-86, SCP 86-DOS, IBM Personal Computer and IBM Displaywriter. Disk and Manual . . . . . \$195
- CP/M-86 BIOS for popular S-100 disk controllers and SCP 8086 computer. Source Code . . . . . \$90

### V-COM Disassembler

Finally a Z-80 disassembler for CP/M which produces easy to read code, a cross reference table and handles INTEL and ZILOG mnemonics. V-COM is exceptionally fast and produces an .ASM file directly from a .COM file. V-COM can accept two user created information files. One contains assignments of labels to 8 and 16 bit values; the second specifies the location of tables and ASCII strings. The resulting .ASM file will then contain labels and proper storage allocation for tables and strings. Each information file may contain nested 'INCLUDE' to other files. Each package includes a 30 page manual, sample program files and variations of V-COM compatible with the TDL, MAC and two types of ZILOG assemblers. . . . . \$80

# Software

## An Industry Standard for CP/M & 8086



### Uniquely User Oriented

VEDIT is user oriented to make your editing for program development and word processing as fast and easy as possible. The customization (installation) process makes VEDIT the only editing package that allows you to determine your own keyboard layout and use any available cursor and function keys. Just think of the difference it makes in your ease of learning and usage to type cursor and function keys instead of memorizing obscure control characters. This customization is menu driven, extends to much more and takes only a few minutes.

### Unequaled Hardware Support

The CRT version directly supports over 35 terminals (including ANSI standard) in its installation menu and utilizes 'smart' terminal features such as line insert/delete, reverse scroll, status line and reverse video. Function keys on terminals like the Televideo 920/950, Heath H19, and IBM 3101 are all supported. The memory mapped version is extremely flexible, supports bank select such as on the SSM VB3 and screen sizes up to 70 X 200.

### Sophisticated Full Screen Editing

VEDIT gives you true 'what you see is what you get' full screen editing with an extensive set of features for creating and editing standard text files of up to one diskette in length. Very large files are effortlessly handled by VEDIT's ability to edit up to 47K of a file entirely in memory without performing any slow and annoying disk accessing. And you can handle multiple files, insert a specified line range of another file anywhere in the text and even change diskettes.

### User Oriented Features

You get the features you expect, like searching, a scratchpad buffer for moving and rearranging sections of text, complete file handling on multiple drives and flexible macros. For ease of use VEDIT has features you won't find elsewhere, like automatic indenting for use with structured languages such as Pascal and PL/I. You are less likely to make a mistake with VEDIT, but if you do, one key will 'Undo' the changes you just made to a screen line. And if you run out of disk space with VEDIT, you can easily recover by deleting old files or even inserting another diskette. It is therefore no surprise that VEDIT is the industry standard for program development editing.

### Word Processing

VEDIT is suitable for simple stand-alone word processing, or it may be used in conjunction with a text processor. Its features include word wrap, adjustable left margin, reformatting of paragraphs, word oriented cursor movement and deleting, and imbedding of printer control characters. VEDIT can print any portion of your file and display the cursor's line and column positions.

Now for  
IBM  
Personal Computer  
XEROX 820

### Ordering

Please specify your micro-computer, video board or the CRT terminal version, the 8080, Z80 or 8086 code version and disk format.

VEDIT - Disk and manual  
For 8080 or Z80 . . . . . \$145  
For CP/M-86 or IBM MDOS . \$195  
Manual only . . . . . \$15

VISA and MASTER CARD Welcome.

Apple II Softcard • TRS-80 II and I  
SuperBrain • Heath H8/H89 • Altos  
NorthStar • Vector • MP/M • IBM

1955 Pauline Blvd., Suite 200  
Ann Arbor, Michigan 48103  
(313) 996-1299

# CompuView

**PRODUCTS, INC.**

CP/M and MP/M are registered trademarks of Digital Research, Inc. Apple II is a registered trademark of Apple Computer, Inc. Softcard is a trademark of Microsoft. TRS-80 is a trademark of Tandy Corporation.

Circle 113 on inquiry card.



# CHECK YOUR MAILBOX!

All U.S. BYTIZ subscribers should receive a **PRIORITY ONE ELECTRONICS Spring 1982 Engineering Selection Guide** in the mail by **May 10, 1982**. If you don't receive yours, send **\$5.00** and we'll send you a copy by **return 1st Class Mail**. **Canada and Mexico** send **\$1.00** in U.S. Currency. **All other countries** send **\$4.00** in U.S. Currency or **22 International Reply Coupons**.





**THE NEW CATALOG IS HERE!**  
**THE NEW CATALOG IS HERE!**



Just attach this coupon to the face of your order form

**DISCOUNT COUPON** \*

From Our **SPRING 1982 ENGINEERING SELECTION GUIDE**

✓ Appropriate Box

**1**  
**PRIORITY ONE ELECTRONICS**  
 9161 Deering Ave., Chatsworth, CA 91311

- \$100 - \$149.99 ..... Deduct \$10.00
- \$150 - \$199.99 ..... Deduct \$15.00
- \$200 - \$299.99 ..... Deduct \$20.00
- \$300 - \$399.99 ..... Deduct \$30.00
- \$400 - \$499.99 ..... Deduct \$40.00
- \$500 & UP ..... Deduct \$ 10%

Valid on Prepaid U.S. Mail Orders Received Before June 15, 1982  
 Present This Coupon at Our Retail Store Before June 15, 1982

\*Sorry, Discount Coupon Not Valid on Shipping Charges, Phone or Foreign orders  
 Circle 341 on inquiry card.



## IBM's Personal Computer

I am in love! After spending considerable time at the local IBM Product Center and reading many highly favorable articles on the IBM Personal Computer, I have concluded that it is the best personal computer on the market today.

I especially enjoyed Gregg Williams's "A Closer Look at the IBM Personal Computer" (January 1982 BYTE, page 36). This was the most complete and detailed article I have seen on the Personal Computer. However, I am confused about one point: does the BIOS (basic input/output system) reside in ROM (read-only memory) or in the DOS? From other sources, I have heard that it occupies 6K bytes of ROM, along with BASIC and the power-on self-test software; Mr. Williams contends that it is in the DOS. Who's right?

Thank you for a terrific article in a terrific magazine!

Arthur A. Glecker  
2726 Saint Paul St.  
Baltimore, MD 21218

*In a long article, pieces of information do not always get grouped in the best possible way. Although the section on the IBM BIOS does not say that the BIOS is in ROM, the last line of table 6 (page 54) does give this information. Thanks for your interest in my article. . . . G. W.*

I enjoyed "A Closer Look at the IBM Personal Computer." It was the first review I've read that contained nontrivial information. I learned things I didn't know even though I've read most of the manuals and have played with the computer to some extent.

On the negative side, I think your benchmarks were not quite fair to the IBM Personal Computer BASIC. Unlike most other BASICs, IBM's BASIC allows the use of integer variables in FOR statements. Since most FOR loops are over integers anyway, it certainly makes sense to use an integer variable index if it is available. In the benchmarks this could be accomplished by changing the Is to I%s or by using DEFINT I to declare I as an integer variable. If you try it, I think you'll

find that it knocks 2+ seconds off each of the IBM PC times.

Jim Mehl  
POB 632  
Los Gatos, CA 95030

*Thank you for your kind words about my article on the IBM Personal Computer. However, I must reiterate a point that seems to be forgotten by many BYTE readers: that a benchmark gains its validity by executing, as much as is possible, the same program on different machines. Integer variables are nothing new; several other Microsoft BASICs have integer variables (e.g., Apple II Applesoft and Radio Shack's TRS-80 Model III BASIC). When the same program coded with integer variables is run, the relative rankings of the machines should be almost exactly the same—but then, that's another benchmark, isn't it? And since we can't run every possible program on a computer, we run a set of benchmark programs that we have carefully chosen to be representative. We did not use a full set of benchmarks in the IBM article due to time constraints; however, a full set of BASIC benchmarks was used to test the six Japanese computers reviewed in this issue (see page 60). . . . G. W.*

Gregg Williams's "A Closer Look at the IBM Personal Computer" was highly informative. It is a worthy successor to Phil Lemmons's article, "The IBM Personal Computer: First Impressions" (October 1981 BYTE, page 26). The comparison between IBM medium resolution (320 pixels per row) and IBM high resolution (640 pixels per row), which is discussed on page 39 and pictured in photo 6, may be unfair. The performance in high-resolution mode is probably limited by the resolution of the red-green-blue (RGB) monitor that was used. The RGB color monitor shown in photo 1 appears to be an Amdek Color II, which is advertised to resolve up to 560 pixels per row—80 less than the high-resolution mode of the IBM Color/Graphics Monitor Adapter.

Incidentally, Amdek is now accepting orders for a \$10 adapter that enables its RGB monitor to use the intensity bit car-

ried on pin 6 of the IBM Color/Graphics Monitor Adapter, and thereby to generate 16 colors.

Gary G. Price, Assistant Professor  
Department of Curriculum and Instruction  
University of Wisconsin—Madison  
Teacher Education Building  
225 North Mills St.  
Madison, WI 53706

*Though the monitor we used was not supplied by Amdek, it is functionally identical. Both are produced by Hitachi and are RGB high-resolution monitors. When ordering the intensity bit adapter from Amdek, ask for the 16-Color Modification. Future models of the Amdek Color II will include built-in 16-color capability. Amdek is located at 2420 E. Oakton St., Suite E, Arlington Heights, IL 60005 (312) 364-1180. . . . M. H.*

## Too Much Praise for IBM?

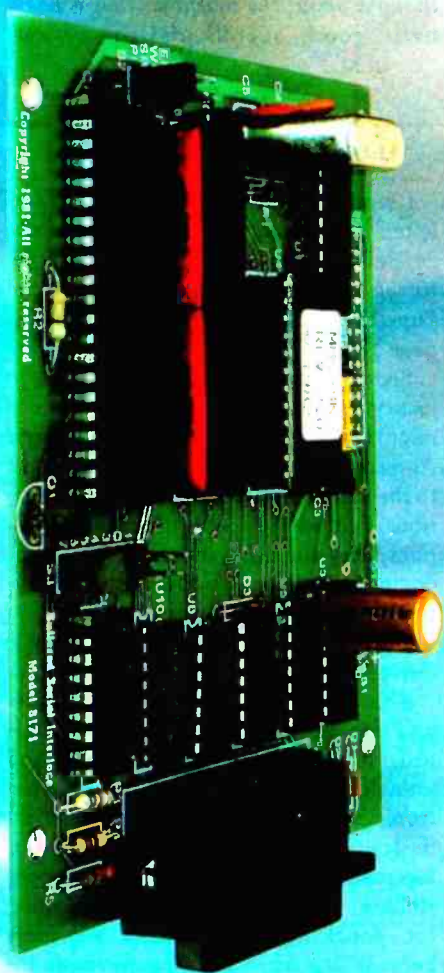
BYTE has defined a new era in personal computing—in terms of IBM. No customer experience taken into account, no long-term usage needed to evaluate—the IBM Personal Computer is arriving, therefore nothing else need be said. Let us all dispose of our several hundred thousand IBM imitations, which just coincidentally predate the Personal Computer by some years.

What has IBM learned from its own and others' experience? First and foremost (to quote Chris Morgan's editorial, "Of IBM, Operating Systems, and Rosetta Stones," January 1982 BYTE), "the keyboard alone is one of the best I've seen, though I wish the shift keys were more conventionally placed. (Oh, well.)" Is "Oh, well" the only comment appropriate to the "best keyboard" designed by a company that has produced what may purport to be the standard of office typewriter excellence? BYTE simply passes off a conscious corporate stupidity with an "oh well." Justify it to the typist who uses a typewriter alternately with the new "oh well" standard and hits the wrong keys consistently on both.

How many other facets of this machine have been glossed over in the same manner but without accompanying comment? Are we seeing the new BYTE objectivity? A 16-bit chip operating in 8-bit mode is



# HOW TO USE YOUR EPSON WITHOUT WASTING COMPUTER TIME:



Your computer is capable of sending data at thousands of characters per second but the Epson can only print 80 characters per second.

This means your computer is forced to wait for the printer to finish one line before it can send the next. A waste of valuable time.

## **THE NEW MICROBUFFER™ ACCEPTS DATA AS FAST AS YOUR COMPUTER CAN SEND IT.**

Microbuffer stores the data in its own memory buffer and then takes control of the printer. This frees your computer for more productive functions.

### **PARALLEL OR SERIAL.**

Microbuffer model MBP-16K is a Centronics-compatible parallel interface with 16,384 bytes of on-board RAM for data buffering.

The MBS-8K is a full-featured RS-232C serial interface with both hardware and software (X-On/X-Off) handshaking, baud rates from 300 to 19,000 and an 8,192 byte RAM buffer.

### **SIMPLY PLUG IT IN.**

Either model fits the existing auxiliary interface connector inside the Epson MX-80, MX-80 F/T or MX-100 without modification, and is compatible with standard Epson cables and printer control software, including GRAFTRAX-80.

### **JUST \$159.00\***

When you think how much time Microbuffer will save, can you afford *not* to have one? Call us for your nearest dealer.



## **PRACTICAL PERIPHERALS, INC.**

31245 LA BAYA DRIVE, WESTLAKE VILLAGE, CA 91362 • (213) 991-8200

Circle 339 on inquiry card.

\*Suggested retail price for either model.



justifiable because IBM is running at 4.77 MHz (let's have another resounding "oh well" for IBM's high speed).

The reason for all this is to point out, to some of your less sophisticated readers, that for each flaw (if I may use such a four-letter word in conjunction with IBM) there appears to be a BYTE rationale to justify it.

I don't remember, in the history of BYTE, any other company or products being accorded such accolades for a product yet unproven in the field with software, other hardware, and peripherals.

McGraw-Hill owns BYTE. Does IBM own McGraw-Hill?

Jack Kahn  
6013 Summerhill Rd.  
Camp Springs, MD 20748

Oh, well. I'm afraid Mr. Kahn misinterpreted my editorial, or failed to read the January BYTE closely enough. If he had, he would have realized that we discussed the shortcomings of the IBM machine in Gregg Williams's review on pages 60 and 61, including comments about the

machine's speed. To imply that we have been less than forthright in evaluating the IBM Personal Computer is patently unfair. In fact, next month's BYTE contains some fairly strong criticism by Jerry Pournelle about shift-key placement on the IBM, and last month we printed an article about the good and bad human-factors design points of the machine ("A Human-Factors Case Study Based on the IBM Personal Computer" by Robert G. Cooper Jr., Paul Thain Marston, John Durrett, and Theron Stimmel, page 56). I'm distressed by Mr. Kahn's implication that we are somehow in cahoots with IBM, or that we are withholding our true opinions. We simply stated what we thought about the machine: that it has a very good overall design—period.  
... C. M.

**Unwarranted Warranties**

I read with interest the interchange of letters between Intertec's Manager of Public Relations and one of the firm's customers (see "Open Letter to Potential Superbrain Buyers," January 1982 BYTE, page 18).

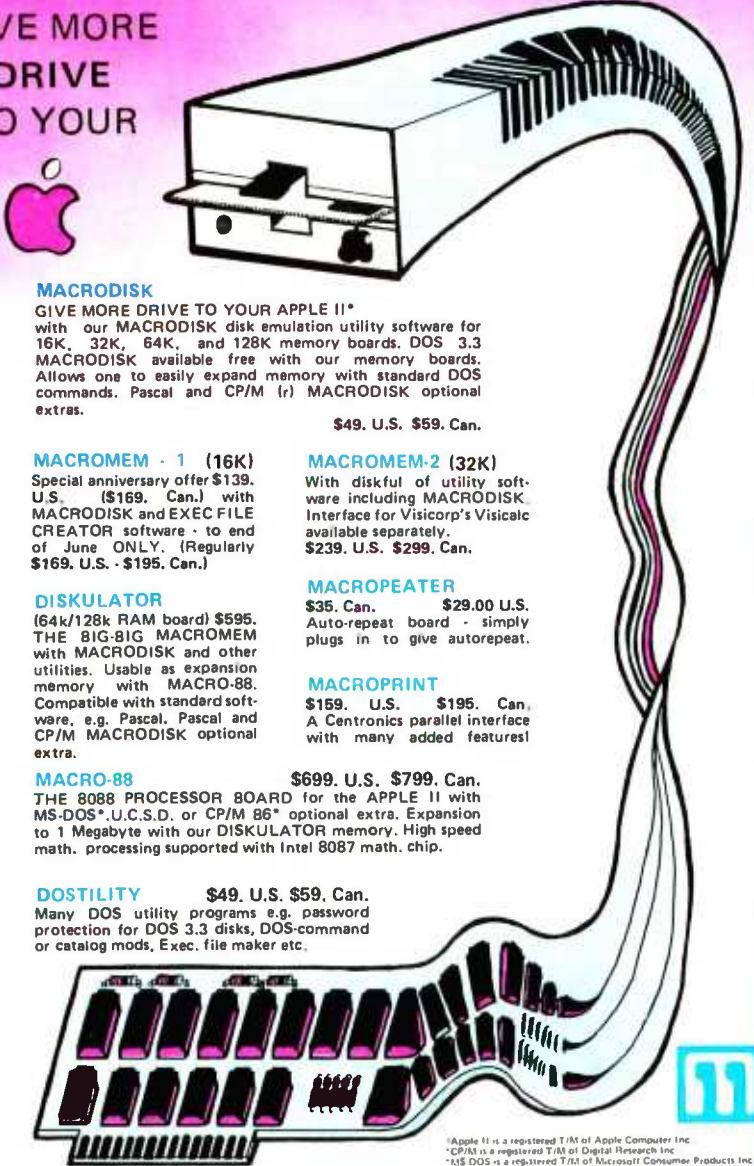
Significantly, Intertec made no case to justify its warranty policies other than to refer to "rules," that is, their Master Agreement. As an independent consultant to the industry for product-support operations, I advise my clients to accept full responsibility for field failures arising out of component failures following delivery. Realistically, there is no such thing as a shelf life for electronic devices; these devices are not loaves of bread.

This ploy is peculiar to the computer and computer peripheral industry. It is not practiced by responsible and knowledgeable manufacturers of electronic devices in other areas of the industry. It appears to be nothing more or less than a ploy to avoid warranty responsibilities. There is simply no justification for penalizing the ultimate consumer because a product did not move off the shelf within some arbitrary time period established by the manufacturer. Business can be bad—the dealer simply may be unable to move his merchandise as promptly as even he would wish.

Certainly, warranty policies of this nature suggest a lack of confidence on the part of the manufacturer in the reliability of its product over the short haul.

Perhaps if Intertec and other companies employing this practice would establish

**GIVE MORE DRIVE TO YOUR**



**MACRODISK**  
GIVE MORE DRIVE TO YOUR APPLE II\* with our MACRODISK disk emulation utility software for 16K, 32K, 64K, and 128K memory boards. DOS 3.3 MACRODISK available free with our memory boards. Allows one to easily expand memory with standard DOS commands. Pascal and CP/M (r) MACRODISK optional extras.  
\$49. U.S. \$59. Can.

**MACROMEM - 1 (16K)**  
Special anniversary offer \$139. U.S. (\$169. Can.) with MACRODISK and EXEC FILE CREATOR software - to end of June ONLY. (Regularly \$169. U.S. - \$195. Can.)

**DISKULATOR**  
(64k/128k RAM board) \$595. THE BIG-BIG MACROMEM with MACRODISK and other utilities. Usable as expansion memory with MACRO-88. Compatible with standard software, e.g. Pascal. Pascal and CP/M MACRODISK optional extra.

**MACRO-88** \$699. U.S. \$799. Can.  
THE 8088 PROCESSOR BOARD for the APPLE II with MS-DOS\* U.C.S.D. or CP/M 86\* optional extra. Expansion to 1 Megabyte with our DISKULATOR memory. High speed math. processing supported with Intel 8087 math. chip.

**DOSTILITY** \$49. U.S. \$59. Can.  
Many DOS utility programs e.g. password protection for DOS 3.3 disks, DOS-command or catalog mods, Exec. file maker etc.

**MACROMEM-2 (32K)**  
With diskful of utility software including MACRODISK. Interface for Visicorp's Visicalc available separately.  
\$239. U.S. \$299. Can.

**MACROPEATER**  
\$35. Can. \$29.00 U.S.  
Auto-repeat board - simply plugs in to give autorepeat.

**MACROPRINT**  
\$159. U.S. \$195. Can.  
A Centronics parallel interface with many added features!

\*Apple II is a registered TM of Apple Computer Inc.  
 \*CP/M is a registered TM of Digital Research Inc.  
 \*MS-DOS is a registered TM of Microsoft Consumer Products Inc.

Canada: 4116 Grace Crescent, North Vancouver, B.C., V7R 4A1 - (604) 986-7633  
 U.S.: 3249 Hackett Ave., Long Beach, California, 90808 - (213) 421-5887

**MACROTECH Computer Products**



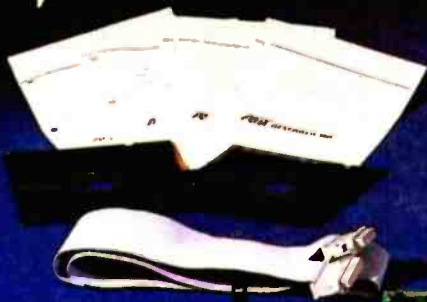
# "IBM Personal Computer" USERS YOU DESERVE THE BEST!

*choose what the professionals\* use*

**NEW!**

Available now  
**COMBO CARD**

Up to 256K parity memory,  
printer & ASYNC ports  
FROM \$435!  
Includes 1 year warranty!



## **Combo Card (User Upgradeable)**

- MC-064 64K From \$435
- MC-128 128K From \$635
- MC-192 192K From \$835
- MC-256 256K From \$1035
- Suffix S = ASYNC comm. option \$60
- Suffix P = parallel printer option \$60
- Suffix SP = both options \$120
- User upgrade document available for sale, order model MC-001SP
- Program compatible with IBM's

## **64KB-256KB Parity Memory**

- MP-064: \$395 • MP-128: \$595
- MP-192: \$975 • MP-256: \$995
- User upgradeable
- Fully assembled, tested & burned-in
- 1-year warranty

## **Advanced Communication**

- CC-232: \$295
- 2 RS232 ports
- Capable of ASYNC, BISYNC, SDLC, HDLC

## **ASYNC Communication**

- CC-032: \$145 • CC-132: \$275
- CC-032 offers 1 serial port
- CC-132 offers 2 ports
- Program compatible with IBM's Serial Com. Card

## **Hardware Prototype**

- WW-068: \$75 • WW-069: \$55
- WW-068 wire wrap card (13" x 4.2")
- WW-069 extender
- Get both for \$95

\*Our customers include: IBM, TRW, Bell Labs, Visicorp, Softech Microsystems Inc., Information Unlimited Software, Context Management, Network Consulting Inc., etc.

# AST RESEARCH INC.

17925 Sky Park Circle, Suite B  
Irvine, CA 92714 (714) 540-1333  
**Dealer Inquiries Welcome**





aggressive Customer Relations departments concerned with the care of customers, there would be no need of Public Relations departments in their organizations. Undoubtedly, they would experience an increase in sales plus improved relations with their dealers.

If the Federal Trade Commission ever took the time to examine this failure to extend warranty coverage to the ultimate consumer, I suspect a "cease and desist" order would be forthcoming.

I suggest that Intertec clean up its act and provide a reasonable level of protection to the guy at the end of the pipeline. He deserves nothing less.

R. C. Redpath  
250 Ramblewood Parkway  
Mount Laurel, NJ 08054

The letter to the editor, in the January 1982 BYTE, from James Ford of Paoluccio Willis Nau Associates regarding the purchase of several Superbrains and a subsequent misunderstanding between Mr. Ford and the dealer he purchased the equipment from points out an industry-wide problem.

Certainly, one should attempt to purchase equipment at the best possible price; however, it's important to remember that the sale is only the beginning of the relationship between the dealer and the customer. From time to time, equipment does malfunction and must be repaired; advice about communications, protocol, and software is sometimes called for.

Here at Compudial/Tristar, we give a guarantee from the date of purchase on Superbrains and other Intertec equipment and stand behind the product with knowledge of its capabilities and limita-

tions. This is not meant to be a self-congratulatory statement; rather, it is to point out to our dealers and potential customers that, just as not all Superbrains are perfect when they come off the production line, neither are all dealers.

Simply stated, when one is purchasing any data-processing equipment, one should look for an established, knowledgeable, and reputable source that is capable of servicing the equipment.

Daniel F. Brown, President  
Compudial Inc.  
2 Keystone Ave.  
Cherry Hill, NJ 08003

---

### More on Intertec from the Federal Trade Commission

---

I read with interest the correspondence relating to the warranty on Intertec's Superbrain computer. Mr. Ford, the computer purchaser, assumed that even if the product was "inoperable when the cartons were first opened [he] would have had to pay repair charges." Intertec does not deny this interpretation of its warranty. Rather, it claims that the "warranty offers [its] customers excellent coverage. . . ." Fortunately for purchasers, Mr. Ford's idea of who has to pay may be as incorrect as Intertec's reply is disingenuous.

The law does not require that merchandise be sold with a *written* warranty. However, whether or not the manufacturer or dealer includes a written warranty, the law of 49 states (under the Uniform Commercial Code) usually implies certain warranties. For example, there is usually an implied warranty of merchantability:

the goods must be fit for the general purposes appropriate to that type of goods. This implied warranty applies at the time of sale regardless of whether the manufacturer's or dealer's warranty has expired. Further, delivery of a defective item may be a total failure of consideration, or breach of contract, by the seller. I suggest that a purchaser of a defective product consult a private attorney if the seller refuses to repair or replace it. Note that this doesn't apply to products sold "as is."

Incidentally, the Federal Trade Commission enforces a law called the Magnuson-Moss Warranty Act. This law sets standards for disclosing the terms of written warranties on consumer (personal) products. Had Mr. Ford purchased a *home* microcomputer, the company's warranty would have had to state: "This warranty gives you specific legal rights, and you may also have other rights which vary from state to state."

Randall H. Brook  
Assistant Regional Director  
Federal Trade Commission  
Seattle Regional Office  
2840 Federal Building  
915 Second Ave.  
Seattle, WA 98174

---

### More on Warranties

---

Isn't it time that our industry grew up? I just resisted purchasing an expensive piece of computer software for which the warranty reads in part:

All . . . computer programs are distributed on an "as is" basis with-



## GRAPHIC SOFTWARE

**GRAPHIC SOFTWARE FOR MICROCOMPUTERS** — This self-teaching guide will show you how to write your own graphics software. 61 programs for 2D and 3D graphics: interactive input, translations, rotation, isometric views, perspective, scaling, stretching, clipping, surface intersections, shading, hidden line removal, tablet software, animation and more. Applications to science, engineering and business. "One of the most outstanding books on computer software" — *A. Grund, U. Illinois*; "The best book available on microcomputer graphics" — *Creative Computing Feb, 1982*. Book — \$21.95; Disk — \$18.95.

Books contain fully documented program listings in BASIC with theory and equations. Disks contain the same programs as the books but without documentation. When ordering disks, please specify APPLE II Plus 48K DOS 3.3 or CP/M.

## ENGINEERING SOFTWARE

**ENGINEERING SOFTWARE FOR MICROS** — A self-teaching guide to developing software for engineering applications of microcomputers. Emphasis is on combining graphics with engineering problem solving. Programs included to interactively create engineering drawings, store on disk file, recall, modify and merge. Other programs for simulation, mechanisms design, heat transfer, circuit analysis, optimizations and including Monte Carlo techniques. Programs for Fourier analysis display frequency spectra graphically. This is a valuable collection of modern engineering analysis software for students and professionals. Book — \$28.50; Disk — \$19.95.

out warranty of any kind. The entire risk as to the quality and performance of such programs is with the purchaser. Should the programs prove defective . . . the purchaser and not the manufacturer . . . assumes the entire cost of all necessary servicing or repair. (The company) shall have no liability or responsibility to a purchaser. . . .

This is not mere legal jargon. It's the embodiment of a business philosophy which seriously harms all of us. It encourages sloppy work and inadequate testing, and it increases the potential for dishonesty. Is it any wonder that so many businessmen are turned off by computers?

To software companies I say: Accept responsibility for your products. Get the bugs out *before* you sell them. Don't try to sell a program debugged by your customers as a "revised" or improved product at additional cost.

To software consumers I say: If possible, avoid products for which there is no warranty. Don't buy on faith. Complain loudly to software companies which provide no warranty.

Of BYTE I ask: Speak out on the importance of product and software warranties. Help your readers by reporting on the warranty provided in your product and software reviews, perhaps in your "At a Glance" boxes. Praise the responsible firms that produce quality products and help to expose the ones with a reputation for bugs.

John Navas II  
490 Mariners Island Blvd., #108  
San Mateo, CA 94404

### Note Pad for the Handicapped

I think that Howard Batie's article "Handi-Writer, A Video Note Pad for the Physically Handicapped" (December 1981 BYTE, page 474) described the most valuable and original application of a microcomputer that I have seen.

I have worked extensively with the handicapped, including many cerebral palsy victims, and I agree with Mr. Batie's estimate that these people are not generally intellectually deficient. Many feel that they are emotionally unstable, but I have never seen any evidence of instability that was not explainable, to me, by their severe frustration. What a boon it would be for such an imprisoned mind to finally be able to communicate!

I am sure it would not be difficult to add another button to the control panel so that data could be output to a printer, or this could be done by intervention of a companion, when the user is satisfied with the text in the buffer.

Imagine—correspondence and creative writing for those who previously had no means of expression.

Ralph Nottingham  
1619 SE 3rd Court  
Deerfield Beach, FL 33441

### Software Copyright Kit

I have received an overwhelming number of inquiries concerning the booklet "The Copyright Kit—How to Copyright Your Computer Software," which was mentioned in a letter published in the October 1981 BYTE (see "Legal Argu-

ments," page 10). You must have an incredible readership! Letters and telephone calls poured in from all over the country, as well as from England and Italy.

Please inform your readers that the Copyright Kit is available for \$12.95 (plus \$2 postage and handling) from B. T. Enterprises, 171 Hawkins Rd., Centereach, NY 11720, and from National Attorneys' Publications Inc., POB 150, East Setauket, NY 11733.

Noel D. Adler  
POB 150  
East Setauket, NY 11733

### Apathetic Advertisers

As one of the millions whose relationship with computers has been an adversary one, my interest in them was zilch until I read *The World Challenge* by Jean-Jacques Servan-Schreiber (Simon and Schuster 1981), a book in which the role of computers in the world of tomorrow is rather graphically delineated. The mention of BYTE in the same book led to my subscribing to your publication.

Although I find much of the material in BYTE less than comprehensible, I'm slowly learning about computers and the many possibilities they offer. I've already decided to buy a home computer; unfortunately, many of your advertisers do little to facilitate the process of evaluating their products and services.

For example, I wrote to Apple for brochures and specifications on its various models, accessories, software, etc. In return, the company sent a booklet outlining the development of its Apple

## STRUCTURAL ANALYSIS SOFTWARE

**STRUCTURAL ANALYSIS ON MICROS** — This self-teaching guide contains a series of programs which calculate stresses and deflections in beams, plates, trusses and frames using conventional and matrix techniques. Theory, equations and program listings fully documented. Written for the non-specialist who wants to use his micro for structural analysis with minimum investment in time. Use the programs as is or modify for your own applications. Book - \$39.95; Disk - \$19.95.

To order, send check drawn on U.S. bank, money order in US funds, Visa or Mastercard number with expiration date to KERN PUBLICATIONS 190 Duck Hill Road, P. O. 1029A, Duxbury, MA 02332. Add \$2 per book 4th cl postage in US and Canada, \$3 1st cl or UPS in US; \$4.50 1st cl Canada; \$12 air Europe and Central America; \$18 elsewhere. Call (617) 934-0445 for faster delivery.

## DATA PLOTTING SOFTWARE

**DATA PLOTTING ON MICROS** — A collection of programs to process and display all types of data: bar charts, stock market charts, engineering and scientific data, 3D views of surfaces, pie charts, sorting, filtering, running averages, curve fitting, and more. Application to business, engineering and science. All programs fully documented and keyed to theory. Use as is or modify for your own applications. Book - \$24.95; Disk - \$19.95.



**KERN PUBLICATIONS**

190 Duck Hill Rd  
Duxbury, MA 02332



III—but none of the more useful materials I'd requested. I've written Atari twice and telephoned once; many weeks later, Atari has not yet deigned to reply. Of the half-dozen or so computer stores I've written for price lists and information, only one has bothered to reply.

I gather, from the heft of your publication and its numerous advertisements, that there is a rather substantial industry centered around home computers and allied products and services. But I also get the impression nobody's particularly interested in showing any initiative to assist a would-be purchaser in obtaining information that would be helpful in making a reasonably rational buying decision.

H. B. Brandon  
1204 Park Lane  
Clarksdale, MS 38614

**More on a Structured 6809 Assembly Language**

Greg Walker's interesting article, "Toward a Structured 6809 Assembly

Language" (November 1981 BYTE, page 370), will be helpful to many people who, for one reason or another, are forced to write in assembly language.

Use of higher-level language control structures in assembly language goes back a long way. In general, there have been two approaches.

The first approach is to write a special assembler which includes high-level control structures as part of the language. The earliest descriptions of this approach with which I'm familiar appeared in Niklaus Wirth's "PL360, A Programmable Language for the 360 Computers" (*Journal of the Association for Computing Machinery*, 15:1 (1968), pp. 37-74) for a large machine, and Bell and Wichman's "An ALGOL-like Assembly Language for a Small Computer" (*Software—Practice and Experience*, 1 (1971), pp. 61-72).

This approach can produce comprehensive error messages and more efficient generated code because long/short branches, etc., can be optimized.

The second approach is to implement the control structures via the manufacturer's standard macro-assembler, as in

Walker's 6809 macros. The first description of this approach that I know of is M. M. Kessler's "CONCEPT" Report 14, *Implementation of Macros to Permit Structured Programming in OS/360* (IBM Corporation, Gaithersburg, MD 20760, 1970). The macro approach has the advantage of being piggy-backed on the standard assembler, thus greatly reducing the amount of documentation and programming needed to support it. Also, the macros can be examined easily and altered, if needed, by the user.

When our laboratory implemented Pascal-like control structures for the PDP-11 Macro-11 Assembler several years ago, we discovered that assembler programs with high-level control structures (IF . . . THEN, DO . . . WHILE, REPEAT . . . UNTIL and CASE) were much easier to write, debug, and maintain than the FORTRAN programs we wrote for the PDP-11 (FORTRAN was the only "high-level" language available to us on the PDP-11 at that time).

Scott Herman-Giddens  
Department of Computer Science  
Duke University  
Durham, NC 27706 ■

**ARBAGATOR**  
*Puts it on the line*

**ARBA Register**  
"on line  
with virtually  
any computer."



**ARBA**  
FINE BUSINESS COMPUTING  
890 E. ROOSEVELT  
LOMBARD, IL 60148  
312-620-8566

- Do real time point of sale inventory control
- RS232C interface at 300 baud
- Standard asynchronous ASCII code
- Time tested LSI circuitry
- \$1295 suggested retail—dealer pricing available

**Coming soon! Point of sale software.**

**BYTE's Bits**

**Experimental Circuit  
Package Described**

At a recent conference of the International Society for Hybrid Electronics, a group of IBM engineers described an experimental circuit package that makes it possible to feed power and information to a complex bipolar logic integrated circuit. The package, with 200 pathways for electrical signals and 16 for power, links thousands of electronic circuits on the chip with the rest of the circuitry in the computer system. The thin metal-film pathways run between 216 connector pins and 354 pads connecting the chip to the package. Previous IBM circuit packages of this nature had a maximum of 96 signal paths and 132 pads, which means that the technique being worked on doubles the signal capacity and nearly triples the number of connection pads.

The chip is the result of an experiment to shrink the size of the IBM System/370's central processing unit to a single integrated circuit measuring one-quarter inch on a side. The System/370 contains nearly 45,000 transistors, resistors, capacitors, and diodes. ■





## Copyrights, Computers, and the Betamax Case

---

Walter Klasson  
77 Seventh Ave., 21P  
New York, NY 10011

---

You've spent hundreds and hundreds of hours bleary-eyed in your computer's glare, hoping that your late-night programming obsession really will pay off. You've missed your favorite television shows and your daughter's childhood. People look at you strangely and ask where you've been. Your wife joins Computer Widows Anonymous.

Then one day your great software masterpiece is finally finished. You

---

### About the Author

Walter Klasson, an attorney with a specialty in computer law, is a member of the working group of the New York State Bar Association Subcommittee on Computer Law, which is considering a computer crime statute for New York. Mr. Klasson is author of a machine-language (Z80) word-processing program and president of Softlaw Inc., a consulting firm which specializes in adapting microcomputer/word-processor systems for small law offices.

---

call out to your wife and kids, and the entire family at long last sits laughing together around your flickering video display, playing your new science-

---

**Copyright is such an absolute right that even "innocent" unauthorized copiers, who may not have known that what they were copying belonged to someone else, are chargeable with infringement.**

---

fiction and fantasy computer game, The Beast That Ate Hoboken.

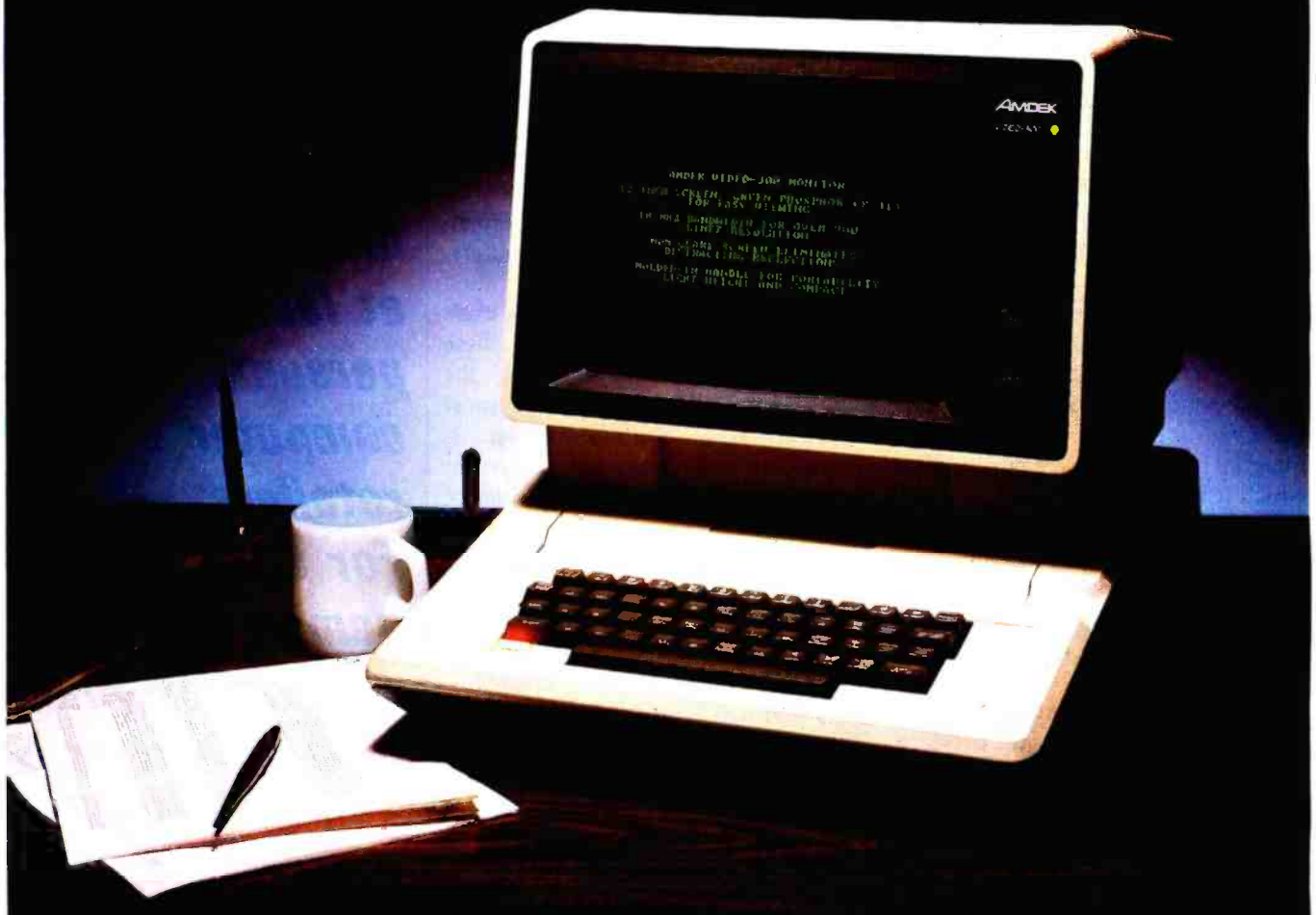
But someone out there wants to destroy your happiness. He buys a copy of your program only to give or sell a copy to a friend. Maybe the

friend gives or sells copies to other people. Maybe the evil spreads. Your royalties fall off. You miss a payment on little Janie's teeth. You can't afford that 10 megabytes of hard disk you wanted. Is there no hope for you anywhere?

Yes, said the United States Ninth Circuit Court of Appeals this past October in what is known as the "Betamax Case." Sitting in California, that middle-level federal court determined that anyone who uses a video-tape recorder (VTR) to make a copy of copyrighted material without permission has infringed upon the copyright owner's statutory rights, even if the copier had no intention to sell the copy to anyone else. While computers weren't involved directly in the Betamax Case, this aspect of the decision seems to apply equally to unauthorized duplication of copyrighted computer software.

This legal development is not so

# IT'S CRISP. IT'S CLEAR. IT'S COMPATIBLE.



## Amdek's Video-300 green phosphor monitor is the easy-reading choice for almost any system — including IBM and Apple.

Everything about our 12" Video-300 monitor was designed to be easy. Easy to read. Easy to use. And easy to match up with practically any computer or word processing system, including the popular Apple and IBM personal computers. So it's easy to see why you should choose Video-300 for your text display needs.

### Amdek's Video-300 monitor features:

- Non-glare screen to eliminate distracting reflections
- P-31 green phosphor display for no-strain viewing
- 80 x 24 character display

- 18MHz band width 900 lines (center) resolution
- Built-in carrying handle for portability
- Light-weight, industrial-grade cabinetry (only 17 lbs.)
- UL, FCC approved
- Full one-year warranty covering parts and labor

So ask your dealer about Video-300 — part of Amdek's complete line of color, green phosphor and black and white monitors. Then match Video-300's performance and price against any other display monitor. For quality and value, you'll choose Amdek.

# AMDEK

Amdek Corporation, 2420 E. Oakton St., Suite E, Arlington Heights, IL 60005. (312) 364-1180 • TLX: 25-4786

See our complete product line at the NCC Show, Booth #A-245, in Houston June 7-10.



surprising, although the Ninth Circuit Court did have to reverse the contrary decision of the federal district court below. The Ninth Circuit rejected the argument that so-called noncommercial, personal use should be considered noninfringing under an implied exception to the copyright statute. The court also interpreted the statutory "fair use" exception to the copyright owner's exclusive rights as applying only where the unauthorized copier used the copyrighted material for limited "productive" purposes, such as "criticism, comment, news reporting, teaching (including multiple copies for classroom use), scholarship, or research." The exception does not apply where the copier merely wanted to use the copied material for the ordinary purposes for which it would be sold.

This part of the Betamax decision seems reasonable enough to me. After all, as the court said, the unauthorized copying of a television program or a movie that is for sale by the copyright owner is in fact quite "commercial" in that it "tends to diminish the potential market" for the product. It is not hard to agree that illegal copying, even for personal use, of someone else's copyrighted "intellectual" property is no more "innocent" than taking anything else of value belonging to another.

The results so far in the Betamax Case may have been of some small comfort to authors and sellers of word processors, computer games, and other relatively inexpensive software (i.e., virtually everything used on a microcomputer), which is easily copied on the rapidly increasing numbers of small computers being sold. But, at least, their copyrights (like those of Walt Disney and Universal Studios, the victorious parties before the Ninth Circuit) have been fully supported by the court.

However, copyright owners of mass-distributed software still face the impracticalities of enforcing numerous separate small claims against individual infringers even though the cumulative dollar loss from widespread software piracy may be very substantial. Unlike phonograph records, for example,

microcomputer software doesn't have to be copied on relatively centralized and specialized counterfeiting equipment, which can be discovered and closed down. On the contrary, as with VTRs, the small-computer software pirates can do their dirty work in the privacy of the home, with little special expertise, cost, or equipment. Also, many small software houses simply don't have the resources necessary to go after the infringers they do suspect. Manufacturers of expensive software for larger computers, whose customers are usually a limited number of relatively responsible business organizations, don't share these problems. In short, although the Ninth Circuit's opinion labels most unauthorized copiers of small-computer software as copyright infringers, the practical difficulties of enforcing the copyright owner's legal rights remain.

While the first part of the Betamax decision could have been predicted, the second part is potentially a very significant new legal development. The Ninth Circuit also decided that the *manufacturer* and *sellers* of a VTR on which illicit copies are made (in this case, the defendants were various divisions of Sony, its advertising agency, and four retail stores) are equally liable for copyright infringement. Even more interesting, the court suggested that a possible solution to the video-tape piracy problem would be to charge the VTR manufacturers a royalty to be paid to the copyright owners. Think of the possibly staggering implications in the halls of Xerox of this novel legal conclusion if it were applied to photocopiers!

"Aha," the small-software author might think upon hearing this news, "a manufacturer of computer 'reproduction' equipment (for example, disk drives, cassette players, or any system incorporating them) is a big enough target for me to sink my legal teeth into for some relief (i.e., money) for all this pirating of my *Beast That Surfed* at Santa Cruz computer game."

Still, maybe the sound of eyeballs dropping out of heads did not accompany receipt of the news of this part

---

---

---

***The Context  
MBA will be  
available  
starting  
May 15, 1982  
at leading  
personal  
computer  
retailers.  
For the  
name and  
address of your  
nearest dealer,  
call or write  
Context.***

## **Context Management Systems**

**23864 Hawthorne Blvd.  
Torrance, CA 90505  
(213) 378-8277  
Telex 181149 WEST LSA**

Circle 119 on inquiry card.

---

---

---

---

---

---

---

AVAILABLE MAY 15

# Personal computers are full of promises. MBA makes them deliver.



You've heard how the personal computer is going to revolutionize the way you work.

So far, the reality hasn't measured up to the promises.

But now there's a remarkable new software package that transforms the IBM Personal Computer into an incredibly powerful management tool (Apple and Xerox owners: read on).

## The first totally integrated management software.

There are a lot of useful programs available for personal computers.

Unfortunately, they all seem to use different commands and different ways of storing data. This creates two major problems:

1. Every time you want to add a new function, you have to learn a whole new command language.
2. You may not be able to exchange data between different programs.

But now there's a better way. It's called the MBA, and it was created by a blue-chip management consultant, an MIT-trained systems designer, and some of the country's most experienced business programmers.

For the first time, MBA combines all the essential management functions in one easy-to-use package:

**Electronic Spreadsheet.** The ultimate financial modeling tool that lets you create a giant spreadsheet of figures and text. Change one number, and every affected item is instantly re-calculated.

**Word Processing.** Compose, edit, and print any kind of document. Make revisions yourself—faster than you can explain them to your secretary. Because MBA is an *integrated* system, it's easy to incorporate data from its other modules into a report you're writing.

**Data Management.** A sophisticated electronic filing system that lets you store information—ANY information—then retrieve it, analyze it, and generate reports to your specifications.

**Graphic Output.** For those occasions when a picture tells your story better than words, you can easily generate clear, readable graphs.

**Communications.** Tie into your company data center, a financial information service, or virtually any other computer system. MBA automatically retrieves the information you want, and lets you edit or rearrange it with a few keystrokes.

## Easy to learn. Easy to use.

MBA's designers devoted great care to giving it a simple, consistent set of commands. So when you've learned one module, you'll immediately be comfortable with the others.

## What, where, and how.

MBA is offered through selected computer retailers who have qualified people to demonstrate and answer questions.

It runs on the IBM Personal Computer, with Xerox and Apple versions available soon. But whichever machine you use, MBA will make a dramatic improvement in your personal productivity.

And that's a promise.



## Context Management Systems, Inc.

Management software for personal computers.

23864 Hawthorne Blvd., Suite 101  
Torrance, California 90505  
(213) 378-8277

© Copyright 1982 Context Management Systems, Inc.

Circle 120 on inquiry card.



# PROOF READER™

The Aspen Software Company Spelling Checker.

+

# GRAMMATIK™

Beyond Spelling Checking

## THE ONLY COMPLETE PROOFREADING PACKAGE

FOR ALL CP/M, MS-DOS,  
AND TRS-80 WORD PROCESSORS

We'll match Proofreader with any other spelling checker on the market. It has a big 38,000 word expandable dictionary, and can check even your largest documents in under four minutes. Proofreader looks up every word, and does not use less accurate root word analysis like some others. Full interactive correction is standard on CP/M and TRS-80 Model II systems, and is a low cost option for the TRS-80 Model I/III.

Spelling checking alone is not enough! No one else has anything like Grammatik! It analyzes your document for common typos, punctuation errors, misused phrases, and poor writing style. Grammatik is receiving rave reviews from both critics and users. Bob Loudon in *InfoWorld* (12/7/81): "Grammatik is a surprisingly fast and easy tool for analyzing writing style and punctuation. If you are currently doing original writing on a word processor, you should consider this product." Eric Balkan in *The Computer Consultant*: "I'm impressed with the imagination that went into this product." A user: "Thanks for making my life easier!"

Grammatik and Proofreader are compatible with all CP/M, MS-DOS (including IBM PC), and TRS-80 word processors.

Current CP/M formats:

standard 8", NorthStar, Omikron TRS-80.

Please call or write for details of minimum system sizes, and availability of additional disk and operating system formats. Shipping costs included.

Please specify your system configuration when ordering. Dealer inquiries invited.

MS-DOS versions scheduled for March 1982 release.

	Proofreader	Grammatik
CP/M, MS-DOS	\$129.00	\$149.00
TRS-80 Model II	\$99.00	\$99.00
TRS-80 Mod. I/III	\$54.00	\$59.00

(Model I/III interactive correction option - \$30.00)

Trademarks: CP/M: Digital Research; TRS-80: Tandy Corp.; Proofreader, Grammatik: Aspen Software Co.

## ASPEN SOFTWARE

## COMPANY™

P.O. Box 339-B, Tijeras, NM 87059  
(505) 281-1634

of the Betamax decision wherever they make or sell disk drives. A brief legal and political explanation is in order to explain how the court found the VTR manufacturers liable along with the copiers and why, nevertheless, Tandy, Apple, Shugart, Percom, and many others may not have to raise their prices to pay royalties so that software authors can retire in luxury (or afford new shoes).

Copyright is such an absolute right that even "innocent" unauthorized copiers who may not have known that what they were copying belonged to someone else are chargeable with infringement. The difference in potential liability is that "innocent" unauthorized copiers, as opposed to deliberate infringers, might escape liability for full statutory minimum money damages, although they would probably be subject to an injunction (a court order that they not repeat the infringing behavior).

In the Betamax Case, however, the Ninth Circuit found that the defendants were not innocent, in that (although the legality of taping television broadcasts was in question) they knew that VTRs would be used to reproduce copyrighted materials and were in fact manufactured, advertised, and sold with that primary purpose in mind because virtually all television programming is copyrighted. The court therefore charged the manufacturers with "contributory infringement." On the other hand, the court, facing the reality of a popular and growing multimillion-dollar industry recognized that an injunction (i.e., shutting the industry down) might not be appropriate and that the whole question of providing relief for the copyright owners was "exceedingly complex." But while suggesting the royalty mechanism, the court directed the district court below (which must, in the first instance, fashion the relief for the winning side) not to "be overly concerned with harm" to the VTR manufacturers.

Thus, by this time every good attorney who represents a manufacturer of modern technological "reproduction" equipment of any kind is busy "distinguishing" the Betamax

Case—that is, showing how his client's circumstances are significantly different from a VTR manufacturer's so that the Betamax decision should not apply. An obvious distinction in the small-computer area is the lack of any "free" source of copyrighted software for computer system buyers comparable to the extremely widespread broadcast of television programs. However, "the airwaves are free" argument sometimes heard (that copyright owners should lose their rights by broadcasting their works) is likewise not available in defense of computer software piracy, which is a more clear-cut form of infringement.

Another important distinction between VTRs and small-computer systems is that most of the latter are *not* promoted primarily as a means of duplicating copyrighted software but rather as *requiring* the purchase of certain copyrighted software (e.g., operating systems) and facilitating the general use of other purchased copyrighted applications software. Fully programmable systems even facilitate the creation of more copyrightable software, which is supportive of copyright's goal of promoting creativity. In contrast, what percentage of VTR owners have or really use video cameras?

In other words, even if you agree with the Ninth Circuit's implicit determination that most VTR owners are potential copyright infringers, most small-computer owners probably aren't. So it would be much more difficult to argue that most small-computer manufacturers and sellers were profiting from or encouraging copyright infringement to such a degree that they should be held liable as contributory infringers.

Even VTR manufacturers may not have to worry about the Ninth Circuit's Betamax decision. First, although at this writing it is still too early to know exactly what legal steps will be taken, Sony is likely to appeal to the United States Supreme Court which could reverse (or affirm) the Ninth Circuit on any number of grounds that could be more (or less) favorable to manufacturers of various types of reproduction equip-

# Childhood's End: The 68000



## ADDRESSING THE NEW FRONTIER... THE MICROCOMPUTER COMES OF AGE.

SAGE COMPUTER TECHNOLOGY IS NOW MANUFACTURING A 68000 BASED SINGLE-BOARD MICROCOMPUTER SYSTEM WHICH DELIVERS THE HIGHEST, PERFORMANCE PER UNIT PRICE OF ANY COMPUTER IN HISTORY.

### THE SAGE II MICROCOMPUTER HAS THE FOLLOWING FEATURES:

- INTERRUPT DRIVEN, 8 MHZ 68000 MICROPROCESSOR
- 2 MILLION INSTRUCTIONS PER SECOND, NO WAIT STATES
- WILL ADDRESS 16 MEGABYTES WITH UP TO 1/2 MEGABYTE OF PARITY RAM ON BOARD
- UP TO 1.5 MEGABYTES OF 5-1/4 INCH FLOPPY DISK STORAGE
- FULLY SUPPORTED IEEE 488 INTERFACE
- TERMINAL AND MODEM RS-232C SERIAL PORTS
- CENTRONICS COMPATIBLE PARALLEL PRINTER PORT
- UCSD PASCAL, BASIC, FORTRAN AND ASSEMBLER AVAILABLE

® TM U. OF CALIF. BERN.

PRICES FOR THE SYSTEM START AT \$3699.  
FOR MORE INFORMATION CONTACT OUR MARKETING  
DEPARTMENT AT 702-521-8983.

**SAGE**  
COMPUTER TECHNOLOGY

Circle 387 on Inquiry card

195 NORTH EDISON WAY, SUITE 14 · RENO, NEVADA 89502



**Compliment  
your  
Apple III®  
or IBM...**



**simply  
\$599<sup>00</sup>**

- \* 13" RGB Color.
- \* 16 Colors on your Apple III® or IBM.
- \* Up to 80 Characters per line.
- \* 360 Dots per color. (horizontal resolution)
- \* Available for immediate shipment.

Other models available:

12" Green Phosphor  
(1200 lines resolution) \$179.00

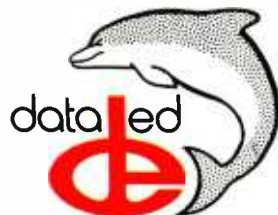
12" Black & White  
(15 Mhz) \$139.00

Contact your local dealer  
or call us direct.

Toll Free 1-800-258-6370



® Apple III is a registered  
trademark of Apple Computer.



18 Bridge Street, Salem, NH 03079  
Tel. (603) 893-2047  
TWX: 710-366-0502

ment. Second, and perhaps more important, the United States Congress may act to set limits on copyright law. While copyright protection is mandated by the Constitution, its exact limits (such as the scope of its "fair use" exception) are a matter of federal statute. Within six weeks of the Betamax decision, at least one bill that, if enacted, would effectively overrule the Ninth Circuit was introduced in each house of Congress.

It is easy to imagine the vast industrial forces that might be arrayed against the Betamax decision, although the decision also has many important supporters among the owners of television, movie, and other copyrights. Intensive lobbying is probably now taking place, but Congress is likely to defer final action

**If the Ninth Circuit's  
Betamax decision is  
judicially or  
legislatively  
overturned, the  
problem of the  
enforceability of the  
copyrights on  
inexpensive mass-  
distributed software  
still remains.**

until the Supreme Court has spoken, which probably won't be before the fall of 1982. "Friends of the court," representing various groups whose interests could be affected by the final judicial decision, may introduce additional briefs or arguments.

If the Ninth Circuit's Betamax decision is judicially or legislatively overturned, the problem of the enforceability of the copyrights on inexpensive mass-distributed software will remain. If the decision is allowed to stand and if it should be extended to the small-computer industry, then any royalty imposed would probably be passed on to the purchaser in higher prices on the hardware affected, almost like a tax on the entire class for the presumed piracy of a lesser number of individuals. This could reduce sales slightly.

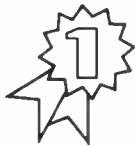
Granting that such a royalty mechanism is not a perfect remedy for the software piracy problem, it is still certain that if there is insufficient legal or economic protection for inexpensive mass-distributed software, its availability will be reduced accordingly. While the actual incidence and cost of software piracy are not precisely known, it is likely to grow rapidly along with increased sales of computers and could become an additional economic barrier to the emergence of new small-software sources. All software authors may have to contend with an unacceptable uncertainty as to the exact economic potential of particularly valuable and innovative software.

The value to a hardware manufacturer of numerous sources of software that supports its system has at last been admitted by no less than IBM in connection with its new Personal Computer. Tandy and Apple, whether they admit it or not, owe much of their small-computer success to the multitudes of independent software sources for their machines, each of which is also promoting the hardware. There is currently software of great practical or entertainment value (as well as the inevitable rubbish) for the microcomputer market that costs anywhere from \$10 to a few hundred dollars. Much of this software is a product of a relatively individualistic, labor-intensive cottage industry. Many members of this cottage industry could not individually support the expense of a full-blown legal defense of their copyrights.

Perhaps the answer is some simple form of voluntary cooperation by those united in interest, as is done in other areas of copyright law. For example, many composers and songwriters are paid royalties from such organizations as the American Society of Composers, Authors, and Publishers (ASCAP) and Broadcast Music Inc. (BMI), which have been legally designed to collect an appropriate amount from those who want to play, perform, or otherwise "copy" the protected material (for example, radio stations). Some type of centralized, less voluntary royalty system established as the result of the

# PICK A WINNER

**Be Picky. Get Economy, Quality, Flexibility and Compatibility from Board Level Products to Complete Multi-User Computer Systems.**



**Bank Selectable S-100 128K Memory.** Systems Group's new 128K dynamic memory board has eight independent 16K software selectable memory banks, each addressable on any 16K boundary. It's jumper selectable so you're not PROM locked in to any one configuration. And with more advanced features, it's the most flexible in the industry.



**Fully Compatible — S-100 Boards.** Use any of Systems Group's bank select memory boards for Alpha

Micro, Cromemco/CROMIX, Dynabyte, North Star, MP/M, OASIS and most other S-100 systems. Other high quality S-100 microcomputer boards include the newest high performance single and multi-user Z80 CPU board with up to 4 serial I/O's, floppy and hard disk controllers with Super CP/M and much more. All fully burned in and tested.



**Eight-Inch Add-On Floppy Disk, Hard Disk, and Tape Drive Subsystems.** This series was created to

provide a full range of mass storage products to complement the System 2800 computers. The subsystems also offer universal systems expansion to the users of other S-100 systems.



**Series 2800 Business Computers.** Systems Group offers a choice of expandable systems with dual floppies (up to 2.4M Bytes) or hard disk (up to 40M Bytes) w/ floppy (1.2M Bytes) or tape (20M Bytes) for back-up.



**Expandability.** Add-on memory, I/O and drive subsystems means never being trapped into systems without flexibility. With Systems Group's reliable designs you can add more floppy and hard disk drives or tape back-up for increasing mass storage requirements. Add more memory and I/O for up to 12 independent users per system. Choose from Super CP/M, MP/M II, or OASIS operating systems.

Come to Systems Group for any of your microcomputer needs. Everything from our new 128K Memory Board to complete systems. We're helping make computers what they should have been in the first place.

All Systems Group's products are warranted for one year. Ask about our 30 day dealer/OEM evaluation policy.

CP/M and MP/M are Registered Trademarks of Digital Research. OASIS is a Trademark of Phase One Systems, Inc.

**Systems Group**

A Division of MEASUREMENT systems & controls incorporated  
1601 Orangewood Avenue  
Orange, California 92668. (714) 633-4460  
TWX/TELEX 910 593 1350 SYSTEMGRP ORGE

For dealers only, circle 401.  
All other inquiries, circle 402.

See us at the Houston Astroville & Astrodome during NCC '82 or at COMDEX/Spring '82 in Atlantic City.



Betamax decision could perform a similar function for software authors, unless Congress or the industry acts to produce some better method of protecting the copyrights involved.

Another legal alternative might be to increase deterrence to software piracy by increasing the criminal sanctions available against copyright infringers. However, this leads into the wholly separate area of computer crime (which is beyond the scope of this article) and away from the copyright law's primary focus on civil, not penal, enforcement of the statutory right. While greatly increasing the minimum statutory money damages awardable against deliberate infringers and including the copyright owner's legal fees in those damages might be effective deterrents, such measures, which would have to be enacted by Congress, do not appear to be under serious consideration.

Of course, assorted hardware-based technological solutions to the piracy problem, such as unduplicat-

able disks or ROM cartridges, exist. While often technologically effective, these methods are not always popular with users, limit the standardization and interchangeability of the various manufacturers' products, and don't encourage independent software sources to write for the machine involved. (A word of caution: those who provide information or equipment to defeat hardware or software antipiracy measures could be chargeable with contributory copyright infringement under the Betamax decision.)

It is therefore easy to predict, without knowing exactly what will or should be done, that the outcome of the Betamax Case and any other legal developments involving computer software piracy could have an important effect on the makeup of the small-computer industry. The courts have designed copyright law to promote human creativity. As the Ninth Circuit stated, "this purpose is to be achieved by reliance on the economic

incentives granted to authors and inventors by the copyright scheme." Such a purpose is not being served where the more widely distributed and lower-priced products of human creativity may have the least effective protection because of technological and social factors. Perhaps, then, some form of royalty system for software copyright owners would help to remove the economic Catch-22 facing small-software authors as a result of the proliferation of small computers for which their programs are sold and on which their work may also be stolen. In any case, in the world of inexpensive computer software, events may now be taking place that will determine just what economic threshold must be crossed before copyrights are really of any value. ■

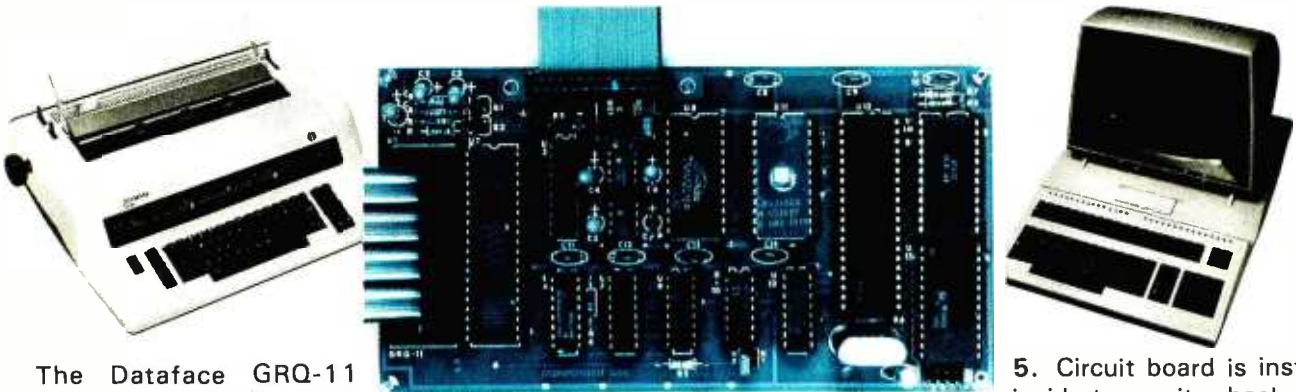
---

Occasionally, BYTE invites industry leaders to comment on topics related to the microcomputer industry. The opinions expressed by these authors are their own and do not necessarily express the opinions of BYTE or its publishers.

---

# DATAFACE GRQ SERIES INTERFACE

## TURNS YOUR ELECTRONIC TYPEWRITER INTO A PRINTER/TYPEWRITER



The Dataface GRQ-11 Interface expands your Olympia ES Series or Remington 200 Series electronic typewriters into a letter press quality printer for your personal or business computer. And, you still have a fully featured electronic typewriter—two machines in one.

The GRQ Series Interface features:

1. Standard EIA RS-232-C Serial Interface and Parallel (Centronics compatible).
2. Standard asynchronous ASCII code, 7 bit data; 1 start bit; accommodates 1 or 2 stop bits automatically; accommodates odd, even or absence of parity bit.
3. Fifty thru 9600 Baud data rate options.
4. Two K buffer; supports X-on, X-off protocol as well as RTS signals.

5. Circuit board is installed inside typewriter back panel along side logic board. The connection between boards accomplished by 40 pin jumper cable using existing socket. No soldering required. Power is provided to the GRQ thru two pins of the 40 lead cable. Installation in 10 minutes.

**GRQ-10 — CALL FOR SPECIAL WHOLESALE PRICE. SUGGESTED RETAIL \$349.50.**

# DATAFACE INC.

2372 A WALSH AVE., SANTA CLARA, CA 95050  
(408) 727-6704

Circle 130 on inquiry card.

# WICAT 68000 MULTI-USER SYSTEM 150

## STANDARD EQUIPMENT

68000 Processor  
256KB RAM  
10MB Winchester  
5¼" Floppy Disk Backup  
5 RS-232 C Serial Interfaces  
Parallel Port  
Multibus™  
WICAT Operating System  
Choice of One Language

## HARDWARE OPTIONS

Graphics CRT  
Up to 1.5MB RAM  
Communications: Auto Answer  
and Auto Dial (1200 Baud)  
Local Networking  
Videodisc Interface

## SOFTWARE OPTIONS

UNIX™ V/7  
CP/M™ Emulator

## LANGUAGE SUPPORT

PASCAL  
C  
FORTRAN  
BASIC  
APL\*  
COBOL  
ADA™  
LISP  
Assembler



**WICAT**systems

P.O. Box 539 1875 South State Street Orem, Utah 84057 (801) 224-6400

Call or write WICAT Systems for additional information.

\*UNIX is a trademark of Bell Labs. Multibus is a trademark of INTEL.

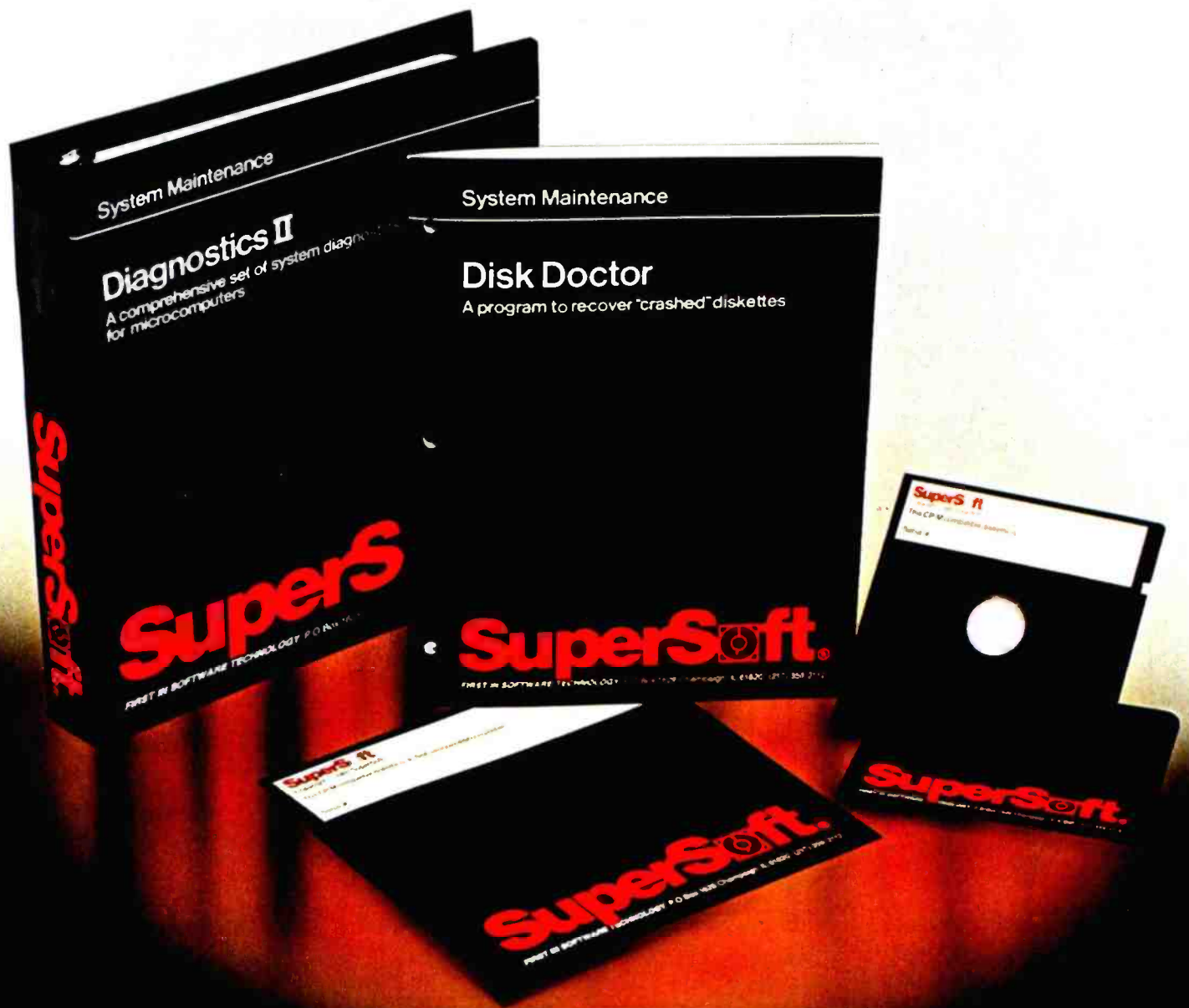
ADA is a trademark of the United States Dept. of Defense

CP/M is a trademark of Digital Research

APL.68000 is a product of the Computer Company



# How to keep cool when your system goes down.



*SuperSoft offers programs designed to check out a downed computer or recover a crashed diskette. Fast.*

## **SuperSoft's System Maintenance Series**

### **Diagnostics II**

Diagnostics II is the finest set of system maintenance routines available for microcomputers. Diagnostics II thoroughly checks all five areas of your computer system: memory, printer, terminal, disk, and CPU, pinpointing hardware problems to help you keep your system in perfect working order.

(Requires: 32K CP/M)

Diagnostics II: \$125.00

Manual Only: \$15.00

### **Disk Doctor**

Disk Doctor is a program which automatically recovers "crashed" diskettes or accidentally erased files. It will place all readable information from a "crashed" file into a good file, and it will unerase files which have been erased but not overwritten. Disk Doctor will not function completely on some double-sided disks.

(Requires: 48K CP/M and two drives for complete operation)

Disk Doctor: \$100.00

Manual Only: \$15.00

### **System Checker**

System Checker is a diagnostic program which will check your entire computer system quickly with very little user interaction. It was designed to be used by persons with no knowledge of computer hardware.

(Requires: 32K CP/M)

System Checker: \$75.00

Manual Only: \$15.00

### **Disk-Edit**

Disk-Edit is a screen oriented disk editor. It gives you complete access to all the raw information on your disk, in both hex and ASCII, with scrolling.

Disk-Edit will let you examine or alter files that cannot be accessed with a normal text editor.

(Requires: 32K CP/M)

Disk-Edit: \$100.00

Manual Only: \$15.00

## **Also Available From SuperSoft:**

### **Language Series:**

Ada\*: \$250, C: \$200, LISP: \$150, BASIC: \$200, FORTRAN: \$275, RATFOR: \$100, FORTH: \$200, TINY PASCAL: \$85, Z8000 ASSEMBLER: \$500.

### **Financial Planning Series:**

ScratchPad: \$200, Data-view: \$200, Stats-graph: \$200, Optimizer: \$200.

### **System Utilities:**

Term II: \$200, Utilities Packs I & II: \$60 each, Elink: \$250, Encode/Decode II: \$100, BCD: \$300.

### **Entertainment Series:**

Nemesis: \$45, Dungeon Master: \$40, Analiza II: \$50.

### **Word Processing:**

Star-Edit: \$225, TFS: \$85.

Available from fine dealers everywhere, or directly from SuperSoft.

U.K. and European Distribution: Digital Devices, 134 London Road, Southborough Kent, Tunbridge Wells, TN4 0PL, England. Tel. Tunbridge Wells (892) 37977/9 Telex. 95582.

Japanese Distribution: ASR Corporation International, 3-23-8, Nishi-Shimbashi, Minato-Ku, Tokyo 105, Japan, Tel. (03)-437-5371. Telex. 0242-2723.

\*Ada is a trademark of the Department of Defense (Ada Joint Program Office).

CP/M is a registered trademark of Digital Research.

SSS FORTRAN copyright Small Systems Services.

Unix is a registered trademark of Bell Laboratories.

***SuperSoft software available for virtually all CP/M systems. Please specify your system. Most products also available for CP/M-86 and IBM PC DOS. Please Inquire.***

# **SuperSoft®**

**FIRST IN SOFTWARE TECHNOLOGY** P.O. Box 1628 Champaign, IL 61820 (217) 359-2112 Telex 270365

Circle 396 on inquiry card.



## Everyone Can Know The Real Time

*Technological advances have made  
real-time clocks simple and inexpensive.*

Steve Ciarcia  
POB 582  
Glastonbury, CT 06033

It's almost three years now since I last discussed real-time clocks. Much has happened since I wrote "Anyone Know the Real Time?" (reference 1). Back then real-time clocks were usually put together either from existing digital watch or clock chips or from a series of TTL (transistor-transistor logic) counters. Microprocessor-bus-compatible real-time-clock chips were just emerging and were very expensive. I had to phrase my article title as a question.

Today, of course, real-time clocks are established, cost-effective products. The expense of adding a true millisecond-to-month time-of-day clock to a personal computer is barely more than the cost of the cheapest, most primitive clock of the kind in wide use just a few years ago. Today, with very little trouble, everyone who really wants to can know the real time.

This month I'd like to update the story a little and describe how to con-

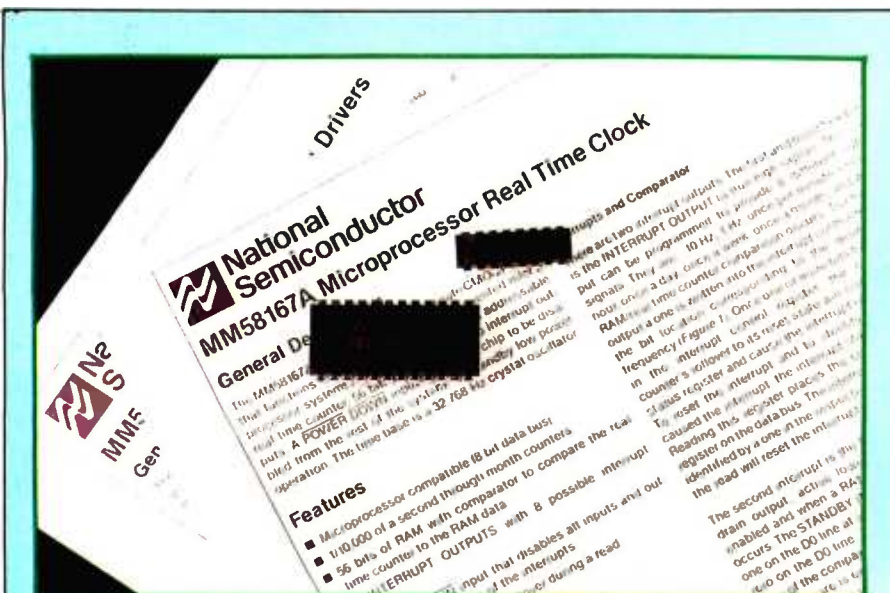
nect one of the latest products of real-time-clock technology to a microprocessor-based computer system, using a minimum-component circuit with battery backup, and I'll show how you can put together an intelligent clock that can function as a stand-alone peripheral device which communicates time data over a serial communication link to a remote computer upon command. But first, some background information.

### What Is Real Time?

Why do we need a clock to keep "real" time? Does this mean there exists "unreal" time?

Before we think too hard about what seems to be a philosophical conundrum, let's consider for a moment a typical application where a computer monitors a number of physical parameters and triggers a series of sequentially timed control outputs in response to certain changes in the parameters.

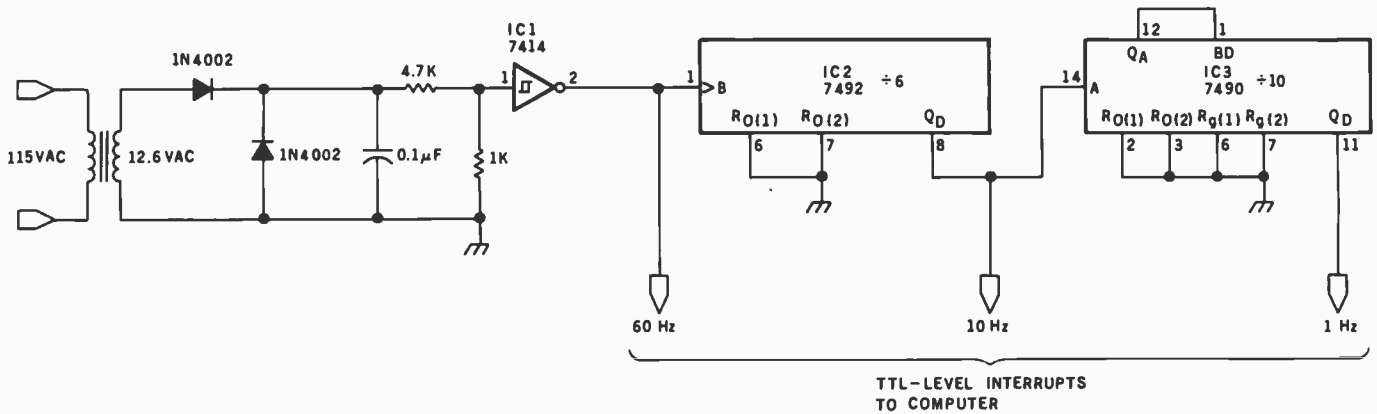
Suppose you have a computer controlling the lights in your home and that you want the control computer



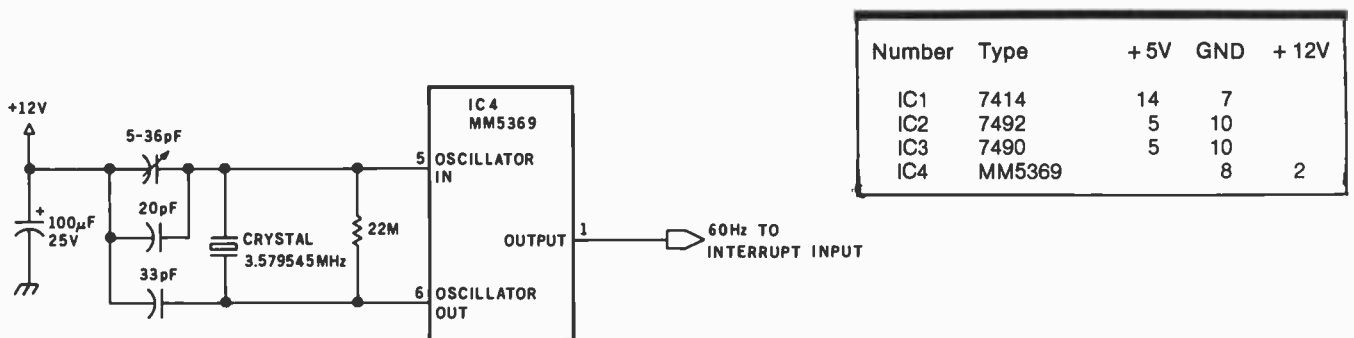
**Photo 1:** No longer must we assemble real-time clocks from digital-watch parts or from small-scale-integrated circuits. National Semiconductor has introduced two components that do all the hard work: the MM58167A and the MM58174A.

Copyright © 1982 Steven A. Ciarcia.  
All rights reserved.

Z8 is a trademark of Zilog Inc. Diagrams and tables pertaining to the MM58167A and the MM58174A are reprinted courtesy of National Semiconductor Corporation.



**Figure 1:** Schematic diagram of a simple real-time clock that uses the 60-Hz power-line frequency as a reference. This provides the computer with only regular pulses or "heartbeat ticks"; the time of day must be kept by software.



**Figure 2:** A simple real-time-clock circuit that relies on a crystal oscillator for its timebase. As in figure 1, the only output is a series of regular pulses.

to be able to tell when you are arriving home so that it can turn on the entrance light and turn it off when you get inside.

One way of setting up such a system is to place a pressure-sensitive switch under the doormat with a connection running to one of the computer's control inputs. As you approach the door and step on the mat, the computer's job is to sense the switch closure and turn the light on for, say, 200 seconds before turning it off. To perform these operations, the computer must be directed by a program which embodies a control algorithm that says, at least in part, "Turn the light on when the switch is closed, and then turn the light off later."

Now here's the catch. An algorithm cannot by itself tell how long the computer's hardware takes to per-

form any part of the algorithm. But you will be quite aware of how long the entrance light stays on, as directed by the control algorithm. So the algorithm must use some means to make 200 seconds pass in your real perception before turning the light off and moving to other tasks.

This is what we mean when we say that a computer keeps track of "real time." An algorithm that may execute at different speeds on different hardware is tied to external events. A hardware circuit or hardware/software combination that accurately records time with respect to an external observer is called a real-time clock.

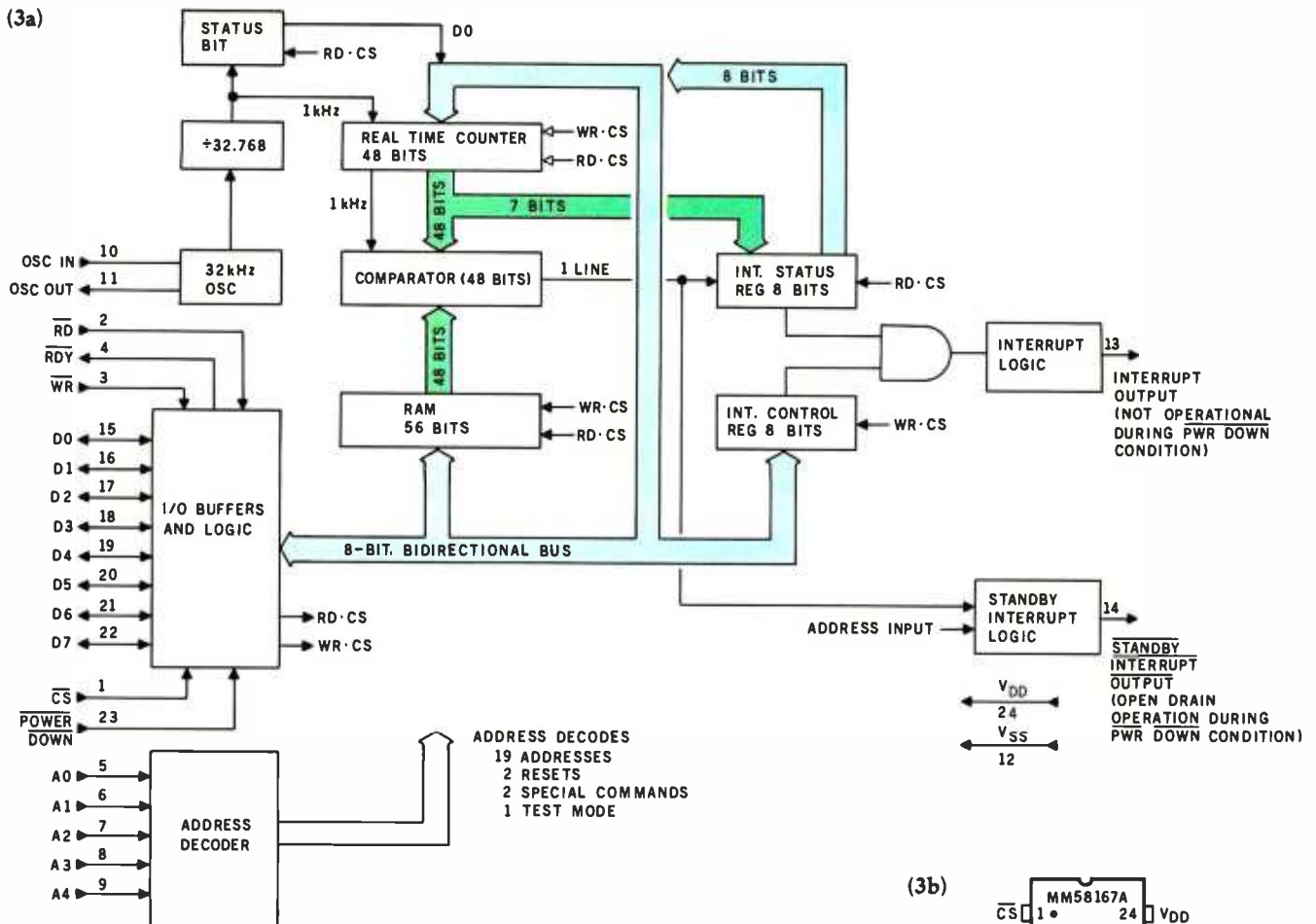
### Limitations of Software Timing

In our simple entrance-light application, it's not very hard to write a program that will satisfy us. We can

use a short BASIC program that monitors an input bit and sets an output state, incrementing a counter variable in a FOR...NEXT loop to provide the 200-second delay. Perhaps 5000 iterations of a 40-ms (millisecond) loop would do the trick.

But what happens if the problem becomes more complex? Suppose we have a second light inside the house and a second mat with a switch under it, with a similar need for the computer to turn the light on for a specified duration. We have to add another set of delay statements to our simple BASIC program, and when we add something, it changes the execution time of the original timing loop. While we could make the FOR...NEXT-loop method work for two lights, the complications mount quickly as the problem becomes larger.





**Figure 3:** Block diagram (3a) and pinout specification (3b) of the National Semiconductor MM58167A Real Time Clock. This integrated circuit and the MM58174A are advertised as being available from several distributors, including Jameco Electronics, 1355 Shoreway Rd., Belmont, CA 94002, (415) 592-8097.

### Hardware Marks Real Time

We escape the convolutions of the software approach by using special hardware circuitry that maintains a record of true elapsed time irrespective of software execution speeds. These circuits can take many forms, but generally such real-time clocks fall into either the time-of-day or "heartbeat-interrupt" category.

The *heartbeat-interrupt* clock is less expensive and uses fewer or simpler components, but more software interaction is needed to perform all the housekeeping chores, while a *time-of-day* clock does almost everything with hardware, requiring relatively little interaction with software.

### Heartbeat-Interrupt Clocks

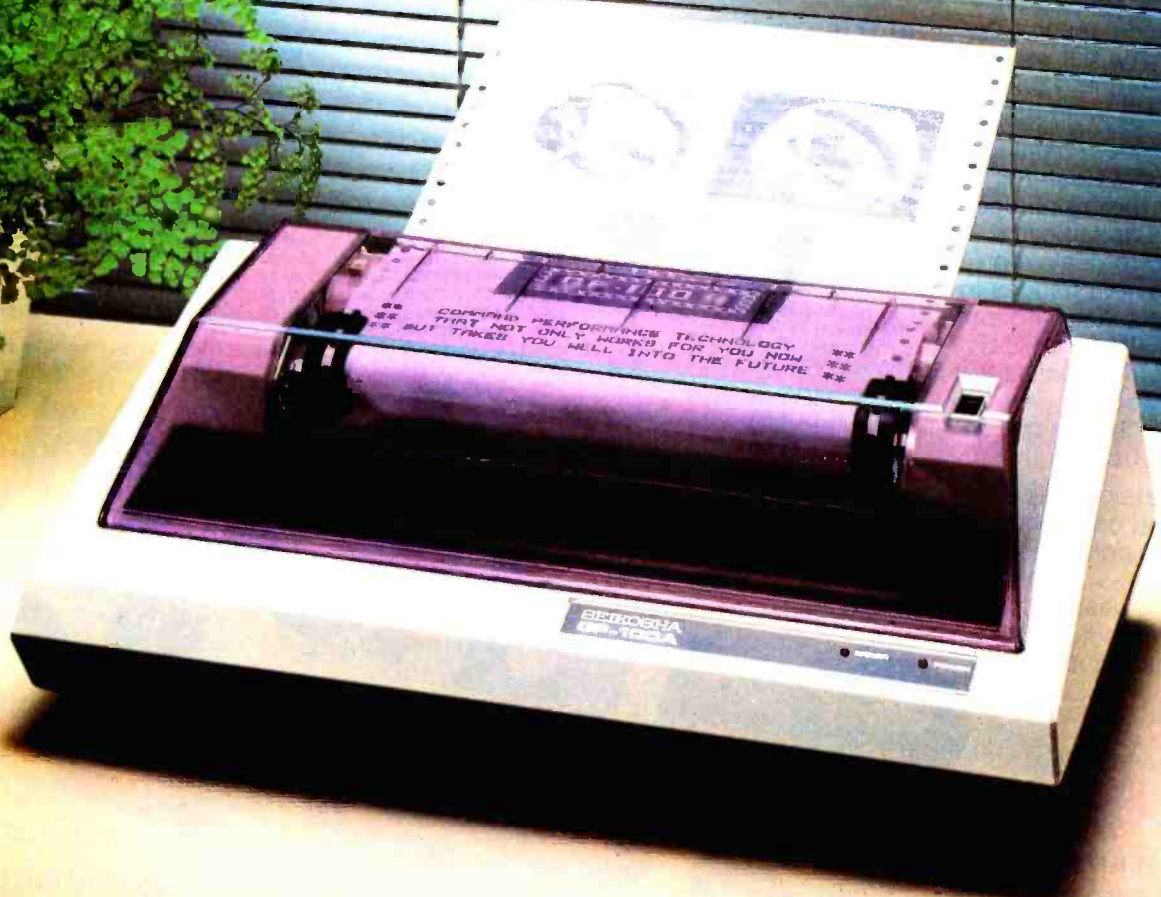
Figure 1 and figure 2 on page 35 show examples of two heartbeat-interrupt circuits, which were the feature attractions of my previous article. The circuit of figure 1 uses a crystal as a convenient timebase, while the circuit of figure 2 uses the 60-Hz power line. Both produce a single regular pulse (a clock "tick") at intervals of some precise fraction of a second. (Typical systems produce a tick at intervals of 1/60, 1/40, and 1/10 second.) The output line of the circuit is connected to an interrupt input on the processor.

Every time the clock ticks, the processor stops what it is doing and increments an elapsed-ticks counter in

memory. When the processor needs to know the real time, it must calculate the time from the number of ticks. For example, using a 1/60-second timebase, a count of 10,860 corresponds to 181 elapsed seconds.

Generally, a computer system with a heartbeat-interrupt clock is initialized with the time of day when it is turned on, with the initialization time stored either in the ticks counter (which is said to count ticks from midnight) or in a separate location (to be summed with the ticks when the value of the time is needed).

SEIKOSHA  
GP-100A



GP-100A: US\$389

## COMMAND PERFORMANCE.

**Seikosh gives you all the best features—including economy and super-clear graphics.**

Unlike some graphic printers, Seikosh's new GP-100A Uni-Hammer Graphic Printer puts full dot addressable graphic at your command. The GP-100A lets you repeat a column of data as many times as needed with just one command. Software control enables double-width character output, and the positioning is both character and dot addressable. Designed for simple operation, it ranks among the most cost-efficient graphic printers on the market. Command performance technology that not only works for you now, but takes you well into the future.

### Other valuable features:

- Graphics, regular and double width character modes can be intermixed on the same line.
- Automatic printing. When the text exceeds the maximum line length, there is no loss of data due to overflow.
- Self-test printing is a standard feature.
- Centronics type parallel interface.
- Paper width is adjustable up to 10 inches.
- Optional Interface: RS232C, IEEE488, apple II, etc.

Graphic Printer  Series

Distributed by **AXIOM CORPORATION** 1014 Griswold Avenue San Fernando, Calif. 91340 Phone (213) 365-9521 TWX (910) 496-1748  
Manufactured by **SEIKOSHA SYSTEM EQUIPMENT DIV.** 4-1-1 Taihei Sumida-ku Tokyo Japan. Phone: 03-623-8111 Telex: 262-2620



...Everything from Apple II to Zork II at the lowest possible prices.

But low prices are only one feature of our new catalog. We think you'll find it to be a very well-organized, well-written reference tool.

When you receive our catalog, you get with it our commitment to help you keep it up to date.

Unlike most catalogs that are obsolete the moment they're printed, ours was specifically designed to deal with the rapid-fire changes in microcomputer hard and software. Its loose-leaf binder format makes it a snap to add the new pages we'll send out on a regular basis.

Our catalog was developed on exactly the same principles as our business — to offer you the lowest possible prices combined with the highest quality of service.

### 16K RAM KITS . . . 13.95

Set of 8 NEC 4116 200 ns Guaranteed one full year

### DISKETTES

#### ALPHA DISKS . . . 21.95

Single sided, certified Double Density 40 Tracks with Hub-ring Box of 10 Guaranteed one full year

#### VERBATIM DATALIFE

MD 525-01 10 16	26.50
MD 550-01 10 16	44.50
MD 557-01 10 16	54.95
MD 577-01 10 16	34.80
FD 32 or 34-9000	36.00
FD 32 or 34-8000	44.95
FD 34-4001	48.60

#### ALPHA DISKS . . . 21.95

Single sided, certified Double Density 40 Tracks with Hub-ring Box of 10 Guaranteed one full year

#### VERBATIM DATALIFE

MD 525-01 10 16	26.50
MD 550-01 10 16	44.50
MD 557-01 10 16	54.95
MD 577-01 10 16	34.80
FD 32 or 34-9000	36.00
FD 32 or 34-8000	44.95
FD 34-4001	48.60

### DISKETTE STORAGE

5 1/4" PLASTIC LIBRARY CASE	2.50
-----------------------------	------

8" PLASTIC LIBRARY CASE	3.50
PLASTIC STORAGE BINDER w/ Inserts	9.95
PROTECTOR 5 1/4" (50 Disk Capacity)	23.95
PROTECTOR 8" (50 Disk Capacity)	29.95
DISK BANK 5 1/4"	5.95
DISK BANK 8"	6.95

### NEC PERSONAL COMPUTERS

PC-8001A CPU	899.00
PC-8012A I/O	559.00
PC-8033A DISK I/O	125.00
PC-8031A DUAL DISK	899.00

### ALTOS COMPUTER SYSTEMS

Call Alpha Byte for our low Altos prices

### ATARI COMPUTERS

ATARI 800	699.00
ATARI 400 (16K)	339.00
ATARI 810 DISK DRIVE	449.00
ATARI 850 INTERFACE	449.00
ATARI 410 PROGRAM RECORDER	79.00
EPSON CABLE	35.00
MEMORY MODULE (16K)	89.95
JOYSTICK CONTROLLERS	10.00
PAADLE CONTROLLERS	19.95
STAR RAIDERS	35.00
MISSILE COMMAND	35.00
ASTERIODS	35.00

### INTEC PERIPHERALS RAM MODULES

48K FOR ATARI 400	279.00
32K FOR ATARI 800	135.00

### ACTIVISION ATARI CARTRIDGES

LAZAR BLAST	21.95
SKIING	21.95
DRAGSTER	21.95
BOXING	21.95
CHECKERS	21.95
BRIDGE	21.95
KABOOM	21.95

### INTEC PERIPHERALS RAM MODULES

48K FOR ATARI 400	279.00
32K FOR ATARI 800	135.00

### ACTIVISION ATARI CARTRIDGES

LAZAR BLAST	21.95
SKIING	21.95
DRAGSTER	21.95
BOXING	21.95
CHECKERS	21.95
BRIDGE	21.95
KABOOM	21.95

### ALPHA DISKS . . . 21.95

Single sided, certified Double Density 40 Tracks with Hub-ring Box of 10 Guaranteed one full year

#### VERBATIM DATALIFE

HP-32E SCIENTIFIC w/ STATS	46.95
HP-33C Programmable Scientific	76.95
HP-41C Advanced Programmable	211.95
HP-41CV Advanced Prog 2K mem	274.95

### HP-41 PERIPHERALS

HP-82106A MEMORY MODULE	27.95
HP-82170A Quad Memory Module	89.00
HP-82143A PRINTER/PLOTTER	324.95
HP-82160A IL INTERFACE	119.00
HP-82161A DIGITAL CASSETTE	419.00
HP MATH PAC	29.00
HP STATISTICS PAC	29.00
HP REAL ESTATE PAC	39.00
HP SURVEYING PAC	29.00
HP STRUCTURAL ANALYSIS PAC	39.00

### HP COMPUTERS

HP-85A PERSONAL COMPUTER	21.95
HP SINGLE 5 1/4" DISK DRIVE	12.95
HP DUAL DISK DRIVE	19.95
HP-85A 16K MEMORY MODULE	239.00
HP-7225B GRAPHICS PLOTTER	21.95
HP PLOTTER MODULE	605.00
HP HP-IB INTERFACE	329.00
HP STD APPLICATIONS PAC	83.00
HP GENERAL STATISTICS PAC	83.00

HP GRAPHIC PRESENTATIONS	159.00
HP VISICALC PLUS	159.00
HP ROM DRAWER	39.00
HP PRINTER/PLOTTER ROM	116.00
HP MASS STORAGE ROM	116.00
HP RS-232 INTERFACE	329.00

### PRINTERS

ANADEX DP 9500	1295.00
ANADEX DP 9501	1295.00
C-1TOH F-10 40 CPS PARALLEL	1595.00
C-1TOH 45 CPS PARALLEL	1770.00
C-1TOH 40 CPS SERIAL	1870.00
C-1TOH PROWRITER PARALLEL	549.00
C-1TOH PROWRITER SERIAL	695.00
C-1TOH COMET I	289.00
EPSON MX-80	SCALL
EPSON MX-80 F/T	SCALL
EPSON MX-100 GRAPHIC	90.00
EPSON GRAFTRAX	90.00
IDS-445G PAPER TIGER	779.00
IDS-460G PAPER TIGER	945.00
IDS-560G PAPER TIGER	1195.00
IDS PRISM 80 W/O COLOR	1099.00
IDS PRISM 132 W/COLOR	1799.00
NEC SPINWRITER 3510 S RO	1995.00
NEC SPINWRITER 3530 P RO	1995.00
NEC SPINWRITER 7710 S RO	2545.00
NEC SPINWRITER 7730 P RO	2545.00
NEC SPINWRITER 7700 D SELLUM	2795.00
NEC SPINWRITER 3500 SELLUM	2295.00
OKIDATA MICROLINE 80	389.00
OKIDATA MICROLINE 82A	549.00
OKIDATA MICROLINE 83A	799.00
OKIDATA MICROLINE 84	1199.00
OUME 9/45	2149.00

### CORVUS

FOR S-100, APPLE OR TRS-80 MOD I, III

Controller Case/Keyboard	38.95
5 1/4" BYTES	38.95
10 1/2" BYTES	46.95
20 1/2" BYTES	55.95
30 1/2" BYTES	63.95
40 1/2" BYTES	71.95
50 1/2" BYTES	79.95
60 1/2" BYTES	87.95
70 1/2" BYTES	95.95
80 1/2" BYTES	103.95
90 1/2" BYTES	111.95
100 1/2" BYTES	119.95
110 1/2" BYTES	127.95
120 1/2" BYTES	135.95
130 1/2" BYTES	143.95
140 1/2" BYTES	151.95
150 1/2" BYTES	159.95
160 1/2" BYTES	167.95
170 1/2" BYTES	175.95
180 1/2" BYTES	183.95
190 1/2" BYTES	191.95
200 1/2" BYTES	199.95
210 1/2" BYTES	207.95
220 1/2" BYTES	215.95
230 1/2" BYTES	223.95
240 1/2" BYTES	231.95
250 1/2" BYTES	239.95
260 1/2" BYTES	247.95
270 1/2" BYTES	255.95
280 1/2" BYTES	263.95
290 1/2" BYTES	271.95
300 1/2" BYTES	279.95
310 1/2" BYTES	287.95
320 1/2" BYTES	295.95
330 1/2" BYTES	303.95
340 1/2" BYTES	311.95
350 1/2" BYTES	319.95
360 1/2" BYTES	327.95
370 1/2" BYTES	335.95
380 1/2" BYTES	343.95
390 1/2" BYTES	351.95
400 1/2" BYTES	359.95
410 1/2" BYTES	367.95
420 1/2" BYTES	375.95
430 1/2" BYTES	383.95
440 1/2" BYTES	391.95
450 1/2" BYTES	399.95
460 1/2" BYTES	407.95
470 1/2" BYTES	415.95
480 1/2" BYTES	423.95
490 1/2" BYTES	431.95
500 1/2" BYTES	439.95
510 1/2" BYTES	447.95
520 1/2" BYTES	455.95
530 1/2" BYTES	463.95
540 1/2" BYTES	471.95
550 1/2" BYTES	479.95
560 1/2" BYTES	487.95
570 1/2" BYTES	495.95
580 1/2" BYTES	503.95
590 1/2" BYTES	511.95
600 1/2" BYTES	519.95
610 1/2" BYTES	527.95
620 1/2" BYTES	535.95
630 1/2" BYTES	543.95
640 1/2" BYTES	551.95
650 1/2" BYTES	559.95
660 1/2" BYTES	567.95
670 1/2" BYTES	575.95
680 1/2" BYTES	583.95
690 1/2" BYTES	591.95
700 1/2" BYTES	599.95
710 1/2" BYTES	607.95
720 1/2" BYTES	615.95
730 1/2" BYTES	623.95
740 1/2" BYTES	631.95
750 1/2" BYTES	639.95
760 1/2" BYTES	647.95
770 1/2" BYTES	655.95
780 1/2" BYTES	663.95
790 1/2" BYTES	671.95
800 1/2" BYTES	679.95
810 1/2" BYTES	687.95
820 1/2" BYTES	695.95
830 1/2" BYTES	703.95
840 1/2" BYTES	711.95
850 1/2" BYTES	719.95
860 1/2" BYTES	727.95
870 1/2" BYTES	735.95
880 1/2" BYTES	743.95
890 1/2" BYTES	751.95
900 1/2" BYTES	759.95
910 1/2" BYTES	767.95
920 1/2" BYTES	775.95
930 1/2" BYTES	783.95
940 1/2" BYTES	791.95
950 1/2" BYTES	799.95
960 1/2" BYTES	807.95
970 1/2" BYTES	815.95
980 1/2" BYTES	823.95
990 1/2" BYTES	831.95
1000 1/2" BYTES	839.95

### APPLE HARDWARE

APPLE II DIGITIZER	259.00
APPLE KEYPAD	119.00
MICROSOFT 2-80 SOFTCARD	29.00
MICROSOFT RAMCARD	13.95
VIDEX 80 x 24 VIDEO	299.00
VIDEX KEYBOARD ENHANCER II	129.00
VIDEX ENHANCER REV D-6	99.00
VIDEX SOFT SWITCH	29.00
M & R SUPERTERM 80 x 24 VIDEO BD	315.00
SSM A10 BOARD (INTERFACE) A & T	165.00
SSM A10 BOARD (INTERFACE) KIT	135.00
APPLE FAN	44.95
T/G JOYSTICK	54.95
T/G PADDLER	34.95
VERSA E-Z PORT	21.95
MICRO SCI A2 W/O CONTROLLER	419.00
MICRO SCI A40 W/CONTROLLER	479.00
MICRO SCI A40 W/O CONTROLLER	409.00
MICRO SCI A70 W/CONTROLLER	629.00
MICRO SCI A70 W/O CONTROLLER	549.00
THE MILL-PASCAL SPEED UP	329.00
PROMETHEUS VERSACARD	229.00
SUPERCLOCK II	129.00
LAZAR LOWER CASE + MICROBUFFER II 16K W/GRAPHICS	59.00
MICROBUFFER II 32K W/GRAPHICS	259.00
WIZARD 80 COL VIDEO	279.00

### APPLE HARDWARE

VERSA WRITER DIGITIZER	259.00
ABT APPLE KEYPAD	119.00
MICROSOFT 2-80 SOFTCARD	29.00
MICROSOFT RAMCARD	13.95
VIDEX 80 x 24 VIDEO CARD	299.00
VIDEX KEYBOARD ENHANCER II	129.00
VIDEX ENHANCER REV D-6	99.00
VIDEX SOFT SWITCH	29.00
M & R SUPERTERM 80 x 24 VIDEO BD	315.00
SSM A10 BOARD (INTERFACE) A & T	165.00
SSM A10 BOARD (INTERFACE) KIT	135.00
APPLE FAN	44.95
T/G JOYSTICK	54.95
T/G PADDLER	34.95
VERSA E-Z PORT	21.95
MICRO SCI A2 W/O CONTROLLER	419.00
MICRO SCI A40 W/CONTROLLER	479.00
MICRO SCI A40 W/O CONTROLLER	409.00
MICRO SCI A70 W/CONTROLLER	629.00
MICRO SCI A70 W/O CONTROLLER	549.00
THE MILL-PASCAL SPEED UP	329.00
PROMETHEUS VERSACARD	229.00
SUPERCLOCK II	129.00
LAZAR LOWER CASE + MICROBUFFER II 16K W/GRAPHICS	59.00
MICROBUFFER II 32K W/GRAPHICS	259.00
WIZARD 80 COL VIDEO	279.00

### MONITORS

NEC 12" GREEN MONITOR	199.00
-----------------------	--------

NEC 13" COLOR MONITOR	399.00
SANYO 12" MONITOR (B & W)	249.00
SANYO 12" MONITOR (GREEN)	269.00
SANYO 13" COLOR MONITOR	469.00
ZENITH 13" HI RES GREEN MON	139.00
AMDEK COLOR I	389.00
AMDEK RGB COLOR	859.00
AMDEK RGB INTERFACE	169.00

### MOUNTAIN HARDWARE

CPS MULTIFUNCTION BOARD	199.00
SUPERTALKER SD200	259.00
ROMPLUS W/ KEYBOARD FILTER	179.00
ROMPLUS W/O KEYBOARD FILTER	130.00
KEYBOARD FILTER ROM	49.00
COPYROM	49.00
MUSIC SYSTEM	369.00
ROMWRITER	149.00
APPLE CLOCK	252.00
A/D + D/A	299.00
EXPANSION CHASSIS	625.00

### CALIF. COMPUTER SYSTEMS

S-100 BOARDS	
2200A MAINFRAME	459.00
2065C 64K DYNAMIC RAM	539.00
2422 FLOPPY DISK CONT & CP/M*	359.00
2710 FOUR SERIAL I/O	279.00
2718 TWO SERIAL/TWO PARALLEL I/O	269.00
2720 FOUR PARALLEL I/O	
2810 Z-80 CPU	

### APPLE BOARD

7710A ASSEMBLY INTERFACE	199.00
7712A ASSEMBLY INTERFACE	199.00
774A ASSEMBLY INTERFACE	199.00
7728A ASSEMBLY INTERFACE	199.00

### CALIF. COMPUTER SYSTEMS

S-100 BOARDS	
2200A MAINFRAME	459.00
2065C 64K DYNAMIC RAM	539.00
2422 FLOPPY DISK CONT & CP/M*	359.00
2710 FOUR SERIAL I/O	279.00
2718 TWO SERIAL/TWO PARALLEL I/O	269.00
2720 FOUR PARALLEL I/O	
2810 Z-80 CPU	

### APPLE BOARD

7710A ASSEMBLY INTERFACE	199.00
7712A ASSEMBLY INTERFACE	199.00
774A ASSEMBLY INTERFACE	199.00
7728A ASSEMBLY INTERFACE	199.00

### VISTA COMPUTER CO.

APPLE VISION 80-80 COL CARD	329.00
APPLE 8" DISK DRIVE CONTROLLER	549.00

### MODEMS

NOVATION CAT ACOUSTIC MODEM	145.00
NOVATION D-CAT DIRECT CONNECT	165.0



## MORROW DESIGNS

### FLOPPY DISK SYSTEMS

Controller P S Microsoft Basic CP/M*	
A & T	
DISCUS 20 (Single Drive - 500K)	869.00
DISCUS 20 (Dual Drive - 1 MEG)	1499.00
DISCUS 2 + 2 (Single Drive - 1 MEG)	1099.00
DISCUS 2 + 2 (Dual Drive - 2 MEG)	1999.00

### HARD DISK SYSTEMS

Controller P S Microsoft Basic CP/M*	
A & T	
DISCUS M10 (10 Megabytes)	3099.00
DISCUS M26 (26 Megabytes)	3749.00

### ISOLATORS

ISO-1 3-SOCKET	53.95
ISO-2 6-SOCKET	53.95

### BARE DRIVES

#### TANDON 5 1/4 INCH

100-1 SINGLE HEAD 40 TRK	19.00
100-2 DUAL HEAD 40 TRK	30.00
100-3 SINGLE HEAD 80 TRK	29.00
100-4 DUAL HEAD 80 TRK	49.00

48-2 SINGLE HEAD 40 TRK	19.00
48-2 DUAL HEAD 40 TRK	29.00

100-1 3-SOCKET	53.95
100-2 6-SOCKET	53.95

### BARE DRIVES

TANDON 5 1/4 INCH	
100-1 SINGLE HEAD 40 TRK	219.00
100-2 DUAL HEAD 40 TRK	299.00
100-3 SINGLE HEAD 80 TRK	299.00
100-4 DUAL HEAD 80 TRK	429.00

8 INCH THINLINE 8 INCH	
848-1 SINGLE SIDE	459.00
848-2 DUAL SIDE	549.00

### MICRO PRO

APPLE CP/M**	
WORDSTAR **	249.00
SUPERSORT **	145.00
MAILMERGE **	90.00
DATASTAR **	215.00
SPELLSTAR **	169.00
CALCSTAR **	169.00

CP/M*	
WORDSTAR	310.00
SUPERSORT	195.00
MAILMERGE	110.00
DATASTAR	245.00
SPELLSTAR	195.00
CALCSTAR	239.00

### MICROSOFT

APPLE	
FORTRAN*	165.00
BASIC COMPILER*	315.00
COBOL*	595.00
Z-80 SOFTCARD	299.00
RAMCARD	159.00
TYPING TUTOR	17.95
OLYMPIC DECATHLON	24.95
TASC APPLESOFT COMPILER	159.00

CP/M*	
BASIC 80	299.00
BASIC COMPILER	319.00
FORTRAN 80	369.00
COBOL 80	595.00
MACRO 80	189.00
mu MATH/mu SIMP	219.00
mu LISP/mu STAR	175.00

### APPLE SOFTWARE

MAGIC WINDOW	79.00
MAGIC SPELL	59.00
BASIC MAILER	59.00
APPLE PIE	99.00
DB MASTER	179.00
PFS: PERSONAL FILING SYSTEM	79.00
PFS: REPORT	79.00

Z-TERM*	89.95
Z-TERM PRO*	129.95
ASCII EXPRESS	63.95
HAYDEN APPLESOFT COMPILER	149.00
EASY WRITER-PRO	199.00
EASY MAILER-PRO	79.00
EXPEDITER II APPLESOFT COMPILER	73.95
A-STAT COMP STATISTICS PKG	129.00
SUPER TEXT II	129.00
FINANCIAL PARTNER	199.00
LISA 2.5	59.95
SUPERSCRIBE II	99.95

### CONTINENTAL SOFTWARE

G/L	199.00
A/R	199.00
A/P	199.00
PAYROLL	199.00
PROPERTY MGMT	199.00
THE HOME ACCOUNTANT	199.00

PERSONAL SOFTWARE	
DESKTOP	199.00
VISIFILE	199.00
VISIPLAN	199.00
VISIPLAN/VISIPILOT	199.00
VISICALC	199.00
VISIFILES	209.00

PERSONAL SOFTWARE	
DESKTOP	199.00
VISIFILE	179.00
VISIPLAN	239.00
VISIPLAN/VISIPILOT	199.00
VISITERM	79.00
VISICALC	199.00
VISIFILES	209.00

### CP/M® SOFTWARE

THE WORD-SPELL CHECK	75.00
d BASE II	599.00
SUPER CALC	229.00
SPELLGUARD	239.00
P & T CP/M* MOD II TRS-80	175.00
COMM TERMINAL PROG	82.50
C BASIC 2	115.00
PASCAL Z	349.00
PASCAL MT+	439.00
PASCAL/M	205.00
SYSTEMS PLUS -	
G/L A/R A/P P/R	1799.00
CONDOR I	579.00
CONDOR II	849.00

### DIGITAL RESEARCH

MAC	89.00
SID	69.00
ZSID	97.00
PL/1-80	439.00

### SUPERSOFT

DIAGNOSTIC I	69.00
DIAGNOSTIC II	89.00
'C' COMPILER	179.00
UTILITIES I	59.00
UTILITIES II	59.00
RATFOR	89.00
FORTRAN	239.00

### TRS-80 GAMES

TEMPLE OF APSHAI	34.95
HELLFIRE WARRIOR	34.95
STAR WARRIOR	34.95
RESCUE AT RIGEL	24.95
CRUSH, CRUMBLE AND CHOMP	24.95
INVADERS FROM SPACE	17.95
PINBALL	17.95
STAR TREK 3.5	17.95
MISSILE ATTACK	18.95
STAR FIGHTER	24.95

### TRS-80 SOFTWARE

NEWDOS/80 2.0 MOD I, II	139.00
LAZY WRITER MOD I, II	165.00
PROSOFT NEWSOFT MOD I, III	99.00
SPECIAL DELIVERY MOD I, III	119.00
X-TRA SPECIAL DELIVERY MOD I, III	199.00

TRACKCESS MOD I	24.95
OMNITERM SMART TERM MOD I, III	89.95
MICROSOFT BASIC COMP FOR MOD I	165.00
LDOS 5.1 MOD I, II	159.00

### APPLE GAMES

#### PERSONAL SOFTWARE

CHECKER KING	21.95
GAMMON GAMBLER	21.95
BRIDGE PARTNER	21.95
MONTY PLAYS MONOPOLY	21.95
ZORK I	32.95
ZORK II	32.95
MONTY PLAYS MONOPOLY	34.95

#### PERSONAL SOFTWARE

CHECKER KING	21.95
GAMMON	21.95
BRIDGE PARTNER	21.95
MONTY PLAYS MONOPOLY	29.95
ZORK I	32.95
ZORK II	32.95
MONTY PLAYS MONOPOLY	34.95

#### AUTOMATED SIMULATIONS

INVASION ORION	20.95
STAR WARRIOR	32.95
TUES MORNING QUARTERBACK	25.95
CRUSH, CRUMBLE AND CHOMP	24.95
THE DRAGON'S EYE	20.95

#### MUSE SOFTWARE

ROBOT WARS	32.95
THREE MILE ISLAND	32.95
A B M	20.95
GLOBAL WAR	20.95
CASTLE WOLFENSTEIN	24.95

#### ON-LINE SYSTEMS

WIZARD AND PRINCES	29.95
MISSILE DEFENSE	25.95
SABOTAGE	20.95
SOFT PORN ADVENTURE	24.95
THRESHOLD	31.95
JAW BREAKER	24.95
CROSSFIRE	16.45
TIME ZONE	69.95
H/R FOOTBALL	32.95
H/R CRIBBAGE	20.95
PEGASUS II	25.95

#### SIRIUS SOFTWARE

SPACE EGGS	24.95
GORGON	32.95
SNEAKERS	24.95
EPOCK	29.95
BEER RUN	24.95
HADRON	29.95
PULSAR II	24.95
EPOCK	29.95

### EDU-WARE

PERCEPTION PKG	19.95
COMPU-READ	24.95
STORY TELLER	18.95
COMPU-MATH ARITHMETIC	39.95
COMPU-MATH FRACTIONS	34.95
COMPU-MATH DECIMALS	34.95
COMPU-SPELL (REQ DATA DISK)	24.95
COMPU SPELL DATA DISKS 1-4, ea.	17.95

### MORE GREAT APPLE GAMES

COMPUTER QUARTERBACK	32.95
TORPEDO FIRE	49.95
THE SHATTERED ALLIANCE	49.95

### MORE GREAT APPLE GAMES

COMPUTER QUARTERBACK	32.95
TORPEDO FIRE	49.95
THE SHATTERED ALLIANCE	49.95
POOL 1.5	29.95
ULTIMA	33.95
RASTER BLASTER	24.95
FLIGHT SIMULATOR	27.95
INTERNATIONAL GRAND PRIX	25.95
SARGON II	28.95
SHUFFLE BOARD	29.95
FIREBIRD	24.95
SNACK ATTACK	24.95
THIEF	24.95
ROACH HOTEL	29.95
JABBERTALKY	24.95
THE WARP FACTOR	32.95
COSMO MISSION	24.95

### SUPPLIES

EVERY TABULABLES	
1,000 3 1/2 x 15/16	8.49
3,000 3 1/2 x 15/16	14.95
5,000 3 1/2 x 15/16	19.95

### FAN FOLD PAPER

(Prices F.O.B. S.P.)	
9 1/2 x 11 18lb WHITE 3,000 ct	29.00
14 7/8 x 11 18lb WHITE 3,000 ct	39.00



To order, or for information, call:  
**(213) 706-0333**

To use our 24-hour modem order line, call: (213) 883-8976.

We guarantee everything for 30 days. If anything is wrong, return the item and we'll make it right. And, of course, we'll pay the shipping charges.

We accept Visa and Master Card on all orders; COD up to \$300.00.

Add \$2.00 for standard UPS shipping and handling on orders under 50 lbs, delivered in continental U.S. Call for shipping charges over 50 lbs. Foreign, FPO and APO orders, add 15% for shipping. Californians add 6% sales tax.

Prices quoted are for stock on hand and subject to change without notice.

31245 LA BAYA DRIVE, WESTLAKE VILLAGE, CALIFORNIA 91362



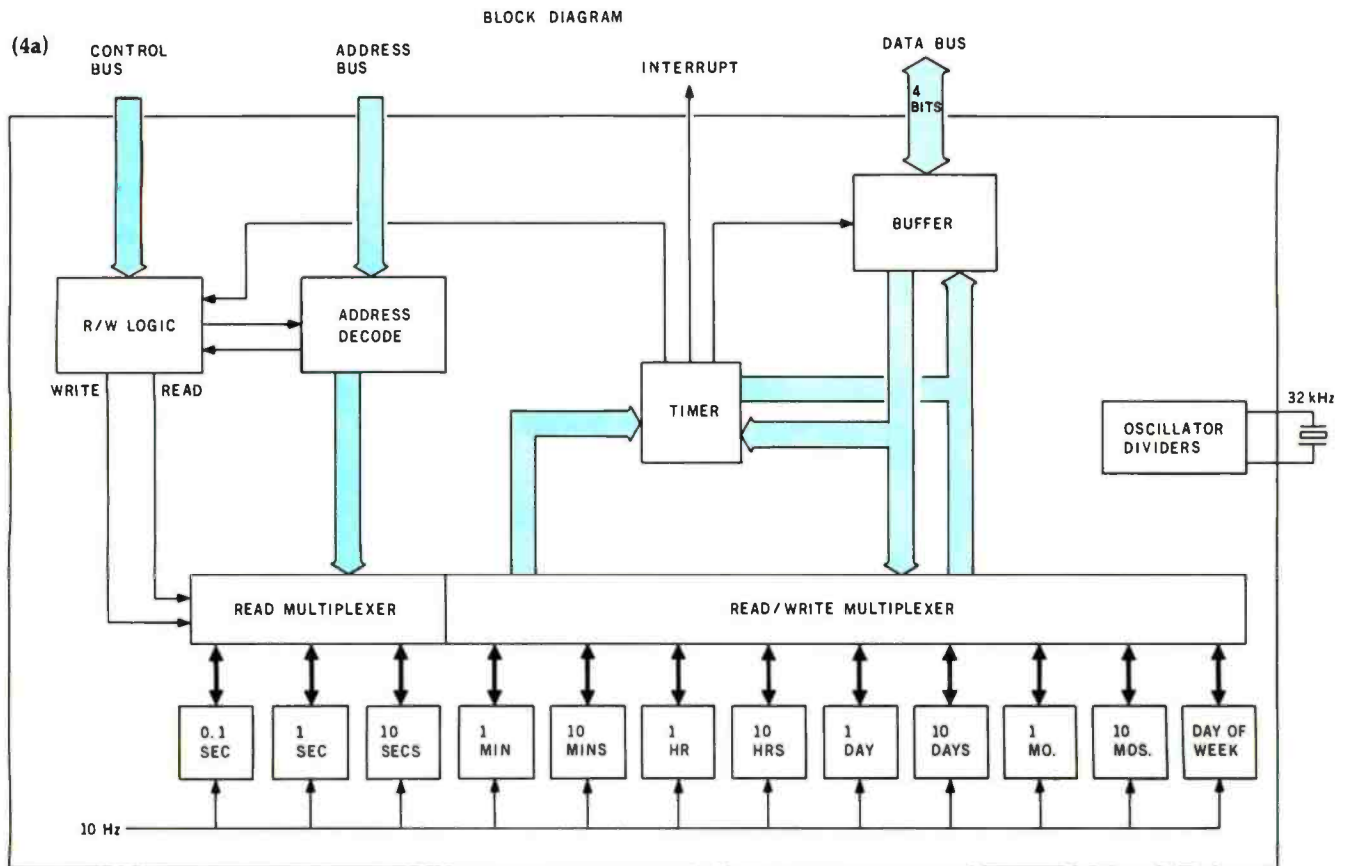
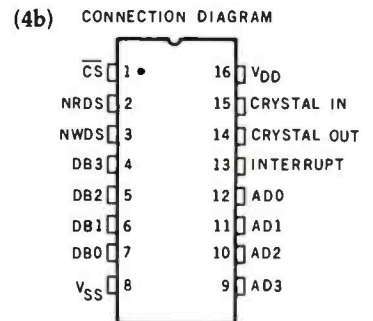


Figure 4: Block diagram (4a) and pinout specifications (4b) of the National Semiconductor MM58174A Real Time Clock.



The heartbeat-interrupt clock has some disadvantages. First, it is totally dependent on the processor's execution time and interrupt-handling capability. When the processor must interact with multiple peripheral devices, often there can be competition for the processor's attention. Computers from one major manufacturer actually ignore the clock at times, shutting it off while I/O (input/output) operations with the disk drive are taking place. The value of this clock is questionable because it loses a second or two with every disk operation.

The second criticism of heartbeat-interrupt timing is volatility. Since the time of day is kept only in software, the clock works only when the computer is powered. It is impossible to keep the clock running all the time without keeping power applied to the

processor and part of the program memory, which can be an expensive undertaking.

### What Is a Good Clock?

The ultimate solution is a separate hardware time-of-day real-time clock interfaced to the processor but running independently. Such a clock should keep track of the time of day to a resolution of milliseconds and should, with battery backup, never need to be reset. Additional features should include variable-rate processor interrupts (once per millisecond or once per month as required) and alarm-clock (coincidence of a preset time-of-day value) interrupts. Fortunately, these capabilities can be added to your system with a modest amount of hardware.

National Semiconductor Corporation has simplified the business of

putting a versatile real-time clock in a computer by introducing two CMOS (complementary metal-oxide semiconductor) LSI (large-scale integrated) circuits, the MM58167A and MM58174A. These real-time-clock chips are designed for direct connection to the control and data buses of common microprocessors. Figure 3 on page 36 is a block diagram of the MM58167A, and figure 4 is a block diagram of the MM58174A.

### Real-Time Clock: the MM58167A

The MM58167A is packaged in a 24-pin DIP (dual-inline package) and contains a 48-bit (14-digit) counter chain clocked from a 32,768-Hz

# CASH FLOW PROBLEMS?



## IT'S NICE TO KNOW SOMEONE WHO HAS THE SOLUTION.



MicroAge is your Solution Store . . . that means at MicroAge Computer Stores we have a wide selection of time-saving computerized business systems designed specifically to solve the daily cash flow problems every businessman faces.

MicroAge has computerized business systems that quickly and affordably allow you to regain control of your critical accounts receivable . . . at last making it possible for you to carry out effective collection procedures on a consistent basis. MicroAge has accounts receivable program packages to automatically display and update account information; prepare trial balance including a balance-due and delinquency aging

report, and take care of dozens of other tasks that eat into your time and profit!

Computerized business systems from the MicroAge Computer Store are available in the \$5,000 to \$15,000 range, to suit the individual budget of your small business or professional practice. MicroAge backs up every system with personalized service, warranty service and repair, installation, systems consulting, even customer training. Visit the MicroAge Computer Store in your area soon with your business problems, and let us help you with the solution.

**MicroAge.**  
**COMPUTER STORE**

*"The Solution Store" SM*

#### VISIT THE STORE IN YOUR AREA:

El Paso, Texas  
(915) 591-3349

Rockville, Maryland  
(301) 762-7585

Tucson, Arizona  
(602) 790-8959

Albuquerque, New Mexico  
(505) 883-0955

Pleasant Hill, California  
(415) 680-1489

Aurora, Colorado  
(303) 696-6950

Rochester, New York  
(716) 244-9000

Hurst, Texas  
(817) 284-3413

Salina, Kansas  
(913) 823-7596

Orland Park, Illinois  
(312) 349-8080

Milwaukee, Wisconsin  
(414) 257-1100

Mountain View, California  
(415) 964-7063

Scottsdale, Arizona  
(602) 941-8794

Anchorage, Alaska  
(907) 279-6688

San Diego, California  
(714) 278-0623

Richardson, Texas  
(214) 234-5955

Minneapolis, Minnesota  
(612) 338-1777

Omaha, Nebraska  
(402) 339-7441

Phoenix, Arizona  
(602) 265-0065

Columbus, Ohio  
(614) 868-1550

Indianapolis, Indiana  
(317) 849-5161

Portland, Oregon  
(503) 256-4713

Norwalk, Connecticut  
(203) 846-0851

St. Louis, Missouri  
(314) 567-7644

Oklahoma City, Oklahoma  
(405) 728-1837

Houston, Texas  
(713) 440-7547

W. Palm Beach, Florida  
(305) 683-5779

Toronto, Canada  
(416) 487-5551

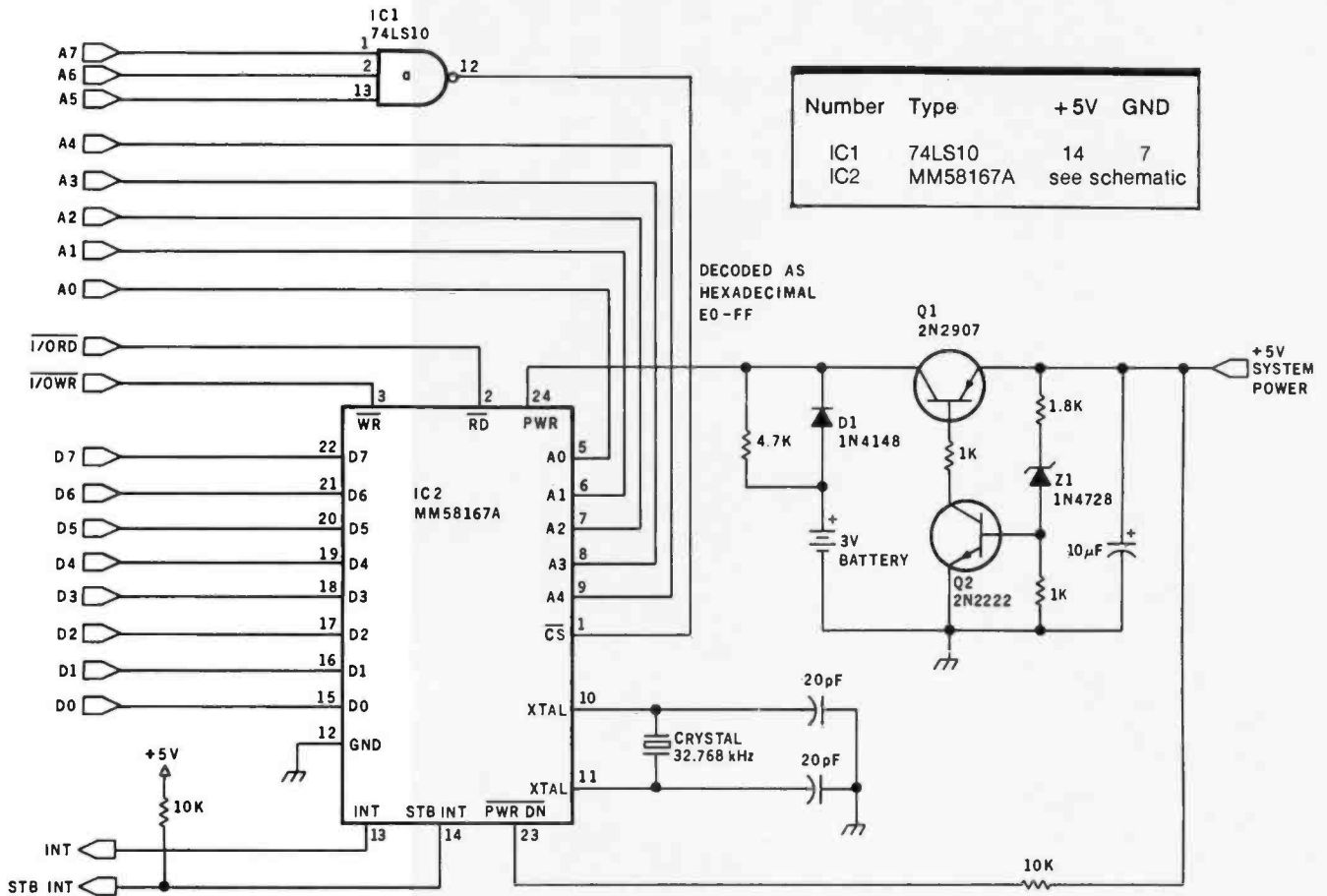
Houston, Texas  
(713) 270-9647

Wilmington, Delaware  
(302) 368-3672

Allentown, Pennsylvania  
(215) 434-4301

**FOR FRANCHISE OPPORTUNITY INFORMATION CALL (602) 968-3168**





**Figure 5:** Schematic diagram of a real-time-clock circuit employing the National Semiconductor MM58167A suitable for direct connection to the bus of a microprocessor-based computer system (Z80, 8080, or 8085). The clock registers are addressed by input/output instructions that reference a set of addresses mapped into the I/O-address space of the processor. Provision is made for keeping the clock running when the computer system is turned off by supplying power from two 1.5-V alkaline battery cells, which should maintain operation for several months.

crystal-reference oscillator. The MM58167A can keep track of and communicate to the processor the time in any increment from 1/10,000 second to months. (Usually, submilli-second resolution isn't required except in critical instrumentation or arguments over processor benchmarks.)

The MM58167A contains a storage latch consisting of 56 bits of on-chip RAM (random-access read/write memory). With backup power from a battery supplied to the clock chip, this storage can be used to keep any desired quantity or time while the system is powered down, or, in the "alarm-clock" mode, to contain a value to be compared to the real-time counter (either in its entirety or against individual digits in the counter). Occurrence of a match be-

tween the storage latch and the counters is signaled on a maskable interrupt line called the Standby Interrupt, which is active in the low logic state.

Another output, called simply the Interrupt Output (active high), can provide the heartbeat interrupt described earlier. This output can be programmed to provide clock ticks at seven regular rates (ten times per second [10 Hz], once a second [1 Hz], once a minute, once an hour, once a day, once a week, and once a month) and when a comparison match occurs between the storage latch and the real-time counter.

#### Real-Time Clock: the MM58174A

National Semiconductor's second real-time-clock chip, the MM58174A, is a 16-pin integrated circuit with

somewhat fewer talents (but a lower cost) than the MM58167A. The timing chain is derived from a 32,768-Hz oscillator, as in the MM58167A, and it counts time intervals from 1/10 second through months. The other major difference is the MM58174A's lack of the comparison-match interrupt. However, the MM58174A does have a tick interrupt programmable for intervals of 1/2 second, 5 seconds, or 60 seconds.

As I write this, the price/performance ratio of the 58167A is more attractive than that of the 58174A, so I have based my construction project solely on the MM58167A.

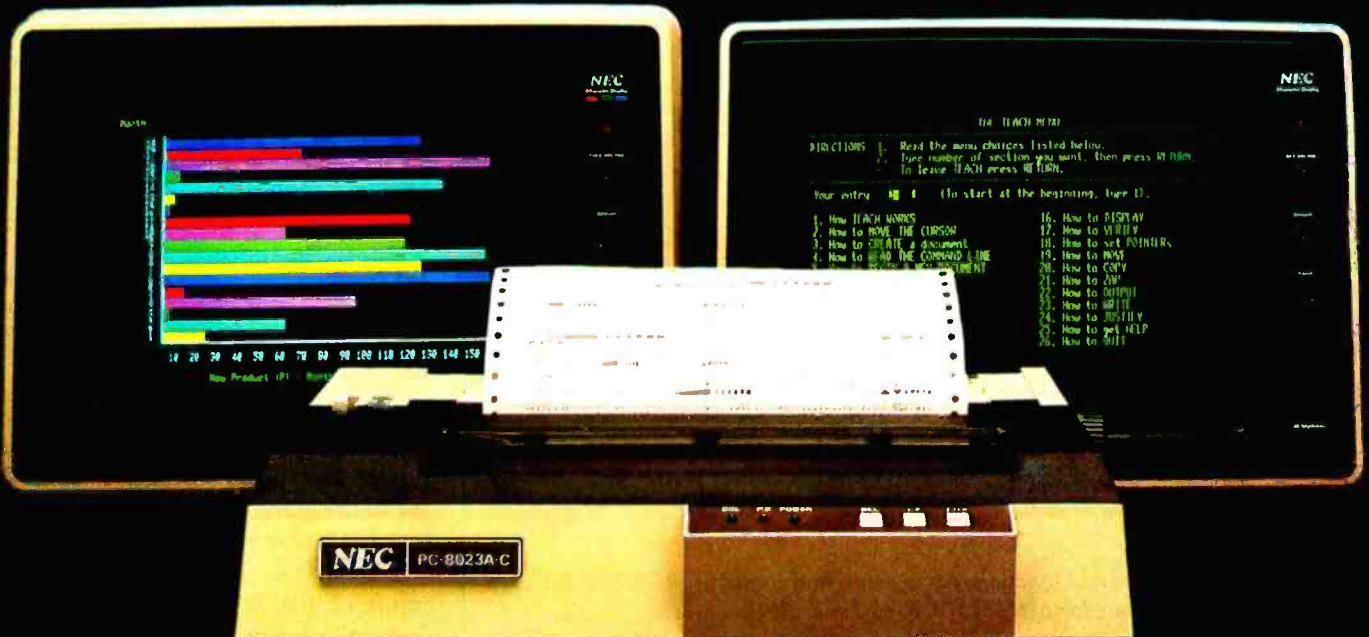
#### Real-Time-Clock Interface

Figure 5 is the schematic diagram of a real-time-clock circuit that incorporates the MM58167A. The circuit is

# Give your system some NEC, and watch its performance soar.

NEC's crisp, clear, high-performance JC1202 RGB color monitor, an industry standard. Also available: the JC1201 composite video version.

NEC's classic green monitor, (JB1201), one of computing's performance legends. Non-glare screen, easy on the eye. And the checkbook.

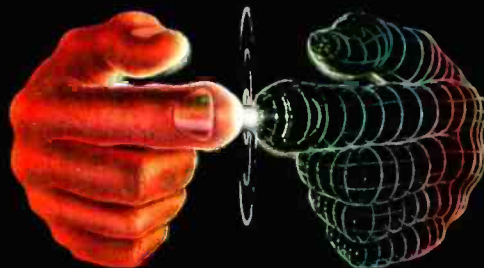


The impressive new NEC dot matrix printer. Parallel Interface, 100 cps, 2K buffer, pin or friction feed. Stunning performance and versatility in the hottest new peripheral of the year.

Peripherals from NEC can make almost any computer system better.

Owners of Apple®, Radio Shack®, Atari®, IBM®, and many other personal computers will find their equipment to be compatible with NEC's famous monitors, as well as our highly-featured new PC-8023A dot matrix printer. (Some configurations may require a different interface.)

Ask your dealer for a demonstration.



**Productivity  
at your fingertips**

**NEC**

**NEC Home Electronics (USA)  
Personal Computer Division**

1401 Estes Avenue  
Elk Grove Village, IL 60007



A4	A3	A2	A1	A0	Function
0	0	0	0	0	Counter—ten thousandths of seconds
0	0	0	0	1	Counter—hundredths and tenths of seconds
0	0	0	1	0	Counter—seconds
0	0	0	1	1	Counter—minutes
0	0	1	0	0	Counter—hours
0	0	1	0	1	Counter—day of week
0	0	1	1	0	Counter—day of month
0	0	1	1	1	Counter—month
0	1	0	0	0	RAM—ten thousandths of seconds
0	1	0	0	1	RAM—hundredths and tenths of seconds
0	1	0	1	0	RAM—seconds
0	1	0	1	1	RAM—minutes
0	1	1	0	0	RAM—hours
0	1	1	0	1	RAM—day of week
0	1	1	1	0	RAM—day of month
0	1	1	1	1	RAM—months
1	0	0	0	0	Interrupt Status register
1	0	0	0	1	Interrupt Control register
1	0	0	1	0	Count Reset
1	0	0	1	1	RAM Reset
1	0	1	0	0	Status bit
1	0	1	0	1	Go command
1	0	1	1	0	Standby Interrupt
1	1	1	1	1	Test mode

**Table 1:** Address codes and functions for registers and comparison latches (RAM) in the National Semiconductor MM58167A Real Time Clock.

relatively simple to attach to most personal computer systems, requiring only an 8-bit data bus and 5 address lines.

The read ( $\overline{RD}$ ), write ( $\overline{WR}$ ), and chip select ( $\overline{CS}$ ) lines on the clock chip are similar to those found on memory devices. To read any register in the clock, external circuitry must place signals on the  $\overline{RD}$  and  $\overline{CS}$  lines while the proper address appears on the address lines; similarly, to write data into the clock registers, external circuitry must enable the  $\overline{WR}$  and  $\overline{CS}$  lines while the address appears. The data bus serves as the data path in and out of the counters and latches; values are loaded and read in BCD (binary-coded decimal) format. The 5 address lines allow activation of 24 counter and memory functions, which are listed in table 1. (The binary values are equivalent to hexadecimal 00 through 1F.)

The MM58167A can be attached to

virtually any microprocessor bus. For example, in 6502- or 6800-based systems, the MM58167A would be addressed as 32 locations in memory-address space. As shown, the circuit of figure 5 contains signals designed to be decoded by the I/O bus of a Z80-, 8080-, or 8085-based computer, with the 24 clock-register addresses extending from hexadecimal E0 to FF. For simplicity and generality, I shall refer to particular registers in this article following the 00 to 1F coding of table 1. When you are using the circuit of figure 5, add hexadecimal E0 to these values.

### Turned-Off Timekeeping

One important attribute of both the MM58167A and the MM58174A is their ability to operate from battery power when the computer-system power is off. Both chips will continue keeping track of the real time when supplied with power at voltages

down to 2.2 volts (V). A small 3-V battery can easily supply the current required (only 20  $\mu$ A [microamps], dissipating 44  $\mu$ W [microwatts] of power).

The circuit of figure 5 contains provision for operating the real-time clock on battery power when the computer is turned off. Transistors Q1 and Q2 serve as a voltage-sensitive on/off switch. When the system power is on at a potential of +5 V, transistor Q1 conducts, supplying power to the MM58167A. Diode D1 blocks any large current flow into the battery, but the two alkaline cells do receive a slight trickle charge from the system power through the 4.7k-ohm resistor. In normal operation the MM58167A requires about 12 mA (milliamps).

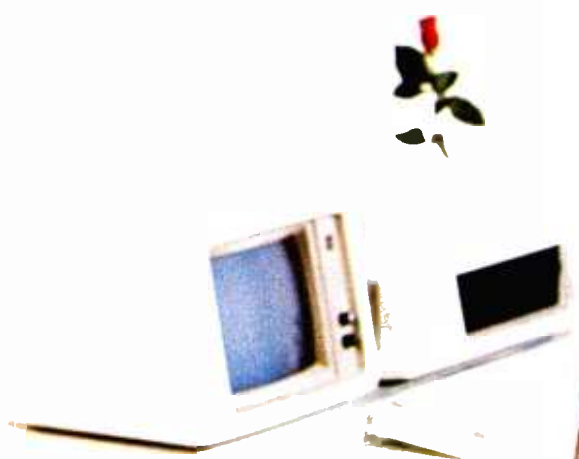
When the computer is shut off and the +5-V supply drops to 0 V, Q1 opens to keep current from the battery from going onto the system's power bus. Current begins to flow from the battery through diode D1 into the clock chip. At the same time, the  $\overline{PWRDN}$  (Power Down, pin 23) input of the MM58167A senses the low-voltage condition of the power bus and causes the clock to enter the powered-down operating mode.

In the powered-down mode, the clock's three-state I/O lines enter a high-impedance condition, effectively disconnected from the computer, and the current drawn from the power source is reduced from 12 mA to 20  $\mu$ A. In this mode, which can be activated at any time by placing a 0-V potential on pin 23, the clock continues to keep time, but only the Standby Interrupt remains active (if it was enabled previously). Using the Standby Interrupt and some external power-control circuitry, you could set up your computer to shut itself completely off and then turn itself on automatically weeks later.

### An Intelligent Clock

Many of you will have no qualms about digging into your computers and adding this simple real-time clock. However, some of us who possess the technical skills to construct the project don't want to em-

# "Only VR Data can offer you a Winchester Hard Disk Drive for your IBM Personal Computer..."



...with the same level of excellence and state-of-the-art technology you'd expect from IBM."

Warren Rosenkranz, President, VR Data

We are tremendously impressed with the IBM Personal Computer. When we set out to increase its capability with our exclusive,

totally compatible Winchester Hard Disk Drive and Memory Board, we dedicated ourselves to making the very finest products possible. Some very knowledgeable dealers and users say we've totally succeeded. See for yourself!!

#### OTHER QUALITY PRODUCTS FROM VR DATA

##### Winchester Hard Disks

6.3 Megabytes  
9.6 Megabytes  
19.0 Megabytes

2x 6.3 Megabytes  
2x 9.6 Megabytes  
2x 19.0 Megabytes

##### Memory Boards with Error Correction

64 Kbytes 192 Kbytes  
128 Kbytes

##### In The Queue

D-Con Direct connect internal modem  
The Echo  
Winchester Backup

As with our Winchester Hard Disk Drive, all our designs are tested, re-tested and "burned in." We're so sure of our quality control that we offer an unconditional 120 day extended warranty covering full costs of parts and labor on all VR Data products.

Insist on the best.  
Ask for us by name.



777 Henderson Boulevard N-6 Folcroft, PA 19032 800-345-8102

MICROCOMPUTER EXCELLENCE SINCE 1972.







# FUTURE DISK

## PHD, the first Personal Hard Disk with full capacity built in backup

Advance to a new degree of computer power and data security with 10 Megabytes: five MB of fast disk storage and 5MB for backup. The savings in operator time will pay for the PHD. Available for a wide range of popular personal computers:

- Apple II — all three operating systems on ONE disk. Ties into available low cost networks for education and office automation.
- IBM Personal Computer — turns the IBM-PC into the fastest personal computer on the market.
- Xerox 820 — add your vertical market software packages for a complete business solution.
- Heath-Zenith and other systems

The compact PHD can also be used as a single 10MB drive. In the future you can expand to a 10 X 10 or 20 MB configuration.

A full dealer program with flooring, service kits and demo package is available now. Suggested List Price: \$3,595.

\*Apple II is a trademark of Apple Computers, Inc.  
IBM Personal Computer is a trademark of IBM Corp.  
Xerox is a trademark of Xerox Corp.  
Heath-Zenith is a trademark of Zenith Data Systems

Circle 440 on inquiry card.

Also available from XCOMP:

- S100 Hard Disk Subsystem at unbeatable OEM prices
- General Purpose (GP) controllers — 8 bit interface — with easy interface to microprocessor-based systems
- SG/R GP controller for SA1000 interface
- SM/R GP controller for Storage Module Drives
- AN/R GP controller for ANSI interface disk and tape
- ST/S, SG/S SM/S and AN/S same as above, for the S100 bus

PHD-type subsystems are also available to OEMs.

Call or write today:

XCOMP, Inc.  
7566 Trade Street  
San Diego, CA 92121  
Tel. 714-271-8730  
Tlx. 182786

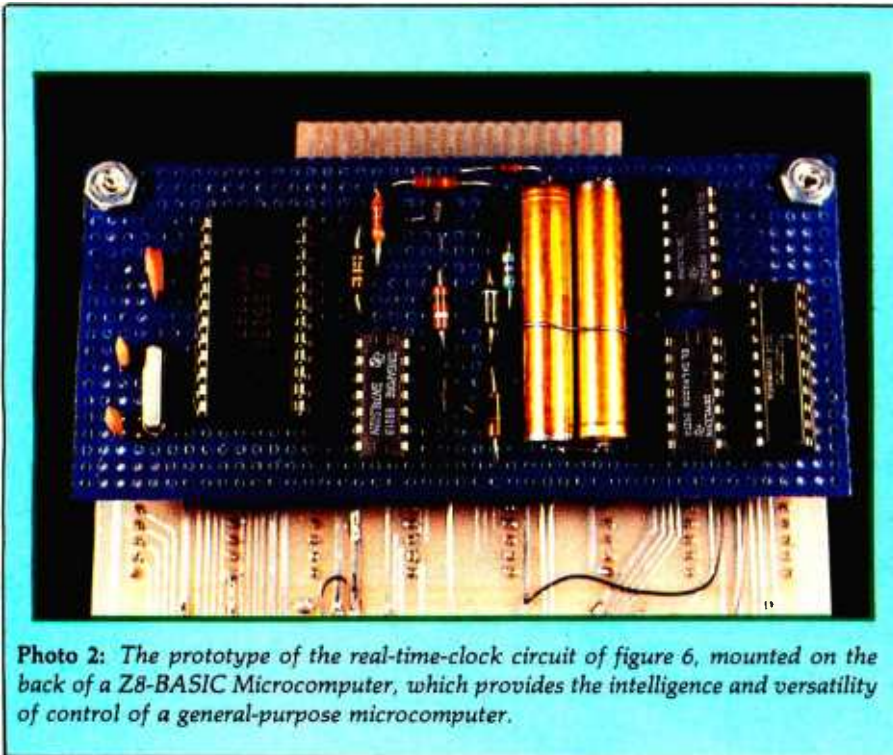
Dealer Info     S100     Other Micro  
 Low Cost S100 Subsystem     OEM Sub  
 Mail Info     Please call me

Name \_\_\_\_\_ Phone \_\_\_\_\_  
Title \_\_\_\_\_  
Company \_\_\_\_\_  
Address \_\_\_\_\_



**XCOMP**  
THE HARD DISK SPECIALISTS





**Photo 2:** The prototype of the real-time-clock circuit of figure 6, mounted on the back of a Z8-BASIC Microcomputer, which provides the intelligence and versatility of control of a general-purpose microcomputer.

ponding to register addresses 00 through 1F on the MM58167A). The Z8 has a multiplexed address/data bus, so the octal latch IC4 is required to latch the 8-bit low-order address. Other than that, circuit operation is as described for figure 5, including battery backup.

### Time-Data Representation

Now that I have described the hardware of the clock interface, we can turn our attention to how to use the real-time clock. Before we start writing programs in BASIC, assembler, or even FORTH, we must understand how the MM58167A stores in its registers the values that represent the current time.

Each unit of time is allotted a two-digit binary-coded-decimal register. Each register has a unique address within the clock chip, which is mapped into the address space of the external logic according to the range of addresses assigned to the clock chip; in the Z8-BASIC Microcomputer, hexadecimal B800 through B81F are the addresses of the clock registers as seen by the outside world.

The BCD internal representation of time is a slight inconvenience when we are programming in a high-level

language; we can't directly load the registers with decimal values or read them with statements that assume decimal radix for arguments. But fortunately, the BCD representation maps directly onto hexadecimal representation for the set of numbers used for timekeeping, so we can load and read the registers using hexadecimal-radix operators, if our high-level language has them.

The BASIC/Debug interpreter of the Z8-BASIC Microcomputer can operate on hexadecimal data, identifying hexadecimal variables and constants with the percent symbol (%) as a prefix character. If your language interpreter has no such ability, you may have to explicitly code some decimal-to-hexadecimal (and vice versa) conversion routines.

### Setting the Clock

The best way to describe the operation of the clock and the computer's interaction with it is to follow a sequence of setting and monitoring the time. For example, choosing a convenient time and date, such as 2:34 p.m. on Friday, May 14, we can set the clock.

First, all the counters are reset by writing hexadecimal FF to the coun-

ter-reset register, which lies at the internal clock-register address of hexadecimal 12. Then appropriate values for each time unit are loaded into the corresponding registers. For the date and time chosen, the decimal-radix values would be as follows (with the hours numbered in a 24-hour scheme):

month:	05
day of month:	14
day of week:	06
hour:	14
minute:	34

As I mentioned before, these two-digit decimal values must be represented in the clock in BCD format. If, for example, we tried to load 34 minutes into the minutes register (at clock address hexadecimal 0B, decimal 11) using the simple integer-arithmetic BASIC statement

```
OUT 11,34
```

the MM58167A would read the 34 as two BCD digits and interpret it as 22 instead of 34. To avoid this error, we use the equivalent hexadecimal-radix statement

```
OUT 11,%34
```

instead, with %34 understood to be a hexadecimal constant. (In the Z8-BASIC Microcomputer, the statement would be %0B,%34.) If your computer can't handle hexadecimal numbers, another possibility is to send 52, the decimal equivalent of hexadecimal 34. The statement

```
OUT 11,52
```

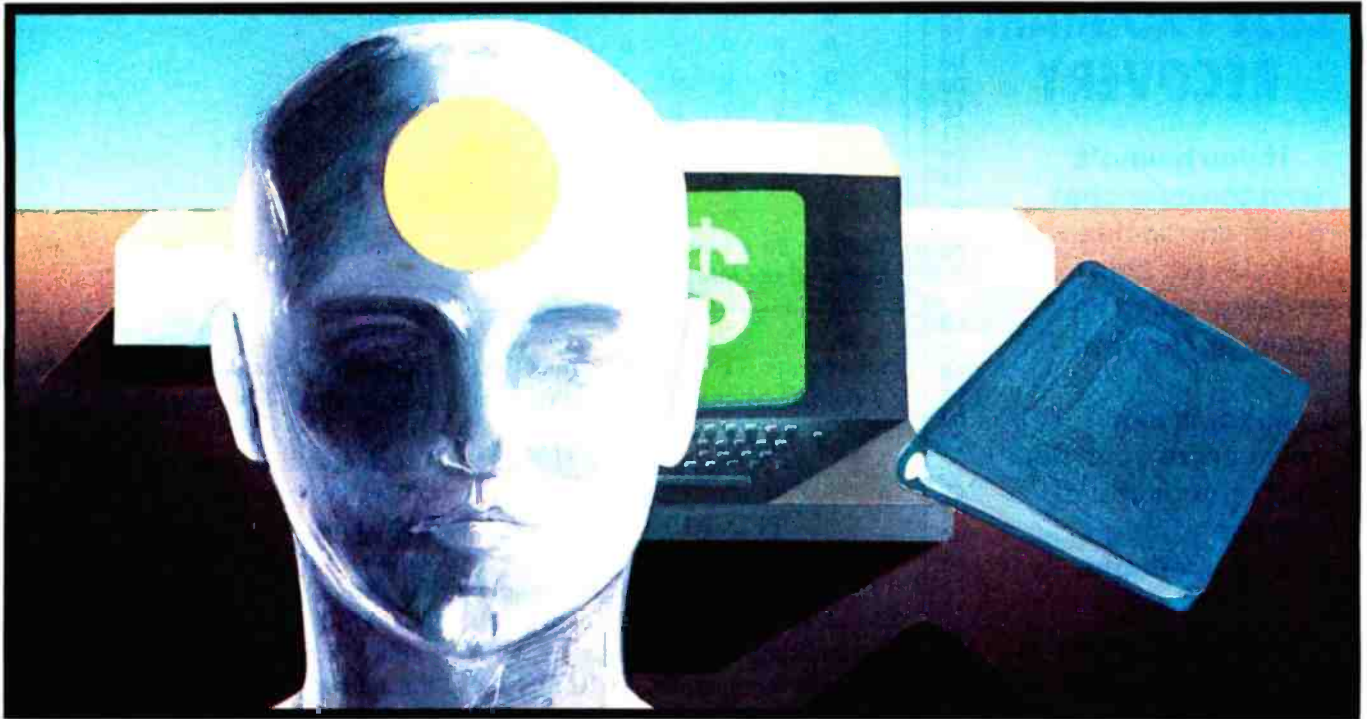
will result in 34 being loaded into the BCD minutes register.

The same problem exists in reading the clock registers. If you try to read the value of 34 minutes in clock register hexadecimal 0B with the BASIC statement

```
PRINT INP(11)
```

the interpreter will return the incorrect decimal value of 52 minutes. The solution is to print the value of deci-

# How To Sell More Software



## With Better User Manuals

### An intensive one-day seminar on Writing User Manuals That Sell

If you're an individual software author or a software company in the business of publishing and selling software, or if you'd like to be, you can benefit from this seminar. Unlike seminars that concentrate on the academic do's and don'ts of technical writing and formatting, this seminar gets down to the business value of the user manual as a marketing and sales tool that helps you get more users and keep them.

Developed and conducted by software marketing professionals with over 50 years of collective experience in writing software manuals for the commercial market, this seminar is loaded with facts and ideas on these subjects:

#### Manual Design

How to make content, organization, page layout, and document format work to your sales advantage. How to publish attractive manuals that speak well of your software without spending a fortune.

#### Training vs. Reference. Can one manual do both?

How to implement the techniques of tutorial writing into a well organized reference format that provides easy access for later questions.

#### Packaging That Controls Point of Sale

How to make your manuals work for you at the point of sale to help the dealer present your software in its most competitive light-- both on the shelf and on the demonstration machine.

#### Automated Manual Writing

How to let the software document itself wherever

possible, and how to use word processing systems effectively to obtain maximum value from automated publishing tools.

#### Seminar Manual



All attendants will receive a detailed How To manual on writing and producing user manuals for commercial use. Many past attendants have praised the manual and other handout materials as being worth the price of attendance by themselves.

<b>Schedule:</b>	Chicago	May 21	
Boston	May 18	Dallas	May 25
New York	May 19	Los Angeles	May 26
Philadelphia	May 20	San Francisco	May 27

#### Only \$125 With Our Guarantee

Price includes lunch and materials. We offer a 10% discount for companies sending more than one person.

#### Get Details at Computerland Today!

Space is limited so make your reservation now. To get enrollment details, simply call (303) 471-9875, or, visit your nearest participating Computerland Store and pick up a complete Seminar Information Packet including an agenda, an outline of the seminar manual, seminar authors' and instructors' resumes and a brochure on Context, Inc.

**context**

833 West Colorado Avenue  
Colorado Springs, CO 80905



A0C4C9D3CBA0D5D4C9CCC9D4D9A0A4B5B0A0

A0  
D2  
C5  
D3  
D4  
CF  
D2  
C5  
A0  
C4  
C5  
CC  
C5  
D4  
C5  
C4  
A0  
C6  
C9  
CC  
C5  
D3  
A0  
A0  
A0  
C5  
D8  
C1  
CD  
C9  
CE  
C5  
A0  
C1  
CE  
C4  
AF  
CF  
D2  
A0  
D0  
C1  
D4  
C3  
C8  
A0  
C1  
CE  
D9  
A0  
C4  
C9  
D3  
CB  
A0  
D2  
C5  
C3  
CF  
D2  
A0  
A0  
A0  
A0  
C1  
A0  
D3  
D7  
C5  
D2  
A0  
C3  
CF  
D2  
D0  
A0  
A0  
A0  
A0  
C1  
A0  
D3  
CF  
C6  
D4  
D7  
C1  
D2  
C5  
A0  
D4  
CF  
CF  
CC  
A0

# Disk Utility for Apple DOS 3.3

## LOST PROGRAM RECOVERY

If you haven't written over that program accidentally deleted, this software can recover it for you.

Also, it can reorganize your disk and inform you of the remaining space available.

And, it allows you to patch any sector: display in Hex and ASCII on standard Apple screen.

Menu driven and easy for the novice while still efficient for the professional. Compatible with M & R Superterm.

For more information or to place your order call: **(208) 263-1213**

**Cost: \$50**

We pay first class postage and insurance. You may use VISA or Master Card.

**TO ORDER:** Send us your check, money order or credit card number and expiration date. Certified checks avoid clearance delay.

**ANSWER Corporation**  
502A North Second Ave.  
Sandpoint, Idaho 83864

A0A0C2D9A0CAC5D2D2D9A0D4C9C6C6D4A0A0

D0	D1	D2	D3	D4	D5	D6	D7	Counter or RAM Reset
1	0	0	0	0	0	0	0	Ten thousandths of seconds
0	1	0	0	0	0	0	0	Hundredths and tenths of seconds
0	0	1	0	0	0	0	0	Seconds
0	0	0	1	0	0	0	0	Minutes
0	0	0	0	1	0	0	0	Hours
0	0	0	0	0	1	0	0	Days of the week
0	0	0	0	0	0	1	0	Days of the month
0	0	0	0	0	0	0	1	Months

Table 2: Bit specifications for the time-counter and comparison latch (RAM) reset format of the MM58167A.

mal register 11 in hexadecimal. The Z8-BASIC Microcomputer statement is

```
PRINT HEX(0B)
```

Returning to our original example, 2:34 on Friday, May 14 is loaded into the real-time clock's registers with five write commands. In BASIC the statements are

- OUT %0F,%05 (month)
- OUT %0E,%14 (day of month)
- OUT %0D,%06(day of week)
- OUT %0C,%14(hours)
- OUT %0B,%34 (minutes)

Next, a write pulse to hexadecimal address 15 is performed to reset the thousandths, hundredths, tenths, units, and tens of seconds counters to zero (the data on the address bus is ignored during the execution). This so-called Go command is used only for precise starting of the clock. If the seconds counter is at a value greater than 40 when the Go is issued, the minutes counter will be incremented; otherwise the minutes counter is unaffected. The Go command is unnecessary to start the clock, since the counters count whenever there is power. Instead, it is a convenient way to precisely synchronize at a given instant.

The time-unit counters and comparison (RAM) registers can be reset to zero at any time by setting the appropriate bits according to table 2 and writing to either the Counter

Reset (hexadecimal 12) or RAM Reset (hexadecimal 13) registers.

### Clock Reading and Interrupts

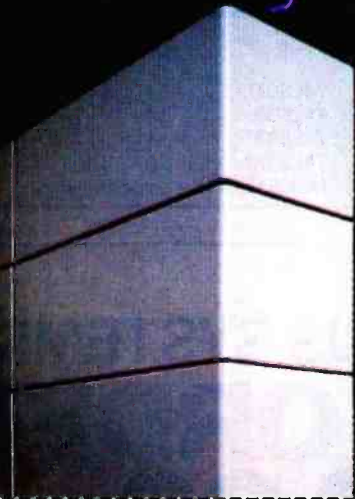
The host processor can find out what time it is by reading the BCD values from registers 00 through 07. To display this information in any different form, you have to write an explicit software routine to convert the numeric output of the real-time clock to the desired format.

The Interrupt Output (pin 13) can be programmed to provide a signal at any of eight different times, as previously discussed. To enable one of these conditions, a logic 1 is written into the Interrupt Control register (hexadecimal 11) at the appropriate bit position corresponding to the desired output frequency. Figure 7 shows the functions of each bit position. (For example, writing hexadecimal 08—a 1 in bit D3—to the Interrupt Control register sets a once-per-minute interrupt.)

When a counter rollover that corresponds to one of the control-register settings occurs, the Interrupt Output goes high. The interrupt is reset by reading the Interrupt Status register (hexadecimal 10).

The second interrupt is the Standby Interrupt (active low, pin 14). This interrupt is enabled by writing 01 to the Standby Interrupt register (hexadecimal 16). The interrupt output occurs when there is a match in the comparison between the comparison latch (RAM) and the real-time counter. The interrupt in this case is reset by writing 00 to this same register.

# ALL COMPUTERS ARE NOT CREATED EQUAL



**ZE $\mu$ S™ is a minicomputer AND a microcomputer.** Through multiprocessor technology, each user has a dedicated Z-80A-based single-board microcomputer module, housed in the system mainframe.

But users enjoy minicomputer performance and capacity. Including modular hard disk storage of 34 to 600 megabytes. Tape backup. Shared printers with spooling and queuing. Disk caching. Access to a common database.

**Unequaled flexibility and reliability.** The completely modular, stackable system can expand to 64 users. To add a user, add only a dumb terminal and an inexpensive user microcomputer module.

## OSM

**ZE $\mu$ S sounds powerful.  
Now prove it.**

Name \_\_\_\_\_

Company \_\_\_\_\_

Address \_\_\_\_\_

City/State/Zip \_\_\_\_\_

Phone \_\_\_\_\_

Trademarks  
ZE $\mu$ S, MUSE: OSM Computer Corporation  
Registered trademark:  
CP/M: Digital Research

And ZE $\mu$ S isn't fazed by lightning, voltage variations, or power failures. Power for the entire system is "buffered" through a battery/recharger system that provides up to 20 minutes of operating power.

**Unequaled value.** MUSE™ multiprocessor operating system is compatible with CP/M®. Minicomputer performance and capacity. New levels of reliability and flexibility. All at a per-user price that is shockingly competitive. If the coupon isn't fast enough, call.

**"See us at the NCC in booth #4722"**

OSM Computer Corporation  
2364 Walsh Avenue  
Santa Clara, CA 95051  
(408) 496-6910 TWX 910-338-2099



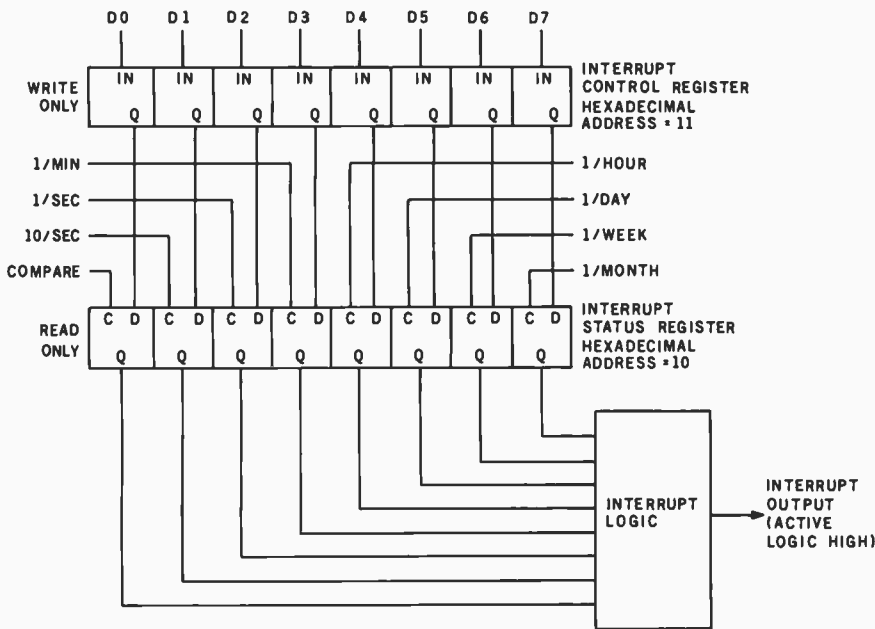


Figure 7: Conceptual diagram of the assignment of bit functions in the Interrupt Control and Interrupt Status registers of the MM58167A.

Number	Type	+5V	GND
IC1	74LS04	14	7
IC2	74LS30	14	7
IC3	74LS02	14	7
IC4	74LS373	20	10
IC5	MM58167A	see schematic	

### Serial-Clock Software

Listing 1 on page 54 is a program written for the BASIC/Debug interpreter of the Z8-BASIC Microcomputer that reads and loads the MM58167A according to commands received from a remote computer over a serial communication link. This software is merely for demonstration and is not indicative of everything you might want in such an intelligent clock.

Because the intelligent clock of figure 6 has its own processor and battery backup, I felt it was unnecessary to include the code for setting the clock initially from the remote computer. For most applications, the clock will have to be set only once.

The subroutines starting at line 1000 allow the clock to be set using an off-line terminal. The program prompts you for entry of the current month, day, hour, etc. It waits after entry for you to issue a start command by pressing the space bar on the keyboard so that the clock can be synchronized with some time reference such as radio station WWV.

# S100 And MULTI-BUS SYSTEMS MADE TO ORDER READY TO GO

A full range of S100, Multi-Bus systems and add-ons are available directly from stock when you need them. We stock the best hardware from floppys to 20 Mb systems, produced by S-D,

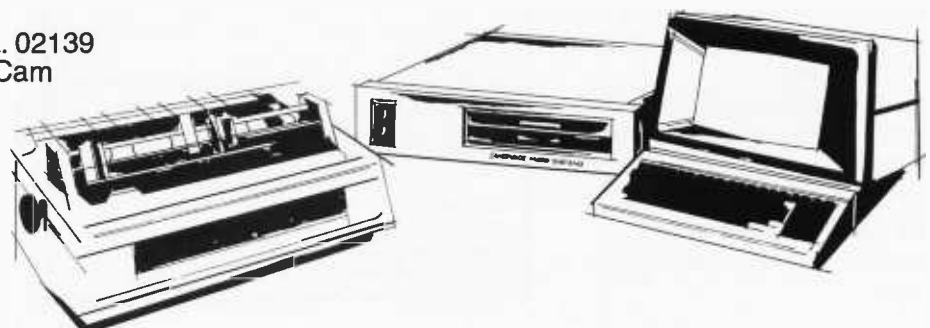
**COMPUMART CORP.**  
**CAMBRIDGE MICRO SYSTEMS DIV.**  
 65 Bent Street, Dept. 104  
 P.O. Box 568, Cambridge, Ma. 02139  
 TELEX: 921401 Compumart Cam  
**800-343-5504**  
 In Mass. call 617-491-2700

NEC, Intel and other solid manufacturers. Choose from single, multi-user and computer network software.

Write for our Cambridge Micro Systems Catalog.

PHONES: open EST Mon.-Thurs. 8:30-7:00, Fri. 8:30-6:00.

We also have Hewlett Packard's HP-85 and 87 systems.



# What Are You Paying . . . For Room And Board?

## TRULY ONE OF A KIND!

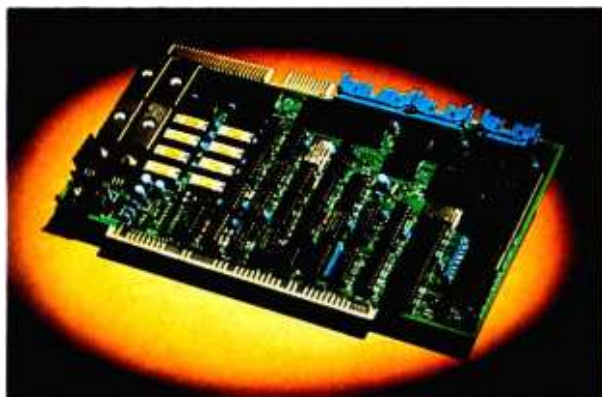
THE FIRST AND STILL THE BEST SINGLE-BOARD Z80 COMPUTER. ONLY \$895.00 BUYS YOU THE FOLLOWING FEATURES:

- Z80A CPU
- 4 TIMERS (ZCTC)
- 64K RAM
- 2 SERIAL PORTS (ZSIO)
- 2 PARALLEL PORTS (ZPIO)
- NEC FLOPPY DISK CONTROLLER

PLUS MORE . . .



Fresno, California  
Marketing Division  
21162 Lorain Avenue  
Fairview Park, Ohio 44126  
(216) 331-8500  
TELEX 980131 WDMR



## NETWORKING NECESSITY!

LIGHTNING BUSS TRANSFERS ARE THE HEART OF THIS S-100 SLAVE COMPUTER. COMBINED WITH THESE OTHER GREAT FEATURES YOU HAVE MAINFRAME POWER IN YOUR GRASP.

- Z80A CPU
- 4 TIMERS
- 64K RAM
- 2 SERIAL PORTS (ZSIO)
- 4 PARALLEL PORTS (ZPIO)
- ON-BOARD EPROM BURNER

PLUS MORE . . .

## NEED HIGH SPEED SERIAL I/O PORTS? MPM?

THIS 4 PORT SERIAL I/O CARD PROVIDES EXPANSION FOR YOUR SYSTEM NEEDS. ALSO AVAILABLE WITH SYNCHRONOUS COMMUNICATIONS CAPABILITIES.

- 4 SERIAL PORTS (ZSIO)
- 4 TIMERS (ZCTC)
- 0-880K BITS/SECOND
- BAUD RATES PROGRAMMABLE 75 TO 19.2K



OUR BOARDS CAN BE CONFIGURED TO OPERATE WITH THE FOLLOWING SOFTWARE PRODUCTS:

\*CP/M      \*MP/M      \*CP/NET  
\*\*TURBODOS SINGLE USER OR NETWORKING  
SPECIAL NETWORKING SOFTWARE  
KONAN HARD DISK SUB SYSTEMS

\*REGISTERED TRADE MARK OF DIGITAL RESEARCH CORPORATION.  
\*\*REGISTERED TRADE MARK OF SOFTWARE 2000.



**Listing 1:** A BASIC/Debug program written for the Z8-BASIC Microcomputer and the MM58167A to allow them to function as an intelligent serial time-of-day clock.

```
100 REM Serial Controlled Real Time Clock
110 Rem
130 a=%b807:b=%b806:c=%b805:d=%b804:e=%b803:f=%b802
140 l=@240
142 if l=161 then 148
143 gosub 600
144 goto 140
148 l=@240
150 if l=137 then 300
152 if l=146 then 200
154 if l=147 then 1000
156 if l=148 then 1300
158 if l=149 then 500
170 goto 148
200 Rem Reset Interrupt
205 m=@%b810
210 goto 140
300 Rem Set interrupt control register
310 input n :@%b811=n
330 goto 140
500 Rem Read Interrupt Status Register
510 print hex (@%b810)
520 goto 140
600 Rem Check Interrupt Line
605 p=@%C000
610 if AND(p,%80)=0 then 140
620 print "I"
630 goto 200
1000 Rem Time Set Subroutine
1005 "Enter date. Preceed entries with %"
1010 "Month (1-12) ";;input g
1020 "Day of the month (1-31) ";;input h
1030 "Day of the week (1-7) ";;input i
1040 "Hour (1-24) ";;input j
1050 "Minute (0-59) ";;input k
1060 "Press SPACE to start clock"
1070 if @240=160 then 1090
1080 goto 1070
1090 @a=g:@b=h:@c=i:@d=j:@e=k
1100 goto 1200
1200 REM print full time parameters
1210 goto 1220+@c
1221 "Sunday ";;goto 1250
1222 "Monday ";;goto 1250
1223 "Tuesday ";;goto 1250
1224 "Wednesday ";;goto 1250
1225 "Thursday ";;goto 1250
1226 "Friday ";;goto 1250
1227 "Saturday ";;goto 1250
1250 if @a>9 then goto 1259+@a-6
1255 goto 1259+@a
1259 goto 1260
1260 " January ";;goto 1280
1261 " February ";;goto 1280
1262 " March ";;goto 1280
```

*Listing 1 continued on page 56*



## Introducing a direct line to a 60 MHz Tektronix scope built for your bench!

**From the world's most respected name in oscilloscopes: a new scope, plus a new direct order number, that finally makes it practical to put Tektronix quality on your bench... at work or home.**

Among professional engineers and technicians there is no substitute for the performance and reliability of Tektronix oscilloscopes.

Now, for the first time, Tektronix is offering an advanced scope at an unprecedented low price—and has a direct order line that lets you get your order processed today!

**The scope: the 2213. Its radical new design brings you Tektronix quality for well below what you would pay for**

### lesser-name scopes.

The 2213's practical design includes 65% fewer mechanical parts, fewer circuit boards, electrical connectors and cabling. Result: a lower price for you plus far greater reliability.

Yet performance is pure Tektronix: there's 60 MHz bandwidth for digital and high-speed analog circuits. The sensitivity for low signal measurements. The sweep speeds for fast logic families. A complete trigger system for digital, analog or video waveforms. And new high-performance Tektronix probes are included!

### 2213 PERFORMANCE DATA

**Bandwidth:** Two channels, dc—60 MHz from 10 V/div to 20 mV/div. (50 MHz from

2 mV/div to 10 mV/div).

**Sweep speeds:** Sweeps from 0.5 s to 50 ns (to 5 ns/div with X10 mag).

**Sensitivity:** Scale factors from 100 V/div (10X probe) to 2 mV/div (1X probe). Accurate to  $\pm 3\%$ . Ac or dc coupling.

**Delayed sweep measurements:** Standard sweep, intensified after delay, and delayed.

**(Need dual time-base performance and timing accuracy to  $\pm 1.5\%$ ?** Ask about our 2215 priced at \$1400.)

**Complete trigger system:** Modes include TV field, normal, vertical mode, and automatic; internal, external, and line sources; variable holdoff.

**Probes:** High perform-

ance, positive attachment, 10-14 pF and 60 MHz at the probe tip.

**The price: Just \$1100 complete\*. Order direct from Tektronix National Marketing Center.** Phones are staffed by technical people to answer your questions about the 2213. Your direct order includes a 15-day return policy and full Tektronix warranty.

**Now it's easier than ever to get your hands on a Tek scope!**

**ORDER TOLL-FREE**

**800-547-1845**

**Ask for Department A03**

(In Oregon, Alaska and Hawaii: 1-503-627-5402 collect.) Lines are open from 8 am EST to 5 pm PST.

\*Price FO B . Beaverton, OR



Listing 1 continued:

```

1263 " April ";goto 1280
1264 " May ";goto 1280
1265 " June ";goto 1280
1266 " July ";goto 1280
1267 " August ";goto 1280
1268 " September ";goto 1280
1269 " October ";goto 1280
1270 " November ";goto 1280
1271 " December ";goto 1280
1280 print Hex(@b)
1290 print hex(@d);" HOURS ";hex(@e);" MINUTES ";hex(@f);" SECONDS"
1295 goto 140
1300 print hex(@d);":";hex(@e);":";hex(@f)
1310 goto 140

```

**For The Best In Price, Selection and Delivery,**

**Call Now TOLL FREE  
800-368-3404**

**(In VA, Call Collect 703-237-8695)**

**AMPEX • INTERTEC • TEXAS INSTRUMENTS • GENERAL DATA  
COMM. • ANDERSON JACOBSON • C. ITOH • QUME • BEEHIVE •  
DATASOUTH • DIABLO • CENTRONICS • NEC • PRENTICE**

**SUPERBRAIN MICROS**

**INTERTEC:**  
64K DD ..... **ONLY \$2638**  
64K QD ..... **ONLY \$2948**  
DDS-10 Meg  
(Hard Disk) ..... **ONLY \$3195**

**PRINTERS**

**DATASOUTH:** ..... Call  
**NEC:**  
7710 ..... \$2196  
7715 ..... Call for Special Price  
7730 ..... \$2196  
7720 ..... Call for Special Price  
7725 ..... Call for Special Price  
Std. Forms Tractor ..... \$ 200  
3510 ..... \$1690

**DIABLO:**  
630-R102 RO ..... \$1995  
**QUME:**  
Sprint 5, 55RO ..... \$2339  
Sprint 5, 55KSR ..... Call  
Sprint 9, 45RO,  
    Limited Panel ..... \$1845  
    Full Panel ..... \$1969  
Std. Forms Tractor ..... \$ 199  
Bi-Dir. Forms Tractor ..... \$ 199

**CENTRONICS:**  
739-1 (Parallel) ..... \$ 649  
739-3 (Serial) Call for Special Price

**TERMINALS**

**AMPEX:**  
Dialogue 30 ..... \$ 775  
Dialogue 80 ..... \$ 939  
**BEEHIVE: (SMART DISPLAY)**  
DM5 ..... \$ 745  
DM5A ..... \$ 930  
DM310 (3101 Emulator) ... \$1095

NOTE: IBM and Burroughs compatible terminals available. Please inquire.

**C. ITOH**  
CIT 101 ..... \$1350

**TEXAS INSTRUMENTS:**  
745 Standard ..... \$1390  
810 Basic ..... \$1249  
810 Package ..... \$1439  
820 Package RO Package .. \$1610  
820 RSR Package ..... Call  
840 RO Basic ..... \$ 795  
840 RO Tractor Feed Pkg. . \$1059

**COUPLERS**

**STAR:**  
300 Baud ..... \$ 149

**Special! While They Last!**

**SOROC TERMINALS**

IQ 120 .....	<b>ONLY \$625</b>	<del>\$ 675</del>
IQ 130 .....	<b>ONLY \$525</b>	<del>\$ 575</del>
IQ 135 .....	<b>ONLY \$659</b>	<del>\$ 709</del>
IQ 140 .....	<b>ONLY \$989</b>	<del>\$1089</del>

**DISC DRIVES**

**QUME:**

Data Trak 5 ... \$325 or 2 for \$599  
Data Trak 8 ... \$549 or 2 for \$1049

**SOFTWARE**

BISYNC-80 RJE ..... \$ 769  
Wordstar ..... \$ 319  
Data Star ..... \$ 215  
Cobol ..... \$ 789  
Forms 2 (Cobol Gen.) ..... \$ 179  
Mail Merge ..... \$ 99  
Spell Guard ..... \$ 229  
Plan 80 ..... \$ 249  
Super Calc ..... \$ 249  
Milestone ..... \$ 249

**In addition, we can make EIA RS232 or RS449 cables to your order, and supply you with ribbons, printer stands, print wheels, thimbles for all printers listed. And many, many more items. CALL NOW.**

Add 2% for shipping and insurance. Superbrain shipped freight collect. VISA and MasterCard welcomed; add 3% for credit card purchases. Virginia residents, add 4% Sales Tax. For fastest delivery, send certified check, money order or bank-wire transfer. Sorry, no C.O.D. orders. All equipment is in factory cartons with manufacturers' warranty. Prices subject to change without notice. Most items are in stock now.

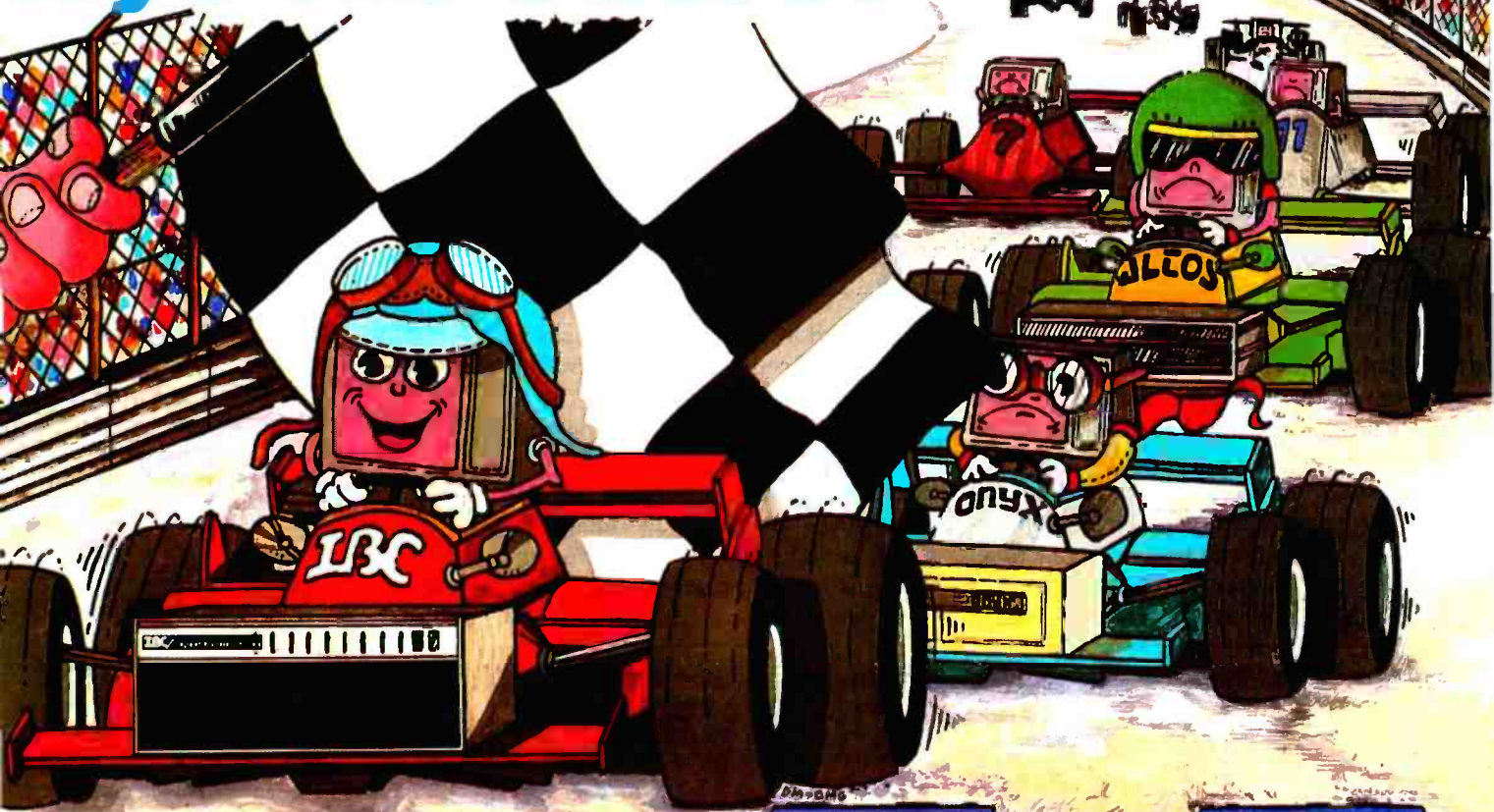


**TERMINALS TERRIFIC**



Terminals Terrific, Incorporated, P.O. Box 1625, Merrifield, VA 22116, 800-368-3404 (In VA, Call Collect 703-237-8695).

# And The Winner Is... IBC By Four Users!



When you are racing toward that finish line, beating the competition is everything. IBC is the choice of OEM's, system integrators and dealers throughout the world, because in benchmark after benchmark our small business computer systems finish first.

We finish first because we are faster, offer higher quality peripherals and can expand our system significantly beyond our nearest competitors. In fact, looking at the chart below, you can quickly see why knowledgeable resellers are choosing IBC.



Circle 198 on Inquiry card.

Join us in the winners circle with high performance equipment and the best dealer plan in the industry. Call or write:

OUTSIDE THE USA

**IBC** / Integrated Business Computers

21592 Marilla Street  
Chatsworth, CA 91311  
(213) 882-9007 TELEX NO. 215349

WITHIN THE USA

**IBC** / DISTRIBUTION

4185 Harrison Blvd., Suite 301  
Ogden, UTAH 84403  
(801) 621-2294

	<b>IBC</b>	<b>onyx</b>	<b>ALLOS</b>
Oasis Operating System (Max. Users)	9	5	4
CPU Speed (MHz)	6	4	4
Disk Speed I/O (MB/Sec.)	.81	.65	.54
Seek (Milli Sec.)	35	50	65
Cache Disk Memory	Yes	No	No



!	Indicates command-sequence initiation (all control commands must be preceded by "!").
Control-I	Set Interrupt Control register. Clock responds with "?". Remote computer sends "%X" and a carriage return (X is the BCD value computed according to figure 7). Each time the interrupt is triggered by a counter rollover, the clock will send "I" and a carriage return to the remote computer.
Control-R	Reset Interrupt Output.
Control-S	Set complete time parameters. This is the manual preset mode and is most easily set using a terminal off line as previously described.
Control-T	Send short time. Clock responds with hours, minutes, and seconds as "10:25:35" plus a carriage return.
Control-U	Read Interrupt Status register. Clock responds with the value stored in the Interrupt Status register. Reading this register resets the Interrupt Output.

**Table 3:** Command codes used by the BASIC/Debug code in listing 1 to control the real-time-clock circuit of figure 6 from a remote computer. These codes were arbitrarily chosen and do not provide for activating all the capabilities of the MM58167A.

The serial communication of time information to the remote computer is commanded by various control codes. Only the minimal required information is transmitted from the intelligent clock so that the information can be more easily used in an application program on the remote machine. A simple response to a time query of "06:34" reduces processor data

manipulation in the intelligent clock. The control codes I chose (arbitrarily) are listed in table 3.

My brief demonstration does not include setting the Standby Interrupt. It should be added for any serious use. Also, because this intelligent clock contains a versatile microcomputer, it can be programmed for any data rate or custom data format.

## In Conclusion

Technology has come a long way from the days when real-time clocks were based on a heartbeat interrupt clocked from the power line. The MM58167A real-time clock is a well-thought-out design which truly meets the market demand. Applications that once demanded expensive hardware/software solutions are now satisfied by low-cost LSI hardware.

National Semiconductor has long had the reputation of being a leader in semiconductor innovation, and I believe the company has justified that reputation with the MM58167A.

## Next Month:

*The high technology of video-image storage has been promising to benefit the computer industry. In June, I'll let you in on how to reap this benefit with a computer controller for the Pioneer VP-1000 Laserdisc video player. ■*

## References

1. Ciarcia, Steve. "Anyone Know the Real Time?," August 1979 BYTE, page 50. Reprinted in *Ciarcia's Circuit Cellar, Volume II*. Peterborough, NH: BYTE Books, 1981, page 96.
2. Ciarcia, Steve. "Build a Z8-Based Control Computer with BASIC, Part 1," July 1981 BYTE, page 38. Reprinted in *Ciarcia's Circuit Cellar, Volume III*. Peterborough, NH: BYTE Books, 1982, page 146.
3. Ciarcia, Steve. "Build a Z8-Based Control Computer with BASIC, Part 2," August 1981 BYTE, page 50. Reprinted in *Ciarcia's Circuit Cellar, Volume III*, page 156.

**Editor's Note:** Steve often refers to previous *Circuit Cellar* articles as reference material for each month's current article. Most of these past articles are available in reprint books from BYTE Books, 70 Main St., Peterborough, NH 03458. *Ciarcia's Circuit Cellar, Volume I*, covers articles that appeared in *BYTE* from September 1977 through November 1978. *Ciarcia's Circuit Cellar, Volume II*, contains articles from December 1978 through June 1980. *Ciarcia's Circuit Cellar, Volume III*, contains the articles that were published from July 1980 through December 1981.

To receive a complete list of Ciarcia's *Circuit Cellar* project kits available from the Micromint, circle 100 on the reader-service inquiry card at the back of the magazine.

## ADD A 5 MBYTE WINCHESTER TO YOUR COMPUTER ARSENAL FOR \$2995.00

### INTERFACES WITH:

- S-100 BUS (CP/M)
- Heath H89, H90 (CP/M, HDOS)
- Zenith Z89, Z90 (CP/M, HDOS)
- TRS 80 Model III (CP/M, TRS DOS)
- Xerox 820 (CP/M)
- IBM Personal Computer (CP/M 86, IBMDOS)



AMT's EZ8X5 is a complete, ready to plug in Winchester Hard Disk Subsystem. Featuring easy implementation, enhanced system interface cards, an extensive disk test package. The EZ-8X5 delivers a full 5, 10, or 20 megabytes. Dealer and Distributor inquiries are being accepted.

# amt

Route 30 West  
Greengate Professional Building  
Greensburg, PA. 15601 412/837-7255  
or call Toll Free 1-800/245-6908

## ... It's What's Inside That Counts.



## The Link™ from Panasonic.

### The portable computer that lets your customers take the advantages of an office computer anywhere they go.

The Link. It's the next major business tool because it's a full-logic computer that's fully portable.



Exchange information with other computers with the telephone modem.

By itself, it can perform a wide variety of sophisticated computer functions because it can store 4K bytes of information. Equally important, it can link you to the information and brainpower of your main office computer — wherever you go. You can program in Microsoft Basic.® Yet it's easy to operate, even if you've never worked with a computer before.

Imagine. Using just The Link, anyone in the field, the plant or on the sales floor — like salesmen, managers, engineers or retailers — can now answer questions that used to mean a trip back to the office. A sales engineer, for example, types data into The Link and gets detailed product information and specs on the spot.

And The Link is part of an entire computer system: By adding different optional components, you can create whatever kind of computer you need. Wherever you need it.

By adding the telephone modem, for example, a salesman can put his company's main office computer or a data bank

to work for him from any telephone booth. He can check credit ratings and inventory, trace

shipments, enter orders, make bids and estimates, and much more. So The Link can make him and his office computer much more productive.

By adding the microprinter, the salesman gets hard copies of information right on the spot — an instant record of his transactions.

By adding the TV adapter, he can display information and 8-color charts on any color TV



screen. So he can use data from his office computer to develop a sales presentation in a motel room. And show it on a client's video monitor the next day.

If the salesman needs to work with a bigger program and

more memory, other optional components increase The Link's capacity to 52K RAM plus 64K ROM. That's more than many desktop computers.

The Link measures only 9" x 4", weighs only 21 ounces,



Take The Link and all its components anywhere in its slim attaché case.

and runs on AC or rechargeable batteries.

And it costs only \$600.00.\* That's amazingly small when you realize the big change it could make in the way you do business.

\*Manufacturer's suggested price.

#### DEALER INQUIRIES INVITED

Panasonic Company, Portable Computers  
One Panasonic Way, Secaucus, N.J. 07094

NAME \_\_\_\_\_ PLEASE PRINT

TITLE \_\_\_\_\_

COMPANY \_\_\_\_\_

TYPE OF BUSINESS \_\_\_\_\_

ADDRESS \_\_\_\_\_

CITY \_\_\_\_\_ STATE \_\_\_\_\_ ZIP \_\_\_\_\_

PHONE NUMBER \_\_\_\_\_

**Panasonic**®  
just slightly ahead of our time.

B

**The Link. It will change the way the world uses computers.**



# Japanese Computers



JONATHAN GRAVES '82

# Six Personal Computers from Japan

*A comparative review of the BMC if800, the Canon CX-1, the Hitachi MB-6890, the NEC PC-8001A, the Fujitsu FM-8, and the Systems Formulate Corporation Bubcom80*

Do you want a Japanese computer? Before you answer too hastily, think back a few years.

The trend setters who bought Toyota automobiles when they first appeared in the United States in the late 1960s got a great deal of bemused attention from their neighbors. The neighbors mandered about spare parts, Detroit styling, and horsepower, but the Toyota owners just smiled. They knew they were getting a low-cost car that was reliable and met their needs at a time when the domestic companies did not care to address that particular set of needs.

Today, of course, American motorists rush to buy Japanese cars while Detroit automakers, scratching their heads and wondering what went wrong, scramble to imitate the virtues of the Japanese imports. And in other industries in which Americans have heretofore led the world, pundits and xenophobes alike are stridently warning, "The Japanese'll getcha if ya don't watch out!" Many steel companies and electronics firms are beginning to feel the uncomfortable heat of Japanese competition.

---

Christopher P. Kocher  
4233 Baltimore Ave.  
Philadelphia, PA 19104

---

Michael Keith  
D-46 Abbingdon Dr.  
Hightstown, NJ 08520

---

What about personal computers? A few Japanese firms have started selling "Americanized" versions of their computers, and a few others plan to start. Will the Japanese take over again?

Our crystal ball is no better than anyone else's, but we would like to help you decide for yourself. In this article, we evaluate and compare six Japanese personal computers: the BMC if800, the Canon CX-1, the Fujitsu FM-8, the Hitachi MB-6890, the NEC PC-8001A, and the Systems Formulate Corporation Bubcom80. Some of them are already being sold here; some are in the process of being adapted for the American market; and some may never be sold here.

Of course, there is no one best computer, just as there is no single

typical computer user. Each computer represents a design team's attempt to assemble a set of features that will appeal to a variety of users. How you rank a computer depends very much on what you plan to do with it. We will try to give as complete a picture of each machine as we can; you must supply the ranking.

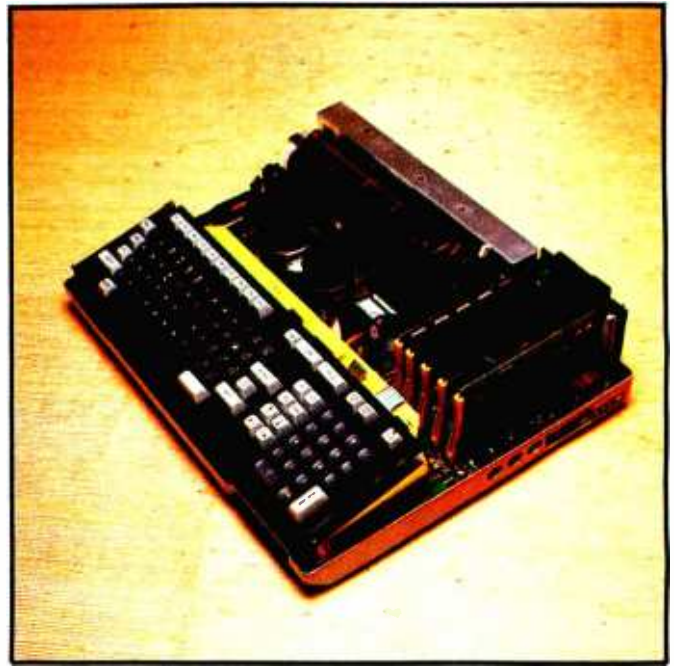
Since the computers examined here are in various stages of adaptation, it would not be fair to rate the documentation of all the machines on the same scale. While some machines came with complete instruction manuals in English, others came with instructions written only in Japanese or with what were obviously first drafts of translations.

Moreover, since we had a limited time in which to examine a large number of very complicated machines, we had to concentrate on what is most salient: features that are conspicuously excellent, egregiously awful, or strikingly unique. We undoubtedly missed many subtleties of each machine. If this gives a misleading picture of any computer, we apologize.





**Photo 1:** The BMC if800 computer. Shown here is the basic machine consisting of a keyboard/processor module, two floppy-disk drives, a color video monitor, and a unique built-in printer. Notice the 10 "super-function" keys along the bottom of the display screen. These are fully programmable function keys that can be used for menu selection or other forms of interaction in programs.



**Photo 2:** Inside the keyboard unit of the if800. The built-in printer mechanism is clearly visible. The printer can operate as either friction-feed or tractor-feed, and produces a high-quality dot-matrix output.

Photographs accompanying this article, except photo 6, were taken by Paul Avis, photographer, and Pauline Elkin, stylist.

## BMC if800

The prize for the most computer in the smallest package goes to the if800 Model 20 computer, manufactured by the Oki Electric Company of Japan. But since it is marketed in this country by BMC Computer Corporation (which has its office in Carson, California—the abbreviation stands for Business Machines Corporation), we refer to it as a BMC product to avoid confusion. Although it is billed as a personal computer, it will receive much consideration as a small-business computer because it has high-resolution color graphics, support for Digital Research's CP/M operating system, a built-in printer and floppy-disk drives, and a very high-level BASIC language all as standard equipment.

### Hardware Overview

The basic if800, shown in photo 1, consists of two pieces, one mounted above the other. One module contains the processor circuitry, the keyboard, and the printer; the other module contains the video-display screen and two 5¼-inch floppy-disk drives. The two modules are connected by two cables, one for the monitor and one for the disk drives. The combined system is sufficiently compact to fit well on even the most crowded table.

### Keyboard

The 98-key keyboard is very solid and has a nice typing feel. In addition to tactile feedback, you receive audio feedback with every key depression

in the form of a faint click from the speaker under the keyboard. If a key is held down for more than a second, it automatically repeats the typing of its character, along with audio feedback.

The 98 keys are separated into several groups: a typewriter-keyboard section, 10 program-assignable function keys, 8 editing keys, a numeric keypad, and several special keys. The special keys include keys for setting tabs, a CAN (cancel) key (which erases the line currently being typed), and three keys for controlling the printer. The typewriter section also has a GRAPH key (for accessing a set of special graphics characters, such as card symbols and line-drawing characters) and a COMD

## At a Glance

### Name

BMC if800 (Model 20)

### Distributor

BMC Computer Corporation  
860 East Walnut St.  
Carson, CA 90746  
(213) 323-2600

### Dimensions (Inches)

19 $\frac{1}{8}$  by 20 by 26 $\frac{1}{2}$

### Microprocessor

Z80, 8-bit

### Size of User Memory

64K bytes

### Number of Keys

98

### Number of Function Keys

20

### Built-in Hardware

Dot-matrix printer; two 5 $\frac{1}{4}$ -inch floppy-disk drives; color video monitor

### Standard Interfaces

RS-232C (DB-25); light pen; monochrome video monitor; RGB color monitor; audio-cassette tape

### Optional Interfaces

8-inch floppy-disk drives; parallel I/O port; IEEE-488 bus; A/D, D/A converters

### Expansion Sockets

3

### Character Sets

Roman, katakana, graphics

### Graphics/Color Resolution

640 by 200

### Number of Colors

8

### Other Features

Time-of-day clock with battery; speaker with music sublanguage

### Price

\$7950 (whole system)

PRINT key, type LIST, and hit RETURN, and you have instant hard copy. A separate HARD COPY key can be used to dump the current screen image (text and/or graphics) to the printer.

It also has a KANA key, which the manual says allows access to Japanese katakana characters. However, in the American unit, the key has been disabled with a metal spacer. (See the text box "Japanese Character Sets.")

### Built-in Printer

The if800's self-contained printer is conveniently placed behind the keyboard so that the paper comes out in the same direction as it does in an ordinary typewriter. The dot-matrix printer uses a wire-impact mechanism and a regular typewriter ribbon, and has both friction- and tractor-feed mechanisms. Its printing speed is 80 cps (characters per second), and the print quality is excellent (almost good enough to conceal the dot-matrix printing method). The only shortcoming we noticed is that in dumping a screen image (as opposed to regular character-by-character text printing) the scan lines are spread quite far apart in the printed image, making text or detailed graphics difficult to read. We hope this is only a software limitation.

### What's Inside?

Photo 2 gives an inside view of the keyboard/processor module, where various components of the computer are visible. The cover lifts off easily for access to the insides. The keyboard sits on top of the main printed-circuit board, which contains the microprocessor (a Z80A running at 4 megahertz [MHz]), memory, and support circuitry, as well as a small speaker for audio output. The keyboard assembly is all metal, providing a degree of electromagnetic shielding for the main circuit board.

Also inside the case is a real-time-clock chip that can be read by software. We were surprised at one feature of the time-of-day clock: the first time we plugged in the if800 and ran

## Japanese Character Sets

*Japanese, unlike most languages, has four separate writing systems, and it is not unusual to see all of them on one page.*

*Kanji characters are pictographs taken from Chinese. One character represents one word or concept. Kanji characters are used to represent roots of nouns or verbs.*

*The hiragana and katakana systems are syllabaries in which one character represents one consonant-vowel pair. Hiragana characters, full of graceful but tiny curlicues, are considered easier to read and are used in most text to indicate inflectional endings and to spell out words that are uniquely Japanese. Katakana characters represent exactly the same syllables as the hiragana but are more angular. They are used for children's books, official documents, and transliterating foreign words, especially foreign technical terms.*

*The Roman alphabet is used for such things as computer commands, in large part due to the ubiquity of Western computer-language systems.*

*Most of the Japanese personal computers reviewed here offer a Roman-alphabet keyboard with some sort of locking shift key that allows the same keys to be used for katakana as well. Generally, a few very common kanji characters are thrown in as graphics keys (the pictographs for "date" and "time," for example), but the hiragana characters require resolution beyond the capability of most noninterlaced video displays.*

*If you think about it, the Japanese character sets might explain much of the feverish technological development in certain segments of the Japanese electronics industry—like the work on very dense read-only memories. The Japanese require great amounts of memory just in character generators to form the complex kanji characters.*

key that allows single-keystroke access to various BASIC keywords.

When the PRINT key is depressed, everything that appears on the display screen is printed by the built-in printer. A small LED (light-emitting diode) on the keytop indicates whether the computer is in print mode. For example, to get a program listing, merely hit the



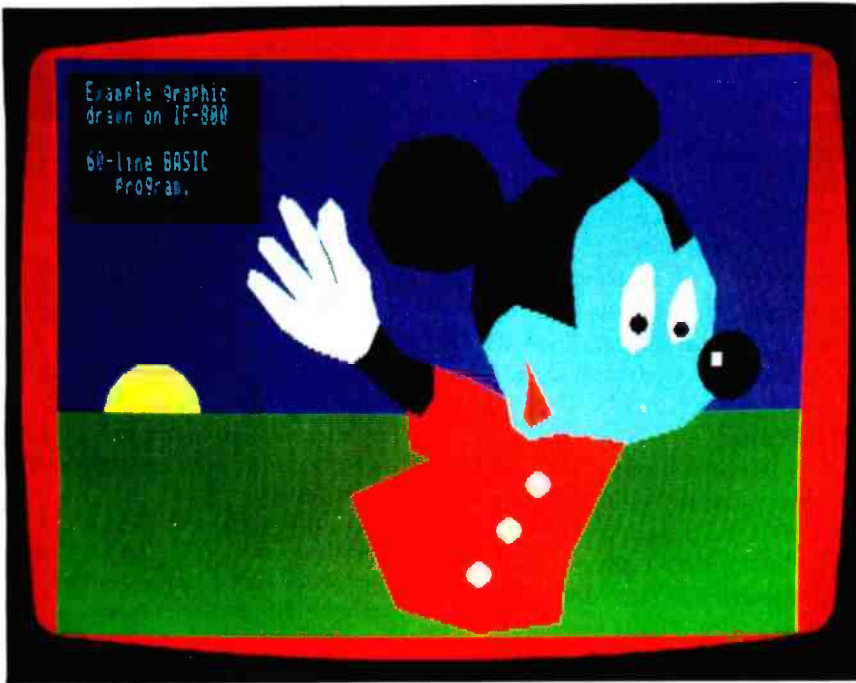


Photo 3: A sample display from the if800, illustrating some of the graphics primitive operators. Most of the picture was produced using LINE commands to draw polygonal outlines followed by PAINT commands to fill the polygons.

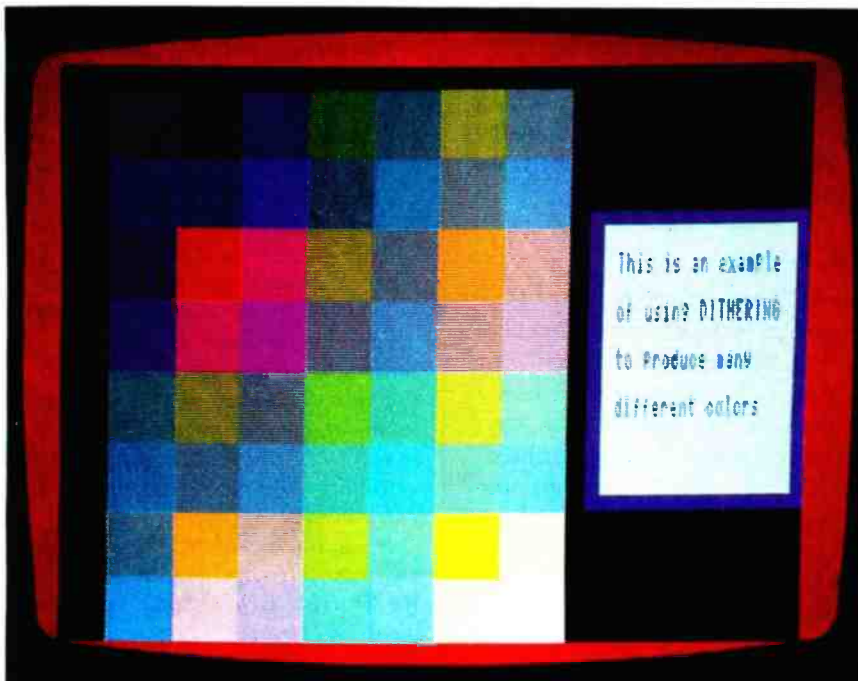


Photo 4: An example of "dithering" on the if800. Even though only eight colors are available, by juxtaposing dots of different colors in different combinations, many different, apparently solid, colors can be displayed. This technique can also be used on the Fujitsu and Bubcom computers.

one of the demonstration programs, the system showed the correct time! A little hunting inside the unit revealed a nickel-cadmium battery that keeps the clock chip going when the computer is unplugged or turned off.

## Connecting to the World

Near the rear of the keyboard/processor module are five slots for peripheral-device-controller circuit cards. Two of these slots are occupied by controller cards for the color video display and the two floppy-disk drives. Many other optional interfaces are available, including a controller for 8-inch floppy-disk drives, a Centronics-compatible parallel printer port, an IEEE-488 interface (an Institute of Electrical and Electronics Engineers standard connection scheme), A/D (analog-to-digital) and D/A (digital-to-analog) converters, and additional RS-232C serial I/O (input/output) ports.

The keyboard/processor module has other switches and connection points. Built into its right side are a DB-25S connector for RS-232C serial communication and DIN (Deutsche Industrie Norm) connectors for a light pen, a black-and-white composite-video monitor, and an audio-cassette recorder. On the left side are two push-button switches that reset the system. The first button, labeled IPL (Initial Program Loader), is a "hard" reset that restarts the system in its power-up state, whereas the second button, NMI (Non-Maskable Interrupt), is a "soft" reset that returns you to the BASIC or CP/M command level (if possible). The NMI button is useful for aborting execution of a program in an infinite loop or some other "hung" state (when Control-C may not work).

## Display Module

The top module of the if800 houses the standard color video monitor, which provides a high-resolution (640 dots horizontally by 200 dots vertically) eight-color display. Characters can be displayed in two sizes and in various screen formats (80 or 40 characters by 20 or 25 rows).

A unique feature of the if800 is the group of 10 "super-function" keys that are located on the video-monitor module, just below the display screen. These 10 keys duplicate the functions of the 10 function keys on the keyboard. Thus, they can be used under program control to produce any desired response. Their location makes it easy for an inexperienced user to select an item from a menu simply by pressing the function key just below the item shown on the screen. This would be especially useful in combination with a light pen because a program could be written that never required you to type on the main keyboard. You would just have to use the super-function keys.

Just to the right of the display screen are the two 5¼-inch two-sided double-density floppy-disk drives. Each floppy disk can store 280k (280,000) bytes.

### Overview of Software

The two major software packages that came with our if800 computer were Oki BASIC, a Microsoft product, and a version of the CP/M operating system. In addition, several demonstration programs that run under each were provided.

Oki BASIC is a very high-level implementation of the BASIC language that fully exploits the hardware of the if800. For example, many of the special functions on the keyboard (such as TAB, DEL [delete], CAN, and the function keys) are supported, as well as the COMD key, which allows single-keystroke typing of commonly used BASIC commands. Most of the peripheral devices can be directly controlled from BASIC, including both disk drives, the printer, the onboard speaker, the light pen, the clock and calendar, and RS-232C ports.

Each peripheral device is supported by a whole array of BASIC keywords. An example of a device-control keyword is ON COM GOSUB, which allows a program to be interrupted by data arriving at the RS-232C port. A subroutine call is performed when a signal is detected

on the port. This in effect allows for interrupt processing—usually reserved for assembly-language programmers—entirely within BASIC.

### Displaying Graphics

Because the if800 contains a high-resolution color display, you might expect good graphics support from BASIC. We were not disappointed; many high-level keywords are available for manipulating the graphics screen. Primitive operators for drawing are available for creating images, including CIRCLE, LINE (which includes the capability of drawing rectangles), and POINT. In addition, a graphics macroinstruction facility called GML (Graphics Macro Lan-

---

## Each computer represents a design team's attempt to assemble a set of features that will appeal to a variety of users.

---

guage) is built into Oki BASIC. This is used by defining a BASIC character string consisting of GML commands, which appear mostly as a single letter followed by a single numeral. Typical GML commands are:

- Un—Move cursor up *n* pixels (there are corresponding commands for other directions)
- Cn—Set color to *n*
- Sn—Set scale factor to *n*
- Xstring—Execute a previously defined GML string

To execute a GML command, the statement DRAW *string* or *string-variable* is issued. One GML string can call another GML string, thus providing a nested-macro facility. Consequently, small detailed objects (such as game pieces or special symbols) can be compactly described and drawn with a single command.

Another facility for describing detailed graphics images is the DEF CHR\$ statement in BASIC, which redefines any of the characters in the character set. Note, however, that characters can be only two colors (foreground and background), whereas GML commands can draw images with multiple colors.

Another interesting BASIC keyword is PAINT. A PAINT statement fills in the area starting at specified Cartesian coordinates and bounded by a specified border color with a specified fill color. The area boundary can be any complex shape bounded by any color (which need not be the same as the drawing color). If the boundary is very large and complex, an OUT OF MEMORY error may result, since a recursive algorithm utilizing a stack is used to process a PAINT command. This command, combined with the geometric commands, can be used to easily create graphics displays using filled polygons. A sample picture drawn by one of the authors is shown in photo 3. This was drawn entirely by a small BASIC program (containing a lot of DATA statements!).

The high horizontal resolution (640 dots across) allows use of a standard trick in computer graphics that can effectively provide many more than eight colors. This technique is called *dithering* and depends on the following effect: if we draw a horizontal line consisting of alternating blue and red pixels, our eyes will area-average the pixels and perceive the line as a solid line of a color somewhere between blue and red. By using different combinations and mixtures of the eight available colors, a whole array of different, apparently solid, colors can be displayed. Photo 4 shows a display created using this technique. Unfortunately, the BASIC PAINT keyword does not support filling with dither patterns, but someone will eventually write such a routine for the if800. Even more impressive graphics will then be possible.

The eight-color display can be thought of as three overlaid planes of red, green, and blue pixels. It is possi-



ble in software to choose whether one or several of these planes are to be displayed at any time. This could be used, for example, to allow superimposing a grid over an image in an architectural application program. The grid could be instantly displayed or removed at the touch of a key.

## Musical Possibilities

A set of commands is also available for making single-voice musical melodies through the onboard speaker. Another sublanguage called MML (Music Macro Language) is used. A BASIC string is defined containing MML commands, which include commands for specifying pitches, octaves, timbres, and rests. To play the melody, the statement *PLAY string* is executed.

## Minor Gripes

We noted only a few minor problems with the if800. When programming in BASIC, the keyboard produces uppercase letters in the normal mode. To get lowercase letters, the SHIFT key must be used. There is no shift-lock or lowercase-lock key, and there does not seem to be any way to reverse this behavior to the behavior most people expect (no shift=lowercase, shift=uppercase). This is fine for most programming, but if you have to type a lot of text (for example, in entering program instructions into the source file), it becomes annoying. The lowercase characters that have descenders are somewhat inelegant, as well; this is because of the small character matrix (8 by 8 dots).

## Other Observations

In addition to Oki BASIC, we tested a 64K-byte version of CP/M. Since CP/M is widely known, we shall mention only a few unique features of the BMC version. First, a library of graphics routines that can be called from Microsoft's MBASIC is available. This allows utilizing most of the Oki BASIC graphics primitives (LINE, CIRCLE, PAINT, etc., but not GML commands) from MBASIC. In

fact, the CP/M graphics library seems to execute these commands slightly faster than Oki BASIC.

A version of Wordstar, the popular word processor from Micropro International, was also supplied. Overall it works quite well, with most of the special features (such as boldface, underlining, and text justification) sup-

ported by the if800's built-in printer. Features not supported include multiple text sizes and proportional spacing, since the if800 printer cannot perform these functions. Also of interest is the fact that Micropro is said to be working on a color version of the if800, which will utilize the color capability of the video display.



Photo 5: The Canon CX-1 computer. All the parts of the basic machine (keyboard, processor, two disk drives, and green video-display screen) are contained within a single molded plastic case.

# Canon CX-1

The CX-1 computer is being presented in the marketplace mainly as a business computer, partly because of its one-piece construction and its monochrome green display screen, which make it quite at home in an office setting. The documentation is well suited for use by inexperienced office workers. It is being marketed in this country by Canon U.S.A. Inc., which has its main office in Lake Success, New York.

## Hardware Overview

The basic parts of the CX-1 computer—the keyboard, processor, memory, video display, and two floppy-disk drives—are housed in a single cabinet measuring 53 by 64 by 33 cm (21 by 25 by 13 inches), shown in photo 5. This single-piece design has both advantages and disadvantages. An advantage is that there are no connecting cables to break or wear out. A disadvantage is that the unit

takes up a lot of desk space and is quite heavy; it weighs 25 kg (55 pounds).

### Keyboard Characteristics

The CX-1's keyboard has 84 keys. In addition to the normal typewriter keys, it includes a numeric keypad, several command keys (SHIFT LOCK, UC, CTRL [Control], CAN, and ESC [Escape]), several editing keys (four cursor-control arrows, HOME, INS [insert], and DEL), two mode-select keys (PROG and OPE), and a HLT (halt) key.

Among the command keys are both a SHIFT LOCK key (which acts like a typewriter shift lock in that both alphabetic and numeric/symbol keys are locked in the shifted position) and a UC key (for "uppercase," which shift-locks only the alphabetic keys). The unfamiliar mode-select keys are used when programming in BASIC to switch between programming and operating modes (this will be explained later).

The HLT key is used to put the computer into a "pause" state. The computer will suspend whatever it is doing and display a special prompt character to show that it is in the pause state. You can then either continue or abort the current process. If this is done during execution of a BASIC program, variables can be examined in the pause state. This is very useful for debugging programs.

Another unfamiliar key is the large one labeled START on the right side of the keyboard. This key usually seems to work just like the RETURN key. It is labeled START because of the feature of Canon's BASIC interpreter that allows you to run a program by just hitting START in the "OPE" mode (rather than having to type "RUN" and then hit the RETURN key).

One notable omission from the keyboard is a REPEAT key (or a provision for automatic repetition of characters from all the keys). This is especially annoying when you are using the cursor-movement keys, as in editing; you have to keep jabbing

away at the keyboard to keep the cursor moving. A REPEAT key would eliminate much of this tedium.

### Other Hardware Features

The 12-inch green monochrome video-display screen sits over the keyboard. The display format is 24 rows

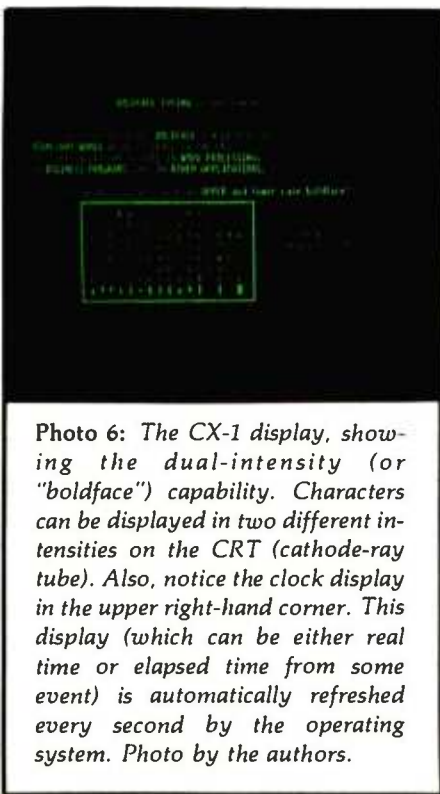


Photo 6: The CX-1 display, showing the dual-intensity (or "boldface") capability. Characters can be displayed in two different intensities on the CRT (cathode-ray tube). Also, notice the clock display in the upper right-hand corner. This display (which can be either real time or elapsed time from some event) is automatically refreshed every second by the operating system. Photo by the authors.

of 80 characters, and the overall display quality is excellent. One rare feature of the CX-1 is its ability to display characters on the screen in two different levels of brightness (sort of an electronic boldface). Photo 6 shows an example of this dual-intensity display, along with the complete character set. The CX-1 is an entirely character-oriented machine; these characters are all that can be displayed on the screen. There are no user-definable characters or any mechanism for displaying bit-mapped graphics.

A unique feature of the CX-1 is a constant display of the time from the internal time-of-day clock; this always appears in the upper right-hand corner of the video screen.

To the right of the screen are two 5¼-inch floppy-disk drives. Each one has a capacity of 320k bytes per disk. The operating system has a software door-lock function that prevents an absentminded user from opening the drive doors when the read/write head is engaged.

In the rear of the case are jacks for two optional additional disk drives, an optional light pen, three RS-232C serial ports, and three Centronics-compatible parallel ports.

### Software: Operating System

The Canon computer is built around an 8-bit 6809 microprocessor and runs an operating system called MCX ("Monitor program for CX-1"), which is both powerful and unconventional. It is a very "mode-oriented" system; that is, you perceive the system as operating in various modes, each identified by a different prompt character. Operating modes, and their prompt characters, include:

```
0> MCX command mode
$ BASIC operating mode
% BASIC programming mode
@ Pause mode
. Editor
```

You can switch modes by various commands or keystrokes. Commands are not always obvious or consistent, however. For example, to switch from BASIC programming mode to operating mode, you must press the OPE key (whereupon a small LED on the OPE key lights up). To switch back, however, you must press PROG and then hit the RETURN key.

Another unconventional characteristic of the MCX operating system is that all user typing appears on the bottom two lines of the screen. Therefore it has no screen editing, and even the method of entering and editing a BASIC program takes some getting used to. When a BASIC statement is entered, it first appears on the twenty-third line of the screen, near the bottom. When the RETURN key is typed, the statement jumps to the



## At a Glance

### Name

Canon CX-1

### Distributor

Canon U.S.A. Inc.  
One Canon Plaza  
Lake Success, NY 11042  
(516) 488-6700

### Dimensions (Inches)

13 by 20 $\frac{1}{8}$  by 25 $\frac{1}{8}$

### Microprocessor

6809, 8-bit

### Size of User Memory

64K bytes

### Number of Keys

84

### Number of Function Keys

0

### Standard Interfaces

Light pen; RS-232C (DB-25); printer; more disks

### Expansion Sockets

4

### Character Sets

Roman, graphics, boldface

### Graphics/Color Resolution

None

### Number of Colors

2

### Other Features

Alphanumeric line labels; other FORTRAN-like features in BASIC

### Price

\$4995 (whole system)

main part of the display and reappears at the correct place in the program. Similarly, to change a BASIC statement, you must first pull it down to the twenty-third line (via an editing command), edit it, and then reinsert it into the program.

MCX acts like CP/M in that when it encounters an unrecognized command, it searches the disk to try to find a BASIC or command file by that name to execute. The MCX operating system seems to read from and write to the system disk more frequently than most systems; this slows down

(1a)

FRC(x) = x mod 1 (i.e., the fractional part of x)

FIX(x,n) = value of x rounded off to n decimal places

MOD(x,n) = x MOD n (i.e., remainder when dividing x by n)

MAX(x1,x2,...,xn) Highest valued member of a set of numbers

MIN(x1,x2,...,xn) Lowest valued member of a set of numbers

(1b)

CX-1 Function Microsoft Equivalent

ASC\$	CHR\$
CHR\$	STR\$
STR\$	MID\$

**Table 1:** Handy arithmetic functions available under Canon CX-1 BASIC (1a), and string functions that are incompatibly named for conversion from Microsoft BASIC (1b).

the operation of many commands. We were surprised that the system accesses the disk during certain phases of operation—for instance, every time the BASIC program in memory is edited and run (the disk access

## The Canon CX-1's one-piece construction and its monochrome green display screen make it quite at home in an office setting.

comes after you type the RUN command).

Another feature of the MCX operating system is the SECURE command, which allows you to cause a BASIC program file on disk to assume the "secured" state. A secured file can only be executed, not listed. This provides a modicum of software protection, since it prevents unauthorized users from reading the source code. When a file is secured, a six-character password is requested. Only by correctly reiterating this password can a file be unsecured.

### Software: BASIC Interpreter

The most important subsystem of MCX is Canon CX-1 BASIC. This in-

teresting dialect of BASIC contains certain features seemingly borrowed from FORTRAN. This version of BASIC uses type declarations akin to those in FORTRAN, the double asterisk ("\*\*") for exponentiation, FORMAT statements, and an interesting form of subprogram linkage. Perhaps the most attractive feature of CX-1 BASIC is its ability to use alphabetic labels for program lines. Here is a sample program in CX-1 BASIC:

```
10 FOR I=1 TO 100
20 N=N+I
30 IF N>2000 GOTO [FINIS]
40 NEXT I
50 [FINIS] PRINT I: END
```

Notice that each line still has a line number, as in ordinary BASIC, but it can also have a label in brackets after the line number. This label can be referenced in GOTO, GOSUB, and IF...GOTO statements.

Another unique feature of CX-1 BASIC is its CALL statement, which allows an executing BASIC program in memory to call a BASIC program on disk as a subroutine. Upon encountering a CALL, the operating system searches for and loads the called program into memory, executes it, and then returns control to

the original calling program. Values of variables can be passed between programs by declaring them with a PARAM statement in the called program. It is possible in this way to have many BASIC routines in memory at once (assuming they all fit, of course).

This powerful capability allows the programmer to write structured, modular programs. Libraries of commonly used Canon-BASIC routines can be developed and tested individually. These routines can then be used by other programs or executed sequentially to form new, more complex programs.

Also, it has a built-in XREF command, which provides a cross-reference listing of a BASIC program, listing all variables and the lines in which they occur. To our knowledge, this is the only BASIC interpreter that comes with this command built in.

CX-1 BASIC contains several unusual and useful functions, such as the arithmetic functions shown in table 1a. Two other unique keywords are SAVECRT% and LOADCRT%, which save and recall the current video-screen image as a 1920-byte disk record.

One last observation about CX-1 BASIC: some of the string functions have nonstandard names compared to almost all other versions of BASIC (certainly the Microsoft-derived varieties). Some examples of these are shown in table 1b. This can be quite confusing at first to an experienced BASIC user. It also complicates the conversion of programs to or from other versions of BASIC.

### Other Software

In addition to the BASIC language, several other important subsystems of MCX come as standard equipment with the computer, including a line-oriented text editor (similar to the familiar ED of CP/M) and a 6809 assembler and debugger. Finally, it also has a text formatter called CROFF (Canon's version of Unix's NROFF?) that, unfortunately, we were not able to test.



Photo 7: NEC's PC-8001A together with the color monitor, PC-8012 I/O unit, and PC-8032 dual floppy-disk drive.

## NEC PC-8001 A

The Nippon Electric Company (NEC) PC-8001A, shown in photo 7, is a version of the PC-8001 that has been adapted for the American market. (We previously reviewed the original unit as it was sold in Japan; see our article "The NEC PC-8001: A New Japanese Personal Computer," January 1981 BYTE, page 72.) As you would expect, there are few differences. To avoid duplication, we shall concentrate on those differences and on the floppy-disk drives and I/O chassis, which we did not review last time.

As closely as we can determine, the software for the PC-8001A is identical to that of the PC-8001—both run Version 1.1 of N-BASIC, written for

NEC by Microsoft. (On the unit we tested, there was one galling difference: the cursor would not appear when the screen was in the 80- or 72-characters-per-line mode. An NEC spokesman, however, assured us that this was due to a defect in the unit we were testing and is not a characteristic of the system.)

### Keyboard and Character Set

The katakana characters available on the PC-8001 display have been replaced by the Greek alphabet and a set of superscripts (see photo 8 on page 70). The keyboard, aside from the absence of kana legends on the keycaps, has only two differences. What was the Roman/katakana key



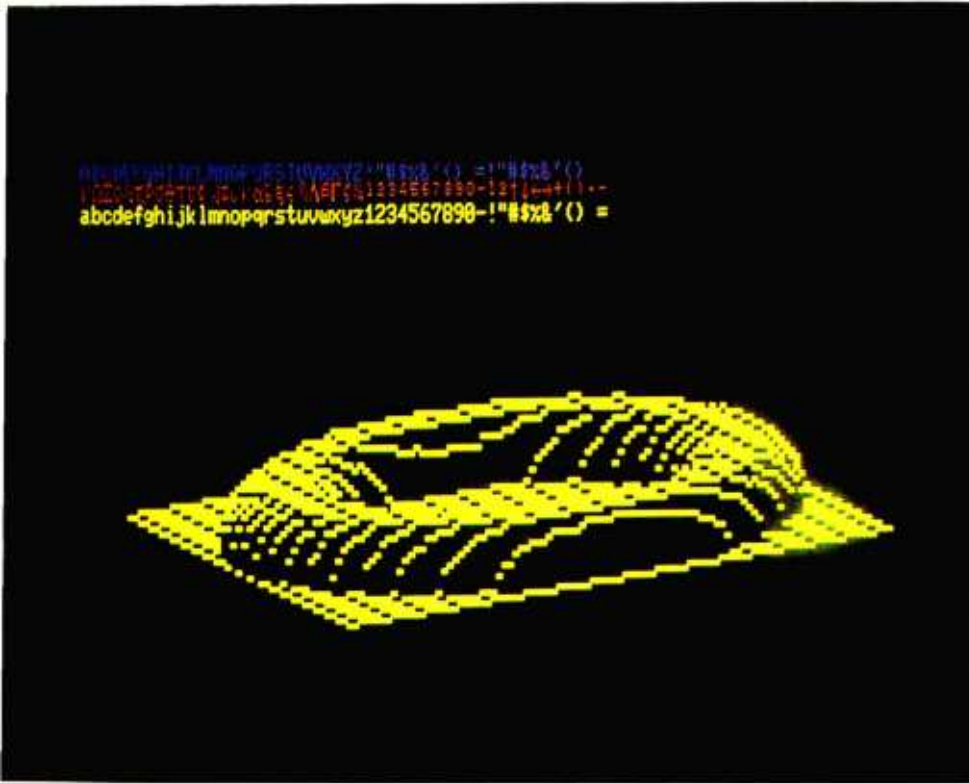


Photo 8: The NEC display. Katakana characters in the Japanese version have been replaced by Greek characters and superscripts in the American version.

on the 8001 is a much needed shift-lock key on the 8001A, and a duplicate “-” (minus) key in the 8001’s numeric keypad has been replaced by a locking “alternate character set” (i.e., Greek and superscripts) key on the 8001A.

Unfortunately, neither the alternate character set nor the graphics character set are indicated by legends on the keycaps—this makes them extremely awkward to use. If you have forgotten which is the Greek “gamma” ( $\gamma$ ) key, for example, you have to open the instruction manual, turn to the keyboard diagram, locate the gamma key, count the number of keys to the edge of the keyboard in the diagram, count the same number of keys in from the edge of the actual keyboard, and finally press the key. While most of the other computers reviewed here make you use this same sequence for graphic-character input, NEC forces you to do it for both graphics and Greek characters. Such a nuisance could and should be remedied, either by inscribing the alternative characters on the tops or fronts of the keys or by offering a set of stick-on labels for both alternative character sets.

## What’s Inside?

Inside the keyboard/processor module, we found only two differences between the Japanese and American versions. The American version has a thick metal cover over the main printed-circuit board. This cover protects and stiffens the board underneath, but it was probably added as a shield to help the PC-8001A meet the Federal Communications Commission’s stringent RFI (radio-frequency interference) emission limits. Also, the American version has more memory, 32K bytes, as standard equipment. (Because part of this memory is used for the display, up to 26,786 bytes are available to the read-only-memory-based BASIC interpreter for program and data storage, while 19,367 bytes are available to the disk BASIC system.) The NEC  $\mu$ PD780C-1 microprocessor, which is

## At a Glance

### Name

NEC PC-8001A

### Distributor

NEC Information Systems Inc.  
5 Militia Dr.  
Lexington, MA 02173  
(617) 862-3120

### Dimensions (Inches)

3¼ by 16¾ by 11

### Microprocessor

$\mu$ PD780C-1 (8-bit, Z80-compatible)

### Size of User Memory

32K bytes

### Number of Keys

82

### Number of Function Keys

5 [shift yields 10 functions]

### Standard Interfaces

RS-232C; audio-cassette tape;  
monochrome video monitor; RGB color  
monitor; printer; expansion bus

### Optional Interfaces

Floppy-disk drives; I/O chassis; communications subsystem (IBM 3270, 3780, and HASP protocols)

### Expansion Sockets

1 (system bus)

### Character Sets

Roman, Greek, superscripts, graphics

### Graphics/Color Resolution

160 by 100; 80 by 25  
(character-oriented)

### Number of Colors

8

### Other Features

Time-of-day clock; beeper

### Prices

Keyboard/processor \$995  
RGB color monitor \$995  
Dual floppy-disk drive \$995  
I/O unit \$649

practically identical to the Zilog Z80, runs at 4 MHz.

Judging from our experience with the Japanese version, the hardware is quite reliable. We have used our PC-8001 both as a computer and as a terminal almost daily for over a year and a half with no trouble.

Our only quibbles have been relatively minor. One is the location of the Reset button, which extends from the rear of the console. It is easily triggered by accident if you push the keyboard against books or a wall at the back of your desk. We eventually remedied this minor problem by hanging a large hex nut on the protruding button. Our other quibble is the RS-232C serial interface—instead of a standard DB-25S connector on the outside of the case, NEC provides only a DIP (dual-inline pin) socket hidden away in a relatively inaccessible spot inside the case. NEC does sell an adapter cable with a DB-25, but the added expense should not be necessary.

The size of the NEC keyboard/processor module is attractively small: only 8.3 by 26 by 43 cm (3¼ by 10¼ by 16¾ inches), hardly bigger than just the keyboard. It is light enough to hold on your lap while you type, and it can easily be shoved to the side of your desk top when it's not in use—a definite advantage if your desk is crowded and doesn't really have room for a computer. Moreover, like most of the Japanese computers reviewed here, it can serve double duty either as a computer or as a remote terminal for a larger system.

### Peripherals and Expansion

Of course, such a small chassis has no room inside for expansion, but to many users that is unimportant. For those who do wish to expand their systems, NEC sells the PC-8012A I/O unit shown in photo 9, a box that contains a power supply, 32K bytes of RAM (random-access read/write memory), sockets for 2K bytes of PROM (programmable read-only memory), interrupt-control circuitry,



Photo 9: The NEC PC-8012A I/O unit has seven slots for expansion and connectors on the back that can carry nonstandard voltages to the bus.

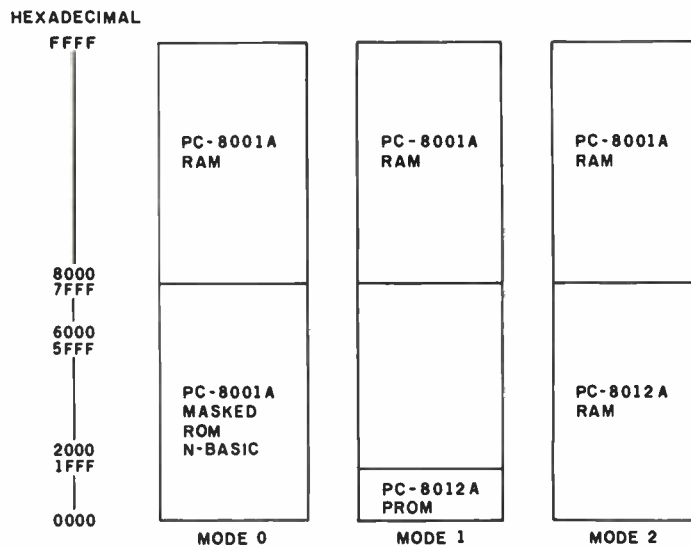


Figure 1: The NEC PC-8001A can operate in any of three memory modes when the PC-8012A I/O unit is connected.



and an extension of the system bus (called the "mother bus") with seven 36-pin slots for plug-in cards. One of these slots normally holds a floppy-disk interface card, and the PC-8031 double disk drive can plug into the 8012A. If you don't need the interface box, the disk drive can apparently be connected to the keyboard/processor module through another less widely advertised accessory, the PC-8033 disk-interface unit. A second double disk unit, the PC-8032, can be daisy-chained to the 8031.

## Making the Connection

NEC will win no industrial-design awards for this arrangement of the peripheral devices. Both the disk drive and the I/O unit are big and awkward, and the interconnecting cables provided with the units are too short to allow you much freedom in the way the boxes can be arranged on a flat surface. The expansion unit *must* sit about six inches behind the keyboard/processor. By straining the cable a bit, you can place the disk drive to either side of the keyboard. The combination of short, wide peripherals and short cables largely negates the advantages of the 8001A's small size.

Nor has the cabling arrangement been designed with an inexperienced or inept user in mind. Instead of separate connectors mounted firmly to the chassis, slots located in the chassis give access to edge connectors on the printed-circuit boards. The boards are recessed and slightly flexible, and, since there is inevitably some play in their mountings, seating the connectors properly or unplugging them requires considerable fumbling.

Moreover, the connectors have not been "idiot-proofed"; they can be inserted upside down about as easily as they can be inserted right side up. Indeed, the disk-unit-to-I/O-unit (8031 to 8012A) cable almost begs to be inserted upside down—an arrow on the connector that is supposed to indicate proper orientation is printed on the bottom of the connector, where it is

invisible when the connector is oriented correctly.

## Using Expanded Memory

Three memory modes are available for using the additional memory in the I/O-expansion unit (see figure 1). In mode 0, none of it is used, while in mode 1, only the PROM in the I/O unit can be addressed, along with the 32K bytes of RAM in the keyboard/processor module. In mode 2, the 32K bytes of RAM in the 8012A are mapped into the memory-address space normally occupied by the BASIC-interpreter ROM, giving a full 64K bytes of user memory, but no BASIC. NEC spokesmen say that CP/M is available for the PC-8001A; undoubtedly, it must run in mode 2. Up to four more 32K-byte banks of RAM can be installed in slots in the motherboard. Any one of these banks can be swapped in address space with the main memory under software control, but no currently available software supports this.

---

**Judging from our  
experience with the  
Japanese version, the  
hardware of the NEC  
PC-8001 is quite  
reliable.**

---

## Control-Line Versatility

The bus structure of the 8012 appears to be designed for either instrumentation or process control. It looks like it could be easily interfaced to the IEEE-488 bus. It has separate lines for eight levels of interrupts, and an 8214 interrupt-control chip is an integral part of the unit. Also included is a 600-hertz (Hz) real-time clock that can be used to generate an interrupt every 1.67 milliseconds (ms); during such an interval, the microprocessor could poll or service many more than eight devices.

In addition to the address, data, control, and interrupt lines, the system bus has six undefined lines, plus

two sets of lines that can carry voltages input through a set of connectors at the rear of the chassis. These features make the bus particularly convenient to those wishing to build homebrew interfaces, even to systems requiring voltages other than the standard +5 volts (V) and  $\pm 12$  V.

## Floppy-Disk System

While, as we noted above, the dual floppy-disk drives take up a lot of real estate on your desk because they are mounted side by side, horizontally, they do hold a lot of data. The soft-sectored 5¼-inch disks are formatted for 256 bytes per sector, 16 sectors per track, with 35 tracks per disk (34 user-accessible), for a total of 139k bytes per disk, although the disk directory won't allow a lot of small files. The cabinet is made of the same sturdy metal as the 8012 I/O unit, and, in addition to the clasp that snaps the drive doors open and shut, each drive has a separate lever that can be used to lock it shut.

The disk-drive unit is also "intelligent"—a separate controller within the drive unit does some of the work associated with storing data on a disk; the unburdened main processor just passes data through an I/O port. This is probably the reason for the major peculiarity of the NEC disk-access software.

In most disk BASICs, you just slide a disk into drive number 2 and type LOAD "2:filename" and the file loads. If you try that with the PC-8001A, you will get the error message "Disk Not Mounted"—you must type MOUNT 2 before you can use the disk. When you are done with the data on the disk, you must similarly type REMOVE 2 before removing the disk; if you insert another disk in the same drive, you must MOUNT it as well. These commands are necessary because the microprocessor works with a copy of the disk's file-allocation table that it reads into user memory when it executes the MOUNT command. The disk's copy of this table is not updated until the

**The revolutionary Discovery multiprocessor** is the only system that allows the total integration of powerful 16 bit 8086 processors with the more standard Z-80 user processors. The DISCOVERY system may be configured in any 8 bit/16 bit combination, or as a totally exclusive 16 bit system only to provide the ultimate in performance and flexibility in advanced micro systems.

**Ultimate performance.** The dpc-186 is the most sophisticated single board microcomputer available today offering more power and faster processing time through the 8086 CPU for bigger, more complex programs. Memory starts at 128 K (compared to the Z-80's 64 K), and is expandable to 1 megabyte. And the dpc-186 is fully compatible with the standard DISCOVERY multiprocessor system permitting efficient upgrading as future needs develop, without sacrificing any of your extensive hardware and software investment.

**World's best multiprocessor system.** The DISCOVERY system provides separate processors and memory for each of its 16 users. It offers full CP/M™ and CP/M-86™ compatibility, interprocessor communication, and shared and private files. Each user can take advantage of shared peripherals and cross submitting of tasks between processors. The system is controlled by a unique, two board dpc-280 service processor and dpc/os distributed processing operating system.

**By the board or by the system.** The DISCOVERY multiprocessor is ready for immediate delivery as a complete system, as processor boards, and everything in between. It offers exclusive technology in multiprocessing, yet is fully compatible with existing standards including CP/M and S-100. It is quite simply unmatched in performance, capabilities and offers a far greater degree of flexibility. DISCOVERY—offering a whole new world of possibilities.

## For the first time, 8 and 16 bit processor intermixing.



Action Computer Enterprises, Inc.



The Multiprocessing Company  
55 West Del Mar Boulevard, Pasadena, CA 91105 USA  
(213) 793-2440, TWX 910-588-1201

Circle 6 on inquiry card.

Dealer and OEM inquiries invited.

\*CP/M is a registered TM of Digital Research, Inc.



REMOVE command is executed. If you forget to issue the REMOVE command, the manual warns, the interpreter will not be able to locate any of the files you have added during that session, and, in the worst case, all data on the disk will be lost.

## Documentation

As we explained earlier, we have not mentioned documentation for most of the machines reviewed here. Because some of them have not yet been introduced into the U.S. market, many of the user's manuals we saw were either preliminary translations or in the original Japanese. But the NEC PC-8001A is already being sold here, and the documentation we saw was what a buyer would see. We therefore decided to mention the documentation briefly to reassure would-be buyers who fear that the instructions for their new, expensive, and complicated Japanese computer may be as mystifying as the instructions that come with a cheap made-in-Japan Christmas toy.

Although NEC's documentation is readable, in places it could be much better. The *PC-8012A I/O Unit User's Manual* would probably be somewhat mystifying to a totally inexperienced user because it seems to presuppose a good knowledge of both hardware and software. There are not enough step-by-step, do-this-then-do-that instructions; complicated features are inadequately explained; and some of the text is just plain bad English.

The *PC-8001A Microcomputer Reference Manual* is uneven in quality. Explanations of the BASIC commands are good, but they duplicate some sections of the NEC *BASIC Language Learning Guide* word for word. Explanations of more complicated hardware or system features, such as the terminal mode and the assembly-language monitor, tend to be confusing and poorly written. (One extreme example discusses the TM (test memory) command: "Note: As for the contents of the FF39 through FF3C numbers, since only

under normal circumstances does TL (*sic*) memory of the FF39 - FF3C numbers become significant, after the TM command is entered in a situation in which an error occurs for a few seconds." Anyone find a verb there?)

Moreover, the English version leaves out a lot of valuable information included in the Japanese documentation, the *PC-8001 User's Manual*. Most conspicuously absent are the pinout tables for the printer interface, system bus, and RS-232C interface. The last is particularly

noticeable because the RS-232C connector is a DIP socket and not a standard DB-25 connector.

On the other hand, the *PC-8031 Mini Disk Unit User's Manual* is pretty good, although it could be improved by the addition of some photographs of assembled systems. And NEC's *BASIC Language Learning Guide* is excellent—a well-planned and well-written primer with many examples and a set of self-test review exercises and answers at the end of each chapter.



Photo 10: The Hitachi MB-6890 personal computer together with the color video display, double floppy-disk drive, and dot-matrix printer.

## Hitachi MB-6890

The word that best describes the Hitachi MB-6890, shown in photo 10, is *flexible*. It offers as standard equipment several features that other manufacturers provide only as expensive add-ons, such as a light-pen interface and an RS-232C interface complete with DB-25 connector. Also, it has such a profusion of hardware- and software-controllable switches and options that each user can configure the machine to individual taste.

### Details of Construction

The case of the Hitachi processor unit is entirely plastic except for the detachable metal lid covering the rear. The rather thin (0.27-mm, 0.070-inch) base is reinforced with plastic posts in the rear where it is often required to bear the weight of the video monitor, and it is protected in front by the overlap of the substantially thicker plastic of the keyboard. This monocoque construction yields

Next to keeping all your data on Verbatim Datalife™ flexible disks, the best thing you can do for your computer or word processor is to keep it running clean and error-free.

And the way to do just that is with Verbatim's new Datalife Head Cleaning Kit. It can remove up to 90% of the debris contaminating your drive heads. Dust, dirt and debris that causes data loss and errors, hinders system performance.

#### Quick and easy to use

All you have to do is remove a Cleaning Disk from its protective pouch, put the disk in the special jacket, insert it into your drive and turn it on.

In just 30-60 seconds, your drive heads are cleaned.

#### Cleaning, with no cleaning mess

With your Datalife Head Cleaning Kit there's no hit-and-miss applying solvents that can splash and spill.

What's more, with Datalife Cleaning Disks every time you clean your heads, you can do it with a fresh, clean, disposable disk.

#### Cleans both Single and Dual Head Drives Safely

There's no worry about damaging your system with Datalife Cleaning Disks. And you can use them on single or dual head drives.

#### Protect your investment

The Datalife Head Cleaning Kit will help you guard against data loss, errors, and degradation of system performance because of debris contamination.

So if you want your data back verbatim, keep it on Verbatim disks. And keep your disk drives clean with Verbatim's Datalife Head Cleaning Kit.

Call (800) 538-1793 for the name of your nearest Verbatim dealer. (In California and outside the U.S. call (408) 737-7771 collect.)

**Verbatim**®

# Introducing the second best thing you can do for your computer.

**Datalife**  
By Verbatim®

Head Cleaning Kit  
(Includes Special Jacket And 2 Cleaning Disks.)

**FREE INTRODUCTORY OFFER!**  
Take this coupon to your Verbatim dealer/distributor and Get a Datalife Head Cleaning Kit FREE when you buy 10 Datalife Head Cleaning Disks.

Name \_\_\_\_\_ State \_\_\_\_\_ Zip \_\_\_\_\_  
Address \_\_\_\_\_  
City \_\_\_\_\_ Dealer/Distributor \_\_\_\_\_  
To the Consumer: This coupon good only on required purchase of specified product. Cash value 1/20 cent. Void where prohibited.  
To Seller: Verbatim Corporation authorizes you to accept this coupon for redemption. We will reimburse you in accordance with our Cleaning Disk Promotion Plan 10/1/81. A copy of the Promotion Plan is available from Verbatim Corporation, or any authorized Verbatim distributor.  
Limit: One coupon per customer. Offer expires 4/30/82.





**Photo 11:** Hitachi provides a set of individually removable panels along the back of the processor enclosure to give access to individual expansion slots on the motherboard.

a processor cabinet that is adequately strong and remarkably light.

The back of the case, shown in photo 11, shows Hitachi's solution to the problem of how to give access to optional peripheral-device circuit boards plugged into the system's bus. Six 56-pin sockets for edge connectors are mounted on the motherboard, perpendicular to the back of the case, and there is a removable plastic slot panel behind each socket.

The disk-controller board shown installed in the first slot incorporates a similar slot panel, mounted on the circuit card, that both stiffens the card and houses the card's connection to the outside world. Thus, no gaping holes are left for options that you may never install, nor must you arrange to snake expensive lengths of ribbon cable all over the inside of the processor cabinet to reach a fortuitous gap between sections of the case.

Since this plastic case provides no electromagnetic shielding, most of the motherboard and the circuit board underlying the keyboard are covered with thin (0.43-mm, 0.017-inch) sheets of aluminized plastic, making them look like hastily wrapped Christmas packages. Because this "gift wrapping" is staked in place and impedes access to the motherboard, it must surely also impede convective cooling of the electronic components underneath. On the other hand, it provides expensive components with an extra layer of protection against dust or an overturned mug of coffee.

## System Versatility

The most striking features inside the case are the large number of miscellaneous unused connectors and a plethora of relocatable jumper connections. This suggests that it may be possible to substantially reconfigure the hardware rather easily.

In fact, a number of such reconfigurations are documented in the user's manual. Several of the jumpers have functions you might expect, such as setting the serial data-transfer rate and the transmission/reception parameters for the terminal mode.

## At a Glance

### Name

Hitachi MB-6890

### American Representative

Hitachi Sales Corporation  
of America  
401 West Artesia Blvd.  
Compton, CA 90220  
(213) 537-8383

### Dimensions (Inches)

4¾ by 17¾ by 20¼

### Microprocessor

6809, 8-bit

### Size of User Memory

32K bytes

### Number of Keys

89

### Number of Function Keys

5 (with shift gives 10 functions)

### Standard Interfaces

RS-232C (DB-25); monochrome video

monitor; RGB color monitor; audio-cassette  
tape; light pen; printer; game paddles

### Optional Interfaces

Disk drives; extra printers

### Expansion Sockets

6 for I/O; 2 for RAM

### Character Sets

Roman, katakana, hiragana, graphics

### Graphics/Color Resolution

640 by 200; 80 by 200

### Number of Colors

8 on 8

### Other Features

Time-of-day clock

### Prices (Yen Equivalent in Dollars)

Keyboard/processor Y = \$1035

Color monitor Y = \$ 860

Disk drive Y = \$1500

Printer Y = \$ 763



WHEN AMERICAN BUSINESS HITS THE ROAD,  
AMERICAN BUSINESS DECIDES ON HILTON.

**HILTON**

AMERICA'S BUSINESS ADDRESS™



Switch Number	Open	Closed
1	BASIC mode	Terminal mode
2	Interlaced screen	Noninterlaced screen
3	80 characters per line	40 characters per line
4	Normal mode	High-resolution mode
5	Function keys labeled	Function keys unlabeled
6	Half duplex when terminal	Full duplex when terminal
7	7 bits/char when terminal	8 bits/char when terminal
8	Hiragana converted to katakana for printer	Hiragana output to printer

Table 2: Functions of the Hitachi state-selection switch.



Photo 12: The Hitachi BREAK key is protected by a transparent plastic clamshell. The KATA/HIRA key can change the machine between any of three states—the color of the LED beside it indicates the state.

More unusual is an eight-position DIP switch on the motherboard that can be used to determine what state the machine will be in when the power is turned on (see table 2). Normally, the switch on the console labeled MODE is wired in parallel with DIP switch number 3, the characters-per-line switch. But by simply moving a jumper on the mother-

board, it can be rewired to parallel DIP switches 1 or 2.

We should add that all these parameters can be reset individually by issuing the appropriate command from the keyboard, e.g., WIDTH 80 to select the 80-characters-per-line display mode. If you would rather change several of them simultaneously, you could reboot the system in the

desired mode with the command NEW ON *b* where *b* is an expression with a value from 0 to 255, inclusive. The 8 bits of the binary representation of *b* serve the same purpose as the eight DIP switches; a 1 in the least significant bit (bit 1) corresponds to switch 1 being in the open position.

This is a fine idea, showing great insight into the wide variety of ways people use personal computers. It allows the person who uses the machine primarily as a remote terminal for a large system to turn the MB-6890 on and find a functioning terminal, rather than a computer that can be turned into a terminal only with a lengthy set of commands; it allows the person who wants both a computer and a terminal to configure a machine that switches from one use to the other with one push of a button; and it lets the person who primarily wants a stand-alone computer to find the machine in this form when it is turned on.

## Keyboard

The keyboard, like that on the other computers reviewed here, has all the typewriter keys, plus a numeric/editing keypad and a set of user-definable function keys. Controls that are used infrequently (the on/off, reset, and mode-select switches, and a knob controlling the loudness of the click that accompanies each keystroke) are hidden behind a small door at the top of the keyboard. The BREAK key (a powerful stop/reset key) has a transparent plastic clamshell around its front edge (visible in photo 12), which prevents you from hitting it accidentally.

The keyboard has four cursor-control keys. The cursor-left and cursor-right keys have two separate modes of operation. Normally, they move the cursor in increments of one character position, but with the SHIFT key depressed, they move the cursor a word at a time.

Every time you hit a key, the speaker in the bottom of the keyboard/processor module produces a click. As we said, a knob adjusts the volume. The electronic clicks are



## **“We provide business programs as individual as your business needs.”**

“Allow me to introduce myself. I'm a Vector computer, dedicated to the advancement of society. And I'd like to tell you how a computer can help you manage your business more efficiently. Especially if that computer is a Vector, like me. Because we're probably the most flexible and cost-effective computers you can find.

“Our programs are the key. Because they enable me to handle sales forecasting, budgeting, job costing and proposals, commissions, personalized mass mailings, charts and graphs. We Vectors can even talk to each other and to other bigger computers.

“Unique combinations of our individual programs can actually customize me to meet your specific requirements. Any combination of our software packages can be assembled right off the shelf, to help you realize your full potential as a salesman, merchant, stockbroker, clergyman, contractor, real estate or insurance agent or whatever your business.

“Choose from Memorite III for word processing and mail list management, Execuplan for financial planning and forecasting, Business Accounting, Data Management for filing and sorting information, Communications and a host of others. And, of course, all we Vectors come with the popular CP/M operating system.

“For more information and your local dealer, call us at (805) 499-5831 or (800) 235-3547. In California, call (800) 322-3577. Or write to us at 500 North Ventu Park Road, Thousand Oaks, CA 91320.

“We'll show you how we small information systems can mean big business for you!”

Circle 425 on Inquiry card.

**VECTOR**  
Vector Graphic, Inc.

**COMPUTERS FOR THE ADVANCEMENT OF SOCIETY.**

Sold and supported by 400 dealers worldwide.  
Vector Products are approved on General Services Administration authorized ADP scheduled price list.



completely inaudible when the knob is set for minimum volume, but the key hitting the mechanical stop at the bottom of its excursion still provides audible feedback. Thus, the only distinctive function served by these clicks is to indicate the repeated entries that occur when a key is held down for more than a half second. Nonetheless, the pitch and duration of beeps from the speaker may be controlled by an assembly-language program. Thus, the speaker can be used to produce sound effects and rudimentary music.

The MB-6890, like most microcomputers, uses a scanned keyboard; the keys are wired in a matrix, with each key capable of closing a connection between a horizontal (row) and vertical (column) electrical line. The keyboard-monitor circuitry detects closure of the switch inside the key by rapidly sending out pulses to successive columns while monitoring the row lines. An input sensed on row *x* while the output is going to row *y* indicates that the key at the intersection of *x* and *y* was pressed. Since the circuitry can typically complete a scanning cycle many times during the interval it takes a key to close and open again, it is unlikely to miss keys hit by even the fastest typist. Software in the keyboard monitor can aid in deciphering key "rollover," hitting a second key before the first is released.

But the MB-6890 keyboard, either through insufficient scanning speed or inadequate rollover software, does not accept key rollover very gracefully. The manual warns, "Be careful not to press more than three keys at the same time." This may seem an unlikely occurrence during text entry; whether it is or not depends on your skill as a typist, your typing speed, and the type of material you are entering. The problem is most apparent when you hold down the GRAPH key (to input either graphics or hiragana characters, depending on graphics mode) and rapidly type D followed by the adjacent key F. The computer often interprets it as a spurious cursor-up character, and the

cursor goes bouncing merrily up to the previous line. Very disconcerting and very annoying!

### Coping with Characters

The key labeled KATA/HIRA solves the problem of dealing with the four character sets used in Japanese text. Hitachi's elegant solution could easily be adapted to more universal problems. To understand its function, you must know that Japanese, unlike most languages, has four separate writing systems: kanji, katakana, hiragana, and the Roman alphabet. A brief discussion of the function of each appears in the text box "Japanese Character Sets" on page 63.

---

**One of the most intriguing features of the MB-6890 is the light-pen interface, which is standard equipment. The pen, both simple and sturdy, is extremely easy to use.**

---

Most of the Japanese personal computers reviewed here offer a Roman-alphabet keyboard with some sort of locking shift key that allows the same keys to be used for katakana as well. There are generally a few very common kanji characters used as graphics keys (the pictographs for "date" and "time," for example), but the hiragana characters require resolution beyond the capability of most noninterlaced video displays.

Here's the way Hitachi approached the problem. The MB-6890 has an interlaced graphics mode (which doubles the vertical resolution of the characters), and in that mode, it offers you a choice of Roman, katakana, or hiragana characters. Normally, the keyboard produces Roman characters. Hit the KATA/HIRA key once and an LED beside it

turns red, indicating that the keyboard is now accepting katakana input. Hit the key again and the LED turns green, indicating that the keyboard is accepting hiragana input. Hit it a third time and the LED goes out—you are back in the Roman mode.

### File Operations

The Hitachi flavor of BASIC (Level-3 BASIC, a product of Microsoft) allows the programmer to pass files of data to or from any of the I/O interfaces—cassette tape, serial port, disk, printer, screen, or keyboard—using a common command format. For instance, to output a program listing to any of these devices, there is the command

```
LIST "file descriptor" [,line  
number [,line number]]
```

where *file descriptor* is a standard string that identifies the device and the other parameters are optional. Thus, LIST "LPT0:" sends the listing to printer 0, whereas LIST "CAS0:TEST" sends it out the cassette interface into a tape file named TEST.

### Light Pen

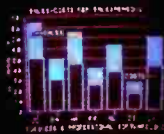
One of the most intriguing features of the MB-6890 is the light-pen interface, which is standard equipment (the pen itself, however, is an option). The pen is remarkably easy to use. Since the photodiode in its tip is mounted in a retractable switch, you can both locate the pen and trigger it by simply poking the tip against the screen. The pen is simple and sturdy; numerous falls from the desk top to the floor did not seem to damage it. This interface is supported in software by Level-3 BASIC, which offers a set of keywords for controlling the light pen (see table 3).

The keywords reflect the areas where light pens are most useful:

- Option selection from a menu. The computer displays a list of choices, each one next to a box, and you in-

# Screen Director

Screen Director™ retrieves and displays any standard image file on your Apple's video monitor, large screen TV or color printer. For only \$150, Screen Director™ gives you a filmmaker's finesse in boardroom presentations, management briefings and demonstrations for clients.



With Screen Director™ you can scroll forwards and backwards through any color displays, with dissolves or cuts from one image to the next — all at the touch of two buttons. You can even enhance your **Apple Business Graphics** with title slides in a variety of fonts and colors.

## Spice your Apple with cinema.

Screen Director™ includes both the two-button controller and all necessary software.

For information on dealers of Screen Director™ in your area, call (617) 491-3377.



**Business & Professional  
Software, Inc.**  
143 Binney Street  
Cambridge, MA 02142

Screen Director™ is a product of Business & Professional Software, Inc., creators of **Apple Business Graphics**.  
Apple is a trademark of Apple Computer, Inc.



ON PEN GOSUB *line number when pen in undefined area [,line number when in nth area...]*  
 —Branches to the *n*th subroutine when the light pen is pushed against the *n*th defined area

PEN *n*:*[(horizontal starting point,vertical starting point)–(horizontal end point,vertical end point)]*  
 —Defines rectangular areas for ON PEN command

PEN ON—Pushing pen causes an interrupt  
 OFF—Pen does not cause interrupt  
 STOP—Pushing pen does not generate interrupts, but the status is stored; the subroutine executes at the next PEN ON

PEN(*argument*)—a variable returning the following values for different values of the argument:

Argument	Value returned
0	TRUE when pen pressed
1	Horizontal position of pen when pen pressed
2	Vertical position of pen when pen pressed
3	TRUE while pen is being pressed, FALSE else
4	Current horizontal position as long as pen is pressed
5	Current vertical position as long as pen is pressed

Table 3: Hitachi MB-6890 light-pen commands.

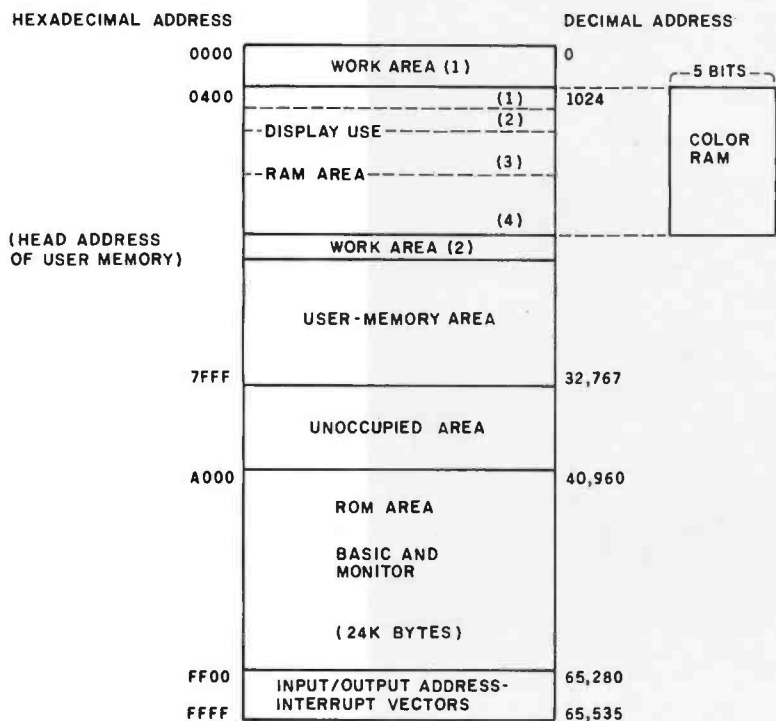


Figure 2: Memory map of the Hitachi MB-6890. This machine has an extra 5-bit-wide segment of memory that is addressed parallel to the segment of RAM that controls the video display. The extra 5 bits are used to specify the color of the corresponding pixel.

ing of the scanning beam, most light pens occasionally make mistakes. You trigger the pen *here* and the computer thinks that it was over *there*. In the Hitachi, the light pen seems particularly prone to wraparound errors. When you touch a point near the left-hand edge of the screen, the computer thinks you touched the right-hand side. But this is a problem that a clever programmer could largely circumvent by adding a verification step, such as letting a small blinking dot confirm the entry location before the computer accepts the data.

The Hitachi system displays another problem that results from the combination of a light pen with a color video display. The photodiode in the pen is not equally sensitive to all three primary additive colors. In fact, it is blind to red. This fact is not mentioned in the English-language version of the manual, but one of the demonstration programs supplied by the manufacturer shows that Hitachi is aware of the problem. In a routine in which you are supposed to select colors by pointing to the correct sample with the light pen, each color swatch has a white square in its center.

### Graphics Display

Hitachi has made an interesting trade-off between memory use and display resolution. As the memory map in figure 2 shows, some of the

dicare your choice by pointing to a box with the light pen. Done properly, this can make use of the keyboard unnecessary.

- Screen location. You indicate where something is to be done on the screen by pointing to it with the light pen—much simpler than fiddling with cursors and control keys.
- Drawing. Instead of entering com-

plicated shapes one point at a time, you just draw them on the screen using the light pen.

Nonetheless, light pens do have some inherent limitations, and the Hitachi unit is no exception. Since they work by detecting the image in the video raster on the screen and inferring the pen position from the tim-

# One of the great masters?

Although the Datasouth DS180 matrix printer may not exactly rate as a work of art, our customers have a *very* high opinion of its value. Over the past year, we have shipped thousands of DS180 printers to customers throughout the world. Many of our sales now come in the form of repeat business—a strong testimonial to the acceptance of a product.

The success of the DS180 in a very competitive market did not happen by accident; rather through our sensitivity to the needs of the industry. This sensitivity we carry through research and development, production and quality control and finally to after sales support and service.

Recently we introduced new enhancements to make the DS180 printer even more versatile. Dot addressable raster scan graphics produces output of computer generated charts, maps and graphs at a resolution of 75 x 72 dots per inch. Variable horizontal pitch selection allows printing at 10, 12 or 16.5 characters per inch plus double wide printing at 5, 6 or 8.25 characters per inch. The expanded 2K FIFO print buffer handles a full CRT screen dump at up to 9600 baud without delaying the host system. We also offer transparent mode for isolating communications problems, and for APL users, the dual ASCII/APL character set option.

Check our list of features and we think you will agree that the DS180 offers the most complete performance package in matrix printers.

#### DS180 PRINTER STANDARD FEATURES

- Microprocessor Control
- 180 CPS Print Speed
- Bidirectional Logic Seeking
- 100K Character Buffer (Expandable)
- 9x7 Dot Matrix
- Expanded Characters
- Adjustable Printhead, 1.6 Copies
- 96 ASCII Character Set
- Cartridge Ribbon
- 1.32 Column Print Width
- Tractor Feed (Front or Bottom)
- Non-Volatile Format Retention
- Top of Form
- Horizontal Tabs

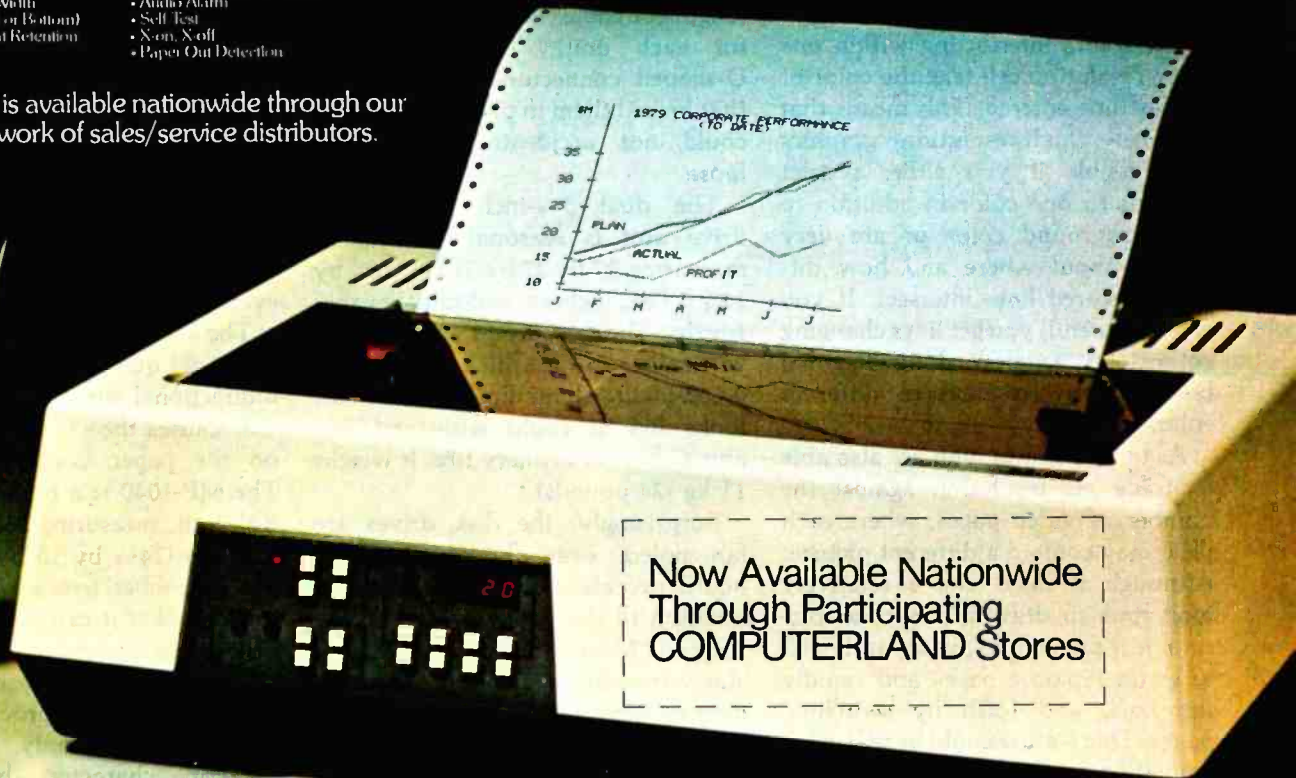
- Vertical Tabs
- Perforation Skip Over
- Auto Line Feed
- 6 S.L.P.
- Auto End of Line Carriage Return
- 5 IPS Paper Slows
- Parallel and Serial Interfaces
- 110 9600 Baud Communications
- Terminal Status Indicators
- Audio Alarm
- Self Test
- X-on, X-off
- Paper Out Detection

#### OPTIONAL FEATURES

- Compressed Print: 10, 12, 16.5 cpi
- High Resolution Dot Addressable Graphics
- 2K Expanded Print Buffer
- APL, ASCII Character Set



The DS180 is available nationwide through our network of sales/service distributors.



Now Available Nationwide  
Through Participating  
COMPUTERLAND Stores

Circle 132 on inquiry card.

**datasouth**  
**computer corporation**

P.O. Box 240947 • Charlotte, NC 28224 • 704/523-8500



		Normal		High-Resolution
Horizontal Characters	40	80	40	80
Graphics Resolution	80 by 100	160 by 100	320 by 200	640 by 200
Color Resolution	40 by 25	80 by 25	40 by 200	80 by 200
Memory	1K	2K	8K	16K
Required/Screen				
Character Mode Usable	40 by 25	80 by 25	40 by 25	80 by 25
Character Matrix		8 by 8 pixels		8 by 16 pixels
Maximum Pages	16	8	2	1
Memory Available to BASIC	29,546	28,522	22,378	14,186

**Table 4:** Hitachi display modes.

RAM is taken up by the display; how much depends on resolution. Apparently, a separate 5-bit-wide memory that controls color parallels the main memory. In the highest resolution mode, each pixel (picture element) of the 640- by 200-pixel screen can be turned on or off individually, but only one color in addition to the background color is available to pixels in a given color-resolution cell. Thus, lines of different colors intersecting within one color-resolution cell take the color of the last line entered. This means that extremely high-resolution graphics are possible if you either restrict yourself to one color in addition to the background color or are very careful about where and how different colored lines intersect. If you are not careful, you get lines changing colors and "jaggies" along diagonal borders between areas of different colors.

As table 4 shows, you are also able to trade off resolution against the number of video pages, where each page may contain a different picture. Although it may take a relatively long time to draw a particular picture, it is possible to put separate pictures on separate pages and rapidly flip back and forth by switching pages. This feature could be useful for animation, games, storytelling, or graph and chart presentation.

## Peripheral Devices

In addition to the display and light pen mentioned above, the system we evaluated included the Hitachi

MP-3540 dual floppy-disk drive and MP-1040 dot-matrix printer. The connectors were well marked and designed so that they could not be inserted backward. Thus, it is nearly impossible to assemble the system incorrectly. We put everything together in less than five minutes without even looking at the manual. Hitachi, unlike some of the other manufacturers discussed here, included generous lengths of cable (more than three feet for each unit). The sockets for D-shaped connectors had wire ears that locked them in place so that they could not accidentally be pulled loose.

The dual 5¼-inch floppy-disk-drive unit is reasonably compact, measuring 27 by 27 by 21 cm (10½ by 10½ by 8½ inches), and unbelievably sturdy. The two drives are mounted vertically in a thick (1.65-mm, 0.065-inch) aluminum chassis that looks like it could withstand any abuse short of artillery fire. It weighs 11 kg (24 pounds).

Surprisingly, the disk drives are fan-cooled, even though the keyboard/processor unit is not. And, in addition to the power switch on the back, a "Motor" button on the front starts the drives spinning, independent of whether the processor is trying to read or write a disk. This might be useful if you have trouble centering disks when you put them in. A disk mounted on a rotating spindle tends to center itself.

The doors to the drive units do take a bit of getting used to. Instead of flipping a latch, to open a door you

push the door in, and a spring pops it open. The springs are very firm, and you initially get the erroneous feeling that you are crunching the floppy disk.

The disks are soft-sectored and single-density, with 128 bytes per sector. With 16 sectors per track and 40 tracks per disk, each disk can store a total of about 80k bytes. The middle tracks on each disk are reserved for the directory.

The Disk BASIC supplied with the system supports both sequential and random-access files. Also, it has a command that permits you to write to a specific sector on a specific drive, irrespective of file status. (This could be a dangerous command; using it carelessly could wipe out files, or even the directory.)

The MP-1040 printer is remarkably quiet and quick, the latter due to the bidirectional motion of the print head that causes the characters to appear on the paper boustrophedonically. The MP-1040 is a bit wider than the disk unit, measuring 36.1 by 32.8 by 13.3 cm (14¼ by 13 by 5¼ inches), but its rubber feet are close enough together that it can sit on top of the disk drives if necessary. It can handle either fan-folded or rolled paper, either friction- or sprocket-feed, and can print not only Roman and katakana characters, but the more detailed hiragana characters as well. A rotary switch on the front panel allows the selection of 10 different form lengths, and push-button switches manually cause form and line feeds.

# DAYSTAR

## BRIGHTENS YOUR DATA.

You have the problem . . . We have the solution . . . The 5¼ Winchester Sub System. This new Day Star Sub System offers you reliability and versatility at a price you can afford. • 5¼-inch drives, with drives available in 4, 8, 12, or 16 megabytes. • Subsystems are available with 1 megabyte floppy backup. • This unit is available with or without case or power supply. • It interfaces to the S-100, TRS-80 Model II, TRS-80 Model III, Apple II, IBM Personal, Heath/Zenith 89, N.E.C., Xerox 820 and soon to many others.

- Intelligent controller using Z80B C.P.U.
- The 5¼ Winchester has an on board addressable data buffer.
- It features a D.M.A. (Direct Memory Access) when available.
- It gives you power fail data protect.
- The Winchester works with 115 or 230 VAC 50/60 C.P.S.
- You can go from Winchester to floppy communications without C.P.U. assistance.
- This small compact package unit gives you 625,000 (625K bytes) bytes per second data transfer.

Let Day Star brighten your data with their new 5¼ Winchester Sub System.



1198 E. Willow St. Signal Hill, CA 90806  
(213) 595-8571 Telex:(814)656-914 ETYBLGB

Circle 133 on inquiry card.





## Fujitsu FM-8

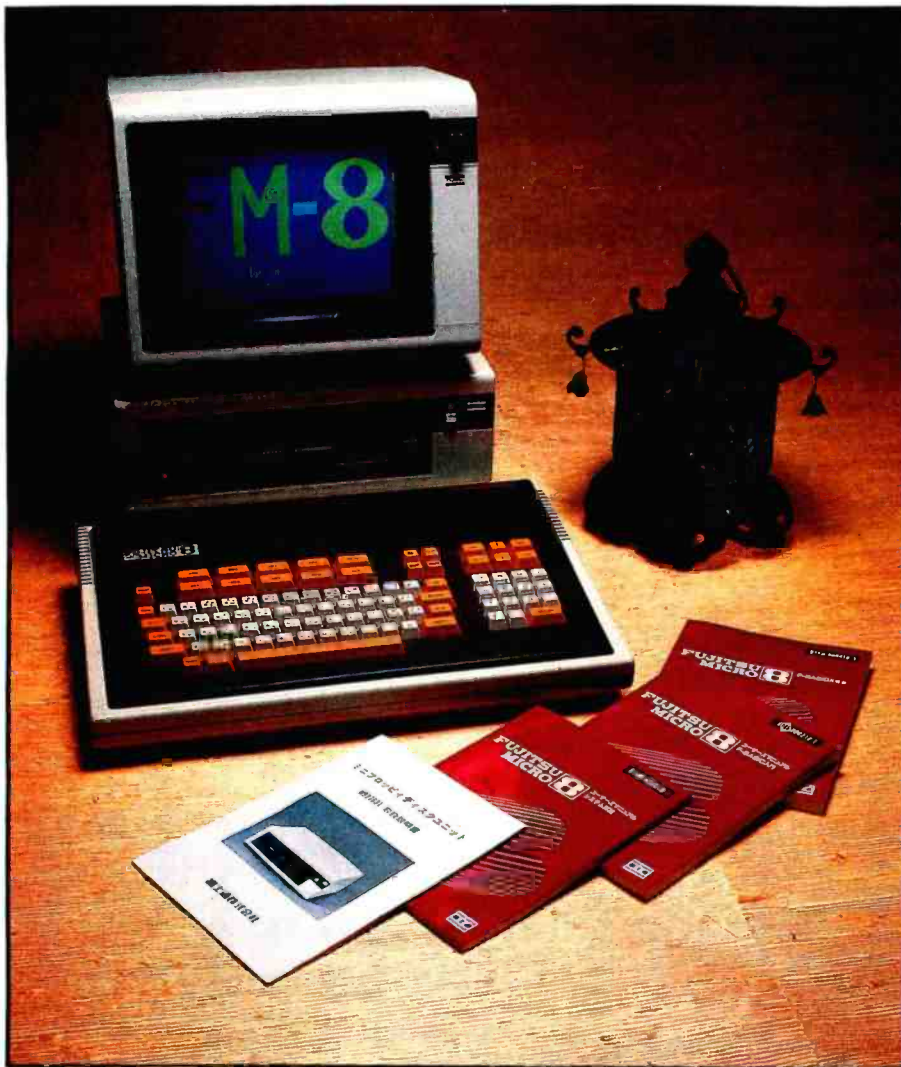


Photo 13: The Fujitsu FM-8 computer. Shown here are the keyboard/processor module, color monitor, and two disk drives, all connected together with lengthy cables for ease of rearrangement. Other optional hardware includes a printer, modem, joystick, and Z80-processor card.

were able to decipher most of the salient features of the machine and obtain a fairly good working knowledge of it.

### Hardware at First Look

The FM-8 computer system consists of three modules: keyboard/processor, 5¼-inch floppy-disk drives, and video monitor, as shown in photo 13. Unlike some of the other computers, however, they are connected with long cables that can be rearranged to fit available desk or wall space. A four-foot ribbon cable goes from the keyboard through a small interface box to the disk drives, and an even longer round cable with DIN connectors goes to the color video monitor.

### Keyboard and Controls

The keyboard has 95 keys in all, including most of the familiar ones encountered already (10 function keys, numeric keypad, editing keys). It does have a few unique features, however. Three of the keys, the CAP (uppercase lock) key, the katakana key, and the INS key, have adjacent red LEDs to indicate their status.

The INS key toggles the computer in and out of insert mode. When in insert mode, characters can be inserted in the middle of lines, and the line is automatically shifted over to accommodate the new characters.

Two other interesting keys are the EL (erase line) key and the DUP (duplicate) key. The EL key performs the standard erase-to-end-of-line function, which is useful but not often found on a keyboard. The DUP key causes the contents of the previous line to be duplicated into the current line being typed, up to the next tab stop. In other words, hitting the DUP key will enter as many as eight characters from the previous line into the current line. This is useful, for exam-

### Update

At press time, we learned from Fujitsu that the company does not plan to sell in America the version of the FM-8 reviewed here. Instead, there is a strong possibility that Fujitsu will introduce an American version of the unit some time in the near future.

With the Fujitsu FM-8 ("Fujitsu-Micro 8"), we were faced once again with the unenviable task of attempting to use a computer for which documentation is not yet available in an English version. (We first went through this when we obtained our original Japanese-version NEC PC-8001.) Fortunately, many technical terms in the manual are written in katakana or English. Therefore, we



## Turn your Apple into the world's most versatile personal computer.

**The SoftCard™ Solution.** SoftCard turns your Apple into two computers. A Z-80 and a 6502. By adding a Z-80 microprocessor and CP/M to your Apple, SoftCard turns your Apple into a CP/M based machine. That means you can access the single largest body of microcomputer software in existence. Two computers in one. And, the advantages of both.

**Plug and go.** The SoftCard system starts with a Z-80 based circuit card. Just plug it into any slot (except 0) of your Apple. No modifications required. SoftCard supports most of your Apple peripherals, and, in 6502-mode, your Apple is still your Apple.

**CP/M for your Apple.** You get CP/M on disk with the SoftCard package. It's a powerful and simple-to-use operating system. It supports more software than any other microcomputer operating system. And that's the key to the versatility of the SoftCard/Apple.

Circle 280 on inquiry card.

**BASIC included.** A powerful tool, BASIC-80 is included in the SoftCard package. Running under CP/M, ANSI Standard BASIC-80 is the most powerful microcomputer BASIC available. It includes extensive disk I/O statements, error trapping, integer variables, 16-digit precision, extensive EDIT commands and string functions, high and low-res Apple graphics, PRINT USING, CHAIN and COMMON, plus many additional commands. And, it's a BASIC you can compile with Microsoft's BASIC Compiler.

**More languages.** With SoftCard and CP/M, you can add Microsoft's ANSI Standard COBOL, and FORTRAN, or

Basic Compiler and Assembly Language Development System. All, more powerful tools for your Apple.

**Seeing is believing.** See the SoftCard in operation at your Microsoft or Apple dealer. We think you'll agree that the SoftCard turns your Apple into the world's most versatile personal computer.

**Complete information?** It's at your dealer's now. Or, we'll send it to you and include a dealer list. Write us. Call us. Or, circle the reader service card number below.

SoftCard is a trademark of Microsoft. Apple II and Apple II Plus are registered trademarks of Apple Computer. Z-80 is a registered trademark of Zilog, Inc. CP/M is a registered trademark of Digital Research, Inc.

# MICROSOFT

CONSUMER PRODUCTS

Microsoft Consumer Products, 10700 Northup Way,  
Bellevue, WA 98004 • (206) 828-8080



## At a Glance

### Name

Fujitsu FM-8

### American Representative

Fujitsu America Inc.  
2945 Oakmead Village Court  
Santa Clara, CA 95051  
(408) 727-4300

### Dimensions (Inches)

4¼ by 19 by 13¼

### Microprocessors

Two 8-bit 6809s, one 4-bit 8841

### Size of User Memory

64K bytes

### Number of Keys

95

### Number of Function Keys

10

### Standard Interfaces

Analog input; RS-232C; expansion port; monochrome video monitor; RGB color monitor; printer

### Optional Interfaces

Z80 processor card; disk drives

### Expansion Sockets

1 (for Z80 card); 1 for system bus

### Character Sets

Roman, katakana, graphics; optional: hiragana, Greek, Cyrillic, kanji

### Graphics/Color Resolution

640 by 200

### Number of Colors

8

### Other Features

Time-of-day clock; optional bubble memory

### Prices (Yen Equivalent in Dollars)

Y = \$3400 (entire system)  
Keyboard/processor Y = \$1035  
Color monitor Y = \$ 860  
Disk drive Y = \$1500  
Z80 expansion card Y = \$50

Two are 8-bit 6809s, one serving as the central processor with the other dedicated entirely to handling video-display functions. The third one, a 4-bit microprocessor (a Fujitsu 8841), handles keyboard scanning. This division of labor means that the main processor is somewhat less taxed than in single-processor designs. This shows up in speed. The FM-8 was the fastest of the six computers reviewed here in a BASIC benchmark test that will be described later.

The main bank of random-access read/write memory is composed of eight 64K-bit memory chips, yielding 64K bytes. An additional 48K bytes of memory store the high-resolution video bit map composed of twenty-four 16K-bit chips.

Also taking up a significant area on the printed-circuit board (in the lower left-hand corner) are 16 integrated-circuit sockets, visible in all their bright-blue glory in photo 14. These were empty in our unit, but are intended to hold up to 16 ROM (read-only memory) chips. These ROMs provide the FM-8 with an amazing capability—an extra character set of 8500 characters! Approximately 8000 of these are Chinese-derived kanji characters; the remaining 500 include complete alphabets (uppercase and lowercase) of Cyrillic (used for Slavic languages, including Russian), Greek, Roman, and hiragana characters, plus some special symbols. Due to the intricate detail of the kanji pictographs, the auxiliary characters are formed in a 16 by 16 dot matrix, and are thus roughly twice the size of the ordinary characters. This character set is accessed from BASIC with the PRINT (x,y),A statement, where A is the hexadecimal address in ROM of the character desired; a table in the user's manual gives addresses for all the characters. Presumably, you could make your own ROMs containing characters for Arabic, Hebrew, APL, or whatever you like!

And if three microprocessors aren't enough, an optional Z80 processor card is available. It appears that this card is required to drive the alternate-

ple, if you have two lines in a program such as:

```
100 A=C(I,J)+D(I,J)+4*E(I,J)
110 R=C(I,J)+D(I,J)+4*E(I,J)
```

Once you have typed line 100, you merely type "110 R=" and then hit the DUP key a few times to enter the rest of the line, which will be copied from the previous line.

The on/off switch for the computer is located under a hinged door in the upper right-hand corner of the keyboard. In our unit, there is nothing else under this door except a little niche that's just the right size for storing a bag of peanuts or a candy bar (to provide a little extra sustenance on those long nights of computing).

Fujitsu's engineers actually reserved this space to contain two optional bubble-memory-cartridge sockets. (We discuss bubble memory more in the review of the Bubcom80, coming up next.)

The back of the keyboard/processor unit contains jacks for several standard interfaces: floppy-disk

drives, serial RS-232C ports and parallel printer port, color video monitor, monochrome video monitor, and audio-cassette tape. A DIN jack labeled ANALOG IN provides at least two analog input ports that can be read from BASIC or assembly-language software. These ports can

## The Fujitsu FM-8's multiprocessor division of labor shows up in speed.

be used, for example, for connecting game paddles or a joystick. There is also a 10-position DIP switch for setting various default parameters such as data rate and parity format for the remote-terminal mode.

### Inspecting the Interior

Inside the keyboard/processor module, several surprises await you. First, it has three microprocessors!

# Extraordinary Microcomputer Systems For The Most Demanding Applications



## Columbia Data Products' Performance Pleases The Hardest-To-Pleasure.

### Intelligent Peripherals.

Columbia Data is a pioneer in intelligent RS-232 storage systems for data logging—and store and forward data communications applications. We offer a variety of data storage capacities, access speeds, and microprocessor intelligence in our tape cartridge and floppy disk storage systems—all with the convenience of RS-232 system compatibility.

### Commander Computers.

Our Commander Computers are integrated desktop systems for industrial, scientific, technical and educational applications. We provide the industry's largest I/O complement, including IEEE bus controllers, RS-232 and parallel interfaces, APU, CTC, 512 x 256 graphics display with dual Z-80A microprocessor architecture and a large selection of RAM, floppy disk and Winchester disk storage with CP/M® and MP/M® operating systems.

### Business Systems.

Columbia Business Systems offer high-performance multi-tasking, multi-user computing systems for distributed processing and data communications, with large shared storage and peripheral selections. Our Concept 1000 can support up to 16 user stations in a true CP/M® and MP/M® operating system environment. Our 1500/1800 Series can support up to five stations.

\*Trademark of Digital Research

**Home Office:**  
8980 Route 108  
Columbia MD 21045  
Telephone 301-992-3400  
TWX 710-862-1891

**West Coast:**  
3901 MacArthur Blvd  
Suite 211  
Newport Beach, CA 92860  
Telephone 714-752-5245  
Telex 692 310

**Europe:**  
P O Box 1118  
4050 Moenchengladbach 1  
West Germany  
Telephone 021-61-33159  
Telex 852 452

# COLUMBIA

## DATA PRODUCTS, INC.

Circle 81 on Inquiry card.





Photo 14: Inside the keyboard of the FM-8. Visible in the lower left are 16 ROM sockets for the alternate-character-set ROMS.

character ROMs, but it apparently can be used as a general-purpose processor as well, since CP/M and other Z80 software are available for the FM-8.

## BASIC Interpreter

Before we describe the software's capabilities, we want to praise whoever wrote the tutorial BASIC manual. Even though we could not read all of it (our edition is in Japanese), we were impressed by the simplicity and humor with which it teaches programming. (It is reminiscent of Roger Kaufman's *A FORTRAN Coloring Book*.) It is sprinkled liberally with good programming examples and amusing illustrations, like the one shown in figure 3, depicting the operation of various BASIC keywords. The other two manuals that come with the FM-8 (system-reference manual and BASIC-reference manual) also appear to be quite good (as far as we can tell).

The FM-8 dialect of BASIC (called FBASIC) is in many ways similar to some of the other BASICs reviewed here, supporting most of the same text, graphics, and I/O keywords as the others. It does have a few extra capabilities, however.

Of the graphics statements available, most notable is the CONNECT ( $x1,y1$ ),( $x2,y2$ ),...,( $xn,yn$ ) statement. This statement draws a connected line segment through the points indicated, and can be used, for example, to draw polygonal outlines. Since most of the computers reviewed here have a polygon-fill command (PAINT), it is surprising that the FM-8 is the only one with a single command to draw an empty polygon (on all the others, you must use LINE commands in a loop to draw the line segments of the polygon). With the CONNECT command, it takes only two program statements to draw a filled polygon—you CONNECT it, then PAINT it.

Another unique keyword is SYMBOL, which provides the FM-8 with the unique ability to write multiple-

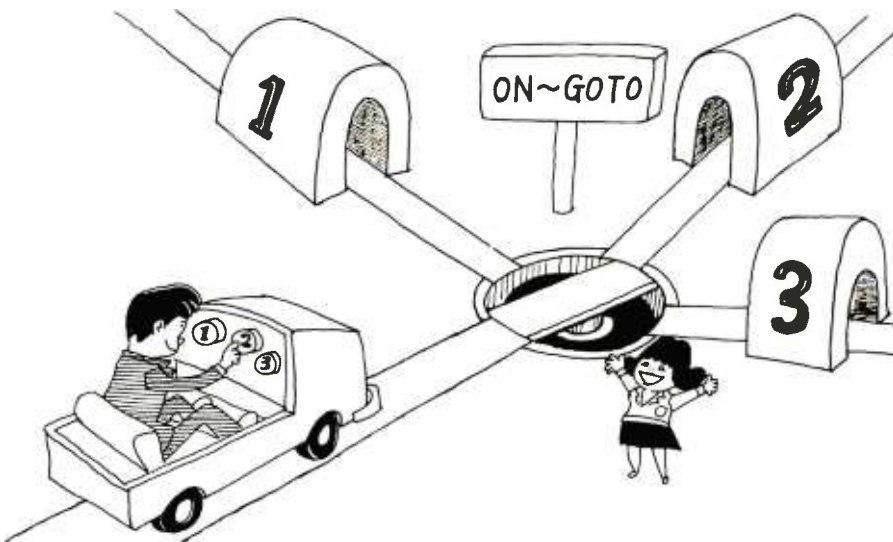


Figure 3: An excerpt from the Fujitsu FM-8 Japanese-language tutorial BASIC manual, illustrating the ON...GOTO statement. The manual contains many such elegant and humorous drawings that are used to teach programming in BASIC.



# II for Apple II

## VERSAbox

The only intelligent SPOOLER/BUFFER with an optional REAL TIME CLOCK interface/display. For use with all Centronics parallel and RS-232C INPUT/OUTPUT interfaces.

VERSAbox's high-speed input combined with up to 60K buffer (more with character compression) frees up your computer from the slow job of printing. Modems and other compatible devices can also be buffered. Multiple software-selectable outputs permit you to choose between two or more VERSAbox outputs or use them simultaneously. You can buffer multiple inputs simultaneously too.

Add the optional REAL TIME CLOCK to VERSAbox and you get a six digit LED numeric time display. Your computer can read the time via the RS-232C port. Another useful option is the SWITCHED 120V SOCKET that can turn external devices on and off by clock control.

VERSAbox is supplied in an attractive, compact 11" wide, 8" deep, 3" high cabinet. Interface cables are available from your dealer or Prometheus. SPECIAL OFFER for Apple II owners: Buy a VERSAbox this month and you will receive a free parallel interface and cable.

VERSAbox, standard model with Centronics parallel INPUT/OUTPUT only and 16K buffer ..... \$249.00

VERSAbox, with both Centronics parallel and RS-232C INPUT/OUTPUT and 16K buffer ..... \$299.00

REAL TIME CLOCK option with DISPLAY ..... add \$150.00

SWITCHED 120V OUTLET option ..... add \$50.00

Additional 16K BUFFER MEMORY KITS each ..... add \$50.00

## PLUS VERSAbox FOR EVERYBODY

### I. VERSAcards

Four cards on one for Apple II. (1) Serial Input/Output Interface, (2) Parallel Output Interface, (3) Precision Clock Calendar, and (4) BSR Control. All on one card with TRUE SIMULTANEOUS OPERATION.

Before you buy Mountain Computer CPS or any other multifunction card, ask these questions:

Can I use CP/M and Apple Pascal with NO disk modification?

Does it have interrupts?

Will I be able to read and set the year?

Does it have BSR control?

Can I use DB Master? Ascii Express? VISI Dex? Easy Writer? WORDSTAR? Z-TERM PRO? VISITERM? . . . other software packages?

If the answer is YES to all of the above, then you're talking about VERSAcards and ONLY VERSAcards. And, the list price has been reduced by \$50 to \$199.00

SPECIAL OFFER: Buy a VERSAcards and we'll sell you GRAFTRIX, a sophisticated screen dump graphics package, with \$25 off the regular list price of \$65 for only \$40.00.

### II. AUTO-DOC

An automatic diagnostics system for your Apple II computer. Get a complete check of your critical Apple hardware EVERY time you power-up

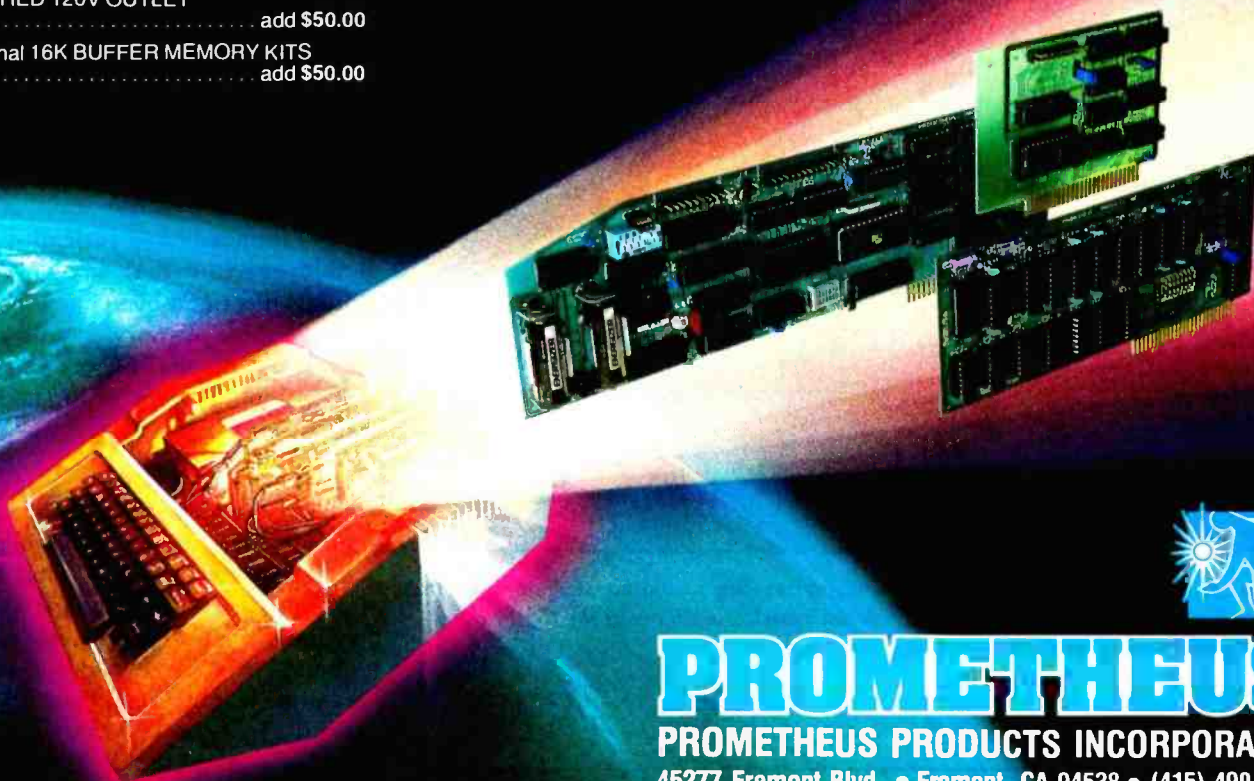
AUTO-DOC saves TIME, ENERGY, and MONEY by identifying problems in your Apple before they make themselves known by system failures. And, you don't have to remember to insert a disk. DOC automatically identifies system problems before you run your programs by doing extensive system diagnostics. If DOC finds a failure, it indicates the problem area and, in some cases, the specific chip or component that's responsible.

DOC includes a memory test, processor test, ROM test, and more. In addition, extensive disk based diagnostics are included for further testing and subsystem checks for many popular peripheral cards.

AUTO-DOC is simple and easy to install. And once installed, DOC will always be there working AUTOMATICALLY everytime you power-up.

Can you afford to be without AUTO-DOC?

AUTO-DOC List Price \$99.00



# PROMETHEUS

PROMETHEUS PRODUCTS INCORPORATED

45277 Fremont Blvd. • Fremont, CA 94538 • (415) 490-2370



size text. The syntax of the statement with all possible parameters is:

`SYMBOL (x,y),string,x-scale,  
y-scale,color,rotation`

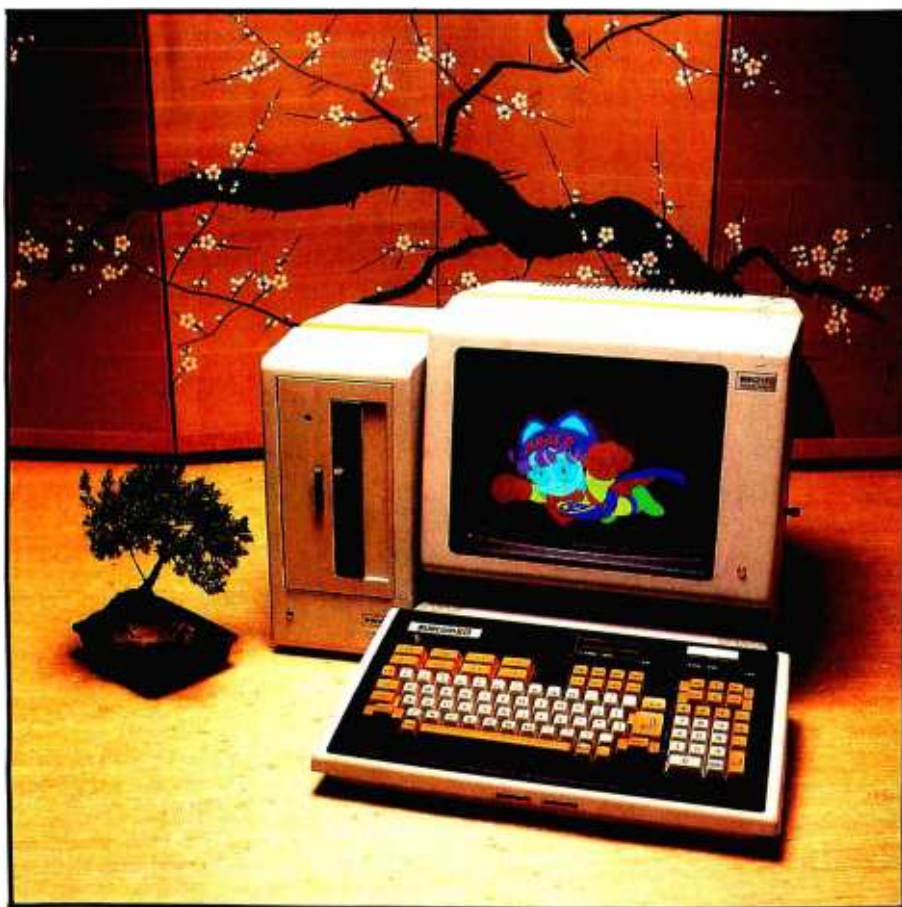
The *x*- and *y*-scale factors cause the characters printed to be scaled in size (independently in each axis, if desired) and rotated (by multiples of 90 degrees). This is very handy for labeling graphs, for example.

To assist in programming, FBASIC has a MERGE command, which allows the combining of two or more programs from disk into one large program. Another command bears the somewhat whimsical name of UNLIST. We still aren't sure exactly what this does. Issuing the command UNLIST 50, for example, causes the program currently in memory to become unlistable starting at line 50.

(It still runs normally, though.) Thus, it seems that the command might be similar to the SECURE command on the Canon CX-1. Unfortunately, there doesn't seem to be a way to undo an UNLIST.

Also quite useful is the ANPORT function, which reads an analog input port, does an 8-bit A/D conversion, and returns a value in a BASIC variable.

## Bubcom80



**Photo 15:** The Bubcom80's high-resolution monitor has a contour at the bottom that lets it fit snugly against the keyboard/processor enclosure. Slots in the top of the keyboard enclosure accept bubble-memory cartridges.

Bubble memories—are they the wave of the future or a vestigial remnant of a technological dead end? In the past year, three American manufacturers have pulled out of the bubble-memory business. On the other hand, several Japanese manufacturers are putting bubble memories into personal computers, either as standard equipment or as an option, in what may be either an attempt to stimulate a lackluster market or an anticipation of wonders to come.

A computer that offers bubble memory as a standard feature is the Bubcom80 (see photo 15), a Z80-based machine developed jointly by Fujitsu, one of the Japanese manufacturers of bubble memories, and Systems Formulate Corporation, a company founded by former Fujitsu employees with that company's encouragement and blessing.

But bubble memory is not the only attraction of the Bubcom80. Let's take a look at some of its other virtues first.

### Hardware

The main keyboard/processor module offers a remarkable collection of features for the price. It has all the features that are standard on the Japanese computers: separate numeric and editing keypads; user-programmable function keys; RS-232C serial interface; and Roman, katakana, and graphic input. It also



# you have one apple... now get a whole bushel

of apple additions

from

## Vista

COMPUTER  
COMPANY,  
INC.

Available through your  
local computer dealer.

### MODEL GB75<sup>®</sup> Typewriter Interface

Apple to IBM Electronic 50, 60, 75 Typewriters Interface ■ Reads IBM keyboard in parallel with Apple keyboard ■ Supports the IBM code functions using an escape sequence ■ Types at about 13 characters per second ■ Prints from Integer or Applesoft programs ■ Supports the "Control I Number N" parallel line length mode sequence ■ Has switch selectable upper/lower case I/O 60, 66, 78 continuous from feed page lengths, 40+video, 80, 95, 132 character line lengths

**Suggested price \$225.00**

### TIMECARD III<sup>®</sup>

Multi-function time utility for the APPLE III computer system. Contains the year of the century, the month, the date, the day of week, the hour, the minute, the second. ■ A countdown timer with a range of one millisecond to 999 hours, 59 minutes, 59 seconds, 999 milliseconds ■ Selectable 12 or 24 hour time formats ■ Diagnostic error reporting ■ Fully compatible with the APPLE SOS operating system

**Suggested price \$195.00**

### MODEL 150 TYPE AHEAD BUFFER

■ Up to 40 character type ahead capability ■ Enter commands or data while your Apple is processing previous instructions ■ Compatible with all Apple computers, keyboards and software ■ No cuts — no jumpers — no software patches required ■ Includes complete instructions for quick and easy installation

**Suggested price \$49.95**

### A800<sup>®</sup> FLOPPY DISK CONTROLLER

■ High speed DMA transfer of data (1 micro-second/byte) ■ Documentation provided — includes theory of operation, schematics and diskettes ■ Uses all standard Apple DOS commands (OPEN, CATALOG, LOCK, DELETE, LOAD, etc.) except for INIT which has been improved and enhanced in a Vista format routine ■ Compatible with Apple DOS 3.3, Pascal 1.1 and CP/M 2.2 (with the Z80 soft card by Microsoft) ■ 2K x 8 PROM contains Autoboot functions and all eight-inch

floppy driver code allowing complete compatibility with Apple DOS 3.3

**Suggested price \$595.00**

### PROM DEVELOPMENT SYSTEM<sup>®</sup>

■ Menu driven program development monitor ■ Programs 2708, 2716, 2532, 2732 and 48016 EPROMS ■ Simulates PROM from RAM 4K ■ Data and address interface for operator location and control ■ Complete user documentation

**Suggested price \$495.00**

### VISION 80

■ Full upper and lower case character with 3 dot descenders ■ 9x10 dot matrix per line U.S. (9x11 Europe) ■ 128 ASCII character set ■ BASIC, FORTRAN and Pascal languages supported ■ Z80™ and CP/M™ compatible ■ Compatible with all standard Apple™ peripherals

**Vista** COMPUTER  
COMPANY,  
INC.

©Copyright 1981 Vista Computer Company, Inc.  
™Apple Computer Company, Inc.

■ Shift and lock for upper and lower case ■ Source switches between 40x24 and 80x24 software and hardware ■ Rated #1 video card by Softalk and Call Apple

**Suggested price \$395.00**

### VISION 40

Softscreen programmable character/generator card for the Apple II computer ■ Allows use of DOS tool kit upper/lower case character sets in Apple 40 column mode ■ Permits creation of new alpha/numeric and graphic characters under Amatrix ■ Ideal for non-English language applications ■ Compatible with most popular word processing software packages

**Suggested price \$195.00**

### VISION 20

■ Cost effective ■ Compatible with the latest Apple II ■ Complete easy to follow installation guide ■ 120 day warranty ■ Immediate delivery

**Suggested price \$29.95**

1317 E. Edinger  
Santa Ana, CA 92705  
(714) 953-0523

™Digital Research, Inc.  
©Designed by Burtronix



## At a Glance

### Name

Bubcom80

### Distributor

Systems Formulate Corporation, U.S.A.  
231-E South Whisman Rd.  
Mountain View, CA 94041  
(415) 969-7499

### Dimensions (Inches)

3 $\frac{3}{8}$  by 17 $\frac{3}{8}$  by 12 $\frac{1}{4}$

### Microprocessor

Z80, 8-bit

### Size of User Memory

64K bytes

### Number of Keys

99

### Number of Function Keys

8 definable, 8 defined

### Standard Interfaces

RS-232C; audio-cassette tape;  
monochrome video monitor; RGB color  
monitor; printer; expansion bus; joysticks;  
two bubble-memory controllers

### Optional Interfaces

Floppy-disk drives; high-resolution graphics

### Expansion Sockets

1 (systems bus)

### Character Sets

Roman, katakana, user-definable graphics

### Graphics/Color Resolution

160 by 100 (standard); 640 by 200  
(optional)

### Number of Colors

8

### Other Features

Time-of-day clock with battery backup;  
speaker with music macroinstructions

### Prices

Keyboard/processor \$1550  
RGB color monitor \$1400 (with expansion  
box)  
Disk drive \$1275 (+ \$450 for interface  
board)

suspended from the keyboard backplane. Two of these are attached to sockets for the bubble-memory cartridges; the third contains circuitry that we assume scans the keyboard and/or operates the bubble memory. One of the mystery circuits on the board is an 88-pin monster with two rows of pins along each side of a square package.

## Software

The Bubcom80 can use nearly all 64K bytes of its memory-address space for read/write memory because, aside from its bootstrap loader, no ROMs for a BASIC interpreter or an operating system are taking up address space—you must boot the system by loading the operating system and interpreter into user memory either from bubble memory or from cassette tape or disk storage. This, of course, gives more software flexibility than the ROM BASICs—a sophisticated user who wants to run assembly-language programs or some language other than BASIC need not sacrifice address space to a BASIC interpreter.

The system we tested came with two versions of BASIC. The standard BASIC, which apparently does not support some of the high-resolution graphics features, left 29,710 bytes of memory free; the extended BASIC, which does support the high-resolution graphics, left 23,610 bytes of memory free. The system specifications indicate that the CP/M operating system will also be available for the Bubcom80, although we did not have a copy.

The extended BASIC (yet another Microsoft product) has several particularly useful keywords (see table 5).

The most notable one is MENU—a real boon to anyone who wants to write programs with menus for selecting options. It allows a program writer, with a single statement, to display a menu of labels anywhere on the screen. When the statement is executed, the labels are displayed on the screen and the cursor blinks on the bullet in front of the first menu item.

offers a set of eight keys for single-key entry of system commands (LABEL, FILES, INIT, STOP, CLS, EDIT, LIST, and RUN).

Connectors are included for both a light pen and joysticks. The numeric keypad, in addition to the 10 digits, includes a 000 key to facilitate the entry of large numbers. A loud-speaker can produce tones (with pitch manipulated by instructions written in a sort of sublanguage similar to the BMC's MML) to provide rudimentary music. And, of course, it has sockets for bubble-memory cartridges. One socket comes as standard equipment; the second is a \$175 option.

The keyboard enclosure is a little larger than the keyboard itself, measuring 44.5 by 10 by 30.5 cm (17 $\frac{1}{2}$  by 3 $\frac{3}{8}$  by 12 inches). Except for a sheet-metal bracket on the rear, which houses the power supply, the enclosure is all plastic. Apparently, its interior has been sprayed with conductive paint to provide electromagnetic shielding. If you push in two plastic tabs under the front edge of

the enclosure, you can tilt up the keyboard for access to the circuit board inside.

Space inside the case is understandably tight. The main printed-circuit board holds the Z80 microprocessor and associated circuitry, 64K bytes of main memory, the read/write mem-

## Bubble memory is not the only attraction of the Bubcom80.

ory for the user-definable graphic-character set, a counter-timer integrated circuit, various interface chips, and some rather large custom integrated circuits, whose function we are unsure of. A small area (about 2.5 by 7.5 cm, 1 by 3 inches) of largely unused plated-through holes in the board is something that an ambitious user might be able to use for patches or custom circuitry.

Three other circuit boards are

# Good Company for a Hard Disk

Hard disk usage is starting to boom. Computer owners are demanding instant output and more flexibility in order to take advantage of today's advanced computers.

Great Plains Software, in anticipation of these growing needs, created a comprehensive hard disk accounting/management system for progressive businesses who expect to grow.

Immediate response at your fingertips – a complete data base of every journal entry posted during fiscal year, CRT display of accounts payable, accounts receivable, customer and vendor records. Other features include budgeting, payroll, inventory, plus much more. Great Plains Software systems expand with your company. Built-in password keeps all information private and confidential. Documentation manual includes easy to follow step-by-step procedures. Screen display/manual cross reference simplify operation.

Great Plains Software is designed specifically for businesses requiring in-depth results today and anticipate a growth potential in the future.

Your computer store has the details on Great Plains' advanced hard disk software systems – or for personal service, call (701) 293-8483.

#### OVERALL

- Password privacy system standard
- Written in UCSD Pascal\*
- Hard disk oriented
- \*TM UC Regents

#### G/L

- All entries on line entire fiscal year
- Flexible format financial statements
- Comparative income statements

#### A/R

- Up to 9999 customers
- Profit by customer, customer type, salesman and state
- Open item or balance forward
- Instant screen inquiry
- Automatically posts to G/L

#### A/P

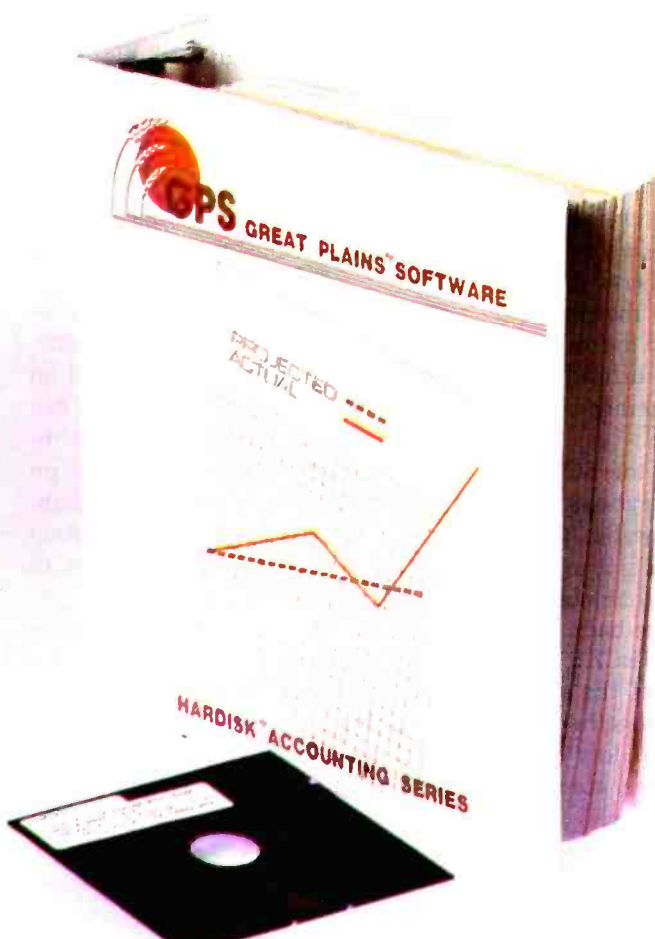
- Up to 9999 vendors
- Instant screen inquiry
- Automatically posts to G/L

#### PAYROLL

- Up to 9999 employees
- Up to 25 deductions per employee
- Withholding computed
- Prints W2, 941 & checks

#### INVENTORY

- FIFO, LIFO, standard cost, weighted moving average or serial number valuation
- 5 price levels per part
- Concise report including profit by part and line
- Point of sale "cash register" program included



*Advanced Software Systems  
for Today and Tomorrow*



**Great Plains Software**  
123 15th Street N., Fargo, N.D. 58102  
(701) 293-8483

Circle 187 on Inquiry card.



```
MENU(hor,vert)spacing "label1","label2"...GOTO Address1,Address2...
```

```
MENU(hor,vert)spacing "label1","label2"...GOSUB Address1,Address2...
```

—Displays a menu of labels, starting at (hor,vert), with number of lines between labels set by spacing parameter. Cursor flashes in front of first label; pushing space bar advances cursor to next line; typing RETURN causes a branch to appropriate address or subroutine.

```
OPTION BASE 0
OPTION BASE 1
```

—Specifies the starting value of array indices.

**Table 5:** Useful Bubcom BASIC statements.



**Photo 16:** The Bubcom color-console/expansion box has slots for four 30.5-cm (12-inch) circuit boards.

If you hit the oversized RETURN key, the program branches to the subroutine or address associated with the first label; if you hit the space bar, the cursor drops down to the next label on the menu. Hitting the space bar when the cursor is in front of the last item on the menu sends it back to the first item on the list.

The BC834 console color video display with expansion box, shown in photo 16, is a bit expensive, but it offers more than most displays. The 40.6- by 40- by 37.5-cm (16- by 15¾- by 14¾-inch) high-resolution color CRT (cathode-ray tube) sits directly above the expansion box, which connects to the system bus and contains slots for four 30.5-cm (12-inch) circuit boards.

The back of the console has something more computer manufacturers should provide: a switched set of four

AC power outlets. Thus, you need not hunt around for extension cords and spare outlets to handle your computer and all its peripheral devices. You plug one cord into the wall and plug everything else into the switched outlets. You can then turn all components on or off together with a single switch.

The bottom front of the BC834 is recessed so that the keyboard/processor module can nestle snugly under the screen. In fact, it *must* fit snugly; the flat cable that connects the expansion unit to the back of the keyboard is no more than 7.5 cm (3 inches) long. This makes the system very difficult to plug together; you need skinny fingers and lots of patience to place the edge connector correctly and push it home.

Both the high-resolution graphics board and the floppy-disk-controller

board go into the expansion box. While the connections to the floppy-disk board are straightforward, the connections to the graphics board are a little bit complicated—the graphics board plugs into the system bus in front and has two unmarked DIN connectors that poke out through holes in the back of the box. To install the board, you must run one cable from the back of the keyboard to the input DIN connector on one side of the graphics board and run another cable from the output DIN connector to the display input. A few labels on the connectors would be very helpful; as it is, you cannot connect the system correctly without consulting the diagram in the user's manual.

Without the high-resolution board, the processor's output can be connected directly to the display input. This mode of operation provides a graphics resolution of 160 by 100 pixels.

With the extra display memory on the high-resolution board, the resolution is 640 by 200 pixels, and the color of each pixel can be specified individually. The high-resolution display is organized as three separate conceptual planes, one each for red, blue, and green. When you clear the high-resolution screen, the three planes are erased sequentially, rather than simultaneously. The effect can be startling.

The main processor memory provides for a fourth character plane, which allows text to be displayed on top of the graphics plane; the text can be written, scrolled, or erased without disturbing the picture drawn on the graphics plane and underneath. Thus, you can list a graphics program on top of the display it creates to compare cause with effect.

Graphics keywords include PAINT, LINE, and CIRCLE, and a graphics macro language similar to that of the BMC is provided. Some of the graphics operations proceed slowly, particularly the PAINT routine. But the display is bright and luminous—figures drawn against a black background appear to float in space.

# New direct-connect MODEM Microboard.

**Auto-dial, auto-answer RCA MODEM Microboard adds data communications to your board-level computer system.**

You don't need a separate modem when you use the new CMOS Microboard MODEM with your board-level computer system.

Just plug it into the Microboard Universal Backplane, connect it to your phone line, and you're ready to transmit or receive data.

FCC-approved for direct connect to phone lines, the CDP18S653

provides auto-originate and auto-answer modes for unattended operation. Other features include:

- 300 baud FDX or 1200 baud HDX operation
- Touch-tone or pulse dialing
- Dial-tone and busy-tone detection for tandem dialing
- Busy-tone detection permits repeated dialing

**Ideal for any remote data acquisition applications.**

Because our MODEM Microboard offers you the CMOS benefits

of low power and  $-40^{\circ}\text{C}$  to  $+85^{\circ}\text{C}$  operation, it is the ideal solution for gathering data at remote locations.

And the MODEM is supported by our large and growing family of CMOS Microboard products and development systems.

So if you want to turn your phone into a data communications center, pick it up right now and call (800) 526-3862.

Or contact any RCA Solid State sales office, representative or distributor.

Circle 292 on Inquiry card.

RCA Solid State headquarters: Somerville, NJ. Brussels. Sao Paulo. Hong Kong.

**Just connect "Old Reliable's" MODEM Microboard to your phone line, and you're ready to transmit and receive data.**





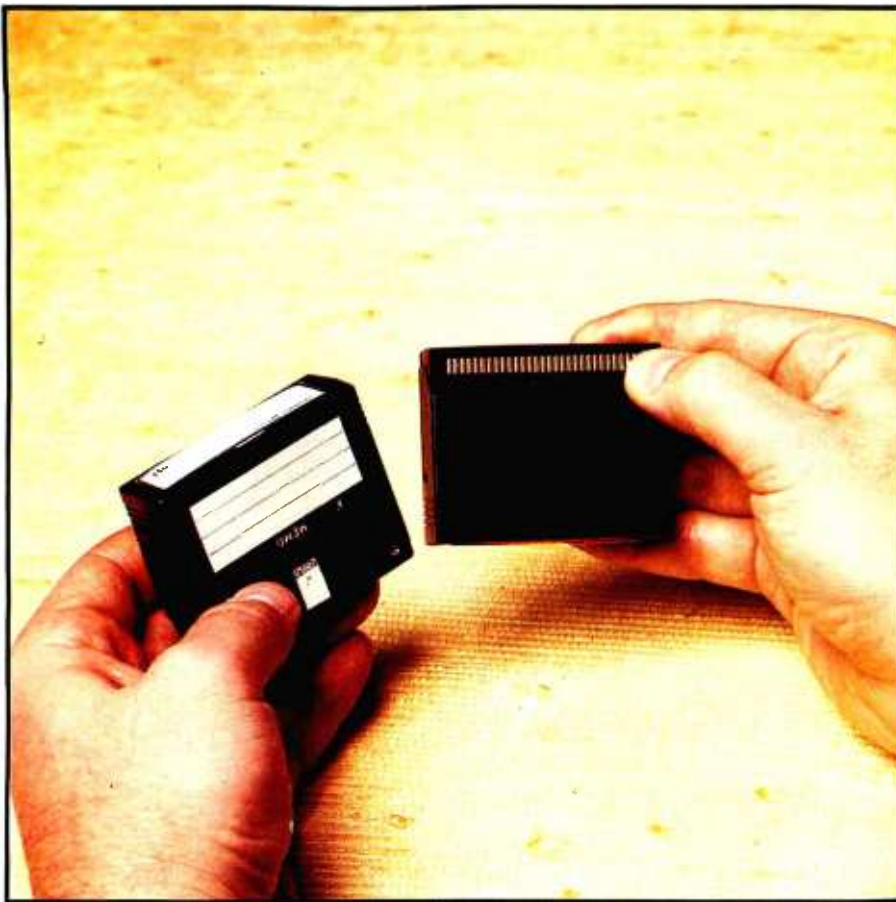


Photo 17: Each Bubcom bubble-memory cartridge holds 32K bytes. The white slide is a write-protect key.

## Floppy-Disk Storage

The Bubcom80's floppy-disk drive, unlike the others reviewed here, uses double-sided IBM-format soft-sectored 8-inch floppy disks. Each disk can hold a whopping 1.2 megabytes, and if one drive is not enough, up to three more can be daisy-chained to the first one. But in spite of its capability, the vertically mounted drive unit takes remarkably little space—it is only 18.4 cm wide, 36.8 cm high, and 40.6 cm deep (7¼ by 14½ by 16 inches).

Curiously, a battery-backed-up real-time clock is on the disk-controller board. (When we started the system, the Bubcom80, like the BMC, displayed the correct time, but it was set for the Tokyo time zone.)

## Bubble Memory

What about the bubble memories?

How do they work and what do they do?

The bubble-memory cartridges, shown in photo 17, are black plastic rectangular packages about the size of a small match box—6.0 by 4.5 by 2.0 cm (1.8 by 2.4 by 0.8 inches). On each one is a little white plastic slide switch that can be used to write-protect the data on the front of each cartridge; a black plastic window at the bottom front of the cartridge covers the metallic contacts on the bottom and slides out of the way when the cartridge is shoved into one of the sockets. You release the cartridge from its socket by pushing a lever on the side of the socket.

Inside each cartridge, circuitry creates magnetic domains—bubbles—and moves the patterns of bubbles along circular loops. The data cannot be accessed in a completely random

fashion, in the way that data in main user memory is. To reach bits at the far end of a loop, you must cycle the intervening data past the read element, just as you must pass over sectors 1 through 15 before you read sector 16 on a disk. But because there is virtually no inertia to overcome when moving the bubbles, the average access time needed to read or write a given set of data is much less for a bubble cartridge than for a disk. (For more information, see A. I. Halsema's article "Bubble Memories: A Short Tutorial," June 1979 *BYTE*, page 166.)

Since the bubbles remain intact in the medium when power is removed, bubble cartridges can be removed and stored just the way disks can. The bubble cartridges supplied with the Bubcom80 machine we evaluated each hold 32K bytes of data, but Fujitsu, the manufacturer of the cartridges, promises that 128K-byte cartridges will be available in a year.

From the user's viewpoint, the bubble cartridges act just like disks. The software pretends that the two bubble-memory controllers are disk drives 1 and 2; the disk drives are considered drives 3 through 6. All the BASIC commands for disks, *LOAD*, *SAVE*, *OPEN*, *CLOSE*, etc., work the same for the bubble memories.

Two LEDs, labeled *BUSY* and *READ ONLY*, tell you when the bubble memory is in operation and when you are trying to write to a cartridge that is write-protected. The most noticeable difference is the speed of operation. Because there are no motors to start and bring up to speed, and no heads to move, the bubble memories are much faster.

## Why Use Bubble Memory?

One disadvantage of the bubble cartridges is the price, currently \$175 for a 32K-byte bubble cartridge; standard BASIC in a bubble cartridge costs \$200, as opposed to \$25 on cassette tape and \$50 on an 8-inch floppy disk. Whether the prices come down substantially will undoubtedly depend on how widely used bubble memories become. On the other

# Your guide to the world of microprocessors.

## The Micro-Professor™ -A low cost tool for learning, teaching and prototyping.

Here in one attractive package and at a price of only \$149.00 is a Z80\* based microcomputer to lead you step by step to a thorough knowledge of the world of microprocessors.

The Micro-Professor is a complete hardware and software system whose extensive teaching

\* Z80 is a trademark of Zilog Inc.

manual gives you detailed schematics and examples of program code. A superb learning tool for students, hobbyists and microprocessor enthusiasts, as well as an excellent teaching aid for instructors of electrical engineering and computer science courses.

But the Micro-Professor is much more than a teaching device. With it you can do breadboarding and prototyping, designing your own custom hardware and software applications with Z80, 8080 and 8085 compatible code.

The standard 2K bytes of RAM is expandable to 4K, and the standard 2K bytes of ROM can be increased to 8K.

All this plus a built-in speaker, a cassette interface, and

sockets to accept optional CTC/PIO. Bus is extendable.

As well as being an exciting learning tool, the Micro-Professor is a great low-cost board for OEM's. Call for details.

### SSB-MPF Speech Synthesizer Board \$129

A vocabulary of up to 400 words based on the TMS 5200 chip.



### EPB-MPF EPROM Programming Board \$169

For all +5V 1KB/2KB/4KB EPROMs. Read/Copy/List/Verify Capability.



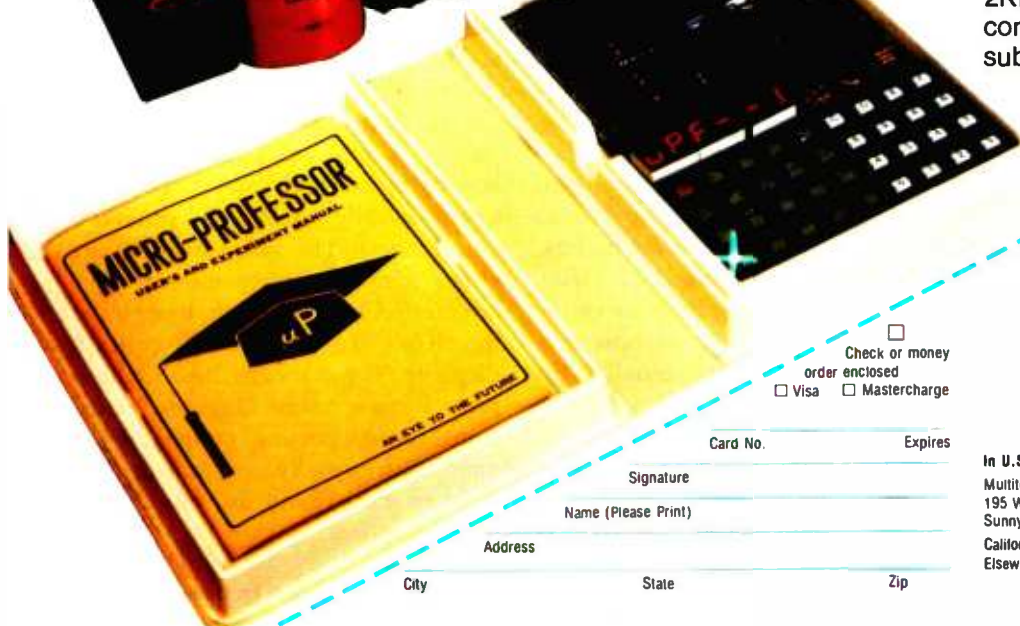
### BASIC-MPF Tiny Basic \$19

2KB BASIC interpreter with hardware control capability. Machine-code subroutine accessible.

Circle 296 on inquiry card.



Multitech Electronics Inc.



I'm ready to enter the world of microprocessing

Call toll free to order.

	Price	Qty.	Amount
MPF-1 Micro-Professor	\$149.00		
SSB-MPF Speech Synthesizer Board	\$129.00		
EPB-MPF EPROM Programming Board	\$169.00		
BASIC-MPF	\$ 19.00		
Shipping and Handling	\$ 4.95		4.95
California residents add sales tax			
<b>TOTAL</b>			

In U.S. and Canada mail to:  
Multitech Electronics Inc.  
195 West El Camino Real  
Sunnyvale, CA 94086  
California Tel. (408) 773-8400  
Elsewhere (800) 538-1542

Outside of North America mail to:  
Multitech Industrial Corporation  
977 Min Shen E Road, 105  
Taipei, Taiwan, ROC  
Tel. 02-769-1225  
TWX 19162 MULTIC.  
23756 MULTIC

Check or money order enclosed  
 Visa  Mastercharge

Card No. Expires

Signature

Name (Please Print)

Address

City State Zip



hand, the bubble-memory controllers are much cheaper than disk drives.

The greatest advantage of bubbles over disks is the shorter data-access time. Then, too, in certain environments—abrasive, dusty at-

mospheres, for example—bubble memories could be expected to be much more reliable than disks. Thus, certain applications exist even today where the bubbles might be preferred to disks. Whether bubble memories

will replace disks in more widespread applications depends on how quickly and how far their prices drop. Nevertheless, the Bubcom80 remains an interesting adventure into this new technology.

## Comparisons

Test	if800 (MBASIC)	if800 (Oki BASIC)	Canon	NEC	Bubcom	Fujitsu	Hitachi
1. FOR...NEXT	9.7	9.7	15.5	9.4	12.5	.9	2.8
2. 10 REMs	46.3	22.1	21.5	27.8	30.2	24.0	26.9
3. IF A>B	22.3	23.4	32.8	28.9	30.3	24.2	35.8
4. A+B	23.5	25.1	28.2	25.9	32.4	27.7	40.6
5. A*B	28.9	32.8	47.2	32.3	42.5	30.3	49.8
6. A/B	34.4	40.6	1:15.1	40.8	52.5	38.4	52.0
7. A!B	2:49.3	3:52.2	15:57.6	3:17.5	4:57.1	2:14.8	4:15.7
8. SIN(A)	1:26.0	1:50.0	5:55.2	1:43.0	2:23.5	1:15.3	2:11.1
9. LOG(A)	:32.3	:56.7	0:25.0	:30.	2:35.8	1:08.4	1:56.9
10. ON...GOTO	22.2	23.4	24.6	20.8	30.2	21.1	30.1
11. GOSUB	18.6	15.	7.5	15.	19.9	4.8	1.8
12. INT	23.3	25.0	24.8	25.3	32.4	25.8	35.9
13. MID\$	25.3	29.8	31.0	30.2	38.3	28.4	41.4
14. RND	29.6	33.5	2:04.0	31.7	43.5	26.4	43.8
15. CHR\$(X)	21.0	21.6	24.4	21.7	27.9	19.8	32.0
16. Sieve	2:44.5	2:56.7	2:35.3	2:44.5	3:48.9	3:10.0	4:51.8

**Table 6:** Results of the benchmark comparison of the six Japanese computer systems. The tests were run twice on the BMC if800, once with each BASIC interpreter. The simple operations in the left column were repeated 5000 times; the prime-number-finding sieve was the most complicated algorithm in the test.

This completes our individual summaries of the features of the six Japanese computers.

But what about performance comparisons, especially speed of program execution? How fast do they execute the same BASIC program? Since execution speed depends on many different things, such as the type of microprocessor, clock rate, and efficiency of the language implementation, it is not easy to predict how a system will perform in this respect.

To compare these six computers, we ran a comprehensive set of 16 benchmark programs. The results of these comparisons are shown in table 6. Each benchmark tests one feature of BASIC, typically using a program

to do 5000 iterations of a simple operation (such as  $C=A*B$ ). The only exception to this pattern is benchmark 16, which is a program to find all prime numbers less than 10,000 using a simple sieve algorithm.

Without attempting to draw too many conclusions from these data, we can safely say that the Fujitsu FM-8 is the fastest of the computers, followed closely by the BMC if800. This is not surprising because of the FM-8's multiprocessor architecture. The Canon CX-1 is usually the slowest of the six, except in a few cases where the Hitachi is slower.

Additional data for comparison can be found in the "At a Glance" boxes accompanying this article.

Data on the floppy-disk drives appears in table 7 on page 102.

### Conclusions

The Japanese penchant for high quality and flexibility is readily apparent in these computers. The keyboards are durable and have many keys (usually including programmable ones). The video displays are either green-phosphor monochrome or color RGB- (red, green, blue) input monitors for crisp 80-column displays. The standard BASIC interpreters have many language extensions for supporting peripheral devices and usually contain a few abilities not found in most computers.

# NOW- Fully Transparent Mass Storage Systems For Your Personal Computer.



The  
**graymatter**<sup>TM</sup> by **IQ**  
**systems**  
Brea, California

***Transparent Operation—Visible Results.***

The graymatter is available in 5, 10, 15 & 20 Mbyte storage systems;  
Contact Your Local Computer Dealer for more information.

**Distributed by:**



**Professional Integration** 2701 Saturn Street, Brea, CA 92821 (714) 524-5470



	BMC	Canon	Hitachi	NEC	Fujitsu	Bubcom
Drive size (inches)	5¼	5¼	5¼	5¼	5¼	8
Number of drives	2	2	2	2	2	1
Sides/disk	2	2	1	1	2	2
Tracks/side	?	?	39	34	39	76
Sectors/track	?	?	16	16	16	26
Bytes/sector	?	?	128	256	?	?
Total bytes per disk	280k	320k	81k	139k	328k	1.2M
Price per drive	not applicable		\$1354	\$1295	\$1500	\$1275
Price/interface card						\$450

Table 7: Comparison chart of the six units' floppy-disk systems. Some specifications were not known at the time of this writing.

Prices for these computers may seem a bit high, and they would seem higher still if we factored in import and export costs and a less favorable yen/dollar exchange rate. But you must remember that these prices include many capabilities (both hardware and software) that are not standard on most American computers. All these machines, for example, have user-definable function keys and full numeric keypads, in addition to the standard typewriter keyboard. Most of them have simple commands that allow them to serve double duty as a remote terminal for another computer. This should be considered when comparing these machines to other currently available personal computers.

The six computers have a 50/50 split between use of the 6809 and Z80 microprocessors. The Fujitsu FM-8 uses three microprocessors (two 6809s plus a 4-bit 8841). Thus, it has an inherent speed advantage over most of the others. Otherwise, neither the 6809 nor the Z80 machines have a clear-cut speed advantage.

While individual system modules are all well designed, at least some of the manufacturers have paid inadequate attention to how the components fit together. Cables are too short, connectors are difficult to insert and remove, and the systems will not readily fit onto a crowded desk top or laboratory bench. Not everyone wants the display directly behind and above the keyboard.

Because most of the BASIC interpreters (all except Canon's) were written by Microsoft, the versions of BASIC are very similar. It is nevertheless noteworthy that many keywords and features not found in most American machines are common to all Japanese computers. (An exception is the new IBM Personal Computer, which has a Microsoft BASIC system that resembles the ones in the Japanese machines.)

Although we have not really addressed the problem here, it is apparent that one major problem the Japanese manufacturers will have to address in penetrating the American market is documentation. Most Americans have experienced the atrociously translated instructions that come with many cheap Japanese toys and consumer goods, and they are likely to be very critical of instructions that are badly translated or confusing. Money allocated by the manufacturers for producing polished translations of software and hardware manuals would be well spent.

Will Japanese personal-computer manufacturers gain a significant portion of the market in North America? It's anybody's guess. Their prices may be slightly high, but they offer quality, along with a mix of features not found in domestically produced machines. And, as the automakers found, entrenched American competition may not be a significant impediment. ■



# LETTER-PERFECT PRINTER DOUBLES AS DATA CRUNCHER.



**Print two ways...correspondence quality and high speed data processing.  
Now priced under \$2000!**

The new T-1805 dual purpose serial printer uses a unique 40 x 18 matrix dot pattern for high quality correspondence printing; or, flip a switch, it uses a 7 x 9 matrix for high speed data processing printing. In the high speed mode, it generates reports at time-saving throughput rates reaching 200 lines per minute. In the reduced speed correspondence mode, its pivoting print head lays down overlapping dots to create a letter-perfect character that looks like it came from an office typewriter.

The T-1805 is the latest evolution in the popular and proven T-1000 series of serial printers. As such, the

T-1805 offers the same quality construction, high reliability, ease of operation and operator conveniences. Plus, for the benefit of the office crew, the T-1805 is exceptionally quiet. Its 53 dbA noise level ranks it as the quietest impact printer on the market.

There's much more to tell, so visit or call your Mannesmann Tally sales outlet today.

Mannesmann Tally, 8301 South 180th Street, Kent, WA 98031. Phone (206) 251-5524.

*Printers for the long run.*

**MANNESMANN  
TALLY** NCC HOUSTON  
JUNE 7-10  
BOOTH 6100





**TO BECOME THE LEADER  
IN TERMINALS, TELEVIDEO  
HAD TO GIVE YOU MORE.**

**WE'RE STILL GIVING YOU  
MORE WITH OUR NEW  
SMALL BUSINESS COMPUTERS.**



The new TS 802 business computer.

In three short years, TeleVideo became the number one independent supplier of CRT terminals in a very competitive marketplace.

We did it by designing and building terminals with more performance, reliability, features and functions than the competition.

But at a lower price.

Now TeleVideo has entered the even more competitive microcomputer marketplace. And we intend to repeat that success with the same basic philosophy:

By providing big system performance and features. And TeleSolutions — a hardware/software package that includes word processing and financial planning software programs.

For a price lower than many of the low performance personal computers.

## TELEVIDEO'S TS 802 AND TS 802H. THE COMPUTERS THAT GIVE YOU MORE.

The TS 802 is TeleVideo's lowest priced computer.

Yet it gives you many more of the important features found only in larger computers costing much more.

- Like modular design for easier maintenance.
- High speed Z80A microprocessor with 64K bytes of RAM main memory — enough memory to handle most business applications.

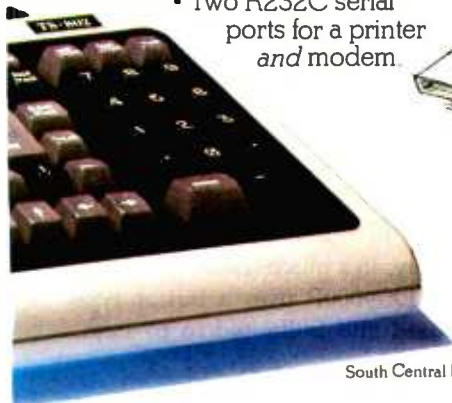
- The CP/M operating system, which is included at no additional cost to give you access to more microcomputer software programs than any other operating system.

- An upward growth path through a unique multiple processor, building block architecture.

- Dual 5¼ inch double density diskettes with a million bytes of unformatted storage capacity.

- A high resolution, non-glare video screen with detached keyboard — just two examples of our innovative, ergonomic computer design.

- Two R232C serial ports for a printer and modem.



- And a high speed port for plug-in expansion to a larger multi-user, multi-tasking TeleVideo computer system.

But suppose you need more storage. TeleVideo's next model up, the TS 802H, gives you all the same features of the TS 802. But instead of two floppy diskettes, it uses one floppy diskette and a 5¼ inch Winchester hard disk to give you 10 million bytes of unformatted storage capacity — 10 times the storage for only twice the price of the TS 802.

## COMPUTERS THAT GROW AS YOUR NEEDS GROW.

The TS 802 and TS 802H are more than just single-user, stand alone computers.

When it's time to expand, simply plug them into TeleVideo's more powerful TS 806 or TS 816 multi-user, multi-tasking systems. The TS 802s then become intelligent, fast response satellite stations.

And because each has its own CPU, there's none of the degradation of throughput and contention for a single CPU that slows down the typical shared system. Each user maintains full processing capability in a shared file environment.

With TeleVideo, there's no obsolescence. Because of the unique multi-CPU architecture and TeleVideo's multi-tasking software, the TS 802s do not have to be replaced as your data processing needs grow.

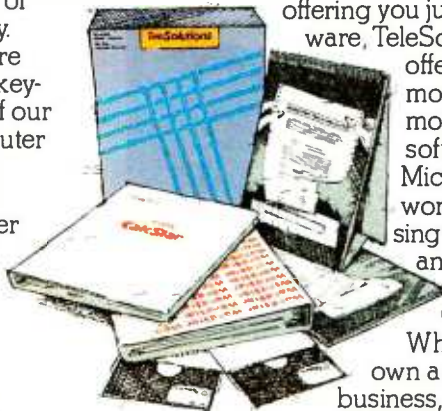
## TELESOLUTIONS™ THE SOFTWARE PACKAGE THAT GIVES YOU MORE.

Instead of offering you just a business microcomputer, TeleVideo is offering a computer and software package called TeleSolutions. And instead of

offering you just any software, TeleSolutions

offers you the most popular, most versatile software: MicroPro's® word processing WordStar™ and business planning CalcStar™.

Whether you own a small business, manage a department in a company, or are your organization's DP manager, the combination of TeleVideo com-



puters with WordStar and CalcStar gives you the quality text editing and financial planning help you'll need. If you do require more software, our CP/M operating system allows you to choose from the widest variety of microprocessor software.

When you buy either the TS 802 at \$3,495\* or TS 802H at \$6,995,\* TeleVideo includes WordStar and CalcStar for a special price of \$500 — a savings of nearly \$300.

## WORLDWIDE SERVICE.

TeleVideo's small business computers are serviced by a professional nationwide service network, and distributors in the U.S. and in 27 countries abroad.

## THE BETTER BUSINESS SOLUTION? PROVE IT TO YOURSELF.

Before you begin evaluating business computers make a list of what you'd like one to do for you. Then bring that list to one of TeleVideo's computer dealers throughout the world. Sit down at a TeleVideo® computer. Study the TeleSolutions Package. Even try another computer. Compare the features, the functions, and the performance.

And compare the price.

We don't think you'll find a better business solution than TeleVideo and TeleSolutions.

For more information call toll free 800-538-1780.



TeleVideo Systems, Inc.  
Dept. #610A  
1170 Morse Avenue  
Sunnyvale, CA 94086

Please send details on TeleVideo computers and TeleSolutions to:

NAME \_\_\_\_\_  
TITLE \_\_\_\_\_  
COMPANY \_\_\_\_\_  
ADDRESS \_\_\_\_\_  
CITY \_\_\_\_\_  
STATE \_\_\_\_\_ ZIP \_\_\_\_\_  
PHONE # (\_\_\_\_\_) \_\_\_\_\_

TeleSolutions™ is a trademark of TeleVideo Systems, Inc. WordStar™ and CalcStar™ are trademarks of MicroPro International Corporation.

CP/M is a registered trademark of Digital Research Inc. \*Prices are suggested retail excluding applicable state and local taxes — Continental U.S.A., Alaska and Hawaii

Circle 410 on Inquiry card.

Northeast Region 617/369-9370, Eastern Region 212/308-0705, Southeast Region 404/447-1231, Midwest Region 312/969-0112, South Central Region 214/258-6776, Northwest Region 408/745-7760, Southwest Region 714/978-6038, European Sales (Holland) 31-075-28-7461



## Japan Update

*The semiannual Consumer Electronics Show is on its way to becoming a showcase for new computer products.*

---

Mark Haas  
Managing Editor

---

The Japanese, formidable competitors in many U.S. and foreign markets, are making great headway into our domestic microcomputer industry. While a large percentage of components of American-made microcomputers are made in Japan, few microcomputers up until now were actually manufactured by

Japanese companies in Japan. This situation is rapidly changing, however. At the Consumer Electronics Show, held in Las Vegas in January, I previewed several new Japanese entries into the United States market by Casio, NEC, and Toshiba. Some companies were featuring soon-to-be-available machines; others were

just offering a taste of what they'll be showing at next month's National Computer Conference in Houston. (For an extensive report on what the Japanese are up to see "Six Personal Computers from Japan" by Christopher P. Kocher and Michael Keith, page 60, in this issue.)

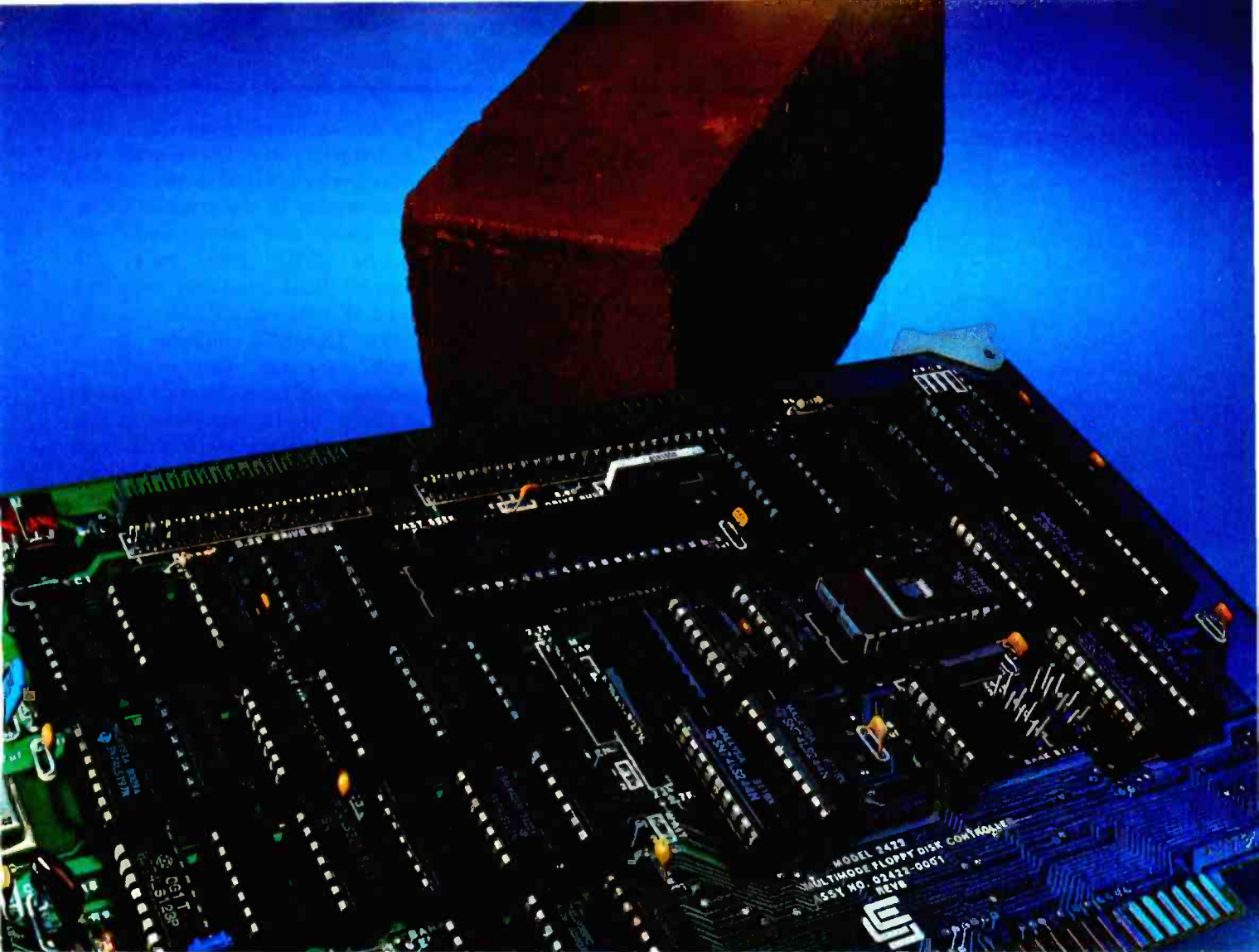
### Casio's FX-9000P

Casio has finally released its FX-9000P personal computer (see photo 1) which is based on a Z80 look-alike microprocessor. Running at 2.75 MHz, Casio's proprietary processor is in a rather unique environment. Casio partitioned the user-memory area (32K bytes maximum) into 10 sections. The philosophy behind this decision is related to the way memory is physically added to the machine: in 4K-byte CMOS (complementary metal-oxide semiconductor) RAM (random-access read/write memory) packs with three-year battery backup. You can write programs to a RAM pack and interchange packs for different applications. While this may sound like a useful way of storing programs, keep in mind that each 4K-byte RAM pack costs \$189. Compare this to the Bubcom80's \$175 bubble-memory cartridges, each capable of holding 32K-bytes indefinitely, in a much smaller package.

The FX-9000P uses a button-type keyboard and is limited to 67 keys.



**Photo 1:** Casio's FX-9000P personal computer was finally introduced at the January Consumer Electronics Show. Using a Z80 look-alike, the basic unit comes with 12K bytes of ROM and one 4K-byte CMOS RAM pack with battery backup. RAM is expandable to 32K bytes, and a 16K-byte dynamic RAM pack is also available. The button-type keyboard contains only 67 keys but allows one-key access to many scientific and statistical functions. The printer is manufactured by Epson.



# SYSTEM BUILDERS: THINK SOLID. THINK PRICE. THINK CCS.

Each month, CCS produces, tests, and ships over 3,000 board-level building blocks. About ten come back for repair. And we're working on that.

**Built like a commodity. Priced like a commodity.**

Volume means we keep our prices down. Low prices and reliability mean our customers keep coming back for more.

**High performance that works.**

You get all the performance that most systems want. Benchmarks prove it. You get the reliability and low price that all systems need.

**S-100 in quantity.**

Whether you want to add capability to an existing S-100 system, or build a system from scratch, chances are you'll find a solution in the CCS product line.

**Call or write for the CCS S-100 product catalogue.**

- 16K STATIC RAM
- 32K STATIC RAM
- 64K DYNAMIC RAM
- SERIAL I/O
- PARALLEL I/O
- FLOPPY DISK CONTROLLER
- HARD DISK CONTROLLER
- Z80<sup>®</sup> CPU
- PROTOTYPING BOARDS
- MOTHER BOARDS
- MAINFRAME / POWER SUPPLY

Z80 is a registered trademark of Zilog Corporation.



*The computer you  
can build a business  
around.*

**California Computer Systems, Inc.**

250 Caribbean Drive Sunnyvale, CA 94086  
408 734 5811 Telex 171959 CCS SUVL

Circle 65 on inquiry card.





**Photo 2:** NEC's PC-6000 computer system was introduced recently in Japan and may be brought to this country soon. Shown here is the PC-6001 computer, the Touch Panel graphics tablet, and the data-cassette recorder. The keyboard on the unit shown is of the button type and allows use of an overlay, but NEC is contemplating the use of a keyboard similar to the one used on the PC-8001 before the PC-6001 is introduced into this country. The Touch Panel, expected to sell here for less than \$200, would mark a breakthrough in low-cost graphic input devices.



**Photo 3:** A close-up view of the PC-6001 as shown at NEC's suite at the Riviera Hotel in Las Vegas. Though the keyboard is of the button type, the feel was very good and not at all toy-like. The gray area surrounding the keyboard is a removable overlay which is very useful in applications where it is necessary to redefine the keyboard. ROM packs can be inserted in the right side of the case, and the speaker opening is visible at the upper left-hand corner of the case. Both the style and layout of the keyboard may change before introduction of the PC-6001 into this country.

The display provides only 16 lines of 32 characters in the text mode but offers 256 by 128 dots on the 5½-inch video display in the graphics mode. The basic unit comes with one 4K-byte CMOS RAM pack, 12K bytes of ROM (read-only memory), and a 4K-byte video RAM.

The FX-9000P includes in its BASIC language many engineering and statistical functions and boasts an accuracy of 12 significant digits. Trigonometric and hyperbolic functions, as well as standard-deviation and correlation-coefficient functions, are built in and can be accessed with single keystrokes. Powerful graphics commands let you easily plot points, lines, curves, and quadrangles, which are useful for a graphics representation of business and scientific data.

Two option boards provide expansion capabilities. The OP-1 (\$379) attaches to the lower rear of the main-frame and contains a cassette-tape interface, clock, alarm, and calendar logic with battery backup, a character printer interface, and a graphics printer interface. Casio designed the graphics printer interface to connect with the Epson MX-82 (an enhanced version of the MX-80 which costs \$1295) and the character printer interface for a yet-to-be-released exclusive character printer. The cassette interface operates at 300 bits per second (bps).

The OP-2, when released, will enable the FX-9000P to access two single-sided, double-density disk drives and will contain the disk operating system (DOS). The system includes an RS-232C interface.

Prices for the FX-9000P start at \$1199. The 4K-byte CMOS RAM packs are \$189, and a 16K-byte dynamic RAM pack is available for \$129.

## NEC to Introduce the PC-6000?

NEC displayed its PC-8000 computer system publicly at the show, but in its hotel suite, I had a private viewing of the PC-6000 system (see photo 2). Recently introduced in Japan, the PC-6001 is obviously aimed directly at Radio Shack's Color

Computer and Commodore's VIC-20 markets. It contains NEC's version of the Z80 microprocessor, 16K bytes of ROM containing a subset of the BASIC found in the PC-8001, and 16K bytes of RAM expandable to 48K bytes. Made to connect to a color television, the display provides 25 lines of 32 characters and is capable of producing multicolored graphics. You can insert a ROM pack in the right side of the unit (see photo 3), and two Atari-type (nonresistive) joystick inputs allow connection of joysticks or other devices. The system includes RS-232C and Centronics ports and can synthesize music.

The keyboard on the unit I tried was of the button type, similar to the Color Computer's but with a much better feel to it. For applications that redefine the keyboard, you can use a keyboard overlay. Before the PC-6001 is introduced in this country, NEC may change its keyboard to resemble more closely that found on the PC-8001, although with that design you couldn't use the keyboard overlay. NEC still hasn't finalized the exact keyboard layout. The PC-6001 could be expected to sell here for well under \$500.

Of equal significance was NEC's new graphics tablet. Expected to sell for less than \$200, the graphics tablet connects to both joystick inputs, using 6 of the 8 bits of input provided. With the pressure-sensitive surface, you can use practically any writing instrument to trace existing artwork such as maps, or you can create new art directly on the tablet. I also viewed NEC's data-cassette recorder for program and data storage.

### Toshiba Enters Personal Computer Market

Toshiba commanded a lot of attention at the show with the preview of its new T100. Part of the same family as the T200 and T250, the T100 provides a 64K-byte Z80-based computer for less than \$1000. In addition to the 64K bytes of user memory, the T100 (see photo 4) contains 32K bytes of ROM and a 16K-byte video RAM.



**Rent the capability to develop a microcomputer-based product, evaluate Ethernet, or manage a network!**

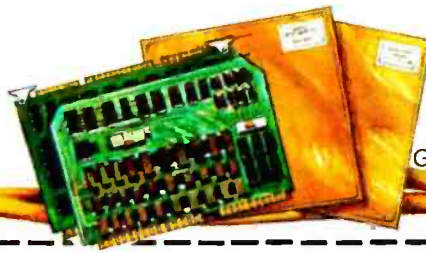
### Off-the-shelf. For 30 days.

Don't mortgage the farm . . . rent all the Intel microcomputer development system power and capability you need off-the-shelf from Genstar REI now. Immediately available for short-term rental (at attractive prices) are virtually every Intellec system and accessory from Intel — including a Network Manager plus a system for evaluating the office of the future, Ethernet; the new Intellec High-Level Language Debugger for all 8086 and 8088 software (P-Scope); and the newest high-performance peripherals — and much, much more. So develop a lot, and save a bundle. Rent from Genstar REI today.

**GENSTAR**

**Rental Electronics, Inc.**  
**(800) 227-8409**

In California (213) 993-7368, (415) 968-8845 or (714) 879-0561



GSA Contract #GS-04S-23560

**I'd like to save money . . . send info by return mail! B582**

- It sounds great. Tell me more! Call me at \_\_\_\_\_  I'm particularly interested in the following equipment: \_\_\_\_\_
- Send me your new Rental Catalog. \_\_\_\_\_
- I'd like a copy of your "like new" equipment for sale catalog, too. \_\_\_\_\_

NAME \_\_\_\_\_ TITLE \_\_\_\_\_

ORGANIZATION \_\_\_\_\_

ADDRESS \_\_\_\_\_ MAIL STOP \_\_\_\_\_

CITY/STATE/ZIP \_\_\_\_\_

TELEPHONE \_\_\_\_\_

Please complete coupon and mail to: Genstar Rental Electronics, Inc., 19525 Business Center Drive, Northridge, CA 91324 © Genstar Rental Electronics, Inc. 1982





**Photo 4:** Toshiba surprised everyone when it previewed the T100 at the show. Shown here with the optional flat liquid-crystal display, the T100 is Z80-based and contains 64K bytes of user memory, 32K bytes of ROM, 16K bytes of video RAM, and provision for 32K-byte RAM and ROM packs. Toshiba will be offering Wordstar, dBase II, and all of the Structured Systems Group software, as well as CP/M, when the unit is officially introduced at next month's National Computer Conference in Houston.



**Photo 5:** The dual 5 1/4-inch floppy disk drive being offered by Toshiba for the T100 is housed in a sturdy steel case containing its own power supply. Each drive is capable of storing 280K bytes, and the basic T100 can support four drives.

The ROM contains Microsoft BASIC, called T-BASIC, and CP/M is available. At the top right-hand corner of the unit, you can insert ROM and nonvolatile CMOS RAM packs with battery backup. Each pack can hold up to 32K bytes.

The T100 has a 90-key keyboard and displays 80 characters by 25 or 20 lines when used with a conventional monitor, or 36 characters by 24 or 19 lines when used with a regular television. Letters are formed in an 8 by 8 dot matrix. The color display can produce black, blue, purple, red, green, light blue, yellow, and white. You can display graphics in two modes: 640 by 200 dots and 160 by 100 dots.

One thing that caught everyone's eye was the optional flat liquid-crystal display, (see photo 4). The LCD pivot mounts on the back of the unit and displays 4 or 6 lines of 40 characters. It is also capable of providing a 320 by 64 dot matrix, which is dot addressable.

The T100 can accommodate up to four disk drives without resorting to use of the expansion unit (which will support four more drives). Two 5 1/4-inch drives, each capable of storing 280K bytes on a 5 1/4-inch floppy

disk, are housed in a sturdy metal enclosure (see photo 5) which also contains a power supply.

The T300, an 8088-based unit operating under MP/M and supporting from one to four users, was not on display at the show but is scheduled to be at the National Computer Conference in June. Toshiba

---

**The T100's optional, flat liquid-crystal display caught everyone's eye. It can display 4 or 6 lines of 40 characters.**

---

will sell the basic T300 for \$1500 and a full-blown four-user system, employing a hard disk, for up to \$20,000.

### Rumors

Reliable sources indicate that NEC is about to introduce an 8086-based all-in-one computer that will employ Digital Research's CP/M-86. Although it's still unofficial, I wouldn't be surprised if NEC were to preview the unit at one of the na-

tional computer conferences in late spring or early summer. NEC in the past has used a similar approach of previewing its computers such as its PC-8000 system before officially announcing them as viable products on the U.S. market.

Hitachi is planning to introduce a 16-bit computer by year's end. Now being completed in Yokohama, the design will most likely include a 68000 microprocessor operating under the new CP/M-65K. Digital Research is developing this new version of its ubiquitous operating system for release in June. Hitachi considered incorporating the 8086 in its new machine, but the availability of CP/M for the 68000 assures Hitachi of a broad base of software.

### More to Come

This by no means covers the range of computer products we can expect to see from Japanese manufacturers this year. Phil Lemmons's article "The Machines Behind the Machines" on page 114 in this issue will bring you up to date on who will be the driving forces behind these new products. The Japanese have been carefully studying the U.S. market and are clearly ready to step right in. ■



# We don't make a Winchester for just anybody.

We're Corona Data Systems and we've made Starfire, a Winchester disk just for Apple II\*.

### What's in it for you?

5 million characters of storage. And that's not all. You'll get Corona's Disk Partitioning which allows for up to 16 separate operating systems such as Apple DOS, CP/M\* and Pascal, all sharing the same disk. Of course, you'll still be able to use DB Master\* and protected software like VisiCalc\*.

### Double Size Volumes.

And with our Double Size Volumes, your Apple DOS is transformed into something special that offers larger data files. And you'll never have to type commands like "catalog"

and "run" or type program names again. You can even forget what volumes the programs are in.

### Reliability.

But you'll never forget Starfire's reliability. That's because we built DataGuard\*, the feature that will correct errors, not just report them. And we also provide a one-year warranty that you can count on. That's reliability.

So why take chances? With Starfire, you're not just adding a hard disk to an Apple II, but transforming an Apple II into a full hard disk business computer.



21541 Nordhoff Street, Unit B Chatsworth, California, 91311 (213) 998-0505

Circle 121 on inquiry card.

## Starfire – the Winchester disk made just for Apple II.

\*Starfire and DataGuard are trademarks of Corona Data Systems

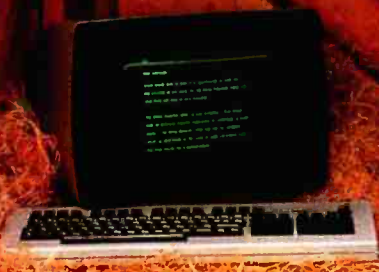
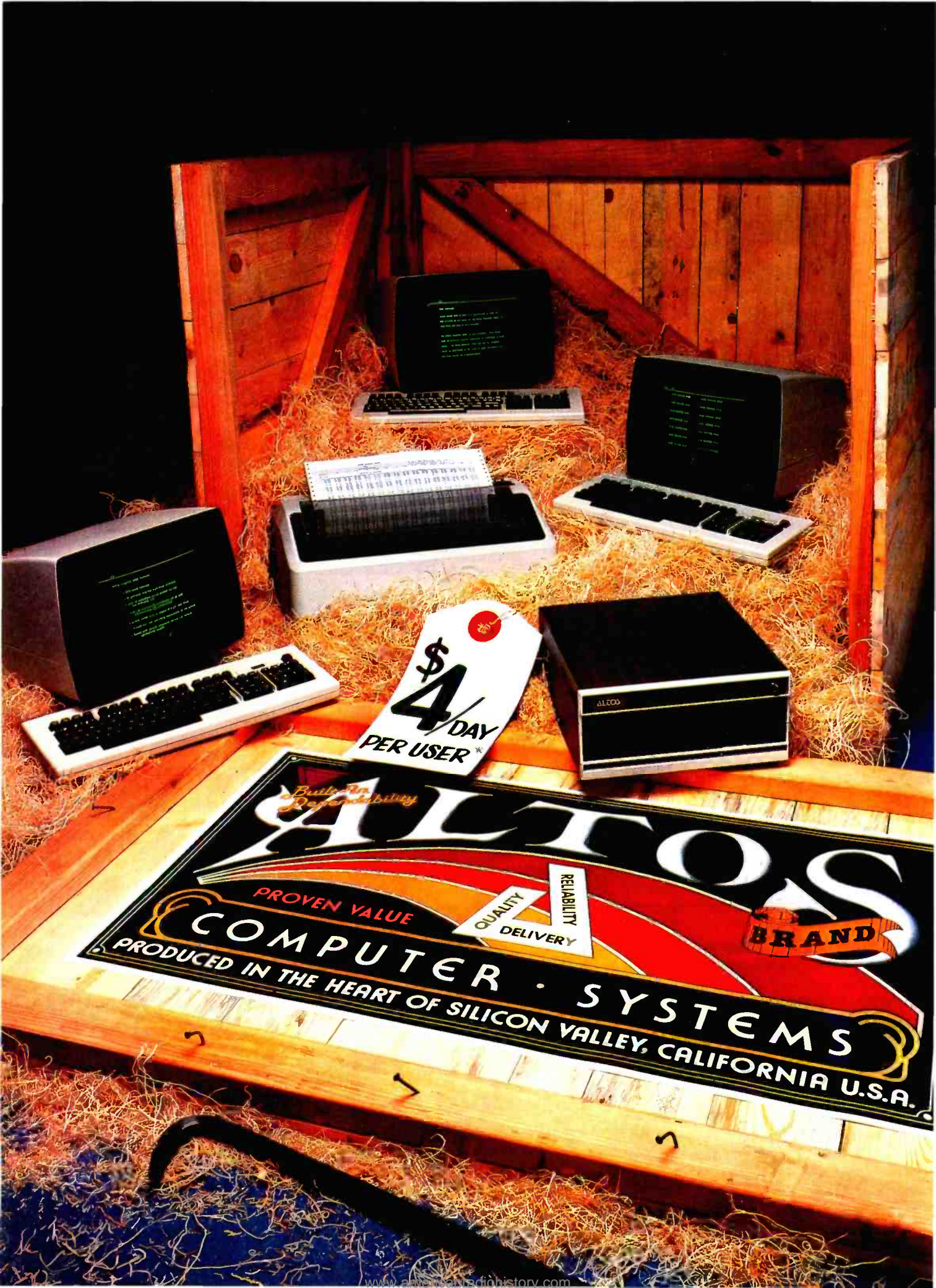
\* Apple II is a registered trademark of Apple Computers, Inc.

\*VisiCalc is a trademark of Personal Software Inc.

\*CP/M is a registered trademark of Digital Research, Inc.

\*DB Master is a trademark of Stoneware





**\$4/DAY**  
PER USER\*

*Built For Reliability*  
**ALTO**  
PROVEN VALUE  
COMPUTER SYSTEMS  
RELIABILITY  
QUALITY DELIVERY  
BRAND  
PRODUCED IN THE HEART OF SILICON VALLEY, CALIFORNIA U.S.A.



# OPEN FOR BUSINESS... THE NEW ALTOS ACCOUNTANT.

## Introducing the complete multi-purpose, multi-terminal desktop business accounting system with a built-in tutor.

Get everything you need to computerize your business. An ALTOS® Series 5 computer (including 5 MByte Winchester hard disk and 1 MByte floppy), three of our new smart terminals and a printer.

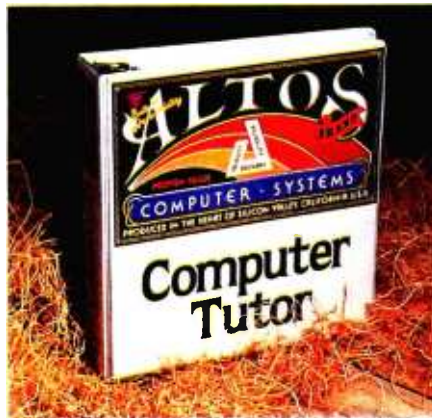
You also get the new ALTOS ACCOUNTANT, a completely integrated business accounting system that includes applications for general ledger, accounts payable, accounts receivable, inventory control, payroll, job costing and order processing.

There's more. You get the unique ALTOS COMPUTER TUTOR, the self-teaching tutorial that provides simple, self-paced, step-by-step training that makes using the computer easy.

Best of all, you get everything for less than \$4 per day per user.\*

Complete hard disk systems start at \$9,980.

An Altos system is like having three computers in one. For example, while your bookkeeper prepares payroll, other users can check inventory, compute cost estimates or produce reports. All at the same time.



Need more? You can choose from hundreds of popular CP/M® and MP/M II™ applications like word processing, business planning, and communicating with other computers or networks. There's also nationwide on-site service available from your dealer.

Join the thousands of businesses that already rely on Altos. For more information, call our toll free number or write: Altos Computer Systems, 2360 Bering Drive, San Jose, CA 95131. We'll put you in touch with your local Altos sales and service dealer who'll introduce you to your very own ALTOS ACCOUNTANT.

### Packed with fresh ideas for business



**800-538-7872**  
**(In Calif. 800-662-6265)**

\*Complete 3 user system for \$4 per day per user. Price approximate and may vary in your area. Daily lease based on \$12,800 principal, 20% annual interest, five-year term. Packaged system includes Altos Series 5-SD computer with 5 MByte Winchester hard disk and 1 MByte floppy, a draft quality printer, three Altos smart terminals, and the ALTOS COMPUTER TUTOR software package. Price does not include tax, installation, additional training and maintenance.

ALTOS is a registered trademark of Altos Computer Systems.  
CP/M is a registered trademark and MP/M II is a trademark of Digital Research, Inc.

© 1982 Altos Computer Systems

Circle 17 on inquiry card.



# Japanese Computers



---

# The Machines Behind the Machines

*Several Japanese companies, both large and small, have their eyes on the American market.*

---

Phil Lemmons  
Consulting Editor

---

When shopping for the products of any rapidly developing industry, you must judge not only the products themselves but also their manufacturers. This is especially true when products are complex. If you buy the world's greatest microcomputer from a company whose business acumen falls far below its engineering genius, that company may not be around two years from now when you need parts or service for the machine. You want to buy a machine from a company that will continue to produce and support microcomputers. When you buy, you're betting on one company to survive.

The temptation is strong to buy only from the largest companies, but that oversimplifies the judgment you must make. Size is, of course, important. Companies that hope to survive in the American microcomputer market must now be able to stand up to giants such as IBM, DEC, and Xerox. Big companies can also achieve economies of scale and further economies by making most or all of

their products' components (which economists call *vertical integration*).

Just as important as a company's size, however, is its determination to continue making microcomputers. Industry pioneers such as Apple Computer Inc. will be formidable competitors because everyone believes their manufacture and support of microcomputers will probably continue. If some huge, diversified company introduces a microcomputer that fails to win a good share of the market, that company can stop making microcomputers and rely on its hundreds of other products.

This article doesn't pretend to judge the contenders in the battle for survival in the U.S. microcomputer market; its purpose is to profile some Japanese companies, including Canon, Oki, Fujitsu, Hitachi, NEC, and Systems Formulate Corporation. (For a comparative review of these companies' microcomputers see "Six Personal Computers from Japan," page 60 in this issue.) To help you put this information in context, I'll first

give some information about the microcomputer industry in Japan and about Japanese pricing policies in the United States. I'll close with a few speculations about Japanese microcomputers in the United States during the next two years. These speculations must be considered strictly amateur.

## The Japanese Microcomputer Industry

The Japanese microcomputer industry is large and diverse, but two generalizations apply: the graphics are excellent, and the competition is fierce. The graphics are excellent because they *must* be in order to represent the complex kanji (Chinese characters) used in Japanese. The competition is fierce because manufacturing personal computers appeals to two different kinds of Japanese companies: the long-standing manufacturers of computers and the consumer electronics firms.

Sixty-four companies manufacture personal computers in Japan. (Sixty-



four; this is not a misprint. Clearly, the Japanese are finding ways to occupy the 40,000 electrical engineers who graduate from Japanese universities each year.) At least eleven Japanese companies are already marketing microcomputers in the United States: Canon, Casio, Seiko (Epson), Fujitsu, Nippon Electric Company (NEC), Oki (through BMC), Panasonic, Sharp, Systems Formulate, Toshiba, and Hitachi (the last delayed by the FCC's changes in rules governing radio-frequency interference). Sanyo and Sony are in the wings, and others are in their dressing rooms.

## Computer Manufacturers

The *Japan Electronics Almanac 1981* lists six major manufacturers of computers in Japan: Fujitsu, Hitachi, NEC, Toshiba, Mitsubishi Electric, and Oki Electric Company. These

companies have experience in developing integrated computer systems and software. Oki is by far the

**We know less about the Intentions of the Japanese consumer electronics manufacturers than we do about the major computer manufacturers.**

smallest with "only" 12,000 employees compared to Fujitsu's 34,000 and Mitsubishi's 49,000. NEC employs 64,000; Toshiba, 98,000; and Hitachi, 151,000.

Each of these major manufacturers has the resources to make a dream machine. The question is, can they ef-

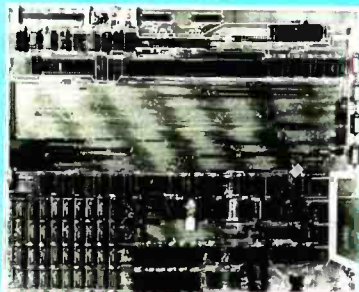
fectively market their microcomputers in the United States?

Fujitsu has the least experience in consumer electronics and has shown a tendency to market its machines through OEMs (that is, to have its machines packaged and sold under the names of other original equipment manufacturers). NEC markets consumer products widely in Japan but not in the United States. On the other hand, NEC has outpaced the other companies in entering the American microcomputer market. Like NEC, Oki has also sold peripherals here, notably its Okidata printers, and is marketing small-business computers through the Japanese trading company BMC (Business Machines Corporation) and BMC USA Inc., its American subsidiary.

Various sources claim that 8086- or 8088-based microcomputers will come from Toshiba, NEC, Hitachi, and Fujitsu. If these rumors are true,

## "THE BETTER BOARD"

### SB-80 Single Board Computer



**Z-80-A  
64K RAM**  
Fully Assembled and Tested

Size: 16" x 13"  
Same as 2.8" floppy drives. Requires:  
+5V 1.5 Amp  
-5V 1.0 Amp  
-12V 1.5 Amp

**\$695.00\*\***

#### CONSTRUCTION

- Sockets for all integrated circuits.
- 50 pin connector allows access to system for future expansion.

#### PROCESSOR

- Z80A with 4 MHz system clock with no wait states.

#### MEMORY

- 64K of 200ns dynamic RAM is standard. 4116 IC's
- Parity protection is standard.

#### ROM

- 256 bytes bootstrap ROM

2 PARALLEL I/O's 2 SERIAL I/O's  
COUNTER TIMERS  
FLOPPY DISK CONTROLLER

#### OPTIONS:

- Character video board 80 x 24 for use with black and white monitor using a stand alone keyboard ..... \$215.00
- Winchester Host Adapter board for Shugart SA-1000 or Corvus Hard Disk. Includes cables ..... \$315.00
- Stand alone keyboard and cable plugs into computer board for 80x24 video option ..... \$190.00



18" W x 19" L x 8" H



#### CPU — DISK DRIVE CABINET ACCOMMODATES:

- SB-80
- BRI 2000
- DIGITAL RESEARCH "The Big Board"
- OTHER SINGLE BOARDS

Metal cabinet with proportionately balanced air flow-convection cooling. AC power cord connector, lighted power switch; Fuse assembly; 0L65 Dual drive power supply (Will also power single board CPU). All hardware included to mount 2.8" disk drives. Includes space area to mount any single board computer. Fully assembled and tested.

SB — ..... Cabinet Kit \$645.00  
SB — ..... Bare Cabinet \$145.00

#### SS/DD DISK DRIVE SYSTEM

SB Assembled tested with 2.8" drives ..... \$1425.00

#### DD/DD DISK DRIVE SYSTEM

SB Assembled tested with 2.8" drives ..... \$1850.00

#### 8" FLOPPY DISK DRIVES

Single Sided/Double Density Double Sided/  
Double Density  
Shugart 800/801R ..... \$395.00. 2/\$780.00  
Shugart 850/851R ..... \$590.00. 2/\$1170.00

#### CP/M\* 2.2 & BIOS

CP/M\* 2.2 & BIOS modified by S & M systems to run on single board is available for ..... \$200.00

**HOW TO ORDER** Phone orders using American Express, Visa, MasterCharge, Bank wire transfer, Cashier's or Certified check, Money Order, or Personal check (allow 10 days to clear). Please add 5% for shipping, handling and insurance minimum \$500.00. Conn. residents add 7.5% sales tax. All equipment is subject to price changes and availability without notice. All equipment is new and comes complete with manufacturers warranty. Showroom prices may differ from mail-order advertisement.

\* CP/M is a trademark of Digital Research Corp.

\*\* 1 to 4 piece domestic U.S. price.



**Colonial Data Services Corp.**

105 Sanford Street Hamden, Conn. 06514

(203) 288-2524 • Telex: 956014



# Expand Your IBM PC



## □ Memory Expansion Board

Datamac's Expansion Board offers 4 TIMES the amount of memory offered by the IBM PC. Configurations can be set at 64K, 128K, 192K and 256K bytes. Board can be easily upgraded in 64K capacities.

## □ Add-In Winchester Disk System

Datamac's Add-In Winchester System is housed within the IBM chassis and is easy to install directly into the floppy disk slot, reducing desktop space. Winchester Controller Board is available for the larger OEM users.

## □ Asynchronous Communications Controller

1 or 2 line capability on one card.  
Totally compatible with IBM software and diagnostics.

See your Computerland Dealer for the ever growing line of Datamac Peripheral Products for the IBM Personal Computer.

# data mac

Peripheral Products Division, 680 Almanor Ave., Sunnyvale, CA 94086 (408) 735-0323



# The Japanese Manufacturers—How Successful Will They Be?

---

by Tod Zipnick  
TMQ Software Inc.  
390 Northeast River Rd.  
DesPlaines, IL 60016

---

America has long awaited the Japanese entry into the U.S. personal computer market. Some Japanese companies have already begun to sell microcomputers here, and more are surely on their way. But a few questions remain unanswered: How successful will the Japanese companies be? What are their plans and what products can we expect from them?

Japanese companies will have to go through a two- to three-year learning curve to understand the American microcomputer market. For one, Japanese methods of conducting business are different from ours. As well, they might encounter problems stemming from a less than thorough understanding of microcomputer distribution, service, and support, FCC regulations, and software and its support.

## Japanese Methods of Conducting Business

When Japanese engineers consider the design of a new product, they accept advice mainly from divisions within their company that have been successful in the past. Because their experience at this point stems from the Japanese rather than the American marketplace, new products are often designed with Japan in mind, not America. The market for microcomputers in Japan is several years behind ours. This explains why one Japanese company can plan to release a cassette-based microcomputer with no means to interface it with a disk drive. The Japanese market will accept such a product,

---

### About the Author

Tod Zipnick is president of TMQ Software, a Chicago-based software and consulting firm to the microcomputer industry.

but the same product will find much resistance in America.

Japan is several years behind us in software capability. They know hardware better than software. Japanese products reflect this lack of knowledge; consequently, their computers are hardware-intensive rather than software-oriented. The hardware is, nonetheless, very good.

## Distribution, Service, and Support

Microcomputer distribution, service, and support are also different here. The Japanese marketplace still contains a lot of hobbyists, and only recently in Japan has there been a transition to the business marketplace—a transition we experienced several years ago. When an American business plan is presented for Japanese approval, the Japanese are naturally skeptical about the distribution, service, and support based on their experiences in Japan. They do not yet understand the amount of money needed to support these functions in the American marketplace.

## FCC Regulations

Having to pass a microcomputer through the FCC for approval is a new experience for the Japanese. Because of this, the Japanese manufacturers will spend a lot of time getting approval for their first line of products. In an industry that moves as fast as this one, such a delay could hurt their marketing plans. Future designs for new products will undoubtedly be passed through more quickly.

## Software

One of the biggest lessons the

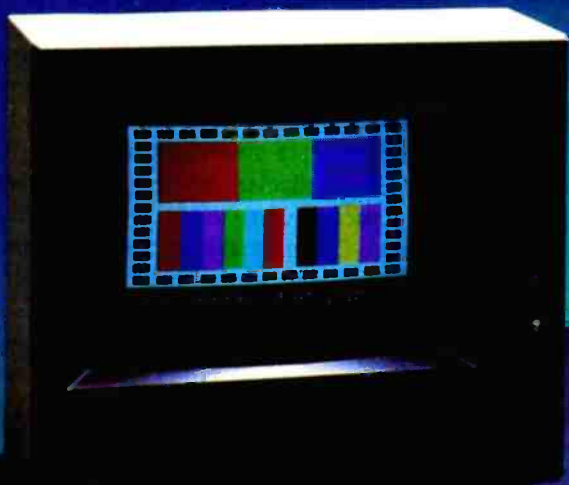
Japanese companies will have to learn is that software sells hardware in America. A Japanese company will look at the third-party support of the Apple, Atari, Radio Shack, and IBM computers and expect the same to occur for their machines. What they may not realize is that they will have to commit \$1 to 3 million to acquire software applications from outside vendors to do the job properly. A lot of money needs to be poured into software evaluations and support of software when it is released. This must be done in America, not in Japan, because the people working in Japan are not aware of the software options available through companies in the United States. At this time, very few Japanese companies have allocated the necessary resources in America to carry out these steps.

For software development, Japanese companies must lend between 50 and 100 machines to software companies. This often adds up to more money than most Japanese companies at first realize is necessary to push a product onto the market. Technical documentation on a system is also very difficult to get from Japanese manufacturers. The time and money needed to produce these documents is a must if software companies are going to support a machine.

We can expect Japanese manufacturers to make many mistakes when they first enter the American market. Remember, however, that American manufacturers had similar problems in the past. As the Japanese learn, and if they remain committed to the U.S. market, we can expect to see some fine products from Japan in the future. ■

# ALPHANUMERIC or GRAPHIC?

**If high resolution required, install  
BMC color/green monitor in your system.**



BM-1401RGB



BM-12A

**RGB Interface Board for  
Apple-II is available now.**

**BM-12A**  
12" Green P4 Phosphor CRT  
Composite Video Signal  
80 Char. X 24 Lines

**BM-1400CLU**  
13" Composite Video Signal  
40 Char. X 25 Lines

**BM-1401RGB**  
13" RGB Separate Video Signal  
5 X 7 Dots, 40 Char. X 25 Lines

**BM-1402RGB**  
13" RGB Separate Video Signal  
5 X 7 Dots, 80 Char. X 25 Lines

Circle 48 on Inquiry Card

## **BMC USA, INC.**

**LOS ANGELES**

20810 Manhattan Place Suite 110, Torrance, CA 90507  
Telex: 698641 BMC USA TRND Phone: 213-320-9880, 9881

**NEW YORK OFFICE**

450 Barell Avenue, Carlstadt, N.J. 07072  
Telex: 133221 BMC NY CARL Phone: 201-939-7079, 7081





# SWORD™

a Screen Oriented  
Relational Database,  
designed to put You in  
control of a powerful  
information management  
system: quickly, easily,  
and at a price you can  
live with.

### Powerful

- User defined CRT entry screens speed data input and editing.
- Makes full use of CP/M 2.0+ facilities for rapid access and retrieval.
- User controlled security access codes.
- Up to 32k records per relation with up to 8k per record.

### User Oriented

- A consistent system of help messages, menus, and prompts assists the user in all phases of operation.
- An English-like query format that is easy to use yet comprehensive.

### Clear Documentation

- Our manual is concise, easy to understand, and indexed.

**\$295** / \$25 manual

VISA, MC and COD welcome

**ISO TECH™**  
INNOVATIVE SOFTWARE TECHNOLOGIES, INC.  
3990 VARSITY DRIVE  
ANN ARBOR, MICHIGAN 48104

(313) 996-1890

REQUIRES: CP/M 2.0+ SYSTEM WITH  
AT LEAST 42K, 64-80 COLUMN SCREEN,  
ADDRESSABLE CURSOR AND 8" DISK  
DRIVES.

\*CP/M is a trademark of Digital Research, Inc.

## Japanese Computers

the Japanese computer companies seem to be swarming around the chips of Intel design. This phenomenon is probably based on a desire to capitalize on the large base of software that already exists for these products.

Only Toshiba, NEC, and Hitachi are significant manufacturers of both computers and consumer products. Only Toshiba and Hitachi have marketed their consumer products on a large scale in the United States.

### Consumer Electronics Manufacturers

Sharp, Sony, Matsushita (Panasonic and Quasar), Casio, Sanyo, Seiko, and Canon have all been successful in marketing consumer electronics in the U.S. These companies know the American consumer market and have impressive distribution and service networks. The demands of the consumer markets for small battery-powered gadgets have made these companies invest heavily in semiconductor research. Sharp and Seiko, for example, have spent millions on developing advanced low-power CMOS (complementary metal-oxide semiconductor) chips. Those chips and their descendants will form the basis of remarkably small, portable, battery-operated microcomputers.

As to the sizes of the companies themselves, Matsushita employs 96,000 people and had semiconductor sales of \$254 million in 1981 (double the sales of Texas Instruments). Sony employs 33,000 and has annual sales of around \$5 billion, Sanyo employs 19,000, and Sharp employs 18,000. Canon is a \$2-billion company. Seiko is a privately held \$3-billion company.

We know less about the intentions of the Japanese consumer electronics manufacturers than we do about the major computer manufacturers, but the consumer electronics companies are clearly interested in the American microcomputer market. Sharp makes the YX-3200 business-oriented computer, a handheld computer, and also manufactures the handheld computer

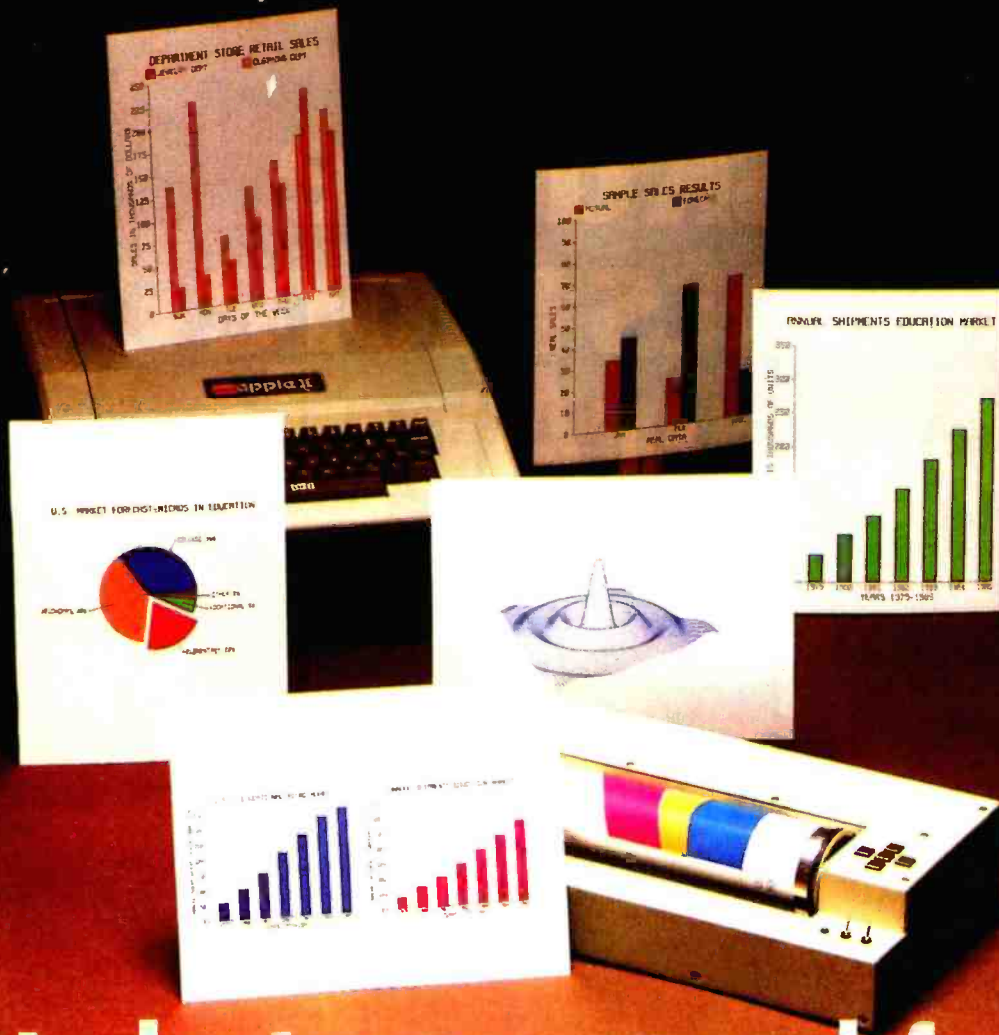
sold here under the Radio Shack name. Casio makes and sells the FX-9000P, a desktop microcomputer aimed at scientists and engineers. Matsushita is producing a 6502-based handheld computer for sale under both the Panasonic and the Quasar names. Sony offers its Typewriter and a word processor that uses 3-inch floppy-disk drives. Matsushita and Hitachi are making 3-inch floppy-disk drives too.

Japanese consumer electronics companies know what an important role convenience of use plays in the sale of consumer goods. If we're lucky, these companies will introduce microcomputers that are not just friendly to users but are downright seductive.

Of particular interest to current microcomputer users is the Suwa Seiko Group, maker of Seiko watches. Suwa Seiko established the Shinshu Seiko Company Ltd. in 1961 to make watch parts. Shinshu Seiko now makes small liquid-crystal displays and digital printers. In the U.S., we know Shinshu Seiko better under the brand name Epson, as in Epson MX-80, the matrix printer that took the U.S. by storm.

Epson has made computers since 1978, when sale of the EX-1 office computer began in Japan. In 1980, Epson introduced to the Japanese market the KX-1, a desktop computer with built-in dual-disk drives. Epson America recently showed the HX-20, a handheld computer that looks very much like the Sony Typewriter, in the United States. At the October 1981 Data Show in Tokyo, Epson exhibited a desktop personal computer, the QC-20, which runs CP/M, has a 4-MHz Z80 processor, and comes with up to 256K-bytes of RAM (random-access read/write memory). The Data Show also gave Epson the opportunity to introduce a slim-line, 5¼-inch floppy-disk drive called the FT-20. Look for Epson to do big things with small packages.

Sony's plans for microcomputers are unknown, but in researching this article, I talked with many executives from Japanese electronics companies in the United States. Three people told



# How to chart your company's fortune without spending one

It's a fact. A single chart or graph can tell you instantly what it takes hours to interpret from printouts or other raw data.

Now, with the Strobe 100 Graphics Plotter and Software package, you can create superb hardcopy graphics directly from your computer. And you can do it for an investment of only \$995.

The Strobe System transforms complex data into dynamic, colorful visuals with a few simple commands from your computer. Charts and transparencies that once took hours to produce are plotted within minutes. Information can be presented as bar charts, pie charts, curves or isometrics in a variety of colors. And with a resolution of 500 points per inch, the Strobe 100 matches or surpasses the quality of plotters costing thousands of dollars more.



You can also save and modify your graphics through Strobe's menu-driven programs. A broad selection of software—including a VisiCalc®-compatible program—is now available.

When the Strobe Graphics System is interfaced to your computer, an 8-1/2 x 11 inch sheet of paper can speak anyone's language—visually. Visit your local dealer and learn

how to start charting your fortunes today. Because a perspective on the present can also be your window on the future.



**Strobe Inc.**  
897-5A Independence Avenue  
Mountain View, CA 94043  
Telephone 415/969-5130

## The Strobe Graphics System

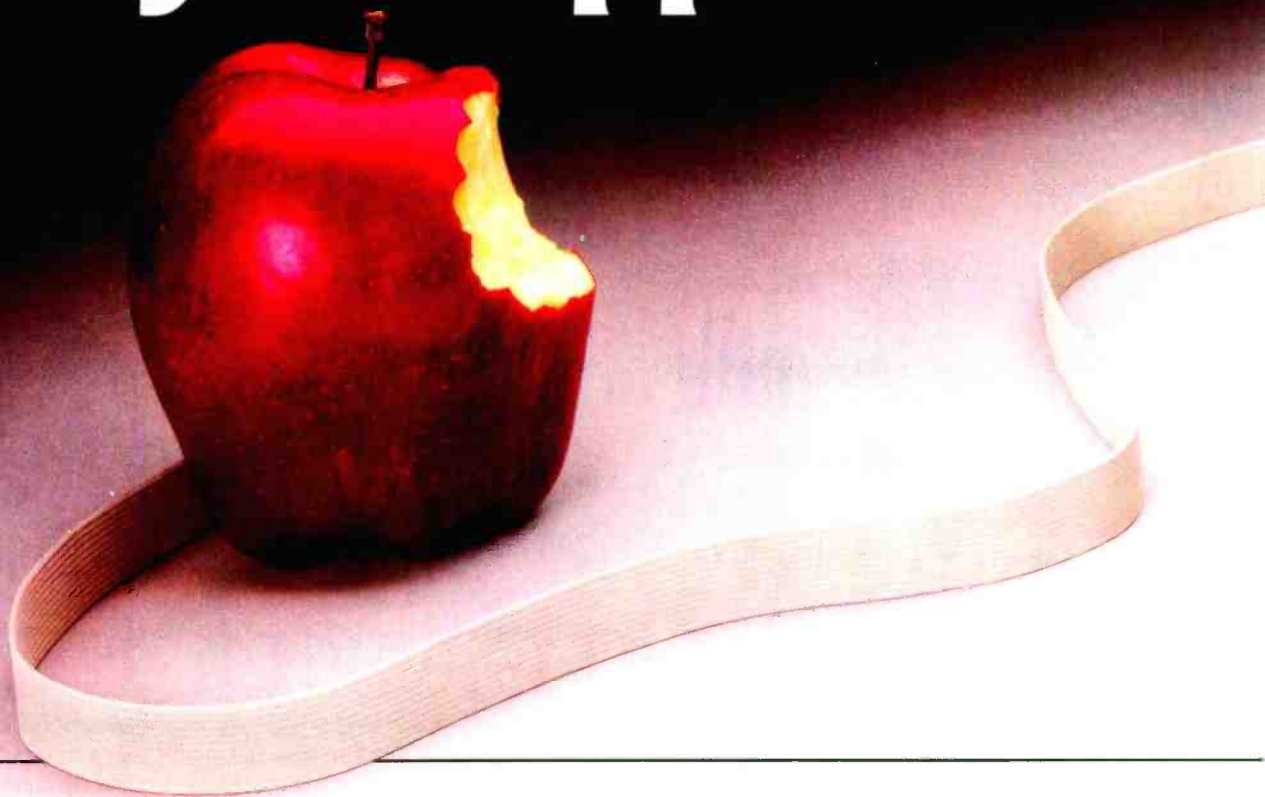
Seeing is believing

Circle 393 on Inquiry card.

\*VisiCalc is a trademark of VisiCorp.



# The disk drive that puts more byte into your Apple.



## **Introducing the first totally compatible Floppy Disk Drive.**

Rana Systems has designed a totally compatible disk drive for Apple, that's better than Apple's. A high density, high capacity disk drive and controller that offers a myriad of features Apple never thought of. Unique advantages that get the maximum efficiency out of your existing Apple II® hardware and software.

At Rana, we knew you wanted more storage, so we went right to the core of the problem. Even our most economical model is designed to give you 15% more storage capacity than Apple's. Our top-of-the-line unit gives

you 4 times the capacity of Apple's comparable unit. Even our design is far more dramatic than theirs. With lines that actually complement the sleek Apple II computer.

## **We're a step ahead of Apple because we have a faster step.**

Holding more information is even more valuable when you can get it faster. The Rana System track positioning mechanism is engineered to access three to four times faster track to track, with greater accuracy than Apple's. Our disk drive offers safeguards like a stall provision to protect spin motor burnout,

Apple II is a registered trademark of Apple Computer Inc.



an advanced write protect feature that keeps your information where you put it, and an energy saving device that "powers down" when your disk drive is taking a break.

**We even took a bite out of Apple's price.**

Our most popular model is 25% more economical per byte than Apple's, providing you with maximum performance, superior cost efficiency, and totally compatible styling. It also comes with a free diskette containing all the optional software and supports you'll need to enhance the capacity and performance. And it's all backed up with an efficient service

support system, and a full 90 day warranty.

The Rana System Floppy Disk Drive. Just plug it into your Apple and all those delicious extra bytes will be yours.

**RanaSystems™**



Circle 358 on Inquiry card.

20620 South Leapwood Avenue, Carson, CA 90746 213-538-2353.  
For dealer information call toll free: 1-800-421-2207.  
In California only call: 1-800-262-1221. Source Number TCT-654.

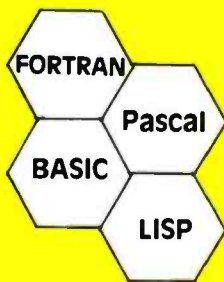


Did you know  
that with  
the new

# UCSD\*

## P-SYSTEM VERSION IV

you can write  
programs in



and run them on

ALTOS, APPLE,  
COMMODORE,  
CROMEMCO, DEC, IBM,  
INTERTEC, PHILIPS,  
OHIO SCIENTIFIC,  
RADIO SHACK, TERAQ,  
TEXAS INSTRUMENTS,  
VECTOR GRAPHIC,  
XEROX, ZENITH,  
and many more...

without change!

(Think about that next time  
you want a larger market)

We support systems  
software and/or applica-  
tions ready-to-run on

APPLE, DEC LSI-II†,  
RADIO SHACK  
MODEL II§ & III§ and ALTOS.

### PCD SYSTEMS

P.O. Box 143  
Penn Yan, NY 14527  
315-536-7428

†TM Digital Equipment  
‡TM of Tandy Corp.  
\*TM U. of California

## Japanese Computers

me that Sony has a marvelous personal computer running. Two of these sources said that the Sony computer is based on the 8086 microprocessor. One of these sources said that Sony had not yet decided to market the computer. Another enticing report claims that Sony is developing a 3-inch Winchester hard disk.

Matsushita will soon introduce a floppy-disk drive module for its handheld computer. The module incorporates a Z80 microprocessor and runs CP/M. Last fall at the press conference introducing the handheld computer, a Panasonic spokesman said, "This is only the beginning."

### An Exceptional Entry

Among the Japanese microcomputers reviewed in this issue is the Bubcom80 from Systems Formulate Corporation. This small company, recently founded with Fujitsu's help by a former designer for Fujitsu, is neither a consumer electronics manufacturer nor a major computer manufacturer. Systems Formulate is, however, entirely devoted to designing and selling microcomputers and to teaching people how to use them. In addition to its own Bubcom80, Systems Formulate sells the Commodore VIC, the NEC PC-8001, the Apple II, and the Oki if800. A more detailed profile of Systems Formulate appears later.

### Japanese Pricing Policies

Some American advertisements are welcoming the entrance of the Japanese into the microcomputer market here. Other voices, however, are warning that the Japanese will use unconscionable pricing policies to drive their American competitors out of the market.

American semiconductor manufacturers reportedly feel that Japanese manufacturers are "dumping" integrated circuits in the United States. That is, they're selling at a loss in order to drive American companies out of the market. The Japanese maintain that they are selling at a small profit despite paying a 4.2-percent tariff.

Chris Rutkowski, marketing and

national sales manager of the peripheral products division of Epson America, offers a strong rebuttal to charges that the Japanese practice unfair pricing. Rutkowski sums up the difference between the way American and Japanese companies price their products with: "The Americans make a product and sell it for as much as they think they can get. The Japanese make a product and then figure out what it actually cost to make and distribute it. Then they add 15 percent. This is fair, equitable pricing."

American car advertisements on television are now verging on racism. While it's convenient for the American auto industry to blame the Japanese for plummeting sales, most consumers realize that Detroit is in trouble mainly because its executives were appallingly slow in realizing the need for small, efficient cars.

The American microcomputer industry seems far more progressive than the car industry. American microcomputer manufacturers expect a challenge and are preparing to meet it—I hope—without resorting to slurs. It seems reasonable to expect that fair competition between domestic companies and the Japanese in the American microcomputer market will lead to better products and lower prices, with several companies surviving on each side and the American consumer being the ultimate victor.

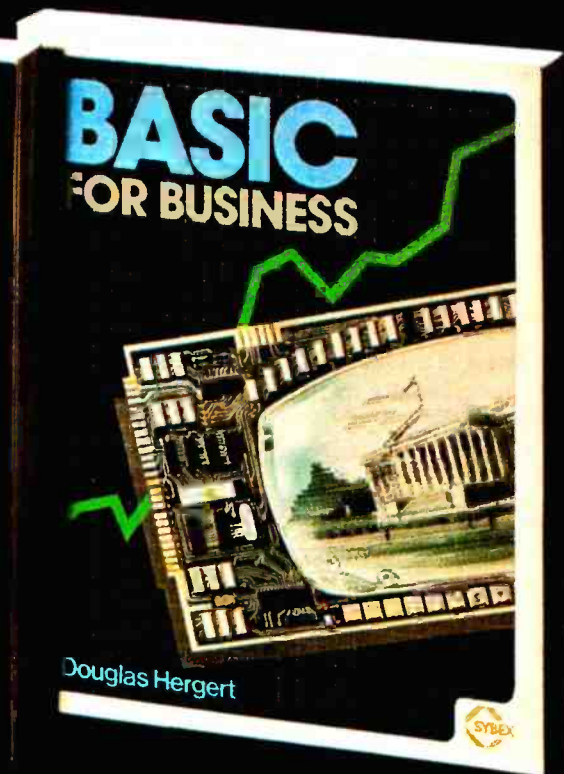
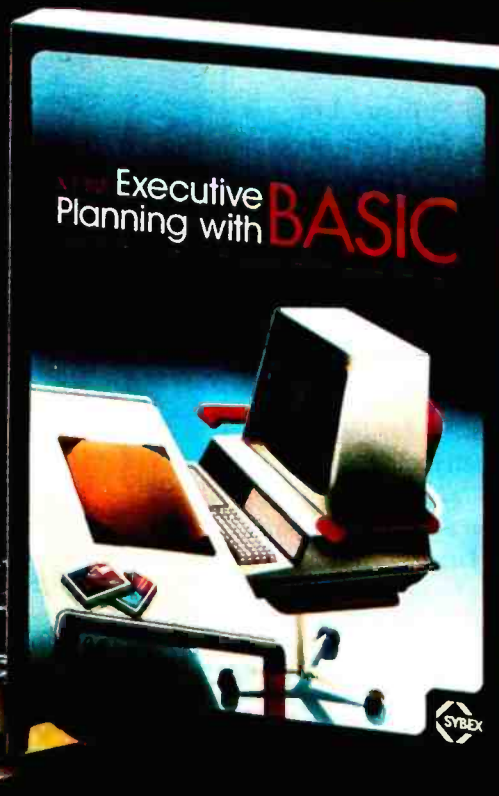
**BMC** BMC International is a Japanese trading company founded in

1977 to specialize in electronic products. BMC sells video monitors and terminals, memory boards, electronic typewriters, printers, the Oki if800 microcomputer, calculators, electronic games, and other products based on integrated circuits. BMC's promotional literature mentions personal computers as well as business computers. Its American subsidiary is known as BMC USA, Inc.

**OKI** Oki Electric Industry Company Ltd. of Tokyo manufactures the if800 distributed here by BMC. Okidata Corporation,



# At last, two books to show you how to make BASIC mean business.



**BASIC for Business** by Douglas Hergert, Ref. B390, \$12.95. This book will show you how to use a small computer to complete business tasks faster, more efficiently. It's a solid, practical introduction to BASIC, the programming language most commonly used in microcomputing.

You'll learn to use the computer to:

- write sales reports and financial statements
- produce graphs and charts
- calculate depreciation and present value
- perform cost/volume/profit analysis
- plus much more!

Realistic sample programs illustrate each element of the language, and exercises at the end of each chapter encourage you to explore new ways of using BASIC on your own. A special feature is a section which introduces three other programming languages: COBOL, FORTRAN and Pascal.

**Executive Planning With BASIC**, X. T. Bui, Ref. B380, \$12.95. This fascinating book presents a collection of BASIC computer programs for the most up-to-date business decision models. It explodes the myth that programming is for computer specialists only. The executive will quickly learn how to accelerate and improve decision-making and planning methods by using a micro-computer.

Here is an overview of what's covered:

#### DECISION MODELS UNDER CERTAINTY

- Cost-Volume-Profit: Finding the Break-Even Point
- Linear Programming: The Simplex Method • Inventory Management: The EOQ Formula

#### DECISION MODELS UNDER UNCERTAINTY

- Sequential Decision Model: a Decision Tree for Discounted Expected Values • Critical Path Analysis and PERT • A Simulation Model for Optimal Queuing

#### FORECASTING MODELS

- Exponential Smoothing • Linear Regression • Multiple Linear Regression

#### INVESTMENT MODELS

- Financial Ratio Analysis • Discounted Cash-Flow Models • Portfolio Management • Multicriteria Decision-Aid Models

SYBEX has the most comprehensive library available, from introductory to business to hardware, programming and assembly language titles; all written by computer professionals. The thorough, readable approach of SYBEX books is favored by both non-technical people and computer specialists.

To order these books or get a free catalog fill out the coupon, or call **TOLL-FREE** 800/227-2346, (within Calif.) 415/848-8233.

Send me  free catalog  BASIC for Business \$12.95  
 Executive Planning with BASIC \$12.95  
 Add  \$1.99/Book UPS  \$5.00/Book 4th Class  
 \$2.99/Book Overseas Mail

Charge by  VISA  MasterCard  American Express

Name  Exp. date

Total Amount Enclosed \$

Signature

NAME

ADDRESS

CITY  STATE  ZIP

Mail to: SYBEX, Inc.,  
 2344 Bluff St., Dept. A-1  
 Berkeley, CA 94710



## Japanese Computers

Oki Electronics of America, Oki Semiconductor, and Oki Electric Overseas Corporation are other subsidiaries of Oki Electric Industry. Last year marked Oki's centennial. While the company's size doesn't rival that of giants such as NEC and Toshiba, Oki does devote all the efforts of its 12,400 employees to electronic and telecommunications equipment.

About 38 percent of its sales consist of electronic business machines. Oki's OKITAC series of computers sells well in Japan, as do Oki's modems and teleprinters. Okidata printers are popular here. Oki Semiconductor's products include 64K-bit RAM chips and other VLSI (very large-scale integration) chips. The company's new VLSI plant opened in 1981 and was producing 3 million 64K-bit dynamic RAMs a month by late 1981. Oki expects production to rise gradually to 10 million a month by 1985.

**Canon** Although better known for calculators and cameras than for computers, Canon is capable of mounting a substantial microcomputer marketing effort in North America. Canon has diversified in recent years and now produces copiers, electronic typewriters, micrographics equipment, magnetic-card readers, magnetic heads for audio and digital devices, and microcomputer disk drives. Canon is conducting research in computer-aided design (CAD) and computer-aided manufacturing (CAM). In fact, 40 percent of Canon's sales in North America are business machines.

The two primary markets for microcomputers are home and office, and Canon USA has extensive experience in North America in both. So far, Canon has produced computers for the office market only. The Canon CX-1 and the BX-3 are general-purpose small-business computers.

The TX-10 and TX-15 are designed for fields such as banking and finance, payroll management, foreign exchange, science, statistics, insurance, real estate, and auto sales. The TX-10

has a numeric pad, and the TX-15 has a standard alphanumeric keyboard. The TX-25 has an alphanumeric keyboard and 4-inch floppy-disk drives. All these machines are based on the Motorola 6809 microprocessor. Canon could seek a larger market through its 7500 independent dealers in the United States and Canada, and its 700 authorized service centers could be a strong selling point for consumer computers.

## FUJITSU

Fujitsu Ltd. is Japan's largest manufacturer of computers and its fourth-largest producer of semiconductors. Although Fujitsu's assets of \$3 billion are less than those of a few other Japanese corporations, Fujitsu devotes most of its efforts to computers and data communications. In fact, of Fujitsu's \$2,769,895,000 in 1981 sales, computers and data communications accounted for \$1,819,495,000 or 66 percent. Fujitsu makes printers, large hard-disk systems, terminals, integrated circuits, and many other computer-related products.

Fujitsu's prowess in making large computers is widely recognized. In May 1981, Fujitsu introduced the world's most powerful general-purpose computer, the FACOM M-382. Its dual processor system has 32 to 128 megabytes of main storage and as many as 64 channels, for a maximum total throughput of 96 megabytes per second.

Fujitsu is one of the world's largest producers of integrated circuits; its 64K-bit dynamic RAM mass-production system is the world's largest. Fujitsu sells integrated circuits in the United States through the subsidiary Fujitsu Microelectronics. In development are high-electron-mobility transistors (HEMT) and Josephson-junction elements, both of which should bring dramatic improvements in circuit performance.

No one is doing more with bubble memories than Fujitsu. Mass production of 64K-bit and 256K-bit bubble

## ISE is an International Consortium of the World's Leading Software and Consulting Firms, Representing Over 5,000 Professionals Around the World

Major companies around the world are joining this consortium to provide mainframe-quality software for microcomputers.

ISE provides professional application developers with the finest array of integrated software tools available anywhere:

- Data Base Management
- Data Communications
- Programming Languages
- Screen Management

Also available—a full spectrum of the most advanced office systems for an integrated approach to office management and control.

These fine products are distributed in most countries through ISE. For more information, contact:

In U.S.:  
ISE-USA  
P.O. Box 248  
Lafayette, Indiana 47902  
Tel: (317) 463-2581

In Germany:  
ISE-ADV/ORG GERMANY  
Lipowskystr. 26  
8000 Munich 70  
Tel: (0 89) 77 60 23-4

In France:  
ISE-CEGOS  
Tour Chenonceaux  
204, Rond-Point du Pont de Sèvres  
92516 Boulogne Billancourt Cedex  
Tel: 620-61-04

In Switzerland and Austria:  
ISE-ADV/ORG SWITZERLAND  
Mainaustraße 17  
CH-8008 Zürich  
Tel: (01) 32 02 70-1

Elsewhere:  
ISE-INTERNATIONAL  
P.O. Box 248  
Lafayette, Indiana 47902  
Tel: (317) 463-2581



P.O. Box 248 Lafayette, IN 47902

For more on one of  
our fine products, see page 303



## As inevitable as evolution.

Two rapidly changing technologies:

1. Computers shrinking in size and price, growing in power.
2. Professional software, steadily increasing in sophistication.

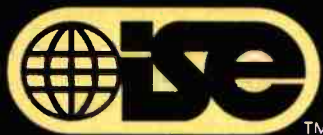
It was inevitable that someone would bring these technologies together. That someone is ISE: a new kind of computing company created to bridge the evolutionary gap between professional-quality software and microcomputers.

The result of an international alliance of software and computer consulting companies, ISE today produces the world's most sophisticated software for the world's smallest professional

computer systems.

ISE's current offerings of data base management systems and application development tools provide all the capability of mainframe software, at a fraction of the price.

For more information on this major development in business computer technology, phone our main office at (317) 463-2581 or contact the ISE affiliate nearest you.

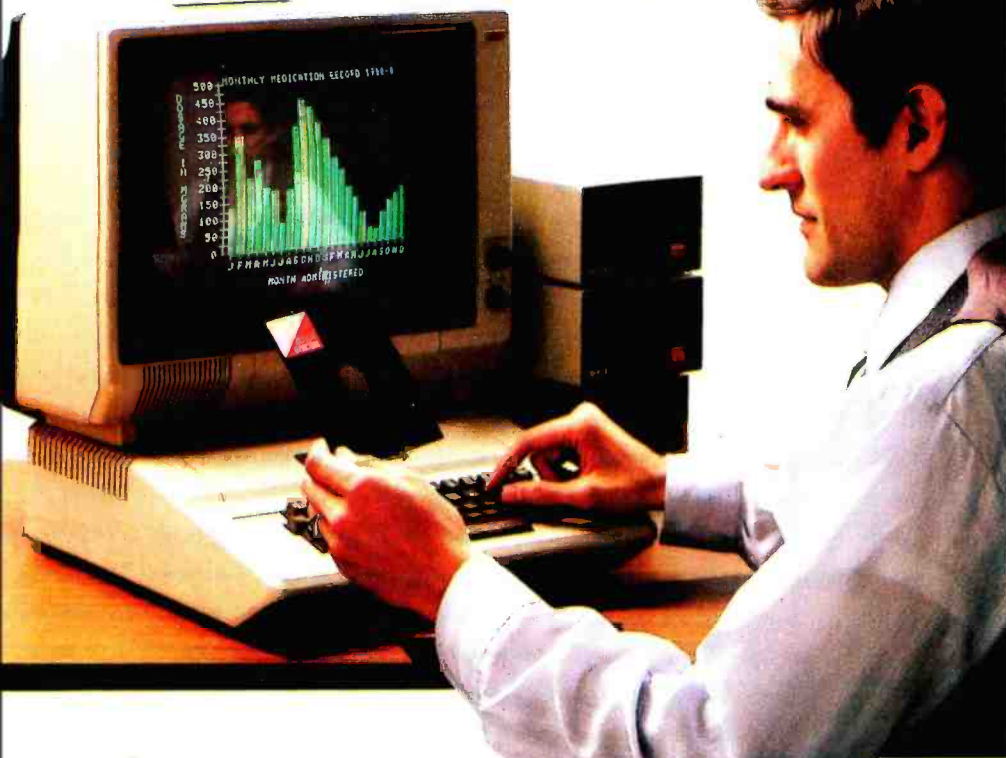


Mainframe-quality software at micro prices.

P.O. Box 248 Lafayette, IN 47902



# What if you want more assurance your valuable data won't fade away?



Rely on SYNCOM diskettes with Ectype<sup>®</sup> coating. Balanced coercivity means long-lasting signal life.

Syncom diskettes assure excellent archival performance in the following ways.

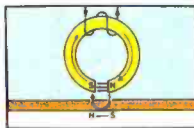
First, with calibrated coercivity – a precisely balanced blend of milled ferrous oxides that allows Ectype<sup>®</sup> coating to respond fully to "write" signals, for strong, permanent data retention.

Then, a burnished coating surface to boost both signal strength and packing density.

Carbon additives drain away static charge before it can alter data.

And, finally, every Syncom diskette is write/read-back certified to be 100% error free.

To see which Syncom diskette will replace the one you're using now, send for our free "Flexi-Finder" selection guide – and the name of the supplier nearest you.



Balanced coercivity of Ectype<sup>®</sup> coating allows write current to saturate fully and permanently.

Syncom, Box 130, Mitchell, SD 57301.  
800-843-9862; 605-996-8200.

## SYNCOM

Manufacturer of a full line of flexible media

"See us at NCC Booth #5510"

A Division of Swann's Sales Enterprises, Inc.

Circle 398 on inquiry card.

[www.americanradiohistory.com](http://www.americanradiohistory.com)

## Japanese Computers

memories will begin soon, and Fujitsu has developed a prototype 1-megabit bubble memory. Although Fujitsu foresees the use of bubble memories in personal computers, price seems an obstacle at present.

In the U.S., Fujitsu markets its small- and medium-scale computers via the TRW-Fujitsu Company, a joint venture with TRW Inc. Fujitsu exports its large-scale computers to Amdahl Corporation, which markets them in an OEM arrangement.

In the realm of microcomputers for the mass market, Fujitsu has yet to establish itself. Fujitsu's "piggy-back" microcomputers, with their detachable ROMs (read-only memories) are certainly innovative. Users find the ease of replacing these ROMs a great aid in program development. The Fujitsu Micro 8 (FM-8), with twin 6809s and an optional Z80, is impressive too, although we have lately learned that it will not be sold in the U.S. in its present form. Fujitsu is among the Japanese firms rumored to have 8086-based systems in development, but they're not expected to be unveiled this year.

**HITACHI** Hitachi is a 70-year-old corporation

whose 151,000 employees turn out thermal, hydroelectric, and nuclear power equipment as well as other electric utility equipment; chemicals; iron, steel, wire, and cable; industrial machinery; consumer products including televisions, video-tape recorders, audio equipment, and air conditioners; and computers, semiconductors, and other electronic equipment. Consumer items accounted for 21.3 percent of 1980 sales; computers, semiconductors, and other electronic equipment accounted for 18.9 percent. Hitachi's Maxell floppy disks have a substantial share of the market here and a reputation for excellent quality. Hitachi's dynamic RAMs also enjoy a good reputation, including the 64K-bit chips. In 1981, Hitachi was Japan's second-largest producer of semiconductors, turning out \$614 million worth of chips.

# THE \$595\* SMART TERMINAL

The Heath 19 Smart Video Terminal gives you all the important professional features you want in a terminal, all for under \$600.\* You get the flexibility you need for high-speed data entry, editing, inquiry and transaction processing. It's designed to be the backbone of your system with heavy-duty features that withstand the rigors of daily use.

Standard RS-232C interfacing makes the 19 compatible with DEC VT-52 and most computer systems. And with the 19, you get the friendly advice and expert service that makes Heath/Zenith a strong partner for you.

Sold through Heathkit Electronic Centers† nationwide (see your white pages for locations). Stop in today for a demonstration of the Heath 19 Smart Video Terminal. If you can't get to a store, send for the latest Heathkit® Catalog. Write Heath Co., Dept. 334-894, Benton Harbor, MI 49022.

## HEATH/ZENITH

Your strong partner

Completely addressable blinking cursor lets you edit anywhere on screen.

Reverse video by character lets you emphasize words, phrases or paragraphs.

High resolution CRT gives you sharp, easy-to-read image, reduces eye-strain.

Z-80 microprocessor-control makes the 19 capable of multitude of high-speed functions. It's the only terminal with ROM source code readily available.

Complete ASCII character set including upper case, lower case with descenders, and special graphic symbols.

80 character by 24 line format, plus 25th line for operator messages and prompts.

Professional quality keyboard, standard typewriter layout, 72 keys, including 12 special function keys.

Insert and delete character or line plus erase to end of line and end of screen make the 19 ideal for sophisticated editors like WORDSTAR.

Cursor and special functions are accessible by keyboard or computer, using either DEC VT-52 or ANSI Standard protocols.

Keypad in calculator format permits fast, easy entry of numeric data.



\*In kit form, F.O.B. Benton Harbor, MI. Also available the completely assembled Zenith Z-19 at \$895. Prices and specifications are subject to change without notice.

†Heath Company and Veritechnology Electronics Corporation are wholly-owned subsidiaries of Zenith Radio Corporation. The Heathkit Electronic Centers are operated by Veritechnology Electronics Corporation.

CP-202C



# IBM

## personal computer

# UCSD

## p-System™ IV-1

A superior implementation of the UCSD p-SYSTEM is available NOW for your IBM Personal Computer.

Network Consulting has added many features which the professional programmer will find useful. These features are not available from any other sources.

- Hard disk support for Corvus, Tall Grass Technology and others
- 25% more floppy storage, without adding or modifying hardware, retaining compatibility with standard IBM diskettes
- Double sided/double tracking/fast stepping floppy disk drive support
- RAM disk support (uses up to 512k RAM)
- Adaptable system support for adding custom I/O drivers
- Remote Terminal support
- XON/XOFF flow control for serial printers
- Disk write verification
- and more!

### Standard p-System features include:

- Program chaining
- Standard I/O redirection (including command files)
- Dynamic program overlays
- Support for asynchronous processes and concurrency primitives in Pascal
- Fast Pascal, Fortran and Basic compilers, all producing universal p-code programs
- A powerful screen oriented editor that runs in both programming and text editing modes
- A Native machine Code Generator that processes your Pascal, Fortran and Basic programs to convert parts of them to Native machine code
- Dynamic runtime binding of separately compile programs and units.
- Turtlegraphics for easy graphics displays
- Print spooler for background printing
- Symbolic debugger
- Extended memory support
- A library of program modules and other utilities

48 HOUR DELIVERY — CALL NOW!

### UCSD p—SYSTEM from Network Consulting

The only serious choice for business  
Dealer Inquiries Welcome

TM The Regents of the University of California



## Network Consulting Inc.

A106 - 1093 W. Broadway  
Vancouver, B.C.  
Canada V6H 1E2  
(604) 738-3500

## Japanese Computers

Hitachi's integrated circuits and computers have been selling well where marketed under Hitachi's own name. Domestic Japanese sales of Hitachi's M and L series computers have been brisk. Hitachi's M-280H is among the world's most powerful computers, with 32 megabytes of main memory. What better place to dump that much data than the Hitachi disk storage unit that holds 2.5 gigabytes? The HITAC E-800 is a formidable super minicomputer, and the HITAC L series is designed for use as terminals in distributed processing. At the smaller end of the size scale, Hitachi offers three microcomputers based on the 6809 processor; the MB-6890, reviewed in this issue, is the most powerful of the three.

Despite its size, technical excellence, and vertical integration, Hitachi has suffered some setbacks in foreign markets. Hitachi was supplying processors to Intel in the United States, and Intel's debacle in computers hurt Hitachi here. In response, Hitachi has signed an agreement to supply large processors to a National Semiconductor Corporation subsidiary, National Advanced Systems Corporation. Hitachi has a similar arrangement in Europe with Olivetti.

The FCC's radio-frequency interference rules postponed the Hitachi 6809-based machines' entry into the American market. Hitachi is showing signs of being unhappy about software support for its 6809-based systems and is considering basing its future microcomputers on the 8086. Whatever Hitachi's decision, this giant company can make anything it wants to make, and it is sure to make interesting microcomputers.

# NEC

Nippon Electric Company is another of the Japanese corporate giants on the international scene. With 64,000 employees and \$5,174,493,000 in assets in 1981, NEC produces consumer products, including color televisions, hi-fi audio equipment, and kitchen appliances; microcomputers such as the PC-8000

series; and minicomputers such as the Astra series. It also produces mainframes, including the NEC System 1000, which can execute 29 million instructions per second, has a 64-megabyte main memory, a 256K-byte high-speed cache memory, and excellent integrated circuits, including NEC's widely used 64K-bit dynamic RAM chips (256K-byte dynamic RAMs and 512K-bit ROMs are in the experimental stage).

NEC's long list of peripherals is headed by the excellent Spinwriter series of letter-quality printers, renowned RGB (red-green-blue) color monitors, matrix printers, band printers, modems, floppy disks, and Winchester hard disks. In 1981, NEC led the world in production of semiconductors with sales of \$805 million, about seven times those of Texas Instruments.

NEC clearly has everything needed for vertically integrated production of microcomputer systems. Moreover, much of its strength is in computers (24 percent), electronic devices (23 percent), and home electronics (13 percent).

Two of NEC's subsidiaries are now selling the PC-8000 series in the U.S. NEC Home Electronics USA, Personal Computer Division, targets the personal-computer market, while NEC Information Systems Inc. sells to the small-business market. NEC Information Systems also offers office furniture designed for the PC-8000 and a new communications board for the PC-8000 in the office environment. Since its inception in 1977, NEC Information Systems has grown to an annual revenue rate of \$100 million.

Indications are that both NEC Home Electronics and NEC Information Systems plan aggressive expansion. NEC exhibited two new 8-bit microcomputers in Japan last year. Reports suggest that NEC Home Electronics will bring out a computer (perhaps the PC-6000) to compete head-on in price with the Commodore VIC.

NEC Information Systems may introduce the PC-8800, which will represent an improvement in mass storage

# FMS-80. THE TWO DOOR DATA BASE PLUS



Door # 1: Reports you'll use *today*.  
Door # 2: The sky is the limit.

We've split the proven, best-selling FMS-80 micro data base manager into two parts. And we've split the price.

Part one (FMS-81) gives you the essential file and reporting features. You can quickly create programs with input questions a clerk can understand, and with reports a manager can use.

And FMS-81 with its new manual, is so easy to use, you'll be generating reports the first day. FMS-81 sells for \$495.

Part two (FMS-82) has all the fancy stuff. Including an Extended File Maintenance language that lets you perform virtually unlimited manipulation on up to 19 different data files simultaneously.

Using FMS-82, you or your computer dealer can make FMS-80 do *just about anything*. FMS-82 sells for \$495.

Naturally, FMS-82 is fully compatible with all the files and functions you generate with FMS-81.

FMS-81 is so useful, it might seem like you'll never need FMS-82.

But as you expand your use of computers, isn't it nice to know it's there?

The FMS family runs under CP/M, MP/M, CDOS, and Turbodos. Call or write today for a brochure detailing the extensive capabilities of the Two Door Data Base Manager, and the name of your nearest dealer.

You'll be impressed.

**Systems Plus, Inc.**



1120 San Antonio Road  
Palo Alto, CA 94303  
(415) 969-7047

o *djr* product  
DJR Associates, Inc.  
2 Highland Lane  
North Tarrytown,  
NY 10591

FMS-80, FMS-81, FMS-82  
TM DJR Associates  
CP/M, MP/M TM Digital Research  
CDOS TM Cromemco  
Turbodos TM Software 2000, Inc.

Circle 403 on Inquiry card.





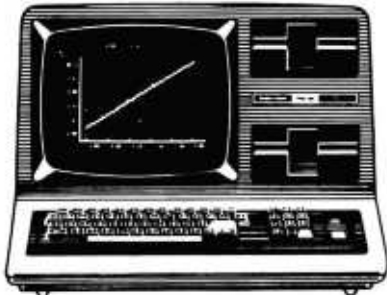
**AMERICAN** Small Business **COMPUTERS**

118 S. MILL ST. PRYOR, OK. 74761

ALL PRICES ARE CASH DISCOUNTED  
3% C.O.D. AND CHARGE ORDERS  
ARE 3% MORE. DEALER INQUIRIES  
INVITED

**DON'T PAY MORE !!!**

**TRS-80 MODEL III**



16K.....	\$825
48K.....	\$849
48K 1-DRIVE.....	\$1499
48K 2-DRIVE.....	\$1749

**TRS-80 DISK DRIVES**

<b>MODEL I</b>	
TEAC or TANDON.....	\$250
<b>MODEL III</b>	
DRIVE 0.....	\$595
DRIVE 1.....	\$239
DRIVE 2, 3.....	\$250
<b>COLOR COMPUTER</b>	
DRIVE 0.....	\$499
DRIVE 1, 2, 3.....	\$250

**EPSON PRINTERS**

ALMOST EVERYONE WHO CALLS ABOUT EPSON PRICES BUYS A PRINTER. THERE ARE TWO REASONS FOR THIS: 1. WE USUALLY HAVE THE LOWEST PRICE IN THE COUNTRY. 2. WE ALMOST ALWAYS HAVE THE PRINTER THEY NEED IN STOCK. SO...CALL US TODAY!

**AW...WHAT THE HECK**

RAM Memory Chips for the TRS-80 Apple

It is the policy of American Business Computers to offer merchandise at the lowest price possible. Several months back we began selling RAM Memory Chips for the TRS-80 for \$65.00 per set. Someone else sold chips for \$44.00. We sold them for \$38.00. They sold them for \$37.95. So we say "AW...WHAT THE HECK!" Let's see the other guys beat this price.

These chips are brand new "4116's". These 200 nano-second chips are fully compatible with all TRS-80 products. Instructions for installation are included, however, the dip switches required for converting a 4K Model I to a 16K Model I are not included at this low price.

\$16.95	PER
16K	SET

<b>COLOR COMPUTERS</b>	
4K LEVEL I.....	\$318
16K LEVEL I.....	\$335
16K EXT. BASIC.....	\$435
32K EXT. BASIC.....	\$520
MODEL II.....	\$3287
MODEL 16 1-DRIVE.....	\$4495
MODEL 16 2-DRIVE.....	\$5218

<b>OKIDATA MICROLINE 80.....</b>	
82A.....	\$399
83A.....	\$469
84.....	\$719
84.....	\$1250
C. ITOH F10-40.....	\$1450
C. ITOH F10-55.....	\$1750
C. ITOH PROWRITER.....	\$499

PACKET MAN FOR COLOR COMPUTER.....\$24.95

**918-825-4844**

**Japanese Computers**

and packaging over the the PC-8000. The 8800 is expected to have 8-inch drives, and, unlike the PC-8000, the whole system can be turned on and off with a single switch. Both NEC Home Electronics and NEC Information Systems are offering more applications software tailored to the PC-8000.

Rumors are also circulating that NEC will introduce a 16-bit micro-computer based on Intel's 8086 micro-processor, but it's unclear whether the machine's target is home, office, or both. If and when NEC does introduce the 8086-based machine, much will be determined by which subsidiary introduces it—NEC Home Electronics, NEC Information Systems, or both.



Akio Watanabe founded Systems Formulate in September 1978. Since 1964,

Watanabe's true love has been small computers. While a hardware designer at Fujitsu, he designed the FACOM 230 and FACOM V series systems. Watanabe struck out on his own in 1978 in order to spread the benefits of microcomputers to the public. Systems Formulate not only designs and sells machines but also provides training courses.

Sales from April 1980 to March 1981 were \$4,300,000, up from \$3,100,000 the previous year. Systems Formulate has already made a full return on its original investment of \$230,000. Fujitsu president Taiyu Kobayashi helped Systems Formulate with technology and personnel as well as financing.

Perhaps the most striking fact about Systems Formulate is that it sells 8 to 10 percent of all the personal computers in Japan. Systems Formulate has four retail stores, three in Japan and one in Palo Alto, California. The systems sold include the Commodore VIC, the Apple, the NEC PC-8001, and the Oki if800.

Systems Formulate has two training "campuses," both in Japan. The campuses, which offer a variety of software training courses, provide a sepa-

rate personal computer for each student. The most popular course? "SB nyu-mon," the beginner's course in small-business computer applications. Students can rent computer time for study outside class hours.

Watanabe and other Systems Formulate staff members designed the Z80-based Bubcom80, which Fujitsu builds. The Bubcom80 is a beautiful machine, and a drop in the price of bubble memory would make it hard to resist. Systems Formulate's direct retail sales of computers may enable the company's talented designers to understand better than others the needs of personal computer users. Add to that the little company's close ties with Fujitsu and apparent ability to use the giant's production facilities, and Systems Formulate seems an attractive dark horse in the American microcomputer market. At this point, however, Systems Formulate's only machine is too expensive for all but a few personal computer users.

**TOSHIBA** A century-old, \$9-billion com-

pany that employs almost 64,000 people, Toshiba offers products that range from light bulbs to a neutral-beam injector for fusion experiments. Perhaps most impressive about Toshiba as a contender in the U.S. personal computer market is that Toshiba combines experience in both consumer electronics and information-processing systems with the capacity for vertical integration. Toshiba is Japan's third-largest producer of semiconductors, with sales of \$541 million in 1981.

Toshiba's technological feats include a pocket liquid-crystal-display television, a voice-driven word processor for the intricate Japanese language, a highly successful family of CMOS integrated circuits, and the world's first microcomputer that uses silicon-on-sapphire (SOS) technology.

The first two microcomputers Toshiba introduced in the United States were its T200 and T250 desktop machines. Both use the 8085A micro-processor and come with CP/M, CBASIC II, and Microsoft BASIC

# G&G ENGINEERING is working wonders with CompuPro™!

You can get *FAST* single and multi-user CompuPro based configurations fully integrated from G&G ENGINEERING.



## MULTI-USER SYSTEMS

### **MP/M™ 8-16**

Are you having trouble deciding whether to go 8 bits (with lots of software that runs *NOW*), or 16 bits (with all that potential power)? Thanks to G&G, it's a split decision—*EVERYBODY WINS!* G&G ENGINEERING's implementation of MP/M 86™ does it all! We call our package **MP/M 8-16** because it uses Digital Research's MP/M 86 to provide a multi-user, multi-tasking environment for running both CP/M 2.2™ and CP/M 86™ compatible programs . . . AT THE SAME TIME!

That's right! Imagine a system where one user could be running Wordstar™, another dBASE II™, a third SUPERCALC™ (all 8 bit CP/M 2.2 compatible programs), while a fourth user runs CBASIC 86™ (16 bits and CP/M 86 compatible)! It's all made possible thanks to CompuPro's powerful hardware, including the 8085/8088 processor board and DMA

disk controllers, and thanks to G&G Engineering's software expertise.

Plus you can install up to a Megabyte of CompuPro high speed static RAM memory and an assortment of hard disk drives. This system means business.

But flexibility isn't the only good news. This system is also *FAST* (naturally, it's by G&G). What's more, it's *BIG*. CP/M 2.2 compatible programs when run under **MP/M 8-16** are not limited to user work areas of 48K, as with 8-bit-only MP/M systems. With MP/M 8-16, your work area for 8 bit software is a whopping 62K!

\*MP/M 8-16 is a proprietary implementation of MP/M 86 version 2.0. This implementation takes advantage of the CompuPro 8085/8088 processor card and can not be run on other CPU cards.

## **UNIX®**

DUAL SYSTEMS and CompuPro make a perfect match in the best micro-computer version of UNIX we've seen. This is not "UNIX-LIKE"—this *IS* UNIX, implemented on the MC68000 processor (32 bit internal registers!). For the software connoisseur.

APPLICATIONS  
(for users of our CompuPro systems)

## **SUPERSHEET™**

Now you can really spread out with **SuperSheet**, G&G's enhancement of Sorcim's SUPERCALC™. Upward compatible with all your existing SUPERCALC files, **SuperSheet** allows up to 15 times more storage! If you are among the many who have been frustrated by the Memory FULL message, **SuperSheet** is the answer to your prayers! This is the largest electronic spreadsheet program on the market. Once again, G&G has taken the best and made it even better. (Requires a minimum of 128K RAM.)

## **WARP DRIVE™**

Compute in the *fast* lane with **WARP DRIVE**, G&G's RAM memory disk drive. **WARP DRIVE** is extended address RAM memory configured with CP/M 2.2 to look like a disk drive. Your programs can run from 10 to 30 times faster! When running CP/M 86, **WARP DRIVE** automatically becomes directly addressable main memory. **WARP DRIVE** is available in sizes ranging from 128K to 1 Megabyte.

## **CPM-IBM**

Turn your G&G system into an IBM-ulator! Your system can become a powerful software development tool for the IBM Personal Computer. (We use CompuPro's Dual Processor 8085/88—the same hardware IBM used for their own development!) Our **CPM-IBM** program allows you to transfer CP/M® compatible files to and from 5¼-inch diskettes in the IBM DOS format. The program discerns what kind of file or diskette it is reading, then does the appropriate conversion—IBM to CP/M or CP/M to IBM. G&G makes it easy!

**G&G ENGINEERING**  
1922 Republic Avenue, San Leandro, CA 94577 (415) 895-0798

G&G Engineering is an authorized CompuPro Systems Center. We specialize in CP/M S-100 Software and Hardware integration. Our engineers are factory-trained experts in CompuPro products. All our CompuPro equipment is covered by a 2-year phone exchange warranty. Single-user systems start at \$5,000 and multi-user systems begin at \$9,000.

\*COMPUPRO is a trademark of Godbout Electronic; MP/M, MP/M 86, CP/M, CP/M 2.2 and CP/M 86 are trademarks of Digital Research; WORDSTAR is a trademark of MicroPro; dBASE II is a trademark of Ashton-Tate; SUPERCALC and SUPERSHEET are trademarks of Sorcim; CBASIC 86 is a trademark of Compiler Systems Inc.; UNIX is a trademark of Bell Laboratories; WARP DRIVE is a trademark of G&G Engineering.





# SITTING PRETTY

You can use just about any desk for a computer terminal stand. But with CF&A, you're sitting pretty. Our full range of desks, workstations, and terminal stands are designed to accommodate a variety of computer equipment. Choose from our Classic Series desks, DR Series desks and enclosures, specialty items like our Apple II desk, or a universal printer stand. You'll be sitting pretty with attractive color selections, durable construction, versatile configurations, useful options, competitive prices, quick delivery, and personal service. It's our way of doing business.

# CF&A

**Computer Furniture and Accessories, Inc.**  
 1441 West 132nd Street  
 Gardena, CA 90249  
 (213) 327-7710

## Japanese Computers

standard. The T200 has two 5¼-inch built-in disk drives, and the T250 has two 8-inch built-in disk drives.

At January's Consumer Electronics Show in Las Vegas, Toshiba surprised everyone by showing a third microcomputer, this one using a Z80A processor. Called the T100, this model has BASIC in a 32K-byte ROM, 64K bytes of user RAM, 16K bytes of video RAM, and the capacity to accept two additional 8- to 32K-byte ROM or RAM packs containing languages or applications programs. The T100's price starts at less than \$1000 and demonstrates the seriousness of Toshiba's interest in the American personal computer market. The T100 may or may not be the same machine as the rumored Toshiba PASOPIA. The PASOPIA was supposedly based on the 6502 processor and was to be priced below the Apple.

Toshiba will introduce another microcomputer at the June National Computer Conference in Houston. The T300 uses the more powerful 8088 microprocessor and is aimed at the small-business market. A single-user system with dual 8-inch, slim-line disk drives may sell for as little as \$3500, with a 10-megabyte Winchester hard-disk drive costing perhaps \$4000. A multiuser system consisting of four T300s, a Winchester drive, and a printer may sell for around \$25,000.

All of a sudden, Toshiba has covered the entire spectrum of the American microcomputer market. Its products range from home computers for under \$1000 to multiuser systems for \$25,000. The T100, T200, T250, and T300 together seem to reflect excellent long-range planning. According to Toshiba, all four machines will run the same software. There may also be a 6502-based PASOPIA in the works.

Toshiba has signed 30 dealers and has a goal of signing 40 more this year. It has also opened two retail computer stores, one in the Westwood section of Los Angeles and the other in Costa Mesa, California. Vice-president and general manager John Rehfeld of Toshiba America stresses that the

retail stores will serve as "learning laboratories for gathering information which can be useful to our dealer network."

### Speculations and a Pipe Dream

At the moment, it looks as if NEC and Toshiba are leading the pack in marketing Japanese microcomputers in the United States. Expect them to maintain their lead for some time. Both companies will soon be offering complete lines of microcomputers ranging widely in price. Both seem determined to win a significant share of the American market. Both have the resources for large-scale, vertically integrated manufacturing. Toshiba has marketed more consumer products here, but NEC has established dealer networks for its Spinwriters and video monitors and, to some extent, for its PC-8000 series.

Later this year or early in 1983, Hitachi can be expected to introduce in the U.S. a series of powerful microcomputers. Despite its setbacks in marketing computers here, Hitachi is such an impressive company that its products are likely to be worth the wait. Hitachi has successfully marketed consumer products in the U.S. and has everything necessary for vertically integrated production. The only questions are whether Hitachi will decide to build the right machines and whether the market will still be waiting by the time the Hitachi machines arrive.

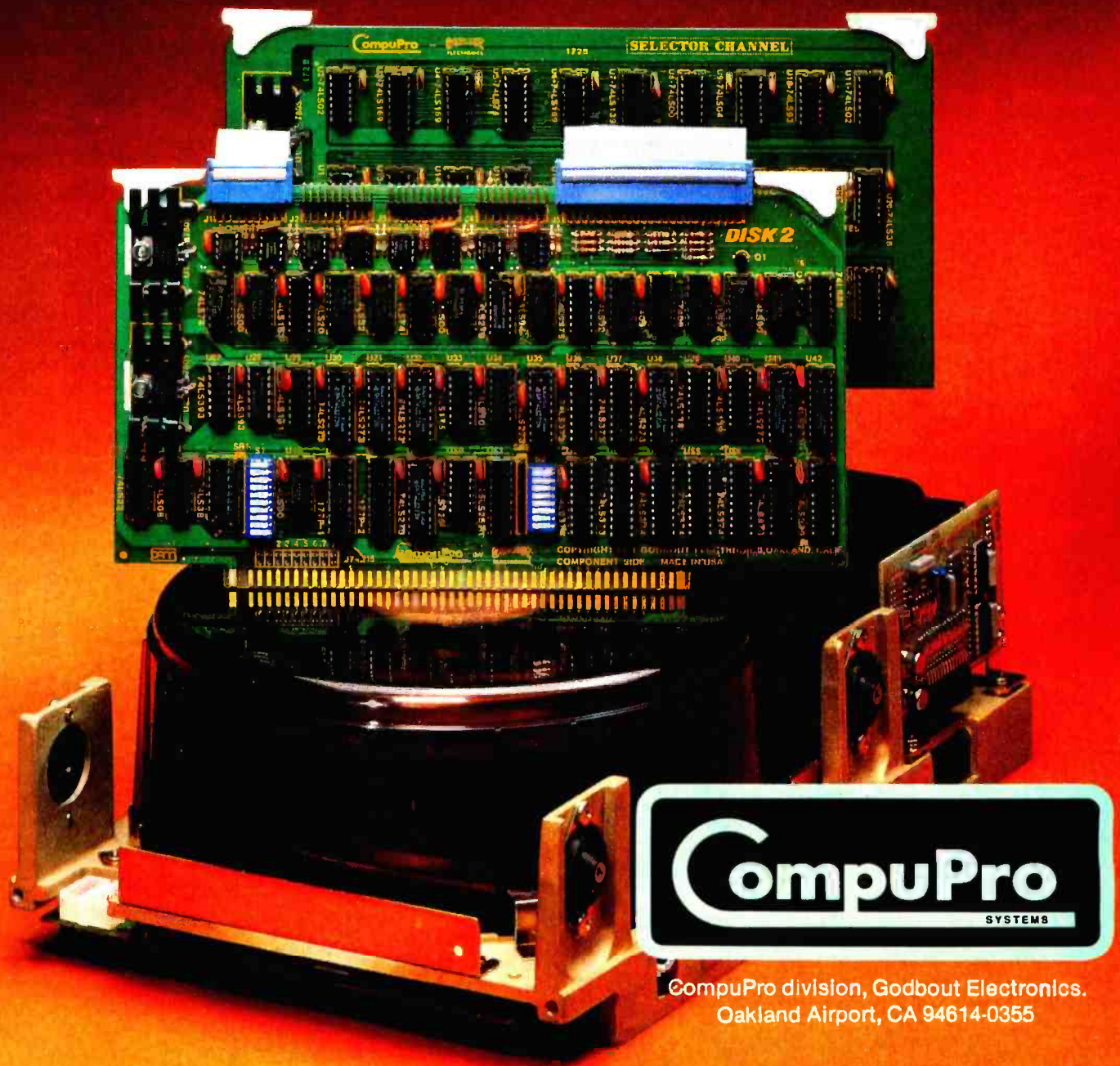
As for the consumer electronics companies, Seiko's Epson subsidiary will probably be the first to make a strong showing. Existing marketing channels and consumer enthusiasm for the MX-80, along with Seiko's state-of-the-art CMOS technology, enormous financial resources, and experience in manufacturing microcomputers, give Epson an excellent chance of winning a significant share of the American market. This is certain if Epson decides to sell its computers, as it does its printers, for very low prices.

Expect Sony and Matsushita to burst on the scene sometime during 1982 with compact, convenient home

# Performance, quality, reliability.

## Disk 2/Selector Channel

Excellence in DMA hard disk control.



**CompuPro**  
SYSTEMS

CompuPro division, Godbout Electronics.  
Oakland Airport, CA 94614-0355

For business, scientific, and industrial computing solutions,  
contact your authorized **CompuPro Systems Center**.



# Performance, Quality, Reliability.

## Disk controllers/ sub-system

**Disk 1.** High performance, DMA floppy disk controller for single or double-density, single or double-sided diskettes. IBM (soft-sector) compatible. \$495, \$595 CSC. CP/M® 2.2 \$175, CP/M-86 \$300.

**Disk 2.** High performance, DMA hard disk controller handles up to four disk drives, up to sixteen heads per drive. Compatible with MP/M, OASIS, CP/M-80, and CP/M-86. Contact factory for pricing.

**Floppy Disk Sub-System.** Two Qume double-sided, double-density drives provide up to 2.4M bytes of on-line mass storage. With all-metal enclosure, **Disk 1** DMA floppy disk controller, CP/M-80, and CP/M-86. \$3295.

### MP/M 8-16 Operating System.

CompuPro's proprietary version of Digital Research's multi-user MP/M-86 (V2.0) gives you the best of both worlds: Run 8 bit (CP/M 2.2) and 16 bit (CP/M-86) software - **simultaneously** - in a multi-user environment. \$990.

## Interfacers

**Interfacer 1.** Two RS-232C serial ports, full handshake, independently selectable Baud rates. \$249, \$324 CSC.

**Interfacer 2.** Three full duplex parallel ports plus one full-feature RS-232C serial port. \$249, \$324 CSC.

**Interfacer 3-5.** Five RS-232C serial ports (2 sync/async, 3 async) with full handshake and selectable Baud rates. \$599, \$699 CSC.

**Interfacer 3-8.** Eight RS-232C serial ports (2 sync/async, 6 async) with full handshake and selectable Baud rates. \$699, \$849 CSC.

**Coming soon: Interfacer 4.** The latest addition to the interfacers series. Three RS-232C serial ports, one parallel port, and one Centronics parallel port.

## Memory

Static operation gives flawless DMA while handling 10 MHz clock speeds.

**RAM 20.** Extended addressing or bank select. **RAM 20-8K: \$210, \$280 CSC.** **RAM 20-16K: \$285, \$355 CSC.** **RAM 20-24K: \$355, \$425 CSC.** **RAM 20-32K: \$425, \$495 CSC.**

**RAM 16.** Works automatically with 8 or 16 bit systems (64K X 8 or 32K X 16). \$650, \$750 CSC.

**RAM 17.** Ultra low power (1.6 Watts typical for 64K). **RAM 17-64K: \$599, \$699 CSC.** 48K version also available.

**RAM 21.** Low power, high density. Works automatically with 8 or 16 bit systems (128K X 8 or 64K by 16). \$1695, \$1895 CSC.

**M-DRIVE.** The first "solid state disk drive" increases operating speeds up to 3500%. Memory saves are virtually instantaneous, spread sheets recalculate faster, long compiles take milliseconds instead of minutes, and disk wear is minimized too. You haven't experienced computing in the fast lane—until you've experienced M-DRIVE. **128K M-DRIVE \$1198, 256K M-DRIVE \$2395** (prices based on RAM 17; also available for other RAM types).

## CPUs

**CPU 8085/88.** Executes today's 8 bit and tomorrow's 16 bit software on an 8 bit bus. Chosen by leading software houses for IBM PC software development. \$425, \$525 CSC.

**CPU Z.** The preferred Z80 board for high speed processing. \$295, \$395 CSC.

**CPU 8086/87.** High-performance 16 bit CPU includes sockets for 8087 math co-processor and 80130 interval timer/interrupt controller. Compatible with 8 bit and 16 bit memory, or any mix thereof. \$695, \$850 CSC.

### Coming soon: 8 bit Slave Processor.

Designed to complement 16 bit CPUs (such as CPU 8086/87 and our upcoming 68K board), and 16/32 bit CPUs, by running existing libraries of 8 bit software.

Your authorized **CompuPro Systems Center** specializes  
Circle the reader-service number for



**CompuPro** delivers results in the toughest business, industrial, and scientific computing environments. Backed by a one year limited warranty (two years for boards qualified under the **Certified System Component** high-reliability program), **CompuPro** system components are the leading choice of systems integrators world-wide.

When you depend on your computer, choose a computer on which you can depend: IEEE 696/S-100 from **CompuPro**.

## High-performance motherboards

**6 Slots.** \$140, \$190 CSC.  
**12 Slots.** \$175, \$240 CSC.  
**20 Slots.** \$265, \$340 CSC.

## Documentation.

**"CompuPro Product User Manuals: 1975 - 1980"**. This 250 + page book includes data on all older Godbout/CompuPro products, as well as many newer products such as the Spectrum Color Graphics board, Interfacers 1 and 2, CPU 8085/88, motherboards, CPU Z, and more. Softcover, \$20.

**"CompuPro Product User Manuals, Volume 2"**. 300 + page book includes data on System Support 1, Disk 1, RAM 17, Interfacer 3, System Enclosure, and STD products. Softcover, \$25.

**"Interfacing to S-100/IEEE 696 Microcomputers"**. By Mark Garetz and Sol Libes; published by McGraw-Hill. Covers operating requirements and characteristics of the S-100 bus with clarity and precision. Softcover, \$15.

**Individual user manuals.** Interfacer 3, \$10; Disk Controller, \$25; System Support 1, \$20; most others, \$5.

## Other computer products

**MPX 1-4** (4K on-board RAM) \$495, \$595 CSC.  
**MPX 1-16** (16K on-board RAM) \$649, \$749 CSC.  
Front end processor ideal for use with multi-user systems.

**Enclosure 2.** Rugged, all-metal construction. Includes 20 slot motherboard, heavy-duty power supply with constant voltage transformer and line filter, cutouts for all popular connectors, positive pressurized fan with dust filter, attractive styling.  
**Desktop model \$825, rack mount \$895.**

**System Support 1.** Battery clock/calendar; sockets for battery backup RAM, 9511 or 9512 math processor, and 2716 ROM options; RS-232C serial port; triple interval timers; dual interrupt controllers; power fail interrupt; more. \$395, \$495 CSC (add \$195 to all prices for optional math processor).

**Selector Channel.** High speed DMA controller. Contact factory for pricing.

**Mullen Extender Board.** Simplifies servicing, troubleshooting, and testing. \$89.00

**Mullen Controller Board.** 8 opto-isolators accept outside world input data; drives 8 reed relays for computer interface to external devices (power relays, lights, etc.). \$219.00

CP/M, CP/M-86, and MP/M are trademarks of Digital Research; OASIS is a trademark of Phase 1.



CompuPro division, Godbout Electronics, Oakland Airport, CA 94614-0355

In business, industrial, and scientific computing.  
The Systems Center nearest you.

Circle 87 on Inquiry card.



# with *Vector-pak* You Can Package Almost ANY System Faster, Have It Look Better, & Cost Less!

Using one of these systems?

- MULTI-BUS,
- Motorola Exorciser,
- Rockwell AIM 65 Expansion,
- STD-BUS,
- S-100 & IEEE 696.

New packaging available.

### Vector exclusives;

Your choice of plastic or metal card guides, fixed or adjustable positioning. Mount connectors or motherboards **without** special

hardware or hole drilling. Vector

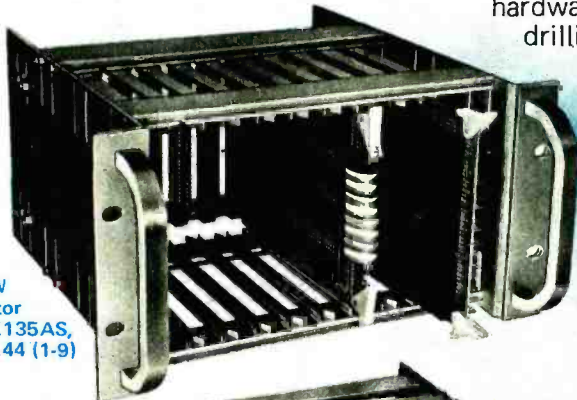
ships more card cages and packaging off-the-shelf, than any other company.

For expert assistance, call the packaging professionals in California, (213)365-9661, outside California, use our toll-free number: (800)423-5659.

"See us at Electro Booth #1510"



Vector CCK100, \$51.79 (1-9)  
for S-100, IEEE696, Motorola Exorciser.



NEW  
Vector  
CCK135AS,  
\$37.44 (1-9)



Complete as shown, Vector  
CMA3A-20 with modules, \$159.60 (1-9)

Prices subject to change without notice.

 **Vector Electronic Company**  
INCORPORATED

17480 Gladstone Avenue, Sylmar, California 91342; TWX (910) 495-1160

## Japanese Computers

computers that will set new standards for ease of use. The marketing channels open to these two companies are so extensive that both can easily recover from a late start.

The challenge to these companies is to design and produce the right machine on the first try. If the machines sacrifice versatility and performance to achieve the kind of compactness that fits neatly on one corner of a coffee table, then Sony and Matsushita will have to work very hard to succeed on the second try. If these two companies come in with machines that are not only compact and convenient but also are as powerful as the IBM Personal Computer, look out!

Any of the companies described in this article, as well as their American competitors, could get a lead on the others by bringing to market a system with clearly superior performance for the price. One obvious strategy would be to sell a standard built-in micro-Winchester hard disk for about the price of two standard floppy-disk drives. Veteran microcomputer users know how much faster the hard disks make many operations, and novices could tell at a glance when shopping for a system. Japanese and American computer companies with experience in manufacturing hard disks could turn that experience to advantage by mass producing micro-Winchesters and selling them at mass-market prices.

Here's where speculation ends and a pipe dream begins (no reference to Unix intended). Imagine an 8086-based system with 256K-bytes of RAM, a CP/M-86 or MS-DOS operating system, BASIC in ROM, and a keyboard of high quality and versatility. That sounds a lot like a fully equipped IBM Personal Computer. Add a built-in micro-Winchester drive, a fold-away flat-screen video display, a built-in LSI 1200-bit-per-second modem, a home-appliance controller, and sell the whole thing for \$3500 or less. Offer a high-quality RGB color monitor for \$500. Then IBM, Radio Shack, and Apple would have something to worry about. ■

# INCREASE SALES OF CP/M®

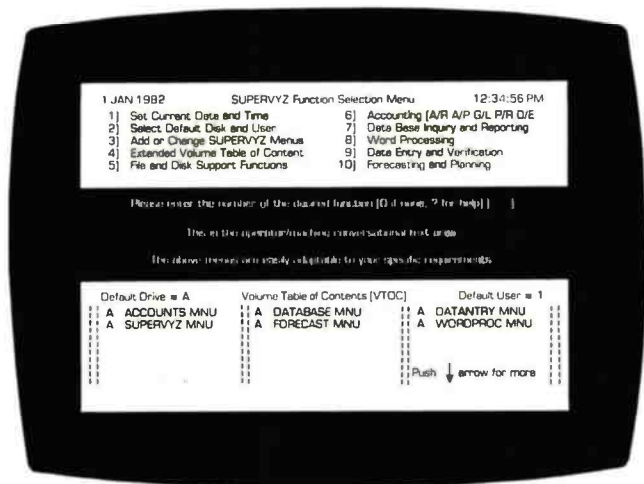
**ANYONE CAN USE CP/M  
WITH SUPERVYZ**

**EXPAND YOUR MARKET  
AND LOWER COSTS**

SUPERVYZ is a revolutionary software concept that serves as a mediator between the user and CP/M, requesting information in plain English and translating the response into the form CP/M recognizes. Users are led from one application to another in a courteous and step-by-step sequence of menus. Aided by descriptive error messages and computer-assisted tutoring, the operator avoids mistakes and is advised of the next step in a polite and friendly manner.

As a Dealer, SUPERVYZ allows you to sell CP/M computers and application software to non-technical markets, without the added expense of teaching the operating system. EPIC supplies the menus or you create your own to meet the exact needs of your customers. Because SUPERVYZ is compatible with over 2,000 programs and 300 computers, you can bundle software from different suppliers and SUPERVYZ does the teaching. This eliminates costly after-the-sale handholding.

For further information about EPIC SUPERVYZ, call or write us today.



Supervyz is a trademark of  
Epic Computer Corporation.  
CP/M is a Trademark of  
Digital Research.

**EPIC**  
EPIC SOFTWARE

Epic Computer Corporation  
7542 Trade Street  
San Diego, CA 92121  
Tel. 714-695-3560

NOW SOLD THROUGH DISTRIBUTORS  
IN POPULAR FORMATS  
**800-421-0814**  
DEALERS ONLY PLEASE

Circle 163 on inquiry card.



TM



## Japan Maps Computer Domination

*Ten-year research and development effort leading to fifth-generation systems for the 1990s is aimed at leapfrogging U.S. technology.*

---

Tom Manuel  
Computers & Peripherals Editor  
ELECTRONICS

---

The Japanese have set out to leapfrog U.S. computer technology and become the world's leading suppliers of advanced computer systems. After two years of study and research, the Japanese Information Processing Development Center—JIPDEC—has hammered out a body of ideas, plans, and recommendations for projects that will culminate in what it calls a fifth-generation system by 1990.

The plan for research and development during the coming decade neatly integrates many of the innovative ideas from researchers in the U.S., Japan, and the rest of the world, extending and fitting them into the new system [ELECTRONICS, November 3, 1981, p. 71].

---

Reprinted from ELECTRONICS, November 17, 1981. Copyright © McGraw-Hill, Inc., 1981. All rights reserved.

---

What makes the goal entirely believable is the Japanese ability to turn such efforts into a national project. That gives them, in effect, a na-

---

**Fifth-generation computers will come in sizes ranging from small personal computers to large mainframe computers.**

---

tional computer policy that is concentrated, organized, and possibly government-backed in a way that other countries cannot match.

### **Problem Solver**

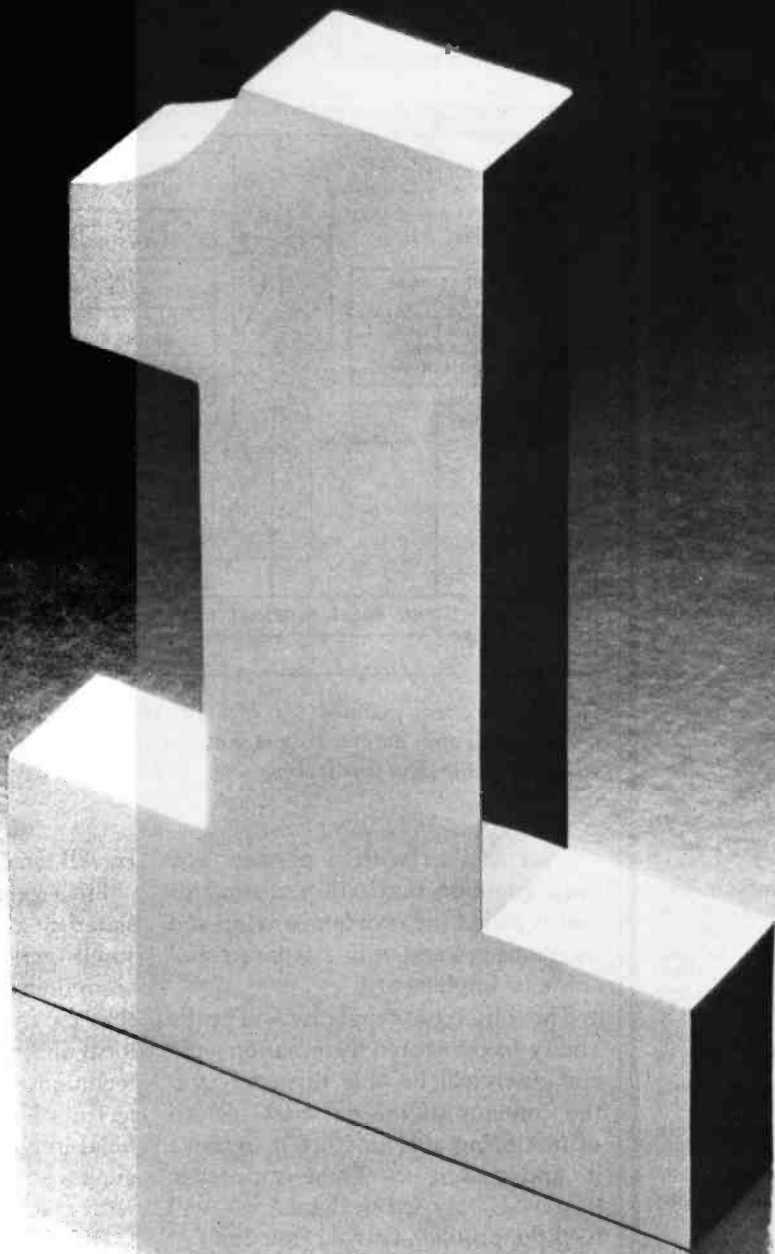
To meet Japan's needs, the computer of the future, in addition to

having a higher performance level at lower cost, must be able to handle many more general problem-solving tasks than today's machines. In addition, the system must be as natural for people to use as it is for them to speak. Access is to be through natural language, everyday speech, and pictures. The system that will perform this feat is being called the intelligent-interface machine (see figure 1).

Another of its three basic functions will be the system's ability to learn, associate, and infer, just as people do. The computer will be able to clarify even vague requests and then, by using its vast store of information or that available from other computers, make judgments that will enhance the thinking capacity of its human masters.

In other words, the computer could carry on an intelligent question-and-

We are dedicated to the achievement of a singular goal . . .  
to market fully supported software that sets standards of excellence.  
Standards against which all software will be measured.  
Standards which require that we, as well as the OEM's and authors  
with whom we labor, constantly offer the state-of-the-art.  
Our commitment to being Number One is too strong for  
Lifeboat to market anything less.



## **Lifeboat Associates**

The standard for fully supported software.

1651 Third Avenue, NY, NY 10028. (212) 860-0300.  
TWX 710-581-2524 (LBSOFT NYK).



# INDUCTIVE COUPLED MODEM

Eliminates noise, vibration problems. Originate/Answer. Bell 103. Cassette port saves data.



**\$129.95** Money back if not delighted

**MFJ-1230 INDUCTIVE COUPLED MODEM** eliminates room noise, vibration caused by acoustic coupling. Gives more reliable data transfer. Used like acoustic modem. 0-300 Baud, Bell 103 compatible. Originate/answer. Half/full duplex. RS-232, TTL, CMOS compatible. Use any computer. Cassette tape ports save data. 110 VAC or 9 V batteries. Crystal controlled. Carrier detect, power LEDs. 9x1 1/2x4". **MFJ-1231, \$39.95.** Optional cable, software for Apple II, II Plus. Plugs into game port. No serial board needed.

**\$99.95**

**MFJ-1108 AC POWER CENTER.** Adds convenience, prevents data loss, head bounce, equipment damage. Relay latches power off during power transients. Multi filters isolate equipment, eliminate interaction, noise, hash. Varistors suppress spikes. 3 isolated, switched socket pairs. One unswitched for clock, etc. Lighted power, reset switch. Pop-out fuse. 3 wire, 6 ft. cord. 15 A/125 V, 1875 watts. Aluminum case. Black. 18x2 3/4 x2 in. **MFJ-1107, \$79.95.** Like 1108 less relay. 8 sockets. 2 unswitched. Other models available.



It's like having an extra port **\$79.95**

**MFJ-1240 RS-232 TRANSFER SWITCH.** Switches computer between 2 peripherals (printer, terminal, modem, etc.). Like having extra port. Push button switches 10 lines (pins 2,3,4,5,6,8,11,15,17,20). Change plug or cable to substitute other lines. Push button reverses transmit-receive lines. LEDs monitor pins 2,3,4,5,6,8,20. PC board eliminates wiring, crosstalk, line interference. 3 RS-232 25 pin connectors. 7x2x6 in.

Order from MFJ and try it. If not delighted, return within 30 days for refund (less shipping). One year unconditional guarantee.

Order yours today. Call toll free 800-647-1800. Charge VISA, MC. Or mail check, money order. Add \$4.00 each for shipping and handling.

**CALL TOLL FREE ... 800-647-1800**

Call 601 323 5869 for technical information, or de/repair status. Also call 601 323 5869 outside continental USA and in Mississippi.

**MFJ ENTERPRISES, INCORPORATED**

921 Louisville Road, Starkville, MS 39759

## Japanese Computers

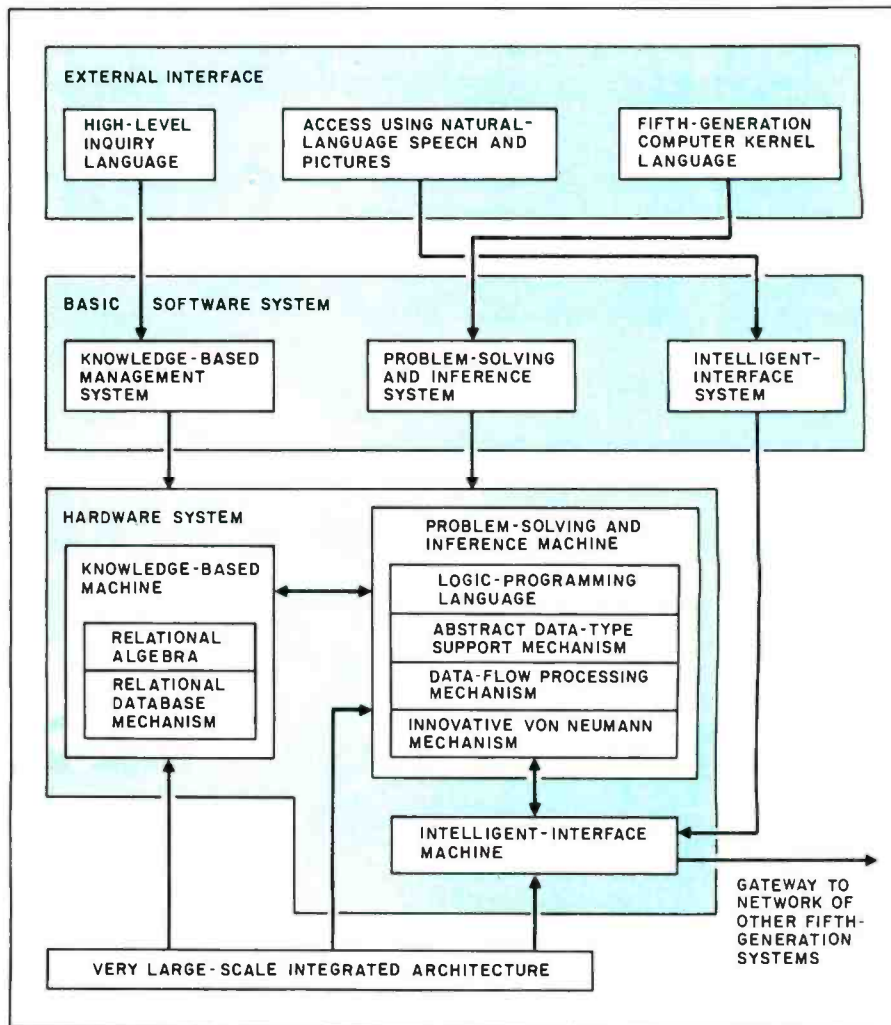


Figure 1: System planned for fifth-generation computers. The intelligent-interface machine will offer natural-language access, the ability to learn and infer, and an understanding of the data it is storing.

answer session with a person. The basic function that will perform this feat is called the problem-solving and inference system, with a separate machine to implement it.

The third basic capability will be the ability to use stored information—the computer will be able to understand the contents of the database instead of just being able to store it, retrieve it, and pass it on. These knowledge bases—as opposed to databases—will feed the problem-solving function.

This part of the tripartite brain will be called the knowledge-based management system. It, like the other two, will have its own specialized machine to use advanced very large-scale integration (VLSI).

### In All Sizes

Fifth-generation computers are slated to come in sizes ranging from small personal to large mainframe computers. It should be no surprise that they will be interconnected with local and global networks. Some new techniques to be used are new architectures like data-flow machines, artificial-intelligence concepts, and languages such as Lisp and Prolog along with machines optimized for them.

JIPDEC has recommended 26 research and development themes, each with several projects. The themes are grouped into seven categories (see table 1). Each theme has target specifications.

For example, a personal work sta-

# Which personal computer can make you better at what you do best?

PERSONAL COMPUTER COMPARATIVE ANALYSIS			
	IBM PC	Apple III	HP-87
MAXIMUM MEMORY	256 K	256 K	544 K
SOFTWARE SELECTIONS	VisiCalc* Data Communications Word Processing	VisiCalc* III Data Communications Word Processing Data Base Mgt. Business Graphics	VisiCalc* PLUS Data Communications Word Processing Data Base Mgt. Graphics Presentations Statistics (3 pkgs.) Financial Decisions Linear Programming Math AC Circuit Analysis Waveform Analysis CP/M* Library Series 80 Users' Library
EASE OF USE			
Programable Soft Keys	10	0	14
Error Messages	73	38	107
Built-in Disc Operating System	No	No	Yes
Built-in Screen Graphics	No	Yes	Yes
RELIABILITY			
Self Diagnostics	Yes	No	Yes
Operating Temperature	61-90°F	No figures available	32-133°F

For you, choosing a personal computer means making an intelligent decision. And isn't that what you do best?

THE BIGGEST MEMORY I'VE EVER HEARD OF.

The first step in your decision-making process is analysis. You look at all the numbers, and all the facts, before you leap. So you don't want a computer that's going to run short on memory. Not when you can have the HP-87 and a memory that expands to over half a million bytes.

MY KIND OF SOFTWARE.

Hewlett-Packard will make sure you don't run short on analytical software, either. For example, our VisiCalc\* PLUS will let you turn up to 16,000 cells of data into bar graphs, pie charts or whatever you need to present your results graphically. And our CP/M\* module gives you access to the expanding world of CP/M software.

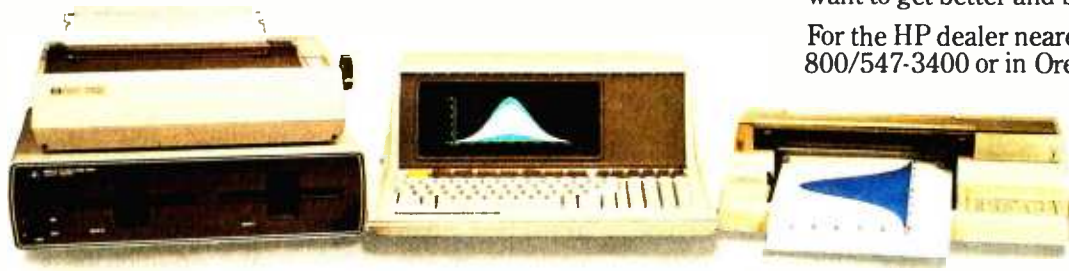
SURE LOOKS EASY.

We call it HP-Easy. Turn on the HP-87, and it's ready to go. The ROM-based operating system puts our built-in, enhanced BASIC to work for you. Instantly. The HP-87 has built-in commands and editing keys that eliminate complicated keystroke sequences. Whether you're generating a complex graph, writing a program or correcting errors.

And interfacing peripherals is as easy as putting a plug into a socket. That's the kind of craftsmanship that's putting all our Series 80 computers on the map. We're building power, friendliness and reliability into every one of them. From our portable partner, the HP-85, to the high-powered HP-87.

The most intelligent thing to do now? Get your hands on an HP-87. And then on the competition. You won't have any trouble making the right decision. Not if you want to get better and better at what you do best.

For the HP dealer nearest you, call TOLL FREE 800/547-3400 or in Oregon, Alaska and Hawaii call 503/758-1010. For additional product information, write Hewlett-Packard, Dept. 276K, Corvallis, OR 97330.



**Introducing the new HP-87.  
It's very good at what you do.**





<p style="text-align: center;"><b>Basic-Application Systems</b></p> <ul style="list-style-type: none"> <li>● Machine-translation system</li> <li>● Question-answering system</li> <li>● Applied speech-understanding system</li> <li>● Applied picture-and-image-understanding system</li> <li>● Applied problem-solving system</li> </ul>	<p style="text-align: center;"><b>Distributed-Function Architecture</b></p> <ul style="list-style-type: none"> <li>● Network architecture</li> <li>● Database machine</li> <li>● High-speed numerical-computation machine</li> <li>● High-level man-machine communication system</li> </ul>	<p style="text-align: center;"><b>Systematization Technology</b></p> <ul style="list-style-type: none"> <li>● Intelligent-programming system</li> <li>● Knowledge-based design system</li> <li>● Systematization technology for computer architecture</li> <li>● Database and distributed-database system</li> </ul>
<p style="text-align: center;"><b>Development Supporting Technology</b></p> <ul style="list-style-type: none"> <li>● Development-support system</li> </ul>	<p style="text-align: center;"><b>New Advanced Architecture</b></p> <ul style="list-style-type: none"> <li>● Logic-programming machine</li> <li>● Functional machine</li> <li>● Relational-algebra machine</li> <li>● Abstract data-type support machine</li> <li>● Data-flow machine</li> <li>● Innovative von Neumann machine</li> </ul>	<p style="text-align: center;"><b>Basic-Software Systems</b></p> <ul style="list-style-type: none"> <li>● Knowledge-based management system</li> <li>● Problem-solving and inference system</li> <li>● Intelligent-interface system</li> </ul>
<p style="text-align: center;"><b>Very Large-Scale Integrated Technology</b></p> <ul style="list-style-type: none"> <li>● VLSI architecture</li> <li>● Intelligent VLSI computer-aided design system</li> </ul>		

*Table 1: Scope of the fifth-generation project.*

tion would be required to perform 2 million instructions per second, have from 0.5 to 5 megabytes of memory, and include 100 megabytes of disk storage with an average access of 1 millisecond. Other specifications include what is referred to as a super high-speed processor to perform from 1 billion to 100 billion floating-point operations per second and have a memory capacity of 8 to 160 megabytes.

### Big Numbers

Designers hope to create a problem-solving and inference function that will have a performance of 100 million to 1 billion logical-inference operations per second (one logical inference equals 100 to 1000 instructions). Another project example is the specifications for a natural-language processing system. In addition, the knowledge-based management function should retrieve a unit of knowledge in several seconds from a knowledge base of 100 to 1000 gigabytes.

Very large-scale integration technologies, first with 1 million tran-

sistors per chip and then up to more than 10 million, are to be used. A design-automation system for these integrated circuits will also be developed.

Newer high-speed device technologies such as gallium arsenide and Josephson junctions are excluded from the program because the researchers believe that such devices will not be ready for general use by 1990. However, they do maintain that the progress of these devices will be closely watched so that they can be incorporated into the project at some intermediate stage should they prove sufficiently practical and capable of superior performance.

The design-automation system is to consist of three parts: the software for automated design of VLSI, a computer system to run it—called System 5G—and the 5G personal computer that will be a logic-programming work station for designers. In the initial stage (the first five years) of the project, the planners intend to implement the Hierarchical Specification Language (HSL) now being used at

the Musashino Electrical Communication Laboratory of the Nippon Telegraph & Telephone Public Corp.

The HSL system has several modules that are integrated into a total design system. It contains a language for describing a circuit, compiler, database, timing simulator, logic simulator, circuit simulator, test-pattern generator, placement and routing program, and design-rule checker.

### Logic Designer

Also part of the design-automation project is the development of the logic-programming work station. No existing personal computer satisfies the requirements of high-speed processing of voice, graphic, and digitized-image input and of performance as a personal-interface machine using languages like Lisp or Prolog. One of the fastest conventional general-purpose computers—one capable of 40 million instructions per second—is planned to be the host computer for the design-automation system until the first models of fifth-generation computers are available. ■

# DOW JONES BLUE CHIP SOFTWARE GIVES YOU BLUE CHIP INVESTMENT CONTROL.

Never before have investors had the electronic capability to track and intelligently manage their own portfolios like this. Using Dow Jones' data base and exclusive portfolio management software you can store, modify and automatically update individual holdings on your own personal computer.

Now you have a remarkable opportunity to use software that can actually minimize risk and increase the chances for investment success—software that allows you to maintain multiple portfolios, automatically value each stock in your portfolio, obtain current quotes (15 to 30 minutes delayed during market hours) and historical quotes, retrieve year-to-date figures and compare them to the stock's original worth. You'll even be able to test the market with hypothetical portfolios—evaluating the “what-ifs” before you buy or sell.

More and more investors are becoming “bullish” about the DOW JONES NEWS/RETRIEVAL® Service—relying on it for instant business and financial data that can save hours of valuable time. You get exclusive electronic access to articles from The Wall Street Journal, Barron's and the worldwide Dow Jones News Service, in-depth background information on thousands of public companies, earnings-per-share forecasts, and much more. It's everything you need to better manage your business and personal finances.

When you make your software purchase, we'll give you a free Dow Jones password. . . as well as one hour of free introductory, non-prime time. And software and usage costs will be tax deductible in many cases (consult your tax advisor).

Find out about Dow Jones' unique ability to help you manage your own portfolio like a professional, improve and broaden your research capabilities, spot and analyze trends. Visit your nearest computer store or call the Dow Jones customer service hotline.

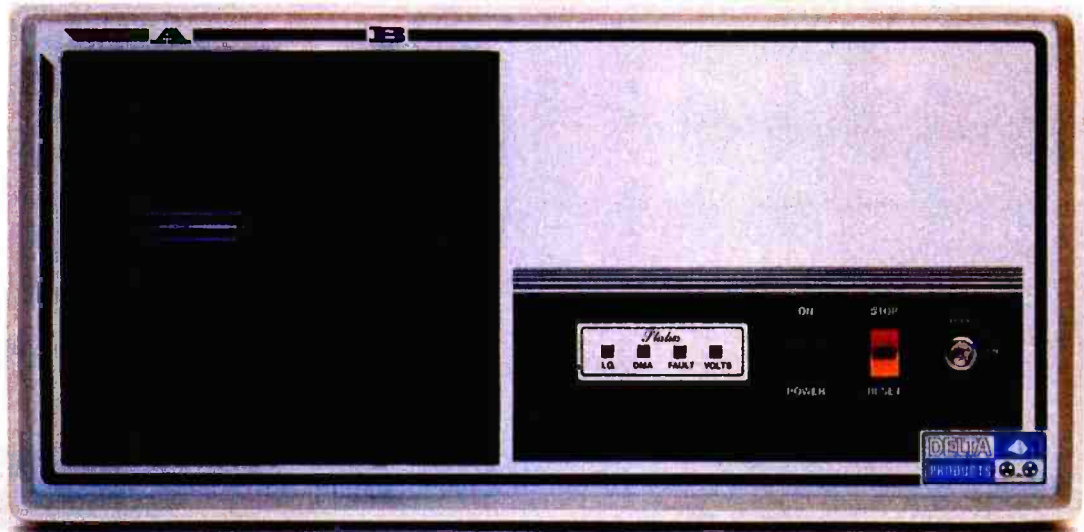
Call Toll Free  
800-257-5114  
(In New Jersey call  
609-452-1511)

**DOW JONES**  
**NEWS/RETRIEVAL®**

DOW JONES NEWS/RETRIEVAL is a registered trademark of Dow Jones & Company, Inc.



# INTERESTED?



# LET'S TALK

# CONCEPT: PRIVATE COMPUTERS

Our marketplace is maturing. Those of you that were around in 1977 will remember what it took then to make a sale...*(anything that worked!)*

The two beautiful faces at the left are evidence that *changes have occurred* in the industry!!!

Besides an excellent, well proven S-100, CP/M, Z-80 4MHZ computer system, we have a few extra things to offer. *(Not the model!)*

Delta specializes in something called a **Private Computer**. It's for those of you systems integrationists that have matured with the market. You stopped assembling systems in your garage a long time ago, but still need a totally flexible computer line that your customers won't find at *Wards* or *Sears*.

- 1.** **A Private Computer means** you will never see one of our computer systems on the shelf of your local department store or computer shop. We only sell to systems integrationists who add value to our product.
- 2.** **A Complete Range of Products** is available. No other micro company in the world offers a more complete line of equipment to satisfy your needs. We have everything from low end single user systems to the top of the line 64 user distributed processing networks.
- 3.** **The DP Software Library** is growing every month. We supply Accounting, Business Management, Code Writing, Medical, Dental, Chiropractic, Word Processing, Property Management and other programs. We have the source code in most cases and can negotiate customization if needed. Video taped training cassetts to aid you and your customers in learning how to use the programs and run the hardware are available.
- 4.** **Factory Support and Service** is available in most large cities. There are 66 fully stocked factory maintainance centers in the U.S. and 12 outside the U.S. In more remote areas, our 24 hour fast turnaround component pool can be used to insure reasonable response times to satisfy customers. We have a customer service *Hotline* independant of sales or service. We have a **24 Hour Modem Engineering Advisory Billboard**.
- 5.** **Our Engineering Assistance and Software Development Program** can make headaches turn into profits. We maintain a staff of Engineers and Programmers whose services can be leased to expand your range of services. Problems from something as simple as hooking up a new printer or modifying an existing software program to customize a screen display can be resolved with this service.
- 6.** **Financial Assistance** is available through a flexible credit program that can not only get the product to you quickly but keep your cash busy where it will do the most good. 30 - 60 - 90 day flooring plans can be arranged to allow you to collect your money before you have to pay us.

Sherry Starkey is on line right now at Delta to direct you to your area representative. If you have a half inch Beta or VHS video machine, ask Sherry for a sales demonstration in your own home or office. ***See the Plant, the People and the Program.***

DELTA PRODUCTS INC. • 15392 ASSEMBLY LANE, HUNTINGTON BEACH, CA 92649  
(714) 898-1492 • MON to FRI - 8 AM to 5 PM • TELEX: 681-367 DELTMAR HTBH

Circle 138 on inquiry card.



# The Atari Tutorial

## Part 9: Even More Colors!

*Television artifacts and the new GTIA chip allow even more colors to be displayed on Atari computers.*

---

Kathleen Pitta and Lane Winner  
Atari Inc.  
30 East Plumeria  
POB 50047  
San Jose, CA 95134

---

The Atari 400 and 800 home computers allow the programmer to display many colors with their powerful color-register systems. Even more colors can be obtained with television artifacts and the new GTIA chip.

### Television Artifacts

A *television artifact* is a pixel on the screen that displays a different color on the screen than the one assigned to it. This happens because the television display signal can become confused. The astute programmer can turn this bug into a feature. The ANTIC modes with which this can be accomplished are 2, 3, and 15. [Remember that the ANTIC mode numbers are not the same as the BASIC "GRAPHICS n" numbers;

---

*This article appears in slightly different form in De Re Atari, published by Atari Inc., and is reproduced with its express permission. De Re Atari is available from the Atari Program Exchange, 155 Moffett Park Dr., POB 427, Sunnyvale, CA 94086.*

---

*ANTIC mode 15 is not a mistake. . . . G. W.] Each of these modes has a pixel resolution of one-half color clock by one scan line; each has one color and two luminances. With the use of artifacts, pixels of four different colors can be displayed on the screen in each of these modes.*

A simple example of artifacts when using the Atari home computer is shown by the following lines of BASIC:

```
GRAPHICS 8  
COLOR 1  
POKE 710,0  
PLOT 60,60  
PLOT 63,60
```

These statements plot two points on a black background, each with a different color. To understand why these colors are different, you must first understand how the display information for the television display is contained in a modulated television signal.

The two major components of this signal are the *luminance* (or bright-

ness) and the *color* (or tint). The luminance information is the primary signal, containing not only the brightness data but also the timing and synchronization signals. The color signal contains the color information and is combined or modulated onto the luminance waveform.

The luminance of a pixel on the screen is directly dependent on the amplitude of the luminance signal at that point. The higher the amplitude of the signal, the brighter the pixel. The color information, however, is a *phase-shifted signal*, which is a constantly oscillating waveform that has been delayed by some amount of time relative to a reference signal. This time delay is translated into the color.

The color signal oscillates at a constant rate of about 3.579 megahertz (MHz). The Atari home computer offers a high-resolution graphics mode (GRAPHICS 8) that displays 320 pixels across one horizontal scan line. The hardware does this by varying the amplitude of the luminance signal at 7.16 MHz, which is twice the color frequency. Since the color and lumi-

# Announcing the Printing Breakthrough of the Century: Smith-Corona® TP-1™ Text Printer



- Low Cost Daisy Wheel Printer

**\$845<sup>00</sup>**

- Microprocessor Electronics
- Serial or Parallel Interface
- Simple, Reliable Mechanism

**ACT NOW: Limited Supply, Low, Low Cost**

Smith Corona, one of the largest manufacturers of small printers in the world, gives a whole new perspective to printing with their electronic text printer—TP-1. The TP-1 is a microprocessor controlled, high quality **daisy wheel printer**. It produces perfectly formed, executive quality printouts at the speed of 120 words per minute. Typewriter quality printing at dot matrix prices.

Simple, durable and dependable, TP-1 may be used with word processing systems, microcomputers and most small business systems. Compact and attractively



Additional daisy print wheels . . . . \$4.95



Additional ribbons . . . . . \$2.95

styled, the TP-1 blends well with any setting.

Now, all your letters, documents forms and reports can have the crisp, professional look you demand—for business or personal use—at an affordable price. TP-1, the electronic text printer.

Don't delay. Order your TP-1 TODAY at the low price of \$845.

**Micro Printer Marketing** offers same day shipping, nationwide service and invites dealer inquiries. Catalogues available. No shipping charges on pre-paid orders.

**Micro Printer Marketing**

**Call Micro-Printer Marketing**

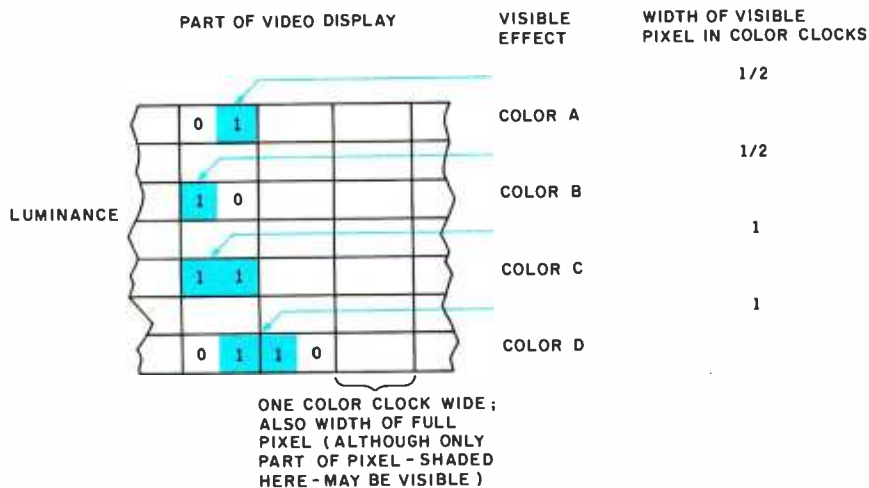
CALL TOLL FREE **1-800-523-9859** MasterCard and Visa Accepted

In PA Call Collect 215 / 433-3366



Circle 271 on inquiry card.





**Figure 1:** In this example of artifact color pixels, the visible portion of a pixel is one-half color clock wide, and its position within a color clock influences the color produced. See figure 2 and listing 1 for another example of artifact color pixels.

nance signals are theoretically independent, you should be able to assign any background color to be displayed and then vary the luminance on a pixel-by-pixel basis. This is, in fact, the way mode 8 works, the background color coming from playfield register 2 and the luminances coming from both playfield registers 1 and 2.

However, a problem does arise. In practice, the color and luminance signals are not independent. They are part of a modulated signal that must be demodulated by the television receiver before they can be used. Since the luminance is the primary signal, whenever it changes, it also has a drastic effect on the color phase shift. For one or more color clocks of constant luminance this is no problem, since the color phase shift will be unchanged in this area. However, if the luminance changes on a half color-clock boundary, it will also produce a color shift at that point. Moreover, the color obtained cannot be controlled from the transmitting end of the signal (the computer). The artifact color obtained is defined by the settings of the television receiver.

(A color clock is a *physical* unit of horizontal distance on the video display—160 color clocks per line of video display. A pixel is a *logical* unit of video display with a size that varies with the graphics mode in use.

Depending on the graphics mode, a pixel may be one-half, one, two, or more color clocks wide.)

Since the luminance can change on half color-clock boundaries, two artifact colors can be generated, one for each side of the color clock. These two artifact color pixels can be combined to form two additional types of

---

**The artifact colors are definitely distinct from each other, and programs can be written that utilize them.**

---

full color-clock pixels. This is illustrated in figure 1.

Each of these pixels requires one color clock of screen space (although the visible part of the pixel is one-half color clock). Hence, the resulting display has an effective horizontal resolution of 160 pixels.

The colors A through D are different for each television set, usually because the tint-knob settings vary. Thus, the actual colors obtained cannot be controlled by the programmer. They are definitely distinct from each other, and programs can be written that utilize these artifact colors.

To illustrate a simple application of artifacting, refer to the sample pro-

gram in listing 1. This program draws lines in each of the four artifact colors (see figure 2) and then fills in areas using three of the colors. (Displaying many pixels of either type C or D next to each other results in the same thing: a line of constant luminance with background color.) The POKE 87,7 command causes the operating system to treat this mode as mode 7 instead of mode 8 and to use 2-bit masks when setting bits in the display memory; this tricks the Atari into creating pixels one-half color clock wide. To generate color A, use the COLOR 1 command. The COLOR 2 command produces color B; the COLOR 3 command produces color C. Color D is generated by displaying COLOR 1 to the left of COLOR 2.

### The GTIA Chip

The new GTIA display chip for the Atari home computer will someday replace the CTIA chip currently in use. The GTIA is nothing more than a CTIA with a few extra features. It provides three additional modes of interpretation of information coming from the ANTIC chip. ANTIC does not require a new display mode to use the special GTIA modes; instead, it uses the high-resolution mode F hexadecimal. GTIA is completely upward-compatible with the CTIA. A brief summary of the CTIA's features follows so that the differences between the two can be explained.

The CTIA is designed to display data on a television screen. It displays the playfield, players, and missiles. CTIA uses the data from ANTIC to display hue and luminance as defined by the four color registers. The GTIA expands this to use all nine color registers or 16 hues with one luminance or 16 luminances of one hue.

The three graphics modes of GTIA are simply three new interpretations of ANTIC mode F hexadecimal, a high-resolution mode. All three modes affect the playfield only. Players and missiles can still be added to introduce new hues or luminances, or to use the same colors and luminances in more than one way. All displays of hues and luminances can still be changed on-the-fly with



# QUME

## SPRINT 9

STANDARD OPERATOR  
CONTROL PANEL.

Switch selection of interface parameters and forms handling allows simple OEM system integration.

Automatic proportional spacing, without decreasing system throughput, sets the new standard for print quality.

To cut service costs and reduce adjustments, the exclusive Kevlar® belt is stronger and lighter than steel, with virtually no stretch.

For the highest accuracy in the history of daisywheel printing, our Microdrive™ carriage drive mechanism has no cables or pulleys.

LIMITED OEM  
CONTROL PANEL.

## Test drive our hot new daisywheelers.

If you've always wanted letter-quality printing from your DP system but the cost has put you off, then a SPRINT 9 is for you. Now you can have the same high quality print—usually only available on word processing systems—at prices that will let you forget all about dot-matrix terminals. With speeds of 45 and 55 cps (average English text, not burst rate), the reliable high performance of SPRINT 9 terminals leaves the crowd behind. Prove it to yourself with a test drive. Call or write Qume at (408) 942-4000. 2350 Qume Drive, San Jose, California 95131.

Circle 355 on Inquiry card.

**Qume**  
A Subsidiary of ITT



# AN ATARI 800™ HOME COMPUTER AND A FATHER'S LOVE COMBINED TO HELP CHILDREN EVERYWHERE.

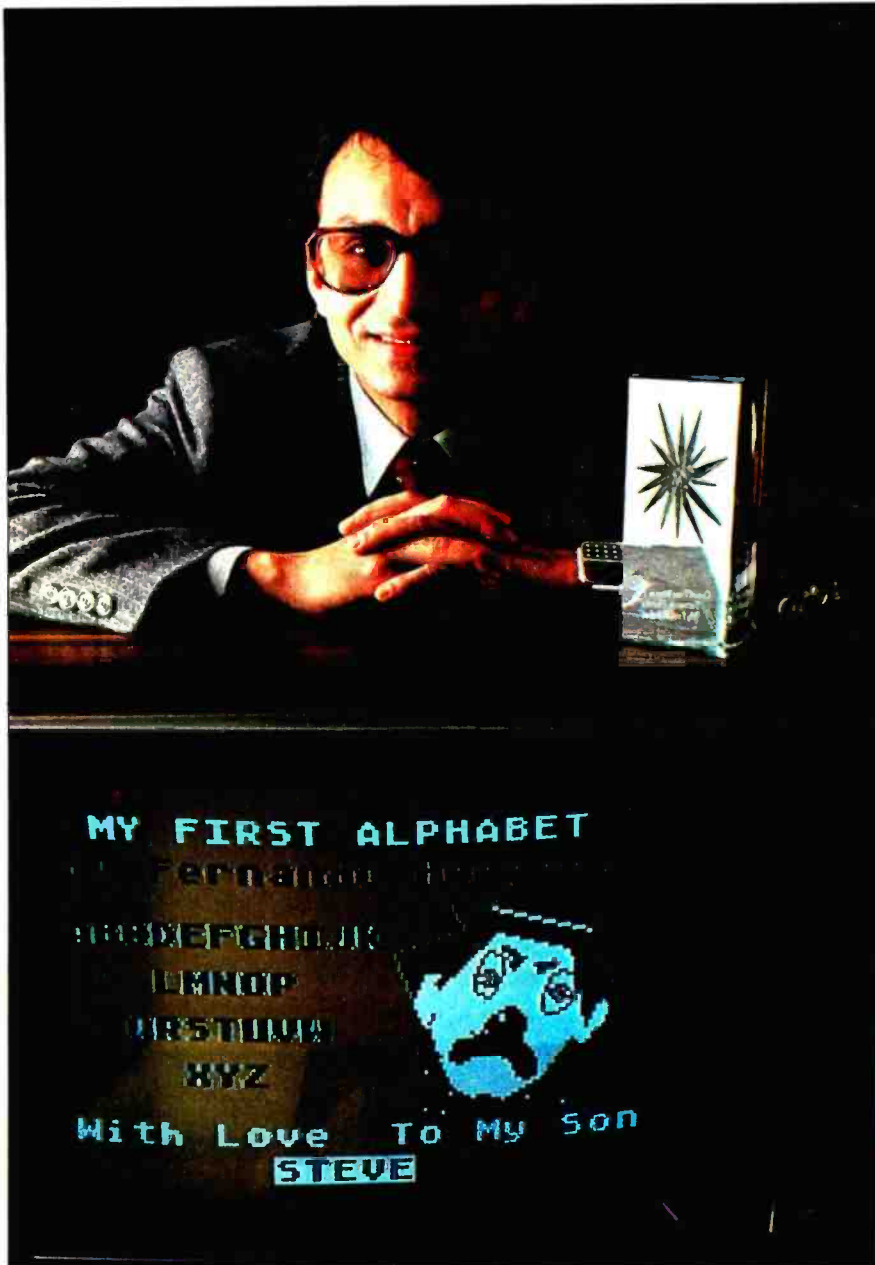
Fernando Herrera became the first grand prize winner of the ATARI Software Acquisition Program (ASAP) competition because he believed in computers, his son and himself.

The story of Herrera's success began with his son's sight problems. Young Steve Herrera had been born with severe cataracts in both eyes and, naturally, his father was concerned. Herrera reasoned that the boy's learning abilities could be seriously affected by growing up in a world he could not see.

Having just purchased an ATARI 800 Home Computer, it occurred to Herrera that this could be the perfect tool for testing Steve's vision. So he wrote a program simply displaying the letter "E" in various sizes.

Success! It turned out that 2-year-old Steve could see even the smaller "E's" without special lenses. Herrera was first relieved, and then intrigued when he discovered that not only could his son see the "E's," but he would happily play with the computer-generated letters for hours. So Herrera added a picture of an elephant to go with the "E," and then more letters and pictures. Thus, "My First Alphabet" was born, a unique teaching program for children two-years and older consisting of 36 high resolution pictures of letters and numbers.

Herrera submitted the program to the ATARI Program Exchange, where it became an instant best-seller. ATARI was so impressed with the outstanding design, suitability and graphic appeal of "My First Alphabet," that the program is being incorporated into the ATARI line of software.



In addition to his grand prize winnings of \$25,000 in cash and an ATARI STAR trophy, Herrera also automatically receives royalties from sales of his program through the ATARI Program Exchange.

But Fernando Herrera wasn't the only software "star" that ATARI discovered. Three other ATARI STARS were awarded at the ASAP awards ceremony for software submitted to the ATARI Program Exchange and

judged by ATARI to be particularly unique and outstanding.

Ron and Lynn Marcuse of Freehold, New Jersey, teamed up to write three winning entries in the Business and Professional category for home computers: "Data Management System," "The Diskette Librarian" and "The Weekly Planner."

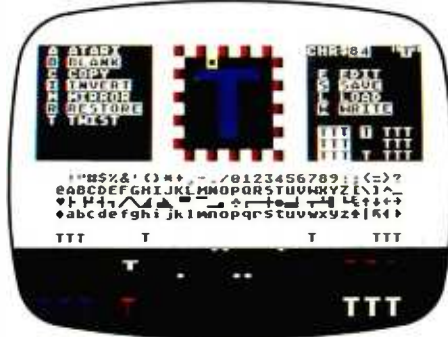
Sheldon Leeman of Oak Park, Michigan, captured an ATARI STAR for his exceptionally well-engineered "INSTEDIT" character set editor.

Greg Christensen of Anaheim, California, became our youngest ATARI STAR winner at the age of 17. Christensen designed the clever "Caverns of Mars" game program, which also will be incorporated into the ATARI product line. Greg designed the program in 1½ months after owning his ATARI Home Computer for less than a year.

Every three months, ATARI awards ATARI STARS to the writers of software programs submitted to the ATARI Software Acquisition Program and judged first, second and third place in the following categories: Consumer (including entertainment, personal interest and development); Education; Business and Professional programs for the home (personal finance and record keeping); and System Software.

Quarterly prizes consist of selected ATARI products worth up to \$3,000, as well as an ATARI STAR, plus royalties from program sales through the ATARI Program Exchange. The annual grand prize is the coveted ATARI STAR trophy and \$25,000 in cash.

To be eligible, your software idea must be accepted by the ATARI Software Acquisition Program. Your program can have a broad application or serve a very specific purpose.



After submittal, consultation from ATARI is available if you need personal assistance with sound, graphics, or other technical aspects of your program.

To make your job easier, ATARI provides some 20 software development tools through the ATARI Program Exchange. A list and description of the various system software is published quarterly in the ATARI Program Exchange Catalog. These tools enable you to utilize all the ATARI resources and software, including the six ATARI programming languages.

Fernando Herrera had a great idea that made him a star. ATARI would like to give you the same opportunity.



Circle 32 on inquiry card.

Enter the ATARI ASAP competition and you could win \$25,000 in cash, royalties, some great prizes and an ATARI STAR.

SUBMIT TO: ATARI® Software Acquisition Program  
Dept. C1R, P.O. Box 427  
155 Moffett Park Dr., B-1  
Sunnyvale, CA 94086

OR CALL: 800-538-1862; in California, 800-672-1850.

I'm reaching for the stars. Please send me an entry form today.

Name \_\_\_\_\_

Address \_\_\_\_\_

City \_\_\_\_\_

State/Zip \_\_\_\_\_

**ATARI HOME COMPUTERS**

We've Brought The Computer Age Home.™

© 1982 ATARI, Inc.



**Listing 1: An Atari BASIC program to display artifact colors. See the text and figures 1 and 2 for details.**

```

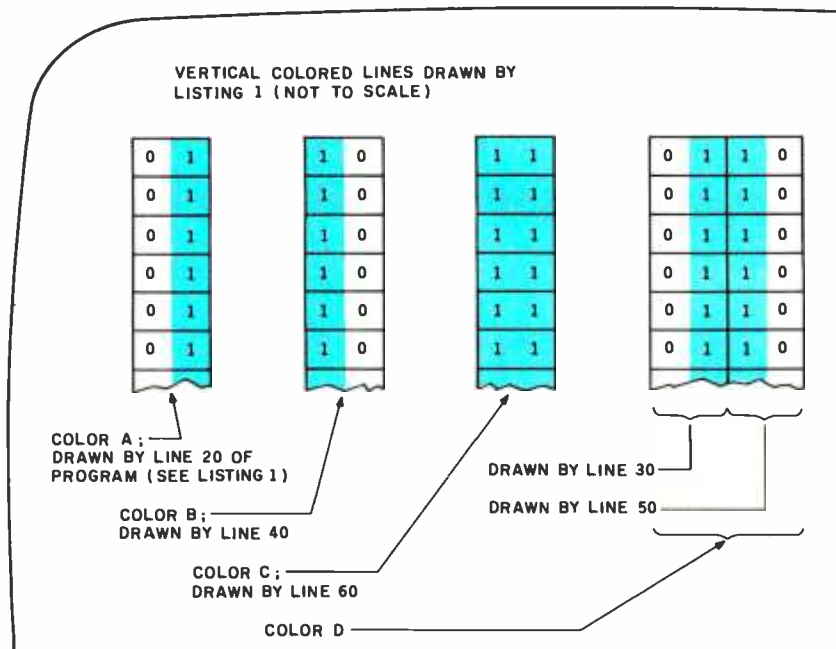
10 GRAPHICS 8:POKE 87,7:POKE 710,0:POKE 709,14
20 COLOR 1:PLOT 10,5:DRAWTO 10,70
30 PLOT 40,5:DRAWTO 40,70
40 COLOR 2:PLOT 20,5:DRAWTO 20,70
50 PLOT 41,5:DRAWTO 41,70
60 COLOR 3:PLOT 30,5:DRAWTO 30,70
70 FOR X=1 TO 3:COLOR X:POKE 765,X
80 PLOT X*25+60,5:DRAWTO X*25+60,70
90 DRAWTO X*25+40,70:POSITION X*25+40,5
100 X10 18,#6,12,0,"S:"
110 NEXT X

```

display-list interrupts. The GTIA uses 4 bits of data from ANTIC for each pixel, called the pixel data. Each pixel is two color clocks wide and one scan line high. Thus, the pixels are roughly four times wider than their height. The display has a resolution of 80 horizontal pixels by 192 vertical pixels. Each line requires 320 bits (40 bytes) of memory, the same number used in ANTIC mode F hexadecimal. Therefore, for a program to run the GTIA modes, it must have at least 8K bytes of free RAM (random-access read/write memory) for the display.

The GTIA modes are selected by the priority register PRIOR, which is located at address D01B hexadecimal and shadowed at address 26F hexadecimal. [The contents of shadow registers are copied into their associated registers every 1/60 second. Thus, you will usually alter shadow registers, not the hardware registers themselves. . . . G. W.] Bits D6 and D7 are the controlling bits. The effects of these bits are presented in figure 3.

Setting up the new GTIA modes is as simple as setting up the present modes supported by CTIA. To implement the modes from BASIC, simply use a GRAPHICS 9, GRAPHICS 10, or GRAPHICS 11 command. In assembly-language programs, selecting one of these modes is done by opening the screen device through CIO. If you are building your own display list, PRIOR must be set to select the correct mode.



**Figure 2: An enlarged view (not to scale) of the upper left-hand corner of the video display produced by listing 1. This figure helps to explain how listing 2 produces four colored vertical lines from three different types of pixels.**

### Mode 9

Mode 9 produces up to 16 different luminances of the same hue. ANTIC provides the pixel data that selects one of 16 different luminances. The background color register provides the hue. In BASIC, this is done by using the SETCOLOR command to set the hue value in the upper nybble (4 bits) of the background color register and to set the luminance value in the lower nybble to all zeros. The format of the command is

```
SETCOLOR 4,HUEVALUE,0
```

where 4 specifies the background

PRIOR			
D7	D6		
0	0	NO GTIA MODES (CTIA OPERATION)	(MODES 0 THROUGH 8)
0	1	1 HUE, 16 LUMINANCES	(MODE 9)
1	0	9 HUES/LUMINANCES	(MODE 10)
1	1	16 HUES, 1 LUMINANCE	(MODE 11)

**Figure 3: Activation of graphics modes 9, 10, and 11. The two most significant bits of the hardware register PRIOR control the selection of these modes. For information on the use of the low 6 bits of the PRIOR register, see page 338 of the November 1981 BYTE.**

# COMPUTER WAREHOUSE

**CALL TOLL FREE 1-800-528-1054**

## ATARI

Special 32K 800 System 800 w/32K, recorder, star raiders, joysticks Above w/48K	<b>Call Call</b>
800 (16K)	<b>\$670</b>
400	<b>\$340</b>
810 Disk Drive	<b>\$440</b>
825 Printer	<b>\$590</b>
850 Interface	<b>\$170</b>
410 Recorder	<b>\$ 75</b>
830 Modem	<b>\$155</b>
16K Memory	<b>\$70</b>
32K Memory	<b>\$125</b>

## COMMODORE

VIC 20	<b>\$250</b>
--------	--------------

## DISK DRIVES

Lobo	
Apple 1st Drive	<b>\$400</b>
Apple 2nd Drive	<b>\$350</b>

## PRINTERS

C. Itoh	
F-10 - Parallel	<b>Call</b>
F-10 - Serial	<b>Call</b>
55CPS - Series	<b>Call</b>
Prowriter	<b>Call</b>
1550	<b>Call</b>

Datasouth	
DS 180	<b>\$1260</b>

Diablo	
630 RO w/Tractors	<b>\$2260</b>
630 RO wo/Tractors	<b>\$2050</b>
630KSR wo/Tractors	<b>\$2435</b>

Epson	
MX-80	<b>Call</b>
MX-80 F/T	<b>Call</b>
MX-100	<b>Call</b>

NEC	
PC-8023A	<b>Call</b>
3510	<b>\$1690</b>
7710	<b>Call</b>
7720	<b>Call</b>

Okidata	
Microline 80	<b>\$330</b>
Microline 82-A	<b>\$455</b>
Microline 83-A	<b>\$740</b>
Microline 84	<b>Call</b>

Tally	
1805/1802	<b>\$1555</b>
1605/1602	<b>\$1325</b>

Texas Instruments	
810 Basic	<b>Call</b>

## MONITORS

Zenith	
12" Green Screen	<b>\$115</b>
Amdtek	
Video 100	<b>Call</b>
Video 300	<b>Call</b>
Color I	<b>Call</b>
Color II	<b>Call</b>

## INTERNATIONAL DEALER INQUIRIES INVITED

Novation SOROC TECHNOLOGY, INC.  
 ATARI TEXAS INSTRUMENTS NorthStar  
 TeleVideo OKIDATA 3M  
 ALTOS EPSON Zenith data systems  
 COMPUTER SYSTEMS EPSON AMERICA, INC.

## SPECIAL WORD PROCESSING SYSTEM

Altos 8000-2, Televideo 950, Diablo 630RO, Word Star, Cables	<b>\$5830</b>
above w/TELEVIDEO 910	<b>\$5500</b>

## VIDEO TERMINALS

Adds	
Viewpoint	<b>\$530</b>
Altos	
Altos I	<b>Call</b>
Soroc	
IQ 120	<b>Call</b>
IQ 130	<b>Call</b>
IQ 135	<b>Call</b>
IQ 140	<b>Call</b>
Televideo	
910 C	<b>\$570</b>
912 C	<b>\$675</b>
920 C	<b>\$735</b>
925 C	<b>\$730</b>
950 C	<b>\$915</b>
Zenith	
Z-19	<b>\$680</b>

## DISKETTS

Elephant	
5 1/4" O. Sector (100)	<b>\$215</b>
Maxell	
5 1/4" O. or 10. Sector (100)	<b>\$300</b>
8" O. Sector (100)	<b>\$370</b>

## SOFTWARE

WordStar	<b>\$295</b>
Mailmerge	<b>\$100</b>
SpellStar	<b>\$160</b>
DataStar	<b>\$240</b>
CalcStar	<b>\$220</b>

## COMPUTERS

Altos	
ACS 8000-15	<b>\$3850</b>
ACS 8000-2 w/CPM*	<b>\$2650</b>
Series 15D	<b>Call</b>
Series 5-5D	<b>Call</b>
Alspa	
ACI-1	<b>Call</b>
ACI-2	<b>Call</b>
California Computer Systems	<b>Call</b>
IBM	
Personal Computer	<b>Call</b>
NEC	<b>Call</b>
Northstar	
Advantage	<b>\$2990</b>
Horizon II 64K QD	<b>\$2690</b>
Televideo Systems	
TS-802	<b>\$2700</b>
TS-802H	<b>\$5050</b>
Zenith	
Z-89 48K w/CPM*	<b>\$2160</b>
Z-90 64K w/CPM*	<b>\$2385</b>
Both above w/supercalc	
MODEMS	
Novation	
CAT	<b>\$140</b>
D-CAT	<b>\$155</b>
Apple Cat II	<b>\$349</b>
Auto Cat	<b>\$235</b>



2222 E. Indian School Rd. • Phoenix, Arizona 85016  
 Order Line: 1-800-528-1054  
 Other Information: 602-954-6109



Store Hours: Tues.-Fri. 10-5 MST Saturday 10-2 MST

Prices reflect 3% cash discount. Product shipped in factory cartons with manufacturers warranty. Add 2% a minimum of \$5 for shipping and handling.

Personal checks will delay shipping two weeks  
 Prices & availability subject to change without notice



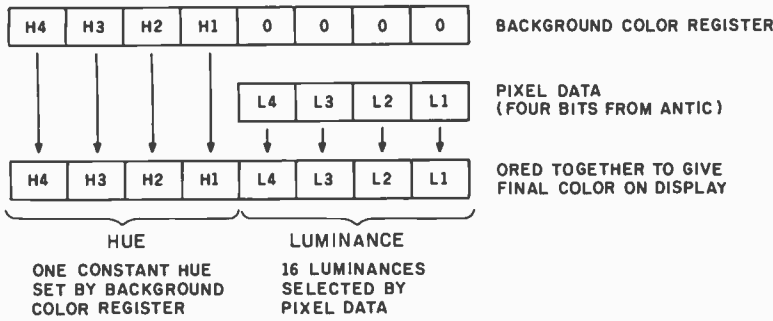


Figure 4: Interpretation of a byte of memory as a color pixel in graphics mode 9. Mode 9 gives one hue at 16 possible luminances.

Listing 2: An Atari BASIC program that illustrates BASIC graphics mode 9 by drawing 16 vertical lines of varying luminances (same hue).

```

10 GRAPHICS 9
20 SETCOLOR 4,12,0:REM initialize the background color to green
30 FOR I=0 TO 15:REM draw in different luminances
40 COLOR I
50 PLOT 2-I,10
60 DRAWTO 2-I,80
70 NEXT I
80 GOTO 80:REM hang up in a loop

```

color register, HUEVALUE sets the hue and can be anything from 0 to 15, and 0 sets the luminance part of the register to zero. The background luminance *must* be zero because the pixel data from ANTIC will be logically ORed with the lower nybble of the background color register to get the luminance that appears on the screen (see figure 4). Use the COLOR command to select luminances for drawing on the screen; its argument (ranging from 0 to 15) specifies the luminance. A sample BASIC program to use mode 9 is shown in listing 2.

Assembly-language programs should write the hue directly into the upper 4 bits of the shadow location for the background color register at location 2C8 hexadecimal. If you use CIO calls to draw to the screen, store the pixel data into ATACHR located at 2FB hexadecimal. This selects the luminance with values from 0 to F hexadecimal. If you are maintaining your own display data, the pixel data goes directly into the left or right half of the display RAM byte.

### Mode 11

Mode 11 is similar to mode 9 except that it provides 16 different hues all with the same luminance. ANTIC provides the pixel data to select one of 16 different hues (see figure 5). In BASIC, use the SETCOLOR command to declare the single luminance value in the lower nybble of the background color register. Set the upper nybble of the background color register (the hue nybble) to zero. The format of the command is

SETCOLOR 4,0,LUMVALUE

where 4 specifies the background color register, 0 sets the upper nybble to zero, and LUMVALUE sets the value of the luminance and can range from 0 to 15. As with the other graphics modes (except mode 9), the lowest bit of the luminance is not used. The effective result is that only even numbers result in distinct luminances, which gives eight possible luminances in this mode. Use the COLOR command in this mode to select the various hues by selecting values from

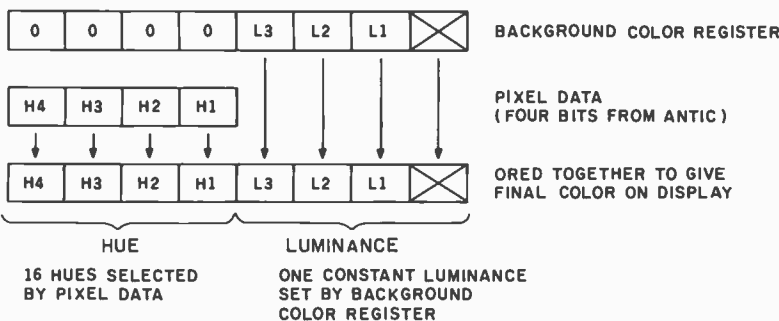


Figure 5: Interpretation of a byte of memory as a color pixel in graphics mode 11. Mode 11 gives up to 9 hues at the same luminance level.

Listing 3: An Atari BASIC program that illustrates BASIC graphics mode 11 by drawing 16 vertical lines of varying hues (same luminance).

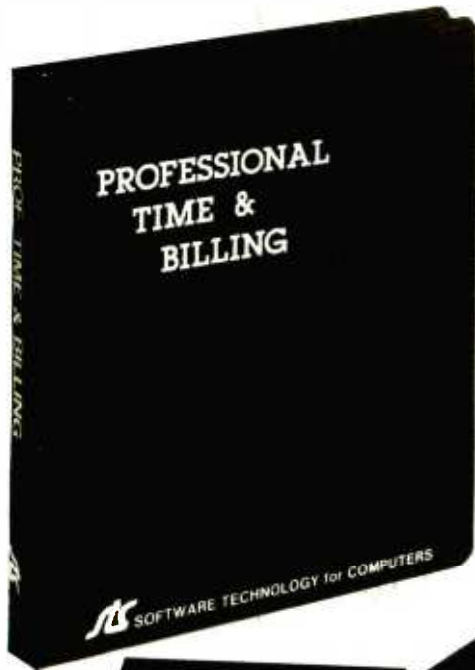
```

10 GRAPHICS 11
20 SETCOLOR 4,0,12:REM initialize the background color
30 FOR I=0 TO 15
40 COLOR I:REM select different colors
50 PLOT 2-I,10
60 DRAWTO 2-I,80:REM draw bars in different colors
70 NEXT I
80 GOTO 80

```

# Introducing a New Software Program for the Apple™ That Helps Manage

# TIME . . .



maxell  
Mini-Floppy Disk



## Every Minute Counts.

When you charge for time, every minute counts. Counting up the charges, determining accountability for your services, making billing decisions—your livelihood depends on these tasks. Time itself and the cost you assign to it—are the real commodities of the professional practitioner.

## Performs Like a Service Bureau.

The Professional Time & Billing program performs time management and billing functions as expertly, efficiently and smoothly as a prestigious service bureau but at a fraction of the cost! With the PTB program, turnaround time is virtually eliminated. Instant access to information and the ability to make quick, effective billing decisions are virtually at your fingertips. With delays eliminated, your cash flow will increase significantly.

## Designed by Professionals.

The Professional Time & Billing program by SOFTWARE TECHNOLOGY for COMPUTERS was designed by professionals who understand that time is money. Their purpose in creating this program is to give you the best possible return on your time.

## PTB Will Help Your Firm.

The PTB program will keep accurate records of WHICH staff member performed WHAT work for WHICH client. Up to 120 user-defined rate codes of time, expenses or fixed fees can be used. Even nonbillable work and non-time-related expenses can be recorded. The program provides accurate records of monies received from clients on account or other receipts you may want to record. The PTB program will correlate all this information, assemble a comprehensive set of internal reports, and generate statements for services rendered.

## The System Will Pay for Itself.

The PTB program will more than pay for itself by increasing the speed, accuracy and efficiency of your client accounting and billing procedures.

## Who Needs the PTB Package?

CPA firms, law practices, advertising agencies, architectural firms, engineering companies, private consultants, health care centers and countless others that depend on the ability to accurately and meaningfully manage billable time and resources.

## All This with Incredible Ease for \$395 (U.S.).

The Professional Time & Billing program requires no previous background in computers or programming. Extensive documentation and detailed explanations of how the system works provide an unparalleled level of trouble-free, user-oriented performance. Furthermore, you can learn to use the program in a minimal amount of time.

The complete package costs \$395 (U.S.) and includes a 3-ring binder, program diskette and user's manual. The program will run on an APPLE II or II Plus computer with 48k, a serial or parallel printer and 2 disk drives. No other special hardware add-ons are required.

## For a Personal Demonstration.

For a personal demonstration of this outstanding program and other fine products from us, contact your local dealer. Call or write us for the whereabouts of your local dealer at:



SOFTWARE TECHNOLOGY  
for COMPUTERS  
P.O. Box 428 Belmont, MA 02178  
(617) 923-4334

"THE DIFFERENCE LIES  
WITH THE SOFTWARE"

If your local dealer does not carry the PTB program ask him to give us a call. We are committed to providing quality software at reasonable prices.

Circle 376 on inquiry card.

Apple is a trademark of Apple Computer Company.

www.americanradiohistory.com



# What's Better Than Basic?

## BASIC B+™ IS!

Delphic Systems has merged its Z80 BASIC with FairCom's MICRO B+™ to produce **BASIC B+™**, the first all purpose interpreter featuring a B-TREE file structure implemented using **NEW** commands. No more messy CALLs or difficult assembly language interfacing! Instead, use the following **BASIC B+™** functions to manage an index without ever reorganizing the file:

BOpen	BClose	NEwB
KILB	FINDB	GETB
NEXB	PREVB	STATS

In addition, **BASIC B+™** was written using Z80 code in order to minimize size and enhance speed performance.

### Features & Requirements

- Search a 10,000 entry index in one second
- No index reorganization needed
- Uses fast and compact Z80 code
- CP/M® Versions 1.4 or 2.2
- 12 Digit precision
- Program Chaining
- Read only file protection
- Sequential and random files



## BASIC B+™

with documentation  
**\$325.00**

**Delphic Systems**  
2260 Compton Avenue  
St. Louis, MO 63104  
314/773-6753

Coming Next  
INVENTORY B+™

VISA MasterCard  
MICRO B+™ is a Trademark of FairCom

COLOR Statement Value	Address of Color Register Used (Hexadecimal)	Address of Operating-System Shadow Location (Hexadecimal)
0	D012	2C0
1	D013	2C1
2	D014	2C2
3	D015	2C3
4	D016	2C4
5	D017	2C5
6	D018	2C6
7	D019	2C7
8	D01A	2C8

Table 1: Addresses of color registers and their shadow locations affected by the COLOR statement in BASIC.

Listing 4: An Atari BASIC program that illustrates BASIC graphics mode 10 by drawing 16 vertical lines of varying hues and luminances.

```

10 GRAPHICS 10
20 FOR I=0 TO 8
30 POKE 704+I,255*RND(I):REM set random colors
40 COLOR I
50 PLOT 2,I,10
60 DRAWTO 2,I,80:REM draw in bars of color
70 NEXT I
80 GOTO 80:REM hang up in a loop
    
```

0 to 15 for its argument. The pixel data from ANTIC will be logically ORed with the upper nybble of the background color register to set the hue part of the value that ultimately generates the color on the screen. A sample BASIC program using mode 11 is presented in listing 3.

In assembly language, use the operating-system shadow location for the background color register (at 2C8 hexadecimal) to set the luminance in the lower 4 bits with values from 0 to F hexadecimal. If you use CIO calls to write to the screen, store the pixel data to be written into ATACHR located at 2FB hexadecimal. This selects the hue with values from 0 to F hexadecimal. If you are maintaining your own display data, the pixel data goes directly into the left or right half of the display RAM byte.

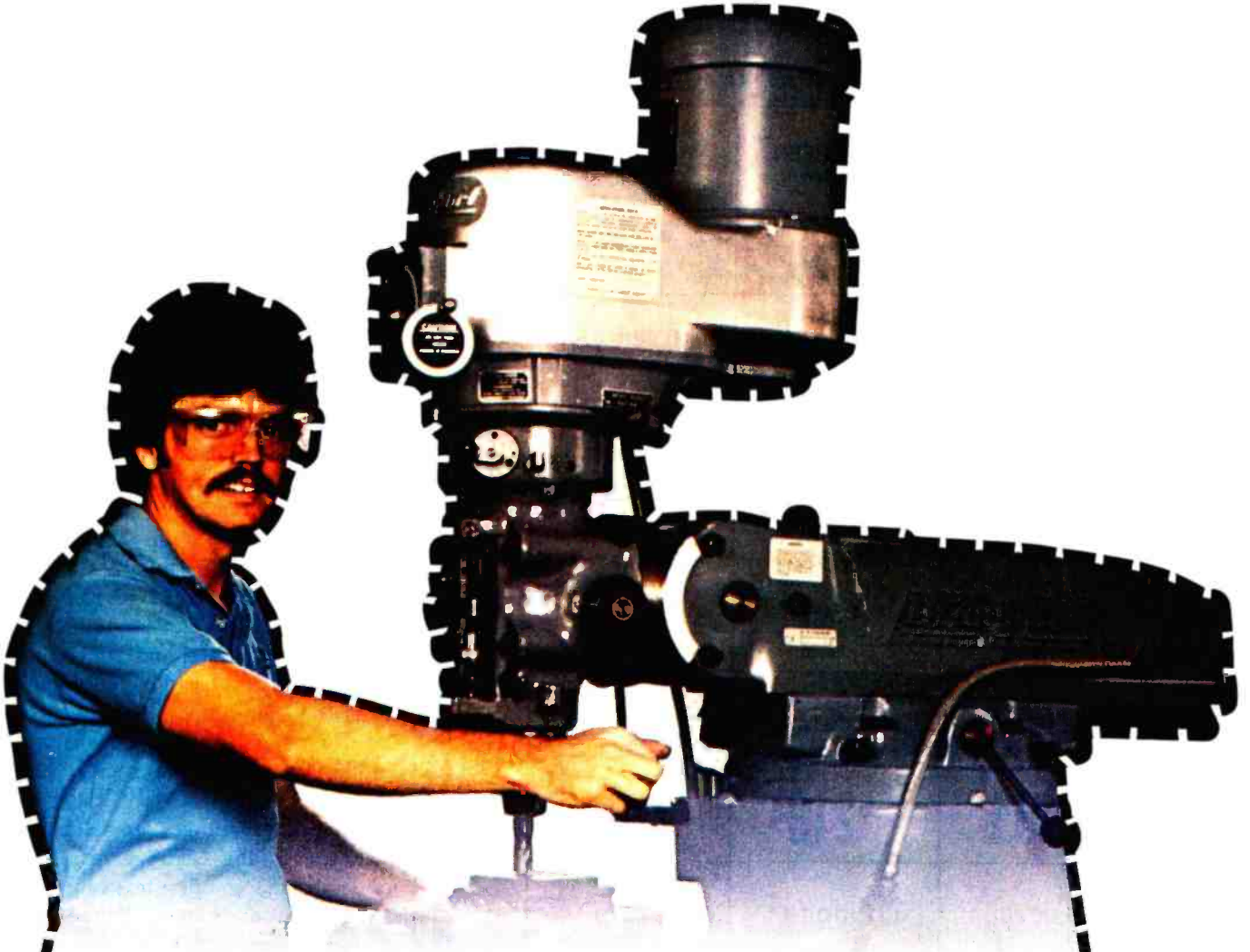
### Mode 10

Mode 10 allows all nine color registers to be used in the playfield at one time. Each color register to be used must be set to some combination of hue and luminance. The pixel data from ANTIC is used in this mode to select one of the color registers for

display. In BASIC, the SETCOLOR command can be used as described in the *Atari 400/800 BASIC Reference Manual* to set the colors in the background and the four playfield registers. These can also be set by using the POKE instruction to addresses 708 through 712 decimal where the four playfield registers and the background register are located. The POKE instruction must be used to set the four player/missile color registers at locations 704 through 707 decimal. The COLOR command is used to select the color register desired, as shown in table 1. The only meaningful values for its argument are 0 to 8. A problem arises with this mode. ANTIC supplies 4 bits of data per pixel, as it does with modes 9 and 11. This allows for the selection of 16 color registers. However, only nine color registers exist in the hardware. An illegal data value between 9 and 15 will select one of the lower-value color registers. A sample BASIC program using mode 10 is given in listing 4.

In assembly language, store the pixel data into ATACHR (location 2FB hexadecimal) or directly into the

# Our attitude is priceless. Our training is free.



Alabama has plenty of people who have a positive attitude about work.

And they're backed up with solid training.

Alabama offers industrial development job training second to none in the country. It's the model program other states are trying to imitate.

Our training begins in mobile units on site with the same kind of equipment used on the real job—even when that equipment is highly specialized such as with chemical processing or precision metal cutting.

Alabama's training assistance costs you nothing but it can mean everything in making you productive right from the start—and profitable sooner.

Cut out for Alabama where people are trained to your specifications and ready to work.

For more information, mail this coupon to Reuben Finney, Director, Alabama Development Office, State Capitol, Montgomery, Alabama 36130, or call him at (205) 832-6980.

Name \_\_\_\_\_

Title \_\_\_\_\_

Address \_\_\_\_\_

City \_\_\_\_\_ State \_\_\_\_\_ Zip \_\_\_\_\_

Phone \_\_\_\_\_

B 1

**Alabama.**  
**Cut out for business.**



# CP/M<sup>®</sup> SOFTWARE

## LARGEST SELECTION IN U.S.A.

dBASE II <sup>®</sup> Ashton-Tate <b>\$595</b>	QUICKSCREEN <sup>®</sup> Fox & Geller <b>\$149</b>	WORDSTAR <sup>®</sup> Micropro <b>\$299</b>
CB-80 <sup>®</sup> Compiler Systems <b>\$419</b>	SUPERCALC <sup>®</sup> Sorcim <b>\$239</b>	SPELLBINDER <sup>®</sup> Lexisoft <b>\$299</b>
SPELLSTAR <sup>®</sup> Micropro <b>\$169</b>	MAILMERGE <sup>®</sup> Micropro <b>\$99</b>	T/MAKER <sup>®</sup> Lifeboat Assoc. <b>\$229</b>
ACCOUNTING PLUS <sup>®</sup> Systems Plus <b>CALL</b>	CALCSTAR <sup>®</sup> Micropro <b>\$219</b>	BASIC COMPILER <sup>®</sup> Microsoft <b>\$325</b>
BASIC 80 <sup>®</sup> Microsoft <b>\$284</b>	CONDOR 1 <sup>®</sup> Condor <b>\$239</b>	FMS-80 <sup>®</sup> Systems Plus <b>\$649</b>

### SAVE ON HARDWARE

TELEVIDEO 910	\$575.00	MICROSOFT SOFTCARD	\$289.00
TELEVIDEO 950	\$955.00	ALTOS PRODUCTS	LESS 20%
C. ITOH STARWRITER	\$1429.00	ZENITH PRODUCTS	LESS 20%
C. ITOH PROWRITER	\$559.00	C. C. S. PRODUCTS	LESS 20%
IDS 560G	\$1060.00	ARCHIVES PRODUCTS	LESS 20%
		XEROX COMPUTERS	LESS 15%

CP/M is a Trademark of Digital Research

# standard software

CORPORATION OF AMERICA

10 MAZZEO DRIVE, RANDOLPH, MA. 02368

**617-963-7220**

ORDERS ONLY — 1-800-343-8420



SOFTWARE - HARDWARE - SUPPLIES - DISCOUNT PRICES

display RAM byte, as in modes 9 and 11. In this mode, the pixel data can range from 0 to 8 and selects one of the nine color registers.

### Advantages and Disadvantages

An important question arises in conjunction with GTIA concerning compatibility. GTIA is fully upward-compatible with the CTIA, and all software that runs on a CTIA system will run the same way on a system with GTIA. This means you still have full use of players and missiles, collision detection, and display-list interrupts. The GTIA graphics modes are supported by the operating system, and all graphics commands and utilities that run in the CTIA modes can be used in GTIA modes.

The GTIA allows the programmer to display more colors on the screen with less work. Sixteen colors can be shown on one horizontal line. This is better than what can be done with horizontal kernels (see "The Atari Tutorial, Part 4: Display-List Interrupts," December 1981 BYTE, page 181) that can give a maximum of 12 colors per horizontal line. Much finer contour and depth can be represented using the shading available in mode 9. This means three-dimensional graphics can be realistically displayed.

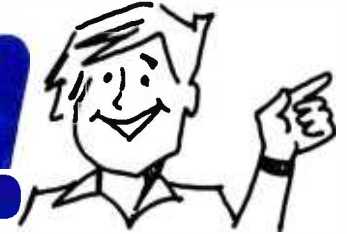
Some disadvantages are associated with use of the GTIA chip. GTIA modes are map modes; text cannot be displayed in these modes without recourse to custom display lists. The GTIA pixel is a long, skinny horizontal rectangle (4:1 ratio, width to height) that does not represent curved lines well. Because each pixel uses 4 bits of information, GTIA requires nearly 8K bytes of free RAM to operate. Although it is upward-compatible, it is *not* downward-compatible. Thus, programs that use GTIA modes will *not* produce correct displays on computers that have CTIAs. There is no way currently for a program to determine whether or not a GTIA is present in a system. Finally, color artifacts produced by a GTIA system will not be identical to the color artifacts produced on the same television with a CTIA system. ■

# AH-HA!



# EUREKA!

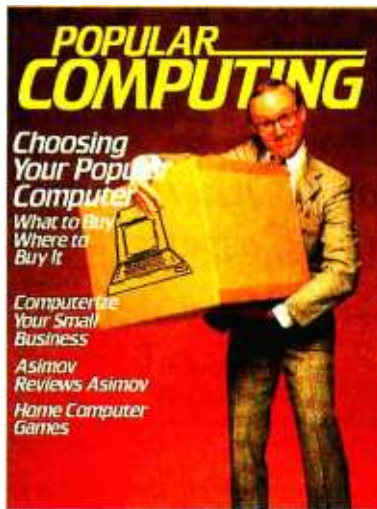
# ALL-RIGHT!



## Introducing "Popular Computing," the key to understanding.

Now you don't have to be a computer professional to unlock all the mysteries, potential, and pleasures of home and small business computers. *Popular Computing*, the new monthly magazine from McGraw-Hill, is the key.

Created in response to growing demand for our informative quarterly *onComputing*, *Popular Computing* explores every aspect of personal computers and their use. All reported in easy-to-understand nontechnical language.



## The answer to "Computerphobia."

Even the most computer-unsophisticated reader will find *Popular Computing* interesting and stimulating. Every issue will contain straight-talking product reviews,

special news briefs, and feature articles by famous guest contributors (like Isaac Asimov). There'll even be a helpful glossary of computer jargon we couldn't avoid using, and much, much more.

## Special Introductory Offer.

Send in this coupon today, and take advantage of *Popular Computing's* Special Introductory Offer.



# POPULAR COMPUTING

THE KEY TO UNDERSTANDING  
P.O. Box 397, Hancock, NH 03449



**SUPER SAVINGS FOR ME...** I'm taking advantage of this super introductory offer of 12 issues for only \$11.97 saving me \$3.03 on the basic rate of \$15.00—and saving me \$18.03 off the 12 issue news-stand rate of \$30.00. If my 30-day review of your first issue doesn't 100% please me, I may cancel my subscription and you will promptly refund ALL my money or give me a FULL credit on my charge card marked below.

Mail Today to:  
**POPULAR COMPUTING**  
P.O. Box 307, Martinsville, NJ 08836

Check Enclosed for \$11.97  
 Charge \$11.97 to:  
 Visa  Mastercard

Card No. \_\_\_\_\_  
Signature \_\_\_\_\_  
Name (Please Print) \_\_\_\_\_  
Address \_\_\_\_\_  
City \_\_\_\_\_ State \_\_\_\_\_ Zip \_\_\_\_\_  
Expires \_\_\_\_\_



# Ports of Entry and Soft Breezes for the Color Computer and Model III

*A \$10 Anemometer and Other Remote Sensing Projects  
Using the Cassette Interface*

---

William Barden Jr.  
28122 Orsola  
Mission Viejo, CA 92692

---

In the last article of this series, I discussed using the cassette output of the Model I and Model III as a single discrete output line to drive a music synthesizer, telephone dialer, and serial port. This month I'll look at the inverse—implementing discrete (binary) inputs on the Color Computer and Model III. (Unfortunately, the schemes I'll be using are not applicable on the Model I, so it will be slighted somewhat in this article.)

Of course, it's possible to implement *dozens* of discrete input lines to the Model I, Model III, or Color Computer by using a peripheral interface adapter (PIA) or peripheral input/output (PIO) device such as the 8255 semiconductor chip. This method requires four or five integrated circuits in addition to the PIO or PIA.

The approaches I'll discuss here, however, involve using few additional components other than sensors. This cheap and dirty approach can be used to detect remote switch

---

**The anemometer is constructed with plastic sprinkler fittings, wooden dowels, and plastic cups. Do some preliminary testing before using it atop a 200-foot tower.**

---

closures (e.g., in burglar alarms and fire detectors); it can even be used to receive serial data (e.g., pulses generated by a telephone-type rotary dial).

Discrete line inputs can also serve as a frequency counter. With the proper sensors and software, you can implement a low-frequency counter that easily measures thousands of counts per second; the software can handle switch bounce too.

As an example of a practical application of this discrete line input, I'll show you how to construct an anemometer that will measure wind speeds from 2½ to over 60 miles per hour. Believe it or not, this device costs less than \$10 and can be made by hackers without opposing thumbs.

## **Where Are the Discrete Inputs?**

Looking at the Color Computer, you can spot several potential discrete inputs: two joystick jacks, a cassette jack, and an RS-232C jack.

# Lack of ZX81 memory giving you headaches..?



## The Memotech 64K Memopak

The growth of interest in computer use caused by the introduction of the Sinclair ZX81 has made new and exciting demands on the ingenuity of electronic engineers. At Memotech we have focused our attention on the design of an inexpensive, reliable memory extension.

The Memopak is a 64K RAM pack which extends the memory of the ZX81 by a further 56K. Following the success of our 48K memory board the new memory extension is designed to be within the price range expected by Sinclair users. It plugs directly into the back of the ZX81 and does not inhibit the use of the printer or other add-on boards. There is no need for an additional power supply or for leads.

The Memopak together with the ZX81 gives a full 64K, which is neither switched nor paged, and is directly addressable. The unit is user transparent and accepts such basic commands as 10 DIM A(9000) 0-8K ...Sinclair ROM

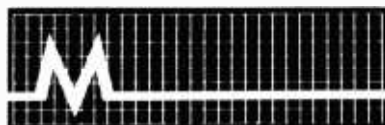
8-16K...This section of memory switches in or out in 4K blocks to leave space for memory mapping, holds its contents during cassette loads, allows communication between programmes, and can be used to run assembly language routines.

16-32K...This area can be used for basic programmes and assembly language routines.

32-64K...32K of RAM memory for basic variables and large arrays.

With the Memopak extension the ZX81 is transformed into a powerful computer, suitable for business, leisure and educational use, at a fraction of the cost of comparable systems.

**DEALER  
ENQUIRIES  
WELCOME**



**MEMOTECH**

Please make cheques payable to: Memotech Corporation

Memotech Corporation  
7550-Westvale Ave No. 220,  
Denver,  
COLORADO 80227.  
Tel (303) 986 0016

Please debit my  
MASTER CHARGE  
VISA \*  
account number:

\*Please delete  
whichever does not apply

Signature \_\_\_\_\_

Date \_\_\_\_\_

NAME \_\_\_\_\_

ADDRESS \_\_\_\_\_

*Please rush me:*

	Quantity	Price	Total
64K RAM, Assembled		\$179.95	

Postage **\$4.00**

**POCI TOTAL**

Memotech Corporation, 7550-Westvale Avenue, No. 220, Denver, COLORADO 80227

Circle 35 on inquiry card.



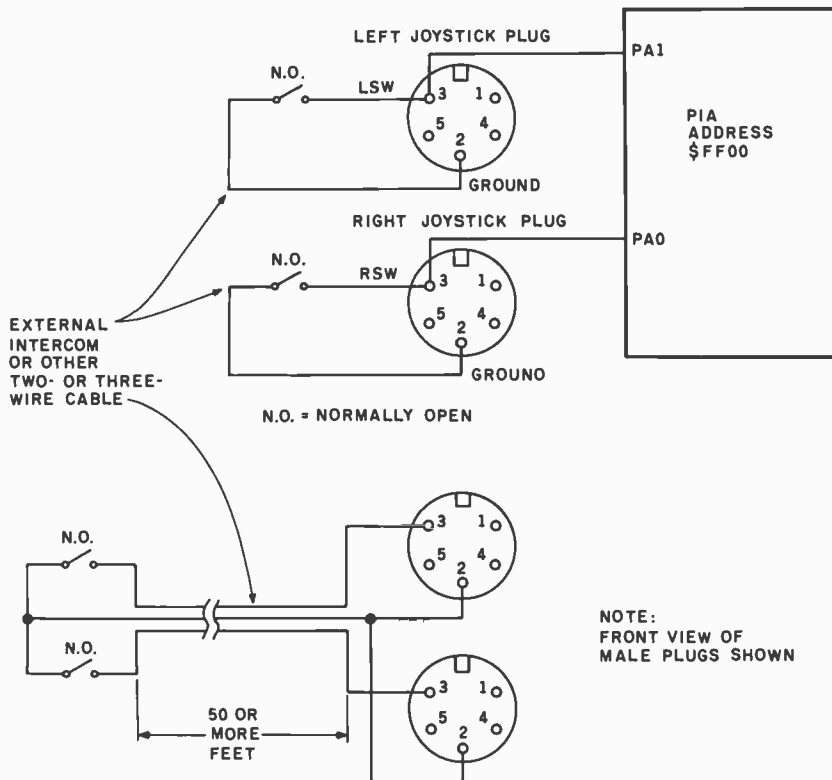
**Joystick switch inputs.** The left and right joysticks have four analog channels that could be used as discrete inputs. Even more promising, however, are the joystick "switch" inputs.

The joystick switches (shown in figure 1) are normally open switches that close to ground. The output of each switch goes to bit 0 (right joystick) and bit 1 (left joystick) of PIA address hexadecimal FF00. As you can see from figure 2, the switch inputs to the PIA are shared by two keyboard rows; normally, you wouldn't be using the keyboard and joystick switches at the same time. The joystick switches connect to the PIA through a small filter made up of a choke and bypass capacitor as shown in the figure; this eliminates some input noise.

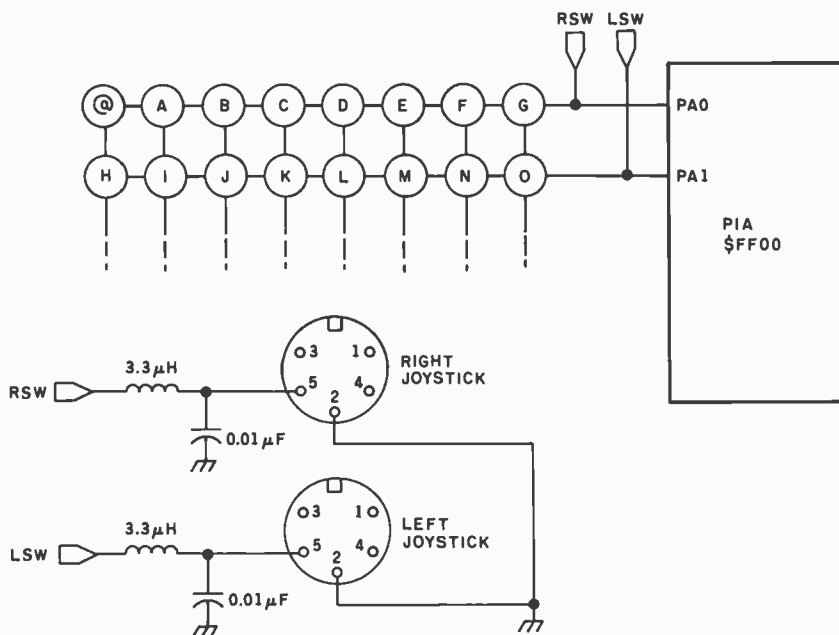
Substituting an external switch (or switches) for the joystick switches, a cable can be run 50 feet or more to a remote location. This procedure is not generally recommended with an unterminated input, but I experienced no difficulties and no false readings in a home environment with a 60-foot intercom cable.

The program used is shown in listing 1, which simply checks for a 1 or 0 on either joystick input. This Extended Color BASIC program loops at about 30 senses per second, making the scheme fine for switch closures in burglar alarms, fire detectors, microswitches in mailboxes triggered by the weight of the mail, and so forth. At this point it's probably well to mention a typical switch that can be used for remote sensing. Radio Shack has submini lever switches with and without rollers (275-017 and 275-016, respectively), which require about 50 grams of force to operate. These switches were used in the applications described here, although virtually any single-pole, double-throw (SPDT) switch could be used.

**RS-232C input.** Another possibility for a discrete input on the Color Computer is the RS-232C read (RD) input. This line is normally used to input serial data and, as figure 3 shows, it connects to an LM339 comparator in the Color Computer. One input to the comparator is a voltage divider made up of a 15-kilohm (k $\Omega$ )



**Figure 1:** The Color Computer joystick switch inputs can be connected to external single-pole, single-throw (SPST) or single-pole, double-throw (SPDT) switches for remote sensing applications. Cable runs can be up to 50 feet.



**Figure 2:** The Color Computer joystick switch inputs are "wire ORed" to two keyboard rows. Since the keyboard is never used at the same time as the switches, this causes no sensing problems.

# COBOL the language of business.

## The language of Micro Focus

# CIS COBOL

Our CIS COBOL product family brings you the most successful business programming tool ever devised, COBOL, in a form optimized for today's most cost effective hardware, the microcomputer. Standard COBOL as defined by ANSI X3.23-1974.

The reliability and performance of CIS COBOL are strongly emphasized by its' continued qualification for U.S. government contracts. In January 1981 CIS COBOL entered its 2nd year of G.S.A. certification.

CIS COBOL is powerful but simple to use. Its screenhandling, dynamic module loading and fast ISAM let you take full benefit from micro computer facilities.

Our FORMS-2 utility is a COBOL source code generator to help you build interactive applications with ease. Using our unique demonstration "How to create a COBOL program in 20 minutes," you can quickly try out new application ideas.

And if you are developing software for resale, the variety of systems running CIS COBOL offers you a very large available market.

WITH  
FORMS-2

CIS COBOL and FORMS-2 are available through our dealers and distributors for many 8080, Z80 and LSI-11 systems including Apple II with Softcard and CP/M.

For OEM purchase on 8086, PDP-11, UNIX and other order codes approach us direct. Our system transfer technology has made CIS COBOL first on a number of processors and enabled us to interface to 30 different operating systems.

For more information about CIS COBOL fill in the coupon below.

To: Micro Focus Inc. 1601 Civic Center Drive,  
Santa Clara, Ca 95050, USA.  
Phone: (408) 496 0176. Telex: 278704 MFCIS UR

Please send me

- A brochure on CIS COBOL  
 A brochure on FORMS-2  
 A set of Applications Notes  
..... (Qty) CIS COBOL manual(s) at \$75  
(inc. p+p) for which I enclose a check  
for \$.....

My chief interest is in; (please tick box)

- 8080  
 8086  
 UNIX  
 Apple II

Name .....

Position .....

Company .....

Address .....

Tel No.....

 **MICRO  
FOCUS**

CIS COBOL and FORMS-2 are trademarks of Micro Focus. 8080 is a trademark of Intel Corp. Z80 of Zilog. LSI-11 and PDP-11 of Digital Equipment Corp. Apple II of Apple Computer. Softcard of Microsoft Consumer Products. CP/M of Digital Research and UNIX of Bell Laboratories.

Circle 267 on Inquiry card.



Listing 1: Sample Color Computer BASIC program for reading joystick switch closures.

```

100 ' SWITCH CLOSURE FOR RIGHT AND LEFT JOYSTICK
110 INPUT "RIGHT(R) OR LEFT(L) DETECT";A$
120 IF A$="R" THEN M=1 ELSE M=2
130 A=(PEEK(&HFF00) AND M)
140 IF A=M THEN PRINT "OFF" ELSE PRINT "ON"
150 GOTO 130
    
```

Listing 2: Sample Color Computer BASIC program for reading RS-232C RD inputs.

```

100 ' SWITCH CLOSURE FOR RS-232-C RD INPUT
110 A=(PEEK(&HFF22) AND 1)
120 IF A=0 THEN PRINT "ON" ELSE PRINT "OFF"
130 GOTO 110
    
```

and a 10-kΩ resistor. The junction point is a constant +2 volts (V) and goes to the "+" (plus) input.

The "-" (minus) input connects to the external RD line via a common diode and 10-kΩ resistor to ground. RS-232C signals are normally above +3 V (logic 0) or below -3 V (logic 1). When the RD line is more positive than about +2.6 V, the input forward-biases the diode, and the "-" input is greater than the "+" input, producing a logic 0 comparator output. When the RD line is negative, the diode is reverse-biased, and the output of the comparator is logic 1. The comparator output goes to bit 0 of a PIA whose address is hexadecimal FF22. Reading bit 0 of PIA hexadecimal FF22 is a process similar to reading the joystick switch, as shown in listing 2.

Figure 4 shows the connections for the RS-232C remote input. Tie the normally closed contact of the switch to the positive terminal of a 6-V battery. Tie the normally open contact of the switch to the negative terminal of a second battery. Tie the opposite ends of the batteries together and to the ground lead of the RS-232C connector. The common contact of the switch goes to the RD line. There will be some switch bounce when the switch is broken (on the order of 50 or 60 milliseconds [ms]), but this arrangement is fine for slow sensing.

Again, this scheme was implemented using ordinary two-conductor cable without termination and with a 60-foot run in a home environment. No false readings were detected. Twisted-pair cable could be used to increase the noise immunity. As this method is essentially current-driven rather than voltage driven, runs even longer than 60 feet should be possible.

**Cassette input.** Now for the third method of implementing a discrete input: using the cassette input. Examination of the Color Computer and Model III shows that the same scheme, a comparator input, is used for both the Color Computer and Model III 1500-bps (bits per second) cassette inputs. (The Model I and Model III 500-bps cassette inputs use

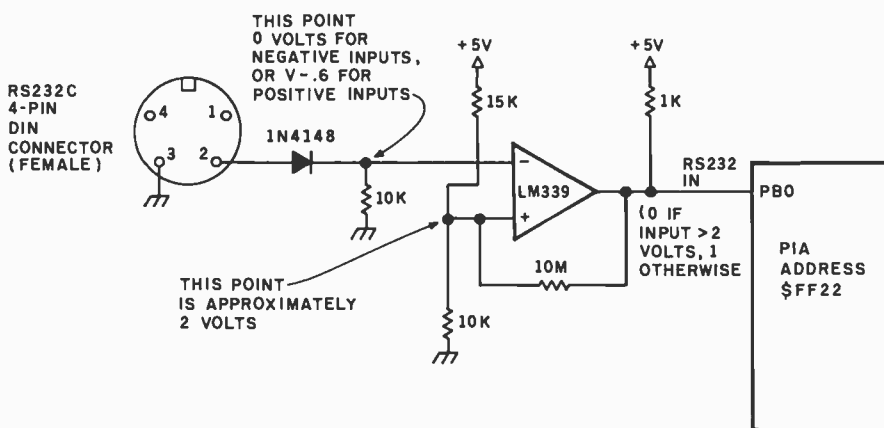


Figure 3: The Color Computer RS-232C RD input goes to an LM339 comparator via a diode. Output of the comparator is a logic 0 for positive signals and a logic 1 for negative signals.

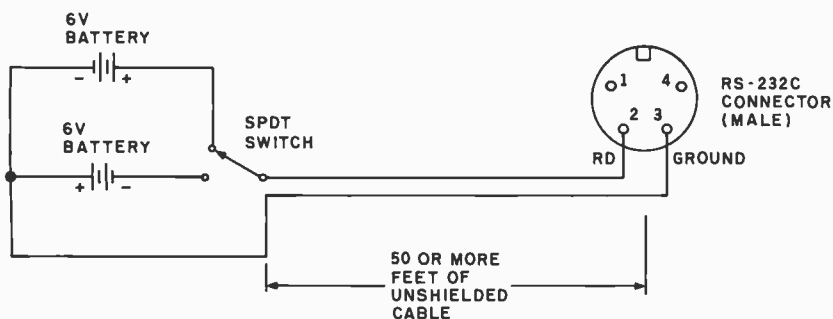


Figure 4: Two 6-V batteries can be connected to an SPDT switch to implement a remote sensing switch connected to the Color Computer RS-232C port.

Ask your dealer for a demonstration



# Chart your financial future with MicroFinesse™

In this fast-paced business world, the best way to stay competitive is to be able to see your financial alternatives clearly and make decisions fast.

That's why P-E Consulting Group Ltd. developed MicroFinesse, a complete package providing professional financial forecasting PLUS full high-resolution color graphics support, including pie charts, histograms and graphs, for the financial projections you create.

Now this evolutionary financial resource planning tool eliminates the time-consuming reprogramming required for financial model

consolidation or expansion. MicroFinesse's menu-driven command format can also generate up to 15 user-defined reports per model, with visuals, without reprogramming.

Previously available only for main-frame applications, the MicroFinesse program can now be purchased at leading Dealers nation-wide. MicroFinesse is specifically designed for the 48K Apple II® with the Apple Language Card.

So when your variables are many and your time is limited, take a good look at the financial artistry of MicroFinesse.



## MicroFinesse

Distributed by:  OSBORNE/McGraw-Hill  
630 Bancroft Way, Berkeley, CA 94710, (415) 548-2805

Apple II is a registered trademark of Apple Computer, Inc.

Circle 316 on inquiry card.

[www.americanradiohistory.com](http://www.americanradiohistory.com)





# DECIS

## Minicomputer performance in

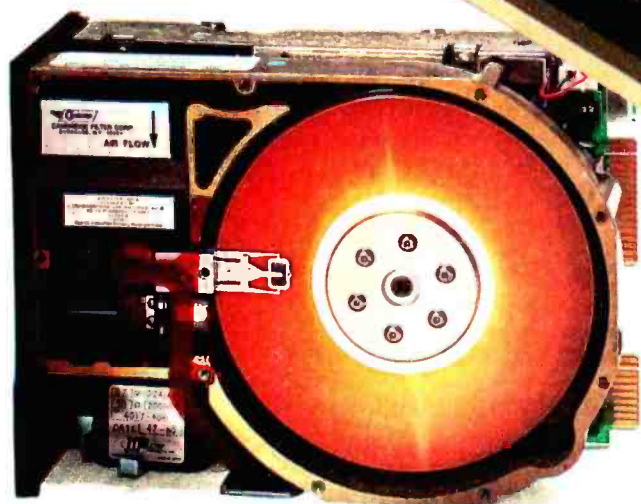
**Multi-user. Multi Tasking.** Decision I™ memory management hardware includes a memory map that is similar to the IBM 360™ and IBM 370™. It supports up to 16 tasks or 15 users and a supervisor without swapping. And, more with swapping. Each task or user enjoys complete memory protection and dynamic memory allocation. One task may be delegated as a supervisor to privileged system functions forbidden to ordinary tasks or users. Such functions (I/O calls, unauthorized memory access, etc.), will trap to the supervisor. If supervisory functions are not required the system can be configured for turnkey multi-user operation.

**Multi-purpose IEEE696/S-100.** Decision I utilizes the Morrow Designs IEEE Standard S-100 Wunderbuss™. That means you can configure it to your specific applications. Add a floating point processor, add memory (to a full megabyte), add I/O, add controllers... add boards from dozens of manufacturers. And S-100 has a major advantage over single-board computers: If a board goes down, you simply replace it. And keep running. If you want to expand your system. Add boards and terminals.

**An unmatched software base.** Decision I runs on the M/OS™ operating system. M/OS supports all system calls source

compatibly with UNIX®. Thus, UNIX programs will compile directly and UNIX documentation is almost totally applicable. Morrow CP/M™ has been configured to run under M/OS and communicate with both CP/M and UNIX standard media for maximum portability. Languages available include BASIC, COBOL, FORTRAN, RATFOR, Pascal and C. That means Decision I offers you a software base unmatched in its price/performance arena.

**The OEM machine.** A basic multi-user system at \$5,225 includes the Decision I, 4 Mhz Z80A-based CPU, sophisticated memory



IBM 360 and 370 are trademarks of IBM Corp.  
Wunderbuss is a registered trademark of Morrow Designs  
Decision I and M/OS are trademarks of Morrow Designs  
UNIX is a trademark of Bell Laboratories, Inc.  
CP/M is a trademark of Digital Research Corp.

# ION I

## a multi-user Microcomputer.



management hardware, CP/M 2.2, M/BASIC 5.2, 3 serial and 2 parallel I/O ports, 14 I/O slots with S-100 connectors, supervisor control in both hardware and software, 128K of RAM and two quad-density disk drives (800K) with DMA controller. Plus, cabinet (either desk-top or rack-mount), and power supply. The same system with 8" floppies and a full Megabyte of formatted storage costs \$5,659. And, we offer OEM pricing.

**A better microcomputer.** Whether you're building a single or multi-user system, the Decision I offers you a hardware/software combination unmatched in the field. Decision I is not simply an improved 8-bit microcomputer. It's a breakthrough. In both computing power and price.

**Systems your way.** Morrow Designs' full range of hard and floppy disk memory, add-in memory boards, I/O

boards, controllers and software allow you to configure your system your way...through a single supplier.

**The decision is yours.** Compare the Decision I, feature-for-feature with mini or microcomputers on the market today. Compare capabilities. Compare flexibility. Compare utility. Then, compare price. We think Decision I will change the way you think about microcomputer systems.

**Complete information?** See your computer dealer. Or, write Morrow Designs.

**LOOK TO MORROW FOR ANSWERS.**



## MORROW DESIGNS

5221 Central Avenue, Richmond, CA 94804  
(415) 524-2101



Circle 290 on inquiry card.



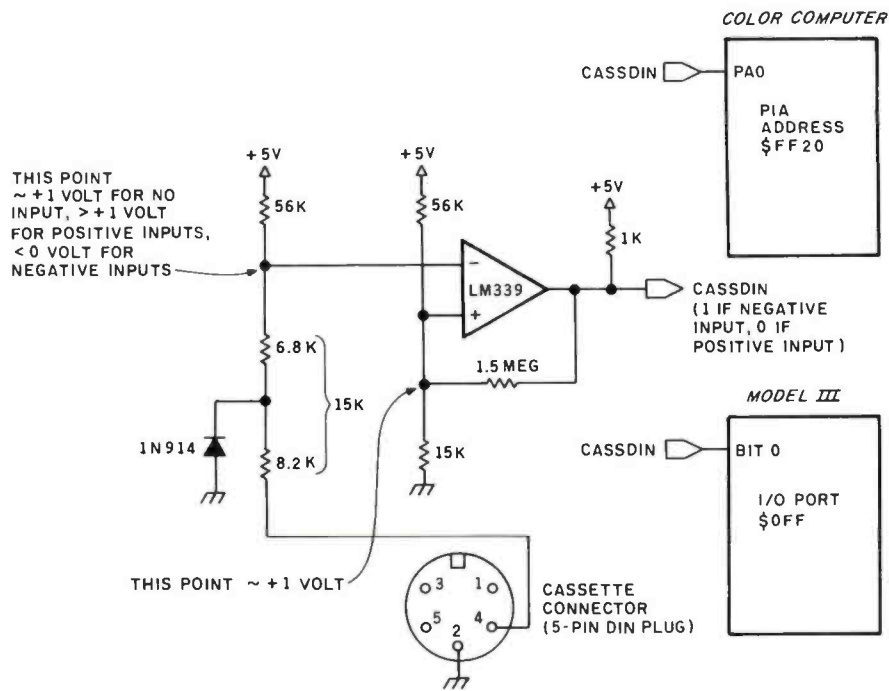


Figure 5: The Color Computer and Model III have identical 1500-bps cassette input logic. An LM339 comparator compares a fixed reference voltage to the cassette data input. Output of the comparator is a logic 0 for positive signals and a logic 1 for negative signals.

a different scheme, one of rectifying pulses. That arrangement is not as functional for random inputs as the one discussed here.) As a matter of fact, the input circuits in the Color Computer and Model III 1500-bps cassette interfaces are identical (see figure 5).

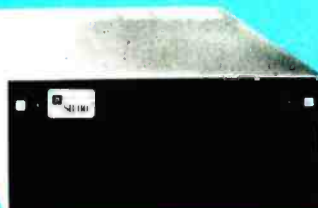
A frequency-shift keying method is used to generate the cassette waveform. A different frequency is used for a 0 and a 1 bit, as shown in figure 6. The Color Computer or Model III firmware measures the frequency of the sine wave by checking the binary output of the LM339 comparator, as shown in the figure.

One input to the LM339 is a fixed voltage of about +1 V from the junction of the 56-kΩ and 15-kΩ voltage divider. The second input is from a similar voltage divider. In the latter case, however, a diode goes to ground at the junction of the 6.8-kΩ and 8.2-kΩ resistors.

Input from the cassette recorder is an alternating current (AC) signal,

## SB-80

### The Price Is Nice.



\$2425.

Basic system with: 600K bytes

- 1.2 megabytes: List \$3650.
- 2.4 megabytes: List \$4650.

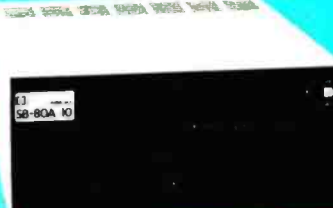
#### Single Board Technology

A Z80A CPU combined with the CP/M® operating system opens new vistas to software availability for eight-bit micros. FORTRAN, COBOL, BASIC, APL, PL/1 and Pascal are available now to accommodate today's scientific, educational, sophisticated small business and personal system users.

- 4 MHz Z80A CPU
- CP/M 2 operating system
- 64K 200ns main memory
- 8-inch floppy drives
- 50-pin expansion connector
- 2-serial ports
- 2-parallel ports
- 4-counter/timers
- Hard disk options available

## SB-80/10


### Floppy and Winchester Microcomputer System



An 8 inch floppy and an 8 inch Winchester hard disk microcomputer system all packaged in a compact, stylish cabinet. We've combined all the fine features of the SB-80 and added the speed of a Winchester to offer you the storage of almost 12 million bytes. The SB-80/10 comes complete with controller, power supply, and the single board computer to give you the total system for less money.

- SB-80/10 Sub-system ..... List \$6500.  
Add-on to the SB-80  
10m byte Winchester disk storage
- SB-80A/10 ..... List \$8500.  
SB-80 Microcomputer System  
600K byte floppy disk storage  
10m byte Winchester disk storage
- SB-80B/10 ..... List \$8900.  
SB-80 Microcomputer System 1.2m byte floppy disk storage  
10m byte Winchester disk storage

Substantial OEM and Dealer discounts available



## Colonial Data Services Corp.

105 Sanford Street Hamden, Conn. 06514 (203) 288-2524 • Telex: 956014

Mid Atlantic Distributor  
**COMPUTER APPLIED SYSTEMS, INC.**  
497 Hill Street, York, Pennsylvania 17403 • (717) 848-2431

New England Distributor  
**S&M SYSTEMS, INC.**  
P.O. Box 1225 • 2 Washington St., Haverhill, MA 01830 • (617) 373-1599

\*CP/M is a registered trademark of Digital Research, Inc.

# "GE's ENERGY AUDIT DIAGNOSED OUR LIGHTING NEEDS AND SAVED US \$17,688."



Robert O'Herron, Vice President of Facilities, Akron General Medical Center.

"I'm always looking for ways to cut costs. That's why I was very interested in General Electric's lighting energy audit.

"I simply filled it out, marking in the number of each type of lamp we use. GE then calculated that we could save more than \$68,000 annually in energy costs with GE energy-efficient lamps.

"We immediately changed one-fourth of our lamps to Watt-Miser® II fluorescents from GE. What's more, we did this without refixturing. Which meant a substantial \$17,688 savings in annual energy costs with no capital investment!"

The GE energy audit may be able to save you a lot of money, too. Just fill out the form below and mail it in.

You'll receive a personalized computer analysis, showing your potential savings.

The GE energy audit. Let it make the right diagnosis for you.











**WE BRING  
GOOD THINGS  
TO LIFE.**

**GENERAL  ELECTRIC**

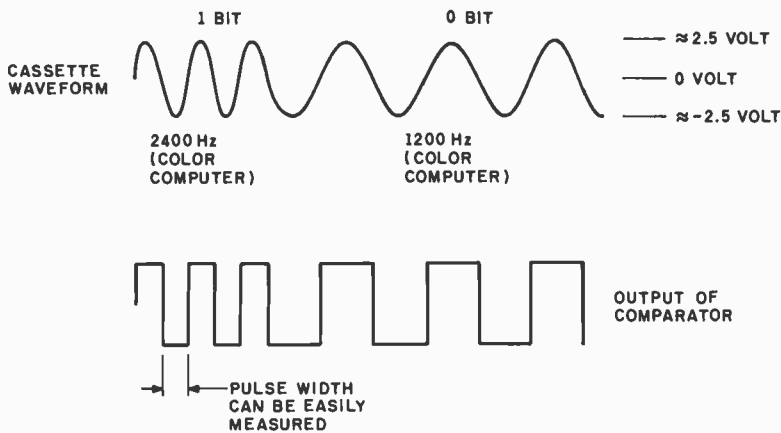
C-202

## SEE WHAT YOU CAN SAVE WITH GE's FREE LIGHTING ENERGY AUDIT.

Fill out this form and mail to General Electric Company,  
Lighting Energy Audit, Department PMN1D, Nela Park, Cleveland, Ohio 44112.

	Now in use	Total Number	Hours each lamp operates per week	
<b>Standard Fluorescents</b>				My energy rate is \$0. <u>    </u> per kilowatt hour. 116 (Divide total dollars from your last bill by total kilowatt hours used.)
12	4' F40/RS 	_____	_____	
20	8' F96 	_____	_____	
<b>Energy Saving Fluorescents</b>				Please send the savings analysis to:
28	4' 35/34W RS 	_____	_____	
36	8' 60W 	_____	_____	
<b>Deep Recessed Downlight Floods</b>				Name _____ 120
44	75R30/FL 	_____	_____	Company _____ 155
52	150R/FL 	_____	_____	Address _____ 190
<b>Incandescent Bulbs</b>				City _____ State _____ 225
60	60 Watt 	_____	_____	Zip Code _____ 260
68	75 Watt 	_____	_____	Phone _____ 265
76	100 Watt 	_____	_____	I buy lamps from:
<b>PAR-Lamps</b>				Contractor _____ 290
84	150PAR/FL 	_____	_____	Distributor _____ 325
92	150PAR/SP	_____	_____	City _____ State _____ 365
100	75PAR/FL	_____	_____	<input type="checkbox"/> Please have someone come out and help me fill out this form. 395
108	75PAR/SP	_____	_____	_____ 396





**Figure 6:** Both the Color Computer and Model III 1500-bps cassette logics use a "frequency-shift keying" recording technique in which two separate frequencies represent logic 0 and 1.

**Listing 3:** Sample Color Computer BASIC program for reading cassette input.

```

100 ' SWITCH CLOSURE FOR CASSETTE INPUT
110 A=(PEEK(&HFF20) AND 1)
120 IF A=0 THEN PRINT "OFF" ELSE PRINT "ON"
130 GOTO 110

```

**Listing 4:** Sample Model III BASIC program for reading cassette input.

```

100 ' SWITCH CLOSURE FOR CASSETTE INPUT
110 A=(INP(255) AND 1)
120 IF A=0 THEN PRINT "OFF" ELSE PRINT "ON"
130 GOTO 110

```

with about 2.5-V swings on either side of 0 V. When the cassette signal is positive, the "-" input is greater than +1 V, and the comparator output is logic 0. When the cassette signal is negative, the diode conducts, dropping the "-" input to below 0 V and forcing the comparator output to logic 1.

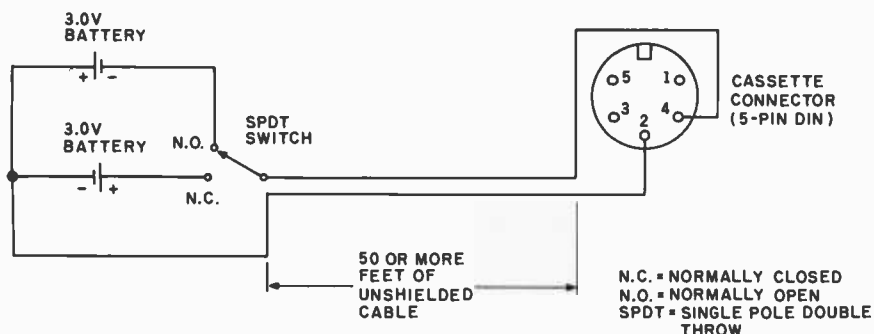
Output of the comparator goes to bit 0 of PIA address hexadecimal FF20 in the Color Computer or to bit 0 of input/output (I/O) port address hexadecimal FF in the Model III. Reading either port requires a single BASIC instruction (PEEK (&HFF20) or INP(255)) or a comparable machine-language instruction. Listing 3 provides a simple Color Computer BASIC test of the cassette-in bit; listing 4 shows the equivalent Model III test.

A remote sensing switch can be implemented in identical fashion to the RS-232C method, as shown in figure 7. Two batteries produce +3 V and -3 V, and these voltages are tied to the normally closed (NC) and normally open (NO) contacts of the remote sensing switch. The switch is connected via ordinary two-conductor cable. Again, twisted wires may be used if desired to improve noise immunity. A 60-foot length of cable was used in a home environment, and no false readings were detected for slow switch closures.

### Switch Bounce

The BASIC programs listed for the three discrete input methods are fine for slowly changing inputs such as burglar alarms. A typical BASIC loop allows sampling at a dozen or so times per second. When the frequency of switch closures is greater, however, you must rely on faster assembly-language code. Assembly-language code can test the inputs thousands of times per second. In fact, assembly language is so fast that switch bounce can cause problems. The typical switches mentioned above do not close instantaneously. Minute movements produce "make and break" conditions during a certain period, as shown in figure 8.

Various hardware schemes can



**Figure 7:** Remote sensing can be implemented in the Color Computer or Model III by connecting an SPDT switch to two 3-V batteries.

# IF YOU BUY MICRO-COURIER™ BEFORE JULY 1, YOU GET A \$100 SUBSCRIPTION TO THE SOURCE® FREE.

Micro-Courier is *the* electronic mail software for Apple™ computers. It lets you send anything in your Apple computer to any other Apple, in any other office, anywhere in the world. It's fast, 100% error-free, and inexpensive. You can send and receive charts, graphs, VisiCalc™ reports and entire programs.

Micro-Courier also takes you right to THE SOURCE.

You can access one of the largest data bases in the world, including news, travel service, commodity updates, educational programs, electronic games and more.

And if you act now, you can get a free \$100 subscription to THE SOURCE with your Micro-Courier package.

See your Apple dealer for complete details.



## MICROCOM

We make little computers talk big.

1400A Providence Highway  
Norwood, MA 02062

Apple is a trademark of Apple Computer Inc. VisiCalc is a trademark of VisiCorp., Inc. THE SOURCE is a servicemark of Source Telecomputing Corporation, a subsidiary of The Reader's Digest Association, Inc.

Circle 265 on inquiry card.



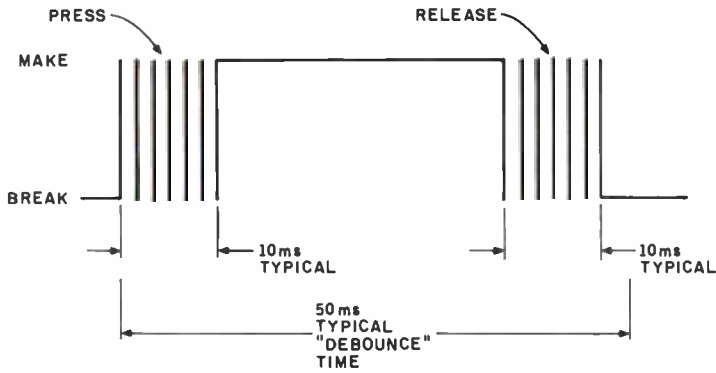


Figure 8: Switch debounce can be accomplished in software by delaying a "debounce time" after initial detection of the switch closure.

eliminate switch bounce, but let's seek software solutions instead. The usual software approach is to delay for a fixed interval after detection of the first switch closure.

The following table suggests debounce requirements. The two Radio Shack switches referred to previously were pressed rapidly for exactly 10 closures within about 2 seconds for various "debounce delays" ranging from 10 ms to 100 ms. The "count" represents the number of switch closures detected. Counts greater than 10 indicate that switch bounces were counted as closures.

Debounce Delay (ms)	Key Closures Detected
100	10
90	10
80	10
70	10
60	10
50	17
40	19
30	22
20	33
10	59

The switch-bounce delay in software varies with the type of switch and action of the operator. Use these figures as a rough guide only.

#### A Low-Frequency Event Counter

Listing 5 gives a low-frequency counter program for the Color Computer, one that will measure events occurring thousands of times per second. The discrete input is on the cassette input line and is designed to interface to a BASIC driver.

Three parameters are stored in high memory in a 16K-byte system. The first, an interval count, is stored in locations hexadecimal 3FFA and 3FFB. The interval count may be any number from 1 through 32,768 and represents the time window during which events will be counted in units of 30.35 microseconds ( $\mu$ s). An interval of 1000, for example, represents 30,350  $\mu$ s or 30.35 ms. Maximum window time is  $32,768 \times 30.35 \mu$ s or .994508 second. (Note: for 32,768, use 0.)

The second parameter, a debounce delay count in milliseconds, is stored in locations hexadecimal 3FFC and 3FFD. This delay count will cause the program to "close" the window for a

THE WORD T.M.

WHY DOES OUR SPELLING CHECKER COST LESS THAN THEIRS?

Maybe we goofed by not charging more for The WORD. Our customers tell us we must be crazy, giving away this much software for only \$75.

**What's wrong with it?**

Frankly, we're a little hurt when people ask us this question. We guess everyone must be getting used to paying \$200 to \$300 for decent software. Anything that costs less must be junk. Right?... WRONG!!!

The WORD is not only cheaper, it's better!

**Available NOW for:**  
 8" single CP/M<sup>®</sup>, CDOS<sup>™</sup>  
 XEROX 820 (8" only)  
 Intertec Superbrain<sup>™</sup>  
 Apple<sup>™</sup> with CP/M Softcard  
(35,000 word dictionary)  
 North Star<sup>™</sup> Double/Quad with CP/M  
CP/M is a registered trademark of Digital Research

**The WORD gives you more!**

- The WORD gives you a 45,000 word dictionary that fits into less than 140K of disk space.
- The WORD works with your favorite text editor and marks mistakes in your document for easy, *in-context*, correction.
- The WORD's one-touch word review lets you add new words to the dictionary with a single keypress. You can build your own custom dictionaries too!
- The WORD will look up the correct spelling of misspelled words.
- The WORD analyzes your writing, counting words and showing you how often *each* word was used.
- The WORD has a special *homonym helper* feature to deal with these pesky words.
- The WORD will find rhyming words, solve crossword puzzles, and much more!

CALL TODAY!  
(714) 291-9489

OASIS SYSTEMS

2765 REYNARD WAY, SAN DIEGO, CA 92103

# The IBM Personal Computer

Personal, Professional, Technical — or somewhere in between ...  
PC-MATE™ makes the IBM Personal Computer a perfect match

PC-MATE™ from TECMAR is the first and only complete expansion series available for the IBM Personal Computer. There are currently more than twenty PC-MATE™ expansion options available, and new products are continuously added to the list.

When you want more from your IBM Personal Computer, look to PC-MATE™.

You can create a SUPER PERSONAL COMPUTER with household lights and appliance control, voice output, and give it more memory than any ordinary personal can handle.

Or make it a PROFITABLE PROFESSIONAL SYSTEM with expansion space and a Winchester disk to handle more business accounts. Increase memory up to

the system limit and process those accounts faster. Add flexible I/O interfaces and put yourself on line to outside information sources.

As an INTELLIGENT LABORATORY TOOL, with interfaces to IEEE 488 instrumentation, analog signals, stepper motors and video signals, your IBM Personal Computer becomes the perfect workbench assistant.

Hardware, Software, Accessories — PC-MATE™ provides the highest quality and the greatest possible range of functionality for the IBM user.

Ask your local computer store for more information on the PC-MATE™ series from TECMAR, or call for the name of your nearest authorized PC-MATE™ dealer.

## PC-MATE™ EXPANSION OPTIONS

Personal Computer Expansion Chassis (see photo)  
192K and 256K Dynamic Memory with Parity  
Winchester Disk Drive and Controller  
Parallel Medium Speed Input/Output Interface  
Serial Medium Speed Input/Output Interface  
Parallel High Speed Input/Output Interface  
Serial High Speed Input/Output Interface  
Analog to Digital Converter - 8, 12, 14, 16 Bit  
Dust Cover Set for IBM PC and Peripherals  
High Speed Static Memory (RAM/ROM)  
Digital to Analog Converter - 8 and 12 Bit  
Multi-System Printer Sharing Facility  
CMOS Memory with Battery Backup  
System Clock with Battery Backup  
Electrically Erasable EPROM  
BSR X-10 Device Controller  
Stepping Motor Controller  
Video Image Digitizer  
IEEE 488 Interface  
Prototyping Board  
Music Synthesizer  
Voice Synthesizer  
Extender Board

One Year Warranty

Additional products are already under development, so if we don't have what you need, chances are good that we soon will.

Circle 408 on Inquiry card.

**Tecmar Inc.** PERSONAL COMPUTER PRODUCTS DIVISION  
23600 Mercantile Rd., Cleveland, OH 44122 (216) 464-7410

[www.americanradiohistory.com](http://www.americanradiohistory.com)





Listing 5: Color Computer assembly-language program for measuring low frequencies through the cassette input port. Switch-debounce time can be varied.

```

3F00          00100          ORG          $3F00
00110 *****
00120 * LOW-FREQUENCY EVENT COUNTER WITH DEBOUNCE *
00130 * INPUT: $03FFA = INTERVAL CNT IN 30.35 MICROSEC *
00140 * UNITS, 2 BYTES *
00150 * $03FFC = DEBOUNCE DELAY CNT IN MS, 2 BY *
00160 * $03FFE = RESERVED FOR COUNT, 2 BYTES *
00170 * OUTPUT: $03FFE = # OF COUNTS IN INTERVAL, 2 BYT *
00180 *****
00190 *
3F00 BE 3FFA 00200 LOWFRE LDX $3FFA GET INTERVAL CNT
3F03 100E 0000 00210 LDY #0 INITIALIZE COUNT
3F07 30 1F 00220 LOW010 LEAX -1,X DECREMENT INT CNT (<5>)
3F09 1F 10 00230 TFR X,D NOW IN D (<7>)
3F0B 4D 00240 TSTA TEST FOR NEGATIVE (<2>)
3F0C 2B 0D 00250 BMI LOW090 GO IF DONE (<3>)
3F0E B6 FF20 00260 LDA $FF20 GET PIA BYTE (<5>)
3F11 04 01 00270 ANDA #1 GET CASSDIN BIT (<2>)
3F13 27 F2 00280 BEQ LOW010 GO IF 0 (<3>)
3F15 31 21 00290 LEAY 1,Y 1, INCREMENT COUNT
3F17 0D 07 00300 BSR DEBNC DEBOUNCE DELAY
3F19 20 EC 00310 BRA LOW010 CONTINUE INTERVAL
3F1B 10BF 3FFE 00320 LOW090 STY $3FFE STORE COUNT
3F1F 39 00330 RTS RETURN FROM SUBROUTINE
00340 *
00350 * DEBOUNCE DELAY SUBROUTINE
00360 *
3F20 34 10 00370 DEBNC PSHS X SAVE INTERVAL COUNT
3F22 0E 3FFC 00380 LDX $3FFC GET DELAY COUNT IN MS
3F25 0D 06 00390 DEB010 BSR DELAY DELAY N MS
3F27 30 1F 00400 LEAX -1,X DECREMENT DELAY COUNT
3F29 26 FA 00410 BNE DEB010 GO IF NOT N MS
3F2B 35 90 00420 PULS X,PC RETRIEVE INTERVAL COUNT,RTN
00430 *
00440 * DELAY SUBROUTINE. DELAYS N MS.
00450 *
3F2D 34 10 00460 DELAY PSHS X SAVE DELAY COUNT
3F2F 0E 006F 00470 LDX #111 FINAGLE FACTOR
3F32 30 1F 00480 DEL010 LEAX -1,X DECREMENT FINAGLE COUNT
3F34 26 FC 00490 BNE DEL010 LOOP FOR 1 MS
3F36 AE 64 00500 LDX 4,S GET INTERVAL COUNT
3F38 30 00 DF 00510 LEAX -33,X ADJUST FOR 1 MS DELAY
3F3B AF 64 00520 STX 4,S RESTORE IN STACK
3F3D 35 90 00530 PULS X,PC RETRIEVE COUNT, RTN
00540 END
00000 TOTAL ERRORS

```

Listing 6: Model III assembly-language program for measuring low frequencies through the cassette input port. Switch-debounce time can be varied.

```

7F00          00100          ORG          7F00H          ;THIS SR NON-RELOCATABLE
00110 ;*****
00120 ;* LOW-FREQUENCY EVENT COUNTER WITH DEBOUNCE *
00130 ;* INPUT: 7FFAH = INTERVAL COUNT IN 26.86 MICROSEC *
00140 ;* UNITS, 2 BYTES *
00150 ;* 7FFCH = DEBOUNCE DELAY CNT IN MS, 2 BYTES *
00160 ;* 7FFEH = RESERVED FOR COUNT, 2 BYTES *
00170 ;* OUTPUT: 7FFEH = # OF COUNTS IN INTERVAL, 2 BYTES *
00180 ;*****
00190 ;
7F00 F3 00191 LOWFRE DI ;DISABLE INTERRUPTS

```

Listing 6 continued on page 178

# TRS-80\* COMPUTING EDITION

©1981 Percom Data Co., Inc.

The Percom Peripheral

35 cents

## Percom's DOUBLER II<sup>™</sup> tolerates wide variations in media, drives

GARLAND, TEXAS — May 22, 1981 — Harold Mauch, president of Percom Data Company, announced here today that an improved version of the Company's innovative DOUBLER<sup>™</sup> adapter, a double-density plug-in module for TRS-80<sup>®</sup> Model I computers, is now available.

Reflecting design refinements based on both theoretical analyses and field testing, the DOUBLER II<sup>™</sup>, so named, permits even greater tolerance in variations among media and drives than the previous design.

Like the original DOUBLER, the DOUBLER II plugs into the drive controller IC socket of a TRS-80 Model I Expansion Interface and permits a user to run either single- or double-density diskettes on a Model I.

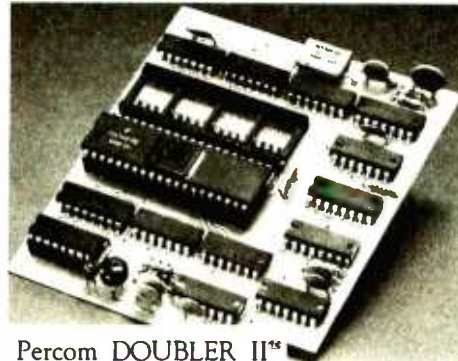
With a DOUBLER II installed, over four times more formatted data — as much as 364 Kbytes — can be stored on one side of a five-inch diskette than can be stored using a standard Tandy Model I drive system.

Moreover, a DOUBLER II equips a Model I with the hardware required to run Model III diskettes.

(Ed. Note: See "OS-80<sup>™</sup>: Bridging the TRS-80<sup>®</sup> software compatibility gap" elsewhere on this page.)

The critical clock-data separation circuitry of the DOUBLER II is a proprietary design called a ROM-programmed digital phase-lock loop data separator.

According to Mauch, this design is more tolerant of differences from diskette to diskette and drive to drive, and also provides *immunity to performance degradation caused by circuit component aging*.



Percom DOUBLER II<sup>™</sup>

Mauch said "A DOUBLER II will operate just as reliably two years after it is installed as it will two days after installation."

The digital phase-lock loop also *eliminates the need for trimmer adjustments typical of analog phase-lock loop circuits*.

"You plug in a Percom DOUBLER II and then forget it," he said.

The DOUBLER II also features a refined Write Precompensation circuit that more effectively minimizes the phenomena of bit- and peak-shifting, a reliability-impairing characteristic of magnetic data recording.

The DOUBLER II, which is fully software compatible with the previous DOUBLER, is supplied with DBLDOS<sup>™</sup>, a TRSDOS<sup>™</sup>-compatible disk operating system.

The DOUBLER II sells for \$29.95, including the DBLDOS diskette.

~~\$29.95~~  
Now \$16.95!

The Percom DOUBLER II is available from authorized Percom retailers, or may be ordered direct from the factory. The factory toll-free order number is 1-800-527-1222.

Ed. note: Opening the TRS-80 Expansion Interface may void the Tandy limited 90-day warranty. Circle 333 on inquiry card.

### All that glitters is not gold

#### OS-80<sup>™</sup> Bridging the TRS-80<sup>®</sup> software compatibility gap

Compatibility between TRS-80<sup>®</sup> Model I diskettes and the new Model III is about as genuine as a gold-plated lead Krugerrand.

True, Model I TRSDOS<sup>™</sup> diskettes can be read on a Model III. But first they must be converted and re-recorded for Model III operation.

And you *cannot write* to a Model I TRSDOS<sup>™</sup> diskette. Not with a Model III. You cannot add a file. Delete a file. Or in any way modify a Model I TRSDOS diskette with a Model III computer.

Furthermore, your converted TRSDOS diskettes cannot be converted *back* for Model I operation.

TRSDOS is a one-way street. And there's no re-treating. A point to consider before switching the company's payroll to your new Model III.

Real software compatibility should allow the *direct, immediate* interchangeability of Model I and Model III diskettes. No read-only limitations, no conversion/re-recording steps and no chance to be left high and dry with Model III diskettes that can't be run on a Model I.

What's the answer? The answer is Percom's OS-80<sup>™</sup> family of TRS-80 disk operating systems.

OS-80 programs allow *direct, immediate* interchangeability of Model I and Model III diskettes.

You can run Model I single-density diskettes on a Model III; install Percom's plug-in DOUBLER<sup>™</sup> adapter in your Model I, and you can run double-density Model III diskettes on a Model I.

There's no conversion, no re-recording.

Slip an OS-80 diskette out of your Model I and insert it directly in a Model III.

And vice-versa.

Just have the correct OS-80 disk operating system — OS-80, OS-80D or OS-80/III — in each computer.

Moreover, with OS-80 systems, you can add, delete, and update files. You can read *and write* diskettes regardless of the system of origin.

OS-80 is the original Percom TRS-80 DOS for BASIC programmers.

Even OS-80 utilities are written in BASIC.

OS-80 is the Percom system about which a user wrote, in Creative Computing magazine, "... the best \$30.00 you will ever spend."<sup>†</sup>

Requiring only seven Kbytes of memory, OS-80 disk operating systems reside completely in RAM. There's no need to dedicate a drive exclusively for a system diskette.

And, unlike TRSDOS, you *can* work at the track sector level, defining and controlling data formats — in BASIC — to create simple or complex data structures that execute more quickly than TRSDOS files.

The Percom OS-80 DOS supports single-density operation of the Model I computer — price is \$29.95; the OS-80D supports double-density operation of Model I computers equipped with a DOUBLER or DOUBLER II; and, OS-80/III — for the Model III of course — supports both single- and double-density operation. OS-80D and OS-80/III each sell for \$49.95. Circle 334 on inquiry card.

## Circuit misapplication causes diskette read, format problems. High resolution key to reliable data separation

GARLAND, TEXAS — The Percom SEPARATOR<sup>™</sup> does very well for the Radio Shack TRS-80<sup>®</sup> Model I computer what the Tandy disk controller does poorly at best: *reliably* separates clock and data signals during disk-read operations.

Unreliable data-clock separation causes format verification failures and repeated read retries.

### CRC ERROR—TRACK LOCKED OUT

The problem is most severe on high-number (high-density) inner file tracks.

As reported earlier, the clock-data separation problem was traced by Percom to misapplication of the internal separator of the 1771 drive controller IC used in the Model I.

The Percom Separator substitutes a *high-resolution* digital data separator circuit, one which operates at 16 megahertz, for the low-resolution one-megahertz circuit of the Tandy design.

Separator circuits that operate at lower frequencies — for example, two- or four-

megahertz — were found by Percom to provide only marginally improved performance over the original Tandy circuit.

The Percom solution is a simple adapter that plugs into the drive controller of the Expansion Interface (EI).

Not a kit — some vendors supply an untested separator kit of resistors, ICs and other paraphernalia that may be installed by modifying the computer — the Percom SEPARATOR is a fully assembled, fully tested plug-in module.

Installation involves merely plugging the SEPARATOR into the Model I EI disk controller chip socket, and plugging the controller chip into a socket on the SEPARATOR.

The SEPARATOR, which sells for only \$29.95, may be purchased from authorized Percom retailers or ordered directly from the factory. The factory toll-free order number is 1-800-527-1222.

Ed. note: Opening the TRS-80 Expansion Interface may void the Tandy limited 90-day warranty. Circle 332 on inquiry card.

PRICES AND SPECIFICATIONS SUBJECT TO CHANGE WITHOUT NOTICE.

PRICES DO NOT INCLUDE HANDLING AND SHIPPING.

PERCOM DATA COMPANY, INC. 11220 Pagemill Road Dallas, Texas 75243 (214) 340-7081

\*Trademark of Percom Data Company, Inc. \*TRS-80 and TRSDOS are trademarks of Tandy Corporation which has no relationship to Percom Data Company. †Creative Computing Magazine, June, 1980, page 26.



```

7F01 DD2AFA7F 00200 LD IX,(7FFAH) ;GET INTERVAL COUNT
7F05 01FFFF 00210 LD BC,-1 ;FOR DECREMENTS
7F08 FD210000 00220 LD IY,0 ;INITIALIZE COUNT
7F0C DD09 00230 LOW010 ADD IX,BC ;DECREMENT INT CNT(15)
7F0E D21F7F 00240 JP NC,LOW090 ;GO IF DONE (10)
7F11 DBFF 00250 IN A,(0FFH) ;GET I/O BYTE (11)
7F13 E601 00260 AND 1 ;GET CASSDIN BIT (7)
7F15 CA0C7F 00270 JP Z,LOW010 ;GO IF 0 (10)
7F18 FD23 00280 INC IY ;INCREMENT COUNT
7F1A CD257F 00290 CALL DEBNC ;DEBOUNCE DELAY
7F1D 18ED 00300 JR LOW010 ;CONTINUE INTERVAL
7F1F FD22FE7F 00310 LOW090 LD (7FFEH),IY ;STORE COUNT
7F23 FB 00311 EI ;ENABLE INTERRUPTS
7F24 C9 00320 RET ;RETURN FROM SR
00330 ;
00340 ; DEBOUNCE SUBROUTINE
00350 ;
7F25 FDE5 00360 DEBNC PUSH IY ;SAVE INTERVAL CNT
7F27 FD2AFC7F 00370 LD IY,(7FFCH) ;GET DEBOUNCE DELAY
7F2B CD357F 00380 DEB010 CALL DELAY ;DELAY N MS
7F2E FD09 00390 ADD IY,BC ;DECREMENT DELAY CNT
7F30 38F9 00400 JR C,DEB010 ;GO IF NOT N MS
7F32 FDE1 00410 POP IY ;RETRIEVE INT COUNT
7F34 C9 00420 RET ;RETURN FROM SR
00430 ;
00440 ; DELAY SUBROUTINE. DELAYS N MS.
00450 ;
7F35 215E00 00460 DELAY LD HL,94 ;FINAGLE FACTOR
7F38 09 00470 DEL010 ADD HL,BC ;DECREMENT FINAGLE CNT
7F39 DA387F 00480 JP C,DEL010 ;LOOP FOR 1 MS
7F3C 11DBFF 00490 LD DE,-37 ;ADJUSTMENT CONSTANT
7F3F DD19 00500 ADD IX,DE ;ADJUST FOR 1 MS DELAY
7F41 C9 00510 RET ;RETURN FROM SR
0000 00520 END
00000 Total errors

```

specified time after each pulse is detected. The number of events detected in the interval, the third parameter, is returned in locations hexadecimal 3FFE and 3FFF.

A similar program for the Model III is shown in listing 6. The three parameters are passed in locations hexadecimal 7FFA through 7FFF and represent the same variables. Because operation for the two programs is similar, I'll describe both in general terms.

The DELAY subroutine delays for 1 ms by a simple loop. An interval count is adjusted for the 1-ms delay in units of 30.35 or 26.86. The DEBNC subroutine gets the debounce delay parameter and calls DELAY to delay for the debounce time in units of 1 ms.

The "main-line" code is in

LOWFRE. The interval count parameter is decreased by 1 each time through the main loop. When the interval count is decremented beyond 0, the interval is completed, and the subroutine returns to the BASIC program. If the interval count is not completed, the PIA or I/O port bit for CASSDIN is read. If the cassette bit is a logic 1, the count of pulses is increased by 1, and the DEBNC subroutine is called for the debounce delay.

These programs detect a logic 1 pulse, i.e., a negative voltage input. The input signal can be any switch closure occurring up to thousands of times per second. A typical example is a roller switch on a rotating cam shaft. A longer time window can be created by repeatedly calling the subroutine.

BASIC drivers for both versions are shown in listings 7 and 8. The machine-language forms of the program are contained within the BASIC program in DATA statements, and the programs are poked into high random-access memory (RAM) by the BASIC code. The BASIC program asks for the interval and debounce delay parameters, pokes them into the parameter block, then calls the machine-language subroutine. A running total of all counts is printed after each call. To see how the program works, connect a switch as shown in figure 7, then close the switch for various delay and interval times.

### Now For the Soft Breezes

To give you a practical example of what can be accomplished with a single discrete input, I'm going to





Listing 7: Color Computer BASIC driver program for LOWFRE. The machine-language code is included in the program and poked into high memory.

```
100 ' LOWFRE DRIVER
110 DATA 190,63,250,16,142,0,0,48,31,31
120 DATA 16,77,43,13,182,255,32,132,1,39
130 DATA 242,49,33,141,7,32,236,16,191,63
140 DATA 254,57,52,16,190,63,252,141,6,48
150 DATA 31,38,250,53,144,52,16,142,0,111
160 DATA 48,31,38,252,174,100,48,136,223,175
170 DATA 100,53,144
180 FOR I=&H3F00 TO &H3F3E
190 READ A:POKE I,A
200 NEXT I
210 DEFUSR0=&H3F00
220 INPUT "INTERVAL, DELAY";IC,DC
230 POKE &H3FFA,INT(IC/256):POKE &H3FFB,IC-INT(IC/256)*256
240 POKE &H3FFC,INT(DC/256):POKE &H3FFD,DC-INT(DC/256)*256
250 A=USR0(0)
260 B=B+PEEK(&H3FFE)*256+PEEK(&H3FFF):PRINT B
270 GOTO 250
```

Listing 8: Model III BASIC driver program for LOWFRE. The machine-language code is included in the program and poked into high memory.

```
100 ' LOWFRE DRIVER
110 DATA 243,221,42,250,127,1,255,255,253,33
120 DATA 0,0,221,9,210,31,127,219,255,230
130 DATA 1,202,12,127,253,35,205,37,127,24
140 DATA 237,253,34,254,127,251,201,253,229,253
150 DATA 42,252,127,205,53,127,253,9,56,249
160 DATA 253,225,201,33,94,0,9,218,56,127
170 DATA 17,219,255,221,25,201
180 FOR I=32512 TO 32577
190 READ A:POKE I,A
200 NEXT I
210 DEFUSR0=&H7F00
220 INPUT "INTERVAL, DELAY";IC,DC
230 POKE &H7FFA,IC-INT(IC/256)*256:POKE &H7FFB,INT(IC/256)
240 POKE &H7FFC,DC-INT(DC/256)*256:POKE &H7FFD,INT(DC/256)
250 A=USR0(0)
260 B=B+PEEK(&H7FFE)+PEEK(&H7FFF)*256:PRINT B
270 GOTO 250
```

describe a plumbing/electronics project—an anemometer. All parts can be purchased at your local hardware store and Radio Shack. The anemometer will measure a wide range of wind speeds and is easy to construct. Best of all, the entire project costs less than \$10.

**The plumbing.** The physical appearance of the anemometer is detailed in figure 9. It's constructed with common 1-inch and ½-inch poly vinyl chloride (PVC) sprinkler fit-

tings, wooden dowels, and plastic cups. Necessary parts are listed in table 1. To assemble the unit, refer to figure 10 and proceed as outlined in steps 1 through 19.

1. Cut a piece of 1-inch PVC thick-wall tubing to a length of 4 inches. (Any saw will do, but a hacksaw is best.)
2. Drill a hole in a 1-inch cap just large enough to pass a ½-inch PVC tube without friction.
3. Cement the cap to the 4-inch piece of tubing from step 1. Push

the cap firmly down on the tube.

4. Drill a ⅜-inch hole completely through the cap about ½-inch up from the bottom of the cap.
5. File off any projections from the bottom of a ½-inch cap.
6. Drill a small, centered hole in the cap and push in a decorative nail having a rounded head. It should fit snugly.
7. Cement the cap to a 6-inch piece of thin-wall ½-inch PVC tubing.
8. Push the ½-inch tubing from step 7 through the hole in the 1-inch

Associates  
States and foreign countries  
proprietorship for worldwide distribution  
promotion of the aforementioned computer program  
by Lifeboat Associates as exclusive marketing agent.

Author's Name \_\_\_\_\_



Lifeboat Associates  
1651 Third Avenue New York

# AS AN AUTHOR THIS MIGHT BE YOUR MOST IMPORTANT LINE.

If you've tried to market your own program, you've probably run into a virtual brick wall of problems. Problems that require time, energy, funds, personnel and expertise to solve.

Lifeboat Associates invites you to bring your problems to us. That way you can do what you do best: create quality software. And we can do what we do best: sell it.

As an international publisher of quality computer software with a strong relationship among business, professional, programming and personal computer users, as well as micro- and minicomputer OEM's, Lifeboat Associates has sold and fully supported more software programs by more authors for more machines to more users in more countries than anyone else.

And we do a lot more than sell. Lifeboat also provides:

- Full after sales support
- A multitude of media formats
- OEM sales
- Extensive promotional campaigns through Lifeboat's *Software Desk Reference*™, specially designed OEM private label catalogs, foreign catalogs, brochures, flyers and direct mail
- Advertising
- Advertising preparation
- Marketing services throughout a wide network of affiliates, dealers and distributors
- Translation facilities into foreign languages
- Seminars
- Typesetting services
- And lots more

So if you've expended your time and genius in writing a great program, bring it to Lifeboat. We'll expend our time and genius in publishing it.

Write for a copy of the *Lifeboat Author Guide*.



## Lifeboat Associates

World's foremost software source

1651 Third Avenue, New York, New York 10028



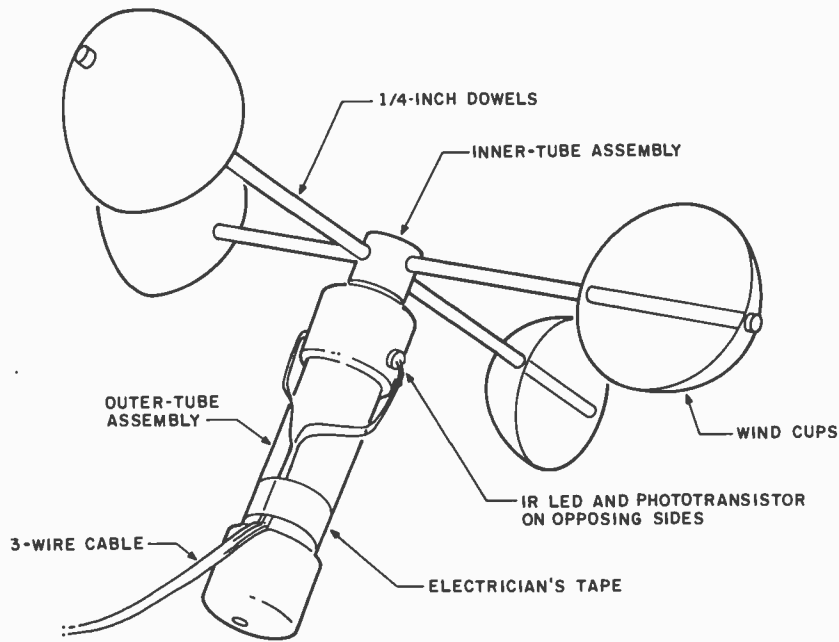


Figure 9: A working anemometer can be easily constructed by using common materials (and a \$600 or \$1000 computer).

Quantity	Description
1	4-inch piece of 1-inch PVC thick-wall tubing
2	1-inch slip caps
2	1/2-inch slip caps
1	6-inch piece of 1/2-inch thin-wall tubing
1	round-head nail or small screw
3 ft	1/4-inch wooden doweling
4	plastic, low-mass cups (halves of plastic ball or toy)
1	container of PVC cement
1	suitable mounting hardware for mast

Table 1: Anemometer parts list.

9. After the cement has dried for an hour, drill a 3/16-inch hole through the inner tube, using the existing hole as a guide. Hold the tubes up to the light. The holes in the tubes should match. If not, drill out the inner tube again.
10. Drill two 1/4-inch holes completely through a 1/2-inch cap. The holes should be at right angles to each other and as close to the top of the cap as possible. The bottom hole should clear the path of the top hole.
11. Cut two 1/4-inch wood dowels to 14 inches. Push through the holes in the cap. Center the dowels.
12. Cement the dowels if they don't fit tightly.
13. Mount four plastic half-spheres (cups) on the four dowels. All four should present the same face to the wind.
14. Align and cement the plastic cups.
15. After the cement has dried, temporarily mount the cup assembly on the inner tube. Cut off enough of the inner tube to that the bot-

## "THIS IS DIGITALKER"™ OUT 127,0

This is all it takes to say this or 143 other expressions with MICROMOUTH™. Absolutely no software drivers or subroutines to load. MICROMOUTH™, the latest Circuit Cellar project can be used as an emergency annunciator, as an aid for the handicapped, for process control and automatic monitoring, and to add new dimensions to computer games.

Sample phrases that can be programmed are:

"THE TIME IS 4 HOURS 23 MINUTES . . . (BEEP)"

"NUMBER 4 IS 3.47 VOLTS"

"THE SPEED IS 100 METERS A SECOND . . . SLOW DOWN"

Thousands of expressions can be added by changing the ROM chips.

MICROMOUTH™ is plug compatible with APPLE II and TRS-80™ computers. Directions are included for S100, H8 and parallel port operation.

\*DIGITALKER is a trademark of National Semiconductor Corp.

Complete Kit (as shown) \$120.00

Assembled and tested:

Apple II.....\$150.00

TRS-80 Model I w/power

supply and cable.....\$170.00

TRS-80 Model III.....\$200.00

call:

1-800-645-3479

In N. Y. 516-374-6793

\*MICROMOUTH is a trademark of MicroMint Inc

The MicroMint Inc.  
917 Midway  
Woodmere, NY 11598

Dealer inquiries  
invited.



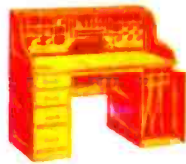
High Technology



High Technology



High Technology



High Technology



High Technology



# Software In Depth

The first time you use our software you'll find it does wonderful things. The more you use it, the more you'll find how useful it is. We have programs for doctors, CPA's, attorneys, retail store managers, contractors, estimators, print shops, schools, and manufacturers. We even have a program for programmers. And the list is growing. We have programs for the Apple™, NEC™, and Atari 800™ computers, and this list is growing, too. To see our software, please visit *The Xerox Store* or another fine computer dealership in your area. Call or write us for a free catalog. High Technology Software Products, Inc., 2201 N.E. 63rd Street, P.O. Box B-14665, Oklahoma City, Oklahoma 73113, 405/478-2105

Apple is a trademark of Apple Computer, Inc.  
Atari is a trademark of Atari, Inc.  
NEC is a trademark of Nippon Electric Company, Ltd.

# High Technology Software

High Technology

High Technology

High Technology

High Technology

High Technology

High Technology

High Technology

High Technology

High Technology

High Technology

High Technology

High Technology

High Technology

High Technology

High Technology



Circle 194 on inquiry card.

[www.americanradiohistory.com](http://www.americanradiohistory.com)



# ORANGE MICRO JUST TURNED A PAGE IN PRINTER HISTORY.

## OUR PRICES, SELECTION & SAME-DAY SHIPPING MAKE US COMPETITIVE...

### NEC 8023 Outstanding Graphics, Print Quality & Performance



144 x 160 dots/inch • Proportional Spacing  
• Lower case descenders • Nx9 dot matrix  
• 8 character sizes • 5 unique alphabets  
• Greek character set • Graphic symbols  
• 100 CPS print speed • Bi-directional logic  
seeking • Adjustable tractors • Single-sheet  
friction feed • Vertical & horizontal tabbing

NEC 8023 ..... List \$795 **\$Call**

### IDS Paper Tiger 560/Prism 80/132 Affordable Color, Speed



Dot Resolution Graphics • 9-wire staggered  
printhead • Lowercase descenders • Over  
150 CPS • Bi-directional logic-seeking  
• 8 character sizes • 80-132 columns  
• Hi-res dot graphics • Proportional spacing  
• Text justifications

Prism 80 ..... List \$899 **\$700**  
IDS Paper Tiger 560G ..... List \$1395 **\$1100**  
Prism 132 (Color) ..... List \$1995 **\$1895**

### NEC Spinwriter 7700 & 3500 Daisy Wheel Quality Leader



High speed, letter quality • 55/33 CPS  
• Typewriter quality • Bi-directional plotting  
& proportional spacing • Quiet • OCR quality  
print • Hi-res plotting/graphing • Quick change  
ribbon • Optional cut-sheet feeder, horizontal  
or bidirectional tractors • Prints up to 8 copies.

NEC Spinwriter RO  
Serial Parallel 77xx ..... List \$3055 **\$2575**  
35xx ..... List \$2290 **\$1975**

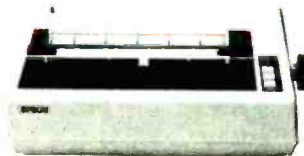
### The Epson Series. High-Quality Printers at a Low Price.



### Epson MX70

Super low priced dot resolution graphics  
• 5 x 7 dot matrix • User replaceable printhead  
• Top of form • 80 CPS optional friction feed  
• 10" paper width

Epson MX70 ..... List \$450 **\$390**



### Epson MX80/MX80FT

9 x 9 dot matrix • Lower case descenders  
• 80 CPS • Bi-directional • Logic seeking  
• 40, 66, 132 columns per line • 64 special  
graphic characters: TRS-80 Compatible  
• Forms handling • Multipage printing  
• Adjustable tractors

Epson MX80 ..... List \$645 **\$Call**

Epson MX80FT ..... List \$745 **\$Call**



### Epson MX100

Same basic features as the MX80 • Plus  
friction feed for single sheets • Plus 15" wide  
carriage • Dot Resolution Graphics

MX100 ..... List \$995 **\$Call**

Full Line of Epson Accessories

### Anadex 9501 High Speed, Commerical Duty Plus Graphics



Dot graphics • Wide carriage • 11 x 9 dot  
matrix • Lower case descender • Dot  
resolution graphics • Bi-directional, logic  
seeking • Up to 200 CPS • RS 232 Serial &  
Parallel • Forms control • X-On/X-Off • Up to  
6 part copy

Anadex 9501 ..... List \$1650 **\$1350**

### INTERFACE EQUIPMENT

Complete stock of options, cables and accessories.

GRAPPLER APPLE INTERFACE .....	\$175
CCS APPLE SERIAL Interface & Cable .....	\$150
ORANGE INTERFACE for Apple II	
Parallel Interface Board and Cable .....	\$110
NOVATION D-CAT direct connect modem .....	\$180
COMPLETE STOCK OF EPSON ACCESSORIES .....	\$Call
CUSTOM PRINTER CABLES FOR Apple, Atari, IBM, TRS-80 (all models) .....	\$Call
HAYES MICROMODEM .....	\$300
PRINTER STANDS: Large .....	\$99
Small .....	\$25
PRINTER RIBBONS—Most Types .....	\$Call

**WE'RE NOW**

# Red Baron

COMPUTER PRODUCTS

**OUR PEOPLE MAKE US EXPERTS.**

**Malibu 200**  
Dot Matrix & Letter Quality  
in One Printer



200 CPS standard • Letter quality font  
• 12 optional fonts • Bi-directional logic  
seeking • 19 x 18 dot matrix • Expanded  
characters (2x, 4x) Optional • Dot resolution  
graphics of 144 x 120 • Underlining  
Malibu 200 ..... List \$2995 **\$2600**

**Okidata 82A**  
Hi-Res & TRS-80 Block Graphics



120 CPS • Bi-directional printing • Logic  
seeking • Double width & condensed printing  
• Friction & tractor feed standard • Font  
selection, character pitch & line spacing are  
program controllable  
Okidata 82A ..... List \$799 **\$Call**

**Centronics 739**  
Crisp Dot-Matrix Characters



Graphics & word processing print quality  
• N x 9 dot matrix • suitable for word  
processing • Underlining • Proportional  
spacing • Right margin justification • Serif  
typeface • 80/100 CPS • 9½" pin feed/friction  
• Optional 2 Color Kit  
Centronics 739-1 ..... List \$695 **\$Call**  
Centronics 739-3 ..... List \$795 **\$725**

**Our People, Our Product: Both Are Specialized.**

Because our salespeople are printer specialists, they know the capabilities of each printer—and how to match one to your exact need. Red Baron's volume stocking assures a low, low price on a wide array of major brands. We're sure you'll like the product and services you get from Red Baron, and we know you'll love our Customer Benefit Package; an exclusive at Red Baron.



**Customer Benefit Package**

**1. Free Expert Consultation.** Before you buy, after you buy. **2. Toll-Free Ordering.** There's never a toll charge when you place your order at Red Baron. **3. Free Catalog.** Get your informative catalog with printer comparison chart and character samples today! **4. Warranty.** The manufacturer's warranty applies where applicable. **5. Same-Day Shipping.** Your order is sent the same day when you call before 11:00 a.m. **6. Free/MasterCard & Visa.** Call us toll-free and charge your printer to your credit card. **7. We Stock What We Sell.** No bait and switch, no hassle. We make every effort to keep a large stock of our advertised products.

**Televideo CRT's**  
Price, Performance & Reliability



910C ..... List \$699 **\$600**  
920C ..... List \$995 **\$770**  
925C ..... List \$995 **\$750**  
950 ..... List \$1195 **\$970**

**Here's how to order.**

Phone orders are welcome; same-day shipment on orders placed before 11:00 a.m. Free use of MasterCard and Visa. CODs accepted. Personal checks require 2 weeks clearance. Manufacturer's warranty included on all equipment. Prices subject to revision.



**CALL FOR  
FREE CATALOG**

**TOLL FREE**

**1-800-854-8275** CA, AK, HI (714) 630-3322

**Orange Micro Retail Stores**  
Sherman Oaks: 13604 Ventura Blvd. (213) 501-3486  
Anaheim: 3150 La Palma, #1 (714) 630-3622  
Santa Clara: 3216 Scott Blvd. (408) 980-1213  
Circle 312 on inquiry card.

# Red Baron

COMPUTER PRODUCTS

1100 N. TUSTIN  
ANAHEIM, CA 92806



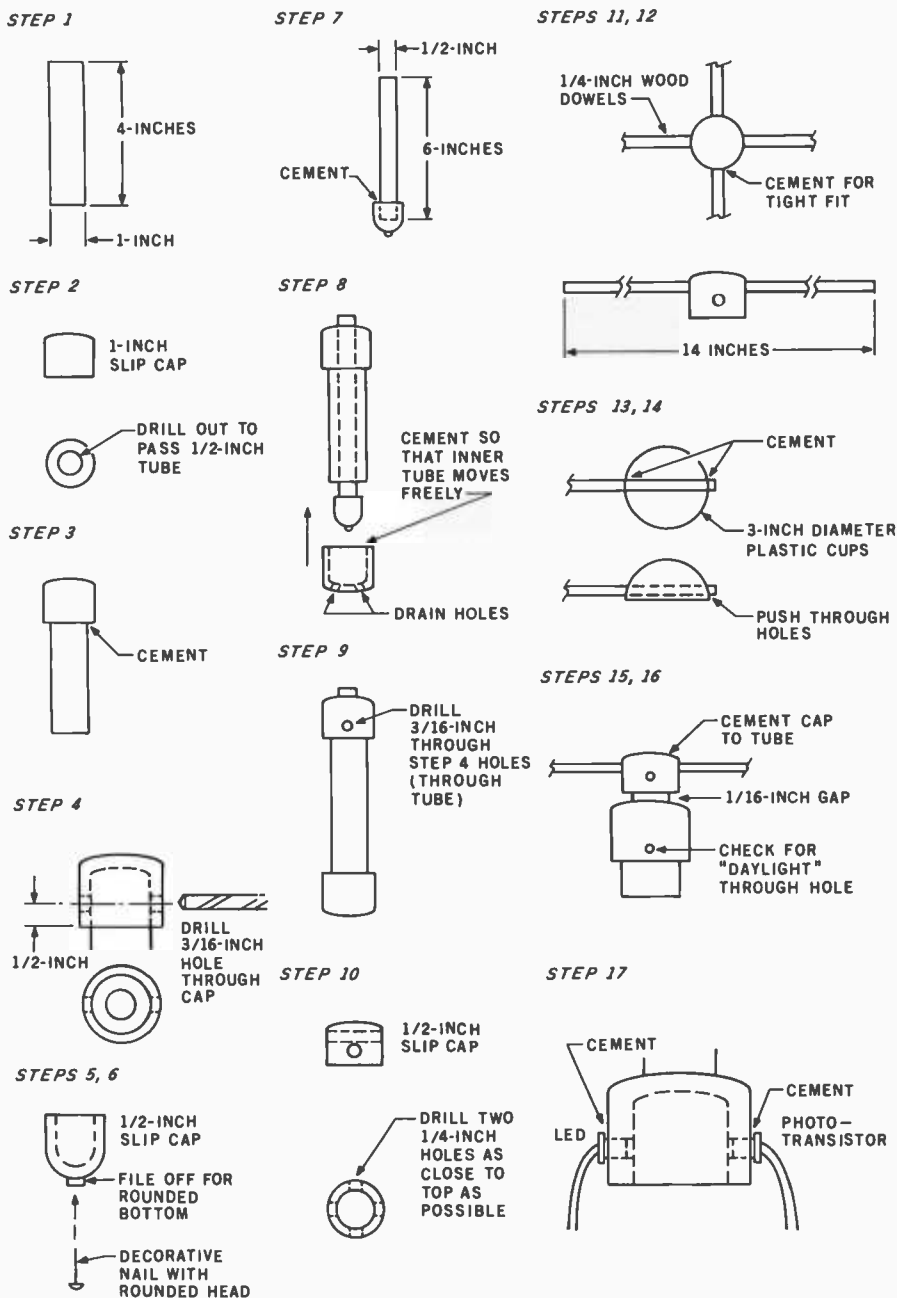


Figure 10: Construction details of the anemometer. Total construction time is approximately one hour if all parts are on hand.

Quantity	Description
1	150-ohm 1/4-watt 10% tolerance resistor
1	1-kilohm 1/4-watt 10% tolerance resistor
1	100-kilohm 1/4-watt 10% tolerance resistor
1	4.7-kilohm 1/4-watt 10% tolerance resistor
1	560-ohm 1/4-watt 10% tolerance resistor
1	741C op-amp (Radio Shack 276-007)
1	Infrared LED (Radio Shack XC880-A, 276-143)
1	Infrared phototransistor (Radio Shack 276-145)
2	6-V batteries or 8 "C" cells in assembly
1	Wire, cable, solder
1	Project board (Radio Shack 276-175)
1	DIN plug, 5-pin (Radio Shack 274-003)

Table 2: Anemometer electronics parts list.

tom of the inner tube cap is about 1/8 inch from the top of the 1-inch cap. Cement the cup assembly to the inner tube.

- Again, check the hole alignment of the inner and outer tubes. Redrill the inner tube if necessary.
- Press-fit the phototransistor and light-emitting diode (LED) into the two holes. Bring down the two leads from each. Cement the components in place using a bead of PVC cement around the edges.
- Spin the cup assembly. It should move very freely, even in a light wind. You should be able to spin it by gently blowing at a cup at a distance of about a foot.

**The electronics.** The electronics assembly is built on a Radio Shack project board. The arrangement of the parts is shown in figure 11, and a parts list is given in table 2. Make a cable assembly of four wires and route to the anemometer. Solder the four cable wires to the LED and phototransistor as shown in figure 12.

After soldering the cable wires, wrap a piece of plastic electrical tape around the cable and tubing for strain relief. Put a dab of PVC cement on each solder joint and exposed lead. This will waterproof the connections.

The circuit for the electronics is shown in figure 13. The electronics produce a +6-V or -6-V signal to the cassette input line. The 741C operational amplifier (op-amp) compares a voltage at the "-" input that is about 82 percent of the positive supply voltage. If the input voltage on the "+" lead drops below this level, the output of the op-amp is -6 V; otherwise it is +6 V.

When the two holes in the anemometer tubing are aligned, the infrared light from the LED strikes the phototransistor and causes current to flow through it. When enough current flows, the "+" input drops below the 82 percent level and the op-amp output drops to -6 V. When no light is striking the phototransistor, no current flows through it, the "+" input is +6 V, and the op-amp output is +6 V. Place the anemometer assembly in a location that's shady yet exposed to the wind. (Don't

# IBM COMPATIBLE BOARDS

BY **ZOBEX**

**256 K** MEMORY WITH PARITY  
Limited time only! **\$598** ~~\$998~~

**HARD DISC** SUBSYSTEM FOR  
**IBM AND S-100 \$2495**

HA62 IBM BUS HARD DISK INTERFACE FOR WD-1000  
4SP 4 SERIAL PORTS FOR IBM  
PB PROTOTYPING BOARD FOR IBM  
EB EXTENDER BOARD FOR IBM

## **S-100** BOARDS

ZOBEX CPU  
Z-80A CPU WITH 4 SERIAL AND 3 PARALLEL PORTS

ZOBEX DDFDC  
DOUBLE DENSITY DISK CONTROLLER

ZMS-100  
64K RAM

HDCI  
S-100 HARD DISK INTERFACE FOR WD-1000

## **ZOBEX**

7343 J. RONSON RD.  
SAN DIEGO, CA. 92111

(714) 571-6971

ZOBEX is trademark of ZOBEX CORPORATION  
IBM is trademark of International Business Machines Corporation



# BRAINS-MAINFRAMES

## SUPERBRAINS



**SUPERBRAIN QD 64K**

List \$3995 . . . . . only \$2949



Z-89 48K  
List \$2895 . . . . . only \$2099  
Z-90 64K DD 3195  
ONLY \$2489

## COMPUSTARS

Available to Dealers

### NORTH STAR

Minicomputer  
Performance

Green Phosphor  
Options:  
Graphics + CP/M

List . . . . . \$3999  
Only . . . . . \$3199

### ADVANTAGE



Monitor Green Phosphor \$118

TERMINALS Z-19 . . . . . \$718  
INTERTUBE III Super Smart . . . . . \$710

## EPSON

MX-80 FT. . . . . \$598  
MX-80 . . . . . \$474  
MX-100 . . . . . \$749



ANADEx 9501 . . . . . \$1290  
NEC Letter Qual Friction & Tractor . . . . . call  
ZENITH printer Z-25 list 1595 only . . . . . \$1256  
STARWRITER letter qual FT . . . . . \$1824



ATARI 400 . . . . . List \$399 . . . . . only \$340  
800 . . . . . List \$899 . . . . . only \$675

Wonderful Games—Education for your family

Main Frames - S-100 . . . . . \$200 up  
Single Board Computer 64K . . . . . \$ 749  
6800-CPU S-100 . . . . . Call us . . . . . Save cash!

AMERICAN SQUARE COMPUTERS is organizing a World Wide Association of Computer Dealers. Open a Store or Start Work Out of Your Home! We Charge NO FRANCHISE FEE! (Our Competitors charge a FRANCHISE FEE of from \$15,000.00 to \$45,000.00.) Be a Winner! Let US help YOU get started MAKING MONEY by HELPING PEOPLE to put COMPUTERS to WORK. Write or Phone today.

## GODBOUT COMPUPRO

Super Sixteen 8085/8088 is the fastest combo 8/16 CPU. LIST . . . . . \$3904 . . . . . Special \$3269

### SEATTLE'S

16 bit COMPUTER is here! 8 MHz 8086 CPU the fastest S-100 computer! 128K Static RAM, DD Disk Controller, 22-slot Main Frame, 86-DOS, #2 128K  
LIST . . . . . \$4185 . . . . . ONLY \$3349  
#1 As above but 64K LIST . . . \$3190 . . . ONLY 2649

### CALIFORNIA COMPUTER 2210A

LIST \$2350 . . . . . ONLY \$1895  
Z80, 64K, I/O, Disk controller + CP/M.  
Model 300-1A is the larger system: 2.4 Mb 8" Z80, 64K, and optional OASIS, CP/M, or MP/M operating system.  
LIST . . . . . \$5695 . . . . . ONLY \$4995

### SYSTEMS GROUP SYSTEM 2800

Runs CP/M or OASIS. Supports single user & multi-user & multi task. Up to 5 megabytes with 8" drives. Optional 10-megabyte hard disk. Optional tape back up #2812 \$5035 . . . . . ONLY \$3775

### TARBELL'S

Empire I&II have two 8" disk drives. The I is single sided, the II is double sided.

### FREE Business Software

Empire I LIST \$4888 . . . . . Only . . . . . \$3666

We sell The Finest Hardware

# AMERICAN



We sell The Finest Software

# COMPUTERS

919-889-4577

4167 Kivett Dr.

Jamestown, NC 27282

919-883-1105

CP/M is a registered trademark of Digital Research, Inc.

# LOWEST PRICE-BEST QUALITY

## NORTH STAR Horizon 2



2-5 1/4" Disk Drives  
64K Double Density  
Factory assem. & tested  
Factory guaranteed

A few left  
Low Price only

**\$2499**

**Powerful North Star BASIC Free  
Superb for Business & Science**

HORIZON STANDARD IS NOW HRZ-2-64K QUAD

Factory Assembled & Tested	List	Only
Horizon-2-32K-Double Density	.....	\$2349
Horizon-2-32K-Quad Density	.....	\$2549
Horizon-2-64K-Quad	\$3599	\$2699
Horizon-2-64K-QHD 5	\$5999	\$4499
Horizon Ram ASM	32K=\$374	64K=\$524
Big Sale on Multi-User Time-Sharing	....	call
English to Basic Translator	.....	\$99
North Star Hard Disk 18 Mb	\$5375	\$3923
North Star Time Sharing Multi-User	....	call
Zbasic 2 to 5 times faster!	\$350	call
Secretary Word Processor	.....	\$99
Wordstar Word Processor	.....	\$318
Floating Point Board	\$399	\$319
Oasis Multi-User Software	SAVE	call
CP/M for N* Extra features	\$230	\$220
Micro Mike Software	SAVE	call
Ecosoft Accounting \$355 .. MICROSTAT	.....	\$265
Pascal-80	\$600	\$515
Extra Precision Basic	.....	\$50
Northword	\$199	\$179
Mailmanager	\$299	\$224
Infomanager	\$399	\$349
General Ledger	\$499	\$429
Accounts Receivable	\$499	\$429
Accounts Payable	\$499	\$429
Inventory	\$499	\$429
Order Entry	\$499	\$429
PROPAC	\$1499	\$1274
DOS + Basic 5.2	.....	27

## DECISION I



"The IBM-360 on the Z-80 & S-100 BUS!"

Sixteen Programs running simultaneously! Free CPM, Microsoft BASIC and WORDSTAR with Complete system!

	LIST	ONLY
DECISION 1 + 65K Static + 8" Disks	\$4375	3500
DECISION 1 + 65K Static + 2- 5" Disks	4195	3356
DECISION 1 + 65K Static + 5" Disk + 5 Mb Hard Disk	5990	4792
DECISION 1 3 user 195K Static + 5" Disk + 5Mb Hard Disk + MICRONIX	8035	6428
DECISION 1 - Z-80 + 1/0=Power	1725	1339

## MORROW 8" Disk

Discus 2D + CP/M 600K only \$849  
Discus 2 + 2 + CP/M 1.2 MEGA B. \$1149  
Add Drives 2D = \$599 2 + 2 = \$795  
Discus 2D-dual + CP/M Only \$1388  
Free Microsoft BASIC from MORROW with Discus system Or hard disk



M-26 MORROW Hard Disk  
26,000,000 Bytes!!  
List \$4495 ..... Only \$3395  
Free CPM + BASIC  
M-20 List \$4795 .. Only \$3835  
M-10 List \$3695 .. Only \$2955  
M-5 List \$2495 .. Only \$1995

## InterSystems

Z-80A CPU 4 MHz  
64K Dynamic RAM  
Front Panel

VI/0-1 - with interrupts  
FDCII Disk Controller  
20 slot motherboard

List \$3795 ..... Only \$2839

Without front panel as above only \$2716  
Front Paneless Recommended for Business

## Save on Memory and Programs

Systems Memory 64K A&T	..... \$459	Corvus Hard Disk	..... SAVE	Cat Novation Modem	..... \$169	Which Computers are Best?—FREE. Insured Shipping at Low Rates. Call For Latest Prices, Details. We Beat Advertised Prices.
Systems Memory 64K Bank	..... \$555	SSM Video BRD VB3 kit	..... \$361	Memory Merchant 16K	..... \$159	
Microangelo	..... \$985	Spectrum Color ASM	..... \$326			

Factory Guarantees

Expert Advice

# AMERICAN



# COMPUTERS

919-889-4577

4167 Kivett Dr.

Jamestown N.C. 27282

919-883-1105

©CP/M is a registered trademark of Digital Research, Inc.

Circle 20 on inquiry card.

www.americanradiohistory.com



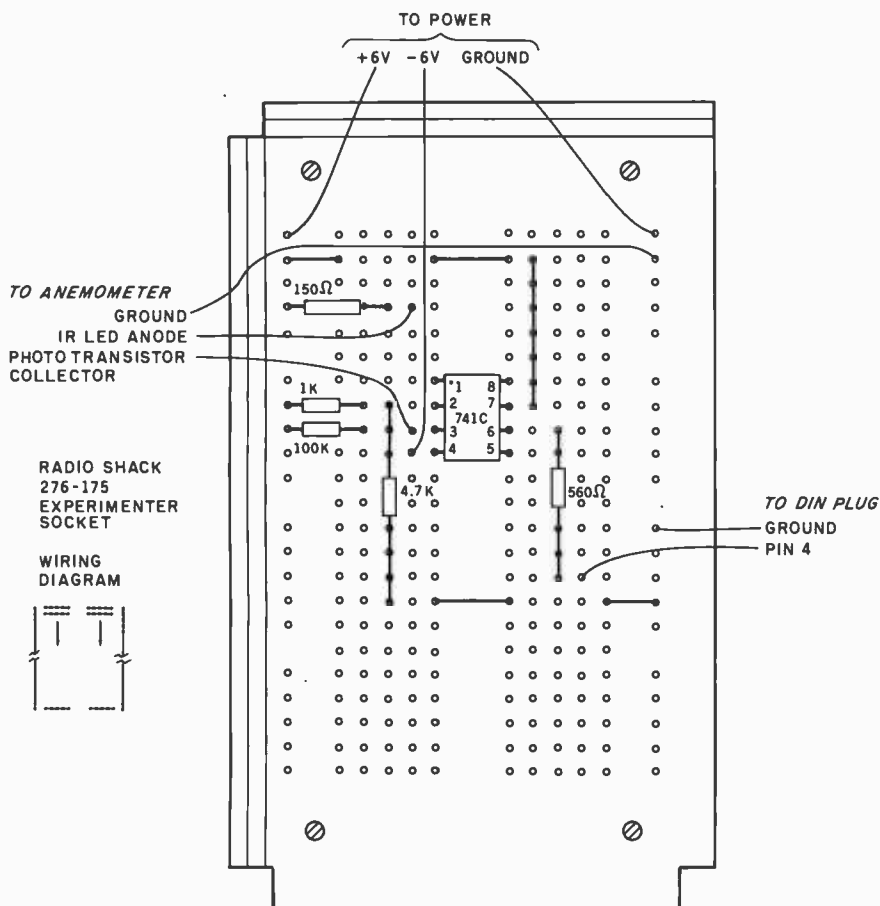


Figure 11: The electronics portion of the anemometer uses a small project board for easy circuit assembly. Three sets of wires go to power connections, the anemometer, and the cassette input plug.

mount it on a 200-foot tower until after additional testing, however.)

**A PERIOD program.** Listings 9 and 10 show PERIOD programs for the Color Computer and Model III, respectively. The PERIOD programs are used with the anemometer, but they are also general-purpose programs for measuring the period of any input signal that does not have to be debounced. The period is measured from the first negative-going transition to the next negative-going transition in 20.23- or 24.33- $\mu$ s units. The period is passed back to a BASIC driver in locations hexadecimal 3FFE and 3FFF (Color Computer) or as the value of the USR function (Model III).

Listings 11 and 12 show the PERIOD programs incorporated as DATA statements in BASIC drivers. The machine-language code is located in high memory in both cases.

**Using the anemometer.** Protect high memory in the Color Computer by a CLEAR 200,&H3EFF. Protect high memory in the Model III by inputting a MEMORY SIZE of 32511. Load the BASIC Anemometer program, connect the cassette input to the electronics, connect the electronics power, and run the program.

The program measures the period for the rotating anemometer. If no

# The Graphics Family...

the most versatile, easiest-to-use graphics available for your Apple II.

The A2-3D1/3D2 with A2-GE1 Graphics Editor package lets you put simultaneous multiple images on your screen . . . where you want, in the size you want, in your choice of orientation, complete with upper and lower case text. Because the most important part of your computer system is you. \$119.85

## subLOGIC

Communications Corp.  
713 Edgebrook Drive  
Champaign, IL 61820  
(217) 359-8482  
Telex: 206995



Apple is the registered trademark of Apple Computer, Inc.

## More Apple II owners choose Hayes Micromodem II than any other modem in the world.

Compare these features before you buy.

You should. It's your money. Thousands of Apple II owners have already compared, considered, and now they are communicating — with Micromodem II. The best modem for your Apple II. The most modem for your money!

**A complete data communication system for the Apple II.** The Micromodem II is not "base priced" *plus* necessary "options." It's a complete, high-performance system, designed specifically for your Apple II and ready immediately to put you in communication with all of North America.

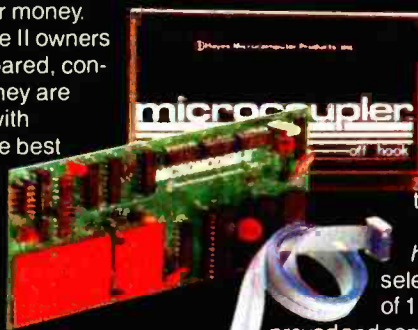
**Unexcelled receive sensitivity level.** Receive sensitivity levels determine the range of error in data transmission.

Micromodem II's excellent receive sensitivity level promises you clearer, more accurate transmission.

**Auto-dial and answer features built in.** Automatically dials the telephone, answers the telephone, receives and transmits and hangs up the telephone — completely unattended. You can take advantage of low evening and week-end telephone line rates.

**Operation can be full or half-duplex.** And with user selectable transmission rates of 110 or 300 bps. FCC approved and completely Bell 103 compatible.

**Quick and easy installation.** The Micromodem II plugs directly into the Apple II, eliminating the need for a serial interface card. And the Microcoupler™ (included) connects the Apple II directly to a standard RJ11 modular telephone jack, eliminating the losses and distortions associated with acoustic couplers.



**Plus a wide variety of software, available right now!** Because of our position in the industry, numerous sources have developed software *specifically* for the Micromodem II. The versatility of these prepared programs gives you a distinct advantage as an Apple II owner. Available in computer stores nationwide.

**So if you're ready to communicate with other computers...** or to access large time-sharing systems like THE SOURCE®, AMERICA'S INFORMATION UTILITY®, then you're ready for Micromodem II. Come on. Compare. Consider. And you'll discover the time is ripe to join the thousands of happy Apple II owners who are communicating with Micromodem II's complete system capability.

Available at computer stores all across America — call or write for the location nearest you. And don't settle for anything less than Hayes.



**Hayes Microcomputer Products, Inc.**  
5835 Peachtree Corners East,  
Norcross, Georgia 30092 (404)449-8791

Your Apple II\*  
just isn't the same without a  
Hayes Micromodem II.™

The Micromodem II can also be used with Bell & Howell Computers.™ Micromodem II and Microcoupler are trademarks of Hayes Microcomputer Products, Inc.  
\* THE SOURCE and AMERICA'S INFORMATION UTILITY are service marks of Source Telecomputing Corporation, a subsidiary of the Reader's Digest Association, Inc.  
\* Trademark of Apple Computer, Inc. © 1981 Hayes Microcomputer Products, Inc. Sold only in the U.S.A.



# Build your own private library for less than \$20 a month!

*Each volume bound in genuine leather and fine fabric . . . the leather embellished with 22 karat gold.*

Imagine being able to glance up at your bookshelf, and see there your own private library. With its proud expanse of leather spines, richly ornamented in gold, bearing the titles of the greatest books ever written.

Here, clearly, would be something of permanence in a changing and uncertain world. Something to treasure now . . . and to pass along to future generations in years to come.

A treasure, indeed, you might think—but surely an expensive luxury. *Far from it.*

For this is The Heirloom Library of the World's Greatest Books. Fifty enduring works of genius, selected by a distinguished board of advisers. In the handsome Collector's Edition, crafted for posterity in bindings of leather and fine fabrics. Ornamented with exclusive designs, the spines embellished with 22 karat gold.

**Beautiful books, at a guaranteed low price—yet you make no long-term commitment**

The Collector's Edition of the Heirloom Library will be

issued at the convenient rate of one great book per month, for just \$19.50 a volume—a price *guaranteed* for the duration of your subscription. However, *you* need make no long-term commitment. You may cancel your subscription at any time, on 30 days' written notice.

## **The rare pleasures of owning this personal library**

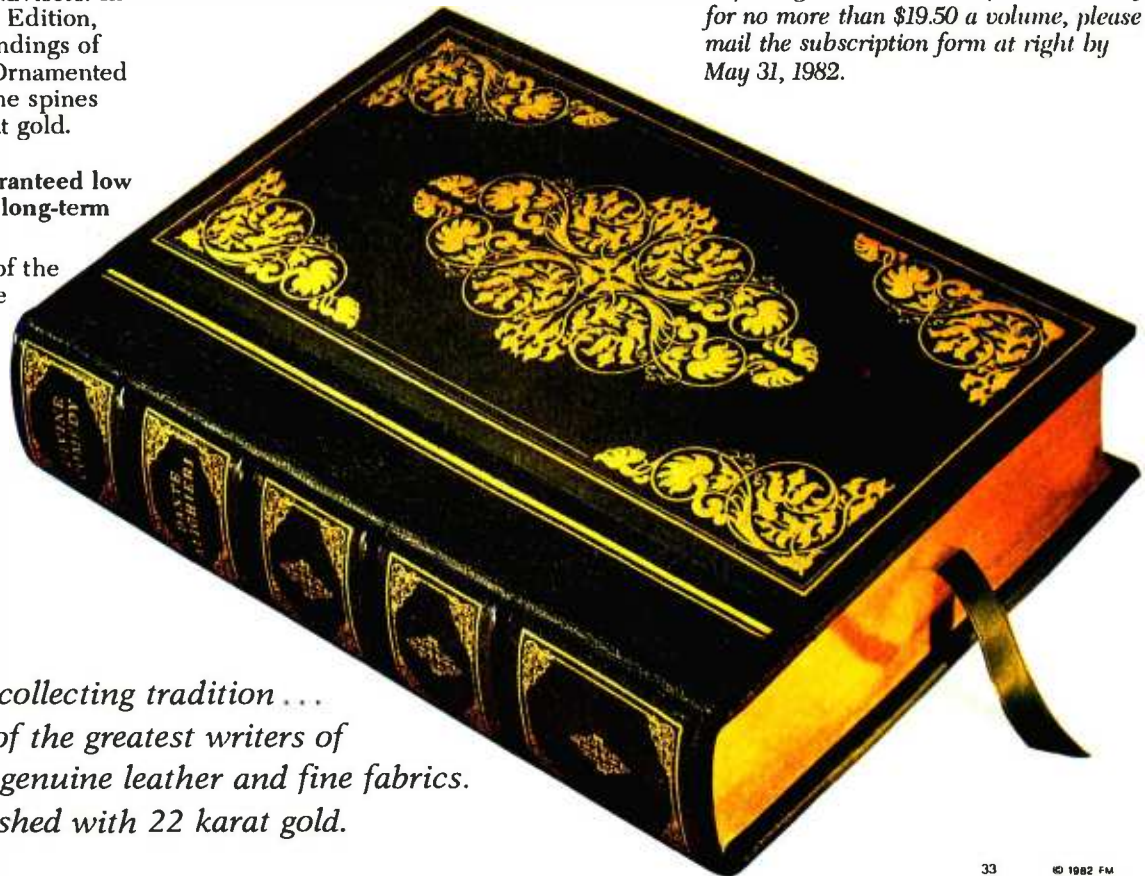
As a subscriber, you would enjoy, whenever you wish, the rich pleasure of taking one of these books from your shelf—with its fragrance of leather, its satisfying weight in your hands. Then savor a moment of anticipation as you open the volume, to see your own inscribed bookplate on the decorated endpapers. And leaf through the pages admiring the burnished edges . . . the smooth, opaque

paper . . . the crisp, legible type . . . the wonderfully evocative illustrations.

Above all, you would be able to enter at will . . . as one embarking on a voyage of discovery . . . the world of Hemingway or Melville, Shakespeare or Dante, Dickens or Mark Twain. The greatest books ever written, in bindings worthy of the incomparable works they contain.

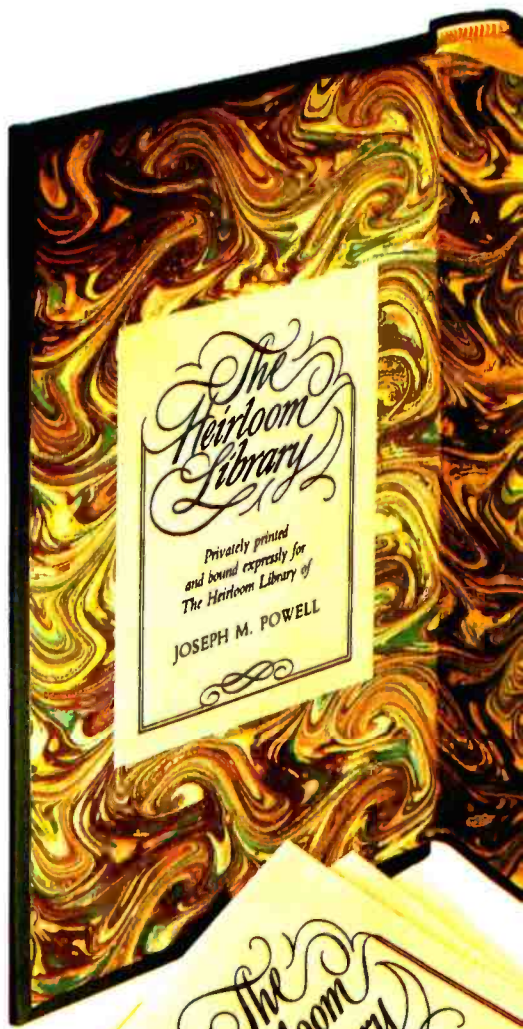
## **Mail your order by May 31st**

By the time your library is complete, even ordinary books may be selling for more than \$19.50. For the costs of materials, of printing and binding, are rising almost daily. And thus it may *never again* be possible to offer subscriptions to the Collector's Edition of the Heirloom Library at this guaranteed low price. *So, to be sure of acquiring this remarkable private library for no more than \$19.50 a volume, please mail the subscription form at right by May 31, 1982.*



*In a time-honored collecting tradition . . . the greatest books of the greatest writers of all time. Bound in genuine leather and fine fabrics. The leather embellished with 22 karat gold.*





- Fifty beautiful volumes to enjoy and display in your home
- Issued monthly at a price not much higher than you pay for an ordinary book – just \$19.50 a volume
- Price guaranteed for the duration of your subscription
- To be sure of acquiring your library at this low price, your subscription form should be postmarked by May 31, 1982



# New CP/M software

## WordIndex II™ \$195

Automatic generation of subject index and tables of contents, figures, etc.

WordIndex commands placed in any document produced by WordStar™ automatically number chapters and 8 levels of sections; create tables of contents, figures, and tables, and a sorted subject index with page references.

WordIndex II is loaded with new features:

**Multiple files.** WordIndex II supports the WordStar™ .fi dot command.

**Free choice of page number format.**

**Multiple choice of layout of all tables.**

**No limit on size of subject index.**

**Automatic generation of headings and footings.**

**Alternating page offset for even and odd pages** simplifies printing procedures.

**SPECIAL OFFER** for owners of all previous versions of WordIndex: return your original WordIndex diskette directly to us and receive WordIndex II at a nominal cost of \$50.

## MicroPlot™ \$395

100% Tektronix Plot-10 TCS compatible graphic package.

Previously available on minis and mainframes only.

Supplied with the original Tektronix™ documentation, MicroPlot fully implements the entire Tektronix Terminal Control System on your 8080/280 based microcomputer at a fraction of the original cost.

This package enables you to run even mainframe-developed software for the Plot-10 TCS on your microcomputer using Tektronix compatible peripherals.

MicroPlot is supplied as Microsoft™ .REL files to be used with Fortran-80™.

## MenuMaster™ \$95

Stop messing around with CP/M commands. MenuMaster makes all your software menu-driven.

Simply create your own menus directly on-screen using any text editor. The menu dispenses of long and hard-to-remember CP/M™ commands. The user may simply select programs from the menu using simple commands of his own choice.

Order your copy today directly from us by phone, telex, or mail. Please send cashier's check or state Visa or Master Charge account no.

Detailed descriptions may be requested at no cost. Just circle reader service. Dealers may apply for free demo-versions of all programs.

## BORLAND Ltd.

69, Upper Georges Street  
Dun Laoghaire  
Dublin, Republic of Ireland

Phone 1802514. Telex 25105 GSOP  
ATTN. BORLAND

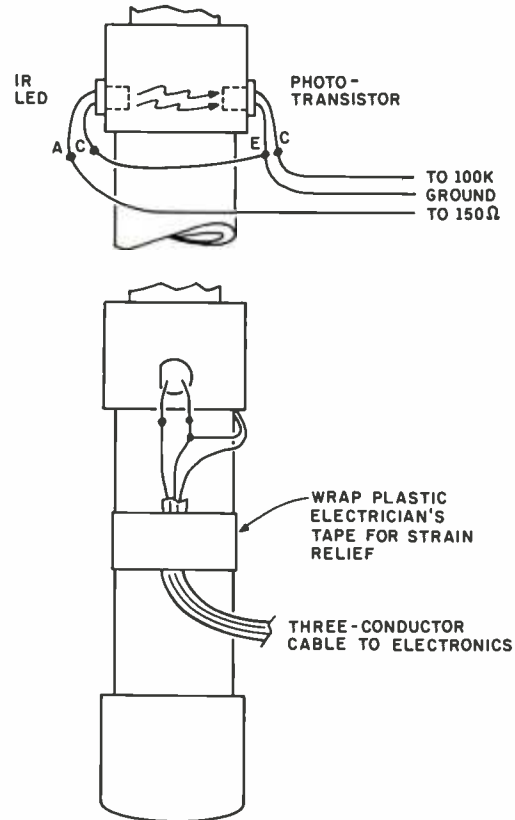


Figure 12: The infrared LED and phototransistor are mounted on opposite sides of the anemometer shaft. Each shaft revolution produces two infrared light detections.

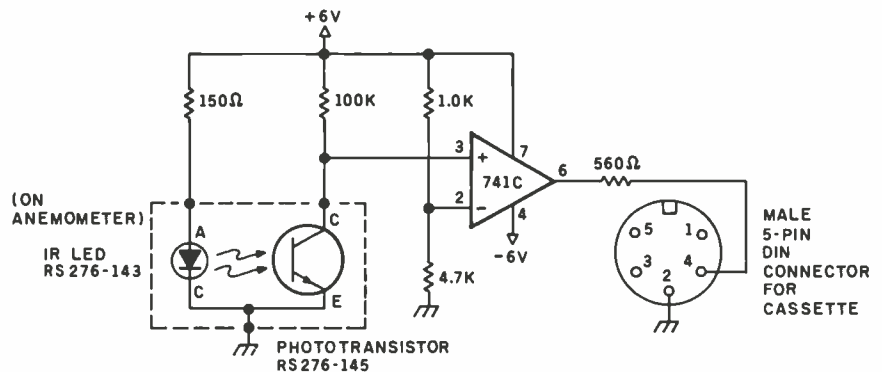


Figure 13: The electronics portion of the anemometer uses a few simple components but can provide a precise measurement of anemometer rotation speed.

# The Guesswork Is Gone!

Thanks to **Strictly Soft Ware**.

Consider the care you invested in buying your computer. We've done the same for your software.

How many times have you wondered: Is the package right? The price? The service?

We've cleared a course for you to the

best software — quality and price.

**Strictly Soft Ware** brings you the best in entertainment, education, performance, and price.

Take a look at the offerings below. And call now (toll-free) for our free catalog.

## \$19.95 SPECIALS

- Track Attack
- Red Alert
- Snack Attack
- Midnite Magic

- Space Eggs
- Sneakers
- Beer Run
- Dark Forest

- Raster Blaster
- Jawbreaker
- Crossfire
- Sabotage

- ABM
- Castle Wolfenstein
- Olympic Decathlon
- Ceiling Zero

### Arcade Games

ABM  
Apple-oids  
Apple Panic  
Autobahn  
Beer Run  
Bug Attack  
Compucube  
Computer Air Combat  
Computer Baseball  
County Fair  
Crossfire  
Cyber Strike  
Dark Forest  
Dogfight  
Epoch  
Firebird  
Flight Stimulator  
Gamma Goblins  
Genetic Drift  
Gobbler  
Golden Mountain  
Gorgon  
Hadron  
Hi Res Soccer  
Intl Gran Prix  
Missile Defense  
Mouskattack  
Olympic Decathlon  
Orbitron  
Outpost  
Pool 1.5  
Pegasus II  
Phantoms Five  
Pulsar II

Raster Blaster  
Reversal  
Robot War  
Ruski Duck  
Snack Attack  
Sneakers  
Super Invaders  
Star Thief  
Space Eggs  
Space War  
Space Quarks  
Thief  
Three Mile Island  
Threshold  
Track Attack  
Trick Shot  
Warp Attack

### Adventures

Adventures 1-12  
Alkemstone  
Akalabeth  
Adventure to Atlantis  
Castle Wolfenstein  
Crush, Crumble, Chomp  
Cyborg  
Galactic Empire  
Lords of Karma  
Creature Venture  
Mystery House  
Napoleon's Campaigns  
Oldori's Revenge  
OO Topos  
The Prisoner  
Race for Midnight

Southern Command  
Space Adventure  
Swordthrust  
Talawa's Last Redobtd  
Stone of Sisyphus  
Tarturian  
Temple of Apschai  
The Terrorist  
Time Zone  
Ulysses/Golden Fleece  
Ullima  
Wizard/Princess  
Wizardry  
Zork

### Business

Accounting  
BPI  
Continental  
Peachtree  
Broderbund  
The Apple Speller  
ASCII Express  
Creative Financing  
Data Capture  
Data Factory  
DB Master  
DB Master Utility  
Desk Top Plan II  
Easywriter  
Eduware  
Financial Partner  
Graphtrix  
Letter Perfect  
Magic Spell

Magic Window  
The Mail Room  
The Merger  
Menu Generator  
Micro Courier  
PFS  
PFS Report  
Real Estate Analyzer  
Spellstar  
Superscribe II  
Super Text II  
TASC Compiler  
Tax Manager  
Tax Preparer  
Versaform  
Visiblend  
Visicalc 3.3  
Visidex  
Visifactory  
Visifile  
Visiterm  
Visitrend/Visiplot  
Wordstar  
Z-80 Cards

### Home/Personnel

Decision Master  
The Correspondent  
Diet Planning  
Financial Management System II  
Home Money Minder  
Mastertype

Above titles are partial selection. Call for prices and catalog.



We take Master Card or VISA (include card # and expiration date). Ohio residents add 5.5% tax. Include \$2.00 for postage.

Send for free catalog. Prices subject to change.

## Strictly Soft Ware

Post Office Box 338  
Granville, Ohio 43023  
order by phone **800-848-5253**  
in Ohio **614-587-2938**





Listing 9: Color Computer assembly-language program to measure the period of a cassette input signal.

```

3F00          00100          ORG          $3F00
00110 *****
00120 * SUBROUTINE TO MEASURE PERIOD OF LOW-FREQ SIGNAL *
00130 * INPUT: NIL *
00140 * OUTPUT: 3FFE=PERIOD IN 20.23 MICROSECOND UNITS *
00150 * OR -1 IF TIME OUT, 2 BYTES *
00160 *****
00170 *
3F00 8E 0000 00180 PERIOD LDX #0 TIME OUT COUNT
3F03 30 01 00190 PER010 LEAX 1,X INCREMENT TIME OUT CNT
3F05 27 30 00200 BEQ PER090 GO IF TIME OUT
3F07 B6 FF20 00210 LDA $FF20 GET PIA BYTE
3F0A 84 01 00220 ANDA #1 GET CASSDIN
3F0C 26 F5 00230 BNE PER010 GO IF AT PULSE
3F0E 8E 0000 00240 LDX #0 INITIALIZE TIME OUT CNT
3F11 30 01 00250 PER020 LEAX 1,X INCREMENT TIME OUT CNT
3F13 27 22 00260 BEQ PER090 GO IF TIME OUT
3F15 B6 FF20 00270 LDA $FF20 GET PIA BYTE
3F18 84 01 00280 ANDA #1 GET CASSDIN
3F1A 27 F5 00290 BEQ PER020 GO IF NOT PULSE
3F1C 8E 0000 00300 LDX #0 INITIALIZE TIME OUT
3F1F 30 01 00310 PER030 LEAX 1,X INCREMENT TIME OUT CNT
3F21 27 14 00320 BEQ PER090 GO IF TIME OUT
3F23 B6 FF20 00330 LDA $FF20 GET PIA BYTE
3F26 84 01 00340 ANDA #1 GET CASSDIN
3F28 26 F5 00350 BNE PER030 GO IF STILL PULSE
3F2A 30 01 00360 PER050 LEAX 1,X INCREMENT TIME COUNT
3F2C 27 09 00370 BEQ PER090 GO IF TIME OUT
3F2E B6 FF20 00380 LDA $FF20 GET PIA BYTE
3F31 84 01 00390 ANDA #1 GET CASSDIN
3F33 27 F5 00400 BEQ PER050 GO IF NOT END
3F35 20 03 00410 BRA PER095 NORMAL RETURN
3F37 8E FFFF 00420 PER090 LDX #-1 FLAG TIME OUT
3F3A BF 3FFE 00430 PER095 STX $3FFE RETURN WITH ARGUMENT
3F3D 39 0000 00440 RTS RETURN
00000 TOTAL ERRORS 00450 END

```

Listing 10: Model III assembly-language program to measure the period of a cassette input signal.

```

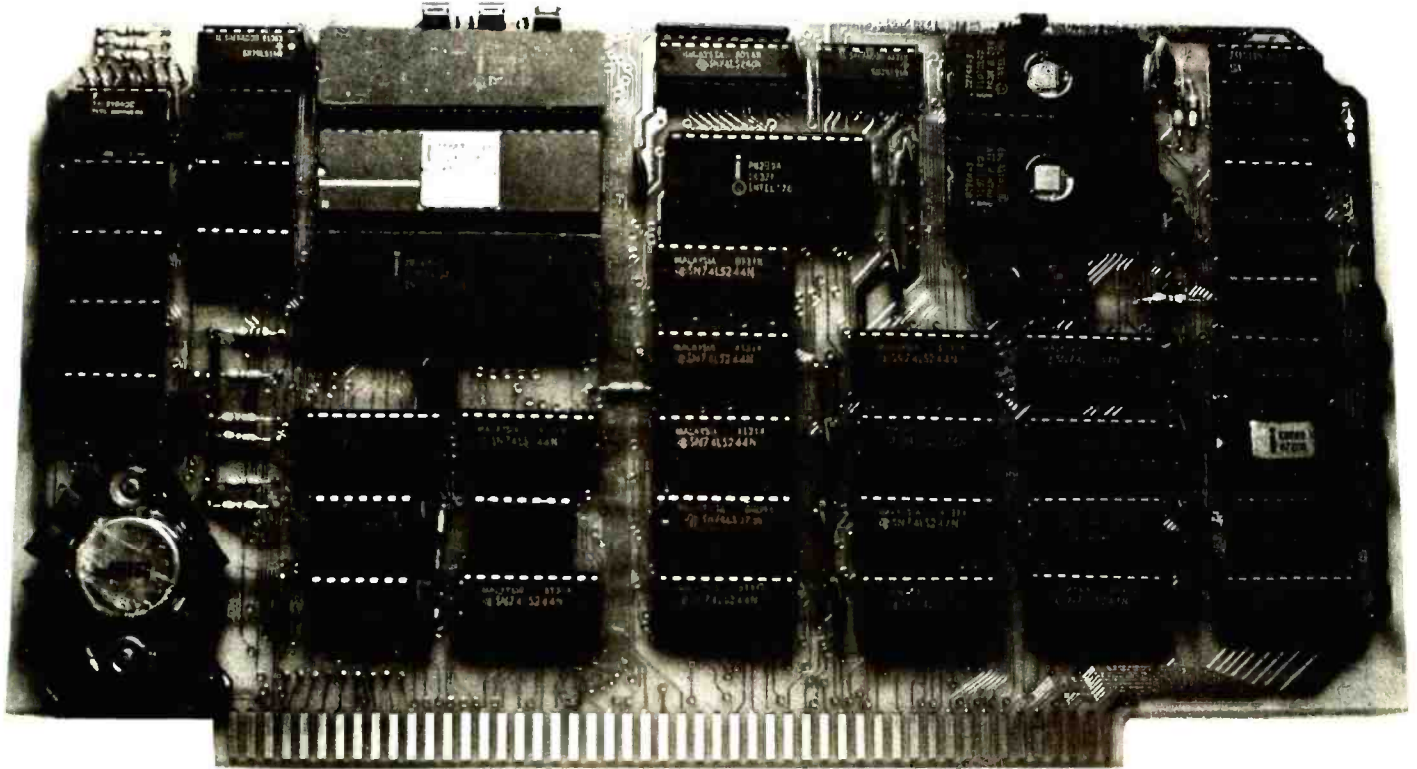
7F00          00100          ORG          7F00H          ;RELOCATABLE
00110 ;*****
00120 ;* SUBROUTINE TO MEASURE PERIOD OF LOW-FREQ SIGNAL *
00130 ;* INPUT: NIL *
00140 ;* OUTPUT: HL=PERIOD IN 24.33 MICROSECOND UNITS *
00150 ;* OR -1 IF TIME OUT, 2 BYTES *
00160 ;*****
00170 ;
7F00 210000 00180 PERIOD LD HL,0 ;TIME OUT COUNT
7F03 010100 00190 LD BC,1 ;INCREMENT
7F06 09 00200 PER010 ADD HL,BC ;INCREMENT TIME OUT CNT
7F07 3829 00210 JR C,PER090 ;GO IF TIME OUT
7F09 DBFF 00220 IN A,(0FFH) ;GET I/O BYTE
7F0B E601 00230 AND 1 ;GET CASSDIN
7F0D 20F7 00240 JR NZ,PER010 ;GO IF AT PULSE
7F0F 210000 00250 LD HL,0 ;REINITIALIZE TIME OUT CNT
7F12 09 00260 PER020 ADD HL,BC ;INCREMENT TIME OUT COUNT
7F13 381D 00270 JR C,PER090 ;GO IF TIME OUT

```

Listing 10 continued on page 198

# The Lightning One™

## 8086/8087/8089 CPU Board



### Features:

- 4, 5, 8 or 10 MHz operation jumper selectable
- 8086 or 8088 main processor
- Independent I/O and memory waitstate generator
- Up to 16K bytes of onboard EPROM
- 9 vectored interrupts expandable to 65
- EPROM monitor with diagnostics and disk utilities
- 8087 and 8089 co-processors available onboard
- CP/M-86\* and MS-DOS\*\* software support

\*CP/M-86 is a trademark of Digital Research.

\*\*MS-DOS is a trademark of Microsoft.

Lightning One is a trademark of Lomas Data Products, Inc.

The *Lightning One*™ is the fastest processor board available on the S100 bus today. It contains not one processor, but three processors all working in parallel. It uses the Intel 8086 as the main processor. The math capability is augmented with the 8087 math processor and the I/O handling capabilities are augmented with the 8089 dual channel I/O processor. The board complies with all IEEE-696 specifications.

If you have an 8 bit system presently, don't despair. The *Lightning One* is available with the 8088. The 8088 is fully software compatible with the 8086, but utilizes an 8 bit bus allowing use of your present 8 bit memories. When you are ready to upgrade to full 16 bit operation, you need only to unplug the 8088 and plug in an 8086 in its place. When using an 8088, the 8087 and 8089 may still be utilized.

In addition to the *Lightning One*, Lomas Data Products has a full line of S100 bus support cards including: memory, disk controllers, and serial and parallel I/O.

Prices for the *Lightning One* start at \$395.

### Coming Soon: New Product Announcements:

- 128 K byte non-volatile static RAM
- M DRIVE for CP/M-86 and MS-DOS
- Dual CP/M-86 and CP/M 2.2 support
- Winchester hard disk controller

**For 16 bit computing  
on the S100 bus,  
come to the leader . . .**

## LOMAS DATA PRODUCTS, INC.

729 Farm Road, Marlboro, Massachusetts 01752 ☐ Telephone: 617-481-2822



Listing 10 continued:

```

7F15 DBFF      00280      IN      A,(0FFH)      ;GET I/O BYTE
7F17 E601      00290      AND      1      ;GET CASSDIN
7F19 28F7      00300      JR      Z,PER020      ;GO IF NOT PULSE
7F1B 210000    00310      LD      HL,0      ;REINITIALIZE TIME OUT
7F1E 09        00320 PER030  ADD     HL,BC      ;INCREMENT TIME OUT
7F1F 3811      00330      JR      C,PER090      ;GO IF TIME OUT
7F21 DBFF      00340      IN      A,(0FFH)      ;GET I/O BYTE
7F23 E601      00350      AND      1      ;GET CASSDIN
7F25 20F7      00360      JR      NZ,PER030     ;GO IF STILL PULSE
7F27 09        00370 PER050  ADD     HL,BC      ;INCREMENT TIME OUT
7F28 3808      00380      JR      C,PER090      ;GO IF TIME OUT
7F2A DBFF      00390      IN      A,(0FFH)      ;GET I/O BYTE
7F2C E601      00400      AND      1      ;GET CASSDIN
7F2E 28F7      00410      JR      Z,PER050      ;GO IF NOT END
7F30 1803      00420      JR      PER095      ;NORMAL RETURN
7F32 21FFFF    00430 PER090  LD      HL,-1      ;FLAG TIME OUT
7F35 C39A0A    00440 PER095  JP      0A9AH      ;PASS ARGUMENT BACK
0000          00450      END
00000 Total errors

```

Listing 11: Color Computer BASIC driver program for the anemometer. This program uses the PERIOD program. The machine-language code for PERIOD is contained in the BASIC program and is poked into high memory.

```

100 'SAMPLE ANEMOMETER PROGRAM
110 DATA 142,0,0,48,1,39,48,182,255,32
120 DATA 132,1,38,245,142,0,0,48,1,39,34
130 DATA 182,255,32,132,1,39,245,142,0,0
140 DATA 48,1,39,20,182,255,32,132,1,38
150 DATA 245,48,1,39,9,182,255,32,132,1,39
160 DATA 245,32,3,142,255,255,191,63,254,57
170 FOR I=&H3F00 TO &H3F3D
180 READ A: POKE I,A
190 NEXT I
200 DEFUSR0=&H3F00
210 CLS
220 A=USR(0)
230 A=PEEK(&H3FFE)*256+PEEK(&H3FFF)
240 IF A=65535 THEN A=0: GOTO 260
250 A=3.75/(A*20.23E-6)
260 PRINT @262,A;"MPH"
270 GOTO 220

```

Listing 12: Model III BASIC driver program for the anemometer. This program uses the PERIOD program. The machine-language code for PERIOD is contained in the BASIC program and is poked into high memory.

```

1100 'SAMPLE ANEMOMETER PROGRAM MODEL III
110 DATA 33,0,0,1,1,0,9,56,41,219
120 DATA 255,230,1,32,247,33,0,0,9,56
130 DATA 29,219,255,230,1,40,247,33,0,0
140 DATA 9,56,17,219,255,230,1,32,247,9
150 DATA 56,8,219,255,230,1,40,247,24,3
160 DATA 33,255,255,195,154,10
170 FOR I=32512 TO 32567
180 READ A: POKE I,A
190 NEXT I
200 DEFUSR0=&H7F00
210 CLS
220 A=USR(0)
230 IF A=-1 THEN A=0:GOTO 250
235 IF A<0 THEN A=65536+A
240 A=3.75/(A*24.33E-6)
250 PRINT @ 532,A;"MPH"
260 GOTO 220

```

rotation is detected, a -1 is returned as the period; both BASIC programs look for this flag and set the period to 0 in this case.

Wind speed will be displayed in the center of the screen. Wind speed in this case is a rough calculation based on preliminary empirical tests. The tests involved driving madly down city streets while keeping one eye on the road and the other on the rotating anemometer held at arm's length out the open car window. The 12-V DC-powered inverter for mobile computer operation is a project I'll leave for you in your spare time.

Each rotation of the shaft produces two pulses. A wind speed of 15 miles per hour (mph) is approximately 2 revolutions per second—thus the "3.75" factor. Rotational speed of the anemometer appears to be linear; 30-mph wind produces 4 revolutions per second and so forth. I would be very interested to hear from readers who construct the anemometer and run some tests with it, especially those who have access to a wind tunnel.

The above examples illustrate what can be achieved without a great deal of additional hardware when using inputs that were not meant to be discrete inputs but were dragged, kicking and screaming, into duty. In a later article, I'll look at a more sophisticated way to interface many lines to the system bus. I promise you won't be cutting up PVC tubing and scrubbing cement off your hands. ■

# Your computer.

Compute.

Compute.

Compute.

Compute.

Compute.

**Dump...**

Compute.

Compute.

Compute.

Compute.

Compute.

# Your printer.

**...Print.**

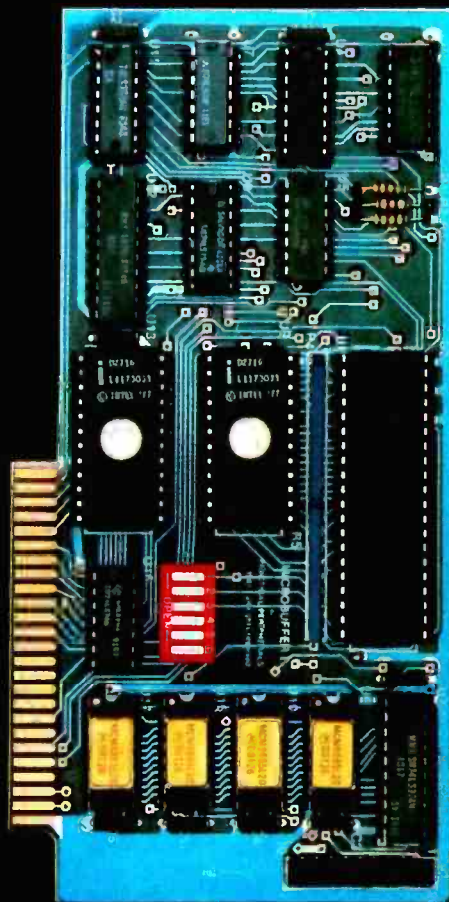
**Print.**

**Print.**

**Print.**

**Print.**

**Print.**



## New Microbuffer II lets you use your printer without tying up your computer.

Time. As an important resource it shouldn't be wasted. One such waste is in printing, where your computer must wait for your printer. Now there's a way to eliminate this waste.

Introducing the Microbuffer II™, a buffered parallel printer interface for the Apple II™ computer with 16K characters of memory (user expandable to 32K). It accepts data as fast as your computer can send it, allowing you to use your computer while the Microbuffer II is in control of your printing.

The Microbuffer II, compatible

with Applesoft, CP/M™ and Pascal, comes with complete print formatting features as well as advanced graphics dump routines for most popular graphics printers.

The Snapshot™ option permits you to dump the text screen or graphics picture to the printer while any program is

running — without interruption.

The 16K Microbuffer II is available for \$259. And the 32K version, for \$299. The Snapshot option is \$69.

So why waste time while your computer waits for your printer? Ask your computer dealer for the Microbuffer II or call us for the name of a dealer near you.

Microbuffer II and Snapshot are trademarks of Practical Peripherals, Inc.  
CP/M is a registered trademark of Digital Research, Inc.  
Apple II is a registered trademark of Apple Computer, Inc.

**PRACTICAL PERIPHERALS, Inc.**  
31245 La Brea Drive  
Westlake Village, California 91362  
(213) 991-8200

# MICROBUFFER II

# MI

Circle 340 on Inquiry card.



# The \$149<sup>95</sup> personal computer.



## Introducing the Sinclair ZX81

If you're ever going to buy a personal computer, now is the time to do it.

The new Sinclair ZX81 is the most powerful, yet easy-to-use computer ever offered for anywhere near the price: only \$149.95\* completely assembled.

Don't let the price fool you. The ZX81 has just about everything you could ask for in a personal computer.

### A breakthrough in personal computers

The ZX81 is a major advance over the original Sinclair ZX80—the world's largest selling personal computer and the first for under \$200.

In fact, the ZX81's new 8K Extended BASIC offers features found only on computers costing two or three times as much.

Just look at what you get:

- Continuous display, including moving graphics
- Multi-dimensional string and numerical arrays

\* Plus shipping and handling. Price includes connectors for TV and cassette, AC adaptor, and FREE manual.

- Mathematical and scientific functions accurate to 8 decimal places
- Unique one-touch entry of key words like PRINT, RUN and LIST
- Automatic syntax error detection and easy editing
- Randomize function useful for both games and serious applications
- Built-in interface for ZX Printer
- 1K of memory expandable to 16K

The ZX81 is also very convenient to use. It hooks up to any television set to produce a clear 32-column by 24-line display. And you can use a regular cassette recorder to store and recall programs by name.

## If you already own a ZX80

The 8K Extended BASIC chip used in the ZX81 is available as a plug-in replacement for your ZX80 for only \$39.95, plus shipping and handling—complete with new key-board overlay and the ZX81 manual.

So in just a few minutes, with no special skills or tools required, you can upgrade your ZX80 to have all the powerful features of the ZX81. (You'll have everything except continuous display, but you can still use the PAUSE and SCROLL commands to get moving graphics.)

With the 8K BASIC chip, your ZX80 will also be equipped to use the ZX Printer and Sinclair software.

### Order at no risk\*\*

We'll give you 10 days to try out the ZX81. If you're not completely satisfied, just return it to Sinclair Research and we'll give you a full refund.

And if you have a problem with your ZX81, send it to Sinclair Research within 90 days and we'll repair or replace it at no charge.

\*\*Does not apply to ZX81 kits.



**NEW SOFTWARE:** Sinclair has published pre-recorded programs on cassettes for your ZX81, or ZX80 with 8K BASIC. We're constantly coming out with new programs, so we'll send you our latest software catalog with your computer.



**ZX PRINTER:** The Sinclair ZX Printer will work with your ZX81, or ZX80 with 8K BASIC. It will be available in the near future and will cost less than \$100.



**16K MEMORY MODULE:** Like any powerful, full fledged computer, the ZX81 is expandable. Sinclair's 16K memory module plugs right onto the back of your ZX81 (or ZX80, with or without 8K BASIC). Cost is \$99.95, plus shipping and handling.



**ZX81 MANUAL:** The ZX81 comes with a comprehensive 164-page programming guide and operating manual designed for both beginners and experienced computer users. A \$10.95 value, it's yours free with the ZX81.



# The \$99<sup>95</sup> personal computer.

## Introducing the ZX81 kit

If you really want to save money, and you enjoy building electronic kits, you can order the ZX81 in kit form for the incredible price of just \$99.95\* It's the same, full-featured computer, only you put it together yourself. We'll send complete, easy-to-follow instructions on how you can assemble your ZX81 in just a few hours. All you have to supply is the soldering iron.

### How to order

Sinclair Research is the world's largest manufacturer of personal computers.

The ZX81 represents the latest technology in microelectronics, and it picks up right where the ZX80 left off. Thousands are selling every week.

We urge you to place your order for the new ZX81 today. The sooner you order, the sooner you can start enjoying your own computer.

To order, simply call our toll free number, and use your MasterCard or VISA.

To order by mail, please use the coupon. And send your check or money order. We regret that we cannot accept purchase orders or C.O.D.'s.

**CALL 800-543-3000.** Ask for operator #509. In Ohio call 800-582-1364. In Canada call 513-729-4300. Ask for operator #509. Phones open 24 hours a day, 7 days a week. Have your MasterCard or VISA ready.

These numbers are for orders only. For information, you must write to Sinclair Research Ltd., 2 Sinclair Plaza, Nashua, NH 03061.

# sinclair



AD CODE	PRICE†	QTY.	AMOUNT
05BY			
ZX81	\$149.95		
ZX81 Kit	99.95		
8K BASIC chip (for ZX80)	39.95		
16K Memory Module (for ZX81 or ZX80)	99.95		
Shipping and Handling	4.95		\$4.95
TOTAL			

MAIL TO: Sinclair Research Ltd., One Sinclair Plaza, Nashua, NH 03061.

NAME \_\_\_\_\_

ADDRESS \_\_\_\_\_

CITY/STATE/ZIP \_\_\_\_\_

† U.S. Dollars



# The Input/Output Primer

## Part 4: The BCD and Serial Interfaces

*A look at one of the least understood interfaces—RS-232C—and one of the first instrument interfaces.*

---

Steve Leibson  
Auto-Trol Technology Corporation  
12500 North Washington St.  
POB 33815  
Denver, CO 80233

---

In Part 3 of this series, we looked at the parallel and HPIB or GPIB (IEEE-488) interfaces. This month we turn our attention to the BCD (binary-coded decimal) interface and

*This article is the fourth in Steve Leibson's six-part series, The Input/Output Primer. The series describes the problems involved in communications between computers and the outside world and explains how some of these problems have been solved. The two remaining articles will discuss character codes and interrupts, buffers, grounds, and signal degradation. "An I/O Glossary," which defines many terms used in these articles, appeared with the first installment (February 1982 BYTE, page 122). Figure and table numbers are continued from Part 3.*

the RS-232C serial interface. Both of these interfaces are older than those previously covered. The BCD interface traces its origins to scientific instruments that have been in use for decades. The serial interface's roots go back much farther, to the days when buffalo grazed the prairies of North America and André Ampère had an idea for a new method of communication. Let's look first at the BCD interface.

### The BCD Interface

The BCD interface has remained popular because it provides a link to older measuring instruments that have been turning out reliable data for years. Some designers still put BCD interfaces in new digital instruments because the BCD interface is simple and inexpensive.

When scientists first connected

measuring instruments to computers, existing instruments lacked the electronic sophistication needed to use either the parallel or the IEEE-488 interface. Engineers were faced with developing an interface that relied on the intelligence of the computer to manage communications between the computer and the instruments.

Because measuring instruments send information to the computer but receive no information from it, the new interface could be unidirectional. There might be control lines from the computer to actuate ranges or control other aspects of the instrument's readings, but the control lines did not have to send data.

The new interface also had to accept a very wide word of data. For reasons that will become clear after I discuss the BCD coding method, high-resolution measuring instru-

# Introducing The FinalWord!

## Word processing that goes beyond the stars.

**H**ow could anyone call their word processor The FinalWord? Take the best features of the most popular word processors, combine them and add a few more in one text editor/formatter and you'd be off to a good start. Then, write the program in C to allow user customization and make it capable of supporting any printer on the market and you'd be ahead of everybody else. If you went one step further and made your word processor transportable from one terminal to another you'd have—The FinalWord.



**Supports multiple printers:** The FinalWord allows you to produce high-speed draft copies on one printer, and letter-quality on another. It also means you'll never need another version just because you bought a new printer.

**User-installable on different hardware:** With The FinalWord you can upgrade your system and still have a familiar screen display. And since we've written The FinalWord in C, new versions are available almost as soon as new computers.

**Features that go beyond the stars:** Look at what you get with The FinalWord: automatic generation of Table of Contents, Index, footnoting and chapter/section numbering; enhanced command sets (delete/move a letter, word, sentence, paragraph, page); multiple buffers and windows, deletion recovery, true proportional spacing and more. And because we wrote The FinalWord to be easily reconfigured for different systems, our price can be lower.

Features	The FinalWord	WordStar	Magic Wand
Full-Screen Editing	Yes	Yes	Yes
Directory Access while Editing	Yes	Yes	Yes
Simultaneous Printing while Editing	Yes	Yes	Yes
External Commands while Editing	Yes	Yes	No
Video Highlighting	Yes	Yes	No
Automatic Footnotes	Yes	No	No
User-Defined Commands	Yes	No	No
Multiple File Editing	Yes	No	No
Deletion Recovery	Yes	No	No
Supports Multiple Printers	Yes	No	No
Crash Recovery	Yes	No	No
Dynamic Include Files	Yes	No	Yes
<b>Suggested Retail Price</b>	<b>\$300</b>	<b>\$495</b>	<b>\$395</b>

The FinalWord requires a 56K CP/M system and video terminal with cursor positioning character sequences. It is presently available in 8" standard format for the TRS-80 Model II, Vector Graphics and Altos Systems. There are compatible versions for the HP-125, Xerox 820, Cromemco, Micropolis, Ohio Scientific and Dynabyte Systems, and there are 5¼" versions for the Heath/Zenith Z-89, Northstar, Apple and Superbrain. **Coming Soon: The FinalWord for the IBM Personal Computer.**

The FinalWord is available through leading retailers, Westico, and Discount Software, or directly from:

Mark of the Unicorn  
 PO BOX 423  
 Arlington, Massachusetts 02174  
 (617) 489-1387

Dealer and OEM inquiries invited.  
 Call for delivery schedule.  
 Reserve yours now!



# Mark of the Unicorn





MicroGANTT is a sophisticated project planning system which uses Critical Path Method (CPM) techniques and PERT to determine task dependencies and project completion dates. The user creates tasks, assigns costs and defines task dependencies. The interactive system immediately redisplay the project plan as data is entered. Projects are displayed as Gantt charts, labor time summaries and financial summaries.

MicroGANTT features: ■ Time scale of days, weeks, months, quarters or years can be varied at any time to present more or less detail. ■ Accommodates unlimited number of tasks in a project plan. ■ Detailed sub-projects can be included as tasks in a project model. ■ Assumptions are easily modified to make "What if?" analyses. ■ Single key-stroke commands page through tasks and calendar of events on display screen. ■ Single key-strokes switch the display from Gantt chart to labor time summary to financial summary. ■ Partial allocation of manpower to tasks. ■ Partial completion of prerequisite tasks. ■ All charts, reports and plans can be printed.

Available for **IBM Personal Computer** and CP/M compatible computers. Software and manual \$395. Manual alone \$25.

**4 ways to order:**

- Write Westico, Inc., 25 Van Zant Street, Norwalk, CT 06855
- Call (203) 853-6880
- Telex 643-788
- Dial-up our 24-hour computer (300 baud) (203) 853-0816

copyright © 1982 Westico, Inc. **WES-44**

**WESTICO**  
The Software Express Service

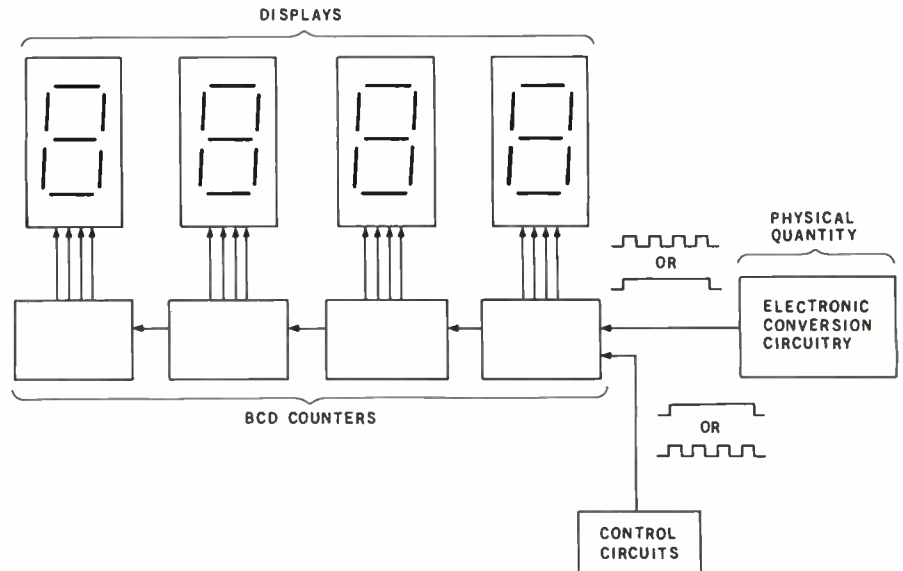


Figure 10: Block diagram of a BCD instrument. Two signals drive a string of single-digit binary-coded decimal (BCD) counters. One signal is a representation of the physical quantity being measured. This signal may be either a pulse of controlled duration or a series of pulses whose frequency is proportional to the physical quantity being measured. The second signal, from the control circuits, is used for timing.

ments may have I/O (input/output) connectors with as many as 40 or 50 pins. The new interface had to permit the peripheral instrument to present its entire message at once, sometimes as many as 50 bits in parallel. Then the interface had to break up this wide parallel word into pieces that the computer could digest more easily.

**Binary-Coded Decimal Numbers**

BCD is a method that expresses each of the 10 decimal numerals (0 through 9) in a binary code. The coding sequence is:

Bit #	Binary Code	Decimal Numeral
	3 2 1 0	
	0 0 0 0	0
	0 0 0 1	1
	0 0 1 0	2
	0 0 1 1	3
	0 1 0 0	4
	0 1 0 1	5
	0 1 1 0	6
	0 1 1 1	7
	1 0 0 0	8
	1 0 0 1	9

Note that 4 binary digits (bits) are required to represent the numerals 8 and 9. Codes 1010 through 1111 are

not used. Consequently, BCD coding is not as efficient as pure binary coding, but the ease with which BCD can be displayed for human operators offsets its inefficiency in code compaction.

The standard calendar presents an analogy. Each page contains 5 weeks, more than enough space to hold the days in any month. The extra spaces for days remain blank. That extra space is useless to the printer, but because we *do* block the days of the year into months, the convenience of placing each month on a separate page more than makes up for the wasted space.

Since each decimal digit in BCD coding takes 4 bits, each digit of a scientific-instrument reading requires 4 wires to transmit the binary values that express that digit. Scientific instruments make all digits available simultaneously on the I/O connector, and high-resolution instruments can have connectors with as many as 50 pins. That explains why the BCD interface has to be able to accept such wide data words.

**Implementing the BCD Interface**

What makes the BCD interfacing technique easy to implement in

WESTICO — The Software Express Service that really delivers:

# LANGUAGE PROCESSORS

When it comes to providing quality programs for serious microcomputer users—come to Westico. And you'll find more than quality software. You'll find instant response. In most cases, your order will be shipped within 24 hours. You'll also find the technical expertise on staff when you need help. For language processors and lots more, it's Westico. Here's just a sample of the more than 150 quality programs currently in stock:

**PL/I-80™** — Powerful application programming language for microcomputers. Implements on a micro the ANS Subset G language for minicomputers. Includes native code compiler, LINK-80 linkage editor, LIB-80 subroutine library manager, PLILIB run-time library and RMAC relocatable macro assembler. \$475/\$35. LINK-80 and RMAC also available separately.

**BT-80™** — Efficient B-tree key indexed access method for PL/I-80. Features key length to 63 bytes, unique or duplicate keys, and data records to 4096 bytes. Datasets can be spread over 8 files for a total of 64 megabytes. \$200/\$30.

**BASIC-80** — Extremely fast interpreter features double precision floating point math, 40 character variable names, CHAIN/Common, random and sequential files, EDIT, CALL with parameters and an overlay technique. \$350/—.

**BASIC COMPILER** — Compatible with BASIC-80. Produces extremely efficient, optimized 8080/Z80 machine code. Includes macro assembler, linkage editor and subroutine library manager. Compiled programs can be linked with FORTRAN-80, COBOL-80, and assembly language programs. \$395/—.

**CBASIC™** — BASIC language compiler/interpreter for development of financial and business application programs. System \$120/\$20.

**CBASIC-86** — Implementation of CBASIC for CP/M-86. INT files compatible with CBASIC and supports 128K main memory. Requires CP/M-86 or MP/M-86. \$325/\$30.

**CB-80™** — Native code 8080 compiler of CBASIC language. Offers all of the features of CBASIC plus the speed and versatility of a compiler. Includes linkage editor which can create overlay modules. Supports CP/M and MP/M II. \$500/\$30.

**FORTAN-80** — Includes full ANSI standard X3.9 except COMPLEX data type. \$500/—.

**LYNX™** — Friendly overlay linkage editor for creating COM files from Microsoft compatible REL files. Constructs programs that use all available memory including that used by LYNX itself. Program size can be increased at least 9K without using the overlay feature. The overlay option is vital to programs larger than available memory. Easy to use with BATCH and HELP commands. \$250/\$25.

**PASCAL/MT+™** — Compiler produces 8080/Z80 code. Standard REL file can be linked with other languages. Includes linker, debugger disassembler and special Speed Programming Package with editor and Pascal syntax checker. \$475/\$30.

**COBOL-80** — Complies with ANSI Level 1 requirements and most useful features of Level 2. SCREEN SECTION for definition of CRTs. \$750/—.

**XASMxx** — Family of microprocessor cross-assemblers. Designed to run on 8080/Z80 based microcomputers under a CP/M-like operating system. Support for Motorola 6800, 6801, 6803, 6805, 6809; RCA 1802; COP400; Intel 8048, 8051; MOS 6502. \$200/\$25.

**XL86™** — Translates Intel 8080 assembly language source code into optimized Intel 8086 source code. \$150/\$10.

**The Westico 24-Hour Computer Hotline (203) 853-0816 (300 baud) for detailed information and quick access ordering.**



• Westico has more than 150 programs for professionals and businesses that use a wide variety of microcomputers including: TRS-80 Model II, Apple, Vector Graphic, Cromemco, North Star, Micropolis, Ohio Scientific, Altos, Dynabyte, IBM, Intertec, Xerox, Zenith, Northern Telecom, AVL Eagle and more. We're working hard to be your software company.

#### 4 Ways to order

- Write Westico, Inc., 25 Van Zant Street, Norwalk, CT 06855.
- Call (203) 853-6880.
- Telex 643-788
- Dial-up our 24-hour computer (300 baud) (203) 853-0816.

COD, MasterCard and VISA accepted.

Prices do not include shipping and are subject to change. In CT add 7½% sales tax. All sales final.

Manual price may be credited toward purchase of software.

Dealer inquiries invited.

WES-43

Copyright © 1982 Westico, Inc.

For FREE catalog  
circle reader service number. More  
than 150 quality programs in stock.

**WESTICO**  
The Software Express Service

25 Van Zant Street • Norwalk, Connecticut 06855  
(203) 853-6880 • Telex 643-788



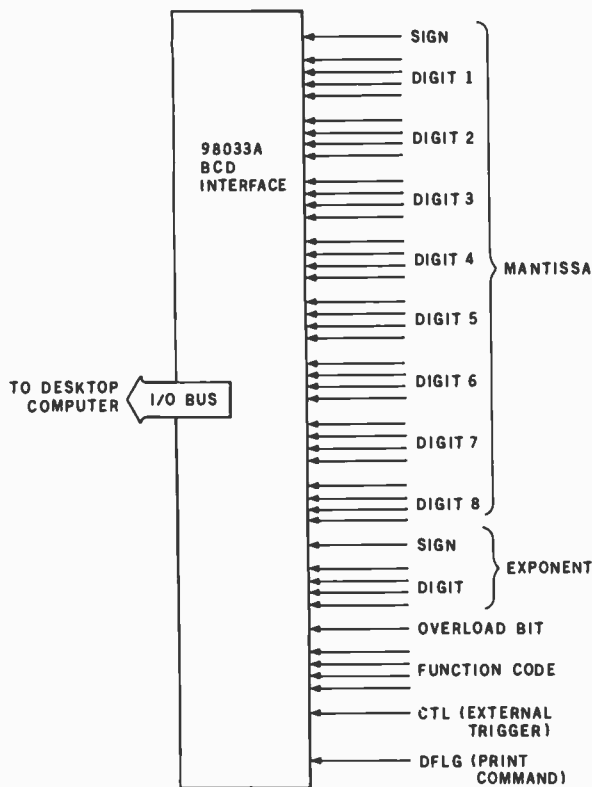


Figure 11: The 98033A BCD interface. This figure shows how a computer reads in the digits of a BCD instrument. The counters are connected to the BCD interface, which reads in each digit, converts the BCD data to characters, adds delimiting characters, and sends the entire message to the computer. CTL is an external trigger that tells the instrument to take a reading. DFLG (print command) is a signal from the instrument indicating that a valid reading is represented on the digit lines. These two signals, CTL and DFLG, are the handshake lines between the interface and the instrument.

measuring instruments? The answer lies in the circuitry used to do the measuring.

Figure 10 shows a diagram of a typical measuring instrument. Input to the instrument such as voltage, current, or weight is fed to an electronic circuit that converts the physical parameter to a signal that represents the parameter. This signal may be either of two types: a square wave or a pulse.

A square wave alternately takes on two different fixed values for equal lengths of time. If the signal produced by the instrument is a square wave, the physical quantity measured by the instrument determines the wave's frequency. The frequency is fed to the input of a counter that is allowed to count for a precisely controlled period of time.

If the signal produced by the instrument is a pulse, the physical quantity measured determines the pulse's dura-

tion. The pulse is used to control a counter that is clocked by a precise square wave of known frequency.

Whether the signal starts as a frequency or a pulse, the result is a count proportional to the input parameter. The counter drives the digits in a display. If the counter counted in binary, the display would be difficult to read because we think in decimal.

Fortunately, it's possible to use BCD counters in the counter that drives the display. If several BCD counters are placed in series (or *cascaded*), they produce outputs easily displayed in decimal. This works in much the same way as an odometer. Each wheel of the odometer has the numerals 0 through 9 printed on it. Every time a wheel on the odometer makes a full turn, it advances the wheel to the left of it by one count. In a chain of BCD counters, each time a digit advances from 9 to 0, it ad-

vances the next higher counter by 1. Each BCD counter has 4 digital output lines that represent the state of the counter. These outputs are used to drive one digit in the display. The digits combine to form the complete reading of the instrument.

This technique is used in a remarkably wide range of digital measuring instruments, including digital clocks. Most instruments use this counting technique to convert a physical quantity into a digital display; in the case of digital clocks, of course, the quantities are periods of time.

### The BCD Interface Is Born

The first accessory that designers added to their digital instruments was a printer, which made it possible for an unattended instrument to log its own readings. Signal lines were brought out of the instruments to drive the print wheels—one print wheel for each digit. These signal lines were nothing more than the digital output lines of the BCD counters in the instrument. The counters drove the display and positioned the print wheel just before it struck the paper.

By supplementing the counter output lines with just two more signals, designers created the BCD interface. One of the added signals told the printer when the reading was valid (*print command*), and the other allowed the printer to pace the readings (*external trigger*) so that the instrument would not take readings faster than the printer could print them. These two signals form the handshake mechanism of the BCD interface.

At its birth BCD interfacing was a big success. Experiments that had required an attendant to write down readings (usually some unlucky graduate student or technician) could now be automated. Printed logs could be obtained for production testing. The tedious job of recording data was greatly simplified. If a printer could do all that, just think what could be done by substituting a computer for the printer! The system would not only log information but also analyze it, process it, and take

# Powerful CP/M Software.

For Apple, Osborne, TRS-80, North Star, SuperBrain, Micropolis, Vector and others.



## NEVADA COBOL

**\$199.95** For all CP/M or MP/M based computer systems with 32K RAM and one disk drive.

When we introduced Nevada COBOL three years ago, it was loaded with innovations. Today's Edition 2 is even better! For example:

- Compare speed. It's 4 to 20 times faster than any other micro COBOL according to an independent study.\* What's more, it's easier to use.
- Compare documentation. You get a 153-page manual with lots of examples and 16 complete COBOL source code programs.
- Compare memory requirements. Extremely compact. You can compile and execute 2500 statements in 32K RAM, 4000 statements in 48K, etc.
- Compare features. It's based upon the ANSI-74 standards with level 2 features such as compound conditionals and full CALL CANCEL.
- Compare royalties. You can distribute your object programs royalty FREE!
- Compare support. If you have a technical question, you talk directly to the author.

## NEVADA PILOT

by John Starkweather.

**\$149.95** For all CP/M based computer systems with 32K RAM, 1 disk drive and CRT or video display and keyboard.

- It's so easy to use, you'll be writing interactive applications within the first hour.
- Perfect for industrial training, office training, drill and testing, virtually all programmed instruction, word puzzle games, and data entry facilitated by prompts.
- What's more, John Starkweather, Ph.D., the inventor of the PILOT language, has added many new features to Nevada PILOT. There are commands to drive optional equipment such as Video Tape Recorders and Voice Response Units. There's a built-in full screen text editor and much more.
- Meets all PILOT-73 standards for full compatibility with older versions.
- You get a diskette, 146-page manual and ten useful sample programs.

\*"A Compiler Benchmark: A Comparative Analysis of Four COBOL Compilers" by Stephen F. Wheeler. CP/M and MP/M are registered trademarks of Digital Research, Inc. TRS-80 is a registered trademark of Tandy Corp.  
© 1982. Ellis Computing.

## NEVADA EDIT

**\$119.95.** For all CP/M based systems with 32K RAM, 1 disk drive and CRT or video display and keyboard.

- A character-oriented full-screen video display text editor designed specifically to create COBOL, BASIC, PASCAL and FORTRAN programs.
- Completely customizable tab stops, default file type, keyboard layout and CRT by menu selection.
- The diskette comes with an easy-to-read manual.

**Order now!**  
**(415) 751-1522**

We welcome COD's



Ellis Computing  
600 41st Avenue, Dept. B  
San Francisco, CA 94121 U.S.A.

  
**ELLIS COMPUTING**  
SOFTWARE TECHNOLOGY





Figure 12: The BCD message format is a floating-point number in scientific notation followed by a comma, an overflow character, a function code, and a linefeed terminator. The floating-point number is represented by a sign, a mantissa, an "E" which indicates that an exponent follows, an exponent sign, and an exponent. Unused BCD digit inputs may be grounded; they will then be transmitted to the computer as 0s.

appropriate action. The eyes and ears of a computerized process control loop were about to come into being.

### A Real BCD Interface

Let's look at an actual BCD interface. My example will be the Hewlett-Packard 98033A BCD interface designed for the 9800 series of desktop computers (see figure 11).

The 98033A has several inputs that connect to the BCD instrument. Enough signal wires are included for an 8-digit mantissa with a sign bit and a 1-digit exponent, also with a sign bit. If this terminology is unfamiliar, think of a number, say, 1,427,327. That is how *you* might write it. In scientific notation, that number is:

$$1.427327 \times 10^6$$

The 1.427327 is called the mantissa and represents the *significant figures* of the number. The 6 is the exponent and represents the power of 10 by which the mantissa is multiplied to get the value of the number.

In addition to the mantissa and exponent inputs, the 98033A has an overload input bit and inputs for a

4-bit function code. Unlike the odometer, most instruments don't roll the display back to 0 when a counter reaches maximum count plus 1. Instead, they indicate an overflow, informing the operator that the input is too big to measure. The function-code bits are useful for instruments that can measure more than one range or quantity.

When the computer takes a reading, the interface scans each digit and converts the BCD values into ASCII characters. The ASCII characters are sent to the computer serially. A reading is composed of 16 characters. As shown in figure 12, 8 digits are available for the mantissa and 1 for the exponent; this format is usually sufficient to interface a BCD instrument. If the instrument has fewer digits to send, unused inputs may be grounded to read 0s.

### Interfacing Flexibility

Because no standard for BCD interfacing yet exists, the 98033A offers flexibility in the interpretation of signal wires. It can be configured to either positive- or negative-true signal

levels. Input-signal voltages are constrained to be TTL-compatible, meaning that the low level is between 0 and 0.7 volts (V) and the high level is between 2 and 5.5 V. This signal level comes from the TTL logic circuit family, which has dominated digital designs since the late 1960s.

The tenth, thirteenth, and sixteenth characters of the ASCII string of characters sent by the interface are generated within the interface itself. They aid the computer in deciphering the meaning of the digits coming from the instrument. Character 10 is always an "E," which is shorthand for *exponent*. The "E" separates the mantissa from the exponent. The thirteenth character is a comma and separates the exponent from the function code. The sixteenth and last character, the linefeed or <LF>, is a message terminator, informing the computer that transmission of the reading is complete.

Intelligence in the 98033A replaces any that might otherwise have to reside in the instrument. The 98033A provides a data path between today's computers and earlier interfacing instruments. Furthermore, the 98033A eases the burden for today's designers who cannot justify the development and manufacturing costs required to include a more complex interface in a new instrument.

### The Unstandard Interface: Serial I/O

The first electronic digital computers appeared in the 1940s, and serious work in computer data com-

## CP/M USERS LOOK OUT: S/S-PASCAL IS FASTER

	Execute (seconds)	Total Size (bytes)
--	----------------------	-----------------------

S/S-PASCAL	12.5	1117
PL/I 80 *	14.0	5977
PASCAL MT + *	19.0	3043
PASCAL/Z *	109	3328

Re: BYTE, September 1981, page 180  
A high level language Benchmark

\* CP/M, PL/I 80 TM of Digital Research  
PASCAL MT+ TM of MT Microsystems  
PASCAL/Z TM of Ithaca Intersystems

### AND REQUIRES ONLY 32K OF MEMORY

#### S/S-PASCAL Version 3.0 for 8080/8085/Z80

Write to get the whole story, or better send \$30.00 for  
— Demo discette with compiler (READ statement not included)  
and sample programs  
— Tutorial manual (over 100 pages)

**DON'T TAKE OUR WORD FOR IT, compile your own programs and test them before buying full compiler**

S/S-PASCAL Version 3.0: \$295 - Demo discette: \$30

P. O. Box 197  
Armdale, N.S.  
Canada B3L 4J9

**SCOTIA SOFTWARE** (902)  
425-3879

#### Standard PASCAL features plus

- Generates optimized native code
- Compiles directly into .com file
- External assembler subroutines
- Random access files
- 14 digit BCD floating point reals
- Chaining and overlays
- Dynamic strings
- Powerful string manipulation
- Direct access to memory
- Address and size functions
- NEW, DISPOSE, MARK, RELEASE
- and more . . .

"We answer all inquiries  
the same day"

Dealer inquiries welcome.

# .001 Second From Wallstreet

Now, a terminal in western Kansas is no more than a micro-second from the data of Wall Street or the Commodities Exchange.

Now, an advanced data communications system allows your CP/M<sup>®</sup> based computer system to access almost any dial-up computer, capture and store the received data, and transfer files between any two CP/M<sup>®</sup> systems — even when disk formats are incompatible.

What would you call a system like this?

## CROSSTALK<sup>™</sup>

What Crosstalk can do for you depends mostly on what you need done. It acts as a "smart terminal," automatically dialing any dial-up system. It allows you total modem control, changing modem speed, data word format and duplex instantly. It captures on-line data for analysis off-line, saving time and money. It transfers any type of file with complete error checking.

When you equip more than one office with Crosstalk, you can exchange information instantly by phone, even if you don't subscribe to an information utilities service.

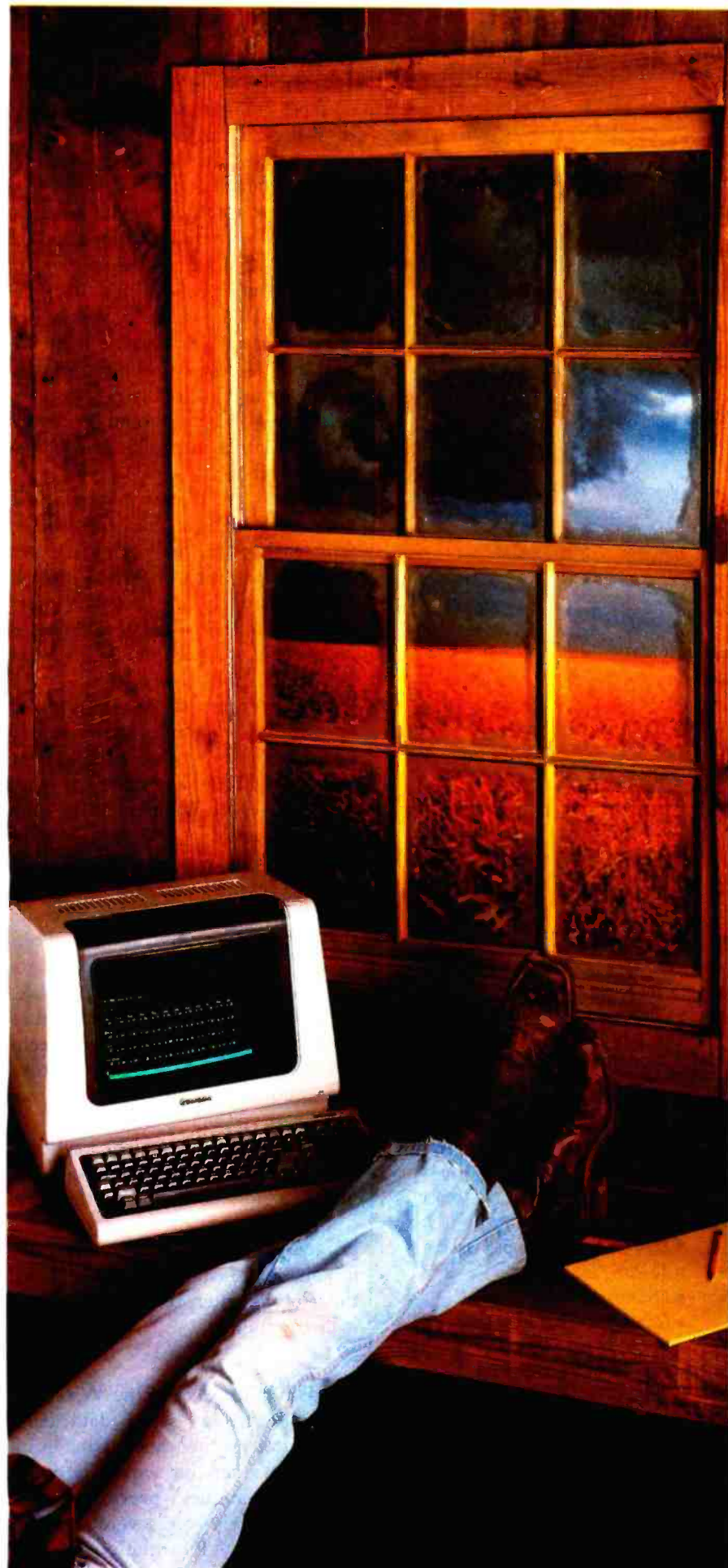
So no matter where your office is located, Crosstalk can give you access to the world, instantly. Call or write for details.



**Microstuf, Inc.**  
1900 Leland Dr., Suite 12  
Marietta, GA 30067  
(404)952-0267

DEALER INQUIRES WELCOME

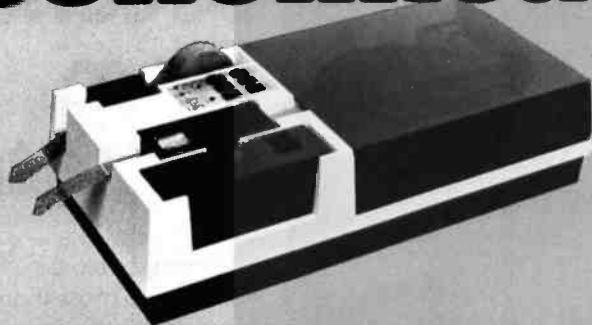
CROSSTALK is a trademark of Microstuf, Inc.  
CP/M is a registered trademark of Digital Research Inc.



Circle 282 on inquiry card.



# Economical



## Designed to economize space and dollars — GNT's 4601 Tape Punch/Reader Combination

Tape reader and punch, housed in the same compact case, operate simultaneously and/or independently. For design, price, and performance, the 4601 tops the competition.

- Size: 19" x 10" x 5" — 14 pounds
- Punching speed: 75 Cps
- Reading speed: up to 150 Cps
- RS-232-C serial interface
- CR/LF delay
- Reliability: MTBF 100 million characters
- Search/edit control
- Utilizes all types of Mylar® and paper tape
- Contact your local dealer or call for complete specifications.

Serviced nationally by **Carterfone**

# GNT AUTOMATIC INC.

1560 Trapelo Road, Waltham, MA 02154 (617) 890-3305 Telex: 923318

# A Smaller Alternative.

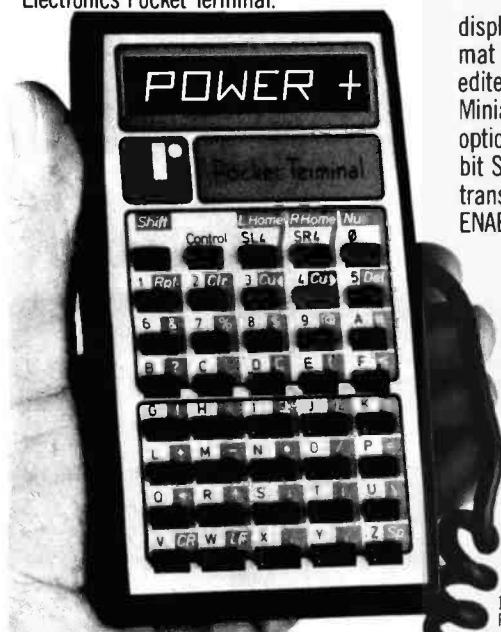
Need a quick, easy way to talk to a computer? Here's a hand-held, fully portable computer terminal that gives instant access to any ASCII transmitting data system with an RS232 interface. It's the revolutionary G.R. Electronics Pocket Terminal.

The silent, solid-state terminal has a 40-key, positive click-response keyboard. From its 32-character internal memory it displays eight bright 16-segment LED characters through a one-line window.

You may select from two alternate display modes. Entries may be in any format required, and all memory data can be edited as desired.

Miniature switches allow selection of these options • Single or dual stop bits • Parity bit SET/RESET/EVEN/ODD • 300/110 baud transmission rates • Control code response ENABLE/DISABLE.

- Compact, Lightweight, Fully Portable
- 40 Multi-Function Keys
- 32-Character Memory
- Format-Controllable Input & Output
- Memory/Display Editing
- Large Eight-Char. LED Display Readable from 6 ft. Distance
- Full 128-Char. ASCII Transmit/Receive
- Two Selectable Transmission Rates



## G.R. Electronics

1640 Fifth Street, Santa Monica, CA 90401  
Phone: (213) 395-4774 • Telex: 652337 (BT Smedley SNM)

munications didn't start until the next decade. When engineers began to connect computers to other devices, they drew upon serial I/O, a technology that had originated in the previous century.

The first electrical device used extensively for communications was the telegraph. Samuel Morse learned of André Ampère's idea for the telegraph in 1832. Morse improved the telegraph mechanically, but more important, he devised the Morse code. This was the first really practical encoding of human communications symbols into a form that is machine-transmittable.

Symbols are represented in Morse code by a series of dots and dashes, with each character having its own unique representation. The dots and dashes may be considered the predecessors of the 1s and 0s of the character codes we use in computer data communications today.

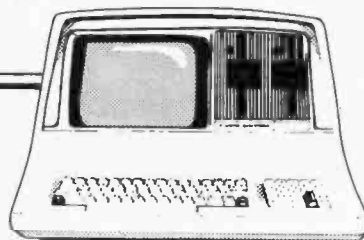
Improvements in the telegraph led to printing telegraphs that required no human operator to decipher the codes. New codes and more advanced machines evolved, culminating with the teletypewriter. By the time the teletypewriter was introduced, dots and dashes had become 1s and 0s. The Morse code gave way to codes that assigned the same number of bits to each character, making messages much easier for a machine to decode.

By the time the electronic computer came into being, a wealth of technology already existed for electronic data communications. Teletypewriters served as I/O devices between people and computers. The keyboard and printer of the teletypewriter provided a low-cost data entry and display mechanism. As technology progressed, cathode-ray tube terminals and faster printers replaced the teletypewriter, but the serial interfacing remained.

### Transmitting Over One Wire

The basis for serial data communications is the transmission of information over one wire. The interfacing techniques previously discussed all rely on several parallel wires to carry information between

From CMC International, world's largest Intertec distributor...



# **SUPERBRAIN and COMPUSTAR - YOUR CUSTOMERS WILL NEVER NEED ANOTHER SYSTEM!**

CMC International is the largest distributor in the world of Intertec Data Systems products -the SuperBrain and CompuStar - Intertec's incredibly expandable microcomputers. No matter how small or large your customers are or become, we doubt that they'll ever outgrow these computers. Both SuperBrain and CompuStar offer the industry-standard CP/M disk operating system and 64K of dynamic RAM. Both are expandable to 10 megabytes of storage with the CompuStar disk storage system. CompuStars can be linked together to form a 255-user network.

Dealers benefit from the service and support offered through CMC. Like advertising co-op, software and hardware support, module replacement. And a toll-free line so you can call from anywhere in the continental United States.

The bottom line is profitability. Our dealers benefit with a combination of quality Intertec products and CMC International's pricing.

Contact us today. We deliver.



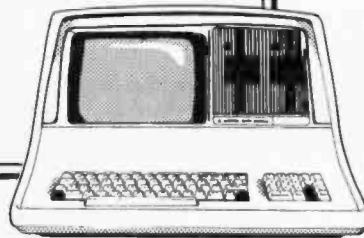
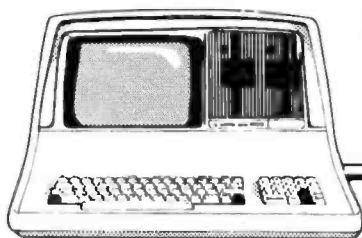
For Information Call (206)453-9777  
To Order, Call Toll-free 1-800-426-2963

## **CMC** INTERNATIONAL

A Division of Computer Marketing Corporation

11058 Main Street, Suite 220  
Bellevue, Washington 98004

**TELEX 152556 SEATAC**



SuperBrain and CompuStar are registered trademarks  
of Intertec Data Systems Corporation  
CP/M is a registered trademark of Digital Research





**GUARANTEED LOWEST PRICES!**  
To celebrate our opening, we are matching any advertised price. Just show us the ad.

**ORDER TOLL FREE - Outside WI**  
**1-800-826-1589**

**ACCESSORIES**

Apple II Dual Thermometer w/ software	260.
Mountain Expansion Chassis	625.
CPS Multifunction	199.
Mountain Music System	395.
100,000 Day Clock	375.
Mountain Clock	252.
Supertalker SD 2000	199.
A/D + D/A	299.
CCS 12K ROM/PROM Board	99.
CCS A/D Converter Board	139.
CCS Serial Asynch. Board	99.
CCS Calendar/Clock Board	375.
VOTRAX Type-n-Talk	495.
ADALAB Package	49.
DOS Dater	125.
ABT Numeric Keypad	150.
ABT Softkey	195.
ABT Barward	295.
ABT Cash Box	75.
ABT Pascal Tools I or II	249.
Scitronic Remote Controller	349.
Scitronic Energy Watcher 1 Ph.	69.
Apple Speed Controller	595.
Applescope (your Apple as an Oscilloscope)	49.
Scope Driver	319.
Videx Videoterm	149.
Videx Enhancer II	115.
K & D Enhancer	29.
Videx Character Sets	225.
Echo Speech Synthesizer	39.
Upper/Lower Character	59.
Joysticks 4	379.
ALS Smarterm	269.
ALS Z-Card	195.
SSM A10 s/p interface + cable	795.
Scott Instrument VET (2)	195.
ALF Music Card MC1	245.
ALF Music Card MC16	16.
ALF Game I/O	18.
ALF Timing Mode I/O	49.
ALF Ear Training	14.
ALF Albums	495.
Microspeed II	

**... AND MANY MORE!**

Quoted prices valid for stock on hand and subject to change without prior notice.

Call for price information:

**Printers** • Epson, Okidata.

**Monitors** • Amdek, Sanyo, NEC.

**Modems** • Novation, Hayes.

**Disk Drives** • Micro Sci, Corvus.

Ask for our **FREE** catalog.

For **Software**

see our other ad, page 447

- Please:
- Wisconsin residents - add 4% sales tax
  - Add \$2.50 for shipping per software and small item. Call regarding others.

- We Welcome:
- Visa, Mastercard - (Add 4%)
  - Checks (Allow 1-2 weeks for clearing)
  - COD (Add \$1.50 per shipment)

**TOLL FREE - Outside Wisconsin**  
**1-800-826-1589**

For Technical Info & in Wisconsin:

**715-848-2322**

**Oryx Software**

205 Scott St., Dept. BB  
P.O. Box 1961 • Wausau, WI 54401

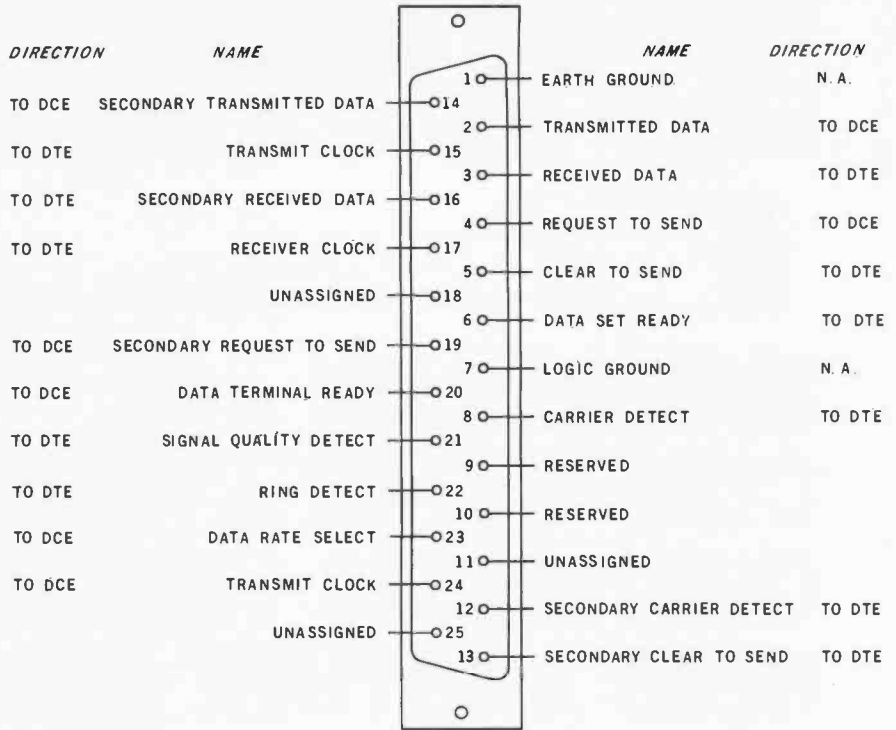


Figure 13: The RS-232 connector. The most abused connector in interfacing, this 25-pin subminiature D connector is used by most manufacturers for RS-232C interfacing. The terminal is supposed to use the male version of the connector, and the modem is to use the female version. Some devices use only pins 2, 3, and 7, while other devices use more pins. The reserved and unassigned pins have been used for anything from handshake signals to current-loop signal pins to power-supply pins. The RS-232C standard endorses none of these uses. The "Basic 8" pins are 1 through 7 and 20. If you manage to get these 8 pins connected correctly, the interface will probably work. Beware the phrase "standard RS-232C." The only standard is that advertising phrase.

devices; each wire carries a single bit of a character that is composed of multiple bits. When long distances separate a computer and its peripheral, the cost of running several wires in parallel becomes prohibitive. Serial interfacing provides a much less expensive solution.

Computer timesharing was born when computers became sufficiently powerful to handle several tasks simultaneously. Because computers were still very expensive, it was desirable to spread their cost over many users. But how were users at several locations to be connected to the central computing facility? Stringing wires to each location was too costly. Fortunately, the telephone system already had a suitable network of communications links.

However, these links were not limited to wires. Satellite and land-based microwave links also made up part of the phone system. Further-

more, all of these links were designed to carry voice, not computer data, and the phone companies winced at the prospect of finding all kinds of strange signals in their networks. Because teletypewriters did not have standardized interfacing requirements, the voltages involved could range from 6 to 140 V. A standard was required.

**The RS-232C Standard**

The Electronic Industries Association (EIA) standard RS-232C was specifically designed to do one thing: to define the electrical characteristics for an interface between a piece of data terminal equipment (DTE) and a piece of data communications equipment (DCE). The DTE is the terminal for the timeshare user, while the DCE is a modulator-demodulator (modem) that encodes computer data into voice-like signals that are permissible on the phone system.

# If you don't know a baud from a floppy ... **YOU NEED TO KNOW THE QDP-100 MICROCOMPUTER**

Most people who need computers don't have the time, or desire, to become full-time computer "wizards."

With the budget-priced QDP-100 you get all the time-saving precision information you want from a computer, now and in the future, without all the unnecessary complexity associated with less considerate computers.

QDP-100 IS A FULL-SCALE 8-bit computer, readily upgradeable to 16 bits as your business or professional information-processing needs grow. It uses the IEEE S-100 bus, compatible with CP/M and MP/M disk operating systems.

QDP-100 HANDLES BOTH floppy disks and hard disks to give you total software versatility.

QDP-100 CONNECTS INSTANTLY to any standard terminal and printer. Both serial and parallel ports are available. Features most microcomputers can't match.

## It does more, does it easier, and costs a lot less.

QDP-100 HAS SINGLE BOARD SIMPLICITY. Eliminates the hassle of complex multi-chip, multi-board computers.

QDP-100 IS EASY to learn and to operate. Most owners use their QDP-100 with professional skill and results in short order. Our instruction manual doesn't need an interpreter.

If you'd rather be a wizard with computer results, than with computers, choose the QDP-100. Call or write for literature and full details.

QDP NEEDS A FEW MORE GOOD DEALERS. Attractive, profitable, protected dealerships are still available in several high-potential computer market areas.



## Quasar Data Products

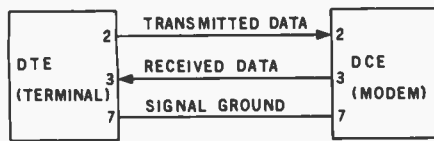
10330 Brecksville Road  
Cleveland, Ohio 44141  
216/526-0838 Telex: 241596

CP/M and MP/M  
are registered trademarks  
of Digital Research Corp.



Circle 352 on inquiry card.





**Figure 14:** A minimal RS-232C link. A minimum of three wires is required to connect two RS-232C-compatible devices for bidirectional communication. Note that the DTE (data terminal equipment) transmits on pin 2 (transmitted data) and receives on pin 3 (received data). The DCE (data communications equipment) transmits on pin 3 and receives on pin 2. The signal names are from the DTE's perspective. Two DTEs or DCEs may communicate by cross-wiring pins 2 and 3. Some people think that is the normal way of connecting RS-232C devices, which shows how "standard" the standard is. Pin 7, the signal ground, is a return path for the signal current, and pin 1 is the earth ground. It's usually a good idea to connect the earth grounds between devices.

Figure 13 depicts the connector used with the RS-232C standard. Note that more than one wire is involved at this interface. Pins 2 and 3, the data-carrying wires, are called *transmitted* and *received data*. Pin 7 is a signal ground and serves as a current return path between the DCE and the DTE. These three wires are sufficient for bidirectional communications between the DCE and the DTE.

What are the other wires for, then? They serve as control wires between the DCE and the DTE and are there to establish and maintain a communication link with the computer. Let's ignore those other wires for now and examine the data lines more closely.

Common sense would tell you that the RS-232C standard allows data to be sent out on the transmitted-data line and received on the received-data line. Right? Wrong! Which device transmits on the transmitted data line, the DTE or the DCE? Both cannot transmit on pin 2 and receive on pin 3. If the DTE transmits on a wire, the DCE must have a receiver on that same wire, or there is no communication.

Note the difference between serial I/O and IEEE-488 (HPIB). The IEEE-488 standard specifies bidirectional data lines. RS-232C was developed earlier, and bidirectionality wasn't possible with the technology of the day. With just two data lines, it wasn't required either.

Which piece of equipment *does* transmit on the transmitted-data line? *All signal names in the RS-232C standard are from the perspective of the*

DTE. Thus, the DTE transmits on pin 2 and receives on pin 3. The DCE transmits on pin 3 and receives on pin 2. Figure 14 should clear up any confusion about this.

Now to become confused again. Suppose you're going to connect a computer to a printer through the "standard RS-232C" port. Which device is a DTE, and which is a DCE? More specifically, which is going to transmit on pin 2 of the RS-232C connector, and which will transmit on pin 3? Neither the computer nor the printer is a terminal or a modem.

Manufacturers of these devices may offer cables which allow their equipment to look like either a DTE or a DCE. More often, however, the RS-232C connector is bolted to the back of the device, and no choice is possible. The manufacturer has had to make an arbitrary decision, one that will be wrong 50 percent of the time.

In the case of two devices of the same type, DTE or DCE, a *haywire* cable will have to be assembled to get signals onto the correct wires. Usually, this task falls to the user.

We have just jumped the first hurdle in connecting RS-232C equipment: physical plug-to-plug incompatibility. Many more potential problems are related to the data signal itself.

First, signal levels differ from those of the other interfaces discussed. RS-232C does not use TTL signals because TTL didn't exist when the standard was written. A positive voltage between 5 and 25 V is used to represent a logic 0 level on the RS-

232C data lines. A negative voltage between  $-5$  and  $-25$  V represents a logic 1 level.

These levels are true only for the data lines on pins 2 and 3; they are negative-true. All other signals in RS-232C are positive-true; therefore, a positive voltage represents a logic 1, and a negative voltage represents a logic 0. The same voltage levels are used; they just represent different logic levels.

Because the bits of a character are separated by time, a waveform is produced on the data line when a character is transmitted. Such a waveform for the transmission of the ASCII character "E" is shown in figure 15. The ASCII code for "E" is 1000101 in binary, and its least significant bit is transmitted first. The data line idles in the logic 1 state, and the waveform of figure 15 is read from left to right.

### Waiting for Start

For asynchronous serial data communications, a start bit is always sent first to mark the beginning of the character. (Synchronous data communications is different and won't be discussed here.) Following the start bit are the data bits in the character, sent in order from least to most significant. Each bit is held on the data line for a precisely controlled length of time called a *bit time*.

The receiver, which is alerted to the incoming character by the start bit, times the incoming signal and samples each bit as near to the center of each bit time as possible. Naturally, the transmitter and the receiver must agree on the length of time a bit will be held on the data line or the transmission will be garbled by samples made at incorrect times.

Bit time determines the maximum rate at which characters may be transmitted and thus defines the *bit rate* at which the RS-232C interface runs. Standard bit rates are 50, 75, 110, 134.5, 150, 300, 600, 1200, 2400, 3600, 4800, and 9600 bits per second (bps).

### Parity and Stop Bits

Following the data bits may be a *parity bit*, which is used for error

# MONITOR COMPATIBILITY. IT MAKES YOUR CHOICE CLEAR

All Electrohome Micro Computer Monitors feature the extra degree of engineering excellence you've come to expect from all Electrohome Electronic products.

Our ECM 1302 series 13" RGB analog color Data Monitors offer the latest in advanced electronic technology and design innovation. Both the medium resolution RGB ECM 1302-1 and high resolution RGB ECM 1302-2 Monitors feature:

- 2000 character (80 x 25) display
- 16 rich, vibrant colors

- compatibility with the IBM PERSONAL COMPUTER as well as many other micros
- optional NTSC to RGB interface

Our new EDM V26 Monochrome data display monitors are available with 9" or 12" screen sizes, white or green phosphor and feature:

- 18 MHZ bandwidth
- 2000 character (80 x 25) display
- 110/220 volts 50/60 Hz
- video loopthrough
- reduced scan adjustable

All Electrohome monitors are backed by a nationwide distribution and service network, feature a full one-year warranty, and are C.S.A. and U.L. approved. F.C.C. approval pending.

Whatever your system, make the clear choice. Electrohome Video Monitors deliver the performance you want at a price that's compatible with your budget.



# ELECTROHOME ELECTRONICS

ELECTROHOME LIMITED, 809 WELLINGTON STREET NORTH, KITCHENER, ONTARIO N2G 4J6

## Electrohome Distributors

Consumer Computer Mktg. Inc., Sudbury, Mass (617) 443-5128  
Components Unlimited Inc., Lynchburg, VA (804) 237-6286  
EMES Systems Ltd., New York, NY (800) 223-1799  
Anderson Associates, Bountiful, Utah (801) 292-8991

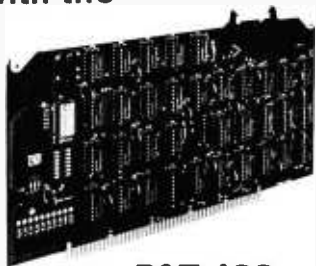
Anthem Systems Company, Burlingame, CA (415) 342-9182  
Microsystems Distributors Inc., Dallas, Texas (214) 669-9370  
Computerland, San Leandro, CA (800) 772-3545 (Ext. 118)  
Outside California (800) 227-1617 (Ext. 118)  
Listec (West) Inc., Glendale, California (213) 247-9247



# INTEGRATED BUSSING



with the



**P&T-488  
INTERFACE**



Inexpensive S-100 computers can now communicate with the IEEE-488 instrumentation bus. The P&T-488 meets the IEEE-488 1980 standard for **controller, listener, & talker.**

Interface **software** allows simple communication with the 488 bus from Basic, Pascal and other high level languages. Interface software is available for CP/M®, North Star, or Cromemco.

Special features include an interactive **busmonitor** program and a functional self-test program.

Price for (1) P&T-488 with software and 18" cable, assembled and tested: \$450 (domestic price) FOB Goleta, CA.



**PICKLES & TROUT**

P.O. BOX 1206, GOLETA, CA 93116  
(805) 685-4641

\*CP/M is a registered trademark of Digital Research

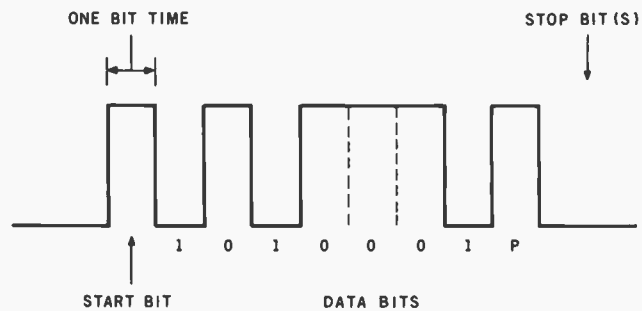


Figure 15: The serial waveform. Serial information uses time to separate the bits of a message. This figure shows a 7-bit character being transmitted serially. A start bit goes first to signal the receiver that a character is coming. The start bit is always a 0 and is followed by the 7 data bits, transmitted from the least significant to most significant bit. The character shown being sent is 1000101, which is the ASCII code for "E". The data bits are followed by an optional parity bit for error checking, then 1 or 2 stop bits which are always 0. The stop bits serve to separate the characters and to give the receiver time to finish assembling a character before the next one starts coming in.

detection. A noise pulse could affect the data line at the wrong time, causing a bit in the transmission to be misread. If the transmitter keeps track of the number of 1s in the character being transmitted, it can set the parity bit so that the total number of 1s is always even (for even parity) or odd (for odd parity). The receiver can also keep track of and use the parity bit to determine whether the transmission was received in error. Parity is useful for detecting single-bit errors. If more bits are affected, parity might not detect the error.

The last bits to be transmitted are the *stop bits*. These are not really bits but stop times to allow the receiver time to assemble the serial bits just received, send the assembled character on, and prepare for the next character. There may be 1, 1.5, or 2 bit times allowed for stop bits. Since this is a rest period, "fractional bits" are allowed.

### Picking Up the Pieces

Now, given the format of the data transmission, what could possibly go wrong? First, the transmitter and receiver must agree on several parameters. The bit rate has been mentioned already. In addition, the parity (odd, even, or none) and the number of stop bits must be set the same in both transmitter and receiver.

Character codes must also be con-

sidered (more on these next month). Our example uses the ASCII character set with 7 bits per character. ASCII is the most popular code in use today, but 5-bit codes (Baudot and Murray), 6-bit codes (IBM Correspondence Code), and 8-bit codes (IBM EBCDIC) also exist. The RS-232C standard does not restrict the number of bits per character.

After connecting the computer and printer so that they use the proper wires and agree on bit rate, parity, number of stop bits, and character code, you may feel that this interface is licked. Not so.

Suppose the printer is set up for ASCII 7-bit characters, odd parity, and 1 stop bit. In addition, the bit rate is set to 9600 bps. Well, that's fine. I've set the bit rate to the fastest rate so that the equipment doesn't waste a lot of time sending characters and the printer will be used at its maximum speed. Assume that the computer side of the interface has been set compatibly.

Now I'll write a program on the computer to send one line of text to the printer to be printed, being careful to put lots of comments in the program so I can remember what I did. The program works! I then list the program on the printer to have a record of my triumph. Unfortunately, several characters seem to have been lost in the transmission. I try again with equally dismal results. Running the program meets again

# TAKE A TEST DRIVE.



With a reliable  
**TRAXX™ 100/200/300**  
 series add-on  
 drive system.

Systems available for Altos, 'Apple,™ Atari,™ Heath,™ North Star,™ S-100, ²TRS-80  
 (Models 1, 11, 111, Color), Zenith.

**EAST**

**CMD Performance**  
 Windsor, Ct. .... (203) 688-3862  
**Digital Data Communications, Inc.**  
 Richmond, Me. .... (207) 737-4447

**MIDWEST**

**Cottage Software**  
 Wichita, Ks. .... (316) 683-4811  
**Web Products, Inc. Software Division**  
 Carol Stream, Il. .... (312) 653-5229

**Meta Technologies**  
 1-800-321-3552

**Insync Systems Corp.**  
 Alvin, Tx. .... (713) 331-2024  
**Central Kansas Computers**  
 Herrington, Ks. .... (913) 258-2575  
**Dataflow Systems**  
 Indianapolis, In. .... (317) 888-3640

**WEST**

**Everett Computer Center**  
 Everett, Wa. .... (206) 259-0024  
**Connection 80**  
 Vancouver, Wa. .... (206) 573-0319  
**H & S Microsystems**  
 Burnaby, BC Canada. .... (604) 430-4145

**TRAXX**  
 COMPUTER CORPORATION

Dealer Inquiries — 1-800-621-3102, (312) 987-1024



¹ Apple is a registered trademark of Apple Computer Int.  
 ² TRS-80 is a registered trademark of Radio Shack, a Tandy Company



# INTELLIGENT PRINTER INTERFACE

Free Your Computer from the  
Mundane Task of Printing



Imagine being able to use your computer seconds after beginning an extensive printout.

Visualize your printout with page breaks, page numbering and titles, margins of your choice, indented carryover lines, on any size paper!

Appreciate the time and money you will save by not waiting for your printer.

SooperSpooler, a buffered printer interface, maintains control over your printer while you go on using your computer for more productive activities. Eliminate waiting while your printer pecks through a long document. SooperSpooler accepts information from your computer at up to 3000 characters per second and feeds it to your printer as fast as it can handle it—without using any of your computer's memory or time!

#### SooperSpooler features include:

- 16K Memory (62K optional)
- Buffer Status Readout
- Space Compression
- Pagination
- Single Sheets
- Headers and Page Numbering
- Indentation on Carryover Lines
- Self Test Routine
- Features also Software Controllable
- Plugs into Most Computer Systems
- ★ 16K Parallel I/O Unit—\$349.00!
- ★ Serial I/O Option—\$95.00
- ★ 46K Memory Option—\$159.00

SooperSpooler by **Compulink**™ —  
The missing link that gives your  
microcomputer mainframe printing.

## COMPLINK CORPORATION

1840 Industrial Circle  
Longmont, CO 80501-(303) 651-2014

Send for brochure  
Dealer inquiries welcome  
Call for information: 800-525-6705

with success and listing again fails. What is going on?

### No Handshake Today

First, let's consider the data rate at which the computer is sending characters. ASCII uses 7 bits plus 1 for the parity bit, 1 for the stop bit, and a start bit, for a total of 10 bits per character. The computer is sending 9600 bits per second, which is equivalent to 960 characters per second.

A quick look at the printer specifications reveals the problem. The printer can print a maximum of only 175 characters per second. We are sending data to the printer five times faster than it can print! Most printers

---

**The success of a  
handshake mechanism  
in an RS-232C  
interface cannot  
be predicted without  
studying manuals for  
both of the devices  
involved.**

---

have buffers and can tolerate this mismatched data rate until the buffer fills. After that, any subsequent characters transmitted will fall on the floor! Running my program required transmitting less than a buffer full of characters. Because the buffer didn't overflow, there was no problem. Listing the program on the printer, however, required sending more characters. When the buffer overflowed, characters were lost.

Other interfaces have handshake mechanisms to prevent data transmitters from going too fast for their receivers. Surely, RS-232C also has a handshake mechanism to prevent this problem? Nope. Returning to figure 13, let's now consider the other RS-232C signals and try to find some to use as a handshake mechanism. Look in particular for two sets of handshake lines: one for the transmitted-data line and the other for the receive-data line.

Aha! Pins 4 and 5 are called *Request to Send* and *Clear to Send*.

These certainly look like prime contenders for handshake lines. Unfortunately, many printer manufacturers have also fallen into this trap. The names of the signals on pins 4 and 5 do indeed lead you to believe that they form a data-handshake mechanism. According to the strict RS-232C definition, the DTE asserts Request to Send when it has data to transmit. It then waits for the DCE to assert Clear to Send before transmitting. That's half of the traditional handshake. The problem is that the DCE is not allowed to drop Clear to Send until the DTE drops Request to Send.

### Take a Long Drink

This situation is similar to taking a drink from a garden hose with a friend controlling the spigot. It's easy to start the flow, but you'd better be prepared to take either a long drink or a short shower.

The DTE and DCE signals on pins 4 and 5 were intended as a handshake between the terminal and the modem (remember those?) to allow the terminal to request control of the communications link from the modem. They also make it possible for the modem to tell the terminal when the link has been acquired. The terminal is then allowed to assume that it will keep the link as long as it wishes. Thus, the DCE cannot arbitrarily drop Clear to Send whenever it wishes.

Request to Send and Clear to Send are indeed handshake lines. Unfortunately, the DTE and the communications link are handshaking, not the DTE and the DCE. Also, this handshake is on a message basis, not character by character. Use of pins 4 and 5 of the RS-232C connector can result in success but usually results in a spectacular failure.

Some manufacturers have ignored the strict definition of pins 4 and 5 and use them for a data handshake anyway. Others avoid the conflict by using the Data Terminal Ready or Data Set Ready lines (depending on whether they are emulating a terminal or a modem). None of these lines was intended to be used for data handshaking. Use of any RS-232C line for handshaking does not

# Move Up to Tarbell



## *The Serious Business Machine*

Do you have a small computer system that operates with mini-floppies and has limited storage capacity? Then it's time to move up to the Tarbell Empire Series System. Tarbell starts where small systems leave off, providing storage from 1 to 20 megabytes. This means Tarbell is capable of growing right along with your business. (It also makes sense to start with Tarbell if you're a first-time computer buyer.)

Tarbell is the serious general purpose business machine, backed by years of experience with disk systems. It gives you word processing, inventory control with bill of materials, mailing lists — all in addition to accounting applications: general ledger, payables, receivables, payroll with cost accounting and order entry. Whatever your need may be, Tarbell can provide the working software that gets the job done.

With the Tarbell System you get a Z80 4 Mhz CPU with memory management, timer and full interrupt capability, 2 RS-232 serial ports with handshaking, 64 K bytes of random-access memory, double density floppy disk interface, 2 double density floppy disk drives, cabinet, power supply, and cables.

The software includes: CP/M™ 2.2 disk operating system, Tarbell Disk BASIC, Tarbell Database System, and all manuals and documentation.

Tarbell also offers the MP/M™ Multi-User Operating System and 4 additional RS-232 serial ports.

The Tarbell Empire Series is delivered assembled, tested, and with a FULL six-month warranty on parts and labor.

And when you need even more mass storage, Tarbell also has a hard disk that's system-compatible and provides easy back-up.

If your business is growing or you need more than a few hundred K bytes — it's time to move up to Tarbell. Call your local Tarbell dealer for competitive prices.

*Tarbell*  
Electronics

*The One-Stop Shopping Service*

950 Dovlen Place, Suite B  
Carson, CA 90746  
(213) 538-4251

CP/M and MP/M are trademarks of Digital Research



guarantee recognition of the handshake by the device at the other end of the cable.

Consider other possibilities of using Clear to Send as a handshake line. If a device drops Clear to Send in the middle of a character transmission, what does that mean? If the transmitter stops immediately, in the middle of the character, that character is sure to be garbled because timing is important in serial communications. If the transmitter waits until that character transmission is complete and then stops, there may be no room in the receiver's buffer for that last character transmitted.

Because this possibility is not considered in the standard, the success of a handshake mechanism in an RS-232C interface cannot be predicted without studying manuals for both of the devices involved. Sometimes even studying the manuals doesn't help.

### Back to the Beginning

Finally, consider the device that started this discussion, the teletype-

writer. The RS-232C standard at least defines a connector pinout and signal levels. No such standards exist for teletypewriters. The serial transmission format is the same, with start

uses presence or absence of current. Presence may be either 20 or 60 milliamperes, depending on the teletypewriter model. No standard connector or standard pinouts exist for current-loop operation.

Despite all these problems, designers of serial interfaces for computers strive to include current-loop capabilities in their interface designs. Where RS-232C is limited to a 50-foot cable (an often-violated part of the standard), current loop can be run much farther. In addition, the current-loop interface has been around for a long time, and several devices other than teletypewriters use this interface. Finally, teletypewriters remain a cost-effective solution as a combination printer and terminal.

## The RS-232C standard defines the electrical characteristics for an interface between a piece of data terminal equipment (DTE) and a piece of data communications equipment (DCE).

and stop bits, data bits, and parity bits.

The signal interface uses a technique called *current loop*. Instead of positive and negative voltages representing logic 1s and 0s, current loop

### Handle with Care


As you can see, serial interfacing needs to be approached more carefully than other hardware interfacing techniques. The "standard RS-232C" nomenclature persists in specification sheets even though most uses of the interface are far from standard.

As technology progresses, serial interfaces become more adept at covering an ever-widening range of hardware. Unfortunately, this still doesn't guarantee an efficient interface in every application because serial I/O remains the unstandard interface.

I've now discussed the four basic interfaces: parallel, IEEE-488, BCD, and serial. Without these interfaces, the computer systems we all know and love wouldn't be able to do much useful work.

Next month I'll examine the character codes used for data transmission. Character codes are another major source of incompatibility in computer communications. I'll discuss the problems presented by different character codes and how today's software strives to cope with incompatibilities. ■

Steve Leibson has written a booklet called "Computer Input/Output Course," published by Instruments & Control Systems, Chilton Way, Radnor, PA 19089. Price of the book is \$9.95



## I See a Byte Future

for the **NEC PC-8000 Series**  
with the **REN TEC WEDGE**

- ★ Emulates all features of the NEC PC-8012A I/O Unit
- ★ 32K RAM card included, expandable to 64K RAM = 96K of RAM
- ★ Two Atari™-type joystick ports
- ★ Attaches easily to the bottom of the PC-8000
  - ★ NEC PC-8001A S/I/O channel brought out to a DB 25 connector
  - ★ Built-in 3-voice synthesizer
  - ★ NEC PC-8012A bus structure is implemented

**The REN TEC WEDGE . . . \$595\***  
KONAN™ Hard Disk Also Available

REN TEC Peripherals for PC-8000	
32K Memory Board . . . . .	\$199
RS-232-C Interface Card . . . . .	\$179
RGB to Composite Video . . . . .	\$149
(40 column only)	
Speech Synthesizer . . . . .	\$295

---

**plus:** Olympia Letter-Quality Printer with **REN TEC ES INTERFACE**

- ★ Converts Olympia typewriter to letter-quality printer
- ★ Easy installation using existing ES100/101/105 cables
- ★ Accepts RS-232-C serial, Centronics parallel, and IEEE-488
- ★ CMOS logic for minimal drain on power supply
- ★ Selectable auto. line feed
- ★ Programmed wait possible

**\$295\***  
\*Commodore slightly higher

THE PLACE for Technical Awareness  
DEALER INQUIRIES WELCOME

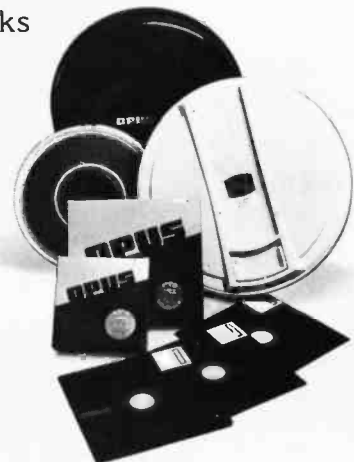
## RENAISSANCE TECHNOLOGY CORPORATION

3347 VINCENT ROAD, PLEASANT HILL, CA 94523 • (415) 930-7707

# Getting rave reviews from the boss may be the best reason to switch to Opus.



Buying products that perform well is one of the yardsticks by which your own performance is measured. So we make sure you take center stage just as soon as we get in on the act. For starters, we guarantee the performance of our products. As well as 48-hour delivery turnaround time. We back you with quality second to none in the industry. And with personal service. So call 800/321-9330 to get our entire supporting cast on the scene. Or write to Computer Resources, Inc., 4650 West 160th Street, Cleveland, OH 44135.



## OPUS<sup>®</sup>

Quality Flexible Diskettes, Single-Disk Cartridges, Multi-Level Disk Packs, and Magnetic Tape.

Circle 99 on inquiry card.

[www.americanradiohistory.com](http://www.americanradiohistory.com)



**SOFTWARE  
CP/M®  
SORCIM**

SUPERCALC ..... 209.00  
List: 295.00

**SOFTWARE  
CP/M®  
ASHTON-TATE**

dBASE II VERSION 2.3A . 529.00  
DATA BASE MANAGEMENT  
SYSTEM AVAILABLE  
IN MANY FORMATS.  
List: 700.00

**SOFTWARE  
APPLE®  
VISICORP**

VISICALC® APPLE  
DOS 3.3 ..... 190.00  
List: 250.00

**HARDWARE  
PRINTERS  
EPSON**

MX-100 ..... 729.00  
List: 995.00  
MX-80 FT with  
GRAFTRAX ..... 619.00  
List: 795.00  
MX-80 FT ..... 549.00  
List: 745.00

**THE MICROHOUSE  
"ddQ" PACKAGE: ..... 699.00**  
ASHTON-TATE's dBASE II  
FOX & GELLER's  
dUTIL and QUICKSCREEN  
List: 924.00

**FOX & GELLER**

QUICKSCREEN ..... 129.00  
List: 149.00  
dUTIL ..... 75.00  
List: 99.00

VISICALC® IBM 64K .... 158.00  
List: 200.00  
VISICALC® IBM 256K ... 190.00  
List: 250.00

MX-80 with GRAFTRAX .. 479.00  
List: 645.00  
8141 SERIAL INTERFACE. 64.00

**MICROSOFT**

BASIC 80 ..... 285.00  
BASIC COMPILER ..... 315.00  
COBOL 80 ..... 568.00  
FORTRAN 80 ..... 345.00  
muSIMP/muMATH ..... 215.00  
MACRO 80 ..... 140.00

VISIDEX ..... 190.00  
List: 250.00

VISIPILOT ..... 158.00  
List: 200.00

VISITERM ..... 79.00  
List: 100.00

VISITREND ..... 249.00  
List: 300.00

VISIFILE ..... 190.00  
List: 250.00

DESKTOP PLAN II ..... 190.00  
List: 300.00

DESKTOP PLAN III ..... 149.00  
List: 250.00

8150 SERIAL  
INTERFACE ..... 140.00  
WITH 2K BUFFER

8151 SERIAL  
INTERFACE ..... 155.00  
WITH 2K BUFFER AND  
Xon/Xoff PROTOCOL

8230 APPLE® CABLE .... 24.00  
PARALLEL

8131 APPLE®  
INTERFACE ..... 63.00  
PARALLEL

GRAPPLER INTERFACE  
AND CABLE: ..... 125.00

FOR APPLE®, MX-80  
(MUST have Graftrax), MX-80 FT,  
MX-100, IDS PAPER TIGERS  
AND C. ITOH PROWRITER

**LEXISOFT**

SPELLBINDER ..... 299.00  
List: 495.00  
SPELLCHECK ..... 225.00  
List: 295.00

VISIPACK: ..... 599.00

INCLUDES VISICALC,  
VISIFILE, & VISITREND/  
VISIPILOT.  
List: 700.00

**Microhouse™ continues to feature  
the best savings on the best software.**

**MICROPRO**

WORDSTAR ..... 293.00  
List: 495.00  
WORDSTAR FOR IBM ... 289.00  
List: 495.00  
SUPERSORT ..... 168.00  
MAILMERGE ..... 103.00  
DATASTAR ..... 235.00  
SPELLSTAR ..... 155.00  
CALCSTAR ..... 199.00

**HAYDEN**

PIE Writer ..... 124.00  
APPLE™ WORD PROCESSOR  
List: 149.95  
APPLESOFT COMPILER . 145.00

**IDS**

PRISM PRINTER 132... 1699.00  
List: 1995.00  
PRISM PRINTER 80 ..... 799.00  
List: 895.00  
PAPER TIGER 560G ... 1149.00

**MICROSOFT**

TIME MANAGER ..... 125.00  
List: 150.00  
TASC  
APPLESOFT COMPILER . 150.00  
FORTRAN 80 ..... 165.00  
COBOL 80 ..... 550.00  
A.L.D.S. .... 105.00

**OKIDATA**

MICROLINE 84 ..... 1199.00  
MICROLINE 83A ..... 749.00  
MICROLINE 82A ..... 499.00  
MICROLINE 80 ..... 365.00

**ACCESSORIES  
APPLE®**

**VIDEX**

VIDEOTERM ..... 290.00  
KEYBOARD ENHANCER. 105.00

**MOUNTAIN**

MULTI I/O ..... 178.00

**MICROSOFT**

PREMIUM SYSTEM: ..... 619.00  
INCLUDES: Z-80 SOFTCARD,  
16K RAMCARD, VIDEX  
VIDEOTERM, and CP/M USER  
GUIDE.  
List: 775.00  
Z-80 SOFTCARD ..... 299.00  
16K RAMCARD ..... 150.00

**MICROPRO**

WORDSTAR ..... 234.00  
List: 375.00  
CALCSTAR ..... 149.00

**C. ITOH**

PROWRITER PARALLEL . 499.00  
List: 845.00  
PROWRITER SERIAL .... 650.00  
List: 885.00  
F-10 PARALLEL ..... 1560.00  
F-10 SERIAL ..... CALL  
COMET I ..... 295.00  
List: 495.00

**MODEMS  
NOVATION**

APPLE® -CAT ..... 325.00  
List: 389.00  
AUTO-CAT ..... 213.00  
D-CAT ..... 156.00

**HAYES**

CHRONOGRAPH ..... 199.00  
List: 249.00  
SMARTMODEM ..... 227.00  
MICROMODEM II ..... 299.00  
APPLE®

STARWRITER I  
PARALLEL ..... 1450.00  
List: 1895.00  
STARWRITER I SERIAL . 1500.00  
List: 1960.00  
STARWRITER II  
PARALLEL ..... 1700.00  
List: 2325.00  
STARWRITER II  
SERIAL ..... 1800.00  
List: 2025.00

Circle 277 on inquiry card.

### TO ORDER:

THE MICROHOUSE ORDER CENTER IS OPEN  
9:00 AM - 8:00 PM EASTERN TIME MONDAY  
THROUGH FRIDAY.

CALL TOLL-FREE FOR ORDERS, PRICE  
QUOTES, AND AVAILABILITY:

**1-800-523-9511**

IN PENNSYLVANIA, AND FOR TECHNICAL  
SUPPORT:

**1-215-868-8219**

### MICROLINE™

MICROHOUSE OFFERS 24 HOUR COMPUTER  
SHOPPING WITH MICROLINE. MICROLINE IS  
A COMPUTERIZED ORDER-ENTRY SYSTEM,  
SIMILAR TO ACCESSING TIME-SHARING  
SYSTEMS. MICROLINE ENABLES YOU TO  
ACCESS SPECIFIC INFORMATION ON OVER  
1000 MICROCOMPUTER HARDWARE AND  
SOFTWARE PRODUCTS, IN ADDITION TO  
NUMEROUS SUPPLIES AND ACCESSORIES.

MICROLINE GIVES YOU THE OPTION OF  
ORDERING AS MUCH AS YOU WANT, AS  
OFTEN AS YOU WANT. MICROHOUSE WILL  
PROCESS YOUR ORDER WITHIN 24 HOURS.

**1-215-868-1230**

MICROLINE OPERATES AT 300 BAUD, 8 BITS,  
NO PARITY, 1 STOP BIT.

### SHIPPING:

ADD 2% TO ALL ORDERS. DIFFERENCE WILL  
BE CREDITED. OUTSIDE CONTINENTAL UNITED  
STATES ADD AN ADDITIONAL \$5.00.

ALL ITEMS SHIPPED UPS GROUND. OTHER  
SHIPPING METHODS AVAILABLE UPON  
REQUEST.

### PAYMENT

ACCEPTED PAYMENT BY PERSONAL CHECK,  
MONEY ORDER, C.O.D., MASTERCARD, OR  
VISA. PURCHASE ORDERS NEED PRIOR  
APPROVAL.

MICROLINE PAYMENTS BY PERSONAL CHECK,  
MONEY ORDER, C.O.D., MASTERCARD, OR  
VISA ONLY.

PENNSYLVANIA RESIDENTS ADD 6% SALES  
TAX.

MICROHOUSE  
1444 LINDEN STREET  
P.O. BOX 498  
BETHLEHEM, PA 18016

PRICES AND SPECIFICATION SUBJECT TO  
CHANGE WITHOUT NOTICE.

ALL ITEMS SUBJECT TO AVAILABILITY.

SUPERCALC is a trademark of SORCIM.  
VISICALC, VISIDEX, VISIPLLOT, VISITERM,  
VISITREND, DESKTOP PLAN, and VISIFILE  
are trademarks of VISICORP.

QUICKSCREEN and dUTIL are trademarks of  
FOX & GELLER ASSOC.

SOFTCARD, RAMCARD, TIME MANAGER,  
and PREMIUM SYSTEM are trademarks of  
MICROSOFT.

WORDSTAR, SUPERSORT, MAILMERGE,  
DATASTAR, SPELLSTAR, and CALCSTAR  
are trademarks of MICROPRO INTERNATIONAL.

dBASE II is a trademark of ASHTON-TATE.

SPELLBINDER and SPELLCHECK are trademarks  
of LEXISOFT.

MICROMODEM II is a trademark of HAYES  
MICROCOMPUTER PRODUCTS, INC.

PRISM is a trademark of INTEGRAL DATA  
SYSTEMS, INC.

APPLE is a registered trademark of APPLE  
COMPUTERS.

CP/M is a registered trademark of DIGITAL  
RESEARCH.

**Microhouse**  
has it. **MicroPro's**  
**WordStar** for  
**IBM: \$289**

**Microhouse**

## NEW FOR APPLE® HAYDEN PIEWRIter

Yes, that's right. Another word processing system for the Apple II. So, what makes the Hayden  
PIEWriter so different? Well, for one - the price. Secondly - you need not purchase any additional  
hardware for your computer to make it operational.

PIEWriter has the ability to do incremental spacing so that fractions of a space can be added between  
words when justifying text. This makes the distribution of the space required to fill out a justified  
line more uniform and less noticeable. In addition, with its optional proportional spacing formatter  
program, PIEWriter becomes the ONLY word processor that can print true proportionally spaced  
documents.

Versatility and compatibility are two important features of PIEWriter. While some word processors  
for the Apple II computer will only work with specific accessories, such as 80-column display  
boards, lowercase adaptors and printers, PIEWriter is versatile enough to work with almost any  
combination of these. If you have any one of these hardware accessories in your system, Hayden  
has a PIEWriter for your particular configuration.

## NEW FROM IDS PRISM PRINTER™

The Prism Printer is the first truly modular, field-upgradable dot matrix printer. Now your printer can  
be as flexible as the rest of your system.

No other printer offers you as much - or as little - as you need. Start with the basic printer which  
features text quality printing; then add the performance modules you need when you need them.  
Getting into word processing? Add the automatic cut sheet feeder. Handling lots of data? Install  
the high speed Sprint Mode. Want to get the big picture? Add the Dot Plot graphic option. And for  
communicating information and ideas faster, nothing is more effective than Prism Color for high  
quality, multi-color output.

And that's just the beginning. Additional Prism option modules will soon be available to help your  
evolving system meet its true potential.

If you are an Apple, IBM, or other professional microcomputer user, Prism Printer is the key to  
your total system solution. At last, the chemistry is right between you and your printer.

Microhouse offers both the Prism 80 and Prism 132 Printers at great savings. Please call for  
availability.

Circle 277 on inquiry card.



## Alien Typhoon

Walt Latocha  
5328 South Narragansett  
Chicago, IL 60638

In the history of arcade games, Space Invaders has been an enduring favorite, as the number and popularity of its descendants will attest. The Bally Company's coin-operated version of Space Invaders was a fantastic success, and when the initial popularity of the game started to fade, the company introduced an improved version, Deluxe Space Invaders. Later, Bally improved upon the basic motif once again to produce Galaxian—the most difficult variation on the Space Invaders theme.

Galaxian's popularity was somewhat eclipsed by the Asteroids craze; nevertheless, Galaxian, like other popular arcade games, was favored enough to be copied for the home-computer market.

One of the first of the Galaxian clones was Broderbund Software's Alien Rain. After great success with that game, Broderbund has issued a more challenging version named, appropriately, Alien Typhoon.

In Alien Typhoon, as in Space Invaders, you control a gun that appears on the bottom of the screen. You can move the gun and fire it either by keyboard input or by a paddle controller. Above the gun hangs a constantly moving swarm of up to forty-six alien spacecraft.

Alien Typhoon differs from Space Invaders in that the aliens don't march down the screen in orderly ranks; rather, the ships peel off from the main cloud and dive-bomb your gun in groups of one to ten ships at a time.

As in Space Invaders, the aliens can attack and destroy your gun with gunfire of their own, but you face an added hazard when a spacecraft uses a ramming maneuver to demolish your gun. You have only two defense options—shoot the alien craft or get out of its way when it comes swooping down.

You are initially allowed three guns per game. If you earn a total of 5000 points (scored by destroying the alien ships that, depending on their types, have various point values) you are awarded a fourth weapon.

Documentation for the game is nonexistent (the only thing that comes close is a warning on the disk's package that reads, "For Fanatics Only!! Twice as many, twice as fast, and twice as tricky!"). However, the lack of documentation doesn't handicap this easily understood game.

But there is absolutely nothing lacking in the game's graphics, which take full advantage of the Apple's resources. Beautiful color increases the excitement as the enemy craft swoop, bank, loop, and curl across the screen. In fact, the graphics are one of the major tactics that the computer uses in the game. Often a player will find himself bedazzled by the wild gyrations of one particular alien craft while another beelines in on a suicide run. The graphics alone make Alien Typhoon worth buying, and the game's sound effects are adequate and give proper emphasis to the mayhem on the screen.

As far as difficulty is concerned, I recommend that you take heed of the warning on the package. This game offers plenty of challenge—perhaps too much for some players. As a rule of thumb, if you haven't mastered Space Invaders or an equivalent game, think twice about purchasing Alien Typhoon.

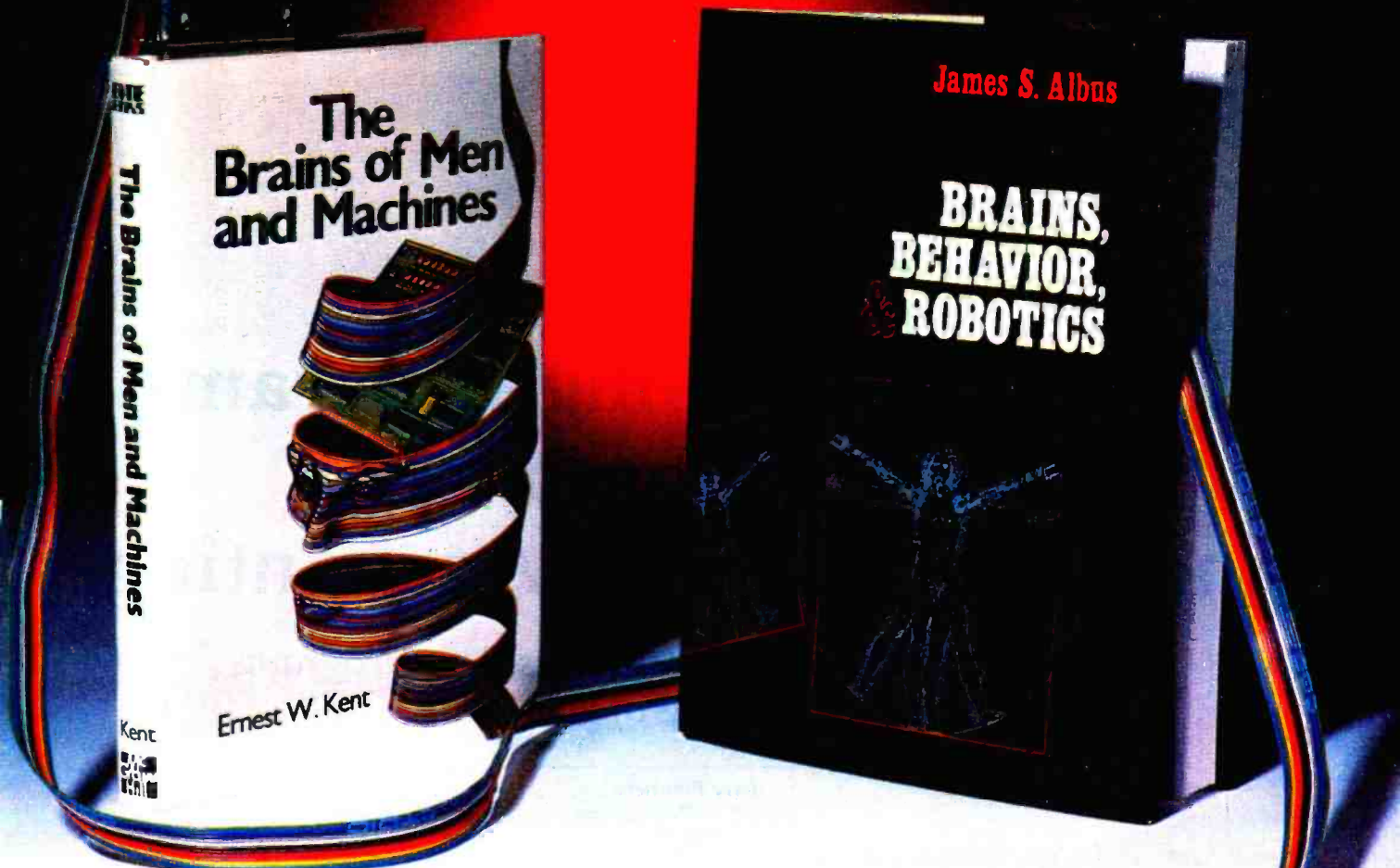
### Conclusion

Alien Typhoon is a fast-action, sophisticated, arcade-type game with exceptional color graphics. The game requires great skill (more, in fact, than Galaxian, the original coin-operated game on which it is based), but if you have the required aptitude, the game should hold your interest for hours. ■

### At a Glance

<b>Name</b> Alien Typhoon	<b>Format</b> 5¼-inch floppy disk
<b>Type</b> Arcade-style game	<b>Language</b> 6502 machine language
<b>Manufacturer</b> Broderbund Software Inc. 1938 Fourth St. San Rafael, CA 94901 (415) 456-6424	<b>Computer</b> Apple II or Apple II Plus with one disk and 48K bytes of memory
<b>Price</b> \$24.95	<b>Documentation</b> None
<b>Author</b> Tony Suzuki	<b>Audience</b> Experienced game players

# Mindful Machines



On the leading edge of the current technological revolution, these two books are written by modern thinkers who, like the Renaissance sages of an earlier time, venture across the boundaries of traditional disciplines to create vivid, detailed studies of humanity's quest for self-contained thinking machines.

In *Brains, Behavior, and Robotics*, Dr. James Albus demonstrates through an analysis of the processing hierarchies of the human brain that in our own heads we find the best model for an artificial intelligence computer. He goes on to survey the state of the art of robotics and concludes by portraying the social and economic impact of the coming "robot revolution."

Dr. Ernest W. Kent writes in *The Brains of Men and Machines* of the complex relationship between humans and machines. Drawing on the latest research in physiological psychology, he predicts that the more intelligent our machines become, the more they will resemble their creators in methods of processing information, storing data, solving problems, and even in their very circuitry.

Complete with extensive bibliographies, both *The Brains of Men and Machines* and *Brains, Behavior, and Robotics* will fascinate the layman and challenge the professional.

Circle 56 on inquiry card.



Please send \_\_\_\_\_ **Brains, Behavior, and Robotics** \$ 16.95  
 \_\_\_\_\_ **Brains of Men and Machines** \$ 15.95

Name \_\_\_\_\_

Check Enclosed \_\_\_\_\_

Address \_\_\_\_\_

Bill Visa/  
Master Card # \_\_\_\_\_

City \_\_\_\_\_

State \_\_\_\_\_

Zip \_\_\_\_\_

Expiration Date \_\_\_\_\_

BYTE Books 70 Main Street Peterborough, N.H. 03458

Please add .75 per book to cover shipping cost.



Call Toll-Free 800/258-5420

**BYTE  
BOOKS**

B 5



# Supercalc, Spelling Programs, BASIC Compilers, and Home-Grown Accounting

*A critical computer user surveys new programs, including one of his own.*

---

Jerry Pournelle  
c/o BYTE Publications  
POB 372  
Hancock, NH 03449

---

"There may not be a lot of *really new* software," I said to my mad friend, "but there's a lot of good stuff coming out."

"What do you have in mind?" he asked.

"Well, there's Sorcim's Supercalc. I really like that one. Whatever you'd like to do with scratch-pad math, it'll do it, and simply. I've got two different versions, one on 5¼-inch disks for the Osborne 1 and another on 8-inch disks for the Godbout. And I love them both."

Which I do. One of the nicest things about Supercalc is the documentation, although it looks a bit formidable when you first open it (there are a lot of pages there). But on inspection it really tells you a lot about how to use the program. Neither I nor

my assistants had any difficulty learning to use the program because there is not only complete program documentation, but also good Help instructions.

---

### **CB80 has all the advantages and disadvantages of CBASIC-2.**

---

"But there's no index," my mad friend said. "Mark 'em down. Tell the world. Dammit, there's no excuse for software without indexed documents."

A sentiment I thoroughly share, but Sorcim has an excuse for this one. Supercalc is so darned easy to use, once you get the hang of it, that the

on-line Help files, plus the handy-dandy little "AnswerCard" that comes with it, are all you really need; most of the documentation is a tutorial, not a reference guide. Me, I think I'd have designed the documents slightly differently, with an indexed reference work appended to the tutorial; but that's a mild preference. Certainly you can learn Supercalc from what Sorcim supplies.

It's worth learning, too. Like dBase II, Spellguard, and WRITE, Supercalc is destined to become a classic, a program that does what it says it will do with very little fuss and bother.

What Supercalc does is calculate. It is, of course, a Visicalc "work-alike," designed to work on 8080/Z80 CP/M systems. Imagine a big work sheet spread out in rows and columns of

# NOW. OASIS-16: STRICTLY BUSINESS.

The 16 bit operating system designed specifically for *business micro-computing*.  
Application software?—it's here, NOW!

OASIS-16\*: the operating system designed for business. Not just a hobby or development system rewritten for business use, it is the natural evolution of OASIS\*\*: the multi-user system with a world-wide reputation as *the standard* for those who take business seriously.

And here's more good news: there's no waiting for application software because what now runs on OASIS is upward compatible to run on OASIS-16. That means plenty of proven software, available immediately.

OASIS-16 puts it all in one package.  
*For manufacturers*: one source for operating systems, languages, tools; custom implementation to maximize hardware potential; international support & training; flexible licensing agreements.  
*For software developers*: complete portability keeps application software machine independent; integrated tool set makes development easier, faster.  
*For end-users*: user-friendliness; data security; portability simplifies system expansion; plus an extensive application software library.

Computing professionals have long told us 'OASIS makes micros run like minis'—with OASIS-16, it's truer than ever. And that's strictly good business.

\*For 8086, 68000, Z8000, LSI-11, & others.  
\*\*For Z80.

*THE OASIS-16 PACKAGE CONTAINS*: Operating System; EXEC JCL Language; Editor; Script Output Text Formatter; Assembler; Linkage Editor; Diagnostic & Conversion Utilities; BASIC Interpreter & Compiler; 'C' Compiler.

*FEATURES*: File & Automatic Record Locking; Logon, Password & Privilege Level; User Accounting; Re-Entrant BASIC Interpreter & Compiler; ISAM, Keyed, Direct & Sequential Files; and more. Plus some of the best, most extensive documentation in the industry.

*OPTIONS*: COBOL; PASCAL; FORTRAN; RDBMS; 2780/3780 Bisync; Networking; and others.

.....  
**PHASE ONE SYSTEMS, INC.**

7700 Edgewater Drive, Suite 830  
Oakland, CA 94621-3051  
Telephone 415/562-8085 TWX 910-366-7139

I'm serious about my business—  
please send me quick:

- OASIS-16 Manual, \$75
- OASIS Manual, \$60
- Free Application Software Directory and put me on your mailing list.

(Add \$3 for shipping; California residents add sales tax.)

Name \_\_\_\_\_

St. (No Box#) \_\_\_\_\_

City \_\_\_\_\_ State \_\_\_\_\_ Zip \_\_\_\_\_

Check enclosed     UPS C.O.D.

VISA     Mastercharge

Card No. \_\_\_\_\_ Exp. date \_\_\_\_\_

Signature \_\_\_\_\_



**OASIS16**  
STRICTLY BUSINESS



cells. Now imagine that into any cell you can enter any darned thing you want: a number, a label such as "sales tax" or "horsefeathers," or perhaps a formula such as "the sum of the five cells above this one." Another formula might be "the average of all the cells in the next row" or "the square of the cell above divided by pi." Finally, imagine that as soon as you enter a number that affects any cells in which you have formulas, the

values, no matter how complex, are instantly recalculated and displayed.

That's Supercalc. Not only does it do all the above, but there are really nifty edit features that make it easy to get at the cells you want to work on; and you can save your work in a disk file at any time. I imagine the IRS is going to just hate Supercalc and all the programs like it; it will now be relatively easy to calculate your taxes in every conceivable way and choose

the one you like best. The nicest part about it, too, is that if you use your computer to do your taxes, it's likely to be deductible—certainly the software is.

Sorcim is a thoroughly professional software company that also supplies the basic input/output system (BIOS) for the Godbout 8085 computer; and therein lies an instructive tale.

Supercalc has an installation program that lets you tell it what terminal you're using. Supercalc likes a half dozen or so terminals and will tolerate a few more. One that it likes is the Zenith Z-19, which is good because that's what I've connected to my new Godbout 8085/88. The Z-19 has a standard 24 lines of 80 columns, plus a special 25th status line that can't be got at without special programming. Supercalc uses the special programming to give some helpful information.

The Z-19 also has a row of special-feature buttons that send an escape sequence—that is, the character "escape" (1B hexadecimal) and then a number or letter. Supercalc catches these and uses them to do nifty things like controlling the cursor and displaying Help files.

Unfortunately, the package I received from Sorcim didn't quite do that. There appeared on the 25th line a message that the "red square" special-purpose button was the "Help" button and that the "blue square" button would toggle the special shift to turn the numeric keypad into cursor controls; but in fact neither the red nor the blue button did anything at all, and trying to use the shift feature on the numeric keypad produced weird results that nothing seemed able to fix.

So now what? I sent a note to Richard Frank, president of Sorcim, and a few days later got a phone call from one of Sorcim's engineers. Other Z-19 terminals worked with Supercalc, so it wasn't the program. A few tests carried out during the phone conversation produced even stranger results: the terminal was operating well, but the computer wasn't receiving the escape sequences

★ ★ ★ FEATURING 8 and 16 BIT S-100 SYSTEMS ★ ★ ★

WE OFFER A WIDE RANGE OF CRTs, PRINTERS, GRAPHICS EQUIPMENT, SOFTWARE FOR ALL SYSTEMS. EACH SYSTEM IS COMPLETELY TESTED, INTEGRATED AND READY FOR PLUG-IN OPERATION WHEN YOU RECEIVE IT. WE TAILOR & CONFIGURE SYSTEMS TO MEET YOUR BUDGET AND NEEDS. WE WELCOME YOUR REQUEST FOR TECHNICAL INFO BY PHONE OR LETTER.

**CROMEMCO:** *Nation-wide maintenance and warranty service now available.*  
 SYSTEM I: Low priced small system with 5MB hard disk ..... \$5,246.  
 SYSTEM I W/O hard disk. . . \$2,996. Cromix multi-user systems starting at \$4,713.  
 High resolution color graphics hard disk system Model Z2HGS ..... \$10,875.

**NEW SYSTEMS FROM IMS** *2 yr warantee on boards! Integrated system with built-in monitor, detached keyboard, 5¼" drives. Systems w/8" drives, optional 10,20 or 40 MB Winchester, built-in tape back up, multi-user capability (TURBODOS or MP/M). Z-80, S-100 bus. Over 150 configurations to match your specific needs. On site service contracts for NY tri-state area.*

**SEATTLE 8086 SYSTEMS** *Featuring 86-DOS, the IBM PC Operating System.*  
 System I: 8MHZ CPU set w/1 serial, 1 parallel I/O (additional I/O option) 64KB 16 bit Static RAM, Tarbell DD controller, TEI 22 slot mainframe w/constant voltage transformer ..... \$2,695. System II: with 128K Static RAM ..... \$3,550.  
 Interfaced to dual Shugarts 801 ..... \$1,275. or dual QUME DT-8 ..... \$1,680.

**CALIFORNIA COMPUTER SYSTEMS 2210A** *High quality, low price. Z80 CPU, 1 serial port, disk controller w/CP/M 2.2 64K RAM ..... \$1,650.*  
 Add our Max Box w/dual Shugarts or Qumes and IMS I/O w/2 serial, 1 parallel.

**LOMAS DATA 8088/8086** *Same CPU & Operating System as IBM PC. Complete LOMAS card set in TEI 12 slot mainframe, 86-DOS, dual Shugarts, Televideo 912, assembled and tested ..... \$4,424.*

**GODBOUT:** Complete product line now available. Discount prices.

**MAX BOX DISK DRIVE SUBSYSTEM** *mfg by John D. Owens Assoc. Dual drive cabinet w/regulated power supply, fan, complete internal cabling. Will hold Shugarts, Qumes, Tandons and/or 8" Winchester, horizontally mounted. Excellent design and engineering. 17½ × 5½ × 22. Attractive buff color.*  
 W/2 Shugart 801 ..... \$1,275. W/2 QUME DT-8 dble sided drives ..... \$1,680.

**TECMAR 8086 and Z80 Video Digitization systems** ..... 5% off list.  
 IBM PC boards and accessories produced by TECMAR also discounted.

**GRAPHIC SYSTEM:** Advertising\*Architects\*Designers\*Package includes powerful interactive graphics software + MicroAngelo Graphics Subsystem + M9900 16 bit, S-100 w/dual 8" floppies, + HIPAD Digitizer + Plotter ..... \$10,200.

**PER SCI:** Model 299B & 277 with or without cabinet & power supply.

**TURBODOS:** *Spectacular CP/M Compatible Multi-user Operating System. Z80 Code interrupt driven. Up to 6X faster than CP/M; up to 35% increased disk capacity. Available for NorthStar, IMS, TRS-80 Model II, CCS & Tarbell controllers.*

*Prices subject to change without notice  
 Write or call for free catalogue*

**JOHN D. OWENS Associates, Inc.**  
 12 Schubert Street, Staten Island, New York 10305  
 212 448-6283 212 448-2913 212 448-6298

the terminal was generating. Just what was going on?

Eventually we found it. The Godbout BIOS for the 8085 expects one pattern of data and stop bits; the Z-19 sends another. To make it worse, the Z-19, although an excellent terminal in many ways—I recommend it as about as good as you can get just now—has some minor bugs in its program chips, and those bugs interact with the Sorcim-supplied 8085 BIOS and Supercalc to generate the strange results I noticed.

If all this seems confusing to you, imagine what I thought about it while it was happening to me! Eventually, though, I got my friend and computer consultant Tony Pietsch together with the Sorcim program specialists, and all was fixed nicely. Moreover, Sorcim is putting the problem and its solution into its Supercalc manual and notifying Godbout. The moral of this story is that if you insist on a state-of-the-art system (such as the Godbout 8085/88), you'd better be prepared for some unexpected results; but if you deal with reputable companies, you'll eventually get satisfaction.

### Microproof and Spellstar

Then there are the smaller companies: they want to do right, but they have limited resources. A lot of really good software comes out of such companies, but there are some problems too.

Example: As a result of my last column, Cornucopia Software has sent me four separate iterations of fixes for Microproof. Each version had problems, and each time I sent Cornucopia notes on what it probably ought to do. Lo! Cornucopia has now managed to take care of nearly all my objections to the program. It has speeded Microproof up enormously, overhauled the error-trapping procedures, made it easier to use, and generally fixed things up. But Microproof still doesn't handle dashes very well—the program thinks, for example, that "well—the" as I used it here is a candidate misspelled word. Quotation marks give Microproof problems too. There's another dif-

ficulty: with Microproof you can correct the word by spelling it properly, after which the program will go through your text file and globally make the changes. What, though, do you do about capitalization? (Mostly you hope you haven't begun any sentences with the word.)

Anyway, it took several iterations, but eventually Cornucopia developed a useful spelling program. A number of other companies have read my

preliminary reviews of other programs and proceeded to patch things up and send me frantic revisions.

"So. You're a quality control department," my mad friend said.

"Well, not for everyone. And sometimes it's a fairly complicated situation like the problems with Supercalc and the Z-19 terminal."

"Yeah, sure," my mad friend said. "But did you ever stop to think how many software houses routinely use

★ ★ ★ GREETINGS TO OUR FRIENDS IN NORWAY ★ ★ ★

<p><b>HOUSTON INSTRUMENTS</b> PLOTTERS Standard &amp; Intelligent models w/surface areas of 8½"×11" to 11"×17". Front panel electronic controls. DMP-2 ... \$ 935. DMP-3 ... \$1,195. DMP-4 ... \$1,295. DMP-5 ... \$1,455. DMP-6 ... \$1,685. DMP-7 ... \$1,865.</p> <p><b>HAYES MICRO MODEM 100</b> ... \$359. Smartmodem .. \$251. Cronograph .. \$224.</p> <p><b>EPSON MX 80</b> ..... \$475. MX80 F/T .... \$630. MX 100 .... \$725. RS232..... \$ 70. 2K BUFFER ...\$140.</p> <p><b>3M SCOTCH®</b> Diskettes In storage box 5 box minimum, price per box. 740, 8" ss/sd ..... \$29.00 741, 8" ss/dd ..... \$35.50 743, 8" ds/dd ..... \$45.50 744-0, 5¼" soft sectored or 744-10, hard sectored, single sided ..... \$28.50 Head cleaning kit ..... \$28.00</p> <p><b>TEI MAINFRAMES, S-100</b> MCS112 ... \$ 620. MCS 122 ... \$ 745. RM 12 ... \$ 655. RM 22 ... \$ 790. OEM &amp; Qty. discounts offered</p> <p><b>TARBELL Z80 CPU</b> ..... \$395. New I/O card 4S + 2P ..... \$347. Double Density Controller ..... \$435.</p> <p><b>PMMI S-100 Modem</b> ..... \$385. Compatible w/telex &amp; Twx. 51 to 600 baud. On board pulse dialer.</p> <p><b>NEW ITEMS AVAILABLE:</b> Summa Graphics Bit Pads • ALTOS systems • Microline printers • Memory Merchant RAM • PIICEON</p> <p><b>HAZELTINE 1500</b> ..... \$ 885. 1510 ..... \$ 980. 1520 ..... \$1,210. ESPRIT ..... \$ 695. 1 yr. on-site service contract! ..... \$ 49.</p> <p><b>TELETYPE</b> Model 4320 AAK ..... \$1,140. Model 43ASR, 8 level, 1" tape... \$2,595.</p> <p><b>dBASE II demo package</b> ..... \$75.</p>	<p><b>MICROPRO:</b> Inventory sale on all Micropro software. <b>WORDSTAR</b> ..... \$290.</p> <p><b>TELEVIDEO 950</b> ..... \$980. 3 pg. memory upgrade ..... \$150.</p> <p><b>MICROANGELO</b> Price Lowered SUBSYSTEM W/LIGHT PEN .... \$2,300. Includes S-100 graphic card, 15" monitor, detached keyboard, light pen. Without light pen ..... \$1,930. Graphics card alone ..... \$ 975. Screenware Pak II ..... \$ 350. <b>TEKEM:</b> Tektronix emulator ... \$ 350. Color systems from 4 to 256 colors. Basic color system (4 colors) ..... \$2,330.</p> <p><b>IDS PRISM COLOR PRINTER</b> .. \$1,795. Enhanced 560 w/software selectable colors; high speed printing at 200cps.</p> <p><b>CORVUS:</b> New Lower Prices! 6.7MB ... \$3,005. 11.3MB .. \$4,655. 20.5MB ..... \$5,595. For S-100 and most other systems.</p> <p><b>KONAN SMC-100 hard disk controller.</b> S-100, 2400MB control ..... \$1,469. Complete KONAN line available</p> <p><b>COMMUNICATIONS SOFTWARE</b> Enables communications from a micro to a terminal or to another micro, mini or maxi computer. <b>HAWKEYE GRAFIX</b> Source Code .. \$500. Object Code .. \$75.</p> <p><b>MICROSOFT COBOL—80</b> ..... \$560. BASIC-80 (interpreter) ..... \$270. BASIC COMPILER: ..... \$305. FORTRAN-80 ..... \$380. X-MACRO-86: ..... \$275. muLISP/muSIMP: ..... \$190.</p> <p><b>FORMULA: ALL-IN-ONE</b> data base + w/p + accounting software ..... \$595.</p> <p><b>QUICKSCREEN</b> ..... \$149. Use CRT as scratch pad, produce quality screens, create reports &amp; forms.</p> <p>Complete software ..... \$595.</p>
---	--

**WE EXPORT** Overseas Callers: TWX 710 588 2844  
Phone 212 448-6298 or Cable: OWENSASSOC

**JOHN D. OWENS Associates, Inc.**  
SEE OUR AD ON FACING PAGE



their *paying customers* as their quality control department? Look—how much advance-notice software do you get?"

I thought about it. "Not too much. Mostly I get advertised stuff because I write and ask for it. Sometimes an outfit will see a review and ask if I want to see its new product. I try to be fair, but I don't have time to help with development."

"But you do anyway. Now think about the poor guy who buys new software that doesn't quite work. He doesn't know what to do. The license agreements discourage sending anything back for refunds. He doesn't even know how to describe the problem, or maybe he hasn't enough experience with competing programs to know he has a lemon. And meanwhile the publishers keep those \$500 price tags—and complain about pirates."

Unfortunately, my mad friend is right. In fact, things are worse than

that. Some companies, like Cornucopia, *try* to fix things when their customers complain and eventually do things right. Others just ignore the complaints and take the money and run.

And yet. It's certainly to our (the users') advantage that a lot of small software houses spring up. We don't want the field dominated by a few giants with ever-more-restrictive licensing policies ("Levitical documentation," as my mad friend calls it). We want a lot of competition, which means, I guess, that those of us who like to try new products just better get used to being unpaid quality control departments. Sigh.

I have another spelling program, Spellstar. It's pretty nifty. It's a bit slow, compared to Spellguard, but it does have some nice features. For example, Spellstar lets you mark the words you're interested in, then shows you the document with those words highlighted; on my Z-19,

they're in reverse video. So, there they are, completely in context and marked so I can't miss them. Very nice.

Even better, if you tell Spellstar to ignore a word in the future, it'll do that: from then on, when it hits the marked word, it will unmark it and go right past it. When you drop out of Spellstar you're in Wordstar, so that you can use a global search and replacement to fix every future instance of the mistake.

Indeed, if I used Wordstar as an editor, I'd be tempted to use Spellstar in connection with it. However, I do have to warn you that a couple of my knowledgeable friends who do use Wordstar and who have Spellstar available to them prefer to use Spellguard on the grounds that it is just overall more convenient, especially for longer documents.

### Languages, Mon Amour

I know of two new BASIC compilers, and they're both excellent. It's almost an *embarras de richesse*. In my last review, I described the new features of Microsoft's BASCOM BASIC Compiler. I mentioned that Microsoft has added CHAIN and COMMON and that now only one run-time package is necessary.

One major consequence of only requiring one copy of the run-time program to be present on the disk (even though you may have half a dozen compiled programs) is that the compiled programs are shorter. Not all *that* much shorter, if you count program and run-time package; but the instant you have several compiled programs present, the disk savings mount. (I chuckle at that now; with my new Qume double-sided double-density disk system, I have more than 2 megabytes of floppy storage available, which means I don't worry so much about disk space. Yet. . . .)

Of course, if you use the run-time package, you're liable for the new royalty payments on any software you sell. (Microsoft dropped the royalty requirement for programs compiled with the old BASCOM, as I discussed in my last column.) You could, I guess, sell programs written

Still Searching?

THE BIBLE

What Does The Bible Say?

And Where?

Now you can use computer technology to search the Bible on any subject. With THE WORD processor (including a disk copy of the complete KJV Bible text) you can create indexes on keywords. Or phrases. Even on concepts.

A full spectrum of text search functions allows detailed analysis for the real student of the Bible.

Print or display selected verses and/or references for personal study or Bible classes. Build your own computerized library of research material.

**THE WORD**  
processor **\$159.<sup>95\*</sup>**

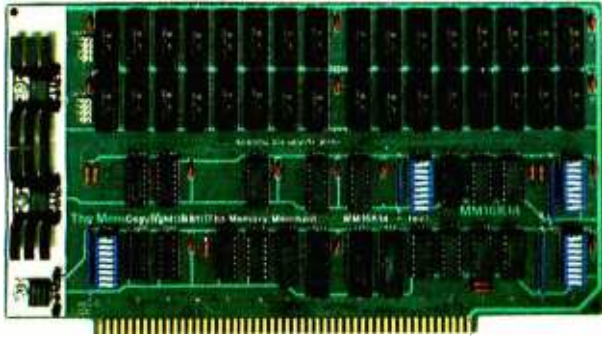
Bible Research Systems • 8804 Wildridge Drive • Austin, Texas 78759 • (512) 346-2181  
or call Your Local Dealer

Requires 48K, 1 disk drive, APPLE or TRS-80  
APPLE is a trademark of APPLE Computer, Inc.

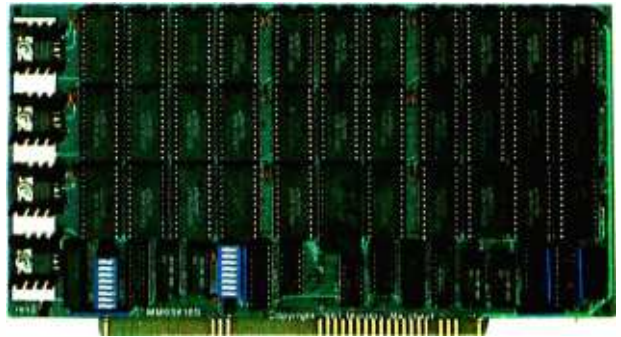
\* Plus \$2.50 postage/handling  
TRS-80 is a trademark of Tandy Corp.

# S-100 STATIC MEMORY BREAKTHROUGH

## MAKE YOUR NEXT PURCHASE A MEMORABLE ONE!



**16K STATIC RAM \$169**



**64K STATIC RAM \$795**

**32K PARTIALLY POPULATED \$479 48K PARTIALLY POPULATED \$659**

### NO RISK TRIAL

We are so convinced that you will be absolutely delighted with our boards that we extend a no risk trial offer. After purchasing one of our boards, you may return it (intact) for any reason within 15 days after shipment and we will refund the purchase price.

### NEW 18 MONTH LIMITED WARRANTY!

The reliability of our boards, through quality controlled production and proven performance, has enabled us to extend our warranty to a full 18 months. This includes a 6 month exchange program for defective units.

### HOW TO ORDER

Please send check, money order, VISA or MASTERCHARGE (add ICA#) with your order. Sorry, no C.O.D.'s. Specify model number, and quantity desired. Shipping and handling charge is \$5.00 per board. California residents add 6% Sales Tax. Credit card purchases may be telephoned to (415) 483-1008.

**OEM and DEALER inquiries invited.**



**14666 Doolittle Drive  
San Leandro, CA 94577  
(415) 483-1008**

Prices, terms, specifications subject to change without notice.

Circle 257 on inquiry card.

Finally, you can buy state-of-the-art S-100 static memory for your computer at unprecedented savings.

Memory Merchant's memory boards provide the advanced features, quality and reliability you need for the kind of operational performance demanded by new high-speed processors.

### COMPLETELY ASSEMBLED

These memory boards are not kits, nor skeletons—but top quality, high performance memories that are shipped to you completely assembled, burned-in, socketed, tested and insured with one of the industry's best warranties.

### SUPERIOR DESIGN & QUALITY

Memory Merchant's boards are created by a designer, well-known for his proven ability in advanced, cost-efficient memory design. Innovative circuitry provides you with highly desired features and incredible versatility.

Only first quality components are used throughout, and each board is rigorously tested to assure perfect and dependable performance.

### SHIPPED DIRECT FROM STOCK

All Memory Merchant's boards are shipped direct from stock, normally within 48 hours of receipt of your order.

### 64K RAM, Model MM65K16S

Cool running operation to 10 MHz  
Ultra low-power consumption  
Fully loaded 64K board draws:  
Typ. 350 Ma. (Max. current 550 Ma.)  
Bank Select Capability

Extended Addressing Capability  
One 16K submodule equipped with a 2K window which may be located in any of the 2K segments

2716 (5V) EPROM Compatibility:  
Programmed 2716 EPROM's may replace any or all of the RAM

Four independently addressable 16K submodules on one board organized as two pair of independent 32K banks or as one 64K Extended Address Page. Each 32K bank responds independently to phantom. Bank Select logic is compatible with either Cromemco Cromix\* or standard Bank Select software.  
\*Cromix is a trademark of Cromemco.

New 16K (2K X 8) 150ns Static RAM  
Runs on any S-100, 8-bit system  
MPM Conversion Option: Write for details.

### 16K RAM, Model MM16K14

Bank Select Capability  
Extended Addressing Capability  
One 4K segment equipped with 1K windows

Four independent 4K X 8 byte segments  
Uses field proven 2114 (1K X 4)  
Low-power consumption (Typ. 1.3 Amps)  
Runs on any S-100 8080, 4 MHz Z-80 or 5 MHz 8085 system.



in Microsoft BASIC and compilable with BASCOM, leaving it to the customer to buy his own copy of BASCOM with a run-time package.

And, of course, you can use BASCOM to develop as many programs as you like for yourself. Since BASCOM is almost the same language as Microsoft's BASIC-80 interpreter, the result is a very powerful tool: you can run programs interpretively, squeezing out the syntax errors, then test the program logic, all while having an instant editor available for fix-up. Now, true, it would be a lot easier if BASIC-80 didn't simply dump your program and scrub all its variables whenever you make any program change whatever (even to add a remark!); but you can't have everything. (I wish we could, though; and if Microsoft wants to update BASIC-80, I strongly suggest that improvement.)

A second major defect of BASCOM is its surprising inability to

deal with arrays. The rule with BASCOM is, once dimensioned, always dimensioned. You cannot change dimensions at all. Worse, you can't compute the size of a dimension, even if the compiler has been told everything it would need for the calculation. You can't even use a variable for dimension size. The result is that if you make up a database program—as I have; see last month's column for details—you must either recompile any time you change the database structure, or you must waste a lot of memory on larger than necessary arrays; neither choice is convenient.

Finally, BASIC-80 and BASCOM have a strange random-access file structure—and you cannot access the random files as if they were sequential. Microsoft's BASIC stores random files in a packed binary-code format that very efficiently uses the disk space; but the files aren't ASCII (American Standard Code for Infor-

mation Interchange) standard and can't be printed by any program not written in Microsoft BASIC, and that can be a pain.

So: given the defects, what are the alternatives?

Digital Research's CB80

One solution might be to turn to Pascal and be done with it. Why mess with BASIC at all? Compiled Pascal MT+, or INT-file Pascal such as is created with Sorcim's Pascal M or UCSD Pascal, is supposed to be faster, easier to write, more efficient, and inherently better structured than the best BASIC ever written. (I'm not convinced; the few tests I've tried show BASIC programs compiled with BASCOM are about as fast as MT+ and faster than UCSD Pascal.)

Besides, now comes Digital Research's new CB80 to challenge the whole notion.

CB80 was written by Compiler Systems, which in essence means

# THE BUSINESS POWER OF 60 MINI DISKS!

## MEGABYTER WINCHESTER DISK SYSTEM

### AMS 5000

Around the world and across the nation, business people and serious Apple II users are stepping up to SVA MEGABYTER SYSTEMS — Dig storage at a low price.

Now the SVA AMS 5000 provides 5 to 10 megabytes of flexible and convenient on line data storage. This complete self contained 5" winchester disk drive memory system is attractively packaged and ready to run.

Imagine the power of accessing more than 60 mini disks simultaneously. And it's so easy to use you won't even know it's there. Most applications using the CP/M, DOS, PASCAL operating system will run on MEGABYTER systems.

Enhance those large and complex applications with near instant program and data access — that means fast and convenient operation of accounts receivables or payables, inventories, medical data, insurance billings, etc. Increase Data Base performance with the superior large file accessing capability of the AMS 5000. Call SVA today for expert application assistance.



CP/M  
PASCAL  
APPLE DOS

Rely on SVA for BACKUP data protection, archival data storage, and data transportability with the AMS 8000 MEGABYTER 8" floppy disk system. This system features high capacity removable media, IBM 3740 compatible, and may be used to transport data to other computers.

Preventative maintenance is not required for the AMS 5000. It's designed to operate continuously and is backed up by SVA's 6 month warranty with optional long term maintenance.

The best news of all is low price — A complete 5 Megabyte AMS 5000 MEGABYTER memory system is only — \$3,339.

To order your AMS 5000, call SVA today or contact your Apple dealer. Look to SVA for a growing line of Apple Memory System products... SVA means business!!

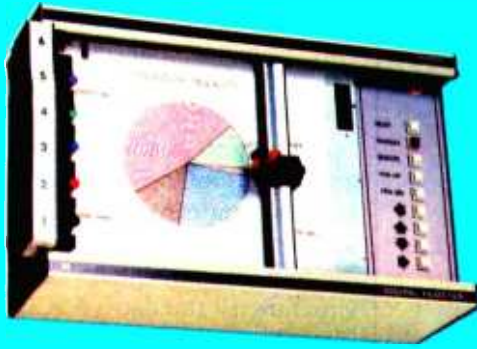


**SORRENTO VALLEY ASSOCIATES**  
11722 Sorrento Valley Road  
San Diego, CA 92121-1084  
(714) 452-0101 TWX 910-335-2047

\*CP/M Trademark Digital Research, APPLE DOS Trademark of Apple Computer.

# Look what's happened to

TM



It's grown into a complete family of quality low cost digital plotters with one, six and eight pen models available

Yes, they are UL listed! \*\*

In just a few short years, the HIPLØT has become the most popular digital plotter among small systems users. With a record like that, what can we do for an encore? WE'VE INTRODUCED A COMPLETE LINE OF HIPLØTS... with a model suited for just about every plotting application.

The HIPLØT DMP Series is a new family of digital plotters with both "standard" and "intelligent" models available with surface areas of 8½"×11" (DIN A4) and 11"×17" (DIN A3). For the user needing a basic reliable plotter, we have the "old standard" DMP-2 (8½"×11") and the "new standard" DMP-5 (11"×17"). For those needing a little more capability, there are the DMP-3 (8½"×11") and the DMP-6 (11"×17")—both microprocessor controlled and providing easy remote positioning of the X and Y axes (perfect for the OEM). For those who want this in-

telligence plus the convenience of front panel electronic controls, we've provided the DMP-4 (8½"×11") and the DMP-7 (11"×17").

The "standard" plotters come complete with a RS-232-C and a parallel interface. The "intelligent" DMP plotters accept data from either an RS-232-C or Centronics® data source. For the "standard" plotters, software is available from our ever expanding "Micrographic Users Group". The "intelligent" HIPLØTs use our exclusive DM/PL™ language which minimizes plot software to a fraction of that normally associated with digital plotting.

And that's only part of the story. Now you can enjoy the advantages of multi-pen plotting capabilities with all six HIPLØT models. The DMP-2, 3, and 4 are available in a 6-pen format

— there's an 8-pen option for the DMP-5, 6, and 7. So you can now have multi-color graphics under program control at an affordable HIPLØT price.

With the new DMP Series, high quality digital plotting can now be a part of your system. It just doesn't make sense to be without this valuable tool when there is a DMP plotter with the plot size, speed and capabilities that are exactly tailored to your specific needs ... and your budget.

Prices for the DMP Series start at only \$1085. Multi-pen plotters start at a low \$1480.

For complete information, contact Houston Instrument, P.O. Box 15720, Austin, Texas 78761. (512) 835-0900. For rush literature requests, outside Texas, call toll free, 1-800-531-5205. For technical information ask for operator #5. In Europe, contact Houston Instrument, Rochesterlaan, 6 8240 Gistel, Belgium, Phone 059/277445.

Circle 39 for literature.

Circle 40 to have representative call.

\*\* DMP 2, 3 and 4 UL listed  
DMP 5, 6 and 7 UL listing pending

TM HIPLØT and DM/PL are Trademarks of Houston Instrument

\* Registered Trademark of Centronics Data Corp.

INSTRUMENTS & SYSTEMS DIVISION

Together...we'll create tomorrow.

BAUSCH & LOMB 

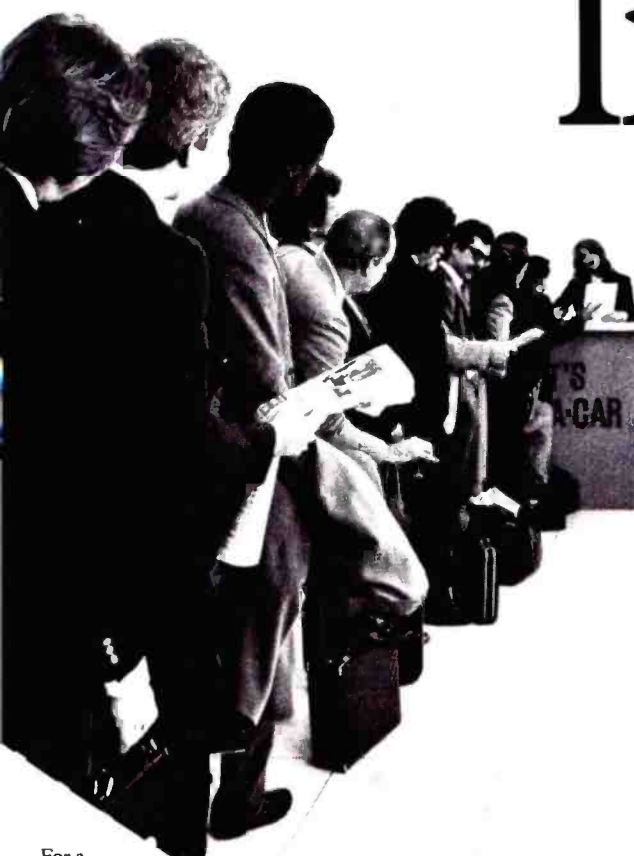
www.americanradiohistory.com





*#1 Express Service.*

# Hertz announces the end of the line.



If you're tired of standing in airport car rental counter lines, Hertz has a way to beat them.

It's called #1 Express™ Service.

To see how easy it is, pick up a #1 Express pass the next time you're at one of our counters. Or ask your travel agent or corporate travel department.

Hertz #1 Express Service. It's the end of the line.

For reservations\* call 1-800-654-3131. Ask for #1 Express.



For a supply of #1 Express passes, send this coupon to:  
#1 Express Pass  
Hertz Corp.  
660 Madison Avenue,  
New York, N.Y. 10021

Name \_\_\_\_\_

Address \_\_\_\_\_

City, State and Zip \_\_\_\_\_



**#1 For Everyone.™**

Hertz rents Fords and other fine cars.

© 1992 HERTZ SYSTEMS, INC.

\*Available at 35 major U.S. airports.

Circle 192 on Inquiry card.

PN-1

# DISCOUNT LINE

1-800-528-8960

## GUARANTEED LOW PRICES

### APPLE CARDS

16K RAM — \$120    Z80 CARD — \$279  
Videx Card — \$249    CPS CARD — \$179  
Graphic Card — \$89    Clock CARD — \$229

### ALTOS

8000-2 — \$2675    8000-15 — \$3975

### ANADEX

9500 — \$1200    9501 — \$1200

### ATARI

400-16K — \$349    800-16K — \$889  
410 — \$59    810 — \$429  
825 — \$589    850 — \$149

### C-ITOM

25CPS-P — \$1299    45CPS-P — \$1459

### DATASOUTH

DS120 — \$595    DS180 — \$1259

### DIABLO

630 — \$1945    1640 — \$2475

### DISKETTES/BOXES

Plain — \$20    Scotch — \$25    Dysan — \$35

### EPSON WITH GRAPHICS

MX70 — \$289    MX80 — \$429  
MX80FT — \$519    MX100 — \$689  
GRAPHIC ROM — \$79    RS232 — \$69

### HAZELTINE

1500 — \$995    ESPRIT — \$595

### LOBO

Apple Drive/Card — \$390/\$90

### MODEMS

HAYS — MICROMODEM — \$290  
Novation — Cat — \$149  
Penril — 300/1200 (212A) — \$795

### MONITORS

Teco-BW — \$99    Teco-Green — \$115  
Sanyo-Green — \$249    Color — \$425  
Amdek-Green — \$159    Color — \$349

### NORTHSTAR

Advantage — \$2995    HR64QD — \$3025

### NEC

8023 — \$489    7710 — \$2350

### MPI

88G — \$589    89G — \$659

### SOROC

120 — \$659    135 — \$689

### TELEVIDEO

912 — \$669    950 — \$915

### TI

810 — \$1240    820 — \$1795

### SOFTWARE

All Major Brands — \$CALL

### MOUNTAIN HARDWARE

Romplus — \$119    Music System — \$429.00

### OKIDATA

M80 — \$325    SL125 — \$3150  
M82A — \$459    SL250 — \$4200  
M83A — \$729    M84 — \$1179

### XEROX

820 — \$2399

### ZENITH

Z19 — \$669    Z89 — \$2129

Arizona 1-602-246-1783

# EXPOTEK CORPORATION

2231R W. Shangri La Rd.  
Phoenix, AZ 85029

## User's Column

meaning that if you come back to your program in six months you have half a chance of understanding it.

And actually CB80 is better than that.

Now it has labels. Instead of "GOSUB 3680" you can say "GOSUB COUNTIT", or "GOSUB PROCESS.ONE.ITEM". Better yet, you can have very complex functions, which you call and pass parameters to; and the functions use purely local variables that can't affect anything in the program outside.

The functions can take up many lines, and they can be "external," meaning that the function can be in an entirely different program "module" that gets called in at link time. Multiple-line functions can also access and change external variables; and the whole mess can be called by value, as in the statement "WHILE FARNUM(FOO)" where "FARNUM" has previously been defined as a function of the variable "FOO."

More yet, a multiline function can have both purely local variables and variables created just for that function (the variable "X" in the function is not the same as the variable "X" in another function or in the main program) and can also affect regular global variables in the rest of your BASIC program. This means you could have a function called "YES" that prints a prompt, gets an input, checks to see if the first letter of that input is either "y" or "Y," and informs the main program.

In other words, CB80 has got pretty darned close to Pascal's functions and procedures, and it seems to be a lot faster than Pascal too. You could sit down and write a really neat set of "software tools." You can, with CB80, build a whole library of useful program modules, setting them up in nice orderly blocks to be called in when needed.

That, of course, is the answer to the "no interpreter" problem: build a set of functions that you know will work and include them in the new programs you write. After a while you'll find that most programming consists of stringing together routines

known to be reliable and once in a while developing a new function to stick into your tool kit.

Although CB80 is marketed by Digital Research and the manual flies Digital's colors, don't despair: the documentation wasn't really written by Digital, meaning that it's not encrypted and translated into Swahili, as much of Digital's documentation is. It does have some of the fine hand of the Digital hacker about it; for example, the text is peppered with incomprehensible "syntax diagrams," as if they were supposed to mean something; and here and there the sentence density gets completely out of hand. For the most part, though, the CB80 manual is in the really excellent style of the old CBASIC manual: clear, concise, and with plenty of examples. You need not be afraid of it.

You might, however, be afraid of CB80's price, which is steep, and its licensing policy, which is sheer madness: that is, Digital Research wants a flat \$2000 a year if you're going to compile, link, and market programs using CB80. (The fee applies only to programs you distribute, not to those developed for your own use; still, it's onerous enough.) Again, I suspect competition will bring this down; meanwhile, we can wait. . . .

### Which Language Now?

So. We have increasingly better BASICs, and one of these days we'll get a compiled language as good as CB80 with an interpreter as good as Microsoft's BASIC-80. When that happens, I think FORTRAN and COBOL and even Pascal are going to suffer a sharp drop in popularity.

My mad friend, meanwhile, continues to praise PL/I, which he says is easy to learn and remarkably effective. I confess I haven't had time to write anything but the simplest programs in PL/I or indeed even had time to examine it; but my mad friend is usually fairly reliable in his judgments and has a very healthy attitude toward computers, namely that they're for him to use and are not masters that control him.

# TIM<sup>TM</sup> III

## The Non-Programming Approach to Data Base Management

### Data Base Management

Data management packages were created to save time and money in the development of software solutions to information problems. Many have been designed to accomplish just that, although most have only the programmer in mind. Sure they would save time in the long run, but what of the initial investment in time and effort required to learn the new language? What about the non-programmers in the world who would like an easy yet powerful applications generator? The solution is one of the most highly acclaimed software packages of our time, T.I.M. III.

### What is T.I.M.?

T.I.M. is **Total Information Management**. Programmers love it due to its original solutions to classic data management problems. Non-programmers adore it since they can use it to achieve the same results as with other more complicated programming-like packages.

### What Makes T.I.M. So Simple to Use?

We at Innovative Software, Inc. designed T.I.M. from day one with the end user in mind. Maybe he is a programmer who doesn't have time to learn a new language. Or perhaps a neophyte who fears coding pads and lines numbered by tens. We felt that a data management package should be able to be used by anyone from a systems analyst to a secretary. That's why T.I.M. takes a full *menu-driven* approach, uses multiple *HELP* screens, and has a manual that sets a new standard in documentation.

### The Manual

Many people believe that the manual is just as important as the software itself, a view that we at Innovative Software, Inc. tend to share. The manual for T.I.M. is divided into two sections, the Reference section and the Primer. The Reference section describes all of T.I.M.'s commands and subcommands. This is done in English, not in technical terms or in our own language. Even if you have

never seen a computer before in your life, you'll be able to read and understand our manual immediately. The second section is a primer which goes through several examples for you, again in plain English. These true-to-life examples take the beginner by the hand, and instructs him what to do and when. You will be able to see for yourself that T.I.M.'s only limitation is the imagination of the user.

### Features of T.I.M.

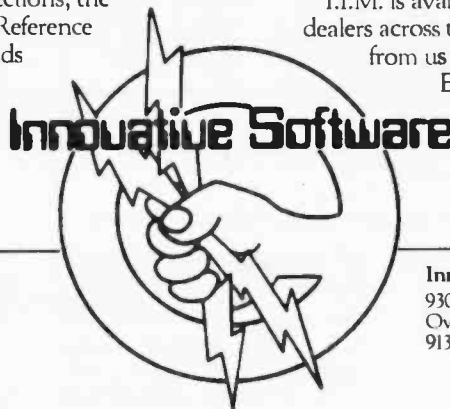
T.I.M. has all of the features one has come to expect from a data management package, as well as many new ones. For example, a *word processing* interface that allows you to merge information from a T.I.M. file with letters or other documents created by a word processor. Now you can automatically send personalized letters to hundreds or thousands—quickly and easily. T.I.M.'s *Select* command enables you to pull specific information from a file. For example, "All customers who live in a certain ZIP code, whose last name begins with the letter A to L, whose balance due is less than \$50.00." A sophisticated *report generator* and even a *list generator* are also included.

How powerful is T.I.M.? With a maximum record size of 2400 characters and the ability to keep up to forty fields sorted properly at all times, T.I.M. is powerful enough to handle just about any application. T.I.M. can handle over 32,000 records per file, and two files can be linked together for reports if your application requires a many-to-one relationship. T.I.M. also includes all of the same editing commands as your word processor, thus making data entry and editing a snap. You can also pull selected records from one file to place them into another. Files may be restructured to add or subtract fields and/or change field lengths or types. T.I.M. even has it's own utility for backing up hard disks onto floppies.

### Where to Find T.I.M.

T.I.M. is available from many fine computer dealers across the country. Or you may purchase from us direct by calling 913/383-1089.

Either way you will have the finest data management program available.



Available for CP/M,\* and IBM PC DOS.\*\*  
CP/M version—'695. IBM PC version—'495.

Innovative Software, Inc.  
9300 W. 110th Street, Suite 380  
Overland Park, Kansas 66210 USA  
913/383-1089

TIM is a Trademark of Innovative Software, Inc.  
\*CP/M and MP/M are Trademarks of Digital Research  
\*\*Trademarks of IBM

Circle 204 on inquiry card.



Accounts Comprehensible

Once again I find myself embarrassed: I have to review a program I've written.

I have most of the many computer accounting packages available. Some, I guess, are really swell for what they do; but not one of them, *not one*, looks too useful for *me*.

I'm a writer. A good part of my life is deductible. It's amazing just how many activities turn out to be

income-related research. And it comes as no surprise that the Internal Revenue Service is very interested in the records demonstrating that.

And therein lies the problem. Sure, I could hire an accountant. Many of my colleagues do, and a lot of them think I'm crazy when I tell them I keep my own books and make out my own tax returns. And yet, when I begin to question those colleagues, I find that I don't work any harder

than they do. By the time they've explained everything to an accountant, turned in all the receipts, and kept all the records and diaries that the accountant wants, they've usually done *more* work than I do; and they pay more taxes too.


I've always kept my own books; one of the main reasons I let my mad friend talk me into buying Ezekial, my Z80, was the hope that I could computerize my accounting system. Thus I have for *years* pounced on every new accounting program eagerly and I've been disappointed every time.

Most "accounting" programs don't produce what I would call accounting books. Instead, they offer "special reports." Now understand: I don't know a darned thing about accounting. Everything I think I know came from two books, Donald H. MacKenzie's *Fundamentals of Accounting* and John N. Myer's *Accounting for Non-Accountants*. Those books explain what accounting is all about; and with pictures and illustrations, they give actual examples of journals and ledgers with the funny single, double, and triple lines, the complex scheme of indentations, and the strange check marks favored by accountants. And as far as I'm concerned, that's what my company's books ought to look like.

Nor am I completely mad; every couple of years I have my boys drift into the local university bookstore and buy all the accounting textbooks they can find, and I look through them; and lo!, the textbooks still show that accountants like double and triple lines, and complicated indentations, and. . . .

Yet, there's no computer accounting program that I know of that produces books that look like the books in the accounting texts; and because that's the only thing I could understand with my cookbook knowledge of accounting, I had no real choice. I had to write programs that *do* make journals and ledgers that correspond with the examples in the elementary accounting textbooks.

Which is what I did. My account-



## Here's 256K Performance At an Economy Price!

InterSystems has done it again! The new Series III operates at 6 MHz and includes software to fully utilize the 256K high speed memory. You can buy it from BRIDGE for \$5545—check out these features. . . .

- Operating system software that effectively utilizes the 256K RAM
- CP/M 2.2 and Cache BIOS™ that speeds operation up to 4 times
- 6 MHz CPU with powerful 1 MByte memory management system
- 256K memory—6 MHz with parity and 8/16 bit transfers
- S-100 Bus follows IEEE 696 Standards
- Two serial ports and four parallel ports with two interrupt controllers
- Dual double-density soft-sectored 5¼" drives (0.8 MByte total)
- Easily upgraded to 6-user MP/M system.

But we are sure that you want turnkey operation, so we have packaged a system that includes . . .

- InterSystems Series III Computer P/N CB-256/525
- BMATE™ screen oriented text editor/word processor
- Zenith Z-19 or Televideo 950 Terminal.

INTRODUCTORY OFFER	List	Special Offer
<b>ORDERING INFORMATION</b>		
InterSystem CB-256/525 Computer with software	\$6545.	\$5545.
As above with BMATE™ and Zenith Z-19 Terminal	7590.	6495.
As above with BMATE™ and Televideo 950 Terminal	7935.	6725.


For something still more powerful, ask about the BRIDGE enhanced systems, including the FORTRAN Development and the Compiler systems, based on InterSystems computers.

Call to order, or send for complete information. Dealer inquiries invited.



**Authorized Distributor**

Cache BIOS is a trademark of Ithaca InterSystems, Inc.  
BMATE is a trademark of BRIDGE Computer Company,  
Division of Sea Data Corporation.



**Computer Company**  
DIVISION OF SEA DATA CORPORATION

ONE BRIDGE STREET  
NEWTON, MASS. 02158 U.S.A.  
PHONE: (617) 244-3203

The MICROMINT Z8 BASIC COMPUTER/CONTROLLER board represents a milestone in microcomputer price-performance. It is cheap enough to be programmed directly in a high level language, and efficient enough to be battery operated if required. The entire computer is 4" by 4½" and includes a tiny BASIC interpreter, 4K bytes of program memory, one RS-232 serial port and two parallel ports, plus a variety of other features. Using a powerful Z8 microcomputer chip and Z6132 4K X 8 RAM, the Z8 BASIC COMPUTER/CONTROLLER board is completely self-contained and optimized for use as a dedicated controller. The unit is assembled and tested and comes with over 200 pages of documentation.

**The price, in single quantity, a tiny \$195.\***

Optional power supply (+5, +12 and -12V) \$35.

Please include \$4 for shipping and handling.

\*Call Micromint for quantity pricing

#### Z8 MICROCOMPUTER

- On board tiny BASIC interpreter.
- Parallel and serial I/O ports.
- 6 interrupts.

#### RS-232 CONNECTOR

- Just attach a CRT terminal and immediately write control programs in BASIC.

#### 4K BYTES OF RAM

- Z6132 4K X 8 low power quasi-static RAM. EPROM pin compatible.

#### SWITCH SELECTABLE BAUD RATES

- 110-9600 BPS.

#### FULLY EXPANDABLE

- Data and address buses available for 124K memory and I/O expansion.
- 2 onboard parallel ports.
- 7.3728MHZ crystal for fast control operations.

#### JUMPER SELECTABLE MEMORY OPTIONS

- 4K RAM, 2716 or 2732 EPROM operation.

#### LOW POWER

- Consumes only 1½ WATTS at +5, +12 and -12V (optional power supply available).

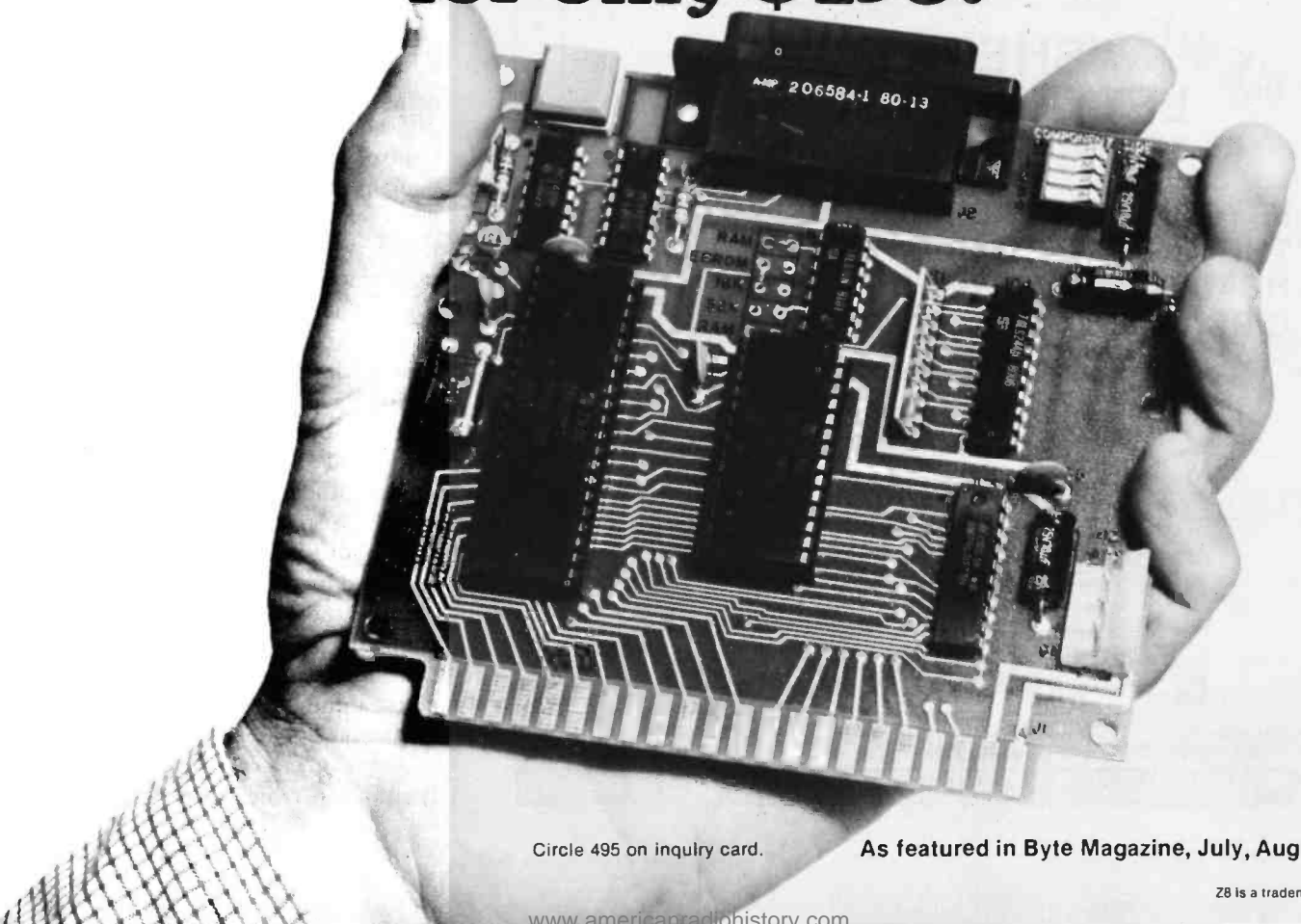
To Order:  
Call Toll Free  
1-800-645-3479

For Information Call  
1-516-374-6793

MICROMINT INC.  
917 Midway  
Woodmere, N.Y. 11598



**Micromint will put both a computer development system and an OEM dedicated controller in the palm of your hand for only \$195.**



Circle 495 on inquiry card.

As featured in Byte Magazine, July, August, 1981.

Z8 is a trademark of Zilog Inc.

ing system starts with a simple-minded thing that lets you build a chart of accounts, essentially a list of ledger page names each with a corresponding ledger page number: for example, 501, postage; 506, office supplies; 506.012, travel supplies; 523, business charitable contributions; 923, family charitable contributions.

You can add to the chart of ac-

counts at any time, and you can use fractional page numbers, from .001 to .999, if you like, because each ledger page will become a CP/M file title "LED-xxx.yyy," as for example LED-506.012.

After you make a chart, you use the Journal program to build journals. A journal entry consists of a line that indicates to whom you paid (or from whom you received) something,

a longer explanation line, an amount, and a series of debits and credits that the program keeps track of (I hate to remember that when you spend money you *credit* cash and *debit* the account you spent it on). The program will not allow you to enter an item that doesn't have equal debits and credits.

You can put stuff into the journal in any order you want; there is then a program that will allocate the journal entries by date, so that the journal becomes a chronological record of what you spent and for what. The program has ways of entering cash, checks (from more than one account if you like; I have two interest-bearing checking accounts and one commercial account, and I need to keep them all straight), a dozen different credit cards, and so forth. It also keeps track of check numbers.

Once you've built a journal, you can print it; that requires a printer that can print solid vertical bars (ASCII character 124 in decimal) in order to reproduce the single, double, and treble lines so loved by accountants.

You can then use the Post program, which takes the journal entries and allocates them among the various ledger pages you created in the chart of accounts. Journal has provision for control accounts. I suppose I better explain that. Let's say a primary expense category is postage, and that's the way I intend to report the expenses to the IRS. However, I often find I have to send express mail packets. These ought to be charged to a particular project—in my case, of course, a project is a book. Thus I debit the book account and credit the controlled account; I also debit postage and credit cash. When I get income from that particular project, the book gets credited, as does "agented income," while the bank account's and the controlled account's summary pages get debits; once again the books balance, and I can get some clues about the profitability of any particular book.

Anyway, Post takes care of all that, after which another program

## COMPUTER FORMS AND SUPPLIES

**WE SUPPORT MORE  
SYSTEMS WITH FORMS  
THAN ANYONE!**

Accounting Plus • Alpha Micro • Apple Computer • BPI Systems • Broderbund • CAD0 • Centurion/Warex/EDS • Cimarron • Compumax Associates • Continental Software • D.B. Software • Dakin-5 • Data Train • Denver Software Company • Designer Software • Digilog • Durango • Datamost • Dynabyte • IBM 5120 • IBM Sys 32/34 • IMS • Insoft • LIBRA • MCBA • NEC • Northstar • Open Systems • Osborne • Peachtree • R & B Systems • Radio Shack • Rocky Mountain Software • Serendipity • Shasta • (SSG) • Systems Plus • Taranto • TCS • The Bottom Shelf • Van Data • Vector Graphic • Wang

**PLUS 86 MORE!**

**NEW!** "SHEER CUT"  
LETTERHEAD WITH  
MATCHING ENVELOPES.

**IF YOU USE WORD PROCESSING, THIS IS  
THE ANSWER TO BULKY TIP-ON LETTER-  
HEAD CALL FOR YOUR FREE SAMPLES. 4  
CIRCA 83 COLORS IN STOCK.**

CHECKS • STATEMENTS  
CUSTOM FORMS • W-2'S  
INVOICES • STOCK TAB

**30% OFF 1982 W-2  
ORDERS PLACED THIS MONTH**

CALL FOR FREE 1982 TAX FORMS CATALOG!

**Checks To-Go**

IN CALIFORNIA  
800-552-8817

8384 Hercules Street  
La Mesa, CA. 92041

NATIONWIDE  
800-854-2750



# the Norpak Color Raster Display Generator

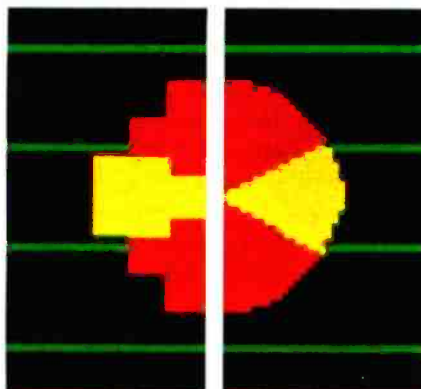
the only  
thing  
better  
than our  
picture  
is our  
price



## Satisfy your demand for text and sophisticated graphics

### Features

- compact single board display controller
- high efficiency 6809 microprocessor
- Telidon alpha-numeric/geometric Videotex software in ROM
- RS232C full duplex communication
- independent transmit/receive baud rates, strap selectable from 75 to 9600 baud (odd, even or no parity)
- 200 x 256 x 4 bit high speed raster video RAM
- 8 grey levels (black to white), 6 colors and blinking white
- RS170 RGB video and composite sync outputs
- input device interface for optional keypad or keyboard
- 8 character sizes including a maximum of 20 lines of 40 characters each.



Block Mosaic

Geometric

### Ease of Operation

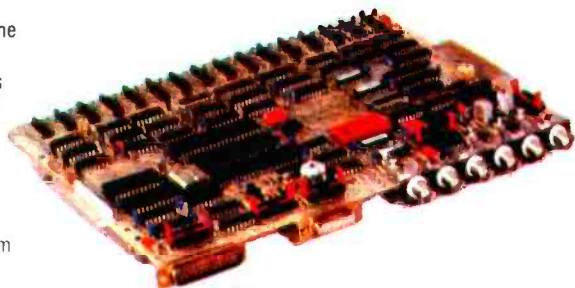
By virtue of the Picture Description Instruction (PDI) protocol used in Telidon Systems, images may be created from familiar graphic primitives such as points, lines, arcs and polygons. This same presentation level protocol is recognized as an international videotex standard and forms the kernel of the protocol selected by AT & T for their image communication networks. The use of an 8 bit data format, ASCII standard characters and RS232C serial communication, enhances the general purpose nature of the NORPAK display generator.

### Applications

The compact size and low power consumption of the basic module facilitates integration into a complete display unit which may include a monitor and other specialized communications interfaces. It may be used as a simple output device connected to a computer or may form part of a stand-alone workstation. Many users who have been introduced to the potential of color graphics, through low resolution mosaic displays, will enjoy the increased spatial resolution of the pixel oriented raster bit plane technology. Some of the many potential applications include:

- display generator for VIDEOTEX applications
- output device for system status in a process control environment
- business graphics generation
- student display for educational applications
- graphic artists sketchpad
- video games

This color display generator is available from stock for \$499.00 (U.S.) FOB Kanata, Ont., Canada. (Shipping and duty extra). For more information contact our sales office. (OEM discounts available).



# norpak

NORPAK LIMITED  
10 Hearst Way  
Kanata, Ontario  
Canada, K2L 2P4  
(613) 592-4164

NORPAK LIMITED  
Bridge Administration Building  
Suite 101  
Ogdensburg, New York  
U.S.A. 13669

Circle 305 on inquiry card.

prints all those ledgers. Each ledger entry contains a reference to the journal page and item number, so there is a complete audit trail back and forth; indeed, the whole thing looks exactly like the demonstration items given in *Myer's Accounting for Non-Accountants*, which ought to be no great surprise since that's what the programs were designed to do.

Now note: the programs do not give a lot of "special reports." They don't claim to do a darned thing that isn't covered in the Myer book (which is still in print, published by E. P. Dutton, 1980). But they do create books that look like what accounting texts expect, which was all I set out to do.

And since my business gets confused with my family's affairs, I've made it easy to segregate business from family expenditures (for example, cases where the kids come on business trips and thus have to have their expenses charged to a different

account from mine. That sort of thing).

I've used these programs since 1977. Eventually some of my friends asked for copies. Then more. Then I was asked to write up a little manual on how to use the programs, and while I was at it, why not include a brief treatise on what accounting is for and. . . .

It was getting out of hand, and one night over the slivovitz, Barry Workman got at me with an offer to publish the programs. "After all," he said, "they really are the best accounting programs you know of, aren't they?"

"No. Just the best for the kind of small business I operate. I don't know how good they'd be for an outfit that has lots of accounts receivable and accounts payable, or a big payroll."

"I use your accounting programs," Barry pointed out. "And so do a number of your friends. Consulting engineers and a couple of freelance

salespeople use it; you know, your programs produce standard ASCII files that can be manipulated to be the input to much more complicated routines if anyone wants more massaging than your stuff gives them."

And so forth. So eventually I agreed, and now I'm in the embarrassing position of reviewing my own software. All I can say on that score is that I do use the programs; they do work for my kind of small business. They are *not* heavy on accounts receivable and accounts payable; they're *far* more useful for recording expenses and income in complex ways than they are for controlling monthly billings. (Writers don't have monthly billings.) Given those limits, they are pretty good. They do make books that you can read and that your accountant will recognize. They preserve the audit trail, and they let you have as complex—or as simple—a chart of accounts as you like.

My mad friend tells me that my little treatise on why one keeps books in the first place is the only thing on that subject he's been able to make sense of; but do recall that he's quite mad.

### Use dBASE II Instead?

I described my accounting package to George Tate of Ashton-Tate, the outfit that distributes dBASE II and WRITE, and he recommended that I throw it away and build an accounting system out of dBASE II. I haven't done that and I'm not likely to, but I'll have to confess that I see his point. Every time I play with dBASE II I find something else to like about it; unlike some programs, this one wears well, and I think you really could construct a pretty good accounting system from it. In fact, I *know* you can because I've seen some of them in operation.

I also have Quickscreen, a "screen builder" program designed for use with dBASE II and Microsoft BASIC. I like Quickscreen. I asked George Tate about it, and he told me a number of his programmers like to use it when they're doing programs in dBASE II, which is a pretty powerful recommendation. Quickscreen lets you build up a form, such as a letter-

## COPIES WITHOUT PROBLEMS:

**FAST:** Turnaround time in hours and days, not weeks. You get your disks when you need them.

**ACCURATE:** Each copied track is checked bit by bit. If it doesn't match your original, it isn't shipped.

**FLEXIBLE:** Standard, double-boot, and copy-resistant formats. 50 copies minimum, no maximum.

**REASONABLE:** Set-up as low as \$10 per disk. Copying only from 30¢, copying and 3M disk from \$2.00. Other disks and services also available.

**RELIABLE:** Years of disk duplication experience insures a problem-free shipment on time — time after time.

For all your Apple® compatible copying needs.

## THE ALF COPY SERVICE.

**ALF**

1448 Estes

Denver, CO 80215

(303) 234-0871

head or a shipping label, or anything like that, which includes lines and permanent labels (such as "Bill To:" or "\*\*\*\*TOTAL\*\*\*\*") as well as variables. You then save the form on disk, and when you call it again, the form returns with values for the variables from a dBASE II file. It all looks very useful, and the manual seems reasonably clear. I confess I haven't done a lot of experimenting with Quickscreen, but people I respect use it with no trouble.

Next time, more on new hardware, including, I hope, the IBM Personal Computer. ■

## Software Reviewed

### Sorcim Corporation

405 Aldo Ave., Dept. A1  
Santa Clara, CA 95050

Supercalc CP/M \$295

### Cornucopia Software

POB 5028  
Walnut Creek, CA 94596

Microproof \$169  
correcting option \$60

### MicroPro International Corporation

1299 Fourth St.  
San Rafael, CA 94901

Spellstar (for Wordstar) Apple \$195

### Microsoft Inc.

10700 Northup Way  
Bellevue, WA 98004

BASCOM compiler for BASIC-80  
CP/M and Apple \$395  
TRS-80 Model I \$195

### Digital Research

POB 579  
Pacific Grove, CA 93950

CB80 compiler for CBASIC \$500

### Workman & Associates

112 Marion Ave.  
Pasadena, CA 91106

CBASIC Accounting 8-inch \$245  
for Non-Accountants single-density  
CP/M disk

### Fox & Geller Associates Inc.

POB 1053  
Teaneck, NJ 07666

Quickscreen for 56K-byte \$149  
FMS-80, dBASE II, CP/M  
CBASIC, Microsoft  
BASIC-80



## A Message to our Subscribers

From time to time we make the BYTE subscriber list available to other companies who wish to send our subscribers promotional material about their products. We take great care to screen these companies, choosing only those who are reputable, and whose products, services, or information we feel would be of interest to you. Direct mail is an efficient medium for presenting the latest personal computer goods and services to our subscribers.

Many BYTE subscribers appreciate this controlled use of our mailing list, and look forward to finding

information of interest to them in the mail. Used are our subscribers' names and addresses only (no other information we may have is ever given).

While we believe the distribution of this information is of benefit to our subscribers, we firmly respect the wishes of any subscriber who does not want to receive such promotional literature. Should you wish to restrict the use of your name, simply send your request to BYTE Publications Inc, Attn: Circulation Department, 70 Main St, Peterborough NH 03458. Thank you.

PERSONAL COMPUTER PERSONAL COMPUTER PERSONAL COMPUTER PERSONAL COMPUTER

## \*\* IBM PC USERS \*\*

**BABY BLUE:** Z80 card with 64K RAM lets you run CP/M® programs. RAM accessible by both Z80 and 8088. Fast, efficient, easy to install ..... \$600.

**BABY BLUE** with WORDSTAR and MAIL MERGE configured for IBM PC function keys. .... \$980.  
Free box 3M diskettes or head cleaner to first 100 orders for BABY BLUE.

### SEATTLE COMPUTER RAM FOR IBM PC

64K RAM + BD ..... \$418.  
128K RAM + BD ..... \$594.  
192K RAM + BD ..... \$770.  
256K RAM + BD ..... \$942.  
64K Chip Kit ..... \$176.

Each RAM card has an RS232 serial port which uses IBM supplied software.

WE EXPORT: Overseas Callers: TWX 710 588 2844, Phone 212 448-6298, or Cable: OWENSASSOC

# JOHN D. OWENS Associates, Inc.

12 Schubert Street, Staten Island, New York 10305  
212 448-6283 212 448-2913 212 448-6298

JOHN D. OWENS ASSOCIATES, INC. JOHN D. OWENS ASSOCIATES, INC. JOHN D. OWENS ASSOCIATES, INC. JOHN D. OWENS ASSOCIATES, INC. JOHN D. OWENS ASSOCIATES, INC.

JOHN D. OWENS ASSOCIATES, INC. JOHN D. OWENS ASSOCIATES, INC. JOHN D. OWENS ASSOCIATES, INC. JOHN D. OWENS ASSOCIATES, INC. JOHN D. OWENS ASSOCIATES, INC.



# 20,000 Programs For The IBM



# Baby CPU PLUS Blue

TM

FOR THE IBM PERSONAL COMPUTER



# Are Now Available Personal Computer!

## INTRODUCING BABY BLUE CPU PLUS

Baby Blue CPU Plus is an accessory printed-circuit board for your IBM Personal Computer and special software on disk.

As far as normal PC DOS operations are concerned, Baby Blue acts just like any other normal, mild-mannered 64K byte random-access memory board.

But when you invoke a CP/M-80\* program, Baby Blue becomes a second computer within your computer, letting you run thousands (literally thousands) of programs written for the CP/M microcomputer operating system.

CP/M, the first microcomputer operating system to gain wide acceptance, has been around since 1975. Not only has it played host to a lot of programs, but those programs are among the most useful, most sophisticated, most thoroughly tested and debugged, most proven programs ever written. More than 200,000 computers were field-testing those programs for you before the IBM Personal Computer even existed.

The total CP/M library is immense. It includes the best efforts of thousands of professional and advanced-amateur programmers. There are time managers, spreadsheet manipulators and professional-office packages. Languages — BASIC, of course, ALGOL, FORTRAN, C, Pascal, LISP, COBOL, PILOT, and FORTH, to name a few. Text editors, text formatters, full-blown word processors, spelling checkers and indexers. Utilities that will massage problem files so that they lie back and purr. Games, including chess, Reversi, Adventure and tournament-level Star Trek. Database managers. Accounting packages that can run a million-dollar business . . . Just about anything you can imagine.

The net result is an integration of CP/M programs into the PC environment that's so smooth, so transparent that you won't need to know or care which operating system a program was originally written for.

## Special Baby Blue Features:

- Z80B\* microprocessor running at 4.77 megahertz.
- Additional 64K memory; fully available to PC DOS — looks just like the IBM 64K board to the system.
- Will accept CP/M programs on any of several popular 5¼" soft-sectored diskette formats.
- 63K of user memory is available for CP/M programs — 7K more than on any other popular machine.
- Files can be shared — CP/M and PC DOS programs can be mixed in a menu-driven system with common data files.
- IBM Personal Computer peripherals are supported — including keyboard, video boards, printer, Asynchronous Communications Adapter.

**ONLY \$600**

Special option —  
Baby Blue bundled  
with WordStar\*  
and Mail-Merge . . . \$980

For only \$60 more than the cost of the IBM 64K Memory Board (\$540) you get 64K of Memory PLUS an interface to over 20,000 programs!

For more information call  
**(212) 247-1400**

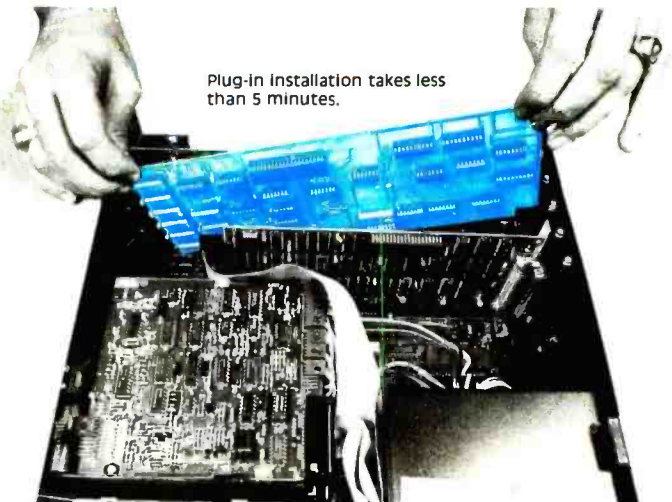
or write XEDEx Corporation  
1345 Ave. of Americas, New York, N.Y. 10105

Circle 442 on inquiry card.

WordStar\*  
and Mail-Merge  
are trademarks of  
MicroPro International  
Corporation.



WordStar\*, the popular CP/M word processor is among thousands of programs that can now be run on the IBM PC with Baby Blue.



Plug-in installation takes less than 5 minutes.

CP/M is a registered trademark of Digital Research.  
WordStar is a trademark of MicroPro International Corporation.  
Z80 is a trademark of Zilog, Inc.  
Baby Blue CPU Plus and Baby Blue are trademarks of XEDEx Corporation.

## PL/I for Microcomputers

John A. Lehman  
716 Hutchins #2  
Ann Arbor, MI 48103

PL/I was originally developed by IBM as the language of choice for the 360 computer series. As such, it was expected to replace FORTRAN, COBOL, ALGOL, and assembler language. The original PL/I was a huge language with more features than a hundred-blade Swiss Army knife. It was inconvenient because it required large chunks of expensive memory and considerable feats of recall on the part of programmers who were trying to remember its features.

Several years ago, ANSI (American National Standards Institute) issued PL/I standards for both a full and a subset language. The latter was

named the G subset and was intended for minicomputer use. It preserved all of the really useful features of full PL/I but cut it down to a manageable size. Implementations are available for most of the popular minicomputers and for any microcomputer that runs CP/M (version 1.4 or later) or MP/M.

Digital Research's PL/I-80 implements all of the level-G features except DEFINED, FLOAT DECIMAL, LIKE, ATANH, DATE, TIME, STRING, and VALID. DATE and TIME are operating system functions that are not supported by CP/M. FLOAT DECIMAL (binary-coded decimal floating-point arithmetic and data storage) is seldom used; FLOAT BINARY (which is supported) is used instead.

The linkage editor (LINK-80), which is included, supports overlays, indexed libraries, and Microsoft .REL files. This means that subroutines compiled under Microsoft FORTRAN, COBOL, and BASIC can be used by PL/I programs. (I can only vouch for the FORTRAN features because I don't have the other two compilers.) A version of the Digital Research MAC macro assembler (called RMAC), which produces relocatable code, is included; thus assembler subroutines can also be used. Assembler source libraries to access all CP/M and MP/M system features are included, as is an entire disk of sample programs. A .SYM file is generated, so Digital Research's

SID (a symbolic debugger) can be used for debugging with symbolic constants.

### Performance

As a combined scientific, business, and system programming language, PL/I isn't as elegant as Pascal or as easy to use as BASIC. It does provide most of the facilities of FORTRAN, COBOL, ALGOL (Pascal), BASIC, and assembler language in a form that encourages structured programming. Generally, programs written in PL/I are much more understandable than those written in BASIC, FORTRAN, COBOL, or assembler language (see listing 1). PL/I is not as clear as Pascal, but it has much better facilities for file management and system programming. Its primary advantage as a programming tool is that you can do *all* of your programming in one language.

This advantage is especially apparent to those of us who use several different computers. I can write a single program in PL/I and run it on my Z80 at home or on the Amdahl, Honeywell, or IBM Series/1 at work. My wife can write programs at home and run them on the IBM 370 OS/VS2 system at work. Any of these programs can also be run on an 8086, a PDP-11, and a NOVA, among others. The only other languages that allow such transportability are FORTRAN and COBOL. I'm allergic to COBOL, and although FORTRAN is my native computer

### At a Glance

**Name:** PL/I-80

**Type**

High-level-language system

**Manufacturer**

Digital Research  
POB 579  
Pacific Grove, CA 93950

**Price**

\$500 (\$35 for documentation alone)

**Format**

Two 8-inch floppy disks (other formats available)

**System Requirements**

CP/M version 1.4 or higher, MP/M, 8080,8085, or Z80 processor with 48K bytes of memory and two 8-inch disk drives (an 8086 version is also available)

**Documentation**

Language manual, operator's guide, applications guide, and pocket reference guide.

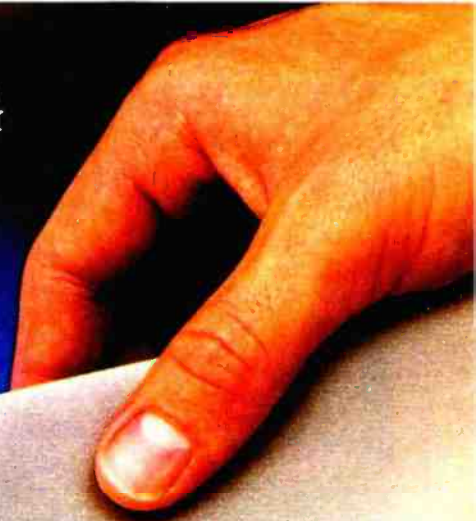
**Audience**

Language enthusiasts, applications and system programmers



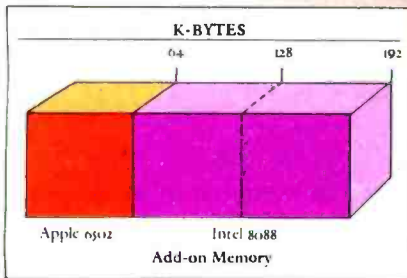
# INTRODUCING MetaCard

## The future for your Apple II.



MetaCard will turn your Apple II personal computer into tomorrow's high performance machine. It triples the memory of your Apple, and at the same time, greatly increases the processing speed with an Intel 8088 16-bit microprocessor. The future for your Apple is built into MetaCard.

**Enough Memory to get the Job Done**  
MetaCard has up to 128K bytes of onboard memory with parity. Adding



MetaCard to your Apple's existing 64K bytes of memory gives you three times the capacity, and opens the

door to applications never before possible on your system.

### Faster Processing Speeds

Speed is just as important as memory. MetaCard is designed to handle all computing tasks at greatly increased speeds. The Intel 8088 operates at the full 5Mhz, running most applications at least 4 times faster than the Apple's 1Mhz 6502. And MetaCard gives you multiprocessing capabilities, allowing both the 8088 and 6502 to run simultaneously at full speed. Increased processing speeds, interprocessor interrupts and a real-time clock enable your Apple to perform like the machine you want.

### Compatibility and Reliability

Compatibility has been designed into MetaCard. Metamorphic's processor card runs CP/M-86, which is included with the card at no extra cost. And Metamorphic offers UCSD Pascal 4.0 and the operating system for the IBM Personal Computer as options. Full parity checking,

power-up diagnostics and a 48 hour burn-in will insure the reliable

performance of your MetaCard.



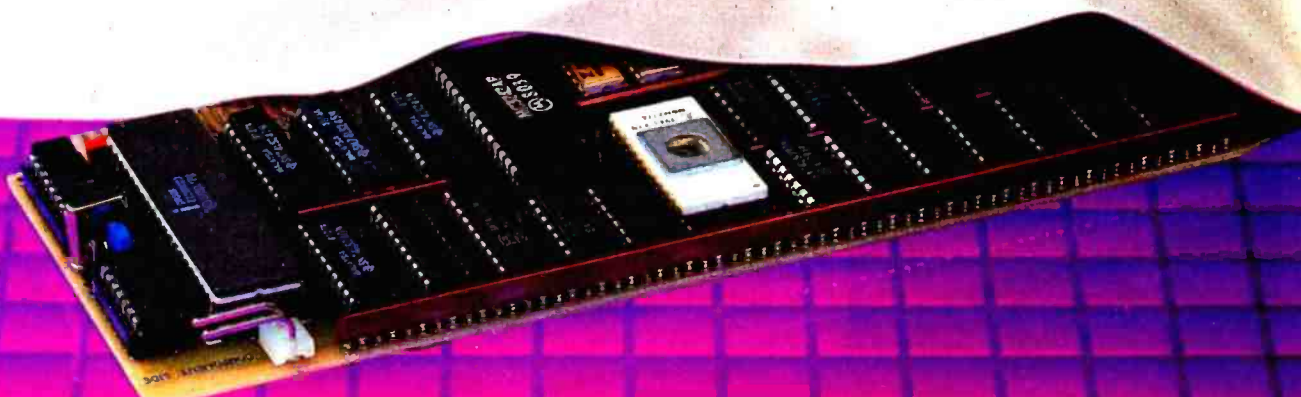
### Find Out More

Not everyone needs greater memory and speed. If you're one of those who does, MetaCard is for you. At an introductory price of \$980 for the 64K configuration, it's

not the least expensive addition you can make to your system, but high performance products never are. Call us today and find out what Metamorphic Systems has in mind for your Apple's future. Dealer inquiries welcome. Metamorphic Systems, Inc., P.O. Box 1541, Boulder, Colorado 80306, (303) 499-6502.

Intel 8088 is a product of Intel Corporation.  
Apple II is a registered trademark of Apple Computer Inc.  
CP/M-86 is a registered trademark of Digital Research Corp.  
IBM Personal Computer is a registered trademark of IBM.  
U.C.S.D. Pascal is a registered trade mark of the University of California.

## METAMORPHIC SYSTEMS, INC.



# Sinclair Owners...

## Expand Yourself! I/O Capability for Your ZX-80, ZX-81.

### ■ 8 Port I/O Board

Special adapter cable mates to Sinclair edge connector.  
Feed-thru accepts Sinclair 16K memory module.

Buffered address lines.

Separate power supply.

I/O command with one line of BASIC.

8-Port bus.

I/O \$109

### ■ A/D and D/A

16-pin cable connects to micro developments I/O bus.

2 channels; A/D, 0-5V input—  
D/A, 0-1V output. AD \$97

### ■ Clock

16-pin ribbon cable connects to micro developments I/O bus.

Switchable 0.1 or 1 sec resolution.

Manual or computer control.  
Beeper. SC \$75

Complete operating instructions and technical documentation included. \$5.00 handling charge on all orders.

### ■ CALL TOLL FREE

800-227-1617 operator 641  
(CA, 800-772-3545  
operator 641),

These numbers for credit card orders only. For information, write us at:

Box 1140  
2000 Center St.,  
Berkeley,  
CA 94704.

**micro  
developments**

**Listing 1: The HYPOCY program.** This sample program shows the easily understood structure of a PL/I program. The program will draw the curves traced by a point on a circle while that circle is rolling internally on the circumference of another circle.

```
hypocy:
proc options(main);
/* Plots hypocycloid onto Microchroma 68 */
/* graphics board using raster addresses which*/
/* is set up as cp/m punch device. */
/* polypx and initgr are separately compiled (assembled) */
/* routines to send groups of dot coordinates and */
/* to initialize the graphics hardware respectively */
dcl initgr entry,
    polypx entry (fixed,{0:255} fixed,{0:255} fixed);

dcl
(x,y,theta,temp1,temp2,temp3) float,
(sines{0:255},cosines{0:255}) float,
(i,ix{0:255},iy{0:255},count) fixed;

dcl
forty fixed initial(40),
one_hundred fixed initial(100),
seventy_five fixed initial(75);

call initgr;
count=255;

circle:
do i=0 to count;
temp3=float(i);
theta=temp3/40;
sines(i)=sin(theta);
cosines(i)=cos(theta);
x=cosines(i)*seventy_five+one_hundred;
y=sines(i)*seventy_five+one_hundred;
ix(i)=fixed(x);
iy(i)=fixed(y);
end circle;
call polypx(count,ix,iy);

hypo:
do i=0 to count;
temp3=float(i);
temp1=cosines(i);
temp2=sines(i);
x=temp1*temp1*temp1*seventy_five+one_hundred;
y=temp2*temp2*temp2*seventy_five+one_hundred;
ix(i)=fixed(x);
iy(i)=fixed(y);
end hypo;
call polypx(count,ix,iy);
end hypocy;
```

language, it's not suitable for non-numeric or data-intensive programming.

So much for why you should use PL/I. How well does it work? Table 1 compares run times (in seconds on a 2-MHz Z80) for PL/I-80, Microsoft FORTRAN, and X BASIC (TDL/Xitan Extended Disk BASIC). The test programs were basically textbook examples, iterated enough times to make timing feasible. X BASIC is included to show how an interpreter compared with the compilers.

One hidden "gotcha" showed up in the tests. PL/I interprets numeric constants as fixed decimals and converts them to fixed binary-coded decimals each time arithmetic operations involving the latter are performed. Thus, using constants (rather than variables which have been set to a desired value) will increase the dura-

tion of execution by as many as fifty times.

In practice, the only time slow run speeds have presented a problem with PL/I has been during interactive video graphics. Otherwise, a floppy-disk-based system is usually so badly disk-bound that the efficiency of the code produced by the compiler doesn't matter much. This characteristic is slightly irritating because both the compiler and the linker make heavy use of the disks; consequently, long programs can take more than five minutes to compile or link. A hard disk would presumably help this. Even so, PL/I-80 and Link-80 work faster with floppy disks than their IBM Series/1 equivalents do with hard disks. They have fewer bugs too.

Version 1.3 of PL/I-80 appears bug-free; at least I haven't found any.





# “WHAT IF...”

Seldom is your first solution to a problem the only one, or the one that's necessarily best to use.

That's why our VisiCalc® program is #1 in the business: the most widely-used business program ever for the personal computer.

It's a powerful “electronic worksheet” that takes the work out of working with numbers. Whether you are working with investments, cash flow, inventory, estimates, budgets, plans—nearly anything numerical, the VisiCalc program will help you work better, smarter, faster.

In just seconds, the VisiCalc program can calculate and display the answers to involved problems you could have spent hours doing by hand.

Its speed and versatility makes it easy for you to explore more alternatives. You can ask “What if?”... just change any number in your problem and instantly, the VisiCalc program recalculates all the numbers and displays the new results. So you can

readily analyze the impact of decisions before you make them.

While the VisiCalc program does a lot by itself, it can do even more for you when used with the other Visi™ programs. That's because they're all inter-related, just like your needs and tasks, to give you a fully integrated solution. For example, automatically bring in data stored in our VisiFile™ program—such as customer or inventory information—for calculation and analysis with your VisiCalc program.

In addition, our series includes the VisiTrend/Plot,™ VisiSchedule,™ VisiDex,™ VisiTerm,™ VisiPlot,™ and Desktop/PLAN™ programs.

Ask your retail computer store salesperson for a demonstration of the VisiCalc program. Discover how easy it is to take the work out of working with numbers.

VISICALC™ FROM  
VISICORP™  
PERSONAL SOFTWARE™





	PL/I	FORTRAN	XBASIC
10,000 iterations	0.5	0.3	20.8
10,000 fixed-point additions	0.9	0.5	NS
10,000 fixed-point multiplications	6.8	0.5	NS
10,000 floating-point additions	10.0	8.4	48
10,000 floating-point multiplications	15.5	14.9	57
10,000 dummy subroutine calls	0.6	0.6	42
10,000 cosine calculations	35.0	23.0	63

Table 1: The results, in seconds, comparing various languages' performance of standard functions on a TDL/Xitan S-100 system with the Z80 running at 2 MHz. The languages were Digital Research's PL/I-80, Microsoft FORTRAN, and XBASIC (TDL/Xitan Extended Disk BASIC). (NS indicates function not supported.)

Earlier versions had problems that were quickly remedied. Version 1.1 (a major upgrade) was sent out free of charge on disk. Version 1.2 was distributed in the form of a free patch sheet. Version 1.3 (with more upgrades) was available for \$25 on disk to owners of the earlier versions.

### Conclusions

The current version of PL/I-80 provides a nearly full ANSI level-G system with excellent facilities for linking and overlays. The file format is compatible with Microsoft compilers and thus allows use of existing program and subroutine libraries

with PL/I. Full access to CP/M and MP/M facilities is also provided.

PL/I is a more powerful language than FORTRAN, COBOL, Pascal, or BASIC. This implementation allows access to all commonly used features of PL/I. It's intended to facilitate both applications and systems programming. The current version for microcomputers is remarkably bug-free and is source-compatible with the dialects used on many mini- and mainframe computers. Thus, users can take advantage of existing software or develop software for larger machines on CP/M-based systems. The existence of an 8086 version promises continued compatibility with more powerful hardware.

Support from Digital Research is excellent. The only difficulty commercial users will encounter is the necessity of licensing use of the runtime library in third-party software products. This is offset by Digital Research's assistance program for OEM customers. ■

SAVE \$\$

# DISCOUNT PRICES

SAVE \$\$




**APPLE COMPUTER SYSTEMS SOLD ONLY IN STORE. CALL FOR PRICES.**

**RAM MEMORY**  
FOR TRS-80, APPLE II  
16K SET 4116's (200 NS) 24.95

**General Information:**  
We carry a large selection of hardware and software by other companies. Send for our catalog.  
We are an authorized repair center for **APPLE, ATARI, NORTH STAR, AND EPSON.**




400 16K	349.00
800 16K	699.00
410 Recorder	89.00
810 Disk	449.00
822 Printer	359.00
825 Printer	779.00
830 Modem	159.00
850 Interface Module	179.00
CX853 RAM	89.00
CX70 Light Pen	64.00
CX30 Paddle	18.00
CX40 Joystick	18.00

**VERBATIM DISKETTES**

Box of 10 5 1/4"	29.50
Box of 10 8"	39.50




ADV-2Q-64K	3150.00
ADV-1Q-64K-HD-5	5195.00



HRZ-2Q-64K	2795.00
HRZ-1Q-64K-HD-5	4695.00
HRZ-1Q-64K-HD-18	6295.00
5 MB HARD DISK	2350.00
18 MB HARD DISK	4195.00

**PRINTERS**

<b>EPSON</b>	
MX-70	299.00
MX-80	469.00
MX-80 F/T	569.00
GRAFTRAX	90.00
INTERFACE (APPLE)	75.00
CABLE (APPLE)	22.50
<b>IDS</b>	
560G	1450.00
PRISM	1795.00
<b>NEC</b>	
3510 35CPS	1995.00
7710 55CPA	2650.00
8023A	599.00
<b>OKIDATA</b>	
MICROLINE 80	389.00
MICROLINE 82A	549.00
MICROLINE 83A	849.00
MICROLINE 84	1245.00
<b>C.I.T.O.H.</b>	
STARWRITER 25CPS	1595.00
STARWRITER 45CPS	2195.00
FORMS TRACTOR	275.00

PRICES SUBJECT TO CHANGE WITHOUT NOTICE. MARYLAND RESIDENTS ADD 5% SALES TAX

## FREDERICK COMPUTER PRODUCTS, INC.

5726 INDUSTRY LANE

**TO ORDER CALL:**  
**(301) 694-8884**

**Store Hours:**  
MON. THRU THURS. 9:30 AM-9:00 PM  
FRI. AND SAT. 9:30 AM-5:00 PM

**FREDERICK, MD. 21701**

Introducing . . .

# THE TEC-86 SERIES OF 16 BIT MICROCOMPUTER SYSTEMS

## TEC-86 — COMPLETE 16 BIT 8086 MICROCOMPUTER SYSTEM — \$4390

### FEATURES

- Two 8 Inch DD Floppy Disk Drives (1.2 MB Total)
- ROM Boot for MP/M-86™
- 64K Bytes of Memory
- Vectored Interrupts
- 16 Bit 8086 CPU
- Heavy Duty Power Supply
- IEEE 696 S-100



- Two RS232 Serial Ports
- Baud Rates from 50 to 19200 Baud
- Independent Baud Rate for each Serial Port
- 24 Parallel I/O lines (Three 8 Bit Ports)
- Attractive Industrial Quality Enclosure

### TEC-86M4 — \$7595.

FOUR USER TEC-86 SYSTEM WITH 1/2 MEGABYTE OF MEMORY

### TEC-86W — \$10990.

TEC-86 SYSTEM WITH WINCHESTER 31 MegaBYTE HARD DISK

ONE YEAR WARRANTY

### TEC-86M4W — \$12990.

FOUR USER TEC-86 SYSTEM WITH 1/2 MEGABYTE OF MEMORY AND 31 MegaBYTE WINCHESTER HARD DISK

## TEC-86 OPTIONS

- CP/M-86™ Single User Operating System
- MP/M-86™ Multi-User Operating system  
Concurrent File Access File Password Protection  
File Time and Date Stamping Print Spooling
- Additional Memory, 64K and 256K byte increments up to a system total of one full Megabyte
- Languages  
BASIC-86™, FORTRAN-86™, PASCAL-86™, CBASIC/86™, PASCAL/M86™, FORTH, CIS-COBOL and other High Level Languages
- Double sided double density floppy disks (2.4 MB total)
- 31 Megabyte Winchester Hard Disk
- Attractive Wood Grain Desk Top Enclosure
- Rack Mounted enclosure
- Alphanumeric terminals (80 chars x 24 lines)
- Matrix, correspondence quality, letter quality, and graphics printers

## ANALOG TO DIGITAL      DIGITAL TO ANALOG DATA ACQUISITION AND CONTROL BOARDS AND SYSTEMS

### APPLE A/D \$695 w/Timer-Counter

ANALOG TO DIGITAL Converter with Timer/Counter

12 Bit Accuracy, 16 Channels, 30 KHz Conversion, Three programmable Timer/Counters to:

- Trigger Conversions
- Count Conversions
- Count External Signals
- Count Bus Clock

Options: Programmable Gain; 14, 16 Bit Accuracy; 40, 100, or 125 KHz; Expansion to 256 Channels

### DIGITAL TO ANALOG CONVERTERS

12 Bit Resolution  
3 Microsecond Conversion  
Jumper Selectable Outputs  
±2.5V, ±5V, ±10V, 0 to +5V, 0 to +10V

Each operates independently  
Each DAC holds previous value until an entire new word is presented to it  
Fully assembled and tested

### \$100 A/D \$765

### Analog to Digital Converter with Timer/Counter

12 Bit Accuracy, 16 Channels, 30 KHz Conversion, Five Programmable Timer/Counters for:

- Time of Day
- Triggering Conversions
- Counting Conversions
- Counting External Signals
- Interrupting the CPU

Options: Programmable Gain; 14, 16 Bit Accuracy; 40, 100, 125 KHz Conversion; Expansion to 256 Channels

### OTHER FINE \$100 and APPLE PRODUCTS AVAILABLE, INCLUDING:

ANALOG to DIGITAL CONVERTERS (12, 14, 16 bit accuracy, 30, 40, 100, 125 KHz Conversion rates, 16 to 256 Channels, programmable gain, timer/counters). DIGITAL to ANALOG CONVERTERS (12 bit accuracy, 3 microsecond conversion rate). 8086 CPU Board, I/O Boards 64K/256K Memory Boards, Real-time Video Digitizer and Display. Complete Systems also available for Data Acquisition, Video Digitization, and General Purpose Applications. Circle 409 on inquiry card.

REQUEST OUR CATALOG FOR COMPLETE LISTING, AND SPECIFICATIONS ON THE ENTIRE TECMAR PRODUCT LINE.



DEALER INQUIRIES INVITED

23600 Mercantile Rd. • Cleveland, OH 44122

TECMAR, INC.

(216) 464-7410

## Apple II 80-Column Video Boards Five Popular Units

---

John E. Howland  
Vanguard Systems Corporation  
6901 Blanco Rd.  
San Antonio, TX 78216

---

The Apple II computer's video-display section was designed with an ordinary television set in mind. This design choice limited the Apple's screen to 40 characters per line because of the limited resolution of ordinary color television sets. Of course, this arrangement allowed Apple II users the option of using their home television set, rather than requiring them to purchase a more expensive video monitor or terminal. However, as the popularity of the Apple II grew, software developers began to write programs that made applications such as accounting and word processing possible. These applications often require a professional-quality 80-character-per-line display. It's not surprising, then, that several enterprising manufacturers have developed Apple II interface cards to provide the more or less standard 24 lines of 80 uppercase and lowercase characters. (See photo 1, page 256.) I have reviewed five popular interface cards, Omnivision, Full-View 80, Smarterm, Sup'R'Terminal, and Videoterm, and this article surveys their characteristics and compares their features.

All the 80-column boards use a large-scale integration (LSI) device, either Motorola's 6845 or Synertek's 6545, as the "heart" of the display circuitry. Because of this, you might think that the boards would be very similar, but each has different features, and they are not entirely compatible with one another or with the standard Apple II software. Yet they do have features in common: all generate uppercase and lowercase characters and require a good-quality black-and-white monitor (not a black-and-white or color television set) for best results. (See the text box "A Fast Scan of Video Monitors," page 254.)

### Accessing the Boards

All the boards are accessed by using the standard Apple II conventions for getting at peripheral devices. For example, the familiar PR#*n* instruction, where *n* is the slot number of the peripheral device, can be used to activate the video boards. The Apple II permits only one peripheral device to be active at a time, so this can pose some difficulties if the board is intended to be used simultaneously with a modem (or serial interface, etc.). Another important consideration is that each board interprets certain control characters as commands to perform special functions. These control characters usually cannot be used by programs for other purposes. Moreover, Integer BASIC does not have the CHR\$ function required to generate the control characters.

Characters are formed on the video display as a matrix of dots within a field of fixed size. (See photo 2, page 257.) Common character sizes are 5 by 7 or 7 by 9 dots. As an example, a character may be formed from a table of dots having 5 columns and 7 rows, within a field of 6 columns and 13 rows. The unused rows and columns in the field provide the spacing between characters on a line and between lines of characters. The lowercase characters *g*, *j*, *p*, *q*, and *y* are generally easier to read when they are allowed to extend down into the lower rows.

Usually, 7 by 9 dot characters can be made to have a more pleasing appearance than 5 by 7 dot characters, due to the higher resolution; however, this may not be apparent unless a higher-bandwidth monitor is used. I suggest that you test the video board with the monitor you intend to use to ensure acceptable character appearance.



# The HiNet™ Local Area Network

## Because man was not meant to work alone

HiNet is the best way yet to get everybody in your company working together. A HiNet desktop work station puts each person in touch with what everybody else in the office is doing – for little more than the cost of a good typewriter.

### "HiNet takes the time out of sharing."™

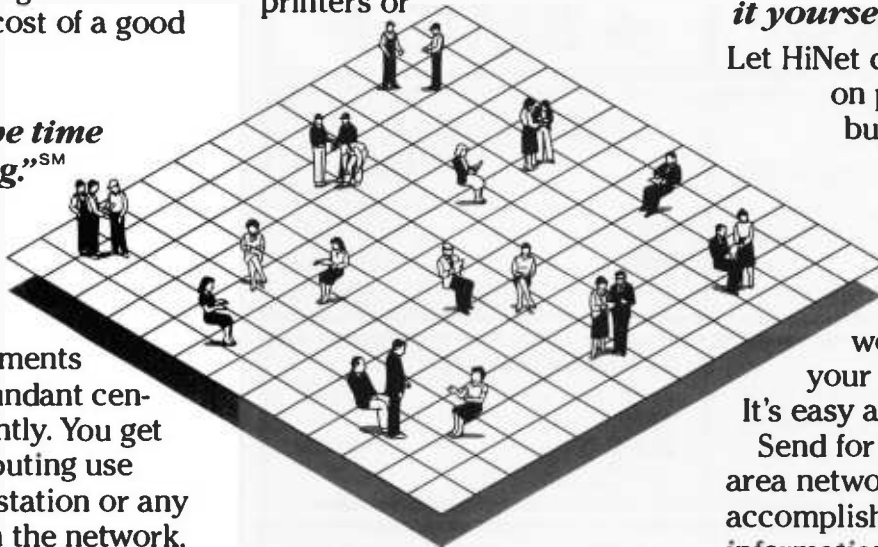
Put an end to big-computer backlogs and share data with different departments – or access abundant central files – instantly. You get maximum computing use from your own station or any other station on the network. And you can *print* on any one of the network's shared printers. There's no need to leave your desk or wait for someone else to assist you!

### No growing pains. Period.

Here, at last, is a system you can't outgrow. With HiNet you can start as small as just two work stations. Add up to 30 stations anywhere you want within your building. And since each low-cost station is a complete computer – not just a terminal – additional stations don't tax the system. They add to its capability.

### The friendliest system ever.

HiNet is so compatible that you can enjoy this advanced network technology and continue to use terminals, printers or



other peripherals you may already have.

HiNet is *hardware and software* – a complete local area network. Advanced systems' utilities provide the utmost in both data

security and system integrity. So advanced, yet HiNet can use virtually any CP/M® applications software program in the world.

### So simple you can plan it yourself.

Let HiNet demonstrate itself on paper before you buy with the Local Area Network Planning Kit. The Kit will show you how to lay out a network according to your office floor plan. It's easy and it's free!

Send for it. See how a local area network can help you accomplish more – and share information – more easily and efficiently than ever before.



**Digital Microsystems**

NOW WITH THOUSANDS OF INSTALLATIONS AROUND THE WORLD.



### Free Network Planning Kit

Please send me a Local Area Network Planning Kit so I can have a clearer understanding of how a local area network could work for me. I have checked the box below that best describes my facility.

- 1,000-2,500 Square Feet
- 2,500-10,000 Square Feet
- 10,000-30,000 Square Feet
- I am a Systems Dealer. Please send ISO/OEM information.

PLEASE PLACE YOUR BUSINESS CARD HERE

**Digital Microsystems** 

Corporate Offices: 1840 Embarcadero, Oakland, CA 94606 (415) 532-3686 TWX 910-366-7310  
England & Europe: Extel House, East Harding St., London EC4P-4HB 01-353-1080 Telex 23721

### HiNET IS COMPLETE HARDWARE AND SOFTWARE LOCAL AREA NETWORK TECHNOLOGY.

HiNet utilizes 8 or 16 bit processors in single board or Multibus™ configurations; advanced memory management and data storage; high-speed local network data and telecommunications; real time processing redundancy and back-up capabilities; multi-level data security provisions; end-to-end diagnostics and automatic error correction routines; international support and comprehensive training. Specially dedicated stations: print spool, telex or voice store & forward, and graphics. For a catalog and complete specifications contact Digital Microsystems.

CP/M is a registered trademark of Digital Research. Multibus is a trademark of Intel Corporation.

# MICROMAIL OFFERS THE LOWEST PRICES AND PERSONAL SERVICE.

## DEC LA 100

DUAL MODE  
MATRIX PRINTER  
CALL FOR PRICE!

★ **NEW** ★

## LIMITED STOCK

**\$499.00**

TEC 511 CRT

★ **SAVE** ★

**SPECIAL**

## DEC

LA 34 DA...\$849.00

DEC LA 120KSR....\$2049.00

VT 100 .....\$1399.00

VT 101.....CALL

VT 131.....\$1499.00

## TELEVIDEO

910 .....\$569.00

912 .....\$689.00

920.....\$725.00

950.....\$939.00

925.....**NEW!**.....CALL

## ANADEX

DP 9500 .....\$1149.00

DP 9501 .....\$1149.00

DP 8000 AP.....\$749.00

**SPECIAL**

## TEXAS INSTRUMENTS

810/2 .....\$1299.00

(includes upper/lower case option)

810/2 VFC/CP .....\$1499.00

(includes u/1 case, forms control & compressed print)

## LETTER QUALITY PRINTERS

### DIABLO

• 630 RO

**\$1949.00**

• 630 KSR... CALL

• 620 ..... CALL

• 1640 ..... CALL

### QUME

• SPRINT 9/45

**\$1849.00**

• SPRINT 9/35

CALL FOR PRICE

### NEC

• 7700 SERIES

• 3500 SERIES

**CALL FOR OUR**

**LOW PRICES**

### "PORTABLES SPECIAL"

T.I. 745 .....\$1399.00

T.I. 743KSR .....\$849.00

★ **NEW 3M WHISPER WRITER**

**CALL FOR PRICE!**

**SPECIAL**

### TELETYPE 43

**PF(TTL) \$899.00**

**CALL TOLL FREE (800) 854-6028**

To Order: Send check to MICROMAIL, P.O. Box 3297, Santa Ana, CA 92703. Personal or company checks require two weeks to clear. Visa/MasterCard accepted. C.O.D. requires a 15% deposit. **Handling:** Add 3% to C.O.D. or credit card orders. Add 5% to 15% deposit on C/C and balance C.O.D. **NOTE:** Handling charges are waived on orders pre-paid in advance by check. **Shipping:** We ship **FREIGHT COLLECT** via UPS or Motor Freight. Air and Express delivery is available. Prices subject to change without notice.

## WE SELL INTERNATIONALLY

**MICROMAIL**

P.O. Box 3297  
Santa Ana, CA 92703  
Phone: 714/731-4338  
TWX: 910 595 1146

## A Fast Scan of Video Monitors

The video image produced by the Apple II and many other personal computers is called a raster-scan display. The image is made up of several hundred horizontal lines of several hundred tiny dots. In a normal television picture, there usually are 262 lines per frame and fewer than 200 dots per line. This allows fewer than 40 characters per line, with a 5 by 7 dot matrix. Lines of dots are displayed at the rate of 15,750 lines per second, so the video bandwidth would be 200 times 15,750 Hz, or about 3 MHz.

**Try a test  
run before  
you buy**

To display a line of 80 characters in a 7 by 9 dot-matrix format would require about 800 dots per line and a video bandwidth of 12 MHz (18 MHz is not uncommon in expensive units).

Some of the video boards in this review generate acceptable images only on monitors. This means that buying an 80-column board may also necessitate the purchase of a monitor, unless you already have one with enough resolution and bandwidth. Monitors are available through most computer dealers, but stick to name brands such as Hitachi, Amdek (formerly known as Leedex), Motorola, NEC Home Electronics, Panasonic, Zenith, etc.

If you have a monitor but are unsure of its suitability for use with the board you have selected, try a test run in a dealer's showroom before you buy. Keep in mind that some of these 80-column boards use more of the video field, so the height and width controls may need to be adjusted.



# Don't gamble with your business!



## Invest in an M System

"Okay, which entry-level, single-user microcomputer should I own?"  
**The BOS M System.**

"Which multi-user system should I own?"

**The BOS M System.**

"If I want a larger system with the ultimate in performance and capacity, what should I own?"

**The BOS M System Multiprocessor.**

"How much more does it cost to own a single-user set-up and upgrade it, than to start with a larger system?"

**Not a penny more.**

"Can I have diskette, tape, and large rigid disk storage?"

**Yes.**

"How about really good accounting software?"

**The MBSI\* package (GL, AR, AP, PR, OE/INV, Sales Analysis — all in Cobol) is probably the best available on any system...this is one you have to see to believe.**

"How about Word Processing?"

**WordStar†‡, and others.**

"Can I run all the other software I've seen?"

**Yes, if it's CP/M\*\*\* compatible, almost certainly!**

"Will I have to change the operating system when I expand?"

**No, with BOS/TURBODOS\*\*\*\*, just upgrade it.**

"Well, this is important...will service be available when I need it?"

**Yes, with a large dealer network, strategically placed maintenance depots, and fast factory repair turn-around.**

"Sounds great! But isn't it too good to be true?"

**No...and it's not even expensive!**

**So, why take a chance with somebody else?**

"Okay, how can I get one?"

**Contact your dealer, systems house, or consultant — or call us toll-free!**

**Dealer and OEM  
Inquiries Welcome**

# BOS

Circle 55 on inquiry card.

**Business Operating Systems, Inc.**  
2835 East Platte Avenue  
Colorado Springs, Colorado 80909  
In Colorado Call: (303) 634-1541  
Toll Free Number: 1-800-525-3898  
**TELEX 45-0647 BOS CSP**

APPLICABLE INDUSTRY STANDARDS: S-100 IEEE 696 • RS 232, HDLC, SDLC, Async, Sync • CP/M;\*\*\* TURBODOS\*\*\*\* • 8" soft sectored diskettes • ANSI X3/B5/15 Tape Cartridge

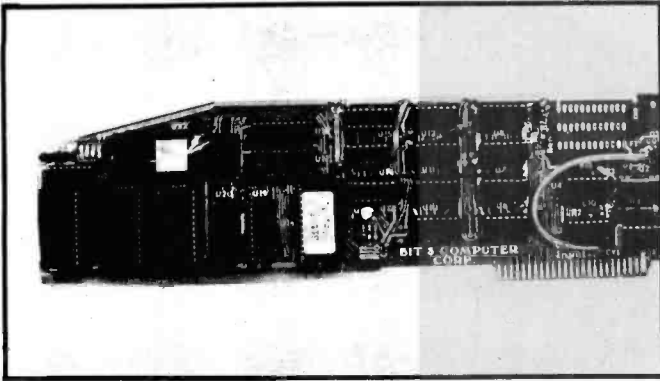
\*Micro Business Software, Inc. • \*\*Trademark of Micropro Int. Corp., San Rafael, CA • \*\*\*Registered Trademark of Digital Research • \*\*\*\*Software 2000, Inc.

[www.americanradiohistory.com](http://www.americanradiohistory.com)

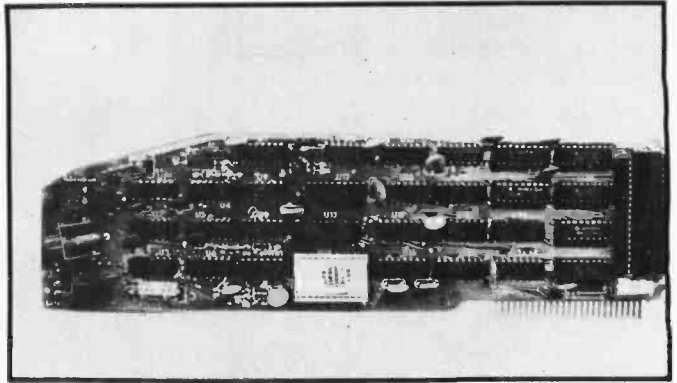


**Photo 1:** Five 80-column video-interface boards for the Apple II computer. The photos are Full-View 80 (1a), Omnivision (1b), Smarterm (1c), Sup'R'Terminal (1d), and Videoterm (1e). Features vary, but most users will need a video monitor to appreciate the full quality of the displays produced.

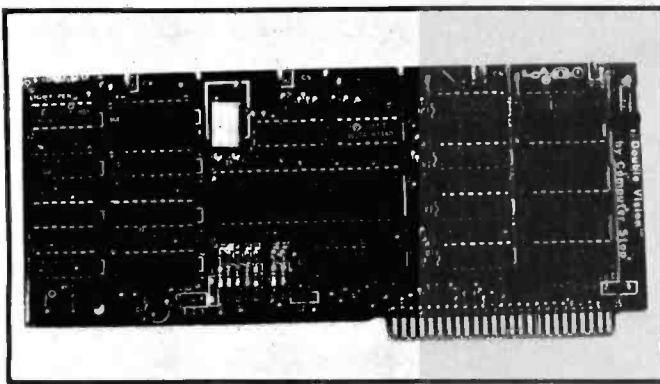
1a



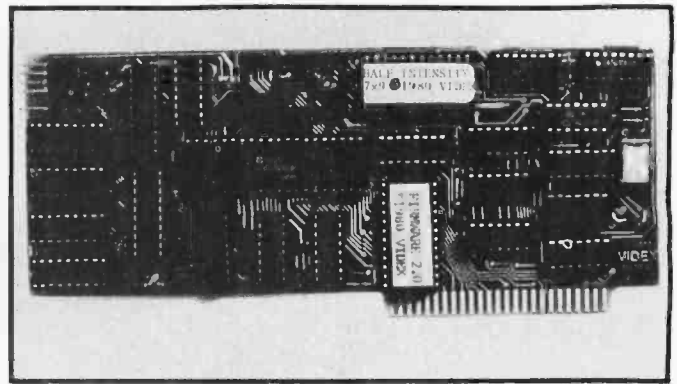
1d



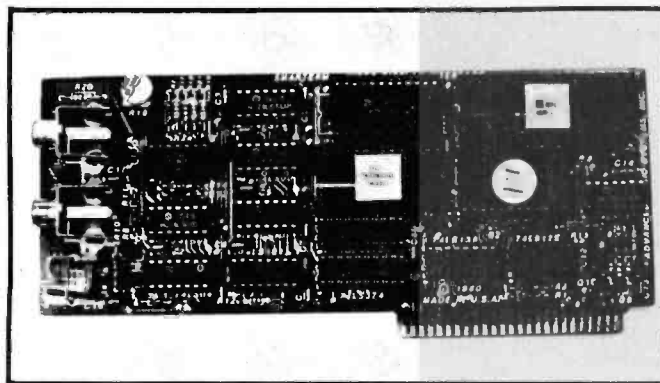
1b



1e



1c



All the boards store the character-dot tables in a read-only memory (ROM). Full-View 80, Sup'R'Terminal, and Videoterm allow an alternate character set to be selected from another ROM or from programmable memory. The alternate character set can be used for foreign languages or for special graphics characters. This is an important feature when special character fonts are needed for word processing or a programming language such as APL.

### Compatibility

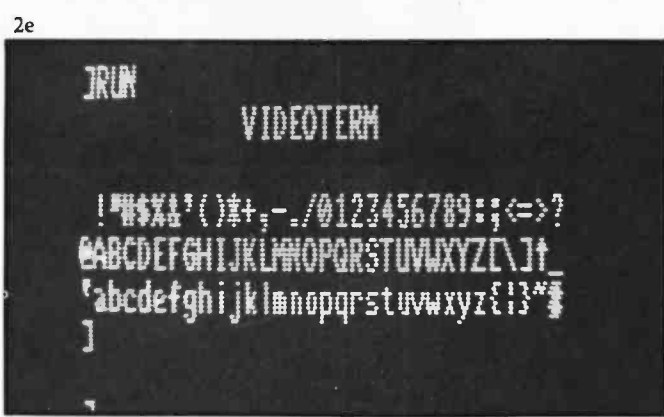
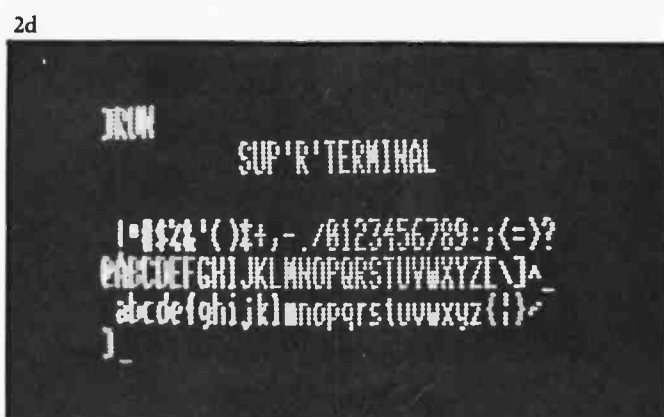
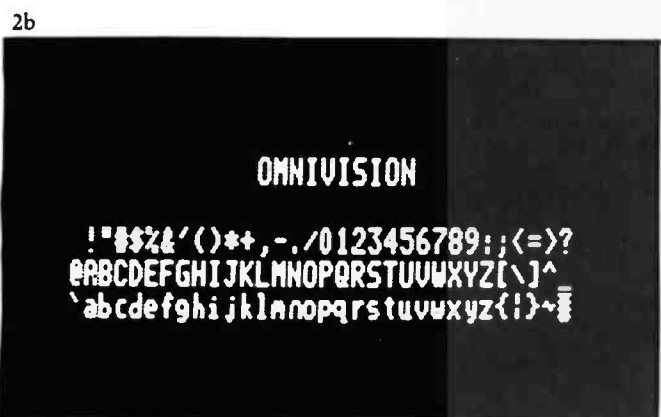
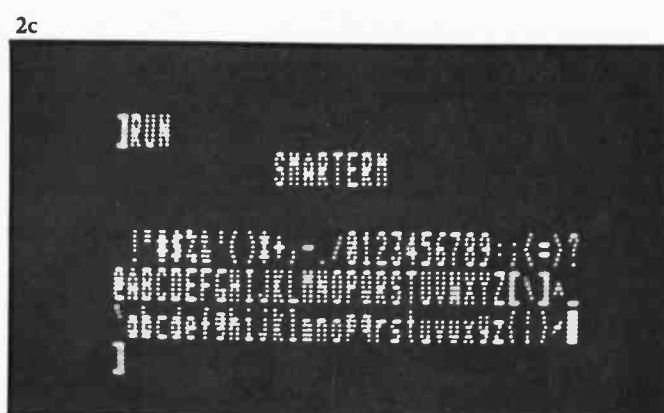
In selecting a video board, software compatibility must be considered, particularly if you plan to use the board

with off-the-shelf software packages. Many word-processing packages are customized for specific 80-column boards. If you are already using a particular word processor, you may want to be sure that a version of that program is available for the video board you intend to use. Most dealers can demonstrate the operation of programs with the video board. If a dealer is reluctant to demonstrate a particular program running with a given video board, beware; there may be a problem with that combination.

Program-compatibility problems are usually the result of two conditions: difference in display size and difference in control functions. For example, HOME, VTAB (vertical tab), and INVERSE (black on white) commands are not supported by all the boards. None of the boards reviewed here supports the Flash Mode of the standard Apple II video display. All offer some support for Pascal.

When the system is initially loaded, the Pascal-language system examines interface-slot 3 for a peripheral card. If an interface card is present, the Pascal system attempts to use that interface as its console device. The video boards, therefore, must be placed in slot 3 to be used with Pascal. All the boards support the Z80-based Microsoft Softcard and Digital Research's CP/M. Again, the board must be in slot 3 to be used.

Photo 2: Sample video displays of the five 80-column video-interface boards. Photos 2a through 2e correspond to the 80-column boards in photo 1.



When you shop for a video board, you must consider two areas of hardware compatibility. The first is how the video signal fed to the monitor is switched between the video board and the Apple II's normal display output. The second is how uppercase and lowercase characters are entered from the keyboard.

Full-View 80, Smarterm, and Videoterm support either a manual video-signal switch or a software video-signal switch. The software switch, however, requires modification of the existing software because the BASIC commands TEXT, GR, and HGR are not compatible with it. A similar problem is encountered with the Pascal Turtlegraphics unit. The boards can, of course, be used with two video displays. If this is done, both monitors can display information at the same time. If color graphics or simultaneous high-resolution graphics and 24 by 80 text displays are desired, then two monitors must be used, and video switching is not a problem.

The Apple II keyboard is a teletypewriter-compatible keyboard, but it does not generate all of the American Standard Code for Information Interchange (ASCII) character codes. In particular, the lowercase alphabetic characters and certain special characters, such as {, }, and |, cannot be generated. The video boards use a control character, such as ESC A (two keystrokes, the

ESCAPE key followed by an A key) or CTRL-A (one keystroke, CONTROL-A), to indicate that the subsequent character is uppercase. Two consecutive control characters toggle the keyboard into a shift-lock mode.

Such conventions for shifting usually make those control characters unavailable for use by a program. All five boards support a hardware modification to the Apple II computer (which invalidates the warranty) that involves connecting the shift-key switch and the game-paddle connector, pin 4. When this modification is performed, the shift key can be used as with a standard typewriter.

# LEARN THE ABC's OF MDL's\*

In a 5-day workshop, you'll follow a microprocessor application from software development through PROM programming on the Tektronix 8550 Microcomputer Development Lab.

If you work with editors and assemblers or compilers on a minicomputer or mainframe computer, or you've used a development system for microcomputers, you're already qualified to learn how the 8550 MDL supports the design process.

For schedules and class registration for the Development System in the Design Process Workshop in your area, call Customer Training collect at (503) 642-8951.

\*Microcomputer Development Labs

**Tektronix**  
COMMITTED TO EXCELLENCE

## At a Glance

**Name**  
Omnivision

**Use**  
80-column video-display interface for the Apple II or Apple II Plus

**Manufacturer**  
The Computer Stop  
16919 Hawthorne Blvd.  
Lawndale, CA 90260  
(213) 371-4010

**Price**  
\$295

**Features**  
Character appearance: 5 by 7 dot matrix; inverse video; character generator in programmable memory

**Software**  
Software on disk, compatible with Integer and Applesoft BASIC, Apple Pascal, and the Microsoft Softcard; Apple cursor editing; supports Pascal type-ahead buffer

**Hardware**  
Motorola 6845 LSI circuit; light-pen input port; consumes 3 watts

## Omnivision

Computer Stop's Omnivision supersedes an earlier board known as Doublevision. The Omnivision board is, however, completely software compatible with the Doublevision. Omnivision is an 80-character video-display board and the only board reviewed here that does not have its software in ROM. The software drivers are supplied on 5¼-inch floppy disks, one for the standard Apple disk operating system (DOS) and the other for the Pascal-language system. (The Pascal language driver is provided for an additional \$25.) This means that a disk-based computer is required for use of Omnivision. Because the software is loaded into user-programmable memory, rather than ROM, it can be changed easily.

Omnivision supports a lowercase mode in which the ESC key is used to indicate that the next character is capitalized. The sequence ESC ESC enters the shift-lock mode. A hardware shift-key modification, where a wire is soldered to the Apple II's shift key at one end and attached to the Omnivision card at the other, is supported. In addition, Omnivision supports the Microsoft Softcard.

Characters are formed from 5 by 7 dot matrices without lowercase descenders. Neither a software-controlled video-signal switch nor a manual switch is provided. Complete program listings are provided in the documentation, which consists of a 60-page manual.



## COMPUTERS

### NORTHSTAR



New low price on the Incredible Advantage™. Your choice GDOs and Basic, or GCP/M \$229. Let us burn and test your Horizon or Advantage and we'll back it with our own fast warranty service.

Advantage	Call
Horizon II 64K Quad	\$2895
TSS 18/4	\$8295

### XEROX



The under \$3000 system with the billion dollar name. Systems include CPU, dual drives, keyboard, monitor, and two serial ports for a printer and modem. CP/M® compatible.

820 w/5" drives	\$2375
820 w/8" drives	\$2949

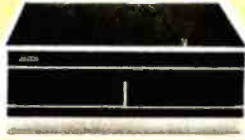
### TELEVIDEO



The new all-in-one that's backed by G.E. Built in CRT, detachable keyboard, 750K formatted, dual floppies, 64K, CP/M® and more. Five software business modules \$695.

Televideo 802	\$2795
Tele 806, w/10 Meg., Most.	\$5395
Televideo 802H (10 Meg.)	\$5095

### ALTOS



Our tech's favorite systems - 8" floppies, hard disks, and multi-user under MP/M or Oasis. Call for prices on Altos' new 16-bit systems and 5 1/4" floppy systems.

8000-2	\$2689
8000-10	\$6375
8000-15,12.40	call

### NEC



The low priced system that's big on features. 4 Mhz Z-80A, real time clock, color output, CP/M® compatible, 5 function keys and more.

PC8001A Computer	\$739
PC8012A I/O w/32K	\$479
PC8013A Dual 5 1/4" drives	\$739

### ZENITH



The all-in-one that's backed by your local Zenith-Hearsh Service center. Green Screen, CP/M®, Supercalc, and Basic Inc.

Z-89 w/48K	\$2135
Z-90-82 w/64K	\$2395

## IMPORTS



NEC PC 8023A	\$489
Epson MX-80	\$444
Okidata 82A	\$469
Epson MX-100	\$719
Okidata 83A w/trac.	\$749
Okidata 84 (200 c.p.s.)	\$1059

## SOFTWARE

**Wordstar** - Easy and powerful - the most popular word processing system for micros.

**MallMerge** - Works with or without Wordstar to keep up-to-date mailing lists and create individually produced letters.

**CalcStar** - Spread sheet analysis which is interactive with the other Micropro packages.

**DataStar** - Micropro's database system works with Wordstar to combine text and numbers.

**dBASE II** - The most popular CP/M based relational database.

**Accounting Plus** - General ledger, Accounts payable, accounts receivable, etc., plus Condor data base management.

**Crosstalk** - Plug into the personal computer networks and link-up with other systems via modem communications.

**S.A.I.L. CP/M** - For use with Northstar Horizons - increases drive capacity 25K on doubles, 50K on Quads.

Software sold only with systems and not warranted for suitability to particular applications. All require CP/M®. All software sales final.

## LOW COST



Viewpoint w/green	\$544
Televideo 910	\$579
ADM 3A	\$569
Soroc IQ 130	\$589

## HIGH SPEED



DataSouth DS-180	\$1269
Anadex 9501	\$1244
T1810 Basic	\$1359
Mallbu 200	call
IDS 560G	\$1129
IDS Prism 80	\$889

## SERVICE/ORDERING

**INTEGRATION:** Prices listed are for new equipment in factory sealed boxes with manufacturer's warranty. We will pretest your equipment. Integrate your system, configure your software, provide special cables, etc., for an additional charge. Call for prices.

**ORDERING:** MAIL ORDER ONLY. Prices listed are for cash. No C.O.D.'s. We sell on a net 20 basis to Fortune 500 companies and Universities (at cash prices). Charge cards add 2%. Prices subject to change, product subject to availability. A.Z. residents add 5%. Personal checks take 3 weeks to clear. 0-20% restocking fee for returned merchandise. Shipping extra - products are F.O.B. point of shipment. CP/M and MP/M are registered trademarks of Digital Research.

## TELEVIDEO



Televideo 912	\$699
Televideo 920	\$728
Televideo 925	\$735
Televideo 950	\$927

## LETTER QUALITY



F10 Starwriter 40 c.p.s.	\$1449
F10 Starwriter 55 c.p.s.	\$1649
NEC 3510	\$1895
NEC 7710/7730	\$2340
NEC 7720	\$2695



# Scottsdale Systems Ltd.

6730 E. McDowell Road, Suite 110, Scottsdale, Arizona 85257

 **(602) 941-5856** 

Call 8-5 Mon.-Fri.  
(We Export) TWX 910-950-0082 (IMEC SCOT)

## TERMINALS



Falco TS-1 (VT52)	\$1069
Falco (VT-100)	\$1199
Zenith Z-19 (VT52)	\$689
Dialogue 80 Amber	\$895
Volker Craig 404	\$599

## MORE PRINTERS

Zenith Z-25	\$1225	DEC LA34AA	\$1049
Prowriter ACD	\$639	Tally MT 1805	\$1645
MPI 99G	\$719	Xerox D80	\$2149

## I/O DEVICES

Houston Instrument:		Hayes Smartmodem	\$219
Hi-Pior DMP-2	\$849	NEC 12"-G Monitor	\$169
Hi-Pior DMP-7/8	\$2057		
Hi Pad DT-11	\$669		

# LEARN $\mu$ P SOFTWARE DESIGN

If you're just getting into microprocessor software design and debugging, this 5-day workshop is just your program.

You'll cover the development system's role in code design, assembling, debugging, software execution on hardware, and PROM programming.

If all this sounds new to you, it won't after you get a week of hands-on experience in the basics of software design and debugging.

For schedules and class registration for the Software Design and Debugging Workshop in your area, call Customer Training collect at (503) 642-8951.

**Tektronix**  
COMMITTED TO EXCELLENCE

## At a Glance

### Name

Full-View 80

### Use

80-column video-display interface for the Apple II or Apple II Plus

### Manufacturer

Bit 3 Computer Corporation  
8120 Penn Ave. S.  
Minneapolis, MN 55431  
(612) 881-6955

### Price

\$379

### Features

Character appearance: 5 by 7, 7 by 9, or 8 by 10 dot matrix, lowercase descenders; inverse video; character generator in EPROM; supports alternate character set in EPROM (option: \$47); graphics

### Software

Software in ROM, compatible with Integer and Applesoft BASIC, Apple Pascal, and the Microsoft Softcard; Apple cursor editing; supports Pascal type-ahead buffer

### Hardware

Synertek 6545 LSI circuit; light-pen input port; consumes 2.5 watts

## Full-View 80

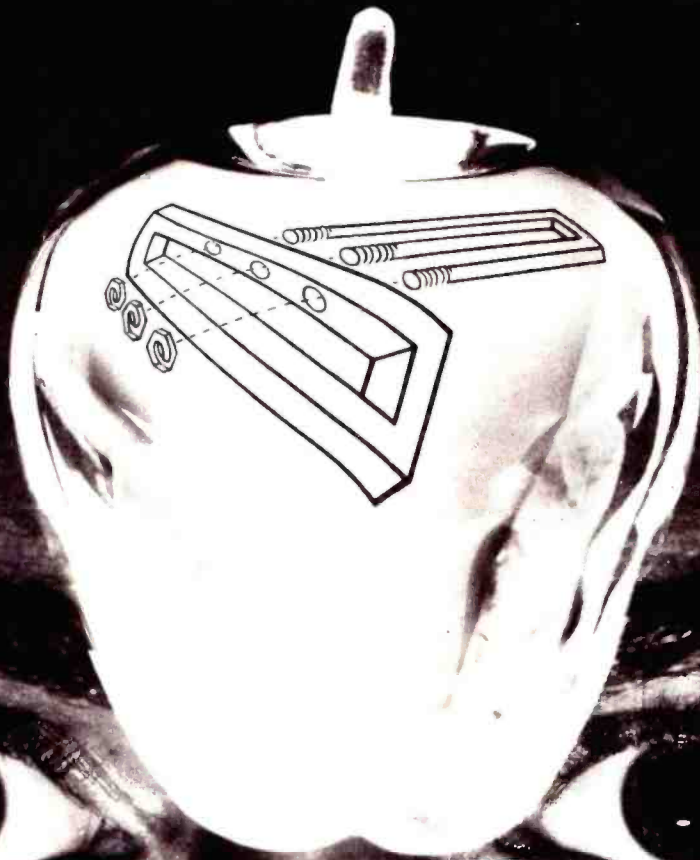
Full-View 80 from Bit 3 Computer Corp. has onboard control software, the latest version being revision 1.2. Software switching of the video signal is supported.

Characters can be formed from 5 by 7, 7 by 9, or 5 by 9 dot matrices (within an 8 by 10 dot framework); however, the 7 by 9 format requires a higher-quality monitor. An optional erasable programmable read-only memory (EPROM) adapter that allows the user to define custom-character fonts is available for \$47. Full-View 80's display fully supports the Pascal-language system and the Microsoft Softcard when used in slot 3. Pascal keypress and type-ahead functions also are supported.

Full-View 80 supports the hardware shift-key modification. Without the keyboard modification, in the lowercase mode a CTRL-A is used to indicate that the next character is uppercase, while the sequence CTRL-A CTRL-A locks the keyboard in uppercase.

Full-View 80 has escape codes for entering certain frequently used commands such as HOME, CATALOG, LOAD, and RUN with two keystrokes. A stick-on legend for these codes is provided for the keyboard. Full-View 80 has a light-pen input, but a light-pen option is not offered at this time. Also, a 60-Hz nonmaskable-interrupt source is available. This can be used to provide a clock in software. Full-View 80's screen memory can be read by programs. The documentation consists of a 37-page manual; no source code is given.

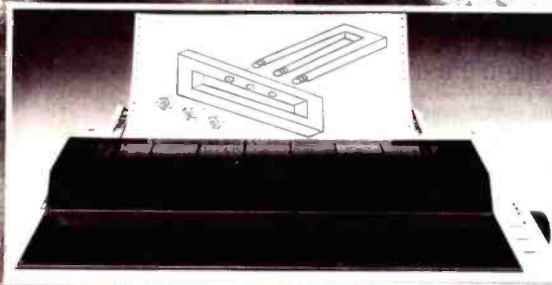
# IMAGINE IT..



## CAPTURE IT

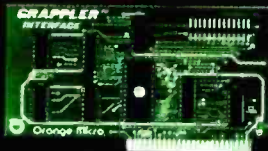
The Grappler™ is the most intelligent Apple Interface available. Simple commands from the keyboard or user program, are all you need to dump screen graphics to your printer. The Grappler's exclusive EPROM chip makes high resolution graphics that easy. There are Grappler versions to accommodate the Xerox, Epson Series,\* IDS Paper Tigers, Centronics 739, DEC 8023, C. Itoh Pro-writer, Tekidata 82A,\* Mallbu 200, and future graphic printers.

Requires Graphics Upgrade.



ACTUAL APPLE II PRINTING USING GRAPPLER™ AND EPSON

With **The Grappler™**  
Printer Interface



The Grappler's features include:

- Graphics Screen Dump
- Inverse Graphics
- Emphasized Graphics
- Double Size Picture
- 90° Rotation
- Center Graphics
- Chart Recorder Mode
- Block Graphics
- Bell Control
- Skip-over-Perf
- Left and Right Margins
- Variable Line Length
- Text Screen Dump.

The Grappler™ works with Pascal and CPM.



**Orange Micro**  
inc.

3150 E. La Palma, Suite G, Anaheim, CA 92806

(800) 854 8275 TOLL FREE

(714) 630 3322 CA; AK; HI.



## At a Glance

### Name

Smarterm

### Use

80-column video-display interface for the Apple II or Apple II Plus

### Manufacturer

Advanced Logic Systems Inc.  
Suite 1009, 491 Macara Ave.  
Sunnyvale, CA 94086  
(408) 730-0306

### Price

\$360

### Features

Character appearance: 5 by 7 dot matrix; inverse video; character generator in EPROM; graphics

### Software

Software in ROM, compatible with Integer and Applesoft BASIC, Apple Pascal, and the Microsoft Softcard; Apple cursor editing; supports Pascal type-ahead buffer

### Hardware

Synertek 6545 LSI circuit; consumes 2.75 watts

## Smarterm

Advanced Logic Systems' Smarterm board has EPROM-based control software and supports software switching of the screen between video sources. Smarterm generates characters formed from 5 by 7 dot matrices with no lowercase descenders. When used in slot 3, Smarterm supports the Pascal system and the Microsoft Softcard. Keypress and type-ahead are also maintained under Pascal.

Smarterm supports the hardware shift-key modification. Without the shift-key modification, CTRL-A capitalizes the next character when the keyboard is in the lowercase mode. CTRL-Z engages the shift-lock mode, where the keyboard will remain until CTRL-A is entered.

Smarterm has a medium-resolution graphics mode (160 elements horizontal by 72 elements vertical). (Basically, each normal character field is divided into three rows and two columns.) Smarterm can clear the screen, set the screen to black or white, plot points, draw lines, or draw a graphics character at the current cursor position. The documentation consists of a 47-page manual; no source code is given. Smarterm is now distributed by Apple Computer Inc.

## Sup'R'Terminal

The Sup'R'Terminal board from M & R Enterprises has EPROM-based control software and generates characters formed from 5 by 8 dot matrices with true lowercase descenders. Sup'R'Terminal's font tables are stored in programmable memory, rather than ROM, so they can be

## At a Glance

### Name

Sup'R'Terminal

### Use

80-column video-display interface for the Apple II or Apple II Plus

### Manufacturer

M & R Enterprises  
Suite E, 285 Sobrante  
Sunnyvale, CA 94086  
(408) 738-3772

### Price

\$375

### Features

Character appearance: 5 by 8 dot matrix, lowercase descenders; inverse video; character generator in programmable memory; supports up to ten alternate character sets; graphics

### Software

Software in ROM, compatible with Integer and Applesoft BASIC, Apple Pascal, and the Microsoft Softcard; Apple cursor editing; supports Pascal type-ahead buffer

### Hardware

Motorola 6845 LSI circuit; consumes 4.5 watts

Apple® Users Acquire Data  
And Control Scientific Instruments  
With  
**ADALAB™**

00000000000000000000000000000000

ADALAB is a small lab computer system with LARGE capabilities from Interactive Microware, Inc.

ADALAB HARDWARE PACKS MORE POWER...for collecting data and controlling your laboratory instruments. It includes a 12-bit analog voltage input, a 12-bit analog voltage output, 8 digital sense inputs, 8 digital control outputs, a 32-bit real-time clock and two 16-bit timers/counters. . .ALL ON A SINGLE APPLE INTERFACE CARD!

QUICK/I/O SOFTWARE MAKES IT EASY. . .Simple commands in BASIC give you control of all hardware features of ADALAB. Sample programs and easy-to-use manuals will enable you to start using your ADALAB system right away. Additional software for laboratory applications is available at extra cost. A complete self-test diagnostic program is included to assure you that all of the hardware is working properly and accurately.

**A** • Saves time by eliminating manual calculations.  
**D** • Is easy to use because the manuals and software are complete and well written.  
**A** • Saves money by adding convenience and utility to older instruments.  
**L** • Has a great memory to store and organize experimental data.  
**A** • Is versatile; it works with many different instruments.  
**B** • Is more accurate than a meter or chart recording.  
**B** • Is fully supported by a dedicated team of scientists.

GREAT PRICE/PERFORMANCE. . .the ADALAB Add-on Package with interface card, cables, self-test module, QUICK/I/O™ software and manuals is available today for ONLY \$495.

Put a complete, reliable computer system in your laboratory FOR ONLY \$3295, including a 48K APPLE II+\* computer, disk drive, graphics/text printer, video monitor and ADALAB Add-on Package.

Send for FREE hardware and software brochures or enclose \$10 for complete manuals. For fastest service, call in your VISA/Master Card order NOW. Dealer inquiries invited!

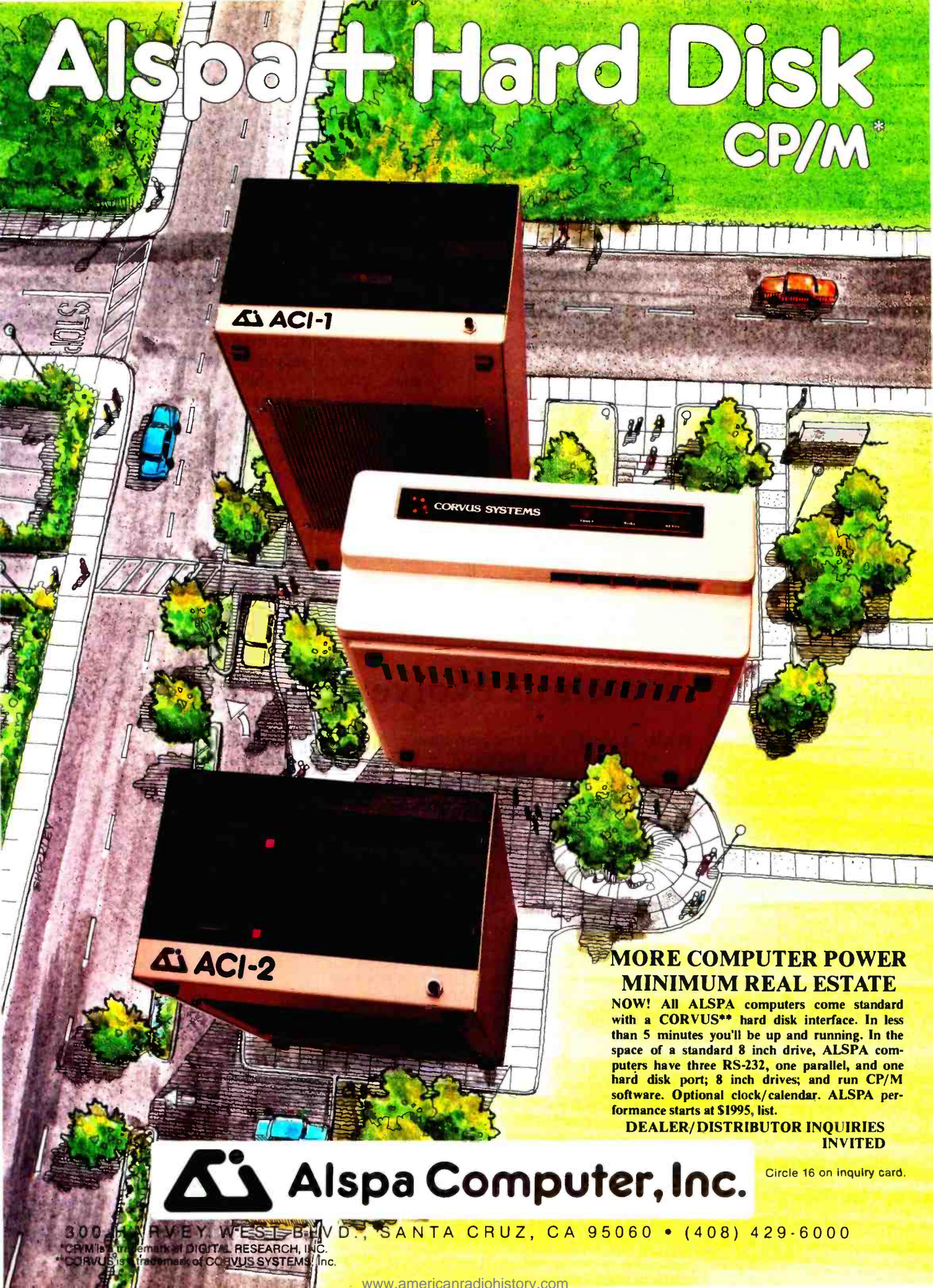
\*Trademarks of Apple Computer, Inc.

**IM** INTERACTIVE MICROWARE, INC.  
P.O. Box 771, Dept. B State College, PA 16801  
CALL (814) 238-8294 for IMMEDIATE ACTION



# Alspa + Hard Disk

## CP/M\*



### MORE COMPUTER POWER MINIMUM REAL ESTATE

NOW! All ALSPA computers come standard with a CORVUS\*\* hard disk interface. In less than 5 minutes you'll be up and running. In the space of a standard 8 inch drive, ALSPA computers have three RS-232, one parallel, and one hard disk port; 8 inch drives; and run CP/M software. Optional clock/calendar. ALSPA performance starts at \$1995, list.

**DEALER/DISTRIBUTOR INQUIRIES  
INVITED**



## Alspa Computer, Inc.

Circle 16 on inquiry card.

300 SURVEY WEST BLVD., SANTA CRUZ, CA 95060 • (408) 429-6000

\*CP/M is a trademark of DIGITAL RESEARCH, INC.  
\*\*CORVUS is a trademark of CORVUS SYSTEMS, Inc.



## At a Glance

**Name**  
Videoterm

**Use**  
80-column video-display interface for the Apple II or Apple II Plus

**Manufacturer**  
Videx  
897 Grant Ave.  
Corvallis, OR 97330  
(503) 758-0521

**Price**  
\$345

**Features**  
Character appearance: 7 by 9 dot matrix, lowercase descenders; inverse video (hardwired); character generator in EPROM; supports alternate character set in EPROM (option: \$39); graphics

**Software**  
Software in ROM compatible with Integer and Applesoft BASIC, Apple Pascal, and the Microsoft Softcard; Apple cursor editing; supports Pascal type-ahead buffer

**Hardware**  
Motorola 6845 LSI circuit; light-pen input port; consumes 2.75 watts

changed easily under program control. Up to ten alternate character fonts for languages and graphics are supported.

Sup'R'Terminal does not support software switching of the video display between the Apple II and its video sources. A manual video switch is not included. Sup'R'Terminal has a special video-balance circuit adjustment that improves the appearance of characters on low-resolution monitors. This circuit tends to correct the difference in intensity between vertical and horizontal lines in a character.

When used in slot 3, Sup'R'Terminal supports the Pascal system and the Microsoft Softcard. M & R Enterprises supplies the source code to provide keypress and type-ahead support for the Pascal system.

Sup'R'Terminal supports the hardware shift-key modification. Without the shift-key modification, CTRL-A capitalizes the next character when the keyboard is in lowercase mode. CTRL-A CTRL-A causes the keyboard to enter a shift-lock mode.

Sup'R'Terminal attaches to the Apple II computer in two places. The main board is inserted into a peripheral slot, while a second, smaller board, which is connected to Sup'R'Terminal by a four-wire cable, is inserted in integrated-circuit location C2. (The C2 integrated circuit must be removed from the Apple motherboard and plugged into the small board.) The documentation con-

# Watch us evolve HERE!!

Finally, a blend of all three generations of MICROCOMPUTERS:  
(ALL SYSTEMS INTERFACE WITH EACH OTHER)

## PRC-851

- \*8-BIT PROCESSOR
- \*REMOTE RF DATA LINK
- \*BASIC COMPILER
- \*8K ROM
- \*16K RAM AREA
- \*REMOTE PERIPHERAL CONTROL
- \*BUILT-IN MODEM 1200 BAUD
- \*SOFTWARE MODULES
- \*ONE USER CAPACITY
- \*UP TO 64K ROM AREA
- \*HUMAN INTERFACE TERMINAL

POCKET SIZED

RETAIL \$934.95

## RM-MS 1686

- \*16-BIT PROCESSOR
- \*REMOTE RF DATA LINK & BUS
- \*EDDIE-86 OPERATING SYS.
- \*32K ROM
- \*128K RAM AREA
- \*DISK DRIVE & VIDEO INTERFACE
- \*BUILT-IN MODEM 1200 BAUD
- \*FOUR LANGUAGE LINKING
- \*THIRTY USER CAPACITY
- \*1MB RAM OPERATING AREA
- \*COMPUTING LINK FOR POCKET UNITS AND MAINFRAME

RETAIL \$3,795.00

## μM 32/272

- \*32-BIT GDP
- \*INTERFACE PROCESSOR
- \*ADATM PROGRAMMING
- \*32K ROM
- \*256K RAM OBJECTS
- \*10MB HARD DISK 1.2MB FLOPPY
- \*VIDEO COLOR DOT BY DOT
- \*OBJECT ORIENTED
- \*250 USER CAPACITY
- \*16MB RAM AREA

RETAIL \$24,145.00

DEALER/DISTRIBUTOR INQUIRIES INVITED!!! CONTACT:

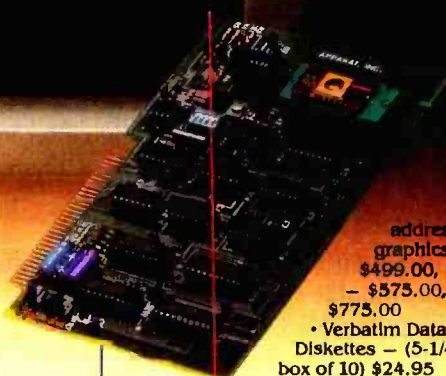
## Remote Evolutionary Computers, Inc.

Route #6; P.O. Box 105, Lebanon, Tennessee 37087

ADA is a trademark of  
U.S. Dept. of Defense  
(ADA Joint Program Office)



# Look What Apparat has for your IBM Personal Computer.



The following add-ons are available

Immediately:

- 2 Dual Headed 40 Track Drives – (appears as four) 640K of storage, software patch, easy internal mount. \$630.00
- Combo Card – Parallel printer, ASYNC communication (RS-232), and clock/calendar functions, uses only one slot. \$279.00
- 2 Single Headed 40 Track Drives – 320K of disk storage, easy internal mount. \$450.00
- 48K additional RAM – 27 chips plug into master PC board \$75.00
- Add-on Memory Card – (uses 64K dynamic RAM chips), 64K – \$425.00, 128K – \$525.00, 192K – \$625.00, 256K – \$725.00
- Prom Blaster – Programs most 1K to 4K EPROMS of 25XX and 27XX single or multivoltage, personality modules, read/write

software. \$149.00

- Apparat Game Diskette – \$24.95
- Clock Calendar – Features seconds, minutes, hours, day of week, date, month and year, backup battery, leap year and crystal time base. \$129.00
- Prototype Card – 3.5 by 8 inch wirewrap holds 150-14 pin dips. \$29.95
- RGB Color Monitors – Includes cable, 16 color modifications, NEC – \$1,095.00, AMDEK – \$899.00, TECO – \$699.00.
- 3rd and 4th Add-on Drives – Expansion cabinet and IBM compatible drives, cabinet and 1 drive – \$499.00, two drives – \$749.00
- 64K Hardware Print-Spooler – Parallel printer adapter, buffers 13 minutes of output at 80 characters/second. \$399.00.
- EPSON MX Printers – MX-80 (with dot

addressable graphics) –

\$499.00, MX-80 P/T – \$575.00, MX-100 – \$775.00

• Verbatim Datalife Diskettes – (5-1/4" 40 track, box of 10) \$24.95

• 16K Memory Kits (9 chips) – \$25.00

• 5-1/4" Flip-Sort – \$21.95

• 5-1/4" Plastic Library Case – \$1.95

Apparat will continue to develop add-on products for your IBM Personal Computer. Call today for more information. Dealer inquiries welcome.

**(303) 741-1778**

IBM Personal Computer is a trademark of IBM.



**Apparat, Inc.**

4401 So. Tamarac Parkway, Denver, CO 80237 (303) 741-1778

**"ON GOING SUPPORT FOR MICROCOMPUTERS"**

Circle 22 on inquiry card.

[www.americaradiohistory.com](http://www.americaradiohistory.com)



sists of a 29-page manual that does not contain the firmware source code but does have many sample BASIC and Pascal programs. One interesting BASIC program converts control codes for Apple II Applesoft programs to the control codes required by Sup'RTerminal.

### Videoterm

Videx's Videoterm board supports software switching of the video display as a \$35 option; in addition, a manual video switch is available for \$19. The board has a light-pen input and supports an optional alternate character-generator EPROM (\$39) of which several are available. (A special half-intensity character generator gave particularly good results on several monitors during my tests.) Characters are generated from a 7 by 9 dot matrix, and lowercase letters have true descenders.

When used in slot 3, Videoterm is compatible with the Pascal system and the Microsoft Softcard. Without the Videx Enhancer II (which, among other things, modifies the Apple keyboard to allow the shift key to work), CTRL-A is used to toggle between the lowercase and uppercase modes. If the video-switching option is installed, the standard single-wire shift-key modification to the Apple keyboard allows Videoterm to recognize both up-

percase and lowercase letters via the shift key.

The documentation consists of a 141-page manual that includes firmware source code, many programming examples, and schematics of the board.

### Conclusions

Which board should you buy? Unfortunately, the decision is not an easy one because no board outshines the others when all features are considered. I recommend that you have the entire package you intend to use demonstrated, including the display board, monitor, software, and other peripherals. Failure to consider all the components as a unit could lead to additional expenditures for a monitor and software updates. The newer boards (i.e., Full-View 80 and Smarterterm) feature software-controlled video-source switching. This feature offers greater user convenience because multiple monitors or manual switches are not required. Having to flip a switch, and not knowing when, can be a source of confusion for the novice. Videoterm's half-intensity character-generator EPROM offered one of the most legible character sets of all the boards tested. The final choice, of course, is yours. You will be most successful if you have your retailer demonstrate the entire system. ■

---

# More Apple 80-Column Boards

---

Gregg Williams  
Senior Editor

---

Two new Apple 80-column boards have recently been introduced. Here's a brief look at both of them.

### Vision-80

Vista's Vision-80 board for the Apple (originally designed in Australia) is a very refined 80-column board. In fact, I've seen the Videoterm, Omnivision, Vision-80, Full-View 80, and Wizard-80 boards, and I'm most impressed with the Vision-80 because of the many things it does. Its two most interesting features are the retention of standard Apple commands associated with manipulating the 40-column Apple II text window and its ability to be used as an intelligent terminal.

First, the prosaic stuff. Vision-80 (see photo 1a, page 268) supports most Apple peripherals, including the Apple Pascal card and the Microsoft Softcard. Vision-80 must be placed in Apple slot number 3. Its software is in erasable programmable read-only memory (EPROM), although the source code for it is not given in the documentation. It supports a shift-key modification that allows the Apple keyboard to produce both uppercase and

lowercase letters, but there is no provision for toggling between uppercase or lowercase if the shift-key modification is not made. The video monitor connected to the Vision-80 can display the 80-column screen or the standard 40-column text and low-resolution or high-resolution graphics screens under software control. The characters are formed in a large 9 by 10 grid (see photo 1b).

One of the problems with all of the 80-column boards *except* Vision-80 is that they do not respond properly to many of the text-screen manipulation commands common to many Applesoft and Integer BASIC programs. This means, for example, that when you use 80-column video board X with a given program, you may have to go into that program and replace, say, all occurrences of the HOME command with PRINT CHR\$(25) because that is what board X recognizes as a command to clear the text screen and home the video cursor. Vision-80 does not respond to *all* text-screen manipulation commands used by the Apple, but it does respond to far more than any other board. The commands it responds to include HOME, TEXT, GR, HGR, HGR2, POKEs to the text-window

# The UniFLEX™ Operating System extracts



# every last drop

## from the 8 bit 6809 microprocessor allowing it to outperform many 16 bit systems

With the UniFLEX™ Operating System, the 8 bit 6809 microprocessor can perform as well as larger CPUs in a multi-user, multi-tasking environment.

Independently developed from the ground up, UniFLEX™ closely models the features found in the UNIX™ Operating System. And in two years of use, UniFLEX™ has proven the abilities of the 6809 to perform large system functions when incorporated into a properly designed mainframe.

Some of the features supported include:

- full multi-user, multi-tasking capabilities
- hierarchical file systems
- device independent I/O
- four Gigabyte disk capacities
- full file protection
- inter-task communication via pipes
- I/O redirection
- task swapping for efficient memory usage
- full random-access files
- comprehensive shell command language
- foreground-background jobs
- electronic mail and printer spooling
- system accounting facilities

The support software currently available for use under UniFLEX™ is extensive.

A sampling of the programs available includes:

- native C compiler (full implementation)
- native Pascal compiler
- FORTRAN 77 ANSI Subset compiler
- COBOL compiler with ISAM files, Report Writer & Sort/Merge
- Extended BASIC interpreter
- Extended BASIC precompiler
- text editing and processing software
- enhanced printer spooler
- variety of absolute and relocatable assemblers
- debug and diagnostic packages

Technical Systems Consultants, Inc. also offers a line of single user FLEX™ software products for 6800 and 6809 processors. For those having an absolute need for a 16 bit processor, UniFLEX™ will be available through OEM licensing arrangements for the 68000 microprocessor. Please call or write for additional information on individual products or OEM licensing arrangements.

UNIX™ is a trademark of Bell Laboratories.  
FLEX™ and UniFLEX™ are trademarks of Technical Systems Consultants, Inc.



technical systems  
consultants, inc.

111 Providence Road  
Chapel Hill, North Carolina 27514  
(919) 493-1451



# FREE NEBS COMPUTER FORMS CATALOG

Send today for our NEW full-color 56-page catalog with continuous checks, statements, invoices, stationery, envelopes, supplies and accessories. We will also send our FORMS SELECTOR GUIDE, to help you find the right forms for your software.

- **Quality products at low prices**
- **Available in small quantities**
- **Fast Service**
- **Money-Back Guarantee**
- **Convenient TOLL-FREE ordering**

**Fast Service by mail or...PHONE TOLL FREE  
1 + 800-225-9550**

Mass. residents 1+800-922-8560  
8:30 a.m. to 5:00 p.m. Eastern Time Monday — Friday

Please rush a new computer forms catalog to:

NAME \_\_\_\_\_

COMPANY \_\_\_\_\_

STREET \_\_\_\_\_

CITY, STATE and ZIP \_\_\_\_\_

PHONE \_\_\_\_\_

Hardware and Software being used. \_\_\_\_\_



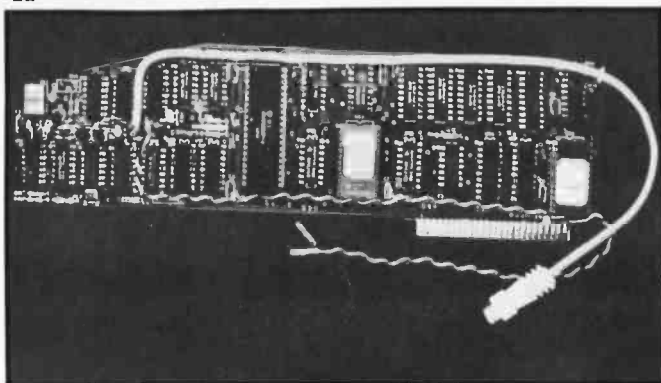
**Nebs  
Computer Forms**

CODE 22460

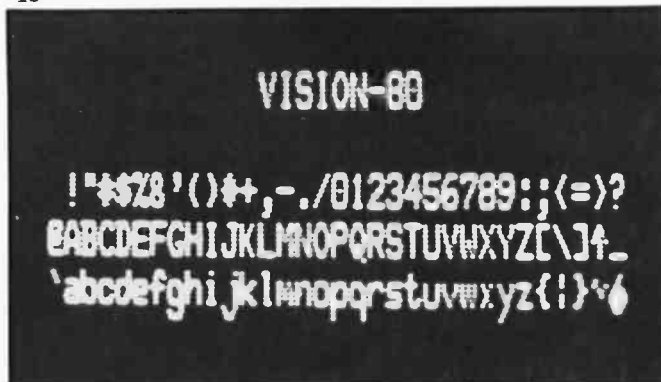
78 Hollis Street, Groton, Massachusetts 01471  
A division of New England Business Service, Inc.

Photo 1: The Vision-80 board (1a) and video display (1b).

1a



1b



values in memory locations 32 through 35, ESCAPE SHIFT-P (same as HOME), ESCAPE E or CHR\$(29) (clear to end-of-line), ESCAPE F or CHR\$(11) (clear to end-of-page), TAB, HTAB, VTAB, INVERSE, NORMAL, the cursor movement and copying keys (right-arrow, left-arrow, ESCAPE A through ESCAPE D, and ESCAPE followed by I, J, K, or M), and CONTROL-S for stopping output to the video screen. In addition, you can switch between text and graphics screens under software control and you have a choice of six cursors (cursor shape can be either a block or an underline and it can be slow, fast, or no blink, a total of six combinations).

An interesting feature of the card is that it can be used with an acoustic modem and either the Apple Communications Card or the California Computer Systems Serial Card to make an intelligent terminal that can operate at data rates of up to 1800 bits per second. With a 48K-byte disk-based Apple, all available memory (about 33K bytes) can be used as a text buffer to store incoming data. Within the "communication option" (as it's called), the board can communicate with the disk operating system (DOS), which allows the saving and transmitting of files. If the remote computer is another Apple II with a Vision-80 board, your Apple can control itself and the remote Apple—potentially a powerful feature. The only thing bad that can be said about this feature is that it is not an option on the board. I'm sure it adds to the board's \$395 price tag, and you may not want to pay for it if you do not need communications capabilities or if you already have them (e.g., in a Hayes Micromodem, which is incompatible with Vision-80).

# C is better than ever.

Whitesmiths, Ltd. is now shipping  
Release 2.1 of our highly acclaimed C Compilers for ten different  
operating system families on four architectures:

8080, 8085, Z80:

CP/M, CDOS  
ISIS-II\*  
Idris/B80

LSI-11, PDP-11:

RT-11  
RSX-11M, RSTS/E, IAS  
Idris/R11, UNIX

MC68000:

VERSA dos  
Idris/S68k

VAX-11:

VMS  
UNIX/32V\*

\*Available in source form only.

Idris is a trademark of Whitesmiths, Ltd. ■ UNIX is a trademark of Bell Laboratories ■ CP/M is a trademark of Digital Research ■ RSX-11M, RSTS/E, RT-11, LSI-11, VAX, and VMS are trademarks of Digital Equipment Corporation ■ VERSAdos is a trademark of Motorola Inc.

We've added optimizations, sped up runtime routines, and (ahem) fixed all known bugs. The portable C library is more extensive than ever, with new math functions, pattern matching routines, and support for Ada-style exception handling. And it's easier than ever to interface to new environments.

Native compilers are only \$750, including shipping in the continental U.S. Cross compilers, for most combinations of host system and target machine, are \$1350. A Pascal Compiler may be included for an additional \$200. Old customers may upgrade for just half of the new price. And maintenance is now only 25% of the license fee per year.

Now's the time to write or call.

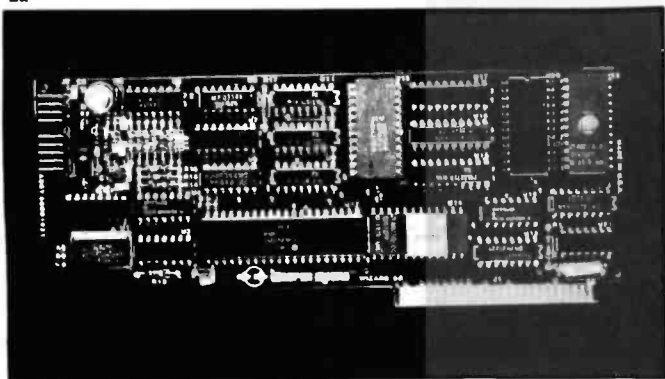
Distributors: Australia, Fawnray Pty Ltd. P.O.B. 224 Hurstville NSW 2220 570-6100  
Japan, Advance Industries, Chiyoda-ku, Tokyo 03-258-0839  
United Kingdom, Real Time Systems, Newcastle upon Tyne 0632 7331 31

## Whitesmiths, Ltd.

P.O. Box 1132 Ansonia Station New York, N.Y. 10023 (212) 799-1200 Telex 645 592

Photo 2: The Wizard-80 board (2a) and video display (2b).

2a



2b



## Wizard-80

Wesper Micro Systems' Wizard-80 board is an adequate 80-column board, but it has a few problems and lacks any outstanding characteristics that would distinguish it from many other Apple 80-column boards. One nice feature is the "medium-resolution" style of black-and-white pixel graphics that the board offers. Each character can be divided horizontally into three square pixels, giving a resolution of 72 rows of 80 pixels each. However, the Smarterm offers the same kind of graphics, but with higher resolution: 72 by 160.

The prosaic stuff is as follows. Wizard-80 (see photo 2a) supports most Apple peripherals, including Apple Pascal and the Microsoft Softcard; to work with them, the card should be placed in Apple slot number 3. Its software is in EPROM, and the source code is provided in the documentation (along with a schematic of the board). The board allows shifting between uppercase and lowercase letters with a CONTROL-A, but it has no provision for mechanically or electrically switching the 40- and 80-column displays to the same monitor. Characters are formed in a 7 by 9 grid (see photo 2b), and the board can display either 18 or 24 lines of 80 characters each; the 18-line mode is a good feature that often makes text more readable.

Wizard-80 has some interesting features, including the medium-resolution graphics I mentioned and a set of 16 geometric characters that can be used to draw lines, corners, and grids (e.g., to draw the outline of a sheet of paper). It allows inverse video and some of the text-screen manipulation commands used in Applesoft and In-

# TELEPHONE VOICE RESPONSE

## The V100 interactive voice synthesizer

with telephone interface is an Apple II® or IBM Personal Computer® compatible, low-cost, solution to remote data base access arrangements.

**\$395.00**

V100-A

- Direct telephone connection, auto-dial/answer
- Touch-tone® generation and detection
- Includes 1000 word, LPC allophone vocabulary
- Software for sentence/library construction
- Expandable with 300 (\$150) or 1300 (\$495) high quality LPC words

### VYNET CORPORATION

2405 Qume Dr., San Jose, CA 95131  
(408) 942-1037

## At a Glance

### Name

Vision-80

### Use

80-column video-display interface for the Apple II or Apple Plus

### Manufacturer

Vista Computer Company  
1317 East Edinger  
Santa Ana, CA 92705  
(714) 953-0523

### Price

\$375

### Features

Character appearance: 9 by 10 dot matrix; inverse video; character generator in EPROM

### Software

Software in EPROM, compatible with Integer and Applesoft BASIC, Microsoft Softcard, and Apple Pascal; supports Apple cursor editing and most Apple screen-manipulation commands

### Hardware

Hitachi HD46505 LSI circuit





## At a Glance

### Name

Wizard-80

### Use

80-column video-display interface for the Apple II or Apple II Plus

### Manufacturer

Wesper Micro Systems  
14321 New Myford Rd.  
Tustin, CA 92680  
(714) 730-6250

### Price

\$295

### Features

Character appearance: 7 by 9 dot matrix; inverse video; character generator in EPROM

### Software

Software in EPROM, compatible with Integer and Applesoft BASIC, Microsoft Softcard, and Apple Pascal

### Hardware

Uses Hitachi HD46505 LSI circuit

teger BASIC programs, including ESCAPE SHIFT-P (to clear the screen and home the cursor); ESCAPE E and ESCAPE F (or CHR\$(29) and CHR\$(11)) to clear to end-of-line and end-of-screen, respectively; CONTROL-S to stop video output; right-arrow, left-arrow; and ESCAPE A through ESCAPE D to control the cursor. One feature not found on some other 80-column boards is a goto-xy control code that lets you position the cursor anywhere on the screen under program control.

Two program bugs were found in the Wizard-80 board. The first is that the board does not respond to one

of the two codes that are supposed to move the cursor up. The board responds to ESCAPE D (as does the unaugmented Apple II), but it doesn't respond to CONTROL-SHIFT-O (as stated in the manual). The second bug occurs when you SAVE or DELETE a command to the disk—the board does not go to the following line to receive your next command but, rather, receives it on the same line. Although the Apple does not malfunction because of this, it is a bug that is definitely there. (The board was tested on two different revisions of the Apple II to verify the validity of these bugs.)

The most serious flaw of the Wizard-80 is too many poor design decisions related to human interaction with the keyboard (which, after all, is the major way that you interact with your Apple). Of the 16 geometric shapes available from the board, four are not available from an unmodified Apple keyboard (although they are available if your Apple has one of several "extender" boards that add features to the keyboard); these shapes are available only through program control (e.g., through the CHR\$(function in BASIC).

Another problem is the cursor control keys. It is to Wesper Micro Systems' credit that the board responds to the standard Apple ESCAPE A through ESCAPE D keys (each a two-keystroke sequence), but the more convenient ESCAPE followed by I, J, K, or M method was not implemented (the four letters form a diamond shape that indicates the direction of cursor movement). Wesper did implement control keys to do cursor movement, but chose CONTROL-SHIFT-O for cursor-up, CONTROL-U for cursor-right, CONTROL-J for cursor-down, and CONTROL-H for cursor-left. If you look at the relative layout of those keys on the keyboard, you'll see that they bear no relation to the cursor-movement direction. I believe that here, as in several other places, the designer was more concerned with making the board easy to implement than with making it easy to use. ■

# Industrial marketing problems?

Regardless of what marketplace you are staking out, its position or size, we can help you draw a precise circle around it.

Why? Because as the leading business/technical/professional publishing company, we probably already know your market and can apply our expertise to your research needs.

Give us a call. Phone Ann Graham-Hannon at 212-997-6401 or write her as Director, Marketing Research, McGraw-Hill Research, 1221 Avenue of the Americas, New York, NY 10020.

# Call McGraw-Hill Research



If it's a marketing research problem,  
we probably pioneered the solution.

# WE'RE STILL



## STANDARD

- 64K internal memory.
- Up to 1.5 Megabytes of dual disk storage – easily expandable to 10 Megabytes.
- Twin RS-232 serial ports.
- A CP/M† disk operating system.
- Two 4 MHz Z80A Processors for faster response.
- A Full 80 x 24 line display on a 12-inch non-glare screen.
- Optional graphics capability.

# SUPERBRAIN™

It used to be that buying a microcomputer was a simple task. There were only two or three manufacturers offering them and comparing prices and specifications was easy to do. Today, Intertec is no longer one of a handful of micro-computer vendors trying to attract your attention, but... we think we're still the best. And for a good reason.

Consider pricing. Our customers tell us we're still the price/performance leader in single-user and multi-user micro-computer systems. Ask around. Most folks (and even some manufacturers) will concede that point. What a lot of people

do not know is that Intertec may very well offer the best customer protection programs in the industry. What is customer protection? It's a totally new, comprehensive product and customer support program which virtually guarantees your long term satisfaction with every new Intertec product you buy. It means that if you are not satisfied with your Intertec purchase, you can get your money back at any time during the original factory warranty.\* Or, in the unlikely event your equipment should become inoperative during the first few weeks of the warranty period, we will

\*At participating dealers only. Refunds are prorated.

# THE BEST!



## FEATURES

- True multi-user capability—network up to 255 users.
- Up to 1.5 Million bytes of local, off-line user storage.
- Four models of user workstations available.
- 64K Internal memory in each workstation.
- A CP/M† operating system.
- 10 – 384 Megabytes of auxiliary disk storage.

# COMPUSTAR™

replace it for you! And we'll even provide a reimbursement allowance to cover your cost of returning the system to us.

Go ahead. Review the pricing and performance specifications of *all* the microcomputers available today. We think you'll agree with us. . . ours are *still* the best! If you want uncompromised performance, competitive pricing, sophisticated expandable products and just plain peace-of-mind, you'll want Intertec.

Ask your dealer about Intertec's SuperBrain and CompuStar microcomputer systems. Or, call or write us at the

†CP/M is a registered trademark of Digital Research, Inc.

address below and get more information on today's best values in single and multi-user microcomputer systems.

 **INTERTEC  
DATA  
SYSTEMS®**

2300 Broad River Rd./Columbia, SC 29210  
(803) 798-9100/TWX: 810-666-2115

Circle 213 on Inquiry card.



# More Maze Building

*A Pascal program to generate mazes efficiently on a printer.*

---

Thomas Edward Neldner  
2223 North Quantico St.  
Arlington, VA 22205

---

A maze may look incredibly complex, yet it must satisfy just three simple conditions. The maze must have only one starting point and one ending point. All points in the maze must be accessible from the starting point. And there must be only one path from the start to the finish. (For a discussion of the theory behind maze building, see "How to Build a Maze," by David Matuszek, in the (December 1981 BYTE, page 190.)

This article presents a complete program, written in Pascal, to generate mazes on a printer. The program is efficient in terms of speed and memory requirements and may readily be modified to create different kinds of traditional random mazes.

To understand the program, we must first examine traditional mazes with a view toward the efficient storage of a maze within a computer. Each maze is a certain number of "cells" wide and high. A standard cell has four sides and looks like this:

```
+ - - +
!   !
+ - - +
```

Because the top and left sides of each cell are the bottom and right sides of some other cell, we consider only the bottom and right sides for our purposes here. We then consider each cell as a matrix position in matrix M. Since we are concerned with only two sides, only four different combinations of open/closed sets of cell sides are possible:

```
+ . . +   + . . +   + . . +   + . . +
.         !         .         !
+   +   +   +   + - - +   + - - +
      1       2       3       4
```

The dots indicate "don't care" sides of the cell.

These are the four possible combinations of openings a cell can have and are thus the four possible values a cell can achieve. We are also going to define a fifth value, that of zero or "no value." Such a cell is in a pristine or "frontier" state—it has yet to be touched by the program.

## To Create a Maze

First, a starting position must be created. Since both the start and stop position are immaterial, this merely amounts to printing the word START and a line of "--+" with one opening.

The program in listing 1 starts at an arbitrary position in the maze: the upper left cell. Note that this is not the upper left cell of the matrix; it is rather the M[1,1] cell, assuming subscripts of zero are allowed. M[0,0] would be the actual upper left cell, but this is part of the boundary described later. The program then tests the cells around it, searching for frontier cells. Since there are four directions out of any cell, there are 2<sup>4</sup> or 16 possible combinations of directions available, which may or may not open onto a frontier cell. The two special conditions are: it is not possible for all neighboring cells to be

frontier (we had to get to this cell somehow, thus making the previous cell nonfrontier); and if it is not possible to go in any direction, the path we were creating has come to a dead end—we are stuck.

The first of the nested CASE statements in listing 1 takes one of the 14 remaining possible combinations of directions (it picks randomly) and goes in that direction, making the cell it is moving into nonfrontier. And so the program winds its way through the matrix, "cutting" a path through the frontier cells as it does so. Sooner or later that path will curl up on itself, reaching a point where there are no frontier cells surrounding it.

When this happens, that cell is vacated, and the program goes back to the arbitrary starting cell (the upper left) and once again tests for frontier cells surrounding it. If there is one, the program once again takes off, blazing a trail through the frontier until it curls up and cannot continue. Once again, the system returns to the upper left cell and tests for frontier cells surrounding it. This can happen only a maximum of twice for the upper left cell; after that the program is stuck indeed.

So the program moves one cell to the right of the upper left cell and starts all over again, testing for frontier cells around it. Once again, this can happen only twice, and thus the program continues until it reaches the right-hand end of the line. Note that this is the only case where the pro-

# Consumer Computers

**SPECIAL OF THE MONTH!**  
**16K RAMBOARD**  
 by ConComp  
 for Apple II Computers  
**\$99**

# NO RISK\* MAIL ORDER DISCOUNTS

\*Call for details

At Consumer Computers we're experts in the business of selling computer products by mail. We have become one of the leaders not only because our prices are better, but because of the reputation we've worked hard to earn. Over the years we have learned what you, the customer, want and need from a mail order company. If we offer any merchandise that you're in the market for, you should seriously compare what we have to offer over the others. Here are just a few of the reasons.

Our helpful salespeople are prepared to meet any currently advertised price on anything we sell (call for details...It's Toll Free!). We pay shipping and insurance

charges on prepaid cash orders (with destinations in the continental US). We accept major credit cards for your convenience. If the product you receive is defective, even up to 30 days after you purchase it, we'll repair or replace it and pay for shipping back to you.

Consumer Computers carefully selects the hardware and software it offers to insure that quality is maintained in everything we sell. Our attention to quality is why we can stand behind our policy, because we stand behind our products.

You'll never regret becoming a member of our growing customer family. You have our word.

## NEC Microcomputer

8001A Microcomputer (32K)  
 Dual Disk Drives  
 I/O unit with 32K ram  
 The Wedge 32K Expansion mod  
 NEC 8023A Printer

CALL FOR  
 BEST  
 PRICE

## Commodore PET CBM

8032 Computer with 32K  
 4022 Dot Matrix Printer  
 4040 Dual Disk Drive (5")  
 8050 (5") Dual Drive System  
 18K Pet  
 32K Pet  
 SuperPet

CALL FOR  
 BEST  
 PRICE



Atari 800 (16K) 699  
 Atari 400 w/16K 349  
 410 Program Recorder 79  
 810 Disk Drive 449  
 825 80 col. 7x8 Dot matrix Impact printer 899  
 822 40 col. Quartz Thermal Printer 349  
 850 Interface Module 159  
 Atari 16K Ram Module 69  
 Aston Ramcrim 32K Module 189  
 Asteroids, Misile Command and Star Raiders 35 ea.

## XEROX Personal Computers

820 System with 5 1/4" drives  
 820 System with 8" drives  
 Xerox 630 (RS-232) Printer  
 Forms tractor for printer  
 Xerox 820 5 1/4" CPIM 2.2  
 Xerox 820 8" CPIM 2.2  
 Systems Plus software for Xerox

CALL FOR  
 BEST  
 PRICE

**CALL OR  
 WRITE  
 FOR FREE  
 CATALOG**

Ordering Information: Phone orders using VISA, MASTERCARD, AMERICAN EXPRESS, DINER'S CLUB, CARTE BLANCHE, bank wire transfer, cash/cr's or certified check, money order, or personal check (allow 10 days to clear). Unless prepaid with cash, please add 5% for shipping, handling and insurance (minimum \$5.00). California residents add 6% sales tax. Foreign customers please call or write for shipping information and charges. OEM's, institutions and corporations please send for a written quotation. All equipment is subject to price change and availability without notice. All equipment is new and complete with manufacturer's warranty (usually 90 days). Showroom prices may differ from mail order prices.

## APPLE II ACCESSORIES



16K RamBoard by ConComp Industries 99  
 Hayes Micromodem II 299  
 Hayes Smartmodem 369  
 Hayes Chronograph 199  
 Novation Apple-Cat 339  
 Novation Cat Modem 189  
 Novation Expansion Mod 39  
 Novation Handset 19  
 Novation BSR 249  
 Videx Videoterm 80 column card 115  
 Videx Keyboard Enhancer (Rev. 6) 115  
 Videx Keyboard Enhancer (Rev. 7) 99  
 Videx Keyboard Enhancer II (Rev. 7 & up) 129  
 Videx Switchplate 15  
 Videx Soft Video Switch 29  
 Z-80 Softcard by Microsoft 299  
 Applesoft Compiler 148  
 Typing Tutor II 20  
 Microsoft Adventure 25  
 Olympic Decathlon 24  
 16K RamCard by Microsoft 159  
 Thunderclock clock/calendar card 129  
 Thunderclock X-10 Inlar/Scheduler 49  
 Smartterm 80 col card 299  
 Corvus Winchester Disk Drives CALL  
 ALF 3 Voice Music Card 199  
 ALF 9 Voice Music Card 149  
 Alphasyntauri keyboard system CALL  
 Lazer Lower Case + 55  
 Lazer Keyboard Plus + 99  
 23 Key Numeric Keypad by Keyboard Co. 120  
 Joystick by Keyboard Co. 45  
 8089 CPU Card (The Mill) by Stellation 319  
 AIO Serial & Parallel Interface by SSM A&T 189  
 DB Master by Stoneware 189  
 Music System (16 voice) 299  
 A/D + D/A Interface 279  
 IntroIX-10 Controller card 569  
 Clock/Calendar Card 169  
 CPS Multi-function Card 225  
 CPS Multi-function Card 175

SuperPrinter SD-200 159  
 Romplus + card 299  
 Romwriter Card 369  
 Syntac Hi-Res Light Pen 210  
 Sup R-Fan 45  
 Sup R-Terminal 329  
 SVA ZXV4 Megabyte 8" Disk Controller 649  
 SVA 2 + 2 Single 8" Disk Controller 345  
 SpeechLink 2000 by Haurilica 249  
 Versawriter Digitizer Tablet 229  
 Asynchronous Serial Interface card by CCS 139  
 Contronics Parallel Interface card by CCS 119  
 VisiCalc version 3.3 149  
 VisiFile (NEW data base manager) 179  
 VisiTrend/VisiPlot 218  
 VisiDex 169  
 VisiTerm 89  
 VisiDex 169  
 Desktop Plan II 550  
 VisiPak (Calc, Trend, Plot, File) 199  
 Easywriter Word Processor 89  
 Tax Preparer '81 version 129  
 Rasi Estata Analyzer 139  
 Creative Financing 79  
 Personal Filing System (PFS) 79  
 PFS-Report 79  
 Peachtree Accounting Software CALL  
 BPI Accounting Software CALL  
 Systems Plus Accounting Software CALL  
 Wordstar by Micro Pro 299  
 DataStar by Micro Pro 249

## VIC-20 \$249

## VIC ACCESSORIES

8K Ram Cartridge for VIC-20 \$50  
 3K Ram Cartridge for VIC-20 \$34  
 Superlot \$24  
 Super Allen \$24  
 Jupiter Lander \$24  
 Draw Poker \$24  
 VIC Software 8 pack 'A' \$49  
 VIC Software 8 pack 'B' \$49  
 Datasette Cassette I/O Unit \$89  
 VIC IEEE-488 Interface \$79  
 Vicmon Machine Lang Monitor \$47  
 VIC Super Expander \$59  
 VIC RS232C Terminal Interface \$34

Voice Synthesizer CBM/PET \$319  
 Pgrm Char SaUGame Graphics ED \$13  
 3D Invaders \$31  
 Spiders of Mars \$39  
 Outworld \$32  
 Saillites and Meteorites \$39  
 Allen Blitz \$32  
 RS-232 Communicator Interface \$40  
 18 In. Communicator Cable M/M \$13  
 36 In. Communicator Cable M/M \$15  
 3K RAM Expander for VIC-20 \$65  
 8K RAM Expander for VIC-20 \$99

## VIDEO MONITORS



Amdek/Leadex Video 100 12" B&W 129  
 Amdek/Leadex Video 100G 12" Green Phosphor 149  
 Amdek (Hitachi) 13" Color w/audio output 389  
 NEC 12" Green Phosphor Display J9-1201M CALL  
 NEC 12" Lo-Res Color Display CALL  
 NEC 12" Hi-Res RGB Color Display CALL  
 Sanyo 9" B&W Display 179  
 Sanyo 9" Green Display CALL  
 Sanyo 12" B&W Display 229  
 Sanyo 12" Green Phosphor display 285  
 Sanyo 12" Color Display 419  
 Zenith 12" Green Phosphor Display 138



256 Dynamic Ram Card CALL FOR  
 Hi-Speed Parallel I/O Card BEST  
 Hi-Speed Serial I/O Card PRICE  
 Real-Time System Clock  
 Card Expansion Chassis

## PRINTERS



Grapple by Orange Micro 145  
 Anadex 9501 W/2K Buffer 1289  
 C. Itoh Starwriter F-10 CALL  
 Epson MX-7U CALL  
 Epson MX-80 & MX-80 FT CALL  
 Epson MX-100 CALL  
 NEC 8023 Impact Dot Matrix 829  
 NEC Spinwriter (Latest models) CALL  
 Paper Tiger IDS-480G w/graphics 899  
 Paper Tiger IDS-580G w/graphics 1099  
 Qume Sprint Daisylwheels (Latest Models) CALL  
 Diablo 830 Daisylwheet 40 CPS 1795

## NEW FOR EPSON NEC PRINTER HI-RES GRAPHICS INTERFACE

**\$145**

COMING SOON!



Send Orders to:  
**consumer computers** Mail Order

8338 Center Drive  
 La Mesa, CA 92041

**ORDER TOLL FREE  
 800-854-6654**

In California and  
 outside continental U.S. **(714) 698-8088**

Telex 695-000  
 Beta CCMO

**FREE SHIPPING\***  
 \*prepaid cash orders  
 (continental US only)

Listing 1: The maze-builder program, written in UCSD Pascal.

```
{ $G+ }
{ 2/28/80 }
PROGRAM MAZE;
LABEL 190,210,500;
CONST H = 10;W = 23;
VAR Q,Z,A,B,I,J,X:INTEGER;
    M:ARRAY [0..11,0..24] OF INTEGER;
    SEED:REAL;

PROCEDURE L150;BEGIN
    M[I,J]:=M[I,J]-1; J:=J+1; M[I,J]:=4; Q:=0; END;
PROCEDURE L380;BEGIN
    J:=J-1; M[I,J]:=3; Q:=0; END;
PROCEDURE L420;BEGIN
    M[I,J]:=M[I,J]-2; I:=I+1; M[I,J]:=4; Q:=0; END;
PROCEDURE L470;BEGIN
    I:=I-1; M[I,J]:=2; Q:=0; END;

PROCEDURE ONCEWITHSTYLE;BEGIN
    WRITE ('+');
    FOR J:=1 TO W DO
        IF J=X THEN WRITE (' +')
            ELSE WRITE ('--+');
    WRITELN; END;

FUNCTION FNA(X:INTEGER):INTEGER;
BEGIN
    SEED:=SEED*27.36947+31.8723423;
    SEED:=SEED-TRUNC(SEED);
    FNA:=TRUNC(SEED*X)+1;END;

PROCEDURE GETRAND;
BEGIN;
    WRITE ('Please input a number -- any number:');
    READ(SEED); SEED:=ABS(SEED);
    REPEAT SEED:=SEED*13 UNTIL SEED>1;
    REPEAT SEED:=SEED/17 UNTIL SEED<1;
    END;

{INITIALIZATION}

BEGIN; GETRAND;
FOR I:=1 TO H DO FOR J:=1 TO W DO M[I,J]:=0;
FOR I:=0 TO W+1 DO BEGIN
    M[0,I]:=1; M[H+1,I]:=1; END;
FOR I:=0 TO H+1 DO BEGIN
    M[I,0]:=1; M[I,W+1]:=1; END;

    X:=FNA(W-2)+1;
    FOR I:=X-1 DOWNTO 1 DO WRITE (' ');

    WRITELN ('START');
    ONCEWITHSTYLE;

I:=1; J:=1; A:=1; B:=1; Q:=0; M[I,J]:=4;

{MAIN LOOP}
```

Listing 1 continued on page 278



# NEC

## PC-8000 SYSTEM



"The end of the compromise."

PC-8001A	CPU/32K	\$745
PC-8012A	I/O - 32K	\$490
PC-8023A	100 CPS Printer:	
	Friction, Tractor, Graphics	\$485
PC-8031A	Dual Disk	\$745
JB-1201M(A)	12" Green	\$159
JC-1202DH(A)	13" RGB Color	\$830
PC-8091A	RGB Cable	\$19
PC-CPM	CP/M DOS FOR NEC	\$119
PC-GA	Gen. Accounting	\$245
PC-AR	Acct. Receivable	\$245
PC-INV	Inventory Control	\$245
PC-JC	Job Cost	\$245
PC-WP	Word Processor	\$350
PC-RM	3-D Report Mgr.	\$139
PC-32K	32K Card	\$155
PC-SER	RS-232 Card	\$199

## PRODUCTS FOR APPLE



AP-16	16K Ram Card	\$95
AP-128	128K Ram Floppy	\$700
AP-B1	Bison Drive W/3.3	\$475
AP-B2	Bison Drive Add-On	\$365
AP-K6	Konan 6MB Hard Disk	\$2265
AP-111	Konan 11 MB Hard Disk	\$2750
AP-K11	Konan 16MB Hard Disk	\$2970
AP-PAR	Parallel Printer Card	\$72

## PRODUCTS FOR IBM

IB-B2	Bison Drive-1 Side	\$275
IB-B3	Bison Drive-2 Side	\$465
IB-A64	AST 64K Card	\$375
IB-A128	AST 128K Card	\$530
IB-A192	AST 192K Card	\$710
IB-A256	AST 256K Card	\$815
IB-A2S	AST Dual Serial	\$235

20% Discount!  
- Entire Line.



## ACS8000-14S/MTU

- 208K, 4 USER, Z80A
  - 5M Floppy
  - 40MB Winchester
  - 17MB Tape Cartridge Backup
  - Nation-wide Service
- AL-40M List \$15,500 BISON .....\$12,400

# BISON

## SINGLE BOARD COMPUTER

- 64K
- 2 Serial
- 2 Parallel
- 5 1/8" Floppy Controller (Double Density)
- Z-80A (4MHZ)
- Hard Disk Expansion
- CP/M DOS

Just add drives, power supply, cables, and CRT terminal .....\$900

## VIDEO MONITORS

V-AC1	Amdek Color I	\$310
V-ACII	Amdek Color II - Apple	\$Call
V-A300G	Amdek 300 Green	\$150
V-Z12G	Zenith 12" Green	\$115
V-J13	JCS 13" RGB	\$625
V-J12G	JCS 12" Green	\$166

Circle 45 on inquiry card.



# BISON PRODUCTS

MAIL ORDERS:  
P.O. Box 9078-184  
Van Nuys, CA 91409

WILL CALLS:  
16709 Roscoe Boulevard  
Sepulveda, CA 91343  
(213) 891-5702

Please confirm price and availability  
by phone prior to ordering.



We accept VISA and Mastercard.



Shipping additional - \$3 minimum.  
Calif. residents add 6% sales tax.

Overseas orders and dealer inquiries accepted.

All merchandise is new and  
comes with factory guarantee.

## SIERRA DATA SCIENCES

### S-100 BOARDS Z-80 Master/Slave Single Board Computers

Master:

- 4MHZ
- 64K
- Serial
- 4 Parallel
- 16K EPROM
- 8" Floppy Disk Controller (Double Density)
- Winchester Interface

S-S4M .....\$690

Slave: Without Disk Controllers

S-S4S .....\$625

Winchester Adapter: Uses Micropolis Drives

S-SW .....\$145



## DISKETTES



F-D8SD	Dysan 8" SSDD, 10 PCS	\$45.00
F-W5SS	Wabash 5 1/4" SSDD, HUB	\$23.50
F-W8SD	Wabash 8" SSDD	\$33.00
F-W8DD	Wabash 8" DSDD	\$40.00

## PRINTERS



P-MX80	Epson MX100	\$405
P-MX80F/T	Epson MX-80 F/T	\$515
P-MX100	Epson MX-100	\$685
P-OK82	Okidata 82A	\$468
P-OK83	Okidata 84, Serial	\$1125
P-PC8023A	NEC PC-8023A	\$485
P-PRO	C. ITOH Prowriter, 120 CPS	\$485
P-PRO II	C. ITOH Prowriter II	\$Call
P-F10	C. ITOH 40 CPS Daisywheel	\$1395
AP-PAR	Parallel Int/Cable/Apple	\$72

## MicroPro SOFTWARE

MP-WS8	Word Star, 8"	\$250
MP-W5A	Word Star, Apple	\$192
MP-MM8	Mail Merge, 8"	\$ 77
MP-MMA	Mail Merge, Apple	\$ 63
MP-SS8	Spell Star, 8"	\$127
MP-SSA	Spell Star, Apple	\$ 53
MP-DS8	Data Star, 8"	\$175
MP-SR8	Super Sort, 8"	\$127
MP-SRA	Super Sort, Apple	\$100
MP-SII8	Super Sort II, 8"	\$105
MP-CS8	Calc Star, 8"	\$149

Many additional software packages are available at similar discounts.

## DISK DRIVES

D-S801R	Shugart 801R	\$390
D-QDT8	Qume DT-8	\$495
D-T81	Tandon Thinline 8", SS	\$390
D-T82	Tandon Thinline 8", DS	\$485

## SIGNALMAN MKI 300BPS MODEM

- RS-232 to Telephone Link, Full Duplex
  - Direct Connect, FCC Approved
  - 1 Year Warranty
  - Low Power Design
- M-S300 List .....\$115 BISON .....\$89

## AB DIGITAL DESIGN LABS 256K BYTE - 128K

### WORD DYNAMIC MEMORY

- 4MHZ with Extended DMA
  - IEEE696, Multi-Layer
  - 1 Year Warranty
- S-B810A List .....\$1245 BISON ...\$975

## STATIC MEMORY SYSTEMS 64K



- 24 Line Addressing
  - 200NS, Lower Power CMOS
  - Intermix RAM and EPROM
  - New Super Low Price
- S-ST64 List .....\$594 BISON .....\$440

## 8086 SUPER MICRO

- 8 MHZ 8086 S-100 SET
  - 128K 70NS Static RAM
  - DD Disk Controller
  - 22 Slot Mainframe
  - Cable for 2 1/2" Drives
  - MS-DOS (86-DOS)
  - Add Drives and Terminal!
- SC-SYS2 System 2 List .....\$4185 BISON ...\$3450
- SC-2/3 8086 2 BRD Set w/DOS  
List .....\$795 BISON .....\$595

## QT S-100 & 8" Floppy Drive Mainframe



- +8V@ 25A/ ±16V@ 5A S-100 Power
- +5V@ 2.5A/ -5V@ .5A/ +24V@ 3A Drive Power
- Keyed Power Switch
- Shielded Motherboard
- Rugged Card Cage
- 9" x 17" x 21" (HxWxD)
- Strappable 110V or 220V AC



QT-MF6	6 Slot, 2-8" Drive	\$525
QT-MF8	8 Slot, 2-8" Drive	\$550
QT-MF12	12 Slot, 2-8" Drive	\$575

## QT S-100 & 5 1/4" Floppy Mainframe

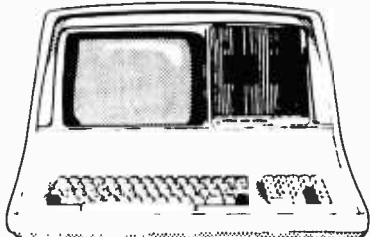
- Similar to 8" Mainframe
  - Power for 5 1/4" Drives
  - 7" x 17" x 20" (HxWxD)
  - 7" x 17" x 20" (HxWxD)
- QT-5MF6 6 Slot, 2-5 1/4" Drive .....\$350
- QT-5MF8 8 Slot, 2-5 1/4" Drive .....\$375
- QT-5MF12 12 Slot, 2-5 1/4" Drive .....\$400



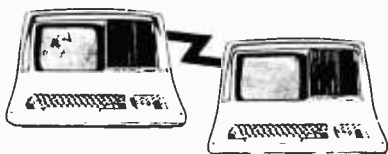
## DRIVE CABINETS

H-BT8	BISON 2 Dr, Vert, 8", Thinline	\$245
H-QT8	QT 1 Drive, 8" Vertical	\$215
H-QT8-2	QT 2 Dr, Horizontal, 8"	\$305

# LET US INTRODUCE YOU TO THE COMPUSTAR™ NETWORK.



**AGAIN**



**AND AGAIN**



**AND AGAIN**

Each CompuStar unit offers the CP/M operating system, 64K of RAM and the ability to start as a floppy-based system and grow to 400 megabytes of hard disk storage. Up to 255 units can be linked together in one shared-disk system.

Just the system for the dealer or OEM who wants to make it big in the business market. The versatility and expandability of the CompuStar network lets you answer your clients' needs today and tomorrow. And our low price lets you offer a package they can afford to buy and you can afford to sell.

If networking is new to you, TriStar will give you a proper introduction. We've got software for CompuStar, including accounts payable, payroll, accounts receivable, word processing and database management. Plus we'll help you with your own software development, systems configuration, communications, hardware service, training, installation and any other needs that might pop up.

Because we're experts in networking and support, Intertec® (the manufacturer of CompuStar) has chosen us to distribute this incredible, expandable business system.

For more information on CompuStar and other Intertec products, call (609) 424-4700.

## TRISTAR

2 Keystone Avenue  
Cherry Hill, NJ 08003

CompuStar is the trademark of Intertec, Inc.

Listing 1 continued:

```
190: X:=0;
      IF M[I,J-1] <>0 THEN X:=X+8;
      IF M[I-1,J] <>0 THEN X:=X+4;
      IF M[I+1,J] <>0 THEN X:=X+2;
      IF M[I,J+1] <>0 THEN X:=X+1;
```

CASE X OF

```
1:CASE FNA(3) OF
  1:L380;
  2:L420;
  3:L470;
  END;
2:CASE FNA(3) OF
  1:L150;
  2:L380;
  3:L470;
  END;
3:CASE FNA(2) OF
  1:L380;
  2:L470;
  END;
4:CASE FNA(3) OF
  1:L150;
  2:L380;
  3:L420;
  END;
5:CASE FNA(2) OF
  1:L380;
  2:L420;
  END;
6:CASE FNA(2) OF
  1:L150;
  2:L380;
  END;
7:L380;
8:CASE FNA(3) OF
  1:L150;
  2:L420;
  3:L470;
  END;
9:CASE FNA(2) OF
  1:L420;
  2:L470;
  END;
10:CASE FNA(2) OF
  1:L150;
  2:L470;
  END;
11:L470;
12:CASE FNA(2) OF
  1:L150;
  2:L420;
  END;
13:L420;
14:L150;
```

Listing 1 continued on page 280

# GALAXY OF FEATURES

A **GALAXY** of features makes the **LNW80** a remarkable computer. As you explore the **LNW80**, you will find the most complete, powerful, ready to run, feature-packed personal and business computer ever made into one compact solid unit.



**MODEL I COMPATIBILITY** – The **LNW80** is fully hardware and software compatible with the Model I. Select from a universe of hardware accessories and software – from VisiCalc<sup>®</sup> to space games, your **LNW80** will launch you into a new world of computing.

**FULLY LOADED** – A full payload includes an on-board single and double density disk controller for 5 1/4" and 8" single or double sided disk drives. RS232C communications port, cassette and parallel printer interfaces are standard features and ready to go. All memory is fully installed – 48K RAM, 16K graphics RAM and 12K ROM complete with Microsoft **BASIC**.

**QUALITY CONSTRUCTION** – Instrumentation quality construction sets **LNW80** computers apart from all the rest. Integrated into the sleek solid steel case of the **LNW80** is a professional 74-key expanded keyboard that includes a twelve key numeric keypad.

**HIGH RESOLUTION GRAPHICS & COLOR** – The stunning 480 X 192 resolution gives you total display control – in color or black and white. The choice of display formats is yours; 80, 64, 40 and 32 columns by 24 or 16 lines in any combination of eight colors.

**PERFORMANCE** – Lift-off with a 4MHz Z80A CPU for twice the performance. The **LNW80** outperforms all computers in its class.



Our down to earth price won't send you into orbit

## LNW Research Corp.

2620 WALNUT Tustin, CA 92680  
(714) 641-8850 (714) 544-5744

Monitor and Disk drives not included  
TM Personal Software, Inc.

Circle 239 on inquiry card.

[www.americanradiohistory.com](http://www.americanradiohistory.com)



```

15:GOTO 210;
END; {OF UPPER-CASE STATEMENT}
GOTO 190;

210: IF B<>W THEN B:=B+Q ELSE
      BEGIN WRITE ('!');
          FOR J:=1 TO W DO IF (M[A,J]=2) OR (M[A,J]=4) THEN WRITE (' !')
                           ELSE WRITE ('  ');
      WRITELN;
      IF A=H THEN GOTO 500 ELSE
          BEGIN WRITE ('+');
              FOR J:=1 TO W DO IF M[A,J]>2 THEN WRITE ('--+')
                               ELSE WRITE (' +');
          WRITELN; B:=1; A:=A+1; END
      END;
I:=A; J:=B; Q:=1; GOTO 190;

500: X:=FNA(W-2)+1; M[H,X]:=M[H,X]-2; ONCEWITHSTYLE;
      FOR I:=X-1 DOWNT0 1 DO WRITE (' '); WRITELN ('STOP');
END.

```

gram will intentionally enter a non-frontier cell.

Now the program has finished the first line of the maze. It is no longer possible for any more work to be done to this line because there are no longer any frontier cells surrounding any cell on the line. So the system prints the top line.

Now the system moves to the left-most cell of the second line of the maze and does exactly the same thing over again for this new line. And so the program continues, left to right, top to bottom, creating and printing the maze.

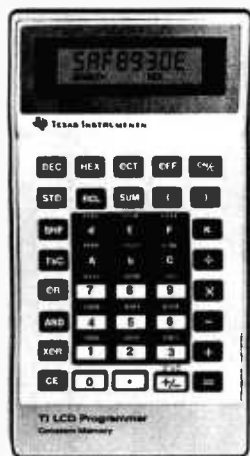
When the program has completed

the maze—but before it has printed the last line—it is time to make the exit. The program randomly picks a spot on the last line of the maze and blows a hole through the bottom of the maze pattern, thus creating the stop point. The last line is printed, then the STOP message, and you have a maze with only one solution. See listings 2a and 2b on page 282 for a sample maze and its matrix.

### Additional Comments

The program makes a boundary by setting the outer rows and columns of the matrix to 1, making them non-frontier. This method wastes the

outer limits of the matrix and decreases the size of the maze but is much faster than any kind of numeric subscript out-of-bounds checking since the program logic treats these outermost nonfrontier cells as off-limits territory. Therefore it won't go beyond them and cause a subscript error. Note that this requires a maze of 10 by 10 to actually be stored in a 12 by 12 matrix. Naturally, the percentage of memory required as overhead to store these outermost values goes down rapidly as the size of the maze increases, so this method becomes highly efficient with very large mazes.



## New! TI LCD Programmer.

### Hexadecimal and Octal Calculator/Converter.

The brand new tilt-top TI LCD Programmer can save you hours of work. It was designed specifically for the problems you do, and has features that make it ideally suited for applications in computer programming, debugging, repair and digital logic design.

- Performs arithmetic in any of three number bases — OCT, DEC, HEX.
- Integer, two's complement arithmetic in OCT and HEX.
- One's complement capability in OCT and HEX.
- Converts numbers between OCT, DEC and HEX.
- Fifteen sets of parentheses available at each of four processing levels.
- Logical functions AND, OR, EXCLUSIVE OR and SHIFT operate bit by bit on OCT or HEX numbers.

Unisource Electronics has committed to buy TI's initial production of this unique product. Availability is limited! Order now.

### 15-Day Free Trial.

The best way to evaluate the TI LCD Programmer is to try it yourself — on the job — for 15 days. If you're not 100% satisfied, simply return it for a full refund. Order now by calling toll-free:

**1-800-858-4580**

In Texas call 1-800-745-8835

Lines open 8 am to 6 pm CST



Just give us your name, shipping address and Visa or MasterCard number and we will charge the tax deductible\* \$75.00 purchase price, plus \$2.00 shipping and handling (Texas residents also add 5% sales tax) to your account. Or send your check or money order to:

**Unisource Electronics, Inc.**  
P.O. Box 64240 • Lubbock, Tx. 79464

\* When used for business.

**Color output for \$1995 . . . and less.**

The Prism color printers from Integral Data Systems give you great color hard copy for less than you'd pay for most other quality colorless matrix printers.

The fully optioned 132 column Prism Printer turns complex data into colorful, communicative information that you can really use. Practical information that can help you develop ideas, make decisions and effectively communicate with others. Detailed inventory data, lengthy sales analyses and financial models can now be displayed more clearly and precisely than ever before with colorful text, charts and graphs.

**And color is just part of the Prism Printer story.**

Text quality print at up to 150 cps,

with proportional spacing and automatic text justification make the Prism Printer ideal for all your correspondence requirements.

A new cut sheet feeder automatically positions an 8½" x 11" sheet for quick, hassle-free loading, while a software selectable Sprint Mode lets you fly through data at over 200 cps. And if your requirement is for

only an 80 column printer, or if you simply don't need some of the performance features mentioned, other configurations of the Prism Printer are available for even less.

How much less? Contact your local dealer to find out. Call toll free (800) 258-1386 (New Hampshire, Alaska and Hawaii, call (603) 673-9100) for your dealer's name. He'll color your output affordable . . . at just \$1995. And less.



# Affordable color. Now. Meet the Prism Printer™ from Integral Data Systems



**Integral Data Systems, Inc.**  
A Whole New Spectrum of Imaging Ideas  
Milford, NH 03055 Telex: 953032

Crayola is a trademark of the Binney & Smith Co., Inc.

www.americanradiohistory.com





# Why wait?

## Announcing the mbp COBOL Compiler



for CP/M-86\*...  
available now.



Recently, 16-bit microcomputers have been the big news. And here's more news just as big: the mbp COBOL Compiler for 16-bit systems. Not a 'sometime-in-the-future' product, it's here now —we're already delivering.

For commercial and administrative applications, COBOL has long been recognized as the language. It's standardized and maintained like no other language—witness its popularity on mainframes for the last twenty years. Now, as 16-bit micros grow in popularity, so will COBOL. How can it miss? For business micro users, it opens up a whole range of benefits that previously only mainframe and mini users enjoyed. For application software developers, it's a completely new market—for dealers, too.

The mbp COBOL Compiler's fine features include: meets ANSI 74 Standard (low intermediate), certification applied for • real executable machine code—run-time efficient, memory efficient • use-proven reliability • user-friendly (example: over 500 error messages) • maximum portability protects software investments.

And it's available now for CP/M-86, iRMX-86\*, and ISIS\*; available soon for OASIS-16\* and MS-DOS\*.

Who is mbp? We're a worldwide company with more than twenty-five years of system software experience—more than twelve in custom COBOL Compiler installations for mainframes and minis. Now, this vast experience is also available to micro users. Take advantage of it—send the coupon or call today and start getting mainframe capabilities from your CP/M-86 micro. Why wait?

**mbp**  
SOFTWARE AND  
SYSTEMS TECHNOLOGY INC.

7700 Edgewater Drive, Suite 626 B  
Oakland, California 94621  
Phone 415/632-1555

mbp COBOL is what I've been waiting for.  
Please send me today:

### Special introductory offer

- mbp COBOL for CP/M-86 at single copy special introductory price of **\$990**. (User's Manual included. Offer expires June 30, 1982 when retail price will become \$1400.)
- mbp COBOL User's Manual only, **\$95**.
- Complete mbp COBOL information.
- Please have a representative contact me with information about OEM and distributor arrangements.



Name \_\_\_\_\_

Title \_\_\_\_\_

Company \_\_\_\_\_

Street (no PO Box numbers) \_\_\_\_\_

City \_\_\_\_\_ State \_\_\_\_\_ Zip \_\_\_\_\_

- Check enclosed       VISA
  - UPS C.O.D.       Mastercharge
- (Add \$3 for shipping. California residents add sales tax.)

Card Number \_\_\_\_\_ Exp. date \_\_\_\_\_

Signature \_\_\_\_\_

Hardware required: 96K memory, hard disk, 8-inch floppy.  
\*CP/M-86 is a Digital Research trademark; iRMX-86 and ISIS are Intel TMs; OASIS-16 is a Phase One Systems, Inc. TM; MS-DOS is a Microsoft, Inc. TM.

See us at  
**COMDEX**  
Booth 1467

**mbp COBOL. Now.**

Q is a Boolean variable that is also used as an arithmetic argument. The value of Q decides whether we advance to the next cell of a line (Q = 1) or not (Q = 0).

The program is very simple. Since it requires only integer arithmetic and uses a maximum integer value of 15, it is a rather trivial task to convert to machine language. Since each maze cell can attain only five values, this means that on a 60K-byte computer, assuming 4K bytes are used for program and operating system, and

assuming each byte is broken into two cells, a maze

$$\sqrt{(60000 \times 2)} \text{ or } 340$$

cells square is possible. Since a 132-column printer can print only 43 cells across, this means a 2500 by 43 maze can be created. Assuming 66 lines per page, a maze almost 80 pages long is possible.

The algorithm is fast. There is almost no delay between successive lines of the maze on my line printer

past the first few (I use a Horizon computer at 4 MHz with an Anadex printer).

### Possible Enhancements

One side effect of the algorithm is that the maze is almost always easier to solve by traveling from bottom to top. This makes sense when you realize that there are more possible pathways for the maze maker when the maze is "young" than when it is "older" (farther down, or more complete). Pathways created will generally be longer near the top of the maze and will have more possible paths diverging from them. A nifty solution to this problem is to duplicate the same algorithm in reverse, starting from the bottom right cell and moving from right to left, bottom to top. However, if the program figures out one line at the top, then one line at the bottom, alternating, the maze will be impossible to solve since the two separate pathways will never intersect. To fix this problem, randomly pick one place where the two pathways run side by side and cut a wall to connect them at that point. Naturally the correct solution of the maze will run through that hole.

Another option to make the mazes more difficult is to weigh the random-number generator in favor of paths that extend vertically—at least for the first several thousand decisions (this is assuming the maze is higher than it is wide, which will normally be the case). Other "derandomizing" operations on the random-number generator output can create beautiful and eye-catching patterns, not to mention some eye-strainers.

After each line of the maze is printed, the corresponding matrix row is never used again. It is possible at that time to shift the entire matrix up one row. The first line disappears, the second becomes the first, the third line becomes the second, and so on through the end of the matrix. Be careful to set the last line to frontier status. The program then becomes capable of making *infinite* length mazes having only a single solution. Implementation of this feature is left to the motivated reader. ■

## How to get a Complete S-100 Bus, Z80A™ Based System With DMA Transfer and Memory Management on an IEEE Spec 696.1/D2 Board for \$1095

This versatile single board computer, model CPZ-48000, can be used in many applications including:

- Single board, stand alone computer
- Network master
- Multiuser host
- Multiprocessor host

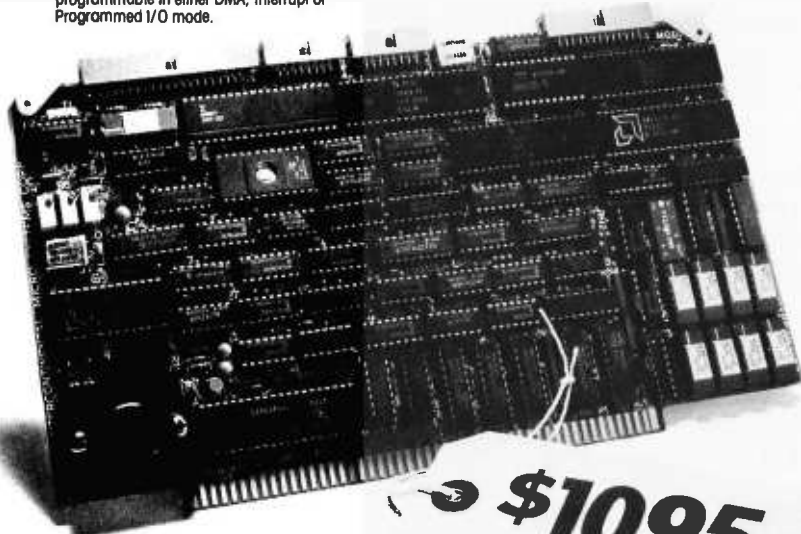
The Model CPZ-48000 features:

- Single or Double Density Floppy Disk controlling up to four 8" or 5 1/4" floppy disk drives in either DMA, Interrupt or Programmed I/O mode.
- 64 Kbytes of onboard Dynamic RAM with Memory Deselect of 4 Kbytes to 64 Kbytes under software control.
- Four Channel Direct Memory Access Controller.
- Two Serial I/O channels with one channel programmable in either DMA, Interrupt or Programmed I/O mode.
- Two Parallel I/O channels with one channel programmable in either DMA, Interrupt or Programmed I/O mode.

- Memory Management of 16 Megabytes of system memory.
- Eight Vectored Priority Interrupts chained together with I/O Interrupts for use with Z80 Mode 2 Interrupts.
- Provisions for either a 2 Kbyte or 4 Kbyte onboard EPROM. (Monitor in a 2 Kbyte EPROM supplied with board).
- CP/M™ and MP/M™ operating systems available, TurboDOS™ available soon.
- Turbo-Disk™ implementation included.

Intercontinental Micro Systems also manufactures a 256K, 16K increment, fully bank selectable memory board.

For any further information please call Intercontinental Micro Systems or circle the bingo number below. Dealer inquiries are welcome.



TM — Z80 is a registered trademark of Zilog, Inc.  
Turbo-Disk is a registered trade-mark of Intercontinental Micro, Inc. CP/M, MP/M are registered trademarks of Digital Research, Inc. TurboDOS is a registered trademark of Software 2000, Inc.



1733 SOUTH DOUGLASS ROAD, SUITE E  
ANAHEIM, CALIFORNIA 92806  
(714) 978-9758 TELEX: 678401-TAB-IRIN

Circle 465 on inquiry card.

**Yes.**

**I want to turn my microcomputer into a powerful information and communications system. Send me your free Information Kit.**

**No.**

**Thanks anyway, I'm already on-line with THE SOURCE.<sup>SM</sup>**

If you are not one of the more than 11,000 microcomputer, data terminal or communicating word processor owners who already subscribe to The Source, send in this coupon or call us toll-free. We will send you our free Information Kit that describes the over 1200 programs and services now available from The Source. You'll see how easy it is to turn your microcomputer into a powerful information and communications system.

With The Source, you get hundreds of useful services for the home or for helping you run your business more profitably. You can get current stock prices, make airline reservations, find a good restaurant, barter goods and services, get up-to-the-minute sports and news from UPI. You can communicate instantly through electronic mail with branch offices and field representatives subscribing to The Source; you can create your own business programs, on either a simple or sophisticated level.

In addition to all this, you also have access to hundreds of easy-to-use data bases, electronic games, informative and educational

programs (including lessons in geometry and spelling, foreign language drills and math reviews), and a unique shop-at-home service that lets you buy over 30,000 brand name

items at discount prices.

You can do all of this easily and inexpensively with a local phone call in more than 350 cities across the country, and at a one-time subscription fee of only \$100.00 and usage costs as low as \$4.25/hour.

If you'd like to get the most out of your personal computer or data terminal, call our toll-free number or send for your free kit today.

You have nothing to lose and a world of information to gain.

**Mail to:**

**Source Telecomputing Corporation, Dept. (22M)  
1616 Anderson Road, McLean, VA. 22102.**

Name \_\_\_\_\_

Company \_\_\_\_\_

Address \_\_\_\_\_

City \_\_\_\_\_ State \_\_\_\_\_ Zip \_\_\_\_\_

Telephone (     ) \_\_\_\_\_

Type of Equipment \_\_\_\_\_

**For free Information Kit  
call toll free 1-800-323-1718.**



**THE SOURCE**  
AMERICA'S INFORMATION UTILITY

The Source is a servicemark of Source Telecomputing Corporation, a subsidiary of The Reader's Digest Association, Inc.



## Colne Robotics Armdroid The Small-Systems Robot

---

Steven W. Leininger  
5402 Summit Ridge Trail  
Arlington, TX 76017

---

If you think you've explored all the possible hardware options for your small-computer system and are looking for some excitement, you might be interested in Armdroid, a new computer-controlled robot arm. The bright orange mechanical arm is available from Colne Robotics in kit or assembled form, complete with power supply and interface electronics. The kit form, besides being less expensive, "enables the person assembling the device to understand the principles of the robot," according to the manufacturer. The robot can be used for a variety of experimental and educational applications. It has 6 degrees of motion and a lift capacity of 10 ounces. I received both a kit and an assembled Armdroid for my evaluation, along with a "preliminary" manual.

### Mechanical Description

The Armdroid has five major mechanical components: the base, the shoulder, the upper arm, the forearm, and the wrist and hand assembly. Each section is connected to its neighbor by a pivoting or rotating joint. The stationary base sits on the tabletop and provides support for the rest of the arm. The base, which also serves as the enclosure for the stepper-motor-drive electronics, contains the motor which rotates the arm about a vertical axis through the base.

---

### About the Author

Steven W. Leininger was the design engineer for the original Radio Shack TRS-80 Model I microcomputer. He is now an independent computer consultant.

---

### At a Glance

**Name**

Armdroid

**Use**

Robotic arm

**Manufacturer**Colne Robotics  
207 NE 33rd St.  
Fort Lauderdale, FL 33334**Dimensions**At shoulder: 18 by 18 by 29 cm (7 by 7 by 11.5 in)  
Shoulder pivot height: 25 cm (10 in)  
Arm length at maximum extension from shoulder pivot to finger tip: 48 cm (19 in)**Price**Kit: \$595  
Assembled: \$695**Features**

6 degrees of motion; menu-driven control software; 10-ounce load capacity

**Additional Hardware Needed**

TRS-80 Model I Level II (other microcomputers will be supported in the future)

**Additional Software Needed**

Learn, an interactive menu-driven control program (included)

**Hardware Option**

Zero-position sense switches

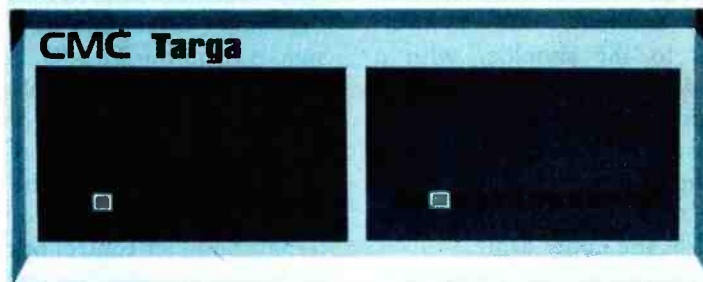
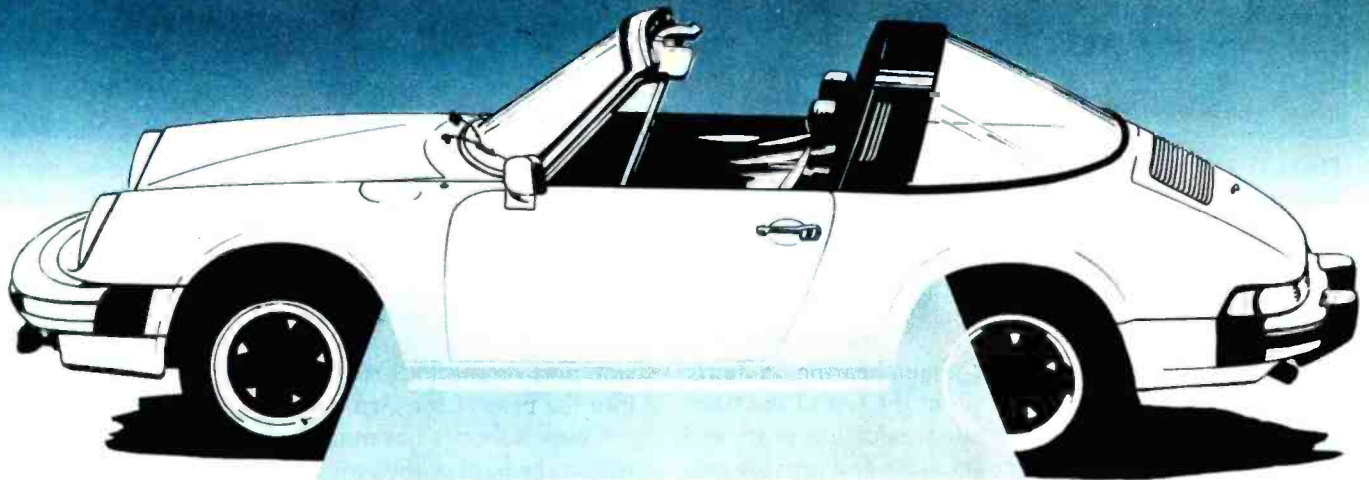
**Documentation**

Construction and Operation Manual, 87 pages

**Audience**

Experimenters, students, and professionals interested in robotics

# TARGA



**5-10-20 Megabytes in an add-on hard disk for:**

**IBM Personal Computer • Xerox 820  
Apple • SuperBrain • Heath-Zenith  
TRS-80 Models II & III**

Targa, a truly high performance design, whether by Porsche or by CMC. Targa hard disk system, a significant extension to the storage capacity of your micro-computer, at an unheard of price/performance ratio. Suggested list for 5 mb:

**only \$2895.**

**Targa 5** 6.38 Mbytes unformatted, 5 MB formatted. Upgradeable to 10 MB  
**Targa 10** 12.8 Mbytes unformatted, 10 MB formatted. Upgradeable to 20 MB formatted  
**Targa 20** 20 Mbytes formatted, 25.6 MB unformatted

Our Targa Winchester-type, hard disk drives are offered in desk-top dimensions of 15" x 5 1/4" x 13 1/2". It comes complete with cables, software and interface. Call or write for complete specifications and/or the dealer nearest you. Dealer inquiries invited.

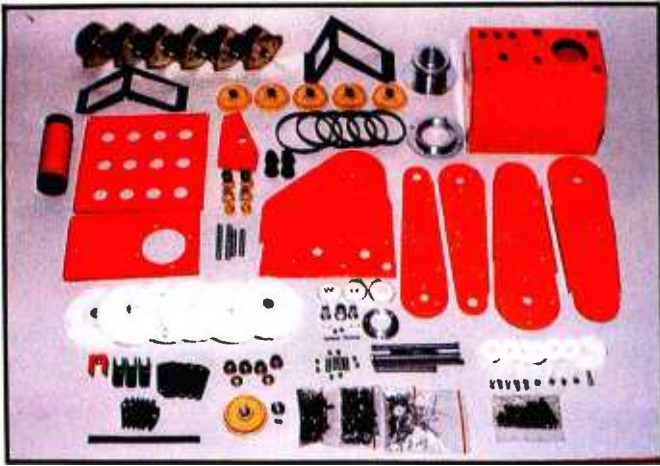
Circle 77 on inquiry card.

## CMC INTERNATIONAL

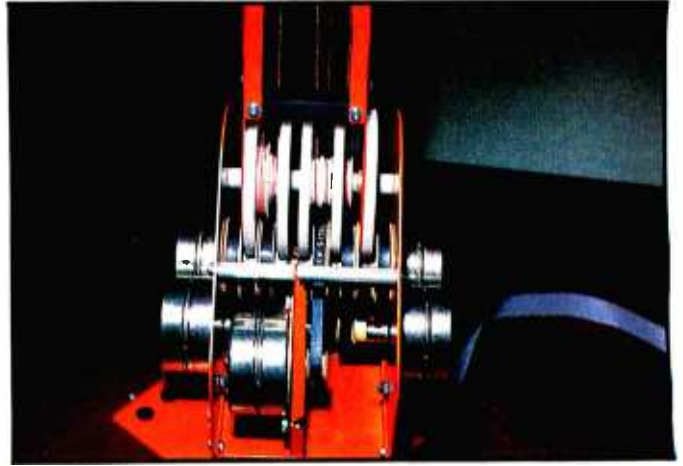
A Division of Computer Marketing Corporation

11058 Main • Suite 220 • Bellevue, WA 98004 • Phone (206) 453-9777 • Telex: 152556 SEATAC

Call Toll-Free 1-800-426-2963



**Photo 1:** The Armdroid kit's many parts. The cost of the six stepper motors (at the top of the photo) is offset by the relatively inexpensive stamped-steel chassis and structural parts. The power supply and interface electronics are not shown.



**Photo 2:** The shoulder contains five of the six stepper motors. Reduction gears are used to increase the force applied via the drive cables.

The shoulder rotates on the main bearing, a fairly heavy-duty ball-bearing assembly at the top of the base. Five stepper motors and associated reduction gears and drive belts are mounted on the shoulder and provide motion control to the arm, wrist, and hand.

The upper arm connects to the shoulder with a horizontal pivot and is rotated on that pivot by one of the stepper motors in the shoulder. If you move the upper arm vertically, the hand is raised and brought closer to the base. Cable-driving gears transmit motion to the forearm and the hand and wrist assembly; these are mounted in the shoulder end of the upper arm.

The forearm fastens to the upper arm with a horizontal pivot and is rotated about that point with one of the motors in the shoulder. The primary response to pivoting the forearm is the raising or lowering of the hand with respect to the tabletop.

The hand and wrist assembly attaches to the end of the forearm with a combination horizontal pivot and bevel gear assembly. The operator uses two motors in the shoulder to either rotate the hand about the pivot (an up-and-down motion) or twist the hand about its axis. The remaining motor in the shoulder opens and closes the hand's three rubber-tipped metal fingers.

You can move any section independently without affecting the orientation of the other sections because of the Armdroid's parallelogram-type construction. This independence of control permits the angle of the hand to remain constant with respect to the workbench while the rest of the arm is manipulated to position the hand in the desired location.

### Interface Electronics

The Armdroid I tested came with an I/O (input/output) adapter for the Radio Shack TRS-80 Model I. This adapter, a nonlatched parallel port, plugs into the expansion

port on the TRS-80. A cable from the adapter plugs into the base of the Armdroid.

Colne Robotics has mounted two printed-circuit cards within the base of the Armdroid: the interface board and the motor-drive board. The interface board accepts signals from the TRS-80, conditions them, and converts them to pulses of the duration and shape suitable for controlling the arm's motors. The motor-drive board amplifies the signals to provide the voltage and current levels required to drive the motors' coils.

You can set the Armdroid's internal electronics for external computer control or operation via manual switches by making the selection on the two printed-circuit boards inside the Armdroid's base.

### Building the Kit

Being a disciple of Erector Set and Heathkit, I had no fears about venturing out into the frontiers of robot kit building. To get a feel for the scope of the project, I laid all the parts out and familiarized myself with the construction section of the manual.

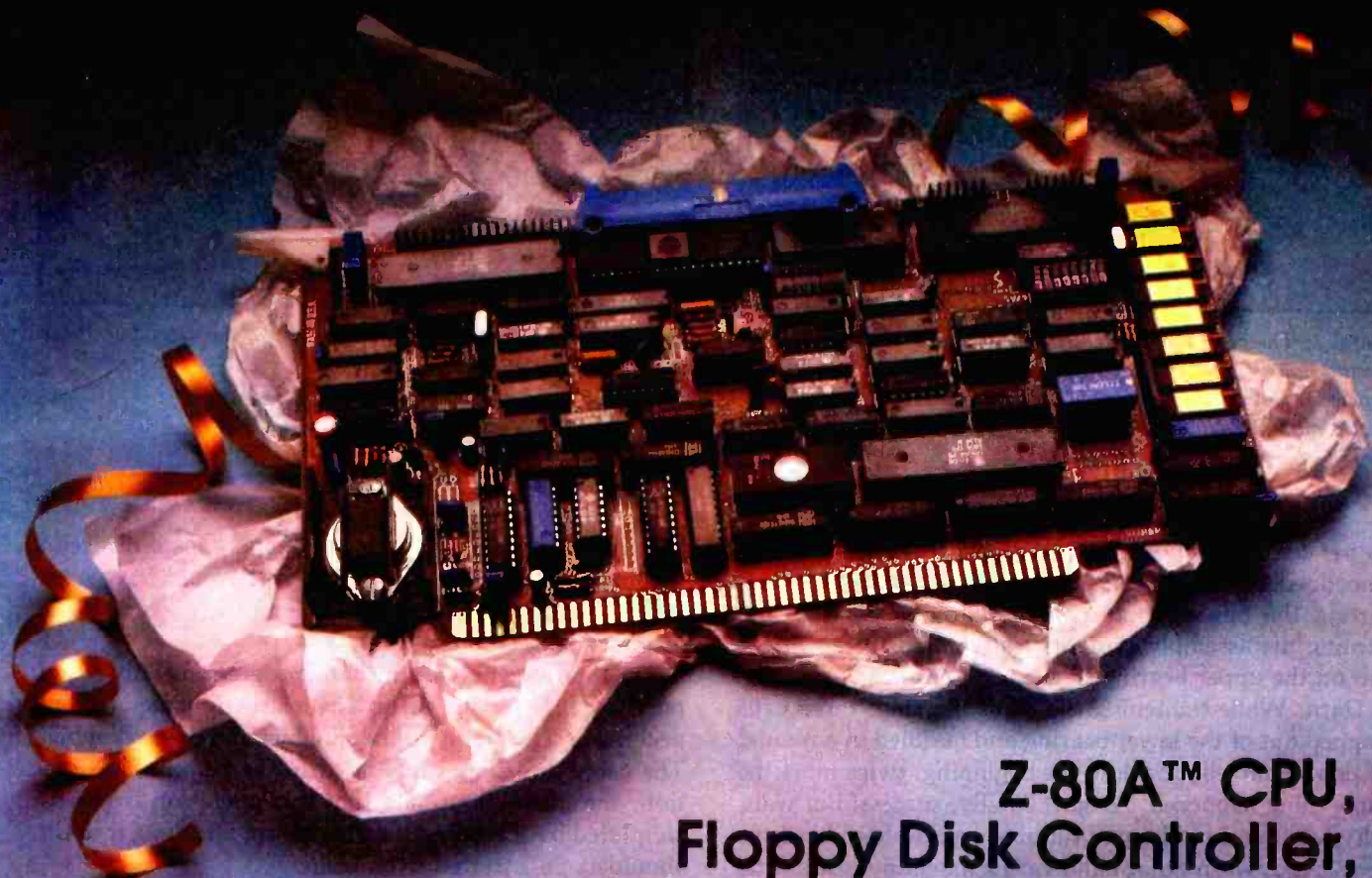
The manual I received was a preliminary version. The entire mechanical assembly instructions were on just six pages! Undaunted, I forged ahead. About halfway through the first paragraph, I was instructed to glue magnets onto some of the gears. Apparently, the magnets are optional (at least they weren't included in the kit), but no mention was made of that fact. The system uses the magnets and their respective reed switches to sense the home position of the gears.

The instructions rambled on, sometimes with several steps in a sentence. The manual specified part numbers (usually) but didn't refer to the drawing numbers.

I knew the next part was going to be tricky because the instructions said that an assistant would be helpful. The task at hand was to assemble a dual-race ball-bearing assembly from scratch. Using refrigerated petroleum jelly



# A Good-Buy Present.



## Z-80A™ CPU, Floppy Disk Controller, 64K of Memory, Serial & Parallel I/O Ports ... all on a SINGLE S-100 BOARD!

Your business computer market has problems—expensive, power-hungry machines that are hard to expand and even harder to service. Advanced Micro Digital Corporation has the solution—SUPER/quad, a TRULY single S-100 board computer that will seem like a dream to skeptical technicians and salesmen—not to mention your customers. SUPER/quad is less expensive, less difficult to service and expand and requires less power than traditional four board S-100 systems; yet it contains all their popular features:

- IEEE S-100 Standard
- Z-80A™ CPU
- 64K Bank Select Memory
- Both 8" or 5 1/4" Floppy Disk Controller (WD 1793 chip)
- 2 Serial & 2 Parallel I/O Ports
- Real Time Clock Interrupts
- 2K Monitor EPROM
- Extended Addressing
- Runs with CP/M™, MP/M™ and CP/NET™ and Turbodos™
- One Year Warranty

Advanced Micro Digital Corporation is dedicated to the research and development of S-100 computer technology. The maintenance of superb quality in our product line is our priority.

Now you can say "Good-Bye!" to all your old S-100 boards without giving up convenience and configurability, because now its all on a single S-100 computer board.



For more information  
on SUPER/quad write or call:

2301 Garden Grove Blvd. • Suite E • Garden Grove, CA 92647 • (714) 691-4004 • TELEX: 878401 • 36 UNIT  
A Division of Digital Research Corp. • Circle 9 on inquiry card. • Copyright © 1981 Advanced Micro Digital Corp.



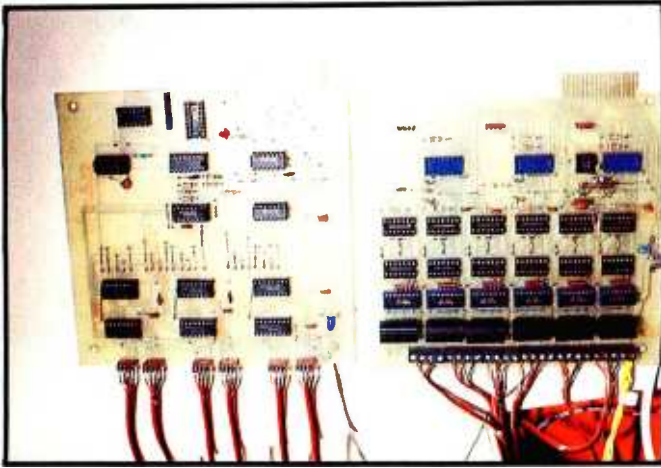


Photo 3: The controlling circuitry is contained on two printed-circuit boards. The motor-drive board (left) and the micro-processor interface board (right) are easy to assemble and connect directly to a TRS-80 Model I (versions for the Commodore PET, the Apple II, and the Sinclair ZX81 are planned).

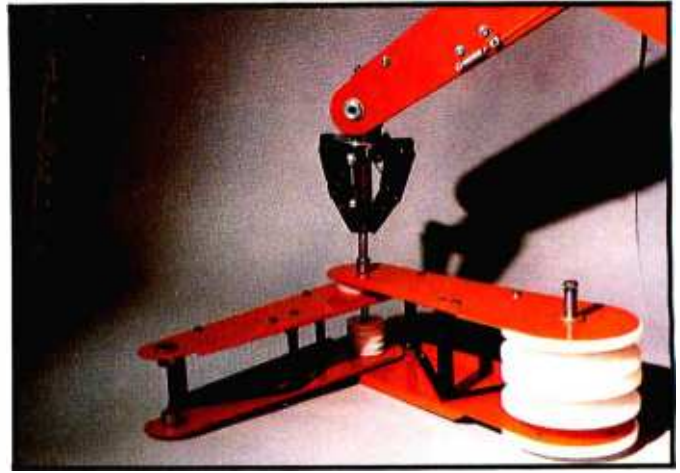


Photo 4: A mechanical assistant can speed the assembly of the arm.

as per the instructions, I greased the bearing track and imbedded 24 ball bearings in the goo. After carefully inserting the base-support column into the bearing and turning the assembly upright, I attempted to repeat the job on the upper bearing track.

Darn. While tightening the adjusting ring, three balls hopped out of the lower bearing and huddled in a mound of petroleum jelly. Back to the beginning; twice more the same thing happened. Arrgh!! Finally, success! But wait, why was the shoulder pan rubbing on the shoulder-drive gear? And, wasn't that ball-bearing assembly just a little bit off parallel? At this point, I decided to cheat and look at the factory-assembled Armdroid. It appeared that the bearing-support column was too short. I described my problem to the gentlemen at Colne Robotics over the phone and was told that I probably had the bearing ring—an almost but not quite symmetrical part—on upside down.

I tried it again: I disassembled the bearing, inverted the bearing ring, and carefully placed the steel balls in the petroleum-jelly-coated track (I'm pretty good at this by now). Continuing as before, I installed the adjusting ring and beheld a smoothly operating shoulder bearing.

The instructions continued: put this motor here, put these gears there, and see the drawing. Well, I looked at the drawing. (The drawings are good up to a point, but they lack fine detail or close-ups in some areas.) I cheated a couple more times by looking at the assembled arm to verify my understanding of the drawings and text.

Assembly continued on the upper arm and forearm. The wrist posed no major problems. Then disaster struck! The fingers are held together with a large number of "circlips" (split rings that fit around the outside of a shaft). The circlips allow you to slide a rod through a hole, then prevent the rod from sliding back again. A special pair of circlip pliers is an absolute necessity to proceed beyond this point. I tried to make do with what I

had (needle-nose pliers, screwdrivers, etc.) and realized I definitely needed the proper tools. It would have been nice if the appropriate pliers came in the kit or were at least available as an option.

The final assembly of the hand progressed easily after I purchased the circlip pliers. The instructions said to connect the arm assembly to the shoulder and base assembly. The cable threading came next. In the helpful hints section, the instructions said that this operation is greatly simplified by threading the arm before attaching it to the shoulder. So I started over again.

The actual cable threading progressed well, except for a clearance problem on one of the wrist cables. After checking the preassembled arm, I decided that cable clearance in the wrist is an assembly problem that Colne Robotics had experienced and corrected but had not updated in the manual. Ten minutes later, the offending cable had been restrung and worked smoothly.

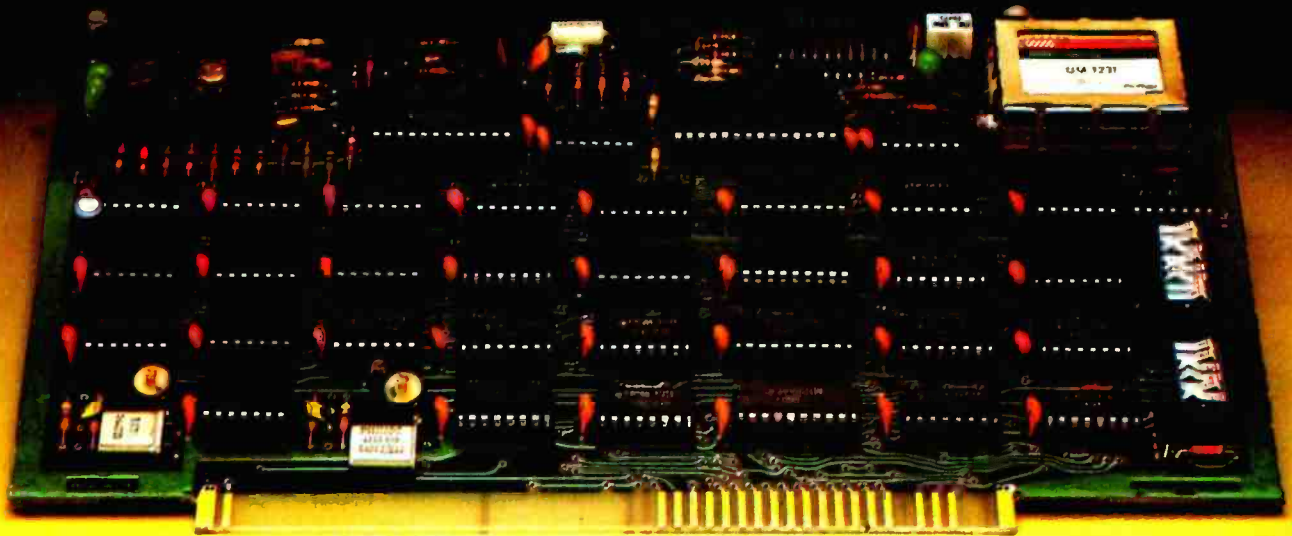
The two printed-circuit boards went together just about as well as one would expect. No part numbers or reference designators were silk-screened on the boards, so I had to rely on the drawings in the manual for parts placement. Mounting the interface and motor-driver printed-circuit boards into the base of the Armdroid and connecting the stepper-motor wires to the driver board completed the assembly operation.

### Using the Armdroid

A machine-language cassette for the TRS-80 Model I Level II microcomputer comes with the Armdroid. The menu-driven program, named Learn, allows you to familiarize yourself with the operation of the robot arm and to create, modify, and save motion sequences.

The manual suggests reading through the software description quickly and proceeding to the "Introductory Demonstration Sequence" section, which tells you to load Learn and enter the learn mode by typing an "L".

# Introducing the METROTECH Viewdata Option



## METROTEL

All you need to extend your S100 Business Computer to bring you the last word in Viewdata Systems, plus the internationally acclaimed Prestel.<sup>(1)</sup>

**METROTEL** – in one flexible package it offers all you need for creating, running and editing the most advanced of in-house viewdata systems – with all the advantages of linking up with the Prestel world-wide videotex service.

**METROTEL** – a new type of information service for general business use. Simple to use, METROTEL brings to the S100 computer a complete viewdata system. Timely information can be displayed in full colour on many remote monitors, and with METROTEL's sophisticated editing facilities, eye-catching screens can be rapidly created.

Ideal for setting up private systems for use in hotels, conference centres, shopping centres or any public area – or anywhere you require 'in your home' or 'in your office' notice board facilities.



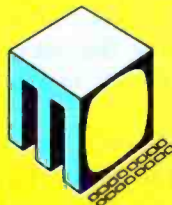
### VIDEOTEX NOW The Prestel World Service

METROTEL places the world at your fingertips via the PRESTEL World Service. Through PRESTEL, world-wide videotex information banks are now available in the United States at the touch of a button – including –  
WORLD-WIDE COMMODITIES' PRICES, INTERNATIONAL MESSAGING, BUSINESS NEWS, WORLD NEWS, TEleshopping, TRAVEL AND RESERVATIONS, INTERNATIONAL NEWSLETTERS, ETC. METROTEL was designed and implemented in England, the birthplace of PRESTEL, and is fully compatible with the PRESTEL system. The PRESTEL World Service offers a low monthly charge and pay-as-you-use billing, and, with METROTEL you can have it on your computer... NOW.

For further information on PRESTEL, contact:  
Logica 212/599-0828,  
666, Third Avenue, New York, NY 10017

To obtain your METROTEL system, 'phone METROTECH in England on Uxbridge (City Code 895) 57780 or telex us on 935302. Better (and cheaper) still, find your nearest METROTEL owner and send us an immediate message via PRESTEL Number 01937 9861.

Circle 118 on Inquiry card.



# METROTECH

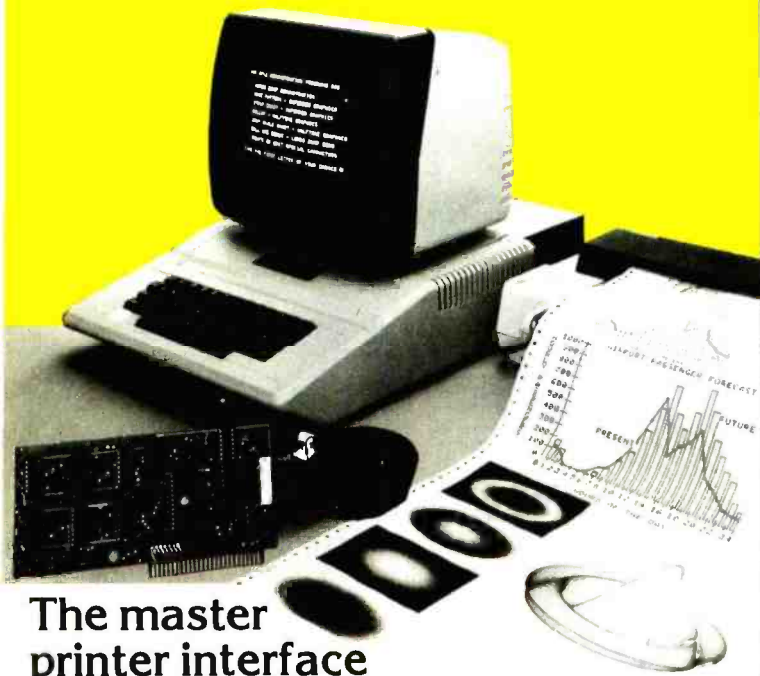
A MEMBER OF THE GRAND METROPOLITAN GROUP

WATERLOO ROAD · UXBRIDGE · MIDDLESEX UB8 2YW · ENGLAND · Tel: 0895 57780 Telex: 935302

(1) Prestel is the trademark of British Telecom



# INTRODUCING PKASO™



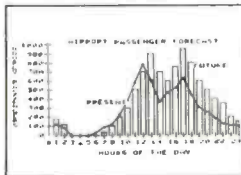
## The master printer interface at a very low cost

For the first time ever a truly affordable Apple interface offers all the most sophisticated text and graphics capabilities on Epson®, Okidata®, Centronics®, and IDS® printers. With the easy to use PKASO Interface, you simply slip it into your Apple Computer, attach the cable to your printer, and enjoy all these features:

- Broadest range of text printing using your software
- HiRes graphics with up to 40 creative options
- LoRes and HalfTone graphics in 16 levels of gray
- SuperRes plotting with up to 2160 x 960 points per page
- User created or software defined characters and symbols
- Full text and graphics dump of absolutely any screen image.



Gray scale printing



Snapshot screen dump



Apple III compatibility

At Interactive Structures we've built our reputation on innovation, quality and service, and we're doing it again with the new PKASO series. The PKASO Interface will bring out the best in your Apple Computer, your data printer and your program. It will perform with all popular languages such as BASIC and ASSEMBLER. It will print both text and graphics with PASCAL. And it's the first and only Apple interface to offer all this plus support for the Apple Z-80 CP/M System and for full Apple III operation.

Don't settle for less. And don't pay more. Call us now for the name of the PKASO dealer near you. Circle 210 on inquiry card.



Interactive Structures, Inc.  
112 Bala Avenue  
P.O. Box 404  
Bala Cynwyd, PA 19004  
(215) 667-1713

Apple Computer is a registered trade name of Apple Computer, Inc. Epson is a registered trade name of Epson America, Inc. Okidata is a registered trade name of Okidata Corporation. Centronics is a registered trade name of Centronics Data Computer Corporation. IDS is a registered trade name of Integral Data Systems, Inc.

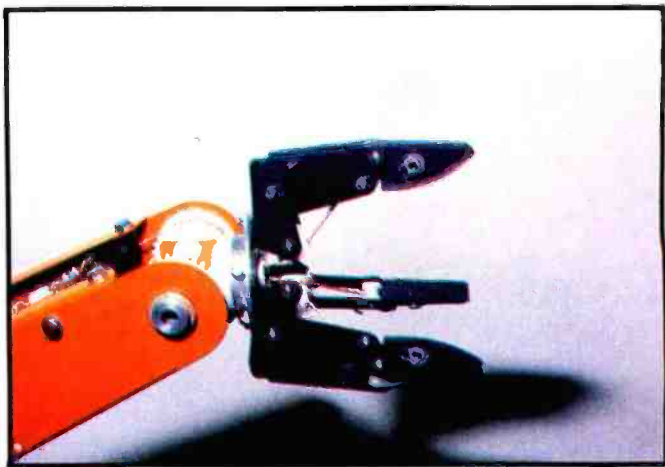


Photo 5: The hand and wrist assembly has three fingers. The fingers are opened and closed in unison under program control. The wrist allows both rotation and up-and-down motion of the hand.

This mode lets you manually operate the robot while programming it to follow the same motions automatically.

The program asks you if you want to start again, continue from the present position, or exit the program. Type "S" to clear the memory and free the arm. The arm is free when no torque is applied to the stepper motors. This allows you to initialize the Armdroid's position by hand using the large gears in the shoulder. When you are satisfied with the starting position, press the space bar. The program applies torque to the arm, effectively stiffening and locking the arm in place.

You can now move the arm using the Q, W, E, R, T, Y, and 1 through 6 keys to manually control the movement of the different parts of the arm. If you're like me, it will take a couple of tries to predictably move the arm, rotate the wrist, and open and close the hand under manual control. Type a "0" to get out of the learn mode.

Now the miracle of life! Press "G" for go, and the Armdroid takes the shortest path to your initial starting position. The program then asks "O" (once) or "F" (forever). Forever seems like a long time for something you haven't tried yet, so type "O".

Wow! The arm is doing just what you taught it to do! And without the long pauses for head scratching and note taking! You are returned to the menu.

To look at the sequence of commands that were sent to the stepper motors, type "D" for display. A table appears on the screen showing the stepper increment values stored in memory.

To extend the sequence of movements, simply reenter the learn mode, and type "C" for continue. You can add additional motions by using the manual-control keys. Once again, you must type "0" to return to the menu mode.

After testing the new sequence, you may decide that some of the motions need to be fine tuned. This can be done using the edit mode.

# The MultiMode Printer with The Magnificent Fonts



**MultiMode Printer  
Offers Flexibility**

**. . . At a Sensible Price—\$1,995 (Qty. 1)**

“Flexibility” means instantaneous call up of any of this trend-setting machine’s many features whether for *word processing*, *data processing*, *graphics* or *forms generation*. Using either of the two built in interfaces, an external keyboard or downloading from your computer, you can program the Qantex Model 7030 to do more.

**The “Beautiful” Font**

Compare the “Beauty” of our printed letters for the word processing fonts which include Cubic, Trend, Spokesman, Courier, Italics, Script, OCR-A, APL, Scientific plus *downloaded* fonts from your computer. Draft copy modes include 8 resident fonts — U.S., U.K., German, French, Spanish, Swedish, Finnish, Norwegian and Danish.

Other features include high resolution graphics — 144 x 144, single pass and double pass word processing, and 180 cps data processing modes and user defined formats.

Operator initiated, the MultiMode printer provides a complete printed status report of operating parameters and diagnostics.

For more information, or a demo, call us about the new Qantex Model 7030 MultiMode Printer.

**Qantex**<sup>\*</sup> Division of North Atlantic  
60 Plant Avenue, Hauppauge, NY 11788  
(516) 582-6060 (800) 645-5292

<sup>\*</sup>Registered Trademark of North Atlantic Industries

D.E.C. LA120 ESCAP  
A) PRINTER CHARACT  
B) ACTIVE POSITION  
C) LINE FEED/NEW  
D) HORIZONTAL  
E) FORMS LE  
F) VER





Photo 6: The Armdroid has a maximum reach of 19 inches from the shoulder base.

Three cassette-tape commands allow you to save your Armdroid sequence for a rainy day. "W" (write) saves the sequence in memory on the tape, "R" (read) retrieves the sequence from tape, and "C" (check) verifies that the data on the tape is the same as that in memory.

Colne Robotics has graciously included the source listing for the Armdroid control software in the manual. The Z80 assembly-language source is well documented and should prove to be a valuable learning tool for the student of robot technology. The source code is also useful to those who wish to modify the control software for a specific application.

I understand that Colne Robotics is developing similar software for other microcomputers, such as the Commodore PET, the Apple II, and the Sinclair ZX81. Watch their advertisements for further details.

## Documentation

The 87-page manual is broken down into four sections. The introduction section is nine pages long and strays from the purpose of an experimental robot arm. Discussions on the economic and social impact of industrial robots, complete with tables and formulas, seem more like padding than useful information.

The second section deals with the mechanical assembly of the Armdroid. As noted above, some deficiencies and inaccuracies in the instructions exist. A hand-holding, step-by-step approach would benefit the novice builder.

The next section details the electronics of the Armdroid. This section was not too bad, but again a step-by-step approach would be helpful.

The final section describes the software package included with the arm. This chapter of the manual was the easiest to use, due in part to the quality of the Learn program itself. And I applaud the inclusion of the program listing as an aid to understanding the ins and outs of microprocessor-controlled robotics.

It should be noted that my review is based on a "preliminary" manual for the Armdroid. I have been reassured that the manual will be revised to eliminate some of the limitations that I have noted above.

## Conclusions

- The Armdroid is a low-cost manipulator with good dexterity and maneuverability.
- The software delivered with the arm is easy to use and serves as a powerful tool in understanding robot operation.
- The Armdroid kit is not for the inexperienced builder, unless the manual is improved.
- I feel I have learned a lot about the mechanics, electronics, and software of robots, thanks to the people at Colne Robotics. ■

# Apple Logo

by Harold Ableson

The name Logo describes not only the evolving family of computer languages detailed in this book, but also a philosophy of education that makes full and innovative use of the teaching potential of modern computers. *Apple Logo* presents the Apple II user with a complete guide to the applications of this unique system and also includes a description of TI Logo for users of the Texas Instruments 99/4 computer.

The designers' vision of an unlimited educational tool becomes a reality for the Apple II user who begins to work with this procedural language. Logo enables even young children to control the computer in self-directed ways (rather than merely responding to it), yet it also offers sophisticated users a general programming system of considerable power.

*Apple Logo* actually teaches programming techniques through "Turtle Geometry"—fascinating exercises involving both Logo programming and geometric concepts. Later chapters illustrate more advanced projects such as an "INSTANT" program for preschool children and the famous "DOCTOR" program with its simulated "psychotherapist."



ISBN 0-07-00425-0  
240 Pages  
Softcover, spiral-bound  
\$14.95

Call Toll-Free 800/258-5420

BYTE Books 70 Main Street  
Peterborough, N.H. 03458



B5



# Hayes Stack™

Microcomputer Component Systems

**Right for the time.** Finally someone invented an RS-232C compatible calendar/clock system, complete with 6-digit display . . . and selling for only \$249. Hayes did it!

Introducing the Hayes Stack Chronograph, the newest addition to the Hayes Stack microcomputer component series. It allows your computer to accurately record all of your system activities by date and time . . . down to the second. Thanks to a battery back-up system, you never have to reset the time when your computer is off, and it will keep on ticking even when there's a power failure. A write-protect switch prevents accidental

changing of day, date or time.

**Right for the job.** The Hayes Stack Chronograph is ideal for any home or business application requiring accurate timekeeping. Use it for timing everything from lights, burglar alarms, or sprinkler systems . . . to sending mail electronically (with the Hayes Stack auto-dial Smartmodem and your computer) . . . logging and recording reports or time-sharing access time . . .

and batching all your messages to send at night, when rates are lowest. Chronograph helps do it all.

**And Chronograph stacks up.** Keep your computer system up-to-date with the Hayes stack-ables, including the RS-232C compatible Smartmodem, the most sophisticated 300-baud originate/answer modem you can buy. And yet, it's probably the easiest to use too.

The Hayes Stack Chronograph and Smartmodem are available wherever fine computer products are sold. It's time. And it's now.

 **Hayes**

The Hayes Stack™ Chronograph.  
There's no better time.



Hayes Microcomputer Products, Inc. 5835 Peachtree Corners East, Norcross, Georgia 30092 404/449-8791

Hayes Stack is a trademark of Hayes Microcomputer Products, Inc. © Hayes Microcomputer Products, Inc.

Circle 190 on Inquiry card.

## Super FORTH Isn't

Gregg Williams  
Senior Editor

Let's imagine that someone has just implemented a language that looks something like BASIC, but that it has some very strange and arbitrary qualities. For example, not every line has to have a number, but all line numbers must end with a 5. All variables must be exactly three characters long. The BASIC keyword STEP is replaced by the word EVERY, and variables used in an INPUT statement must begin with the letter I. Although the language works—you can write programs in it—how would you feel if the manufacturer called the product Super BASIC?

It's apparent that I'm very disappointed with Hayden's Super FORTH and that I don't believe it is a worthwhile product. When I first saw the ads, I was very excited about the product. It ran on the Apple (only one very expensive Apple FORTH existed at the time); it implemented Apple high-resolution graphics, floating-point numbers, and string variables (none of which are usually supplied in a standard FORTH); and the \$49.95 price was right. At the time, I thought Super FORTH might become the de facto standard for the Apple II.

I have been working with different versions of FORTH for about a year and a half and have used versions based both on and independent of the FORTH Interest Group (fig) version. I say this to indicate that I can be fair with a non-fig-FORTH implementation. I spent several nights programming on the Super FORTH system, and my conclusion is this: if you want to use this particular version of FORTH because of the features mentioned above, fine. However, if you're interested in interacting with the world of FORTH outside the confines of the Super FORTH instruction manual, you should buy a different version.

### Problems

To indicate why I formed my opinion of this software, here are some of the problems I found.

Super FORTH lacks the "screen" mechanism almost universally used to store FORTH source code for later compilation. It has only two commands that let you store either the entire contents of the FORTH system at that time or only newly defined words. This means that if you want to modify a definition, you have to FORGET it (oops—Super FORTH has no word for FORGET) and retype it. If the word you're redefining isn't the most recent one defined, you automatically lose every word defined after that word, and you have to retype those words as well. The absence of this feature alone puts an unreasonable burden on the Super FORTH user.

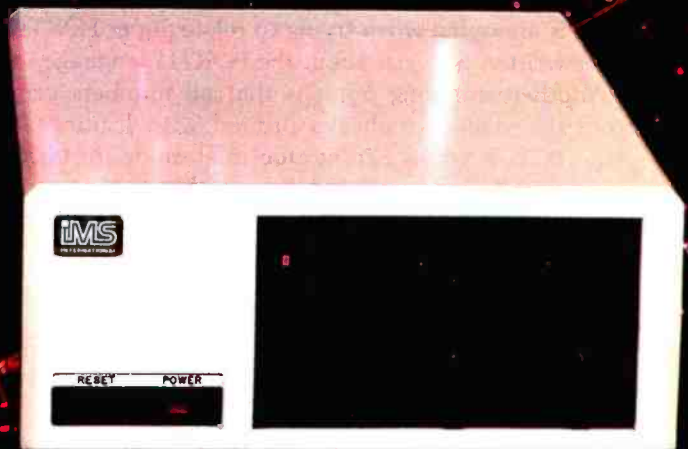
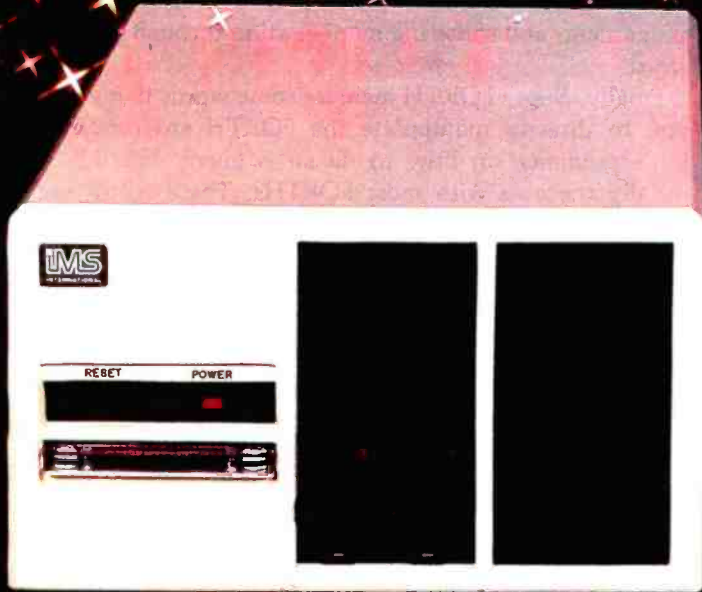
Certain essential FORTH words are missing; others have arbitrary nonstandard definitions. For example, the words ROT (which rotates the top three numbers on the stack), { +! } (which adds a number to a variable), and FORGET are missing in Super FORTH. (The braces are standard BYTE notation for FORTH words that include punctuation and for lists of FORTH words.) In addition, other words behave differently. The word C@ in other FORTHS takes the contents of a single byte and puts the byte on top of the FORTH stack; in Super FORTH, the corresponding word 1@ must be followed (don't ask me why) by the words { OPUSH SWITCH } to make the number available on the top of the stack.

### At a Glance

<b>Name</b> Super FORTH	under DOS 3.2 or BASIC's disk)
<b>Type</b> Version of the FORTH programming language	<b>Language Used</b> 6502 threaded machine code
<b>Manufacturer</b> Hayden Book Company Inc. 50 Essex St. Rochelle Park, NJ 07662 (201) 843-0550	<b>Computer Needed</b> Apple II with 48K bytes of memory and Applesoft either in ROM or loaded into the Apple Language Card
<b>Price</b> \$49.95	<b>Documentation</b> 35 pages in a 3-ring binder
<b>Author</b> Larry Bugbee	<b>Audience</b> People interested in FORTH
<b>Format</b> 5¼-inch floppy disk (boots	



# SX Is a Two Letter Word...



... describing the price performance leaders in table top computers.

Owning an SX from IMS International is a joy no matter which model you choose.

Both give you Winchester performance and a lot more.

Our 5000 SX table top computer features either a 5.5 or 11 MByte Winchester subsystem, plus one or two 5 1/4" floppy drives.

And our 8000 SX offers a 10, 20 or 40 megabyte Winchester, plus one or two 8" floppies, and a 17 megabyte

incremental cartridge tape drive subsystem.

Both high performance Winchester subsystems deliver awesome speed — ten times faster than floppies, on the average. You can load a 20 KByte system program in less than a second.

More importantly, IMS systems are engineered for reliability, so downtime won't take away the gains Winchester technology brings. They're strictly business, from their metal-not-plastic cabinets to their test-don't-guess circuitry.

And with our full 2-year warranty, you have it in writing.

Software for the SXs includes either single user, or our new high performance multiuser/multi-processor operating systems, plus BASIC, FORTRAN and COBOL languages, and a host of compatibility-tested application programs.

For complete information and specifications on the 5000 SX and 8000 SX, along with the location of your nearby IMS International dealer, just contact us.

We'll tell you everything you ever wanted to know about SX.

Call (714) 978-6966 or (702) 883-7611 today, or write:

**IMS**  
INTERNATIONAL

**WE BUILD COMPUTERS AS IF YOUR BUSINESS DEPENDED ON THEM.**

2800 Lockheed Way, Carson City, NV 89701 • Telex: 910-395-6051

Circle 200 on inquiry card.



Another arbitrary difference is that do-loops in Super FORTH cannot be nested in the same word (contrary to the way all other versions I know of work). In Super FORTH, you must define a word that contains the inner do-loop, then use this word within the do-loop of another word. Again, this is a problem only if you plan to interact with the rest of the FORTH world. Unfortunately, Super FORTH has too many such problems.

Although the Super FORTH system worked most of the time, it "went away" (irretrievably malfunctioned) many more times than my two other versions of FORTH. I counted four fatal malfunctions in one session.

Many FORTH functions, given the same name in every other FORTH implementation, are given other names in Super FORTH. For example, the FORTH words { C@ C! C, } are in Super FORTH { 1@ 1! 1, }. This small point is annoying when trying to relate Super FORTH to other written material about the FORTH language.

Another annoying point is that all numbers printed from the stack are always printed with leading zeros (e.g., 0005 if you are in hexadecimal mode, or 00005 if you are in decimal mode). Although this would be useful in printing tabular material, I think the fixed display width indicates a lack of craftsmanship.

### Good Points

To be fair to Super FORTH and its author Larry Bugbee, the product does contain a number of things that are quite good.

The documentation for Super FORTH is better than average when compared to other FORTH products. Word definitions are grouped by function and are explained with a minimum of jargon. In a radical departure from most FORTH documentation, most word definitions include an example of their use, and some even give guidance for their proper use.

Super FORTH includes words that allow you to do Apple high-resolution graphics on high-resolution page 1. It allows you to draw boxes, blocks (filled-in boxes), points, lines, and shapes in any available high-resolution color. You can draw shapes, but the XDRAW function is

not supported. You must have Applesoft in ROM or in a Language Card for these commands to work. (The bulk of Super FORTH will work without Applesoft.)

Another set of words implements a stack for floating-point numbers and operations. (The regular FORTH stack works on 16-bit signed integers only.) The list of floating-point words is quite long and comprehensive, making it probably the best feature of Super FORTH. These words also require Applesoft to work.

Super FORTH includes a set of words that allows you to manipulate character strings. The words do the following operations: creation of string variables, string constants, and a string stack; string concatenation; string assignment; and substring manipulation through a MID\$ word.

Finally, Super FORTH includes some words that allow you to directly manipulate the FORTH environment. Little guidance on how to do so is given, but this is usually the case with most FORTHS. These words are meant for use only by veteran FORTH programmers, and it is good they are there. For example, it should be possible to use them to make a call to the Applesoft ROM to implement the high-resolution XDRAW function.

### Conclusions

The inability to store FORTH source code for later modification and recompilation is a major defect of Super FORTH.

On the other hand, the implementation of string, floating-point, and high-resolution graphics words is a definite advantage for someone who wants to use FORTH with these capabilities. They can be added to other FORTHS, but this would be a lot of work in itself.

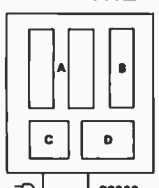
Unfortunately, I cannot recommend Super FORTH to people interested in learning FORTH. The many differences between it and the two leading versions of FORTH (those supported by FORTH Inc. and the FORTH Interest Group) would make it difficult for the user to learn from the existing body of information on FORTH. It could be done, but it would require a lot of extra work. ■

The **HOME BRAIN™** is a dedicated microcomputer system in a stand-alone package. **HOME BRAIN'S™** I/O potential exceeds 300 channels.

### ACHIEVE TOTAL HOME CONTROL

- Energy Management
- Home Security
- Lighting Control
- Safety Monitoring
- Appliance Control

## THE HOME BRAIN™ IS




### the First Total Home Control Computer

- Communicate with the **HOME BRAIN™** using your personal computer RS232 Interface
- **HOME BRAIN™** controls your home using your define logic sequences
- Logic diagrams, timers, counters, alarm clocks, calendars, are directly implemented by the **HOME BRAIN™** microprocessor
- **HOME BRAIN™** logs controlled operating times for the month

The **HOME BRAIN™** operates totally independent of your personal computer. Crashing your computer *will not* crash **HOME BRAIN™** leaving your home defenseless.

### EVALUATE THE HOME BRAIN™

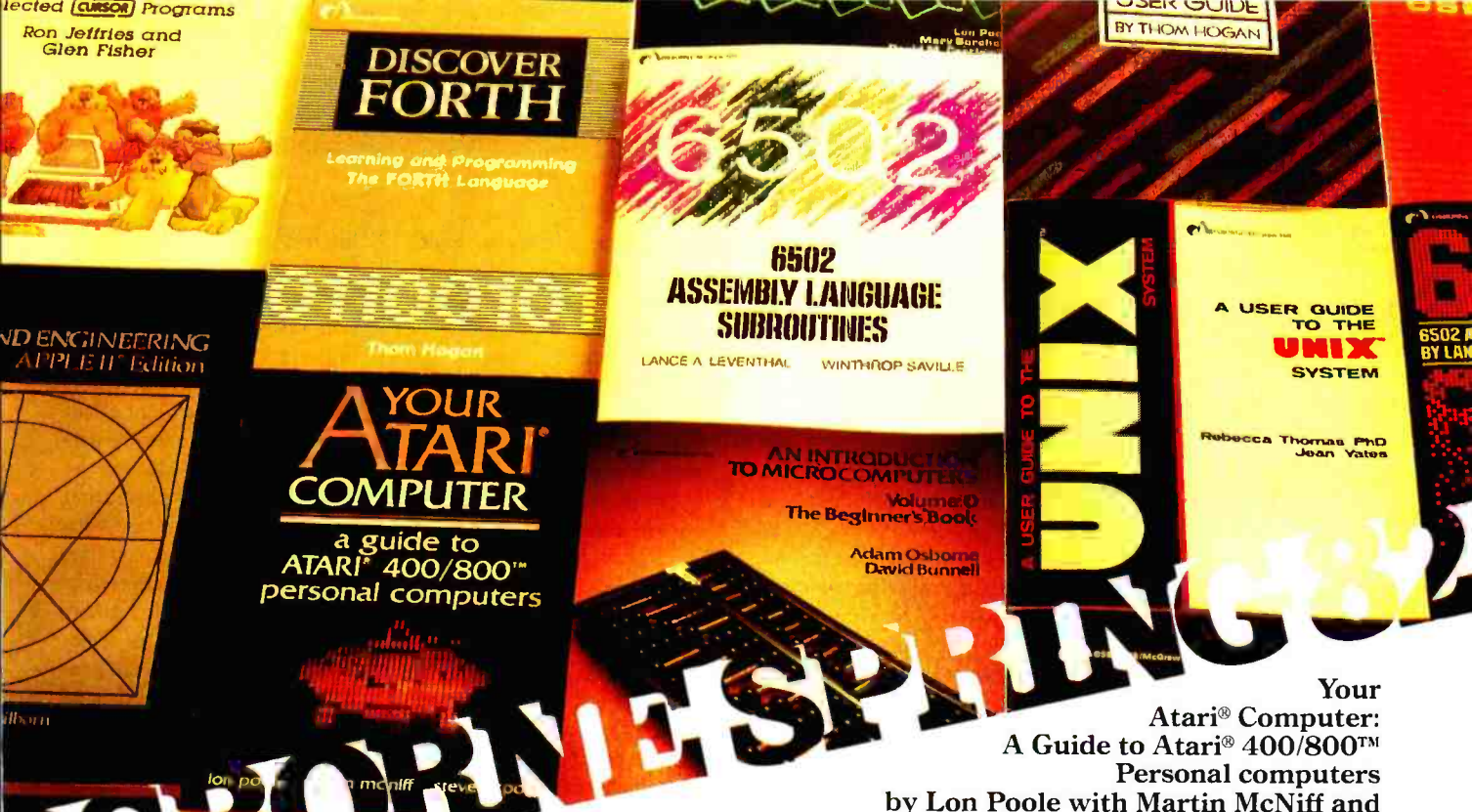
Order Now By Calling Toll-Free  
**1-800-228-2028 EXT. 332** 

Lines Open 8 AM To 6 PM C.S.T.

Just give us your Name, Shipping, Address and Visa or MasterCard number and we will charge the \$750.00 purchase price, plus \$20.00 shipping (N.J. residents add 5% sales tax) to your account. Or, **SEND\*** your **CHECK\*** or **MONEY ORDER\*** to:

**HYPERTEK, INC**  
30-4 FARM ROAD  
SOMERVILLE, NEW JERSEY 08876

\*Sending your check will qualify you for an INTRODUCTORY REBATE of 10%. Allow 6-8 weeks for delivery.



**An Introduction To Microcomputers: Volume 0—The Beginner's Book, Third Edition**  
by Adam Osborne and David Bunnell

One of our most popular titles, Volume 0 has been expanded and revised to include new sections on software and communications. Written for the complete novice, this book introduces the construction and operation of microcomputers. *Paper \$7.95.*

**6502 Assembly Language Subroutines**  
by Lance Leventhal and Winthrop Saville

This book includes over 50 indispensable, ready-to-use subroutines. A boon to every 6502 programmer, it will save hours of programming time. Includes array, bit and string manipulation, sorting and searching operations, much more. *Paper \$12.99*

**Assembly Language Programming for the Apple II™**  
by Robert Mottola

This comprehensive, easy to understand introduction provides solid groundwork for getting started in assembly language programming on the Apple II. Many subroutines written in assembly language are provided, and most explanations are shown with equivalent examples in BASIC. *Paper \$12.95.*

**Discover FORTH: Learning And Programming the FORTH Language**  
by Thom Hogan

Using a friendly approach, the author explains the history and uses of FORTH, as well as how to program to an intermediate level. Includes notes on logical extensions and alterations to the current standard FORTH syntax. *Paper \$14.95.*

Now at your dealer, or write Osborne/McGraw-Hill, 630 Bancroft Way, Berkeley, CA 94710. Phone orders: CALL TOLL FREE 800-227-2895. In California call 415-548-2805. Canadian orders contact L.A. Varah (416) 561-9311, McGraw-Hill-Ryerson (416) 293-1911.

**Osborne/McGraw-Hill**

Atari® 400/800™ are trademarks of Atari, Inc. PET™ is a trademark of Commodore Business Machines, Inc. CURSOR™ is a trademark of The Code Works. Unix™ is a trademark of Bell Laboratories. Apple II® is a registered trademark of Apple Computer, Inc. VisiCalc® is a registered trademark of VisiCorp.

Circle 317 on inquiry card.

www.americanradiohistory.com

**Your Atari® Computer: A Guide to Atari® 400/800™ Personal computers**  
by Lon Poole with Martin McNiff and Steven Cook

*Your Atari® Computer* provides invaluable reference material for Atari® home computer users. This "how-to" guide written for the novice covers all the common external devices, including disk drives and printers. The reader can also learn to program in Atari® BASIC. *Paper \$15.00.*

**Trade Secrets: How to Protect Your Ideas and Assets**  
by James Pooley

Attorney James Polley provides legal advice on a "hot" topic: who owns your ideas in today's business world. Employers can learn to tighten company security systems and protect their intellectual assets. Employees can become familiar with their rights to take "commercial" ideas to new jobs or start competing businesses without being sued. *Cloth \$19.95.*

**A User Guide to the UNIX™ System**  
by Rebecca Thomas and Jean Yates

Designed to ease the novice through the difficult learning stages, this volume is also an excellent reference for those already familiar with the UNIX™ operating system. Computer-side tutorials teach forty basic commands plus there's a list of UNIX™ system resources, and a bibliography for further study. *Paper \$15.99.*

**VisiCalc®: Home and Office Companion**  
by David M. Castlewitz and Lawrence Chisausky with Patricia Kronberg.  
Illustrated by L. D. Chukman

Contains 50 models that can be used immediately for personal and business applications. Provides models for loans and investments, advertising and sales, inventory control, personnel, household aids and more. Designed to accommodate most micros and every version of the VisiCalc® program. *Paper \$15.99.*

## **Fifty BASIC Exercises**

Jean-Pierre Lamoitier  
Sybex  
Berkeley, CA, 1981  
253 pages, softcover  
\$12.95

Reviewed by  
Paul Swanson  
97 Jackson St.  
Cambridge, MA 02140

While BASIC is widely acclaimed as an easy-to-learn, easy-to-use programming language, teaching yourself BASIC can be a problem. The manuals that accompany many computer systems are very dry, and while you can learn BASIC (Beginner's All-purpose Symbolic Instruction Code) from them, they serve better as reference manuals than teaching guides. Some computers do come with teaching guides, but these generally explain BASIC at a very elementary level, using simple text and cartoons.

For those who don't want to learn by trial and error with a manual designed for reference, but want a more intellectually written teaching guide than the cartoon approach, *Fifty BASIC Exercises* by Jean-Pierre Lamoitier could be the book you're looking for. This book uses the learn-by-doing approach, a truly effective teaching method, well suited to programming. In the introduction, the author cautions that the book assumes some background in a scientific or technological field. I think a mathematical background in particular would be most helpful to the reader; a few of the included programs are based on mathematical algorithms that are not exactly on the tip of everyone's tongue. There is sufficient explanation, however, so that even if you aren't familiar

with the mathematics you can still learn something about BASIC from the program. Then too, you might try using a reference book such as the *C.R.C. Standard Mathematical Tables* to help you with the math.

Two chapters of introductory material include discussions of flowcharting and a few basic rules and techniques, along with some simple programs to write. The remaining chapters are divided into such topics as "Elementary Exercises in Geometry," "Financial Computations," and "Statistics." Each chapter builds on the information presented in the previous chapters, and each set of new material is accompanied by at least one exercise. The exercises, which are all short BASIC programs, cover many problems commonly confronted in programming, such as finding the number of days between two dates, calculating loan repayments, sales forecasting, and several calculations involving income tax.

The programs in the book were designed to run on the Radio Shack TRS-80 and so will run with some minor changes on any system using Microsoft BASIC. Where the differences in BASIC are important, Lamoitier discusses them.

The book was translated from French and may have lost a few things in translation. The glossary, in this English version at least, is missing, and this is a serious drawback. Definitions are the most common barrier to anyone learning a new subject, and a computer language is certainly no exception. A better index would also help; as it stands, the index fails to cover many of the subjects that are in the text, and the ones that are included are listed with

single page references, which makes it very difficult to relocate topics that appear in several places throughout the book. I don't know if the French version has a better index, but I find it hard to believe that no one thought to include a glossary.

From my observations, a person learning BASIC or any other first language on computers seems to go through four phases. The first, or orientation, phase is when any fears of the computer are dispelled and the rudiments of operating it are learned. This is well covered in the first two chapters alone. This brevity is geared toward the reader who is serious about, and adept at, learning, in which case more discussion at that level would be boring. The rest of the book deals quite successfully with the second phase, during which the programmer-to-be learns to write programs with loops and more sophisticated algorithms. The third phase, which the book should leave the reader ready to pursue, is when the programmer starts using a very structured approach and tackles applications that may use the programs written in phase two as

interim calculations. (The fourth phase, which I see as learning data file manipulation on a large scale, is not important here.) My purpose in mentioning these phases is to state one more point about this book: in order for the person learning BASIC to be ready for the third phase, that person should be familiar with subroutine use. Lamoitier uses subroutines quite effectively in the exercises and, further, discusses organizing, or structuring, the program in general. However, I would have liked more explanations of how the subroutines fit into the scheme of structuring; as programs get more sophisticated, subroutine use gets more important.

But in general, *Fifty BASIC Exercises* is a worthwhile book. It has its shortcomings, for while the need for more discussion on subroutines can be argued, I think that most readers of the book will agree that it would benefit considerably from a glossary and an expanded index. Nevertheless, it should serve the novice well as a practical and intelligently written guide to the fundamentals of BASIC programming. ■

## **BYTE's Bugs**

### **Mystery Coil Turns Up In Circuit Cellar**

Several readers contacted us with a complaint about Steve Ciarcia's article "Build a Computerized Weather Station" (see the February 1982 BYTE, page 38). An inductive coil labeled only "\*\*L1" appeared in the schematic diagram of figure 11b on page 64 with no explanation of its origin or value.

Coil L1 is meant to be wound by hand from eight turns of number-26 copper wire around a coil form with an inside diameter of one-quarter inch.

We apologize for the omission of this information, which should have been placed in the figure caption.

Thanks to Rick Parrot of Data General in Apex, North Carolina, and to others for pointing out this error. ■





**YOU'VE  
GOT  
TO  
SEE IT.**

**SEE HOW MUCH MORE WORD PROCESSING  
YOU CAN GET FOR LESS FROM EXXON OFFICE SYSTEMS.**

If you're just starting out in word processing. Expanding. Or want to start over. You owe it to yourself and your business to see the new Exxon 500 Series Information Processor.

It makes word processing easier. Unlike most, it's not menu-bound. So operators don't get bogged down with lists.

It has an Explain key to help the operator along. All queries are answered on the screen. In plain English.

It comes with a 50,000-word dictionary. It spots misspellings and corrects them. Automatically. You can even teach it more words. Up to 10,000 more. Words that are special to your business or profession.

The 500 Series is the word processor to start with. Compare. We think you'll agree that it does more, more easily, for less.

And what you start with you can stay with. Its modular design allows for future enhancements such as increased communications with other machines, including computers. Additional state-of-the-art software and programmability to handle a wide range of applications. Seeing is believing.

Mail coupon or call toll-free for a demo: 800-327-6666. In Conn. 800-942-2525. See how the 500 will fit your business.

Circle 169 on inquiry card.

**EXXON** OFFICE SYSTEMS

**START WITH US. STAY WITH US.**

Exxon Office Systems Company  
P.O. Box 10184  
Stamford, CT 06904

BY1 04 82

- Please send me your "Start with us. Stay with us." product information kit on your new 500 Series Information Processor.  
 I'd like a demonstration. Have your representative call me.

NAME \_\_\_\_\_

TITLE \_\_\_\_\_

COMPANY \_\_\_\_\_

PHONE \_\_\_\_\_

ADDRESS \_\_\_\_\_

CITY \_\_\_\_\_

STATE \_\_\_\_\_

ZIP \_\_\_\_\_

# Book Review

## Programmer's Guide to the 1802

Tom Swan  
Hayden Book Company  
Rochelle Park, NJ, 1981  
156 pages, softcover  
\$7.95

Reviewed by  
Harley Shanko  
15025 Vanowen, #209  
Van Nuys, CA 91405

Users of the 1802 8-bit microprocessor are sure to enjoy Tom Swan's *Programmer's Guide to the 1802*. It is written in such a way that the novice should be able to understand quickly the 1802 instruction set and begin writing assembly-language programs; yet the more advanced programmer should find this book useful also. The author's style

and occasional interjections of humor make for easy reading, with references and comparisons that simply and clearly illustrate the subject matter.

The book is divided into four sections. Beginning with "A System of Numbers—A Number of Systems," Swan quickly acquaints the reader with the hexadecimal number system. This foundation should allow the computer novice to proceed without difficulty through the next section, "Fundamentals of Assembly Language," to which one third of the book is devoted.

Arithmetic and logic operations are explained, using binary and hexadecimal examples to introduce various computer instructions (add, subtract, carry/borrow, com-

plement, AND, OR, exclusive OR, and shift). Then program flow (branch, skip, and call) and data flow (load and store) are covered, as well as register control, input/output, and other features and instructions unique to the 1802. The last ten pages of this section use assembly-language routines as examples to introduce certain programming concepts.

A quarter of the book is spent clearly explaining the 1802 instruction set. Each instruction mnemonic is defined, its symbolic actions are represented, and a textual discussion and programming example are included. Sprinkled throughout the book are illustrations, tables, and figures, all courtesy of RCA; interestingly, these are not referred to by the author.

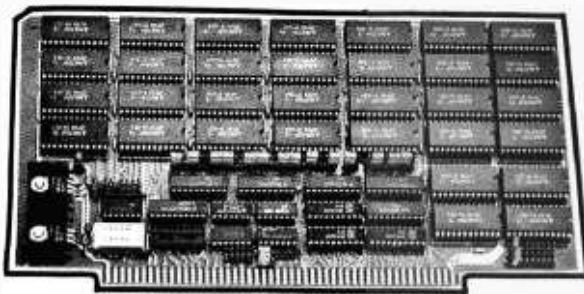
The last quarter of the book includes a thoroughly commented assembler and disassembler source listing and text describing it, a library of subroutines which can be used in many programs, and the answers to the examples included at various points by the author. The assembler does not support the use of labels, macros, or mathematical expressions; thus the user must assign starting addresses and branch and call addresses. Nevertheless, this line-at-a-time assembler allows a programmer to enter mnemonics, addresses, and immediate data, and frees him from error-prone mnemonic-to-object-code conversion. The assembler can be run on small systems (2½K bytes of programmable memory, minimum) and still provide space for assembling 1K bytes of object code.

To test its usability, I installed the assembler in my homebrew 1802 system. Despite its limitations, the assembler does provide a means to enter a program in source form and get immediate dis-

play of valid entries (invalid entries are flagged with an ERROR message) via the disassembler, which overwrites the entry display. The assembled object code can then be run, saved, or programmed into an EPROM (erasable programmable read-only memory) if both hardware and software support these last two features. It is assumed that the user can write his own "handler" which normalizes the user system and the assembler interfaces and provides a keyboard/display for the assembler/disassembler. Depending on the operating system's register usage, this handler software can range from quite simple code to the rewriting of all the keyboard input, display output, and SCRT (Standard Call and Return Technique) routines. My handler used about 150 bytes, using existing keyboard and video-display subroutines.

In summary, this book is what 1802 users have needed for years. In fact, it might have been better received five years ago when I started into microcomputing. Still, it does provide the explanations necessary to clarify several points and better explain some of the interrupt-type instructions. For all except perhaps the most advanced 1802 programmers, this book should prove to be a worthwhile acquisition. ■

## S-100 MEMORIES



### 64K STATIC RAM

150 ns 2Kx8 Rams  
Extended Addressing  
Bank Select  
Low Power Consumption  
Cromix, MPM Compatible

M12 \$625.00

### 256 DYNAMIC RAM

150 ns Access—270 ns Cycle  
8— or 16— Bit Data  
Parity Error Detection  
Extended Addressing  
ROM Driven Bank Select

M23 \$945.00

Industrial Quality  
FULL 12 Month Warranty

indigo tech

(408) 727-4710 Master Charge and Visa  
670 Nuttman Ave. No. 110 Santa Clara, CA 95050

**If you know  
HUNTINGTON'S  
DISEASE  
we need to know  
about you...  
and your parents,  
and your children.  
(it can make a big  
difference)**

**H** NATIONAL  
HUNTINGTON'S DISEASE ASSOCIATION  
Call this number: 212-966-4320

THIS SPACE CONTRIBUTED BY THE PUBLISHER



MDBS: Superior Data Base Management for Application Developers

# Mainframe solutions at micro prices.

MDBS solves the problem of expensive, time-consuming application development and maintenance.

Here's what makes the MDBS Data Base Management System so unique:

**ECONOMY**—Our state-of-the-art system cuts application development costs by up to 80%.

**EFFICIENCY**—Data compression allows optimum use of space.

**HARDWARE COMPATIBILITY**—From 8080, Z80...to the PDP-11, MDBS delivers uniformly excellent results.

**PORTABILITY**—MDBS operates under most popular operating systems and languages, including CP/M, UNIX, IBM PC DOS, COBOL, BASIC, PASCAL, C, PL/1, FORTRAN, and many more.

**INTEGRITY**—RECOVERY, RESTART, and the ability to roll the data base back are available. Data base integrity is supported through advanced data structuring techniques.

**AUTHENTICITY**—MDBS is the first and only true and complete DBMS currently available on microcomputers.

**CAPABILITY**—Our system includes features you won't find anywhere else, at any price.

- Fully-integrated, dictionary-driven.
- Unparalleled data structuring ability—far superior to hierarchical, CODASYL, and relational approaches.
- Powerful, English-like query system entirely non-navigational. Fully supports spur-of-the-moment "what if" inquiries.
- Query nesting allowed. Automatic sorting of output tables.
- Built-in data security down to the field level. Data encryption capability.
- Performance tuning, including the ability to influence physical storage structures.
- Extremely fast retrieval even for large volume data bases.
- Multi-users capabilities including active and passive lockout.

MDBS is not restricted to the limitations of data base "pretenders" like file management systems.

To help make application development more effective and efficient, MDBS also offers extensive consulting services and professional training seminars.

**MDBS and other fine products are distributed in most countries through ISE.**

For more information please contact:

In U.S.:  
ISE-USA  
P.O. Box 248  
Lafayette, Indiana 47902  
Tel: (317) 463-2581

In Germany:  
ISE-ADV/ORG GERMANY  
Lipowskystr. 26  
8000 Munich 70  
Tel: (0 89) 77 60 23-4

In France:  
ISE-CEGOS  
Tour Chenonceaux  
204, Rond-Point du Pont de Sèvres  
92516 Boulogne Billancourt Cedex  
Tel: 620-61-04

In Switzerland and Austria:  
ISE-ADV/ORG SWITZERLAND  
Mainaustraße 17  
CH-8008 Zürich  
Tel: (01) 32 02 70-1

Elsewhere:  
ISE-INTERNATIONAL  
P.O. Box 248  
Lafayette, Indiana 47902  
Tel: (317) 463-2581



**Professionals know the difference.**

Note: For more about ISE see page 127

Please call me immediately at ( ) \_\_\_\_\_  
(phone no.)

Please tell me about your half-day seminar

Please tell me about your three-day workshop

I'm enclosing \$105 in payment for the MDBS manual (\$135 overseas; Indiana residents please add \$3.80 sales tax)

Please charge to my VISA \_\_\_\_\_ or MasterCard \_\_\_\_\_

Card Number \_\_\_\_\_ Phone No. \_\_\_\_\_

Signature \_\_\_\_\_ Expiration Date \_\_\_\_\_

Name \_\_\_\_\_ Title \_\_\_\_\_

Company \_\_\_\_\_

Address \_\_\_\_\_

City \_\_\_\_\_ State \_\_\_\_\_ Zip \_\_\_\_\_

Phone \_\_\_\_\_ (area code) \_\_\_\_\_ (ext.) \_\_\_\_\_

MAIL TO: Your local ISE affiliate.



# Book Review

## TRS-80 Color Computer Technical Reference Manual

Tandy Corporation  
Fort Worth, TX  
1981, 71 pages  
softcover, \$14.95

Reviewed by  
Yvon Kolya  
POB 22  
Peterborough, NH 03458

I was astounded to see Radio Shack's TRS-80 Color Computer Technical Reference Manual on the shelf at the local Tandy Computer Center Store. After I had purchased it and began sifting through its information-packed pages, I realized what

an incredible find this book was.

Radio Shack, along with many other major computer manufacturers, has had a reputation of closely guarding all the information about its computer systems, releasing only the bare minimum of facts necessary to sell the computers and software. With the appearance of this manual, Radio Shack seems to be reversing this policy.

This book gives all the information that any TRS-80 Color Computer (Level I and II) owner might want to know. It covers memory maps, block diagrams, schematics, pin connections—everything that could be of interest to either a software designer or a hardware hacker.

## The Inscrutable PIA

Unfortunately, this manual is not as explicit as it should be. Apparently, it was originally written for Radio Shack's internal use, and after it was finished, Tandy decided to release it to the general public. The descriptions and explanations are quite sketchy, and I found myself rereading the material in order to make sense of it. For example, the second paragraph on page 4 states:

*The next two pages of the Map [Color Computer Memory Map] explain the addressing for the PIA's. In general, the even numbered locations are the I/O registers and the odd numbered memory locations are the control registers. Bit two of the control registers*

*determines what is addressed at the even numbered memory locations. If this bit is set high (logic 1) the data I/O register is addressed. If it is low the data direction register is addressed. Normally the data direction register is addressed only during initialization to allow configuration of the data inputs and outputs. (By clearing bit 2 and writing to the even numbered memory location one address below, each bit of the PIA may be set as an input or an output. A 1 in the data direction register sets the bit as an output and a 0 sets the bit as an input.)*

When I proceeded to the corresponding diagram, I found it was not clear to which of many registers the paragraph

## All about LOGO— how it was invented and how it works

"Changes the learning experience from a matter of discipline into one of discovery."

— Marvin Minsky, MIT

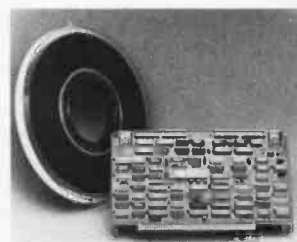
"A revolutionary book...required reading for anyone with an interest in computers, children, education, or the future." — 80 Microcomputing

## MINDSTORMS CHILDREN, COMPUTERS, AND POWERFUL IDEAS SEYMOUR PAPERT

Now in paperback, \$6.95

**BASIC BOOKS, INC.**  
10 East 53rd Street, New York, NY 10022

## S-100 USERS



### INTERFACE 9-TRACK TAPE DRIVES

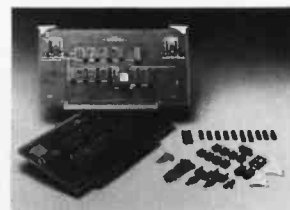
With the DTI - DMA  
Tape-Unit Interface

- Transfers data via DMA up to 200K bytes per second
- Allows full control over all tape-drive functions

### SPEED NUMBER-CRUNCHING SOFTWARE 5-10 X's AND MORE

With the FMP -  
Fast Math Processor

- Kit or assembled
- 32-bit floating point operations for arith., trig., exponential, etc. functions
- Or 64-bit floating point operations for arithmetic functions



Both the DTI and FMP meet the IEEE S-100 standard. Software is available.

For further information contact:



A MEMBER OF THE SPC GROUP  
**SPC TECHNOLOGIES, INC.**

P.O. Box 248, Arlington, VA 22210  
(703) 841-3632

# WHY THE MICROSOFT RAMCARD™ MAKES OUR SOFTCARD™ AN EVEN BETTER IDEA.

Memory — you never seem to have quite enough of it.

But if you're one of the thousands of Apple owners using the SoftCard, there's an economical new way to expand your memory dramatically.

## 16K ON A PLUG-IN CARD.

Microsoft's new RAMCard simply plugs into your Apple II®, and adds 16k bytes of dependable, buffered read/write storage.

Together with the SoftCard, the RAMCard gives you a 56k CP/M® system that's big enough to take on all kinds of chores that would never fit before (until now, the only way to get this much memory was to have an Apple Language Card installed).

## GREAT SOFTWARE: YOURS, OURS, OR THEIRS.

With the RAMCard and SoftCard, you can tackle large-scale business and scientific computing with our COBOL and FORTRAN languages. Or greatly increase the capability of CP/M

applications like the Peachtree Software accounting systems. VisiCalc™ and other Apple software packages can take advantage of RAMCard too.

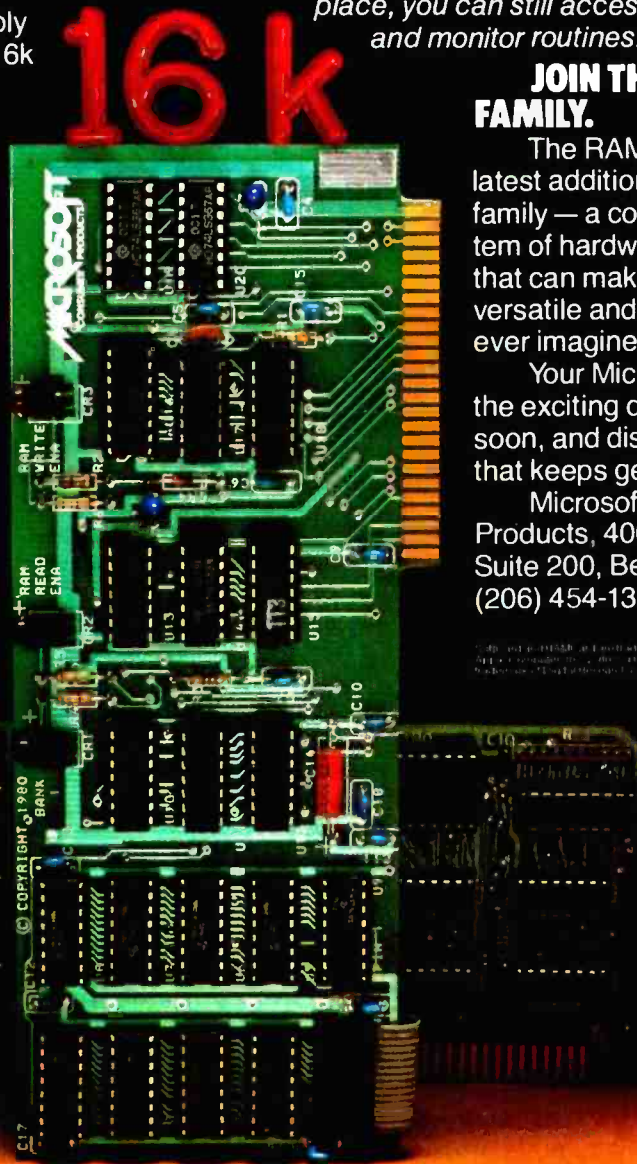
And RAMCard gives you the extra capacity to develop advanced programs of your own, using the SoftCard and CP/M. *Even with the RAMCard in place, you can still access your ROM BASIC and monitor routines.*

## JOIN THE SOFTCARD FAMILY.

The RAMCard is just the latest addition to the SoftCard family — a comprehensive system of hardware and software that can make your Apple more versatile and powerful than you ever imagined.

Your Microsoft dealer has all the exciting details. Visit him soon, and discover a great idea that keeps getting better.

Microsoft Consumer Products, 400 108th Ave. N.E., Suite 200, Bellevue, WA 98004. (206) 454-1315.



# MICROSOFT

Circle 281 on Inquiry card.

# LET YOUR FINGERS DO THE TALKING!

DON'T TYPE IT IN FROM THE KEYBOARD . . . POINT IT OUT ON THE SCREEN!  
 IIAT's touch sensitive monitor gives you an alternative to keyboard entry  
 that's easier, faster, more accurate . . . and fun.

13" Color Monitor with Integrated Touch Sensitive Bezel and Sense Circuitry: \$1595

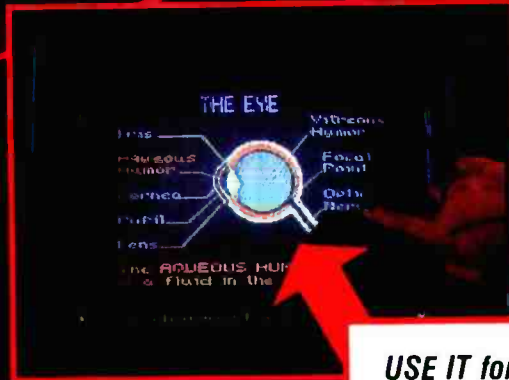
Monitor Interface Card with cable and documentation  
 For Apple II: \$159  
 For IBM PC:\*  
 For Atari 800:\*

DiscoVision or Sony Videodisk Interface Card with Monitor Interface, Cables and Documentation  
 For Apple II: \$599  
 For IBM PC:\*  
 For Atari 800:\*

PILOT plus™ CAI Course Authoring Software: \$150

\*IBM AND ATARI INTERFACES SCHEDULED FOR AVAILABILITY IN JUNE 1982. CALL FOR PRICE.

ALL PRICES DO NOT INCLUDE SHIPPING COSTS.



## FEATURING . . .

- High Quality Color Monitor for super graphics and text
- Touch sensitive Bezel with 80 by 36 infrared sensing matrix for precise response with no loss of image quality
- High speed sensing circuitry for multi-point tracking
- Interfaces for Apple II, IBM PC and Atari 800 for flexibility
- PILOT plus™ software for programming power in Computer Aided Instruction (CAI)

## USE IT for . . .

- Education, Training & Testing
- Order Entry and Processing
- Process Control
- Retail Point of Sale
- Database Query Programs
- Any application where you need quick and easy user interaction.

ALSO FROM IIAT:

# NEW GRAPHICS FOR APPLE II

## ULTRAPEN

Graphic pad version: \$250  
 Joystick version also available

Finally . . . A professional graphics editor for the Apple. Written in machine language for ultimate speed, Ultrapen provides a simple, low cost way to create still and animated graphics to stand alone for computer-based visual presentations. Ultrapen will also work with your BASIC programs. Write us for details.

Putting ACTION into interACTIVE computing

# IIAT

International Institute  
 of Applied Technology, Inc.  
 20010 Century Boulevard  
 Germantown, Maryland 20874  
 (301) 428-9010

APPLE AND APPLE II ARE REGISTERED TRADEMARKS OF APPLE COMPUTER, INC. ATARI 800 IS A REGISTERED TRADEMARK OF ATARI, INC. IBM PERSONAL COMPUTER IS A REGISTERED TRADEMARK OF IBM CORPORATION. PILOT plus IS A REGISTERED TRADEMARK OF ONLINE COMPUTER SYSTEMS.



## Book Reviews

was referring. In general, the explanations are too terse.

Section 1, which is 11 pages long, is devoted to a block diagram of the Color Computer and to a series of precise memory maps of the random-access memory.

These maps are very useful if you like to experiment with the different memory pages, modes, and displays. For example, I found out how to get limited higher-density video graphics on my Level I 4K-byte system after only a little experimentation. And using the POKE command to place a 0 into location FFD7 causes the system to operate at a clock rate of 1.8 MHz instead of the normal .89 MHz.

Section 2 is only two pages long and details the proper sequence of operations needed to disassemble the computer, as well as the reassembly procedure.

Section 3, "Theory of Operation," concentrates on the 6809E microprocessor, which is the heart of the TRS-80 Color Computer, and how it is interfaced to the outside world through the rest of the computer's components. Block diagrams, programming models, timing diagrams, cassette formats, and peripheral schematics are all included in the 26 pages that comprise this section. All of the components of the system are covered: joysticks, the RS-232C serial port, sound port, cassette port, and power supply.

The next section, labeled

"Troubleshooting," lays down general guidelines on where to look for the most common problems that you may encounter. Like the rest of the manual, the explanations do leave a lot unsaid and aren't very thorough. For example, the sound went out on my computer, and I discovered, much to my dismay, that the audio circuitry isn't covered in the troubleshooting section. However, using the schematics in the following sections, I was able to diagnose the problem and locate the bad chip on the circuit board.

Sections 5, 6, and 7 are gold mines for the hardware hacker. Section 5 features a complete list of all of the parts used in the Color Computer, including the screws! Section 6 is an actual-scale drawing of both the component side and the printed-circuit side of the computer board used in the Color Computer. Section 7, the last one in the manual, is composed of three 11 by 16 inch fold-out pages that give the complete circuit diagram of the Color Computer.

The *TRS-80 Color Computer Technical Reference Manual* (order no. 26-3193) is a bit skimpy on the explanations, but the diagrams and schematics more than make up for these deficiencies. If you are interested in the hardware/interfaces aspect or the software aspect, or even if you're just curious about the machine, then I recommend this manual. ■

## BYTE's Bits

### Computer Stores Listed

A mailing list of all the known computer stores in the United States and Canada has been compiled by NACS (National Association of Computer Stores). Approximately 1500 stores are listed, and most entries contain

company name, street address, city, state, and zip code. The list is broken down by state and includes a number of entries for foreign countries.

The list is available for \$110. For details, contact the National Association of Computer Stores, 3255 South U.S.#1, Fort Pierce, FL 33450, (305) 465-9450. ■

← Circle 205 on inquiry card.

# TRS-80™ DISCOUNT BUY DIRECT

WE SELL THE FULL LINE OF TRS-80'S  
AT WHOLESALE PRICES

\*\*\* PERSONAL COMPUTERS \*\*\*



**MODEL II**  
26-4002 64K I Drive..... **\$3279**  
Ask About Hard Drives

**MODEL III**  
26-1062 16K..... **\$819**  
26-1066 48K with  
2 Drives, RS232..... **\$2049**

**COLOR COMPUTER**  
26-3001 4K..... **\$309**  
26-3002 16K Ext. Basic..... **\$455**  
26-3003 32K Ext. Basic..... **\$569**

**POCKET COMPUTER**  
26-3501 Pocket Computer..... **\$155**

**COLOR COMPUTER DISK DRIVES**  
26-3022 Color Disk Drive #1..... **\$498**  
26-3023 Color Disk Drive #2, 3, 4..... **\$338**

•LARGE INVENTORY WRITE FOR YOUR  
•FAST DELIVERY FREE CATALOG

**THOUSANDS OF SATISFIED  
CUSTOMERS**

**ORDER TOLL FREE**

**1-800-841-0860**

**MICRO MANAGEMENT  
SYSTEMS, INC.**

DEPT. NO. 1  
115 C. SECOND AVE. S.W. CAIRO, GA. 31728

GA. 912-377-7120

TM - TANDY CORPORATION  
FREE COPY OF WARRANTY UPON REQUEST

Circle 269 on inquiry card.

May 1982 © BYTE Publications Inc 307

## Structured Strings in BASIC

Dr. David W. Stockburger  
 Psychology Department  
 Southwest Missouri State University  
 Springfield, MO 65802

The applications programmer often needs to create a sequence of events to direct the activity of a program. In many cases, the events are repeated at various levels within the sequence. The following describes a general-purpose routine in BASIC that allows the programmer to create a great variety of structured strings easily; these strings may then be used to sequence events in control programs. It has potential use in music generation, industrial control, robotics, and animation.

As an example, suppose a program to demonstrate animation techniques had 26 possible screens or displays, each symbolized by a small letter *a* through *z*. Input to this program might be in the form of a string (e.g., `<aabzccabzrabz>`), which would sequentially display

the screen associated with each small letter. These strings can be constructed and entered by the user. This may be a laborious task, however, if the input strings are long and complicated. Because it is likely that some patterns of small letters are repeated within the final string, considerable time and effort can be saved by creating a production system that inputs strings of capital and/or small letters (e.g., `<aBZcD>`) and produces strings consisting of only small letters (e.g., `<aaabccdefcddd>`). A set of production rules govern the replacement of any capital letter by a string of capital and/or small letters.

In this routine, an initial string of capital and/or small letters entered by the user is expanded until a string with only small letters remains; this last string is called the structured string. The expansion is performed by user-defined production rules. A production rule is a string that begins with a capital letter and is followed by capital and/or small letters.

The routine works by setting the pointer to the first letter in the initial string and examining that symbol. If it is a small letter, the routine increments the pointer and repeats the process. If it is a capital letter, it expands the initial string by replacing the capital letter with all symbols that follow it in the appropriate production rule. The pointer is *not* incremented in this case and the process is repeated, beginning at the position of the first letter of the newly inserted string. If a symbol is encountered that is neither a capital letter for which a production rule has been defined nor a small letter, the routine will generate an error. The routine will repeat the above process until the expanded string contains only small letters or until a string longer than some predefined length results. The flowchart for this routine is presented in figure 1.

For example, given the following set of production rules:

```
AaabbB
Bcccd
CeAe
DABCD
```

and the initial string `<CD>`, the routine proceeds as follows: it initially sets the pointer (*p*) to 1 and expands `<C>` in `<CD>`. The result is the string `<eAeD>`. When the routine now finds a small letter `<e>` in the

**ELECTRONIC/COMPUTER ENGINEERS**



**YOU SPENT LONG HOURS STUDYING TO GET YOUR DEGREE, BUT NOW YOU'RE PUZZLED ABOUT WHERE YOU CAN GO TO BEST USE THOSE SKILLS.**

**WARNER ROBINS AIR LOGISTICS CENTER** offers a civil service career as an engineer with a chance to work with state-of-the-art technology to support the most advanced defense weapons systems in the world. Warner Robins ALC will hire approx. 180 electronic/computer engineers in 1982. For more info. call toll free 1-800-841-9193 or 1-800-342-0570 (in Georgia) or write to: DPCSC-Employment office, Robins A.F.B., Georgia 31098

**WARNER ROBINS AIR LOGISTICS CENTER**  
**ROBINS A.F.B., GEORGIA 31098**

U.S. CITIZENSHIP REQUIRED - AN EQUAL OPPORTUNITY EMPLOYER



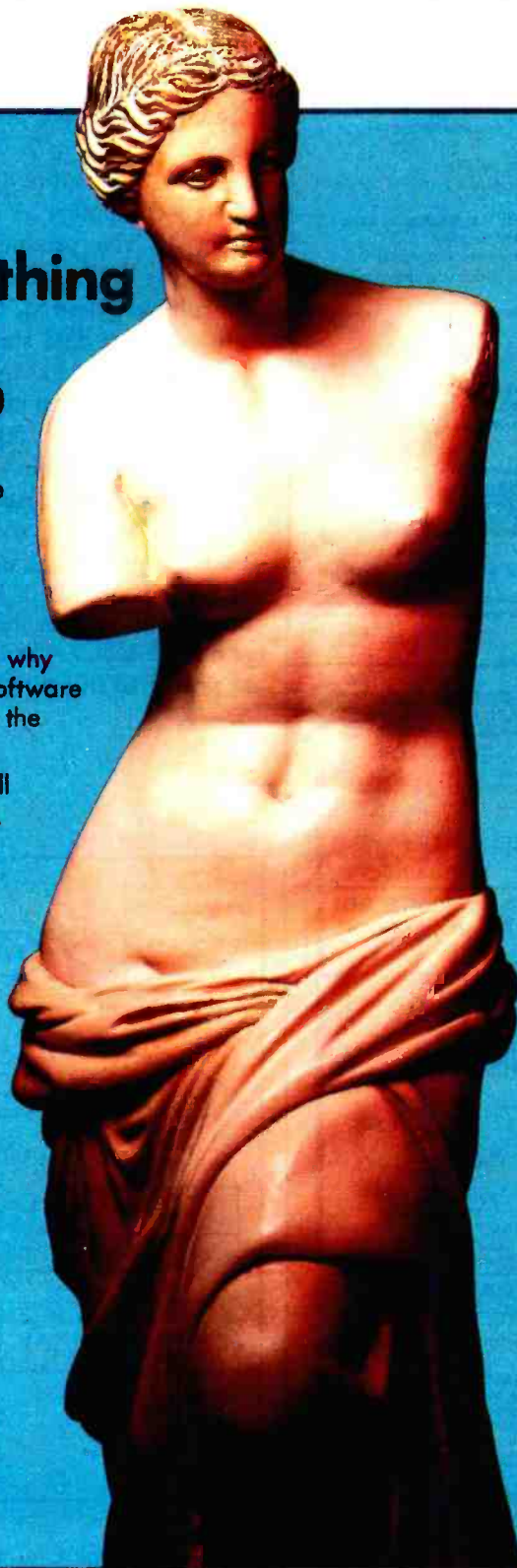
# YOU DON'T HAVE TO PAY AN ARM AND A LEG FOR DEMONSTRATION SOFTWARE!

**Get everything  
you need  
for \$295.00**

Whether you are selling your customer hardware or software, the three best ways to close the sale are:  
1) demonstration;  
2) demonstration; and  
3) demonstration. That's why we offer you the best software demonstration system in the microcomputer industry.

The package includes all the software listed here, plus important promotional materials and our exclusive video sales presentation designed to help you make the sale. You get the whole package for just \$295.00.

We offer you the largest selection of quality business applications and the best support available anywhere. Everyone claims to be the best ... but we're willing to demonstrate it. All you have to do is give us a call, or drop us a card.



## FINANCIAL

- General Ledger • Accounts Payable • Accounts Receivable • Payroll • Cash Receipts/Disbursements • Job Costing • Mailing List Management

## MEDICAL/DENTAL

- Office Scheduler • Patient Billing • Accounts Receivable • Insurance Forms

## GOVERNMENTAL / EDUCATIONAL

- Student Record Keeping • Student Scheduling • Fund Accounting

## WHOLESALE DISTRIBUTION

- Purchasing and Receiving • Inventory Control • Invoicing and Receivables • Sales Commission Reporting • Backorder Management

## MANUFACTURING INVENTORY CONTROL

- Finished Goods Inventory Management • Parts Inventory Management • Parts Purchasing and Receiving • Bill of Material • Production Scheduling

All IMS business applications require CP/M® or MP/M® and CBASIC II®... registered trademarks of Digital Research Corp.



**INTERNATIONAL  
MICRO SYSTEMS**

6445 Metcalf • Shawnee Mission, KS 66202  
(913) 677-1137

Circle 206 on inquiry card.



## Supercharge Your Micro's Performance With



### The Professional Operating System with CP/M™ Compatibility

- Spectacular Performance. Programs run 3 to 10 times faster compared with TRSDOS or CP/M. Benchmark results up to 20 times faster obtained with some applications by independent firm!
- Double-Sided Drive Support. Provides 1 25 Megabytes of storage per 8" double-sided/density disk. Intermix any combination of single- or double-sided drives on-line.
- Expanded Directories. Store larger number of files and more information per disk.
- Automatic Density/Side Recognition. Detects changes in disk format automatically. Change disks at any time without compromising data or "BDOS/Read-Only" errors.
- Fast Disk Backups. Copy a complete 8" SS/DD diskette (610K) in less than 80 seconds. Copy a double-sided/density diskette (1 25 Megabytes) in less than 1 minute 45 seconds!
- Hard Disk Drive Support. Supports large hard disks in excess of 1,000 Megabytes without partitioning.
- Advanced Utilities. Complete set of disk utilities, system, date and time functions, communications channel interface, etc. provided as standard features.
- Enhanced Automatic Print Spooling. Run multiple printers simultaneously; support for multiple queues and printers is standard feature on spooling versions.
- CP/M Compatibility. Virtually any CP/M (version 2.x) program will run under TURBODOS without modification. Also fully media compatible with standard CP/M-format diskettes.
- Advanced Mainframe-like features. Includes read-after-write validation of all disk update operations, type-ahead buffers, incremental disk backup utility, password/log-on security, system date and time functions, accepts string of multiple commands, and numerous other capabilities not available under CP/M or TRSDOS. Multi-user, networking versions also available.

TRS-80 Model II and Xerox 820 versions  
**\$195** Dealer and OEM inquiries invited  
 Special Introductory Price  
 Easily adaptable to any Z80-based computer.

**Data-Rx, Inc.**

(408) 375-2775 • 686 Lighthouse Avenue • Monterey, 93940

TURBODOS is the registered trademark of Software 2000  
 CP/M, MP/M, and CP/NET are registered trademarks of Digital Research

## Programming Quickies

first position of the string, it increments the pointer and examines the second letter in <eAeD>, which is <A>. Finding a capital letter, it looks it up in the set of production rules, finds it, and expands the string to <eaabbBeD>. The next capital letter to be expanded is <B>, and the expanded string would now be <eaabbcceD>. Continuing the process would yield <eaabbcceABCD>, which could be infinitely expanded. The routine would stop, however, because the pointer would have become larger than the limit set by the user.

The BASIC routine (written in Poly Disk BASIC for a Poly-88 computer) as described above is presented in listing 1. The production rules are read in as data statements in the string variable T\$. If different production rules are desired, they may be substituted or added to the existing data statements. If a number of different production systems are desired, it would probably be easiest to store them in mass storage, such as disk or tape files, and read them into T\$ as desired.

The string variable A\$ is used for both the input and output string. The user inputs the initial string into the routine through this variable, and the routine returns the expanded string back into this variable. The routine uses the BASIC commands RIGHT\$, LEFT\$, and MID\$ to accomplish the expansion. (This should pose no problem for most BASICs.) Examples of the results of the routine are presented in listing 2.

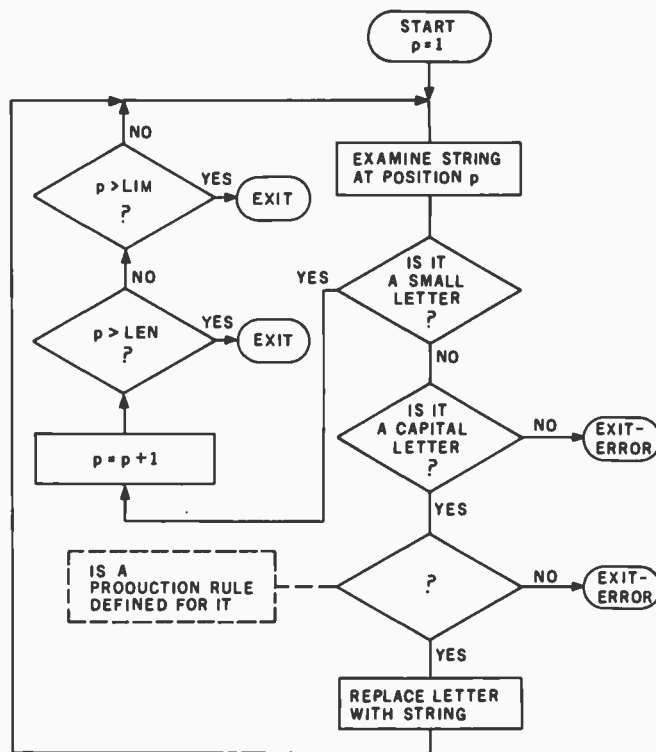


Figure 1: Flowchart for the structured string-generation program in listing 1.

**QUALITY parts at DISCOUNT PRICES**

<p><b>SUPER SMALL PHOTO FLASH</b>                  170 MFD 330 VOLT                  1 1/4" x 1/8"                  2 for \$1.50                  10 for \$7.00</p>	<p><b>BLACK PLASTIC CASE</b>                  PAC-TEC SERIES C                    BLACK PLASTIC ENCLOSURE                  ADJUSTABLE HEIGHT FROM                  1.63" TO 2.93"; WIDTH                  6.85"; DEPTH 8". BUILT-                  IN STAND OFFS FOR P.C.                  BOARDS. FRONT AND BACK                  PANELS NOT INCLUDED.                  \$5.25 PER CASE</p>	<p><b>JOYSTICK</b>                  PRECISION DEVICE                  CONTAINS 4                  50K CENTER                  TAPPED ALPS                  POTS.....                  \$4.75 each</p>
<p><b>500K LINEAR SLIDE POT</b>                  2 7/8" LENGTH                  1 3/4" TRAVEL                  75¢ EACH</p>	<p><b>SPECIAL MRF 901</b>                  MICROWAVE TRANSISTOR                  \$2.50 EA.</p>	
<p><b>COMPUTER GRADE CAPACITOR</b>                  1700 mfd. 150VDC \$2.00                  2 1/2" DIA X 4 3/4" HIGH                  3,600 mfd.                  40VDC \$1.00                  1 3/8" DIA. X 3" HI                  6,400 mfd.                  60VDC \$2.50                  1 3/8" DIA X 4 1/4"                  12,000 mfd. 40 VDC \$3.00                  2" DIA X 4 1/4" HIGH                  18,000 mfd. 75 VDC \$4.00                  2 1/2" DIA X 4 1/2" HIGH                  20,000 mfd. 25VDC                  2" DIA. X 2 1/2" HIGH \$2.00                  22,000 mfd. 15 VDC                  2" DIA X 2 1/2" HIGH \$2.00                  22,000 mfd. 40VDC                  2" DIA. X 6" HIGH \$3.00                  25,000 mfd. 75 VDC \$4.50                  3" DIA X 4 3/8" HIGH                  45,000 mfd. 25 VDC                  2" DIA. X 4" HIGH \$3.50                  72,000 mfd. 15 VDC                  2" DIA. X 4" HIGH \$3.50                  CLAMPS TO FIT CAPACITORS 50¢ EA</p>	<p><b>L.E.D.'s STANDARD JUMBO DIFFUSED</b>                  RED 10 FOR \$1.50                  GREEN 10 FOR \$2.00                  YELLOW 10 FOR \$2.00  <b>FLASHER LED</b>                  5 VOLT OPERATION                  JUMBO SIZE                  2 FOR \$1.70  <b>BI POLAR LED</b>                  2 FOR \$1.70  <b>SUB MINI LED</b>                  .079" x .098"                  20 mA at 1.75v                  10 FOR \$1.00                  200 FOR \$18.00                  QUANTITY PRICES AVAILABLE</p>	<p><b>14 CONDUCTOR RIBBON CABLE</b>                    SCOTCHFLEX #3365                  28 AWG STRANDED                  GRAY WITH RED MARKER                  10 FEET for \$2.50                  100 FOOT ROLL \$12.00</p>
<p><b>SEND FOR NEW 1982 Free! 40 PAGE CATALOG Free!</b></p>		
<p><b>TRANSFORMERS</b>                  120 volt primaries                  6 VOLTS at 150 mA \$1.25                  12 V.C.T. at 500 mA \$2.50                  16.5 V. at 3 AMPS \$6.50                  18 VOLTS at 350 MA \$2.00                  18 VOLTS at 1 AMP \$4.50                  25.2 VCT at 2.8 AMP \$5.50</p>		
<p><b>FLAT LEVER MINI-TOGGLE S.P.D.T (ON-OFF)</b>                  5 AMP @ 120 VAC                  C&amp;K # 7105                  \$1.00 EACH                  10 for \$8.50                  100 for \$75.00</p>		

**ALL ELECTRONICS CORP.**  
 905 S. Vermont Ave.  
 P.O. BOX 20406  
 Los Angeles, Calif. 90006  
 (213) 380-8000  
 Mon. - Fri. 9 AM - 5 PM Saturday 10 AM - 3 PM

TERMS:  
 • Quantities Limited  
 • Min. Order \$10.00  
 • Add \$2.50 Shipping USA  
 • Calif. Res. Add 6%  
 • Prompt Shipping

# Turn To The Future With COMPUTE! Publications

## The Beginner's Guide To Buying A Personal Computer

A Novice's handbook of useful, helpful information designed to teach you the basics of evaluating and selecting a personal computer. Written in plain English for the interested beginner. Complete with personal computer specification charts and buyer's guide. Applicable to home, educational, and small business buyers. ISBN 0-942386-03-5. Paperback. \$3.95.



## Inside Atari DOS

From the authors of the Atari Disk Operating System, an exciting step-by-step guide to the DOS software. Complete with listings of commented source code and detailed explanations of each module of code. Author: Bill Wilkinson, Optimized Systems Software, Inc. Spiral bound for ease of access to listings. For intermediate to Advanced Atari Users. ISBN 0-942386-02-7. Paperback. \$19.95

## COMPUTE!'s First Book Of Atari

192 pages of useful, informative applications and programs from **COMPUTE!** magazine issues now out of print. Includes previously unpublished information including Memory Map. Contents include such articles and programs as "Adding A Voice Track to Atari Programs," "Designing Your Own Atari Graphics Modes," and "Inside Atari BASIC." Spiral bound for ease of access to listings. For Beginner level to Advanced Atari users. ISBN 0-942386-00-0. Paperback. \$12.95.

## COMPUTE!'s First Book Of PET/CBM

256 pages of Commodore PET and CBM articles from **COMPUTE!** magazine issues now out of print. Includes such classic articles and programs as "Feed Your PET Some Applesoft," "Disk Lister: A Disk Cataloging Program," and "Cross Reference For The PET." Spiral bound for ease of access. ISBN 0-942386-01-9. Paperback. \$12.95.

**COMPUTE! Books** invites dealer inquiries. Call the Toll Free Number below for Dealer Information.

ATARI is a registered trademark of Atari, Inc. PET and CBM are trademarks of Commodore Business Machines, Inc.

### To Order COMPUTE! Books

Send coupon to  
**COMPUTE! Books, P.O. Box 5406, Greensboro, NC 27403 USA**

For fastest service, in the US call  
**Toll Free 800-334-0868**  
In NC call 919-275-9809.

All orders must be prepaid (money order, check or charge). All payments must be in US funds. (Outside the US add \$4.00 shipping and handling for air mail, \$2.00 for surface mail.) NC residents add 4% sales tax.

Payment Enclosed  
Please charge my  VISA  MasterCard  American Express

Account No. \_\_\_\_\_ Expires \_\_\_\_/\_\_\_\_/\_\_\_\_

Please send me:

Quan.	Price	Shipping/Handling	
___ <b>Beginner's Guide</b>	\$ 3.95 ea.	+ \$1.00 ea.	_____
___ <b>First Book of Atari</b>	12.95 ea.	+ 2.00 ea.	_____
___ <b>Inside Atari DOS</b>	19.95 ea.	+ 2.00 ea.	_____
___ <b>First Book of PET/CBM</b>	12.95 ea.	+ 2.00 ea.	_____
		Total	_____

Name \_\_\_\_\_

Address \_\_\_\_\_

City \_\_\_\_\_ State \_\_\_\_\_ Zip \_\_\_\_\_

Country \_\_\_\_\_

Allow 4-6 weeks for delivery. Foreign surface delivery allow 2-3 months. Dept. 111

## Programming Quickies

---

Listing 1: *The structured string-generation program (written in Poly Disk BASIC). In practical applications, this program would be used as part of a larger program.*

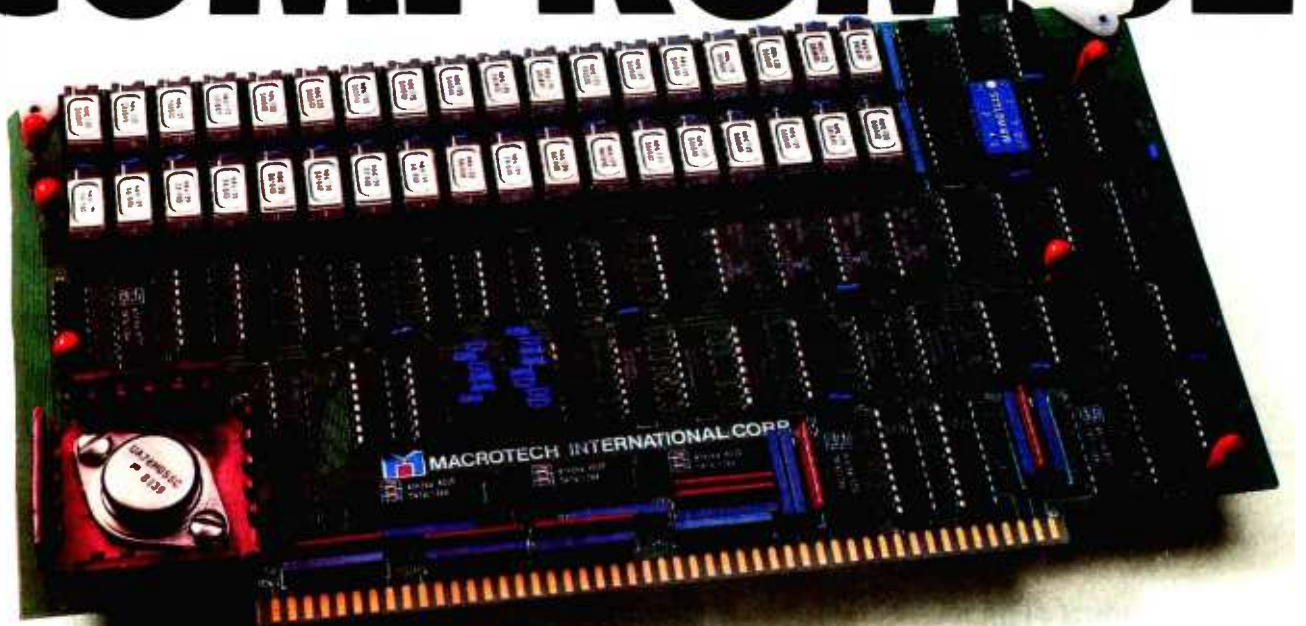
```
10 REM ***** STRINGS *****
20 REM A PROGRAM TO GENERATE STRUCTURED STRINGS
30 REM
40 REM Copyright, 1981 by David W. Stockburger
50 REM          PSYCHOLOGY DEPARTMENT
60 REM          SOUTHWEST MISSOURI STATE UNIVERSITY
70 REM          SPRINGFIELD, MISSOURI 65804
80 REM
90 DIM S$(1:400)
100 REM CONTAINS STRING TO BE GENERATED
110 DIM T$(26:20)
120 REM CONTAINS PRODUCTION RULES
130 DIM A$(1:1)
140 REM TEMPORARY STRING USED BY STRINGS
150 REM
160 REM READ IN TRANSFORMATION STRINGS TO BE USED
170 REM N IS THE NUMBER OF TRANSFORMATION STRINGS
180 N=10
190 FOR I=1 TO N
200 READ T$(I)
210 NEXT
220 DATA "Aaabbcc"
230 DATA "Bcdefgh"
240 DATA "CtAbt"
250 DATA "Dxyz"
260 DATA "Etiser"
270 DATA "Fnnop"
280 DATA "GvFZeeD"
290 DATA "HGCEH"
300 DATA "IwwzcbDBACH"
310 DATA "Zmmmm"
320 REM
330 INPUT "Enter maximum length of expanded string (1 to 300) ",L
340 INPUT "ENTER STRING TO BE EXPANDED ",S$
350 GOSUB 430
360 PRINT S$
370 INPUT "Do you wish to continue (Y or N)? ",A$
375 PRINT
380 IF A$="N" THEN STOP
390 IF A$="Y" THEN 340
400 GOTO 370
410 REM
420 REM
430 REM ***** SUBROUTINE TO EXPAND STRINGS *****
440 REM
450 P=0
460 REM P IS POSITION IN STRING
470 REM FIND CURRENT LETTER
480 P=P+1
490 IF P>L THEN RETURN
500 IF P>LEN(S$) THEN RETURN
510 A$=MID$(S$,P,P)
```

*Listing 1 continued on page 314*



THE MULTI-USER FRIENDLY 256K MEMORY BOARD WITH

# NO COMPROMISE



## No Compromise in Performance

- Main-frame type memory mapping for optimal BANK SWITCHED applications or 24-BIT extended addressing
- Operates in any S-100 System IEEE/696\* or non IEEE
- DMA operation fully supported†
- 8/16 data transfer protocol†
- Up to 6 MHZ with no wait states: Up to 10 MHZ with automatic wait state assertion
- Parity error detection†
- Double parity in 16-BIT operation

## No Compromise in Features

- All memory/refresh cycle timing is generated ON BOARD providing easy CPU independent characterization
- Ideal for use with the new generation of operating systems: CP/M-80™, CP/M-86™, MP/M-11™, MP/M-86™, OASIS™, UNIX™...

## No Compromise in Quality

- Multilayer board and bus signal filtering for noise-free operation
- Thorough 100% final test and burn-in

## No Compromise in Versatility

- Manual provides source listing and complete installation guide for MP/M-II™ BANK SWITCHED multi-user applications
- For the CP/M-2.2™ user: Manual includes implementations of 'Virtual Disk' for solid state disk/file applications

## No Compromise in Customer Support

- Comprehensive technical manual
- User hot-line
- Full one year parts and labor warranty

†In accordance with IEEE-696 standard  
Registered trademarks of \*Digital Research.  
\*\*Phase I and \*\*\*Bell Labs

## ORDER NOW

**(213) 887-5737**

If you wish, send a check or money order for \$1,379 (in California add 6% sales tax where applicable).

Manual available at \$25.00 each refundable with order.

MACROTECH International Corp.,  
22133 Cohasset St., Canoga Park,  
California 91303



MACROTECH International Corp.,  
22133 Cohasset St., Canoga Park,  
California 91303

## Programming Quickies

Listing 1 continued:

```

520 IF A$>="a" AND A$<="z" THEN 470
530 IF A$<"A" OR A$>"Z" THEN 670
540 REM THE LETTER IS A CAPITAL
550 REM CAN EXPANSION LETTER BE FOUND?
560 J=0
570 FOR I=1 TO N
580 IF A$=LEFT$(T$(I),1) THEN J=I
590 NEXT
600 IF J=0 THEN 720
610 REM IF J=0 THEN NO EXPANSION LETTER WAS FOUND
620 REM NOW EXPAND USING J
630 L1=LEN(T$(J))-1
640 L2=LEN(S$)-P
650 S$=LEFT$(S$,P-1)+RIGHT$(T$(J),L1)+RIGHT$(S$,L2)
660 GOTO 510
670 REM ERROR - SYMBOL IN STRING NOT A CAPITAL OR SMALL LETTER
680 PRINT "ERROR IN INPUT STRING OR PRODUCTION RULE"
690 PRINT "THE INCORRECT SYMBOL WAS ",A$
700 PRINT
710 RETURN
720 REM ERROR - PRODUCTION RULE NOT FOUND IN TRANSFORMATION TABLE
730 PRINT "CAPITAL LETTER NOT A PRODUCTION RULE"
740 PRINT "THE INCORRECT SYMBOL WAS ",A$
750 PRINT
760 RETURN
    
```

## NEW \* APPLE II PRODUCTS

### \* DUAL COMM PLUS™ TWO SERIAL PORTS



- Two fully independent serial I/O ports
- Combines the features of the APPLE HIGH SPEED SERIAL CARD™ and the APPLE COMMUNICATIONS CARD™ in one card (with handshaking)
- Thumbwheel switches select the Apple slot locations. Sixteen switch selectable baud rates for each port (50 to 19200 baud)
- On-board firmware provides extensive printer and U/L case terminal/modem support. Great with an 80 x 24 card and a Novation CAT or Hayes Smartmodem
- Can be programmed for async., sync., or even SDLC operation. Supports interrupts. Uses Z80 SIO chip.

LIST PRICE: \$239.00  
MANUAL ONLY: \$15.00

### \* MEMORY PLUS™ 16K RAM EXPANSION



- Add another 16K to your 48K APPLE
- Works with PASCAL, DOS, CP/M, FORTRAN, COBOL, PILOT. Personal Software's VisiCalc, INTEGER and APPLESOFT BASIC. Many other Apple software packages benefit from the additional storage provided by the MEMORY PLUS card.
- Three LED's show memory select and read/write protect status
- Toggle switch to shut the card off or to select between the standard monitor ROM or the on-board firmware socket. The firmware socket can hold an alternate Apple monitor ROM or a 2716 program (user provided).

LIST PRICE: \$149.00  
MANUAL ONLY: \$15.00

### FULL-VIEW 80™ 80 X 24



- Permits selection of 80 column or Apple 40 column/graphics on a single monitor via keyboard or program control
- 8 x 10 cell size upper/lower case character set with full lower case decoders
- User definable EROM character sets via 2716 (127 chars) or 2732 (255 chars)
- On-board 2K firmware supports HTAB, VTAB, U/L case keyboard, DATAMEDIA CONTROL CODES, INVERSE/NORMAL VIDEO, and a special printer driver
- Low power requirement
- Easy installation - just plug it in!
- Compatible with many 80 column word processors
- Compatible with the D.C. Hayes MICROMODEM™

LIST PRICE: \$379.00  
(2716 std. char set)  
MANUAL ONLY: \$15.00

All Bit 3 Apple products features:

- Easy plug-in installation • Operation with PASCAL Z80 SOFTCARD™, APPLE II and APPLE II PLUS
- 50/60 hz operation



BIT 3 COMPUTER CORPORATION  
8120 Penn Avenue South • Suite 548  
Mpls., MN 55431 • (612) 881-6955

Apple II is a registered trademark of Apple Computer, Inc.; Z-80 Softcard is a registered trademark of Microsoft Consumer Products. D.C. Hayes Micromodem is a trademark of D.C. Hayes, Associates, Inc.; Novation CAT is a registered trademark of Novation, Inc.

# LOGO

## Language of the 80's

**Apple Logo** and **Logo** introduce you to a dynamic new computer language that not only enables educators to make full and innovative use of the teaching potential of modern computers but also offers programmers an easy-to-use system of considerable power.

Readers of this book will see that the designers' vision of Logo as a virtually unlimited educational tool has now become a reality. Logo enables even young children to use the computer in rewarding, self-directed projects, while at the same time providing sophisticated users with a powerful and expressive general programming system. This book presents the reader with a complete guide to the exciting applications of this unique procedural language.

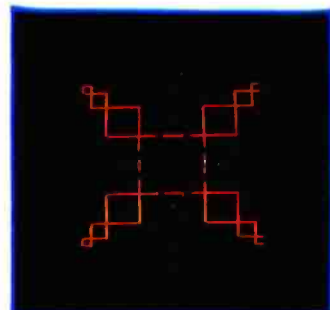
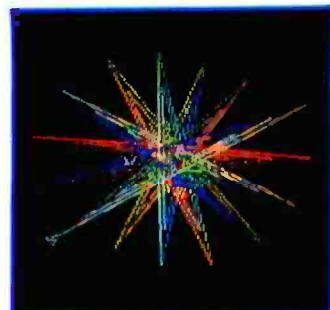
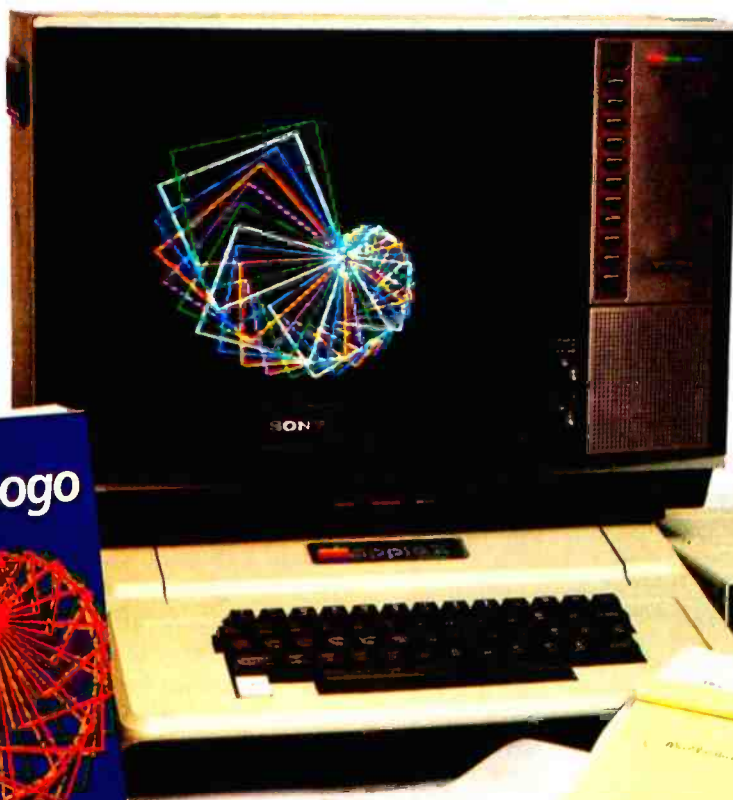
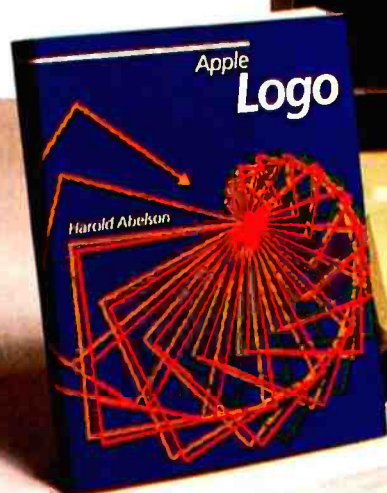
The author introduces programming techniques through Turtle Geometry—a series of fascinating exercises involving both Logo programming and geometric concepts. Later chapters illustrate more advanced projects that utilize Logo's sophisticated list-processing capabilities; these include the conversational DOCTOR program with its simulated psychotherapist and an INSTANT program with which parents and teachers can create a programming environment for preschool children. The book also contains reference material of enduring value to sophisticated users.

Get in on the ground floor of the burgeoning Logo movement with this comprehensive, detailed guide to the up-and-coming computer language of the Eighties!

This book is published in two versions: *Apple Logo* is for users of Apple Logo™ software (distributed by Apple Computer Company) and contains an appendix for users of TI Logo™. *Logo* is specifically for users of Logo software developed at MIT for the Apple II computer (distributed by Krell Software and Terrapin, Inc.). *Logo* also contains appendices that enable users of Apple Logo™ and TI Logo™ to carry out the projects in the book. Be sure to specify *Apple Logo* or *Logo* when ordering!

Apple Logo  
\$14.95  
240 pages,  
softcover, illustrated

Logo  
\$14.95  
240 pages,  
softcover, illustrated



ORDER TOLL FREE  
800-258-5420

BYTE Books 70 Main St Peterborough, N.H. 03458

Circle 58 on inquiry card.  
[www.americanradiohistory.com](http://www.americanradiohistory.com)





## Programming Quickies

Listing 2: Examples of structured string generation from program in listing 1. The production rules used are given in lines 220 through 310 of listing 1.

```
ENTER STRING TO BE EXPANDED  sdefslkiawZBCD
sdefslkiawmmmmodefshtaabbbcccodefshtxyz
Do you wish to continue (Y or N)?  Y
```

```
ENTER STRING TO BE EXPANDED  J9T
CAPITAL LETTER NOT A PRODUCTION RULE
THE INCORRECT SYMBOL WAS  J
```

```
J9T
Do you wish to continue (Y or N)?  Y
```

```
ENTER STRING TO BE EXPANDED  EFG
tiserannopvnnofmmmeexsz
Do you wish to continue (Y or N)?  Y
```

### Cautions

Remember:

- The string variable A\$ must be dimensioned longer than the cutoff limit given to the routine because, upon exiting the routine, the expanded string may contain both small and capital letters to the right of this length. The additional length needed will depend upon the type of production rules that have been employed.
- The replacement string of a production rule may not

contain the capital element in the first position. For instance, *AAa* is not permitted because first position would never be expanded to a small letter. More complex versions of the same phenomenon may occur when replacement rules cyclically replace capital letters. For example, the replacement rules *ABa* and *BAb* would recursively call one another without replacing the initial portion of the string by small letters.

- The routine is fairly slow and may not function in real-time applications, where short time intervals (i.e., seconds) are important. For example, it would probably not be possible to generate strings of musical notes and play them simultaneously with the result sounding anything like music. Where time is critical, the strings must first be generated and stored in a mass storage medium, such as floppy disk, tape, or programmable memory. They may then be recalled when needed.

- The routine cannot easily generate all useful strings. Some transformations of existing strings cannot be produced by this routine. For example, when a musical phrase an octave higher or lower than an existing phrase is desired, it may not be easily produced using this system.

The inspiration for the routine came from the discussion of formal systems by Douglas Hofstadter (in *Gödel, Escher, Bach: an Eternal Golden Braid*, Basic Books, New York, 1979) and the formal theory of grammar (see *Automata Theory: Machines and Languages* by Richard Y. Kain, McGraw-Hill, New York, 1972). In these systems, a given string is expanded by the use of production rules to generate an axiom (discussed by Hofstadter) or an element of the language (discussed by Kain). The major difference between these systems and the present one is that, in the former cases, each capital letter may have a number of different replacement strings so that any number of possible expansions are possible, defining either a formal system or formal language. In the case of the above routine (where only one possible expansion is allowed for any capital letter), the initial string will always produce the same expanded string. ■

# S-100 Modem

An Atlanta bulletin board system uses a Hayes S-100 modem around the clock. Since March 1979, it has logged over 21,500 calls and been down a mere 10 minutes. For performance like this, depend on the Hayes Micromodem 100.™ Features include automatic dialing/answering, 45 to 300 baud operation, a built-in serial interface and direct connection to any modular phone jack.

The Micromodem 100 – and Micromodem II™ for Apple II® computers – are now available nationwide. Call or write for the name of your nearest dealer.



Hayes Microcomputer Products Inc.

5835 Peachtree Corners East, Norcross, GA 30092 (404) 449-8791

Micromodem 100 & Micromodem II are trademarks of Hayes Microcomputer Products Inc. © 1981 Apple Computer Inc.

# We Have It!



**Integrated Desk Top Computer with 12 inch Bit-Mapped Graphics or Character Display, 64Kb RAM, 4 MHz Z80A,® Two Quad Capacity Floppy Disk Drives, Selectric® Style 87 Key Keyboard, Business Graphics Software**

FOLLOW THE STAR  
**NorthStar**™

## The New ADVANTAGE

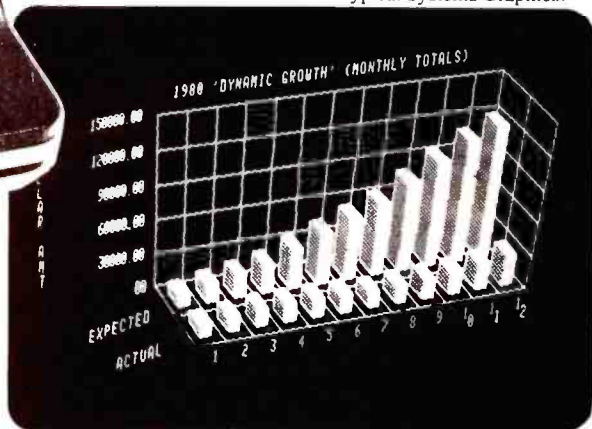
w/ graphics running in sepearte 20K of RAM; also includes 2K Boot Strap ROM.

**Optional operating systems.**

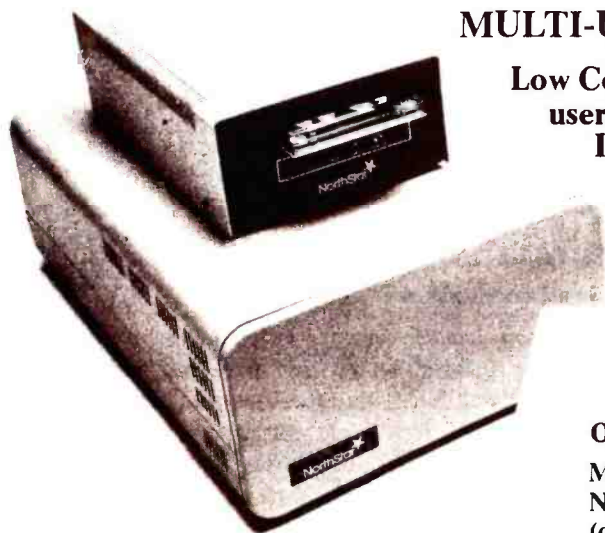
G/DOS runs existing NorthStar programs; Graphics C/PM® also runs conventional NorthStar C/PM® programs. Serial ports and parallel ports are available as options.

**Call for prices.**

Typical Systems Graphics:



**3-DIMENSIONAL CHART**



## MULTI-USER HORIZON SYSTEMS

**Low Cost, Packaged, High Performance, Multi-user HORIZON® systems with 5Mb or 18Mb Integrated Winchester Hard Disks, Up to Five Users.**

**HRZ-IQ-64K-HD5**

w/5 Megabyte Winchester . . . . . **\$4749\***

**Four-User HORIZON 1Q-64K-18H**  
w/ 18Mg Hard Disk. **only \$8260\***

*\* To May 30, 1982*

**Optional Operating Systems.**

Multi-user operating systems now available to run both NorthStar DOS/BASIC and standard C/PM® programs (offers more available RAM than an MP/M system)

**HORIZON 2Q-64K, \$2896\***  
(with metal case)

**H RAM 64K Memory Board, \$595\***

*\* To May 30, 1982*

All prices, F.O.B. shipping point, subject to change. All offers subject to withdrawal without notice. Advertised prices reflect a 2% cash discount (order prepaid prior to shipment). C.O.D.'s and credit card orders are 2% higher.



# MiniMicroMart, Inc.

943 W. Genesee St. P.O. Box 2991B Syracuse, N.Y. 13220 (315) 422-4467 TWX 710-542-0431

# TRS-80 BASIC Program Hang-ups

## The Reasons and Some Solutions

*Understand and eliminate those mysterious crashes*

---

Glenn Tesler  
POB 83  
North Hollywood, CA 91603

---

Have your TRS-80 BASIC programs ever stopped for no apparent reason or hung up in the middle of an operation? There are at least six reasons why this can happen:

1. The program is trying to output to a nonexistent printer or to one that's not ready.
2. String space collection, also known as garbage collection, is taking place.
3. Your program is large and has many line references to the middle or end.
4. Your program uses variables that were not defined in the *proper* order (the proper order will be explained later).
5. Your program is stuck in an endless loop.
6. Your system has crashed, your memory has dropped out, etc.

These problems occur often, and can be annoying, especially when you have to load the program again and start over. Here are some solutions to the first four possibilities, some of which should improve your program execution time.

### Printer Not Ready

Occasionally, you may run a program that contains LPRINT (output to printer) statements when your printer is off or disconnected. If so,

your program will hang up when it reaches the first LPRINT, because the TRS-80 printer-driver software waits until the printer sends a ready signal before it transmits each character to be output. If the printer is off, this software routine never receives the ready signal, staying in a loop without sending a warning message to the

---

**Often a TRS-80 BASIC program will stop during an operation for no apparent reason.**

---

user. To prevent this, you need a routine that checks for the printer's presence without getting stuck. Listing 1 shows two methods, using both BASIC and Z80 machine language, that will alert you to the printer-not-ready situation.

If you use the NEWDOS operating system, accidentally pressing the J, K, and L keys simultaneously (the NEWDOS screen-print command) will result in a hang-up for the same reasons. To prevent this, you can disable the screen print by POKEing the decimal number 201 (hexadecimal C9) into decimal location 17333 (hexadecimal 43B5). To re-enable this function, you must POKE the decimal number 103 (hexadecimal 67) into the same location.

### Garbage Collection

If you define 20 strings as 3 characters in length and then you redefine those same 20 strings as 2 characters, it should take up 40 bytes, right? Wrong! It takes 100 bytes: 60 for the old strings—now garbage—and 40 for the new strings. Eventually, the computer has to get rid of the garbage to free string space. This procedure sometimes seems to take forever.

The program in listing 2 repeatedly picks a random number from five to nine and defines 100 strings to that length; the random numbers are displayed between the asterisks. The program also shows how much string space is left in memory. Occasionally, this program pauses when the numbers get low. This means that it is time for string space compression, also known as garbage collection, which the computer usually does without a warning. This doesn't have to happen anymore!

Save the BASIC program from listing 2, then decide whether you want to use BASIC or machine language to create a string-compression detector. If you select BASIC, enter the program in listing 3; use the program in listing 4 if you select machine language.

The BASIC version POKES a machine-language program similar to that in listing 4 into memory. Before running the BASIC version, you must



# THE DAWN OF A NEW ERA "THE COMPUTER-LINE"™

V I S T A B O C N E P S O N H X O R E X  
 D E C S T A B O C N H X O R E X  
 H E W L E T T . P A C K A R D  
**APPLE** **MBI™**



Our Volume Sales Are So High  
That Our Prices Are The World's Lowest - Period!

CALIFORNIA COMPUTER SYSTEMS		MOUNTAIN HARDWARE	
7710 Async. Serial Int.	\$135	CPA Multi-Function Card	\$169
7490 GPIB (IEEE-488) Int.	\$239	The Clock	\$229
7470 Ana. to Dlg. Converter	\$ 99	Supertalker	\$159
7711 Async. Serial (Term)	\$135	Music System	\$319
7712 Sync. Serial Int.	\$149	Expansion Chassis	\$599
7721 Apple Parallel Int.	\$109	Romwriter	\$139
Calendar/Clock Module	\$ 99	Ram Plus (32K Board)	\$149
Programmable Timer	\$ 99		

### PRINTERS

NEC		ANADEX	
Spinwriter 7710	\$ 2339	DP9500/9501	\$ 1275
8023 A	\$CALL	INTEGRAL DATA SYSTEMS	
<b>EPSON</b>		Prism 80	\$ 1195
MX 80	\$CALL	Prism 132 Color Printer	\$ 1595
MX 80 Ft.	\$CALL	MPI	
MX 100	\$CALL	88 G Printer	\$ 659
		99 G Printer	\$ 749

### BUSINESS SOFTWARE

VISICORP, INC.		STONEWARE	
Desktop Plan III	\$229	DB Master	\$169
Desktop Plan II	\$189	DB Utility Pack	\$ 69
Visiffles	\$189	MICRO PRO	
Visiplot	\$159	Apple CP/M	
Visitrend/Visiplot	\$229	Word Star	\$219
Visidex	\$189	Super Sort	\$119
Visiterm	\$ 79	Mail Merger	\$ 79
Visicalc 3-3	\$189	Data Star	\$179
Visipak	\$539	Spell Star	\$119
		Call Star	\$119

### INFORMATION UNLIMITED

Pro Easy Writer \$169

Call For Continental, DakIn 5, Broderbund, Automated Simulations, Avant-Garde, Edu-Ware, Denver, Howard, Sirius, Sensible, Synergistic Software, Etc.

### COMPARE!

DRIVES FOR  
APPLE

WITH  
CONTROLLER  
\$459  
ADD-ON \$389

Hard Disks + 8" Disks for Apple, TRS-80 \$CALL  
Apple Computer Products \$CALL



PRODUCTS • PLEASE CALL  
OR WRITE FOR CATALOG.

### MODEMS

Hayes Micromodem II	\$289
Hayes Smartmodem	\$229
Hayes Chronograph	\$199
Novation Cat	\$145
Novation D-Cat Modem	\$165
Novation Apple Cat II	\$339
Novation Auto Cat	\$209

### DISKETTES (Boxes of 10)

Verbatim Datalife	\$ 24-95
Verbatim 8"	
Double-Side/DD	\$39-95
RAM CARDS	
Ramex 16 K Card	\$ 119
Ramex 128 K Card	\$CALL
Wesper 16 K Card	\$ 119
Microsoft 16 K Card	\$ 139
Dana 16 K Card	\$ 119

### MONITORS

Zenith ZVM-121 Phosphor	
15 MHZ	\$119
NEC 1201 Phosphor	
20 MHZ	\$179
NEC 0112 Composite	
Color	\$335
NEC 2112 RGB Color	\$899
Amdek 300 Phosphor	\$199
Amdek Composite Color	\$355
Amdek IBM Compatible	
Color	\$899

### 80 COLUMN CARDS

FOR APPLE	
Wesper 80 Card	\$259
Vision 80 Card (Vista)	\$299
Videx 80 Card	\$259

### MISCELLANEOUS

APPLE PRODUCTS	
Enhancer II	\$ 119
Dana Apple Fan	\$ 39
Sup R Mod	\$27-95

IN COLORADO (303) 279-2727

CALL "THE COMPUTER-LINE"™ 7 DAYS

1-(800)-525-7877



IN COLORADO  
SUITE 108  
THE GOLD OFFICES  
607 10TH ST.  
GOLDEN, CO 80401

COMPUTERWORLD INTERNATIONAL, INC.

SUITE 133, P.O. BOX 81, WHEAT RIDGE, COLORADO, U.S.A. 80034-0081

TERMS: RETAIL/MAIL ORDER: MASTERCHARGE/VISA ACCEPTED. WE CALCULATE UPS FREIGHT.

**Listing 1:** Two methods of alerting a user to a printer-not-ready condition on a TRS-80 Model I. Listing 1a is a one-line BASIC statement that prints a warning message if the printer is absent. Listing 1b is the machine-language equivalent (users must write their own code to display the warning).

1a

```
IF (PEEK(14312) AND 240) <> 48 THEN PRINT "PRINTER IS NOT READY"
```

1b

```
LOOP    CALL    5D1H        ;IS PRINTER READY?
        JR      Z,PRTRDY   ;YES, START PRINTING
        CALL    PRTMSG     ;DISPLAY WARNING (CODE NOT SHOWN)
        CALL    49H        ;WAIT TILL KEY PRESSED
        JR      LOOP       ;SO WE CAN TEST AGAIN
PRTRDY  EQU    $           ;PRINTER IS READY
```

set the TRS-80 memory size to at least 71 bytes below the actual end of memory (or at least 65 bytes below where you usually set it if you have other programs in high memory). When you run it, the program will ask where in memory you want the machine-language program to be

POKEd. Answering with an ENTER will tell the program to use the current memory size. An address below the memory size will result in an error; otherwise, the program will POKE the data to the location specified.

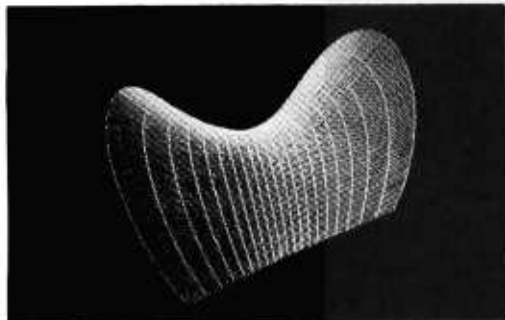
To use the machine-language ver-

sion, first assemble the source code given in listing 4 using a TRS-80 assembler. If you are using a tape-based system (Level II), save the object (executable) code to tape with the name CKSTR. Then reset the memory size as described above, ready the tape for loading, go into the system mode, type in "CKSTR," and hit ENTER to begin loading. When the tape is loaded, type "/" and ENTER. This will run the CKSTR program and return to BASIC. On a disk-based system, save the object code to disk with the name CKSTR. Type in this file name when you are in DOS (disk operating system). It will load, initialize, and return to DOS. You should then enter BASIC, setting your memory size as explained above.

Once you have a version of CKSTR in memory, load and run the program in listing 2 again. When it is time for a string compression to occur, the CKSTR routine displays a graphic character that looks like the letter C (for compression) in the

## S-100 HIGH RESOLUTION GRAPHICS

16 colors, 640 x 512 resolution \$3,175\*



High speed: up to 500,000 dots per second with 8 bit processor, even faster with 16 bit processor

Lightpen option  
Bit plane write protect option for overlays  
Gray levels and monochrome systems  
Full user's guide, separate Service Guide  
Compatible printers and monitors

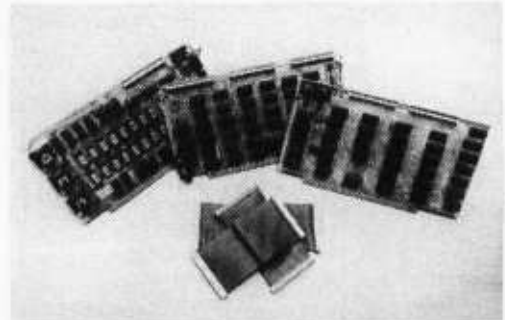
\*includes hardware, basic software package, 160 K bytes of graphics memory



**CAMBRIDGE DEVELOPMENT  
LABORATORY**

36 Pleasant St., Watertown, MA 02172  
(617) 926-0869

### Graphics Software



Program in BASIC, FORTRAN, PASCAL, or assembler

Programmable characters with 80 characters per line

Graphical BASIC interpreter with PEEK and POKE

Logo TURTLE graphics, relative coordinates

Tektronix emulator

Cartesian plotting package

3-D perspective with rotation

Hidden line processing

Screen dump to matrix printer or pen plotter

Screen dump to disk and replay



Quality Computer Services presents..

# Hard Disk Systems



For TRS®, Apple®, Heath®, S-100, IBM.....  
6,12,20,40 and 80 Megabyte systems

Completely assembled and tested subsystem including:

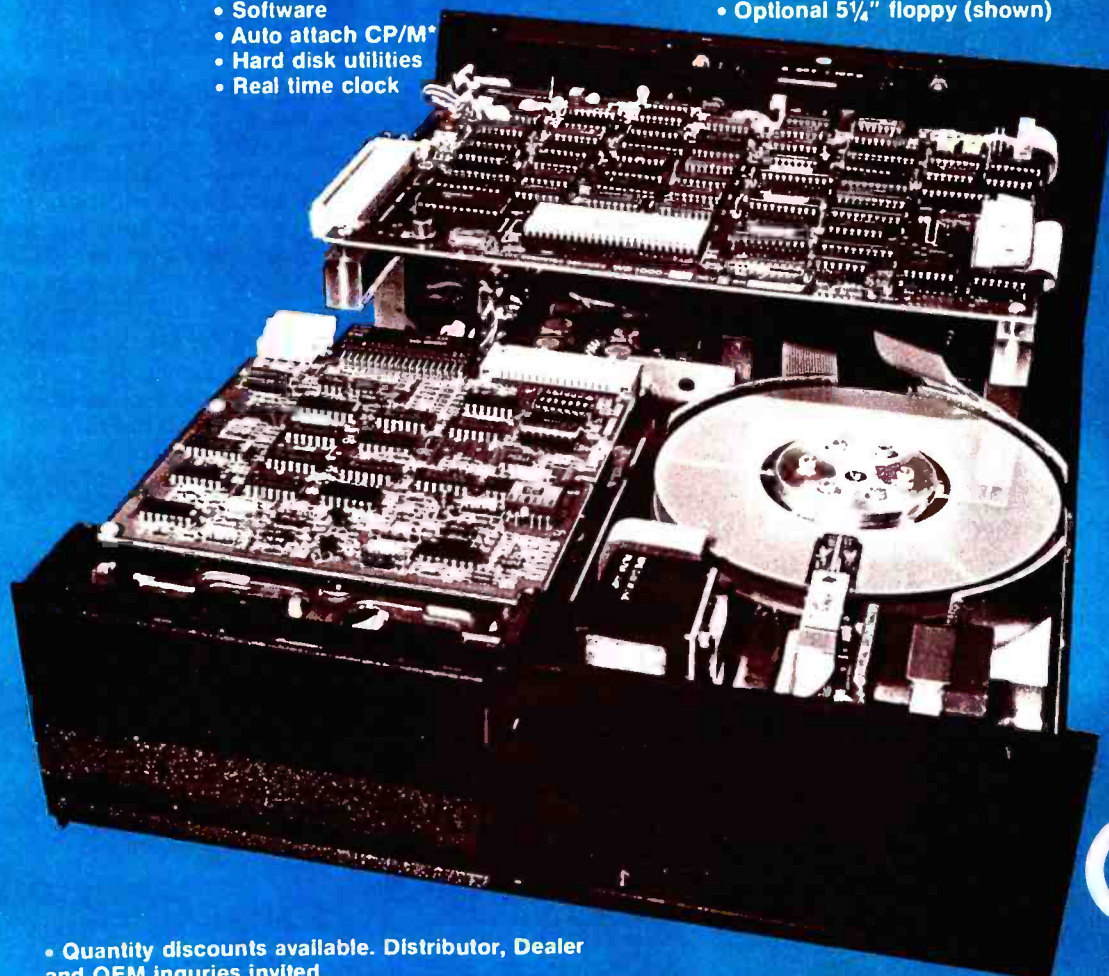
- Switching power supply
- Winchester drive
- Host adapter card
- Sealed case
- Expansion

The enclosure, controller and power supply have been designed to allow for future backup hardware or increased storage

- Software
- Auto attach CP/M\*
- Hard disk utilities
- Real time clock

- Formatting program  
Assigns alternate sectors for any weak sectors detected during formatting assuring the lowest possible error rate

- Warranty: The system has a full one year warranty on all parts and workmanship
- Also available: attach for TRSDOS, OASIS\*, Apple DOS
- Optional 5 1/4" floppy (shown)



See local dealer  
or call:  
Quality Computer  
Services  
178 Main Street  
Metuchen, New Jersey  
201-548-2135

**QCS**  
Quality Computer Services inc

• Quantity discounts available. Distributor, Dealer and OEM inquiries invited.

\*OASIS is a trademark of Phase One Systems, CP/M is trademark of Digital Research

Toll free number: 800 631 5944





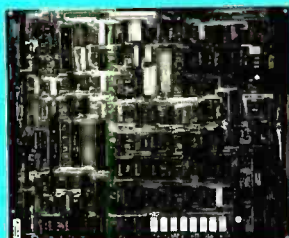
Colonial Data

Introduces the

# SB-80/4



SINGLE USER



MULTI-USER



The SB-80/4 computer has the hardware features needed for today's sophisticated small business systems that demand speed and storage capacity for a single user or the multiuser application that demands up to four users.

- 5 separate 4 MHZ Z80A CPU's Interface
- 320K 200ns Main Memory
- 8 or 5 1/4 Inch Dual Density Floppy Drives
- CP/M Compatible Operating System
- 4 Parallel Ports (Master Board)
- 6 Serial Ports (2 Master Board - 4 Slave Board)
- Winchester Hard Disk
- Four Channel DMA Controller
- 50 Pin Expansion Connector
- Real Time Clock

### SINGLE BOARD TECHNOLOGY

By utilizing the latest in Large Scale Integration, engineers have packaged into a single board a complete computer system with features found only in other costly multi-board systems. Each user has a dedicated Z80A microcomputer module with dedicated 64K RAM housed in the system mainframe.

Any computer is only as good as its software, and the combination of a Z80A CPU and CP/M allows access

to the largest library of software available for eight-bit micros. BASIC, FORTRAN, Pascal, COBOL, APL, and PL/I languages are available now. Complete integrated business and engineering systems are ready to run. In addition, our multi user I/O supervisory operating system allows up to four users to simultaneously perform computer functions or share the same database on the SB-80/4.

### LARGE CAPACITY DISK

Eight-inch drives store three times as much data at twice the transfer speed of smaller drives. The SB-80/4 cabinet can house two single or double sided drives, and two more drives can be attached. That's up to four megabytes of floppy disk storage. For extended applications, hard disks and multi SB-80/4 networks are available.

### WINCHESTER HARD DISK

Hard disk options from 10 megabytes up to 104 megabytes are available for applications requiring large database files and records.

### AFFORDABLE

The result is a high-speed, full featured microcomputer system at a price that beats the competition. The SB-80/4 gives you minicomputer performance and capacity at microcomputer size and price.



Colonial Data Services Corp.

105 Sanford Street Hamden, Conn. 06514

Mid Atlantic Distributor

COMPUTER APPLIED SYSTEMS, INC.

497 Hill Street, York, Pennsylvania 17403 • (717) 848-2431

\*CP/M is a registered trademark of Digital Research, Inc.

(203) 288-2524 • Telex: 956014

New England Distributor

S&M SYSTEMS, INC.

P.O. Box 1225 • 2 Washington St., Haverhill, MA 01830 • (617) 373-1599

Circle 453 on Inquiry card.

**Listing 2:** This BASIC program will show the delays caused by TRS-80 string compression and how these delays are caused by the way string space is maintained.

```

100 'STRING      (c) COPYRIGHT 1980 by Glenn Tesler
110 '
120 'THIS PROGRAM SHOWS THE DELAYS CAUSED BY STRING
130 'COMPRESSION, AND ALSO HOW THESE DELAYS ARE CAUSED
140 'BY THE WAY STRING SPACE IS MAINTAINED.
150 '
160   GOTO 560           'GO DO INITIALIZATION
170 '
180   A=RND(5)+4       'PICK A RANDOM LENGTH
190                     'FROM 5-9.
200 '
210   PRINT : PRINT "*" ; A ; "*"   'DISPLAY IT BETWEEN
220                                     'ASTERISKS
230 '
240 'NOW DEFINE EACH ELEMENT IN THE ARRAY TO THE RANDOM LENGTH
250 'WHICH WAS JUST PICKED. THEN, DISPLAY THE AMOUNT OF
260 'STRING SPACE LEFT TO ALLOCATE TO STRINGS BEFORE GOING
270 'THROUGH THE STRING COMPRESSION ROUTINE. FRE(A$) IS NOT
280 'USED SINCE IT INVOKES THE STRING COMPRESSION ROUTINE,
290 'AND THAT WOULD DEFEAT THE PURPOSE OF THIS EXAMPLE.
300 '
310   FOR B=1 TO X/10   'ARRAY ELEMENT COUNTER
320     A$(B)=STRINGS(A,32) 'DEFINE AN ELEMENT
330                                     'TO THE RANDOM LENGTH
340     X1=PEEK(16598) + 256*PEEK(16599) 'STRING WK AREA PTR
350     X2=PEEK(16544) + 256*PEEK(16545) 'START OF STRING DATA
360                                     'POINTER
370     PRINT X1-X2;      'CALCULATE & DISPLAY
380                                     'THE AMOUNT OF FREE
390                                     'STRING SPACE
400   NEXT B           'LOOP TILL EACH ELEMENT
410                                     'HAS BEEN DEFINED
420   GOTO 180        'PICK A NEW RANDOM
430                                     'LENGTH
440 '
450 '   E N D   O F   M A I N   P R O G R A M
460 '
470 '
480 'INITIALIZATION
490 '
500 'ALLOCATE STRING SPACE. WHEN THE ARRAYS ARE DEFINED, THE
510 'AMOUNT OF STRING SPACE ALLOCATED BY THE CLEAR/10 WILL BE
520 'THE NUMBER OF ARRAY ELEMENTS IN ALL. THIS WAY, YOU CAN
530 'CAUSE MORE STRINGS OR LESS STRINGS TO BE DEFINED TO
540 'RANDOM LENGTHS. CURRENTLY, THERE ARE 100 STRINGS IN ALL.
550 '
560   CLEAR 1000
570   CLS           'CLEAR SCREEN
580   DEFINT A-W,Y-Z 'USE INTEGERS FOR SPEED
590 '
600 'PRE-DEFINE VARIABLES FOR SPEED
610   A=0 : B=A : X1=0 : X2=0
620 '
630 'GET AVAILABLE STRING SPACE. FRE IS BEING USED AS THERE
640 'HAVE BEEN NO STRINGS DEFINED ALREADY, THUS NO GAPS
650 'HAVE BEEN CREATED.
660 '
670   X=FRE(A$)
680 '
690 'NOW SET UP AN ARRAY.
700 '
710   DIM A$(X/10)
720   GOTO 180

```

**Listing 3:** This BASIC program tells the user if any string compression or garbage collection is occurring by displaying a graphics character in the upper right-hand corner of the screen.

```

1000 'ROUTINE TO POKE "STRING COMPRESSION DETECTOR" INTO MEMORY
1020 '      (c) COPYRIGHT 1980 by Glenn Tesler
1040 '
1060   GOTO 4120           'GO DO INITIALIZATION
1080 '

```

*Listing 3 continued on page 324*

upper right-hand corner of the screen. When the garbage collection is finished, the character is removed. With this routine in memory, you will never have to wonder if the computer has crashed or is merely collecting garbage.

The garbage collection routine (starting at hexadecimal location 28E6) uses the Z80 RST instruction, and my detection program takes advantage of this. An RST causes the processor to begin executing at a location in low memory; the garbage collector contains an RST 18, effectively the same as a subroutine call to location hexadecimal 18. Contained in this location, which is in ROM (read-only memory), is a jump vector to another location in programmable memory (hexadecimal 4006), which in turn points to the routine that is the target of programs calling this particular RST. By replacing the information in the second jump vector (locations 4006 to 4008 hexadecimal), any call to RST 18 must first go through my program, where it then checks to see if the call came from the compression routine. If so, the graphics character is displayed, a "switch" in memory is set, and the program jumps to the original target of the RST 18; otherwise, it just does the RST 18.

To erase the graphics character when the compression routine is finished, RST 20 is also checked. This points to a routine that tests data type (i.e., string, integer, etc). Since almost every command has to check the data type, RST 20 is used a lot. When this RST is called, the program checks to see if the "switch" in memory is set and the graphics character is being displayed. If so, it resets the switch and erases the character, and continues with the regular RST 20.

The machine-language program is only 65 bytes long, including the initialization routine. If you are wondering whether an RST 20 is performed in the string-compression routine, it is not. Also, if you are wondering why I didn't use FRE(A\$) in the BASIC program, it is because it uses the string-compression routine before calculating the available string space.

# Z8000

**MICRO PRICE for MINI POWER**  
**MICRO-MINI™ matches Series I by IBM**  
**DELIVERING CURRENT ORDERS**

You cannot buy a more powerful micro:

- **Power:** 1 to 32 independent users
- **Memory:** directly addresses to 16 Meg!
- **Mapping:** efficient memory management
- **Disk:** 2M to more than 250M
- **Speed:** throughput 10 times Z80
- **Files:** simultaneous access
- **Communication:** inter-user via terminals
- **Security:** all files password protected
- **Options:** expandable in the field
- **Bus:** Intel Multibus™ compatible
- **Languages:** Pascal, BASIC, COBOL, FORTRAN

## System 3 \$7053

This 16-bit Multibus™ computer system includes:

- Z8001 CPU and 256K RAM
  - 8 serial I/O ports
  - 15-slot backplane
  - Dual floppy disk drives
  - Multiuser Operating System
- Field upgrade to 16MB RAM,  
 268MB of hard disk, 32 users.  
 Pascal, BASIC, C, COBOL and  
 FORTRAN languages.

Call for further system specifications.



### AMPEX Dialogue 80™

Dialogue 80™ fully-featured video terminal:

- Full ASCII with numeric and edit keypads
- Elegant case with detachable keyboard
- Display 24 lines with 25th status line
- 20 user programmable function keys
- 2 pages display memory (4 optional)
- 11 graphics and 21 control codes
- 10 modes including block, protect, program
- Transparent mode displays control codes

Dialogue 80™ .....\$1045

Dialogue 80™ with phone coupler.....1194

Applications: word processing, data entry, interactive programming, data base inquiry/response/update, transaction processing, whether on-site or remote. For our system or for yours, this interactive terminal is the perfect match.

Prices: Prepaid or Purchase Order Net 10.  
 Prices subject to change without notice.  
 Warranty: 120 day minimum on all systems.  
 Interfacing cables free with all systems.  
 10% down fixes price, guarantees priority.  
 MasterCard and VISA cards accepted.



(312) 684-3183  
**COMPUTEX**  
 MICROCOMPUTER SYSTEMS  
 5710 Drexel, Chicago, IL 60637

Listing 3 continued:

```

1100 'SET UP A DEFAULT LOAD ADDRESS AT WHICH TO POKE DETECTOR,
1120 'THEN LET USER OVERRIDE IT IF NECESSARY
1140 '
1160     M1=M                'DEFAULT LOAD ADDRESS
1180     CLS                'BEGIN WITH FRESH SCREEN
1200     PRINT "WHERE SHOULD THE STRING COMPRESSION DETECTOR"
1220     PRINT "          BE LOADED (DEFAULT IS: "; M1; ")";
1240     INPUT M1
1260     IF M1 >= M THEN 1460 'LOAD POINT MUST BE >= MEM SIZE
1280     PRINT
1300     PRINT "MEMORY SIZE IS SET AT"; M;          'ERROR MESSAGE
1320     PRINT "SO RESET MEMORY SIZE AND TRY AGAIN"
1340     END : GOTO 1300    'DON'T LET PROGRAM CONTINUE
1360 '
1380 'SAVE FINAL LOAD ADDRESS, THEN CONVERT IT TO VALID VALUES
1400 'FOR THE "POKES": 0-32767 REMAIN THE SAME, BUT
1420 '65536 MUST BE SUBTRACTED FROM 32768-65535.
1440 '
1460     M=M1                '"M" IS LOAD ADDRESS FOR PGM.
1480     IF M > 32767 THEN A=M-65536 ELSE A=M
1500 '
1520 'POKE THE MACHINE LANGUAGE PROGRAM INTO HIGH MEMORY.
1540 'ANOTHER ROUTINE WILL HANDLE THE RELOCATION AS NEEDED.
1560 '
1580     PRINT : PRINT "NOW POKING PROGRAM INTO HIGH MEMORY..."
1600     FOR B=1 TO NB      'LOOP TO DO THE POKES
1620         READ C          'ONE BYTE AT A TIME
1640         POKE A,C        'INTO HIGH MEMORY
1660         IF A=32767 THEN A=-32768 ELSE A=A+1 'CHECK BOUNDARY
1680         NEXT B         'TO KEEP 'A' A VALID INTEGER
1700 '
1720 'INTEGERS MUST BE IN THE RANGE: -32768 TO 32767
1740 'IF "M" EXCEEDS 32767, IT WOULD BE AN ERROR. BY
1760 'SUBTRACTING 65536 FROM "M", A NEGATIVE NUMBER RESULTS,
1780 'WHICH ACTUALLY IS A Z-80 ADDRESS BETWEEN 32768 AND 65535
1800 '
1820     IF M > 32767 THEN M=M-65536 'CHECK AND ADJUST RANGE
1840 '
1860 'MACHINE LANGUAGE IS NOT SELF-RELOCATABLE,
1880 'SO NOW IT IS NECESSARY TO CALCULATE AND ADJUST SOME
1900 'OF THE ADDRESSES IN IT.
1920 '
1940 'THE CALCULATION IS DONE THIS WAY:
1960 ' 1. CALCULATE ABSOLUTE ADDRESS OF A VARIABLE
1980 '    WITHIN THE MACHINE LANGUAGE PROGRAM:
2000 '    M0 = PROGRAM LOAD ADDRESS + VARIABLE DISPLACEMENT
2020 '    WITHIN PROGRAM
2040 ' 2. CONVERT ADDRESS 'M1' TO TWO SINGLE BYTES: LSB, MSB:
2060 '    M2 = LSB, M1 = MSB
2080 ' 3. CALCULATE WHERE TO STORE ADJUSTED VARIABLE ADDRESS
2100 '    AND STORE IT THERE. THIS MAY HAVE TO BE DONE MORE
2120 '    THAN ONCE IF THE VARIABLE IS REFERENCED MORE THAN
2140 '    ONCE.
2160 '
2180     PRINT : PRINT "NOW RELOCATING INTERNAL ADDRESSES..."
2200     M0=M+13            'ADDRESS OF GRAPHIC DISPLAY RTN
2220     M2=M0 AND 255      'EXTRACT LSB FROM 2-BYTE ADDR.
2240     M1=INT(M0/256) AND 255 'EXTRACT MSB ALSO
2260     POKE M+1, M2      'STORE LSB INTO MACH LANG PGM
2280     POKE M+2, M1      'STORE MSB
2300 '
2320     M0=M+38            'ADDRESS OF "GRAPHIC REMOVER"
2340     M2=M0 AND 255      'CALC LSB OF GRAPHIC REMOVER
2360     M1=INT(M0/256) AND 255 'CALC MSB
2380     POKE M+7, M2      'STORE THEM INTO PROGRAM
2400     POKE M+8, M1
2420 '
2440     M0=M+64            'ADDRESS OF A SWITCH IN PGM
2460     M2=M0 AND 255      'LSB OF SWITCH ADDRESS
2480     M1=INT(M0/256) AND 255 'MSB
2500     POKE M+33, M2     'STORE SWITCH ADDRESS INTO
2520     POKE M+34, M1     'PROGRAM IN THREE LOCATIONS.
2540     POKE M+39, M2     'IN THREE PLACES
2560     POKE M+40, M1
2580     POKE M+47, M2
2600     POKE M+48, M1
    
```

Listing 3 continued on page 326



*There's great business ahead!*

# And here is THE DATA BASE to get you there.

Meet **GBS**...the most complete, most powerful **relational** database management system available. It was designed to go beyond the capabilities of ordinary DBM systems. And it does. Where others may possibly be state-of-the-art...GBS, our General Business System, is **ahead-of-the-art!**



hand with plenty of tutorials and easily understandable examples. And, the entire documentation is typeset for ease of reading.

**You can.** Because GBS is fully supported by **QUALITY SOFTWARE**. So, if you ever have a question, or need assistance, simply contact **QUALITY SOFTWARE** and our professional support people will be happy to help.

**You can.** Because we offer a special **30-Day Money Back Guarantee**. Order your edition of GBS at \$700 (on disk, with complete professional documentation) and try GBS in your own business environment. If GBS isn't all we say it is, and more, simply return it within 30 days for a full refund. This offer is for a limited time only, so please act immediately.

## Call Today

There's great business ahead. And GBS is the relational data base management system which can help you control your information and data quickly, efficiently and effectively. Call us today for additional information or to take advantage of our special **30-Day Money Back Guarantee**.

GBS -- it's the best business decision you can make, for today and the future.



## QUALITY SOFTWARE

6660 Reseda Blvd., Suite 107  
Reseda, CA 91335 (213) 344-6599

\*CP/M is a registered trademark of Digital Research.

## A program generator, par excellence

Included as a part of GBS is a very powerful applications development tool, called **QUICK GEN**. Basically, this function allows almost anyone -- even those unsophisticated about computers -- to generate useful business programs. Think of the efficiency you gain when anyone on your staff can quickly generate a needed program to solve a particular problem! But, GBS versatility doesn't stop there. GBS is also ...

## ...a Fully Programmable system...

... which allows you, or those with deeper computer interest, to create almost any business application program, such as accounts payable/receivable ... payroll ... general ledger ... order entry ... mailing lists ... personnel files ... cost accounting ... real estate listings ... time/expense management, and many more. And each one will be a personalized program ... individualized to the specific requirements of your firm!

## Start using GBS now

**You can.** Because GBS is up and running on most popular CP/M\* based computers, like those made by Apple, Tandy, Xerox, Sharp, NEC, Hewlett Packard, Toshiba, Osborne, Televideo, Vector, Altos and more.

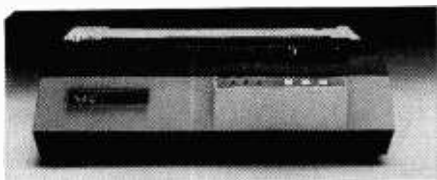
**You can.** Because GBS documentation is written in a friendly, free-flowing, style...and it leads you by the

**B**ecause it is relational, GBS is far more valuable to you and your business. It has the capability to access an almost unlimited amount of data from a variety of files, then combine that data and display or print it in a format that you specify.

## Relational, Efficient & Automatic

GBS can automatically search for, locate, and interrelate information from many files. For example, on each order entry it can automatically decrement inventory; automatically post the data to your Accounts Receivable and automatically update your General Ledger. You don't have to spend countless hours making redundant entries, with the chance for numerous errors. GBS' inter-file relationships and adjustments save you considerable time, and thus many hours of high-cost labor.

Most other business programs are limited single file systems, whereas GBS allows you to work with 3 different files at the same time. All indexes are updated automatically. What's more, a large GBS data file can extend over 4 different disk drives...not merely one. No other data base system has the power and flexibility of GBS!



**NEC PC-8023A-C Printer**

**\$499<sup>88</sup>** DELIVERED

- 100 cps bi-directional printing
- Adjustable tractor/friction feed
- Proportional spacing
- Hi-res dot-addressable graphics
- True descenders in 5 fonts
- Subscript, Superscript & underlining

**Okidata Printers**

MICROLINE 80 .....	\$369 <sup>88</sup>
MICROLINE 82A .....	\$479 <sup>88</sup>
MICROLINE 83A .....	\$739 <sup>88</sup>
MICROLINE 84 (Parallel).....	\$1059 <sup>88</sup>
MICROLINE 84 (Serial) .....	\$1194 <sup>88</sup>
OKIGRAPH ROM—adds Hi-Res capabilities to 82A and 83A Printers .....	\$89 <sup>88</sup>

**IDS Printers**

PRISM 132 (Color) .....	\$1699 <sup>88</sup>
PRISM 80 .....	\$989 <sup>88</sup>

**Epson Printers**

MX-80 w/GRAFRAX .....	\$474 <sup>88</sup>
MX-80/F-T .....	\$569 <sup>88</sup>
MX-80/F-T w/GRAFRAX .....	\$619 <sup>88</sup>
MX-100 .....	\$719 <sup>88</sup>
GRAFRAX .....	\$89 <sup>88</sup>

**Centronics Printers**

CENTRONICS 739 (Parallel) .....	\$539 <sup>88</sup>
CENTRONICS 739 (RS-232-C).....	\$644 <sup>88</sup>
2-Color Adapter.....	\$69 <sup>88</sup>

**C.Itoh Printers**

C.ITOH COMET I .....	\$284 <sup>88</sup>
C.ITOH PRO WRITER w/3K buffer (parallel and serial).....	\$639 <sup>88</sup>
C.ITOH F-10 DAISY WHEEL (40cps) .....	\$1539 <sup>88</sup>

Cables and interfaces available for the APPLE, ATARI, CBM/PET, IBM, OSBORNE, and TRS-80.

**Orders & Information:**

**CALL (603)-673-8857**

Orders Only: CALL (800)-343-0726

We accept CODs—No surcharge for credit cards  
No charge for UPS shipping—Stock shipments next  
day—All equipment shipped factory fresh with the  
manufacturer's warranty

Prices subject to change

HIGH TECHNOLOGY AT AFFORDABLE PRICES



12 Johnson Street, Milford NH 03055-0423

Listing 3 continued:

```

2620 '
2640 'NECESSARY RELOCATIONS ARE COMPLETE.
2660 '
2680 'SET UP THE "USR" CALL: ASSUME LEVEL II, BUT IF IN
2700 'DISK BASIC, SET IT UP THROUGH A "DEFUSR":
2720 '
2740 'POKE 16526, M AND 255 'LSB OF DETECTOR START
2760 'POKE 16527, (M/256) AND 255 'MSB
2780 '
2800 'NOW SEE IF IN DISK BASIC. IF SO, ABOVE DIDN'T HURT.
2820 'IF PEEK (16809) <> 201 THEN DEFUSR=M
2840 '
2860 'NOW ACTIVATE THE STRING COMPRESSION ROUTINE.
2880 'IT WILL REMAIN IN HIGH MEMORY UNTIL YOU RE-BOOT OR
2900 'RE-INITIALIZE BASIC. YOU CAN LOAD AND RUN OTHER
2920 'BASIC PROGRAMS NOW, AS LONG AS THEY DO NOT POKE OTHER
2940 'MACHINE LANGUAGE PROGRAMS INTO THE SAME PLACE AS THE
2960 'STRING COMPRESSION ROUTINE.
2980 '
3000 ' *** MAKE SURE YOUR OTHER PROGRAMS DO NOT ***
3020 ' *** DESTROY THE DETECTOR !!! ***
3040 '
3060 'M=USR(0) 'ACTIVATE THE DETECTOR
3080 '
3100 'END OF MAINLINE OF PROGRAM
3120 '
3140 'PRINT : PRINT "STRING COMPRESSION DETECTOR ACTIVE"
3160 'END : GOTO 3160 'MAKE SURE PROGRAM STOPS HERE
3180 '
3200 ' E N D O F M A I N P R O G R A M
3220 '
3240 '
3260 'ERROR ROUTINE FOR HANDLING OVERFLOWS IN A CERTAIN BLOCK
3280 'OF LINES. IF THE ERROR IS SOMEPLACE ELSE, OR IS NOT
3300 'AN OVERFLOW, THEN BASIC'S NORMAL ERROR MESSAGE IS GIVEN.
3320 'IF IT IS AN OVERFLOW IN THAT BLOCK, THEN THIS ROUTINE
3340 'MODIFIES THE APPROPRIATE VARIABLE.
3360 '
3380 'CHECK TO SEE IF VALID ERROR
3400 '
3420 'IF ERR<>10 OR ERL<2200 OR ERL>2820 THEN ON ERROR GOTO 0
3440 '
3460 'IF ERROR OCCURED WITH M0, CHANGE M0 ELSE CHANGE M
3480 '
3500 'IF ERL=2200 OR ERL=2220 OR ERL=2240 THEN 3700
3520 'IF ERL=2320 OR ERL=2340 OR ERL=2360 THEN 3700
3540 'IF ERL=2440 OR ERL=2460 OR ERL=2480 THEN 3700
3560 '
3580 'IN THE NEXT TWO LINES: IF THE VARIABLE IS NEGATIVE,
3600 '65536 IS ADDED. IF POSITIVE, 65536 IS SUBTRACTED. THIS
3620 'SHOULD TAKE CARE OF THE OVERFLOW. NEXT IT RESUMES TO
3640 'GIVE CONTROL BACK TO THE ERROR LINE.
3660 '
3680 'M=M+(-SGN(M)*65536) : RESUME
3700 'M0=M0+(-SGN(M0)*65536) : RESUME
3720 '
3740 ' E N D O F E R R O R R O U T I N E
3760 '
3780 '
3800 'THESE DATA STATEMENTS CONTAIN THE MACHINE LANGUAGE
3820 'PROGRAM THAT IS THE "STRING COMPRESSION DETECTOR"
3840 '
3860 DATA 33, 181, 255, 34, 7, 64, 33, 206, 255, 34
3880 DATA 10, 64, 201, 227, 213, 17, 253, 40, 205, 144
3900 DATA 28, 209, 227, 32, 10, 62, 183, 50, 63, 60
3920 DATA 62, 1, 50, 232, 255, 195, 144, 28, 58, 232
3940 DATA 255, 203, 71, 40, 16, 175, 50, 232, 255, 58
3960 DATA 63, 60, 254, 183, 32, 5, 62, 32, 50, 63
3980 DATA 60, 195, 217, 37, 0
4000 '
4020 ' E N D O F D A T A S T A T E M E N T S
4060 '
4080 'INITIALIZATION
4100 '

```

Listing 3 continued on page 328

# 8086-SUPER MICRO.



## Superfast in its class and ready to run.

Computer Benchmarks—All systems running the same BASIC program.

Manufacture-Model	Class	Operating System	Language (Type*)	Run Time (Seconds)
IBM 3033	Mainframe	VS2-10RVYL	Stanford BASIC	10
Seattle Computer System 2	Micro	MS-DOS	Microsoft BASIC (C)	33
Digital Equipment PDP 11/70	Mini	n/a	BASIC (I)	45
Prime 550	Mainframe	PRIMOS	BASIC V16.4 (I)	63
Digital Equipment PDP-10	Mainframe	TOPS-10	BASIC (I)	65
IBM System 34	Mainframe	Release 05	BASIC (I)	129
TEI System 48	Micro	MAGIC 1.0	Microsoft BASIC (C)	178
Hewlett-Packard HP3000	Mini	Time Share	BASIC (I)	250
Seattle Computer System 2	Micro	MS-DOS	Microsoft BASIC (I)	310
Alpha Micro AM-100/T	Micro	AMOS 4.3a	Alpha BASIC (SC)	317
Digital Equipment PDP 11/45	Mini	n/a	BASIC (I)	330
Data General NOVA 3	Mini	Time Share	BASIC 5.32	517
Ohio Scientific C4-P	Micro	OS65D 3.2	Level 1 BASIC (I)	680
North Star Floating Point	Micro	NSDOS	NorthStar BASIC (I)	685
Radio Shack TRS-80 II	Micro	TRSDOS 1.2	BASIC (I)	792
Apple II +	Micro	DOS 3.2	Applesoft II (I)	960
Cromemco System 3	Micro	CDOS	32K BASIC (I)	1074
Commodore Pet 2001	Micro	n/a	Microsoft BASIC (I)	1374
IBM 5100	Micro	n/a	BASIC (I)	1951
Vector MZ	Micro	n/a	Micropolis BASIC (I)	2251

\*C = Compiler; I = Interpreter. Times (except for Seattle Computer) taken from August 1981 issue of Interface Age.

The Seattle Computer System 2 is the fastest micro on the block. In fact, System 2 outperforms many minis and mainframes.

Even the big boys such as: IBM System 34, Prime 550, and Hewlett-Packard HP 3000 are left in the dust when System 2 starts running.

The speedy System 2 consists of 8 Mhz. 8086 CPU set, 128K of 85 nsec. static RAM, double-density disk controller, 22-slot constant voltage mainframe, a cable for two 8" drives, and MS-DOS operating system (also called 86-DOS, IBM PC-DOS, Lifeboat SB-86).

High-level languages like Microsoft's Basic, Pascal, Fortran, Cobol are available now for your application programs.

System 2 comes fully assembled, tested and ready to run with the addition of disk drives (that we can supply) and terminal.

Call (206) 575-1830 for the location of your nearest System 2 dealer.

Dealer inquiries welcome.



1114 Industry Drive, Seattle, Washington 98188

Circle 374 on inquiry card.



Listing 3 continued:

```
4120  DEFINT A-L,N-Z          'USE INTEGER VARIABLES
4140  M=PEEK(16561)+256*PEEK(16562)+1  'MEM SIZE
4160  ON ERROR GOTO 3420    'OVERFLOW ERROR HANDLER
4180  C=0:B=C:A=C:M1=C:M2=C  'SET UP VARIABLES FOR SPEED
4200  ON ERROR GOTO 3420    'TAKE CARE OF OVERFLOW
4220  C=0:B=C:A=C:M0=C      'SET UP VARIABLES FOR SPEED
4240  M1=C:M2=C
4260  NB=65                  'LENGTH OF MACH. LANG. PGM.
4280  GOTO 1160              'GO BACK TO MAIN PROGRAM
4300  '
4320  '          E N D   O F   I N I T I A L I Z A T I O N
```

### Line Searches

When the TRS-80 BASIC interpreter encounters a GOSUB, GOTO, RUN, LIST, etc., it has to search for the associated line number. The interpreter always starts at the beginning of the program unless it is looking for a GOTO, RUN, or GOSUB, in which case it does one of the following:

- If the line referenced is earlier than the line the command is on, it will begin the search at the start of the program.
- If the line referenced is not earlier than the line the command is on, the search begins on the command line.
- If the command is entered as a direct statement, the search begins at the start of the program.

The further the line is from the command referencing it, the longer the interpreter takes to find it. This can take a long time in large programs. Here are three ways to prevent this situation:

1. Try to use subroutines as much as possible. This cuts down wasted program space.
2. Put frequently used routines near the start of the program to reduce search time.
3. Place your initialization routines at the end of the program, and start your program with a GOSUB to the routine. Then your program won't have to waste time going over lines that are used only once.

Also, when entering additional lines near the top of a large program, it takes a long time to get the prompt after hitting ENTER. Here are several reasons for this:

- The BASIC interpreter searches for the line, starting at the beginning of the program.
- If the line is currently in the program, it is deleted. When the interpreter deletes a line, the lines above must fill the empty space.
- Next, the interpreter moves the lines that are past where the new one has to go to accommodate it.
- The line pointers for each line are changed, starting with the new line.
- The interpreter finishes up by executing a CLEAR.

### Defining Variables

Here are some recommendations on how to define variables. If you define them in these ways, the time it takes to find each variable should be reduced and the program execution time should improve.

- Use integer variables whenever possible.
- Define all variables in the statements of the program that will be executed first. These statements should be placed at the end of the program, and invoked by a GOSUB from the beginning of the program, as mentioned before. Then, it will not be necessary for BASIC to scan them when looking for GOTO and GOSUB targets during the rest of the run.
- Define simple variables before defining arrays.
- Define the most frequently used variables before defining infrequently used ones. (This is mentioned in the Level II manual on page 11/2.)

Combining these suggestions, you should define your frequently used variables before your seldomly used ones. Frequently used arrays should

# CALL YOUR LOCAL DYSAN OFFICE

St. Louis, Missouri  
(314) 434-4011

San Francisco, California  
Sunnyvale, California  
(408) 730-2145

Sherman Oaks, California  
(213) 907-1803

McLean, Virginia  
(703) 356-6441

Irvine, California  
(714) 851-9462

New York, New York  
(212) 687-7122

Schaumburg, Illinois  
(312) 882-8176

Fair Oaks, California  
(916) 966-8037

Glendora, New Jersey  
(609) 939-4762

Bellevue, Washington  
(206) 455-4725

Atlanta, Georgia  
(404) 952-0919

Arlington, Texas  
(817) 261-5312

Burlington, Massachusetts  
(617) 273-5955  
(617) 229-2800 (OEM)

Rocky River, Ohio  
(216) 333-3725 (Cleveland)  
(412) 261-0406 (Pittsburgh)

Livonia, Michigan  
(313) 525-8240

Dysan Flexible Diskettes are also available from all ComputerLand Stores, Sears Business System Centers, and independent computer outlets nationwide.

For the location of the Dysan sales outlet nearest you, contact Dysan at:  
(408) 988-3472;  
Toll Free: (800) 538-8133;  
Telex 171551 DYSAN SNTA;  
TWX: 910-338-2144.

Circle 150 on Inquiry card.

# DID YOU KNOW THAT THE BEST MEDIA AVAILABLE IS NOW AVAILABLE NEAR YOU?

Well, it is.

For years, we've been supplying discriminating data processing professionals worldwide with the finest magnetic media made anywhere...Dysan diskettes, mini-diskettes, disc packs, disc cartridges and single rigid disks.

Is there any reason why **you** should have to settle for second best?

Now you can buy Dysan precision diskettes and mini-diskettes direct from the Dysan sales office or authorized dealer near you. And they're not just any diskettes. They're certified 100% error-free both on **and** between the tracks to insure you of flawless performance. That means no lost data. No need to re-program. Or de-bug again. Dysan diskettes work the first time, every time. Think about how much time, energy and aggravation you can save.

Why wait for problems to occur to convince you that a bargain diskette is really no bargain? Call the Dysan office nearest you. Or stop in your nearest authorized Dysan dealer. Once you experience the Dysan difference you won't settle for anything less.



 **Dysan**  
CORPORATION

Our Media Is Our Message

5201 Patrick Henry Drive  
Santa Clara, CA 95050

Listing 4: The machine-language equivalent to listing 3.

```

00100 ;CKSTR          (C) COPYRIGHT 1980 BY GLENN TESLER
00110 ;
00120 ;THIS PROGRAM TESTS TO SEE IF BASIC IS IN ITS
00130 ;STRING COMPRESSION ROUTINE. IF IT IS, IT DISPLAYS
00140 ;A GRAPHICS CHARACTER, ELSE IT CHECKS TO SEE IF THE
00150 ;GRAPHICS CHAR IS ON THE SCREEN. IF SO DISPLAY A BLANK.
00160 ;NEXT, DO RST18H
00170 ;
1C90   00180 RST18H EQU    1C90H          ;16 BIT COMPARE
25D9   00190 RST20H EQU    25D9H          ;TEST DATA TYPE
00B7   00200 CMPSYM EQU    183            ;CHAR TO DISPLAY
00210 ;
F618   00220          ORG    63000          ;<== YOU MAY CHANGE THIS
00230 ;
F618 2127F6 00240 SETSTR: LD    HL,CKSTR    ;OVERLAY JUMP VECTOR
F61B 220740 00250          LD    (4007H),HL ;TO GIVE ME CONTROL.
00260 ; ;OVERLAY JUMP VECTOR
F61E 2140F6 00270          LD    HL,CKBYT   ;TO BE ABLE TO TAKE IT
F621 220A40 00280          LD    (400AH) HL ;OFF SCREEN AFTERWARDS.
00290 ;
00300 ;SELECT ONE OF THE NEXT TWO JUMPS, DEPENDING ON WHERE
00310 ;YOU ARE RUNNING THIS PROGRAM AT EXECUTION TIME
00320 ; (BASIC VIA "SYSTEM" OR DOS VIA "CKSTR/CMD").
00330 ;
F624 C3191A 00340          JP    1A19H      ;USE THIS TO ENTER BASIC
00350 ; ;OR USE THIS TO ENTER DOS
00360 ;
F627 E3     00370 CKSTR:  EX    (SP),HL     ;SAVE HL, GET RET ADDR.
F628 D5     00380          PUSH   DE      ;SAVE DE
F629 11FD28 00390          LD    DE,28FDH  ;RET ADR IF IN STR CMPSRN
F62C CD901C 00400          CALL  RST18H  ;IS IT THAT ADDRESS?
F62F D1     00410          POP    DE      ;RESTORE DE
F630 E3     00420          EX    (SP),HL  ;SAVE RET ADD, GET HL
F631 200A   00430          JR    NZ,DORS18 ;NOT ADDR, SKIP
F633 3EB7   00440          LD    A,CMPSYM ;GET SYMBOL
F635 323F3C 00450          LD    (3C3FH),A ;DISPLAY
F638 3E01   00460          LD    A,1       ;SET SWITCH
F63A 325AF6 00470          LD    (CMPSW),A ;..
F63D C3901C 00480 DORS18 JP    RST18H    ;DO 16 BIT COMPARE
00490 ;
F640 3A5AF6 00500 CKBYT  LD    A,(CMPSW) ;GET SWITCH
F643 CB47   00510          BIT    0,A      ;ON?
F645 2810   00520          JR    Z,DORS20  ;NO, DO RST20
F647 AF     00530          XOR    A        ;ZAP A
F648 325AF6 00540          LD    (CMPSW),A ;ZAP SWITCH
F64B 3A3F3C 00550          LD    A,(3C3FH) ;GET SCN BYT
F64E FEB7   00560          CP    CMPSYM   ;IS IT THE CHAR?
F650 2005   00570          JR    NZ,DORS20 ;NO, DO RST20H
F652 3E20   00580          LD    A,32     ;BLANK
F654 323F3C 00590          LD    (3C3FH),A ;PUT BYTE ON SCREEN
F657 C3D925 00600 DORS20 JP    RST20H    ;DATA TYPE
00610 ;
F65A 00     00620 CMPSW  DEFB  0         ;SWITCH
0043   00630 ZSIZE  EQU    $\-SETSTR
F618   00640          END    SETSTR
00000 TOTAL ERRORS

CKBYT  F640 00500 00270
CKSTR  F627 00370 00240
CMPSW  F65A 00620 00470 00500 00540
CMPSYM 00B7 00200 00440 00560
DORS18 F63D 00480 00430
DORS20 F657 00600 00520 00570
RST18H 1C90 00180 00400 00480
RST20H 25D9 00190 00600
SETSTR F618 00240 00630 00640
ZSIZE  0043 00630

```

be defined and then seldomly used arrays. All these definitions should be in an initialization routine at the end of the program, and a GOSUB at the beginning of the program should pass control to this initialization routine.

### Conclusion

Even if you don't add these detection routines to your system, knowing what the computer is doing will help you avoid rebooting unnecessarily (say, during string compression).

If you do add them, and use some of the variable-definition sequences suggested, then you'll find the computer doing more of what it was meant to do: making your life easier and more fun! ■



# LETTER PERFECT T.M. LJK

WORD PROCESSING

## ATARI 400/800

## APPLE II & II+

**EASY TO USE** — Letter Perfect is a single load easy to use program. It is a menu driven, character orientated processor with the user in mind. **FAST** machine language operation, ability to send control codes within the body of the program, mnemonics that make sense, and a full printed page of buffer space for text editing are but a few features. Screen Format allows you to preview printed text. Indented margins are allowed. Data Base Merge with **DATA PERFECT** by LJK, form letters, accounting files and mailing labels only with **MAIL MERGE/UTILITY** by LJK. **FEATURES** — Proportional/Incremental spacing \* Right Justification \* File Merging \* Block movement \* Headers \* Footers \* Print Multiple Copies \* Auto Page Numbering \* Scroll forward/backward \* Search and Replaces \* Full cursor control \* Underlining \* Boldface \* Superscripts \* Subscripts \* Auto page numbering \* Insert character/line \* Delete character/line \* Centering \* Horizontal tabs/changeable \* Multifunction format line (line spacing — left margin — page width — lines/page — change fonts — top/bot margin adjust) **MUCH MORE! \$149.95**

### ATARI VERSION 2.0 #2001

Uses proportional font, right justified with Atari 825/Centronics\* 737, 739 printers. Uses EPSON MX\* Series + Grafrax/italicized font. Can mix type fonts on same page; mix boldface and enhanced font in same line with justification. Can be used with 16K Atari/400.

"Compared to the price of many other word processors, this package is a steal. It does everything the advertisement claims and more. On top of this the software is very easy to use." A.N.A.L.O.G. MAGAZINE

### APPLE VERSION 5.0 #1001

DOS 3.3 compatible — Use 40 or 80 column interchangeably (Smarterm — ALS; Videoterm-Videx; Full View 80 — Bit 3 Inc.; Vision 80 — Vista; Sup-R-Term — M&R Ent.) Reconfigurable at any time for different video, printer, or interface. **USE HAYES MICROMODEM II\***LCA necessary if no 80 column board, need at least 32 K of memory. Files saved as either Text or Binary. Shift key modification allowed. Data Base Merge compatible with **DATA PERFECT\*** by LJK.

"For \$150, Letter Perfect offers the type of software that can provide quality word processing on inexpensive micro-computer systems at a competitive price." INFOWORLD

## DATA PERFECT T.M. LJK

## APPLE & ATARI DATA BASE MANAGEMENT \$99.95

Complete Data Base System. User orientated for easy and fast operation. 100% Assembly language. Easy to use. You may create your own screen mask for your needs. Searches and Sorts allowed, Configurable to use with any of the 80 column boards of Letter Perfect word processing, or use 40 column Apple video. Lower case supported in 40 column video. Utility enables user to convert standard files to Data Perfect format. Complete report generation capability. Much More!

## EDIT 6502 T.M. LJK

## MAIL MERGE/UTILITY ATARI \$29.95

This is a coresident — two pass **ASSEMBLER, DIS-ASSEMBLER, TEXT EDITOR, and MACHINE LANGUAGE MONITOR.** Editing is both character and line oriented. Disassemblies create editable source files with ability to use predefined labels. Complete control with 41 commands, 5 disassembly modes, 24 monitor commands including step, trace, and read/write disk. Twenty pseudo opcodes, allows linked assemblies, software stacking (single and multiple page) plus complete printer control, i.e. pagination, titles and tab setting. User can move source, object and symbol table anywhere in memory. Feel as if you never left the environment of BASIC. Use any of the 80 column boards as supported by **LETTER PERFECT**, Lower Case optional with LCG.

This menu driven program combined with **LETTER PERFECT** allows user to generate form letters and print mailing labels. With the Atari, you may **CONVERT ATARI DOS FILES**, or Visicalc files compatible for editing with **LETTER PERFECT**. Utility creates Data Base files for Letter Perfect.

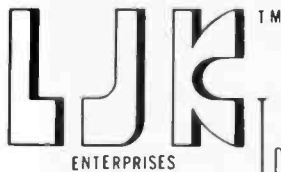
## LOWER CASE CHARACTER GENERATOR \$24.95



Lower Case Character Generator for the Rev. 7, Apple II or II+ computers. When installed, this Eprom will generate lower case characters to the video screen. Lower case characters set has two dot true descenders. Installation instruction included. Manual includes listing of software for full support and complete instructions for shift key modification. Compatible with **LETTER PERFECT**.

## LJK DISK UTILITY APPLE \$29.95

This menu driven program allows the user to manipulate a variety of different file types. Binary, Text, and Source files may be easily converted into each other. The program may be used with **APPLESOFT\***, **VISCALC\***, and other programs. These program files may be readily adapted for multiple use including editing with **LETTER PERFECT** word processings.

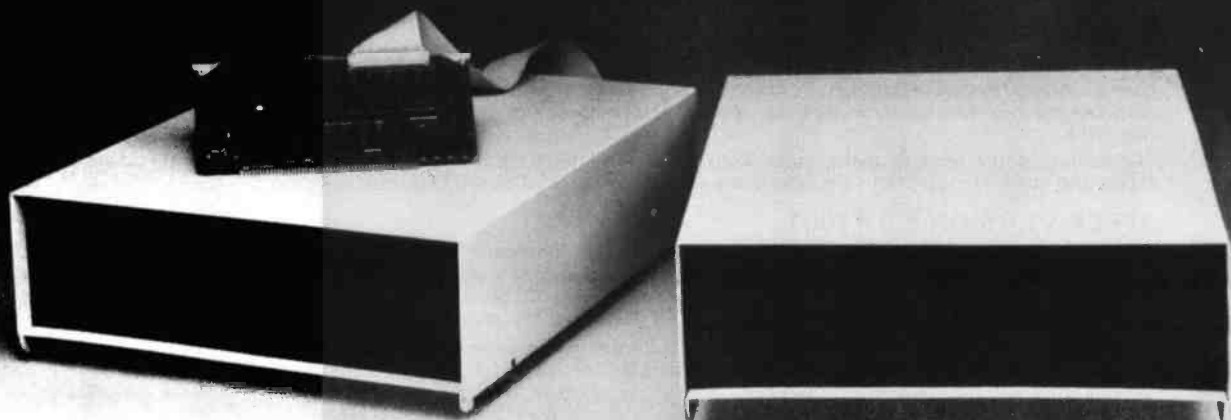


LJK ENTERPRISES INC.  
P.O. Box 10827  
St. Louis, MO 63129  
(314) 846-6124

**DEALER  
INQUIRES  
INVITED**

\*Trademarks of: Apple Computer — Atari Computer — Epson America — Hayes Microcomputers — Personal Software — Videx — Bit 3 Inc. — M&R Ent. — Advanced Logic Systems — Vista Computers

# WE'LL "DRIVE" YOU WILD



with our variety of quality disk drives.

ASAP carries only the highest quality floppy disk drives, to provide you with years of trouble-free service and superior performance.

Data Trak™ double-sided, double-density drives from Qume® feature state-of-the-art technology. You get superior data integrity through improved disk life, data reliability and drive serviceability.

Data Trak™ 5 (ANSI 5¼" compatibility) ..... Call for price

Data Trak™ 8 (IBM compatibility) ..... Call for price

Shugart drives have been setting industry quality and reliability standards for years. Shugart's Bi-Compliant™ head assembly provides superior media compliance and high reliability.

Model 801 (standard floppy) ..... \$400.00

Model 850 ..... \$640.00

ASAP also provides a full line of high reliability disk drive subsystems. For superior quality, high reliability disk drives, contact ASAP today.

Part No. — Description\* Price

CAB5V — Single cabinet for either Shugart or Qume 5¼" floppy disk drives (cabinet only) ..... \$ 75.00

CAB5V/1Q — Single cabinet with (1) Qume® DT-5, double-sided double-density 5¼" floppy disk drive installed .... \$ 425.00

CAB8H — Dual cabinet for 8" floppy disk drives (horizontal mounting) ..... \$ 225.00

CAB8V — Cabinet for 8" floppy disk drives (vertical mounting) ..... \$ 225.00

CAB8H/V+1S — Dual cabinet with (1) Shugart SA801R 8" floppy disk drive installed (horizontal or vertical mounting) ..... \$ 665.00

CAB8H/V+2S — Dual cabinet with (2) Shugart SA801R's 8" floppy disk drives installed (horizontal or vertical mounting) ..... \$1055.00

CAB8H+1M — Dual cabinet with (1) Mitsubishi double-sided double-density, 8" floppy disk drive installed ..... \$ 695.00

CAB8H+2M — Dual cabinet with (2) Mitsubishi double-sided double-density, 8" floppy disk drives installed ..... \$1155.00

CAB8H/V+1Q — Dual cabinet with (1) Qume® DT-8 double-sided double-density drive installed (horizontal or vertical mounting) ..... \$ 725.00

CAB8H/V+2Q — Dual cabinet with (2) Qume® DT-8's double-sided double-density drives installed (horizontal or vertical mounting) ..... \$1205.00

HDC8/1-HD — Cabinet with (1) Priam 10 megabyte hard disk drive with Microbyte Controller ..... Call for price

HDC8/1F+1HD — Cabinet with (1) Qume® DT-8 double-sided, double-density drive, and (1) Priam 10 megabyte hard disk drive with Microbyte Controller ..... Call for price

CAB8V/2F-9SMB — Desk top cabinet for (2) 8" Shugart or Qume floppy disk drives, 9-slot motherboard, card cage, fan, dust filter, power supply, and all power and drive cables ..... Call for price

X5 — Cabinet for desk top mainframe (small power supply) ..... \$ 200.00

800D — Cabinet for desk top mainframe (standard power supply) ..... \$ 255.00

\*All cabinets come complete with power supply, fan and internal cables.

Terminals		
Manufacturer	Model #	Price
Ampex	Dialogue 80	\$ 875.00
Lear Siegler	ADM-5	\$ 660.00
Lear Siegler	ADM-3A	\$ 635.00
Lear Siegler	ADM-3A+	\$1225.00
Lear Siegler	ADM-31	\$1095.00
Lear Siegler	ADM-32	\$1225.00
Lear Siegler	ADM-42	\$1195.00
Televideo	TVI 910	\$ 625.00
Televideo	TVI 912C	\$ 725.00
Televideo	TVI 925	\$ 825.00
Televideo	TVI 950C	\$ 925.00

Components		
4116's (200 nS)/5290-3		
Apple TRS-80 Heath		
1-15	\$1.70 each	50-99 \$1.50 each
16-49	\$1.60 each	100 up \$1.30 each

2114 L-2/200 nS		
Low Power 1K x 4 Static RAM		
1-16	\$2.80 each	50-99 \$2.60 each
17-49	\$2.70 each	100 up \$2.45 each

2708/450 nS		
1K x 8 EPROM	\$4.00 each	8/\$28.00

2716/5 Volt		
2K x 8 EPROM		\$4.95 each

Regulators		
32015		\$ 80
32015		\$ 70
320112		\$ 80
320112		\$ 75

Connectors			
	1-9	10-24	25 up
DR25P	\$2.00	\$1.90	\$1.75
DR25S	\$2.95	\$2.75	\$2.50
DR25C	\$ 95	\$ 85	\$ 75

100 Pin IMSAI		
Gold/S-100 Soldered Connectors		
52-60 each	100/52-40 each	

Capacitors		
1 1/2 Volt Ceramic	8c each	100/\$7.00

DIP Sockets				
Description	1-9	10-49	50-99	100 up
14 pin tin st	\$ 15	\$ 13	\$ 12	\$ 11
16 pin tin st	\$ 16	\$ 14	\$ 13	\$ 12
18 pin tin st	\$ 19	\$ 18	\$ 16	\$ 14
20 pin tin st	\$ 25	\$ 23	\$ 21	\$ 20
20 pin tin st	\$ 26	\$ 24	\$ 22	\$ 20
28 pin tin st	\$ 32	\$ 30	\$ 29	\$ 27
40 pin tin st	\$ 42	\$ 40	\$ 38	\$ 34

## SYSTEMS WITH SPICE from CALIFORNIA COMPUTER SYSTEMS

FOR S-100 USERS	
32K Static RAM Board	Price \$595.00
Part Number 2032C	
16K Static RAM Board	Price \$300.00
Part Number 2116C	
64K Dynamic RAM Board	Price \$550.00
Part Number 2065C	
280A CPU Board	Price \$270.00
Part Number 2810A	
Floppy Disk Controller	Price \$370.00
Part Number 2422A	
CP/M™ Version 2.2 Free With Purchase	
S-100 Mainframe	Price \$475.00
Part Number 2200A	
S-100 Motherboard	Price \$150.00
Part Number 2501A	
4-Port Serial I/O Interface	Price \$285.00
Part Number 2710A	
2-Serial, 2-Parallel I/O Board	Price \$280.00
Part Number 2719A	
4-Port Parallel I/O Board	Price \$195.00
Part Number 2720A	

FOR APPLE II™ USERS	
Synchronous Serial Interface	Price \$149.00
Part Number 7712A	
Programmable Timer	Price \$ 95.00
Part Number 7440A	
Asynchronous Serial Interface	Price \$139.00
Part Number 7710A	
Calendar/Clock Module	Price \$ 99.00
Part Number 7424	
3 1/2" Digit BCD A-to-D Converter	Price \$ 95.00
Part Number 7470A	
12K ROM/PROM Module	Price \$ 85.00
Part Number 7114A	
Parallel Interface	Price \$125.00
Part Number 7720A	
Arithmetic Processor	Price \$349.00
Part Number 7811A	
Centronics Printer Interface	Price \$125.00
Part Number 7728A	

## Printers

### Epson MX-80

80 Column Dot Matrix Printer  
Character set: full 96-character ASCII with descenders  
Graphics characters: 64 block characters  
Centronics-style 8-bit parallel interface  
standard: Apple TRS-80, RS-232 interfaces optional.

### MX-80 FT/Friction Feed

#### MX-100/132 Column

#### Okidata Dot Matrix Printers

82A — 80 column printer w/tractor  
Throughput @ 80 characters per line: 76 lines per minute  
Print Speed: 120 CPS

83A — 136 column printer w/tractor  
Throughput @ 136 characters per line: 76 lines per minute  
Print Speed: 120 CPS

84A — 136 column printer w/tractor  
Throughput @ 136 characters per line: 114 lines per minute  
Print Speed: 200 CPS

Centronics & RS-232C interfaces standard on models 82A & 83A. 2K serial buffer board (RS-232) optional on all models. 84A: Centronics 8-bit parallel interface optional: Hi-RES Graphics standard.

CALL FOR PRICE & DELIVERY

Apple Parallel Interface:  
AEI-1 W/Cable ..... \$69.95

- Standard Interface
- Compatible with Epson & Okidata Printers
- On-board Firmware (2708)
- Optional Cables \$20.00
- AEC-2/Atari to Epson Printer
- TREC-2/TRS-80 to Epson/Okidata Printer
- RSC-1/RS-232 (male to male)

Serial Interface SEI-1 ..... \$55.00

- Asynchronous 300 1200 2400 or 9600 BPS
- Compatible with Epson Printers
- 75 to 9600 BPS

Manufacturer/Model # Price

Anadex-9501 W/2K buffer ..... \$1295.00

Diablo-630R0 ..... \$2095.00

Citoh Pro/Writer II ..... Call for price

Citoh F-10 Printmaster ..... Call for price

Texas Instruments-810 ..... \$1650.00

Modems		
Manufacturer	Model #	Price
Novation	CAT	\$ 149.00
Novation	d-CAT	\$ 160.00
Novation	Auto-Cat	\$ 229.00
DC Hayes	Smart Modem	\$ 235.00
DC Hayes	Micro Modem II (Apple)	\$ 320.00
DC Hayes	Micro Modem 100	\$ 320.00
Lexicon	Lex-11	\$ 139.00
Livermore	LIV-Star 20M	\$ 149.00
UDS	UDS 103 LP (300 Bd)	\$ 185.00
UDS	UDS 202 LP (1200 Bd)	\$ 245.00

Monitors		
Manufacturer	Model #	Price
Amdek	100/12" B&W	\$ 110.00
Amdek	100-80	\$ 169.00
Amdek	100G/12" Grn.	\$ 125.00
Amdek	Color-1 13"	\$ 350.00
Sanyo	DM 5109CX/9" Grn.	\$ 175.00
Sanyo	DM 5012/12" B&W	\$ 270.00
Sanyo	DM 5112ex/12" Grn.	\$ 290.00
Sanyo	DM C6013/13" Color	\$ 425.00
Zenith	ZVM-121/12" Grn	\$ 115.00

## ATARI COMPUTER PRODUCTS

### ATARI 800

(16K) Personal Business Computer Features:

- Computer console
- Atari 8K basic
- 57 full stroke alpha-numeric keyboard with four function keys
- Operator's manual
- RF modulator
- Power supply

Call for price

ATARI 400 ..... \$349.00

Atari Optional Accessories

Model #	Description	Price
410	Program Recorder	\$ 80.00
810	Disk Drive System	\$ 455.00

822	40 Column Thermal Printer	\$ 299.00
820	40 Column Dot Matrix Printer	\$ 279.00
825	80 Column Dot Matrix Printer	\$ 625.00
830	Acoustic Modem	\$ 159.00
850	Interface Module	\$ 169.00
410	Cassette Recorder	\$ 80.00
CX30-04	Paddle Controls	\$ 17.95
CX40-04	Joysticks (pair)	\$ 17.95

### INTRODUCING ASAP'S

#### Atari 800 16K RAM Module: \$55.00

1 year warranty parts & labor

### Software

Atari

Basketball	\$ 27.00
Super Breakout	\$ 30.00
Chess	\$ 32.00
Video Easel	\$ 25.00
3-D Tic Tac Toe	\$ 25.00
Star Raiders	\$ 36.00
Asteroids	\$ 32.00
Music Composer	\$ 42.00
Assembler/Editor	\$ 45.00
Telink I	\$ 24.00
Space Invaders	\$ 30.00
Kingdom	\$ 12.95
Missile Command	\$ 32.00
Biorhythm	\$ 12.95
Graph It	\$ 17.95
Energy Quiz	\$ 12.95
Mailing List	\$ 19.95
Touch Typing	\$ 19.95
Stock Charting	\$ 22.95
Stock Analysis	\$ 19.95
Bond Analysis	\$ 19.95
Word Processor	\$119.00
Personal Finance	\$ 64.95
Microsoft BASIC	\$ 75.00

Datasil

Atari Mailing List Disk	19.95
Atari Character Generator Disk	16.95
Text Wizard Disk	89.95
Micropainter Album 1 Disk	16.95
Micropainter Album 2 Disk	16.95
Hi Stuck Accessory	30.00
Innovative Design Software, Inc.	
Pool 15 Hi-RES 48K	\$28.95
On-Line Systems	
Hi-RES Adv #0 — Mission Asteroid Disk	19.95
Hi-RES Adv #2 — Wiz & Princess Disk	25.00
Roadwork Disk	29.95
Jawbreaker Disk	25.00
Softpoint Adventure (X-rated) Disk	25.00
The Next Step Disk	29.95

Personal Software

Viscasil Disk	169.00
Arcade Plus	
Ghost Hunter (Cassette)	\$ 25.00
Ghost Hunter (Disk)	\$ 30.00

FOR HOME ENTERTAINMENT SYSTEMS	
Activision	
Dragster Cartridge	18.50
Boxing Cartridge	18.50
Checkers Cartridge	18.50
Fishing Derby Cartridge	18.50
Skunk Cartridge	18.50
Bridge Cartridge	23.95
Tennis Cartridge	18.50
Laser Blast Cartridge	18.50
Freeway Cartridge	18.50
Kaboom! Cartridge	18.50

Stampede Cartridge ..... 18.50

Ice Hockey Cartridge ..... 23.95

## DISKETTES from ASAP

### Verbatim

Part #	5 1/4" Diskettes	Sector	Price
MD525-01	Soft	10/S27.50	
MD525-10	Hard 10	10/S27.50	
MD525-16	Hard 16	10/S27.50	
FD32-1000	8" Diskettes		
FD34-1000	Hard	10/S35.00	
	Soft	10/S35.00	

### Memorex

Part #	5 1/4" Diskettes	Side/Dens	Sector	Price
MEM 3481	1/Dbt	Soft	10/S26.50	
MEM 3483	1/Dbt	Hard 10	10/S26.50	
MEM 3485	1/Dbt	Hard 16	10/S26.50	
	8" Diskettes			
MEM 3060	1/Sgl	Soft	10/S35.00	
MEM 3101	2/Sgl	Soft	10/S45.00	
MEM 3090	1/Dbt	Soft	10/S45.00	
MEM 3102	2/Dbt	Soft	10/S55.00	

### Scotch 3M

Part #	5 1/4" Diskettes	Side/Dens	Sector	Price
744-0	1/Sgl	Soft	10/S33.00	
744-10	1/Sgl	Hard 10	10/S33.00	
744-16	1/Sgl	Hard 16	10/S33.00	
745-0	2/Dbt	Soft	10/S49.00	
745-10	2/Dbt	Hard 10	10/S49.00	
745-16	2/Dbt	Hard 16	10/S49.00	

### Maxell

Part #	5 1/4" Diskettes	Side/Dens	Sector	Price
MD1	1/Sgl	Soft	10/S32.00	
MD20	2/Dbt	Soft	10/S44.00	
MH1	1/Sgl	Hard 16	10/S39.00	
MH20	2/Dbt	Hard 16	10/S50.00	
	8" Diskettes			
FD1-128	1/Sgl	Soft	10/S41.00	
FH1-32	1/Sgl	Soft 32	10/S41.00	
FD2-XD	2/Dbt	Soft	10/S50.00	

### Elephant Memory Systems

Part #	5 1/4" Diskettes	Side/Dens	Sector	Price
EMS 1	1/Sgl	Soft	10/S25.00	
EMS 2	1/Dbt	Soft	10/S27.50	
EMS 3	1/Dbt	Hard 10	10/S27.50	
EMS 4	1/Dbt	Hard 16	10/S27.50	
EMS 5	2/Dbt	Soft	10/S33.00	
EMS 6	2/Dbt	Hard 10	10/S33.00	
EMS 7	2/Dbt	Hard 16	10/S33.00	

### Control Data

Part #	5 1/4" Diskettes	Side/Dens	Sector	Price
1221-60	1/Sgl	Soft	10/S38.00	
1223-00	1/Dbt	Soft	10/S43.00	
1225-00	2/Dbt	Soft	10/S48.00	
	5 1/4" Diskettes			
1241-00	1/Sgl	Soft	10/S25.00	
1241-10	1/Sgl	Hard 10	10/S25.00	
1241-16	1/Sgl	Hard 16	10/S25.00	
1242-00	1/Dbt	Soft	10/S30.00	
1242-10	1/Dbt	Hard 10	10/S30.00	
1242-16	1/Dbt	Hard 16	10/S30.00	
1244-00	2/Dbt	Soft	10/S40.00	
1244-10	2/Dbt	Hard 10	10/S40.00	
1244-16	2/Dbt	Hard 16	10/S40.00	

### FLEXCASE Disk Storage

Call for price

### SRW

Part #	Media Storage Cases	Size	Price
SRW-5	5 1/4"	\$2.50 ea	
SRW-8	8"	\$3.25 ea	

All prices subject to change without notice. Call for best price.

ASAP offers a 15-day buyer protection policy: full money-back guarantee if not totally satisfied.

Ordering Information: name, address, phone, ship by: UPS or Mail Shipping charge: add \$2.50 up to 1 lb. for UPS blue; add \$1.50 for U.S. Mail (U.S. only) (\$25.00 minimum order). Call for larger shipments.

Terms: We accept cash, check, money orders, Visa & Master Charge (U.S. Funds only). Tax: 6% Calif. res. COD's and terms available on approval (school PO's accepted).

## asap

computer products, inc.

1198 E. Willow St., Signal Hill, CA 90806

Toll free outside California:  
**(800) 421-7701**

Inside California:  
**(213) 595-6431**  
**(714) 891-2663**



# Anatomy and Development of a Batch-Processing System

*A software system lets your computer run a series of programs without your intervention.*

---

Gene Walters  
779 Vereda Court  
San Jose, CA 95123

---

Most microcomputer programs require responses or input from the user during their execution. For some applications, however, interactive computing has drawbacks. Programs that include updating, sorting, and listing files can take the computer a lot of time and leave you sitting idle. And many programs—even common ones for the home—do require such tasks. Suppose you want to keep a household inventory sorted by item descriptor and also by room or location or you want to catalog your collection of phonograph records and sort by title, performing artist, and composer. Programs for either of these domestic tasks would require time-consuming sorts.

Two basic approaches can be used to design programs that include lengthy operations like those described above. You can write several programs—one for updating, one for sorting, one for listing, and one for each additional function required—or you can write one large program that combines all the functions.

Each approach has advantages and disadvantages. Using the first method, you have more RAM (random-access read/write memory) free for sorting. However, you must run each program separately, which leaves you an unpleasant choice. You

can watch the computer while one program executes so that you will be ready when the time comes to initiate the next program, or you can leave the computer and come back later. If you wait and watch, you waste your own time. If you leave and come back, you will find either that the program has not finished running or that the program has finished and the computer has been idle for some indefinite period. I find it frustrating to run back and forth to check on the computer's progress.

The second approach lets you enter all the desired options at the beginning of the program's run and then let the computer do all the required processing. Because all the program functions reside in memory at the same time, however, the computer may have little memory space free for processing. As a result, the program will run more slowly.

I wanted the best features of both methods: a third approach that would provide for continuous unattended running of all the required functions but leave plenty of memory space free for processing. I decided to write an executive program that would let me set up a file containing all the instructions and commands that the computer would need to run a number of separate programs in

succession without operator intervention. This approach is called *batch processing*.

I developed my batch-processing system on a North Star Horizon computer with 56K bytes of RAM, a video-display terminal, and a printer. I tested the programs on both release 4 and release 5.2 of North Star system software. You can use batch-processing software like mine on any microcomputer that has a CHAIN feature (which permits one program to call another).

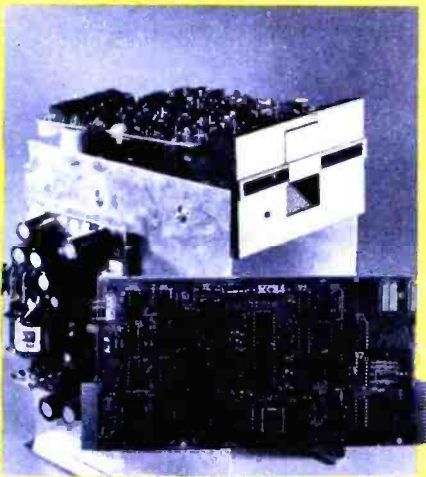
## Design Goals

I tried to set up the executive program and its supporting programs in a way that would permit me to use them in many other applications without making extensive changes. I wanted to have one executive for a system consisting of many programs that would support an unattended run of several programs. I required that maximum memory, date and time information, and common parameters be available for all programs and that the parameters specific to the execution of one program be easily available.

Other features that I felt the batch-processing system should include are error checking of all input parameters

# How to maximize your Model III:

You don't have to settle for standard equipment. Let MTI and Alpha Byte help you build the Model III you want.



## MTI FLOPPY DISK ADD-ON KITS

Now you can upgrade your 16K level II Model III to a full 48K Disk System the easy way with MTI's Double Density Disk Controller and your choice of Disk Drives. You can choose 40 track, Double-Sided 40 track or Double-Sided 80 track Drives to supply your disk storage needs. Forty Track Drives store 175K. Double-sided 40 Track drives store 350K. Four Double-Sided 80 Track Drives provide up to 3 MEGABYTES of On-Line storage.

## INTERNAL DISK DRIVE KITS

The first drive kit includes one Tandon Disk Drive, MTI Double Density Controller, Switching power supply, 32K of RAM, all mounting hardware, cables and Detailed Installation Instructions. The second internal drive kit includes a second drive and the necessary installation hardware.

40 TRACK DRIVE SYSTEM	
DRIVE NO. 1 KIT	649.00
DRIVE NO. 2 KIT	259.00
40 TRACK DUAL HEAD SYSTEM	
DRIVE NO. 1	729.00
DRIVE NO. 2	369.00
80 TRACK DUAL HEAD SYSTEM	
DRIVE NO. 1	889.00
DRIVE NO. 2	549.00

## EXTERNAL DRIVE KITS

Two external drives can be attached to any dual drive Model III Computer.

40 TRACK EXTERNAL DRIVES	
DRIVE NO. 3	359.00
DRIVE NO. 4	339.00
DUAL HEAD 40 TRACK EXTERNAL DRIVES	
DRIVE NO. 3	479.00
DRIVE NO. 4	459.00
DUAL HEAD 80 TRACK EXTERNAL DRIVES	
DRIVE NO. 3	659.00
DRIVE NO. 4	639.00

## FIVE MEGABYTE EXTERNAL WINCHESTER HARD DRIVE . . . . . 2795.00

Add the Ultimate in Fast High Capacity Disk Storage to any Model III Floppy Disk system. Reliable Winchester technology provides enough storage for the largest business files. Winchester disk drives have greatly increased data transfer rates and that means faster program and file loading. This is a complete self contained system that connects to a standard Model III Disk System in minutes without any modification to the computer.

## MODEL III DIAGNOSTIC PROGRAM . . . . . 49.95

A complete diagnostic program for the Model III. Tests RAM and ROM, video display and all disk drives. Catch problems while they're small and be sure that your Model III is in perfect running condition.

## MODEL III CP/M-80 NOW AVAILABLE! . . . 799.00 CP/M® & 80 Column Kit.

Now you can run proven CP/M based software on your Model III, with standard 80-column display. A simple internal modification will transform your Model III into a NEW computer and allow you to run CP/M the industry-standard operating system and assure you of a large supply of fine software. Includes CP/M 2.2.

## MODEL III SPEED-UP MOD . . . . . 149.00

Now you can run your Model III at 4 MEGAHERTZ, that's almost double the standard speed. This simple-to-install kit does require some soldering.

## MODEL III COOLING KIT . . . . . 44.95

Heat build up is a major cause of system failures and 'flakey' operation. This kit provides excellent cooling.

## DOSPLUS OPERATING SYSTEMS FOR THE MODEL III

Solid BUG-FREE operating systems for the Model III. Supports different size drives on the same system and Basic Program Chaining with variables saved in memory.

40 TRACK . . . . .	99.00
80 TRACK . . . . .	119.00
EXPANDED DOSPLUS 3.3.8 . . . . .	149.00
Read and Write 40 Track Diskettes on an 80 Track System	
HARD DISK DOSPLUS . . . . .	299.00
Supports the MTI 5 MEG HARD DISK	

# Alpha Byte

## COMPUTER PRODUCTS

We guarantee everything for 30 days. If anything is wrong, return the item and we'll make it right. And, of course, we'll pay the shipping charges.

We accept Visa and Master Card on all orders; COD orders, up to \$300.00.

Add \$2.00 for standard UPS shipping and handling on orders under 50 lbs, delivered in continental U.S. Call for shipping charges over 50 lbs. Foreign, FPO and APO orders add 15% for shipping. Californians add 6% sales tax.

Prices quoted are for stock on hand and are subject to change without notice.

**31245 LA BAYA DR, WESTLAKE VILLAGE, CALIFORNIA 91362**

To order, or for information, call:  
**(213) 706-0333**

To use our 24-hour modem order line, call: (213) 883-8976.







# Now you don't have to decide between a personal computer and a VT100 terminal.



Digital's introduced a personal computing option which can turn a VT100 terminal into a personal computer that uses the CP/M® operating system.

It's called Digital's Personal Computing Option. You can purchase just the option, or you can buy the complete terminal/computing package called the VT180.

Either represents significant advantages over the choices available to you now. For now, you can provide access to a large computer and personal computing at the same terminal.

More than that, you save the additional cost of putting personal computers and terminals side by side on the top of a desk.

With the CP/M operating system Digital's personal computing terminal will run the literally hundreds of programs available for it. Including word processing, mailing lists, financial modeling, statistics, even data base communications—in addition to the many more being specially edited for this terminal.



And by virtue of the fact that Digital's personal computing terminal is VT100-based, you get all the features that people buy VT100s for in the first place. Features like smooth scrolling with up to 132 columns display, split-screen viewing, double-height and width characters, and reverse video.

Plus a reputation that's second to none in the industry. Plus Digital's service, on-site, anywhere in the world.

All of this should make great sense when you're confronted with the choice of terminals or personal computers.

Because now you can pick one and get both.

See your Digital dealer for more information or write: Digital Equipment Corporation, Terminals Product Group, 2 Mt. Royal Avenue, UPI-5, Marlboro, MA 01752. Telephone toll-free 800-225-9378 (outside the continental U.S. or in Massachusetts call 617-480-4077) between 8:30am and 5:00pm Eastern time. In Europe: 12 Av. des Morgines, CH-1213 Petit-Lancy/Geneva. In Canada: Digital Equipment of Canada, Ltd.

**digital**

Circle 445 on Inquiry card.

CP/M® is a registered trademark of Digital Research, Inc.

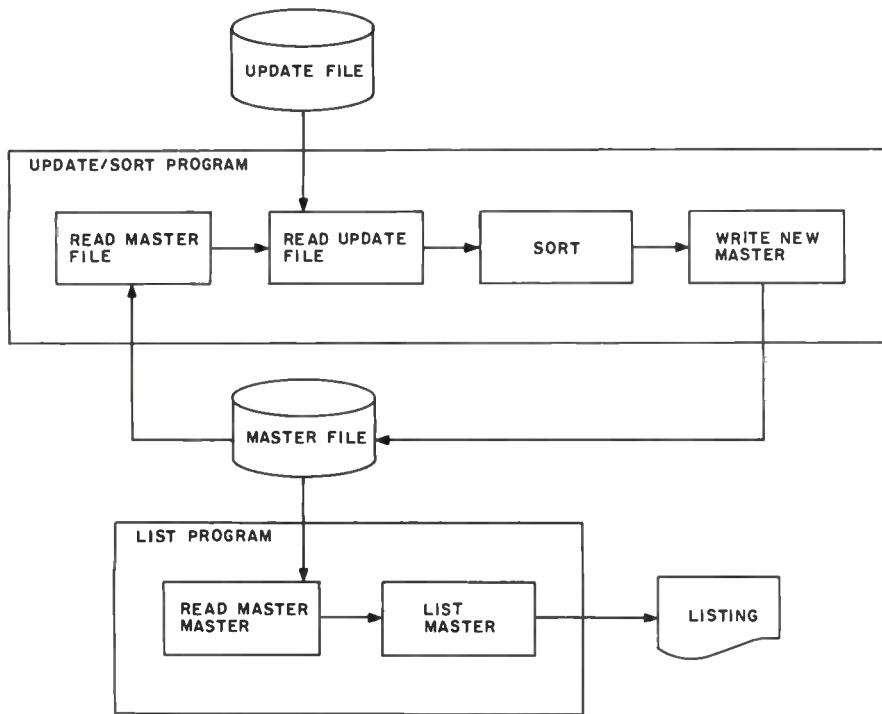


Figure 1: A diagram of relations between the update/sort program and the list program in the Article/Book Maintenance System. Either the master file or an update file must be present before execution of the update/sort program.

when the executive is set up to run a batch job, video display of processing status during execution, a built-in HELP command, automatic seeking of the batch-processing system on any disk drive, and cancellation of any command during job setup. The system should allow for both short and long forms of commands to the executive and for the easy addition of new commands, new programs, and additional parameters for all programs or a single program. Finally, I wanted to use general utility routines in the executive to set up job-control information.

### Constructing the System

To illustrate how to construct a batch-processing system, I'll describe a set of four programs, called the Article/Book Maintenance System, for maintaining and listing a file on books and articles and show how this small system can serve as the basis for other systems.

The Article/Book Maintenance System maintains one record (a collection of a fixed number of related data items) for each article or book. Each record contains three fields (data items), one each for the title, the author, and the publication date. The system has two programs that work directly on the data:

1. a program that creates or updates the article/book master file and sorts the information by any of the three fields
2. a program that lists the current master file

Figure 1 shows the relationships among the functions performed by the update/sort program and the list program. Note that either the master file or an update file must exist before the update/sort program is run.

Execution of a single job may require calling either the update/sort program, the list program, or both more than once. A simple example is the following sequence:

1. Update an existing master file with an update file and sort the information by title.

**PHONE 1 FILLS THE VOID IN DATA COMMUNICATION**

Powerful Z-80® communications software tools are now available. Fill the void between your microcomputer and mainframe.

Z-80 is a registered trademark of Zilog.

3740 FORMATTED DATA ENTRY SOFTWARE  
KTDS

WORKSTATION EMULATOR  
3780

3276-2 REMOTE CLUSTER CONTROLLER EMULATION SOFTWARE  
CLEO

HAND HELD ORDER ENTRY RECEIVER  
HHOE

**PHONE 1**  
1011 River Lane • Loves Park, Illinois 61111 • 815/877-9008

# INTRODUCING CALCSTAR.<sup>™</sup> ANOTHER INDISPENSABLE BUSINESS PROGRAM FROM MICROPRO,<sup>™</sup> THE WORDSTAR<sup>™</sup> PEOPLE.

Presenting CalcStar — another standard-setting software product in the WordStar tradition.

CalcStar is MicroPro's new electronic spread sheet and financial modeling program — a sophisticated, yet easy to use, calculating and planning tool for CP/M<sup>®</sup>-based computers.

**The ultimate electronic spread sheet.**

CalcStar calculates solutions to complex numerical problems in business and finance. Helps you make budget plans and sales forecasts with greater speed and accuracy. And projects figures into the future to answer the "what if" questions you face in business.

And CalcStar also has a unique MicroPro advantage: It joins with WordStar to combine spread-sheet and word-processing capabilities in several powerful ways.

CalcStar software eliminates the need to use ledger paper ever again. It turns your video screen into a "window" on a giant electronic ledger sheet, with up to 600 entries arranged the way you want. Then, by inserting formulas into CalcStar, you create financial models that simulate the future numerically. And predict the outcomes of your business decisions.

When you notice what CalcStar can do for your business, you'll wonder how you ever got along without it. (If you're now a WordStar user, you probably already know the feeling.)

**The MicroPro bonus.** Like WordStar, CalcStar is packed with innovative features that make it versatile and easy to use. Features like Automatic Forms Mode, which lets an inexperienced user enter data into a spread sheet quickly and with less chance of error.

CalcStar's greatest innovation is its ability to join with WordStar. Which means, for example, you can use WordStar's printing options, like boldface and underlining, to dress up financial documents. And you can insert sections of CalcStar's spread sheets into your WordStar documents.

This kind of flexibility should come as no surprise if you're already familiar with the MicroPro software family — a line of programs designed to work together to multiply your problem-solving power. Visit your MicroPro dealer to find out just how big a difference *all* our products can make in your business. We predict you'll discover it's not just CalcStar or WordStar that's indispensable. It's MicroPro.



A glance at CalcStar features

Runs on CP/M version 2.0 or above with 80-column screen, addressable cursor, and at least 48K memory. 56K or more is recommended for fullest utilization.

Highly user friendly: Call up full screen of help or use help menu. WordStar-like cursor commands. User's guide shows you the basics. Install from menu OR a WordStar file.

Stores formulas and formats along with data, for convenience and less chance of error.

Math functions include average, minimum, maximum, logarithms, exponents, and regression analysis.

SOFTWARE  
THAT MEANS BUSINESS<sup>™</sup>

**MicroPro<sup>™</sup>**

INTERNATIONAL CORPORATION

1299 Fourth Street, San Rafael, California 94901  
(415) 457-8990; Telex: 340-388

CP/M is a trademark of Digital Research, Inc.  
Dealer and distributor inquiries invited





# A Great Price For A Great Printer



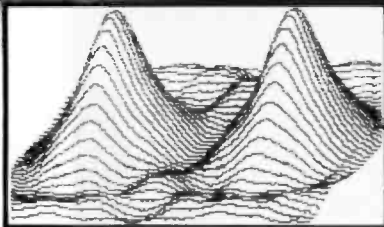
ALPHACOM INTRODUCES THE  
ALPHACOM 42

USER-SELECTABLE INTERFACE:

1. PARALLEL - 7 BIT ASCII WITH DATA STROBE, BUSY AND ACK.
2. SERIAL - SWITCH SELECTABLE WITH BAUD RATES OF 110 TO 9600 BAUD.

PRINT SPEED:

120 LINES PER MINUTE. TAKES ONLY 14 SECONDS TO PRODUCE A FULL 280 DOT LINE CRT DISPLAY IN HARDCOPY.



Results of the ALPHACOM 42 Thermal Printer

Quality graphics and symbols for business and pleasure.

**SPECIAL OFFER**

**\$ 199<sup>95</sup>**

**Order by Phone Today!**

**FAST · QUIET · LOW COST**

The remarkable ALPHACOM 42 high speed 40 column thermal printer is now available through this mail offer for only \$199.95.<sup>\*</sup> For Apple, Commodore, Atari and other home computer users, this is the opportunity to own one of the most reliable printers ever introduced. It's a fool-proof printing mechanism that is backed by field experience with more than a million similar units in industry, government and education, plus a 90 day warranty. Fast, quiet and easy to operate, the ALPHACOM 42 prints up to 120 text lines per minute! Dump a 24 line CRT in 14 seconds!!

Order your ALPHACOM 42 today using the convenience of Master Card or Visa. Call for immediate action, or mail your check to ALPHACOM.

In California, dial 408-559-8000.

**800 · 538 · 7047**

<sup>\*</sup>Interface Cables available for as little as \$24.95.

# Alphacom

Visa

2323 S. Bascom Avenue, Campbell, CA 95008

MasterCard

2. List the sorted master file.
3. Sort again, but by author.
4. List the newly sorted master file.

The Article/Book Maintenance System has an executive program and a subexecutive which together enable the system to call the update/sort and list programs in sequences like the one above. I'll discuss the executive and subexecutive programs in detail after I describe how the system looks in operation.

The system accepts an update file in the format of a North Star BASIC program file. Adoption of this format permits use of the North Star editor, normally used for entering BASIC programs, with the Article/Book Maintenance System. Listing 1 shows the formats for update data—title, author, and date on each new book or article. The format requires line numbers and quotes. In the absence of the quotes, the North Star editor would convert any BASIC keywords in the line to an internal representation different from an ASCII (American Standard Code for Information Interchange) string. Note the use of the minus sign after the line number of a record to be deleted.

Listings 2 through 5 show examples of two typical job executions in the Article/Book Maintenance System. Underlined text in the listings represents user input. Listing 2 shows an update file created with the North Star editor and saved under the name UPDATE1. The first job, shown in listing 3, is a sample run of the main program in the Article/Book Maintenance System. This run uses the file UPDATE1 to create a new master file, MASTER, then sorts and lists MASTER. Since no MASTER file existed when the job was set up, the program asks the user during the input dialogues of both the update/sort and the list commands to confirm that it's all right to proceed without MASTER.

Listing 4 shows the new update file, UPDATE2. The second run of the main program appears in listing 5. The dialogue in listing 5 causes MASTER to be updated with the data in UPDATE2, then sorted and listed by title, then sorted and listed by

# BOY, IS THIS COSTING YOU.

It's really quite basic: time is money.

And BASIC takes a lot more time and costs a lot more money than it should every time you write a new business software package.

Especially when you could speed things up with dBASE II.

## dBASE II is a complete applications development package.

Users tell us they've cut the amount of code they write by up to 80% with dBASE II.

Because dBASE II is the high performance relational database management system for micros.

Database and file handling operations are done automatically, so you don't get involved with sets, lists, pointers, or even opening and closing of files.

Instead, you write your code in concepts.

And solve your customers' problems faster and for a lot less than with BASIC (or FORTRAN, COBOL or PL/I).

## dBASE II uses English-like commands.

dBASE II uses a structured language to put you in full control of your data handling operations.

It has screen handling facilities for setting up input and output forms.

It has a built-in query facility, including multi-key and sub-field searches, so you can DISPLAY some or all of the data for any conditions you want to apply.

You can UPDATE, MODIFY and REPLACE entire databases or individual characters.

CREATE new databases in minutes, or JOIN databases that already exist.

APPEND new data almost instantly, whether the file has 10 records or tens of thousands.

SORT the data on as many keys as you want. Or INDEX it instead, then FIND whatever you're looking for in seconds, even using floppies.

Organize months worth of data in minutes with the built-in REPORT. Or control every row and column on your CRT and your printer, to format input and output exactly the way you want it.

You can do automatic calculations on fields,



records and entire databases with a few keystrokes, with accuracy to 10 places.

Change your data or your entire database structure without re-entering all your data.

And after you're finished, you can protect all that elegant code with our run-time compiler.

## Expand your clientbase with dBASE II.

With dBASE II, you'll write programs a lot faster and a lot more efficiently. You'll be able to write more programs for more clients. Even take on the smaller jobs that were out of the economic question before. Those nice little foot-in-the-database assignments that grow into bigger and better bottom lines.

## Your competitors know of this offer.

The price of dBASE II is \$700 but you can try it free for 30 days.

Call for our Dealer Plan and OEM run-time package prices, then take us up on our money-back guarantee. Send us your check and we'll send you a copy of dBASE II that you can exercise on your CP/M<sup>®</sup> system any way you want for 30 days.

Then send dBASE II back and we'll return all of your money, no questions asked.

During that 30 days, you can find out exactly how much dBASE II can save you, and how much more it lets you do.

But it's only fair to warn you: business programmers don't go back to BASIC's.

Ashton-Tate, 9929 Jefferson, Los Angeles, CA 90230. (213) 204-5570.



## Ashton-Tate

©Ashton-Tate 1981

®CP/M is a registered trademark of Digital Research.

author. The end of listing 5 shows both the system's listing by title and the listing by author. This simple example, which uses the same system of programs repeatedly to do a set of tasks and requires no attention from the operator after the job is set up, shows the convenience and flexibility of the executive of the Article/Book Maintenance system.

### Programs

The Article/Book Maintenance System contains four programs. The main executive (MAIN) program handles all interaction between the Article/Book Maintenance System and the user. Handling the user interaction includes checking the validity of all input parameters. In addition, the MAIN program constructs a job-control file containing both the global data (to be used by all programs) and the parameters entered by the user to

determine the course of program execution. MAIN provides a set of utility routines that can be used for the MAIN program in other batch-processing systems.

The subexecutive (%I) program reads the next entry in the job-control file to determine which program to call next for execution.

The update/sort (%ISORT) program performs updates and sorts. It reads global data from the job-control file and uses the data as parameters for the updates and sorts. The data read include parameters for listings (top and bottom margins, number of lines per page) and for adjusting the position of the paper after an error listing, the names of files to be sorted, and the field to use for the sort. After completing the update and the sort, this program returns control to the subexecutive.

The listing (%ILIST) program

reads parameters from the job-control file, including the name of the master file to be listed and the order of fields for the listing.

### Data Files

The Article/Book Maintenance System contains three kinds of data files. The job-control file (%IJCL) contains all the parameters and control information for the system. It is organized as a North Star Type 3 data file; figure 2 shows the file's format. Update files are defined by the user; they are files of North Star Type 2, which is normally used for BASIC programs. Master files, also user-defined, are files of North Star Type 3 as well.

File-naming conventions of the Article/Book Maintenance System are as follows: the MAIN program can have any name you wish, the subexecutive is %I, the job-control file is

*Listing 1: The formats for data in an update file for the Article/Book Maintenance system. These formats were chosen so that the North Star BASIC editor could be used for entering and deleting data in the batch-processing system.*

#### Add Entry

```
line number"title\author\date"
```

or

```
line number"title\author\date\"
```

#### Example:

```
10"Art of Computer Programming - Fund. Al. Vol I\Knuth, D.E.\1968"  
20"Compiler Design Theory\Lewis, P.M., et al\1976"
```

#### Delete Entry

Same as add except for the addition of a minus sign between line numbers and the quote. All master file entries whose fields match the fields specified in the delete entry will be deleted. In other words, one, two or all three fields may be used in making a match for deletion.

#### Example:

```
10-"Erroneous Title\Author\1973"
```



# MICRO



**BUSINESS WORLD INC.**  
 Information Line (213) 996-2252  
 TOLL FREE MAIL ORDER LINES  
 (800) 423-5886 Outside Calif.



**HP 41CV**  
 OUR PRICE **\$239.00** *Save*  
 MSL 325.00 **86.00**

**EXPANSION BOARD**  
 Q STAR  
 16K RAM BOARD  
 MSL 199.00



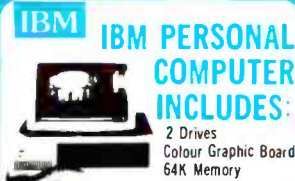
**OUR PRICE**  
**\$99.00** *Save*  
**100.00**



**MICRO-SCI**  
**APPLE II+ COMPATIBLE DRIVE**

W/ CONTROLLER MSL 549.00 **OUR PRICE 429.00**  
 W/O CONTROLLER MSL 449.00 **OUR PRICE 379.00**

*Save* COMPARE TO 216.00 APPLE DRIVE  
*Save* COMPARE TO 146.00 APPLE DRIVE  
 APPLE IS A REG. TRADE MARK OF APPLE COMPUTER



**IBM PERSONAL COMPUTER INCLUDES:**  
 2 Drives  
 Colour Graphic Board  
 64K Memory

**CALL FOR PRICE**

\*Subject to availability

**FRANKLIN 64K ACE 100**  
**APPLE COMPATIBLE INTRODUCTORY OFFER**  
 MSL 1595.00 **Call for Price**



The Franklin ACE 100 is a professional personal computer that is hardware and software compatible with the Apple II and includes many features not found on the Apple unit. All programs written for the Apple II will run on the Franklin ACE 100 without modification including those using high and low resolution black and white graphics. The ACE 100 is plug compatible with Apple. All peripherals designed for the Apple II will operate with the ACE 100 without modification.

**Franklin ACE 100 Features**

- Apple II compatible
- 64K of RAM memory
- Upper and lower case
- Typewriter-style keyboard
- Twelve key numeric pad
- Alpha lock shift key
- VisiCalc friendly
- 50 watt power supply
- Built-in fan

**COMPARE OUR COMPUTER**

FEATURES	APPLE II	FRANKLIN ACE 100
Computer with 48K RAM Memory	\$1530.00	STD
Microsoft 16K RAM Card (16K RAM Memory)	195.00 (option)	STD
ABT 10 Key Pad	125.00 (option)	STD
Videx Keyboard Enhancer	149.00 (option)	STD
R.H. Electronics Super Fan II (Muffin Fan)	69.00 (option)	STD
<b>TOTAL</b>	<b>\$2068.00</b>	<b>\$1595.00</b>

APPLE IS A REG. TRADE MARK OF APPLE COMPUTER



**LE MONITOR**

METAL CABINET SANYO TYPE  
 9" GRN. PHS. MONITOR  
 12" GRN. PHS. MONITOR

MSL 189.00 **OUR PRICE 119.00** *Save* 70.00



**APPLE II PLUS 48K**

\*Subject to availability

**CALL FOR PRICE**

APPLE IS A REG. TRADEMARK OF APPLE COMPUTER



**HP 85**  
 The professional's choice:  
 Hewlett-Packard's HP-85

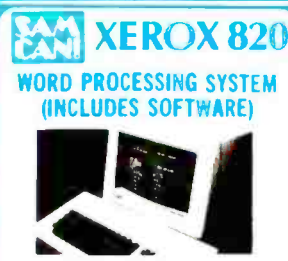
MSL 2750.00 **OUR PRICE 1975.00** *Save* 775.00



**HP 125**

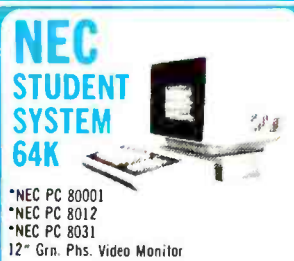
**OUR PRICE 1975.00** *Save* 775.00  
 MSL 2750.00

**DUAL MASTER DRIVE**  
 MSL 2500.00 **OUR PRICE 1595.00** *Save* 905.00



**XEROX 820**  
 WORD PROCESSING SYSTEM  
 (INCLUDES SOFTWARE)

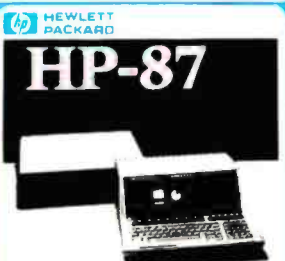
MSL 3495.00 **OUR PRICE 2649.00** *Save* 846.00



**NEC STUDENT SYSTEM 64K**

\*NEC PC 80001  
 \*NEC PC 8012  
 \*NEC PC 8031  
 12" Grn. Phs. Video Monitor

MSL 2839.00 **OUR PRICE 2095.00** *Save* 744.00



**HP-87**

MSL 2495.00 **OUR PRICE 1749.00** *Save* 746.00



**commodore VIC-20**

Vic-TV Modul \$19.00  
 Vic Cassette \$69.00  
 Vic Disk Drive \$ Call  
 Vic 6 Pack program \$44.00

MSL 299.00 **OUR PRICE 255.00** *Save* 44.00



**EPSON**

MSL 645.00 **OUR PRICE 429.00** *Save* 216.00  
 MX 80FT 745.00 **535.00** 210.00  
 MX 100 995.00 **719.00** 276.00



**commodore STUDENT SYSTEM**

4032 - 32K 40 COL CRT  
 4940 - DUAL DISK DRIVE  
 MSL 2590.00 **OUR PRICE 1978.00** *Save* 612.00

WE RESERVE THE RIGHT TO CORRECT TYPOGRAPHICAL ERRORS. THIS AD SUPERCEDES ALL PREVIOUS ADS.



**RADIO SHACK 48K TRS 80 W/2 DRIVE MOD III**

MSL 2495.00 **OUR PRICE 1799.00** *Save* 696.00

**1 Year Extended WARRANTY \$99.00**  
 INQUIRE

**AVINGS SERVICE ELECTION ATISFACTION**

**MICRO BUSINESS WORLD WAREHOUSE**  
 18720 Oxnard, #108  
 Tarzana, CA 91356  
 (800) 423-5886 IN CA (213) 996-2252

Telex: 182852  
 Answer: MICKO TZNA

\*California residents add 6% sales tax  
 \*\*Add 3% Shipping & Handling - Add 3% surcharge for credit cards - Orders cannot be shipped unless accompanied by payment, including shipping, handling and tax where applicable

Name (Please print) \_\_\_\_\_  
 Address \_\_\_\_\_  
 City \_\_\_\_\_ State \_\_\_\_\_ Zip \_\_\_\_\_

Qty	Make	Model	Description	Price	Total

TOTAL ORDER \$ \_\_\_\_\_  
 TAX IF APPLICABLE\* \_\_\_\_\_  
 SHIPPING & HANDLING\*\* \_\_\_\_\_  
 TOTAL ENCLOSED \$ \_\_\_\_\_

Certified Check or M.O. Allow 2 weeks clearance for personal check  
 Bank Wire Transfer

CREDIT CARD # \_\_\_\_\_  
 Exp Date \_\_\_\_\_

Signature \_\_\_\_\_

**VISA MasterCard**

Listing 2: The update file UPDATE1. This file is used in listing 3 to create a new master file.

```
10"Art of Computer Programming - Fund. Alg. Vol I\Knuth, D.E.\1968"  
20"Z80 Software Gourmet Guide & Cookbook\Wadsworth, N.\1979"  
30"Basic with Style\Nagin, P, Ledgard, H\1978"
```

Listing 3: A sample run of the MAIN program in the Article/Book Maintenance System. Underscored items are entries made by the user. The dialogue causes the system to create a new master file, sort it, and list it on the printer.

SAMPLE MAIN

TYPE 'HELP' IN RESPONSE TO 'COMMAND:' IF YOU NEED DETAILED INSTRUCTION.  
TO CANCEL ANY COMMAND JUST TYPE A 'RETURN' TO ANY INPUT REQUEST.

DATE: 01/05/81

TIME: 13:00

COMMAND: Sort

MASTER FILE NAME: MASTER

MASTER FILE DOESN'T EXIST. IS THIS OKAY (Y/N)? Y

PROCESS UPDATE FILE (Y/N)? Y

UPDATE FILE NAME: UPDATE1

Sort BY TITLE, AUTHOR OR DATE (T/A/D)? T

COMMAND: LIST

MASTER FILE NAME: MASTER

MASTER FILE DOESN'T EXIST. IS THIS OKAY (Y/N)? Y

EACH PRINT LINE WILL CONTAIN THE TITLE, AUTHOR AND DATE.

PLEASE SPECIFY THE ORDER TO PRINT.

ENTER 'T' FOR TITLE, 'A' FOR AUTHOR AND 'D' FOR DATE.

FIRST ONE: T

SECOND ONE: A

THIRD ONE: D

COMMAND: QUIT

...EXECUTING...UPDATE/SORT PROGRAM

...EXECUTING...LIST PROGRAM

-----Output on the printer:

TITLE	AUTHOR	DATE
Art of Computer Programming - Fund. Alg. Vol I	Knuth, D.E.	1968
Basic with Style	Nagin, P, Ledgard, H	1978
Z80 Software Gourmet Guide & Cookbook	Wadsworth, N.	1979

# SUPERFILE™

SOLVES YOUR FILING PROBLEMS

**SUPERFILE makes your information files an ASSET!**

Menu driven	<b>CLIENT RECORDS</b>	Learn in minutes
	<b>SALES LEADS</b>	
	<b>CORRESPONDENCE</b>	
	<b>JOURNAL ABSTRACTS</b>	
Customize	<b>PERSONNEL RECORDS</b>	Ready to run
program	<b>MAILING LISTS</b>	Demo data base
included	<b>CARD FILES</b>	included
	<b>LEGAL CONTRACTS</b>	
	<b>ALMOST ANYTHING!</b>	

The **USERS MANUAL** tells you how to use **SUPERFILE** to index and retrieve information for these and other practical uses.

**IF YOU CAN TYPE, YOU CAN TEACH YOURSELF TO USE SUPERFILE IN MINUTES.**

## You Need

Computer with Z-80® cpu and at least 48K memory

CP/M® operating system

2 or more floppy disk drives or hard disk

## Disk Formats

8" single density

5" including:

Osborne, Xerox,

North Star, Intertec,

Apple (cp/m), Vector.

## Technical Specifications

SEARCH SPEED: 100 records per second\*

RECORD ENTRY: your own text processor or easily convert your present files

# RECORDS PER DATA BASE: max. 8,000 on 8" SD (depends on disk capacity)

RECORD LENGTH: variable to 512,000 char. (free format - no fixed length fields)

# KEY WORDS PER SEARCH: max. 64 using "and", "or" & "not"

# KEY WORDS PER DATA BASE: max. 3,000 alpha-numeric plus 32,000 integers

# KEY WORDS PER RECORD: max. 250

KEY WORD LENGTH: max. 64 char. each

# FILES PER DATA BASE: no limit

FILE SIZE: max. 512,000 bytes

SORT: alpha-numeric by record

MERGE and/or SPLIT: records and files

## Where

Your Dealer

Call FYI, INC.

Write FYI, INC.

Reader Service #

SUPERFILE costs only \$195 (including DEMO data base and manual) (30 day money back guarantee)

MANUAL only: \$50 (applies to purchase)

Special Dealer DEMO free, on request from qualified Dealers and OEM's.

SUPERFILE (TM) trademark of FYI, INC.

Z-80® registered trademark of Zilog

CP/M® registered trademark of Digital Research

\* Using Z-80, 4mhz, 8" DD, av. 10 keywords/record.

Please add \$10 outside the US, Canada, Mexico

## FYI, INC.

P.O. BOX 10998 #615

AUSTIN, TX. 78766

MC/VISA (800) 531-5033

Inside Texas (512) 346-0133

**IT'S WHAT YOU CAN FIND THAT COUNTS!**



**MAY SPECIAL SALE ON PREPAID ORDERS**  
 (CHARGE CARDS, C.O.D. OR P.O.'S NOT AVAILABLE)  
**WAMECO CRT-1 INTRODUCTION (AT LAST)**  
 16 X 80 DR 24 X 80 VIDEO BOARD I/O  
 MAPPED SIMULATES INTELLIGENT TERMINAL  
 PCBD. .... \$36.95. KIT. .... \$239.95  
 A & T ..... \$299.95



**CALIFORNIA COMPUTER SYSTEMS**

**\$100**  
 2032 32K STATIC RAM A & T 200 NSEC. .... \$629.00  
 2065 64K DYNAMIC RAM A & T. .... \$548.95  
 2200 S-100 MAIN FRAM A & T. .... \$379.95  
 2422 FLOPPY DISC WITH CPM 2.2" .... \$329.95  
 2810A Z80 CPU A & T. .... \$249.95  
 2710A 4 SERIAL I/O A & T. .... \$291.95  
 2718A 2 SERIAL, 2 PARALLEL A & T. .... \$305.95  
 2720A 4 PARALLEL A & T. .... \$214.95  
 PHOTO BOARDS WW ..... \$39.95

**APPLE PRODUCTS**  
 7114A 12K ROM/PROM. .... \$68.50  
 7424A CALENDAR/CLOCK. .... \$106.95  
 7440A PROGRAMMABLE TIMER. .... \$98.50  
 7470A A TO O CONVERTER ..... \$105.95  
 7490A GPIB (IE 488) INTERFACE. .... \$265.95  
 7710A ASYNC SERIAL. .... \$125.95  
 7712A SYNC SERIAL. .... \$153.95  
 7720A PARALLEL STANDARD. .... \$98.95  
 7720B PARALLEL CENTRONICS. .... \$98.95  
 7811B ARITHMETIC PROCESSOR W/DISC. .... \$342.95  
 7811C ARITHMETIC PROCESSOR W/ROM. .... \$342.95  
 7500A WW BOARD. .... \$22.95  
 7510A SOLDETAIL BOARD. .... \$23.95



**MICROCOMPUTER PRODUCTS**

**\$100 PRODUCTS**  
 CB-2 280 PROCESSOR BOARD.  
 KIT ..... \$198.95. A & T ..... \$269.95  
 VBIC 64 x 16 VIDEO, PCBD. .... \$32.95  
 KIT ..... \$153.95. A & T ..... \$199.95  
 VB3 80 CHARACTER VIDEO 4MHZ.  
 KIT ..... \$345.95. A & T ..... \$425.95  
 I04 2 PARALLEL, 2 SERIAL, PCBD. .... \$32.95  
 KIT ..... \$155.95. A & T ..... \$194.95  
 PB-1 2708, 2716 PROGRAMMER BOARD  
 KIT ..... \$135.95. A & T ..... \$185.95

**APPLE PRODUCTS**  
 A10 SERIAL/PARALLEL INTERFACE  
 A & T. .... \$155.95  
 AS10 SERIAL I/O  
 A & T. .... \$97.95  
 AP10 PARALLEL I/O W/O CABLES  
 A & T. .... \$87.95



**BOARDS WITH MIKOS PARTS**

MEM-3 32K STATIC RAM, PCBD. .... \$36.95  
 KIT LESS RAM ..... \$95.95. A & T ..... \$135.95  
 CPU-2 Z80 PROCESSOR, PCBD. .... \$32.95  
 KIT LESS ROM. .... \$109.95. A & T. .... \$149.95  
 EPM-2 16K/32K EPROM, PCBD. .... \$32.95  
 KIT LESS ROM. .... \$65.95. A & T ..... \$99.95  
 FPB-1 FRONT PANEL, PCBD. .... \$48.50  
 KIT ..... \$144.95. A & T ..... \$184.95  
 QMB-12 13 SLOT MOTHER BOARD, PCBD. .... \$39.95  
 KIT ..... \$95.95. A & T ..... \$135.95



MONDAY-FRIDAY, 8:00 TO 12:00, 1:00 TO 5:30  
 THURSDAYS, 8:00 TO 9:00 P.M.  
 (415) 728-9121

P.O. BOX 955 • EL GRANADA, CA 94018  
 PLEASE SEND FOR IC, XISTOR AND COMPUTER PARTS LIST  
 VISA or MASTERCARD Send account number, interbank number,  
 expiration date and sign your order. Approx. postage will be added  
 Orders with check or money order will be sent post paid in U.S. If you are  
 not a regular customer, please use charge, cashier's check or postal  
 money order. Otherwise there will be a two-week delay for checks to  
 clear. Calif. residents add 6% tax. Money back 30-day guarantee. We  
 cannot accept returned IC's that have been soldered to. Prices subject to  
 change without notice. \$28.00 minimum order. \$2.00 service charge on  
 orders less than \$20.00.

%I)JCL, and application-program files have names prefixed with %I (restricting the name to six characters).

**Flow of Execution**

Figure 3 shows the flow of execution of the Article/Book Maintenance System. The MAIN program executes first, then shifts to the subexecutive. The subexecutive determines whether the job is at an end. If not, the subexecutive determines, based on data from the job-control file, the next program to execute—whether %ISORT or %ILIST. Either the sort or the list program CHAINs to the subexecutive.

**The MAIN Program**

Listing 6 is the MAIN program. MAIN contains remarks identifying the functions and variables used. I'll comment on MAIN from beginning to end, with emphasis on use of the utility routines. I gave the utility routines line numbers from 64000 to 65040; this numbering should make it easy for you to use the delete and append features of BASIC to separate the utility routines and use them for another application. Now for the comments, by line number.  
 170-200 Drive Determination. A search determines the disk drive on which the Article/Book Maintenance System is located. This eliminates the need to specify the drive when running MAIN.  
 290-400 Command Interpretation. This block of code starts by determining the command. Line 300 calls a utility routine at line 64990 to check for null input. MAIN calls this routine to handle input throughout the program. The GOTOs on line 370 correspond to the functions defined in the DATA statement on line 100. In this case, 1000 is HELP, 2000 is QUIT, 3000 is SORT, and 4000 is LIST. The command-processing routine matches each character in the input string with each character in the commands defined in the DATA statement at 100. This permits the user to enter short forms for each command (H, Q, S, and L) and still identify the desired function in a unique manner.

1000-1130 HELP-Command Processing. These lines display the available commands as they were defined in the DATA statement at line 100.  
 2000-2030 QUIT-Command Processing. These lines close the job-control file and call the subexecutive.  
 3000-3500 SORT-Command Processing. Lines 3010-3030 start a new entry in the job-control file. The GOSUB 64260 goes to the utility routine that saves the name of the program to be executed. Line 3050 transfers control to the routine at 64460, which will add a descriptive phrase for the program to be executed. Lines 3070 and 3080 call utility routines to process

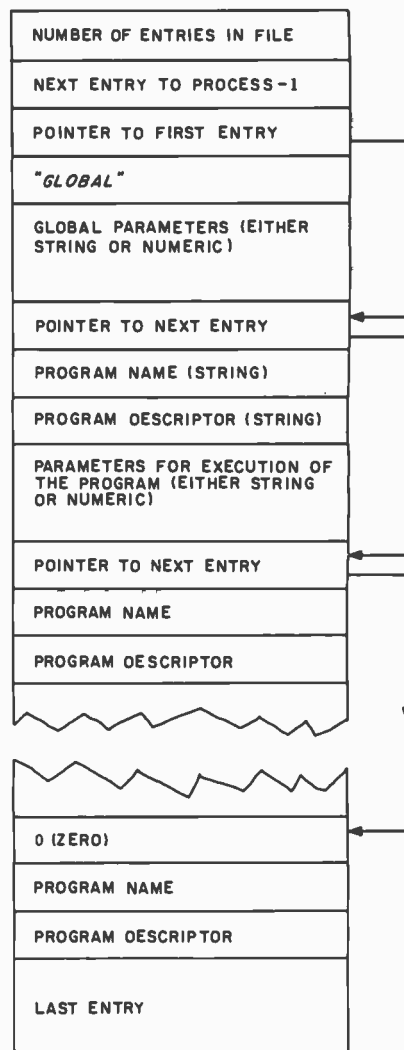
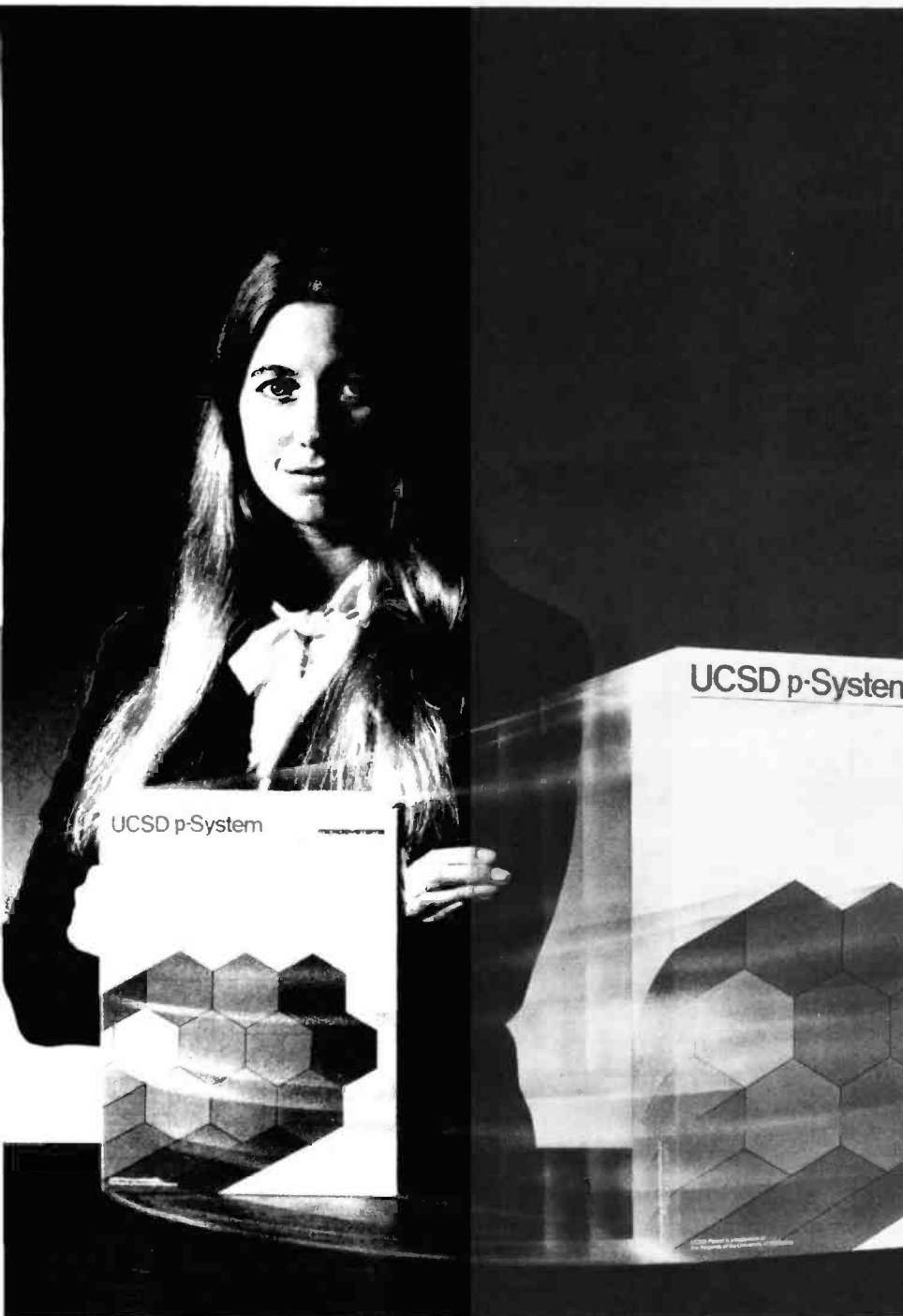


Figure 2: The structure of the job-control file. The file contains "global" parameters—parameters needed by more than one program in the Article/Book Maintenance System—and the parameters that determine which program is executed next.

“Without touching your program  
I can move it to and from Z80, LSI-11™,  
8086, 6502, 8080, 6809, 68000 and  
9900-based computers.”

JULIE ERWIN, Vice President, Marketing, SofTech Microsystems, Inc.



**Y**ou can do it too, with SofTech Microsystems' unique software development and execution environment, the UCSD p-System™.

Our UCSD p-System is the only genuinely machine-independent operating system for 8-bit and 16-bit microcomputers. And to over 50,000 end-users and scores of applications developers it is the one proven, reliable answer to software obsolescence.

For software development, it allows you to work in any combination of UCSD Pascal™, FORTRAN-77, BASIC, and assembly language. It provides support for dynamic memory management and multitasking, with a full arsenal of powerful enhancements, such as a versatile Screen Editor, Native Code Generators, a Print Spooler, TURTLEGRAPHICS and XenoFile™, for easy access to CP/M® disks and files.

Users report that our UCSD p-System's friendly, fast and compact execution environment makes it their first choice in software. So whether you're buying or developing software for your IBM, Apple®, Tandy, Commodore, Texas Instruments, Philips or any other small computer, your best move is to our UCSD p-System. Nothing else touches it.

Our UCSD p-System is available for distribution licensing as well as single copy purchase. Visa and MasterCard orders are welcome, or you may write to us for more details.

**SOFTech**  
**MICROSYSTEMS**  
A SUBSIDIARY OF SOFTech

9494 Black Mountain Road, San Diego,  
CA 92126. (714) 578-6105  
TWX: 910-335-1594

*UCSD p-System and UCSD Pascal are trademarks of the Regents of the University of California. LSI-11 is a trademark of Digital Equipment Corporation. XenoFile is a trademark of SofTech Microsystems, Inc. CP/M is a registered trademark of Digital Research, Inc. Apple is a registered trademark of Apple Computer, Inc.*

**FREE**  
with software purchase—  
One CPM Handbook

# DISCOUNT SOFTWARE

## Ad #25

### ULTIMATE SOFTWARE PLAN

We'll match any advertised price on any item that we carry. And if you find a lower price on what you bought within 30 days of buying it, just show us the ad and we'll refund the difference. It's that simple.

Combine our price protection with the availability of full professional support and our automatic update service and you have the Ultimate Software Plan.

It's a convenient, uncomplicated, logical way to get your software.

✓ (New items or new prices)  
\* Special price of the month.

CP/M users:  
specify disk systems and formats. Most formats available.

CP/M®	DISK WITH MANUAL ONLY	MANUAL ONLY
<b>ARTIFICIAL INTELLIGENCE*</b>		
Medical(PAS-3)	\$849/\$40	
Dental (PAS-3)	\$849/\$40	
<b>ASYST DESIGN*</b>		
Prof Time Accounting	\$549/\$40	
General Subroutine	\$269/\$40	
Application Utilities	\$439/\$40	
<b>COMPLETE BUS. SYSTEMS*</b>		
C/ptor	\$129/\$25	
Reporter	\$129/\$20	
Both	\$299/\$45	
<b>COMPUTER CONTROL*</b>		
Fabs (B-free)	\$119/\$20	
UltraSort II	\$119/\$25	
<b>COMPUTER PATHWAYS*</b>		
Pearl (level 1)	\$ 99/\$25	
Pearl (level 2)	\$299/\$40	
Pearl (level 3)	\$549/\$50	
<b>DIGITAL RESEARCH*</b>		
CP/M 2.2		
NorthStar	\$149/\$25	
TRS-80 Model II (P+T)		
Micropolis	\$159/\$35	
PL/I-80	\$169/\$25	
BT-80	\$459/\$35	
Mac	\$179/\$30	
Sid	\$ 85/\$15	
Z-Sid	\$ 90/\$15	
Tex	\$ 90/\$15	
DeSpool	\$ 50/\$10	
CB-80	\$459/\$35	
CBasic-2	\$ 98/\$20	
<b>D.M.A.</b>		
Ascrom	\$149/\$15	
Formula	\$539/\$45	
<b>GRAHAM-DORIAN*</b>		
General Ledger	\$729/\$40	
Acct Receivable	\$729/\$40	
Acct Payable	\$729/\$40	
Job Costing	\$729/\$40	
Payroll II	\$729/\$40	
Inventory II	\$729/\$40	
Payroll	\$493/\$40	
Inventory	\$493/\$40	
Cash Register	\$493/\$40	
Apartment Mgt	\$493/\$40	
<b>MICRO-AP*</b>		
S-Basic	\$269/\$25	
Selector IV	\$295/\$35	
Selector V	\$495/\$50	
<b>MICRO DATA BASE SYSTEMS*</b>		
HDBS	\$269/\$35	
MDBS	\$795/\$40	
DRS or QRS or RTL	\$269/\$10	
MDBS PKG	\$1295/\$60	
<b>MICROPRO*</b>		
WordStar	\$319/\$60	
Customization Notes	\$429/\$na	
Mail-Merge	\$109/\$25	
WordStar/Mail-Merge	\$419/\$85	
DataStar	\$249/\$60	
WordMaster	\$119/\$40	
SuperSort I	\$199/\$40	
Spell Star	\$175/\$40	
CalcStar	\$259/\$na	
<b>MICROSOFT*</b>		
Basic-80	\$298	
Basic Compiler	\$329	
Fortran-80	\$349	
Cobol-80	\$629	
M-Sort	\$175	
Macro-80	\$144	
Edit-80	\$ 84	
MuSimp/MuMath	\$224	
Mul.isp-80	\$174	
Multi Plan	Call	
Manager Series	Call	

<b>ORGANIC SOFTWARE*</b>		
Tex/Writer III	\$111/\$25	
DateBook II	\$269/\$25	
Milestone	\$269/\$30	
<b>OSBORNE*</b>		
General Ledger	\$ 59/\$20	
Acct Rec/Acct Pay	\$ 59/\$20	
Payroll w/Cost	\$ 59/\$20	
All 3	\$129/\$60	
All 3 + CBASIC-2	\$199/\$75	
Enhanced Osborne	\$269/\$60	
<b>PEACHTREE*</b>		
General Ledger	\$399/\$40	
Acct Receivable	\$399/\$40	
Acct Payable	\$399/\$40	
Payroll	\$399/\$40	
Inventory	\$399/\$40	
Surveyor	\$399/\$40	
Property Mgt	\$799/\$40	
CPA Client Write-up	\$799/\$40	
P5 Version	Add \$129	
Magi/Calc	\$269/\$25	
Other	less 10%	
<b>SOFTWARE WORKS*</b>		
Adapt (CDOS to CP/M)	\$ 49/\$na	
Ratfor	\$ 68/\$na	
<b>SOHO GROUP*</b>		
MatchMaker	\$ 89/\$20	
WorkSheet	\$159/\$20	
<b>STRUCTURED SYSTEMS*</b>		
Business Packages.		
Call for Price		
<b>SORCIM*</b>		
SuperCalc	\$269/\$na	
Trans 86	\$115	
Act	\$157	
<b>TCS*</b>		
GL or AR or AP or Pay.	\$ 79/\$25	
All 4	\$269/\$99	
Compiled each	\$ 99/\$25	
Inventory	\$ 99/\$25	
<b>SUPERSOFT*</b>		
Diagnostic I	\$ 49/\$20	
Diagnostic II	\$ 84/\$20	
Disk Doctor	\$ 84/\$20	
Forth (8080 or Z80)	\$149/\$30	
Fortran	\$219/\$30	
Fortran w/Ratfor	\$299/\$35	
C Compiler	\$174/\$20	
Star Edit.	\$189/\$30	
Other	less 10%	
<b>UNICORN*</b>		
Mince	\$149/\$25	
Scribble	\$149/\$25	
Both	\$249/\$50	
<b>WHITESMITHS*</b>		
"C" Compiler	\$600/\$30	
Pascal (incl "C")	\$850/\$45	
<b>"PASCAL"</b>		
Pascal/MT+ Pkg	\$429/\$30	
Compiler	\$315	
Sp Prog	\$175	
Pascal/Z	\$349/\$30	
Pascal/UCSD 4.0	\$670/\$50	
Pascal/M	\$355/\$20	
<b>"DATA BASE"</b>		
FMS-80	\$649/\$45	
dBASE II	\$595/\$50	
Condor II	\$899/\$50	
<b>"WORD PROCESSING"</b>		
WordSearch	\$179/\$50	
SpellGuard	\$229/\$25	
VTS/80	\$259/\$65	
Magic Wand	\$289/\$45	

Magick Spell	\$269/\$25
Spell Binder	\$349/\$45
Select.	\$495/\$na
The Word	\$ 65/\$na
<b>"OTHER GOODIES"</b>	
Micro Plan	\$419/\$na
Plan 80	\$269/\$30
Target	\$189/\$30
BSTAM	\$149/\$na
BSTMS	\$149/\$na
Tiny "C"	\$ 89/\$50
Tiny "C" Compiler	\$229/\$50
Nevada Cobol	\$179/\$25
MicroStat	\$224/\$25
Vedit	\$130/\$15
MiniModel	\$449/\$50
StatPak	\$449/\$40
Micro B+	\$229/\$20
Raid	\$224/\$35
String/80	\$ 84/\$20
String/80 (source)	\$279/\$na
ISIS CP/M Utility	\$199/\$50
Lynx	\$199/\$20
Supervyz	\$ 95/\$na
CP/M Power	\$ 75/\$na
Mathe Maglc	\$ 95/\$na
<b>APPLE II®</b>	
<b>INFO UNLIMITED*</b>	
EasyWriter	\$199
Datadex	\$249
EasyMailer	\$128
Other	less 15%
<b>MICROSOFT*</b>	
Softcard (Z-80 CP/M)	\$298
Fortran	\$179
Cobol	\$499
Tasc	\$139
<b>MICROPRO*</b>	
Wordstar	\$269
MailMerge	\$ 99
WordStar/MailMerge	\$349
SuperSort I	\$159
SpellStar	\$129
<b>PERSONAL SOFTWARE/ VISICORP®</b>	
Visicalc 3.3	\$225
Desktop/Plan II	\$225
Visiterm	\$ 90
Visidex	\$225
Visiplot	\$180
Visitrend/Visiplot	\$300
Visifile	\$225
<b>PEACHTREE*</b>	
G/L A/R, A/P, Pay or Inventory (each)	\$224/\$40
<b>"OTHER GOODIES"</b>	
VU #3R (use w/Visicalc)	\$ 49
Context Connector (use w/Visicalc)	\$ 99
Micro Courier	\$219
Super-Text II	\$127
Data Factory	\$134
DB Master	\$184
<b>IBM PC SOFTWARE</b>	
Business/Med/WP	
Call for Price	
<b>8086 SOFTWARE</b>	
CBASIC 86	\$300/\$na
Pascal MT + 86 Pkg	\$730/\$na
Pascal UCSD 86	\$700/\$na
Macro 86	\$259/\$na

ORDERS ONLY—CALL TOLL FREE VISA • MASTERCARD  
1-800-854-2003 ext. 823 • Calif. 1-800-522-1500 ext. 823

Outside Continental U.S.—add \$10 plus Air Parcel Post • Add \$3.50 postage and handling per each item  
\* California residents add 6% sales tax • Allow 2 weeks on checks. C.O.D. \$3.00 extra • Prices subject to change without notice. All items subject to availability • ®—Mfgs. Trademark. Blue Label \$3.00 additional per item.

**THE DISCOUNT SOFTWARE GROUP**

6520 Selma Ave. Suite 309 • Los Angeles, Ca. 90028 • (213) 837-5141  
Int'l TELEX 499-0446 DISCSOFT LSA • USA TELEX 194-634 (Attn: 499-0446)  
TWX 910-321-3597 (Attn: 499-0446)

file-name inputs. Two additional utility routines, found at lines 64460 and 64360, are called to process string and numeric values respectively. Whenever the routine at line 64990 is called to check for null input (e.g., line 3110), the jump for null value indicated on the next statement (e.g., line 3120) goes to 65050 to reset the pointers for starting the entry over. To complete command processing, line 3490 calls the routine at 64150 to update the pointers in the job-control file.

4000-4570 LIST-Command Processing. Setting up an entry in the job-control file requires the same kind of processing required in the SORT command. The first and last lines of the code for each command that adds an entry to the job-control file are the same, as shown here:

P1=P (start of command processing)

Text continued on page 366

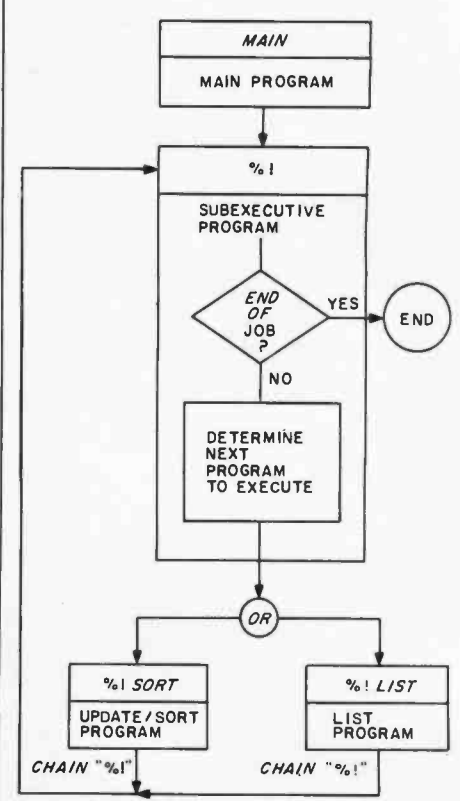


Figure 3: A diagram of control flow in the Article/Book Maintenance System. The main program executes first and calls the subexecutive. Based on data from the job-control file, the subexecutive determines which program executes next.



# STOP SOFTWARE FAILURES

*Using a micro in a product sounds easy...  
One piece of software can make the difference  
between success and failure.*

What do you do when the software doesn't work? Over the years, we have seen many good products fail, either before or after they reached the market, because the microprocessor software did not do its job.

## WHAT WENT WRONG?

Many of the failures occurred because the people programming the micro did not know how to organize a large control program. Those responsible for the product implementation were wizards at hardware design and had easily coded small micro control programs before. But the programming techniques that worked for less than 2K bytes of code simply fell apart as the program grew beyond 4K bytes.

Unfortunately, the loops and tests and flags that work so well for a small program get out of control very rapidly as the program grows. Pretty soon, some of the things the program must do are not being done fast enough. The code gets too complicated, difficult to modify and unreliable. The result: another software failure!

Fortunately, these problems can be avoided by using a program manager. You can divide your complex control program into a number of separate, more manageable programs, called *tasks*, each designed to do one job. For example, a Keyboard Task might handle user input; a Printer Task might generate reports. Each task can be written and tested separately and then combined to form a reliable, finished system.

The program manager, called a *multitasking executive*, supervises the orderly execution of these tasks, assuring that the most important jobs always get done first. Tasks appear to be executing simultaneously. It's almost like having a separate CPU for each task!

That is why professional software designers are now turning to AMX as the starting point for their product and system designs. They know that AMX will shield them from the difficulties of managing the micro, freeing them to concentrate on their application.



AMX is our **multitasking executive** for the 8080, 8085, Z80 and 6809 processors. We're rather proud of it. We made AMX compact, very fast, and ROMable to meet our own application needs. Even though the AMX nucleus is less than 1400 bytes in size, it features multiple task priorities, intertask message passing with priority queuing, external event synchronization, and interval timing with 32-bit precision. Each feature is clearly explained in the AMX Reference Manual.

## RELIABILITY BUILT IN

We don't know anyone who can write an executive without errors, so we thoroughly tested AMX in real applications before ever offering it as a product. That is why not one system malfunction has ever been attributed to AMX. That kind of reliability just isn't an accident.

## HARDWARE INDEPENDENCE

AMX does not require a particular hardware configuration. Of course, it does need a microprocessor, but even there we offer you a choice. *You* control your environment. *You* pick the I/O method. *You* decide the most optimum interrupt service technique for your system. AMX will support your choice.

High level language interface modules are available separately to allow AMX to be used with most popular programming languages including PASCAL, C, PL/M and FORTRAN. Of course, you can also code in assembly language if required.

Users of the CP/M and FLEX Operating Systems can utilize our AMX interface modules to access information on diskette in real time.

## COMPLETE DOCUMENTATION

AMX can be judged by the quality of our documentation. The positive response from our users has exceeded our expectations. Our manuals are especially valuable to those just being introduced to real-time multitasking. More experienced users will appreciate the fact that we deliver AMX source on diskette to permit AMX to be moved to the software development system of your choice.

## HOW TO ORDER

A specification sheet and price list are available, free. Your check or money order for \$75 will purchase the AMX Reference Manual for immediate evaluation (specify 8080, 8085, Z80 or 6809 processor). Add \$25 for postage and handling outside USA and Canada. The standard AMX Multitasking Executive package, including source code, is available for \$800 after signing our liberal license agreement.

AMX is the choice of professionals the world over. Make it yours, today.



## KADAK Products Ltd.

1847 West Broadway Avenue  
Vancouver, B.C., Canada V6J 1Y5  
Telephone (604) 734-2796  
Telex 04-55670

Listing 4: The update file UPDATE2. Line 20 deletes an old entry and replaces it with the data in line 30. The dialogue in listing 5 shows how the Article/Book Maintenance System incorporates UPDATE2 in a new master file.

```
10"Pascal - User Manual & Report\Jensen, K, Wirth, N\1974"  
20-"Basic with Style\\"  
30"Basic with Style - Programming Proverbs\Nagin, P, Ledgard, H\1978"
```

Listing 5: A second sample run of the MAIN program in the Article/Book Maintenance System. Underscored items are entries made by the user. The dialogue causes the system to update the master file, sort and list it by title, then sort and list it by author. Both sets of sorted data appear at the end of the listing.

SAMPLE MAIN

TYPE 'HELP' IN RESPONSE TO 'COMMAND:' IF YOU NEED DETAILED INSTRUCTIONS.  
TO CANCEL ANY COMMAND JUST TYPE A 'RETURN' TO ANY INPUT REQUEST.

DATE: 01/06/81

TIME: 09:00

COMMAND: Sort

MASTER FILE NAME: MASTER

PROCESS UPDATE FILE (Y/N)? Y

UPDATE FILE NAME: UPDATE2

SORT BY TITLE, AUTHOR OR DATE (T/A/D)? T

COMMAND: List

MASTER FILE NAME: MASTER

EACH PRINT LINE WILL CONTAIN THE TITLE, AUTHOR & DATE.

PLEASE SPECIFY THE ORDER TO PRINT.

ENTER 'T' FOR TITLE, 'A' FOR AUTHOR AND 'D' FOR DATE.

FIRST ONE? T

SECOND ONE? A

THIRD ONE? D

COMMAND: Sort

MASTER FILE NAME: MASTER

PROCESS UPDATE FILE (Y/N)? N

SORT BY TITLE, AUTHOR OR DATE (T/A/D)? A

COMMAND: List

MASTER FILE NAME: MASTER

EACH PRINT LINE WILL CONTAIN THE TITLE, AUTHOR AND DATE.

PLEASE SPECIFY THE ORDER TO PRINT.

ENTER 'T' FOR TITLE, 'A' FOR AUTHOR AND 'D' FOR DATE.

FIRST ONE? A

SECOND ONE? T

THIRD ONE? D

COMMAND: Quit

...EXECUTING...UPDATE/SORT PROGRAM

...EXECUTING...LIST PROGRAM

...EXECUTING...UPDATE/SORT PROGRAM

...EXECUTING...LIST PROGRAM

Listing 5 continued on page 352

# DUAL/68000

... Hard Power from  
the Soft Support of

## UNIX<sup>®</sup>

A new and powerful computer has been born... the System 83. The versatile UNIX\* operating system pilots the System 83's raw power through a myriad of software such as "C", FORTRAN, PASCAL, BASIC, COBOL, and even Networking. Step into a bold new frontier with more power than you ever dreamed possible.

### FEATURES:

- UNIX V7 configured by UNISOFT\*\*
- Full IEEE 696/S-100 Compatability
- MC68000 8Mhz Processor
- 32-Bit Data Operations with 32-Bit Internal Registers
- 16-Bit Data Transfer Operations
- Memory Management Allows Concurrent Use of Mapped and Non-mapped Address space
- Rugged Industrial Grade Components at all Levels
- 16 Mb of Main Memory Directly Addressable
- 7 Vectored Interrupt Levels
- 192 Device-supplied Interrupts
- 256 Kb of RAM with Parity Per Board Slot
- Up to 3.2 Mb of RAM Per Cabinet

\* UNIX is a trademark of Bell Laboratories and is supported on the DUAL System 83 by UNISOFT

\*\*UNISOFT is a trademark of UNISOFT Corporation of Berkeley, CA.

Circle 146 on Inquiry card.

**DUAL SYSTEMS CONTROL CORPORATION**

system reliability/system integrity

720 Channing Way • Berkeley • CA 94710 • (415) 549-3854 • Telex: 172029 SPX

www.americanradiohistory.com



-----Output on the printer:

ARTICLE/BOOK LIST	01/06/81 09:00	PAGE 1
TITLE	AUTHOR	DATE
Art of Computer Programming - Fund. Alg. Vol I	Knuth, D.E.	1968
Basic with Style - Programming Proverbs	Nagin, P, Ledgard, H	1978
Pascal - User Manual & Report	Jensen, K, Wirth, N	1974
Z80 Software Gourmet Guide & Cookbook	Wadsworth, N.	1979
...		
ARTICLE/BOOK LIST	01/06/81 09:00	PAGE 1
AUTHOR	TITLE	DATE
Jensen, K, Wirth, N	Pascal - User Manual & Report	1974
Knuth, D.E.	Art of Computer Programming - Fund. Alg. Vol I	1968
Nagin, P, Ledgard, H	Basic with Style - Programming Proverbs	1978
Wadsworth, N.	Z80 Software Gourmet Guide & Cookbook	1979

## YOU'VE NEVER SEEN DISCOUNTS LIKE THESE!



**CROMEMCO**

**SYSTEM ONE \$2999**  
**SYSTEM 1H 5395**



**SYSTEM TWO \$3995**  
**SYSTEM Z2H 7495**



**SYSTEM THREE \$5999**



**VIDEO TERMINAL 3102 \$2099**

**NEW CROMEMCO PRODUCTS**

8 and 16 BIT DUAL PROCESSORS

CSID2E (256K RAM)	\$4299
CSID5E (512K RAM)	4999
CSIHD2E (256K, 5 Meg. H.D.)	5999
CS3D5E (512K RAM)	7299
CS3HD40E (5 Meg. H.D., 4 Meg. RAM)	20995

**MAXELL DISKETTES Boxes of 10**

<b>MD 1 \$39.95</b>	<b>FD 1 \$42.95</b>
<b>MD 2 49.95</b>	<b>FD 2 57.95</b>

**MORE SPECIALS**

<b>ATARI 800 \$ 699</b>	<b>EPSON MX80 \$ 499</b>
<b>TI 810 Printer 1349</b>	<b>EPSON MX80 FT 599</b>
<b>QANTEX Printer 1049</b>	<b>EPSON MX100 759</b>
<b>ADDS Viewpoint 599</b>	<b>SOROC IQ130 699</b>
<b>ADDS Regent 25 879</b>	<b>DEC LA34 949</b>

CALL FOR INFORMATION ON  
NORTHSTAR, HAZELTINE,  
LEAR-SIEGLER, QUME, INTEGRAL DATA  
SYSTEMS, OKIDATA, TELEVIDEO,  
DIGITAL MICRO SYSTEMS

All prices are CASH. American Express, Visa, Master Card, add 5%  
Prices subject to change without notice

**DATA DISCOUNT CENTER**  
P.O. BOX 233, Greenvale, New York 11548

**PHONE ORDERS CALL**  
**516-869-8537**

# Now NRI takes you inside the new TRS-80 Model III microcomputer to train you at home as the new breed of computer specialist!

**NRI teams up with Radio Shack advanced technology to teach you how to use, program and service state-of-the-art microcomputers...**

It's no longer enough to be just a programmer or a technician. With microcomputers moving into the fabric of our lives (over 250,000 of the TRS-80™ alone have been sold), interdisciplinary skills are demanded. And NRI can prepare you with the first course of its kind, covering the complete world of the microcomputer.

## Learn At Home in Your Spare Time

With NRI training, the programmer gains practical knowledge of hardware, enabling him to design simpler, more effective programs. And, with advanced programming skills, the technician can test and debug systems quickly and easily.

Only NRI gives you both kinds of training with the convenience of home



study. No classroom pressures, no night school, no gasoline wasted. You learn at your convenience, at your own pace. Yet you're always backed by the NRI staff and your instructor, answering questions, giving you guidance, and available for special help if you need it.

## You Get Your Own Computer to Learn On and Keep

NRI training is hands-on training, with practical experiments and demonstrations as the very foundation of your knowledge. You don't just program your computer, you go inside it... watch how circuits interact... interface with other systems... gain a real insight into its nature.

You also work with an advanced liquid crystal display hand-held multimeter and the NRI Discovery Lab, performing over 60 separate experiments. You learn troubleshooting procedures and gain greater understanding of the information. Both microcomputer and equipment come as part of your training for you to use and keep.

## Send Or Call For Your Free Catalog...

You'll get all the details in NRI's FREE, 100-page catalog. It will show you all the equipment, lesson outlines and facts on other electronic courses, including Communications Electronics, TV/Audio/Video, Electronic Design and more. Send coupon below or phone right now using our TOLL-FREE number 1-800-323-1717, at no expense to you. If coupon is missing, write NRI Schools, 3939 Wisconsin Avenue, Washington, DC 20016.

## MAIL COUPON OR CALL TOLL-FREE 1-800-323-1717

Ask for Operator 52 (In Illinois, phone 1-800-942-8881)



Training includes new TRS-80 Model III microcomputer, 6-function LCD Beckman multimeter, and the NRI Discovery Lab with hundreds of tests and experiments.

(TRS-80 is a trademark of the Radio Shack division of Tandy Corp.)



**NRI Schools**  
McGraw-Hill Continuing  
Education Center  
3939 Wisconsin Avenue  
Washington, D.C. 20016  
**We'll give you tomorrow.**



All career courses approved under GI bill.  
 Check for details

### CHECK ONE FREE CATALOG ONLY NO SALESMAN WILL CALL ON YOU

- Computer Electronics including Microcomputers
- Color TV, Audio, and Video System Servicing
- Electronics Design Technology
- Digital Electronics
- Communications Electronics • FCC Licenses • Mobile CB • Aircraft • Marine

- Industrial Electronics
- Basic Electronics
- Small Engine Servicing
- Appliance Servicing
- Automotive Servicing
- Auto Air Conditioning
- Air Conditioning, Heating, Refrigeration, & Solar Technology
- Building Construction

Name (Please Print) Age

Street

City/State/Zip

Accredited by the Accrediting Commission of the National Home Study Council

170-052

**Listing 6:** The MAIN program in the Article/Book Maintenance System. This program is the executive that manages the other programs. It handles all interaction with the user and sets up a job-control file. MAIN repeatedly calls the utility subroutines found at lines 64000 through 65040.

```
10 REM* MAIN EXECUTIVE (SAVED IN FILE "MAIN")
20 REM* 12/16/80 WRITTEN BY GENE F. WALTERS
30 REM* SET UP PARAMETERS
40 DIM V$(80)
50 D1=0 \REM DEVICE FOR CONSOLE
60 D3=0 \REM DISK FILE FOR THE SYSTEM
70 U=3 \REM NO. OF DRIVES IN SYSTEM
80 L1=5 \REM NO. OF BYTES FOR NUMERIC VALUES
90 L2=2 \REM NO. OF BYTES OF OVERHEAD FOR A STRING < 256 CHAR
100 DATA "HELP","QUIT","SORT","LIST" \REM AVAILABLE COMMANDS
110 N9=4 \REM NO. OF COMMANDS THAT CAN BE EXECUTED
120 N=0 \REM NO. OF COMMANDS IN JOB CONTROL FILE
130 B=5 \REM NO. OF BLOCKS FOR JOB CONTROL FILE
140 P=L1+L1 \REM POSITION OF NEXT AVAILABLE BYTE IN JOB CONTROL FILE
150 S$="%!" \REM PREFIX FOR SYSTEM FILE NAMES
160 GOSUB 64520 \REM SIGN-ON MESSAGE
170 FOR I=1 TO U
180 U$=CHR$(I+48)
190 IF FILE(S$+" "+U$)=2 THEN EXIT 220
200 NEXT I
210 PRINT #D1,"COULDN'T FIND SUBEXECUTIVE FILE [",S$,"]." \END
220 F$=S$+"JCL,"+U$
230 IF FILE(F$)=3 THEN 250
240 CREATE F$,B
250 OPEN #D3,F$
260 WRITE #D3,N,0
270 GOSUB 5000 \REM SET UP GLOBAL PARAMETERS IN JOB CONTROL FILE
280 REM* INPUT NEXT COMMAND
290 RESTORE \INPUT #D1,"NEXT COMMAND: ",C1$
300 I$=C1$ \GOSUB 64990 \REM CHECK FOR NULL INPUT
310 ON Z GOTO 320, 290
320 FOR I=1 TO N9
330 READ C2$
340 IF LEN(C1$)>LEN(C2$) THEN 380
350 IF C1$<>C2$(1,LEN(C1$)) THEN 380
360 N=N+1
370 ON I GOTO 1000, 2000, 3000, 4000 \REM GOTO FOR EACH COMMAND
380 NEXT I
390 PRINT #D1,"INVALID COMMAND!"
400 GOTO 290
1000 REM* HELP COMMAND
1010 RESTORE
1020 PRINT #D1
1030 PRINT #D1,"COMMANDS AVAILABLE: ",
1040 FOR I=1 TO INT((N9+5)/6)
1050 FOR J=1 TO N9-INT(N9/6)*6
1060 READ C2$
1070 PRINT #D1,C2$,
1080 IF (I-1)*6+J<>N9 THEN PRINT #D1,", "
1090 NEXT J
1100 PRINT #D1 \PRINT #D1,TAB(20),
```

Listing 6 continued on page 356



# EPSON

## PRINTERS & ACCESSORIES

If you buy your EPSON somewhere else you'll probably pay too much!

### Common Features of the MX80, MX80FT & MX100 Printers

- 80 characters per second
- Replaceable print head by user
- User programmable from BASIC
- Bi-directional logic seeking printhead
- 96 ASCII characters
- Programmable tabs (vert./horz.)
- Cartridge ribbons
- Self-test mode
- Tractor/pin feed paper flow
- Extreme reliability
- 12 type fonts under software control
- 9x9 & 9x18 matrix
- Programmable form leads
- Compressed/expanded letters
- Parallel interface standard
- Double strike & emphasized modes

**MX80**...The Printer that started it all. All of the above features plus extreme ease of use. Complete TRS80 block graphics set as well as user selectable international symbols. Gives correspondence quality printing in several user selectable modes. Dip switch pins may be set for dedicated applications. Complete forms programmability from BASIC software.

**MX80FT**...All the features of the MX80 but with FRICTION feed as well for the use of single sheets of paper or roll paper. An exceptional buy for the user needing the single sheet capability. In the compressed mode 132 characters can be printed across the width of a page which means it can be used for any printouts that normally need a 15 inch wide printer.

**MX100**... An exceptional printer with an extra quiet printhead and extra heavy duty construction for the intense use of a business environment. Does not have the TRS80 graphic blocks but comes standard with Bit-Image graphics which allow the user control of individual dots for designing specialized graphs, symbols, etc. A best buy for business use.

**MX70**...For the budget minded an excellent entry level printer. It has most all of the features mentioned above including Bit-Image graphics in place of the TRS80 graphic blocks set. The Printer is unidirectional only. Expandable text can be printed but not compressed. Only single density printings is supported on the MX70. An inexpensive heavy duty printer.

**BEST prices on Epson Printers**  
**All Printers & accessories in STOCK now!!!**

### EPSON ACCESSORIES, INTERFACES & CABLES

- GRAPHTRAX 80 option (bit-image/italics)...\$79
- CABLE Model I interface & Model III.....\$35
- \$25 if purchased with EPSON printer
- CABLE & INTERFACE to Model I keyboard...\$85
- APPLE interface & cable.....\$89
- GRAPPLER Apple hi resolution graphics...\$Call
- IEEE interface & cable (CBM/Pet).....\$79
- ATARI cable (must have 850 interface).....\$35
- SERIAL RS232 2k buffered int. card.....\$149
- RS COLOR computer to Epson card/cable...\$59

REBUNDLES AND CARTRIDGES IN STOCK NOW

**CALL 800-433-5184**

### EPSON PACK 2 - GRAFTRAX

version for MX80, 80FT & MX100. This package includes updated versions of modules in original Epson Pack. A screen oriented BIT IMAGE GRAPHICS generator utility is provided. Create your special characters, symbols, etc. directly on your monitor and then send to printer. Printout includes code to generate graphics and will save needed code as BASIC program line to disk. Then MERGE these into your BASIC program. Also demo programs showing use of Bit-Image graphics. Full documentation. **INTRO SPECIAL: \$24.95 with printer or GRAFTRAX. \$34.95 separately. \$7.50 for update of old Epson Pack**

## PRINTERS

### MATRIX PRINTERS

EPSON MX70	\$CALL
EPSON MX80	\$CALL
EPSON MX80 FT	\$CALL
EPSON MX100 FT	\$CALL
LINE PRINTER VII RS	\$325
NEC 8023A	\$495
C. ITOH 8510	\$495
OKIDATA 82A	\$499
OKIDATA 82A w/tractor	\$559
OKIDATA 83A	\$769
LINE PRINTER VIII RS	\$649
CENTRONICS 739parallel	\$599
CENTRONICS 739 serial	\$749
OKIDATA 84 / 200cps	\$1295
LINE PRINTER VI RS	\$988
CENTRONICS 704	\$1559
ANADEx 9500/01 2k buf.	\$1295
TEXAS INST. 810 Basic	\$1595
LINE PRINTER V RS	\$1549
Centronics 352 / 200 cps	\$1795
Centronics 353 / dual mode, 200cps data proc., 50cps super letter quality	\$2495

### LINE PRINTERS

CENTRONICS 6080/81	
600 lines per minute high speed band printer. For serious business applications.	
6081 standard	\$7676
6080 quietized cabinet	\$6399

### LETTER QUALITY

#### Daisy Wheel / Spinwriters

C. ITOH F-10 / 40 cps	\$1595
DAISY WHEEL II RS	\$1695
NEC SPINWRITERS	
3510 RS232	\$1795
3530 Centronics pa'lel	\$1795
7710 Read Only	\$2375
7710 R/O w/tractor	\$2575
7720 kybd w/tractor	\$2750
7730 R/O parallel	\$2375
7730 R/O par. w/tract.	\$2575
DIABLO 630 R/O	\$2350
DIABLO 630 keyboard	\$2850
QUME 9/35 R/O	\$1850
QUME 9/35 keyboard	\$1950
QUME 9/45 limited	\$2295
QUME 9/55 limited	\$2395

Interfaces & cables available for most printers with any TRS80, Apple, Atari & most other computers. **\$\$\$CALL FOR PRICES!**

### HIGH RESOLUTION MONITOR

NEC green monitor	\$179
NEC color monitor	\$349

### ALTOS COMPUTERS \$CALL

## TEXAS COMPUTER SYSTEMS

Offers Lowest Prices on

# TRS-80



MODEL II 64k.....	\$3248
MODEL II 1 Drive Expansion.....	\$995
MODEL II 2 Drive Expansion.....	\$1495
MODEL II 3 Drive Expansion.....	\$1995
Radio Shack HARD DISK.....	\$3995
TCS 1 Drive/single cabinet.....	\$849
TCS 1 Drive/triple cabinet.....	\$949
TCS 2 Drive/triple cabinet.....	\$1424
TCS 3 Drive/triple cabinet.....	\$1899
TCS uses original Shugart drives	
MODEL 16 1 Drive.....	\$4499
MODEL 16 2 Drive.....	\$5199
DT-1 DATA TERMINAL.....	\$629

### CORVUS HARD DISKS

CALL FOR PRICES \$\$\$\$

Add 5, 10 or 20 megabytes of storage to your TRS80, Apple, Atari, Heath, Zenith, Intertec, IBM, S-100 and many others. One or several computers can share a hard disk. Get simultaneous access to data for multiple users. Available NOW at SUPER SAVINGS!

**DEALERS...You can buy CORVUS from us for less. Call & SAVE.**

### COLOR COMPUTERS

Original mfg.warranty on these items:	TCS 180 day Limited warranty on TCS Items:
4K Level 1.....\$308	16K Level 1.....\$369
16K Level 1.....\$439	16K Extended Basic.....\$439
16K Extended Basic.....\$459	32K Extended Basic.....\$499
32K Extended Basic.....\$569	32K Upgrade Kit (TCS).....\$79
Color Disk 0...\$499	Disk 1...\$349
	EPSON/COLOR Int.& cable...\$59

### MODEL III SYSTEMS

The following with Radio Shack Warranty:

Model III 16k.....	\$818
Model III 32k.....	\$918
Model III 48k.....	\$1018
Model III 48k 2 Drives RS232	\$2049

The following come with quality TCS memory and our own 180 day limited warranty. No warranty when customer opens computer or adds internal components.

MODEL III 16k TCS.....	\$788
MODEL III 32k TCS.....	\$818
MODEL III 48k TCS.....	\$848

### MODEL III DISK EXPANSION KITS

We use the highest quality fiberglass CONTROLLER BOARDS with double sided glass epoxy board and gold plated contacts in our TCS systems. The finest switching POWER SUPPLY available is also provided. The aluminum MOUNTING HARDWARE has slotted holes for easy installation of the drives and includes all the power and data cables necessary to install the controller, drives and power supply.

Our DISK DRIVES are made by Tandon the same company that makes the drives used by Radio Shack. These drives are 40 track, double density, 5 millisecond stepping rate and are fully burned in for 48 hours. These drives have the same specifications as the drives used by Radio Shack. No soldering or modifications to existing circuitry is necessary. The following kits are available:

KIT 1 Controller, Power Supply & Mounting Hardware.....	\$379
KIT 2 Controller, Power Supply, Hardware & 1 Disk Drive.....	\$595
KIT 3 Controller, Power Supply, Hardware & 2 Disk Drives.....	\$819
KIT 4 One Tandon Disk Drive (bare drive only).....	\$219
KIT 5 16K of High Quality TCS Memory chips.....	\$49.95
KIT 6 32k of High Quality TCS Memory chips.....	\$79.95

### MODEL III 48k 2 DISK DRIVES ... \$1795

Above KIT fully assembled, with 48 hour burn-in test & 180 day TCS Limited Warranty!!

### CUSTOM SOFTWARE FROM TCS

Completely Integrated BINARY SEARCH TREE programs now available. This series of programs fully implements the B-TREE structures including INSERTION, DELETION, EDITING & TRAVERSAL. No more sorting or long data file searches and yet files can be larger than memory. Duplicate keys are fully supported. Files can be retrieved in sorted order via B-TREE Traversal. Each of the programs come with fully commented source code so that you can use the modules in your own programming.

B-TREE Library (organize your home library keyed by author).....	\$39.95
B-TREE Video (organize your video cassette library, prints labels, etc).....	\$39.95
B-TREE Mailing List (keyed by name or zip,label printing,etc).....	\$49.95

For fast, efficient service. **Heart of** we can air freight from Dallas

## TEXAS COMPUTER SYSTEMS

P.O. Box 1327 Arlington, Texas 76004-1327

★ Toll Free Number 800 433-5184

Texas Residents 817 274-5625

Payment: Money order, cashiers or certified check. Prices above reflect 3% cash Discount. Call for Visa/MC card prices.

• Prices subject to change at any time  
• No Tax out-of-state (Texans add 5%)  
• Many items shipped FREE. Call for quote.

Listing 6 continued:

```
1110 NEXT I
1120 PRINT #D1
1130 GOTO 290
2000 REM* QUIT COMMAND
2010 WRITE #D3%P,0
2020 CLOSE #D3
2030 CHAIN S$+A$+", "+U$
3000 REM* SORT COMMAND
3010 P1=P \REM SAVE CURRENT POSITION OF BYTE POINTER
3020 P$=S$+"SORT"+A$+", "+U$
3030 GOSUB 64260 \REM SAVE BYTE COUNTER & PROGRAM NAME TO EXEC
3040 V$="UPDATE/SORT PROGRAM"
3050 GOSUB 64460 \REM ADD STRING PARAMETER FOR PROGRAM DESCRIPTOR
3060 PRINT #D1,"MASTER ",
3070 GOSUB 64870 \REM GET FILE NAME
3080 GOSUB 64670 \REM SEPARATE OUT UNIT & CHECK FOR EXISTENCE
3090 ON Z GOTO 3170, 3100
3100 INPUT #D1,"MASTER FILE DOESN'T EXIST. IS THIS OKAY (Y/N)? ",X$
3110 I$=X$ \GOSUB 64990 \REM CHECK FOR NULL INPUT
3120 ON Z GOTO 3130, 65050
3130 IF X$="Y" THEN 3170
3140 IF X$="y" THEN 3170
3150 IF X$="N" THEN 65050
3160 IF X$="n" THEN 65050 ELSE 3100
3170 V$=F1$ \GOSUB 64460 \REM ADD STRING PARAMETER F1$, MASTER FILE NAME
3180 V$=F2$ \GOSUB 64460 \REM ADD STRING PARAMETER F2$, MASTER UNIT NO.
3190 INPUT #D1,"PROCESS UPDATE FILE (Y/N)? ",X$
3200 I$=X$ \GOSUB 64990 \REM CHECK FOR NULL INPUT
3210 ON Z GOTO 3220, 65050
3220 IF X$="Y" THEN 3290
3230 IF X$="y" THEN 3290
3240 IF X$="N" THEN 3260
3250 IF X$<>"n" THEN 3190
3260 V$="" \GOSUB 64460 \REM ADD NULL STRING FOR UPDATE FILENAME
3270 GOSUB 64460 \REM ADD NULL STRING FOR UPDATE UNIT NO.
3280 GOTO 3370
3290 PRINT #D1,"UPDATE ",
3300 GOSUB 64870 \REM GET FILE NAME
3310 GOSUB 64670 \REM SEPARATE OUT UNIT & CHECK FOR EXISTENCE
3320 ON Z GOTO 3350, 3330
3330 F9$=F$ \GOSUB 64800 \REM COULDN'T FIND FILE
3340 GOTO 65050
3350 V$=F1$ \GOSUB 64460 \REM ADD STRING PARAMETER F1$, UPDATE FILE NAME
3360 V$=F2$ \GOSUB 64460 \REM ADD STRING PARAMETER F2$, UPDATE UNIT NO.
3370 V=0
3380 INPUT #D1,"SORT BY TITLE, AUTHOR OR DATE (T/A/D)? ",X$
3390 I$=X$ \GOSUB 64990 \REM CHECK FOR NULL INPUT
3400 ON Z GOTO 3410, 65050
3410 IF X$="T" THEN V=1
3420 IF X$="t" THEN V=1
3430 IF X$="A" THEN V=2
3440 IF X$="a" THEN V=2
3450 IF X$="D" THEN V=3
3460 IF X$="d" THEN V=3
```

Listing 6 continued on page 358

# THE FORTH SOURCE™

## FORTH DISKS WITH DOCUMENTATION

- fig-FORTH Model and Source Listing**, with printed Installation Manual and Source Listing.
- APPLE II 5%  8080/Z80® 8
  - 8086/8088 8  H89/Z89 5% \$65.00
  - APPLE III/II +** by MicroMotion. Version 2. FORTH-79 Standard, editor, assembler, 200 pg manual, 5% 100.00
  - APPLE III/II + COMBO 1** by MicroMotion. Version 2. All of the above plus floating point and HiRes Turtle graphics 140.00
  - APPLE II** by Kuntze. fig-FORTH editor, assembler, source listing and screens, 5% 90.00
  - ATARI®** by Pink Noise Studio. fig-FORTH, editor, assembler, missile graphics, sound and handle drivers, 5% 90.00
  - CP/M** by MicroMotion. Version 2.x. FORTH-79 Standard, editor, assembler. 200 pg manual, 8 100.00
  - CP/M Combo 1** by MicroMotion. 2.x. All of the above plus floating point. 140.00
  - CROMEMCO®** by Inner Access fig-FORTH editor, assembler, 5% or 8 100.00
  - H89/Z89** by Haydon. fig-FORTH Stand Alone, source, editor, assembler & tutorial on disk. 5% 250.00
  - H89/Z89** by Haydon. fig-FORTH, CP/M®, source, editor, assembler, & tutorial on disk, 5% 175.00
  - HP-85** by Lange. fig-FORTH, editor and assembler, 5% 90.00
  - IBM® PC/FORTH** by Laboratory Microsystems. fig-FORTH, editor and assembler. Manual, 5% 100.00
  - IBM-Floating Point** by Laboratory Microsystems. Requires PC/FORTH. Specify software or for AMD 9511, AMD 9512 or Intel 8087 100.00
  - IBM-Cross Compiler** by Laboratory Microsystems. Requires PC/FORTH. (Nautilus Systems Model) 300.00
  - PET®** by FSS. fig-FORTH editor and assembler, 5%  **PET®** with floating point, strings, disk I/O 90.00  
150.00
  - TRS-80/II** by Nautilus Systems. fig-FORTH, editor and assembler, 5% 90.00
  - TRS-80/II or III** by Miller Microcomputer Services. MMSFORTH, FORTH-79 subset, editor, assembler, dbi-precision, arrays, utilities & applications. 210 pg. manual, 5% 130.00
  - 6800** by Talbot Microsystems. fig-FORTH, editor, assembler, disk I/O, FLEX® 5% or 8 100.00
  - 6809** by Talbot Microsystems. fig-FORTH, editor, assembler, disk I/O, FLEX® 5% or 8 100.00
    - 6809 Enhanced 2nd screen editor, macroassembler, tutorial, tools and utilities, FLEX** 250.00
  - Z80** by Laboratory Microsystems. Editor and assembler, CP/M, 8 50.00
    - Z80, floating point, requires Z80 above 150.00
    - Z80, AMD 9511 support, requires Z80 above 150.00
  - Z80** by Inner Access. Editor, assembler and manual, CP/M, 8 100.00
  - 8080** by Inner Access. Editor, assembler, and manual, CP/M, 8 100.00
  - 8086/88** by Laboratory Microsystems. Editor, assembler, CP/M-86®, 8 100.00
    - 8086/88 with floating point, CP/M-86 200.00
    - 8086/88 with AMD 9511 support CP/M-86 200.00

## PRICE

## FORTH MANUALS, GUIDES, & DOCUMENTS

- "All About FORTH"** by Haydon. Ideograms (words) of fig-FORTH, FORTH-79, Starting FORTH and much more. A MUST! A *public domain* product. 20.00
- "FORTH Encyclopedia"** by Baker and Derick. A complete programmer's manual to fig-FORTH with FORTH-79 references. Flow Charted 25.00
- "Starting FORTH"** by Brodie. Prentice Hall. Best user's manual available. (soft cover) 16.00
- "Starting FORTH"** (hard cover) 20.00
- "METAFORTH"** by Cassidy. Cross compiler with 8080 code. 30.00
  - Proceedings of Technical Conferences
  - "1980 FORML" (FORTH Modification Laboratory) 25.00
  - "1981 FORML" Two Volume Set 40.00
  - "1981 Rochester University" 25.00

## PRICE

## MORE FORTH BOOKS & MANUALS

- "Systems Guide to fig-FORTH"** 25.00
- "Using FORTH"** 25.00
- "A FORTH Primer"** 25.00
- "Caltech FORTH Manual"** 12.00
- "Threaded Interpretive Languages"** 20.00
- "Invitation to FORTH"** 20.00
- "PDP-11 FORTH User's Manual"** 20.00
- "AIM FORTH User's Manual"** 12.00
- "APPLE® (MicroMotion) User's Manual"** 20.00
- "CP/M® (MicroMotion) User's Manual"** 20.00
- "TRS-80® MMSFORTH User's Manual"** 18.50
- "FORTH-79 Standard"** 15.00
- "Tiny Pascal in fig-FORTH"** 10.00
- "FORTH-79 Standard Conversion"** 10.00

## INSTALLATION DOCUMENTS

- Installation Manual for fig-FORTH**, contains FORTH model, glossary, memory map, and instructions Source Listings of fig-FORTH, for specific CPU's and computers. The above Installation manual is required for implementation. Each 15.00
- 1802  6502  6800  AlphaMicro
- 8080  8086/88  9900  APPLE II®
- PACE  6809  NOVA  PDP-11/LSI/11

## FORTH PROGRAMMING DISKS

- "MVP-FORTH"** by Haydon & Boutelle. An extended program development system. Based on "All About FORTH" and optimized for CP/M and 8080/Z80. A *public domain* product. 8 inch \$ 75.00
- "FORTH PROGRAMMING AIDS"** by Curry Assoc. Decompiler, Subroutine Decompiler, Callfinder and Translator requires fig-FORTH nucleus. Specify CP/M, 8" or Apple 3.3, 5% 150.00

## CROSS COMPILER DISKS

*Allows extending, modifying and compiling for speed and memory savings, can also produce ROMable code.*

*Nautilus (NS), Talbot Microsystems (TM), Laboratory Microsystems (LM) and Inner Access (IA).*

- CP/M (NS) 200.00  IBM (LM)\* 300.00
- H89/Z89 (NS) 200.00  8086 (LM)\* 300.00
- TRS80/1 (NS) 200.00  Z80 (LM)\* 200.00
- Northstar (NS) 200.00  CP/M (IA) 450.00
- 6809 (TM) 350.00  Cromemco (IA) 450.00

\* Requires FORTH disk

## ORDERS ONLY (415) 961-4103

## DEALER & AUTHOR INQUIRIES INVITED

**Ordering Information:** Check, Money Order (payable to MOUNTAIN VIEW PRESS, INC.), VISA or MasterCard accepted. No COD's or unpaid PO's. California residents add 6 1/2% sales tax. Shipping costs in US included in price. Foreign orders, pay in US funds on US bank, include for handling and shipping by Air: \$5.00 for each item under \$25.00, \$10.00 for each item between \$25.00 and \$99.00 and \$20.00 for each item over \$100.00. Minimum order \$10.00. All prices and products subject to change or withdrawal without notice. Single system and/or single user license agreement required on some products.

Specializing in the FORTH Language

# MOUNTAIN VIEW PRESS, INC.

PO BOX 4656

MOUNTAIN VIEW, CA 94040

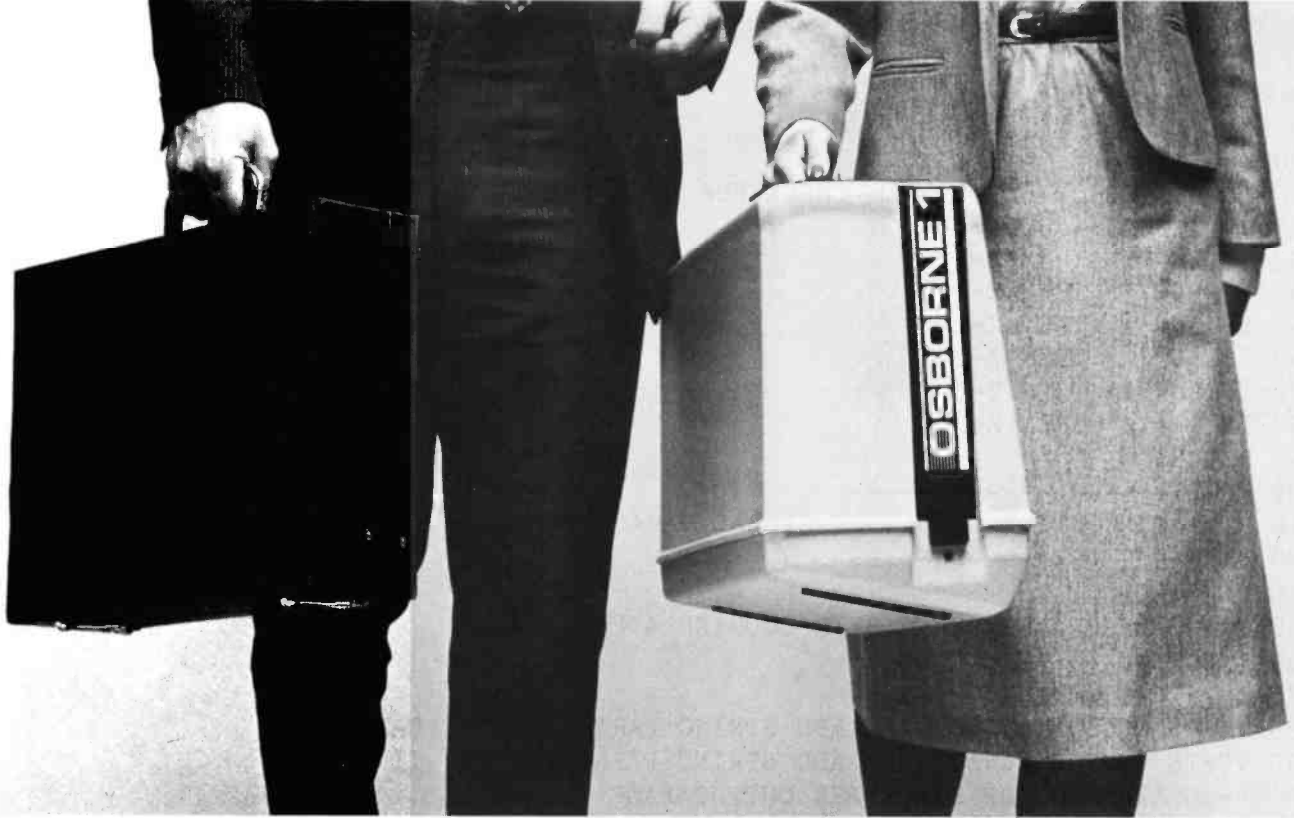
(415) 961-4103



Listing 6 continued:

```
3470 IF V=0 THEN 3380
3480 GOSUB 64360 \REM ADD NUMERIC PARAMETER, SORT OPTION
3490 GOSUB 64150 \REM UPDATE NO. OF COMMAND ENTRIES
3500 GOTO 290
4000 REM* LIST COMMAND
4010 P1=P \REM SAVE CURRENT POSITION OF BYTE POINTER
4020 P$=S$+"LIST"+A$+", "+U$
4030 GOSUB 64260 \REM SAVE BYTE COUNTER & PROGRAM NAME TO EXEC
4040 V$="LIST PROGRAM"
4050 GOSUB 64460 \REM ADD STRING PARAMETER FOR PROGRAM DESCRIPTOR
4060 PRINT #D1,"MASTER ",
4070 GOSUB 64870 \REM GET FILE NAME
4080 GOSUB 64670 \REM SEPARATE OUT UNIT & CHECK FOR EXISTENCE
4090 ON Z GOTO 4170, 4100
4100 INPUT #D1,"MASTER FILE DOESN'T EXIST. IS THIS OKAY (Y/N)? ",X$
4110 I$=X$ \GOSUB 64990 \REM CHECK FOR NULL INPUT
4120 ON Z GOTO 4130, 65050
4130 IF X$="Y" THEN 4170
4140 IF X$="y" THEN 4170
4150 IF X$="N" THEN 65050
4160 IF X$="n" THEN 65050 ELSE 4100
4170 V$=F1$ \GOSUB 64460 \REM ADD STRING PARAMETER F1$, MASTER FILE NAME
4180 V$=F2$ \GOSUB 64460 \REM ADD STRING PARAMETER F2$, MASTER UNIT NO.
4190 PRINT #D1,"EACH PRINT LINE WILL CONTAIN THE TITLE, AUTHOR & DATE."
4200 PRINT #D1,"PLEASE SPECIFY THE ORDER TO PRINT."
4210 PRINT #D1,"ENTER 'T' FOR TITLE, 'A' FOR AUTHOR AND 'D' FOR DATE."
4220 INPUT #D1,"FIRST ONE? ",B$
4230 I$=B$ \GOSUB 64950 \REM CHECK FOR NULL INPUT
4240 ON Z GOTO 4250, 65010
4250 GOSUB 4490 \REM CONVERT B$ TO 1=T, 2=A, 3=D, 4=NONE
4260 B1=Z
4270 ON Z GOTO 4280, 4280, 4280, 4220
4280 INPUT #D1,"SECOND ONE? ",B$
4290 I$=B$ \GOSUB 64950 \REM CHECK FOR NULL INPUT
4300 ON Z GOTO 4310, 65010
4310 GOSUB 4490 \REM CONVERT B$ TO 1=T, 2=A, 3=D, 4=NONE
4320 B2=Z
4330 ON Z GOTO 4340, 4340, 4340, 4280
4340 IF B2=B1 THEN 4470
4350 INPUT #D1,"THIRD ONE? ",B$
4360 I$=B$ \GOSUB 64950 \REM CHECK FOR NULL INPUT
4370 ON Z GOTO 4380, 65010
4380 GOSUB 4490 \REM CONVERT B$ TO 1=T, 2=A, 3=D, 4=NONE
4390 B3=Z
4400 ON Z GOTO 4410, 4410, 4410, 4350
4410 IF B3=B1 OR B3=B2 THEN 4470
4420 V=B1 \GOSUB 64360 \REM ADD NUMERIC PARAMETER B1, 1ST PRINT FIELD
4430 V=B2 \GOSUB 64360 \REM ADD NUMERIC PARAMETER B2, 2ND PRINT FIELD
4440 V=B3 \GOSUB 64360 \REM ADD NUMERIC PARAMETER B3, 3RD PRINT FIELD
4450 GOSUB 64150 \REM UPDATE NO. OF COMMAND ENTRIES
4460 GOTO 290
4470 PRINT #D1,"INPUT ERROR. PLEASE START OVER."
4480 GOTO 4220
4490 REM SUBROUTINE TO CONVERT B$ TO 1=T, 2=A, 3=D, 4=NONE
```

Listing 6 continued on page 360



# The guy on the left doesn't stand a chance.

He's carrying a briefcase with two file folders, a news-magazine, and a sandwich.

She's carrying the OSBORNE 1®—the portable personal business computer. Using the OSBORNE 1, she is going to get more work done and better work done—in less time, and with less effort. She won't have to eat lunch at her desk.

## Is competition a question of getting ahead, or of not being left behind?

Hardly an academic question in today's business environment. The computer is here to stay. And those who are grasping the tools of this technology are moving forward faster.

The OSBORNE 1 is a powerful computer that can handle all the details of the words, numbers, and information you deal with every day. You free up time to work with the essence of your day, not the detail. And you master a powerful new personal extension. A tool that will enable you to do jobs you simply could not consider before.

Consider the built-in advantage you gain over the person who is still shuffling tedium.

## The most intelligent purchase you can make.

Lots of big and little computers can make a similar promise. But none can match this: the OSBORNE 1 delivers two disk drives, a **complete** computer with communications capabilities, a business keyboard, and CRT screen. Plus five productivity

software packages with a retail value of over \$1500. Including CP/M®, word processing, an advanced electronic spreadsheet, and BASIC languages. All for a total price of only \$1795. All in a portable package that fits under the seat of your airplane.

To explore the very competitive capabilities of the OSBORNE 1, visit your local authorized computer retailer. A demonstration will show you just how easily you can put the power of the OSBORNE 1 into your career.

And you will quickly see why the OSBORNE 1 is the \$1795 productivity investment that is changing the way people go to work.

**\$1795.  
Complete**



# OSBORNE

The \$1795 suggested retail price for the Osborne 1 (a registered trademark of Osborne Computer Corporation) includes the following software packages: WORDSTAR™ with MAILMERGE® (a trademark and a registered trademark of MicroPro International Corporation of San Rafael, California, U.S.A.); SUPERCALC™ (a trademark of Sorcim Corporation); CBASIC® (a registered trademark of Complier Systems); MBASIC® (a registered trademark of Microsoft); and CP/M (a registered trademark of Digital Research).

Listing 6 continued:

```
4500 Z=4
4510 I$=B$ \GOSUB 64990 \REM CHECK FOR NULL INPUT
4520 ON Z GOTO 4530, 65050
4530 IF B$="T" THEN Z=1
4540 IF B$="t" THEN Z=1
4550 IF B$="A" THEN Z=2
4560 IF B$="a" THEN Z=2
4570 IF B$="D" THEN Z=3
4580 IF B$="d" THEN Z=3
4590 RETURN
5000 REM*-----
5010 REM* SUBROUTINE TO SET UP GLOBAL PARAMETERS
5020 REM*-----
5040 P$="GLOBAL"
5050 GOSUB 64260 \REM SAVE BYTE COUNTER & ENTRY ID
5060 INPUT #D1,"DATE: ",D$
5070 INPUT #D1,"TIME: ",T$
5080 V$=D$ \GOSUB 64460 \REM ADD STRING PARAMETER D$, DATE
5090 V$=T$ \GOSUB 64460 \REM ADD STRING PARAMETER T$, TIME
5100 V=66 \REM NO. OF LINES PER OUTPUT PAGE
5110 GOSUB 64360 \REM ADD NUMERIC PARAMETER IN V
5120 V=2 \REM NO. OF LINES FOR TOP MARGIN
5130 GOSUB 64360 \REM ADD NUMERIC PARAMETER IN V
5140 V=3 \REM NO. OF LINES FOR BOTTOM MARGIN
5150 GOSUB 64360 \REM ADD NUMERIC PARAMETER IN V
5160 V=48 \REM MAX LENGTH OF TITLE
5170 GOSUB 64360 \REM ADD NUMERIC PARAMETER IN V
5180 V=20 \REM MAX LENGTH OF AUTHOR
5190 GOSUB 64360 \REM ADD NUMERIC PARAMETER IN V
5200 V=10 \REM MAX LENGTH OF DATE
5210 GOSUB 64360 \REM ADD NUMERIC PARAMETER IN V
5220 WRITE #D3%L1+L1,P,NOENDMARK \REM UPDATE BYTE POINTER
5230 RETURN
64000 REM#-----
64010 REM*-----
64020 REM* SUPPORTING ROUTINES
64030 REM*-----
64040 REM*-----
64050 REM
64060 REM*-----
64070 REM* SUBROUTINE TO UPDATE THE NUMBER OF COMMAND ENTRIES IN THE JCL
64080 REM* FILE AND SET UP THE POINTER TO THE NEXT COMMAND ENTRY
64090 REM*-----
64100 REM
64110 REM* VARIABLES USED BY ROUTINE -
64120 REM* N - CURRENT COUNT FOR NUMBER OF COMMAND ENTRIES
64130 REM* P1 - BYTE POSITION OF POINTER TO NEXT COMMAND ENTRY
64140 REM* P - BYTE POSITION OF FIRST BYTE OF NEXT COMMAND ENTRY
64150 WRITE #D3%0,N,NOENDMARK
64160 WRITE #D3%P1,P,NOENDMARK
64170 RETURN
64180 REM*-----
64190 REM* SUBROUTINE TO SAVE CURRENT BYTE POINTER AND PROGRAM NAME TO
64200 REM* EXECUTE IN CURRENT COMMAND ENTRY IN THE JCL FILE
```

Listing 6 continued on page 362



# NEC's new letter-quality printer gets personal with IBM.

## The Spinwriter® 3550 lets the IBM PC get down to business.

NEC's new Spinwriter letter-quality printer is the *only* one plug-compatible with the IBM Personal Computer. So you get the business applications you've been wishing for. Letter-quality output for word and data processing. Multi-language, scientific, and technical printing. Simple forms handling. Quiet operation. And the reliability of the industry's most popular printer line.

NEC designed the new Spinwriter especially for the IBM PC. It comes complete with documentation and training materials to fit your PC user's handbook. Just plug the Spinwriter in and your PC instantly becomes more versatile and flexible.

## More than 8 forms handlers and 50 print thimbles boost PC versatility.

NEC designed the Spinwriter's 8 modular forms handlers to accommodate a wide range of paper and document sizes and types. The easily mounted handlers let

your computer print out the forms you need for data processing, word processing, graphics, accounting or other business applications.

The Spinwriter's 50 print thimbles can more than triple your PC's usefulness. They come in both constant pitch and proportional-spaced fonts, plus in foreign language, technical and scientific versions. They snap in and out in seconds, and let you print up to 203 columns on 16-inch paper. They each last for more than 30 million impressions.

## This printer's special features make everything look better on paper.

The Spinwriter's software-invoked features include automatic proportional spacing; bidirectional, bold and shadow printing; justification; centering; under-scoring; and sub/super scripting, all at speeds up to 350 words per minute.

## That big extra, Spinwriter reliability.

The new 3550 is part of NEC's renowned Spinwriter family, the world's most popular line of letter-quality printers.

Spinwriters have the industry's best mean-time-between-failure rating, in excess of 3,000 hours. In terms of average personal computer usage, that's more than five years.

NEC Information Systems, Inc.  
5 Militia Drive, Lexington, MA 02173

Send me more information on the Spinwriter 3550.

Name \_\_\_\_\_

Title \_\_\_\_\_

Company \_\_\_\_\_

Address \_\_\_\_\_

City \_\_\_\_\_

State \_\_\_\_\_

Zip \_\_\_\_\_

**NEC**

**NEC Information Systems, Inc.**

Circle 300 on inquiry card.

We're Made

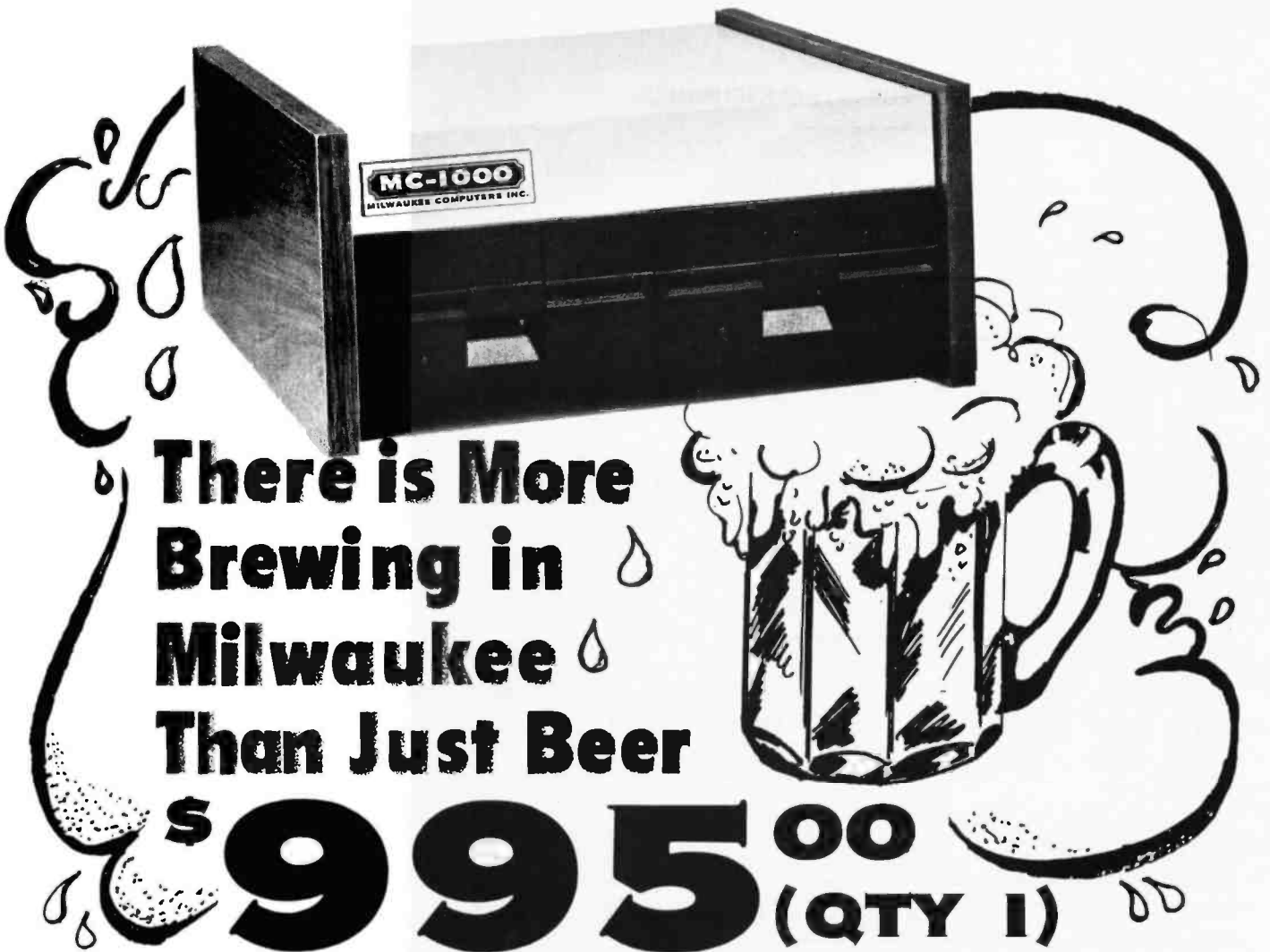
for Each Other.



Listing 6 continued:

```
64210 REM*-----
64220 REM
64230 REM* VARIABLES USED BY ROUTINE -
64240 REM*   P$ - NAME OF PROGRAM TO EXECUTE (INCLUDES UNIT NUMBER)
64250 REM*   P - BYTE COUNTER FOR JCL FILE
64260 WRITE #D3%P,P,P$
64270 P=P+L1+LEN(P$)+L2
64280 RETURN
64290 REM*-----
64300 REM* SUBROUTINE TO ADD A NUMERIC PARAMETER TO A COMMAND ENTRY
64310 REM*-----
64320 REM
64330 REM* VARIABLES USED BY ROUTINE -
64340 REM*   V - NUMERIC VALUE TO ADD
64350 REM*   P - BYTE COUNTER FOR JCL FILE
64360 WRITE #D3,V
64370 P=P+L1
64380 RETURN
64390 REM*-----
64400 REM* SUBROUTINE TO ADD A STRING PARAMETER TO A COMMAND ENTRY
64410 REM*-----
64420 REM
64430 REM* VARIABLES USED BY ROUTINE -
64440 REM*   V$ - STRING VALUE TO ADD
64450 REM*   P - BYTE COUNTER FOR JCL FILE
64460 WRITE #D3,V$
64470 P=P+LEN(V$)+L2
64480 RETURN
64490 REM*-----
64500 REM* SUBROUTINE TO DISPLAY INITIAL SIGN-ON MESSAGES
64510 REM*-----
64520 PRINT #D1,"SAMPLE MAIN" \PRINT #D1
64530 PRINT #D1,"TYPE 'HELP' IN RESPONSE TO 'COMMAND:' IF YOU ",
64540 PRINT #D1,"NEED DETAILED INSTRUCTION."
64550 PRINT #D1,"TO CANCEL ANY COMMAND JUST TYPE A 'RETURN'",
64560 PRINT #D1," TO ANY INPUT REQUEST."
64570 PRINT #D1
64580 RETURN
64590 REM*-----
64600 REM* SUBROUTINE TO REMOVE UNIT NO. FROM FILE NAME
64610 REM*-----
64620 REM
64630 REM* USES           F$ - FILE NAME WITH UNIT NO.
64640 REM* RETURNS      F1$ - FILE NAME
64650 REM*              F2$ - UNIT IN THE FORM ',X'
64660 REM*              Z   - 1 FOR FILE EXISTS, 2 IF IT DOESN'T
64670 IF FILE(F$)=-1 THEN Z=2 ELSE Z=1
64680 F1$=F$
64690 F2$=",1"
64700 FOR I=1 TO LEN(F$)
64710 IF F$(I,I)<>"," THEN 64730
64720 F1$=F$(1,I-1) \F2$=F$(I) \EXIT 64740
64730 NEXT I
64740 RETURN
64750 REM*-----
```

Listing 6 continued on page 364



**There is More  
Brewing in  
Milwaukee  
Than Just Beer**

**\$995.00  
(QTY 1)**

**MC-1000 SERIES  
COMPUTERS**

Our new **MC-1000 Computer System** is proof that the age of affordability in computers has arrived. Thanks to single board design we can offer not only the **lowest priced** computer in its class but also the **most reliable**. *For information and ordering call:*

**(414) 784-2312**

**ALL STANDARD**

- 64K Memory
- 2-5/4" Disk Drives (225K Total Storage)
- Real Time Clock
- 2-RS-232 Interfaces
- Parallel Printer Port (Centronics Type)
- Extensive Self Diagnostics (In Rom)
- 2 Year Limited Warranty

**OPTIONS**

- Disk Capacity to 1.8 MBYTE
- UCSD\* Pascal, Basic, Fortran

\*TM U. Of California

**MILWAUKEE COMPUTERS INC.**

**16235 W. RYERSON ROAD \* NEW BERLIN, WI 53151 \* (414) 784-2312**

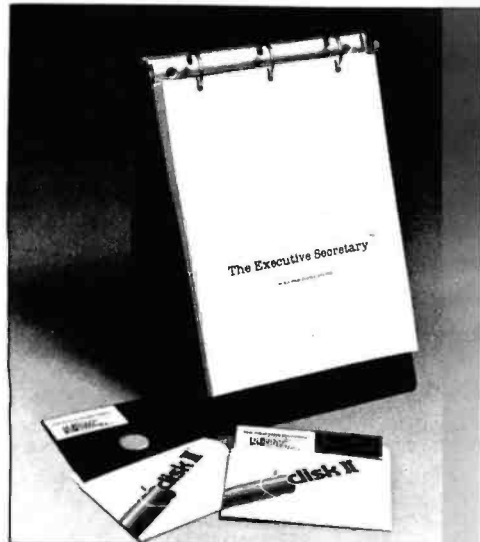


```
64760 REM* SUBROUTINE FOR FILE ERROR MESSAGE
64770 REM*-----
64780 REM
64790 REM* USES      F9$ - FILE NAME
64800 PRINT #D1,"COULDN'T FIND FILE ",F9$
64810 RETURN
64820 REM*-----
64830 REM* SUBROUTINE FOR REQUESTING FILE NAME
64840 REM*-----
64850 REM
64860 REM* RETURNS FILE NAME IN F$
64870 INPUT #D1,"FILE NAME: ",F$
64880 I$=F$
64890 GOSUB 64990 \REM CHECK FOR NULL INPUT
64900 ON Z GOTO 64910, 65050
64910 RETURN
64920 REM*-----
64930 REM* CHECK FOR NULL STRING
64940 REM*-----
64950 REM
64960 REM* USES      I$ WHICH CONTAINS THE INPUT STRING TO CHECK
64970 REM* RETURNS  Z = 1 IF THE LEN(I$)>0
64980 REM*          2 IF THE LEN(I$)=0
64990 Z=1
65000 IF I$="" THEN Z=2
65010 RETURN
65020 REM*-----
65030 REM* BACKUP FILE POINTER TO BEGINNING OF ENTRY
65040 REM*-----
65050 READ #D3%P1-1,&Z \REM READ TO POSITION PTR AT P1
65060 P=P1 \REM BACKUP RUNNING BYTE COUNTER
65070 N=N-1 \REM BACKUP ENTRY COUNTER
65080 GOTO 290
```

**If you won't  
read these  
7 signals  
of cancer...  
You probably have  
the 8th.**

 American Cancer Society

- 1.** Change in bowel or bladder habits.
- 2.** A sore that does not heal.
- 3.** Unusual bleeding or discharge.
- 4.** Thickening or lump in breast or elsewhere.
- 5.** Indigestion or difficulty in swallowing.
- 6.** Obvious change in wart or mole.
- 7.** Nagging cough or hoarseness.
- 8.** A fear of cancer that can prevent you from detecting cancer at an early stage. A stage when it is highly curable. Everyone's afraid of cancer, but don't let it scare you to death.



# We'd like your apple<sup>®</sup> to meet The **Executive Secretary<sup>™</sup>**

The professional  
 word processing system  
 for the Apple<sup>™</sup> computer

<b>GENERAL</b>		<b>check this chart:</b>	
Editing, printing, form letters, mail-merge, and electronic mail all in one package at one price?	✓	<b>INTEGRATED CARD FILE FEATURES</b>	
User's manual designed for the user?	✓		
User-controlled configuration of printers, slots, drives, and 40/80 column editing?	✓		
<b>THE MANUAL</b>		Allows multiple card files per disk?	✓
Complete index included?	✓	Allows user to define size and content of 'cards' in each file?	✓
Organized as a set of lessons?	✓	Generates new subset card files based on search or sort criteria for an existing file?	✓
Easel-bound for ease of use?	✓	Incorporates one/multiple line report printer for card files?	✓
<b>THE DOCUMENT PRINTER</b>		Allows totals and subtotals during report printing?	✓
Integrates files from DB MASTER's Utility Pack <sup>™</sup> , The Data Factory <sup>™</sup> , Visicalc <sup>™</sup> , Information Master <sup>™</sup> , and most DIF <sup>™</sup> files.	✓	<b>THE DOCUMENT EDITOR</b>	
Accepts keyboard input at print time?	✓	Keeps up with professional typing speeds?	✓
Supports all major printers, including Centronics 737 and IBM ET-series?	✓	User-defined phrase abbreviations?	✓
Has IF and related commands to allow conditional printing of information based on the contents of a database or on keyboard input?	✓	40 or 80 character edit modes user-selectable?	✓
Prints page headers of arbitrary complexity?	✓	Supports Smarterm <sup>™</sup> , Superterm <sup>™</sup> , Videoterm <sup>™</sup> and Full View 80 <sup>™</sup> .	✓
Prints page numbers wherever you want them?	✓	Uses real shift key?	✓
Automatically generates alphabetical index for words you specify?	✓	Supports file merge and unmerge?	✓
Supports file chaining and file nesting?	✓	Global search and replace?	✓
Has multi-level outline indenting?	✓	Block operations: move, transfer, delete?	✓
Has left- and right-justified tab stops?	✓	Character/word/line: insert/replace/delete?	✓
Gives full control of all margins, dynamic text reformatting, centering, and justification?	✓	Allows embedded commands to control special printer functions?	✓
Supports Thunderclock <sup>™</sup> and the CCS clockcard for automatic dating?	✓	<b>ELECTRONIC MAIL SYSTEM</b>	
		Menu driven?	✓
		Multiple document queuing?	✓
		Fully automatic with Hayes modem?	✓

Published by:

Available at computer stores nationwide.  
 \$250 suggested retail.



4306 Upton Avenue South  
 Minneapolis, Minnesota 55410  
 Phone (612) 929-7104

Now available: The Executive Speller<sup>™</sup>. Allows on-the-fly corrections and specialized dictionaries. 25,000 word capacity. Suggested retail \$75.00.

**Listing 7:** *The subexecutive program (%!). This reads the next entry in the job-control file and determines which program to call next.*

```

10 REM* SUBEXECUTIVE (SAVED IN FILE %!)
20 REM* 11/11/80
25 DIM P$(80)
30 D1=0 \REM DEVICE FOR CONSOLE
40 D3=0 \REM DISK DRIVE FOR SYSTEM
41 L1=5 \REM NO. OF BYTES FOR NUMERIC VALUES
42 L2=2 \REM NO. OF OVERHEAD BYTES FOR A STRING < 256 CHAR
43 S$="%!" \REM PREFIX FOR SYSTEM FILE NAMES
50 FOR I=1 TO 3
60 U$=CHR$(I+48)
70 IF FILE(S$+"JCL,"+U$)=3 THEN EXIT 100
80 NEXT I
90 PRINT #D1,"COULDN'T FIND JOB CONTROL FILE." \END
100 OPEN #D3,S$+"JCL,"+U$
110 READ #D3,N,NO,N1
120 IF NO=N THEN END
130 P=N1 \REM NO. OF BYTES FOR N+NO
140 FOR I=0 TO NO
150 READ #D3%P,P1
160 P=P1
170 NEXT I
180 READ #D3,X$,P$
190 WRITE #D3%L1,NO+1,NOENDMARK
195 PRINT #D1,"...EXECUTING...",P$
200 CHAIN X$

```

*Text continued from page 348:*

```

P$=S$+(program name)+
  A$+" "+U$
GOSUB 64260
V$=(program description)
GOSUB 64460

```

```

.
.
.
GOSUB 64360
GOTO 290      (end of command
              processing)

```

**5000-5230 Setting Up Global Parameters.** These lines repeatedly call utility routines to put parameters common to all programs into the job-control file. Since the code does not evaluate the date and time variables, D\$ and T\$, the user can input date and time in any form so long as the entries are ten characters or fewer in length.

**The Subexecutive**

Listing 7 is the subexecutive (%!) program. Since the subexecutive's only functions are to read the next en-

try in the job-control file and transfer control to the program indicated by that file, the subexecutive is independent of application. Here are comments, by line number, on the subexecutive.

**50-80 Drive Determination.** The subexecutive searches for the disk drive that contains the job-control file.

**100-110 Read Initial Job-Control Parameters.** These lines read the number of entries in the file (N), the last entry processed (NO), and the pointer giving the byte position (N1).

**130-180 Read Name of Program for CHAINing.** The first parameter of each entry is the pointer to the next entry, except in the case of the last entry, whose first parameter is set to 0. This program segment exploits North Star BASIC's direct addressing of disk files for positioning and reading parameters at the correct byte. This segment also reads the name of the program, X\$, and the descriptive phrase about the program, P\$.

**190 Update the Entry Counter.** This updates the entry counter (the second parameter in the file) by 1, so that it

points to the next entry to be processed.

**195-200 Transfer Control to Next Program.** These lines display on the console a message that tells which program is running and then CHAIN the next program.

**The Update/Sort Program**

Listing 8 is the update/sort (%!SORT) program. I will describe only those features of this program that relate to its overall structure and its use of the executive.

**30-90 Overall Program Flow.** These lines all call subroutines. The simplest way to develop a program for execution in this system is to call a series of subroutines, each of which performs a major function. This allows isolation of the part of the program at lines 1000, 2000, and 7000 that interfaces with the executive and the job-control file. The other subroutines at lines 3000, 4000, 5000, and 6000 actually do the updating and sorting.

**1000-1270 Read in Global Data.** This section of code dimensions arrays, initializes variables, and reads in the

*Text continued on page 378*



# McGraw-Hill Bookstore



## The James Martin Files

Published by Prentice-Hall



**1. The Telematic Society**  
350 pp. \$12.95

**2. Design and Strategy for Distributed Data Processing**  
624 pp. \$37.50

**3. Computer Networks and Distributed Processing**  
562 pp. \$34.00

**4. An End-User's Guide to Data-Base**  
144 pp. \$21.95

**5. Application Development Without Programmers**  
350 pp. \$32.50

## Break Into The Future

With the World's Foremost Authority on Computer Technology

**6. Design of Real-Time Computer Systems**  
629 pp. \$24.95

**7. Computer Data-Base Organization, 2nd Ed.**  
713 pp. \$33.00

**8. Systems Analysis for Data Transmission**  
910 pp. \$39.95

**9. Communications Satellite Systems** 398 pp. \$39.50

**10. Principles of Data-Base Management**  
352 pp. \$23.95

**11. Teleprocessing Network Organization** 290 pp. \$17.95

**12. The Computerized Society** 560 pp. \$18.95

**13. Future Developments in Telecommunications, 2nd Ed.** 668 pp. \$37.00

**14. Telecommunications and the Computer** 670 pp. \$37.50

**15. Design of Man-Computer Dialogues** 559 pp. \$32.00

**16. Programming Real-Time Computer Systems** 386 pp. \$19.95

**17. Security, Accuracy and Privacy in Computer Systems** 626 pp. \$34.00

**18. Introduction to Teleprocessing** 266 pp. \$22.95

McGraw-Hill Bookstore  
1221 Ave. of the Americas  
New York, New York 10020

BY5



Please send me \_\_\_\_\_ copies of book no. \_\_\_\_\_  
 \_\_\_\_\_ copies of book no. \_\_\_\_\_  
 \_\_\_\_\_ copies of book no. \_\_\_\_\_  
 \_\_\_\_\_ copies of book no. \_\_\_\_\_

Check or credit card: AmerExp.  MasterCard  Visa

Acct. No. \_\_\_\_\_ Expires \_\_\_\_\_

Name \_\_\_\_\_

Address \_\_\_\_\_

City \_\_\_\_\_ State \_\_\_\_\_ Zip \_\_\_\_\_

Add local sales tax plus \$2.50 postage and handling for the first book, \$1.00 for each additional book.

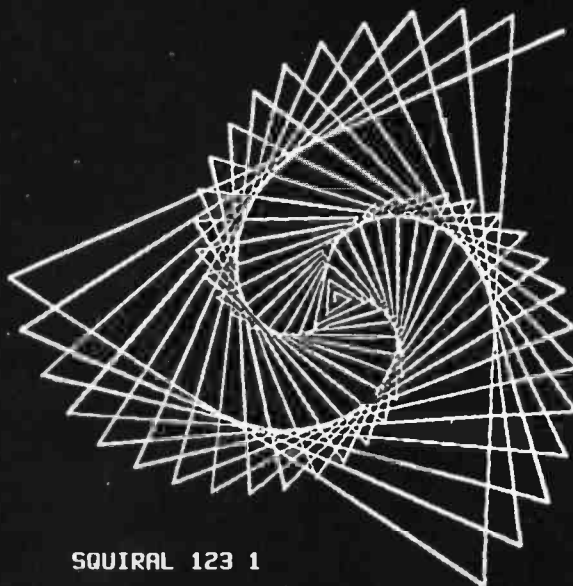
Listing 8: The update/sort program (%!SORT). Lines 30 through 90 control the flow of the program by calling seven subroutines—one for each major program function.

```
10 REM* SAMPLE SORT PROGRAM (SAVED IN FILE '%!SORT')
20 REM* 12/16/80 WRITTEN BY GENE F. WALTERS
30 GOSUB 1000 \REM READ IN GLOBAL DATA
40 GOSUB 2000 \REM READ IN SORT COMMAND DATA
50 GOSUB 3000 \REM READ IN MASTER FILE
60 GOSUB 4000 \REM READ UPDATE FILE AND MERGE WITH MASTER DATA
70 GOSUB 5000 \REM SORT MERGED DATA
80 GOSUB 6000 \REM WRITE OUT NEW MASTER FILE
90 GOSUB 7000 \REM RETURN TO SUBEXECUTIVE
1000 REM*-----
1010 REM* SUBROUTINE TO READ IN GLOBAL DATA
1020 REM*-----
1030 DIM P$(80)
1040 D1=0 \REM DEVICE FOR CONSOLE
1050 D2=1 \REM DEVICE FOR PRINTER
1060 D3=0 \REM DISK FILE FOR THE SYSTEM
1070 D4=1 \REM MASTER FILE
1080 D5=2 \REM UPDATE FILE
1090 U=3 \REM NO. OF DRIVES IN SYSTEM
1100 S$="%!" \REM PREFIX FOR SYSTEM FILE NAMES
1110 FOR I=1 TO U
1120 U$=CHR$(I+48)
1130 IF FILE(S$+"JCL,"+U$)=3 THEN EXIT 1160
1140 NEXT I
1150 PRINT #D1,"COULDN'T FIND JOB CONTROL FILE." \END
1160 OPEN #D3,S$+"JCL,"+U$
1170 READ #D3,N,NO,N1 \REM-# CMD ENTRIES, CURRENT CMD, PTR TO 1ST ENTRY
1180 READ #D3,P$ \REM PASS OVER FIRST STRING
1190 READ #D3,D$,T$ \REM READ IN DATE AND TIME
1200 READ #D3,P5,P6,P7 \REM LINES/PAGE, TOP MARGIN, BOTTOM MARGIN
1210 READ #D3,K1,K2,K3 \REM MAX LENGTH FOR TITLE, AUTHOR, DATE
1220 K9=K1+K2+K3
1230 DIM E$(125*K9),X$(K9+3),A(132),E1$(K1),E2$(K2),E3$(K3)
1240 DIM Q$(K9),QO$(K9),B$(K9),BO$(K9)
1250 P=0 \REM PAGE COUNTER
1260 L=0 \REM LINE COUNTER
1270 RETURN
2000 REM*-----
2010 REM* SUBROUTINE TO READ IN SORT COMMAND DATA
2020 REM*-----
2030 P2=N1
2040 FOR I=1 TO NO
2050 P1=P2
2060 READ #D3,P1,P2
2070 NEXT I
2080 READ #D3,P$,P$ \REM PASS OVER FIRST TWO STRINGS
2090 READ #D3,F1$,U1$ \REM FILE NAME & UNIT FOR MASTER
2100 READ #D3,F2$,U2$ \REM FILE NAME & UNIT FOR UPDATES
2110 READ #D3,M \REM FIELD TO SORT ON
2120 CLOSE #D3
2130 RETURN
3000 REM*-----
```

Listing 8 continued on page 370

# The Logo Language is Here for the Apple II

```
TO SQUIRAL :ANGLE :DISTANCE
  IF :DISTANCE > 200 THEN STOP
  FORWARD :DISTANCE
  RIGHT :ANGLE
  SQUIRAL :ANGLE :DISTANCE + 3
END
```



SQUIRAL 123 1

Terrapin, the Turtle Company, brings you the Terrapin Logo Language for the Apple II with Turtle graphics, now ready for immediate delivery.

The Terrapin Logo language is a sophisticated and powerful language that is easy for anyone to use. Although originally intended for children, the Logo language is one that the most advanced programmers will enjoy using too. It includes many features common to artificial intelligence research languages permitting programs of great power to be written quickly and easily. Writing comparable programs in other languages is usually much more difficult and time consuming.

The Turtle graphics is fun and easy. With simple commands such as FORWARD, RIGHT, and PENUP you can draw in six hi-res colors. In just a few short sessions you can learn to create figures more complex than the one above whether you know how to program or not.

But the Terrapin Logo language is more than just a graphics language. It supports:

- list structure, allowing easy manipulation of words (strings) and lists
- user defined procedures which can be used exactly as if they were part of the language.
- fully integrated screen editor for procedures and text
- floating point and integer arithmetic
- a total of 120 primitives (commands) including 30 graphics commands
- recursion
- assembly-language interface capability

The Terrapin Logo language was developed by the Artificial Intelligence lab at the Massachusetts Institute of Technology. Terrapin is now authorized by MIT to distribute the results of its 12 years of research to you. To provide quality support for the language, Terrapin has assembled a team that includes two of the three authors who developed the Logo language for the Apple II at MIT, as well as Dr. Feurzeig, the originator of the Logo language.

Every copy of the Terrapin Logo language comes with complete documentation. To run the language, a 48K Apple II with a 16K RAM card or a language card, and one disk drive is required.

Terrapin also offers the robot Turtle, and the following books: *Turtle Geometry*, *Special Technology for Special Children*, *Mindstorms*, *Katie & the Computer*, and *Apple Logo* from Byte Books.

Suggested retail price: \$149.95

To order or for more information, call or write:



**Terrapin, Inc.**

678 Massachusetts Avenue  
Cambridge, MA 02139  
(617) 492-8816

"Logo" trademark under license from Bolt, Beranek & Newman, Inc.



```

3010 REM* SUBROUTINE TO READ MASTER FILE
3020 REM*-----
3030 E=0 \REM NO. OF ENTRIES
3040 E$="" \REM STRING ARRAY FOR ENTRIES
3050 IF FILE(F1$+U1$)<>3 THEN RETURN
3060 OPEN #D4,F1$+U1$
3070 IF TYP(D4)=0 THEN 3120
3080 READ #D4,E1$,E2$,E3$
3090 E$=E$+E1$+E2$+E3$
3100 E=E+1
3110 GOTO 3070
3120 CLOSE #D4
3130 RETURN
4000 REM*-----
4005 REM* SUBROUTINE TO READ UPDATE FILE
4010 REM*-----
4015 IF F2$="" THEN RETURN
4020 OPEN #D5%2,F2$+U2$
4025 READ #D5,&A(1) \REM READ # OF BYTES IN LINE
4030 IF A(1)=1 THEN 4355 \REM END OF BASIC TYPE 2 FILE
4035 FOR I=2 TO A(1) \REM READ IN BASIC LINE
4040 READ #D5,&A(I)
4045 NEXT I
4050 X$="" \REM INITIALIZE STRING FORM OF BASIC LINE
4055 S=0 \REM SET S TO INDICATE ADD ENTRY OPERATION
4060 FOR I=4 TO A(1)-1
4065 IF A(I)=34 THEN EXIT 4085 \REM SEARCH FOR QUOTE
4070 IF A(I)=229 THEN S=1 \REM SET S TO INDICATE DELETE ENTRY
4075 NEXT I
4080 GOTO 4340
4085 J1=I+1
4090 FOR I=A(1)-1 TO J1 STEP -1 \IF A(I)=34 THEN EXIT 4100 \NEXT I
4095 GOTO 4340
4100 J2=I-1
4105 FOR I=J1 TO J2 \REM CONVERT LINE TO A STRING
4110 X$=X$+CHR$(A(I))
4115 NEXT I
4120 C=0
4125 FOR I=1 TO LEN(X$) \REM CHECK FOR PROPER NO. OF `\'
4130 IF X$(I,I)="\" THEN C=C+1
4135 NEXT I
4140 IF C<2 THEN 4340 \REM LINE IN ERROR
4145 IF C=2 THEN 4160
4150 IF C>3 THEN 4340
4155 IF X$(LEN(X$))<>"\" THEN 4340
4160 E1$=""
4165 FOR I=1 TO LEN(X$)
4170 IF X$(I,I)="\" THEN EXIT 4185
4175 E1$=E1$+X$(I,I)
4180 NEXT I
4185 IF E1$="" THEN CO=1 ELSE CO=0 \REM CO = NO. OF BLANK FIELDS
4190 FOR K=1 TO K1-LEN(E1$)
4195 E1$=E1$+" "
4200 NEXT K

```

## Project Recording

Projects are recorded on individual cards. New projects can be added and completed projects removed easily and quickly.

## Separate Project Calendars

Each step is scheduled on a separate linear calendar space for each project. You simply place a mark or notation whenever something is to occur.

## Fast Review

A quick daily scanning tells you instantly which projects need attention that day, or during the days ahead. It keeps you on top of all the details about what should be going on. At the same time, it gives you the "big picture" of all your projects and how they inter-relate.

## Completely Flexible

Comes with four pads of 31 day MONTHLY calendars. Additionally, 52 week YEARLY, 7 day WEEKLY and 24 hour DAILY calendars are also available.

## Rugged Construction

Made of handsome, Bavarian tan leather like material that will stand up to years of heavy use.

## Expandable

Initially accommodates 40 projects. Additional panels can be added to expand to 100 projects.

# New Scheduling Tool!

*At last, a unique and completely portable scheduling system that's guaranteed to improve management productivity.*

It's called the **ScheduleMate™** scheduling system, and it can literally do away with scheduling conflicts, missed deadlines, last minute rushes and the resulting costly overtime. How? By providing a compact and completely portable "scheduling center" for all your project activities.

The **ScheduleMate™** utilizes a separate project card and a separate scheduling calendar for each project, which means you can schedule each one individually. Then there's no more relying on memory, or trying to jam everything onto a single appointments calendar. And unlike bulky wall mounted units, the ScheduleMate is completely portable, so you can take it wherever you need it.

As a result, you have complete control over all your projects, including all the details of who is supposed to do what... and when. Then, in a matter of seconds, you can see what's due today... or... tomorrow... or even next week. As a result, you eliminate the disappointments and chaos that come from a lack of good scheduling and follow up. Instead, you are always prepared, and all of your projects run smoothly on schedule.

## Satisfaction Guaranteed

We know you'll be pleased with the way the **ScheduleMate™** system improves productivity. However, if you are not, *for any reason*, you may return it within 30 days for a complete and courteous refund.

We honor American Express, MasterCard, Diners Club and Visa.

National  
Introductory Price

**\$59<sup>95</sup>**

Add \$3 shipping and handling. Ohio residents add sales tax.

## To order phone

**800-848-2618**

IN OHIO CALL: 800-282-2630

or mail check to:

**Executive ScanCard™ Systems Dept. 307  
6480 Busch Blvd. Suite 200  
Columbus, Ohio 43229**

Circle 167 on Inquiry card.

Orders outside the U.S. are assessed a minimum Air Parcel Post charge per unit as follows: Canada \$7.50; Mexico \$12; all other countries \$18

PATENTS PENDING © COPYRIGHT 1982 EXECUTIVE SCANCARD™ SYSTEMS

Listing 8 continued:

```
4205 E2$=""
4210 FOR J=I+1 TO LEN(X$)
4215 IF X$(J,J)="\" THEN EXIT 4230
4220 E2$=E2$+X$(J,J)
4225 NEXT J
4230 IF E2$="" THEN CO=CO+1 \REM INCREMENT BLANK FIELD COUNTER
4235 FOR K=1 TO K2-LEN(E2$)
4240 E2$=E2$+" "
4245 NEXT K
4250 E3$=""
4255 FOR I=J+1 TO LEN(X$)
4260 IF X$(I,I)="\" THEN EXIT 4275
4265 E3$=E3$+X$(I,I)
4270 NEXT I
4275 IF E3$="" THEN CO=CO+1 \REM INCREMENT BLANK FIELD COUNTER
4280 FOR K=1 TO K3-LEN(E3$)
4285 E3$=E3$+" "
4290 NEXT K
4295 IF S=0 THEN 4310
4300 GOSUB 4365 \REM DELETE ENTRY
4305 GOTO 4025
4310 IF CO<>3 THEN 4325 \REM CHECK FOR ALL FIELDS BLANK
4315 GOSUB 4465 \REM ERROR IN ENTRY
4320 GOTO 4025
4325 E$=E$+E1$+E2$+E3$
4330 E=E+1
4335 GOTO 4025
4340 GOSUB 8000 \REM CHECK FOR PAGE HEADING
4345 PRINT #D2,"COULDN'T PROCESS LINE",%6I,A(2)+A(3)*256," IN UPDATE FILE."
4350 GOTO 4025
4355 CLOSE #D5
4360 RETURN
4365 REM* ROUTINE TO DELETE AN ENTRY
4370 X$="" \FOR I=1 TO K9 \X$=X$+" " \NEXT I
4375 S1=0 \REM INDICATOR FOR ENTRY FOUND
4380 REM DETERMINE WHICH FIELDS ARE BLANK
4385 IF E1$=X$(1,K1) THEN I1=0 ELSE I1=1
4390 IF E2$=X$(1,K2) THEN I2=0 ELSE I2=1
4395 IF E3$=X$(1,K3) THEN I3=0 ELSE I3=1
4400 FOR I=1 TO E
4405 IF I1 THEN IF E1$<>E$(K9*I-K9+1,K9*I-K2-K3) THEN 4425
4410 IF I2 THEN IF E2$<>E$(K9*I-K2-K3+1,K9*I-K3) THEN 4425
4415 IF I3 THEN IF E3$=E$(K9*I-K3+1,K9*I) THEN EXIT 4490
4420 IF NOT I3 THEN EXIT 4490
4425 NEXT I
4430 REM ENTRY NOT FOUND
4435 IF S1=1 THEN RETURN \REM ENTRY HAS BEEN FOUND - NO MSG
4440 GOSUB 8000 \REM CHECK FOR PAGE HEADING
4445 PRINT #D2,"COULDN'T FIND ENTRY TO DELETE THAT IS ON LINE ",
4450 PRINT #D2,A(2)+A(3)*256,","
4455 RETURN
4460 REM INVALID DELETE REQUEST
4465 GOSUB 8000 \REM CHECK FOR PAGE HEADING
```

Listing 8 continued on page 374



Shugart, Qume, Tandon, MPI, Siemens, Remex,  
Altos, Apple, Epson, NEC, Tally and more.

## Apple II Add-on Disk Drive\* (Runs 3.2 or 3.3 DOS)

**for only \$339.00**

### DISK DRIVES

Shugart	
SA 400	\$230
SA 450	\$285
SA 800/801	\$385
SA 850/851	\$535

Qume	
DT-8	\$479
DT-5	\$285

Tandon	
TM100-1	\$225
TM100-2	\$285
TM100-3	\$285
TM100-4	\$399
TM848-1	\$449
TM848-2	\$549

MPI	
92-M	\$389

Siemens	
FDD 200-8	\$525
FDD 100-8	\$370

Tandon Winchester	
TM 602-5MB	\$1040
TM 603-10MB	\$1199

Corvus	
5MB	\$2999
10MB	Call
20MB	for
Mirror Backup	price

### COMPUTERS

Altos	
8000-10	Call
8000-12	for
8000-14	price

### PRINTERS

Epson	
MX-80	\$469
MX 80 FT	\$569
MX 100	\$769

Tally	
MT1602	\$1399
MT1605	\$1399
MT1802	\$1699
MT1805	\$1699

NEC - Spinwriter	
Model 7710	\$2339
Model 7720	\$2690
Model 7730	\$2340
Model 7715	\$2599
Model 7725	\$3100
PC 8023	\$ 625

Data Products	
D50	\$1499

Prices are subject to change without notice.

Contact:

**P.D.S., inc.**  
PERSONAL COMPUTERS

2630 Walnut Avenue, Suite H, Tustin, CA 92680

(714) 730-7207

\*INCLUDES CABLE AND CABINET

```

4470 PRINT #D2,"AT LEAST ONE FIELD MUST BE NON-BLANK ON LINE ",
4475 PRINT #D2,A(2)+A(3)*256, "."
4480 RETURN
4485 REM FOUND ENTRY TO DELETE
4490 FOR J=I TO E-1
4495 E$(K9*J-K9+1,K9*J)=E$(K9*J+1,K9*J+K9)
4500 NEXT J
4505 E$=E$(1,LEN(E$)-K9) \REM TRUNCATE STRING BY ONE ENTRY
4510 E=E-1 \REM DECREMENT ENTRY COUNTER
4515 S1=1 \REM SET INDICATOR TO ENTRY FOUND
4520 GOTO 4400 \REM LOOK FOR ANOTHER TO DELETE
5000 REM*-----
5010 REM* SUBROUTINE TO SORT THE MERGED DATA
5020 REM*-----
5030 DEF FNF$(X)
5040 ON M GOTO 5050, 5060, 5070
5050 RETURN E$(K9*X-K9+1,K9*X-K2-K3)
5060 RETURN E$(K9*X-K2-K3+1,K9*X-K3)
5070 RETURN E$(K9*X-K3+1,K9*X)
5080 FNEND
5090 DEF FNP(X)=(X-((X/2-INT(X/2))*2))/2
5100 DEF FNB(X)
5110 K=0
5120 IF FNF$(X+X)<FNF$(X+X+1) THEN K=1
5130 RETURN X+X+(K AND (X+X<T))
5140 FNEND
5150 FOR T=2 TO E
5160 Q$=FNF$(T) \QO$=E$(K9*T-K9+1,K9*T) \I=T
5170 IF I=1 THEN 5220
5180 J=FNP(I)
5190 IF Q$<=FNF$(J) THEN 5220
5200 E$(K9*I-K9+1,K9*I)=E$(K9*J-K9+1,K9*J) \I=J
5210 GOTO 5170
5220 E$(K9*I-K9+1,K9*I)=QO$
5230 NEXT T
5240 T=E
5250 B$=FNF$(T) \BO$=E$(K9*T-K9+1,K9*T)
5260 E$(K9*T-K9+1,K9*T)=E$(1,K9) \T=T-1 \I=1
5270 IF I+I>T THEN 5320
5280 J=FNB(I)
5290 IF FNF$(J)<=B$ THEN 5320
5300 E$(K9*I-K9+1,K9*I)=E$(K9*J-K9+1,K9*J) \I=J
5310 GOTO 5270
5320 E$(K9*I-K9+1,K9*I)=BO$
5330 IF T>=2 THEN 5250
5340 RETURN
6000 REM*-----
6010 REM* SUBROUTINE TO WRITE OUT NEW MASTER
6020 REM*-----
6030 F$=F1$+U1$ \L9=INT((LEN(E$)+3*L2*E+255)/256)
6040 IF FILE(F$)=-1 THEN 6060
6050 DESTROY F$
6060 CREATE F$,L9
6070 OPEN #D4,F$

```

# C. ITOH F-10 PRINTMASTER

## False Advertising?

**...and, you may have to  
get in line to get the best price.**



**C. ITOH F-10 PRINTMASTER  
40 CPS DAISY WHEEL  
PRINTER**

What a mess. If you saw our ad last month, and a lot of people did, you probably know we are selling the best price/performance daisy wheel printer on the market at the unbelievable price of \$1295. Now we are being told we are embarrassing C. Itoh Electronics and using false advertising. Well, you decide.

Since we believe in free enterprise and competition, we recognized this printer would be a big success. The F-10 printer is everything a great printer should be. It's not a toy, but a full function 40 CPS printer designed to go after the Diablo 630 and it's competitors from Qume and NEC. Constructed on a cast aluminum base with durable metal parts, the quality is second to none.

To offer the \$1295 price we arranged to buy the unit from a source that has the best price C. Itoh offers to a volume purchaser.

We scheduled the printers shipments, placed our advertising, and got ready. We knew the market was waiting for this kind of quality at the right price.

What we weren't ready for was the reaction of C. Itoh Electronics and their distributor Leading Edge Products. To say the least it wasn't pleasant.

Before the first ad hit the street some people received pre-publication copies. The phone started ringing off the hook. The callers are asking a lot of questions about who we are and do we have printers. Kind of like the questions a competitor might ask to see if you are for real. We are.

### THE PRESIDENT CALLS

Then the president of C. Itoh Electronics calls and wants to know where we got the printers from and if we have them in stock. A very nice man, but a funny question. We decline to answer.

It's not over yet. The national sales manager calls next, and boy is he mad. Seems that he doesn't like us calling the F-10 a C. Itoh printer since we don't buy them directly from them. A rose by any other name. He tells us that our offer of a factory warranty is misleading, and they are getting a lot of calls. Since our supplier has warranty service from C. Itoh it

seemed like a good idea to pass it on to you. Maybe not. We tell him we will clarify this in future advertising. He seems satisfied.

About this time we start our wholesale program to dealers and resellers. To say the least they were as excited as we were about the printer. Orders started rolling in, and we started shipping the printers. Sounds like everyone is happy so far. You are getting a great price, the dealers get a wholesale price, and C. Itoh is getting their asking price.

About this time two guys from Leading Edge Products come walking in the door to check us out, we're flattered, they leave. We can't say they are thrilled about our price, but that's what competition is all about. They sell parallel units to the dealers at \$1250, and recommend a list price of \$1995. Have you seen their ad about saving \$800?

### THE STING

Our customers start telling us that they've been told by Leading Edge Products that we're not for real. We call posing as an end user and they tell us the same thing. Dirty pool.

Oh well, the phone is ringing off the hook, we are going crazy because unlike many distributors we take each unit out of the box and test it. This takes time and the buyers seem to be in a hurry. We start to think about our next shipment, and hiring another technician.

Now the rub. Our source for these units is being hassled. Three heavyweights from C. Itoh tell them that they don't like the way we are selling the units, and that this might jeopardize their shipments in the future, and in fact the units confirmed for delivery the next two months are now "not confirmed."

### A PRICE PROBLEM

Our source is told the low price is giving the unit a cheap image and they don't like it. Their marketing plans are being spoiled by these low prices, and they are going to stop it. We think you can tell the difference between "cheap quality" and "cheap prices."

You may be getting the feeling that

we are a bunch of nuts for selling this printer at such a low price. Not so, we make a nice profit and we intend to sell a lot of printers.

We also sell lots of accessories to go with the printers at great prices. Another profit center — and one stop shopping for our customers.

What C. Itoh is really unhappy about is that they are being flooded with calls about us wanting to know what the catch is. What you should really call about is to tell them you want them to get off our case so you can get this great printer at a great price.

### LET THEM KNOW

Better yet send the president a note telling him that free enterprise and competition is what America is all about.

The man to tell is:

Mark Takeuchi - President  
C. Itoh Electronics  
5301 Beethoven Street  
Los Angeles, CA 90066

If you will send us a copy of your letter with your order we will throw in a box of ribbons and a couple of print wheels of your choice as a gesture of our appreciation for your support.

Just circle the reader service card and we will send you a full set of specifications, and our warranty policy (we do our own service). Doesn't exactly like sound like your typical mail order distributor does it. And if you ask we will even tell you the names of some happy users. Happy because of our service, the great product, the low price, and our money back guarantee if not satisfied in 30 days.

**Write  
Writer, inc.**

**1703 STEWART STREET  
SANTA MONICA, CA 90404  
TELEPHONE (213) 829-6871**



Listing 8 continued:

```
6080 FOR I=1 TO E
6090 WRITE #D4,E$(K9*I-K9+1,K9*I-K2-K3)
6100 WRITE #D4,E$(K9*I-K2-K3+1,K9*I-K3)
6110 WRITE #D4,E$(K9*I-K3+1,K9*I)
6120 NEXT I
6130 CLOSE #D4
6140 RETURN
7000 REM*-----
7010 REM* RETURN TO SUBEXECUTIVE
7020 REM*-----
7030 IF P=0 THEN 7070
7040 FOR I=P5-L-2 TO P5 \REM EJECT TO A NEW PAGE
7050 PRINT #D2
7060 NEXT I
7070 CHAIN S$+",""+U$
8000 REM*-----
8010 REM* SUBROUTINE FOR PAGE HEADING
8020 REM*-----
8030 IF L=0 THEN 8060
8040 L=L-1
8050 RETURN
8060 IF P=0 THEN 8100
8070 FOR I=1 TO P7 \REM BOTTOM MARGIN
8080 PRINT #D2
8090 NEXT I
8100 P=P+1
8110 FOR I=1 TO P6 \REM TOP MARGIN
8120 PRINT #D2
8130 NEXT I
8140 PRINT #D2,"ERRORS",TAB(40-INT((LEN(D$)+LEN(T$)+2)/2)),
8150 PRINT #D2,D$," ",T$,TAB(73),"PAGE",%3I,P
8160 PRINT #D2
8170 L=P5-P6-P7-3
8180 RETURN
```



Get Omni quality  
for as little as \$1.99...  
even if all you  
want is a  
10 pack.

Call toll-free for great savings on Omni's complete line of 5 1/4" premium disks. Each is certified error-free at a minimum of twice the error threshold of your system. Each is rated for more than 12 million passes without disk-related errors or significant wear. And each is precision fabricated to exceed all ANSI specifications with such standard features as reinforced hub rings and Tyvec sleeves. Get same day shipment and an unconditional, no hassle money-back guarantee.

## ARCHIVE

23 Alvarado Ave., Worcester, MA 01604  
(800) 343-0314; In Mass:  
(617) 756-2960



Call toll free  
(800) 343-0314  
In Mass: (617) 756-2960

Call if you're not sure which disk is compatible with your system. Call for prices on 96 tpi and special formats. We offer an unconditional money-back warranty. We're here to help.

Be sure to indicate system name and model # at right.

# of 10 Packs	5 1/4" Disks	Price Per 10 Pack	Total Price
_____	Single side/single density	\$19.90	\$ _____
_____	Single side/double density	\$23.90	\$ _____
_____	Double side/double density	\$39.90	\$ _____
_____	Flip/Floppy reversible Double side/double density	\$39.90	\$ _____
_____	Protective plastic library case (in lieu of soft storage box)	\$ 2.99	\$ _____
	Shipping and handling		\$ 1.50
	5% sales tax (Mass. only)		\$ _____
	<b>Total</b>		\$ _____

Check  
 COD

Master Card  
 VISA

Card # \_\_\_\_\_ Exp. \_\_\_\_\_

System and model # \_\_\_\_\_

Name \_\_\_\_\_

Address \_\_\_\_\_

Tel. \_\_\_\_\_

Circle 310 on Inquiry card.

Listing 9: The list program (%!LIST). The subroutines at lines 1000, 2000, and 5000 isolate interaction with the subexecutive program and the job-control file.

```

10 REM* SAMPLE LIST PROGRAM (SAVED IN FILE '%!LIST')
20 REM* 11/18/80 WRITTEN BY GENE F. WALTERS
30 GOSUB 1000 \REM READ IN GLOBAL DATA
40 GOSUB 2000 \REM READ IN LIST COMMAND DATA & INITIALIZATION
50 GOSUB 3000 \REM READ AN ENTRY FOR PRINTING
60 IF Z THEN 90 \REM TEST FOR END OF FILE
70 GOSUB 4000 \REM PRINT ENTRY
80 GOTO 50
90 GOSUB 5000 \REM PROGRAM WRAPUP & RETURN TO SUBEXECUTIVE
1000 REM*-----
1010 REM* SUBROUTINE TO READ IN GLOBAL DATA
1020 REM*-----
1030 DIM P$(80),L(3)
1040 D1=0 \REM DEVICE FOR CONSOLE
1050 D2=1 \REM DEVICE FOR PRINTER
1060 D3=0 \REM DISK FILE FOR THE SYSTEM
1070 D4=1 \REM MASTER FILE
1080 U=3 \REM NO. OF DRIVES IN SYSTEM
1090 S$="%!" \REM PREFIX FOR SYSTEM FILE NAMES
1100 FOR I=1 TO U
1110 U$=CHR$(I+48)
1120 IF FILE(S$+"JCL,"+U$)=3 THEN 1150
1130 NEXT I

```

Listing 9 continued on page 380

Text continued from page 366:

global data stored at the beginning of the job-control file.

2000-2130 Read in Parameters for Program Execution. Using the current-entry pointer near the beginning of the job-control file, lines 2040 through 2070 position to the entry containing the parameters for the update/sort program's execution. Lines

2090 through 2110 then read in those parameters.

7000-7070 Return to Subexecutive. This section of code first positions the paper when an error listing is produced. The code uses the current line number, L, and the number of lines per page, P5, to calculate the number of blank lines to print in order to eject the listing to a new page. As a result,

the printer should start at the top of a new page after each program's execution. Line 7070 CHAINs to the subexecutive.

### The List Program

Listing 9 is the list program (%!LIST). Again, I will describe only those features of the list program that

Text continued on page 382

## BYTE Back Issues For Sale

The following issues are available:

<b>\$2.00 ea.</b>	<b>\$2.75 ea.</b>	<b>\$2.75 ea.</b>	<b>\$3.25 ea.</b>
July 76	May 78	Oct. 79	Feb. 81
Apr. 77	June 78	<b>\$3.25 ea.</b>	Mar. 81
May 77	July 78	Nov. 79	Apr. 81
June 77	Aug. 78	Dec. 79	May 81
July 77	Sept. 78	Jan. 80	July 81
Aug. 77	Oct. 78	Mar. 80	Aug. 81
<b>\$2.75 ea.</b>	Dec. 78	Apr. 80	Oct. 81
Sept. 77	Jan. 79	May 80	Nov. 81
Nov. 77	May 79	June 80	Dec. 81
Dec. 77	June 79	July 80	<b>\$3.70 ea.</b>
Feb. 78	July 79	Aug. 80	Mar. 82
Mar. 78	Aug. 79	Oct. 80	
Apr. 78	Sept. 79	Dec. 80	



Prices include postage in the US. Please add \$.50 per copy for Canada and Mexico; and \$2.00 per copy to foreign countries (surface delivery).

Send requests with payment to:

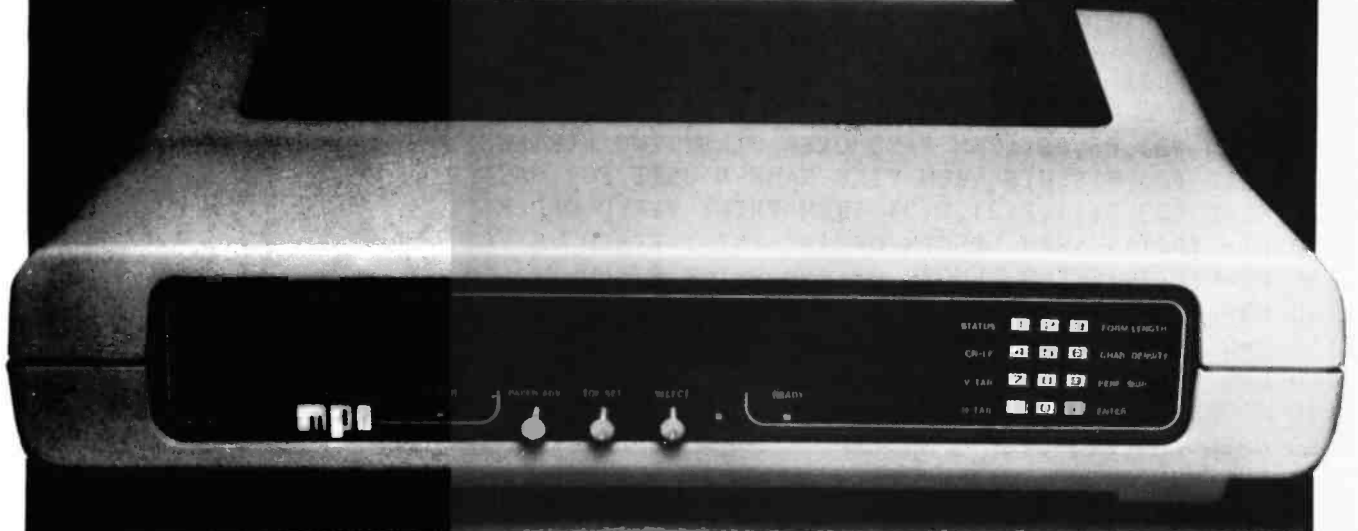
**BYTE Magazine**  
70 Main St, Peterborough NH 03458  
Attn: Back Issues

\* Payments from foreign countries must be made in US funds payable at a US bank.

\* Please allow 4 weeks for domestic delivery and 8 weeks for foreign delivery.



# WE'VE WIDENED OUR HORIZONS.



With the new MP150G Wide Carriage Dot Matrix printer, a whole new world of extended capability stretches out before you. Performance-priced at \$1095,\* the MP150G gives you data processing options you may have thought unavailable for such a low cost.    **Extended capability means enhanced performance.** A nine wire head prints six character densities, and gives you a choice between data processing, or correspondence quality fonts.    The microprocessor-controlled bi-directional logic seeking head zips along at 150 CPS, with thruputs of up to 200

LPM for average text, and as many as 226 columns on 15 inch wide paper. That's speed in two directions. Dot graphics; a full 1000 character buffer (with up to 8000 character capability optionally available); and an optional non-volatile soft-switch keypad for configuration selection and retention. All dressed up in sleek, attractively styled casework.    Set your sights on performance, versatility and extended capability with the MP150G Wide Carriage Dot Matrix Printer from MPI. It's worlds apart from the ordinary.

\*Suggested list price. Substantial OEM discounts available.

 **mpi**  
The Printer People

Micro Peripherals, Inc.  
4426 South Century Dr.  
Salt Lake City, Utah 84107  
(801) 263-3081

Arizona PLS Associates (602) 246-8477 • California VITEK (714) 744-8305 • Computer Potentials (408) 738-1740 • Colorado PLS Associates (303) 773-1218 • Florida Computer Village (305) 266-5965 • Georgia Micro Graphics (404) 790-5771 • Illinois CW Electronic Enterprises (312) 298-4830 • Massachusetts Butler Associates (617) 985-1080 • Consumer Computer Marketing (617) 443-5128 • Minnesota Bohlig & Associates (612) 922-7011 • New Jersey Hansen & Hughes (201) 652-7055 • Ohio EQS (218) 729-2222 • Oregon Microware (503) 620-8150 • Pennsylvania QED Electronics (215) 674-9600 • Texas Computer Wares (214) 373-4443 • Thorson Distributors (214) 233-5744 • Utah PLS Associates (801) 468-8729 • Washington Microware (206) 451-8586 • International: Europe Russet Instrument, Ltd. (0734) 868147 Telex: 849721 • Australia Datatel Pty. Ltd. 690-4000 Telex: AA30996 • Canada Norango (416) 498-5332 Telex: 06966710 • Mexico, Central and South America Siscom-trol (905) 689-02-09

Circle 293 on inquiry card.

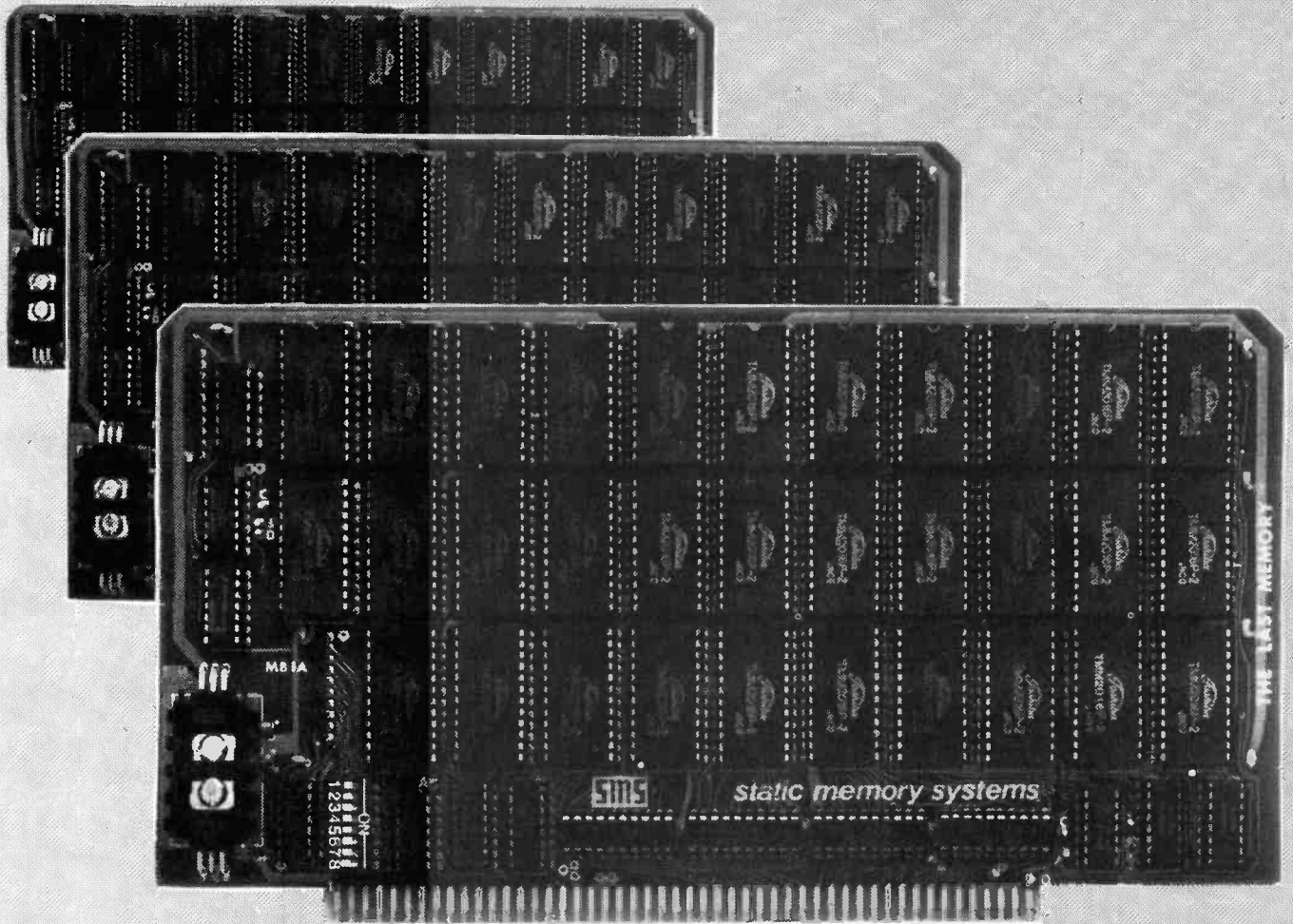
www.americanradiohistory.com

Listing 9 continued:

```
1140 PRINT #D1,"COULDN'T FIND JOB CONTROL FILE." \END
1150 OPEN #D3,S$+"JCL,"+U$
1160 READ #D3,N,NO,N1 \REM-# CMD ENTRIES, CURRENT CMD, PTR TO 1ST ENTRY
1170 READ #D3,P$ \REM PASS OVER FIRST STRING
1180 READ #D3,D$,T$ \REM READ IN DATE AND TIME
1190 READ #D3,P5,P6,P7 \REM LINES/PAGE, TOP MARGIN, BOTTOM MARGIN
1200 READ #D3,L(1),L(2),L(3) \REM MAX LENGTH FOR TITLE, AUTHOR, DATE
1210 RETURN
2000 REM*-----
2010 REM* SUBROUTINE TO READ IN LIST COMMAND DATA & INITIALIZATION
2020 REM*-----
2030 DIM P1$(80),P2$(80),P3$(80),P(3),X1$(80),X2$(80),X3$(80)
2040 P2=N1
2050 FOR I=1 TO NO
2060 P1=P2
2070 READ #D3%P1,P2
2080 NEXT I
2090 READ #D3,P$,P$ \REM PASS OVER FIRST TWO STRINGS
2100 READ #D3,F1$,U1$ \REM FILE NAME & UNIT FOR MASTER
2110 READ #D3,P(1),P(2),P(3) \REM PRINT FIELD ORDER
2120 L1=L(P(1)) \REM LENGTH OF 1ST PRINT FIELD
2130 L2=L(P(2)) \REM LENGTH OF 2ND PRINT FIELD
2140 L3=L(P(3)) \REM LENGTH OF 3RD PRINT FIELD
2150 P=0 \REM INITIALIZE PAGE NUMBER COUNTER
2160 L=0 \REM INITIALIZE LINE COUNTER
2170 CLOSE #D3
2180 OPEN #D4,F1$+U1$
2190 RETURN
3000 REM*-----
3010 REM* SUBROUTINE TO READ AN ENTRY
3020 REM*-----
3030 Z=0
3040 IF TYP(D4)<>0 THEN 3060
3050 Z=1 \RETURN \REM END OF FILE
3060 READ #D4,X1$,X2$,X3$
3070 ON P(1) GOTO 3080, 3090, 3100
3080 P1$=X1$ \GOTO 3110
3090 P1$=X2$ \GOTO 3110
3100 P1$=X3$
3110 IF LEN(P1$)>L1 THEN P1$=P1$(1,L1) \REM TRUNCATE IF TOO LONG
3120 ON P(2) GOTO 3130, 3140, 3150
3130 P2$=X1$ \GOTO 3160
3140 P2$=X2$ \GOTO 3160
3150 P2$=X3$
3160 IF LEN(P2$)>L2 THEN P2$=P2$(1,L2) \REM TRUNCATE IF TOO LONG
3170 ON P(3) GOTO 3180, 3190, 3200
3180 P3$=X1$ \GOTO 3210
3190 P3$=X2$ \GOTO 3210
3200 P3$=X3$
3210 IF LEN(P3$)>L3 THEN P3$=P3$(1,L3) \REM TRUNCATE IF TOO LONG
3220 RETURN
4000 REM*-----
4010 REM* SUBROUTINE TO PRINT AN ENTRY
4020 REM*-----
```

Listing 9 continued on page 382

# THE LAST MEMORY™



## OFFERS MORE FOR LESS

THE LAST MEMORY™, 64K static RAM/EPROM board, sets the industry standard in cost and performance. That's why it's the choice of system integrators, research laboratories, small businesses, large corporations, universities, and hobbyists from Dayton to Tasmania.

Now, how could we make the standard in S100 memory boards better? **BY LOWERING THE PRICE!!**

	KIT		ASSEMBLED & TESTED	
Board Without RAM	<del>99.99</del>	99.00	<del>139.99</del>	139.00
16K	<del>219.99</del>	199.00	<del>259.99</del>	239.00
64K	<del>549.99</del>	459.00	<del>689.99</del>	499.00

All boards supplied with 150ns RAM  
Any board configuration (i.e. 2K, 4K, etc.) available.  
OEM discounts available  
All prices are F.O.B. Freeport, IL  
Dealer inquiries invited.



**static memory systems Inc.**

15 So. Van Buren Ave.

Suite 209

Freeport, Illinois 61032

(815) 235-8713





```

4030 GOSUB 4060 \REM PRINT HEADING IF REQUIRED
4040 PRINT #D2,P1$,TAB(L1+1),P2$,TAB(L1+L2+2),P3$
4050 RETURN
4060 REM*-----
4070 REM* SUBROUTINE TO PRINT HEADING
4080 REM*-----
4090 IF L=0 THEN 4120
4100 L=L-1
4110 RETURN
4120 IF P=0 THEN 4160
4130 FOR I=1 TO P7 \REM BOTTOM MARGIN
4140 PRINT #D2
4150 NEXT I
4160 P=P+1
4170 FOR I=1 TO P6 \REM TOP MARGIN
4180 PRINT #D2
4190 NEXT I
4200 PRINT #D2,"ARTICLE/BOOK LIST",TAB(40-INT((LEN(D$)+LEN(T$)+2)/2)),
4210 PRINT #D2,D$," ",T$,TAB(73),"PAGE",%3I,P
4220 PRINT #D2
4230 ON P(1) GOTO 4240, 4250, 4260
4240 PRINT #D2,"TITLE",TAB(L1+1), \GOTO 4270
4250 PRINT #D2,"AUTHOR",TAB(L1+1), \GOTO 4270
4260 PRINT #D2,"DATE",TAB(L1+1),
4270 ON P(2) GOTO 4280, 4290, 4300
4280 PRINT #D2,"TITLE",TAB(L1+L2+2), \GOTO 4310
4290 PRINT #D2,"AUTHOR",TAB(L1+L2+2), \GOTO 4310
4300 PRINT #D2,"DATE",TAB(L1+L2+2),
4310 ON P(3) GOTO 4320, 4330, 4340
4320 PRINT #D2,"TITLE" \GOTO 4350
4330 PRINT #D2,"AUTHOR" \GOTO 4350
4340 PRINT #D2,"DATE"
4350 PRINT #D2
4360 L=P5-P6-P7-5
4370 RETURN
5000 REM*-----
5010 REM* RETURN TO SUBEXECUTIVE
5020 REM*-----
5030 FOR I=P5-L-2 TO P5 \REM EJECT TO A NEW PAGE
5040 PRINT #D2
5050 NEXT I
5060 CLOSE #D4
5070 CHAIN S$+",""+U$

```

Text continued from page 378:

relate to its overall structure and its use of the executive.

30-90 Overall Program Flow. I again used the approach of controlling program flow by using a series of GOSUB statements. The subroutines at lines 1000, 2000, and 5000 isolate interaction with the subexecutive and the job-control file.

1000-1210 Read in Global Data. These lines are similar to lines 1000 through 1270 in the update/sort program but do less processing after reading the parameters.

2000-2190 Read in Parameters for Program Execution. These lines read in parameters for executing the rest of this program.

5000-5070 Return to Subexecutive. After positioning the printer to a new page, this section transfers control back to the subexecutive.

#### Adapting for your Application

You can adapt these programs for your application in two ways. One is to retain the same basic functions in the system but change the fields to be



# COMMODORE VS. IBM

APPLE, TANDY AND ALL THE OTHERS

**"READ THE CHART AND SEE WHICH COMPUTER COSTS LESS  
AND GIVES YOU MORE FOR YOUR MONEY?"**

—WILLIAM SHATNER

## COMPARE OUR \$995 COMPUTER

FEATURES	COMMODORE 4016	IBM®	APPLE II®	TRS-80® MODEL III
Base Price	\$ 995	\$1565	\$1330	\$ 999
12" Green Screen	Standard	345	299	NO
IEEE Interface	Standard	NO	300	NO
<b>TOTAL</b>	<b>\$ 995</b>	<b>\$1910</b>	<b>\$1929</b>	<b>\$ 999</b>
Intelligent Peripherals	Standard	NO	NO	NO
Real Time Clock	Standard	NO	NO	NO
Upper & Lower Case Letters	Standard	Standard	NO	Standard
Separate Numeric Key Pad	Standard	Standard	NO	Standard
Maximum 5¼" Disk Capacity Per Drive	500K	160K	143K	178K

These systems were configured to approximate the capabilities of the 16K PET® 4016. Disk drives and printers are not included in prices. Models shown vary in their degree of expandability.

### WHY COMMODORE

The idea of a computer in every office and home used to be science fiction. But that idea is now becoming reality.

The question is, with so many to choose from, which computer should you buy. When you consider the facts, the clear choice is Commodore:

- 1 Commodore is the only personal computer company with a full line of computers—from our \$299.95 VIC-20 to the economical PET® and CBM™ (see chart) to our new SuperPET computer that speaks 5 computer languages.
- 2 Commodore is the only U.S. personal computer company that manufactures its own semiconductor microprocessors—the "heart" of all personal computers. As a result, Commodore's computer system is more affordable.
- 3 Commodore's proprietary "6502" microprocessor is so technologically advanced and reliable that it's used in all Apple and Atari computers, as well as many others.
- 4 Commodore's CBM provides more storage power—1,000,000 characters on 5¼" dual disks—than any system in its price range. More than IBM. More than Apple. More than Tandy.
- 5 Commodore computer systems can be expanded to meet the needs of a growing business.
- 6 With over a quarter of a million computers sold worldwide, Commodore is proven for performance and reliability.
- 7 Sales in excess of \$200,000,000 annually.
- 8 Commodore is listed on the New York Stock Exchange.

### USES AND APPLICATIONS

Word Processing. It's easy on Commo-

dore—the most versatile, efficient and economical computers in their price range.

**Financial Planning and Budgeting.** Through the use of VisiCalc™<sup>1</sup>, the electronic worksheet. It lets you explore all your financial alternatives in seconds.

**Dow Jones Portfolio Management System**<sup>2</sup>. Gives you up-to-the-minute data on over 6,000 securities. And more.

**Data Management and Retrieval System.** OZZ<sup>3</sup>, our information wizard, makes it easy for you.

**Doctors' System.** Our Medical Accounting System (MAS)<sup>4</sup> offers a fast, flexible billing and accounts receivable package.

**Legal Time Accounting System (LTA)**<sup>4</sup>. Automatically processes activities by client, attorney and action. **Accounting and Bookkeeping Systems.**

• Accounts receivable • Accounts payable • Payroll • Inventory control • Job costing • Engineering • Personnel recordkeeping • Tax preparation.

### WE WROTE THE BOOK ON SOFTWARE

The Commodore Software Encyclopedia is a comprehensive directory of software programs for:

• Business • Education • Recreation • Personal Use  
Contains over 1,000 software applications to choose from. Pick up a copy at your local Commodore dealer.

### FULL SERVICE, FULL SUPPORT

Commodore dealers throughout the country offer prompt local service. And our new national service contract with TRW provides nationwide support. TRW is the largest third-party related computer service organization in the U.S., with over 2,000 skilled technicians, nationwide.

<sup>1</sup> VisiCalc is a Trademark of Personal Software, Inc.

<sup>2</sup> The Portfolio Management System was created by Micro Business Systems, Inc.

<sup>3</sup> OZZ was created by the Bristol Software Factory.

<sup>4</sup> MAS and LTA were created by Cimarron Corp.



Commodore Computer Systems  
681 Moore Road, King of Prussia, PA 19406  
Canadian Residents: Commodore Computer Systems  
3370 Pharmacy Avenue  
Agincourt, Ontario, Canada M1W 2K4  
Please send me more information.

Name \_\_\_\_\_  
Company \_\_\_\_\_ Title \_\_\_\_\_  
Address \_\_\_\_\_  
City \_\_\_\_\_ State \_\_\_\_\_ Zip \_\_\_\_\_  
Telephone \_\_\_\_\_  
Interest Area  
 Business  Education  Personal

**C commodore**  
COMPUTER

# CHOOSE...

## Choose an Apple Desk



A compact Bi-Level desk ideal for the Apple computer system. This 42" x 29½" desk comes with a shelf to hold two Apple disk drives. The top shelf for your TV or monitor and manuals can also have an optional paper slot to accommodate a printer. It is shown here with the optional Corvis shelf which will hold one Corvis disk drive. The Corvis shelf is available on the 52" x 29½" version of the Apple desk.

## Choose a Micro Desk



The Universal Micro desk accommodates the S-100 type microcomputers. The desk is available in four sizes: 17.75 inch, 19.06 inch, and 20.75 inch wide openings with 24 inch front-to-rear mounting space. The fourth size is a 20.75 inch wide opening with a 26.50 inch front-to-rear mounting space.

## Choose a Mini Rack



Mini racks and mini micro racks have standard venting, cable cut outs and adjustable RETMA rails. Choose a stand alone bay or a 48", 60", or 72" desk model in a variety of colors and wood tones. A custom rack is available for the Cromemco.

## Choose a Printer Stand



The Universal printer stand fits the:

Centronics 700's	Diablo 1600's & 2300's
Dec LA 34	T.I. 810 & 820
NEC Spinwriter	Okidata Slimline
Lear Siegler 300's	Anadex 9500's

Delivery in days on over 200 styles and colors in stock. Dealer inquiries invited.

**ELECTRONIC SYSTEMS  
FURNITURE  
COMPANY**

17129 S. Kingsview Avenue  
Carson, California 90746  
Telephone: (213)538-9601

maintained; the other is to use the structure and the supporting utility routines for an entirely different set of tasks.

As an example of the easier case, let's assume you want to maintain a directory of all your program and data files where each entry contains the following fields: disk identification, file name, type of file, date of last update, and description of file contents. This system has five fields rather than the three in the Article/Book Maintenance System. The lines of the programs to change are shown in table 1. As this example shows, you can retain much of the original system for the new application. But this system has a major limitation on the number of entries that can be maintained, because the entire file must be in memory for the

sort process. Additional code could be written in the update/sort program to perform the sorting process on disk to remove this limitation.

Now let's look at how to adapt the batch-processing system for an application quite different from the original Article/Book Maintenance System. The MAIN program is made to be flexible. You can adapt it to meet the requirements of the programs that are to be incorporated; just set up the appropriate global parameters and parameters specific to the programs you want to use. This is done by deleting lines 3000 through 5230 from the MAIN program (see listing 6). Also change lines 100 and 360 to reflect the commands that you need. Determine all the parameters that will be used by two or more programs to be run in a batch. Then,

### MAIN Program (Save in a file with a name of your choice)

Lines	Modification
3380-3460	Change for your options
4130-4580	Change for your options
5160-5210	Change for proper length of each field
64520	Change the name to one of your choice

### Subexecutive (%!)

No change required

### Update/Sort Program (%!SORT)

Lines	Modification
1210-1240	Change for the different fields
3080-3090	Change for the different fields
4290	Provide more code for the two additional fields
4310	Change 3 to 5 for the proper number of fields
4325	Change for the additional two fields
4395-4560	Change and provide more code for the two additional fields
5040-5070	Change and provide more code for the two additional fields
6090-6110	Change and provide more code for the two additional fields

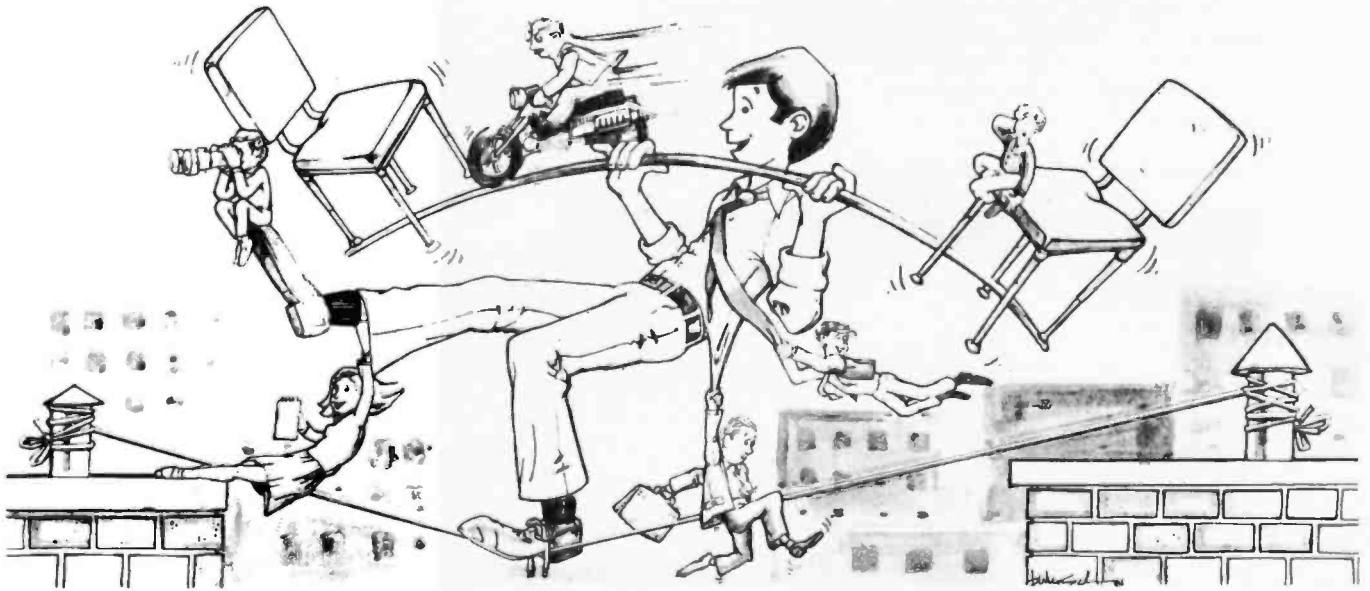
### List Program (%!LIST)

Lines	Modification
1030	Change for additional fields
1200	Change for additional fields
2030	Change for appropriate length of print line
2110	Change for additional fields
2140	Provide more code for additional fields
3060-3210	Change and provide more code for the two additional fields
4040	Change for the additional fields
4200	Change for the appropriate heading and print line length
4230-4340	Change subheading

Table 1: Changes required to adapt the Article/Book Maintenance System for maintaining disk directories. This table shows the required changes in each of the batch-processing system's four programs, with line-number references in each.



# RM/COBOL™<sup>1</sup> MAKES IT ACROSS!



**...FROM ONE OPERATING SYSTEM TO ANOTHER!  
A VITAL WAY TO PROTECT YOUR SOFTWARE INVESTMENT FOR THE FUTURE!!**

The **RM/COBOL** language runs on more different Operating Systems and more

different-sized computers than any other similar language. For starters, it runs on NCR and TI minicomputers and, in the micro field, on the CPM<sup>2</sup>, MP/M<sup>2</sup>, CP/M86<sup>2</sup>, MP/M-86<sup>2</sup>, TRSDOS<sup>3</sup>, OASIS<sup>4</sup>, MOASIS<sup>4</sup>, and UNIX<sup>5</sup>. (ONYX version) Operating Systems... to mention only a few.

Until now, serious business software of the scope and flexibility seen in the minicomputer world has not been available on micros. **RM/COBOL** now allows transfer of such software with a minimum of fuss.

We have participated in such a mini-to-micro transfer of a major set of general business software... using **RM/COBOL**, as the transfer mechanism, of course. Running on literally thousands of minicomputers, these refined, enhanced, and proven software packages cover A/R, A/P, G/L, P/R, Order Entry (with Invoicing and Inventory Control) as well as Sales Analysis. The Packages define a new level of achievement for features and flexibility in micro applications software and offer top quality at a reasonable price.

For immediate information, call 714/848-1922 for your complete product descriptions.

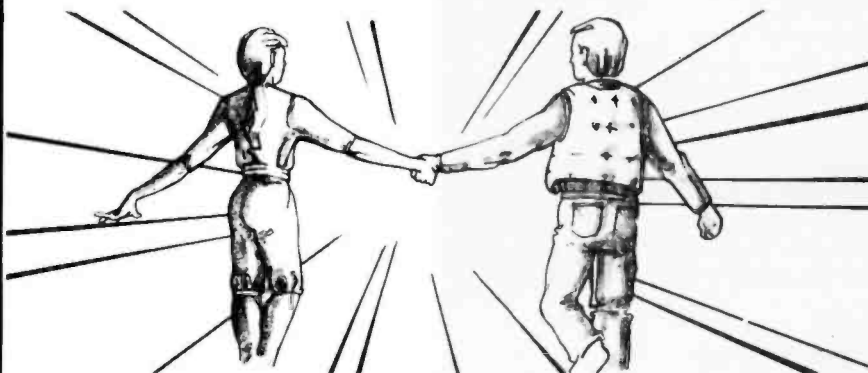
**Trademarks of:**

1-Ryan-McFarland Corp.; 2-Digital Research, Inc.; 3-Tandy Corp.; 4-Phase One Systems, Inc.; 5-Bell Telephone Laboratories, Inc.; 6-Cybernetics, Inc.



8041 NEWMAN AVE., SUITE 208  
HUNTINGTON BEACH, CA 92647  
714/848-1922

## **RM/COBOL and CRT!™<sup>6</sup> from CYBERNETICS ARE GOING STEADY...**



**...AND YOU'RE GONNA LOVE 'EM TOO!!**

Use your computer to program itself. **CRT!** (Cobol Reprogramming Tool!) from Cybernetics is a program generator for **RM/COBOL**, that produces error-free **RM/COBOL** source programs for data input, file maintenance, and report printing programs.

A full feature interactive program generator, not a subset! Call Now! 714/848-1922.

# BUYING?

You can save on computers and software using our commercial buying service. We buy wholesale for you. Our fee is one fourth of what we save you off list. We offer you:

- Access to over 500 Manufacturers
- 1500 Satisfied Clients
- Leasing
- Exporting Services

Examples of prices paid by our clients (including fee) are:

## Computers

Adds Multivision	\$ 3,075.00
Adds Multivision I	3,074.00
Alpha Micro 1030	12,047.00
Alpha Micro 1051	17,634.00
Alspa AC1-2/SS	2,320.00
Altos 8000-02	2,629.00
<b>Altos 8000-10</b>	<b>6,141.00</b>
Altos 8000-15	3,585.00
Altos 8600-10	7,586.00
Apple 2 + 48K	1,208.00
Archives Model I	4,700.00
CCS Series 300-1A	4,414.00
Cromemco System 0	3,200.00
Cromemco System 1	2,946.00
Cromemco System 2	3,400.00
<b>DEC VT-180xx</b>	<b>3,344.00</b>
Dynabyte	30% OFF
IBM Personal	CALL
Micromation	CALL
NEC 8001A	750.00
NEC 8012A	490.00
NEC 8031A	750.00
<b>North Star Advantage</b>	<b>2950.00</b>
North Star Hoz II 64K DD	2,995.00
North Star Hoz II 64K QD	3,040.00
Onyx 5001 MU-6	7,350.00
Osborne	CALL
Seattle System 2	3,251.00
Televideo TS-802	2,600.00
Televideo TS-802H	5,000.00
Televideo TS806	5,100.00
Toshiba T-200 w/Printer	4,099.00
Toshiba T-250 w/Printer	5,099.00
Toshiba EW-1000/4	6,799.00
Toshiba EW-1000/2 w/Ptr	5,999.00

Vector 2600	4,221.00
Vector 3005	6,458.00
Vector 5005	7,308.00
Wicat	CALL
Xerox 8205 1/4	2,300.00
Xerox 8208"	2,900.00

## Printers

C. Itoh F-10	1,400.00
C. Itoh 40 CPSSerial	1,500.00
C. Itoh 45 CPSPar	1,675.00
C. Itoh Comet II	800.00
Diablo 630	1,965.00
IDS 560	1,099.00
IDS Prism 132 Column	1,395.00
NEC 3510	1,830.00
NEC 7710R/O	2,325.00
NEC 7720 KSR	2,700.00
NEC 8023	603.00
Olivetti 231	2,104.00
Qume 9/35	1,795.00
Qume 9/45	2,045.00
Sellem I	2,725.00
Tally	CALL

## Others

Anderson Jacobsen	641.25
Corvus IOMEG	3,825.00
DEC VT-100	1,430.00
Houston Instrument DMP-2 I	1,147.00
Houston Instrument DMP-4 I	1,460.00
Houston Instrument DMP-7 2	2,077.00
Morrow 20MEG	3,650.00

For latest wholesale prices and to order Call Toll Free 800-227-2283. In California call 415-376-9020. Assembly, integration and testing also available from our service department.

**Ask about our Leasing Program.** We are buying agents for overseas computer dealers. **EXPORT SERVICES available.** International Telex 470851.

Mastercard, VISA at 3% handling fee. Prices subject to change without notice. Minimum fee \$100. 15% cancellation fee.

## THE PURCHASING AGENT

1635 School St., Suite 101, Moraga, CA 94556

using the utility routines found in lines 64000 through 65080, write a routine to set up the global parameters in the job-control file. This approach assures that if you want to change a parameter later, you will need to make only a simple modification in the MAIN program.

Next, again using the utility routines, write a routine for each command required. Remember the importance of checking that all parameters to be written to the job-control file are reasonable. The Article/Book Maintenance System handles only string input. If you want to accept a numeric value, first read it in as a string, then call the routine at line 64990 to check for null input, and then convert the string to a numeric value by using the BASIC function VAL.

Finally, use the basic structure of the programs listed here as the model for the programs to be run under your batch-processing system.

## Conclusion

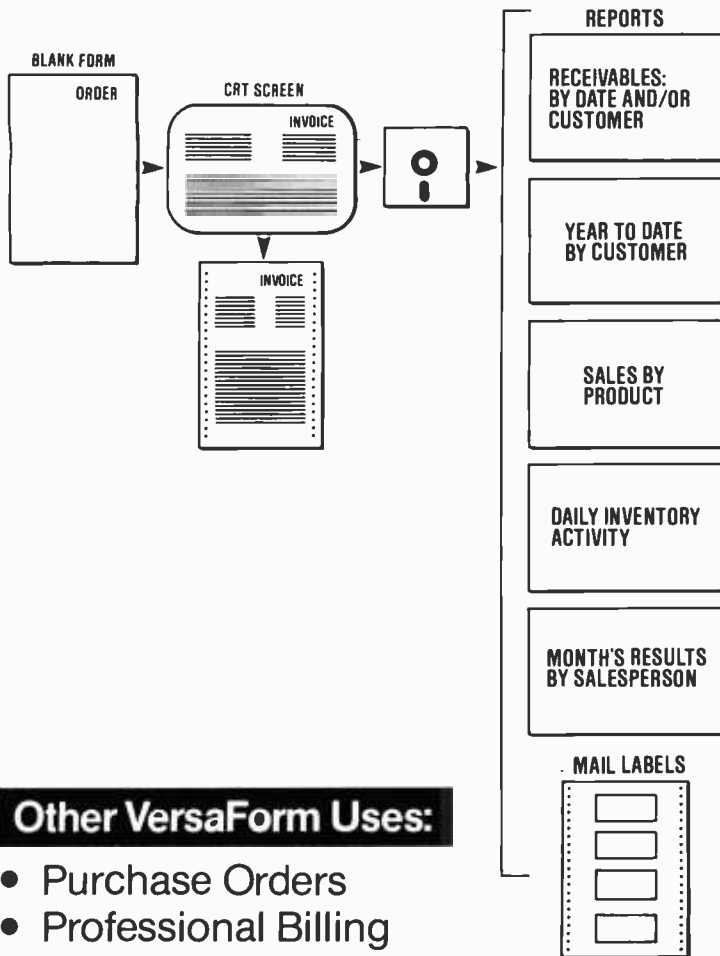
It is irritating to have to attend a computer and nurse it through a series of repetitive operations. After all, the computer is supposed to be a laborsaving and timesaving device, especially useful for repetitious tasks that people hate. But what will save you from the labor and time required to supervise and redirect the computer through a series of repetitions?

The answer is batch-processing software. Once you have a batch-processing system working, you'll find that you can easily adapt it for various specific applications. While the computer works on one set of tasks, you will be free to concentrate on another, or simply relax. I hope that the batch-processing system that I have described proves as helpful to you as it has to me. ■

*The author will send interested BYTE readers a 5 1/4-inch, single-density North Star disk containing the programs described in this article. The programs on the disk, which costs \$15, include both the Article/Book Maintenance System programs and the set of programs for maintaining disk directories.*

# BUSINESS FORM PROCESSING

## Application Memo #1: INVOICES



### Other VersaForm Uses:

- Purchase Orders
- Professional Billing
- Inventory Ledgers
- Job Costing
- Personnel Records

Send for Application Note INV-01

VersaForm supports  
Apple II and Apple III.  
Hard Disk  
versions available

**Now there's a way** to quickly automate specific areas of your business . . . using existing forms. In a single session you can emulate a standard invoice on a personal computer (as shown on side). Automatic filling, calculating and data checking features to speed error-free processing. It's called Business Form Processing, a brand new concept in desktop computing. **Producing management reports** that used to take days now takes minutes. Just specify which items contained within your form are to be sorted, sub and summary totalled. Each report as shown took only minutes to specify, and minutes to produce. It's the combination of the easy-to-use reporting facility with its powerful forms emulator that makes VersaForm more than just a data base.

**You can use existing forms.** With a simple output formatting module, VersaForm lets you overprint processed information to a pre-printed form, or to blank paper that becomes its own custom form. It even customizes your output to your printer's line spacing and number of characters per line, and can omit confidential data from final customer drafts. **If you have a form,** we've got the system and solution to higher productivity. Visit your local computer store where Apples are sold.

# VersaForm™

**Business  
Form  
Processor**

Applied Software Technology  
14125 Capri Drive  
Los Gatos, California 95030  
(408) 370-2662



## News and Speculation about Personal Computing

Conducted by Sol Libes

**R**andom Rumors: IBM is expected to expand distribution of its Personal Computer in the second half of this year; look for distribution through channels other than Computerland and Sears. Reportedly, IBM is taking a look at mail-order and nonfranchised computer stores. It's also rumored that IBM is readying a smaller computer system designed specifically for mail-order sales and that the Pick operating system for the Personal Computer will be released soon. There's word of a deal between IBM and Motorola for the development of a 370/4300-computer-compatible system of software to run on Motorola's 68000. . . . Epson America is rumored to be developing a desktop personal computer for the low-end business market. . . . Software Arts, Cambridge, Massachusetts (the outfit that developed Visicalc) is said to be developing another revolutionary program for a leading hardware manufacturer. . . . Commodore is expected to finally release its 16-bit microprocessor that will be software compatible with the 6502.

**N**CC Predictions: Here are some of the new items that I expect to see introduced at the NCC show next month in Houston: look for Apple Computer Inc. to finally introduce the Apple IV using a 68000 microprocessor, a Unix-like operating system, sophisticated graphics, and networking functions. . . . Expect DEC (Digital Equipment Corporation) to finally

introduce its personal computer system based on the venerable PDP-8. . . . Look for Zenith to introduce its Z-100 16-bit computer system, rumored to use the Microsoft MS-DOS (the operating system used on the IBM Personal Computer). . . . Commodore will formally introduce its new personal computer that can emulate the Apple, Radio Shack, and IBM systems and run CP/M. . . . I expect Xerox to introduce a portable version of its Xerox 820 computer/word-processor system. . . . Expect a 3.25-inch 3.3-megabyte "baby Winchester" disk drive from a U.S. vendor (check out the Sony, Monroe, Osborne, and Otrona booths for prototypes) and 5¼-inch hard-disk drives with 30-megabyte capacity from Tandem and Control Data. . . . Epson is rumored to be readying a 1-megabyte, very thin 5¼-inch floppy-disk drive for showing at NCC. . . . Also, Integral Data Systems is expected to debut a dot-matrix printer with an 18-wire head to provide high-quality print.

**G**rowing 68000 Market: As predicted several months ago in this column, Radio Shack has released its TRS-80 Model 16 using a 68000 16-bit microprocessor. Following in the footsteps of companies such as Godbout and Cromemco, the Model 16 is a dual-processor system that uses both an 8-bit Z80 processor and a 16-bit 68000 processor. This "hardware now, software later" strategy will allow purchasers to run

Z80 software until 68000 software becomes available. Tandy expects to release a three-user (reportedly Unix-like) operating system over the summer and may have several languages available later. Applications software should be available starting in 1983.

Although the Radio Shack TRS-80 Model II has proved to be a very good single-user business system, the Model 16 represents a significant step upward for Tandy in its attempts to compete with IBM, DEC, et al., in the very lucrative multiuser business market. The Model 16 also offers options of an Arcnet local network interface, memory expansion up to 512K bytes and hard-disk storage.

Rather than design a completely new computer from the ground up, as Apple is doing, Tandy has developed its Model 16 by adding the 68000 system to its Model II, replacing the single 8-inch floppy-disk drive with two slim-line drives (1.25 megabytes per drive), and changing the color of the cabinet from battleship gray to ivory-white. The basic unit with 128K bytes of memory and 1.25 megabytes of disk storage lists for \$5000; however, if you want additional memory, a second floppy-disk drive, and a hard disk, you can expect a price of over \$10,000 (some Radio Shack dealers are already offering 15 percent discounts). Tandy also offers to upgrade Model II machines to most of the features of the Model 16 for \$1500—it's nice to see a company that doesn't forget

its old customers.

Considering that Radio Shack's line of computers now ranges from tiny pocket computers to 16-bit multiuser systems, the next question is Will Radio Shack's next machine be a true 32-bit micro-computer?

Apple and PET users who want to upgrade to 16-bit processors need not feel left out in the cold. Several independent vendors are already offering plug-in and add-on 68000 and 8088 processor cards. For example, Digital Acoustics, Santa Clara, California, offers a 68000 processor card that can be attached to an Apple or PET for \$700 to \$1400, depending on the amount of additional memory (actually, the unit can be interfaced to any system via I/O ports and appropriate software). Metamorphic Microsystems, Boulder, Colorado, offers a card for the Apple that incorporates an Intel 8088, and also has available CP/M-86, MP/M-86, and UCSD Pascal 4.0. A 68000 Apple plug-in card is already being sold in England. (As yet, no software is available for the 68000 product.)

For almost a year now S-100 system owners have had 68000 processors available to them, with a variety of different multiuser Unix-like operating systems and development languages, from suppliers such as Empirical Research Group, Milton, Washington; MicroData-Sys, Santa Monica, California; Dual Systems Control, Berkeley, California; and Cromemco, Mountain View, California. Already available

# Ten reasons why your floppy disk should be a BASF FlexyDisk®.



More than four decades of experience in magnetic media – BASF invented magnetic recording tape, the forerunner of today's wide range of magnetic media, back in 1934, and was the first independent manufacturer of IBM-compatible floppy disks.

Tough Tyvek sleeve – no paper dust, no static electricity.

Special self-cleaning jacket and liner help eliminate data errors and media wear and tear.

Packaging to suit your requirements – standard flip-top box, Kasette 10® storage case, or bulk pack.

Center hole diameter punched to more accurate standards than industry specifications, for top performance.

100% certification – every single disk is tested at thresholds 2-3 times higher than system requirements, to be 100% error-free.

Bi-axially oriented polyester substrate – for uniform and reliable performance year after year.

For the name of your nearest supplier, write BASF Systems, Crosby Drive, Bedford, MA 01730, or call 617-271-4030.

Cross-linked oxide coating – for low head wear and long trouble-free media life.

Total capability – one of two manufacturers in the world that makes both 8" and 5.25" models, has tape and disk experience, and manufactures floppy disk drives.

Double lubrication – lubricants both in the formula and on the disk surface, to minimize media wear due to head friction.



Floppy Disks Mag Cards Cassettes Computer Tapes Disk Packs Computer Peripherals

Circle 38 on inquiry card.

[www.americanradiohistory.com](http://www.americanradiohistory.com)

for these systems are languages such as Pascal, FORTH, FORTRAN, and BASIC. Prices for these systems are equal to or less than the Radio Shack prices.

Several other 68000-system suppliers are already delivering 68000 systems at under \$5000. Most notable are the Fortune 32:16 (already in Computerland stores) and the Sage II from Sage Computer Technology, Reno, Nevada, starting at \$3600.

Apple Computer's 68000 machine, which will not become available until the second half of the year at the earliest, will encounter a highly competitive 68000 marketplace. It will have to be darned good to compete.

**IBM Doings:** Like every other personal computer

manufacturer, IBM underestimated the market for its product. It initially expected to sell about 100,000 units this year, but the company has greatly expanded its manufacturing facilities and now is expecting to ship 200,000 Personal Computers, thus generating between \$500 and \$600 million in revenue (which should still be a small fraction of IBM's total yearly \$30 billion revenue). This should make IBM number three in the personal computer marketplace, following Apple Computer Inc. and Radio Shack (both companies are expected to ship over 300,000 systems this year). In fact, just about every personal computer manufacturer expects to set records this year. In the meantime, many IBM customers must wait as long as two months for delivery.

Sales of the IBM Personal Computer are currently limited to the U.S., although some dealers are reshipping to dealers outside the U.S. However, IBM is expected to start shipping to foreign dealers before the year is out.

Although users are generally pleased with the Personal Computer, there are some complaints: users say IBM has not made it easy to expand its system with additional memory and accessory devices, that the keyboard differs from IBM's conventional keyboards, that the system takes up more desk space than competing systems, that competitors can match or even exceed the IBM's performance in many areas, and—the biggest complaint—that the few programs available are too complex. Also, IBM hampered independent suppliers of add-

on peripherals by not releasing technical information until several months after the unit was released.

There are rumors that IBM will introduce a new, lower-cost personal computer later this year or in early 1983. Also of interest is the fact that Telesoft, San Diego, California, recently demonstrated its new Ada compiler on an IBM Personal Computer enhanced with 256K bytes of memory and a 6-megabyte hard-disk drive.

**Justice Department vs AT&T and IBM:** The Justice Department, after many years of pursuit and incalculable expense, has finally settled its antitrust suit with AT&T and dropped its suit against IBM. This means that AT&T is now free to become a formidable competitor in

## BUY A 212A-TYPE MODEM AND GET A \$212 REBATE.

Now, as an introductory offer, when you buy Cermetek's new fully-featured Bell 212A compatible modem, the CERMETEK 212A, you'll get a \$212 rebate.

Just consider the CERMETEK 212A's features:

- Integral Auto-Dialer
- 0-300 or 1200 BPS Operation
- Bell 212A Compatibility. Bell 103/113 compatibility or 0-300 BPS mode
- Auto-originate/Auto Answer/Auto-Speed sense
- User option menu
- Full Duplex operation
- Seven (7) diagnostic modes
- One year limited warranty



To get your CERMETEK 212A modem, contact:

A.C.T.  
Rocky Mountain  
2640 Youngfield  
Lakewood  
CO 80214  
(303) 233-4431

A.C.T.  
15800 Addison Rd.  
Addison TX 75001  
(214) 980-1888

P & L Associates  
11 Laura Lane  
P.O. Box 481  
East Setauket  
NY 11733  
(516) 221-7623

Offer expires September 30th, 1982. Limited to two modems per customer.

Circle 69 on inquiry card.



# Computer Exchange

ALL MAIL: P.O. Box 1380, Jacksonville, OR 97530

Ad # 931B

WAREHOUSE AND OFFICES, BY APPOINTMENT AT 6791 APPLGATE ROAD.



## apple supply center

Free gift with your order if you mention this ad.

### HARDWARE for Apple II/III+ CLOSEOUT on Apple Computer, Inc. products

Apple II 48K or 64K		
Apple III 128K		
Disk Drives, II and III		
Profile III, Hardisk	\$2750	22%
Interface Cards	CALL	25%
Sitetype II or III	Up to	25%

CLOSE OUT CALL

### Direct Substitute for Apple Drives

Micro-Sci A2 is a direct substitute for Apple II drives. It will run all Apple II software. Save \$350 on a dual A40 disk system.		
Micro-Sci 5" Drives for Apple II		SAVE
A2 Drive, 5", 143K	\$395	18%
Controller with DOS for A2	\$ 95	15%
A70 Drive, 5", 286K	\$489	20%
A40 Drive, 5", 160K	\$369	18%
Controller Card for A70 or A40	\$ 79	21%
Sorrento Valley		
8" Disk Drive Controller 2 * 2	\$ 199	60%

### MONITORS:

NEC	12" Color	\$359	24%
	12" Green	\$169	22%
SANYO:	9" B&W	\$149	31%
	9" Green	\$159	31%
	12" B&W	\$219	30%
	12" Green	\$229	30%
ZENITH	13" Color	\$399	28%
	12" Green	\$119	20%

### DISKETTES, 5", box of 10:

Maxell	\$ 39	33%
Memorex	\$ 25	45%

### 80 COLUMN VIDEO CARDS:

Videx Videoterm	\$249	28%
M&R Sup R Term	\$295	22%
ALS: Smarterm	\$269	30%

### MISCELLANEOUS:

CCS: Serial Interface 7710A	\$139	22%
Parallel Interface 7720A	\$ 99	20%
Other CCS Cards In Stock	CALL	CALL
Hayes: Micromodem II	\$289	25%
Smartmodem	\$229	20%
ISC Videostick Paddle	\$ 35	23%

### Keyboard Company:

Joystick II	\$ 45	10%
Game Paddle	\$ 25	17%
Numeric Keypad	\$119	21%
M&R: RF Modulator	\$ 25	27%
SUP R FAN	\$ 39	25%
Microsoft: Z80 Softcard	\$279	33%
15K RAM Card	\$159	20%

### Mountain:

CPS Multifunction Card	\$209	13%
Clock/Calendar	\$239	15%
Novation Applcal Modem	\$329	16%
Orange Micro Grappler	\$129	21%
Dan Paymar LCA New rev.	\$ 34	33%
Saturn System 32K RAM Card	\$149	36%
64K RAM Card	\$375	12%
128K RAM Card	\$525	12%
VC-Expand for Visicalc	\$ 75	25%
SSM AIO Serial/Para. Interface	\$159	20%

### ALS: Smarterm 80 Col Card

Z-Card (Z-80)	\$209	22%
Address 16K Card	\$119	20%
Synergizer Package	\$549	27%

### Videx Videoterm 80 col.

Soft Video Switch	\$ 25	29%
Enhancer II	\$ 99	34%
Full Videx Line, Call	up to	35%

### PAPER: Fan Fold, Call for sizes, thickness and prices

### LETTER QUALITY PRINTERS:

Gume Letter quality printer		SAVE
Sprint 945RO	\$2195	23%
Sprint 545RO	\$2395	20%
NEC 3510 RO Serial	\$1995	20%

### Olympia (Typewriter/Printer)

ES-100, 18CPS, with full cable and interface to Apple II	\$1695	22%
--	--------	-----

### PRINTERS:

Epson. See special Epson section at right		
Integral Data		
Prism 132, Color Printer w/Graphics	\$1695	16%
Prism 80, B&W, ASF, W/Graphics	\$ 995	12%
445 Tiger W/Graphics & 2K	\$ 695	23%
560 Tiger W/Graphics	\$1095	22%
Okidata Microline 82A	\$ 495	25%

### ORDERING INFORMATION:

Minimum order \$100. Cashiers Checks and Money Orders welcomed. Personal Checks allow 20 days to clear. Add 3% for shipping, insurance and handling. UPS is standard. Additional 7% for US Postal or APO. Additional 3% for VISA or MC. Include telephone #. No COD. Prices subject to change and typo errors. Call to verify. Order desk hours are 8 to 6 PDT, 10 to 3 Saturdays.

### CLOSEOUT on Apple Computer, Inc. products

Apple Software:		SAVE
Apple Plot	\$ 49	30%
The Controller	\$ 495	21%
Dow Jones News & Quotes	\$ 69	28%
How to!	\$ 39	22%
Microcourier	\$189	24%
Many others	CALL	CALL

Artsci Magic Window	\$ 75	25%
Ashton-Tate CP/M dBase II for Apple II	\$ 495	30%
Aurora Systems		
Executive Secretary-WP	\$ 189	25%
Beagle Bros. DOS Boss	\$ 18	25%

Broderbund Software		
Payroll	\$269	30%
General Ledger	\$349	30%
Apple Panic	\$ 21	30%
Arcade Machine	\$ 32	30%
Red Alert	\$ 21	30%
Space Warrior	\$ 18	30%
Many Others In Stock	CALL	CALL

Budgetco, Raster Blaster	\$ 22	27%
Calif. Pacific, Ultima	\$ 30	25%
Central Point Software: Copy II Plus ver. 4	\$ 35	10%

Will copy most copy protected software for your backup in 45 seconds! NEW

Continental Software		
Home Accountant	\$ 56	25%
Home Money Minder	\$ 26	25%
Data Most		
Snack Attack	\$ 22	25%
Thiel	\$ 22	25%
Denver Software		
Financial Partner	\$185	25%
Epson, MX 80 Graphics Dump	\$ 9	30%
Hayden, Sargon II (chess)	\$ 29	22%
Apple Pie (specify brd.)	\$ 99	25%

High Technology		
Store Manager	\$189	25%
Job Control System	\$469	40%
Howard Software		
Tax Preparer	\$115	25%
Real Estate Analyzer	\$145	25%
Creative Financing	\$145	25%

### SOFTWARE on disk for Apple II/III+

Infocom Zork II	\$ 29	30%
Info Unlimited, Easywriter (PRO)	\$139	25%
Innovative Apple Spellguard CP/M	\$219	28%
Insoft:		
Electric Duet NEW	\$ 25	20%
ALD System II or III	\$110	10%
TransFORTH II or III	\$110	10%
Insoft Accountant CP/M	\$355	68%
GraFORTH NEW!	\$ 69	25%

LJK Letter Perfect	\$112	25%
Micro Lab		
Data Factory, ver. 5.0	\$249	20%
Invoice Factory	\$129	35%
Tax Manager	\$ 95	38%

Micro Pro all CP/M		
Word Star	\$239	36%
Mail Merge	\$ 79	36%
Spell Star	\$159	36%
Data Star	\$189	36%
Calc Star	\$189	36%
Super Sort	\$129	36%

Microsoft		
A.L.D.S.	\$110	10%
BASIC Compiler	\$299	25%
Cobol 80	\$559	25%
Fortran 80	\$149	25%
Olympic Decathlon	\$ 24	24%
TASC Compiler	\$159	22%
Typing Tutor II	\$ 19	30%

Muse		
Super Text II	\$113	25%
Castle Wolfenstein	\$ 23	25%
Robot War	\$ 29	25%
On-Line	\$ 75	25%

Expediter II	\$ 25	25%
Superscribe II/Screenwriter II	\$ 95	27%
Lisa 2.5	\$ 59	26%
Pegasus II	\$ 22	25%
Threshold	\$ 30	25%
Cranston Manor	\$ 26	25%
Mission Astroid	\$ 15	25%
Mystery House	\$ 19	25%

Osborne (Disk and Book)		SAVE
Some Common Basic Programs, 75 Business, Statistics and Math programs for the Apple II	\$ 49	50%
Peachtree Software all CP/M		
Magic Wand	\$250	37%
GL, AR, AP, PR or Inv	\$189	38%

Personal Software/VisiCorp		SAVE
VisiCalc 3.3	\$189	25%
VisiDex	\$189	25%
VisiFile	\$189	25%
Desktop Plan II	\$189	25%
VisiPlot	\$159	30%
Desktop Plan III	\$209	30%
VisiSchedule	\$239	20%
VisiTrend and VisiPlot	\$ 79	20%
VisiTerm	\$ 33	20%
Zork		

Softech Int'l		
Stockfile	\$250	60%
Stockseller	\$423	30%

Software Publishing:		
PFS II (NEW)	\$ 89	26%
PFS III	\$ 69	26%
Report II or III	\$ 69	26%
Sorcim Supercalc CP/M	\$219	25%
Stoneware,		
DB Master (new version)	\$179	22%
Sub Logic Flight Simulator	\$ 28	20%

**OTHER BRANDS IN STOCK:**  
 Accent, Adventure International, Astar, Auto. Simm., Avalon, Avant-Garde, Beagle, CPU, Cavalier, Datasoft, Delta, Edu-Ware, Info Com, Lazer, LJK, Phoenix, Quality, Sensible, Sentient, Sirius, Strategic, Synergistic and United

**CP/M Software 8" and 5"**  
 All Ashton-Tate, Insoft, Micro Pro, and Peachtree CP/M software available for most 5" and 8" drives, and computers at similar discounts.

**IBM** 3101-10 Terminal **CLOSEOUT** **SAVE**  
 \$ 995 30%

**commodore** VIC 20 Home Computer **CLOSEOUT** **SAVE**  
 \$ 249 16%

**hp** HEWLETT H/P 85A **PACKARD** **STAR** \$1,995 **SAVE**

H/P 85 Microcomputer/Mcinit/Printer	\$1995	27%
H/P 87 CP/M Microcomputer NEW!	\$1995	20%
H/P 125 CP/M Microcomputer NEW!	\$1995	27%
H/P 82901M 5" Dual Drives	\$1650	27%
H/P 7225B Professional Graphics Plotter	\$2060	25%
H/P 7470A Graphics Plotters	\$1249	19%
H/P 41C Calculator	\$ 185	25%
H/P 41CV Calculator 2.2K	\$ 245	25%
Full Accessories and Software Line	CALL	CALL

**ATARI** 800 16K \$ 666 17%  
 400 16K \$ 333 26%

Microtek 16K RAM	\$ 75	25%
Microtek 32K RAM	\$149	25%
410 Recorder	\$ 79	17%
810 Disk Drive	\$449	26%
850 Interface	\$169	25%
Other Hardware	20 to 30%	
Full Line of Software		
Visicalc	\$ 159	21%
Pac Man Avail 5/82	\$ 34	25%
Communicator Kit	\$ 345	25%
Educator Kit	\$ 129	27%

**ALTO** **CLOSEOUT** **COMPUTER SYSTEMS**

8000-15 208K, 4 User, 2 Disk Drives	\$3995	20%
MTU-1 Tape Backup for Hard Disk	\$2795	25%
8000-10 208K, 4 User, 10 Meg	\$6495	25%
Others in Stock	CALL	CALL

**INTERTEC DATA SYSTEMS** SUPERBRAIN **While They Last**  
 64K QD \$ 2795 30%

**EPSON** **PRINTERS**

MX80	\$ 449	31%
MX80 F/T	\$ 555	25%
MX100 F/T w/Graphics	\$ 729	27%
70/80/100 Apple Interface and Cable	\$ 95	15%
MX80 Friction feed adapter	\$ 59	22%
MX80 Graftrax Chip	\$ 79	20%

**NEC** **Microcomputer**

8001 32K Computer	\$ 750	25%
286K Total Dual Drive PC8031	\$ 750	25%
32K add-on and I/O Unit PC8012	\$ 495	24%
Ren Tec "The Wedge" 32K	\$ 495	17%
8023 Impact Printer F/T	\$ 595	25%
Impact Printer Cable	\$ 49	25%
3510 Letter Qual. Printer	\$ 1995	20%
NEC PC Software	CALL	CALL

**Corvu** **CLOSE OUT PRICES**

5 Meg Hard Disk	\$2995	21%
10 Meg Hard Disk	\$4345	20%
20 Meg Hard Disk	\$5245	20%
Omni-Net, Constellation, Mirror, In Stock		

Circle 92 on inquiry card.

**STAR INDICATES BEST BUYS**

Free gift with your order if you mention this ad

Ad # 931B

REFERENCES: We have been a computer dealer since 1978. Our bank reference is First Interstate Bank (503) 776-5620. We belong to the Chamber of Commerce, (503) 772-6293.

\* Apple is a registered trademark of Apple Computer, Inc.

**NO SALES TAX**  
**Oregon Order Desk**  
 (503) 772-3803

**TOLL FREE NATIONAL ORDER DESK**  
**(800)547-1289**

master charge VISA

## BYTE LINES

the nonregulated computer/communications marketplace. To grasp the potential impact of this decision, consider that last year AT&T's Bell Laboratories spent \$1.6 billion on research and development—more than the total amount spent by Japan's Ministry of International Trade and Industry.

Last year alone Western Electric, AT&T's manufacturing arm, produced more 64K-bit dynamic-memory integrated circuits than any other U.S. supplier and is already producing the MAC-32 32-bit microprocessor. Bell Labs has already disclosed the design of a 256K-bit dynamic-memory chip. Consider also the attention the industry is focusing on Unix. AT&T's Advanced Communications Service, scheduled to go online shortly, promises to

tie together computers, networks, and communications terminals in an incredibly advanced and massive computer operation.

IBM is free to pursue the same path. The company has already reentered the time-sharing business and is spending about 10 percent of its revenues (almost \$2 billion) on research.

**Apple Doings:** After failing in the courts to cancel Apple Computer Inc.'s ban on mail-order sales, one of the six mail-order dealers cut off by Apple has filed a formal complaint with the Federal Trade Commission, charging Apple with price fixing and violation of the Sherman Antitrust Act. In the meantime, mail-order sales continue from nonauthorized

Apple dealers who buy their units from authorized Apple dealers and still manage to offer discounts.

Apple finally appears to have gotten the Apple III off the ground by cutting the price by \$400, increasing the dealer margin to 33.4 percent, offering a new, sophisticated operating system and seven application software packages (including CP/M), and making significant hardware improvements and options (including a built-in 5-megabyte hard disk). Reportedly, only 10,000 of the original Apple IIIs were sold compared to more than 350,000 Apple IIs sold through the end of 1981.

Word has it that Apple has spent \$30 million in the development of its two new microcomputer systems, which it hopes to formally

announce at NCC. Apple has kept tight wraps on information about these two units; however, rumors abound that one, called "Lisa," is intended for the business market and will be a workstation system using a 68000 processor. It should have a Unix-like operating system, hard disk, 128K bytes of memory, Ethernet interface, and a base price of at least \$5000. The second system is rumored to be a low-cost portable system that will be software-compatible with the Apple II. It has been designated the "Super II." One question is: What will happen to the Apple II and III when these new units are released?

**Slim-line Floppy Race Heats Up:** The slim-line 8-inch floppy-disk drives are

## Marymae INDUSTRIES, INC.

In Texas Orders  
Questions & Answers  
1-713-392-0747

21969 Katy Freeway  
Katy (Houston) Texas 77450

To Order  
1-800-231-3680  
800-231-3681

### SAVE BIG DOLLARS ON ALL TRS-80® HARDWARE & SOFTWARE

TRS-80® BY RADIO SHACK. Brand new in cartons delivered. Save state sales tax. Texas residents add only 5% sales tax. Open Mon.-Fri. 9-6, Sat. 9-5. We pay freight and insurance. Come by and see us. Call us for a reference in or near your city. Ref: Farmers State Bank, Brookshire, Texas.

#### WE OFFER ON REQUEST

- Federal Express (Overnight Delivery)
- Houston Intercontinental Airport Delivery (Same Day)
- U.P.S. BLUE (Every Day)
- References from people who have bought computers from us probably in your city



In stock TRS-80 Model II and III

No Tax on Out of Texas Shipments!

Save  
**10% 15%**

OR MORE

Reserve Your Model 16 Today

Telex 77-4132 (Flaks Hou)

#### WE ALWAYS OFFER

- NO extra charge for Master Card or Visa.
- We use Direct Freight Lines. No long waits.
- We always pay the freight and insurance
- Toll free order number
- Our capability to go to the giant TRS-80® Computer warehouse 5 hours away, in Ft. Worth, Texas, to keep you in stock.

JOE McMANUS

\*TRS-80 is a Registered Trademark of Tandy Corp

ED McMANUS







the first major redesign of this hardware to have occurred in several years. These drives are typically half the height of a standard drive. This makes it possible to double storage capacity without changing the cabinet, because you can stack two slim-line drives in the space previously occupied by one standard drive. Furthermore, manufacturers have reduced the length of the new 8-inch drives by at least two inches.

The genesis of the slim-line design is credited to Micro Peripherals, Chatsworth, California, which introduced the first slim-line drive in the spring of 1980 but did not start shipping until November of that year. Tandon, also in Chatsworth, introduced a slim-line drive at last year's NCC show and has since introduced a double-sided version. Tandon is currently the

only high-volume supplier of these drives. Shugart Associates has introduced an 8-inch slim-line drive, and Siemens is expected to show prototypes of its drive at NCC next month. At least six Japanese suppliers are expected to show 8-inch slim-line drives at NCC, many of which are already being delivered in Japan.

Although prices for the slim-line drives are currently higher than standard drives, these prices are expected to fall quickly as manufacturers gear up to full production. In the long run, prices are expected to be significantly lower than standard drives because manufacturers are further along the learning curve in design and manufacturing techniques.

Last year saw a turning point in the floppy-disk market as shipments of 5¼-inch

drives overtook shipments of 8-inch drives. Although the new slim-line 8-inch drives are expected to bolster sales of 8-inch drives in general, they are not expected to significantly affect 5¼-inch shipments. Estimates for 1982 are that 1.9 million 8-inch and 3 million 5¼-inch drives will be shipped.

Incidentally, a reported 250 million disks were sold through the end of 1981; 125 million were sold in 1981 alone.

**Microcomputer Profits:** Apple Computer reported that its net income for the first quarter of 1981 rose 83 percent to \$13.6 million on revenues of \$133.6 million. But that's nothing compared to Atari! Warner Communications, which owns Atari, reported that Atari sales last year doubled to \$1.2 billion, while income quadrupled to \$287 million. Incidentally, when Warner bought Atari in 1976, sales were about \$40 million—Warner is reaping a video game bonanza. Corvus Systems reported that its sales for 1981 more than quadrupled over the previous year, from \$2.7 million to \$11.4 million. Corvus is now two and a half years old.

Exxon Corp., which for the last few years has attempted to establish itself in the microcomputer field (with Zilog, Vydec, et al.) reported that its Office Systems subsidiary lost \$76 million in 1981—oh well, I guess Exxon needed a big tax loss.

**Dvorak Keyboard on Personal Computers:** The Dvorak typewriter keyboard configuration has long been recognized as considerably more efficient than the conventional QWERTY keyboard configuration. Unfortunately,

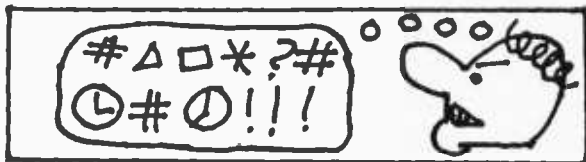
the conventional configuration has been with us for many years and changing it is assumed to be difficult and expensive; however, owners of personal computers whose keyboards are software controlled can make the change easily by changing the software which scans the keys, and recent studies show that increased production more than balances the slight effort required. Software is already available for the TRS-80 Models I and III, Apple II, and Exidy Sorcerer microcomputers. People who are interested in reconfiguring their personal computers to use the Dvorak keyboard configuration should contact Quick Strokes (the newsletter for Dvorak keyboard users), POB 643, West Sacramento, CA 95691.

**Videodiscs that can Record:** Sharp Corp., Osaka, Japan, has disclosed that it has developed a videodisc system with recording capability. Based on a thermomagnetic effect, it employs a silicon laser and a 5¼-inch disk, similar to a floppy disk, that can store up to 200 megabytes. The unit is expected to be in production within two years.

**Foreign Exchange:** If you're into computer bulletin boards and are tired of accessing U.S. bulletin board systems, why not try a foreign BBS such as FORUM-80 London (01-286-6207), CBBS-London (01-286-6207), or FORUM-80 Holland (010-313-512-533).

**Illegal Access:** Before the FBI and the courts put him out of business, a California teenager developed a hobby of illegally accessing computer systems. He had ac-

## BDOS ERROR ON B:BAD SECTOR



Before disk errors ruin your work again order BADLIM.

- BADLIM assures the reliability of your CP/M computer.
- You can use your disks 10 times longer without losing your data AND your time.
- BADLIM checks thoroughly your disk marking all the blocks which have defective sectors. The operating system will know that those sectors should be skipped.
- BADLIM is the only program that gives protection for soft and hard errors.
- The first time BADLIM will list which files in your disk are on bad sectors, so you can take action to correct it.
- But thereafter the bad areas in your disk will be automatically by-passed.
- For CP/M 1.4 single density and for CP/M 2.xx of any format and density. It is a must for Winchester as the media cannot be replaced.

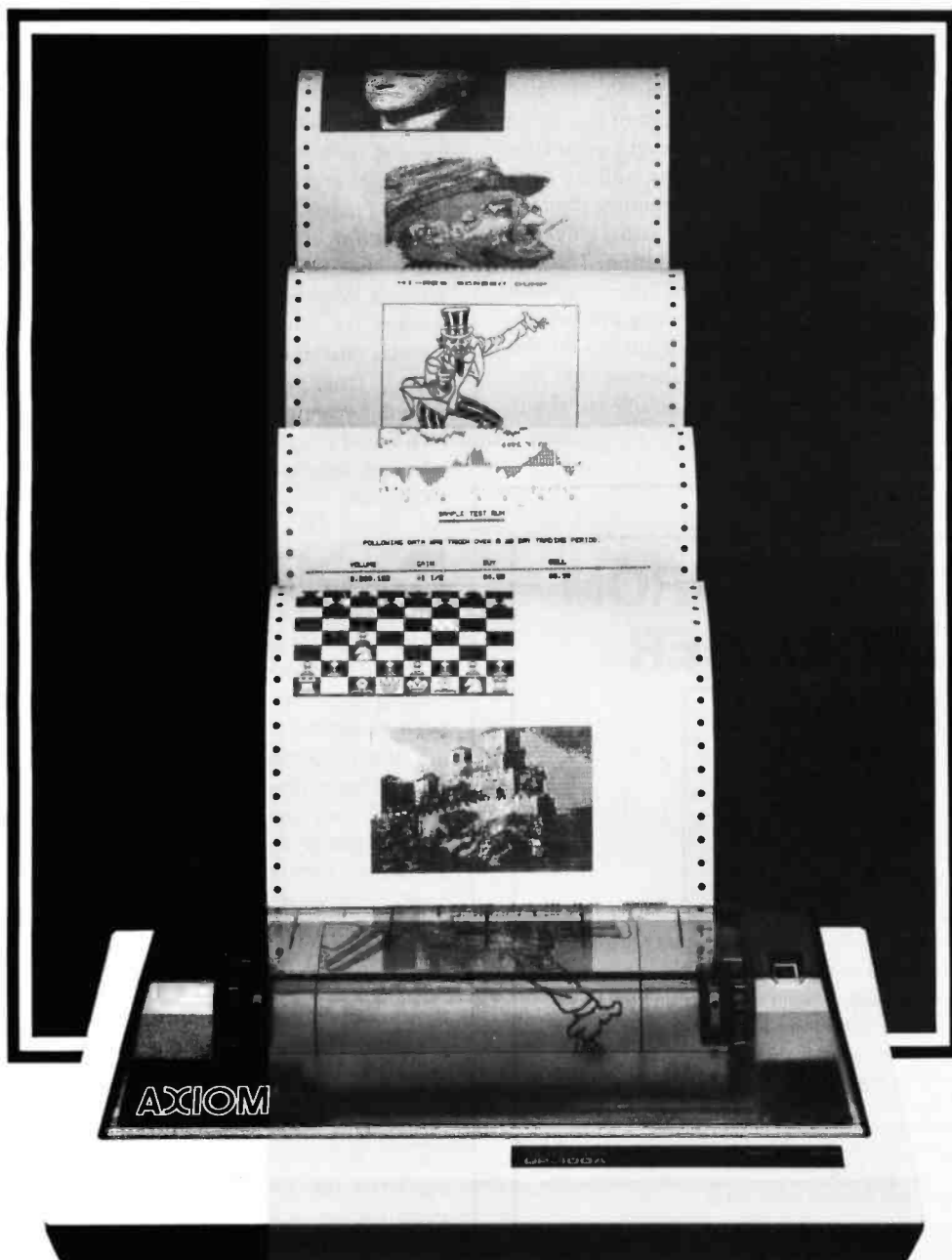
BADLIM cost only \$73. Whatever the reason you have to use a computer you need BADLIM. Contact your dealer or call us today:

BLAT R&D Corp., 8016 188th. St SW, Edmonds WA 98020. Phone: [206] 771-1408

DEALER INQUIRIES INVITED. **BADLIM**

# \$389.

Made by Seikosha, AXIOM's new GP-100 is the finest printer a little money can buy. It uses standard 8-1/2 x 11 paper and has AXIOM's fabulous graphics interfaces for Apple, TRS-80, Atari, PET, HP and more! See the GP-100 at your AXIOM dealer today!



## AXIOM

AXIOM CORPORATION

Seikosha is the leading company of the worldwide Seiko Group.

1014 Griswold Avenue, San Fernando, CA 91340 • Telephone: (213) 365-9521 • TWX: 910-496-1746

Circle 36 on inquiry card.

[www.americanradiohistory.com](http://www.americanradiohistory.com)

cessed computers belonging to U.S. Leasing, UCLA, UCA, DEC, and even law enforcement agencies. How did he do it? How did he get the access codes and passwords? Some he got by going through printouts he found in company trash cans, some by trial and error, and others by posing as a law officer or computer repairman. Why did he do it? "Just for kicks!"

**C**omputers and the **Handicapped:** Microcomputers are being used in many ways to help the handicapped help themselves to become more effective in the job market, more independent as individuals, and able to coexist with nonhandicapped persons on a more equal basis. A new organiza-

tion to help this effort is "Computers to Help People," Madison, Wisconsin, founded by John Boyer, a grad student in computer science who is both deaf and blind.

**Intel Upgrades 8086:**

Intel has introduced a new microprocessor, called the 80286, that is software-compatible with the company's 8086 16-bit microprocessor. The new processor has an on-chip multilevel protection mechanism as well as capabilities for memory management and virtual-memory address translation. Thus, it's targeted for the multiuser and multitasking market. The integrated circuit has 68 pins.

Another upgrade that Intel is expected to release shortly

is to be called the 80186. It will have on-chip clock and interrupt controllers, two DMA (direct memory access) channels, timers, counters, and random chip-select logic.

**U**nix Rumors: Tandy is expected to announce at NCC a Unix-like operating system for its new TRS-80 Model 16. Experts are betting that it will be Microsoft's Xenix. Rumors also suggest that Xenix will be implemented on the IBM Personal Computer and National Semiconductor's new 16-bit microcomputer. . . . Word has it that Unix IV with the Writer's Workbench is being readied for release to commercial customers early next year. . . . Unix System V is reportedly being tested by AT&T and is expected to be adopted internally in about six months.

**R**andom News Bits:

Mattel Electronics has a new microcomputer game called Dallas. The processor, when playing the role of J.R., has been programmed to cheat, lie, and blackmail. . . . Ithaca Intersystems' new version of Pascal/Z (version 4.0) has a unique feature: an interactive symbolic debugger called Swat. . . . If your rug is creating static problems with your computer, try spraying the rug with a mixture of two-thirds Downey Fabric Softener and one-third water in a spray bottle. . . . M/A-Com's purchase of Ohio Scientific Inc. seems to have determined Ohio Scientific's moving from the personal computer market to the business computer market—I note that the name of Ohio Scientific has been changed to "M/A-Com Office Systems Inc." . . . According to a report from Market Venture Consultants, Newport Beach,

California, 20 percent of all personal computers sold today are used in business, and this should increase to over 30 percent by 1985. . . . Disk Trends, another marketing research organization, predicts that the 3½-inch floppy-disk drive is likely to become a major product, especially in office machines. It also predicts 3½-inch Winchester drives with 5-megabyte capacity in volume production by 1983. . . . Pertec Computer has given up manufacturing floppy-disk drives to concentrate on higher-margin tape and Winchester disk-drive products. . . . Lifeboat Associates has released CP/Emulator, a program that will allow software written with it to run under CP/M-86 and under Microsoft's MS-DOS (used on IBM's Personal Computer and others). Cost is \$750. . . . Lifeboat Associates and Intel have cooperatively formed iRUG, a users group for Intel's iRMX-86 operating system. For information write iRUG, Lifeboat Associates, 1651 Third Ave., New York, NY 10028. . . . Intel is reportedly shipping its Ada compiler for the iAPX432 32-bit microprocessor and hopes to have its 432 development system available in the last quarter of this year.

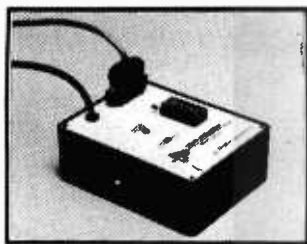
**Q**uote of the Month:

"CP/M 2.2 is extremely important, and the Z80 chip will live forever because of it." Dr. Portia Isaacson Future Computing Inc.

**MAIL:** I receive a large number of letters each month as a result of this column. If you write to me and wish a response, please include a self-addressed, stamped envelope.

**Sol Libes  
POB 1192  
Mountainside, NJ 07092**

**Model 953A EPROM PROGRAMMER**



- Programs 2508, 2758, 2516, 2716, 2532 and 2732 five volt EPROMS.
- Complete - no personality modules to buy.
- Intelligent - microprocessor based, programs and verifies any or all bytes.
- RS-232 serial interface - use with computer or terminal.
- Verify erasure command - verifies that EPROM is erased.
- Extended diagnostics - error output distinguishes between a bad EPROM and one which needs erasing.
- May be used for extremely reliable data or program storage.
- All power on programming socket under processor control. LED warning light indicates when power is applied.
- Complete with Textool zero insertion force socket.
- High performance/cost ratio.
- Standard DB-25 I/O connector.

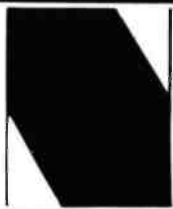
PRICE \$289



**BAY TECHNICAL ASSOCIATES, inc.**

HWY. 603, P.O. BOX 387  
BAY ST. LOUIS, MISSISSIPPI 39520  
(601) 467-8231





# NEECO

## WHY BUY FROM THE BEST? Service... Support... Software...



### MULTI-CLUSTER

For Commodore Systems, allows 3 CPU's (Expandable to 8) to access a single Commodore Disk  
MULTI-CLUSTER (3 CPU's) . . . . . \$ 795  
Each Additional CPU (up to 8) . . . \$ 199



16K B (16K RAM-40 Column) - Lim. Qty	\$ 995
32K B (32K RAM-40 Clm.) - Lim. Qty	\$1295
4016 (16K RAM 4.0 Basic-40 Clm.)	\$ 995
4032 (32K RAM 4.0 Basic-40 Clm.)	\$1295
8032 (32K RAM 4.0 Basic-80 Clm.)	\$1495
8050 Dual Disk (1 Meg Storage)	\$1795
4040 Dual Disk (343K Storage)	\$1295
8010 IEEE Modem	\$ 280
C2N Cassette Drive	\$ 95
CBM - IEEE Interface Cable	\$ 40
IEEE - IEEE Interface Cable	\$ 50
VIC 20 Home/Personal Computer	\$ 295

### CALL NEECO FOR ANY OF YOUR COMMODORE COMPUTER NEEDS

### EPSON PRINTERS

MX-80 PRINTER	\$ 645
MX-80 FT	\$ 745
MX-100	\$ 945
MX-70	\$ 459

#### INTERFACE CARDS

8141 (RS-232)	\$ 75
8150 (2K Buffered RS-232)	\$ 150
8161 (IEEE 488)	\$ 55
8131 (Apple Card)	\$ 85
8230 (Apple Card)	\$ 25
8220 (TRS-80 Cable)	\$ 35

### DIABLO 630 PRINTER

DIABLO 630 - Serial - RS-232	\$2710
Tractor Option	\$ 250

### AMDEK MONITORS

Video 100 12" B+W	\$ 179
Video 300 12" Green	\$ 249
Color I 13" Low Res	\$ 449
Color II 13" High Res	\$ 999

### INTERTEC COMPUTERS

64K Superbrain (360 Disk Storage), CP/M™	\$3495
64K QD Superbrain (700K Disk Storage), CP/M™	\$3995

\*CP/M is a registered trademark of Digital Research.

### NEC SPINWRITER PRINTERS

5530 (Parallel)	\$3055
5510 (Serial)	\$3055
5520 (KSR-Serial)	\$3415
Tractor Option	\$ 225



### APPLE

16K APPLE II+	\$1330
32K APPLE II+	\$1430
48K APPLE II+	\$1530
APPLE DISK w/3.3 DOS	\$ 650
APPLE DRIVE Only	\$ 490
APPLE III 128K - In Stock!	
w/Monitor +	
Info Analystpak	\$4740



### ATARI COMPUTERS

Atari 400 (16K RAM)	\$ 399
Atari 800 (32K RAM) - good thru 8/31	\$1080
Atari 410 RECORDER	\$ 89.95
Atari 810 DISK DRIVE	\$ 599.95

NEECO carries all available ATARI Software and Peripherals.

### PROFESSIONAL SOFTWARE

WordPro 18K	\$ 29.95
WordPro 3 (40 Clm.) 16K	\$ 199.95
WordPro 3+	\$ 295
WordPro 4 (80 Clm.) 32K	\$ 375
WordPro 4+	\$ 450

JUST A SAMPLE OF THE MANY PRODUCTS WE CARRY, CALL US FOR OUR NEW 60-PAGE CATALOG.  
WE WILL MATCH SOME ADVERTISED PRICES ON CERTAIN PRODUCTS LISTED UNDER SIMILAR "IN STOCK" CONDITIONS.



# NEECO

679 HIGHLAND AVE.  
NEEDHAM, MA 02194

## (617) 449-1760

Telex: 951021

MON-FRI 9:00 - 5:00



MasterCharge and VISA Accepted

# Ask BYTE

Conducted by Steve Clarcla

## Cows and Catalogs

Dear Steve,

Another gentleman and I are currently trying to adapt the Radio Shack TRS-80 Color Computer for farm-control applications. Initially, we plan to develop a system for computer-controlled feeding of dairy cows.

One of our biggest hurdles involves reliably identifying each cow (up to 250) as she approaches the feeder. We'd like the computer to decide how much feed she is to receive and to update each cow's statistics.

We need a unit that can be worn by the cow like a necklace and mated with control circuitry on the feeder. Obviously, durability and temperature sensitivity are major concerns. Do you have any ideas that might prove useful?

In a different vein, my library of device manufacturers' and distributors' catalogs is very small. Although it's not too difficult to get catalogs from distributors listed in magazines like *BYTE*, I know that there are many outfits that could prove more useful. I have the feeling that many distributors ignore the most versatile and useful components because of their limited appeal. Can you suggest a method of building a larger device and component library?

Gary L. Filkins Jr.  
Otsego, MI

*I am not familiar with cows, but I assume that you are not looking for a totally automated feeding arrangement and that someone will be available at the feeder to do whatever is necessary.*

*For reliability, I would suggest that the device around*

*the cow's neck be a passive one, i.e., no batteries to replace. The first thing that comes to mind is a dog tag (cow tag?) with a bar code (similar to the Universal Product Code) printed on it. When a cow approaches the feeder, the tag is read with a light-sensitive wand and the computer prints out the feed requirements and other pertinent data. This would require an optical bar-code interface to your computer.*

*Another device would need a resistive element molded into the cow tag with two ends brought out to a connector or wiper. As a cow approached, she would "punch in" to a device that would incorporate the resistance in an oscillator circuit and output a frequency unique to each cow. The computer would identify each cow by the generated frequency. A unit must be constructed to use this concept.*

*Here are a couple of approaches to beef up your device manufacturers' and distributors' catalog library. First, the major semiconductor manufacturers publish data catalogs and application notes about their products. You can contact their literature departments directly. Second, you might like to get the Electronics Engineers Master Catalog, which covers many manufacturers. It's available from United Technical Publications, Circulation Department, 645 Stewart Ave., Garden City, NY 11530. . . . Steve*

## TV Jitter Bugs

Dear Steve,

When I use my TRS-80 Color Computer with an old

Motorola tube-type color TV set, the picture is great. When I use it with my new 12-inch Sanyo, lots of evenly spaced horizontal bars fade in and out at about 1 Hz. Sometimes they disappear, at other times they appear diagonally or vertically. The controls have no effect, and similar bars appear much more dimly on a set in the Radio Shack store. On a 12-inch black-and-white portable TV, the bars are worse still and, in addition, the picture will sometimes bend as a "bump" rises slowly up the screen.

Is there something wrong with my set, or do all radio-frequency (RF) modulators do this? Can I just tap the signal going into the Astec RF modulator and pipe it directly into the video section of the set? I wrote Tandy Corporation and was referred to the manufacturer of my television. But why would it care whether my Color Computer works?

Charles Hall  
Raleigh, NC

*Your problem is not caused by the RF modulator, but by a slight "sync" incompatibility between the computer and the TV. Many of the newer TVs use phase-locked synchronization circuitry and their capture range is not great enough for some computers.*

*It's interesting to note that an article in the January 1981 Consumer Reports, "19-inch color TV's" (see page 36), dealt with this phenomenon. Consumers Union tested a number of televisions with an Apple II computer. It found that two models (Zenith and Sylvania) had a "severe vertical jitter, making the display almost unreadable."*

*While this is little consola-*

*tion to you, in your case it may not be your TV. You mentioned the same effect occurred with your computer on a television in a store. Did the store's Color Computer exhibit these bars? If not, you may have a defect in your computer.*

*In summary, the problem exists with some television sets. Run a swap test with a Color Computer that functions normally and determine where the fault lies. . . . Steve*

## Downloading to CP/M

Dear Steve,

A brochure on Visicorp's Visiterm software package claims that it will allow information to be downloaded from a larger host computer to an Apple II. Do you know of any similar software packages that will allow downloading to a CP/M-based microcomputer? My company has a Z80-based computer with a Soroc IQ-120 terminal and CP/M 2.2. The host computer is an IBM 360/370.

John E. O'Hare  
Tucson, AZ

*Lifeboat Associates (1651 Third Ave., New York, NY 10028, (212) 860-0300) sells a utility program, called BSTMS, which allows you to download certain software from a large mainframe computer. BSTMS is available for many CP/M configurations at a cost of \$400.*

*A popular public-domain telecommunications program is Modem73, which is the latest version of a program written by Ward Christensen. Modem73 is available at a low cost from the CP/M User's Group, which can be*

## Wild Hare Software Systems Multiply the Capabilities of Data General's

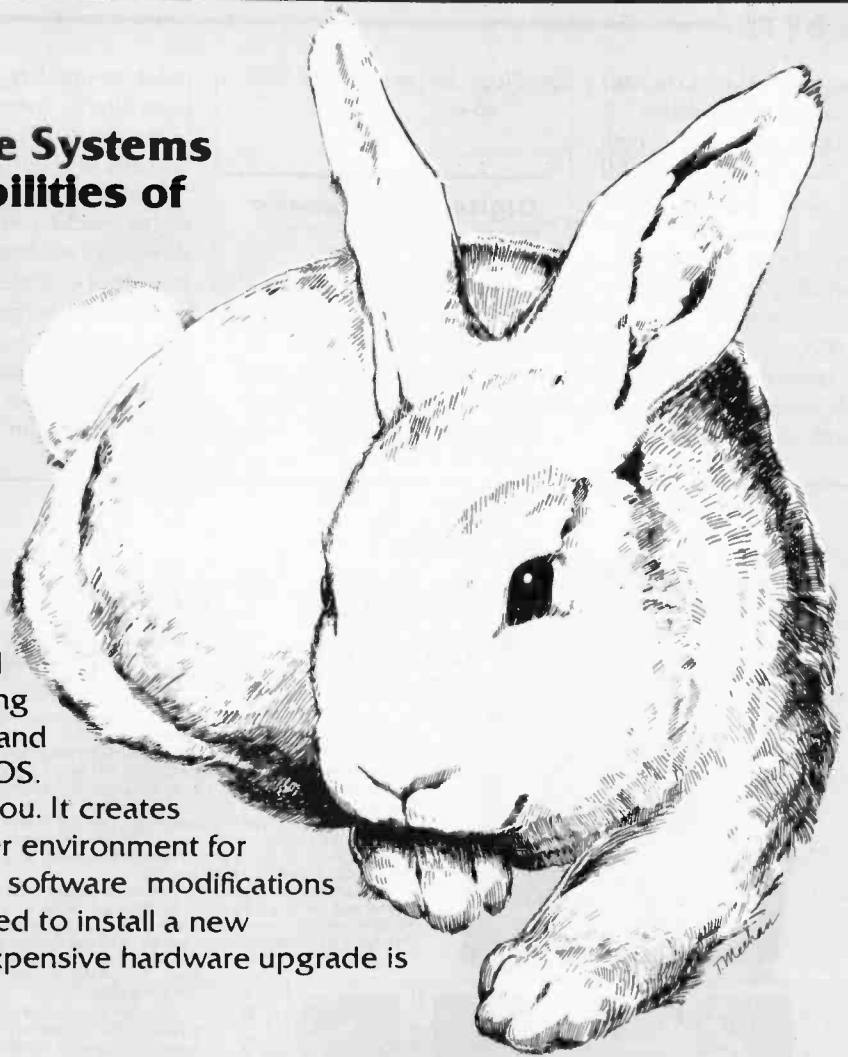
**RDOS**  
**INFOS®**  
**ICOS**  
**DOS**

Wild Hare gives Data General users a choice when upgrading to a multi-user environment and eliminates the need to use AOS. Wild Hare makes it easy for you. It creates a true multi-lingual, multi-user environment for your current system. No user software modifications are necessary. There is no need to install a new operating system. And, no expensive hardware upgrade is required.

### Features

- Each user is totally independent of all other users.
- Each user may run all standard Data General software.
- Each user may independently edit, compile, execute and debug programs written in any language supported by RDOS, INFOS®, ICOS and DOS.
- Standard languages supported include: Fortran IV, Fortran V, COBOL, ALGOL, RPG, DG/L™, BASIC, PASCAL, MAC, etc.
- All NOVA's® and ECLIPSE's® are supported.
- Wild Hare guarantees its software systems on a money back basis.

**Wild Hare's Software  
Gives Data General Users  
A Choice!**



**WILD HARE** COMPUTER  
SYSTEMS, INC.

P.O. Box 3581, Boulder, Colorado 80307  
(303) 494-0221

NOVA, ECLIPSE, and INFOS are registered trademarks of Data General Corporation.





Interested in computers or robotics? Looking for info on hardware, software, theory, and applications?



The Computer Book Club offers you an incredible range of computer books and a huge variety of tapes and disks . . . ALL at low, low member prices!

Select 6 fact-filled books for only \$2.95 (total value up to \$106.70)

1295 List \$16.95: 55 Advanced Computer Programs in BASIC

1082 List \$12.95: THE A TO Z BOOK OF COMPUTER GAMES

1341 List \$18.95: HOW TO DESIGN & BUILD YOUR OWN CUSTOM ROBOT

1398 List \$14.95: COOL

1275 List \$14.95: 33 Challenging Computer Games for TRS-80/Apple/PET

1200 List \$16.95: HOW TO BUILD YOUR OWN WORKING MICROCOMPUTER

1228 List \$12.95: 34 MORE Tested, Ready-To-Run Game Programs in BASIC

1299 List \$16.95: MASTER HANDBOOK OF MICROPROCESSOR CHIPS

1394 List \$15.95: PROGRAMMING YOUR APPLE II COMPUTER

1111 List \$15.95: 80 PRACTICAL TIME-SAVING PROGRAMS FOR THE TRS-80

1276 List \$15.95: THE MASTER IC COOKBOOK

1088 List \$13.95: ILLUSTRATED DICTIONARY OF MICROCOMPUTER TERMINOLOGY

1205 List \$15.95: PASCAL

1293 List \$15.95: 1001 THINGS TO DO WITH YOUR PERSONAL COMPUTER

1199 List \$16.95: 1000

1055 List \$8.95: 1088

1053 List \$13.95: 1000

1160 List \$12.95: 1055

1000 List \$10.95: 1333

1333 List \$16.95: 101 MICROPROCESSOR SOFTWARE & HARDWARE PROJECTS

1276 List \$15.95: COMPUTER GRAPHICS with 29 ready-to-run programs

1169 List \$15.95: THE GIANT Handbook of Computer Projects

1391 List \$17.95: PROJECTS IN MACHINE INTELLIGENCE FOR YOUR HOME COMPUTER

1045 List \$11.95: Programmer's Guide to LISP

1330 List \$15.95: TEACHING YOUR COMPUTER TO TALK

1070 List \$14.95: Digital Interfacing With An Analog World

1251 List \$16.95: PLAYING THE STOCK & BOND MARKETS WITH YOUR PERSONAL COMPUTER

1380 List \$18.95: 30 COMPUTER PROGRAMS FOR THE HOMEOWNER IN BASIC

Join now and get The "Compulator" Book . . . FREE! (List \$7.95)

### 7 very good reasons to try The Computer Book Club

Blue Ridge Summit, PA 17214

- **Reduced Member Prices.** Save up to 75% on books sure to increase your know-how
- **Satisfaction Guaranteed.** All books returnable within 10 days without obligation
- **Club News Bulletins.** All about current selections—mains, alternates, extras—plus bonus offers. Comes 10 times a year with dozens of up-to-the-minute titles you can pick from
- **"Automatic Order".** Do nothing, and the Main selection will be shipped automatically! But . . . if you want an Alternate—or no books at all—we'll follow the instructions you give on the reply form provided with every News Bulletin
- **Continuing Benefits.** Get a Dividend Certificate with every book purchased after fulfilling membership obligation, and qualify for discounts on many other volumes
- **Extra Bonuses.** Take advantage of added-value promotions, plus special discounts of software, games, and more
- **Exceptional Quality.** All books are first-rate publisher's editions, filled with up-to-the-minute info



### THE COMPUTER BOOK CLUB

Blue Ridge Summit, PA 17214

Please accept my membership in the Computer Book Club and send the 6 volumes circled below, plus a free copy of The "Compulator" Book. I understand the cost of the books selected is \$2.95 (plus shipping/handling). If not satisfied, I may return the books within ten days without obligation and have my membership cancelled. I agree to purchase 4 or more books at reduced Club prices during the next 12 months, and may resign any time thereafter.

1000 1045 1053 1055 1062 1070 1088 1111 1160  
 1169 1187 1199 1200 1205 1228 1251 1275 1276 1293  
 1295 1299 1330 1333 1341 1380 1391 1394 1398

Name \_\_\_\_\_ Phone \_\_\_\_\_

Address \_\_\_\_\_

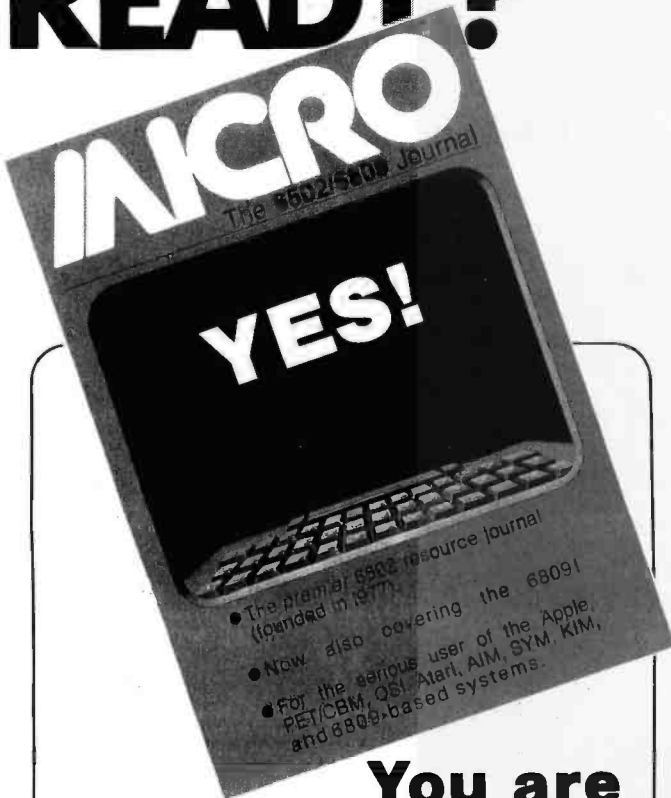
City \_\_\_\_\_

State \_\_\_\_\_ Zip \_\_\_\_\_

(Valid for new members only. Foreign and Canada add 20%. Orders outside U.S. or Canada must be prepaid with international money orders in U.S. dollars.)

BY-562

# ARE YOU READY?



## You are ready for MICRO if you want to. . .

- Go beyond canned software
- Use your computer for more than games
- Learn advanced programming techniques
- Understand the inner workings of your computer
- Get the most out of your 6502/6809 system

Month after month, MICRO gives readers sophisticated software applications, detailed discussions of programming languages, and in-depth hardware tutorials.

To get the most out of your machine, say YES to MICRO today! We accept VISA or Mastercard. **\$24.00** per year in the U.S., **\$27.00** elsewhere.

Use Our 24-hour Toll-free Service

**800-227-1617** Ext.546

In California: 800-772-3545, Ext.546

**MICRO**

34 Chelmsford Street  
P.O. Box 6502  
Chelmsford, MA 01824

## Ask BYTE

was operating. Although the power line used by the system is not "dedicated," it is not overloaded.

I'm confused by the various advertisements for "line conditioners," protectors, and regulators. How do you know if you really need one of these things, barring frequent catastrophes, and how do you choose the one suited for your installation? A 1-kilovolt-ampere (kVA) capacity regulator costs about \$500, so it would be nice to know it would help before making the purchase. It would even be better to save part of the cost by building it!

James R. Monnahan  
Provo, UT

Basically, two types of power-line problems affect computers: voltage transients and voltage fluctuations. Transients tend to place spikes (i.e., short-duration, high-voltage pulses) on the power-supply line. Spikes can raise havoc with a computer. Fortunately, a well-designed and regulated power supply can suppress many of them. Poorly designed power supplies generally fail under a severe transient, usually by means of shorted diodes.

Ordinarily, voltage fluctuations are visible in the form of lights dimming or flashing. The problem here is that if the voltage goes too low, the regulators in the power supply cannot compensate and the voltage in the computer drops below the minimum specifications. The result is garbled data.

On the other end, high line voltages should be taken care of by power-supply regulator circuits. Because a computer's power transformers are usually step-down devices, higher voltages result in an increase in heat dissipation by the regulators.

Line conditioners and protectors are often metal-oxide

varistors (MOVs) or zener diodes designed to clip transients above a certain level, which protects circuits downstream. The regulators are designed to maintain the line voltage between prescribed limits.

Which device is required for your computer? I would try to be more aware of the lights dimming or flashing (e.g., when a large motor starts or stops). If this is the case, either add a regulator or eliminate the offending device. Otherwise, try a clipping device. . . . Steve

## Wanted: RS-232C-to-IEEE-488 Interface

Dear Steve,

I recently assumed a new position at Kenyon College and discovered that some of the scientists on campus have become very frustrated trying to use a Hewlett-Packard HP-9872A Plotter that is attached to an HP-2647 Graphic Terminal. They have managed to learn about handshaking sequences and other protocols, but the problem seems to be the interface. A salesman informed me that the plotter interface is an IEEE-488 and not the RS-232C type that is standard on an Digital Equipment Corporation PDP-11/70.

Two solutions are obvious: to replace the plotter with a different model that has the appropriate interface, or to buy or build a "black box" that does bidirectional RS-232C-to-IEEE-488 conversion. Since I'm not truly informed about electronics, I am wondering about the difficulty of making such a black box and about the cost of obtaining one, if I could even locate such a device.

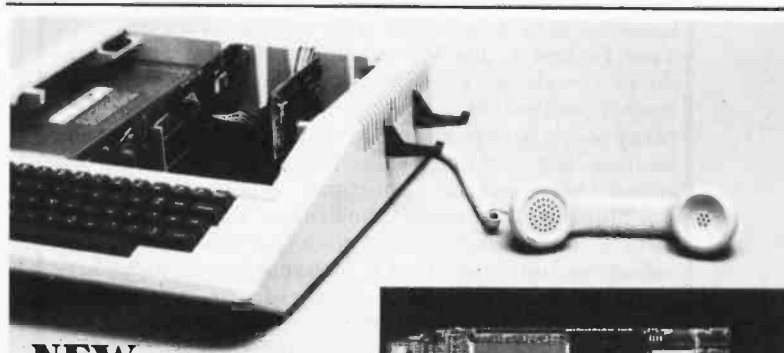
Perhaps you know of someone or some company that has made such a device—or could you give me some estimates on the relative



# Take your pick of the litter.

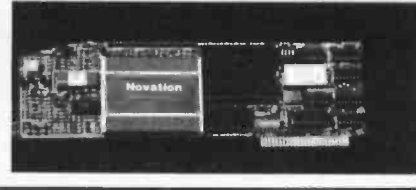
When you're ready to let your computer out and introduce it to the rest of the world, one of the Cat family of Modems is the way to do it.

Take your pick. You can't go wrong. They're all purebreds—from Novation, the recognized world leader in personal communications.



**NEW**

## Apple-Cat II™



Major breakthrough—the intelligent modem. Slips into your Apple. All auto functions, selectable baud rates, Serial RS-232 port, BSR X-10 controller\*\*\* easy-to-use self-prompting format. Other options available.

From \$389\*\* including software

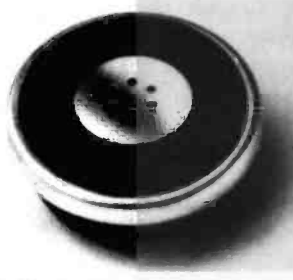
## Cat Acoustic Modem

Fast, accurate, reliable originate/answer modem—with built-in diagnostics. Just add your computer and phone. Then dial up the world. \$189\*\*

## Super Mike

Replace your phone's carbon mike with Super Mike. No more carbon granule problems. Making things perfectly clear has never been so easy.

\$14.95\*\*



## D-Cat

Get the performance and reliability of a direct connect modem (up to 20dB improvement) with the portability and price of an acoustic. Use it at home. Use it at work. Truly unique. So's the price. \$199\*\*



## Auto-Cat

Answers automatically and stores data in your computer until you're ready. The world's first LSI 103 modem. State-of-the-art, all digital, crystal controlled direct connect.

You're off the hook for under \$250\*\*



Call for details: **(800) 423-5410**

In California (213) 996-5060

Available from Avnet Electronics, Hamilton Electro, Hamilton Avnet, Kierulff Electronics, Byte Shops, Computerland, and your local computer store.

Novation, Inc., 18664 Oxnard Street, Tarzana, California 91356

\*Apple is a registered trademark of Apple Computer Inc. Cat is a trademark of Novation, Inc. which does not make Apple computers.

\*\*Suggested retail price \*\*\*BSR is a trademark of BSR Corporation

# STARTING YOUR OWN MICROCOMPUTER BUSINESS

Starting your own microcomputer business is easy if you know the right steps to take. Two volumes of the new book **Your Fortune In The Microcomputer Business** describe the things you should know to start right and to build your business successfully.

Many people have good ideas for a successful microcomputer business. But they don't know how to put their ideas into action. These people are plenty smart. That's not the problem. The problem is in knowing simple things: How to analyze the market. How to select the right product or service. How to get enough startup money. How to plan your growth and success. The answers to these problems are not hard to understand. All you need is the right information. **Your Fortune In The Microcomputer Business** gives you the knowledge tools to start right, grow and prosper.

This practical reference manual has no hocus-pocus. It does not tell you how to do astrology or dating services. It does give you clear, complete, step-by-step instructions on how to get started right and insure your success!

## Volume I Includes:

- The hottest trends in the market
- The seven best test markets
- How to read between the lines at a trade show
- 107 ways to reach your market
- Examples of the best ads in the business
- How to get free advertising
- The 21 steps to set up your business
- How to start a manufacturing business
- How to write a newsletter
- How to give a seminar
- How to start a service business
- How to package software for the mass market
- How to be a highly paid consultant
- Franchising—the good, the bad and the ugly
- Interviews with six successful microcomputer businesses
- How to use the RLC factor to be street smart, lean, mean and successful



## Volume II Includes:

- Strategies for growth
- Straight facts on incorporation
- How to build your organization
- How to manage cash flow
- How to develop your accounting system
- How to manage employees, wages and salaries
- How to survive a cash crunch
- What to do if things get really bad
- How to maximize your profits
- How to grow by acquisition
- How to value your business
- How and when to sell your business



**WRITE OR CALL—DON'T WAIT!**

Wildfire Publishing, P.O. Box 420-DS  
Carpinteria, CA 93013 Ph. (805) 684-1489

Please send the following book(s) by return mail. I understand if I want to return them for any reason within 30 days of receipt, I can do so and get a prompt full refund.

- Your Fortune In The Microcomputer Business Vol. I, Getting Started, \$20.00. (Postpaid)**
- Your Fortune In The Microcomputer Business Vol. II, Growth, Survival and Success, \$20.00. (Postpaid)**

Calif. residents please add \$1.20 each sales tax.

Name \_\_\_\_\_  
Street \_\_\_\_\_  
City \_\_\_\_\_ State \_\_\_\_\_ Zip \_\_\_\_\_  
Enclosed is \_\_\_\_\_ or charge my MasterCard  or Visa   
Card # \_\_\_\_\_  
Ex. Dt. \_\_\_\_\_ MCInterbank # \_\_\_\_\_  
Signature \_\_\_\_\_ © 1982 Wildfire Pub.

## Ask BYTE

ease or difficulty of building one?

Robert A. Rennert  
Kenyon College  
Gambier, OH

*Any easy solution is always expensive (Murphy's Law) and the cheap solution very hard (again, Murphy's Law). However, don't give up hope.*

*Your first idea, replace the plotter, is a good one. The Hewlett-Packard 7221A Plotter is the RS-232C equivalent of the 9872A Plotter and it costs about the same. Your second solution is also good. One type of black box on the market is the GPIB (general-purpose interface bus, equivalent to the Hewlett-Packard interface) controller with RS-232C interface. Another is the PDP-11-to-GPIB interface card of which the National Instruments series is a good example.*

*Finally, building you own interface is less expensive but more difficult than buying one ready-made.*

*Here are some sources for literature and hardware.*

... Steve

Fairchild Camera and Instrument Corporation  
464 Ellis St.  
Mountain View, CA 94042  
(Re: 96LS488 GPIB circuit)

Hewlett-Packard Company  
9920 Carver Rd.  
Cincinnati, OH 45242  
(Re: Publications 5952-0058 and 5952-0156)

### RS-232C-to-GPIB interface

Physical Data Inc.  
8089 Southwest Cirrus Dr.  
Beaverton, OR 97005

ICS Electronics Corporation  
1620 Zanker Rd.  
San Jose, CA 95112

### Unibus-to-GPIB interface

National Instruments  
Building A-117  
8900 Shoal Creek  
Austin, TX 78758. ■

In "Ask BYTE," Steve Ciarcia answers questions on any area of microcomputing. The most representative questions received each month will be answered and published. Do you have a nagging problem? Send your inquiry to:

Ask BYTE  
c/o Steve Ciarcia  
POB 582  
Glastonbury CT 06033

If you are a subscriber to The Source, send your questions by electronic mail or chat with Steve (TCE317) directly. Due to the high volume of inquiries, personal replies cannot be given. Be sure to include "Ask BYTE" in the address.

## And then there were none.

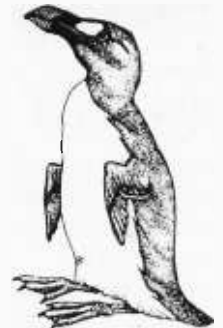
The list of already extinct animals grows... the great auk, the Texas gray wolf, the Badlands bighorn, the sea mink, the passenger pigeon...

What happens if civilization continues to slowly choke out wildlife species by species?

Man cannot live on a planet unfit for animals.

Join an organization that's doing something about preserving our endangered species. Get involved. Write the National Wildlife Federation, Department 105, 1412 16th Street, NW, Washington, DC 20036.

It's not too late.





# AIM 65. The professional's microcomputer.

Printer, display, full keyboard. Only \$465.00.

For professional learning, designing and work, Rockwell's AIM 65™ microcomputer gives you an easy, inexpensive head start.

- 20-column printer and display
- Dual cassette, TTY and general purpose I/O
- R6502 NMOS microprocessor
- System expansion bus
- Read/write RAM memory

- PROM/ROM expansion sockets
- Self-prompt interactive monitor firmware
- Terminal-style keyboard
- Options available include:
  - PROM programmer module
  - RM 65 standard modules and card cages
  - power supply and enclosure

For more on the AIM 65 microcomputer and how you can develop programs in assembly language, BASIC, PL/65, Pascal or FORTH\*, write Rockwell International, Electronic Devices Division, RC55, P.O. Box 3669, Anaheim, CA 92803. For location of nearest distributor or dealer call 800-854-8099 (in California 800-422-4230).

\*FORTH is a trademark of FORTH, Inc.  
AIM 65 is a trademark of Rockwell International



**Rockwell International**

Circle 365 on inquiry card.

...where science gets down to business



# Birth of a legend.



## Epson.

A whole new generation of Epson MX printers has just arrived. And while they share the family traits that made Epson famous — like unequalled reliability and ultra-fine printing — they've got a lot more of what it takes to be a legend.

For instance, they've got a few extra type styles. Sixty-six, to be exact, including italics, a handy subscript and superscript for scientific notation, and enough international symbols to print most Western languages.

What's more, on the new-generation MX-80, MX-80 F/T and MX-100, you get GRAFTRAX-Plus dot addressable graphics. Standard. So now you can have precision to rival plotters in a reliable Epson printer. Not to mention true back-space, software printer reset, and programmable form length, horizontal tab and right margin.

All in all, they've got the features that make them destined for stardom. But the best part is that beneath this software bonanza beats the

# Uh...three legends.

heart of an Epson. So you still get a bidirectional, logical seeking, disposable print head, crisp, clean, correspondence quality printing, and the kind of reliability that has made Epson the best-selling printers in the world.

All of which should come as no surprise, especially when you look at the family tree. After all, Epson *invented* digital printers almost seventeen years ago for the 1964 Tokyo Olympics. We were

the first to make printers as reliable as the family stereo. And we introduced the computer world to correspondence quality printing and disposable print heads. And now we've given birth to the finest printers for small computers on the market.

What's next? Wait and see. We're already expecting.

**EPSON**  
EPSON AMERICA, INC.

3415 Kashiwa Street • Torrance, CA 90505 • (213) 539-9140

FEATURE	ORIGINAL MX-80	GRAFTRAX-80*	ORIGINAL MX-100	MX-80 with GRAFTRAX-Plus	MX-80 F/T	MX-100
Bidirectional printing	X	X	X	X	X	X
Logical seeking function	X	X	X	X	X	X
Disposable print head	X	X	X	X	X	X
Speed: 80 CPS	X	X	X	X	X	X
Matrix: 9 x 9	X	X	X	X	X	X
Selectable paper feed			X		X	X
<b>PAPER HANDLING FUNCTIONS</b>						
Line spacing to n/216		X		X	X	X
Programmable form length	X	X	X	X	X	X
Programmable horizontal tabs	X	X	X	X	X	X
Skip over perforation			X	X	X	X
<b>PRINT MODES AND CHARACTER FONTS</b>						
% ASCII characters	X	X	X	X	X	X
Italics character font		X		X	X	X
Special international symbols				X	X	X
Normal, Emphasized, Double-Strike and Double/Emphasized print modes	X	X	X	X	X	X
Subscript/Superscript print mode				X	X	X
Underline mode				X	X	X
10 CPI	X	X	X	X	X	X
5 CPI	X	X	X	X	X	X
17.16 CPI	X	X	X	X	X	X
8.58 CPI	X	X	X	X	X	X
<b>DOT GRAPHICS MODE</b>						
Line drawing graphics				X	X	X
Bit image 60 D.P.I.		X	X	X	X	X
Bit image 120 D.P.I.		X	X	X	X	X
<b>CONTROL FUNCTIONS</b>						
Software printer reset		X		X	X	X
Adjustable right margin			X	X	X	X
True back space		X		X	X	X
<b>INTERFACES</b>						
Standard — Centronics-style 8-bit parallel	X	X	X	X	X	X
Optional — RS-232C current loop w/2K buffer	X	X	X	X	X	X
RS-232C x-on/x-off w/2K buffer	X	X	X	X	X	X
IEEE-488	X	X	X	X	X	X

\*Tandy TRS-80 block graphics only available with GRAFTRAX 80.

ABCDEFGHIJKLMNOP abcdefghi jklmn ABCDEFGHIJKLMNOP abcdefghi jklmn 01234  
 ABCDEFGHIJKLMNOP abcdefghi jklmn ABCDEFGHIJKLMNOP abcdefghi jklmn 01234  
 ABCDEFGHIJKLMNOP abcdefghi jklmn ABCDEFGHIJKLMNOP abcdefghi jklmn 01234  
 ABCDEF abcdef ABCDEF abcdef 0123456  
 ABCDEFGHIJKLMNOPQRSTUVWXYZ abcdefghi jklmnopqrstuvwxyz ABCDEFGHIJKLMNOPQRSTUVWXYZ abcdefghi jklmnopqrstuvwxyz 01234567  
**ABCDEFGHIJKLMN abcdefghi jklmn ABCDEF abcdef 0123456**  
 ABCDEFGHIJKLMNOPQRSTUVWXYZ abcdefghi jklmnopqrstuvwxyz ABCDEFGHIJKLMNOPQRSTUVWXYZ abcdefghi jklmnopqrstuvwxyz 01234567

Circle 165 on inquiry card.

# Event Queue

## May 1982

### May

**Courses from Boeing Computer Services**, various sites throughout the U.S. Boeing Computer Services is offering a wide variety of computer-related courses at its regional service centers. Course topics range from "Introduction to Data Processing" to "Structured Program Development in FORTRAN." For a complete schedule of times, locations, and fees, contact Boeing Computer Services Co., Education and Training Division, POB 24346, Seattle, WA 98124, (206) 575-7700.

### May

**Courses in Structured Systems**, various sites throughout the U.S. Courses in "Structured Systems Design," and "Structured Requirements Definition" are being offered by Ken Orr and Associates. For information on meeting times, places, and fees, contact Ken Orr and Associates Inc., 715 East 8th, Topeka, KS 66607, (800) 255-2459; in Kansas, (913) 233-2349.

### May

**Courses from George Washington University**, San Jose, CA; Washington, DC; Mexico City; Mexico; and Berlin, West Germany. Among the courses scheduled are "Computer Performance Evaluation," "Workshop in Data Communications for Microcomputers," and "Microcomputer Applications Workshop." Fees range from \$590 to \$760. Contact Continuing Engineering Education, School of Engineering and Applied Science, George Washington University, Washington, DC 20052, (800) 424-9773; in the District of Columbia, (202) 676-6106.

### May

**Seminars and Conferences from Datapro Research**, various sites throughout the U.S. Among the topics to be presented are "IBM's Systems Network Architecture," "Data Dictionary/Directory Systems," and "Data Processing: Fundamental Concepts." Enrollment fees are \$640 for Datapro subscribers and \$690 for nonsubscribers. For a complete catalog with descriptions, dates, and locations, contact Datapro Research Corp., 1805 Underwood Blvd., Delran, NJ 08075, (800) 257-9406; in New Jersey, (609) 764-0100.

### May

**Technology Transfer Institute Seminars**, Washington, DC, and San Francisco, CA. "Fundamentals of Database Management," "Fundamentals of Data Structures," and "X.25 and Other Protocol Interfaces" are among the seminars being offered. Contact Technology Transfer Institute, 741 10th St., Santa Monica, CA 90402, (213) 394-8305.

### May-June

**Intensive Two-day Seminars for Professional Development**, various sites throughout New England. Among the seminars to be offered by Worcester Polytechnic Institute are "Fundamentals of Data Processing," "Distributed Systems: The Architecture and Utilization of this Revolutionary Technology," and "Microprocessors: Hardware, Software, and Applications." Registration fees range from \$445 for a two-day program to \$990 for a seven-day executive institute. For complete details, contact Ms. Ginny Bazarian, Office of Continuing Education, Worcester Polytechnic Institute, Worcester, MA 01609, (617) 793-5517.

### May-June

**Cooperative Education Program**, various sites throughout the U.S. This series of more than 100 data-processing courses is presented by Q.E.D. Information Sciences Inc. Course topics include systems development, structured methodologies, database, telecommunications, management, and human relations. These two- to five-day courses are tailored for analysts, designers, programmers, managers, and other users. For additional details, contact the Manager of Education Programs, Q.E.D. Information Sciences Inc., Q.E.D. Plaza, POB 181, Wellesley, MA 02181, (800) 343-4848; in Massachusetts, (617) 237-5656.

### May-June

**Courses and Seminars from Sira Institute**, various sites throughout England. Sira Institute is sponsoring seminars on a wide variety of subjects, ranging from microprocessor familiarization to design and development of microprocessor-based equipment. For details, contact Conferences & Courses Unit, Sira Institute Ltd., South Hill, Chislehurst, Kent BR7 5EH, England.

### May-June

**National Computer Graphics Association Seminar Program**, various sites throughout the U.S. Topics include "Computer Graphics: Technology and Applications," "Successful Business Graphics," and "Applications of Computer Graphics to Transportation Problems." Seminar fees are \$395 for association members and \$425 for nonmembers. For complete details, contact Eloise Wenker, NCGA Seminar, 2033 M St. NW, #300, Washington, DC 20036, (202) 466-4102.

### May-June

**Datamation Institute Seminars on Information Management**, various sites throughout the U.S. Databases and communications, systems performance, data-processing management, word processing, office automation, computer graphics, and topics of general interest are among the areas to be covered by these two-day seminars. Fees range from \$495 to \$595. For schedules of times and places, contact Karen Smolens, the Center for Management Research, Datamation Institute Seminar Coordination Office, 850 Boylston St., Chestnut Hill, MA 02167, (617) 738-5020.

### May-June

**Education and Training Seminars**, various sites throughout the U.S. and Europe. Among the seminar topics offered by STSC Inc. and APL+Plus International are "Nested Arrays," "Intermediate APL," and "Advanced APL Programming Techniques." For complete details on these and other seminars, contact the Seminar Administrator, STSC Inc., 11 Clearbrook Rd., Elmsford, NY 10523, (914) 347-5560. In Europe, contact APL+Plus International, Tour Neptune, Cedex N°20, 92086 Paris La Défense, France, Tel: 773.79.64.

### May-June

**The Master Method of Selling Small-Business Systems**, Westlake Village, CA. This one-day seminar is designed for mini- and microcomputer manufacturers and software vendors who sell small-business systems. The seminar fee is \$150. For details, contact Seminar Information, M. W. L. Inc., 32038 Watergate Court, Westlake Village, CA 91361, (213) 889-2607.



**NEW**  
**512KB W/RS232 PORT**

# YOU CAN'T KEEP A GOOD MEMORY DOWN

## EXCEPT IN PRICE AND AT CHRISLIN WE PROVE IT!

We offer new super competitive memory prices for your LSI 11, Motorola, IBM PC, S100, and Multibus microprocessor based systems.

Our CI-S100 64KB single card is compatible with most S100 bus systems.

The CI-6800/2 expansion memory for EXORCISOR I and EXORCISOR II microprocessors has a capacity of 64KB on a single card, parity is standard.

Our new add-in expansion memory for IBM's Personal Computer has capacity up to 512KB on a single card with one RS232-C port and parity.

The CI-1123 add-in memory has capacity up to 256KB on a single board, parity is standard.

The CI-8086 is compatible with the Multibus 8 bit and 16 bit microprocessors. The memory has capacity up to 512KB on a single card, and parity is standard.

**DON'T ASK WHY WE CHARGE SO LITTLE, ASK WHY THEY CHARGE SO MUCH.**



## **Chrislin Industries, Inc.**

31352 Via Colinas • Westlake Village, CA 91362 • 213-991-2254  
TWX 910-494-1253 (CHRISLIN WKVG)

## Event Queue

May-June

**One- and Two-day Professional Development Seminars**, various sites in the greater Boston area. Among the courses being offered by Boston University are "Business Writing for Results," "Improving Customer Service," and "Assertive Management." Registration fees range from \$295 for a one-day program to \$445 for a two-day program. These seminars can be conducted within your company. For details, contact Ms. Joan Merrick, Center for Management Research, 850 Boylston St., Chestnut Hill, MA 02167, (617) 738-5020. For information on the in-company seminars, contact Ms. Elaine Dee at the same address.

May-June

**Productivity '82**, various sites throughout the U.S. and Canada. This two-day show

features hands-on demonstrations of Hewlett-Packard's newest computer and application solutions ranging from personal and small-business computers to the top-of-the-line computer systems for office computing, distributed data processing, and factory automation. Sixteen different seminars are held each day on such topics as using personal computers, choosing financial and applications software, and preparing easy-to-read graphics. Additional information can be obtained from local Hewlett-Packard sales offices or from Rudanne Clark, Hewlett-Packard, 3000 Hanover St., Palo Alto, CA 94304, (415) 857-7247.

May-June

**Sensors & Systems '82**, various sites throughout the central and western regions of the U.S. This series of three-day

conferences will cover all aspects of sensor technology from temperature sensors through to displacement, velocity, acceleration, magnetic field, and moisture. Other topics to be covered include signal conditioning, digital interfaces, and system interfaces. Contact Network Exhibitions, 785 Harriet Ave., Campbell, CA 95008, (408) 370-1661.

May-July

**Computerized Robots**, various sites throughout the U.S. This four-day course is tailored for managers concerned with the planning and design of advanced manufacturing methods and for those who will be involved with the development and integration of high-technology robot systems. Course topics include the extent of robot automation in the U.S., Japan, and Europe; technical

capabilities and limitations of robots; robot sensory mechanisms, vision, touch, proximity; and programming techniques for robot control. The course fee is \$845. For details, contact Ruth Dordick, Integrated Computer Systems, 3304 Pico Blvd., POB 5339, Santa Monica, CA 90405, (800) 421-8166; in California, (800) 352-8251.

May-July

**Meetings, Seminars, and Programs from the Electronic Industries Association (EIA)**, various sites throughout the U.S. Among the events planned are the Electronic Components Conference, the Government/Industry Executive Roundtable '82, and a symposium on "Telecommunications: Trends and Directions." Contact EIA, 2001 Eye St. NW, Washington, DC 20006, (202) 457-4981.

hp HEWLETT PACKARD 7470 hp HIGHER PERFORMANCE 7470 hp HEWLETT PACKARD 7470 hp HIGHER PRODUCTIVITY 7470

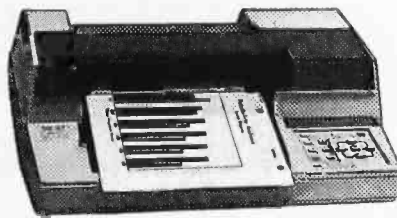
**THE LOW COST PLOTTER \$1125** mfr. sugg. list \$1550

With a choice of Interfaces to work with

**APPLE • COMMODORE • HEWLETT PACKARD • IBM**

PERSONAL COMPUTERS

- Inexpensive to own
- Easy to operate
- Charts in minutes
- Superior resolution
- 2-pen auto plotting
- May use up to 10 COLORS
- For paper presentations
- For transparency presentations



Quality graphics made affordable by Hewlett Packard and Elek-Tek. The revolutionary new HP-7470 personal computer plotter helps you chart such diverse data as statistical analysis, sales - profit-debt, engineering analysis, production and machine efficiencies, reports and forecasts, Return on equity and capital, project schedules, Working capital and cash flow, "what if" planning, market shares and more and more and MORE.

OF COURSE, it's **hp HEWLETT PACKARD** quality, reliability, service, support and SOFTWARE AVAILABLE so you don't need to program.

**CALL TOLL-FREE 800-621-1269 (except Illinois, Alaska, Hawaii)**

Accessories discounted too. **Corporate Accounts Invited.** Mastercharge or Visa by mail or phone. Mail Cashier's Check, Money Order, Personal Check (2 wks to clear). Add \$4.00 1st item; (Alaska, Hawaii, Puerto Rico, Canada add \$8.00 first item) \$1.00 ea. add'l shpg. & handl. Shipments to IL address add 6% tax. Prices subject to change. **WRITE for free catalog. ALL ELEK-TEK MERCHANDISE IS BRAND NEW, FIRST QUALITY AND COMPLETE.**



**ELEK-TEK, inc.**

6557 North Lincoln Avenue, Chicago IL 60645  
(800) 621-1269 (312) 677-7660

# The Hard & Soft of It: Atari from ASAP

If you're into Atari, get into ASAP. When it comes to Atari, ASAP has it all — computers, a full line of accessories, and one of the most complete lines of software on the market. Whether you use your Atari for work or play, make ASAP your source. Call today.

The Atari® 800™ Computer features color graphics and English characters with truly high resolution, high quality sound, expandable memory and sleek modular appearance.

Atari® 400™ — 16K also available: **\$349.00.**

OPTIONAL ACCESSORIES	PRICE
ATARI® 410™ Program Recorder . . . . .	80.00
ATARI® 810™ Disk Drive . . . . .	455.00
ATARI® 822™ Thermal Printer . . . . .	299.00
ATARI® 820™ 40-column Dot Matrix Impact Printer . . . . .	279.00
ATARI® 825™ 80-column Dot Matrix Impact Printer . . . . .	625.00
ATARI® 830™ Acoustic Modem . . . . .	159.00
ATARI® 850™ Interface Module . . . . .	169.00
ATARI® Paddle (CX30-04) and Joystick (CX40-04) . . . . .	17.95
ASAP 16K RAM Module . . . . .	55.00

## COMPLETE SOFTWARE LIBRARY INCLUDES THESE POPULAR UNITS:

### Atari®

Video Easel ROM . . . . .	25.00
Music Composer ROM . . . . .	42.00
Assembler/Editor ROM . . . . .	45.00
Mortgage Loan Analysis Tape . . . . .	15.95
Stock Analysis Disk . . . . .	19.95
Bond Charting . . . . .	22.95
Stock Analysis Disk . . . . .	19.95
Mailing List Tape . . . . .	19.95
Touch Typing (2 tapes) . . . . .	19.95
Graph It (2 tapes) . . . . .	17.95
Word Processor . . . . .	119.00
Personal Finance . . . . .	64.95
Microsoft Basic . . . . .	75.00
Basketball ROM . . . . .	27.00
Super Breakout ROM . . . . .	30.00
Computer Chess ROM . . . . .	32.00
3D Tic Tac Toe ROM . . . . .	25.00
Star Raiders ROM . . . . .	36.00
Kingdom Cassette . . . . .	12.95
Blackjack Cassette . . . . .	12.95
Biorhythm Cassette . . . . .	12.95

Energy Czar Tape . . . . .	12.95
Telelink (Terminal ROM) . . . . .	24.00
Space Invader ROM . . . . .	30.00
Scram . . . . .	18.95
Asteroid . . . . .	32.00
Missile Command . . . . .	32.00
<b>Arcade Plus</b>	
Ghost Hunter Cassette . . . . .	25.00
Ghost Hunter Disk . . . . .	30.00
<b>Datasoft</b>	
Atari Mailing List Disk . . . . .	19.95
Atari Character Generator Disk . . . . .	16.95
Text Wizard Disk . . . . .	89.95
Micropainter Album 1 Disk . . . . .	16.95
Micropainter Album 2 Disk . . . . .	16.95
Le Stick Accessory . . . . .	30.00
<b>On-Line Systems</b>	
HI-RES Adv #0 — Mission: Asteroid Disk . . . . .	19.95

HI-RES Adv #2 — Wiz & Princess Disk . . . . .	25.00
Roadwork Disk . . . . .	29.95
Jawbreaker Disk . . . . .	25.00
Softporn Adventure (X-rated) Disk . . . . .	25.00
The Next Step Disk . . . . .	29.95
<b>Personal Software</b>	
Visicalc Disk . . . . .	169.00
<b>FOR HOME ENTERTAINMENT SYSTEMS:</b>	
Activision	
Dragster Cartridge . . . . .	18.50

Boxing Cartridge . . . . .	18.50
Checkers Cartridge . . . . .	18.50
Fishing Derby Cartridge . . . . .	18.50
Skiing Cartridge . . . . .	18.50
Bridge Cartridge . . . . .	23.95
Tennis Cartridge . . . . .	18.50
Laser Blast Cartridge . . . . .	18.50
Freeway Cartridge . . . . .	18.50
Kaboom! Cartridge . . . . .	18.50
Stampede Cartridge . . . . .	18.50
Ice Hockey Cartridge . . . . .	23.95



**asap**  
computer  
products, inc.

1198 E. Willow St., Signal Hill, CA 90806

### ALL PRICES SUBJECT TO CHANGE WITHOUT NOTICE. CALL FOR BEST PRICE

ASAP offers a 15-day buyer protection policy: full money-back guarantee if not totally satisfied. **Ordering information:** name, address, phone; ship by: UPS or Mail. Shipping charge: add \$2.50 up to 1 lb. (UPS blue), U.S. Mail add \$1.50 (U.S. only) (\$25.00 minimum order).

**Terms:** We accept cash, check, money orders, Visa and Master Charge (U.S. funds only). Tax: 6% Calif. res., COD's and terms available on approval (School PO's Accepted).

Toll free outside California: **(800) 421-7701**. Inside California: **(213) 595-6431 (714) 891-2663**.



## Event Queue

*May-July*

**Speech Synthesis and Recognition**, various sites throughout the U.S. This four-day seminar is for product development and design engineers, systems analysts, programmers, and technical managers who will be involved with the planning, design, and implementation of voice input/output (VIO) systems. Among the topics to be covered are understanding voice-processing algorithms and software, evaluating available VIO hardware components and systems, and using speech-synthesis techniques. In-class presentations of VIO systems, components, and techniques will illustrate discussions. The course fee is \$795. Contact Ruth Dordick, Integrated Computer Systems, 3304 Pico Blvd., POB 5339, Santa Monica, CA 90405, (800) 421-8166; in California, (800) 352-8251.

*May-July*

**Structured Design and Programming**, various sites throughout the U.S. This four-day course emphasizes the development of skills that facilitate the efficient production of reliable, well-documented, and maintainable programs, on time and within budget. Some of the topics to be addressed are structured software design methods, how to write structured programs for mini- and micro-computers, and how to improve program readability and reliability. The course fee is \$795. Contact Ruth Dordick, Integrated Computer Systems, 3304 Pico Blvd., POB 5339, Santa Monica, CA 90405, (800) 421-8166; in California, (800) 352-8251.

*May-July*

**Technical Classes from Zilog**, Campbell, CA. Zilog is offering a series of one- to five-day

technical classes at its California-based training facility. Topics range from "Microprocessors: A General Introduction" to "Zeus/System 8000 User." Contact Zilog, Training and Education Dept., 1315 Dell Ave., Campbell, CA 95008, (408) 446-4666.

*May-July*

**Computer Network Design and Protocols**, various sites throughout the U.S. This four-day course will focus on the practical aspects of network design, interfacing, protocols, and packet switching. Among the topics to be covered are how to determine system requirements and perform design trade-offs, how to carry out network communication and control protocols, and how to evaluate available network hardware and software components. The course fee is \$845. For complete details, contact Ruth Dordick, Integrated Computer Systems, 3304 Pico Blvd., POB 5339, Santa Monica, CA 90405, (800) 421-8166; in California, (800) 352-8251.

*May-August*

**Engineering Summer Conferences**, Chrysler Center for Continuing Engineering Education, North Campus, University of Michigan, Ann Arbor, MI. Among the conferences being offered are "Interactive Design with Computers," "Applied Numerical Methods," and "Robotics: Concepts, Theory, and Applications." For complete details, contact Engineering Summer Conferences, 200 Chrysler Center, North Campus, University of Michigan, Ann Arbor, MI 48109, (313) 764-8490.

*May 9-12*

**The Seventeenth Annual Meeting of the Association for the Advancement of Medical Instrumentation**

(AAMI), Hyatt Regency Embarcadero, San Francisco, CA. Approximately 50 scientific and technical sessions will explore such topics as nuclear magnetic resonance imaging, computerized data management for surgical anesthesia monitoring, and patient data management. Exhibits will be featured. For details, contact the AAMI, Suite 602, 1901 North Fort Myer Dr., Arlington, VA 22209, (703) 525-4890.

*May 10-12*

**Dexpo 82**, Marriott Hotel, Atlanta, GA. This exposition features DEC- (Digital Equipment Corporation) compatible hardware, software, and services. Contact Expoconsul International Inc., 19 Yeger Rd., Cranbury, NJ 08512, (609) 799-1661.

*May 10-13*

**The Annual Meeting and Technical Conference of the IEEE Industrial Power Systems Department**, Marriott Hotel, Philadelphia, PA. For details, contact Dr. Paul Reece, General Electric Co., 6901 Elmwood Ave., Mail Drop 06302, Philadelphia, PA 19142, (215) 726-2800.

*May 10-14*

**Introduction to Microprocessor Systems Engineering**, University of Tennessee Space Institute, Tullahoma, TN. For details, contact Jules Bernard, University of Tennessee Space Institute, Tullahoma, TN 37388, (615) 455-0631, ext. 278.

*May 10-14*

**The Twentieth Annual Convention of the Association for Educational Data Systems (AEDS)**, Sheraton Twin Towers, Orlando, FL. This convention includes presentations on the state of the art in educational computing. Administrative and instructional computing applications will be presented, and new ways

## In Less Than 3 Minutes

Your IBM Model 50, 60, or 75  
Electronic Typewriter  
can be an RS232C PRINTER or TERMINAL



CALIFORNIA MICRO COMPUTER Models 5060 and 5061 can be installed easily and require NO modifications to the typewriter.

For additional information contact:

CALIFORNIA MICRO COMPUTER  
9323 Warbler Ave., Fountain Valley, CA.  
92708 (714) 968-0890

# YOUR COMPUTER HEADQUARTERS



## SUPER SPECIAL!

- THE NEW APPLE III
- Apple III plus 128K
- Apple III SOS package
- 12" High Resolution Green Monitor

**\$2999.00**

## HIGHLY RATED BY TAX PROS!

- Apple II plus 48K
- Apple Disc Drive II w/interface DOS 3.3
- 12" High Resolution Green Monitor
- HOWARD Tax Preparer 1982

**\$1999.00**

## WORD PROCESSOR SYSTEM

- Apple II plus 48K
- Apple Disc Drive II w/DOS 3.3
- 12" High Resolution Monitor
- OKIDATA Microline 80 Printer
- Printer cable w/interface
- IUS Orig. Easywriter

**\$2399.00**

### ACCESSORIES FOR APPLE

Videx Videoterm - 80 Col.	\$269.95
Videx Keyboard	
Enhancer II	\$119.95
DC Hayes Micromodem II	\$298.00
Microsoft Z-80 CPM Card	\$289.00
Microsoft 16K Ram Card	\$159.95
Saturn 32K Ram Card	\$199.95
VC Expand for Saturn Card	\$84.95
Mountain CPS	
Multifunction Card	\$179.00
Mountain Clock	\$239.95
Keyboard Company	
Numeric Keypad	\$135.95
Apple Pascal	\$209.95
Apple High Speed	
Serial Interface	\$158.95
Dan Paymar	
Lower Case Chip	\$39.95
R.H. Superfan II	\$64.95
Apple Graphics Tablet	\$649.95
Verawriter Graphic Tablet	\$249.00

### WORD PROCESSORS

IUS - Pro Easywriter	\$200.00
IUS - Pro Easymailer	\$120.00
Orig. Easywriter	\$79.95
Apple Pie (W/P 40 Col.)	\$105.00
LJK Letter Perfect	\$129.95
Supertext II	\$129.95
Superscribe II (70 Col.)	\$104.95
Executive Secretary	\$200.00
Magic Window	\$85.00

### EDUCATIONAL F/APPLE

Edu-Ware Math/Fractions	\$34.95
Math/Decimals	\$34.95
Arithmetic Skills	\$43.00
Algebra I	\$34.95
Compuspell System	\$26.00
Data Disc Lev. 4-5-6-7-8 ea.	\$18.00
CMA Teacher Plus	\$44.95
CMA Teacher Plus Pack	\$60.00
PDI New Step-by-Step	\$69.95

### SOFTWARE FOR APPLE

Fortran 80	\$154.95
A.L.D.S.	\$99.95
BASIC Compiler	\$295.00
Tasc Compiler	\$149.95
Cobol - 80	\$595.00
Context Connector	\$145.00

Apple World	\$49.95
3D Super Graphics	\$33.00

### SENSIBLE

The Apple Speller	\$59.95
Wordstar 3.0	\$269.95
Spell Star	\$170.00
Mail Merge	\$95.00
Super Sort-1	\$139.95

### MICRO PRO

Data Factory	\$120.00
Invoice Factory	\$159.95
Tax Manager	\$120.00

### HOWARD SOFTWARE

Tax Preparer New 1982	\$119.95
NEW! Real Estate Analyzer	
2nd Addition	\$149.95

### PERSONAL SOFTWARE

Viscalc 3.3	\$199.95
Visiplot	\$159.95
Visidex	\$159.95
Visitrend/Visiplot	\$239.00
Visiterm	\$79.95
Visitile	\$199.95
Desktop Plan II	\$199.95
Desktop Plan III	\$253.95

### THE SOURCE

Telecommunication	\$90.00
-------------------	---------

### AARDVARK

Personal Tax Plan	\$105.00
Individual Tax Plan	\$200.00

### SYSTEM PLUS

Accounting Plus II	CALL
--------------------	------

### ASHTON TATE

DBase II	\$524.95
----------	----------

### HIGH TECHNOLOGY

Info. Master	\$119.00
Store Manager	\$199.00
Data Master	\$79.00
Job Control System	\$595.00
Client Billing System	\$279.00

### SOUTHEASTERN SOFTWARE

Data Capture 4.0 40 Col.	\$149.95
Data Capture 4.0 80 Videx	\$69.95

### SOFTWARE PUBLISHING

PFS	\$77.00
PFS Report	\$77.00

### PHOENIX SOFTWARE

Zoom Graphics	\$35.00
---------------	---------

### Master Diagnostic

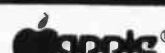
(Formerly Brain Surgeon)	\$42.95
--------------------------	---------

### STONEWARE

DB Master Vers. 3	\$179.95
Utility Pack I	\$89.95
Z-Term (CP/M)	\$99.00
ASC II Express 3.3	\$65.00
Brodebund Payroll	\$299.95
Microbuffer II 16K	\$224.95
Microbuffer II 32K	\$259.95
Snapshot	\$59.00

### GAME AND HOBBY

Temple of Asphal	\$32.95
Hellfire Warrior	\$32.95
Rescue at Rigel	\$24.95
Crush, Crumple & Chomp	\$24.95
Jabber Talky	\$24.95
Major League Baseball	\$26.95
Alien Rain	\$21.95
Apple Panic	\$24.95
Snack Attack	\$24.95
Joy Breaker	\$24.95
Space Quarks	\$24.95
Genetic Drift	\$24.95
Red Alert	\$24.95
Ultima	\$32.95
Star Thief	\$24.95
Bug Attack	\$24.95
Sargon II	\$30.00
Pool 1.5	\$30.00
Shuffle Board	\$24.95
Trick Shot	\$32.95
Dog Fight	\$24.95
Olympic Decathlon	\$24.95
Three Mile Island	\$32.95
ABM	\$21.95
Robot War	\$32.95
Castle Wolfenstein	\$24.95
Zork or Zork II	\$32.95
Falcons	\$30.00
Beer Run	\$24.95
Raster Blaster	\$24.95
Space Eggs	\$32.95
Gorgon	\$30.00
Cops and Robbers	\$32.95
Tigers in the Snow	\$32.95
The Battle of Shiloh	\$48.95
The Shattered Alliance	\$32.95
Computer Baseball	\$32.95
Computer Quarterback	\$24.95
Sneakers	\$48.95
TG Joystick	\$34.95
TG Game Paddles	\$34.95
NEW! LOGO for Apple	\$149.95



## THE COMMUNICATOR PACKAGE

- Apple II plus 48K
- Apple Disc Drive II w/controller DOS 3.3
- DC Hayes Micromodem II
- 12" Green Monitor
- Source Telecommunication

**\$2255.00**

## BUSINESSMAN'S SPECIAL

- Apple II plus 48K
- Apple Disc Drive II w/interface DOS 3.3
- 12" High Resolution Green Monitor
- Visicalc 3.3 Software

**\$2074.00**

## THE FAMILY SYSTEM NOW ONLY \$2099.00

### NEW! FIBERBUILT CASE FOR APPLE!

- Fits Apple & 2 Disc Drives
  - Detachable Cover
- \$65.95**

VP-3501 Videotex Data Terminal  
Turn your home TV into a time-sharing videotex display.



Only **\$359.00**



### ★ SHARP MINI COMPUTERS ★

#### PC-1500 LED POCKET COMPUTER

Extended BASIC system capable of 2 dimensions. arrays. Full graphic commands.

Now Only **\$254.95**

#### PC-1211 POCKET COMPUTER

Formidable computing power. Programmable with BASIC language. 24 digit LCD.

Now Only **\$139.95**



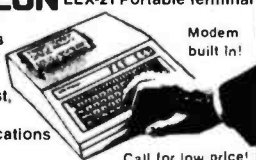
#### CE-122 16-DIGIT MINI DOT PRINTER

Print out program & program performance CASSETTE INTERFACE: Saves data or programs on cassette tape. Search saved data by file name.

Now Only **\$104.95**

### LEXICON LEX-21 Portable Terminal

The world's smallest, lightest, lowest cost, Printing Communications Terminal



### PERSONAL COMPUTER

VIC 20 and RF Modulator

**PRICED TOO LOW TO PRINT**

8K Memory Expansion ..... 53.95

Phone Modem I/VIC by Bizcom ..... 139.95

DATACORDER (I/Cass. Prog.) ..... 69.95

VT 106A 6 Pk. Recreational Prog. .... 49.95

Super Expender ..... 57.95

### Texas Instruments



#### TI 99/4A COMPUTER

**NEW LOW PRICE \$329.95**

**FREE!** RF Modulator with purchase of TI 99/4A

Full line of Hardware, Software & Accessories IN STOCK!

TI LOGO PHM 3040 ..... \$89.95

**FREE!** Buy any 4 TI modules from us & get the New MUNCHMAN ARCADE game free from TI.

OFFER EXPIRES 5/15/82

ATARI 800 w/16K ..... \$699.95

ATARI 400 ..... \$329.00

810 Disc Drive ..... \$459.00

410 Programmable Recorder ..... \$79.95

**POPULAR ATARI GAMES IN STOCK!**

**We carry the full line of TI and HP Programmable Calculators.**



### A Complete Computer System In One Small Package.

The HP-85A is a powerful BASIC language computer, complete with keyboard, CRT display, printer and disc drive all in one self contained 20 lb. unit. 16K RAM memory, expandable to 32K.

**HP-85A New Low Price \$1982.00**

**PLUS! 2 Free Software Application Packs \$190.00 Value!**

(WHILE SUPPLY LASTS).

**HP-125 New Low Price \$1982.00**

HP 82091M 5 1/4" Disc Drive ..... \$1650.00

HP 7225B Graphics Plotter ..... \$1939.00

HP 82905B Serial Printer ..... \$749.00

### PRINTERS

OKIDATA 83A Graphics, 120 CPS, Bidirectional, Friction & Tractor. 136 Col. Serial & Parallel. Takes 15" Paper 729.95

OKIDATA 82A Graphics, 120 CPS, Bidirectional, Friction and Tractor Feed. Serial & Parallel, 80/132 Columns. 489.95

Tractor Feed, opt. 55.00

OKIDATA OKIGRAPH™ Create Illustrations, Graphs, Charts or whatever a CRT screen tells it to 69.00

CENTRONICS 739-I Graphics, 100 CPS Monospaced Mode, Right Justification, Friction and Tractor ..... 525.00

XEROX Diablo 630 with word processing enhancement ..... 2399.00

Bi-directional Tractor (optional) ..... 205.00

**NEW! C.ITOH F10-40 Daisy Wheel, Letter Quality Printer ..... 1595.00**

C.ITOH 8510 Pro Writer, 120 CPS. 136 Columns, Parallel, Bidirectional, FT, High Resolution Graphics ..... 519.00

NEC 8023 Pro Writer, 100 CPS, 136 Col. Parallel, Bidirectional, Tractor and Friction, High Resolution Graphics ..... 519.00

**EPSON**

MX-80 ..... 449.00

MX-100FT ..... 739.00

**MONITORS**

SANYO VM-4509 9" B&W ..... 169.95

SANYO DM-8112CX 12" Green ..... 269.95

SANYO DMC-6013 13" Color ..... 449.95

NEC JB1201 12" Green ..... 179.95

NEC JC1201 12" Color ..... 349.95

CORPORATE ACCOUNTS WELCOME

(212)260-4410

TOLL FREE OUT-OF-STATE

**800-221-7774**

**800-221-5858**

**800-223-5661**



**47st photo**

Cameras • Electronics • Audio • Video • Computers • Dark room • Accessories

67 West 47th Street, New York, N.Y. 10036

115 West 45th Street, New York, N.Y. 10036

MAIL ORDER ADDRESS: 36 E. 19th St. New York, N.Y. 10003

Items on sale for limited time only, and are subject to limited availability. Not responsible for typographical errors. This ad supersedes all other ads prior to May '82. Prices effective as of March 23, 1982, and are subject to change without notice. All orders subject to verification and acceptance. Minimum shipping and handling \$4.95

## Event Queue

of improving educational processes will be explored. Contact AEDS, 1201 Sixteenth St. NW, Washington, DC 20036, (202) 833-4100.

*May 11*

**DEC-Compatible Show**, Omni International, Atlanta, GA. This conference for Digital Equipment Corporation (DEC) users is sponsored by MDB Systems. It is designed to provide users with selection assistance and application support for a wide range of products. Contact MDB Systems Inc., 1995 North Batavia St., Orange, CA 92665, (714) 998-6900.

*May 14-15*

**The Second Annual Southern California Computers-in-Education Conference**, University High School, Irvine, CA. This conference covers the application of computers in education from kindergarten through two-year college. All areas of curriculum will be covered, including reading, mathematics, science, language, and special education. Hands-on workshops and field trips are planned. Contact Craig Walker, Arrowview Intermediate School, 2299 North G St., San Bernardino, CA 92405, (714) 886-9118.

*May 14-16*

**Applefest/Boston**, Hynes Auditorium, Boston, MA. This show will feature more than 200 displays and booths of Apple-compatible products and accessories. Seminars and panel discussions will be held. Ticket prices are \$6 per day or \$15 for a three-day pass. Contact National Computer Shows, 824 Boylston St., Chestnut Hill, MA 02167, (617) 739-2000.

*May 15-16*

**The North American Computer Othello Championship**, Learning Resources Center, Andersen Hall, Northwestern

University, Evanston, IL. This two-day tournament is sponsored by the United States Othello Association. Champions will be determined in three categories: microcomputer systems (located on site), mainframe systems (telephone hookup), and special-purpose Othello machines. For complete tournament details, write to Professor Peter W. Frey, Dept. of Psychology, Northwestern University, Evanston, IL 60201.

*May 16-21*

**Advanced DP Training Management Workshop**, Los Angeles, CA. This workshop is intended for training managers directly responsible for planning, monitoring, and evaluating data-processing training and reporting to upper-level management. The prerequisite for this workshop is completion of Deltak's Training Managers' Workshop (see May 23-28) and a minimum of one year's experience since completion or the equivalent on-the-job experience. The registration fee is \$850. Contact Linda Hubacek, Deltak Inc., 1220 Kensington Rd., Oak Brook, IL 60521, (312) 920-0700.

*May 17-21*

**Graphics Interface 82**, Toronto, Ontario, Canada. This conference and exhibition is sponsored by the Canadian Man-Computer Communications Society and the National Computer Graphics Association of Canada. Papers and speakers will address a wide variety of topics, including man-computer interaction, animation, graphics algorithms, and computer-aided design and manufacturing. For details, contact Rich MacKay, Dataplotting Services Inc., 160 Duncan Mills Rd., Don Mills, Ontario M3B 1Z5, Canada, (416) 447-8518.

*May 18-20*

**Microcomputers in Education**, Gutman Library, Cambridge, MA. This series of workshops is designed for educators at all levels. Topics include an overview of the educational uses of microcomputers, BASIC and graphics, Pascal, and the administrative uses of microcomputers. Hands-on experience will be emphasized. For information, contact Technical Education Research Centers, 8 Eliot St., Cambridge, MA 02138, (617) 547-3890.

*May 18-20*

**Northcon/82 High-Technology Electronics Exhibition and Convention**, Seattle Center Coliseum, Seattle, WA. Contact Electronics Conventions Inc., 999 North Sepulveda Blvd., El Segundo, CA 90245, (800) 421-6816; in California, (213) 772-2965.

*May 19-21*

**Computer Hong Kong 82**, Regent Hotel, Hong Kong. This three-day program, which embraces the Fifth Hong Kong Computer Conference, will focus on the electronic data-processing market. For further details, contact Kallman Associates, 5 Maple Court, Ridgewood, NJ 07450, (201) 652-7070.

*May 20-21*

**The Third Annual Computer Law Institute**, Los Angeles, CA. This institute will provide an in-depth program on antitrust, proprietary rights, and contractual issues confronting the computer industry. Among the topics to be covered are fair trade practices and the negotiation and structuring of distributor, dealer, and original equipment manufacturer contracts. Contact Ami Silverman, University of Southern California Law Center, University Park, Los Angeles, CA 90007, (213) 743-2582.

*May 20-21*

**The Third Annual Electronic Mail Seminar**, BBN Conference Center, Cambridge, MA. This seminar is designed for anyone investigating, planning, implementing, or expanding computer-based message systems. The technical, social, and managerial issues involved in a successful electronic mail program will be studied. Hands-on experience will be provided. Contact BBN Information Management Corp., 10 Moulton St., Cambridge, MA 02238, (617) 497-2929.

*May 21-23*

**The 1982 Computer Showcase Expo**, Boston, MA. The Computer Showcase is designed for small-business owners, independent professionals, and corporate managers. Admission is \$7.50. For further details, contact the Interface Group, 160 Speen St., POB 927, Framingham, MA 01701, (800) 225-4620; in Massachusetts, (617) 879-4502.

*May 22*

**The First Regional Conference on Technology and Special Education**, Mill Neck Manor Lutheran School for the Deaf, Mill Neck, NY. Sponsored by the New York State Association for Educational Data Systems, this conference will focus on computer applications in special education for administrators, teachers, and parents. Contact Dr. Dolores Shanahan, Commack Public Schools, Indian Hollow Computer Laboratory, Kings Park Rd., Commack, NY 11725, or Jerry Burke, Half Hollow Hills High School, Dix Hills, NY 11746.

*May 22*

**The Third Annual New Jersey Microcomputer Show & Flea Market**, Holiday Inn (North), Newark International Airport, Newark, NJ. This event will feature more



# PERSONAL COMPUTERS PERSONAL COMPUTERS PERSONAL COMPUTERS PERSONAL COMPUTERS

## EPSON MX-80



**\$439.00**

INTERFACES & CABLES  
IEEE \$55.00 RS-232 \$70.00  
APPLE INTERFACE & CABLE \$90.00  
TRS-80 CABLE \$35.00

Amdek Video-300 .....	199.00
Amdek Color-1 Monitor .....	359.00
Atari 400 16K .....	349.00
Atari 810 Disk Drive .....	449.00
Atari 850 Interface .....	169.00
Atari 830 MODEM .....	159.00
Atari 800 16K .....	749.00
Diablo 630 .....	2095.00
Epson MX-70 .....	329.00
Epson MX-80 FT .....	549.00
Epson MX-100 FT Printer .....	739.00
Hayes Micromodem II (Apple II) .....	299.00
Microtek 16K Ramboard for Atari 800, .....	79.00
Microtek 32K Ramboard for Atari 400 & 800 .....	149.00
M&R Sup-R-Terminal .....	279.00
Microsoft Soft Card (Z-80) .....	279.00
Microsoft Ramcard 16K for Apple .....	159.00
NEC 3510 Spinwriter .....	1850.00
NEC 3515 Spinwriter .....	1895.00
NEC 3530 Spinwriter .....	1850.00
NEC PC-8023 Printer .....	569.00
NEC JC1201 M(A) - Color 12" Monitor .....	359.00
NEC GREEN JB1201M - 12" Monitor .....	169.00
Okidata Microline-80 Matrix Printer .....	329.00
Okidata Microline-82A .....	499.00
Okidata Microline-83A .....	729.00
Televideo 910 .....	559.00
Televideo 912C .....	669.00
Televideo 920C .....	749.00
Televideo 925 .....	849.00
Televideo 950 .....	929.00

**CALL TOLL FREE!  
800-343-0873**

Stock Shipments Same Day or Next  
No Surcharge for Credit Cards  
All Equipment Factory Fresh w/MFT Warranty  
Prices do not Reflect Shipping Charges  
Mass. Residents Please Add 5% Sales Tax

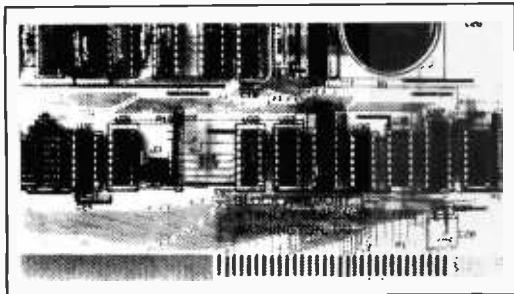
**PRICES ARE SUBJECT TO  
CHANGE WITHOUT NOTICE**

# OMEGA SALES COMPANY

(Not an affiliate with Omega Sales Co., Inc., A Delaware Corporation)

**430 PEARL STREET, STOUGHTON, MA 02072  
(617)344-6645**

## IBM Personal Computer 128 K + Clock/Calendar



**64k of parity checking memory PLUS battery supported Clock/Calendar.**

- Solid Electrolyte (Lithium Iodide) battery eliminates leakage problems.
- Two or less standard loads per I/O pin per IBM specification.
- Gold flashed edge fingers and plated through holes for high reliability.
- 64k & Clock/Calendar . . . \$445.  
128k & Clock/Calendar . . \$540.

**Tenley Design, Inc.**  
PO Box 39155 Wash DC 20016

## Event Queue

### June 1982

*June*

**Knowledge Engineering in the 1980s**, Chicago, IL. Expert Systems are computer programs that reason in tasks requiring considerable human expertise, such as locating computer malfunction, monitoring intensive care patients, analyzing noisy signal data, and diagnosing medical problems. This one-day executive briefing provides an introduction to the potential benefits and costs of Expert Systems. For further information, contact Dina Barr, Teknowledge, 151 University Ave., Palo Alto, CA 94301, (415) 326-6827.

*June-August*

**Database Concepts and Design**, various sites throughout the U.S. Sponsored by the American Management Associations (AMA), this five-day seminar is designed for data-processing managers, system designers, and other personnel involved in database activities. Topics include an overview of the database environment; evaluating and measuring performance, costs, and results; determining organizational needs and the systems software to meet them; and implementing, integrating, and supporting the database within company plans and budget. Highlighting this seminar is a comprehensive review of database products. Individual fees are \$850 for AMA members and \$975 for nonmembers. Team discounts are available. Contact AMA, 135 West 50th St., New York, NY 10020, (212) 586-8100. To register by phone, call (212) 246-0800.

*June 6-11*

**Advanced DP Training Management Workshop**, Calgary, Alberta, Canada. For details, see May 16-21.

than 50 commercial exhibitors and 150 flea market sellers. Hardware, software, and accessories for all popular systems will be featured. Contact Kengore Corp., 3001 Rte. 27, Franklin Park, NJ 08823, (201) 297-2526, for additional information.

*May 23-28*

**DP Training Managers' Workshop**, Dallas, TX. This workshop is intended for individuals with less than 18 months' experience in coordinating data-processing training programs. Participants will learn to establish in-house education programs that will meet management objectives and ensure a high return on their organization's investment in training. The registration fee is \$850. Contact Linda Hubacek, Deltak Inc., 1220 Kensington Rd., Oak Brook, IL 60521, (312) 920-0700.

*May 25-27*

**Electro/82 High-Technology Electronics Exhibition and Convention**, Hynes Auditorium, Commonwealth Pier, and Sheraton-Boston Hotel, Boston, MA. Contact Electronics Conventions Inc., 999 North Sepulveda Blvd., El Segundo, CA 90245, (800) 421-6816; in California, (213) 772-2965.

*May 31-June 4*

**Personal Microcomputer Interfacing and Scientific Instrument Automation**, Virginia Polytechnic Institute and State University, Blacksburg, VA. This workshop is designed to teach users how to interface and use personal computers in instrumentation and automation systems. Hands-on experience working with and designing interfaces for personal computers will be featured. Contact Dr. Linda Leffel, CEC, Virginia Tech, Blacksburg, VA 24061, (703) 961-4848.

**STOCK ORDERS SHIPPED IN 24 HOURS**

**ADDS VIEWPOINT \$499\*** QTY. 1

TERMINAL

The Best Equipped Printer for the Money  
MODEL 880  
88C FEATURES

Graphics  
Friction Feed  
Adjustable Tractor Feed  
Parallel Interface  
Serial Interface  
Data Buffer  
Correspondence Form II x 7  
Print Speed  
Number of Columns  
Variable Form Length

Standard  
Standard  
Standard  
Standard  
K Standard  
Standard  
80, 110, 132  
Standard



**mpi**  
**\$649\*** QTY. 1  
Interface cables for RS-80 14-8 Apple Centronics, Altos and PE1

### DISC DRIVES

<b>QUME:</b> DT-8...\$525.00* QTY. 1 8 DSDD 48 TP	<b>DT-5...</b> \$310.00* QTY. 1 5 1/2" DSDD 48 TP
<b>TANDON:</b> TM-100-2...\$335.00* QTY. 1 5 1/2" DSDD 48 TP	<b>TM-100-4...</b> \$425.00* QTY. 1 5 1/2" DSDD 96 TP
<b>TM-848-1...</b> \$475.00* QTY. 1 8 DSDD 134 IN LINE	<b>TM-848-2...</b> \$550.00* QTY. 1 8 DSDD 134 IN LINE
<b>TM-602...</b> \$995.00* QTY. 1 5 1/4" 5M BYTE WINCHESTER	<b>TM-603...</b> \$1175.00* QTY. 1 5 1/4" 10M BYTE WINCHESTER

**QUME LETTER QUALITY PRINTERS**

**SPRINT 9/45 \$2245\*** QTY. 1

OTHER MODEL AND CONFIGURATIONS AVAILABLE



**(408) 438-5454**

4444 SCOTTS VALLEY DR., SCOTTS VALLEY, CA 95066

TERMS: Cashiers Check, VISA, M/C, COD

Shipping charges added to all orders

\*Quantity Discounts Available







## Model EP-2A-79 EPROM Programmer

North Star  
Apple  
S-100  
SS-50  
STD-Bus  
Atari  
Pet  
Kim-1



TRS-80  
H-8  
H-89  
Ohio  
Scientific  
SWTP  
Aim-65  
Sym-1

Three years in the field with unsurpassed performance. Software is available for the EP-2A-79 for most all of the microcomputers including the popular CP/M, FLEX, HDOS operating systems. Write or call for specific hardware/software interfacing. Driver packages available for F-8, 6800, 6809, 8080,8085, Z-80, 1802, 6502 and 2650 based systems.

EP-2A-79 115V 50/60 HZ .....\$169.00

### Personality Modules

PM-0	TMS 2708	\$17.00	PM-5	2716, 2758	\$17.00
PM-1	2704, 2708	17.00	PM-5E	2816	35.00
PM-2	2732	33.00	PM-8	MCM68764	35.00
PM-2A	2732A	33.00	PM-9	2764	35.00
PM-3	TMS 2716	17.00	SA-64-2	TMS 2564	39.00
PM-4	TMS 2532	33.00	SA-64-3	2764	39.00

## Optimal Technology, Inc.

Phone (804) 973-5482

Blue Wood 127

Earlsville, VA 22936

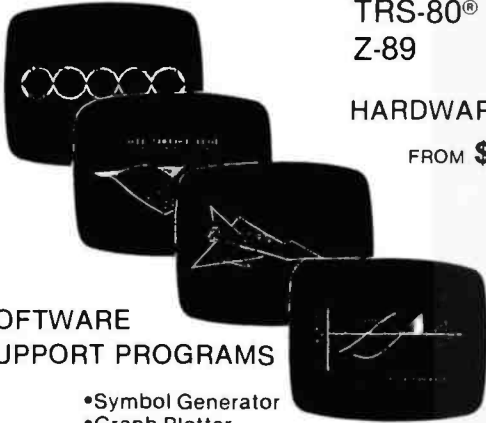
## XCEL™ MICROCOMPUTER RETROFIT GRAPHICS

512 x 240  
RESOLUTION

FOR COMPUSTAR®  
SUPERBRAIN®  
TRS-80® MODEL II  
Z-89

HARDWARE RETROFIT

FROM \$895.00



SOFTWARE  
SUPPORT PROGRAMS

- Symbol Generator \$175.00
  - Graph Plotter \$175.00
  - 3D Generator \$345.00
  - Surface Plotter \$395.00
  - Graphics Terminal Emulator \$395.00
  - Screen Printer \$65.00
- ANADEX  
EPSON  
IDS

(800) 421-1423

IN CALIFORNIA CALL  
(213) 320-6604

**MAXTEK, INC.** 2908 Oregon Court, Torrance, CA 90503  
Available in Europe from Micronex Ltd., Chew Magna, England 3042 (STD 027-589 3042)

TRS-80 registered trademark Tandy Corp. Superbrain trademark Intertec Data Systems  
Trademark registered trademark TeXTerm Inc. CPM registered trademark Digital Research

## Event Queue

June 6-11

**DP Training Managers' Workshop**, Philadelphia, PA. For details, see May 23-28.

June 7-9

**Microcomputers in Education**, Taft School, Watertown, CT. For details, see May 18-20.

June 7-10

**The 1982 National Computer Conference**, Astrohall, Houston, TX. This show will feature sessions commemorating the twenty-fifth anniversary of the first FORTRAN compiler. For more details, contact the American Federation of Information Processing Societies Inc., 1815 North Lynn St., Arlington, VA 22209, (703) 558-3612.

June 7-11

**The Eleventh Annual Meeting of the MUMPS Users' Group**, Denver Hilton Hotel, Denver, CO. This conference will embrace a wide assortment of topics relating to the MUMPS computer language, including medical and business applications, small and large MUMPS systems, technical issues, and new areas of opportunity. Roundtable discussions, workshops, and tutorials for new and experienced programmers will be held. Hardware, software, and systems will be exhibited. Contact the 1982 MUMPS Users' Group Meeting, POB 37247, Washington, DC 20013, (301) 779-6555.

June 9-11

**The International Conference on Consumer Electronics (ICCE)**, Arlington Park Hilton, Arlington Heights, IL. The technical program will include papers and panel discussions on such topics as personal computing, computer-aided design techniques, home information systems, and videotex, teletext, videodisc, video-cassette recorders, and

cameras. Exhibits will be featured. This conference is sponsored by the Consumer Electronics Group of the IEEE (Institute of Electrical and Electronics Engineers). Contact the IEEE, 445 Hoes Lane, Piscataway, NJ 08854.

June 13-16

**The Fifteenth Annual Conference of the Association of Small Computer Users in Education**, Chatham College, Pittsburgh, PA. This conference will include papers and demonstrations on the educational and administrative uses of computers. Other topics to be covered are robotics, Pascal programming, computer literacy, and the use of packaged software in computer courses. For more information, contact Jan Carver, Computer Center, Chatham College, Pittsburgh, PA 15232, (412) 441-8200.

June 14-16

**The Fifteenth Power Modulator Symposium**, Hyatt Regency Baltimore, Baltimore, MD. This symposium will focus on the technology, devices, and systems associated with rep-rated power modulators, including switches, auxiliary devices, energy storage, radio-frequency systems, and low-frequency generators. For details, contact Leonard Klein, Palisades Institute for Research Services Inc., 201 Varick St., New York, NY 10014, (212) 620-3377.

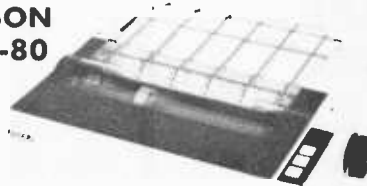
June 15-17

**The 1982 IEEE MTT-S International Microwave Symposium**, Hyatt Regency Hotel, Dallas, TX. The theme of this symposium is "Thirty Years of Microwaves." Papers and tutorials on a wide range of topics, including computer-aided design and measurement techniques, microwave field and network theory, as well as satellite communica-

# SPECIALS

WE CARRY THE COMPLETE LINE OF ATARI SOFTWARE, PERIPHERALS AND ACCESSORIES.

**EPSON  
MX-80**



INTERFACES & CABLES  
IEEE \$55. RS-232 \$70.  
APPLE INTERFACE & CABLE \$90.  
TRS-80 CABLE \$35.

**\$439.00**

W/GRAPHTRAX \$459.00

**ATARI 400 16K**



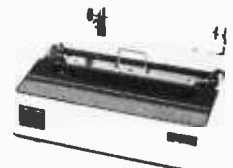
**\$339.00**

# PERSONAL COMPUTERS

Televideo 925	849.00	NEC 3510 Spinwriter	1750.00
Televideo 950	929.00	NEC 3515 Spinwriter	1795.00
CBM 8032 Computer	1149.00	NEC 3530 Spinwriter	1750.00
CBM 8050 Disk Drive	1349.00	NEC PC-8023 Printer	629.00
CBM 4032 Computer	975.00	NEC 7710 Spinwriter	2345.00
CBM 4040 Disk Drive	975.00	NEC 7720 Spinwriter	2695.00
CBM 4022 Printer	649.00	NEC 7730 Spinwriter	2345.00
CBM VIC-20	269.00	NEC JC 1201 M(A) — Calar 12" manitor	359.00
Microtek 16K Ramboard for Atari 800	79.00	Okidata Micraline-82A	499.00
Microtek 32K Ramboard for Atari 400 and 800	149.00	Okidata Microline-83A	729.00
Qume Sprint 9/45 (Full Panel)	2095.00	Diablo 630	1995.00
Atari 810 Disk Drive	449.00	M & R Sup-R-Terminal	279.00
Atari 850 Interface	169.00	Microsoft Soft Card (Z-80)	279.00
Atari 830 MODEM	159.00	Microsoft Ramcard 16K for Apple	149.00
Atari 800 16K	699.00	Hazeltine 1420	799.00
Epson MX-70	319.00	Amdek 100 G	169.00
Epson MX-80 FT	549.00	Anadex DP-9500/9501	1249.00
Amdek Video-300	199.00	Televideo 910	559.00
Hayes Micromadem II (Apple II)	299.00	Televideo 912C	669.00
Sanyo 9" B & W	189.00	Televideo 920C	689.00



**NEC GREEN  
12" MONITOR JB 1201M  
\$159.00**



**OKIDATA MICROLINE 80A  
MATRIX PRINTER  
\$329.00**



**AMDEK COLOR-1 MONITOR  
\$339.00**



**EPSON MX-100 FT PRINTER  
\$729.00**

**PRICES ARE SUBJECT  
TO CHANGE  
WITHOUT NOTICE**

**CALL TOLL FREE!**

**1-800-556-7586**

**COMPUTER SHOPPING CENTER INC.**

12 Meeting St.

Cumberland, RI 02864

1-401-722-1027

TELEX 952106

## COMPUTER SHOPPING CENTER

We Accept C.O.D.'s • Stock Shipments Same Day or Next • No Surcharge for Credit Cards  
• All Equipment Factory Fresh w/MFT Warranty • We Carry the Complete Line of Personal Software  
• Prices do not Reflect Shipping Charges  
Rhode Island Residents please add 6% Sales Tax





# SUBARU OFFERS GREATER TRACTION. AND EVEN GREATER TRACTION.

We congratulate all the car makers who've finally noticed that front wheel drive improves traction. We, however, introduced front wheel drive in 1969. And we just don't think there's any substitute for experience.

As pioneers of front wheel drive, we use this experience to balance all the factors — drive train, steering, weight distribution, suspension — which make for remarkable adhesion to the road. Even around curves, in rain or snow.

The people of Maine, Idaho, Alaska and West Virginia think so much of our front wheel drive that they've helped make Subaru the best selling import in those states! States where good traction is absolutely essential.

But if you want even more traction, we suggest our wagon with *On Demand Four Wheel Drive*. Which allows you to go from front wheel drive to four wheel drive with the flick of a lever. *On Demand. Without stopping.*

(Any other 4 wheeler around requires a full stop before switching. And stopping is exactly what you can't do sometimes.)

Both models also help you keep things under control when it comes to gas mileage. So while you're holding on to the road, you can also hold on to your money.

And both offer plenty of room, with plenty of options, like power windows, power steering, AM/FM cassette tape deck, cruise control. The works.

But the best option of all is deciding what level of traction you want. Greater. Or even greater.



## SUBARU® INEXPENSIVE. AND BUILT TO STAY THAT WAY.



4WD WAGON  
**\$7,019\*\***

FWD WAGON  
**\$6,269\*\***

†1981 YTD REGISTRATIONS JUNE 1981 R.L. POLK AND COMPANY REPORT

\*1982 EPA ESTIMATES FOR OUR FWD 5-SPEED WAGON. USE EST. MPG FOR COMPARISONS. YOUR MILEAGE MAY DIFFER DEPENDING ON DRIVING SPEED, WEATHER CONDITIONS AND TRIP LENGTH. ACTUAL HWY. MILEAGE WILL PROBABLY BE LESS.

\*\* TOTAL SUGGESTED POE FOR OUR DL MODELS — NOT INCLUDING DEALER PREP, INLAND TRANSPORTATION, STATE AND LOCAL TAX, LICENSE AND TITLE FEES. CERTAIN ITEMS SHOWN OPTIONAL AT EXTRA COST.

© SUBARU OF AMERICA, INC. 1981

## Event Queue

July 13-14

**Controlling Electromagnetic Interference**, Hyatt Hotel at LA Airport, Los Angeles, CA. This seminar is sponsored by *Electronics* magazine, a McGraw-Hill publication, and is designed for electronics industry professionals who must make technical or cost decisions based on an understanding of electromagnetic interference. Topics of discussion include intersystem problems, designing against environmental noise, how to determine the best frequency for a given application, and the structure and use of intrasystem electromagnetic compatibility models. The fee is \$595; in-plant programs can be arranged. Contact Ms. Barbara Bancroft, McGraw-Hill Seminar Center, Room 3112, 305 Madison Ave., New York, NY 10017, (212) 687-0243.

July 18-22

**The Fourth General Assembly of the World Future Society**, Sheraton Washington Hotel, Washing-

ton, DC. The conference theme is "Communications and the Future." All areas of the communications field from telecommunications to interpersonal communication will be covered. The impact of new technologies on society will be explored. Contact the World Future Society, 4916 St. Elmo Ave., Bethesda, MD 20814, (301) 656-8274.

July 19-21

**Summer Computer Simulation Conference (SCSC)**, Marriott City Center Hotel, Denver, CO. The SCSC covers all aspects of computer simulation methodology and applications. Technical sessions and presentations on mathematical methods, model design, simulation languages, and validation techniques will be featured. Information is available from Harvery Marks or Phylia Marks, Transaction Technology Inc., 7648 Capistrano Ave., Canoga Park, CA 91304, (213) 346-5376.

July 21-23

**The Computer: Extension of the Human Mind**, Eugene Hilton Hotel, Eugene, OR. Sponsored by the University of Oregon College of Education, this conference will feature workshops, speakers, and presentations on the use of computers in education. Topics of interest include preparing teachers to teach with computers, the ethical and social issues associated with computers, and how computers assist learning. The conference fee is \$95; students enrolled in the university's summer session can register for \$55 and earn a single credit hour. For additional information, contact Judy Ohmer, College of Education, University of Oregon,

Eugene, OR 97403, (503) 686-3405.

July 25-31

**Family Computer Camp**, Clarkson College, Potsdam, NY. Each member of your family can gain skill with computers while participating at his or her own level (beginner to expert) and age group (ranging from age 5 to adult). Among the topics to be covered in laboratory and lecture sessions are BASIC programming, word processing, graphics, and home and recreational computer use. Additional details are available from the Conference and Information Center, Clarkson College, Potsdam, NY 13676, (315) 268-6647. ■

In order to gain optimal coverage of your organization's computer conferences, seminars, workshops, courses, etc, notice should reach our office at least three months in advance of the date of the event. Entries should be sent to: Event Queue, BYTE Publications, POB 372, Hancock NH 03449. Each month we publish the current contents of the queue for the month of the cover date and the two following calendar months. Thus a given event may appear as many as three times in this section if it is sent to us far enough in advance.

High Resolution 4-Color For Your TRS-80 I or III?

# RESOLVED.

Resolved. National Graphics' new Four Color Adaptor gives your TRS-80 Model I or III 256 x 192 pixels of high definition resolution. \$150 - Kit; \$200 - Assembled and Tested; \$52 - PC Board only.

Make check payable to National Graphics of Colorado: (303) 492-5927

## National Graphics

1310 College Ave. Su. 1057, Boulder, CO 80302

Circle 297 on Inquiry card.



## Scotch® Diskettes

Rely on Scotch® diskettes to keep your valuable data safe. Dependable Scotch diskettes are tested and guaranteed error-free. The low abrasivity saves your read/write heads. They're compatible with most diskette drives.



**(800)235-4137**

DEALER INQUIRIES INVITED

**PACIFIC EXCHANGES**  
 100 Franklin Blvd  
 San Luis Obispo, CA  
 93401 In Cal call  
 (805)542-5415 or  
 (805)541-1117

Circle 320 on Inquiry card.

**LEO ELECTRONICS, INC.**  
 8921 S. Sepulveda #208  
 Los Angeles, CA 90045  
 (213) 641-3101 (800) 421-2418

**WHY PAY MORE? SAVE MONEY!  
 LOWEST PRICES ON PARTS!**

EPROMS		REGULATORS	
2708	2.60	7805	.75
2716	4.00	7812	.75
2716-1(350ns)	6.50	7815	.75
TMS 2716	6.00	7905	.85
2732	10.00	7912	.85
2532	12.00	7915	.85

RAMS		MICROPROCESSORS	
4116(200ns)	8/13.00	Z-80A-CPU	5.50
4116(150ns)	8/16.00	8080A	2.25
2114(200ns)	8/18.00	8085A	7.00

**TERMS:** Check, Visa, Mastercard. Call for C.O.D. U.S. Funds only. California Residents add 6% Sales Tax.  
**SHIPPING:** Add \$2.00 for Ground \$5.00 for Air.  
**ALL MAJOR MANUFACTURERS  
 ALL PARTS 100% GUARANTEED**

Circle 236 on Inquiry card.

# BYTE'S Best Cellar List



## Ciarcia's Circuit Cellar, Volumes I, II, & III by Steve Ciarcia

Collections of Steve Ciarcia's perennially popular columns from BYTE Magazine, these three volumes are sure to please home computer users and electronics hobbyists. **Volume I** includes power conversions, programming EPROMs, remote terminal interfacing, touch-input video display, and more. **Volume II**, focusing on projects which interface the personal computer with the home, features useful applications such as a computer-controlled home security system, computerized appliances, input-output expansion for the TRS-80, and even a computer-controlled wood stove. **Volume III** offers low-cost construction projects such as an ultrasonic rangefinder, handheld remote computer control, two speech synthesizers, and a remote-control motorized platform, to name just a few.

## Build Your Own Z80 Computer

This complete guide to building a working computer offers engineers, students, and hobbyists an exciting alternative to buying a computer. With clear instructions, Steve Ciarcia fully explains how to build a basic single-board micro-computer based on the Zilog Z80 microprocessor. The finished product features a 1 K-byte operating system, serial and parallel ports, hexadecimal display, audio cassette mass storage, and easy expansion to include a video terminal.



Please send

- Ciarcia's Circuit Cellar, Vol. I \$8.00
- Ciarcia's Circuit Cellar, Vol. II \$12.95
- Ciarcia's Circuit Cellar, Vol. III \$12.95
- Build Your Own Z80 Computer \$15.95

Call Toll-Free 800/258-5420

Name \_\_\_\_\_

Check Enclosed \_\_\_\_\_

Address \_\_\_\_\_

Bill Visa/  
MasterCard # \_\_\_\_\_

City \_\_\_\_\_

State \_\_\_\_\_

Zip \_\_\_\_\_

Expiration Date \_\_\_\_\_



70 Main Street Peterborough, N.H. 03458

Please add .75 per book to cover shipping cost.

B5



# ATARI HOME COMPUTERS



**ATARI 800**  
**16K ... \$679**  
**32K ... \$749**  
**48K ... \$819**

**ATARI 400**  
**16K.... \$329**  
**32K.... \$478**  
**48K.... \$555**

410 Recorder	\$76.00
810 Disc Drive	\$449.00
822 Printer	\$269.00
825 Printer	\$629.00
830 Modem	\$159.00
820 Printer	\$269.00
850 Interface	\$169.00
New DOS 2 System	\$29.00

**PACKAGES**

481 Entertainer	\$83.00
482 Educator	\$130.00
483 Programmer	\$57.00
484 Communicator	\$344.00

**ATARI HOME COMPUTER PROGRAMS**

<b>Home Office</b>	
CX404 ATARI Word Processor	\$119.00
CX8102 Calculator	\$29.00
CX412 Dow Jones Investment Evaluator	\$99.00
CX4109 Graph II, Joystick optional	\$17.00
CX4104 Mailing List	\$20.00
CX4115 Mortgage & Loan Analysis	\$13.00
CX406 Personal Financial Management System	\$59.00
CX4103 Statistics I	\$20.00
CX8107 Stock Analysis	\$20.00
CXL4015 TeletLink I	\$23.00
<b>Home Study</b>	
CX4101 An Invitation to Programming 1	\$20.00
CX4106 An Invitation to Programming 2	\$23.00
CX4107 Biorhythm	\$13.00
Conversational Languages (ea)	\$46.00
CX4121 Energy Czar	\$13.00
CX4114 European Countries & Capitals	\$13.00
CX4108 Hangman, Joystick optional	\$13.00
CX4102 Kingdom	\$13.00
CXL4007 Music Composer	\$47.00
CX4123 Scram, uses joystick	\$20.00
CX4112 States & Capitals	\$13.00
CX4110 Touch Typing	\$20.00

**Home Entertainment**

**PAC MAN** ..... \$35.00  
**Centipede** ..... \$35.00  
**Caverns of Mars** ..... \$32.00

CXL4013 Asteroids	\$35.00
CXL4004 Basketball	\$27.00
CX4105 Blackjack	\$13.00
CXL4009 Computer Chess	\$33.00
CXL4012 Missile Command	\$35.00
CXL4008 Space Invaders	\$35.00
CXL4011 Star Raiders	\$42.00
CXL4006 Super Breakout	\$33.00
CXL4010 3-D Tic-Tac-Toe	\$27.00
CXL4005 Video Easel	\$24.00

**Programming Languages and Aids**

CXL4003 Assembler Editor	\$47.00
CXL4002 ATARI BASIC	\$47.00
CX8126 ATARI Microsoft BASIC	\$70.00
CXL4018 PILOT	\$72.00
CX405 PILOT	\$105.00

CX30 Paddle	\$18.00
CX40 Joy Stick	\$18.00
CX853 16K RAM	\$89.00
Microtek 16K RAM	\$75.00
Microtek 32K RAM	\$159.00
Ramdisk (128K)	\$539.00
Inteck 48K Board	\$249.00
One year extended warranty	\$50.00

**THIRD PARTY PROGRAMS**

<b>ATARI Program Exchange:</b>	
Eastern Front '41	\$25.50
Avalanche	\$15.50
Outlaw	\$15.50
747 Landing Simulation	\$15.50
Babel	\$15.50
Dog Daze	\$15.50
Downhill	\$15.50
Attack!	\$15.50
Blackjack-Casino	\$15.50
Reversi II	\$15.50
Domination	\$15.50
Solitaire	\$15.50
Disk Fixer	\$15.50
Supersort	\$15.50
Data Management	\$15.50
Chameleon	\$15.50
Insleat	\$15.50
Insomnia	\$15.50
My First Alphabet	\$25.50
Mapware	\$18.00
Number Blast	\$11.50
Family Cash Flow	\$15.50
Weekly Planner	\$15.50
Bowler's Data Base	\$13.00
Banner Generator	\$11.50

<b>Crystal Software</b>	
Bermuda Fantasy	\$26.00
Beneath Pyramids	\$20.00
Galactic Quest	\$26.00
House of Usher	\$20.00
Forgotten Island	\$26.00
Haunted Palace	\$33.00
CompuMax (Acc. Rec., Gen. Ledger, (Inventory, Payroll, ea.)	\$110.00
Visicalc	\$169.00
Letterperfect (Word Processor)	\$109.00
Ricochet	\$14.50
Crush Crumble & Champ (cassette or disk)	\$24.00
Star Warrior (cassette or disk)	\$29.00
Rescue at Rigel (cassette or disk)	\$24.00
Datestones (cassette or disk)	\$16.00
Invasion Orion (cassette or disk)	\$18.50
Mission Asteroid	\$22.00
MouskATTACK	\$31.00
The Next Step	\$34.00
Softporn	\$27.00
Wizard & Princess	\$29.00
K-BYTE Crazy Shoot Out (ROM)	\$39.00
Protector (Disk 32K)	\$32.00
Jaw Breaker (on line disk)	\$27.00
Ghost Hunter (cassette)	\$24.00
Ghost Hunter (disk)	\$30.00

# PRINTERS

Centronics 739-3	\$619.00
Centronics 739-1	\$519.00
Diablo 630 Special	\$1799.00
<b>Epson</b>	
MX70	\$359.00
MX80	\$469.00
MX80FT	Call
MX100	Call
<b>NEC</b>	
8023	\$549.00
7730	Call
7720	Call
7710	Call
<b>Okidata</b>	
82A	\$499.00
83A	\$769.00
84	\$1129.00
<b>Citoh Starwriter</b>	
F10-40 CPS	\$1469.00
F10-55 CPS	Call
<b>Paper Tiger</b>	
445G	\$699.00
460G	\$899.00
560G	\$1129.00
<b>Talley</b>	
8024-7	\$1399.00
8024 L	\$1629.00
MPC Apple Parallel Board & Cable	\$69.00

# XEROX®

<b>Xerox 820</b>	
System I 5" x 7"	\$2450.00
System II 8"	\$2950.00
CPM 5"	\$169.00
Word Processing	\$429.00
Super Calc	\$269.00

# Texas Instruments



**TI-99/4A \$299**

PHA 2100 R F Modulator	\$43.00
PHP 1600 Telephone Coupler	\$179.00
PHP 1700 RS-232 Accessories Interface	\$179.00
PHP 1800 Disk Drive Controller	\$239.00
PHP 1C50 Disk Memory Drive	\$389.00
PHP 2200 Memory Expansion (32K RAM)	\$319.00
PHP 1100 Wired Remote Controllers (Pair)	\$31.00
32K Expansion	\$329.00
PHP Printer Solid State	\$319.00
PHM 3006 Home Financial Decisions	\$26.00
PHM 3013 Personal Record Keeping	\$43.00
PHD 5001 Mailing List	\$60.00
PHD 5021 Checkbook Manager	\$18.00
PHM 3008 Video Chess	\$60.00
PHM 3010 Physical Fitness	\$26.00
PHM 3009 Football	\$26.00
PHM 3018 Video Games I	\$26.00
PHM 3024 Indoor Soccer	\$26.00
PHM 3025 Mind Challengers	\$22.00
PHM 3031 The Attack	\$35.00
PHM 3032 Blast	\$22.00
PHM 3033 Blackjack and Poker	\$22.00
PHM 3034 Hustle	\$22.00
PHM 3036 Zero Zap	\$18.00
PHM 3037 Hangman	\$18.00
PHM 3038 Connect Four	\$18.00
PHM 3039 Yantzee	\$22.00
Tombstone City 21st Century	\$34.00
Munch Man	\$34.00
T I INVADERS	\$34.00
CAR WARS	\$34.00

All items subject to availability and price change.

# computer mail order west

CALL TOLL FREE **800-648-3311**

Franco  
 Habla  
 Espanol

IN NEVADA, CALL (702) 588-5654

P.O. BOX 6689, STATE LINE, NEVADA 89449

**hp HEWLETT  
PACKARD**



**HP-85 \$1999**

80 Column Printer	\$799.00
HP-125	\$1999.00
HP-83	\$1699.00
HP-85 16K Memory Module	\$169.00
5 1/4" Dual Master Disc Drive	\$1929.00
NEW! HP-87	\$1999.00
Hard Disk w/Floppy	\$4349.00
Hard Disk	\$3440.00
Sweet Lips Plotter	\$1149.00

**HP-41CV Calculator . . . \$249.00**

41 C	\$189.00
11 C	\$119.00
12 C	\$129.00
34 C	\$117.00
38 C	\$119.00
HP-41 Printer	\$340.00

**HPIL CALCULATOR PERIPHERALS**

IL Modul	\$104.00
Digital Cassette	\$449.00
Printer/Plotter	\$419.00
Card Reader	\$164.00
Optical Wand	\$99.00

**NEC**

8001-A	\$669.00
8031	\$669.00
8012	\$549.00

**Disks**

Maxell	
MD I (box of 10)	\$36.00
MD II (box of 10)	\$46.00
MFD I (8")	\$44.00
MFD II (8" Double Density)	\$54.00
Syncom (box of 10)	\$29.00

**Apple**

Call for availability and prices on all Apple computers and peripherals.

**Monitors**

Amdex 12" B&W	\$129.00
12" Green	\$139.00
13" Color	\$349.00
NEC	
12" B&W	\$169.00
12" Color	\$339.00
Ti 10" Color	\$349.00

**Terminals**

Televideo	
910	\$579.00
912C	\$699.00
920C	\$749.00
950	\$939.00
Call for computers	
Zenith Z19	\$749.00
Adds	\$549.00



**CBM 8032  
\$1069**

4032	\$969.00
4016	\$769.00
8096 Upgrade Kit	\$399.00
Super Pet	\$1599.00
2031	\$529.00
8050	\$1299.00
4040	\$969.00
8300 (Letter Quality)	\$1799.00
8023	\$769.00
4022	\$599.00
Pe: to IEEE Cable	\$37.00
IEEE to IEEE Cable	\$46.00
Tractor Feed for 8300	\$240.00
8010 Modem	\$229.00



**VIC 20 \$259**

**COMPLETE**

VIC 6 Pack Program	\$44.00
VIC 1530 Commodore Datassette	\$69.00
VIC 1540 Disk Drive	\$499.00
VIC 1515 VIC Graphic Printer	\$339.00
VIC 1210 3K Memory Expander	\$32.00
VIC 110 8K Memory Expander	\$53.00
VIC 1011 RS232C Terminal Interface	\$43.00
VIC 1112 VIC IEEE-488 Interface	\$86.00
VIC 1211 VIC 20 Super Expander	\$53.00
VT 232 VICTerm I Terminal Emulator	\$9.00
VIC 1212 Programmers Aid Cartridge	\$45.00
VIC 1213 VICMON Machine Language Monitor	\$45.00
VIC 1901 VIC AVENGERS	\$23.00
VIC 1904 SUPERSLOT	\$23.00
VIC 1906 SUPER ALIEN	\$19.00
VIC 1907 SUPER LANDER	\$23.00
VIC 1908 DRAW POKER	\$23.00
VIC 1909 MIDNIGHT DRIVE	\$23.00

Terminal	\$13.00
Un Word	\$13.00
Grafix Menagerie	\$11.00
VIC PICS	\$15.00
Ticker Tape	\$13.00
Banner Headliner	\$13.00
RS 232	\$39.00
VT 106A Recreation Pack A	\$44.00
VT 107A Home Calculation Pack A	\$44.00
VT 164 Programmable Character/Graphic Graphics	\$12.00
Household Finance	\$27.00
VIC Games	\$19.00
VIC Home Inventory	\$13.00
VIC Rec/Ed II	\$13.00
VL101 Introduction to Computing	\$19.00
VL 102 Introduction to BASIC Programming	\$19.00
VM110 VIC 20 Programmers Reference Guide	\$15.00

In-stock items shipped same day you call.

No risk, no deposit on C.O.D. credit card or phone orders. No waiting period for certified checks or money orders. All prices shown are cash prices, add 3% for Master card and Visa. Pre-paid orders receive free shipping in the continental United States.

Nev. & Pa. residents add sales tax.

**computer mail order east**

CALL TOLL FREE **800-233-8950**

INTERNATIONAL CALLS AND IN PA. CALL (717) 327-9575  
477 E. THIRD ST., WILLIAMSPORT, PA 17701

Patricio  
Habla  
Español

# CHEDIT

## A Graphics-Character Editor

*Define your own character set for Apple Pascal.*

---

Jerry N. Sweet  
30 Willow Tree Lane  
Irvine, CA 92715

---

Apple's Pascal system provides the graphics character set `SYSTEM.CHARSET`, which is manipulated with the `TURTLE-GRAPHICS` procedures `WSTRING`, `WCHAR`, and `CHARTYPE`. These procedures allow you to employ limited graphics text on displays when the various hardware modes (text only, graphics only, and partially mixed text and graphics as described in the manuals) are insufficient. However, no presently supplied program allows you to edit the character set. Therefore, you are stuck with those characters defined by Apple, as nice as they may be. Herein lies a remedy.

The `CHEDIT` program allows editing of Apple-format graphics character sets (see listing 1). Although the program is easy to use, it has a number of idiosyncrasies because of its short implementation time. It is not entirely orthogonal and does not contain bulletproof input procedures.

The format of `CHEDIT` is loosely based on a program of the same name written for the Terak 8510a micro-computer by Keith Allan Shillington. His program was reasonably fast

because it used all kinds of UCSD Pascal magic and byte-manipulation intrinsic procedures. However, there was no documentation available internal or external to the program, making it difficult to understand. In contrast, `CHEDIT` is quite slow in spots, but quite easy to read and understand.

### Execution

Because the program uses `TURTLE-GRAPHICS` procedures, the `SYSTEM.LIBRARY` must be online when `CHEDIT` is executed. In addition, since the program makes use of the `SYSTEM.CHARSET` file for prompts, it too must be online. If you are using a nongraphic display (e.g., an 80-column CRT), make sure that the graphics-output device is hooked up (i.e., your TV set). When everything is in order, execute the program (enter X followed by `CHEDIT`). You are confronted with the prompt `INPUT FILE`. Then, you must give the name of a file containing a graphics character set. Initially, this will probably be `SYSTEM.CHARSET`. You are then asked for the name of the output file. I suggest something like

`TEMP.CHARSET` for starters, unless you have something specific in mind, like `APL.CHARSET`.

Once these preliminaries are out of the way, an 8-row by 16-column character menu is set up in the lower center portion of the screen, an 8-row by 7-column editing pallet is set up in the upper right-hand portion, and a new prompt appears in the upper left-hand portion. This is your cue to select a character for editing (see table 1 on page 440).

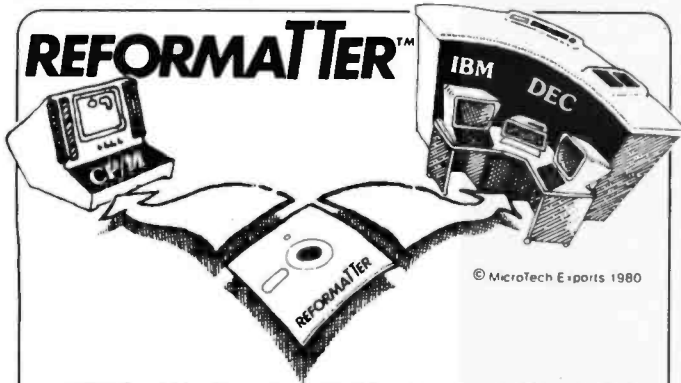
### Character Selection

The prompt at this stage is `ABORT, QUIT, MAKE CHARACTER`. The appropriate replies are `A`, to abort the program and editing (you are asked to confirm this with `Y` or `N`); `Q`, to terminate editing and save the result in the output file; and `M`, to perform character selection and editing.

Once you have typed `M` to make a character, the prompt `' ACCEPTS, UP, DOWN, LEFT, RIGHT` appears accompanied by a flashing cursor that is placed initially in the upper left-hand corner of the character menu. Two methods are used to

*Text continued on page 440*





© MicroTech Exports 1980

# GETS FILES ACROSS!

With **REFORMATTER** disk utilities you can read and write IBM 3740 and DEC RT-11 single density formatted diskettes on your CP/M<sup>®</sup> system.

**REFORMATTER** enables you to access large system databases, improve data exchange with other organizations, increase program development capabilities, and use your micro in distributed processing.

**REFORMATTER** programs feature bi-directional data transfer and full directory manipulation. ASCII/EBCDIC conversion provided with CP/M → IBM. *MP/M II is now fully supported.*

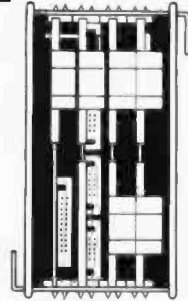
Program Data Sheets, Application Guides, and Machine Compatibility Guides available.

Each program \$249.00 from stock. Specify CP/M ↔ IBM or CP/M ↔ DEC. Order from MicroTech Exports, Inc., 467 Hamilton Ave., Suite 2, Palo Alto, CA 94301 ☐ Tel: 415/324-9114 ☐ TWX: 910-370-7457 MUH-ALTOS ☐ Dealer and OEM discounts available.

CP/M<sup>®</sup> is a registered trademark of Digital Research.

# DEC LSI-11 Components

Dependable service at discount prices  
Domestic and Export



## Mini Computer Suppliers, Inc.

25 Chatham Rd., Summit, N.J. 07901  
Since 1973  
(201) 277-6150 Telex 13-6476

©Mini Computer Suppliers, Inc. 1979

### TERMINALS

★ ADDS ★  
**VIEWPOINT**  
**\$579.00**



**IQ 120**  
**\$689.00**

**82 I.C. MASTER**  
**\$59.95**

CARDS MICROSOFT  
**Z80 \$295.00**  
**16K RAM \$160.00**  
VIDEO TERMINAL 80 column  
**\$295.00**

### COMPUTERS

## ATARI<sup>®</sup> 800™ COMPUTER SYSTEM



400 w/16K \$350.00  
800 w/16K \$699.00  
\*800 Computer w/48K  
\*BEST BUY  
**\$825.00**

### ATARI PERIPHERALS:

Printer B25 - 650.00 Asteroids  
Disk Dr 810 - 485.00 Missile Com → 32.50  
Record 410 - 820.00 Sup Brk Out  
Paddle (pr) > 16.95 Assem Edit - 490.00  
Joystick (pr) Star Raiders - 450.00  
32k RAM - 179.95 Basketball - 280.00  
Basic Cart - 490.00 Chess - 320.00

### COMPONENTS

74LS SERIES		7400 SERIES							
74LS00	34	74LS583	70	74LS165	85	7400	.18	7454	.19
74LS02	24	74LS586	38	74LS169	155	7402	.18	7470	.25
74LS03	24	74LS590	60	74LS170	155	7406	.21	7474	.30
74LS04	24	74LS591	85	74LS174	85	7408	.23	7475	.40
74LS05	24	74LS592	24	74LS175	85	7409	.18	7476	.30
74LS06	30	74LS593	60	74LS190	90	7810	.18	7480	.55
74LS08	28	74LS595	60	74LS191	90	7411	.22	7481	1.00
74LS10	24	74LS597	80	74LS192	110	7412	.28	7489	3.95
74LS11	33	74LS107	38	74LS201	110	7413	.32	7490	.30
74LS12	33	74LS109	38	74LS240	95	7414	.45	7491	.35
74LS13	45	74LS112	40	74LS241	95	7416	.24	7492	.45
74LS14	69	74LS113	40	74LS244	85	7417	.24	7494	.60
74LS15	45	74LS114	45	74LS244	165	7418	.24	7495	.60
74LS20	24	74LS122	40	74LS248	100	7420	.30	74100	.90
74LS21	24	74LS123	85	74LS249	90	7425	.25	74107	.25
74LS26	30	74LS125	90	74LS258	90	7427	.25	74122	.40
74LS27	28	74LS126	85	74LS259	80	7428	.18	74125	.40
74LS28	32	74LS132	70	74LS259	80	7432	.25	74144	2.50
74LS30	24	74LS133	80	74LS258	90	7438	.18	74145	3.50
74LS32	32	74LS138	85	74LS259	125	7440	.18	74145	1.00
74LS37	50	74LS139	85	74LS260	60	7442	.45	74154	1.00
74LS38	32	74LS145	110	74LS273	150	7443	.60	74157	.45
74LS42	50	74LS151	70	74LS275	3.00	7444	.60	74158	.80
74LS48	70	74LS153	70	74LS279	50	7445	.60	74161	.80
74LS51	24	74LS157	70	74LS283	75	7447	.60	74166	.90
74LS55	35	74LS158	70	74LS373	90	7448	.60	74174	.90
74LS74	35	74LS161	85	74LS374	1.50	7451	.18	74181	1.95
74LS75	48	74LS162	85	74LS377	1.40	7453	.18	74393	1.00
74LS76	38	74LS183	85						
74LS78	50	74LS184	85						

DYNAMIC RAMS		74S SERIES					
4027	2.00	8/175**	74500	35	74586	1.10	
4116	200ns	1.75	8/13.00	74502	38	74512	1.45
4164	200ns	9.50		74503	38	74513	1.10

STATIC RAMS		MORE MISC.			
2111	2.85	8/2.50**	8212	1.95	
2112	2.05	8/2.50**	8216	1.80	
2114	2.05	4/14.00	8218	1.95	
2114L	2.00ns	2.25	4/2.00	8218	1.95
HM6116	200ns	11.50	4/10.50**	8218	1.95

MISC.		VOLTAGE REGULATORS	
8728	1.20	7805	7805
8728	1.20	7808	7808
8038	2.75	7812	7812
8080A	3.75	7818	7818
8155	10.50	7905	7905
8255	4.50	7908	7908
MC1350	1.05	7912	7912
MC1350	1.15	7912	7912
MC1358	1.50	7912	7912
MC1458	55	7912	7912
LM339	1.10	7912	7912
LM386	1.40	7912	7912
LM565	.95	7912	7912
LM741	2.1	7912	7912
LM1310	2.90	7912	7912
LM1800	2.95	7912	7912
LM1889	1.45	7912	7912

EPROMS		I.C. SOCKETS			
1702	4.25	8/3.95**	10/5/30	8	10/1/30
2708	2.95	8/2.85**	10/5/10	16	10/1/40
2718(15V)	5.00	8/4.50**	10/5/10	16	10/1/40
TMS2716	8.95	8/8.00**	10/5/10	16	10/1/40
2732(15V)	10.50	8/9.25**	10/5/10	24	10/2/70
TMS2732	11.50	8/10.25**	10/5/10	24	10/2/70
			10/5/10	28	10/3/00
			10/5/10	40	10/3/00

### DISKETTE «SALE»

Wabash:  
5 1/4 → 10  
8inch → \$24.90  
SS/SD - More Avail.  
QTY. PRICE AVAIL

### REAL-TIME CLOCK CALENDAR (MSM 5832)

Driver: Mono Metal Gate CMOS I.C.  
Features:  
- Time, Month, Date, Year, & Day of Week  
- Bus Oriented  
- 4 Bit Data Bus  
- 4 Bit Address  
- R/W Hold Select  
- Inter Signal  
- 32 768kHz steel Control  
- 5v Pwr Supp  
- Low Power Dissipation  
**\$7.45**  
XTAL  
**\$2.85**

### SPECIALS

ZENITH ZVM-121  
17 inch  
15 MHz  
**\$118.50**  
8255 → \$5.95  
8748-B → \$31.00  
3341PC → \$2.00  
MM5060 → 35¢  
MC6800 → \$7.75  
MC6802 → \$14.95  
MC6850 → \$4.50  
MC6821 → \$4.95

### GLOBAL LPK-1:

Logic Probe Kit - complete nothing extra to buy Min. pulse width 300nsec.  
**\$18.95**

ALL SYSTEMS OF INTEREST!!!  
**THE MPD 117**  
turns an ordinary outlet into a controlled power source  
**\$79.50**

### Bare Bones

w/o Keyboard  
w/o Pwr. Supply  
with 48k RAM  
**\$450.**

## APPLE II

### ★ MONITORS ★

ZENITH 1  
12in. 15MHz  
1. Green Phos. Hi-Res. → **\$118.50** ☆  
J.C.S. 2  
12in. 18MHz  
2. Green Phos. Hi-Res. → **\$169.50** ☆  
AMDEK 3  
12in. 12MHz  
3. Green Phos. Hi-Res. → **\$155.50** ☆  
13in. Color 3a  
3a Lo-Res. → **\$375.50** ☆

# CONCORD COMPUTER PRODUCTS

1971 SO. STATE COLLEGE ANAHEIM, CALIF. 92806  
(714) 937-0637  
CHICR - M/O  
NO COD  
10 MIN ORD R. C.A. RES. ADD 6% FRT  
10 20 30 40 50 60 70 80 90 100  
200 240 280 320 360 400 440 480 520 560 600 640 680 720 760 800 840 880 920 960 1000 UP CALL

**\$ SAVE \$**  
**CALL MBC... (203) 342 2747**

**Mainframes**

ONYX C8002	
256K 10 MEG HD	\$14990
" " 20 MEG HD	\$16990
ALTO SYSTEMS	
ACS 8000-2 1 MEG FD	\$2990
ACS 8000-6 14 MEG HD	\$8990
ACS 8000-10 10 MEG HD	\$6895
COMMODORE	
CBM 9000 SUPERPET	\$1699
CBM 8300 LETTER QUALITY	\$1990
CBM 8023 (132COL,150CPS)	\$ 799
CBM 8052 2 MED FD	\$1750



HEWLETT-PACKARD	
HP-87	\$1995
HP-85	\$2190
HP-83	\$1790
HP-125	\$2190
HP CALCULATORS - 20% OFF	\$\$\$
XEROX SYSTEMS	
810 5 1/4 FLOPPY SYS	\$2395
820 B " FLOPPY SYS	\$2990
NORTH STAR	
HRZ-1Q-64K-HD5 SAVE	\$1600 \$\$\$
ADVANTAGE 64K-QD	\$3350
INTERTEC SUPERBRAIN	
64K-DD	\$2975
64K-QD	\$3380

DISKETTS	
SINGLE SIDE (BOX OF 10)	\$24.50
DOUBLE SIDE (BOX OF 10)	\$35.00
CABLES- RS232 M/M 6'	\$17.95
M/F 6'	\$18.95

**Printers**

OLYMPIA ES-100 TYPEWRITER	
WITH_RS-232 PARALLEL IEEE	\$1250
IDS PRISM-80 (200CPS) F/T	\$ 999
PRISM-80 COLOR	\$1350
560G - 132	\$1090
PRISM-132 COLOR F/T	\$1690
CENTRONICS 739-1	
739-3	\$ 675
OKIDATA MICROLINE 82A	\$ 495
MICROLINE 83A	\$ 749
EPSON MX-80, MX80-F/T, MX-100 \$\$\$	
IN STOCK INCLUDING CARDS&CABLES	
ALWAYS COMPETATIVELY PRICED \$\$	
C. ITOH F-10 40CPS	\$1490
DJABLO 630	\$1990
NEC SPINWRITER 7710/7730	\$2590
NEC SPINWRITER 3510/3530	\$1950
NEC SPINWRITER 7720 KSR	\$2890
ANADIX 9500/9501	\$1225

ABOVE ITEMS MAY BE ORDERED BY  
 MAIL OR PHONE. FACTORY SEALED.  
 MANUFACTURERS WARRANTY INCLUDED  
 -----PRICES SUBJECT TO CHANGE-----

**Multi-Business  
 Computer Systems Inc.**

28 MARLBOROUGH STREET  
 PORTLAND, CONN. 06480  
 TWX/TELEX 710-428-6345

Listing 1: The CHEDIT program listing, designed for the Apple II. The program requires 48K bytes of memory, the Language System card, and the Apple Pascal package.

```

($S+)
program MakeGraphicChars;
(version [3], June 21, 1981 by Jerry Sweet)
uses TurtleGraphics; (kindly provided by Apple Computers, Inc.)

const xmin = 0; ymin = 0; xmax = 279; ymax = 191; (screen parameters)
      xboxcorner = 216; yboxcorner = 119; (exploded character box)
      HellFreezesOver = false;
      CharRows = 8; (number of rows of characters)
      TopRow = 6; (top-most row of display)
      CharsPerRow = 16; (number of characters per row)
      xblocksize = 12; yblocksize = 13; ("logical" character block size)
      xbmax = 11; ybmax = 12; (sizes less one)

title = 'Graphic character generator, version [3], 25-Jun-81';

type legalset = set of char;

      onebit = 0..1;
      block = packed array [0..7, 0..7] of onebit;
      cblock = packed array [0..ybmax, 0..xbmax] of onebit;
      charimage = packed array [0..7] of 0..255;
      Charset = packed array [0..127] of charimage;
      Charfile = file of Charset;

      color = (fblack, fwhite); (turtle graphics uses 'black' and 'white')
      ortho = (horizontal, vertical);

var filler : array [color] of cblock; (exploded character 'bits')
    filename, cnum : string;
    icfile, cfile : Charfile;
    selx, sely : integer;

procedure wrxy (x, y : integer);
{ places the turtle at the logical character position (x, y), where
  (0, 0) is the at the top-left corner of the screen }
begin
  if x < 0 then x := 0 else if x > 39 then x := 39;
  if y < 0 then y := 0 else if y > 22 then y := 22;
  pencolor (none); moveto (x * 7, ymax - (y + 1) * 8)
end;

procedure wr (p : string; x, y : integer);
{ writes the prompt p at the logical text position (x, y), unless the
  prompt is null, in which case the screen is cleared from lines x through
  y. }
var i, j : integer;
begin
  if length (p) > 0 then begin wrxy (x, y); wstring (p) end
  else
    for i := 0 to y - x do begin
      wrxy (0, x + i); for j := 1 to 30 do wchar (' ')
    end
end;

procedure wrst (p : string; x, y : integer);
var i : integer;
begin
  wr (p, x, y); for i := length (p) + x to 29 do wchar (' ')
end;

procedure rd (p : string; x, y : integer; var s : string);
{ writes the prompt p at the logical text position (x, y), then
  reads, character-by-character (echoing), and returns s }
const bs = 8; can = 24;
var c : char;
    pn : integer;
    t : string [1];
    stop : Boolean;
begin
  wr (p, x, y); pn := length (p); s := ''; t := '';
  repeat
    read (keyboard, c);
    stop := eoln (keyboard);
    if not stop then begin
      case ord (c) of
        bs : if pn > length (p) then begin
              pn := pn - 1; wr (' ', pn, y);
              delete (s, length (s), 1)
            end;
        can : begin
              wr ('', y, y); wr (p, x, y); pn := length (p); s := ''
            end
      end;
    if (pn < 40) and not (ord (c) in [bs, can]) then begin
      t [1] := c; s := concat (s, t); wr (t, pn, y); pn := pn + 1
    end
  until stop
end;
end;
    
```

Listing 1 continued on page 430

## Presenting a C Compiler for CP/M-86® and IBM® PC-DOS® That Speaks Your Language!

The C86™ Compiler offers the most up-to-date language available, especially designed for CP/M-86™. Special features include the C language pre-processor, externals, statics, data initialization, pointers, arrays, structures, longs and floats.

You can't beat the convenience, dependability and affordability of the C86™ compiler, and with no assembly step required, it's faster than you ever imagined!

The C86™ system includes a linking loader, librarian and a large support library. All library source code is included, so that you may extend or modify the library. You may combine code written in C with code written using ASM-86™.

IBM® personal version available soon.

For more information write or call. Dealer inquiries invited.

‡450 Disk and Documentation. Computer Innovations, Inc.  
 † 25 Documentation only. 75 Pine Street  
 † 20 Overseas Airmail. Lincroft, New Jersey 07738  
 Telephone: (201) 530-0995

C86 is a trademark of Computer Innovations, Inc.; CP/M-86 and ASM-86 are trademarks of Digital Research; IBM and PC-DOS are registered trademarks of International Business Machines, Inc.;

# START YOUR OWN COMPUTER CO.

**HOW TO START YOUR OWN SYSTEMS HOUSE** \$36.  
 7th edition, November 1981

Written by the founder of a successful systems house, this fact-filled 220-page manual covers virtually all aspects of starting and operating a small systems company. It is abundant with useful, real-life samples: contracts, proposals, agreements and a complete business plan are included in full, and may be used immediately by the reader. Proven, field-tested solutions to the many problems facing small turnkey vendors are presented.

**HOW TO BECOME A SUCCESSFUL COMPUTER CONSULTANT** \$28.  
 by Leslie Nelson, 4th revised edition, December 1981

Independent consultants are becoming a vitally important factor in the micro-computer field, filling the gap between the computer vendors and commercial/industrial users. The rewards of the consultant can be high: freedom, more satisfying work and doubled or tripled income. This manual provides comprehensive background information and step-by-step directions for those interested to explore this lucrative field.

**FREE-LANCE SOFTWARE MARKETING** \$30.  
 by B.J. Korites, 3rd edition, June 1980

Writing and selling computer programs as an independent is a business where you can get started quickly, with little capital investment • you can do it full time or part time • the potential profits are almost limitless. This best-seller by Dr. Korites explains how to do it.

**HOW TO START YOUR OWN WORD PROCESSING SERVICE** \$39.50  
 by Leslie Nelson, February 1982

Turn a small investment into a steady, money making business that adds \$10,000, \$50,000 or \$100,000 to your income. Detailed start-up, marketing and operations plans are included.

Send check, money order, VISA, Master Charge or American Express # and exp. date. Publisher pays 4th class shipping. Add \$1.00 per book for UPS shipping (USA only). NJ residents add 5% sales tax. For faster shipment on credit card orders call (201) 783-6940.

**ESSEX PUBLISHING CO.** Dept. 2  
 285 Bloomfield Avenue • Caldwell, N.J. 07006

**ORDER: 1-800-547-2492**  
 IN OREGON CALL  
**SERVICE: 503-479-4150**

**SPECIAL ON APPLE REPAIRS — ALL PRICES PLUS PARTS**

APPLE II \$50 DRIVES \$40 PRINTERS \$100  
 APPLE III \$100 SILENTYPE \$50 PERIPHERAL CARDS \$45

**ATARI** 

400 (16K) \$325  
 800 (16K) \$675

I.D.S.  
 560G Printer \$1049

**EPSON**

MX-80 \$439  
 MX-80FT \$539  
 MX-100 \$699

**OKIDATA**

80 \$389  
 82A \$539  
 83A \$829  
 84 \$1229

**WORD PROCESSOR PACKAGE — WORDSTAR, 80 Column, w/enhanced character set, Z-80 & 16K Card by ALS \$1049**

**MAGNUM SYSTEM — OLIVETTI 121 Printer/Typewriter w/RS 232 or Parallel Interface \$1495**

**TERMS:**  
**SHIPPING:** Add 3% of total transaction for UPS brown (ground) or 5% for UPS blue (air), Parcel Post, or any special arrangements.  
**PAYMENT:** Cashier's checks, certified checks, money orders, and bank wires honored immediately. Wire transfer funds in U.S. National Bank of Oregon, South Grants Pass Branch. Credit RCE, account number 501-981. Add 3% for Visa and Master Charge. Allow 20 days for personal checks to clear.  
**REFUNDS:** 10% restocking charge on all returns or exchanges. No refunds on opened software. Call first.  
**GUARANTEE:** All products with full manufacturer's warranty. Sanyo and Apple warranty available. We have full repair and service facilities for all electronic repairs with HP, Dynascan, Pioneer, Sanyo and Apple trained and certified technicians. For any technical service call them for instant advice or questions right on their benches at (503) 479-4150.  
**REPAIRS:** Out of warranty guarantee: Labor 30 days from date of your receipt, 90 days on parts. Call for details on quality guaranteed discount repair and reconditioning service. We have been repairing electronic equipment for 12 years and love it!

**"A Unique Combination of Quality Products, Competitive Prices, and Service"**

### APPLE HARDWARE

MICRO SCI DISK DRIVES (DIRECT APPLE REPLACEMENT)  
 A-2 DISK DRIVE \$429  
 A-70 \$489  
 A-40 \$369  
 CONTROLLER 3.3 & 3.2 \$79  
 CCS 7710A SERIAL INT \$139  
 CCS 7710D SERIAL INT \$139  
 VIDEX 80 COLUMN \$269  
 VIDEX ENHANCER II \$139  
 LOWER CASE ADAPTOR \$39  
 16K RAM CARD \$149  
 MICROSOFT OR MPC \$139  
 ALS \$139  
 Z-80 CARD (MICROSOFT) \$299  
 MICROMODEM (HAYES) \$289  
 SMART MODEM (HAYES) \$229  
 NOVIATION MODEMS  
 APPLE CAT \$309  
 AUTO CAT \$209  
 CAT \$139  
 IC CAT \$149  
 BIGCOMP MODEM \$139  
 MOUNTAIN CLOCK \$239  
 MOUNTAIN MUSIC SYSTEM \$299  
 MOUNTAIN A/D CONVERTER \$299  
 MOUNTAIN INTROL/X-10 CARD \$169  
 MOUNTAIN C.P.S. \$199  
 RUD 23 KEYPAD \$139  
 SUP-R TERM (80 COLUMN) \$299  
 SUP-R MOD R.F. MODULATOR \$24  
 J10 STICK (I.C.) \$45  
 9" B&W MONITOR (SANYO) \$145  
 12" B&W MONITOR (SANYO) \$189  
 12" GREEN MONITOR (SANYO) \$229  
 12" GREEN MONITOR (ZENITH) \$119  
 13" COLOR MONITOR (SANYO) \$385  
 EPSON CABLE & INTERFACE \$79  
 POWERLINE PROTECTOR \$39

### ATARI HARDWARE

410 PROGRAM RECORDER \$69  
 810 DISK DRIVE \$429  
 820 PRINTER \$249  
 822 PRINTER \$339  
 825 PRINTER \$579  
 830 MODEM \$149  
 850 INTERFACE MODULE \$159  
 853 16K MEMORY EXPANSION \$79

### SOFTWARE

VISICALC (ATARI) \$159  
 BASIC (ATARI) \$49  
 VISICALC \$139  
 VISIOEX \$149  
 VISIPILOT \$129  
 VISITERM \$109  
 VISITREND/PLOT \$189  
 MICROLAB DATA FACTORY \$129  
 D B MASTER (STONEWARE) \$179  
 SUP-R TEXT II \$109  
 WORDSTAR \$349  
 B.P.I. SOFTWARE (earth) \$319  
 STOCKFILE INVENTORY \$269  
 ZORK \$35  
 SARGON CHESS \$29  
 GALAXIAN \$22  
 VERBATIM DISKS \$29  
 MAXELL DISKS \$38

MINIMUM ORDER—\$100.00

MINIMUM SHIPPING CHARGES—\$4.00

PRICES SUBJECT TO CHANGE WITHOUT NOTICE

WRITE FOR CATALOG



**RALSTON-CLEARWATERS ELECTRONICS**

530 N.E. 'E' Street • Grants Pass, Ore. 97526  
 ALL BRAND NAMES ARE REGISTERED TRADE MARKS

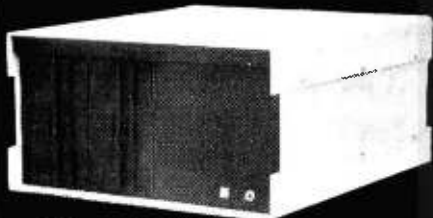


# Main/Frames

# Main/Frames

from  
**\$200**

- 30 Models of Enclosures
- Assembled and tested
- Quasi-Coax Motherboards
- Power Supply
- Card cage and guides
- Fan, line, cord, fuse, power & reset switches



8" Floppy Main/Frame



8" Disc Enclosure



Phase/80 8" Floppy Mainframe



Phase/80 Desk + Mainframe

Write or call for our brochure which includes our application note:

"Building Computers — A Recipe"

## INTEGRAND

8620 Roosevelt Ave. • Visalia, CA 93291  
209/733-9288

We accept BankAmericard/Visa and MasterCard

Listing 1 continued:

```
function rdc (p : string; x, y : integer) : char;
var c : char;
begin
  wr (p, x, y); read (keyboard, c); rdc := c
end;

procedure clrdisp;
begin
  wr ('', 0, 3)
end;

procedure boxlines (angle : ortho; x, y, n, p, LineLength : integer);
{ Draw n + 1 lines at the angle specified, p pixels apart }
var i : integer; {index}
begin
  if angle = horizontal then turnto (0) else turnto (90);
  for i := 1 to n do begin
    pencolor (none); moveto (x, y);
    pencolor (white); move (LineLength);
    if angle = horizontal then y := y + p else x := x + p
  end { for }
end; { boxlines }

procedure Drawcharbox (x, y : integer);
{ This draws the exploded character box (the "pallet") onto the screen }
begin { Drawcharbox }
  boxlines (horizontal, x, y, 9, 9, 63); {9 horizontal lines 9 pixels apart}
  boxlines (vertical, x, y, 8, 9, 72); {8 vertical lines 9 pixels apart}
end; { Drawcharbox }

function keysense : Boolean;
{ Tell me when the user has pressed a key with the Sup-R-Term board }
const clear = -16368; {location to clear keyboard strobe}
      kbd = -16384; {location of keyboard input byte}

function peek (addr : integer) : integer;
type word = packed array [0..1] of 0..255;
      trix = record
        case Boolean of
          false: (ptr: ^word); {pointer to a Pascal word}
          true: (int: integer) {its representation}
        end;
var magic : trix;
begin
  magic.int := addr; {set up the pointer}
  peek := magic.ptr^ [0] {look at what the pointer illuminates}
end;

begin {keysense}
  keysense := peek (kbd) > 128; {data come in as negative ASCII}
end;

function upcase (c : char) : char;
{ Translate the character to upper case }
begin
  if c in ['a'..'z'] then upcase := chr (ord (c) - ord ('a') + ord ('A'))
  else upcase := c
end;

function gc (legal : legalset; prompt : string; echo : Boolean) : char;
{ Read a character from the keyboard until it is legal }
var c : char;
      s : string [1];
begin
  s := ' ';
  repeat
    if echo then c := rdc (prompt, 0, 0) else read (keyboard, c);
    c := upcase (c);
  until c in legal;
  gc := c
end;

procedure nextchar (x, y : integer);
{ Causes the turtle to move to logical text position (x, y). Top left
  corner is (0, 0). }
begin {nextchar}
  pencolor (none);
  if x < 0 then x := 0 else if x > 22 then x := 22; {set x min and max}
  if y < 0 then y := 0 else if y > 13 then y := 13; {set y min and max}
  moveto (x * xblocksize, ymax - (y + 1) * yblocksize + 1)
end; {nextchar}

procedure onbox (c : char);
{ put the turtle at the logical "box" of the character specified }
begin
  nextchar (ord (c) mod CharsPerRow + 3, TopRow + ord (c) div CharsPerRow)
end;

procedure stepchar (c : char);
{ Move the turtle to the next character to be edited }
begin
  onbox (c); turnto (0); move (2); turnto (90); move (2);
end;

procedure drawallchars;
```

Listing 1 continued on page 432

# THE ENCRYPTOR™



## DATA SECURITY

- 5-100 COMPUTERS, IEEE-696 DESIGN.
  - CP/M SOFTWARE ON 8 INCH SINGLE DENSITY DISKETTE AVAILABLE.
  - NATIONAL BUREAU OF STANDARDS ENCRYPTION ALGORITHM.
  - HIGH SPEED A.M.D. 9518 DATA CIPHERING PROCESSOR.
  - 1.3 MEGABYTES PER SECOND THROUGHPUT.
  - 3 ENCRYPTION/DECRYPTION FORMATS.
  - OVER 72 QUADRILLION 56 BIT MASTER KEYS.
  - PLUG SELECTABLE I/O PORT ADDRESSES AND INTERRUPTS.
  - GOLD PLATED FINGERS, CARD EJECTORS AND SOLDER MASK.
  - ASSEMBLED, BURNED-IN AND TESTED.
  - 1 YEAR LIMITED WARRANTY.
  - \$425.00 SINGLE QUANTITY.
- 2% CASH DISCOUNT FOR MONEY ORDERS AND C.O.D.'S.
  - MASTERCARD AND VISA CREDIT CARDS ACCEPTED.
  - SHIPPING CHARGES ADDED TO ALL ORDERS.
  - 6% SALES TAX ADDED TO PENNSYLVANIA DESTINATIONS.
  - PRICES AND SPECIFICATIONS SUBJECT CHANGE WITHOUT NOTICE.
- DEALER AND D.E.M. INQUIRES INVITED.
- TELEPHONE 215-865-1222
  - MONDAY-FRIDAY, 9AM-5PM, EASTERN TIME
- LEHIGH VALLEY LOGIC, INCORPORATED
  - 2503 NORTH COURT
  - BETHLEHEM, PENNSYLVANIA 18017 U.S.A.
- CP/M IS A REGISTERED TRADE MARK OF DIGITAL RESEARCH, INC.

## How to buy a screen editor for your IBM Personal Computer:

1. Find one of CompuView's full-page ads for VEDIT.
2. See if VEDIT can:
  - Simultaneously edit multiple files.
  - Split the screen into as many as 4 windows—horizontally, vertically or both.
  - Scroll each window up-and-down and side-to-side.
  - Move and copy text within and between windows.
  - Globally search or replace using regular expression pattern matching.
  - Give you online help when you need it, at the touch of a button.

(EDIX, the world's finest microcomputer text editor, can do all of this and more!)

3. Send \$195 to us (instead of to them).
4. We'll send EDIX to you.

EDIX requires an IBM Personal Computer with 64K and one floppy. Call or write for our detailed brochure.

**ETC** Emerging Technology Consultants, Inc.  
 Box 154 Louisville, CO 80027  
 (303) 447-9495

EDIX is a trademark of Emerging Technology Consultants, Inc.



# DISCOUNT TRS-80® Computers

We have the Largest Inventory in the Central United States. Discount prices on all software and accessories for your TRS-80 computer needs.

Model II  
26-4002

**\$3288<sup>00</sup>**

8 Megabyte

**Hard Disk**

(Primary)  
26-4150.

**\$3994<sup>00</sup>**

BUY

DIRECT

Toll Free Order:

1-800-835-9056

Kansas Residents:

1-800-362-9091

- ★ No out of state Taxes
- ★ Immediate Shipment
- ★ Several Payment Methods
- ★ Direct Buying

**Jimscot, Inc.**

P.O. Box 607 - 1023 N. Kansas

Liberal, Ks. 67901

**WRITE TODAY FOR YOUR  
FREE CATALOG!**

\* TRS-80 is a Registered Trademark of Tandy Corporation

# Buy with Confidence from the best

GREAT PRICES. GREAT SERVICE. GUARANTEED  
COMPUTERS. PRINTERS. TERMINALS

HP Calculators TOO

CALL TOLL FREE: 1 800 421-1520  
In Calif 213 320-4772

**CALL TOLL FREE FOR PRICES**

**COMPUTERS:**

- Allos
- Apple
- Atari
- Commodore
- Hewlett-Packard
- B M C
- Intertec/Superbrain
- N E C
- Northstar
- Onyx
- Point Four
- Sharp
- Televideo
- Vector

**VIDEO TERMINALS & MONITORS:**

- ADDS
- Amdek
- Ampex
- Apple
- B.M.C
- Hazeltine
- I B M
- Learn-Siegler
- N.E.C.
- Sanyo
- Soroc
- Televideo
- Zenith

Special #1  
Jovon for your  
Apple Use 2 Apple  
paddles & 2 Atari  
paddles  
Reg \$74.95  
Only \$58.95



Special #2  
9 1/2" Sun RS232  
cable  
Only \$18.95

**PRINTERS**

D.C. Hayes  
Modems  
at great prices

**THERMAL**

- Apple
- Trendcom
- DOT MATRIX
- Anacom
- Anadex
- Cenitronix
- Commodore

**LETTER QUALITY**

- Diablo/Xerox
- N E C

Epson 80 Ribbons - \$11.50

**ACCESSORIES**

CP/M  
Fortran  
Pascal  
Vanguard AP/L

**OTHER PRODUCTS**

- Bar Code Readers
- Card Readers
- Game Controls
- Graphics Tablet
- Music System
- Numeric Keyboards
- Programming Aids
- Type-and-Talk
- Video Digitizers
- Voice Entry

The best non-technical  
"How to Choose a Computer  
Book for Laymen." \$12.95  
Complete Directory for  
Apple Software only \$14.95

**PRINTERS - MONITORS**

**MONITORS**

BMC & NEC Green Screen  
NOW IN STOCK

**EDUCATORS**

We have the CORVUS  
systems to hook up several  
Apple computers at once!

**NEC & DIABLO PRINTERS**

Anadex Paper  
Tiger CALL  
for latest prices

NEW  
MX 100 &  
MX 80 F/T

The new 136  
column Epson  
printer with graphics and the  
Friction tractor MX 80 are in  
stock WE HAVE THE GRAPHIC  
PACKAGE FOR Mx 80 call

SILENTYPE PRINTER  
ONLY \$284.00

Computer furniture too

**ACCESSORIES - SOFTWARE**

Call for catalog

- VIRTUAL 33 \$159 Req 399
- BP1 GL INV AR 299 Req 399
- Lotus Freepack by Howardsolt 139 Req 150
- Real Estate Analyzer Howardsolt 125 Req 150
- Creative Financing Howardsolt 125 Req 150
- ASCHI Express II by SDS 55-Req 65

Special #2  
1440 P/S and  
P/S Repro for  
Apple  
Reg \$99.00  
Only \$69.00 each

**CALL TOLL FREE**

1(800)421-1520  
In Cal (213)320-4772

Dysan Disks for Apple only  
\$3.95 Avery mailing labels  
5000 for only \$14.95

20% OFF RETAIL ALL SOFTWARE  
If you don't see it, call us and we'll get it!

Mail orders ONLY:  
NET PROFIT COMPUTERS  
2908 Oregon Court Bld G1  
Torrance Ca 90503  
1(800)421-1520  
In Cal 213 320-4772

2% shipping and 3% for charge cards.

Visit our retail store  
Net Profit Computers  
521 W Chapman Ave  
Anaheim Cal 92802  
714 750-7318

Listing 1 continued:

```
( Crank out the characters in the charset file in a nice format )
var c : char;
    line : integer;

procedure stepback (ic : integer);
{ Moves the turtle to the specified character and back one pixel }
begin
onbox (chr (ic)); turnto (-90); move (1); turnto (180); move (1)
end;

begin (drawallchars)
(reset did an initial 'get' for us)
for c := chr (0) to chr (127) do begin
    stepchar (c);
    drawblock (icfile^ (ord (c)), 1, 0, 0, 7, 8, turtlex, turtley, 10)
end;
close (icfile); {keep it kosher}
stepback ((CharRows - 1) * CharsPerRow); {go to the bottom line}
boxlines (horizontal, turtlex, turtley, CharRows + 1, yblocksize,
    CharsPerRow * xblocksize);
stepback ((CharRows - 1) * CharsPerRow); {put the turtle back}
boxlines (vertical, turtlex, turtley, CharRows + 1, xblocksize,
    CharRows * yblocksize)
end;

procedure Genchar;
{ This procedure does the actual editing }
type cursor = (pallet, menu);
var c : char; {the character for edit}
    x, y : integer; {cursor position}
    bitbox : block; {edit box}
    inc : char; {input character}
    stack : array [0..7] of block; {bitbox stack for saving characters}
    sp, ts : integer; {stack pointers}

procedure clearbits;
{ Initialize the edit parameters }
var i, j : integer;
begin
    x := 0; y := 0;
    for i := 0 to 7 do for j := 0 to 7 do bitbox [i, j] := 0
end;

procedure placechar (c : char);
{ Put the character in the bitbox where it's supposed to go }
begin {placechar}
    stepchar (c);
    drawblock (bitbox, 2, 0, 0, 7, 8, turtlex, turtley, 10);
end; {placechar}

procedure putblock (which : color; x, y : integer);
{ Put a block of the specified color both on the edit screen and
on the current edit character's corresponding position. This also
changes the contents of bitbox }
begin
    if (x in [0..6]) and (y in [0..7]) then begin
        drawblock (filler [which], 1, 0, 0, 8, 8,
            xboxcorner + (x * 9) + 1, yboxcorner + (y * 9) + 1, 10);
        drawblock (filler [which], 1, 0, 0, 1, 1,
            turtlex + x, turtley + y, 10);
        bitbox [y, x] := ord (which)
    end
end;

procedure newchar;
{ Finish the edit }
begin
    placechar (c); {draw the character as it will appear}
    exit (Genchar)
end;

procedure clearchar;
{ Clear the current character }
var i, j : integer;
begin
    clearbits; {reinitialize}
    for i := 0 to 6 do for j := 0 to 7 do putblock (fblack, i, j)
end;

procedure sprychar (c : char);
{ Put the specified character onto the pallet }
var i, j : integer;
begin
    stepchar (c);
    for i := 0 to 6 do for j := 0 to 7 do
        if screenbit (turtlex + i, turtley + j) then putblock (fwhite, i, j)
        else putblock (fblack, i, j)
    end;

procedure flashit (where : cursor; x, y : integer);
{ flash the cursor at the current edit position }
var k : Boolean;
```

Listing 1 continued on page 434



# FILL THE GAPS IN YOUR SYSTEMS' PERFORMANCE

## INTELLIGENT DATA BUFFER

Applications for:

- Printers, Terminals and Data Communications

## AUTO SWITCHER

- Remote Selection of Common Port to One of 4 Destinations

## UTILITY INTERFACE

- Sales Aid
- Instruction Aid
- Demonstration Aid

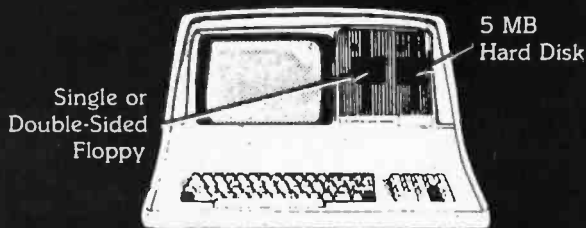
# REITH WALCOTT ENGINEERING INCORPORATED

15074 N.E. 40th St. • Redmond, WA 98052

Order (206) 882-2225

Dealer Inquiries Welcome

# SUPERBRAIN™ 5 MB Plus (K System Five)



Now available INTERTEC'S amazing SUPERBRAIN with a built-in 5MB Hard Disk Storage. The K SYSTEM FIVE looks and operates like a normal SUPERBRAIN but with the advantage of 5 MB of hard disk storage and hard disk speed that are immediately available to the operator.

Kramer Systems International, Inc. has successfully installed COMPUSTAR™ and SUPERBRAINTM Systems worldwide.

Dealer and International inquiries invited.  
Available on the GSA schedule.



**Kramer Systems International, Inc.**  
8403 Dixon Avenue  
Silver Spring, Maryland 20910  
(301) 585-7480

Call today for additional information

## Give Your TRS-80\* a Tremendous Boost with RACET COMPUTES Software

RACET COMPUTES Utility Software makes the TRS faster, more efficient, and easier to use. Our programming aids improve your productivity. Our reputation is for products that are professional in design and work as advertised!!!

### FIELD PROVEN HARD DISK DRIVES AND OPERATING SYSTEM

Now you can use RACET's Hard/Soft Disk Operating System (HSDS) with the ARM Winchester Disk Drive on the Model II. This cost effective combination provides 15 Megabytes per drive including ECC Error Correction Code and an advanced sequencer to further ensure data integrity. An incremental backup to floppy is provided so that only those sectors that were changed from the last backup are saved. A full monthly service contract is available at \$30 per month per drive.

The HSDS Software has more than One Year's FIELD Experience. The latest HSDS version adds several enhancements including maintenance of system files on the hard drive, files as large as the disk, the ability to segment the disk as logical drives, definable directory size, and many utilities including bulk copies between floppy and hard drives, multiple purge, Superzap, and Directory Catalog System. Full program compatibility with TRSDOS 2.0a is maintained. Mixed floppy and hard drive operation is supported.

HSDS is available for the Cameo, Cynthia Bull, Corvus, Data Peripherals, and Santa Clara Systems hard disk systems as well as the ARM Winchester Drive.

ARM 15 Megabyte Drive Subsystem \$3895. HSDS Software \$400.  
Cameo 5/5 Cartridge Drive \$5995. Cynthia Bull 10/10 Drive \$7995

### NEW PRODUCT ★ Model II Fast Backup Utility ★ \$75

5 to 10 times faster backups!!! Full disk backup (including verify) 55 seconds!!! on two drive system — 2:15 on single drive system. In business, time is money, and one BACKUP is worth 1000 tears!!!

### NEW PRODUCT ★ INTEGRATED BUSINESS SYSTEM ★

ISAM File Structure — Multi-Company Capability. Modular structure. Each module includes complete user documentation which guides the user through installation and allows "practice" using a sample data base. When ready, the user simply names his data base and begins. The Integrated Business System program set includes General Ledger, Accounts Receivable, Accounts Payable, Payroll, Inventory, General Journal, Asset Management and more.

Business Programs \$250/module Mod III, \$300/module Mod II, \$795 for all four Mod III, \$995 for all four Mod II. General Ledger and Accounts Receivable available now. Accounts Payable and Payroll 1st Quarter 1982.



1330 N. GLASSELL, SUITE M, ORANGE, CA 92667

CIRCLE READER RESPONSE BELOW FOR FREE CATALOG  
\*TRS-80 IS A REGISTERED TRADEMARK OF TANDY CORPORATION

CHECK, VISA, M/C, C.O. PURCHASE ORDER  
TELEPHONE ORDERS ACCEPTED (714) 997-4950

Circle 457 on inquiry card.

## GET THE MOST FROM YOUR NEC PC-8001 WITH RACET COMPUTES SOFTWARE!!

### RACET NECDOS \$175

RACET NECDOS does more for your PC-8001 than any other DOS. It's faster, more efficient and easier to use. It's loaded with extra features to let you stretch the limits of your system. This advanced operating system works with the ROM NBASIC to give full compatibility with color and other BASIC commands.

**USER FRIENDLY — Emphasizes Integrity.** No MOUNT or REMOVE commands!!! Excellent protection from improper diskette swapping. AGAIN, HELP, FIND and REF commands. File password protection.

**ADVANCED DESIGN.** RACET NECDOS utilizes the computer in the 8031 for most disk I/O functions minimizing memory utilization in the PC-8001. The Dynamic Transient Area (DTA) allows multiple transients to be scatter loaded and relocated in memory simultaneously. This unique capability optimizes use of valuable memory, yet provides an almost limitless growth potential.

**ADVANCED FEATURES.** All DOS functions and commands may be used directly in a BASIC program!!! Special RUN option allows merging of programs, retaining all variables in memory. Fixed block spaced records. AUTO and DO commands. Machine language loads and saves. MATPRINT and MATINPUT to disk. Complete directory. ALL supervisory calls documented and available to the machine language programmer. Superzap utility included.

### CONVERT TRS-80\* PROGRAMS TO RACET NECDOS WITH 'PROTRAN' \$99.95

COMPLETE utilities for file transfer and BASIC program conversion. Model III diskettes may be read directly. Model I and II via RS-232. Transfer BASIC programs, data files, or machine language files. NO support is provided for conversion of machine language files or PEEK's, POKE's, or USR's to function on PC-8001. Includes Mod I, Mod II and RACET NECDOS Datadisk with complete documentation on conversion requirements and syntax differences.

### MULTI-KEY SORT 'MKS' \$60

SUPER FAST Machine Language In-Memory Sorts. Three-key sort on 500 elements in 4 Seconds!!! Simple one-line BASIC functions — SORTV and SORTC verbs. Mixed ascending and descending keys.

### KFS-80 KEYED FILE SYSTEM \$150

Machine language BASIC ISAM utility provides keyed and sequential access to multiple files. Simple interface to BASIC. Binary tree keyed-file index system provides rapid access to records.

RACET COMPUTES software for the NEC is distributed by the Waybern Corporation and is available from your local NEC Dealer.

## Waybern Corporation

13911 Enterprise Dr., Garden Grove, CA 92643  
(714) 554-4520 • (213) 222-7514

CIRCLE READER RESPONSE BELOW FOR FREE CATALOG

RACET COMPUTES

Circle 458 on Inquiry card.

BYTE May 1982 433

## FOR TRS-80 MODEL I OR III AND SOON FOR THE NEW IBM PERSONAL COMPUTER!

### ★ MORE SPEED

10-20 times faster than Level II BASIC.

### ★ MORE ROOM

Very compact compiled code plus VIRTUAL MEMORY makes your RAM act larger. Variable number of block buffers. 31-char-unique word-names use only 4 bytes in header!

### ★ MORE INSTRUCTIONS

Add YOUR commands to its 79-STANDARD-plus instruction set!  
Far more complete than most Forths: single & double precision, arrays, string-handling, clock, more.

### ★ MORE EASE

Excellent full-screen Editor, structured & modular programming  
Word search utility  
THE NOTEPAD letter writer  
Optimized for your TRS-80 or IBM with keyboard repeats, upper/lower case display driver, full ASCII, single- & double-width graphics, etc.

### ★ MORE POWER

Forth operating system  
Interpreter AND compiler  
8080 or 8086 Assembler  
(Z80 Assembler also available for TRS-80)  
Intermix 35- to 80-track disk drives  
Model III and IBM can read, write and run each other's and Model I diskettes!  
VIRTUAL I/O for video and printer, disk and tape (10-Megabyte hard disk available)

# MMS FORTH

## THE PROFESSIONAL FORTH FOR TRS-80

(Thousands of systems in use)

MMSFORTH Disk System V2.0 (requires 1 disk drive, 32K RAM) For Radio Shack TRS-80 Model I or III ... \$128.95  
For IBM Personal Computer (advance order) ... \$248.95

## AND MMS GIVES IT PROFESSIONAL SUPPORT

Source code provided  
MMSFORTH Newsletter  
Many demo programs aboard  
MMSFORTH User Groups  
Inexpensive upgrades to latest version  
Programming staff can provide advice, modifications and custom programs, to fit YOUR needs.

MMSFORTH UTILITIES DISKETTE: includes FLOATING POINT MATH (L2 BASIC ROM routines plus Complex numbers, Rectangular-Polar coordinate conversion, Degrees mode, more), plus a full Forth-style Z80 ASSEMBLER; plus a powerful CROSS-REFERENCER to list Forth words by block and line. All on one diskette (requires MMSFORTH V2.0, 1 drive & 32K RAM) ... \$39.95\*

FORTHCOM: communications package provides RS-232 driver, dumb terminal mode, transfer of FORTH blocks, and host mode to operate a remote TRS-80 (requires MMSFORTH V2.0, 1 drive & 32K RAM) ... \$39.95\*

THE DATAHANDLER V1.2: a very sophisticated database management system operable by non-programmers (requires MMSFORTH V2.0, 1 drive & 32K RAM) ... \$59.95\*

MMSFORTH GAMES DISKETTE: real-time graphics & board games w/source code, includes BREAK-FORTH, CRASH-FORTH, CRYPTOQUOTE, FREEWAY, OTHELLO & TICTAC-FORTH (requires MMSFORTH V2.0, 1 drive & 32K RAM) ... \$39.95\*

Other MMSFORTH products under development

## FORTH BOOKS AVAILABLE

MMSFORTH USERS MANUAL - without Appendices, for non-owners ... \$17.50\*

STARTING FORTH - best companion to our manual ... \$16.95\*

THREADED INTERPRETIVE LANGUAGES - advanced, excellent analysis of MMSFORTH-like language. ... \$18.95\*

PROGRAM DESIGN & CONSTRUCTION - intro. to structured programming, good for Forth ... \$13.95\*

FORTH -79 STANDARD MANUAL - official reference to 79-STANDARD word set, etc ... \$13.95\*

FORTH SPECIAL ISSUE, BYTE Magazine (Aug. 1980) - we stock this collector's item for Forth users and beginners ... \$4.00\*

\* - ORDERING INFORMATION: Software prices include manuals and require signing of a non-transferrable single system, single-user license. Describe your Hardware. Add \$2.00 S/H plus \$3.00 per MMSFORTH and \$1.00 per additional book; Mass. Orders add 5% tax. Foreign orders add 20%. UPS COD, VISA & M/C accepted; no unpaid purchase orders, please.

Send SASE for free MMSFORTH information  
Good dealers sought

Get MMSFORTH products from your  
computer dealer or

**MILLER MICROCOMPUTER  
SERVICES (B5)**

61 Lake Shore Road, Natick, MA 01760  
(617) 653-8138

Listing 1 continued:

```
procedure delay (var k : Boolean);
( insert a delay between flashes )
var i : integer;
begin
  i := 100;
  while (not k) and (i > 0) do begin i := i - 1; k := keysense end;
end;
```

```
procedure dopallet;
var original : onebit;
    origscr : Boolean;
```

```
procedure putdot (on : Boolean; x, y : integer);
( also flash the corresponding pixel in the edit character )
var fcolor : color;
begin
  if on then fcolor := fwhite else fcolor := fblack;
  drawblock (filler [fcolor], 1, 0, 0, 1, 1,
    turtlex + x, turtley + y, 10)
end;
```

```
begin {dopallet}
  original := bitbox [y, x];
  origscr := screenbit (turtlex + x, turtley + y);
  while not k do begin
    putblock (fwhite, x, y); putdot (true, x, y); delay (k);
    putblock (fblack, x, y); putdot (false, x, y); delay (k)
  end;
  if original = 1 then putblock (fwhite, x, y)
  else putblock (fblack, x, y);
  putdot (origscr, x, y)
end;
```

```
procedure domenu;
var reversed : Boolean;
```

```
procedure xor;
begin
  drawblock (filler [fwhite], 2 * ((xblocksize + 15) div 16), 0, 0,
    xblocksize, yblocksize - 1, turtlex, turtley, 6)
end;
```

```
begin {domenu}
  onbox (chr (y * CharPerRow + x));
  reversed := false;
  while not k do begin
    xor; delay (k); reversed := not reversed;
  end;
  if reversed then xor
end;
```

```
begin {flashit}
  k := false;
  case where of
    pallet : dopallet;
    menu : domenu
  end; {case}
end;
```

```
procedure push;
( save the current bitbox on the stack )
begin
  stack [sp] := bitbox;
  sp := (sp + 1) mod 8
end;
```

```
procedure pop;
( restore the bitbox from the top of stack )
begin
  sp := sp - 1; if sp = -1 then sp := 7;
  bitbox := stack [sp];
  stepchar (c);
  drawblock (bitbox, 2, 0, 0, 7, 8, turtlex, turtley, 10);
  spraychar (c)
end;
```

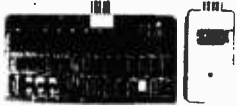
```
procedure shift;
( shift the character up, down, left, or right )
var x, y : integer;
```

```
procedure shiftup;
begin
  for y := 7 downto 1 do for x := 0 to 6 do
    bitbox [y, x] := bitbox [y - 1, x];
  for x := 0 to 6 do bitbox [0, x] := 0
end;
```

```
procedure shiftdown;
begin
  for y := 0 to 6 do for x := 0 to 6 do
    bitbox [y, x] := bitbox [y + 1, x];
  for x := 0 to 6 do bitbox [7, x] := 0
end;
```

Listing 1 continued on page 436

**S100 EPROM PROGRAMMER/16K MEMORY MODULE**



- Programs, copies or verifies the most popular 5 volt EPROMS (2758, 2516, 2716, 2532, & 2732) • Adjustable 25 volt on board supply.

- External programming console - Includes 24-pin ZIF socket • Sockets also included for up to 8 memory chips (2716/2732 EPROMS or 2K X 8 NMOS Static RAMS) • Memory addressable in 4K/2K windows • Memory management - 4 memory chips may be independently enabled/disabled under program control • 8-bit I/O port w/handshake • Software - CP/M version on 8" disk, PET 2001 (requires S100 adapter) on cassette.

**S100 PROTOTYPE MODULE**



- Unique prototype module takes up only one computer slot • Uses low cost W/W posts, and if desired, solder tail sockets.

- Wiring & components are on the same side • Provisions for 3 voltage regulators - 5 volt regulator may be TO-3 or TO-220 case • Any size integrated circuit on .300, .400, or .600 centers may be used • Typical configurations - 36 16/14-pin IC's, or 4 40-pin & 28 16/14-pin IC's, or 1 40-pin & 4 24-pin & 14 20-pin & 14 16/14-pin IC's, etc. • Also has provisions for: toggle switch, trimpot, & 2 50-pin ribbon cable headers • Power & ground traces to each IC position • Ample de-coupling provisions.

**PRICES**

Prog/Mem Mod. \$195(kit)\$240(A&T)	Prototype (Pins) .....	\$35/M
EPROMS:2Kx8 (5V) . \$8.00(450NS)**	Software: CP/M version	
4Kx8 (5V) . . . \$16.00 (450NS)**	(8" diskette) .....	\$15.00
RAMS 2Kx8 (5V) . \$11.50 (150NS)**	PET (specify ROMS) .....	\$8.00
Prototype (Board) . . . . . \$35.00	Shipping & handling .....	\$2.00

CALIFORNIA RES. ADD 6% SALES TAX.  
 PAYMENT: MONEY ORDER OR CHECK (ALLOW 10 DAYS TO CLEAR)  
 \*\*WITH PURCHASE OF PROGRAMMING BOARD

**SIERRA COMPUTER PRODUCTS**

3645 Gold Ridge Trail, Pollock Pines, CA 95726/(916)644-5932

**EPISODE™**  
**THE**  
**VERSATILE**  
**COMPUTER**



**JUST ADD PERIPHERALS**

EPISODE is a CP/M® computer with 1.6 M byte of disk storage on dual 5¼ floppies. Its compact design provides a wide range of standalone or network applications including data base sharing.

EPISODE includes a unique software system called SUPERVYZ™ - a menu based software control system that allows the user to integrate application programs.

EPISODE gives you total flexibility. You can add your own CRT and Printer, whatever brand and price range you choose. All the logic including the 64K RAM memory is contained on a single 6" x 8" circuit board ensuring maximum reliability.

Dealer inquiries invited, foreign and domestic.

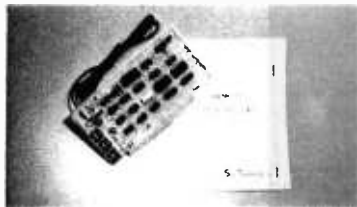


Epic Computer Corporation  
 7542 Trade Street  
 San Diego, CA 92121  
 Tel: 714-695-3560

\*Supervyz is a trademark of Epic Computer Corporation. CP/M is a trademark of Digital Research.

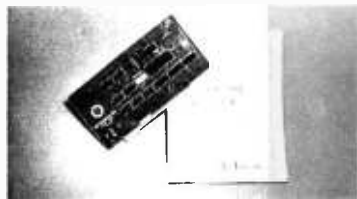
**S-100 INNOVATORS:**

**C  
I  
T  
R  
O  
N  
I  
C  
S  
I  
N  
C.**



**REMOTE CONTROLLER—Innovative Features:**

- \* Complete 256 address control—not just 16
- \* No ultrasonic link—prevents erratic operation
- \* 120,208,240 and 277VAC control—for single & 3 phase operation
- \* Hardware driven—requires minimal software
- \* Complete line of industrial switches available—to 5.5KW



**REAL TIME CLOCK—Innovative Features:**

- \* First to use LSI OKI clock chip
- \* Crystal controlled for .002% accuracy
- \* 4 software selectable clock generated interrupts
- \* Full clock and calendar data
- \* Lithium battery backup good for 6000 hours!



**ENERGY WATTCHER™—Innovative Features:**

- \* First microcomputer based energy monitor
- \* Clip on probes for easy installation
- \* Monitors **Real Power**, not volt-amps
- \* Peak Power and continuous power readings
- \* Single and 3 phase operation

See your local computer dealer or contact SciTronics directly for more information. Watch for future innovative products from SciTronics Inc., 523 So. Clewell St., P.O. Box 5344, Bethlehem, PA 18015 (215) 868-7220



# Fancy Shmancy

Elaborate microprocessor development systems cost a lot of money, and they can close off your engineering options by locking you into just one or two kinds of chips. Sound familiar? Well, read on—we've got a better idea.

Use your desktop computer; anything that will run CP/M<sup>®</sup> is fine. With our microprocessor cross-assemblers you can produce software for eleven of the most popular chip families, and more are on the way.

In two years on the market, our cross-assemblers have gained a reputation for quality, performance, and reliability. Hundreds of Industrial R&D labs and several major semiconductor houses have found these products a fast, cost-effective way to develop their microprocessor software. We invite you to join them.

## CP/M CROSS-ASSEMBLERS

Extremely fast absolute assemblers, running under CP/M. Generate object file (Intel hex or Motorola S-record format) and listing from standard assembly language for the target processors listed. Features include comprehensive syntax checking, listing control, nested conditional assembly, and insertion of external source files. All versions listed have been thoroughly field-tested and are available now.

	XASM05	.....	6805
	XASM09	.....	6809
	XASM18	.....	1802
	XASM48	.....	8048/41
	XASM51	.....	8051
	XASM85	.....	8502
	XASM88	.....	8800/01
NEW!	XASM75	.....	NEC 7500
	XASMF8	.....	F8/3870
NEW!	XASMZ8	.....	Z8
	XASM400	....	COP400

Assemblers ..... \$200.00 each  
except XASM75 ..... \$500.00

Visa and Mastercard accepted. We ship on 8" single-density and Softcard + 5.25" diskettes. Ask us about other formats. OEM INQUIRIES INVITED.

\*Trademark of Digital Research  
+ Trademark of Microsoft



804 S. STATE ST., DEPT. BY52  
DOVER, DEL. 19901  
302-734-0151

Listing 1 continued:

```

procedure shiftleft;
begin
  for x := 0 to 5 do for y := 0 to 7 do
    bitbox [y, x] := bitbox [y, x + 1];
  for y := 0 to 7 do bitbox [y, 6] := 0
end;

procedure shiftright;
begin
  for x := 6 downto 1 do for y := 0 to 7 do
    bitbox [y, x] := bitbox [y, x - 1];
  for y := 0 to 7 do bitbox [y, 0] := 0
end;

begin (shift)
  wrst ('Shift character', 0, 4);
  case gc ('U', 'D', 'L', 'R', '2', '4', '6', '8'), '', false) of
    'U', '8' : shiftup;
    'D', '2' : shiftdown;
    'L', '4' : shiftleft;
    'R', '6' : shiftright
  end; (case)
  placechar (c); spraychar (c)
end;

procedure invert;
( invert the entire character )
var x, y : integer;
begin
  for y := 0 to 7 do for x := 0 to 6 do
    bitbox [y, x] := 1 - bitbox [y, x];
  placechar (c); spraychar (c)
end;

function select : char;
( select a character for editing )
var comm : char;
begin
  clrdisp;
  wr ('''.' accepts', 0, 0);
  wr ('Up,Down,Left,Right', 0, 1);
  repeat
    flashit (menu, selx, sely);
    read (keyboard, comm);
    case upcase (comm) of
      'U', '8' : if sely - 1 in [0..CharRows - 1] then sely := sely - 1;
      'D', '2' : if sely + 1 in [0..CharRows - 1] then sely := sely + 1;
      'L', '4' : if selx - 1 in [0..CharsPerRow - 1] then selx := selx - 1;
      'R', '6' : if selx + 1 in [0..CharsPerRow - 1] then selx := selx + 1;
      '.', '5' : begin
        select := chr (sely * CharsPerRow + selx);
        exit (select)
      end
    end; (case)
  until HellFreezesOver
end;

procedure getchar;
( Duplicate another character for editing )
var sc : char;
begin
  wrst ('Get character', 0, 4);
  sc := select; (select the character)
  push; (push the old character)
  spraychar (sc); (put the new character onto the pallet)
  placechar (c) (put it into the edit position)
end;

procedure PromptState;
begin
  wrst ('Edit character', 0, 4);
  stepchar (c)
end;

procedure PromptEdit;
begin
  clrdisp;
  wr ('New,Clear,Pop,Invert,Get', 0, 0);
  wr ('[Shift] Up,Down,Left,Right', 0, 1);
  wr ('''.' (set),'' '' (clear)', 0, 2);
  PromptState
end;

procedure setup;
begin
  clearbits; sp := 0;
  spraychar (c); (put the selected character onto the pallet)
  for ts := 0 to 7 do push; (fill stack with original character)
  PromptEdit
end;

begin ( Genchar )
  wrst ('Select character for edit', 0, 4);
  c := select; (select character for edit)

```

Listing 1 continued on page 438

### MODEM HEADQUARTERS

Connect any computer or terminal to the phone lines!

1200 Baud — 120 Characters per Second

Penril 300/1200 ..... \$739

Bell 212A identical. Full duplex, RS232. 1200 and 300 Baud. Originate/auto-answer. Phone connection via RJ11C standard phone jack. One year warranty. Self-test. Fits under phone.

300/1200 Auto-Dialer ..... \$225

Allows any computer to automatically dial out through the Penril 300/1200.

300 Baud — 30 Characters per Second

Phone Link Acoustic Modem ..... \$129

Originate and Answer. Half/Full duplex. RS232. Operates with any standard telephone. Indicators for On, Carrier, Self-test, Send Data, Receive Data. One year warranty.

Micro-link ..... \$179

Originate/Auto-Answer, Half/Full duplex. RS232. Phone connection via RJ11C standard phone jack. Indicators for On, Carrier Detect, Self-test, Send Data, Receive Data. Two year warranty. Fits under phone.

ADDS Viewpoint CRT ..... \$529

GE2120 Printing Terminal ..... \$1,799

150 CPS. 300/1200 Baud.

GE2030 Printing Terminal ..... \$999

60 CPS. 300/1200 Baud.

All equipment is in stock. Your satisfaction guaranteed. Any product may be returned for full credit. Write or call for full product information.



U.S. ROBOTICS INC.

203 N. WABASH  
SUITE 1718  
CHICAGO, ILL 60601  
(312) 346 5650

### CATCH THE S-100 INC. BUS!



### ODDS & ENDS

	LIST PRICE	OUR SPECIAL CASH PRICE
Mullen TB-4 Extender card w/logic probe - kit	59.00	49.00
Shugart SA801 bare drive 8"		399.00
3M Scotch 740-0 8" diskettes — 10 box		26.00
SSM I/O-4 2P+2S Ports Kit	210.00	168.00
Morrow Designs 8 Slot Motherboard A&T	124.00	93.00
Hayes Computer "Stack" Smart Modem A&T	279.00	237.00
All S.D. Systems Kits (call for available items)		30% OFF

Subject to Available Quantities • Prices Quoted Include Cash Discounts. Shipping & Insurance Extra.

We carry all major lines such as S.D. Systems, Cromemco, Ithaca Intersystems, North Star, Sanyo, ECT, TEL, Godbout, Thinker Toys, SSM. For a special cash price, telephone us.

### S-100, inc.

14425 North 79th Street, Suite B  
Scottsdale, Arizona 85260  
SALES 800-528-3138 • TECHNICAL 602-991-7870

### Best Price • Good Quality • Swift Delivery • Export

Computer Channel

	COMPUTER	
LNW 80	Graphic Computer	\$
	I 48K	1,400
	II CP/M	2,300
CROMEMCO	28% off System & software	
	15% off boards & components	
CS1	5 1/4" Floppy	2,956
Z2H	hard disk system	7,396
CS3	64K, 8"	5,916
Zenith	Z 90-80 new,	
	64K	2,290
	Z 90-82 64K,	
	1 SS, DD	2,490
	Z 89 48K,	
	1 floppy	2,095
SWTPC	S/O9 128K,	
	8809	3,450
	89/K kit, 6809,	
	8K	860
	68/09 48K,	
	8809	1,500
	/09 64K	1,835
ATARI	400 16K	340
	800 16K	695
NORTH STAR	HORIZON, 2	
	quad drive, 64K	3,200
	ADVANTAGE, 2	
	quad drive, 64K	3,100
TI	99/4 16-bit	399
DYNABYTE	5200 64K,	
	1 MB	3,300
	5615 64K,	
	11 MB hard disk	8,000
TERAK	8510A Graphic,	
	320 x 240, DD	8,000
	8600 Graphic,	
	640 x 480,	
	Color, DD	17,000
XEROX 820	I 5 1/4"	2,399
	II 8"	2,995
NEC	CP/M, 32K	799
DEC, ADDS, ALTOS		\$CALL

	TERMINAL	
ZENITH	Z 19	635
ZENTEC	Zephyr	1,050
TELEVIDEO	912C	705
BEEHIVE, ESPRIT, HAZELTINE		\$CALL

	MONITOR	
ZENITH	ZVM121 12"	\$
	8/W	119
NEC	12" green	170
	12" color	340
SANYO	13" color	445
	RGB monitor	950

	PRINTER (G-w/graphic feature)	
	Integral Data System	\$
PRISM 80	150 cps	720
	84 x 84 G	785
	color G	1,099
PRISM 132	14 5/8"	1,050
	color G	1,497
MALIBU	200 letter quality/	
	165 cps G	2,380
PRINTEK	910 144 x 144,	
	200 cps G	\$CALL
	920 144 x 144,	
	340 cps G	\$CALL
EPSON	MX70 G	305
	MX80	4
	MX100	735
ZENITH	Z25 150 cps	1,250
	WH14 75 cps	400
C.I.TOH	Starwriter	
	40c serial	1,350
	45c parallel	1,550
	25c Serial	1,450
	COMET I	350
	DS 180	1,299
DATA SOUTH	Printer Cable	below \$ 30

	DIGITIZER/PLOTTER	
	HOUSTON INSTRUMENT	
	HI PAD DIGITIZER DT-11 11" x 11"	725
	OT-11A w/APPLE interface	750
	HI PLOT DMP-2 8 1/2" x 11"	975
	COM PLOT DP-11 4000 steps/sec	4,000
	B411A PRINTER/PLOTTER	5,200

	SOFTWARE	
	database	\$
	dBASE II Ashton-Tate	575
	CONDOR I	250
	II	450
	III	850
	financial (AR, AP, Inventory etc.)	
	Accounting Plus	450
	Peachtree	500
	other	
	VISICALC	150
	MICROSOFT softcard	330
	FORTRAN 80	345
	BASIC 80	285
	BASIC Compiler	310
	SUPERCALC Sorcim	250
	Micro Pro WORDSTAR	295
	MAILMERG	105
	SUPERSORT I	185
	CP/M 2.2 Digital Research	130

	COMPUTER SYSTEM & TECHNOLOGY, INC.	
ZBOASEM	Z80 Macro Assembler	130
Z80BUG	Z80 Symbolic Debugger	130
68ASEM	6800 Cross Assembler	200
68BUG	6800 Debugger & board	350

	DISK DRIVES	
	Micropolis, Tandon	\$CALL

Prices subject to change. Visa/Mastercard add 3%. F.O.B. point of shipment. 20% restocking fee for returned merchandise. Personal checks take 3 weeks to clear. COD on certified check only. N.Y. residents add sales tax.

CALL (212) 937-6363  
free consultation, catalogue

CABLE: COMSYSTEC NEW YORK  
TELE: 429418 CSTNY  
21-55 44th Road  
L.I.C., NY 11101

\*special

# XAVAX Ada™ Now 68000

## XAVAX One/32KB \$1,500

- 68000 8MHz single board computer
- Multibus™/IEEE 796 compatible
- 2 RS232C, 2 parallel ports
- Sockets for 64KB ROM
- Motorola KDM module compatible
- 128KB RAM on board, add....(\$500)
- Manual of boards, chips.....(\$15)

## XAVAX Two \$8,500

- 68000 8MHz Multibus™ computer
- 256KB RAM expandible to 1MB
- 10MB Winchester, 960KB floppy
- One parallel, 2 RS232C ports
- Graphics display monitor
- Multitasking operating system
- Editor, filer, linker, utilities
- Language: (Pascal, C, COBOL, FORTRAN, BASIC, or Assembler)
- UNIX/7 and APL are options.
- Manual with OS summary.....(\$15)
- Operating system manual.....(\$25)
- System manuals set [7].....(\$85)

## XAVAX Two/3 \$10,850

- Multibus™/IEEE 796 bus, 3 users
- /6 includes 512KB RAM, 6 users
- /6 adds 3 RS232C ports [5 total]

## XAVAX Two/6 \$12,850

## XAVAX Three \$12,850

- XAVAX Two features, plus:
- Second 68000 processor
- Memory management on board
- Ada™ and Pascal with OS... (\$5000)
- Initial XAVAX Two/3, add... (\$2350)
- Initial XAVAX Two/6, add... (\$4350)

## XAVAX 10 Cartridge Backup \$5,000

- 10MB high speed mini-Winchester
- 7MB integrated backup [3 min.]
- Multibus™ controller [32KB RAM]
- 960KB floppy [in main cabinet]
- Interface to XAVAX Two, Three.

## HARDWARE [Multibus™]

- 880 Kilobaud I/O controller \$1,500
- 8 channel RS232C
- Bisync and ASCII asynchronous
- CRC generate, detect, check
- ports individually programmable
- 8 channel RS232C I/O board \$300
- 8 channel intelligent RS232C \$580
- 4 channel parallel board \$400
- ANSI Winchester controller \$500
- 512KB RAM [parity, 270ns] \$1,700
- 256KB RAM [half populated] \$1,500

## SOFTWARE

- BizBooks™ [80 modules] \$4,500
- Accounting, inventory control
- BizGraf™ [8 colors] \$2,500
- Business color graphs, plots.

MasterCard and VISA accepted.

Ask your distributor for XAVAX.

- ™ UNIX trademark of Bell Laboratories.
- ™ Multibus trademark of Intel Corporation.
- ™ Ada trademark Department of Defense.

(319) 344-0550

**XAVAX CORPORATION**  
300 Northwest Tower  
Bettendorf, IA 52722

TWX:  
910-525-1177

Cable:  
XAVAXCORP

## Listing 1 continued:

```

setup;          (set up the pallet)
repeat
  flashit (pallet, x, y); (flash the cursor at the current position)
  read (keyboard, inc);   (read the character just typed)
  case upcase (inc) of   (convert to upper case and select action)
    'N' : newchar;          (accept and exit)
    'C' : begin push; clearchar end; (clear pallet)
    'U', 'B' : if y + 1 in [0..7] then y := y + 1; (move cursor up)
    'D', '2' : if y - 1 in [0..7] then y := y - 1; (move cursor down)
    'L', '4' : if x - 1 in [0..6] then x := x - 1; (move cursor left)
    'R', '6' : if x + 1 in [0..6] then x := x + 1; (move cursor right)
    'S' : pop; (pop char from stack)
    'P' : begin shift; PromptState end; (shift char)
    'I' : invert; (invert char)
    'G' : begin getchar; PromptEdit end; (retrieve another char)
    '.', '5' : putblock (fwhite, x, y); (white space)
    ' ', '0' : putblock (fblack, x, y) (black space)
  end; (case)
until HellFreezesOver.
end; ( Genchar )

procedure gather;
( get all the edited characters into their output configurations )
const msg = 'writing out';
var i, x, y : integer;
    cval : charimage;
    bitshift : array [0..6] of integer;
    dotcount : integer;

procedure writedot (i : integer);
begin
  if i mod CharsPerRow = 0 then begin
    wr ('.', length (msg) + dotcount, 0);
    dotcount := dotcount + 1
  end
end;

begin
  wr ('', 0, 3); wr (msg, 0, 0);
  bitshift [0] := 1; bitshift [1] := 2;
  bitshift [2] := 4; bitshift [3] := 8;
  bitshift [4] := 16; bitshift [5] := 32;
  bitshift [6] := 64; dotcount := 0;
  for i := 0 to 127 do begin
    stepchar (chr (i));
    for y := 0 to 7 do begin
      cval [y] := 0;
      for x := 0 to 6 do
        if screenbit (turtlex + x, turtley + y) then
          cval [y] := cval [y] + bitshift [x];
    end; (for)
    cfile^ [i] := cval;
    writedot (i)
  end (for)
end;

procedure getfiles;
( Get input and output file names and open them )
var sysio : integer;
begin
  repeat
    wr ('', 0, 0); rd ('Input file: ', 0, 0, filename);
    if length (filename) = 0 then exit (program);
    ($I-) reset (icfile, filename); ($I+)
    sysio := ioreult;
    if sysio <> 0 then wr (concat ('?Cannot open ', filename), 0, 1);
    until sysio = 0;
    repeat
      wr ('', 1, 1); rd ('Output file: ', 0, 1, filename);
      if length (filename) = 0 then exit (program);
      ($I-) rewrite (cfile, filename); ($I+)
      sysio := ioreult;
      if sysio <> 0 then wr (concat ('?Cannot open ', filename), 0, 2);
      until sysio = 0;
    end;
  end;

procedure initialize;
begin
  Initturtle;
  fillscreen (black);
  fillchar (filler [fwhite], sizeof (cblock), 255);
  fillchar (filler [fblack], sizeof (cblock), 0);
  getfiles; fillscreen (black);
  drawcharbox (xboxcorner, yboxcorner); drawallchars;
  selx := 0; sely := 0; (initialize character selection coordinates)
end;

procedure shutdown;
( Get the edited characters and output the charset file )
begin
  gather;
  put (cfile);
  close (cfile, lock);
  clrdisp; wr (concat ('[', filename, ' made!'], 0, 1);
  if gc ([ 'Y', 'N'], 'new edit? ', true) = 'N' then exit (program);

```

Listing 1 continued on page 440



**DYMARC**  
INDUSTRIES, INC.



**LINE VOLTAGE  
TRANSIENT SUPPRESSORS**  
Features Parallel Operation 5000 Hits/Second

**Clipstrip™ AND Clipper™**

**PROTECTS:**

- Computers
- Micro-Computer Systems
- Word Processors
- Cash Registers
- Power Supplies

**PROTECTS AGAINST:**

- High Energy Voltage Transients
- On-Off Switching
- Lightning Induced Transients.
- Inrush of On/Off Power

**DYMARC**  
INDUSTRIES, INC.  
DEALER INQUIRIES INVITED

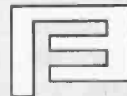
Clipstrip 977E LISTED      Clipper 678F LISTED

7133 Rutherford Rd. Baltimore, Md. 21207  
(301) 298-3130      800-638-9098

# Computer Based PROM Programming

Interface your S-100 Bus Computer with our PPS-100 MULTI-PROM Programmer.

- Disk storage of data/ no master PROMS required
- Clear English commands
- Programs up to 8 EPROMS simultaneously- each with different data
- \$1500



**FRYE  
ELECTRONICS,  
INC.®**

9826 SW TIGARD ST.  
TIGARD, OR. 97223  
(503-620-2722)

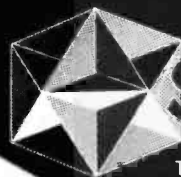
# What's Good for the Space Shuttle is good for your Apple II! . . .



**MICROWARE** creator of OS-9/BASIC Ø9 (used by N.A.S.A., and leading Universities, government agencies, and corporations Worldwide) joins with **STELLATION TWO** to deliver the same Operating system and Programming Language to the APPLE II.

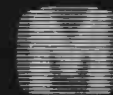
OS-9/BASIC Ø9 are the result of a 3 year research project-designed with the 6809 in mind. This "Operators dream machine" combines with THE MILL microprocessor board to provide Apple II users with software features previously reserved for Mainframes and mini's.  
**JUST PLUG IN THE MILL AND LET BASIC Ø9 WORK FOR YOU!** other Stellation Two products include:

- Spooler: Allows Apple II to print while processing
- Pascal Speedup: THE MILL with software for a 50% faster Apple with Pascal
- Floating Point: Extends the MILL's power to floating point numbers.



**STELLATION  
TWO**

The Lobero Building P.O. Box 2342  
Santa Barbara, Ca, 93120  
(805) 966-1140 TELEX 658439



**MICROWARE®**

OS-9 is a trademark of Microware, BASIC Ø9 is a trademark of Microware and Motorola.

Apple II is a trademark of Apple computers.

# MTI stocks 'em all for faster delivery.

Ask about our "QED" discounts.  
VISA and MasterCard orders accepted.

VIDEO TERMINALS	MTI Price
VT 100 DECscope	\$ 1595
VT 18X Computing option	2400
VT 101 DECscope	1215
VT 131 DECscope	1785
VT 132 DECscope	1995
ADM 3A (dumb terminal)	595
ADM 5 (dumb with visual attributes)	645
ADM 31 (two page buffer)	1095
ADM 21, 24, 32, 36, 42	*
Hazeltine Esprit	645
Hazeltine Executive 80 Model 20	1495
Hazeltine Executive 80 Model 30	1715
1410 (Hazeltine dumb terminal)	575
1421 (Consul 580 & ADM 3A comp.)	595
1500 (dumb terminal)	825
1520 (buffered, printer port)	1105
RETRO-GRAPHICS TERMINALS	
VT 100 with graphics pkg.	3250
VT 125 (DEC graphics)	3280
ADM 3A with graphics pkg.	1795
ADM 5 with graphics pkg.	1845
300 BAUD TELEPRINTERS	
LA 34-DA DECwriter IV	1045
LA 34-AA DECwriter IV	1095
LA 36 DECwriter II	1095
Diablo 630 RO	2295
Diablo 630 KSR	2695
Diablo 1650 KSR	2635
TI 743 (portable)	1190
TI 745 (port/built-in coupler)	1485
TI 765 (port/bubble/b.i. coupler)	2595
600 BAUD TELEPRINTERS	
Epson MX-80	645
TI 825 KSR impact	1570
TI 825 KSR pkg.	1795
1200 BAUD TELEPRINTERS	
Epson MX-100	995
LA 120 RA (receive only)	2095
LA 120 AA DECwriter III	2295
TI 783 (portable)	1645
TI 785 (port/built-in coupler)	2270
TI 787 (port/internal modem)	2595
TI 810 RO impact	1545
TI 810 RO pkg.	1795
TI 820 RO impact	1850
TI 820 RO pkg.	2025
TI 820 KSR impact	2025
TI 820 KSR pkg.	2195
Lear Siegler 310 ballistic	1945
2400 BAUD	
Dataproducts M200 (2400 baud)	2910
DATAPRODUCTS LINE PRINTERS	
8300 (300 LPM band)	5455
8600 (600 LPM band)	6930
81000 (1000 LPM band)	11330
BP1500 (1500 LPM band)	19700
ACOUSTIC COUPLERS	
A/J A242-A (300 baud orig.)	242
A/J 247 (300 baud orig.)	315
Vadic VA 3413 (300/1200 orig.)	845
Vadic VA 3434 (1200 baud orig.)	845
MODEMS	
GDC 103A3 (300 baud Bell)	395
GDC 202S/T (1200 baud Bell)	565
VA 3212 (Bell 212A comp.)	825
VA 103 (300 baud modem/phone)	235
VA 3451 (orig/ans triple modem)	885
VA 3455 (1200 baud orig/ans.)	770
VA 2450 (Bell 201 comp.)	725
CASSETTE STORAGE SYSTEMS	
Techtran 816 (store/forward)	735
Techtran 817 (store/for/speed up)	915
Techtran 818 (editing)	1225
Techtran 822 (dual)	1640
FLOPPY DISK SYSTEMS	
Techtran 950 (store/forward)	1395
Techtran 951 (editing)	1995

\* Please call for quote.



Distributors, New York, New Jersey and Ohio.  
New York:  
516/482-3500, 212/895-7177, 518/449-5959  
Outside N.Y.S.: 800/645-8016  
New Jersey: 201/227-5552  
Ohio: 216/464-6688

Listing 1 continued:

```

initialize
end;

procedure abort;
begin
  clrdisp;
  if gc ('Y', 'N'), 'Abort: are you sure? ', true) = 'Y' then exit (program)
end;

begin ( MakeGraphicChars )
initialize;
repeat
  clrdisp; wrst ('Character Editor', 0, 4);
  case gc (['A', 'Q', 'M'], 'Abort, Quit, Make character: ', true) of
    'A' : abort; {terminate with no save}
    'Q' : shutdown; {terminate with save}
    'M' : Genchar {make new character}
  end; ( case )
until HellFreezesOver
end.

```

Text continued from page 426:

move the cursor about within the menu. In the first method, you type the letters U, D, L, and R (for up, down, left, and right, respectively). In the second method, you use a standard numeric keypad (not normally present on the Apple) by pressing the number corresponding to the direction of desired cursor movement (i.e., 2 = down, 4 = left, 6 = right, 8 = up). When the cursor is placed over the character that you wish to edit, press the period key or 5. The character is displayed on the editing pallet and the list of edit options appears.

### Character Editing

A new cursor appears in the lower left-hand corner of the editing pallet.

As with character selection, the cursor is moved about within the pallet with the letters U, D, L, and R, or with the digits on the keypad. The latter method is somewhat easier to use. However, if your Apple is like mine, you will have to suffer use of the directional mnemonics.

In order to make a white block, the period key or 5 is pressed. To make a black block, the space bar or 0 is pressed. If you are observant, you may have noticed by now that all cursor movement and flashing are duplicated by a one-pixel cursor within the menu box of the selected character. In fact, any action taken in the pallet is duplicated to scale within the selected character.

But there is more to it than that. Typing C clears the pallet, giving you

Prompt	Options
ABORT,QUIT,MAKE CHARACTER:	A = abort; do not save editing done Q = quit; save editing done M = select and edit a character
.' ACCEPTS UP,DOWN,LEFT,RIGHT	'' (or 5) = select character U (or 8) = move cursor up D (or 2) = move cursor down L (or 4) = move cursor left R (or 6) = move cursor right
NEW,CLEAR,POP,INVERT,GET [Shift] UP,DOWN,LEFT,RIGHT '.' (SET), '' (CLEAR)	N = new character; terminate edit C = clear pallet P = pop character from stack I = invert pallet G = get and copy alternate character S = shift character (up, down, left, right) U (or 8) = move cursor up D (or 2) = move cursor down L (or 4) = move cursor left R (or 6) = move cursor right '' (or 5) = set current pixel '' (or 0) = clear current pixel

Table 1: A summary of commands for the CHEDIT program.

# DUAL THERMOMETER

For Apple II\*  
COMPLETE WITH SOFTWARE



- Display temperature, maximum, minimum and difference.
- Sound alarm for over/under temperature.
- Store data on disk or printer automatically.
- Display time with on-board timer.

- Up to 7 boards with 14 probes in one Apple\*.
- -55°C to 125°C range, 0.4° accuracy over most of range.
- Requires 48K Apple\* with Applesoft\* and disk.

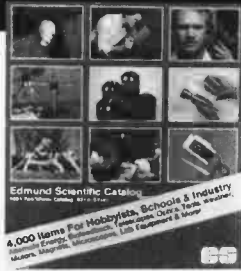
**\$260.00**  
If your dealer doesn't have it, call or write us at dept. A

**Strawberry Tree Computers**  
949 Cascade Drive  
Sunnyvale, Ca. 94087  
(408) 736-3083

\*TM of Apple Computer, Inc.

# New, Unique Products Alternate Energy, Telescopes, Optics, Weather, Magnets, Microscopes & More!

In One Giant FREE Catalog



**Biggest Catalog!  
Finest Quality!**  
Since 1941, thousands of engineers, craftsmen & hobbyists nationwide have been coming directly to the Edmund Scientific Catalog for quality products...fully guaranteed!

**FREE!** Simply fill in below, mail today, and your Edmund Scientific Catalog will be on its way to you.

Send **FREE** Catalog  
Name \_\_\_\_\_  
Address \_\_\_\_\_  
City \_\_\_\_\_ State \_\_\_\_\_ Zip \_\_\_\_\_

**Edmund Scientific**  
Dept. 8211 KH10 Edscorp Bldg.  
Barrington, N.J. 08007  
No. 3484 ©1982 Edmund Scientific Co.

## PRODUCTS FOR YOUR RADIO SHACK

**NEW!**

# COLOR COMPUTER

MICROTEXT COMMUNICATIONS VIA YOUR MODEM!

Now you can use your printer with your modem! Your computer can be an intelligent printing terminal. Talk to timeshare services or to other personal computers; print simultaneously through a second printer port; and re-display text stored in memory. Download text to Basic programs; dump to a cassette tape, or printer, or both. Microtext can be used with any printer or no printer at all. It features user-configurable duplex/parity for special applications, and can send any ASCII character. You'll find many uses for this general purpose module! Available in ROMPACK, ready-to-use, for \$59.95.

### SOFTWARE DEVELOPMENT SYSTEM

The Micro Works Software Development System (SDS80C) is a complete 6809 editor, assembler and monitor package contained in one Color Computer program pack! Vastly superior to RAM-based assemblers/editors, the SDS80C is non-volatile, meaning that if your application program bombs, it can't destroy your editor/assembler. Plus it leaves almost all of 16K or 32K RAM free for your program. Since all three programs, editor, assembler and monitor are co-resident, we eliminate tedious program loading when going back and forth from editing to assembly and debugging!

The powerful screen-oriented Editor features finds, changes, moves, copys and much more. All keys have convenient auto repeat (typamatic), and since no line numbers are required, the full width of the screen may be used to generate well commented code.

The Assembler features all of the following: complete 6809 instruction set; complete 6800 set supported for cross-assembly; conditional assembly; local labels; assembly to cassette tape or to memory; listing to screen or printer; and mnemonic error codes instead of numbers.

The versatile ABUG monitor is a compact version of CBUG, tailored for debugging programs generated by the Assembler and Editor. It features examine/change of memory or registers, cassette load and save, breakpoints and more. SDS80C Price: \$89.95

### GAMES



- Star Blaster** — Blast your way through an asteroid field in this action-packed Hi-Res graphics game! Available in ROMPACK; requires 16K. Price: \$39.95
- Pac Attack** — Try your hand at this challenging game by Computerware, with fantastic graphics, sound and action! Cassette requires 16K. Price: \$24.95
- Berserk** — Have fun zapping robots with this Hi-Res game by Mark Data Products. Cassette requires 16K. Price: \$24.95
- Adventure** — *Black Sanctum* and *Calixto Island* by Mark Data Products. Each cassette requires 16K. Price: \$19.95 each.

**ROMLESS PAK I** — is an empty program pack capable of holding two 2716 or 2732 EPROMs, allowing you up to 8K of program! The PC board inside comes with sockets installed, ready to go with the addition of your custom EPROMs. Price: \$24.95

**2-PASS DISASSEMBLER** — with documentation package. 16K; cassette. 80C Disassembler Price: \$49.95

**CBUG** — Machine language monitor. CBUG Cassette Price: \$29.95

**CBUG ON 2716 EPROM**: Can plug into Romless Pak I. CBUG ROM Price: \$39.95

**PARALLEL PRINTER INTERFACE** — serial to parallel converter allows use of all standard parallel printers. P180C Price: \$69.95

**Assembly Language Programming**, by Lance Leventhal. Price: \$16.95

**MEMDRY UPGRADE KITS**: 4-16K Kit Price \$39.95. 16-32K (requires soldering experience) Price: \$39.95

**PARTS & SERVICES**: SAMs, 6809Es, RAMs, PIAs. Call for prices.

THE **MICRO WORKS**



**GOOD STUFF!**

**WE SHIP FROM STOCK!**

Master Charge/Visa and COD Accepted

P.O. BOX 1110 DEL MAR, CA 92014 714-942-2400



# North Star's Advantage over IBM and Apple is easy to see.

The North Star ADVANTAGE desktop computer has higher precision graphics, better software, and greater disk capacity than the IBM Personal Computer or the Apple III. Plus, nationwide on-site service and free business graphics software. See it for yourself. Then check the price. You'll see how easy it is to own the North Star ADVANTAGE. For the name of the North Star dealer nearest you, call today.

CALL TOLL FREE  
**1-800-447-4700**  
(ILLINOIS 1-800-322-4400)



FOLLOW THE STAR  
**NorthStar**™

14440 Catalina Street, San Leandro, California 94577

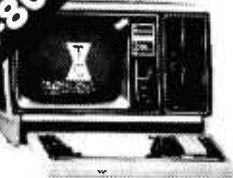
the proverbial clean slate. If you have done this by accident, don't panic; the character is not lost forever. While in edit mode (as opposed to initial character selection mode), the character is saved in an 8-level circular stack. To recover the original character, type P (for pop). Upon entry to edit mode, the stack is filled with the original character found. Therefore, subsequent pops will only yield the same character. However, no mechanism yet exists for recovering from an accidental pop. Thus, this should be used as a "restart edit" command, rather than as a method of comparing or saving succeeding edits. Commands that "push" characters onto the stack are Clear (C) and Get (G). The number of pushes is finite; only the eight most recently cleared characters are saved.

If you wish to obtain another character for editing that might be similar in form or dimension to the one you have in mind, the Get command copies a specified character into the character currently under consideration. As previously mentioned, this operation performs a push of the old character. To perform a Get, typing G places you into a character-selection mode that is used in the same way as the initial selection. The letters U, D, L, and R are used to move the cursor about within the menu; the period is used to select the character under the cursor. A copy of the character specified then appears in the pallet and within the menu box of the character currently being edited.

A Shift mode allows you to move a character about within the pallet. Although pixels shifted off the edges of the pallet are lost and cannot be recovered, the entire original character may be recovered with the pop command mentioned earlier. To shift the character, press S followed by the direction of the shift (U, D, L, or R). Since only one shift is performed, subsequent shifts require S to be pressed again before specifying the direction.

Finally, an Invert command causes all black pixels to become white and vice versa. This is done by pressing I.

**SAVE  
TRS-80's**



# TRS-80's™ and Hewlett-Packards

## Best Discounts Possible

WE PAY SHIPPING in the 48 continental states on prepaid orders of \$100.00 or more.

NO TAXES are collected on out-of-state shipments.

WE ACCEPT Visa, MasterCard and American Express, or you can save additional money by paying cash.

TOLL FREE ORDER NUMBER 800/531-7466

# Pan American Electronics

1117 Conway • Dept. 16  
Mission, Texas 78572  
Phone 512/581-2766  
Telex Number 767339

FORT WORTH BRANCH  
2912 N. Main  
Ft. Worth, Texas 76106  
Phone 817/625-6333  
Telex Number 794836



**Hewlett-Packard**

TM — Trademark of Tandy Corporation

# TERMINALS FROM TRANSNET

PURCHASE PLAN • 12-24 MONTH FULL OWNERSHIP PLAN • 36 MONTH LEASE PLAN

DESCRIPTION	PURCHASE PRICE	PER MONTH		
		12 MOS	24 MOS	36 MOS
<b>DEC</b>				
LA36 DECwriter II	\$1,095	\$105	\$ 58	\$ 40
LA34 DECwriter IV	995	95	53	36
LA120 DECwriter III KSR	2,295	220	122	83
LA120 DECwriter III RD	2,095	200	112	75
VT100 CRT DECscope	1,695	162	90	61
VT101 CRT DECscope	1,195	115	67	43
VT125 CRT Graphics	3,295	315	185	119
VT131 CRT DECscope	1,745	167	98	63
VT132 CRT DECscope	1,995	190	106	72
VT18XAC Personal Computer Option	2,395	230	128	86
<b>TEXAS INSTRUMENTS</b>				
T1745 Portable Terminal	1,595	153	85	58
T1765 Bubble Memory Terminal	2,595	249	138	93
T1 Insight 10 Terminal	695	67	37	25
T1785 Portable KSR, 120 CPS	2,395	230	128	86
T1787 Portable KSR, 120 CPS	2,845	273	152	102
T1810 RD Printer	1,695	162	90	61
T1820 KSR Printer	2,195	211	117	80
<b>LEAR SIEGLER</b>				
ADM3A CRT Terminal	595	57	34	22
ADM5 CRT Terminal	645	62	36	24
ADM32 CRT Terminal	1,165	112	65	42
ADM42 CRT Terminal	1,995	190	106	72
<b>DATAMEDIA</b>				
EXCEL 12 CRT Terminal	1,695	162	90	61
EXCEL 42 Smart Buffered CRT	995	96	54	36
COLORSCAN 10 Color CRT	3,195	307	171	116
<b>TELEVIDEO</b>				
925 CRT Terminal	850	82	46	31
950 CRT Terminal	1,075	103	57	39
<b>NEC SPINWRITER</b>				
Letter Quality, 7715 RD	2,895	278	154	104
Letter Quality, 7725 KSR	3,295	316	175	119
<b>GENERAL ELECTRIC</b>				
2030 KSR Printer 30 CPS	1,195	115	67	43
2120 KSR Printer 120 CPS	2,195	211	117	80
<b>HAZELTINE</b>				
Executive 80/20	1,345	127	75	49
Executive 80/30	1,695	162	90	61
<b>EPSON</b>				
MX-80 F/T Printer	745	71	42	27
MX-100 Printer	895	86	48	32
<b>TIMEPLEX</b>				
E0400 4 Channel Stat Mux	1,525	147	82	55
E0800 8 Channel Stat Mux	2,050	197	110	74

FULL OWNERSHIP AFTER 12 OR 24 MONTHS • 10% PURCHASE OPTION AFTER 36 MONTHS

### MICROCOMPUTERS

APPLE • COMMODORE • HP85 • DEC LSI 11

ACCESSORIES AND PERIPHERAL EQUIPMENT

ADJUSTIC COPLERS • MODEMS • THERMAL PAPER • RIBBONS • INTERFACE MODULES • FLOPPY DISK UNITS



**TRANSNET CORPORATION**

1945 ROUTE 22 • UNION, N.J. 07083 • (201) 688-7800  
TWX 710-865-5485 800-526-4965 OUTSIDE N.J.

# KEELE CODES

# DISTRIBUTORS — DEALERS FOR A UNIQUE NEW PRODUCT

## AVAILABLE ALSO TO END USERS

Micro, mini and mainframe users can cut costs and save time with Keele Codes unique E40 compression utility.

If you — make back-up copies from Winchester or floppy disk

- archive your database files
- save reports or correspondence on tape or disk
- need more media space accessible from the terminal
- send written material via line or telephone

then Keele Code E40 could halve your disk costs and save transfer time by compressing natural English to about 40% of its original size. Through compression you achieve more than twice as much material on each disk in the same time as it would take to make a copy.

Optimised for English — E40 will compress any written/data/program material and all 256 ASCII characters can be coded and faithfully restored. Numeric tables too!

Available for most CP/M machines, including 8" IBM, Xerox 820, Superbrain, North Star, Z80 Apple, Osborne, Vector, Heath/Zenith, Televideo.

Also available for PDP11 and GEC 4080 series. Other languages to follow.

Write or phone for full details  
**Keele Codes Limited,  
University of Keele,  
Keele, Staffs. ST5 5BG England.  
Tel: 011 44 782-629221.  
Telex: 851 36113.**

Cut out the coupon BS/01  
Mastercharge accepted.  
You may phone or telex your order

Please send me Tick  
E40 for CP/M ..... Retail price \$ 99   
(inc air mail postage)

CP/M manual only ..... Retail price \$15   
further details

Name.....

Address.....

I enclose a cheque/  
money order for.....

Mastercharge.....

My computer is .....

Year of purchase .....

# STRIKE A PERFECT MATCH...



## Wed a Data General Eclipse to the ALPS Word Processing System

Marry ALPS word processing software with Data General terminals for a complete text entry, editing, formatting and text output system.

The wedding costs about \$4,000.

You get all standard word processing features with:

- Fast response.
- "Short Stroke" dictionary facility that provides user defined shorthand and spelling corrections.
- Ease of use for minimal training.
- Search and replace feature yields quick replacement of selected characters or strings.

### Plus these options:

- Foreign language capability for rapid translation and word processing in any Romanized alphabet.
- Dictionary look-up of words and phrases to improve translation production.

For complete information on any ALPS system, contact ALPS, 750 North 200 West, Suite 104, Provo, Utah 84601. Telephone 801/375-0090.



Pressing I twice in a row yields the original character. The drawback to use of this command is that shifting causes black pixels to be brought in on one edge of the pallet. If you want a white background, these pixels must be filled in separately. The alternative is to make the background black before shifting, then change the background back to white with the Invert command.

### Terminating the Edit

Once you are satisfied with an edit, type N (for new character). This makes the change permanent. The ABORT, QUIT, MAKE CHARACTER prompt is then displayed and a new character may be selected for edit, or the new characters may be saved in the output file with the Q command. Then you are asked whether you want to begin a new edit session. Typing N terminates the program. Typing Y causes prompts for new input and output files to appear. If a null (Return key only) is entered for either file name, the program is terminated.

## 8086 SOFTWARE

From Dynamic Microprocessor Associates, Inc.

### EM80/86™

An emulator which will permit an 8086, using 86-DOS (IBM Personal DOS, MS-DOS, SB-86\*) or CP/M-86\*, to run CP/M\* programs written for 8080 without modifications. Complete system \$200.

### THE FORMULA™

An information manager incorporating characteristics of a data base manager, a word processor, and a compiler language into a "system language" for application development. Delivered with the General Accounting System including General Ledger, Accounts Payable, and Accounts Receivable. Complete system \$595; manual only \$60.

### ASCOM™

The Asynchronous Communication Control Program allows a microcomputer to communicate with another computer through a serial port; ideal for interfacing with a time sharing system. Includes various protocols and supports both batch and interactive processing. Complete system \$175; manual only \$20.

### UT86™

System utilities designed to improve the user friendliness of systems using 86-DOS. UT86 provides neatly formatted and sorted directories, interactive copy routines which permit selection of individual files or groups of files, formatted file printouts with pagination and headings, and more. Complete system \$180.

### THE FOUNDATION™

An advanced data entry and query language. Available Summer 1982.

## DMA • WE SPEAK YOUR LANGUAGE

Dynamic Microprocessor Associates, Inc.

545 Fifth Avenue, New York, New York 10017 • (212) 687-7115

We ship prepaid and COD orders. Shipping & Handling charges extra: \$5 UPS areas; \$7 non-UPS areas. Mexico, Canada, \$10+ elsewhere. MasterCharge and VISA accepted. \*Trademarks: 80-DOS, Seattle Computer Products; CP/M and CP/M-86, Digital Research; SB-86, Lifeboat Associates; MS-DOS, Microsoft.

### Using the New Character Set

In order to use a character set that you create, you must rename the file output from CHEDIT to SYSTEM.CHARSET. This is required by the TURTLEGRAPHICS unit.

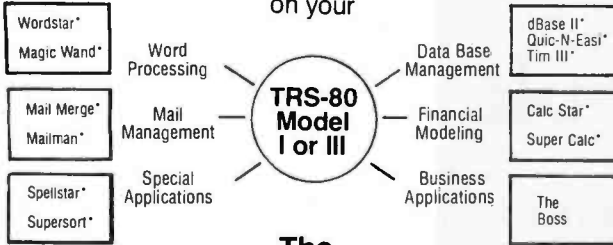
The alternative is to write your own versions of WCHAR, WSTRING, and CHARTYPE by using DRAWBLOCK, in which case you must match some of the declarations made in CHEDIT (*charimage*, *charset*, and *charfile*), and read in the character-set file of your own choosing (see procedure *drawallchars*).

### Summary

CHEDIT is a simple editor for Apple-format character sets. If required, modifications should be easy to make. I graciously forgive Apple for providing such a limited form of graphics support with its Pascal package; it is adequate for many small applications. But with CHEDIT, there is no reason why you should be restricted only to the character sets provided by Apple. ■



CP/M Compatibility  
for your TRS-80  
Pluggable boards & powerful operating  
system (T8/OS) run this  
power packed lineup of CP/M  
program applications  
on your



**The Freedom Family**

- Freedom Option .....\$275.00  
CP/M Compatibility
- Freedom Plus .....\$490.00  
CP/M Compatibility Plus 64K RAM  
Manual Only \$25.00

**Freedom Technology International, Inc.**

Helping Small Computers Do Big Things  
To Order call 1-800-523-4067  
In Pennsylvania call 569-2381  
Dealer Inquiries Invited

\*CP/M is a trademark of Digital Research, Inc.  
\*TRS-80 is a trademark of Tandy Corp.

# THE NEW ZIPPER!



**FEATURES:**

- Menu driven zip code data base. You simply type in the street address, or P.O. box anywhere in the U.S. Instantly, you have the zip code needed. CP/M compatible.

**\$225.**

For more information, call or write to:

**COMPUTORIAL, INC.** (213) 933-8268  
4520 Wilshire Blvd. • Los Angeles, CA 90010

# Olympic Sales Company

SEVING YOU SINCE 1947  
CABLE: "OLYRAV" LSA  
Main Showroom & Offices:  
216 So. Oxford Ave.  
Los Angeles, CA 90004  
Telex: 67 34 77

**WE HONOR VISA and MASTERCHARGE**

**ORDER DESKS**  
open 6 days a week!  
7:00 am to 7:00 pm Mon thru Sat  
Order Desks: (213) 739-1130

**TOLL-FREE TOLL-FREE**  
(outside Calif.) (within Calif.)  
**800-421-8045 800-252-2153**

Prices shown are for mail or phone orders;  
Walk-in slightly higher.

Goods subject to availability;  
OSC will meet or beat almost  
any advertised price as long as  
the competition has the goods  
on hand; not responsible for  
typographical errors; prices &  
specifications subject to change  
without notice; this ad supercedes  
all previous ads; min shipg & hndlg  
\$.95; Send \$2 for 112-pg catalog!

**hp HEWLETT PACKARD**

HP-87	32K Bytes standard	\$1885.00
82907A	32K Mem. mod.	239.00
82908A	64K Mem. mod.	337.00
82909A	128K Mem. mod.	537.00
HP-85A	Computer	\$1985.00
HP-125	Computer	1985.00
HP-41C	Prog. scientific	188.00
HP-41CV	Prog. scientific	248.00
HP-41	Card reader	169.00
HP-41	Printer	297.00
HP-41	Optical wand	99.00
82106A	41C Memory module	26.00
82170A	41C Quad mem. mod.	84.00
82160A	HP-IL interface	109.00
82161A	Cassette drive	437.00
82162A	HP-IL printer	397.00
HP-97	Prog. scien./printer	584.00
HP-32E	Scientific	55.00
HP-33C	Prog. scientific	89.00
HP-34C	Adv. prog. scientific	114.00
HP-37E	Business	74.00
HP-38C	Prog. financial	119.00
HP-11C	Prog. scientific	114.00
HP-12C	Prog. financial	127.00
82905A	Impact printer	619.00
82901M	5 1/4" dual drive	1699.00
9895A	8" dual drive	4499.00
2631B	Impact printer	2999.00
2601A	Letter qual. ptr.	2999.00
85-15001	Mass storage ROM	124.00
85-15002	Plot/print ROM	124.00
85-15003	I/O ROM	239.00
85-15004	Matrix ROM	124.00
85-15005	Adv. prog. ROM	124.00
85-15007	Assembler ROM	239.00
82903A	16K mem. module	169.00
82837A	HP-IL interface	328.00
82939A	Serial interface	338.00
82840A	GPIO interface	408.00
82841A	BCD interface	408.00
82845A	Parallel ptr. int.	239.00
HP-7470A	Hi-speed color graphic plotter w/interface	1269.00



New TI-99/4A - 48K RAM  
100% TI parts w/Extended Basic  
or TI-LOGO Re: \$1300 Y/C: \$5689.95

**Texas Instruments Home Computer**



**16K**

- 10" color monitor high res
- 32K memory module
- Extended Basic
- Speech synthesizer
- Disk memory drive
- Telephone coupler (modem)
- Printer (solid state)
- TI-LOGO

**TI-99/4A Only \$299.95**

RETAIL	Your Cost
374.95	339.95
399.95	314.95
100.00	75.00
149.95	129.95
499.95	394.95
224.95	189.95
399.95	319.95
250.00	99.95

**AMDEK Lealex**

**High Quality Monitors**

Model	Description	Retail	Your Cost
100	12" 8W, 12 MHz	189.00	149.00
300-G	12" Green, 18 MHz	269.00	199.00
Color I	13" Color, NTSC comp. input, audio amp & spkr	499.00	359.00
Color II	13" Color, RGB input, hi res graphics, spkr	1295.00	799.00

**SANYO MONITORS**

High resolution, number one seller!	Retail	Your Cost
15" Black & white	390.00	199.00
13" color (DM 6113) RGB, High Res	1195.00	989.00
13" color (new) high quality!	650.00	449.00
12" Green phosphorus	360.00	269.00
12" Black & white	340.00	249.00
9" Black & white (the best seller)	235.00	179.00
9" Green phosphorus	295.00	199.00

**commodore COMPUTER VIC-20**

5K Personal Computer  
(Expands to 32K) Works with any TV!  
Retail: \$300.00 Your SPECIAL Cost: \$259.95  
FREE with purchase of VIC-20 one \$49.50 LCD Pen Watch!  
Commodore Datasette Recorder  
for VIC-20 Your Cost: \$68.95 We carry all peripherals,  
software & access. for the VIC-20 (we will beat any price!)

**IN STOCK ATARI COMPUTERS**

FOR ATARI 400 & 800-  
GHOST HUNTER (similar to Pac-Man)  
Disk \$34.95 Cassette \$29.95

Model	Retail	Your Cost
800 16K	1080.00	689.95
800 48K	1280.00	789.95
810 Disk drive	600.00	469.95
Atari VisiCalc	200.00	169.95
825 Impact Ptr	1000.00	779.95
SUPER SPECIAL-ATARI 400 (16K)	Retail: \$595.00	Your Cost: \$299.95
400 Lang. card opt.	\$49.95	

**ATARI** Programmable Color TV Game  
Your Cost: **\$139.95**  
Large selection of Cassettes Retail: \$225.00

Atari's game cartridge  
**Pac-man IS HERE!**  
one per customer  
**\$35.95** While supply lasts-the hottest game in town!

**Epson PRINTERS** Your Cost

MX70	\$339.95
MX80	449.95
MX80 with graftrax	499.95
MX88 FT	599.00
MX100	749.00
Graphtrax chip	95.00

**APPLE COMPUTERS**

	Retail	Your Cost
Apple II 48K+	\$1530.00	\$1139.00
Disk w/controller	645.00	548.00
Disk w/o	525.00	459.00
Pascal language system	495.00	389.00
Graphics tablet	795.00	669.00
Silentype	395.00	339.00
Family System	2495.00	1999.99
Apple III 128K	3495.00	2895.00
Profile 5MB	3495.00	2795.00

Software & access. at similar discounts

# Give Your Apple a Voice

## A Speech-Development System Using the Radio Shack Speech Synthesizer

---

John Blankenship  
Professor of Computer Technology  
DeVry Institute of Technology  
2858 Woodcock Ave.  
Atlanta, GA 30341

---

"Speech. It separates man from the lower forms of life and from mere machines." In the not-too-distant past, this statement would have been true. Now, with many consumer products gaining the power of speech, it seems only natural that the complete home-computer system have the power of verbal communication.

I added the power of speech to my Apple II with the aid of a Radio Shack Voice Synthesizer. To make the same conversion with your Apple you will need to tinker with its hardware: if you own a TRS-80 you will have to modify some of the software presented here, and if you own anything else you will have to do a little of both. I will attempt to cover the subject in such a manner that modifications will be as painless as possible. They might even be fun!

### Speech Alternatives

I had wanted to add the power of speech to my computer for some time and had explored several alternatives. I found that the best speech quality resulted from methods that *reproduced*, rather than *created*, the human sounds desired.

A simple sampling method that uses an A/D (analog-to-digital) converter can produce superb sound quality if the sample rate is suffi-

ciently high. Each sample, however, uses 1 byte of memory, so it is not unreasonable for one second of speech to require 4000 bytes. In addition, the vocabulary is fixed and considerable effort is required to increase it.

Another method for reproducing speech is LPC (linear predictive coding). This technique is used in Texas Instruments' Speak & Spell, and while it reduces the memory requirement to several hundred bytes per second, the quality of speech is slightly reduced (and it still has the disadvantage of a fixed vocabulary).

The Radio Shack Speech Synthesizer generates the sounds that make up speech, called phonemes, through the use of Votrax circuitry. The Speech Synthesizer can generate 45 different sounds, 10 of which are

capable of varying durations (see samples in table 1). The major advantage of this method is that the words are not reproduced, but *created* from a single-byte code, which translates to less than 20 bytes for each second of output. These phonemes can be combined in any order, thus permitting an essentially unlimited vocabulary.

In the past I had heard speech that was generated from phonemes, and it was generally of poor quality. After a great deal of practice, I discovered that quality was more a function of the programmer than of the hardware. One major consideration in understanding speech is the rhythm. As an example, pronounce the word "kick." You will notice a pause before the last "k." The *word flow* can be improved through the insertion of such pauses.

Even the phonemes themselves can present problems. Let's examine the word "name." When asked what sounds form this word, most people initially respond with "n", "a", "m", where the "a" is long. If these sounds were sent to the synthesizer it would say something that *resembled* "name," but it would hardly sound proper.

A closer examination of the word "name" reveals the sounds "n", "a", "e", "m", where both the "a" and "e" are long. When these sounds are re-

Phoneme Sound	Example Usage	ASCII Characters
"a"	day	)
"ah"	honest	:
"aw"	law	1
"e"	meet	E
"eh"	heavy	3
"oo"	book	%
"u"	school	U

Table 1: Examples from among the 45 phonemes available with Radio Shack's Speech Synthesizer. These sounds can be combined to form words and sentences.

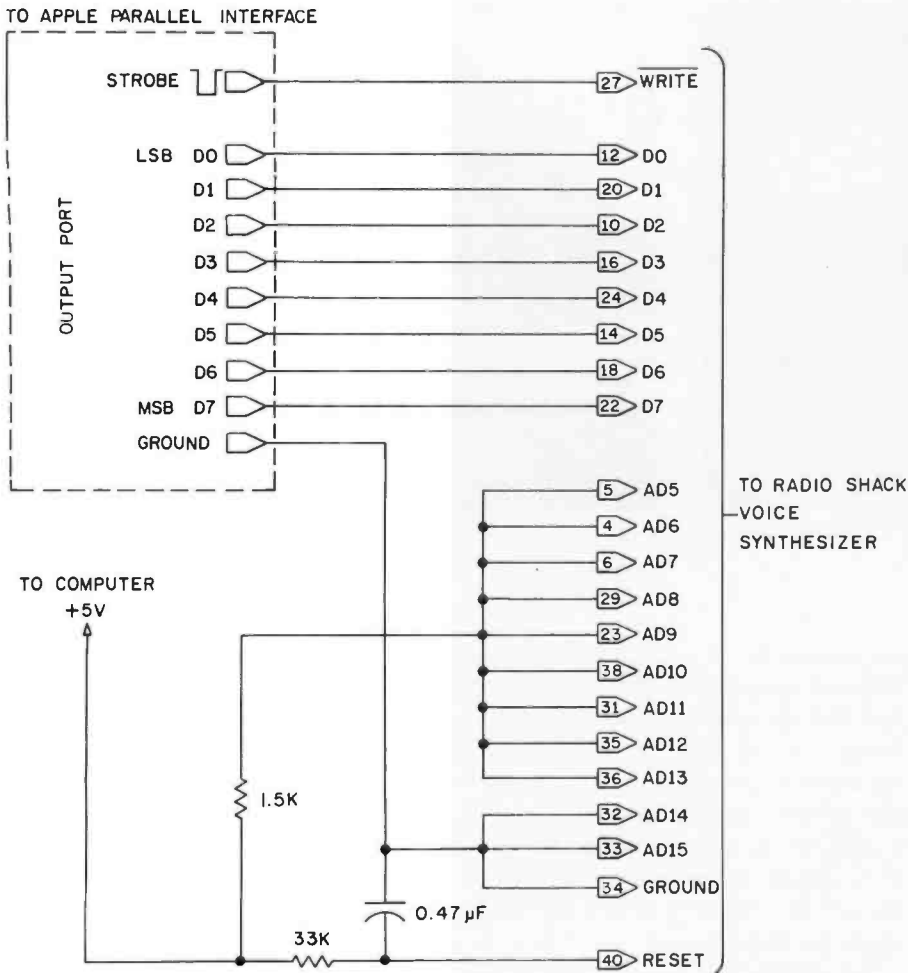


Figure 1: Schematic diagram for the interface between the Apple II Parallel Interface card and the Radio Shack Speech Synthesizer.

produced by the synthesizer, the word is easily recognized. Now, however, the word ends too abruptly. The addition of another "m" to form the combination "n", "a", "e", "m", "m" sounds nearly human. (By lengthening the "a" or the "e" sound you can attain a pronunciation applicable to a particular region of the country.)

Word flow can also be improved by the addition of such neutral phonemes as "eh" and "uh." The transition between sounds in the word "name" is improved by adding an "uh" between the "n" and the "a" sounds.

By varying these techniques, I convinced myself that above-average speech quality could be achieved with phonemes. In order to manipulate the sounds quickly and easily, I decided to write a program that could perform the following:

- Aid in determining the proper sounds
- Keep those sounds in a dictionary
- Convert words to sounds automatically

I wanted to write the program in a modular format for two reasons. First, although the program would be written on an Apple II, I expected that many Radio Shack TRS-80 owners would want to convert it. The use of small modules, each with specific functions, would simplify the modification process considerably.

Second, although this program would be used to develop a dictionary, it would also be used in an application program to decode and output the words. If I wrote the original program in modules, the sections not required in the application program could be deleted to conserve memory.



**GUARANTEED LOWEST PRICES!**  
To celebrate our opening, we are matching any advertised price. Just show us the ad.

**ORDER TOLL FREE - Outside WI**  
**1-800-826-1589**

**SOFTWARE**

Graphpower	299
Tax Preparer '82	127
Real Estate Analyzer	127
Creative Financing	127
Word Processor 1	425
DB Master	179
Mail Management	250
Micropro Wordstar (Apple)	248
Mailmerge (CP/M)	90
Spellsar (CP/M)	169
Supersort II (CP/M)	159
Context Connector	180
Easywriter (Pro)	195
Easymover	45
Superscribe II	95
Easymaller	160
Datadex	249
Microplan Basic	419
Wizardy	42
Nevada CoBol	159
Visicalc (3.3)	209
Apple Panic	25
SpellGuard	239
Computer Air Combat	53
PFS & Report	80
Sublogic Flight Simulator	28
SpeedStar	115
Systems Plus Acc'lg. Module	425
Crossword Magic	42
Zork II	33
Edu-ware (Apple)	35
Painter Power	34
Invoice Factory	148
Locksmith	99
Raster Blaster	25
SuperCalc	269
Visiterm	88
Visiplot	165
Visidex	209
Visitrend/Visiplot	249
Magic Window	79
Int'l Grand Prix	25
Estimator	295
A-stat 79	145
SuperVyz	95
Graphic Software	19
C. D. R. P. I	235
Snack Attack	22
Electronic I, II, or III	39
WordPro 3+	295
Mailing List Program	50
Apple Doc	49

**... AND MANY MORE!**

Quoted prices valid for stock on hand and subject to change without prior notice.

Programs for popular microcomputers.

Ask for our **FREE** catalog.

For **Peripherals** see our other ad, page 212

- Please:
- Wisconsin residents - add 4% sales tax
  - Add \$2.50 for shipping per software and small item. Call regarding others.

- We Welcome:
- Visa, Mastercharge - (Add 4%)
  - Checks (Allow 1-2 weeks for clearing)
  - COD (Add \$1.50 per shipment)

**TOLL FREE - Outside Wisconsin**  
**1-800-826-1589**

For Technical Info & in Wisconsin:

**715-848-2322**

**Oryx Software**

205 Scott St., Dept. BB

P.O. Box 1961 • Wausau, WI 54401





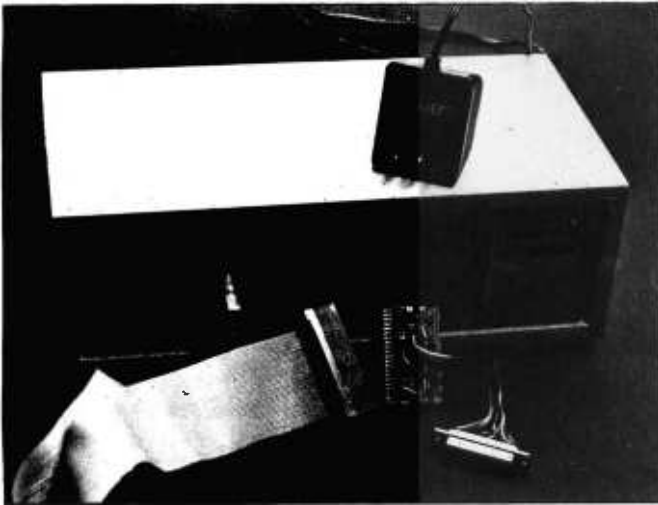


Photo 1: The Radio Shack Speech Synthesizer with the author's adapter for the Apple II computer.

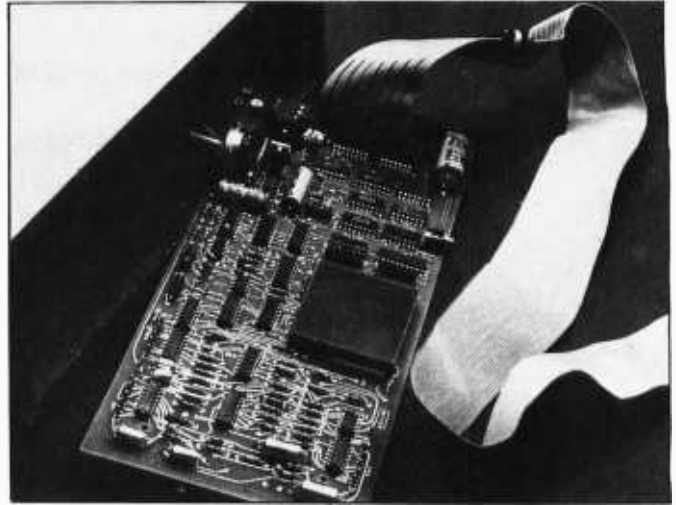


Photo 2: Inside the Speech Synthesizer. The Votrax circuitry is encased in plastic, and none of the supporting integrated circuits have markings.

Let's take a closer look at the Radio Shack Voice Synthesizer to determine the requirements of such a program.

### What the Synthesizer Needs

The synthesizer (see photo 1) has a built-in amplifier and speaker, and the ribbon cable plugs directly into the TRS-80 keyboard or expansion connector. It uses memory-mapped I/O (input/output) so that anything stored in the last 32 screen memory locations is sent to the synthesizer.

In order to use this system with my Apple II computer, I made an adapter (also shown in photo 1) to connect it to my parallel interface card, which doubles as my printer interface when

the system is not speaking. The only unusual requirement of the adapter is that the memory-mapped port inside the synthesizer must be hardwired to an address that will keep it enabled. I also added a power-on reset so that I would not have to contend with random sound each time the unit was turned on. Figure 1 shows the schematic for the adapter.

It is difficult to identify any of the internal circuitry of the synthesizer. The Votrax unit is completely sealed, and none of the surrounding integrated circuits are marked (see photo 2). But the central component, the Votrax SC-01 integrated circuit, is available to experimenters from the

Micomint, 917 Midway, Woodmere, NY 11598, (516) 374-6793.

### Software

Actual operation of the unit is easy. Listing 1 shows a simple program that converts entered sentences to phoneme codes and sends the codes to the synthesizer.

The words and their respective sounds are kept in data statements. I soon found that the major disadvantage of this method was loss of speed. After I acquired several hundred words in my dictionary, the time that elapsed between words spoken became several seconds; this is obviously excessive for real-time output. However, the small program works well for vocabularies of less than 100 words, and it is very easy to add to an application program.

In addition to the speed problem of those applications that require large vocabularies, I still needed to develop the proper sounds. The program in listing 2, which fulfills all of the requirements set forth earlier, is the result of my effort. Let's examine each module in this program individually.

The first section provides the basic documentation. Note that all variables start with the letter T. In general, variable names should be easily identifiable, but I chose to modify this policy. Since this program would be added to other programs, I wanted to avoid using the same variable in both.

Listing 1: Simple Apple program to convert sentences into phoneme codes. This routine uses information stored in DATA statements and performs a linear search to produce the proper output. The relatively slow speed limits it to use with vocabularies of less than 100 words.

```

10 INPUT T$
15 COSUB 60000
20 GOTO 10
30 END
60000 T1$ = "":OUT = 49361
60005 FOR T = 1 TO LEN (T$)
60007 T1$ = T1$ + MID$ (T$,T,1)
60010 IF MID$ (T$,T,1) = " " THEN 60050
60020 NEXT T
60030 RETURN
60050 RESTORE
60055 READ T2$,T3$: IF T1$ ( ) T2$ + " " THEN 60055
60057 T3$ = T3$ + " "
60060 FOR T1 = 1 TO LEN (T3$)
60070 POKE OUT, ASC ( MID$ (T3$,T1,1) )
60071 PRINT MID$ (T3$,T1,1);
60080 POKE (OUT + 3),0
60090 NEXT T1
60095 T1$ = "": GOTO 60020
60100 DATA YOU,Y(CU
60101 DATA WILL,W(W#;I#LL0
60102 DATA NOT,"NNA:ASTT0"
60103 DATA LIE,"0LAA:A*0"
60104 DATA TO,TTH(UUU0
60105 DATA ME,MME.&0
  
```

Text continued on page 454

# THE LIBRARY OF COMPUTER AND INFORMATION SCIENCES

—the oldest, largest and most respected book club for the computer professional



## Take any 3 books for only \$1.00 each (values to \$74.95)

You simply agree to buy 3 more books — at handsome discounts — within the next 12 months.

(Publishers' Prices Shown)

**56680. INVERSIONS: A Catalog of Caligraphic Cartwheels.** *Scott Kim.* Explores the myriad mysteries of written human language and the way in which the human brain interprets it. Softcover. **\$8.95**

**52140-2. THE HANDBOOK OF ARTIFICIAL INTELLIGENCE. Volume 1.** *Edited by Barr and Feigenbaum.* An outstanding collection of articles which demonstrate how computers exhibit near-human intelligence. Over 400 pages. *Counts as 2 of your 3 books.* **\$30.00.**

**42000-2. DESIGN AND STRATEGY FOR DISTRIBUTED DATA PROCESSING.** *James Martin.* Coverage of the impact of DDP on the ultimate users of a system, the office-of-the-future concept and much more. *Counts as 2 of your 3 books.* **\$37.50**

**82522. TEACHING YOUR COMPUTER TO TALK: A Manual of Command and Response.** *Edward R. Teja.* A fact-filled guide to voice equipment for computers. **\$15.95**

**42053-2. DESIGNING A DISTRIBUTED PROCESSING SYSTEM.** *Hamish Donaldson.* Includes file strategy, communication networks, and workflow design. *Counts as 2 of your 3 books.* **\$34.95**

**54425. IDA: A User's Guide to the IDA Interactive Data Analysis and Forecasting System.** *Ling and Roberts.* An essential handbook that explains how to use the IDA package. **\$12.50**

**70745. A PROGRAMMER'S GUIDE TO COBOL.** *William J. Harrison.* **\$18.95**

**70691. PROGRAM FLOW ANALYSIS.** *Edited by Muchnick and Jones.* A comprehensive look at a statistical method which can yield more efficient and reliable software. **\$23.50**

**62757. MINICOMPUTERS: Low-Cost Computer Power For Management. Revised Edition.** *Donald P. Kenney.* How to use minicomputers to cut data processing costs and set up more manageable information handling systems. **\$14.95**

**79167. SOFTWARE RELIABILITY GUIDEBOOK.** *Robert L. Glass.* Analysis of technical tools available for software design and implementation. Includes applications for small operations to mammoth projects. **\$18.95**

**39960. COMPUTER-ASSISTED DATA BASE DESIGN.** *George V. Hubbard.* A complete look at data models, editing, design tactics, root anchor points and much more. **\$24.95**

**39977-2. COMPUTER CONTRACT NEGOTIATIONS.** *Auer and Harris.* Shows the computer professional how to handle every phase of successful negotiation, from preparation through signing the final agreement. *Counts as 2 of your 3 books.* **\$34.50**

**34115. APL IN PRACTICE.** *Edited by Allen J. Rose et al.* Covers topics including writing maintainable APL codes, evaluating telecommunications networks, using APL for construction accounting and more. **\$25.00**

**70230. PRINCIPLES OF SOFTWARE ENGINEERING AND DESIGN.** *Marvin V. Zelkowitz et al.* A practical guide which shows you how to handle everything from small programs all the way through the design of large, complex software systems. **\$24.50**

**78333-2. SIMPLIFIED ACCOUNTING FOR ENGINEERING AND TECHNICAL CONSULTANTS.** *Hays and Baker.* Easy-to-follow, plain language format. Covers partnership share accounting, compensation plans, time accounting, systems of billing and more. *Counts as 2 of your 3 books.* **\$27.95**

**53667-2. HOW TO BUILD YOUR OWN SELF-PROGRAMMING ROBOT/ROBOT INTELLIGENCE...WITH EXPERIMENTS.** *David L. Heiserman.* A two-volume set. *Counts as 2 of your 3 books.* **\$29.90**

**42420. THE DISTRIBUTED SYSTEM ENVIRONMENT: Some Practical Approaches.** *Grayce M. Booth.* Covers horizontal and hierarchical distributed structures, networking and much more. **\$21.95**

**34440. THE ART OF ELECTRONICS.** *Horowitz and Hill.* Emphasizes circuit intuition and non-mathematical design techniques. Packed with diagrams, schematics, and illustrations. **\$24.95**

**51955-2. A GUIDE TO THE SUCCESSFUL MANAGEMENT OF COMPUTER PROJECTS.** *Hamish Donaldson.* Invaluable advice on project management and documentation, systems design strategy, and programming. *Counts as 2 of your 3 books.* **\$34.95**

**79155. SOFTWARE INTERPRETERS FOR MICROCOMPUTERS.** *Thomas C. McIntire.* How to design a reliable software interpreter for any microcomputer system. **\$23.95**

**42213. DICTIONARY OF BUSINESS AND MANAGEMENT.** *Jerry M. Rosenberg.* Over 8000 entries. **\$24.95**

**81895. SYSTEMS ANALYSIS AND MANAGEMENT: Structure, Strategy, and Design.** *Donald V. Steward.* Insightful discussion of critical path scheduling, management modelling, system modelling, structural models and more. **\$25.00**

**32270-2. ADVANCES IN COMPUTER PROGRAMMING MANAGEMENT. Vol. I.** *Edited by Thomas A. Rullo.* Covers programmer evaluation, goal setting and performance standards, productivity measurements and more. *Counts as 2 of your 3 books.* **\$29.50**

**48494. FILE TECHNIQUES FOR DATA BASE ORGANIZATION IN COBOL.** *Johnson and Cooper.* Includes technical considerations in choosing a file structure, data structures and more. **\$20.95**

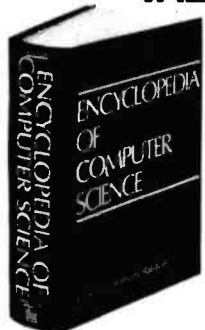
**42303. A DISCIPLINE OF PROGRAMMING.** *Edsger W. Dijkstra.* A programming classic. **\$22.95**

**70725-2. THE PROGRAMMER'S ANSI COBOL REFERENCE MANUAL.** *Donald A. Sordillo.* Alphabetized and heavily cross-referenced, provides a complete reference to COBOL verbs, syntax concepts and uses. *Counts as 2 of your 3 books.* **\$27.95**

**81857. SYSTEMATIC PROGRAMMING.** *Niklaus Wirth.* A classic work on programming as an exercise in constructing algorithms by the noted author. **\$23.95**

**79240. SOFTWARE PSYCHOLOGY: Human Factors in Computer and Information Systems.** *Ben Shneiderman.* **\$24.95**

## EXTRAORDINARY VALUE!



**ENCYCLOPEDIA OF COMPUTER SCIENCE.** *Edited by Anthony Ralston.* Monumental 1,500-page volume on every aspect of the computer sciences—software, hardware, languages, programs, systems, mathematics and more. Over 700 charts, tables, graphs and diagrams. *Counts as 3 of your 3 books.* **\$60.00**

If reply card has been removed, please write: **The Library of Computer and Information Sciences** Dept. 7-BB3, Riverside, N.J. 08075, to obtain membership information and application.

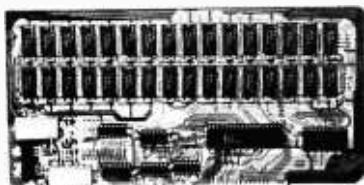
# Big sale on K's!

16K... \$149.95

32K... \$199.95

48K... \$249.95

64K... \$299.95



## New JAWS-IB

### The Ultrabyte Memory Board

Due to the tremendous success of our JAWS I, we were able to make a special purchase of first-quality components at below-cost prices for JAWS-IB. And we are sharing our cost saving with you. But don't be surprised if the next time you see this ad the prices have gone up substantially. Better yet, order now, and get the best memory on the market at the best price on the market.

#### ONE CHIP DOES IT ALL

JAWS-IB is the Rolls-Royce of all the S100 dynamic boards. Its heart is Intel's single chip 64K dynamic RAM controller. Eliminates high-current logic parts... delay lines... massive heat sinks... unreliable trick circuits. JAWS-IB solves all these problems.

#### LOOK WHAT JAWS-IB OFFERS YOU

Hidden refresh... fast performance... low power consumption... latched data outputs... 200 NS 4116 RAM's... on-board crystal... RAM jumper selectable on 8K boundaries... fully socketed... solder mask on both sides of board... phantom line... designed for 8080, 8085, and Z80 bus signals... works in Explorer, Sol, Horizon, as well as all other well-designed S100 computers.

10-DAY MONEY-BACK TRIAL: Try a fully wired and tested board for 10 days — then either keep it, return it for kit, or simply return it in working condition.

Continental U.S.A. Credit Card Buyers Outside Connecticut:  
**TO ORDER CALL TOLL FREE 800-243-7428**  
From Connecticut Or For Assistance:  
(203) 354-9375

Please send the items checked below:

#### JAWS-IB kit:

- 16K... \$149.95\*
- 32K... \$199.95\*
- 48K... \$249.95\*
- 64K... \$299.95\*

#### JAWS-IB Fully Assembled, wired & Tested:

- 16K... \$179.95\*
- 32K... \$239.95\*
- 48K... \$299.95\*
- 64K... \$359.95\*

EXPANSION KIT, 16K RAM Module, to expand JAWS-IB in 16K blocks up to 64K. \$59.95

\*All prices plus \$2 postage and insurance (\$4.00 Canada). Connecticut residents add sales tax.

Total enclosed: \$

- Personal Check  Money Order or Cashier's Check
- VISA  Master Card (Bank No. \_\_\_\_\_)

Acct. No. \_\_\_\_\_ Exp. Date \_\_\_\_\_

Signature \_\_\_\_\_  
Print Name \_\_\_\_\_

Address \_\_\_\_\_

City \_\_\_\_\_

State \_\_\_\_\_ Zip \_\_\_\_\_

**NETRONICS R&D Ltd.**  
333 Litchfield Road, New Milford, CT 06776

Listing 2: Completed speech-development program for the Apple. This program incorporates features that help determine proper sounds, maintain a dictionary, and automatically convert entered words to sounds.

```
60000 REM *****
60001 REM *   SPEECH   *
60002 REM *  DEVELOPEMENT *
60003 REM *   SYSTEM   *
60004 REM *     BY     *
60005 REM * JOHN BLANKENSHIP *
60006 REM *****
60007 REM THIS PROGRAM HAS BEEN DESIGNED TO BE INCLUDED INTO ANY
60008 REM OTHER PROGRAM REQUIRING SPEECH OUTPUT
60009 REM
60010 REM ALL VARIABLES BEGIN WITH 'T' TO HELP PREVENT CONFLICTS
60011 REM WHEN WRITING THE APPLICATION PROGRAM
60012 REM
60013 REM THE ENTIRE PACKAGE PROVIDES FOR COMPLETE DEVELOPMENT
60014 REM AND MAINTENANCE OF A PHONETIC DICTIONARY AS WELL AS THE
60015 REM SOFTWARE TO MAKE THE REQUIRED RUN TIME CONVERSIONS
60016 REM
60017 REM THE SYSTEM IS MODULAR SO THAT UNNEEDED ROUTINES MAY BE
60018 REM DELETED FROM THE APPLICATION PACKAGE
60019 REM
```

```
60020 REM *****
60021 REM *  INITIALIZATION *
60022 REM *****
60023 DIM TW$(300),TP$(300)
60024 LET D$ = CHR$(4)
60025 REM
```

```
60026 REM *****
60027 REM *   MENU     *
60028 REM *****
60029 TEXT : HOME
60030 PRINT "   SPEECH DEVELOPEMENT SYSTEM"
60031 PRINT "   WRITTEN BY JOHN BLANKENSHIP": VTAB 8
60032 PRINT "   1. INPUT OATA FROM DISK"
60033 PRINT "   2. SAVE DATA TO OISK"
60034 PRINT "   3. PREPARE NEW WORD FOR ENTRY"
60035 PRINT "   4. SAY A SENTENCE"
60036 PRINT "   5. LIST DICTIONARY"
60037 PRINT "   6. RETURN TO BASIC"
60038 VTAB (20): PRINT "WHICH? ";: GET TT$
60039 IF VAL (TT$) = 6 THEN HOME : END
60040 LET T1 = VAL (TT$): IF T1 < 1 OR T1 > 5 THEN PRINT CHR$(
60041 7): GOTO 60038
60042 ON T1 GOTO 60043,60062,60081,60137,60122
60042 REM
```

```
60043 REM *****
60044 REM *  INPUT DATA *
60045 REM *  FROM DISK  *
60046 REM *****
60047 HOME
60048 PRINT "   INPUT DATA FROM DISK": VTAB 8
60049 INPUT "WHAT FILE NAME ":TN$
60050 IF LEN (TN$) = 0 THEN 60026
60051 PRINT D$"OPEN SPEECH."TN$

60052 PRINT D$"READ SPEECH."TN$
60053 INPUT TA
60054 VTAB 20: PRINT "FILE ";: INVERSE : PRINT TN$:: NORMAL : PRIN
60055 T " CONTAINS "TA" WORDS "
60056 FOR T1 = 1 TO TA
60057 INPUT TW$(T1)
60058 INPUT TP$(T1)
60059 NEXT T1
60059 PRINT D$"CLOSE SPEECH."TN$
60060 GOTO 60026
60061 REM
```

```
60062 REM *****
60063 REM *  SAVE DATA TO DISK *
60064 REM *****
60065 HOME : PRINT "   SAVE DATA TO DISK": VTAB 8
60066 IF LEN (TN$) = 0 THEN 60068
60067 PRINT "USE FILE NAME ";: INVERSE : PRINT TN$:: NORMAL : PRIN
60068 T "? (Y/N) ": GET TT$
60069 IF TT$ = "Y" THEN 60070
60069 VTAB 12: INPUT "WHAT FILE NAME ":TN$
60070 VTAB 20: PRINT "SAVING "TA" WORDS"
60071 PRINT D$"OPEN SPEECH."TN$
```

Listing 2 continued on page 452



# FOR ONLY \$129.95 Learn Computing From The Ground Up

Build a Computer kit that grows with you, and can expand to 64k RAM, Microsoft BASIC, Text Editor/Assembler, Word Processor, Floppy Disks and more.

## EXPLORER/85

Here's the low cost way to learn the fundamentals of computing. The all-important basics you'll need more and more as you advance in computer skills. For just \$129.95 you get the advanced-design Explorer/85 motherboard, with all the features you need to learn how to write and use programs. And it can grow into a system that is a match for any personal computer on the market. Look at these features: 8085 Central Processing Unit, The microprocessor "heart" of the Explorer/85. (Join the millions who will buy and use the 8085/85 this year alone!) Four 8-bit parallel bit input/output ports from which you can input and output your programs, as well as control exterior switches, relays, lights, etc. a cassette interface that lets you store and reload programs you've learned to write. A flux 2,000 byte operating ROM system that makes it easy to learn computing in several important ways. • It allows simpler, faster writing and entering of programs. • It permits access by you to all parts of the system so you can check on the status of any point in the program. • It allows tracing each program step by step, with provision for displaying all the contents of the CPU (registers, flags, etc.) ... and it does much more!

You get all this in the starting level (Level A) of the Explorer/85 for only \$129.95. Incredible! To use just plug in your 8VDC power supply and terminal or keyboard/display — if you don't have them, see our special offers below.

- Level A computer kit (Terminal Version) \$129.95 plus \$3 P&I\*
- Level A kit (Hex Keypad/Display Version) \$129.95 plus \$3 P&I\*

**LEVEL B** — This "building block" converts the motherboard into a two-slot S100 bus (Industry standard) computer. Now you can plug in any of the hundreds of S100 cards available.

- Level B kit \$49.95 plus \$2 P&I\*
- S100 bus connectors (two required) \$4.85 each, postpaid.

**LEVEL C** — Add still more computing power. This "building block" mounts directly on the motherboard and expands the S100 bus to six slots.

- Level C kit \$39.95 plus \$2 P&I\*
- S100 bus connectors (five required) \$4.85 each, postpaid.

**LEVEL D** — When you reach the point in learning that requires main memory, we offer two choices: either add 4k of a memory directly on the motherboard, or add 16k to 64k of memory by means of a single S100 card, our famous "JAWS".

- Level D kit (CHECK ONE)
  - 4k on-board \$49.95 plus \$2 P&I\*
  - 16k S100 "JAWS" \$149.95 plus \$2 P&I\*
  - 32k S100 "JAWS" \$199.95 plus \$2 P&I\*
  - 64k S100 "JAWS" \$249.95 plus \$2 P&I\*
  - 128k S100 "JAWS" \$299.95 plus \$2 P&I\*

**LEVEL E** — An important "building block." It activates the 8k ROM/EPROM space on the motherboard. Now just plug in our 8k Microsoft BASIC or your own custom programs.

- Level E kit \$5.95 plus \$0 P&I\*

**MICROSOFT BASIC** — It's the language that allows you to talk English to your computer! It is available three ways:
 

- 8k cassette version of Microsoft BASIC (requires Level B) and 12k of RAM minimum, we suggest a 16k S100 "JAWS" — see above) \$89.95 postpaid.
- 8k ROM version of Microsoft BASIC (requires Level B) and 4k RAM; just plug into your Level E sockets. We suggest either the 4k Level D RAM expansion or a 16k S100 "JAWS" \$99.95 plus \$2 P&I\*
- Disk version of Microsoft BASIC (requires Level B) 32k of RAM, floppy disk controller, 8" floppy disk drive) \$325 postpaid.

**TEXT EDITOR/ASSEMBLER** — The editor/assembler is a software tool (a program) designed to simplify the task of writing programs. As your programs become longer and more complex, the assembler can save you many hours of programming time. This software includes an editor program that enters the programs you write, makes changes, and saves the programs on cassettes. The assembler performs the clerical task of translating symbolic code into the computer-readable object code. The editor/assembler program is available either in cassette or a ROM version.

- Editor/Assembler (Cassette version; requires Level B) and 8k (min.) of RAM — we suggest 16k "JAWS" — see above) \$39.95 plus \$2 P&I\*
- Editor/Assembler (ROM version supplied on an S100 card; requires Level B and 4k RAM (min.) — we suggest either Level D or 16k "JAWS") \$99.95 plus \$2 P&I\*

**8" FLOPPY DISK** — A remarkable "building block." Add our 8" floppy disk when you need faster operation, more convenient program storage, perhaps a business application, and access to the libraries of thousands of programs and program languages available today. You simply plug them into your Explorer/85 disk system — it accepts all IBM-formatted CP/M programs.

- 8" Floppy Disk Drive \$499.95 plus \$12 P&I\*
- Floppy Controller Card \$199.95 plus \$2 P&I\*
- Disk Drive Cabinet & Power Supply \$69.95 plus \$3 P&I\*
- Drive Cables (set up for two drives) \$25.00 plus \$0 P&I\*

**CP/M 2.2 Disk Operating System**, includes Text Editor/Assembler, dynamic debugger, and other features that give your Explorer/85 access to thousands of existing CP/M-based programs \$150.00 postpaid.

**NEED A POWER SUPPLY?** Consider our AP-1. It can supply all the power you need for a fully expanded Explorer/85 (note: disk drives have their own power supply). Plus the AP-1 fits neatly into the attractive Explorer steel cabinet (see below).

- AP-1 Power Supply kit (1V @ 5 amps) in deluxe steel cabinet \$299.95 plus \$2 P&I\*

**NEED A TERMINAL?** We offer you choices: the least expensive one is our Hex Keypad/Display kit that displays the information on a calculator-type screen. The other choice is our ASCII Keyboard/Computer Terminal kit, that can be used with either



1. Plug in Netronics's Hex Keypad/Display
2. Add Level B to convert to S100
3. Add 4k RAM
4. Plug in Level E, here, excerpts Microsoft BASIC or Editor/Assembler in ROM
5. Add two S100 boards
6. Add your own custom circuits (prototyping area)
7. Connect terminal

- CR1 monitor or a TV set (if you have an RF modulator).
- Hex Keypad/Display kit ... \$69.95 plus \$2 P&I\*

**FASTERM - 64 TERMINAL KIT** — Featuring a 56 key ASCII Keyboard, 128 character set upper and lower case, 75 ohm output, 8 baud rates 150 to 19,200 (switch select), RS232-C or 20 mA output, 32 or 64 character by 16 line format, complete with Deluxe Steel Cabinet and Power Supply ... \$199.95 plus \$3 P&I\*

**RF Modulator kit** (allows you to use your TV set as a monitor) \$4.95 postpaid

**12" Video Monitor** (10MHz bandwidth) ... \$139.95 plus \$3 P&I\*

**Deluxe Steel Cabinet** for the Explorer/85 ... \$49.95 plus \$3 P&I\*

**Fan for cabinet** \$15.00 plus \$1.50 P&I\*

### ORDER A SPECIAL-PRICE EXPLORER/85 PAK — THERE'S ONE FOR EVERY NEED.

**Beginner Pak** (Save \$26.00) — You get Level A (Terminal Version) with Monitor Source Listing (\$25 value) AP-1, 5-amp power supply, Intel 8085 Users Manual ... (Reg. \$199.95) SPECIAL \$149.95 plus \$4 P&I\*

**Experimenter Pak** (Save \$53.40) — You get Level A (Hex Keypad/Display Version) with Hex Keypad/Display, Intel 8085 User Manual, Level A Hex Monitor Source Listing, and AP-1, 5-amp power supply ... (Reg. \$279.95) SPECIAL \$229.95 plus \$6 P&I\*

**Special Microsoft BASIC Pak** (Save \$103.00) — You get Levels A (Terminal Version), B, D (4k RAM), E, 8k Microsoft in ROM, Intel 8085 User Manual, Level A Monitor Source Listing, and AP-1, 5-amp power supply ... (Reg. \$439.70) SPECIAL \$339.95 plus \$7 P&I\*

**Add a Rom-Version Text Editor/Assembler** (Requires levels B and D or S100 Memory) ... \$99.95 plus \$2 P&I\*

**Starter 8" Disk System** — Includes Level A, 1 floppy disk controller, one CDC 8" disk drive, two-drive cable, two S100 connectors; just add your own power supplies, cabinets and hardware ... (Reg. \$1065.00) SPECIAL \$999.95 plus \$13 P&I\*

**8k Starter System**, \$1045.95 plus \$13 P&I\*  
**4k Starter System**, \$1095.95 plus \$13 P&I\*  
**64k Starter System**, \$1145.95 plus \$13 P&I\*

**Add to any of above Explorer steel cabinet**, AP-1 five amp power supply, Level C with two S100 connectors, disk drive cabinet and power supply, two sub-1) connectors for connecting your printer and terminal ... (Reg. \$225.95) SPECIAL \$199.95 plus \$3 P&I\*

**Complete 64K System** — Wired & Tested ... \$1650.00 plus \$28 P&I\*

**Special Complete Business Software Pak** (Save \$265.00) — Includes CP/M 2.2 Microsoft BASIC, General Ledger, Accounts Receivable, Accounts Payable, Payroll Package ... (Reg. \$1325) SPECIAL \$699.95 postpaid.

\*P&I stands for "postage & insurance." For Canadian orders, double this amount.

Continental Credit Card Buyers Outside Connecticut:

## TO ORDER Call Toll Free: 800-243-7428

To Order From Connecticut, or For Technical Assistance, Call (203) 354-9375

CP/M is a reg. trademark of Digital Research

★ (Clip and mail entire ad) ★

SEND ME THE ITEMS CHECKED ABOVE

Total Enclosed (Conn. Residents add sales tax.) \$

Pay by:

Personal Check  Cashier's Check/Money Order

VISA  MASTER CARD (Bank No. \_\_\_\_\_)

Acct. No. \_\_\_\_\_ Exp. Date \_\_\_\_\_

Signature \_\_\_\_\_

Print Name \_\_\_\_\_

Address \_\_\_\_\_

City \_\_\_\_\_

State \_\_\_\_\_ Zip \_\_\_\_\_

# ANNOUNCING TWO NEW TERMINALS

Smart • Fast • Graphics • Matching Modem and \$295 Printer

Netronics announces a state of the art breakthrough in terminals. Now at prices you can afford, you can go on-line with data-bank and computer phone-line services. It's all yours: "electronic newspapers," educational services, Dow-Jones stock reports, games, recipes, personal computing with any level language, program exchanges, electronic bulletin boards ... and more every day!!!



Netronics offers two new terminals, both feature a full 56 key/128 character typewriter-style keyboard, baud rates to 19.2 kilobaud, a rugged steel cabinet and power supply. The simplest one, FASTERM-64, is a 16 line by 64 or 32 character per line unit, with a serial printer port for making hard copy of all incoming data, and optional provisions for block and special character graphics. The "smart" version, SMARTERM-80, features either 24 line by 80 characters per line or 16 by 40 characters per line, it offers on-screen editing with page-at-a-time printing, 12,000 pixel graphics, line graphics, absolute cursor addressing, underlining, reverse video, one-half intensity and much more ... Simply plug them into your computer or our deluxe green-phosphor monitor pictured above. For hard copy just add our matched printer.

Price break-through!!! Own the FASTERM-64, a complete terminal kit, ready to plug in for just \$199.95 or order the SMARTERM-80 kit for just \$299.95, (both available wired and tested) Be on-line with the million-dollar computers and data services today ... we even supply the necessary subscription forms.

More good news: All the components in our terminals are available separately (see coupon), so you buy only what you need!!!

**FASTERM-64** ... DISPLAY FORMAT: 64 or 32 characters/line by 16 lines ... 96 displayable ASCII characters (upper & lower case) ... 8 baud rates: 150, 300, 600, 1200, 2400, 4800, 9600, 19,200 (switch sel) ... LINE OUTPUT: RS232C or 20 mA current loop ... VIDEO OUTPUT: 1V PIP (EIA RS-170) ... CURSOR MODES: home & clear screen, erase to end of line, erase cursor line, cursor up & down, auto carriage return/line feed at end of line & auto scrolling ... REVERSE VIDEO ... BLINKING CURSOR ... PARITY: off, even or odd ... STOP BITS: 1, 1.5, 2 ... DATA BITS PER CHARACTER: 5, 6, 7 or 8 ... CHARACTER OUTPUT: 5 by 7 dot matrix in a 9 by 12 character ... PRINTER OUTPUT: prints all incoming data ... 1K ON BOARD RAM ... 2K ON BOARD ROM ... SERIAL CONTROLLED ... COMPLETE WITH POWER SUPPLY

**OPTIONAL GRAPHICS MODE:** Includes 34 Greek & math characters plus 30 special graphics characters ... ASCII ENCODED KEYBOARD: 56 key/128 characters. **SMARTERM-80** ... DISPLAY FORMAT: 80 characters by 24 lines or 40 characters by 16 lines 128 displayable ASCII characters (upper & lower case) 8 baud rates: 110, 300, 600, 1200, 2400, 4800, 9600, 19,200 ... LINE OUTPUT: RS232C or 20 mA current loop ... VIDEO OUTPUT: 1V PIP (EIA RS-170) ... EDITING FEATURES: Insert/delete line, insert/delete character, forward/back tab ... LINE OR PAGE TRANSMIT ... PAGE PRINT FUNCTION ... CURSOR POSITIONING: up, down, right, left, plus absolute cursor positioning with read back ... VISUAL ATTRIBUTES: underline, blink, reverse video, half intensity, & blink ... GRAPHICS: 12,000 pixel resolution block plus line graphics ... ON-SCREEN PARITY INDICATOR ... PARITY: off, even or odd ... STOP BITS: 1 to 2, all others 1 ... CHAR. OUTPUT: 7 by 11 character in a 9 by 12 block ... PRINTER OUTPUT: 60 OR 50 Hz VERTICAL REFRESH ... BLINKING BLOCK CURSOR ... CRYSTAL CONTROLLED ... 2K ON BOARD RAM ... ASCII ENCODED KEYBOARD: 56 key/128 character ... 4K ON BOARD ROM ... COMPLETE WITH POWER SUPPLY.

**TELEPHONE MODES 103 O/A ... FULL DUPLEX, FCC APPROVED ... DATA RATE: 300 baud ... INTERFACE: RS232C and TTY ... CONTROLS:** talk/data switch (no need to connect and disconnect phone), originate/answer switch on rear panel ... NO POWER SUPPLY REQUIRED.

**OPTIONAL ASCII KEYBOARD ASCII-3 ... 56 KEY/128 CHARACTER ASCII ENCODED ... UPPER & LOWER CASE ... FULLY DEBOUNCED ... 2 KEY ROLL-OVER ... POS OR NEG LOGIC WITH POS STROBE ... REQUIRES +5 & -12V DC (SUPPLIED FROM VIDEO BOARDS) ... PRINTER COMET I ... SERIAL I/O TO 9600 BAUD ... 80 CHARACTER COLUMN (132 COMPRESSED) ... 10 TRACTOR FEED ... UPPER/LOWER CASE ... INDUSTRY STANDARD RIBBONS ... 4 CHARACTER SIZES ... 9 BY 7 DOT MATRIX ... BI-DIRECTIONAL PRINTING**



Continental U.S.A. Credit Card Buyers Outside Connecticut  
**CALL TOLL FREE 800-243-7428**

To Order From Connecticut Or For Tech. Assit. Call (203) 354-9375

## NETRONICS R&D LTD. Dept. 333 Litchfield Road, New Milford, CT 06776

Please send the items checked below:

- COMPLETE FASTERM-64 TERMINAL (Includes FASTVID-64 video board ASCII-3 keyboard, steel cabinet and power supply) ... kit \$199.95 plus \$3 P&I ... wired & tested \$249.95 plus \$3 P&I ... graphics option: add \$19.95 to ea. of above
- COMPLETE SMARTERM-80 TERMINAL (Includes SMARTVID-80 video board, ASCII-3 keyboard, steel cabinet and power supply) ... kit \$299.95 plus \$3 P&I ... wired & tested \$369.95 plus \$3 P&I
- FASTVID-64 VIDEO BOARD (requires +5 & -12V DC) ... kit \$99.95 plus \$3 P&I ... graphics option add \$19.95 ... wired & tested \$129.95 plus \$3 P&I ... graphics option add \$19.95
- SMARTVID-80 VIDEO BOARD (requires +5 & -12V DC) ... kit \$199.95 plus \$3 P&I ... wired & tested \$249.95 plus \$3 P&I
- DELUXE STEEL TERMINAL CABINET ... \$199.95 plus \$3 P&I
- ASCII-3 KEYBOARD (requires +5 & -12VDC) ... kit \$69.95 plus \$3 P&I ... wired and tested \$89.95 plus \$3 P&I
- POWER SUPPLY (132 characters ASCII-3 keyboard & video boards) ... kit only \$19.95 plus \$2 P&I
- ZENITH VIDEO MONITOR (high resolution green phosphor) ... wired & tested \$149.95 plus \$6 P&I
- TELEPHONE MODEM MODEL 103 O/A ... wired & tested \$189.95 plus \$3 P&I
- DOT MATRIX PRINTER Comet I ... wired & tested \$299.95 plus \$10 P&I
- RF MODULATOR MOD RF-1 ... kit only \$8.95 plus \$1 P&I
- 3FT-25 LEAD MODEM/TERMINAL OR PRINTER/TERMINAL CONNECTOR CABLE ... \$14.95 ea plus \$2 P&I

For Canadian orders, double the postage. Conn. res. add sales tax.

Total Enclosed \$ \_\_\_\_\_

Personal Check  Cashier's Check/Money Order

VISA  MasterCard (Bank No. \_\_\_\_\_)

Acct. No. \_\_\_\_\_ Exp. Date \_\_\_\_\_

Signature \_\_\_\_\_

Print Name \_\_\_\_\_

Address \_\_\_\_\_

City \_\_\_\_\_ State \_\_\_\_\_ Zip \_\_\_\_\_

**NETRONICS Research & Development Ltd.**  
 333 Litchfield Road, New Milford, CT 06776

**more . . .  
SPECTACULAR  
OFFERS**



We stock the complete line of BASF diskettes, reel-to-reel tapes, mag cards, disk packs and cartridges. We also carry MAXELL, OPUS and WABASH products. All are 100% certified and fully guaranteed.

Box of 10 diskettes:	5 1/4" *	8" *
OPUS ss/sd .....	\$20	\$21
BASF ss/sd .....	23	24
WABASH ss/sd .....	23	24
MAXELL . . . TOO LOW TO QUOTE. CALL		
5 1/4" -10 sector-now available		
Sectoring must be specified		

5 1/4" or 8" Vinyl Storage Pages ..... 10/\$5

**LIBRARY CASES**

8" Kas-sette/10 .....	\$2.99
5 1/4" Mini Kas-sette/10 ..	\$2.49



**HARDHOLE DISK PROTECTORS**

Reinforcing rings of tough mylar protect disk hole edge from damage.

Applicators .....	5 1/4" *	8" *
Hardhole Rings (50) .....	\$3	\$4
	\$8	\$8

**DISK DRIVE HEAD  
CLEANING KITS**

Prevent head crashes and ensure error-free operation.  
5 1/4" or 8" ..... \$19.50



**SFDC-10 CASSETTES ..... 10/\$7**  
(All cassettes include box and labels.)



Get 8 cassettes, C-10 Sonic, and Cassette/8 Library-Album, as illustrated, for only ..... \$8

**SNAP-IT POWER CENTER**

Turns 1 outlet into 6. Wall mount or portable. Circuit breaker, lighted switch and UL approved.



4"x3"x2" ..... \$19.95

We also offer printer ribbons, printwheels, type elements, equipment covers, power consoles, paper supplies, storage and filing equipment, furniture and many other accessories for word and data processing systems. Write for our free catalog.

VISA • MASTERCHARGE • MONEY ORDERS • CERTIFIED CHECK • FOR PERSONAL CHECKS ALLOW TWO WEEKS • C.O.D. REQUIRES A 10% DEPOSIT • CAL. RES. ADD 6% SALES TAX • MIN \$2 SHIPPING & HANDLING • MINIMUM ORDER \$10 • SATISFACTION GUARANTEED OR FULL REFUND

**ABM  
PRODUCTS**

8868 CLAIREMONT MESA BLVD.  
SAN DIEGO, CALIFORNIA 92123

Toll Free 800-854-1555 Order Only  
For information or California Orders  
(714) 268-3537

*Listing 2 continued:*

```
60072 PRINT D$ "WRITE SPEECH." TN$
60073 PRINT TA
60074 FOR T1 = 1 TO TA
60075 PRINT TW$(T1)
60076 PRINT TP$(T1)
60077 NEXT T1
60078 PRINT D$ "CLOSE SPEECH." TN$
60079 GOTO 60026
60080 REM
```

```
60081 REM *****
60082 REM * PREPARE NEW WORD *
60083 REM *****
60084 HOME : PRINT " PREPARE AND ADD NEW WORD TO DICTIONARY"
60085 LET T3 = FRE (0)
60086 VTAB 4: INVERSE : PRINT "INSTRUCTIONS": NORMAL
60087 PRINT " 1. ENTER PHONETIC SOUND"
60088 PRINT " 2. HIT RETURN TO HEAR IT"
60089 PRINT " 3. CONTINUE THE PROCESS UNTIL CORRE
```

```
CT"
60090 PRINT " 4. HIT RETURN (NO ENTRY) TO SAVE"
60091 PRINT
60092 PRINT " NOTE: A SPACE AT THE END OF A WORD IS
REQUIRED TO STOP SOUND"
60093 POKE 34,12: REM SET TOP OF WINDOW
```

```
60094 LET TS$ = ""
60095 REM INPUT LINE WITH EDITING TO MEMORY STARTING AT 512 - THE
N CONVERT TO STRING
60096 POKE 51,160: CALL 64874
60097 LET TS$ = "" : FOR T1 = 1 TO 255: IF PEEK (511 + T1) = 141 T
HEN 60099
```

```
60098 LET TS$ = TS$ + CHR$ ( PEEK (511 + T1) - 128) : NEXT T1
60099 IF LEN (TS$) = 0 THEN GOTO 60103
60100 LET T1$ = TS$
60101 LET T$ = TS$: GOSUB 60186
60102 GOTO 60094
```

```
60103 IF RIGHT$ (T1$,1) = " " AND T1$ ( ) = " " THEN T1$ = LEFT$
(T1$, LEN (T1$) - 1): GOTO 60103
60104 PRINT "DO YOU WISH TO SAVE THE SOUND": INVERSE : PRINT T1$:
NORMAL : PRINT " (Y/N) ": GET TT$: PRINT
60105 IF TT$ ( ) = "Y" THEN TEXT : GOTO 60026
```

```
60106 INPUT "WHAT WORD HAS THIS SOUND ": TT$
60107 IF LEN (TT$) = 0 THEN 60028
60108 REM FIND ALPHABETICAL POSITION OF NEW WORD IN ARRAY
60109 IF TA = 0 THEN 60118
60110 FOR T1 = 1 TO TA
```

```
60111 IF TW$(T1) ( TT$ THEN NEXT T1
60112 IF TW$(T1) ( ) TT$ THEN 60115
60113 LET TP$(T1) = T1$
60114 TEXT : GOTO 60081
60115 LET T2 = T1
60116 REM MOVE ARRAY TO MAKE ROOM FOR NEW WORD
```

```
60117 FOR T1 = TA TO T2 STEP - 1: TW$(T1 + 1) = TW$(T1): TP$(T1 + 1)
= TP$(T1): NEXT T1
60118 LET TA = TA + 1
60119 IF T2 = 0 THEN T2 = 1
60120 LET TW$(T2) = TT$: TP$(T2) = T1$
60121 TEXT : GOTO 60081: REM
```

```
60122 REM *****
60123 REM * LIST DICTIONARY *
60124 REM *****
60125 HOME : PRINT " LIST DICTIONARY": VTAB 3: PRINT "(A
NY KEY TO CONTINUE - ESC FOR MENUE)": VTAB 10
60126 IF TA = 0 THEN PRINT "NO WORDS IN DICTIONARY": FOR T3 = 1 T
O 1000: NEXT T3: GOTO 60026
```

```
60127 PRINT "DO YOU WANT THE PRINTER ON (Y/N) ": GET T$
60128 IF T$ = "Y" THEN CALL 768: REM TURN PRINTER ON
60129 HOME : T3 = 1: FOR T2 = 1 TO TA
60130 LET T3 = T3 + 1: IF T$ ( ) = "Y" AND T3 = 20 THEN GET T1$: T3
= 1: IF T1$ = CHR$ (27) THEN 60026
```

```
60131 PRINT TW$(T2), TP$(T2)
60132 NEXT T2
60133 IF T$ ( ) = "Y" THEN GET T1$
60134 PRINT D$ "PR#0": REM TURN PRINTER OFF
60135 GOTO 60026
60136 REM
```

```
60137 REM *****
60138 REM * SAY A SENTENCE *
60139 REM *****
60140 HOME : PRINT " SAY A SENTENCE"
60141 PRINT : PRINT "DO YOU WANT GRAPHICS (Y/N) ": GET TS$
60142 LET TC = 0: TF = 0: IF TS$ = "Y" THEN TC = 1
60143 PRINT
```

```
60144 POKE 34,5: VTAB 6: REM SET WINDOW
60145 PRINT "WHAT SENTENCE ": INPUT TS$
60146 IF LEN (TS$) = 0 THEN 60026
60147 GOSUB 60150: IF TC = 1 THEN TEXT : GOTO 60137
60148 GOTO 60145
60149 REM
```

```
60150 REM *****
60151 REM * SAY TS$ *
60152 REM *****
```

Listing 2 continued:

```

60153 IF TG = 0 THEN 60155
60154 IF TF = 0 THEN GOSUB 60182:TF = 1
60155 LET TS% = TS% + " ":T1% = "":T3 = FRE (0)
60156 FOR T1 = 1 TO LEN (TS%)
60157 IF MID% (TS%,T1,1) = " " THEN 60161
60158 LET T1% = T1% + MID% (TS%,T1,1)
60159 NEXT T1
60160 RETURN
60161 REM BINARY SEARCH OF ARRAY FOR WORD
60162 IF LEN (T1%) = 0 THEN 60159
60163 LET TL% = TA:TS% = 1
60164 LET T2% = TW%(TS%):TT% = TW%(TL%)
60165 IF T1% > T2% AND T1% < TT% THEN 60168
60166 IF T1% = T2% THEN T = TS%:GOTO 60178
60167 IF T1% = TT% THEN T = TL%:GOTO 60178
60168 LET T% = ((TL% - TS%) / 2) + TS%
60169 LET TY% = TW%(T%)
60170 REM NOT FOUND - SEND ORIGINAL WORD
60171 IF TY% = T% THEN T% = T1%:T1% = "":GOSUB 60181:GOTO 60159
60172 LET T% = TY%
60173 IF T1% > TY% THEN 60175
60174 LET TL% = T%:TT% = TY%:GOTO 60164
60175 LET TS% = T%:T2% = TY%:GOTO 60164
60176 REM FOUND AT ELEMENT T
60177 REM FOUND AT T - SEND PHONETIC EQUIVALENT
60178 LET T% = TP%(T):GOSUB 60181
60179 LET T1% = "":GOTO 60159
60180 REM

60181 REM *****
60182 REM * OUTPUT T% *
60183 REM * TO SYNTHESIZER *
60184 REM *****
60185 LET T% = T% + " ":IF TG THEN GOSUB 60226:IF RND (1) > .7
THEN GOSUB 60214
60186 FOR T3 = 1 TO LEN (T%)
60187 POKE 49361,ASC (MID% (T%,T3,1)):POKE 49364,0:REM SEND T
O OUTPUT PORT
60188 NEXT T3
60189 IF TG THEN GOSUB 60234
60190 RETURN
60191 REM

60192 REM *****
60193 REM * DRAW LORES FACE *
60194 REM *****
60195 REM MAIN FACE
60196 GR : POKE - 16302,0:REM FULL SCREEN GRAPHICS
60197 FOR T2 = 40 TO 47:HLIN 0,39 AT T2: NEXT T2
60198 COLOR= 8:HLIN 9,30 AT 0:COLOR= 7
60199 FOR T2 = 1 TO 39:HLIN 9,30 AT T2: NEXT T2
60200 VLIN 2,37 AT 8:VLIN 2,37 AT 31
60201 VLIN 4,35 AT 7:VLIN 4,35 AT 32
60202 VLIN 8,33 AT 6:VLIN 8,33 AT 33
60203 VLIN 13,32 AT 5:VLIN 13,32 AT 34
60204 VLIN 18,26 AT 4:VLIN 18,26 AT 35
60205 HLIN 9,30 AT 40:HLIN 10,29 AT 41
60206 HLIN 10,29 AT 42:HLIN 11,28 AT 43
60207 HLIN 12,27 AT 44:HLIN 13,26 AT 45
60208 HLIN 14,25 AT 46:HLIN 15,24 AT 47
60209 REM FACIAL FEATURES
60210 COLOR= 10:VLIN 23,33 AT 19:VLIN 23,33 AT 20
60211 COLOR= 3:VLIN 30,32 AT 18:VLIN 30,32 AT 21
60212 COLOR= 8:PLOT 18,33:PLOT 21,33
60213 HLIN 10,15 AT 16:HLIN 24,29 AT 16:GOSUB 60234
60214 REM EYES
60215 COLOR= 7:FOR T4 = 18 TO 21
60216 HLIN 11,14 AT T4:HLIN 25,28 AT T4: NEXT T4
60217 LET TH% = RND (1) * 5:TV% = RND (1) * 2:COLOR= 0
60218 FOR T4 = 10 TO 11:FOR T5 = 19 TO 20
60219 PLOT T4 + TH%,T5 + TV%:PLOT T4 + 14 + TH%,T5 + TV%: NEXT T5
,T4
60220 COLOR= 3:HLIN 11,14 AT 18 + TV%:HLIN 25,28 AT 16 + TV%
60221 COLOR= 8:HLIN 10,15 AT 18:HLIN 24,29 AT 18
60222 HLIN 10,15 AT 22:HLIN 24,29 AT 22
60223 VLIN 19,21 AT 10:VLIN 18,21 AT 15
60224 VLIN 18,21 AT 24:VLIN 18,21 AT 28
60225 RETURN
60226 REM MOUTH OPEN
60227 COLOR= 10:HLIN 16,23 AT 37:HLIN 17,22 AT 40
60228 COLOR= 8:PLOT 14,37:PLOT 25,37
60229 COLOR= 3:PLOT 13,36:PLOT 26,36
60230 COLOR= 0:HLIN 15,24 AT 38
60231 HLIN 16,17 AT 39:HLIN 22,23 AT 38
60232 COLOR= 8:HLIN 18,21 AT 39
60233 RETURN
60234 REM MOUTH CLOSE
60235 COLOR= 7:HLIN 15,24 AT 39:HLIN 15,24 AT 40
60236 COLOR= 10:HLIN 16,23 AT 37:HLIN 17,22 AT 38
60237 COLOR= 8:PLOT 14,37
60238 COLOR= 3:PLOT 13,36:PLOT 26,36
60239 COLOR= 0:HLIN 16,17 AT 38:HLIN 22,23 AT 38
60240 COLOR= 8:HLIN 18,21 AT 38
60241 RETURN
    
```

# We Beat All Prices!

**hp** HEWLETT  
PACKARD

HP-85

OR  
HP-125  
CP/M<sup>®</sup> based.

**\$1989**

Your Choice



## NEW HP-87... CALL

5 1/4" Dual Master Disk Drive	CALL
8" Dual Master Disk Drive	CALL
5meg WINCHESTER Hard Disk	\$3599
5meg WIN. w/5 1/4" DSDD floppy	\$4399
APPLE II PLUS, 48K	CALL
APPLE III	CALL
TI 99/4	\$387
COMMODORE VIC-20	\$255
NEC PC-8001-A, 32K	\$989
XEROX 820 5 1/4" Disk Drives	\$2489
XEROX 820 8" Disk Drives	\$3095

### TI CALCULATORS

TIP-55-II	\$38
TIP-Business Analysis II	\$38
TIP-58C	\$79
TIP-59	\$189
TIP-P-100C	\$148

**HP-41CV**

w/Five times  
more memory

**Built In**  
List, \$325

**\$244**

**NOW IN STOCK**



**\$189**  
HP-41C  
list, \$250

HP-41CV Printer	\$289.00
HP-41CV Quad Memory	\$83.95
HP-41CV Card Reader	\$167.95
HP82160A HP-IL Module	\$99.00
HP82161A Digital Cassette Drive	\$449.00

**ATARI® 800 \$689**

\*Limited time only



**ATARI 400 \$339**

Atari 830 Acoustic Modem	\$145
Atari 825 80 Col. Impt. Ptr	\$65
Atari 410 Prog. Recorder	\$69
Atari 810 Disk Drive	\$418

**Personal  
PCs  
Systems**

P.O. Box 1073  
Syracuse, N.Y. 13201  
**(315) 478-6800**

Prices do not include shipping by UPS. All prices and offers are subject to change without notice



# Remember when driving was fun?



## The MG-TD Replica By FIBERFAB

Rediscover the *fun* of driving, in this genuine replica of the '52 MG-TD. Detailed, authentic, this sporty roadster gives you all the pleasure of a classic sportscar – with easy maintenance and reliability, too! Easy-to-assemble kit comes complete with everything you need to build the car at home in your leisure time, over a VW chassis and engine. Factory-built models also available. Fuel efficient, economical, and beautiful: you'll enjoy

building it now, and driving it for years. Why long for the "good old days" – they're here now! Call toll-free for complete information:  
**1-800-328-5671\***

\*In Minnesota, (612) 544-2781.  
International TWX: 910-576-3150.  
Or write for complete brochures: send \$3.00 with your name, address, telephone number and the name of this publication, to Fiberfab, 1000 Turners Cross Rd., Minneapolis, MN 55416. Specify information on the MG-TD Replica.



Text continued from page 448:

The INITIALIZATION section dimensions the WORD and PHONEME arrays to hold 300 entries each. This situation can be modified, of course, to suit your needs. In addition, the string variable D\$ is initialized by setting it equal to control-D for use in disk operation of the Apple. (This step would be omitted for such computers as the TRS-80.)

The MENU section allows easy selection of the desired function when developing a vocabulary. The GET statement permits you to enter data from the keyboard without using the Return key.

The two DISK modules save and retrieve the two arrays that contain the vocabulary. Two variables are particularly important if you are converting this program for use on another computer. The number of words in the dictionary, and thus the number of entries in each array, is the first number in the disk file. It is read into the variable TA, and it controls the number of words that are subsequently read into each array. The variable TN\$ holds the name of the disk file; this allows you to use several dictionaries. Dictionaries can also be loaded and saved to other disks when required.

The section for PREPARING A NEW WORD allows you to easily develop the proper sounds for a new dictionary entry.

Any character or group of characters will be "said" by the synthesizer when the Return key is hit. The last sound is continually voiced, so each word should be followed by a space. This "problem" is actually a design feature. When developing a word, you can listen to each sound by typing its character and hitting Return with no space. This feature is indispensable when comparing different phonemes.

When the word is finally correct, hit Return with no entry, and you will be asked if you wish to save that sound. If you do, you will also be asked to supply a word that demonstrates the sound. Both the word and its sound will be automatically entered into the dictionary in alphabetical order. The importance of this will become apparent in a moment.



## 68000 MINI-SYSTEMS

IEEE-696 S-100 Compatible

### Special Offer

**ERG-I \$7995** — CPU, 4 RS232 SERIAL PORTS, 64K STATIC RAM, 10 SLOT BACK PLANE, 2 8" DOUBLE DENSITY, DOUBLE SIDED FLOPPIES OR A 5MB 5¼" WINCHESTER, 68KFORTH<sup>1</sup> SYSTEMS LANGUAGE WITH MACRO ASSEMBLER, ALL INTEGRATED INTO DESK TOP CABINET, BURNED-IN AND TESTED.

**ERG-II \$9795** — SAME AS ERG-I EXCEPT FOR MASS STORAGE; ERG-II HAS A 5MB 5¼" WINCHESTER AND ONE 8" DOUBLE DENSITY, DOUBLE SIDED DRIVE.

**ERG-III \$12995** — CPU, 4 RS232 SERIAL PORTS, 256K DYNAMIC RAM, 10 SLOT BACK PLANE, 5MB 5¼" WINCHESTER AND ONE 8" DOUBLE DENSITY, DOUBLE SIDED DRIVE, IDRIS<sup>2</sup> MULTI-USER, MULTI-TASKING OPERATING SYSTEM AND C COMPILER, ALL INTEGRATED INTO DESK TOP CABINET, BURNED-IN AND TESTED.

**ERG-IV \$18995** — CPU, 8 RS232 SERIAL PORTS, 512K DYNAMIC RAM, 10 SLOT BACK PLANE, 24MB 8" WINCHESTER AND 20 MB ¼" TAPE CARTRIDGE, IDRIS<sup>2</sup> MULTI-USER, MULTI-TASKING OPERATING SYSTEM WITH BOTH C AND PASCAL COMPILERS, ALL INTEGRATED INTO DESK TOP CABINET, BURNED-IN AND TESTED.

8MHz CPU Standard, 10MHz Optional; OEM Pricing for CPU, Card Sets and Integrated Systems Available.

Trademark <sup>1</sup> ERG; <sup>2</sup> WHITESMITHS LTD.

30 Day Delivery for Integrated Systems with valid purchase order

#### EMPIRICAL RESEARCH

United Kingdom  
MicroAPL LTD.  
London 834-2687

GROUP, INC.  
POB 1176  
MILTON, WA 98354  
206-631-4855

Australia/New Zealand  
S.I. MicroComputer  
Prod. LTD.  
Sydney 231-4091

If you convert this program to another BASIC, lines 60095 to 60098 could present problems. These lines utilize a subroutine in the Apple's monitor that enters characters into the buffer area. A simple INPUT T\$ could have been used, but my method allows you to enter such illegal characters as semicolons and quotes. In addition, it preserves all of the Apple editing features.

The LIST DICTIONARY allows you to dump all the present words and their sound codes to the screen (or a printer). The listing scrolls a new screen full each time a key is pressed. ESC will abort the listing and return to the MENU.

The section SAY A SENTENCE is used to say the words contained in T\$. It may be used as a separate subroutine if it is entered at line 60150, which only says T\$, without entering it from the keyboard. This module performs a binary search of the words in the dictionary and outputs the appropriate sound to the synthesizer.

By using a binary search of the dictionary, conversion is done very quickly. For example, 256 words can be examined with only eight reads. This is possible because the words are organized in alphabetical order and the program divides the remaining words in half with each successive guess.

If the word is not found in the dictionary, it (not its phonemes) is sent to the synthesizer. Such words are, at best, poorly pronounced, but at least the system does not crash in the middle of a big demonstration. In most cases you'll find that one bad word is easily recognized in the context of a complete sentence.

The FRE(0) function in lines 60085 and 60155 forces an internal clean-up of the Applesoft string variables. This operation can require several seconds, depending on the length of the dictionary. When utilizing subroutines from this system in other programs, FRE(0) can be postponed until several sentences have been voiced. This will allow pauses at the most natural points.

Section OUTPUT T\$ sends the phoneme code of each individual



**BUSINESS SOFTWARE YOU CAN SELL WITH NO ROYALTIES!**

Vandara has an incredible deal for dealers, OEMs and mature users. Buy the complete Vandara business software package for a low \$295, and then resell it as often as you wish to end users without paying royalties.

This is the best-debugged, easiest-to-install, enhanced Osborne-based system on the market. The industry standard accounting package with thousands of users. It's well worth up to \$995 to end users.

You'll receive both source and object code for General Ledger, Accounts Receivable, Accounts Payable and Payroll & Cost Accounting. Plus, our custom installation program that tailors the system to most terminals and disks.

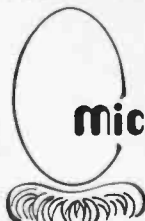
Minimum requirements are 48K RAM, CP/M™ or CDOS, CBASIC2,™ a CRT, and a 132-column printer. Vandara can provide standard 8", NorthStar 5" double-density or Heath/Zenith 5" diskettes. Our installation manual is included and the Osborne/McGraw-Hill application manuals are available separately.

**VANDARA**

17544 Midvale Ave. N., Suite 205, Seattle, WA 98133. (206) 542-7611

**The Birth of UNIX™ for CP/M™!**

Brings to CP/M  
Some of the  
**BEST FEATURES**  
of UNIX!



**microShell™** The...  
•POWER of UNIX  
•POPULARITY OF CP/M

Available for adoption by: CP/M SOFTWARE DEVELOPERS  
CP/M SOFTWARE USERS

CP/M Compatibility	<ul style="list-style-type: none"> <li>• Loads and Executes as a normal program under CP/M. Installing itself under the CP/M operating system</li> <li>• Other CP/M programs - editors/word processors/application programs/compilers/assemblers - may then be run using all MicroShell features</li> <li>• CP/M compatibility is generally not affected by MicroShell's presence</li> <li>• Adds UNIX Power without losing CP/M Compatibility</li> </ul>
Console Input/Output Redirection	<ul style="list-style-type: none"> <li>• Send Console Output to a File instead of or in addition to the screen Example: stat "." &gt; status - sends "stat" output to file "status"</li> <li>• Take Console Input from a File instead of the Keyboard Example: ed filename &lt; script - takes "ed" commands from the file "script"</li> <li>• Indispensable for: graphic debugging, saving exact Screen Output for documentation, etc.</li> </ul>
Automatic Command File Search Path	<ul style="list-style-type: none"> <li>• MicroShell finds your program. User concentrates on the big tasks, MicroShell does the details</li> <li>• Permits development or data files on one drive and all programs on another</li> <li>• User-specified file types for Automatic Search. Example: ".com", ".int", etc.</li> <li>• User-specified Search Path. Example: Current Drive 1st, then Drive A, etc.</li> </ul>
Multiple Commands Per Line	<ul style="list-style-type: none"> <li>• User types a logical group of commands to be executed Example: compile file; link file; file</li> <li>• MicroShell executes the commands one at a time</li> </ul>
Direct Command File Execution	<ul style="list-style-type: none"> <li>• Files of CP/M or MicroShell commands are executed by MicroShell simply by typing file name</li> <li>• User-specified Command Filetypes. Example: ".sh", ".sub", etc.</li> <li>• Argument substitution (\$1, \$2, etc.) as with CP/M SUBMIT/XSUB</li> </ul>
Additional Features	<ul style="list-style-type: none"> <li>• User definable prompt with Disk Drive and/or User Number optional</li> <li>• Install program to customize MicroShell to user's needs &amp; system</li> <li>• Others - ORDER MANUAL FOR FULL DETAILS</li> </ul>

CP/M 2.2/32K with 6080/8085/280 CPU Required

★ ADOPTION FEE: \$150.00  
Manual Only: \$ 25.00

(VA residents add 4% sales tax)

VISA, MC, Check or Money Order

**NEW GENERATION SYSTEMS, inc.**

Mail or Phone Adoption Requests to:  
2153 Golf Course Drive  
Reston, VA 22091  
(703) 476-9143

CP/M - TM of Digital Research Corp  
UNIX - TM of Bell Telephone Labs

# "RAIR" AND WELL DONE!



The Rair family of computers combine high performance features for a fraction of what you would expect to pay. Rair's Black Box Micro Computers were designed with all the features that today's users want most. Desk-top design requires no special environment. "Black Box" architecture allows

computer systems to be configured for the widest range of computing applications. Black Box systems are supported by common development software allowing total program portability across the entire range. Drake Microsystems puts it all together. A complete line of hardware and software, and the know-how to make it work.



2777 Orchard Run Rd.  
West Carrollton, Ohio  
45449  
(513) 435-2283

word to the synthesizer. My program sends it to a port at address 49361 and strobes it in by writing to address 49364. On a TRS-80 you would only need to print T\$ into the last 32 screen locations. The example programs provided in the synthesizer manual should aid in converting this module for use with a TRS-80.

One peculiarity of operating the system should be mentioned. Sending a "7" to the synthesizer will toggle it on or off depending on its present state. Since Reset does not turn the synthesizer on, you may or may not have to send a "7" to initially activate it.

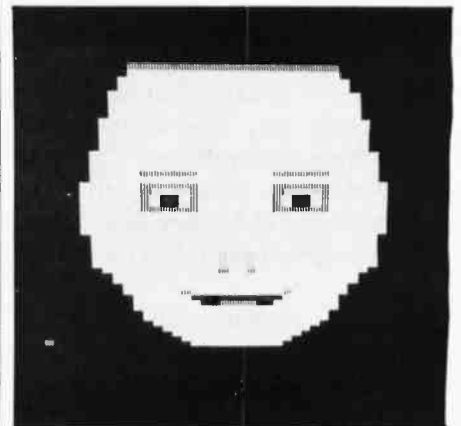


Photo 3: Low-resolution graphics display adds life to the speech program.



## Carbonless checks, invoices and statements

- ★ Standard formats...plus Custom Design Service!
- ★ Small quantities (as low as 500)...plus money-saving prices!
- ★ Super-fast service (shipped 5 days after receipt of order!)

SEND COUPON...OR CALL TOLL-FREE: 1-800-328-9697.



To: Delmart Company, Division of Deluxe Check Printers, Inc., 530 N. Wheeler St., P.O. Box 43495, St. Paul, MN 55164-0495

**YES**, please send free color catalog!

Name \_\_\_\_\_ Title \_\_\_\_\_  
 Firm \_\_\_\_\_  
 Street \_\_\_\_\_ Phone (\_\_\_\_\_) \_\_\_\_\_  
 City \_\_\_\_\_ State \_\_\_\_\_ Zip \_\_\_\_\_

85

As an afterthought, I decided to add a little spice to the program. The final module (draw a low-resolution face) produces the graphics shown in photo 3. Such an addition would have to be greatly modified if run on a TRS-80, but I heartily recommend it. The mouth opens and closes with each word and the eyes (complete with eyelids) move at random. I can't tell you the reaction a talking face gets from a person not used to working with computers.

I'm extremely happy with the addition of voice output to my personal computer, and it has inspired several applications that may be discussed in future articles. If you want your machine to talk, compare the phonetics approach with other methods. If it meets your requirements, I hope that my speech-development system will make your life easier. ■



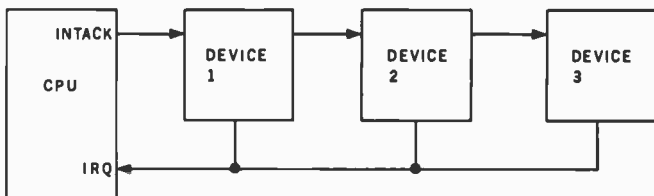
## Hierarchical Interrupts

Caxton C. Foster  
Computer and Information Science  
University of Massachusetts  
Amherst, MA 01003

Most popular microprocessors will support daisy-chained peripheral devices. These allow a peripheral close to the processor to gain priority over a more distant peripheral when both devices request interrupt service simultaneously. This is normally done by using two lines between the processor and its set of peripheral devices (see figure 1). The first line is the IRQ (interrupt-request line). Any device is allowed to "pull" this line to ground, thus generating a request for interrupt service. At the convenience of the processor, the second line (the interrupt-acknowledge line or INTACK) is energized, indicating that the processor is ready to accept an interrupt.

The INTACK line goes sequentially from device to device, thus giving rise to the term "daisy chain." If a device isn't requesting an interrupt, it passes the unchanged INTACK signal to its successor in the chain. If, however, a device is in the active state and is requesting an interrupt, it "traps" the acknowledge signal. Since devices farther down the line never receive the acknowledge signal, they don't take control of the processor or the system bus.

In any imaginable interrupt system, if devices A and B request interrupts simultaneously, either A wins or B wins (ties are not permitted). We have, in effect, a strict ordering of all the peripheral devices by priority. Adding



**Figure 1:** Daisy-chain connection of interrupting peripherals. If two peripheral devices interrupt simultaneously, the device closer to the computer takes priority over the one farther away. This system allows a higher-priority device to interrupt a lower-priority device.

a hierarchical level mechanism merely gives the device at level  $n$  priority over the devices on level  $n - 1$  or lower. In this sense, a daisy chain is a general solution to the problem of resolving simultaneous requests.

Unlike a daisy chain, a hierarchical scheme keeps low-priority devices from interrupting the code processing the interrupt of a high-priority device. In a typical hierarchical scheme, the processor has a level at which it is currently running. Each peripheral device requests an interrupt on one of several lines: IRQ0, IRQ1 . . . IRQ $n$  where  $n$  is commonly 3 or 7 (see figure 2). A priority encoder examines these request lines and outputs a binary number corresponding to the number of the highest active request line. This binary number is compared with the processor's current level and, if the level of the processor is greater than or equal to the level of the request, the request is not acted upon and no new interrupt is generated. Only if the request level exceeds the processor level will the current program be interrupted. If an interrupt is to be honored, the interrupt-acknowledge line (INTACK0, INTACK1 . . . INTACK $n$ ) corresponding to the level of the highest request is activated.

Three difficulties accompany the hierarchical-interrupt scheme. Foremost is the fact that many otherwise attractive microprocessors don't have one. Second, microprocessors that *do* incorporate such a scheme usually have too many levels (causing some hardware to go unused) or too few (almost as difficult as none at all). Third, for  $n$  levels,  $2n$  lines must be added to the I/O (input/output) bus to convey requests and acknowledgments.

### The Present Method

In a daisy chain, each peripheral device has an interrupt flag that has two states: on and off. To turn the processor's interrupt system back on (so that other, more important interrupts can be recognized), this initial interrupt flag must be cleared (thus releasing the IRQ line)

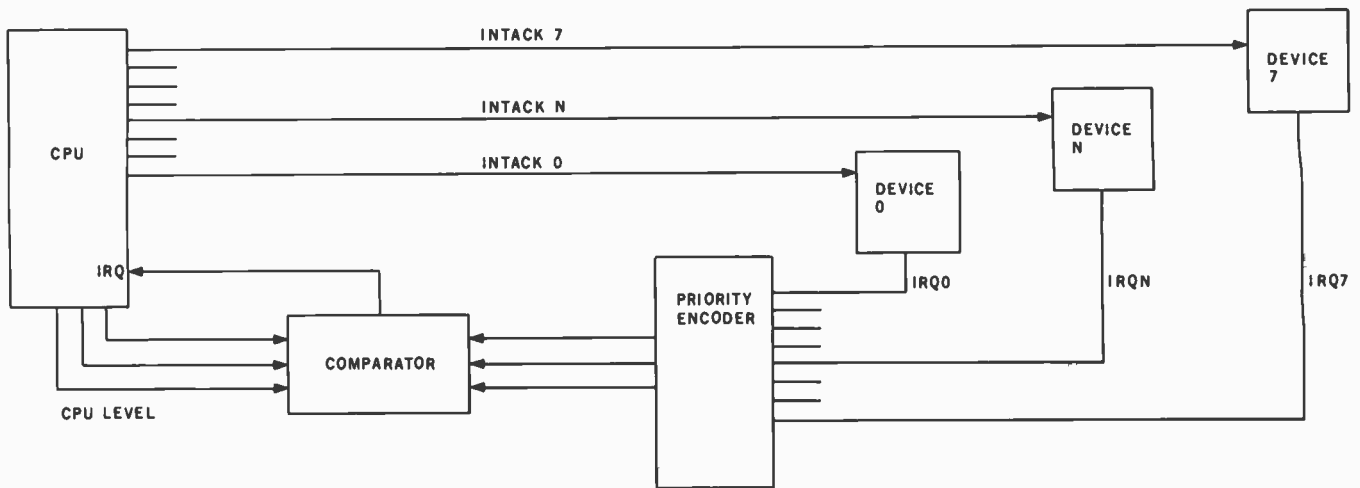


Figure 2: A typical hierarchical-interrupt scheme. The processor keeps track of the interrupt level it's currently servicing and will pause to give service only if an interrupt occurs at a higher level.

soon after its recognition. If this is not done and all interrupts are serviced with the interrupt system disabled, the intended hierarchy becomes a first-come-first-served system.

Peripheral devices could be equipped with a three-state interrupt flag:

- Off—not requesting service (does not affect IRQ); passes INTACK down the chain (away from the processor) and passes IRQ up the chain (toward the processor).
- On—requesting service (asserts IRQ); does not pass INTACK down line but traps it instead.
- Blocking—not requesting service; does not pass IRQ up the chain.

States Off and On correspond to the two conventional states. In the Blocking state, the device refuses to allow lower-priority devices (those farther down the chain) to break into its interrupt-service routine, thus protecting its own priority and incidentally providing a hierarchy with as many levels as there are peripheral devices. When a device needs service, it changes from Off to On. At the first clear-interrupt flag (issued by the processor prior to re-enabling the interrupt system), the device changes its state from On to Blocking. This releases the IRQ line and also prevents lower-priority devices from pulling it down. At the second clear-interrupt flag (issued by the processor at the end of the interrupt routine), the device changes from Blocking to Off.

Clearly a paragon of interrupt systems, it allows each device to protect its own service routine from all lesser requests. The system allows infinitely fine discrimination, with classes of devices having one member each.

### A Less Expensive Realization

The system described above requires an additional flip-flop and a few additional gates at each peripheral device.

If this configuration is too expensive, it's possible to envision an intermediate system.

Into the daisy chain we insert a few *blocking nodes* (see figure 3). To the processor, these look like normal peripheral devices with a peripheral address. They are capable of executing two operations: Block and Unblock. In the Unblock state these special nodes are transparent and have no effect on the daisy chain, but in the Block state they inhibit any interrupt requests from devices beyond them in the chain.

After recognizing an interrupt and before re-enabling the interrupt system, the processor issues a Block command to the node just inboard of the active peripheral. At the conclusion of the service routine, the processor Unblocks the node and allows all peripheral devices an opportunity to compete for attention.

If the processor had one more output line (the Unblock line), we could dispense with the addresses for these nodes. On interrupt request, the nearest inboard node could set itself automatically to the Block state and forward the interrupt request to the processor. At the conclusion of an interrupt-service routine, the processor could issue an Unblock command on the Unblock line, and the Blocked node nearest the processor could reset itself.

### Conclusion

Either of these solutions would provide a moderate-cost, reasonably flexible means of keeping low-priority devices from interrupting high-priority service routines. To be sure, the priority of a device would depend on its position in the daisy chain. Not only would it be a considerable nuisance to rearrange the priorities, but it would, in fact, be impossible to accomplish without operator assistance.

Using memory-mapped I/O with PIAs (peripheral interface adapters) or VIAs (versatile interface adapters) is a more flexible solution than either proposed here,

Number	Type	+5 V	GND
IC1	7402	14	7
IC2	7430	14	7
IC3	7474	14	7

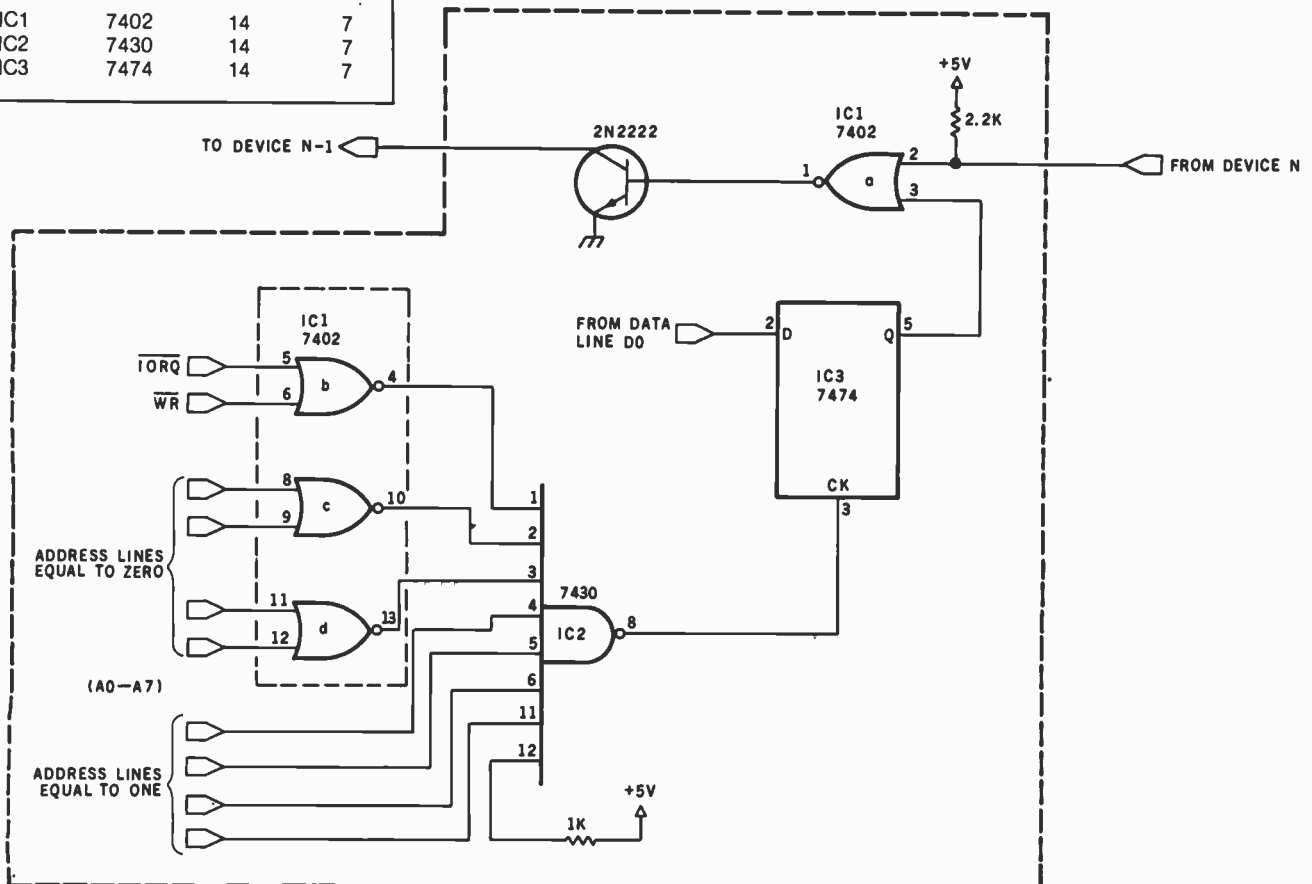


Figure 3: A compromise hierarchical system. This method reduces cost by using "blocking nodes" in a daisy-chain system.

because an arbitrary priority hierarchy can be constructed that doesn't even need to be transitive (A can block B and C, B can block C, and C can block A and B). The mask bits in the VIA permit and block interrupts from devices in any fashion that seems acceptable to the

system at a particular time. For a system organized on an I/O bus, however, either of the schemes proposed here offers a great improvement over the simple interrupt armed or interrupt disarmed that have been the usual implementations to date. ■

## JAY WEINBERG: LIVING PROOF YOUR CONTRIBUTIONS COUNT.

These days, Jay Weinberg's most difficult battles take place on the tennis court. Five years ago, he had a different kind of fight on his hands: against one of the toughest forms of cancer.

Cancer research and treatment have made Jay's kind of recovery possible for almost 2 million people. Which means that your donations have helped buy Jay Weinberg a very beautiful gift: his life.

**CANCER CAN BE BEAT.**

**American  
Cancer Society**



# Books Received

*Apple II/III Software Directory*, G. Van Diver and R. Love. Overland Park, KS: Vital Information Inc. (7899 Mastin Dr.), 1982; 1148 pages, 13 by 20.5 cm, softcover, ISBN none, \$19.95.

*Assembly Language for the PDP-11*, Charles Kapps and Robert L. Starford. Boston, MA: CBI Publishing Company, 1981; 353 pages, 17.5 by 23.5 cm, hardcover, ISBN 0-87150-304-2, \$23.50.

*BASIC Programs for Home Financial Management*, W. B. Goldsmith Jr. Englewood Cliffs, NJ: Prentice-Hall, 1981; 314 pages, 21.5 by 28 cm, hardcover, ISBN 0-13-066522-3, \$18.95.

*BASIC Programs for Scientists and Engineers*, Alan R. Miller. Berkeley, CA: Sybex, 1981; 318 pages, 17.5 by 23.5

cm, softcover, ISBN 0-89588-073-3, \$14.95.

*A Bibliography of Computer Music*, Sandra L. Tjepkema. Iowa City, IA: University of Iowa Press, 1981; 276 pages, 15 by 23 cm, hardcover, ISBN 0-87745-110-9, \$17.50.

*CAI Sourcebook*, Robert L. Burke. Englewood Cliffs, NJ: Prentice-Hall, 1982; 206 pages, 15 by 23 cm, hardcover, ISBN 0-13-110155-2, \$14.95.

*Computers for People*, Jerry Willis and Merl Miller. Beaverton, OR: Dilithium Press, 1982; 200 pages, 13 by 21 cm, softcover, ISBN 0-918398-64-9, \$7.95.

*Computer Simulation of Classical Substitution Cryptographic Systems*, Rudolph F. Lauer. Laguna Hills, CA:

Aegean Park Press, 1981; 111 pages, 21.2 by 27.2 cm, softcover, ISBN 0-89412-050-6, \$24.80.

*Database Management System Anatomy*, James A. Larson. Lexington, MA: Lexington Books, 1982; 183 pages, 15.5 by 22.5 cm, hardcover, ISBN 0-669-04544-6, \$22.95.

*Databook of Venture Capital Sources for High-Technology Companies*, Richard Loftin. Washington, DC: Financial Data Corporation, 1981; 576 pages, 14.5 by 22.3 cm, softcover, ISBN 0-940758-00-8, \$115.

*The 8085/SDK-85 [Hands-On, Volume 2]*, Howard Boyet. New York: MTI Publications, 1981; 814 pages, 15.5 by 23 cm, softcover, ISBN none, \$19.95.

*The 8051: Programming, Interfacing, Applications*, Howard Boyet and Ron Katz. New York: MTI Publications, 1982; 396 pages, 17 by 25.2 cm, softcover, ISBN none, \$19.95.

*Experiments in Electronics, Instrumentation, and Microcomputers*, F. Holler, J. Avery, S. Crouch, and C. Enke. Menlo Park, CA: The Benjamin/Cummings Publishing Co., 1982; 326 pages, 21.2 by 27.2 cm, softcover, ISBN 0-8053-6918-X, \$13.95.

*From Chips to Systems: An Introduction to Microprocessors*, Rodney Zaks. Berkeley, CA: Sybex, 1982; 552 pages, 17.5 by 23.5 cm, softcover, ISBN 0-8988-063-6, \$14.95.

*H-8 Programming for Beginners*, Ron Santore, Don

## YOU'VE JUST FOUND THE MISSING LINK!



Computer Shopper is your link to individuals who buy, sell and trade computer equipment and software among themselves nationwide. No other magazine fills this void in the marketplace chain.

Thousands of cost-conscious computer enthusiasts save by shopping in Computer Shopper every month through hundreds of classified ads. And new equipment advertisers offer some of the lowest prices in the nation.

Computer Shopper's unbiased articles make for some unique reading among magazines and there's a "help" column to answer difficult problems you may have with interfacing, etc.

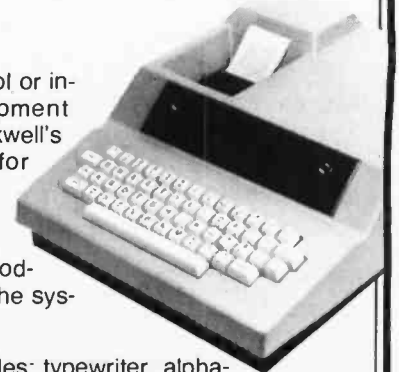
For a limited time you can subscribe to Computer Shopper with a six month trial for only \$6.

**6 month trial, \$6<sup>00</sup>** Call Toll Free **MC & VISA 800-327-9920**

or send a check to:  
**COMPUTER SHOPPER**  
P.O. Box F301 • Titusville, FL 32780  
305-269-3211

## AIM for Control

For process control or industrial development systems, put Rockwell's AIM 65 to work for you. Use off-the-shelf AIM-Mate Series and STD BUS expansion products to configure the system you need.



The AIM 65 includes: typewriter, alpha-numeric LED display, and fast thermal printer.

Plug-in options include: memory (to 48K), ROM languages, parity protection, video display, floppy disk storage, STD BUS expansion cage, TTL and real world interfaces, and complete system software.

Call or write for complete AIM-Mate Series information.

**FORETHOUGHT  
PRODUCTS**

87070 Dukhobar Road, Eugene, Oregon 97402 (503) 485-8575

Inman, and Bob Albrecht. Portland, OR: Dilithium Press, 1980; 195 pages, 13 by 20.5 cm, softcover, ISBN 0-918398-17-7, \$8.95.

*Information Systems Development, A Systematic Approach*, Mats Lundeborg, Göran Goldkuhl, and Anders Nilsson. Englewood Cliffs, NJ: Prentice-Hall, 1981; 337 pages, 17.5 by 23.5 cm, hardcover, ISBN 0-13-464677-0, \$24.95.

*Introduction to Interactive Computer Graphics*, Joan E. Scott. New York: John Wiley & Sons, 1982; 255 pages, 14.6 by 22.3 cm, hardcover, ISBN 0-471-05773-8, \$24.95.

*Introduction to Real-Time Software Design*, S. T. Allworth. New York: Springer-Verlag, 1981; 140 pages, 14.6 by 22.3 cm, softcover, ISBN 0-387-91175-8, \$14.

*Inventory Management for Small Computers*, Chuck Atkinson. Beaverton, OR: Dilithium Press, 1982; 194 pages, 13 by 20.5 cm, softcover, ISBN 0-918398-48-7, \$16.95.

*Minds and Mechanisms*, Margaret A. Boden. Ithaca, NY: Cornell University Press, 1981; 311 pages, 13.5 by 22 cm, hardcover, ISBN 0-8014-1431-8, \$29.50.

*Oh! Pascal!*, Doug Cooper and Michael Clancy. New York: W. W. Norton & Company, 1982; 476 pages, 17.5 by 23.5 cm, softcover, ISBN 0-393-95205-3, \$15.95.

*Pascal: A Problem Solving Approach*, Elliot B. Koffman. Reading, MA: Addison-Wesley, 1982; 470 pages, 15.5 by 22.5 cm, softcover, ISBN 0-201-10341-9, \$14.95.

*PET Fun and Games*, Ron Jeffries and Glen Fisher. Berkeley, CA: Osborne/McGraw-Hill, 1981; 192 pages, 21.2 by 27.2 cm, softcover, ISBN 0-931988-70-5 \$10.

*Practical Data Base Management*, edited by the Auerbach Publishers Staff. Reston, VA: Reston Publishing Company, 1981; 430 pages, 14.6 by 22.3 cm, hardcover, ISBN 0-8359-5591-5, \$24.95

*Robot Manipulators, Mathematics, Programming, and Control*, Richard P. Paul. Cambridge, MA: The MIT Press, 1981; 279 pages, 15 by 23 cm, hardcover, ISBN 0-262-16082-X, \$25.

*Simple Pascal*, James J. McGregor and Alan H. Watt. Rockville, MD: Computer Science Press, 1981; 182 pages, 15 by 22 cm, softcover, ISBN 0-914894-72-2, \$10.95.

*Strategic Financial Planning with Simulation*, Dennis

E. Grawoig and Charles L. Hubbard. Princeton, NJ: Petrocelli Books, 1982; 643 pages, 14.6 by 22.3 cm, hardcover, ISBN 0-89433-115-9, \$35.

*Trends in Information Processing Systems* (Proceedings of the Third Conference of the European Cooperation in Informatics, Munich, October 20-23, 1981), volume in the Lecture Notes in Computer Science series, edited by G. Goos and J. Hartmanis. New York: Springer-Verlag, 1981; 349 pages, 16 by 23.8 cm, softcover, ISBN 3-540-10885-8, \$20.

*A User Guide to the Unix System*, Jean Yates and Rebecca Thomas. Berkeley, CA: Osborne/McGraw-Hill, 1982; 496 pages, 7.4 by 9 cm,

softcover, ISBN 0-931988-71-3, \$15.99.

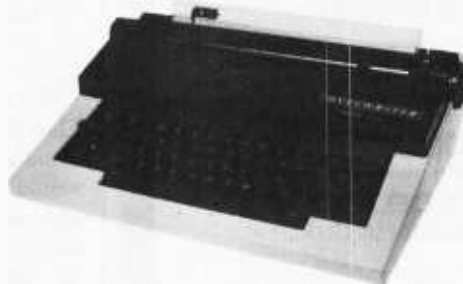
*Writing Interactive Compilers and Interpreters*, P. J. Brown. New York: John Wiley & Sons, 1981; 265 pages, 14.6 by 22.3 cm, softcover, ISBN 0-471-10072-2, \$14.50. ■

This is a list of books received at BYTE Publications during this past month. Although the list is not meant to be exhaustive, its purpose is to acquaint BYTE readers with recently published titles in computer science and related fields. We regret that we cannot review or comment on all the books we receive; instead, this list is meant to be a monthly acknowledgment of these books and the publishers who sent them.

BYTEWRITER

## DAISY WHEEL PRINTER LETTER QUALITY PRINTER AND TYPEWRITER IN ONE PACKAGE

The BYTEWRITER is a new Olivetti Praxis 30 electronic typewriter with a micro-processor controlled driver added internally.



**\$795**  
plus shipping

Dealer  
Inquiries  
Invited

### FEATURES

- Underlining • 10, 12, or 15 characters per inch switch selectable • 2nd keyboard with foreign grammar symbols switch selectable • Changeable type daisy wheel
- Centronics-compatible parallel input operates with TRS-80, Apple, Osborne, IBM and others • Cartridge ribbon • Typewriter operation with nothing to disconnect
- Service from any Olivetti dealer • Self test program built in.

BYTEWRITER

125 NORTHVIEW RD., ITHACA, N.Y. 14850  
(607) 272-1132

Praxis 30 is a trademark of Olivetti Corp.  
TRS-80 is a trademark of Tandy Corp.  
BYTEWRITER is a trademark of Williams Laboratories.

## Clubs and Newsletters

### Hobbyists Compute Under the Big Sky

The Big Sky Micro-Computer Club currently has about 35 members. All types of computers are of interest to the club. Beginners and experts alike are invited to join and help with the newsletter. Contact the Big Sky Micro-Computer Club, POB 21456, Pioneer Station, Billings, MT 59102, or call Wes Henley at (406) 656-4013.

### Personal Computer Group in Capital

IBMMicro is a new group for IBM Personal Computer users in the Washington, DC, area. The club has created a charter and bylaws and is busily at

work on a newsletter, a bulletin board, and hardware and software exchanges. The group plans to have monthly meetings with guests speakers and feedback from members. Special-interest groups for word processing, graphics, games, and other applications are planned. Contact IBMicro, 1414-C Wright Circle, Bolling AFB, Washington, DC 20336.

### Nevada COBOL Users Group

The Nevada COBOL Users Group has been formed to distribute information on applications and routines written in the language. The club will provide coordination among users developing extensions to

Nevada COBOL. Information will be distributed through periodic newsletters. Contact Bob Blum, Nevada COBOL Users Group, 5536 Colbert Trail, Norcross, GA 30092, (404) 449-8948.

### Starter Kit Group

Cary Davids has started a users group for owners of the Z80 Starter Kit from SD Systems. The club produces a newsletter. Contact Cary Davids, 6000 Puffer Rd., Downers Grove, IL 60516.

### Osborne Group Assembling

A new group for Osborne Computer users is being formed in the Tampa Bay area. For further details, contact Frederick Dunn, POB 517, Clearwater, FL 33517, (817) 446-7239.

### South American Hobbyists

The Concepción Computer Club is interested in all areas of microcomputing. The club would appreciate information and newsletters from other users groups. A special edition of the group's newsletter, *Boletín del Concepción Computer Club*, is produced in English. Contact Raúl H. Figueroa Rebolledo, Concepción Computer Club, POB 685, Concepción, Chile, Tel: 24854.

### 6800/6809 Fans in Sweden

PD 68 is a group of Motorola 6800 and 6809 users

in Sweden. The group meets on the last Thursday of each month, excluding June, July, and December, at ABF Huset, Hammarby-Centrum, in Stockholm. The Flex operating system is of particular interest to group members, who number about 300. A newsletter, *MPU-laren*, is produced each quarter. The club would like to hear from the personal-computing community in the U.S. Contact Jason King, Ludwigsbergsgatan 13<sup>1</sup>, S-117 26, Stockholm, Sweden, Tel: 08/68 23 11.

### New Address

The new mailing address for the Amateur Computer Group of New Jersey (ACG-NJ) is POB 319, South Bound Brook, NJ 08880.

### Explorer 85 Users Group

A new group is being formed for owners of Netronics' Explorer 85 system. The group plans to produce a free newsletter of hardware and software ideas. For more information, contact Gord Wiggins, POB 88, Cartwright, Newfoundland, A0K 1V0, Canada.

### Graphics Club Forming

A computer graphics club is being formed in the Connecticut/Westchester County, New York area. Plans call for group meetings with manufacturers of graphics products and creating a newsletter. For further details, contact Howard Rothman, 218 Huntington Rd., Bridgeport, CT 06608, (203) 579-0472. ■

## ATTENTION S-100 USERS, OEMs & ISOs!

### MM-103 IS THE ONLY MODEM FOR YOUR NEEDS!

In previous issues, we listed more than 50 reasons why PMMI MM-103 modems are superior, along with a list of satisfied users that is now too long to print. Quality, integrity and low cost have made the MM-103 America's most popular modem. PMMI was the first to gain FCC approval and meet IEEE-696 S-100 standards. You won't find another modem for the S-100 bus with a wider range of baud rates, more extensive and controllable software and such an unbeatable warranty. And since PMMI has eliminated the need for an acoustic coupler or an RS 232 adapter, your connection is more reliable and you buy no unnecessary hardware.

**SO DON'T DELAY!**  
GO WITH THE MODEM WITH EXPERIENCE!



**COMMUNICATIONS**  
(POTOMAC MICRO-MAGIC, INC.)

For further information, call or write:

Three Skyline Place  
5201 Leesburg Pike, Suite 604  
Falls Church, VA 22041  
(703) 379-9660

Or dial into our 24 hour-a-day Modem Test Center.  
(703) 379-6383 (300 Baud)

**AFTER ALL...  
ALL MODEMS ARE NOT  
CREATED EQUAL!**



# Software Received

## Apple

**AgDisk Financial Management Series One**, an agricultural financial-management package in Pascal for the Apple II. Floppy disk, \$140. Harris Technical Systems, 624 Peach St., POB 80837, Lincoln, NE 68501.

**Alkemstone**, an adventure-type game for the Apple II. Floppy disk, \$39.95. Level-10, Suite 507, 7475 Dakin St., Denver, CO 80221.

**Apple-Aids**, a disk-utility package for the Apple II. Floppy disk, \$49.95. Advanced Operating Systems, 450 St. John Rd., Michigan City, IN 46360.

**Beer Run**, an arcade-type game for the Apple II. Floppy disk, \$29.95. Sirius Software Inc., 10364 Rockingham Dr., Sacramento, CA 95827.

**Enhanced Graphics Software** for the IDS 460G/560G, a graphics utility for the Apple II. Floppy disk, \$44.95. Computer Station Inc., 11610 Page Service Dr., St. Louis, MO 63141.

**Graphic Writer**, utility to combine graphics with Applewriter text for the Apple II. Floppy disk, \$34.95. Computer Station Inc. (see address above).

**Hadron**, an arcade-type game for the Apple II. Floppy disk, \$34.95. Sirius Software Inc. (see address above).

**Hi-Res Computer Golf**, a computerized golf game for the Apple II. Floppy disk, \$29.95. Avant-Garde Creations, POB 30160, Eugene, OR 97403.

**The Liberator**, a programming utility and library of subroutines for the Apple II. Floppy disk, \$29.95. Pear Software, 407 Terrace, Ashland, OR 97520.

**Pascal Hi-Res Graphics Dump Routine** for the IDS 460G, a graphics utility in Pascal for the Apple II.

Floppy disk, \$44.95. Computer Station Inc. (see address above).

**Snake Byte**, an arcade-type game for the Apple II. Floppy disk \$29.95. Sirius Software Inc. (see address above).

**Sneakers**, an arcade-type game for the Apple II. Floppy disk, \$29.95. Sirius Software Inc. (see address above).

**Ultra Hi-Res Graphics**, utility for use with the IDS 460G/560G printers with the Apple II. Floppy disk, \$49.95. Computer Station Inc. (see address above).

## Atari

**Atari Word Processor**, a word-processing system for the Atari 800. Floppy disk, \$149.95. Atari Inc., Computer Division, POB 427, Sunnyvale, CA 94086.

**The Duplicating Machine**, a program-duplication utility for the Atari 400 and 800. Floppy disk, \$19.95. Midwest Software, 2707A Ridge Court, Lawrence, KS 66044.

## CP/M

**CP/M Adventures 1-12**, a series of Scott Adams's adventures for CP/M (Z80). 8-inch floppy disk, \$129.95. Adventure International, 507 East St., POB 3435, Longwood, FL 32750.

**Ficomp CP/M 2.2. Utilities**, a set of utility programs for CP/M (Z80). 8-inch floppy disk, \$24.95. Ficomp Inc., 3017 Talking Rock Dr., Fairfax, VA 22031.

**Copy86**, a utility program for copying Z80 CP/M files to and from 86-DOS. 8-inch floppy disk, \$120. GIOS Enterprises, 9784 Woodhollow Way, Sacramento, CA 95827.

## PET

**Concentration, Memory, Cosmic Collision, Hangman, and Torpedo Command**, games for the PET 2001.

Cassette, \$5.99 each. Royal Software, 149-45 83rd St., Howard Beach, NY 11414.

**PET/CBM Cross-Reference Program**, a cross-reference utility program for the PET/CBM. Floppy disk, \$29.95. Oppenheimer Software, 79th Street Boat Basin #39, New York, NY 10024.

## Texas Instruments

**Adventureland**, an adventure-type game for the TI-99/4. Floppy disk, \$29.95. Texas Instruments Inc., 13500 North Central Expressway, POB 225012, Dallas, TX 75265.

**Car Wars**, an arcade-type game for the TI-99/4. Command Module (i.e., ROM cartridge), \$39.95. Texas Instruments Inc. (see address above).

**The Count**, an adventure-type game for the TI-99/4.

Floppy disk, \$29.95. Texas Instruments Inc. (see address above).

**Ghost Town**, an adventure-type game for the TI-99/4. Floppy disk, \$29.95. Texas Instruments Inc. (see address above).

**Pirate Adventure**, an adventure-type game for the TI-99/4. Floppy disk and Command Module (i.e., ROM cartridge), \$29.95. Texas Instruments Inc. (see address above).

**Pyramid of Doom**, an adventure-type game for the TI-99/4. Floppy disk, \$29.95. Texas Instruments Inc. (see address above).

## TRS-80

**Bisplan**, a business-modeling program for the TRS-80 Models I and III. Cassette, \$20. Mariah Com-

## Your FREE reference guide to COMPUTER SUPPLIES



Here's our latest edition . . . yours FREE for the asking! This direct order catalog features 48 pages of more than 1000 supply products for your small business computer. Thousands of data processing managers nationwide buy their supplies direct from this catalog because they like the large selection, the ease of ordering, the fast delivery and the quality products. Plus, we've just introduced 100 new products to meet the demands of an ever-changing computer environment.

To receive your FREE 1982 catalog, simply call Toll-Free 800-323-0628 (in Illinois, call 312-377-0990) or circle the Reader Service Card number below.

Send for your free copy today!

**VISIBLE COMPUTER  
SUPPLY CORPORATION**

A Subsidiary of Wallace Computer Services, Inc.  
3626 Stern Drive | 1615 S. Stockton St.  
St. Charles, Illinois 60174 | Lodi, CA 95241

# MAIL ORDER DISCOUNTS



## SOFTWARE & ACCESSORIES

VISICALC	169
VISITREND/VIPILOT	215
VISIFILE	210
DESKTOP PLAN II	159
BPI BUSINESS SOFTWARE	335
CONTINENTAL BUS. SOFTWARE	215
SUPERSCRIBE II	110
SUPERTEXT II	105
EASYWRITER	219
WORDSTAR (CP/M)	299
REAL ESTATE ANALYZER	120
TAX PREPARER	85
CREATIVE FINANCING	120
HAYES MICROMODEM II	299
MICROSOFT Z-80 SOFTCARD	299
MICROSOFT 16K RAM CARD	169
VIDEX 80 COLUMN CARD	269

## NEC PC-8000

PC-8001A SYSTEM W/32K	750
PC-8012A I/O & EXPANSION SLOTS W/32K	525
PC-8031A DUAL DRIVES	750
PC-8023A MATRIX PRINTER TRACTOR/FRICTION	550
PC-8033A I/O PORT FOR DISK DRIVES	145
THE WEDGE-DISK RS232 & GAME I/O W/32K	515

## DISKETTES

BASF 5 1/4" DISKETTES (10)	25
BASF 8" DISKETTES (10)	29

TO ORDER: Please send cashier's check, money order or personal check (allow 10 business days to clear); VISA and Master Card credit card service add 3%. Shipping, handling and insurance in U.S. add 3% (minimum \$5). California residents add 6% sales tax. Foreign orders add 10% for shipping. Equipment is subject to price change and availability. All equipment carries factory warranty. TELEX 697120 DATAMAX-SDG

# COMPUTER HORIZON

16766 Bernardo Center Drive, Suite 110B, San Diego, CA 92128  
(714) 565-7092 (800) 854-1941

## Epson PRINTERS

EPSON MX-70	350
EPSON MX-80	450
EPSON MX-80FT	550
EPSON MX-100	730
QUME SPRINT 5/45	2499

## MONITORS

AMDEX LOW-RES 13" COLOR I	369
AMDEX HI-RES 13" COLOR II	850
SANYO 9" B&W	185
ZENITH 12" GREEN	125
NEC 12" GREEN	169
NEC 12" LOW-RES COLOR	365
NEC 12" HI-RES RGB COLOR	875

## ATARI® 800 & 400

ATARI 800 (16K)	675
ATARI 400 (16K)	335
810 DISK DRIVE	439
16K RAM MEMORY MODULE	89
850 INTERFACE MODULE	165
830 ACOUSTIC MODEM	159
ATARI WORD PROCESSOR	125

## XEROX 820 "SAM"

SYSTEM I (5 1/4" DRIVES)	2395
SYSTEM II (8" DRIVES)	2995
XEROX 630 PRINTER	2325
WORD PROCESSING (WORDSTAR)	425
CP/M OPERATING SYSTEM	175

## Software Received

puting, POB 513, Columbia, MO 65205.

DOSfix, a set of modifications for TRSDOS for the TRS-80 Models II and III. Floppy disk, \$15 (Model II) and \$10 (Model III). Snapp-Ware, 3719 Mantell Ave., Cincinnati, OH 45236.

Macro-Mon, a machine-language utility program for the TRS-80 Models I and III. Cassette, \$54.95; floppy disk, \$59.95 (Model I) and \$69.95 (Model III). Advanced Operating Systems, 450 St. John Rd., Michigan City, IN 46360.

Omniterm, a telecommunications software package for the TRS-80 Models I and III. Floppy disk, \$95. Lindbergh Systems, 41 Fairhill Rd., Holden, MA 01520.

Rubik's Cube Coach, a simulator and solution for the Rubik's Cube puzzle for the TRS-80 Model I. Cassette, \$14.95. H & S Computer Co., 1024 Alamosa Dr., Claremont, CA 91711.

Snapp-II, extended BASIC for the TRS-80 Models II and III. Floppy disk, \$200 (Model II) and \$125 (Model III). Snapp-Ware (see address above).

Snapp-III, language enhancements for the BASIC interpreter for the TRS-80 Models II and III. Floppy disk, \$100 (Model II) and \$75 (Model III). Snapp-Ware (see address above).

Snapp-IV, screen-manage-

ment utilities for the TRS-80 Models II and III. Floppy disk, \$100 (Model II) and \$75 (Model III). Snapp-Ware (see address above).

Snapp-V, disk input/output file-management utilities for the TRS-80 Models II and III. Floppy disk, \$75 (Model II) and \$60 (Model III). Snapp-Ware (see address above).

Snapp-VI, a string space-management utility for the TRS-80 Models II and III. Floppy disk, \$100 (Model II) and \$75 (Model III). Snapp-Ware (see address above).

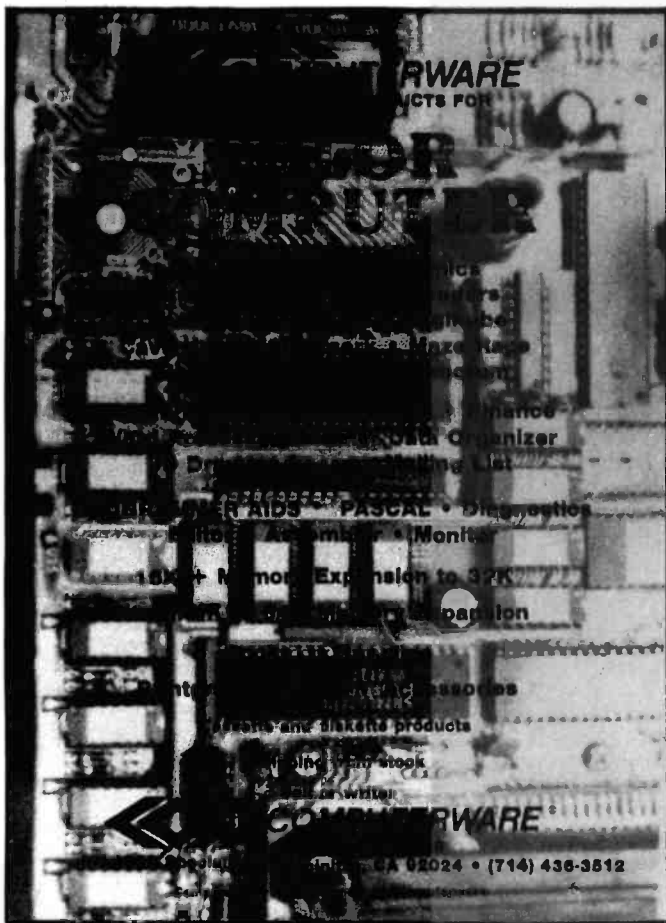
Snapp-VII, a reformatter for BASIC programs to increase readability for the TRS-80 Model III. Floppy disk, \$40. Snapp-Ware (see address above).

Super Color Terminal, telecommunications software for the TRS-80 Color Computer. Cassette and floppy disk, \$69.95. Nelson Software Systems, POB 19096, Minneapolis, MN 55419.

Time Quest, an adventure-type game for the TRS-80 Models I and III. Floppy disk, \$24.95; cassette, \$19.95. The Programmer's Guild, POB 66, Peterborough, NH 03458.

## Other Computers

Adventure A, an adventure-type game for the Sinclair ZX80 and 81. Cassette, \$19.95. Softsync, POB 480, Murray Hill Station, New York, NY 10156. ■



This is a list of software packages that have been received by BYTE Publications during the past month. The list is correct to the best of our knowledge, but it is not meant to be a full description of the product or the forms in which the product is available. In particular, some packages may be sold for several machines or in both cassette and floppy-disk format; the product listed here is the version received by BYTE Publications.

This is an all-inclusive list that makes no comment on the quality or usefulness of the software listed. We regret that we cannot review every software package we receive. Instead, this list is meant to be a monthly acknowledgment of these packages and the companies that sent them. All software received is considered to be on loan to BYTE and is returned to the manufacturer after a set period of time. Companies sending software packages should be sure to include the list price of the packages and [where appropriate] the alternate forms in which they are available.

# Programming PERT in BASIC

*A method for planning complex activities  
where no precedents exist.*

---

Steven Zimmerman  
College of Business  
and Management Studies  
University of South Alabama  
Mobile, AL 36688

Leo M. Conrad  
Imagineering Concepts  
POB 9843  
Mobile, AL 36691-0843

---

The Performance Evaluation and Review Technique (PERT) is a powerful method of planning complex activities, especially pioneering projects like the creation of a new business or the development of a new machine. The innovative nature of these projects assures that few precedents exist to help estimate performance time.

PERT gives managers the tools to deal with uncertainty; PERT is management in action. It plans, schedules, and controls activity. Using PERT, contractors, builders, engineers, and businessmen can improve planning in the midst of uncertainty and save money as a result.

Until now, only large businesses with access to large computers could use PERT. The program in listing 1 brings PERT's power to micro-computer users. (Our article "Programming the Critical-Path Method in BASIC" in the July 1982 issue of *BYTE* will present the Critical-Path Method, which places greater emphasis on the trade-off between the time and the costs required to complete a project.)

Before presenting our program,

however, we'll give you a glimpse at PERT's history, briefly describe the nature of PERT analysis, suggest one possible PERT application for a manager, and examine the mathematics behind PERT.

---

## **The events that have zero slack time form the critical path.**

---

### **Origins of PERT**

PERT dates back to a team created by the Navy Special Projects Office, Lockheed Aircraft Corporation, and the management consulting firm of Booz, Allen, and Hamilton. Work during World War I on the Gantt scheduling chart and the Gantt milestone chart should also be noted because these precipitated the development of the network diagram (described later) used in PERT.

Managers of many different kinds of tasks have successfully applied PERT. One particularly spectacular result of the PERT approach is the

Polaris missile, which also occasioned PERT's development. (Lockheed Aircraft was the major contractor for Polaris.) Completion time was critical in the Polaris program, but there was considerable uncertainty about how long the required activities would take. Moreover, the start of many activities depended on the completion of others. These are the chief reasons why PERT employs a network scheme and focuses on the probability of various activities finishing at specified times.

### **The Start of PERT Analysis**

PERT analysis begins by reducing a project description to a list of events and activities. An activity is a part of a project that consumes resources or time and has a definable beginning and end. An event is a point in time, an instant. The beginning and ending points of an activity are events. To apply PERT to a complex project, you must identify all the events needed to complete the project and all the activities that result in the identified events.

As an example, we'll use a simplified version of an actual con-



Letter	Activity	Beginning Event	End Event
A	assemble accounting data	1	2
B	look for bank	1	3
C	look for real-estate agent	1	4
Z	seek permits	2	7
D	make market study of area	2	3
G	look for contractor	2	5
F	seek insurance for construction	2	6
H	get basic architectural plans	3	5
E	make cost study	3	4
I	buy land	4	5
J	list materials	5	6
K	get more detailed architectural plans	5	7
L	have survey made	5	8
M	buy first batch of materials	6	8
O	buy second batch of materials	6	9
N	complete detailed internal layout of foundation	7	8
Q	hire crew	7	9
P	build foundation	8	9

**Table 1:** The activities required to build a foundation. The program in listing 1 uses the letters at left to identify the activities. The two columns at right list the first and last event during each activity. An event is the completion of one or more activities.

struction project that we just completed. To simplify, we'll end our example with the completion of the building's foundation. We identified 18 activities needed to complete this foundation. Table 1 lists the activities, assigned letters A through Q and Z. Each of the nine events in the project consists of the completion of one or more activities.

### The Bubble Diagram

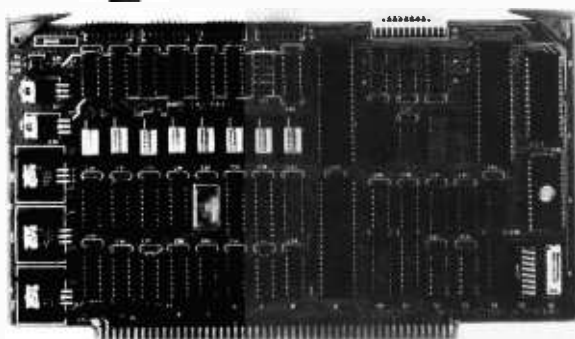
The second stage in PERT analysis is the layout of a "bubble" diagram that shows how the necessary activities and events form a sequence of steps. Figure 1 is the bubble diagram of our foundation-building example. With or without PERT, specifying the sequence of a project's steps is obviously an important planning activity. Most contractors lay out the sequence of tasks in a project in some fashion, but PERT makes task sequencing a formal activity. Formalizing this process lends valuable structure to essential planning. In particular, making a bubble diagram forces the planner to specify which activities depend on the completion of others.

Diagrams like that shown in figure 1 are also called networks. A PERT network has one initial event, at the extreme left, and one terminal event, at the extreme right. The circles in figure 1 are numbered and represent events. The lines are lettered and represent activities; each line has an arrow indicating its direction in time from beginning to completion. The network as a whole shows the series of activities that must be performed to complete the project. The arrows show which activities and events logically precede others.

An event that results from completion of more than one activity is called a merge event; an event that represents the joint beginning of more than one activity is called a burst event. Before any activity can start, all preceding activities must be completed (but not all simultaneously). An arrow's length and its compass direction are insignificant.

Dashed lines in network diagrams represent "dummy" activities. A

# \$495.



## SBC can be redundant!!

- Z80A 4MHz, 64K RAM, 2K ROM
- 2 serial, 2 parallel, 4 timer ports
- Bi-directional inter-processor channel
- Multi-processor architecture capability
- Redundant processor manipulation capability
- Matching double-density disc controller with SASI and PRIAM interface
- Application note for system configurations

**JC SYSTEMS** (415) 657-4215  
1075 Hiawatha Ct. Fremont, CA 94538

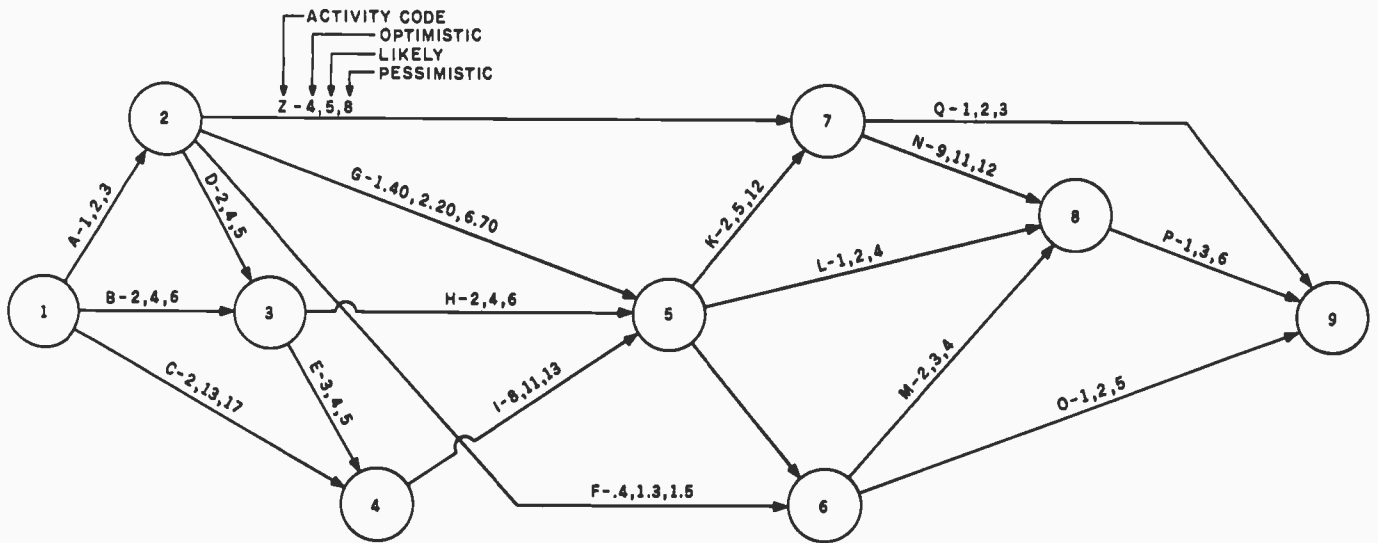


Figure 1: The PERT network diagram of the activities required to build a foundation. Each circle represents an event and each line between circles represents one of the activities listed in table 1. The three numbers given for each activity represent human estimates of the optimistic (minimum), likely, and pessimistic (maximum) time in weeks that each activity will take. The network has one initial event, event 1 at the extreme left, and one terminal event, event 9 at the extreme right. The critical path is the one that takes the most time to get from event 1 to event 9.

dummy activity exists when the completion of one event depends on the completion of another but requires no additional work or activity. PERT handles dummy activities like any others but assigns the activity zero time and zero costs.

### The Critical Path

The longest route from the beginning of the network on the left to its end on the right determines the time required to complete the project. This line is the critical path, which determines the minimum time required to complete a job. Although the concept of a critical path may sound complex, it is simple once you've laid a project out in a bubble diagram.

Critical-path analysis can reveal ways to shorten the critical path and to control the total length of a job. Because of the size of our computer, a TRS-80 Model I with 32K bytes of memory, we wrote a program that analyzes the critical path but does not attempt to shorten it.

### Three Time Estimates

Along each activity line in figure 1, you see three decimal numbers. Each

**DISCOUNT & BONUS COUPONS**
  
 for
   
**PRINTERS, DISK DRIVES, DISKETTES, SOFTWARE, BOOKS**
  
 and MORE!
   
 just circle **258** on your
   
**Reader Service Card** and mail it today.
   
 just good business...
   
  
**or write to: FREE COUPONS**
  
 P.O. Box 32010
   
 Cleveland, Ohio 44132
   
 (216) 289-1100

# MULTIPROGRAMMER

KITS AVAILABLE

## SYSTEM-10

### PROGRAMS OVER 200 POPULAR PROMS & EPROMS



#### Standard Features:

- RS232 Serial Port - Standard Formats
- 5K Bytes RAM (Expandable)
- Device Read, Compare & Verify
- Editing & Special Functions
- Less Than \$1,000 for Programmer
- Less Than \$400 for Module and Adapter
- Attractive OEM Prices  
*REP AREAS AVAILABLE*



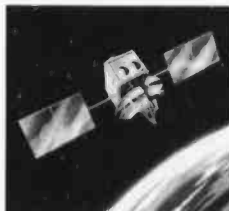
COMPUTER SYSTEMS CORPORATION

100 E. Linton Blvd  
Delray Beach, Fla 33444

Phone (305) 272-2051

## The cost of calling the Big Apple shouldn't make you feel rotten.

The cost of calling city to city needn't put you in a state of shock. Whether you transmit voice, data or facsimile, we could cut your company's long-distance phone bill 40%. With no capital investment or change in equipment. Contact Walt Pioli, RCA Americom, 400 College Road East, Princeton, NJ 08540. (609) 734-4300.



Name/Title \_\_\_\_\_

Company/Phone \_\_\_\_\_

Address \_\_\_\_\_

City/State/Zip \_\_\_\_\_

PMN-4

**RCA** American Communications  
The solution that beats the system

number represents a time expressed in weeks (though you could use any unit of time if you used the same unit for all items). The first of the three numbers represents the optimistic (minimum) estimated time required to complete the activity that the line represents; the second number represents the time that you expect will be required to complete the activity (the likely time); the third number represents the pessimistic (maximum) time, or the time the activity may require if everything goes wrong.

An example will clarify this. Line A in figure 1 connects event 1 to event 2. Line A stands for the activity of gathering and organizing the required accounting data. Event 2 is the completion of the accounting papers needed for construction of our foundation. The minimum time required for line A is estimated at one week, the likely time at two weeks, and the maximum time at three weeks; so the three values 1, 2, 3 are written on line A.

One reason PERT requires these three time estimates is that, as noted earlier, PERT originates from a research project. Since most research project activities are unprecedented, planners can't make a single, accurate estimate of the time each activity requires. The three estimated times are the basis for a statistical estimate of the probability of completing a project or an activity by any given time.

### Applying PERT

Applying PERT is simple. A manager who can identify a project's critical path can control time and costs by concentrating on activities along the critical path. If an activity not on the critical path slips behind schedule, the slippage will not usually affect the time required to complete the entire project (although the slippage can hurt if the critical path shifts). Should an activity on the critical path slip, however, the time required to complete the project will increase and the project may be in trouble.

One obvious application of PERT is in making decisions about authorizing overtime on a specific activity. If

*Text continued on page 473*



Listing 1: A program for PERT. Written in TRS-80 Level II Basic, the program asks a list of the activities in a project, the beginning and ending events of each activity, and estimates of the optimistic, most likely, and pessimistic durations of each activity. The program then uses statistical methods to find the critical path of the project, the time required to complete the critical path, and the probability of completing the project by any scheduled completion time.

```

10 CLEAR 1000:CLS:REM "PERT"
20 PRINT"PERT/CRITICAL PATH SCHEDULING PROGRAM"
30 PRINT"DEVELOPED BY STEVEN M. ZIMMERMAN,PH.D. & LEO M. CONRAD 1980"
40 INPUT"DISK SYSTEM OR LEVEL II BASIC (D/B)";S$
50 PRINT:PRINT"*** NOTE BEGINNING EVENTS WILL BE SORTED INTO NUMERICAL ORDER *"
:INPUT"DIMENSION FOR ACTIVITIES";D%:PRINT
60 DIM A$(D%,2),A(D%,11),SV(11)
70 PRINT"INPUT MENU"
80 PRINT" K KEYBOARD"
90 PRINT" D DISK FILE"
100 PRINT" R READ STATEMENT"
110 PRINT" T1 TAPE RECORDER #-1"
120 PRINT" T2 TAPE RECORDER #-2"
130 INPUT"SELECTION";IO$
140 IFIO$<>"K"THEN 220
150 INPUT"NUMBER OF ACTIVITIES";M%:EE=0
160 PRINT"THIS IS GOING TO BE WORK YOU MUST NOW INPUT UP TO ";M%;" AC
TIVITIES"
170 FOR I=1 TO M%
180 INPUT"ACTIVITY CODE ";A$(I,1)
190 INPUT"DESCRIPTION, BEGINING EVENT NUMBER, END EVENT NUMBER, MOST OPTIMISTIC
TIME, MOST LIKELY TIME AND MOST PESSIMISTIC TIME";A$(I,2),A(I,1),A(I,2),A(I,3),A
(I,4),A(I,5)
200 NEXTI
210 GOTO480
220 IFIO$="T1"ORIO$="T2"THEN230 ELSE330
230 PRINT"SETUP TAPE #-";IO%;" TO PLAY":REM TAPE INPUT
240 IF S$="D"CMD"T"
250 IFIO$="T1"INPUT#-1,M%,EE
260 IFIO$="T2"INPUT#-2,M%,EE
270 FORI=1TOM%
280 IFIO$="T1"INPUT#-1,A$(I,1),A$(I,2):INPUT#-1,A(I,1),A(I,2),A(I,3),A(I,4),A(I,
5)
290 IFIO$="T2"INPUT#-2,A$(I,1),A$(I,2):INPUT#-2,A(I,1),A(I,2),A(I,3),A(I,4),A(I,
5)
300 NEXTI
310 IFS$="D"CMD"R"
320 GOTO480
330 IFIO$<>"D"THEN420
340 LINEINPUT"NAME OF FILE:DISK ";B$:REM DISK INPUT
350 OPEN"I",1,B$
360 INPUT#1,M%,EE
370 FORI=1TOM%
380 INPUT#1,A$(I,1),A$(I,2),A(I,1),A(I,2),A(I,3),A(I,4),A(I,5)
390 NEXTI
400 CLOSE1
410 GOTO480
420 IFIO$<>"R"THEN70
430 READM%,EE
440 FORI=1TOM%:REM READ INPUT
450 READA$(I,1),A$(I,2),A(I,1),A(I,2),A(I,3),A(I,4),A(I,5)
460 IFA$(I,1)="END"THEN480
470 NEXTI
480 REM PRINTS INPUT DATA FOR VERIFICATION
490 M=M%:TP=0:FORI=1TOM: IFA(I,2)>TPTHENTP=A(I,2)
495 NEXT:EE=TP
500 FORI=1TOM-1
510 FORJ=I+1TOM
520 IFA(I,1)<=A(J,1) THEN550

```

Listing 1 continued on page 470

Listing 1 continued:

```
530 FORK=1TO11:SV(K)=A(I,K):A(I,K)=A(J,K):A(J,K)=SV(K):NEXTK
540 FORK=1TO2:SV$(K)=A$(I,K):A$(I,K)=A$(J,K):A$(J,K)=SV$(K):NEXTK
550 NEXTJ,I
560 XX=5:PRINT"VERIFICATION OF INPUT"
570 Z1$="CODE DESCRIPTION EXPECTED EARLY EARLY LAST LAST SLACK"
580 Z2$=" TIME START FIN START FIN TIME"
590 Z3$="CODE DESCRIPTION BEGIN END OPTIMIST LIKELY PESSI"
600 Z4$=" EVENT EVENT TIME TIME TIME"
610 PRINT"NO ";Z3$
620 PRINT" ";Z4$
630 K=0
640 C4$="### "
650 FORI=1TOM%
660 PRINTUSINGC4$;I;
670 C1$="#### "
680 C2$="% % % %":C3$="####.## "
690 PRINTUSINGC2$;A$(I,1),A$(I,2);
700 FORJ=1TO2
710 PRINTUSINGC1$;A(I,J);:NEXTJ
720 FORJ=3TO5
730 PRINTUSINGC3$;A(I,J);:NEXTJ
740 K=K+1:IFK>=13 THENPRINT:INPUT"ENTER TO PAGE";DU$:K=0
750 PRINT:NEXTI
760 INPUT"-2 TO ADD, -1 TO CONTINUE OR NUMBER TO CHANGE";L:IFL=-1THEN810
770 IFL<>-2THEN790
780 L=M%+1:M%=L:N%=N%+1
790 INPUT"INPUT CODE, DESCRIPTION, BEGINNING EVENT NUMBER, END EVENT NUMBER
, MOST OPTIMISTIC TIME, MOST LIKELY TIME AND THE MOST PESSIMISTIC TIME";A$(L
,1),A$(L,2),A(L,1),A(L,2),A(L,3),A(L,4),A(L,5)
800 GOTO480
810 INPUT"HARD COPY OF INPUT DATA (Y/N)";P$
820 IFP$<>"Y"THEN960
830 INPUT"TITLE";T$:LPRINT"TITLE: ";T$
840 INPUT"DATE";T$:LPRINT"DATE: ";T$
850 LPRINT"NO ";Z3$
860 LPRINT" ";Z4$
870 FORI=1TOM%
880 LPRINTUSINGC4$;I;
890 LPRINTUSINGC2$;A$(I,1),A$(I,2);
900 FORJ=1TO2
910 LPRINTUSINGC1$;A(I,J);:NEXTJ
920 FORJ=3TO5
930 LPRINTUSINGC3$;A(I,J);:NEXTJ
940 LPRINT" "
950 NEXTI
960 REM NOW THE WORK BEGINS BEGINNING EVENT IS 1 EARLY START =0 FOWARD PASS
970 FORI=1TOM%
980 A(I,6)=(A(I,3)+4*A(I,4)+A(I,5))/6
990 IFA(I,1)=1THENA(I,7)=0:A(I,8)=A(I,6):GOTO1070
1000 MAX=0.0
1010 FORJ=1TOM%
1020 IFA(J,2)<>A(I,1)THEN1050
1030 IFA(J,8)>MAXTHENMAX=A(J,8)
1040 A(I,7)=MAX
1050 NEXTJ
1060 A(I,8)=A(I,7)+A(I,6)
1070 NEXTI
1080 REM BACKWARD PASS
1090 XM=0.0
1100 FORI=M%TO1STEP-1
1110 IFA(I,2)<>EETHEN1130
1120 IFXM<A(I,8)THENXM=A(I,8)
1130 NEXTI
1140 FORI=M%TO1STEP-1
1150 IFA(I,2)=EETHENA(I,10)=XM:GOTO1220
```

Listing 1 continued:

```
1160 MIM=99999
1170 FORJ=M%TO1STEP-1
1180 IFA(I,2)<>A(J,1)THEN1210
1190 IFA(J,9)<MIMTHENMIM=A(J,9)
1200 A(I,10)=MIM
1210 NEXTJ
1220 A(I,9)=A(I,10)-A(I,6)
1230 NEXTI
1240 REM SLACK VARIABLE CALCULATIONS
1250 FORI=1TOM%
1260 A(I,11)=A(I,10)-A(I,8)
1270 NEXTI
1280 K=0:REM PRINT OUTPUT
1290 PRINT"CODE DESCRIPTION EXPECTED EARLY EARLY LAST LAST SLACK"
1300 PRINT"          TIME      START  FIN    START FIN    TIME"
1310 C5$=" ###.##"
1320 FORI=1TOM%
1330 PRINTUSINGC2$;A$(I,1),A$(I,2);
1340 FORJ=6TO11
1350 PRINTUSINGC5$;A(I,J);:NEXTJ
1360 PRINT:K=K+1:IFK=13INPUT"ENTER TO PAGE";DU$:K=0
1370 NEXTI
1380 INPUT"HARD COPY OF RESULTS (Y/N)";P$:IFP$<>"Y"THEN1450
1390 LPRINT" ":LPRINTZ1$:LPRINTZ2$
1400 FORI=1TOM%
1410 LPRINTUSINGC2$;A$(I,1),A$(I,2);
1420 FORJ=6TO11
1430 LPRINTUSINGC3$;A(I,J);:NEXTJ
1440 LPRINT" ":NEXTI
1450 PRINT"OUTPUT MENU"
1460 PRINT"      C      CRITICAL PATH AND TIME"
1470 PRINT"      D      DISK"
1480 PRINT"      E      END"
1490 PRINT"      R      RECYCLE"
1500 PRINT"      T1     TAPE#-1"
1510 INPUT"      T2     TAPE#-2          SELECTION ";OP$:IFOP$="R"THEN480
1520 IFOP$<>"C"THEN1690
1530 REM IDENTIFICATION OF CRITICAL PATH AND COSTS
1540 CO=0:PATH$=" ":SI=0
1550 FORI=1TOM%:IFA(I,11)>0.00001THEN1570 :REM NOTE >0 SHOULD WORK BUT .00001 U
SED
1560 CO=CO+A(I,6):PATH$=PATH$+" "+A$(I,1):SI=SI+((A(I,3)-A(I,5))/6)[2
1570 NEXTI:C6$="###,###,###.##":SI=SQR(SI)
1580 CLS:PRINT"CRITICAL PATH":PRINTPATH$:PRINT
1590 PRINT"TIME OF CRITICAL PATH":PRINTUSINGC6$;CO:INPUT"SCHEDULED PROJECT TIME
(USE SAME TIME UNITS AS DATA)";ST:Z=(ST-CO)/SI:XX=0
1600 BB$="PROBABILITY OF BEING COMPLETED ON TIME":IFZ<0THEN1640
1610 A=.4361836:B=-.1201676:C=.937298:D=(2.7182818[(-Z[2/2])]*(2*3.1415926)[(-.5)
:E=(1+.3326*Z)[(-1):P=1.-D*(A*E+B*E[2+C*E[3]:IFXX>0THEN1630 :REM TAYLOR SERIES
1620 PRINT"Z= ";Z,BB$:P:GOTO1650
1630 PRINT"Z= ";-Z,BB$:1-P:GOTO1650
1640 XX=99:Z=-Z:GOTO1610
1650 INPUT"HARD COPY (Y/N)";P$:IFP$<>"Y"THEN1450
1660 LPRINT" ":LPRINT"CRITICAL PATH":LPRINT PATH$:LPRINT" ":LPRINT"SCHEDULED PRO
JECT TIME IS ";ST
1670 LPRINT"TIME OF CRITICAL PATH":LPRINTUSINGC6$;CO:IFXX=0LPRINT"Z= ";Z,BB$:P:G
OTO1450
1680 LPRINT"Z= ";-Z,BB$:1-P:GOTO1450
1690 IFOP$="E"THENEND
1700 IFOP$<>"D"THEN1750
1710 LINEINPUT"NAME OF FILE:DISK ";X$:OPEN"O",1,X$
1720 PRINT#1,M%,EE
1730 FORI=1TOM%:PRINT#1,CHR$(34);A$(I,1);CHR$(34);", ";CHR$(34);A$(I,2);CHR$(34);
A(I,1);A(I,2);A(I,3);A(I,4);A(I,5):NEXTI
1740 CLOSE1:GOTO1450
```

Listing 1 continued on page 472



Listing 1 continued:

```

1750 IFS$="D" THEN CMD "T"
1760 IFOP$="T1" PRINT#-1, M%, EE:FORI=1 TOM%:PRINT#-1, A$(I,1), A$(I,2):PRINT#-1, A(I,1), A(I,2), A(I,3), A(I,4), A(I,5):NEXT I
1770 IFOP$="T2" PRINT#-2, M%, EE:FORI=1 TOM%:PRINT#-2, A$(I,1), A$(I,2):PRINT#-2, A(I,1), A(I,2), A(I,3), A(I,4), A(I,5):NEXT I
1780 IFS$="D" THEN CMD "R"
1790 GOTO 1450
1800 REM PUT DATA HERE FIRST # ACTIVITIES THEN ENDING EVENT NUMBER THEN CODE, DESCRIPTION, BEGINNING EVENT, ENDING EVENT, OPT. TIME, LIKELY TIME, PESS. TIME FOR EACH ACTIVITY.
1810 DATA 18, 9
1820 DATA A, ACCT. PAPERS, 1, 2, 1, 2, 3
1830 DATA Z, PERMITS, 2, 7, 4, 5, 8
1840 DATA B, SHOP BANKERS, 1, 3, 2, 4, 6
1850 DATA C, SHOP REAL EST., 1, 4, 2, 13, 17
1860 DATA D, MARKET STUDY, 2, 3, 2, 4, 5
1870 DATA G, CONTRACTOR, 2, 5, 1.4, 2.2, 6.7
1880 DATA F, INSURANCE, 2, 6, .4, 1.3, 1.5
1890 DATA H, ART. PLANS, 3, 5, 2, 4, 6
1900 DATA E, COST STUDY, 3, 4, 3, 4, 5
1910 DATA I, LAND, 4, 5, 8, 11, 13
1920 DATA J, MATERIAL, 5, 6, 2, 3, 4
1930 DATA K, PLANS, 5, 7, 2, 5, 12
1940 DATA L, SURVEY, 5, 8, 1, 2, 4
1950 DATA M, BUY MAT #1, 6, 8, 2, 3, 4
1960 DATA O, BUY MAT #2, 6, 9, 1, 2, 5
1970 DATA N, LAYOUT, 7, 8, 9, 11, 12
1980 DATA P, FOUNDATION, 8, 9, 1, 3, 6
1990 DATA Q, HIRE CREW 2, 7, 9, 1, 2, 3

```

### MICROSTAT™ Release 2.0

**NEW RELEASE!**

Just some of the new features of Microstat Rel. 2.0 include: new programs for moments about the mean, skewness, kurtosis and stepwise multiple regression, longer file names, faster sort routine, the ability to declare each data file's numeric precision and drive location plus an expanded user's manual with new appendices for the equations and file structures used in Microstat. Also included is a Data Management Subsystem for file maintenance (edit, list, destroy, augment, sort, rank-order, move and merge) plus transformations (add, subtract, multiply, divide, reciprocal, log, natural log and antilog, exponentiation and linear) that allow you to create new variables from existing variables.

After file creation with DMS, programs for analysis include: Descriptive statistics, Hypothesis testing (mean and proportion), ANOVA (one-way, two-way, and random blocks), Scatterplots, Frequency distributions, Correlation analysis, Simple, Multiple and Stepwise Multiple Regression (including files larger than available memory), Time series, 11 Nonparametric tests, 8 Probability distributions, Crosstabs and Chi-square, Combinations, Permutations and Factorials (up to one million factorial). All program output is neatly formatted for easy use.

The price for Microstat Rel. 2.0 is \$295.00 and the user's manual is available for \$25.00 (credited towards purchase) and includes sample printouts with file labels that reference standard statistical texts and journals so you can compare the results from Microstat to those produced on much larger systems. Compare Microstat to any other package on the market and we think you'll agree that Microstat is the best at any price.

**ECOSOFT, INC.**

P.O. BOX 68602  
INDIANAPOLIS, IN 46268-0602  
(317) 283-8883



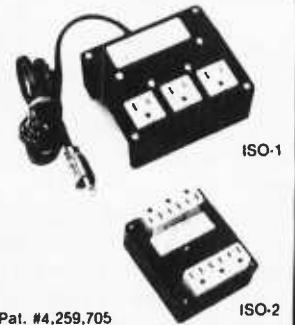
### WARNING!

Electric Power Pollution.  
Spikes & Lightning  
HAZARDOUS to  
MICROCOMPUTERS!!

Patented ISOLATORS provide protection from ...

- Computer errors caused by power line interference
- Computer errors due to system equipment interaction
- Spike damage caused by copier/elevator/air conditioners
- Lightning caused damage

Pat. #4,259,705



- \*\* FULLY GUARANTEED \*\*
- ISOLATOR (ISO-1) 3 isolated 3-prong sockets; Spike Suppression; useful for small offices, laboratories, classrooms. .... \$69.95
- ISOLATOR (ISO-2) 2 isolated 3-prong socket banks; (6 sockets total); Spike Suppression; useful for multiple equipment installations. .... \$69.95
- SUPER ISOLATOR (ISO-3) similar to ISO-1 except double isolation & oversize Spike Suppression; widely used for severe electrical noise situations such as factories or large offices. .... \$104.95
- SUPER ISOLATOR (ISO-11) similar to ISO-2 except double isolated socket banks & Oversize Spike Suppression; for the larger system in severe situations. .... \$104.95
- MAGNUM ISOLATOR (ISO-17) 4 Quad Isolated Sockets; Multiple Spike Suppressors; For ULTRA-SENSITIVE Systems in extremely Harsh environments. .... \$181.95
- CIRCUIT BREAKER, any model (Add-CB) ..... Add \$9.00
- CKT BRKR/SWITCH/PILOT (-CBS) ..... Add \$17.00

AT YOUR DEALERS MasterCard, Visa, American Express  
ORDER TOLL FREE 1-800-225-4876 (except AK, HI, PR & Canada)

**Electronic Specialists, Inc.**

171 South Main Street, Natick, Mass. 01760

Technical & Non-800: 1-617-655-1532

the activity is not on the critical path, a manager's decision to authorize expenditures for overtime would be foolish and wasteful. All activities not on the critical path have "slack time," the difference between the earliest and latest expected finish. By definition, only the activities on the critical path have zero slack time. We'll elaborate later.

### Our PERT Program

Our PERT program is shown in listing 1. A dimension (DIM) statement at line 60 provides places to store data on activities. The same DIM statement also provides storage for a dummy variable, SV, to be used later during sorts.

On a system with 32K bytes of memory and two disk drives, our program can handle more than 200 activities. We have yet to need more than 100 activities. Your machine's memory capacity and the limits of your DIM statement will determine the size of the problem that our program can handle for you. You can find the limits by experimentation.

One way to save memory is to carefully omit remark (REM) statements. We used REM statements to index some of our GOTO statements; you must send the GOTO

to the line following any REM statement you drop. Another approach divides the problem into subproblems and treats each subproblem separately. If you can't reduce the problem's memory demands, you can always use the PERT program to determine how to obtain a machine with 48K bytes of memory.

As noted before, the critical path consists of a series of activities that have zero slack time. To find the critical path, you must identify activities that have zero slack time. The program output, consisting of two tables, is designed to identify these activities.

The first table (see listing 2) shows the program's input, listing all the activities in the project, their beginning and ending events, and the three estimates of the time each activity requires. You should check your input whenever you use this program, because otherwise you may get crazy results.

The second table (see listing 3) is the program's output. Notice the last column, "Slack Time." Zeros in this column identify the critical path. You can, of course, trace the activities in the critical path by looking in the first column, "Code," for each activity with zero slack time. But our pro-

Listing 2: A printout of the input for the PERT program sample run shown in listing 1. Input includes the beginning and ending event of each activity and three estimates of the time each activity requires.

TITLE: SAMPLE PROBLEM									
DATE: 01/19/81									
NO	CODE	DESCRIPTION	BEGIN	END	OPTIMIST	LIKELY	PESSI		
			EVENT	EVENT	TIME	TIME	TIME		
1	A	ACCT. PAPE	1	2	1.00	2.00	3.00		
2	B	SHOP BANKE	1	3	2.00	4.00	6.00		
3	C	SHOP REAL	1	4	2.00	13.00	17.00		
4	Z	PERMITS	2	7	4.00	5.00	8.00		
5	D	MARKET STU	2	3	2.00	4.00	5.00		
6	G	CONTRACTOR	2	5	1.40	2.20	6.70		
7	F	INSURANCE	2	6	0.40	1.30	1.50		
8	H	ART. PLANS	3	5	2.00	4.00	6.00		
9	E	COST STUDY	3	4	3.00	4.00	5.00		
10	I	LAND	4	5	8.00	11.00	13.00		
11	J	MATERIAL	5	6	2.00	3.00	4.00		
12	K	PLANS	5	7	2.00	5.00	12.00		
13	L	SURVEY	5	8	1.00	2.00	4.00		
14	M	BUY MAT #1	6	8	2.00	3.00	4.00		
15	O	BUY MAT #2	6	9	1.00	2.00	5.00		
16	N	LAYOUT	7	8	9.00	11.00	12.00		
17	Q	HIRE CREW	7	9	1.00	2.00	3.00		
18	P	FOUNDATION	8	9	1.00	3.00	6.00		

## ELCOMP

BOOKS and SOFTWARE

For ATARI - PET - OSI - APPLE II - 8502

**ATARI BASIC - Learning by Using**  
This new book is an "Action" Book. You do more than read it. Learn the intricacy of ATARI-BASIC through the short programs which are provided. The suggestions challenge you to change and write program routines. Yes, it's exciting -  
Order-No. 184 \$9.95

**Games for the ATARI-Computer**  
How to program your own games on the ATARI. Complete listings in BASIC and Machine Language of exciting games. Tricks and hints.  
Order-No. 182 \$4.95

**ATOMNA-1**  
Machine Language Monitor for the ATARI 400/800.  
This powerful monitor provides you with the firmware support that you need to get the most out of your powerful system. ATOMNA-1 comes on a bootable cassette. No cartridges required. Disassemble, Memory Dump HEX + ASCII, (Change Memory Locations, Blocktransfer, fill memory buffer, save and load machine language programs, start mach. lang. Progr. (Printer optional). Comes with introductory article on how to program the ATARI computer in machine language. (Available also in ROM).  
Order-No. 7022 \$19.95

**ATOMNA-2 Superstepper**  
A very powerful Tracer to explore the ATARI ROM/RAM area. Stop at previously selected address. Decode or operand (cassette).  
Order-No. 7049 \$49.95

**EDITOR/ASSEMBLER for ATARI 800, 32K RAM**  
Extremely fast and powerful Editor/Assembler (8K source code in about 5 seconds) includes ATOMNA-1.  
Order-No. 7098 \$49.95

**MACRO Assembler for ATARI 800, 48K RAM**  
Please specify your system: RAM, disc or cassette.  
Order-No. 7099 \$89.00

**Gunfight - For ATARI 400/800**  
16K RAM, needs two joysticks, animation and sound. (8K machine language).  
Order-No. 7207 \$19.95

**EPROM BURNER for ATARI 400/800**  
Bare boards only with description, schematic + software (2716, 2732).  
Order-No. 7041 \$99.00

**Invoice Writing for very small business with ATARI 400/800**  
16K RAM.  
Order-No. 7022, case. \$29.95  
Order-No. 7200, disc. \$99.00

**Wordprocessor for ATARI 800, 48K RAM**  
Order-No. 7210 \$29.95

**How to connect your EPSON-Printer to the ATARI 400/800.**  
Construction article with printed circuit board and software. (Screenprint and variable characters per line).  
Order-No. 7210 \$19.95

**OSI OSI OSI OSI OSI**  
The First Book of Ohio Scientific Introduction to OSI computers. Diagrams, hardware and software information not previously available in one compact source. 192 pages.  
Order-No. 157 \$7.95

**The Second Book of Ohio Scientific**  
Very valuable information about OSI microcomputer systems. Introduction to OS-85 D and OS-85U networking. Hardware and software hints and tips. Systems specifications. Business applications.  
Order-No. 158 \$7.95

**The Third Book of Ohio Scientific**  
is now available!  
Very important information for the OSI system experimenter. Instance techniques, system extensions, accessories and much more (EPROM-Burner, 6522 I/O-card with 1K RAM, Soundboard, EPROM/RAM board).  
Order-No. 159 \$7.95

**The Fourth Book of Ohio Scientific**  
Very important information for the OSI experimenter. Many interesting programs for OSI computers. Sorting (Binary Tree), Differential Equations, Statistics, Astrology, Gas Consumption, Games, s. o.  
Order-No. 160 \$9.95

**VIP Package - Above book plus a cassette with the programs.**  
Order-No. 160 A \$19.95

**The Fifth book of Ohio Scientific**  
Many exciting programs, programming hints and tricks, Testwriter, Debugger for CIP Games, Utilities and much more (pointed keyboard).  
Order-No. 161 \$7.95

**Invoice Writing Program for OSI-CIPMF, C4P, Disk and Cassette.**  
8K RAM.  
Order-No. 8234 \$29.80

**Mailing List for CIPMF or C4P/MF 24K RAM**  
250 addresses incl. phone number and parameters on one 5 1/4 disk.  
Order-No. 8240 \$29.80

**8K Microsoft BASIC Reference Manual**  
Authoritative reference for the original Microsoft 8K BK BASIC developed for ALTAIR and later computers including OSI, PET, TRS-80 and VIC.  
Order-No. 141 \$9.95

**Expansion Handbook for 8502 and 8802**  
S-4 Card Manual describes all of the 4.5 x 6.5 44-pin S 44 cards incl. schematics. A MUST for every 8502 system user (KIM, SYM, AIM, VIC, PET, OSI).  
Order-No. 152 \$9.95

**Microcomputer Application Notes**  
Reprint of Intel's most important application notes including 2708, 8085, 8255, 6251 chips. Very necessary for the hardware buff.  
Order-No. 153 \$9.95

**Complex Sound Generation**  
New revised applications manual for the Texas Instruments SN 76477 Complex Sound Generator.  
Order-No. 154 \$6.95

**Small Business Programs**  
Complete listings for the business user. Inventory, Invoice Writing, Mailing List and much more. Introduction to Business Applications.  
Order-No. 156 \$14.80

**Microcomputer Hardware Handbook**  
Descriptions, pinouts and specifications of the most popular microprocessor and support chips. A MUST for the hardware buff.  
Order-No. 29 \$14.95

**Care and Feeding of the Commodore PET**  
Eight chapters exploring PET hardware. Includes repair and interfacing information. Programming tricks and schematics.  
Order-No. 150 \$9.95

**Prototype-Expansion Board for VIC-20 (S-4-Bus).**  
Order-No. 4844 \$18.95

**16K RAM/RAM Board for 844-bus.**  
Any combination of RAM and ROM on one board. (SY2128 or 2716).  
Order-No. 613 \$39.95

**Low cost expansion boards for your APPLE II.**  
Bare board comes with extensive description and software.  
Pretyping card  
Order-No. 604 \$29.00  
6522 VIA-I/O Exp.  
Order-No. 606 \$39.00  
2716 EPROM-Burner  
Order-No. 607 \$49.00  
8K EPROM/RAM Card  
Order-No. 608 \$29.00

**ELCOMP Publishing, Inc., 53 Redrock Lane  
Pomona, CA 91766. Phone: (714) 823-8314**

Payment: Check, Money Order, VISA, Mastercard, Eurocheck. POSTPAID or PREPAID in USA. \$5.00 handling fee for C.O.D. All orders outside USA: Add 15 % shipping. CA add 6.5 % sales tax. ATARI is a registered trademark of ATARI Inc. APPLE II is a registered trademark of APPLE Inc.

May 1982 © BYTE Publications Inc 473

www.americanradiohistory.com

# Announcing Expanded Disk Storage For IBM Personal Computers

Simple plug-in installation  
no additional electronics or wiring required.

## Internal Drives

168K Bytes - IBM Format. ....	\$470.00
(Single sided drive)	
336K Bytes - IBM Format. ....	\$570.00
(Double sided drive)	
672K Bytes - IBM Format. ....	\$1140.00
(Dual double sided drives)	

## External Drives

Single sided drive with 168K Bytes. ....	\$570.00
(Maximum two drives)	
Double sided drive with 336K Bytes. ....	\$670.00
(Maximum one drive)	

Includes cable, power supply and cabinet.

Drives are IBM compatibility tested with a 90-day warranty.  
For more information, call or write:

**I<sup>2</sup>** INTERFACE, INC.  
20932 CANTARA STREET  
CANOGA PARK, CALIFORNIA 91304  
(213) 341-7914

Quantity and dealer discounts available upon request.

gram also provides a menu option C CRITICAL PATH AND TIME, which prints both the critical path and the time required to complete it.

A word of caution about using the program: round-off problems in cal-

## PERT and CPM

The Performance Review and Evaluation Technique (PERT) and the Critical-Path Method (CPM) are managerial tools that emerged in the late 1950s. Both PERT and CPM rely on network diagrams to analyze projects. PERT was developed to guide the management of complex research and development projects.

By their nature, such projects have no precedents to guide planners in estimating how long each activity in a project will take. Planners must resort to statistical methods to estimate actual performance time. PERT's developers wanted to know how long a project could be expected to last and, given a scheduled completion date, what probability there was of actually meeting the date.

CPM, on the other hand, was developed by duPont and Remington Rand Univac to determine how time required for routine construction and maintenance can be reduced. Here experience can serve as a guide for estimating the time required for each activity in a project. CPM assumes these are reliable estimates and concentrates on determining the optimal trade-off of total time required for a project and the total cost of a project. Rather than asking how long the project will probably take or what chance there is of meeting a schedule, CPM seeks to determine a project schedule to minimize direct and indirect costs. (An example of an indirect cost is production time lost while a manufacturing plant closes for maintenance.)

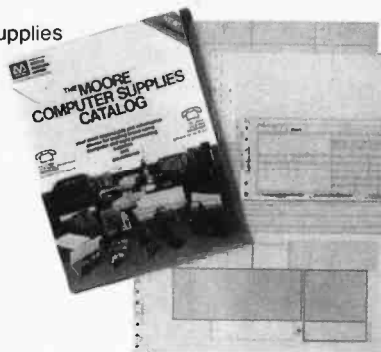
An article entitled "Programming the Critical-Path Method in BASIC" by Dr. Zimmerman and Mr. Conrad will appear in the July issue of BYTE. That article will use the same construction project that appears as a sample case in this article. Although the routine character of the project makes it better suited to analysis by CPM than by PERT, the authors chose to use the same example for both articles to show the similarities and contrasts between the two managerial techniques. . . . P.L.

# Free Moore Sample-Pac™ when you request your free Moore Computer Supplies Catalog

- Large selection of leading brand name supplies at low prices.
- Fast delivery from regional warehouses.
- Only toll-free technical assistance line in the industry.
- Your bonus—free samples of our most popular products.

For your free Moore Computer Supplies Catalog, call toll-free, **800-323-6230\***, ext. 139 or complete and mail the coupon below.

\*In Illinois, call 312-459-0210, ext. 139  
In Alaska and Hawaii, 800-323-4185, ext. 139



Catalog Group  
**MOORE BUSINESS CENTER**

A Division of Moore Business Forms  
Moore Computer Supplies Catalog  
Department 139  
P.O. Box 20  
Wheeling, Illinois 60090

Name \_\_\_\_\_ Title \_\_\_\_\_  
Company \_\_\_\_\_  
Address \_\_\_\_\_  
City \_\_\_\_\_ State \_\_\_\_\_ Zip \_\_\_\_\_  
Mail this coupon today!



culating the critical path forced us to define zero slack time as 0.00001 instead of true zero. Where small differences are important, this approximation of zero can cause problems. The value 0.00001 is entered at line 1550; perhaps you can change the value to true zero for some of your applications. Furthermore, since we used statistical methods to determine the probability of a project's being

completed on time, given a scheduled completion date, you should remember that data generated by the program is based on estimates and is itself an estimate.

### Running the Program

The easiest way to input data is to use DATA statements at the end of the program. Entering data from the keyboard takes time and increases the

number of errors. The following description of a program run assumes that DATA statements were used for input.

The data needed (see listing 2) include the name of each activity, its beginning and ending events, and the optimistic, likely, and pessimistic estimates of the activity's length.

Whether you input data from DATA statements or the keyboard,

**Listing 3:** Output of the PERT program sample run in listing 1. Activities on the critical path are identified by zero slack time (shown in column on far right), where slack time is the difference between earliest (column 5) and latest (column 7) expected finish. The program has printed the critical path, C I K N P, the project's expected duration (42.3333 weeks), and the probabilities of project completion in 35 weeks and 50 weeks.

CODE	DESCRIPTION	EXPECTED TIME	EARLY START	EARLY FIN	LAST START	LAST FIN	SLACK TIME
A	ACCT. PAPE	2.00	0.00	2.00	2.00	4.00	2.00
B	SHOP BANKE	4.00	0.00	4.00	3.83	7.83	3.83
C	SHOP REAL	11.83	0.00	11.83	0.00	11.83	0.00
Z	PERMITS	5.33	2.00	7.33	23.00	28.33	21.00
D	MARKET STU	3.83	2.00	5.83	4.00	7.83	2.00
G	CONTRACTOR	2.82	2.00	4.82	19.85	22.67	17.85
F	INSURANCE	1.18	2.00	3.18	34.98	36.17	32.98
H	ART. PLANS	4.00	5.83	9.83	18.67	22.67	12.83
E	COST STUDY	4.00	5.83	9.83	7.83	11.83	2.00
I	LAND	10.83	11.83	22.67	11.83	22.67	0.00
J	MATERIAL	3.00	22.67	25.67	33.17	36.17	10.50
K	PLANS	5.67	22.67	28.33	22.67	28.33	0.00
L	SURVEY	2.17	22.67	24.83	37.00	39.17	14.33
M	BUY MAT #1	3.00	25.67	28.67	36.17	39.17	10.50
O	BUY MAT #2	2.33	25.67	28.00	40.00	42.33	14.33
N	LAYOUT	10.83	28.33	39.17	28.33	39.17	0.00
Q	HIRE CREW	2.00	28.33	30.33	40.33	42.33	12.00
P	FOUNDATION	3.17	39.17	42.33	39.17	42.33	0.00

CRITICAL PATH  
C I K N P

SCHEDULED PROJECT TIME IS 42.3333  
TIME OF CRITICAL PATH  
42.33

Z= 0 PROBABILITY OF BEING COMPLETED ON TIME .5

CRITICAL PATH  
C I K N P

SCHEDULED PROJECT TIME IS 35  
TIME OF CRITICAL PATH  
42.33

Z= -2.24537 PROBABILITY OF BEING COMPLETED ON TIME .0123852

CRITICAL PATH  
C I K N P

SCHEDULED PROJECT TIME IS 50  
TIME OF CRITICAL PATH  
42.33

Z= 2.34743 PROBABILITY OF BEING COMPLETED ON TIME .990536

**SOMEDAY . . . in the comfort of your own home or office, you'll be able to shop and bank electronically, read instantly updated major newswires, analyze the performance of a stock that interests you, send electronic mail to business associates across the country, then play Bridge with your best friend in San Francisco and two strangers in Chicago and Dallas.**

## WELCOME TO SOMEDAY

Someday is today with the CompuServe Information Service. All this and more can be accessed with a local phone call in most major U.S. cities. For hardware you need a terminal or personal computer and a modem. The CompuServe Information Service costs only \$5.00 per hour, billed in minute increments to your charge card.

Ask for a demonstration at a Radio Shack® Computer Center. Videotex software is available for various brands of personal computers. CompuServe Information Service, 5000 Arlington Centre Blvd., Columbus, Ohio 43220. (614) 457-8650.

# CompuServe

## INVESTMENT ANALYSIS FROM CENTENNIAL

CENTENNIAL SOFTWARE / 410 17TH ST. SUITE 1375 / DENVER, CO 80202 / (303) 595-9193

### STOCK-FOCUS

Find out how low is low and how high is high. Using capital structure and performance data, Stock-focus objectively calculates the underlying value of a stock. The system was first developed by the management science department of a major money center bank, and is now in use by investment advisors, trust companies and brokerage houses. On your screen, Stock-focus will plot an estimate of lowest value, highest value and the current price. You then decide what to buy, sell or hold.

### REAL-FOCUS

Exhaustively analyze potential real estate investments using the Wharton School's approach to real estate analysis. In minutes you can project profit, costs, and IRR for any project over a 10 year period. Real-focus accounts for amortization, debt, income, operating expenses, taxes, depreciation, and cash flows for both after-tax holding and the results of sale. With Real-focus you can analyze any potential investment from a single building project to a complex time-phased planned unit development.

### THE FOCUS TECHNIQUE

FOCUS is CENTENNIAL SOFTWARE's new approach to Program Architecture, providing a natural interaction between microcomputers and users. It provides worksheet style input screens, free access to all program segments, and the ability to com-



bine individual results files for portfolio analysis. You also receive a usable reference manual, menu helps, a program glossary, multiple report formats and spooling. With our FOCUS technique even the most complex programs are versatile and easy to use.

COMPUTER	MEMORY-K	REAL-FOCUS	STOCK-FOCUS
IBM PC	64	\$179.00	\$189.00
Apple (plus) II	32/48	149.00	159.00
TRS-80 I	32/48	149.00	159.00
TRS-80 II	64	179.00	189.00
TRS-80 III	32/48	149.00	159.00

### ALL PROGRAMS IN DISK BASIC

IBM is a trademark of IBM, Apple is a trademark of Apple Computer Corp., TRS-80 is a trademark of Tandy Corporation.

**ORDER NOW! FILL IN OR CALL 800-525-2003 (Toll Free)**

PROGRAM NAME \_\_\_\_\_ COMPUTER \_\_\_\_\_ MEMORY \_\_\_\_\_  
 NAME \_\_\_\_\_ PHONE # \_\_\_\_\_  
 ADDRESS \_\_\_\_\_      
 ACCOUNT # \_\_\_\_\_ EXP. DATE \_\_\_\_\_

the program begins by giving an identification message and then asks:

DISK SYSTEM OR LEVEL II  
BASIC (D/B)?

Our example will work the same way whichever answer you give. The program next asks the number of activities, using the answer as the basis for a dimension statement. As noted earlier, you must have enough memory to dimension the number of activities in your project.

The program presents the message:

\*\*\* NOTE BEGINNING EVENTS  
WILL BE SORTED INTO  
NUMERICAL ORDER \*

when asking

DIMENSION FOR ACTIVITIES?\_\_

As you see in listing 2, events are arranged according to the earliest starting event in each activity, and ties are broken by reference to the earliest ending event for each activity.

Now the program presents the input menu:

### INPUT MENU

K KEYBOARD  
 D DISK FILE  
 R READ STATEMENT  
 T1 TAPE RECORDER# - 1  
 T2 TAPE RECORDER# - 2  
 SELECTION?\_\_

Option R causes the program to read DATA statements at the end of the program. After a brief delay, the program will display for verification the input that was read.

The video display of the input will look slightly different than the table in listing 2 because of differences in the screen and printer sizes. If a single screen won't accommodate all the input, the program will ask you to page through.

After listing all the input, the program will say:

-2 ADD, -1 TO CONTINUE OR  
NUMBER TO CHANGE?\_\_

The number referred to is the number

of any activity that you wish to change. Assuming you want to continue and enter -1, the program will ask:

HARD COPY OF INPUT DATA (Y/N)?\_\_

If you request hard copy, the program will ask

TITLE?\_\_  
DATE?\_\_

and will print your responses at the top of the page. Our sample set of data used the title SAMPLE PROBLEM and the date 01/19/81.

After the input is printed, the screen will display the results, as shown in listing 3. For each activity, you will see computations of how long it should be expected to take, the earliest week it can start, the earliest week it can finish, the last week it can start, the last week it can finish, and the slack time (the difference between the earliest and latest possible finish). You may have to page through a screen display of this data. The program will again ask if you want hard copy.

Then you will see:

```

OUTPUT MENU
C  CRITICAL PATH AND TIME
D  DISK
E  END
R  RECYCLE
T1 TAPE#-1
T2 TAPE#-2
SELECTION?__
    
```

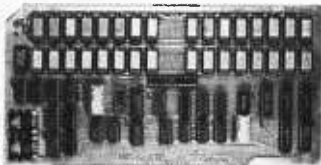
Option C, for our example, results in a display like the following:

```

CRITICAL PATH
C I K N P
TIME OF CRITICAL PATH
42.33
SCHEDULED PROJECT TIME
(USE SAME TIME UNITS AS DATA)?__
    
```

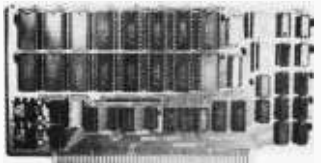
For our example, the critical path consists of shopping for a real-estate agent, obtaining land, getting architectural plans, getting a detailed

### 3 Great Memory Boards From S.C. Digital



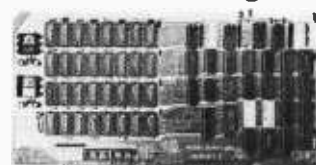
#### 64K DYNAMIC RAM 'Uniselect: 2'

features: **Model 64KUS**  
 ● 16 or 24 bit address. ● 8 bit data. ● Bank select by SW settable port, bits in two blocks. ● Two 32kb (128KB) addressing. ● Transparent refresh - same as M:256KE. ● Fast access time - 220nsec, will run with Z80, Z8000 to 4mhz, 8080, 8085, 8086, 8088 to 5mhz without Wait States. ● Can be configured to various multiusers OS's. ● Expandable to 256KB using 4164's.



#### 32 STATIC RAM 'Uniselect: 3'

features: **Model 32KUS**  
 ● Fully Static using 2k by 8 NMOS chips. ● 16 or 24 bit address. ● 8/16 bit wide data. ● Bank Select by port and bit in 32K block. ● Two 16K block addressing with window capability in 2k increments. ● EPROM can be mixed with RAM. ● Fast access - 250nsec from address valid - will run with Z80, Z8000 to 4mhz, 8080, 8085, 8088, 8086 or 88000 to 8mhz without Wait States. ● Provision for Battery Backup using NMOS or CMOS.



#### 256K DYNAMIC RAM

features: **Model 256KE**  
 ● 16 or 24 bit address. ● 8/16 bit wide data. ● Transparent refresh with unlimited DMA, immune to Wait States, halts, resets. ● Fast access time 180nsec from Smemr or Psync high, will run with Z80, Z8000 to 4mhz, 8080, 8085, 8086 to 8mhz without Wait States. ● Accepts 4116, 4064's.

Model	Prices	Assembled & Tested
256KE	\$795	256KB
256KE-128	\$535	128KB
64KUS-128	\$515	128KB
64KUS-64	\$395	64KB(4164's)
64KUS	\$395	64KB(4116's)
64KU-16	\$285	16KB
32KUS	\$399	32KB
32KUS-16	\$269	16KB
32KUS-N	\$149	No Memory
32KUS-B	\$ 72	Bare board with Doc

All boards conform to IEEE696/S100 specifications, fully socketed, legends, masks, Gold contacts. Guaranteed One Full year.

Delivery is within 3 working days. MC, Visa or CDD orders accepted. Illinois residents add 5 1/4% sales tax.

O.E.M. & DEALER PRICING AVAILABLE

S.C. DIGITAL

P.O. Box 906, Aurora, Illinois 60507

Phone (312) 897-7749

## multiuser WICAT system 150

The WICAT 150-WS set a new standard of price/performance with its powerful Motorola 68000 processor, large memory, hard disk, floppy disk, and complete system software.

Now there is a flexible efficient multiuser System 150. Memory and resources are assigned dynamically to each user as needed. Program code is shared to avoid multiple copies. Background processing can be initiated. All of the power of the top of the line WICAT System 100 is here.

Concurrent Corporation will be adding full network database and screen management software as well as applications soon. We can discuss your needs with you and help select the proper configuration. Please write or call (513) 281-1270.



\$8500

WICAT System 150-WS (single user)  
 Motorola 68000, terminal, 10MB Winchester, 960KB floppy, 256K memory, 1 parallel and 2 serial ports, system software ..... \$8500

WICAT SYSTEM 150-3 (three user)  
 Motorola 68000, terminal, 10MB Winchester, 960KB floppy, 256K memory, memory management, 1 parallel and 2 serial ports, system software ..... \$10850

WICAT SYSTEM 150-6 (six users)  
 Motorola 68000, terminal, 10MB Winchester, 960KB floppy, 512K memory, memory management, 5 serial and 1 parallel ports, system software ..... \$12850



**Concurrent** Corporation  
 1870 Madison Road Cincinnati, Ohio 45206



layout for construction, and actually building the foundation. The time of the critical path is expected to be 42.33 weeks.

You can now input the scheduled time for the project, and the program will use the Z calculations explained in the textbox "A Glance at the Mathematics of PERT" to tell you the probability of meeting the schedule.

As shown in listing 3, there is a 0.0123852 probability of finishing in 35 weeks and a 0.990536 probability of finishing in 50 weeks. As noted earlier, there is also a 0.500 probability of finishing in the expected time of the critical path—42.33 weeks.

### Conclusion

If you need help planning and

scheduling complex projects, our PERT program can provide it. You can use it without knowing how to perform the calculations involved. Although we repeat our caution about relying on estimate-based estimates, we still believe PERT has proved itself a valuable managerial tool and that our program accurately represents PERT. ■

### A Glance at the Mathematics of PERT

The mathematics of PERT involves some interesting statistical concepts. You don't have to understand the mathematics to use PERT, but it helps you to understand how our program works.

First, we must refresh your recollection of some basic statistical terms. The mean of a set of occurrences of some variable is the arithmetic average of the values of the occurrences; the standard deviation shows the variability of occurrences from the mean (more precisely, the standard deviation is the square root of the mean of the squares of the deviations of individual occurrences from the mean); the variance is the square of the standard deviation.

For example, if we have three values 9, 12, and 15, their mean is  $36/3 = 12$ , their variance is

$$(9-12)^2 + (12-12)^2 + (15-12)^2 = 18$$

and the standard deviation is the square root of 18, which is approximately 4.24.

It is a common statistical assumption that the standard deviation in unimodal distributions (distributions that have only a single most-likely-occurring value) is roughly a sixth of the range of distribution. The basis for this estimate is the fact that 89 percent or more of any distribution lies within three standard deviations of the mean; and for the normal distribution, 99.7 percent of the distribution lies within three standard deviations of the mean.

Since we have estimates of the minimum time  $a$  and the maximum time  $b$  required to complete an activity, we have established an estimated range of actual times. We can estimate the standard deviation of the actual time as:

$$\frac{(b-a)}{6}$$

Since PERT assumes that chance, or random, factors will influence the actual time needed to complete an activity, we can expect the actual times to be distributed along some curve. PERT assumes that the mean actual time will follow the distribution known as the beta distribution, which is contained in a finite interval and may be either symmetric or skewed. Our most likely time of completion  $m$  is the mode of the curve for each activity. The following equation, based on the assumption that our formula for the standard deviation is correct, is a linear approximation of the value of the expected value,  $EV$ , of the mean time:

$$EV = \frac{(a+4 \times m+b)}{6}$$

As you can see, this is just a weighted average, counting the minimum and the maximum each once and the mode four times, then dividing the total by six. On line 980 of listing 1, the same equation is expressed as:

$$A(I,6) = (A(I,3) + 4 \times A(I,4) + A(I,5))/6$$

The following equation gives the variance of the beta distribution for each activity:

$$VAR = ((b-a)/6)^2$$

For each activity, the program applies the statistical principles described above and calculates the time the activity should last, the earliest time at which it can start, the earliest finish, the latest start, and the latest finish. Calculation of the earliest start and finish times is called the "forward pass" and takes place in our program at lines 960 through 1070. Calculation of the latest start and finish is called the "backward pass" and takes place at lines 1080 through 1230.

The difference between the earliest and latest projected finish for each activity is called "slack time." At lines 1240 through 1270, the program calculates slack time for each activity. The events that have zero slack time form the critical path.

To obtain the approximate variance for the critical path, add the variances of the activities on the path:

$$VAR(\text{Path}) = VAR(1) + VAR(2) + \dots + VAR(n)$$

It happens that the Central Limit theorem enables us, based on the foregoing, to assume that the distribution of the time required to complete the critical path is normal. Based on this assumption, we can calculate the probability of the project's being on time, given some specified target completion time. The calculation's basis is the deviation of the scheduled completion time from the estimated mean completion time, with the deviation measured in units of standard deviations. This deviation is called  $Z$ . The  $Z$  calculation for the standard normal table is:

$$Z = \frac{\left( \begin{array}{l} \text{scheduled} \\ \text{time} \end{array} - \begin{array}{l} \text{time of} \\ \text{critical path} \end{array} \right)}{VAR(\text{path})}$$

Rather than require you to use normal tables with our program, we have built in a Taylor series to approximate the tables. (A Taylor series is a power series that gives the expansion of a function  $f(x)$  in the neighborhood of a point  $a$ , provided all derivatives exist and the series converges.) The Taylor series is located at line 1600 and following in our program.

The expected time of the critical path is the sum of the expected times of all the activities on the path. If the scheduled time of the project equals the expected time of the critical path, you have a 50 percent chance of completing the project on time.

# CP/M, Your Time Has Come

*A real-time clock for the most popular microcomputer operating system.*

---

J. L. Calaway and B. Hill  
c/o Teleshows Inc.  
6842 Ranchito Ave.  
Van Nuys, CA 91405

---

Have you ever looked with envy at big computers that have built-in, real-time clocks? If so, this project may be for you. We had a business program that required such a clock, but the application neither warranted the expense of a clock board nor required split-second accuracy. We needed a time-of-day reference rather than a precise generator of program interrupts and we needed to be able to access the clock and print the time from either the operating system or a BASIC program. We wanted something like the clock in Digital Research's MP/M, but we also wanted our clock to work with earlier versions of CP/M.

The project turned out to be reasonably easy to implement in both hardware and software. Anyone running CP/M with a disk drive and a Z80 or 8080 processor can have a clock like ours with little difficulty. The part of the project that requires the most care is integrating the software into the existing CP/M system. If you're rusty at using CP/M's DDT (debugger), ED (editor), and ASSEMBLER programs, here is a chance to practice on a worthwhile project.

## Building the Clock Hardware

Figure 1 shows all the hardware we need. The unregulated +8 V power bus in most computers has a lot of 120-cycle ripple riding on top. We differentiate this ripple with a condenser (C1) and a resistor (R1). By

---

### About the Authors

*Jack Calaway is an engineering consultant specializing in hardware and software systems for the television post-production industry. He is interested in computer languages and flying. His computer equipment consists of a mature S-100 system with four disk drives, a line printer and several types of processors, including Intel 8080, Zilog Z80, Motorola 6800, and Intel 8088.*

*Ben Hill is president of Teleshows Inc, which provides television production services to the industry. He is interested in music and photography and has a special interest in business applications for computers. His equipment is a three-disk S-100 system with a Perkin-Elmer OWL terminal and a Diablo printer.*

---

feeding the result into a high-gain LM324 operational amplifier (IC1), wired as a comparator, we get a 120-cycle pulse output. (The output isn't quite symmetrical, but that's not a problem in this application.)

Now that we have pulses to count, the rest of the hardware is easy. The 7490 (IC2) is used as a divide-by-10 counter, and its output feeds the 7492 (IC3), which is connected as a divide-by-12. The result: a divide-by-120 and one pulse per second on the output of the counter chain. Thanks to your friendly utility company, the pulse is accurate to 0.05%.

This one-second pulse is now fed to a 7400 NAND gate (IC4). Two of the gates in this device are connected as a familiar set/reset latch. Another gate is used to invert the processor interrupt-acknowledge pulse (SINTA, pin 96 on the S-100 bus). The diode on the POC (power-on clear) line (pin 99 on the S-100 bus) allows setting the latch on power-up but prevents the acknowledge pulse from feeding back down the POC line. Since the count pulse is too wide, we differentiate it with a condenser (C2) and a resistor (R2) and then feed it to pin 5 of IC4. The output of the latch (pin 3) is fed to the PINT (processor-interrupt) line (pin 73 on the S-100 bus). In operation, the clock pulse triggers the latch and PINT goes low. It stays low until the processor acknowledges the interrupt via SINTA and again presets the latch.

We could use a faster pulse time, but it would complicate the project. Each disk access by a running program will disable the interrupts. If clock pulses came in at a faster rate—say 60 times a second—then some method would have to be devised to keep track of those pulses occurring during disk access. Otherwise the pulses that occurred while the interrupts were disabled would be lost and the clock would lose time. Fortunately, disk-access times are usually less than 1 second. Since the latch will hold the clock request that long, the processor will recognize the clock pulse when the disk controller turns the interrupts back on.

The switch on the PINT line is there so that you can disable the clock. Some programs enable interrupts. DDT

is an example. Since DDT uses the same restart instruction as the clock program (RST.7), you must disable the clock to prevent mutual interference whenever you use DDT. Furthermore, if you use interrupts in your system, you won't be able to use the hardware described here.

You can construct the circuit using space on one of your boards or on a piece of perf-board. The layout is not critical. You can use either wire-wrap or point-to-point wiring with solder. When you complete your board, check for a one-second pulse at pin 3 of the 7400. If you have it, your clock hardware is working properly.

### Clock Software

The clock software consists of four parts:

- code that establishes an area in memory to act as a communications link between the BIOS (basic input/output system) and the clock program on disk
- a program that controls, sets, and reads the clock
- modifications in the BIOS to prepare it for handling the clock-generated interrupts
- code that adds BIOS to the clock routines that are accessed during each interrupt to update the time

If you have a listing of your BIOS, now is the time to dust it off and use it. If you don't have a listing, get the name of your BIOS file from your system manual and print a listing to use as a reference while implementing this clock. You can print the listing by using the TYPE command on the ASM file that contains the BIOS or on the PRN file produced by assembling the file.

Note that some of the file names used in this article may not match the names used in your system. To prevent confusion, we describe file references as fully as possible.

### Establishing a Communications Area

There are 16 unused bytes in CP/M's BIOS, starting at address 40 hexadecimal. We will use 7 bytes of this for our communications area. But first, look at the EQUATES or SYMBOL TABLE section at the beginning of your freshly printed BIOS. See if any of the labels or equate statements use address 40. If none does, then you are free to use any of those 16 bytes. If some of the locations are used, don't write over them or you will "clobber" your operating system. Instead, pick another location. The CP/M manual lists the addresses that are free in low memory. Look in the section called the CP/M

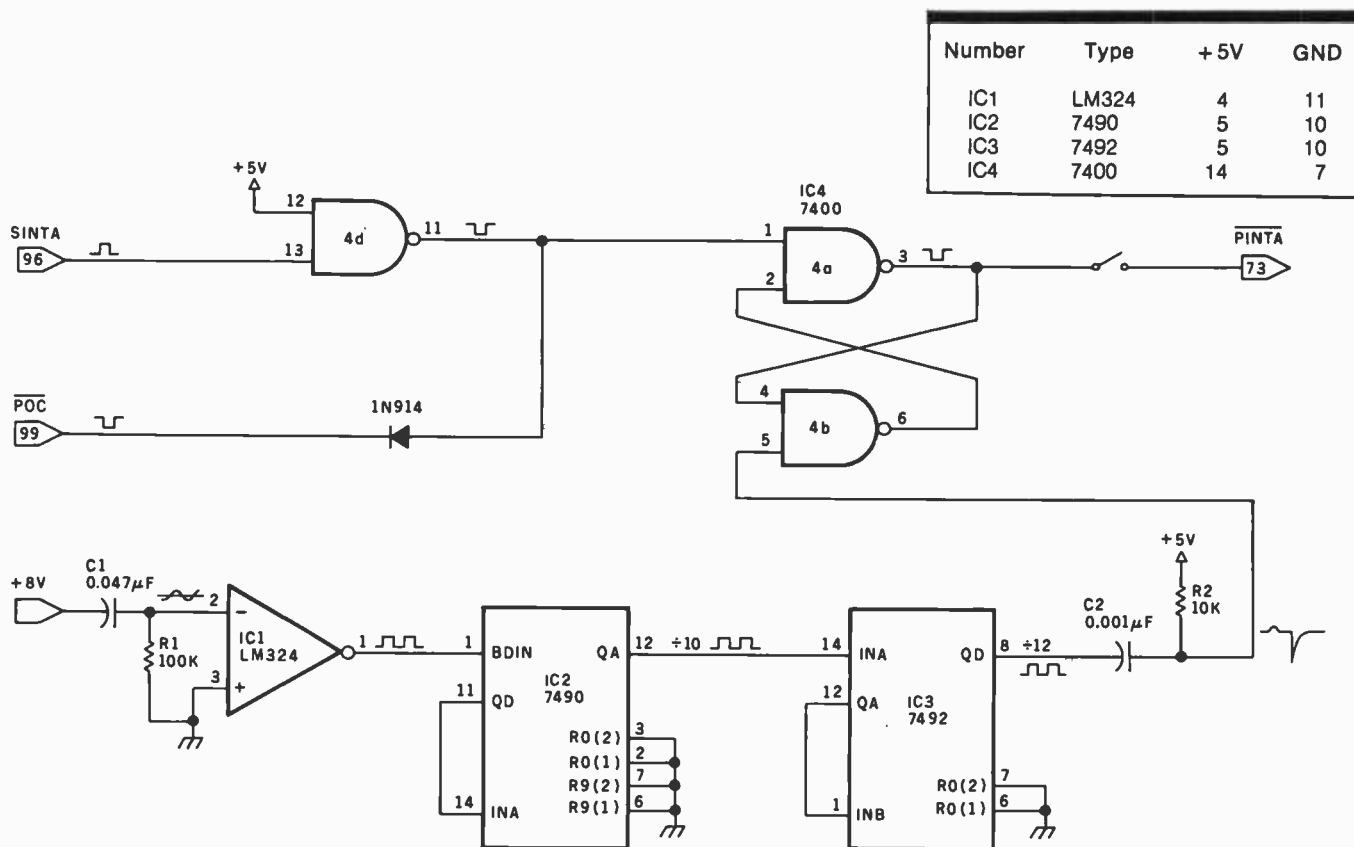


Figure 1: The hardware required to generate the clock interrupts for the CP/M clock programs. This design uses the inherent stability of the AC line to generate accurately timed pulses. The LM324 sees the few hundred millivolts of AC ripple riding on top of the computer's +8 V supply and makes a pulse out of it. Using this approach makes it unnecessary to bring AC into the board. The counters divide the pulse down to one per second.



Alteration Guide, under the heading "Reserved Locations in Page Zero."

You don't have to use the locations at 0040 hexadecimal, or even low memory for that matter. You can use any location that isn't reserved by CP/M. If you decide to use a high-memory location (i.e., above the BIOS), remember that you will have to change the addresses of all programs that use the clock whenever the size of the CP/M system is changed. Also, whatever location you do choose will become the value to be used in the TIME program equate: BASE.

Assuming we have picked 0040 hexadecimal as the starting location for our communications area, here is how hexadecimal addresses are employed: the address of the clock routine is stored at 0040 and 0041. This is set by the BIOS and is used by the time program when starting the clock. The clock ON/OFF flag is at 0042 (ON=1, OFF=0), 0043 is the seconds register, 0044 is the minutes register, 0045 is the hours register, and 0046 is the AM/PM flag (AM=0, PM=FF).

### The TIME Program

TIME is a short machine-language program that resides permanently on your system disk. In addition to reading and setting the clock, TIME checks to see if the BIOS has the code to handle the required interrupts. TIME also checks for valid time entries from the terminal.

As a command file, TIME may be called in response to CP/M's prompt. The time-of-day registers maintained by the BIOS may also be read by a BASIC program that uses the PEEK instruction. The clock may be called as often as desired with either method, but the actual starting and stopping of the clock can be done only in TIME's command mode.

To set the time and start the clock with this program, get the A> prompt, and then type:

```
TIME 120000PM (or any valid 12-hour clock time)
```

The program will respond with:

```
START CLOCK BY PRESSING RETURN
```

When return is pressed, the clock is started and the following message is displayed:

```
TIME SET TO = 12:00:00 PM (the set time)
```

The clock is now running and will continue to run without intervention. The clock won't interfere with your other programs unless they require the use of interrupts.

To read the time, type:

```
TIME
```

The program will display the time in this format:

```
12:00:15 PM
```

To stop the clock, type:

```
TIME STOP
```

This will stop the clock and display a message like:

```
STOPPED AT 12:00:15 PM
```

When you start the clock again, you must, of course, reset it. There is no provision for a split-time register.

### Modifications

Now that we have a clock pulse, a program to process it, and a place in memory to store it, we need a few changes in the system BIOS to make it all work. The areas in BIOS that are affected by the clock program are as follows:

- The EQUATE area. We need to add EQUATES to tell the assembler what addresses we have chosen for the communications section.

- The cold boot (bootstrap) routine. When initializing the system or using the cold boot start, RST-7 has not yet been set up, so the clock must be disabled by setting the ON/OFF flag to OFF (0).

- The GOCPM area in the BIOS is used at program exits and by both cold and warm boots. During the cold boot, the ON/OFF flag is set to 0 and the interrupts are not turned on. With a warm boot, however, we don't know whether the clock is ON or OFF, so we check it. The program then decides what to do: either turn the clock OFF, or leave it OFF if it already is.

- The SETUP routine section sets up jumps into CP/M in low memory. Since the CP/M size changes if you add memory, we add a bit of code here to tell the communications area the address of the clock in BIOS. The TIME program, which sets up the restart address-link to the BIOS clock, must get the address from the communications area.

- The READ and WRITE routines. If the disk controller does not use DMA (direct memory access), or if it does but uses it in the direct-transfer mode, we must disable the interrupts while we are doing a read or write to disk. The code entered here turns off the interrupts and then turns them back on again as soon as possible to avoid losing any counts. Check your disk-controller manual to see what kind of read/write system it uses. If your controller tolerates interrupts during the read/write cycles, then you need not implement this section of code.

- Add the clock coding to BIOS. The program in listing 1 provides the coding necessary to handle and service the clock interrupts. At the end of this code is a short section called INTON. This code saves the processor status in a register, then checks the ON/OFF locations. If the clock ON/OFF location is ON (1), the interrupts are enabled. If the clock is OFF (0), the interrupts are left disabled. Note again that if your terminal or printer input/output routines in BIOS use interrupts, you will not be able to implement this clock.

The preceding summarizes the changes needed in BIOS to implement the clock. The clock counter is kept in binary-coded-decimal form. The lower 4 bits of each byte hold the units of time, while the upper 4 bits hold tens of units. Since there is no way of knowing how much stack space your system has allowed, the interrupt handler routine is coded as simply as possible.

### Putting It All Together

The new code to be added to the BIOS is shown in listing 1. It is generally compatible with all versions of CP/M, but in version 2.0 and later, make sure that add-

ing this code doesn't exceed the BIOS size allowed by your system.

To start, find the equivalent code in your listing, and with your editor call up your CBIOSXX.ASM (where C stands for "custom" and XX is the size of your system). Put in the new EQUATES at any convenient location in your BIOS EQUATE area, and follow listing 1 for the rest of the new code. Remember: don't write over or delete any code in your BIOS. Just make additions.

After you have made the changes, save the file. This will give you a new CBIOSXX.ASM file that contains the additions. Starting at this point you should work on a

*Text continued on page 486*

**Listing 1:** *The clock program that is added to the CP/M BIOS. It enables the system BIOS to handle the one-a-second interrupts generated by the clock hardware and maintains the accumulated time in registers located in low memory. Once the clock is started, this program maintains the time registers without interference with other operating programs.*

```

; CLOCK PROGRAM BIOS CODE BY J. L. CALAWAY AND
; B. HILL. FEB 10, 1981 LISTING #1 REVISION 1

; CODE TO BE ADDED TO THE SYSTEM BIOS TO IMPLEMENT THE
; CLOCK PROGRAM

; IN THE AREA USED BY BIOS TO SET THE VARIOUS EQUATES
; AND CONDITIONALS, WE ADD THE EQUATES NEEDED TO
; DEFINE THE CLOCK COMMUNICATIONS AREA
;

CLOCK EQU TRUE ; ENABLE REAL-TIME-CLOCK
BASE EQU 00040H ; COMMUNICATIONS AREA
CLKADR EQU BASE ; ADDRESS INITIATED BY BIOS
ONOFF EQU CLKADR+2 ; ON/OFF FLAG 0=OFF
SEC EQU ONOFF+1 ; BCD SECONDS
MIN EQU SEC+1 ; BCD MINUTES
HRS EQU MIN+1 ; BCD HOURS
AMPM EQU HRS+1 ; AM=0, PM=FF

; IN THE COLD BOOT SECTION
;
XRA A ; EXISTING CODE, NO CHANGE
STA IOBYTE ; EXISTING CODE, NO CHANGE

IF CLOCK ; NEW CODE TO BE ADDED
STA ONOFF ; SET ONOFF=0
ENDIF ; END OF NEW CODE IN THIS SECTION

; IN THE GOCPM SECTION WHERE CONTROL IS TRANSFERED
; TO CP/M, WE ADD A CHECK TO SEE IF THE INTERRUPTS
; SHOULD BE ON, OR OFF
;
LDA DISKNO ; EXISTING CODE, NO CHANGE
MOV C,A ; EXISTING CODE, NO CHANGE

IF CLOCK ; NEW CODE TO BE ADDED
LDA ONOFF ; GET FLAG
ORA A ; TEST

```

Listing 1 continued:

```
        JZ      CPMB          ; START WITHOUT INTERRUPTS
        EI      ; TURN ON INTERRUPTS
        ENDIF   ; END OF NEW CODE

        JMP     CPMB          ; BACK TO OLD CODE, NO CHANGE
; IN THE AREA WHERE A JUMP TO LOW MEMORY IS SETUP, WE
; SET CLKADR TO THE ADDRESS OF CLOCK
;
        SHLD   DMAADD        ; EXISTING CODE, NO CHANGE

        IF     CLOCK         ; ADDED CODE BEGINS
        LXI   H,CLK          ; ADDRESS
        SHLD  CLKADR
        ENDIF   ; END OF NEW CODE

; NOTE, WE DO NOT NEED TO PUT A JUMP INSTRUCTION IN
; NOW, AS THAT IS DONE BY THE TIME PROGRAM, WHEN
; THE CLOCK IS STARTED

; IN THE WARM BOOT AREA, WE CHECK TO SEE IF
; THE USER PROGRAM HAS TURNED THE CLOCK OFF
;
WBOOT:  LXI    SP,80H        ; OLD CODE, NO CHANGE

        IF     CLOCK         ; NEW CODE STARTS HERE
        CALL  INTON          ; CHECK
        ENDIF   ; END OF NEW CODE

        LDA   DISKNO        ; OLD CODE, NO CHANGE

; IN THE READ ROUTINE, SINCE MANY CONTROLLERS ARE NOT
; DMA, WE MUST TURN OFF THE INTERUPTS DURING THE
; ACTUAL READ PROCESS.

        XTHL          ; EXISTING CODE, NO CHANGE
        XTHL          ; EXISTING CODE, NO CHANGE

        IF     CLOCK         ; NEW CODE STARTS HERE
        DI      ; KILL INTERUPTS
        ENDIF   ; END OF NEW CODE

        LDA   SECTOR        ; EXISTING CODE, NO CHANGE

; NOW, AS SOON AS POSIBLE AFTER WE HAVE COMPLETED THE DISK
; TRANSFER, WE WANT TO TURN THEM BACK ON
;
RDDONE: IN     DSTAT        ; READ DISC STATUS, OLD BIOS CODE

        IF     CLOCK         ; NEW CODE STARTS HERE
        CALL  INTON          ; CHECK
        ENDIF   ; END OF NEW CODE

; WE DO THE SAME THING FOR WRITE AS WE DID FOR READ
;
```

Listing 1 continued on page 484



Listing 1 continued:

```

XTHL          ; EXISTING CODE, NO CHANGE
XTHL          ; EXISTING CODE, NO CHANGE

IF          CLOCK          ; NEW CODE STARTS HERE
DI          ; TURN OFF
ENDIF       ; END NEW CODE

; AND AGAIN, BACK ON AS SOON AS POSSIBLE
;
WDONE: IN     DSTAT          ; OLD CODE, NO CHANGE

IF          CLOCK          ; NEW CODE HERE
CALL       INTON          ; CHECK - TURN BACK ON
ENDIF       ; END NEW CODE

; THIS IS THE ACTUAL CLOCK SUBROUTINE TO BE ADDED TO THE BIOS.
; IT MAY BE PLACED ANYWHERE IN BIOS PROVIDING YOU DON'T BREAK
; UP A BIOS SUBROUTINE.  A GOOD PLACE TO PUT IT IS AT THE END
; OF THE PROGRAM JUST BEFORE THE CBIOS MESSAGES.

; CLOCK TIME IS KEPT IN BCD FORMAT AND
; IN LINE CODE IS USED TO MINIMIZE STACK USAGE.
;
; (NOTE: THE 3RD AND 4TH LOCATION FROM THE
; START OF CLK, IS CHECKED BY THE "TIME" PROGRAM BEFORE
; TURNING THE CLOCK ON AND IT MUST BE THE SAME AS THE ADDRESS
; IN THE TIME PROGRAM USED FOR SECONDS.)
;
IF          CLOCK

CLK:  PUSH     PSW          ; SAVE USER
      PUSH     H
      LXI     H,SEC        ; SECONDS
      MOV     A,M          ; GET CURRENT
      ADI     1            ; + 1
      DAA                    ; BCD CORRECTION
      MOV     M,A          ; PUT IT BACK - DATA MAY BE GOOD
      CPI     060H        ; BCD FOR 60 SEC
      JNZ     CLK2        ; OK, EXIT
      XRA     A            ; A=0
      MOV     M,A          ; RESET SECONDS, CHECK MINUTES
      INX     H            ; TO MINUTES
      MOV     A,M          ; CURRENT
      ADI     1            ; + 1
      DAA                    ; BCD CORRECTION
      MOV     M,A          ; PUT IT BACK AGAIN
      CPI     060H        ; BCD FOR 60 MINUTES
      JNZ     CLK2        ; OK, EXIT
      XRA     A            ; A=0
      MOV     M,A          ; RESET MINUTES, DO HOURS
      INX     H            ; TO HOURS
      MOV     A,M          ; GET CURRENT
      ADI     1            ; + 1
      DAA                    ; BCD CORRECTION
```

Listing 1 continued:

```

MOV      M,A
CPI      013H      ; OVERFLOW?
JNZ      CLK2      ; OK
MVI      M,001H    ; SET TO 1 HR
INX      H          ; TO AM/PM FLAG
MOV      A,M       ; GET CURRENT
CMA      ; REVERSE
MOV      M,A       ; NEW
CLK2:    POP      H ; RESTORE
JMP      INTON1    ; DO ON/OFF CHECK

```

```

; THIS ROUTINE IS USED TO CHECK AND SEE IF THE
; INTERRUPTS SHOULD BE ON OR NOT, IT ENABLES THEM
; IF NECESSARY
;
;

```

```

INTON:   PUSH     PSW      ; SAVE
INTON1:  LDA      ONOFF    ; GET FLAG
ORA      A          ; AND TEST
JZ       INTON2      ; OFF
EI       ; TURN ON
INTON2:  POP      PSW     ; RESTORE USER
RET
ENDIF

```

```

; THIS COMPLETES THE CODE ADDED TO BIOS FOR CLOCK OPERATION

```

ALITOS		OUR	Special! Apple Deals... Call	
LIST	PRICE		New Panasonic-Link... Call	
ACS8000-15	4990	3915		
ACS8000-10	8500	6665		
ACS8000-10SMTU	11990	9400		
TERMINALS		OUR	Televideo Computer Systems... Call	
LIST	PRICE		DYNABYTE	
Adds Viewpoint	650	599	LIST	PRICE
Televideo-910	699	CALL	5200 A2	2995
Televideo 912C	950	695	5505 A1	6995 5229
			5615 A1	8995 6650
			5701 A1	8995 6950
XEROX 820		OUR	PRINTERS	
LIST	PRICE		LIST	PRICE
System 1-5 1/4"			Diablo 630	2900 CALL
Disk Drive(s)	2995	2450	Qume Sprint	2895 2695
System 2-8"			Okidata 82A	595 495
Disk Drive(s)	3795	3425	Okidata 63A	940 765
			Epson-100	995 885
Zenith-Z90-80			Anadex 132	1350
64K-1.2MB			Column DP9501	1650 1407
with CP/M+microsoft basic+supercalc		All For 3690	NEC 3510	2290 1900

Large Library of CP/M-MP/M-Oasis Software  
Call for Price List  
Visit our NYC Showroom for a free Demo

**COMPUCO**  
Business Systems Inc.

170 Broadway, New York, NY 10038  
Call 212-619-3360  
— WE SHIP EVERYWHERE! —  
Full Service & Support  
Free Consultation at all times  
Dealers of many other Hardware Products... Call

# Apple, Printers, Memory etc...

## PRINTERS

Microline 82A	\$499.00	NEC 8023A	\$ 499.00
Microline 83A	740.00	MX-100	685.00
Microline 84	1200.00	Parallel Card & Cable	70.00

## DISK DRIVES

Add on Drive for Apple (Tandom)	\$370.00
Controller for Apple (Micro Sci)	89.00
Shugart 801R (Sgl / Dbl)	389.00
Shugart 851R (Dbl / Dbl)	525.00
Qume DT-8 (Dbl / Dbl)	499.00

## TERMINALS & MONITORS

Adds Viewpoint	\$ 520.00	Zenith Grn. Screen	\$118.00
Televideo 950C	910.00	NEC JB1201	179.00

## COMPONENTS

	Ea.	8 pcs	100 pcs
2114L2 (200NS)	\$2.25	\$2.10	\$1.90
2708 (450NS)	2.50	2.40	2.20
2716 (5V)	4.30	4.20	3.90
2716 (5 & 12)	5.00	4.80	4.60
2532 (450NS)	7.50	7.25	6.95
2732 (450NS)	7.50	7.25	6.95
4116 (200NS)	1.75	1.70	1.50
6116-3 (150NS)	8.00	7.60	7.00

## SPECIALS

Apple II 48K	\$1199.00
Super R-Mod II	27.95
5 1/4 Disks (10 ea)	22.00

We will try to beat all other Ad prices. We have available much, much more!

**Computer Components Unlimited**  
ORDER DESK CALL (213) 644-3311  
Send Mail Order—VISA / MC, Check, Wire Transfer  
P.O. Box 1936 / Hawthorne, CA 90250

Text continued from page 482:

temporary disk so that any mistakes won't wipe out your good disk.

Now assemble the BIOS file. If you have any errors, be sure to correct them before continuing. When the program assembles correctly, you will have two files: CBIOSXX.PRN and CBIOSXX.HEX. Transfer these two files along with SYSGEN (the CP/M command file that initializes new disks), CPMXX.COM (the command file for changing system size—sometimes called MOVCPM.COM), BOOT.HEX (the source file for the cold-start loader program), and DDT. You are now ready to add the new BIOS to your system. The following sequence shows how:

```
A> DDT CPMXX.COM (Call your file with DDT.)
DDT VERS X.X
NEXT PC
2100 0100 (system response after loading)
-
-ICBIOSXX.HEX (Input your CBIOS hex file.)
-RXXXX (This number varies. Check your manual for correct offset bias.)
NEXT PC (system response after loading CBIOS.HEX)
2286 0000
```

```
-
-IBOOTXX.HEX (Input your BOOT hex file.)
-R900 (This offset number is always 900 for BOOT.)
NEXT PC (system response after loading BOOT.HEX)
2286 0000
-
-^C (Exit DDT with a warm boot.)
A>SYSGEN (Call SYSGEN and follow the prompts on your terminal to complete initializing the new system.)
```

Now it's time to try the new system. Put in your new disk and cold boot. If all is well, your system should run normally. Be sure to check out the CP/M operating system thoroughly to make sure you haven't added a bug somewhere. If the system crashes, one way to get a cross-check is to print out the CBIOS.PRN file and compare it with your old listing. If the listings check, it is likely that you inserted some of the clock code in the wrong place. You'll have to do the BIOS over.

Once you get this far, the rest is easy. Call in your editor again and start a new file: TIME.ASM. This little program (listing 2) will reside permanently on your new

# NO RISK \* MAIL ORDER DISCOUNTS \* Call for details

<p><b>Apple Cards and Hardware</b></p> <p>16K Ram Board by ConComp Industries ..... 129          Hayes Micromodem II ..... 299          Novation Apple-Cat ..... 339          Video Videoterm 80 Column card ..... 249          Video Keyboard Enhancer ..... 115          Z-80 SoftCard by Microsoft ..... 299          16K Ram Card by Microsoft ..... 159          Thunderlock Plus clock/calendar card ..... 129          Smarterm 80 column card ..... 299          Corvus Winchester Hard Disk Drive ..... CALL          ALP 2 Voice Music Card ..... 199          ALP 5 Voice Music Card ..... 149          Laser Lower Case Plus + ..... 55          Laser Keyboard Plus + ..... 99          23 Key Numeric Keypad by Keyboard Co ..... 120          Joytech II by Keyboard Co ..... 48          6809 CPU Card (The MID) by Stallion ..... 319          AIO Serial &amp; Parallel Interface by 80M&amp;T ..... 109          Music System (16 voices) ..... 299          A/D + D/A Interface ..... 279          Expansion Chassis (8 slots) ..... 569          Intel X-16 Controller Card ..... 169          Clock/Calendar Card ..... 225          CP8 Multi-Function Card ..... 175          SuperTalker 9D-200 ..... 159          Romplus 4 Card ..... 135          Romwriter Card ..... 149          Syntec Hi-Res Light Pen ..... 310          Sep-R-Fan ventilation system for Apple II ..... 45          Sep-R-Terminal 80 column card by M&amp;B ..... 329          SVA ZXV4 MegaByte 8" Disk Controller ..... 645          SVA 2 + 1 Single Des. 8" Disk Controller ..... 345          SpeechLab 2000 by Hearstics ..... 249          Versawriter Digitizer Tablet ..... 229          Asynchronous Serial Interface Card by CCS ..... 139          Centronics Parallel Interface Card by CCS ..... 119          We carry all California Computer System Cards CALL          We stock many more items for the Apple II.          Please call or write for current price list.</p>	<p><b>VIC-20 \$249</b></p> <p><b>Personal Computer</b></p> <p>Color * Sound * Graphics          Call or write for more info.          Disk drives available soon!</p> <p><b>Video Monitors</b></p> <p>Amdek/Leodes Video 100 12" B&amp;W ..... 129          Amdek/Leodes Video 100G 12" Green Phosphor 149          Amdek (Hitachi) 18" Color w/audio output ..... 389          NEC 12" Green Phosphor Display JB-1201M ..... CALL          NEC 12" Lo-Res Color Display ..... CALL          NEC 12" Hi-Res RGB Color Display ..... CALL          Sanyo 9" B&amp;W Display ..... 185          Sanyo 9" Green Display ..... CALL          Sanyo 12" B&amp;W Display ..... 269          Sanyo 12" Green Phosphor Display ..... 285          Sanyo 13" Color Display ..... 449          Zenith 12" Green Phosphor Display ..... 139</p> <p><b>Printers</b></p> <p>Anadex 9501 w/ 2K Buffer ..... 1289          C. Itoh Stenographer F-18 ..... CALL          IDS Prism Printers ..... CALL          Epson MX-70 ..... CALL          Epson MX-80 &amp; MX-90 FT ..... CALL          Epson MX-100 ..... CALL          NEC 803 Impact Dot Matrix ..... 629          NEC 803 Printers (Latest models) ..... CALL          Paper Tiger IDS-560G w/ graphics ..... 1199          Qemu Sprint Datasystems (Latest models) ..... CALL          Diablo 630 Datasystems 48 CPS ..... 1795</p>	<p style="text-align: center; font-size: 2em; font-weight: bold;">NEC</p> <p style="text-align: center; font-size: 1.5em; font-weight: bold;">Microcomputer</p>  <p style="text-align: center; font-weight: bold; font-size: 1.2em;">CALL FOR BEST PRICES</p> <p>The NEC PC-8001A has all these features and much more. Expandability you want, expandability you get. Through the use of the PC-8012A I/O unit, total system RAM can be extended to 160K. The PC-8031 Dual Disk Drive puts 286K of floppy disk storage at your command.</p> <p>The NEC PC-8001A has so many things that are options on other computers built right in that you may never have to buy another accessory! The quality that the NEC name has come to stand for, has been built-in, too. Compare the competition, and then call Consumer Computers for the NEC PC-8001.</p>	<p style="text-align: center; font-weight: bold; font-size: 1.2em;">ATARI 800 16K</p> <p style="text-align: center; font-weight: bold; font-size: 1.2em;">CALL FOR BEST PRICE</p>  <p>Atari 400 w/ 16K ..... 349          418 Program Recorder ..... 85          818 Disk Drive ..... 649          825 80 col. 7&amp;8 Dot matrix Impact printer ..... 699          822 40 col. Quiet Thermal Printer ..... 349          850 Interface Module ..... 159          Atari 16K Ram Module ..... 69          Atari Ramercom 32K Module ..... 199</p> <p style="text-align: center; font-weight: bold; font-size: 1.2em;">IBM</p> <p style="text-align: center; font-weight: bold;">ACCESSORIES</p> <p>256 K Dynamic Ram Card ..... CALL FOR BEST PRICE          Hi-Speed Parallel I/O Card ..... CALL FOR BEST PRICE          Real-Time System Clock ..... CALL FOR BEST PRICE          Card Expansion Chassis ..... CALL FOR BEST PRICE</p> <p>Ordering information: Phone orders using VISA, MASTERCARD, AMERICAN EXPRESS, DINER'S CLUB, CARTE BLANCHE, bank wire transfer, cashier's or certified check, money order, or personal check (allow ten days to clear). Unless prepaid with cash, please add 5% for shipping, handling and insurance (minimum 5.00). California residents add 6% sales tax. Foreign customers please add 10% for shipping. OEM's, Institutions and corporations please send for a written quotation. All equipment is subject to price change and availability without notice. All equipment is new and complete with manufacturer's warranty (usually 90 days). Showroom prices may differ from mail order prices.</p>
<p><b>16K RAMBOARD by ConComp for Apple II Computers</b></p> <p style="text-align: center; font-size: 1.5em; font-weight: bold;">FOR ONLY \$99</p> 	<p style="text-align: center; font-weight: bold;">Software for the Apple</p> <p>VisiCalc version 3.3 ..... 149          VisiFile (NEW data base manager) ..... 129          VisiFriend/VisiPlot ..... 219          VisiDoc ..... 169          VisiTerm ..... 99          Desktop Plus II ..... 169          DB Master ..... 189          Wordstar (Apple 80-col version) by MicroPro ..... 299          Easywriter Word Processor (80 col) ..... 199          Tax Preparer '81 version ..... 89          Real Estate Analyzer ..... 129          Coaxtra Financing ..... 139          Personal Filing System (PFS) ..... 79          Peachtree Accounting Software ..... CALL          BPI Accounting Software ..... CALL          Systems Plus Acctg Software ..... CALL</p>	<p style="text-align: center; font-weight: bold;">INVENTORY REDUCTION SALE</p> <p>Atari Educational Software ..... CALL          Apple Special Delivery Software ..... CALL          AE 9 Voice Music Card ..... 139          CCS 8-100 64K Dynamic Ram Card ..... 449          CCS 8-100 4 MHz Z-80 CPU Card ..... 229          Centronics 737 Dot Matrix Printer ..... 499          Epson MX-70 Dot Matrix Printer ..... 299          Okidata 82-A Printer W/Tractor ..... 439          Sanyo 12" B&amp;W Video Monitor ..... 229          Sanyo 13" Hi-Res Color Monitor ..... 310</p> <p style="text-align: center; font-size: 0.8em;">Call or write for special price list for our INVENTORY REDUCTION SALE.</p>	<p style="text-align: center; font-weight: bold;">Send Orders To:</p> <p style="text-align: center; font-size: 1.5em; font-weight: bold;">consumer computers</p>  <p style="text-align: center; font-weight: bold;">Mail Order</p> <p style="text-align: center;">8336 Center Drive          La Mesa, CA 92041</p> <p style="text-align: center; font-weight: bold; font-size: 1.2em;">FREE SHIPPING * (continental US only)</p> <p style="text-align: center; font-size: 0.8em;">*prepaid cash orders</p>
<p style="font-size: 1.5em; font-weight: bold;">ORDER TOLL FREE 800-854-6654</p> <p style="font-size: 1.5em; font-weight: bold;">In California and outside continental U.S. (714) 698-8088</p> <p style="font-size: 1.5em; font-weight: bold;">FREE SHIPPING * (continental US only)</p>			



operating system disk. The coding is straightforward and heavily commented. After coding is complete, assemble the file and use the CP/M LOAD command to create the TIME.COM file on your new disk.

If you wired up the hardware on a kludge board, now is the time to install it. Power down and put in your board with the clock-disable switch OFF. Power up again and type the word "TIME" in response to the CP/M prompt. You can expect to see a garbled message, such as:

```
A> <d: #:B> AM
```

If you get this answer—with strange characters for time—all is well. The time characters are just junk put in

the time registers by the power-up start. "AM", "PM", or " : ", however, should appear in the proper position.

Now type in any valid 12-hour clock time. The display should read:

START CLOCK BY PRESSING RETURN

When you press return the display should read:

TIME IS SET TO = 12:00:00 PM (your set time)

If this message sequence doesn't occur, look for a problem in the TIME program. Fix this section before pro-

*Text continued on page 492*

**Listing 2:** TIME, a program that initializes the clock in the CP/M command mode. It resides permanently on disk and, when called, sets, starts, and stops the clock and reads the time. TIME may be called from any drive.

```
; CLOCK PROGRAM BY J. L. CALAWAY & B. HILL
; FEB 10, 1981 LISTING #2, 03:35:40 PM
; COMMUNICATIONS AREA EQUATES
;
BASE      EQU      040H          ; COMM. AREA
CLKADR    EQU      BASE          ; ADDR OF CLK IN BIOS
ONOFF     EQU      CLKADR+2      ; ON=1, OFF=0
SEC       EQU      ONOFF+1       ; BCD SEC
MIN       EQU      SEC+1         ; BCD MIN
HRS       EQU      MIN+1         ; BCD HOURS
AMPM      EQU      HRS+1         ; AM=0, PM=1
RSTLC     EQU      038H          ; RST-7

; CP/M ADDRESS EQUATES
;
ENTRY     EQU      00005H        ; DOS ENTRY
TAIL      EQU      00080H        ; COMMAND TAIL

; CP/M FUNCTION EQUATES
;
PMSG      EQU      009H          ; PRINT BUFFER
GCHR      EQU      001H          ; KEYBOARD

; ASCII EQUATES
;
CR         EQU      00DH          ; CARRIAGE RET
LF         EQU      00AH          ; LINE FEED
BELL      EQU      007H          ; BELL
EOM       EQU      024H          ; CP/M EOM

          ORG      0100H          ; CP/M TPA

; HERE WE BEGIN
;
START:    LXI      D,CRLF          ; CLEAR SCREEN
          MVI      C,PMSG
          CALL     ENTRY

; WHAT TO DO
; SHOW, SET, STOP
;
```

*Listing 2 continued on page 488*

Listing 2 continued:

```
LDA    TAIL          ; COUNT
ORA    A             ; TEST
JZ     DISP         ; SHOW IF 0
LXI    D,TAIL+1     ; FIRST CHAR
MOV    L,A          ; COUNT
MVI    H,0
DAD    D             ; END
XRA    A             ; A=0
MOV    M,A          ; EOF
; SCAN TO FIRST NON-BLANK CHAR
;
SCAN:  LDAX  D        ; CHAR
ORA    A             ; EOM?
RZ     ; YES-SKIP
CPI    ' '          ; SPACE?
JNZ    SCAN1        ; NO
INX    D
JMP    SCAN

; NON-BLANK
;
SCAN1: CPI    061H   ; LOWER CASE
JM     $+5          ; NO
SBI    020H        ; MAKE LOWER
CPI    'S'         ; STOP
JZ     STOP

; LOOKS LIKE WE WILL SET TIME
; CHECK TO SEE IF BIOS HAS CLOCK
;
LHLD   CLKADR
INX    H
INX    H
INX    H            ; TO ADDRESS
MOV    C,M
INX    H
MOV    B,M
LXI    H,NOT SEC-1
DAD    B
MOV    A,L
ORA    H
JZ     SCAN3
LXI    D,BIOSMG
MVI    C,PMSG
CALL   ENTRY
RET

; CONVERT INPUT TIME
;
SCAN3: DCX    D            ; BACK UP POINTER

; TEST
; 0-9 TIME
; :/M SKIP
; A/B SET AM/PM
; SPACE = SKIP
; 00 = END
TEST:  INX    D            ; SRC
LDAX  D            ; CHAR
ORA    A            ; END?
```

Listing 2 continued:

```
JZ      FINI
CPI     061H      ; LOWER
JM      $+5
SBI     020H      ; CONVERT
CPI     '0'       ; NUMBER?
JC      TEST1    ; NO
CPI     '9'+1
JC      PACK     ; VALID
TEST1:  CPI     'A'       ; AM
JZ      SETA
CPI     'P'       ; PM
JZ      SETP
CPI     'M'       ; JUNK?
JZ      TEST
CPI     ':'       ; COLON
JZ      TEST
CPI     ' '       ; SPACE
JZ      TEST
ERROR:  LXI     D,IVMSG  ; NG
MVI     C,PMSG
CALL    ENTRY
RET

; PACK INTO BCD
;
PACK:   MVI     C,3      ; TO DO
        PUSH   D        ; SAVE
        LXI   H,BUFF+3
        LXI   D,BUFF+2
PACK1:  LDAX   D
        RAR
        RAR
        RAR
        RAR          ; SHIFT NIBBLE
        ANI   00FH    ; CLEAR HIGH
        MOV   B,A     ; TEMP
        MOV   A,M
        RLC
        RLC
        RLC
        RLC          ; SHIFT TO HIGH
        ANI   0F0H    ; CLEAR LOW
        ORA   B       ; COMBINE
        MOV   M,A     ; SAVE
        DCX   D
        DCX   H
        DCR   C       ; DONE
        JNZ   PACK1
        POP   D       ; SRC
        LDAX  D       ; GET NEW
        ANI   00FH    ; TO BCD
        MOV   B,A     ; TEMP
        INX   H
        MOV   A,M
        ORA   B
        MOV   M,A
        JMP   TEST    ; NEXT
;
SETA:   XRA   A
```

Listing 2 continued on page 490



Listing 2 continued:

```
JMP          SETAP
SETP:  MVI    A,0FFH
SETAP: STA    BUFF+4
      JMP    TEST          ; CONT

; FINISH
;
FINI:  LXI    H, TABLE    ; TIME CHK
      LXI    D, BUFF+1
      MVI    C, 3
FINI1: LDAX   D          ; GET TIME
      CMP    M
      JNC   ERROR
      INX   D
      INX   H
      DCR   C
      JNZ   FINI1
      DCX   D
      LDAX  D          ; MIN
      CPI   001H      ; BCD 1 HR
      JC    ERROR
      DI    ; HOLD OFF
      LHLD  BUFF+1    ; COPY
      SHLD  SEC
      LHLD  BUFF+3
      SHLD  HRS
      LHLD  CLKADR    ; SET VECTOR
      SHLD  RSTLC+1
      MVI   A, 0C3H   ; JMP
      STA   RSTLC
      MVI   A, 1
      STA   ONOFF     ; START
      LXI   D, STMSG   ; ASK FOR A START
      MVI   C, PMSG
      CALL  ENTRY
      MVI   C, GCHR
      CALL  ENTRY     ; GET KEY
      LXI   D, TIMSG   ; GIVE AN ANSYER
      MVI   C, PMSG
      CALL  ENTRY
      CALL  DISP      ; SHOW
      EI    ; INTERRUPTS ON
      RET

; TABLE OF MAX. TIMES
;
TABLE: DB      060H, 060H, 013H

; STOP CLOCK
;
STOP:  DI    ; INTERRUPTS OFF
      XRA   A    ; A=0
      STA   ONOFF ; HALT
      LXI   D, STPMMSG
      MVI   C, PMSG
      CALL  ENTRY ; TELL WHEN
      CALL  DISP
      RET    ; BACK TO CPM
; DISPLAY TIME 12HR FORMAT
;
```

```

DISP:      LXI      H,HRS
           LXI      D,BUFF
           CALL     DTIM      ; SET UP
           LDA      AMPM      ; AM OR PM
           ORA      A          ; AM/PM
           MVI      A,'A'
           JZ       DISPl
           MVI      A,'P'
DISPl:     INX      D
           STAX     D
           LXI      D,BUFF
           MVI      C,PMSG
           CALL     ENTRY
           RET              ; QUICK TO CP/M

; DISPLAY TIME
;
DTIM:      MVI      C,3      ; TO DO
DTIM1:     MOV      A,M      ; GET DATA
           RAR      ; ISOLATE HI NIBBLE
           RAR
           RAR
           RAR      ; MSN
           ANI      00FH     ; CLEAR
           ORI      '0'      ; TO ASCII
           STAX     D        ; STORE IN BUFFER
           INX      D
           MOV      A,M      ; LOW NIBBLE
           ANI      00FH
           ORI      '0'
           STAX     D
           DCX      H
           INX      D
           DCR      C        ; DONE
           RZ
           MVI      A,':'      ; ADD COLON
           STAX     D
           INX      D
           JP       DTIM1

; DATA AND MESSAGE AREA
;
BIOSMG:    DB      BELL,'NO CLOCK IN BIOS',CR,LF,EOM
IVMSG:     DB      BELL,'INVALID TIME',CR,LF,EOM
STPMMSG:   DB      'STOPPED AT ',EOM
STMSG:     DB      'START CLOCK BY PRESSING RETURN ',EOM
TIMSG:     DB      CR,LF,'TIME SET TO = ',EOM
BUFF:      DW      0          ; DISPLAY DATA
           DW      0
           DW      0
           DW      0
           DB      ' AM'
CRLF:      DB      CR,LF
CRLF1:     DB      CR,LF,EOM
           DS      32        ; ROOM
STACK     EQU      $

;
END

```

ceeding.

Now again type "TIME" in response to the prompt and the display should read:

```
A > 12:00:00 PM
```

At this point you should have a working clock. Turn on the disable switch in your clock board and go through the set-time sequence again. There should be a time change in the seconds column whenever you type "TIME" in response to the CP/M prompt.

Check out the minutes and seconds registers by setting the clock to 12:59:50. In 10 seconds, it should make the change to 01:00:00. If it does, congratulations! You now have a time-of-day clock—just like the expensive mainframe computers. If you have problems, then double-check your steps. This program has been thoroughly tested and should work.

If you program in BASIC, include one or two of the BASIC subroutines (listings 3, 4, and 5) in your pro-

grams. You will then be able to get a time readout whenever you want by simply calling one of these subroutines.

Note that there are two listings for reading the clock. Listing 3 is a program in Microsoft BASIC with the instruction HEX\$(X). Not all BASICs have this instruction, so there is an alternate clock read (listing 4), which does the same thing but less elegantly.

An interesting note here about the way that the HEX\$(X) instruction works: remember that the program stores the clock as a binary-coded-decimal number. For example, 25 seconds would be stored in the register as 0010/0101. The 2 is stored in the upper 4 bits and the 5 in the lower 4 bits. Due to the binary weighting of the 8 bits in the register, the HEX\$(X) instruction sees what it thinks is decimal 37. When called, the instruction dutifully returns the hexadecimal value of this number, or 25. Furthermore, it gives us that value as a string. Just what we need! Sneaky, isn't it? And very useful in cutting code down to size and setting up a printout.

Listing 5 is a short BASIC program that enables you to

**Listing 3:** A clock-read program in Microsoft BASIC. It can be used as a subroutine in a larger program to allow reading the clock when desired. This program makes interesting use of the HEX\$(X) instruction.

```
10 REM CLOCK PROGRAM BY J.L. CALAWAY & B. HILL
20 REM FEB 12, 1981 02:20:47 PM LISTING #3
30 REM
40 REM READ CLOCK PROGRAM FOR BASIC WITH HEX$(X) COMMAND
50 REM
60 REM-----READ THE REGISTERS-----
70 REM
80 T(1)=PEEK(69):T(2)=PEEK(68):T(3)=PEEK(67):M1=PEEK(70)
90 IF M1=0 THEN M1$="AM" ELSE M1$="PM"
100 REM
110 REM-----LOOP TO CHANGE REGISTER VALUES TO DECIMAL STRINGS-----
120 REM
130 FOR I=1 TO 3
140 IF VAL(HEX$(T(I)))<10 THEN T$(I)="0"+HEX$(T(I))
ELSE T$(I)=HEX$(T(I))
150 NEXT I
160 REM
170 REM-----PRINT IT-----
180 REM
190 PRINT "TIME: ";T$(1);":";T$(2);":";T$(3);" ";M1$
200 REM
210 REM-----STORE AND/OR RETURN-----
```

**Listing 4:** A clock-read program for users who have a version of BASIC without a HEX\$(X) instruction. It works the same as listing 3, but takes twice as much code. It assumes that DIM(X) need not be used if X is less than 10.

```
100 REM CLOCK PROGRAM BY J. L. CALAWAY AND B. HILL
110 REM FEB 12, 1981 03:05:19 PM LISTING #4
120 REM
130 REM READ CLOCK PROGRAM FOR BASIC WITHOUT THE HEX$(X) COMMAND
140 REM
150 REM-----READ THE REGISTERS-----
160 REM
170 T(1)=PEEK(69):T(2)=PEEK(68):T(3)=PEEK(67):M1=PEEK(70)
```



Listing 4 continued:

```
180     IF M1=0 THEN M1$="AM" ELSE M1$="PM"
190 REM
200 REM-----LOOP CHANGES HEX CODE TO DECIMAL STRINGS-----
210 REM
220     FOR I= 1 TO 3
230         X=T(I)
240         X=X-16
250         IF X<0 THEN GOTO 290
260         IF X<10 THEN T(I)=T(I)-6
270         IF X>10 THEN T(I)=T(I)-6: GOTO 240
280 REM
290         IF T(I)<10 THEN T$(I)="0"+RIGHT$(STR$(T(I)),1)
           ELSE T$(I)=RIGHT$(STR$(T(I)),2)
300     NEXT I
310 REM
320 REM-----PRINT THE STRINGS-----
330 REM
340     PRINT T$(1)":";T$(2);":";T$(3);" "; M1$
350 REM
360 REM-----STORE AND/OR RETURN AS DESIRED-----
```

Listing 5: A BASIC program to set the clock by jamming a time into the clock registers. The clock has previously been started in the CP/M command mode and is running continuously. The program makes a cursory check for valid entries; an exhaustive examination for invalid time would require more code. The clock cannot be stopped and started from a BASIC program.

```
200 REM CLOCK PROGRAM BY J. L. CALAWAY & B. HILL
210 REM FEB 12, 1981 02:23:07 PM LISTING 5
220 REM
225 REM BASIC PROGRAM TO SET TIME IN RUNNING CLOCK
230 REM
240     LINE INPUT "WHAT TIME DO YOU WANT SET (HHMMSS(AM OR PM)"; T$
250     IF LEN(T$)<>8 THEN PRINT CHR$(7); "INVALID TIME": GOTO 240
260 REM
270     T(1)=VAL(MID$(T$,5,2)): T(2)=VAL(MID$(T$,3,2)): T(3)=VAL(LEFT$(T$,2))
280     IF MID$(T$,7,2)="AM" THEN T(4)=0 ELSE T(4)=1
290 REM
300 REM-----LOOP TO CHANGE SET TIME TO BCD-----
310 REM
320     FOR I=1 TO 4
330         X=T(I)
340         X=X-10
350         IF X<0 THEN 380
360         IF X<=9 THEN T(I)=T(I)+6
370         IF X>9 THEN T(I)=T(I)+6: GOTO 340
380         POKE 66+I,0+T(I)
390     NEXT I
400 REM
410 REM-----PRINT/STORE OR RETURN AS DESIRED-----
```

set the clock from BASIC. But this program doesn't start or stop the clock. The time code is simply jammed into the running clock registers.

Depending on your variety of BASIC, you may have to make a few more changes in the code. If you use CBASIC, for example, then you will have to add DIM statements to initialize the arrays. Or you could forget the arrays and simply use separate variables for the hours, minutes, seconds, and the AM/PM registers. If

your BASIC requires the DIM statement, you may also have to initialize the arrays to 0.

While the BASIC listings serve as a starting point, you can embroider them as you wish. Maybe you would like to store the time in registers to be printed back later in the program. Perhaps you would like to display the seconds ticking away to add a sense of pressure to a favorite game program. Now that you have a clock, you can easily do such tricks. We hope you enjoy it. ■

# What's New?

## SYSTEMS

### Ace 100

Franklin Computer Corp. claims that its Ace 100 personal computer is 100% hardware- and software-compatible with the Apple computer. According to the company, all programs written for the Apple II, including high- and low-resolution black-and-white graphics, will run on the Ace without modification. Standard features include 64K bytes of RAM (random-access read/write memory) and a Videx Keyboard Enhancer. The Ace has an uppercase and lowercase 72-key typewriter-like keyboard and a 12-key numeric keypad.

The Franklin Ace 100 is available for \$1595. Contact Franklin Computer Corp., 7030 Colonial Highway, Pennsauken, NJ 08109, (609) 488-1700. Circle 500 on inquiry card.

### Expandable Pocket Computer

The Model PC-2 TRS-80 Pocket Computer features a BASIC interpreter with 42 statements, 34 functions, and 6 commands. The expandable PC-2 has full string-handling abilities with 80-character string length and two-dimensional arrays, a 26-character alphanumeric LCD (liquid-crystal display) with uppercase and lowercase characters, 2.5K bytes of memory, and a built-in real-time clock. Additional fea-

tures include fully addressable 7 by 156 dot-matrix LCD graphics and a 60-pin I/O interface connector.

Options for the PC-2 include an RS-232C interface and software, a four-color printer/plotter with nine different character sizes, and add-on RAM (random-access read/write memory) and ROM (read-only memory) modules. The PC-2 costs \$279.95. A 4K-byte memory module is available for \$69.95. Contact local Radio Shack stores, computer centers, and participating dealers, or the Tandy Corp., 1300 One Tandy Center, Fort Worth, TX 76102.

Circle 501 on inquiry card.

### Wicat System 150

The high-capacity Wicat System 150 includes an 8-MHz Motorola 68000 microprocessor (a 16-bit processor), memory, display screen, storage, and storage backup in a single desktop unit. The 150's main memory ranges from 256K bytes to 1.5 megabytes; standard mass storage includes a 10-mega-byte Winchester hard-disk drive and a 960K-byte 5¼-inch floppy-disk drive for backup. The single-user, real-time, multitasking 150 can be configured with 5¼-inch floppy disks or as an intelligent terminal without mass storage. The System 150 supports two RS-232C serial interfaces, a 16-bit parallel interface, and Pascal, C, APL, Ada,

COBOL, FORTRAN, LISP, WBASIC, and 68000 assembly languages.

Hardware options include a videodisc interface and a battery backup. Optional operating systems include Unix version 7 and a CP/M emulator. The Wicat System 150 ranges in price from under \$4000 for the intelligent terminal to \$8500 with the Winchester hard-disk unit. Contact Wicat Systems, 1875 South State St., Orem, UT 84057, (801) 224-6400.



### Desktop Computer

The ACI-2 desktop computer features two high-performance 8-inch floppy-disk drives and 64K bytes of RAM (random-access read/write memory). The Z80-based ACI-2 can run Digital Research's CP/M 2.2 software and interface with most industry-standard terminals, modems, and printers through three RS-232C serial ports. The ACI-2, which can be used with a modem for communications over telephone lines and as a smart timeshare terminal, is available for \$2995 from Alspa Computer Inc., 300 Harvey West Blvd., Santa Cruz, CA 95060, (408) 429-6000. Circle 503 on inquiry card.

## PUBLICATIONS

### Konan Products Catalog

Hard-disk drives and controllers, I/O controllers, cables, power supplies, and other items are listed in a free catalog of Konan products. Contact Konan Corp., 1448 North 27th Ave., Phoenix, AZ 85009, (800) 528-4563; in Arizona, (602) 269-2649. Circle 504 on inquiry card.

### Understand Your VIC

Understanding Your VIC, Volume 1: Basic Programming is a step-by-step guide to learning about your Commodore VIC-20. Many of the book's exercises give the correct results so that you have feedback at your fingertips. The VIC's color and sound abilities can be mastered with the help of chapters that show you how to build demonstration programs with these features. Another chapter describes how the proper use of pseudocode and data dictionaries can help you refine programming problems.

Available in softcover for \$11.95, Understanding Your VIC, Volume 1 can be purchased from Commodore dealers or directly from Total Information Services, POB 921, Los Alamos, NM 87544, (505) 455-7049. Circle 505 on inquiry card.

# What's New?

## 8088 User's Manual

Intel's iAPX 88 Book details the 8088's architecture and discuss its 8- and 16-bit registers, megabyte memory-addressing modes, and instruction set. An overview of the 8088's key features, addressing techniques, and functional extensions is provided. A separate hardware section covers bus timing and interface considerations, interrupt handling, direct memory addressing, and interfacing memory and peripherals. Examples are given of multiplexed- and demultiplexed-bus personal and small-business computers, an S-100-bus-based design, and an 8088-based video-display controller.

The iAPX 88 Book costs \$7.50. Contact Intel Corp., Literature Dept., 3065 Bowers Ave., Santa Clara, CA 95051, (408) 734-8102. Circle 506 on inquiry card.

## Microprocessor Operating Systems

Microprocessor Operating Systems provides in-depth descriptions of National Semiconductor's BLMX-80, Intel's iRMX 80/88 and iRMX 86, Data General's MP/OS, Texas Instruments' Rx, Bell Lab's Unix, Motorola's VERSAdos, and Zilog's RIO/CP and ZRTS operating systems. The book is available for \$11.95 from Microcomputer Applications, POB E, Suisun City, CA 94585, (707) 422-1465.

Circle 507 on inquiry card.

## Software Business Review

ICP Software Business Review analyzes software solutions to business problems for the corporate and data-processing executive. Existing and potential information-management problems are identified, and software solutions are proposed. Contact International Computer Programs, 9000 Keystone Crossing, Indianapolis, IN 46240, (800) 428-6179; in Indiana, (317) 844-7461. Circle 508 on inquiry card.

## TI Logo Source

Microcomputers Corporation has a new catalog and a newsletter for Texas Instruments' TI-99/4A computer users. The bimonthly TI Logo Source newsletter is filled with reviews and news of the latest developments in Logo software. The catalog is packed with lists of available Logo programs. Both are free from Microcomputers Corp., POB 191, Rye, NY 10580, (914) 967-8370. Circle 509 on inquiry card.

## Data Manual

The design and operation of the OB68K1 single-board computer are described in a data manual available from Omnibyte. The OB68K1 computer system features the Motorola 16-bit MC68000 microprocessor on a Multi-

bus/IEEE P796 bus and software compatibility with Motorola's MEX678KDM. The manual is available for \$10 from Omnibyte Corp., 245 West Roosevelt Rd., West Chicago, IL 60185, (312) 231-6880. Circle 510 on inquiry card.

## Microcomputer Buyer's Guide

Webster's Microcomputer Buyer's Guide reviews more than 150 microcomputer systems from more than 50 suppliers. Individual chapters elaborate on the general topics of theory, applications, independent software vendors, and a wide range of display and printing terminals. The guide costs \$25, plus \$2.50 postage and handling. Contact Computer Reference Guide, 135 South Harper Ave., Los Angeles, CA 90048, (213) 852-4886. Circle 511 on inquiry card.

## CP/M Users Software Directory

Vital Information's CP/M software directory is designed to aid hobbyists in the selection of software and peripherals. The directory contains more than 3000 entries, divided into 33 sections by subject. Program entries include publisher and list price. A toll-free hotline is available for subscribers who have software, hardware, or peripheral questions.

The directory costs \$19.95, plus \$1.50 postage. Contact Vital Information Inc., 7899 Mastin Dr., Overland Park, KS 66204, (800) 255-5119; in Kansas, (913) 381-1818. Circle 512 on inquiry card.

## PERIPHERALS



## Hide Your Modem

The MB10303 is a compact Bell-compatible 300-bit-per-second (bps) modem intended for space-saving applications. It measures 5.8 by 5.75 by 2 cm (2 $\frac{1}{8}$  by 2 $\frac{1}{4}$  by  $\frac{3}{4}$  inches) and requires 33.5 square cm (5 $\frac{1}{2}$  square inches) of circuit-board area. It operates in full-duplex, manual originate, and manual or automatic answer. It interfaces at standard transistor-transistor logic (TTL) levels. Power requirements are 40 milliamperes (mA) at +5 volts (V) DC, 25 mA at +8 to +18 V DC, and 25 mA at -5 to -12 V DC. It can



# What's New?

communicate with Bell System 103 and 113 series modems, with Bell 212A and Vadic 3400 series modems operating in the low-speed (300 bps) mode, and with acoustic-coupler data sets that use complementary signaling and handshake sequences. For further information, contact Micro-Baud Systems Inc., 3393 De La Cruz Blvd., Santa Clara, CA 95050, (408) 727-5275.

Circle 513 on inquiry card.



## KIM-Compatible Mini-Disk Systems

Percom Data Company's MFD mini-disk storage systems for AIM-65, KIM, and SYM computers are available in one-, two-, and three-drive versions. The MFD systems are available in 40- and 80-track models and in both standard- and "flippy-" drive versions. The 40-track drive can store 102K bytes of formatted data; the 80-track drive stores 205K bytes.

An MFD system includes a disk-controller circuit card, a disk operating system (DOS) in ROM and on a disk, an interconnecting cable, user's manual, and disk drives. Two controllers are available: one for the AIM-65, the other for Percom's System-50 (SS-50) bus. Utilities and a 20-command library are supplied on the system disk. The DOS communicates directly with an Aim Monitor, Editor, BASIC, or other AIM program through your I/O and F1 and F2 keys.

The Percom MFD drive systems start at \$599.95.

An interface for connecting the drives to your computer costs \$49.95. Contact Percom Data Co., 211 North Kirby, Garland, TX 75042, (214) 272-3421. Circle 515 on inquiry card.

## Paddle-Adapple

The Paddle-Adapple I/O expansion adapter lets software writers create four-player games with each player having paddle and push-button controls. Paddle-Adapple plugs into the Apple II's game port and works in two modes: the first lets you select between two devices plugged into the Apple; the second takes advantage of the Apple's ability to handle up to four game controllers. In either mode, the Paddle-Adapple's "jumper" sockets can be configured to meet designer needs, such as exchanging X and Y axes or reassigning push-button numbers.

The Paddle-Adapple is compatible with all Apple software and with most game I/O devices. The shift-

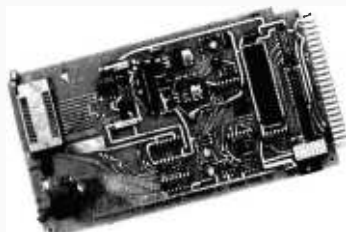
key modification is supported. It costs \$29.95 and is available from Southern California Research Group, POB 2231-B, Goleta, CA 93118, (805) 685-1931. Circle 516 on inquiry card.

## Clock/Calendar Board

Columbus Instruments' IB-902AB interface card converts the AIM-65, PET, KIM, 6502, and 6800 computers into dedicated laboratory and industrial measurement systems. It contains a 12-bit A/D (analog-to-digital) converter, a 16-channel multiplexer, a real-time clock/calendar with battery backup, and space for an additional 16K bytes of memory. The clock/calendar is crystal-controlled to three seconds per month and provides time in seconds, minutes, hours, day of week, date, month, and year. A 12- or 24-hour clock is selectable, and programmable interrupts from 1024 per second to 1 per second are available. The onboard battery backup will provide the accurate time of day for up to four years. Conversion time of the A/D converter is 35 microseconds. Power requirements are  $\pm 15$  volts.

Supplied with demonstration programs for setting up the clock/calendar, reading analog channels, and addressing and testing memory, the IB-902AB costs \$1270. Contact Columbus Instruments, 950 North Hague Ave., Columbus, OH 43204, (614) 488-6176.

Circle 517 on inquiry card.

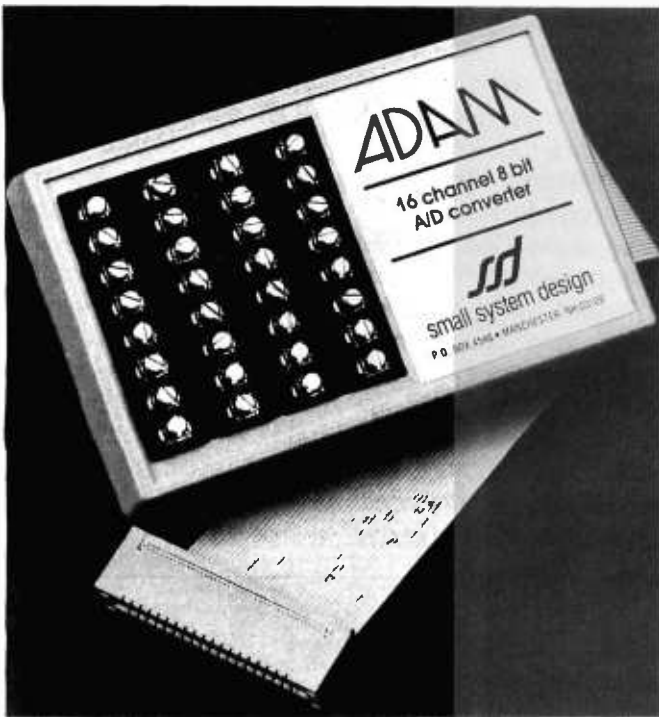


## Single-Card EPROM Programming

Giddings & Lewis Electronics' single-card EPROM Programmer Module is designed to program 2708 EPROMs (erasable programmable read-only memories). It doesn't require a special software-development system because it plugs directly into your production system. The module fits into a standard 114-millimeter- (4½-inch-) wide nest. The easy-to-use Programmer pulses each EPROM 100 times per byte; total programming time is 100 seconds per kilobyte of memory.

The EPROM Programmer Module costs \$295. Contact Giddings & Lewis Electronics, 142 Doty St., POB 590, Fond du Lac, WI 54935, (414) 921-9400. Circle 514 on inquiry card.

# What's New?



## Adam Family

The Adam family of add-on modules are designed to bring mini- and microcomputers into the world of data acquisition. The modules accept up to 16 analog inputs from a wide variety of analog devices and transducers such as temperature, flow-rate, and current sensors. The modules convert input voltage to digital values

with a resolution of 8 bits.

Adam modules are available with either an interface for the TRS-80 Expansion Interface or with an RS-232C asynchronous interface. The TRS-80 version costs \$190; the RS-232C interface is \$250. For details, contact Small System Design, POB 4546, Manchester, NH 03108, (603) 432-7929. Circle 518 on inquiry card.

## 5-Megabyte Memory System

The LS525, a 5-megabyte memory system, incorporates a Seagate ST506 5¼-inch Winchester hard-disk drive, Logical Systems' LDOS disk operating system, a linear power supply, and the LSI 500 series controller. A separate host adapter provides cross-connections to different central processors and

buses. All TRS-80 programs currently running under TRSDOS or NEWDOS will operate with LDOS.

The LS525 costs \$3750, including a manual that details LDOS operations. Contact Laredo Systems Inc., 2264 Calle de Luna, Santa Clara, CA 95050, (408) 980-1888. Circle 519 on inquiry card.

## To Alphasyntauri and Bach

The Alphasyntauri synthesizer is a modular instrument system that uses computer programs rather than hard-wired components to create and control sounds. Based on the Apple II microcomputer, the Alphasyntauri gives musicians an all-digital instrument that doesn't require programming or computer expertise.

An Alphasyntauri music system is made up of the Alphaplus operating system, instrument definitions, software utilities, a 61-note keyboard, foot pedals, and a computer interface. Mountain Computer's Musicsystem synthesizer provides 8-voice stereo polyphony. The complete system, including the Apple II, costs \$5000. The instrument alone costs \$2100. The Alphasyntauri is available from selected Apple dealers. A demonstration record costs \$2. Contact Syntauri Corp., 3506 Waverly St., Palo Alto, CA 94306, (415) 494-1017. Circle 520 on inquiry card.

voice/data button, long space disconnect, five diagnostic tests, and built-in "A" control. The modular-designed rack-mountable modem will operate with any telephone over dial networks or over two-wire leased lines. The computer-to-terminal interface is a standard RS-232C connection.

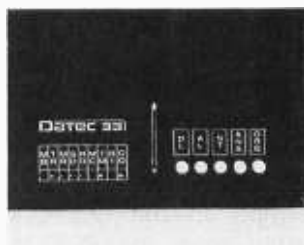
The Datec 33 has a suggested retail price of \$399 in a stand-alone version and \$325 for a card model. Contact Datec Inc., 300 East Main St., Carrboro, NC 27510, (919) 929-2135.

Circle 521 on inquiry card.

## Joystick Interface

Joy-6 is a joystick interface for TRS-80 Models I and III that features push buttons, sound-effects capability, and control software. It can be used as a 6-channel analog-to-digital converter with temperature sensors or other transducers, and it can drive an external relay for control applications.

A complete Joy-6 package includes two joysticks with push buttons, power supply, user's manual, and the Joypak-1, a 16K-byte machine-language cassette packed with six joystick games. The Model III version requires an adapter cable. Joy-6 costs \$124.95; a kit version is available for \$99.95. Contact Mega Systems Inc., 262 Park Lane, King of Prussia, PA 19406, (215) 337-3876. Circle 522 on inquiry card.



## Bell-Compatible Modem

The Datec 33 is a 0- to 300-bit-per-second (bps) Bell-compatible originate/answer modem featuring a front panel

# What's New?



## New Products from Commsoft

Commsoft's CW89 software package lets ham-radio operators send and receive Morse code with their Heath H-8/H-19 or Heath/Zenith Z-89 micro-computers. The CW89 features a split-screen display, 4- to 99-word-per-minute operation, the ability to receive autotrack, a 1000-character pretype buffer, ten user-definable messages, a break-in mode, on-screen system status, disk I/O, hard-copy capabilities, and a code-practice section. All communications can be sent to a printer or stored on a disk. The CW89, which requires a hardware interface such as Commsoft's Codem, is available for \$99.95, postpaid.

The Codem interface is a universal continuous-wave (CW) interface that converts received CW audio into RS-232C or TTL signal levels and RS-232C or TTL signal levels to transmitter keying, so the Codem doubles as a code-practice oscillator and CW regenerator. The Codem costs \$124.95; a 9-volt DC power supply is \$9.95. A complete package consisting of the software, Codem, an interface cable, power supply, documenta-

tion, and shipping fees is available for \$249.95. Contact Commsoft, 665 Maybell Ave., Palo Alto, CA 94306, (415) 493-2184. Circle 523 on inquiry card.

## Modem Plus

The Modem-Plus is a 1200-bit-per-second (bps) 202C/S-compatible modem for the S-100 bus. The address-selectable, originate/answer modem provides S-100 interface requirements, an on-board modem UART (universal asynchronous receiver/transmitter) with selectable word format, hardware-automatic pulse-dialing, 16-digit memory for redial, and modem sense and control lines using polling methods. Registered with the FCC for direct connection to the telephone system, the Modem-Plus is available in two models: one has a second on-board UART with selectable word format connected to a separate RS-232C I/O port; the other provides modem interrupts to the processor rather than the RS-232C port. The Modem-Plus is available for \$595 from Integrated Design Engineering Inc., POB 16307, St. Louis, MO 63125, (314) 487-1188.

Circle 524 on inquiry card.

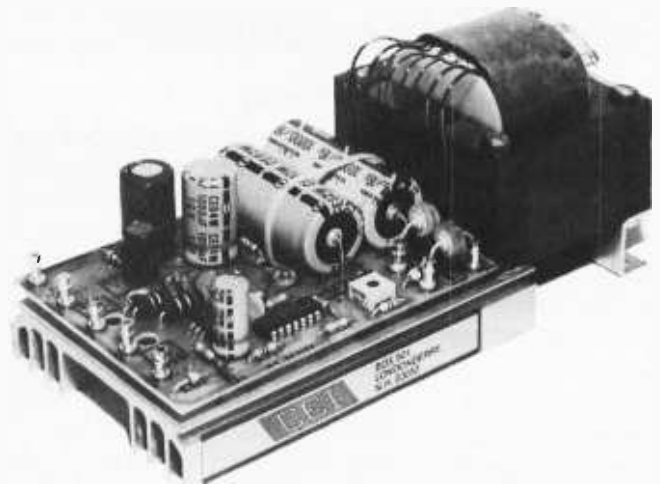
## Get Into Warp Drive

The Warp Drive hardware and software package allows extended-address S-100 RAM (random access read/write memory) to emulate a disk drive under CP/M version 2.2, providing an increase in speed up to 40 times faster than floppy disks. The Warp Drive is based on Compupro's dual-processor 8085/8088 board, which allows as much as 1 megabyte of extended-address RAM to behave

like a disk drive under CP/M-80 on the 8-MHz 8085 and to appear as directly addressable memory when running CP/M-86 on the 8-MHz 8088. All CP/M 2.2-compatible software runs on the Warp Drive without modifications.

The Warp Drive is available from G & G Engineering, 13708 Doolittle Dr., San Leandro, CA 94577, (415) 895-0798.

Circle 525 on inquiry card.



## Multiple-Output Power Supply

The Model MP400 Power Supply can drive small line printers and low-current floppy-disk drives. It provides outputs of +5 volts (V) DC at 5 amperes (A) with overvoltage protection, +12 V DC at 0.5 A, -5 V DC at 0.5 A, and +24 V DC at 0.75 A with a 1.2-A surge capability. The +5-V DC output is regulated to 0.1%; all others to 5%. Noise and ripple are less than 10 millivolts. The MP400 fits into

standard slope-front micro-processor enclosures and requires either 115 or 230 V AC  $\pm 10\%$  input power. An aluminum heat sink maintains low ambient temperatures. The MP400 Power Supply costs \$72 in original-equipment-manufacturer quantities and is available from CEI Corp., Grenier Industrial Park, POB 501, Londonderry, NH 03053, (603) 623-8888. Circle 526 on inquiry card.



# What's New?

## Microspeed

Apple II, II Plus, and III users can realize processing speeds up to 100 times faster than Applesoft BASIC with the Microspeed Language System. Developed from an extended FORTH, Microspeed is a hardware and software package that uses the Intel 8231A arithmetic processor and interactive compiler to provide enhanced programming capabilities such as print formatting, fast high-resolution and "turtle" graphics, and extended, high-speed mathematical functions.

System utilities include line- and screen-oriented text editors and a 6502 assembler. Each Microspeed comes with an auxiliary processor card, a user's manual, and two disks of software.

Two Microspeed configurations are available: Microspeed II, which uses a 2-MHz 8231A arithmetic processor, and Microspeed II+, which uses the newer 4-MHz 8231A. Microspeed II costs \$495, Microspeed II+ costs \$645. The manual is available separately for \$35. Contact Applied Analytics Inc., Suite 200, 8910 Brookridge Dr., Upper Marlboro, MD 20772, (301) 627-6650. Circle 527 on inquiry card.

## Mice In Your System

Upgrade your microcomputer to a development tool with MICE—Micro In-Circuit Emulator. A dual-processor, two-board device with a built-in line

assembler and a two-pass disassembler, MICE features real-time emulation up to 5 MHz and an RS-232C interface for modems or terminals with data rates from 110 to 9600 bits per second.

MICE is available for 8085A, Z80, Z80A, Z80B, 6502, NSC800, 8048, 8049, and 8050 microcomputers. Prices range from \$1495 to \$5000. Obtain additional details from Microtek Lab Inc., 17221 South Western Ave., Gardena, CA 90247, (213) 538-5369.

Circle 528 on inquiry card.

## Hollister Microsystems

Hollister Microsystems supplies interface boards, peripheral devices, and software for the Apple II, the IBM Personal Computer, and other microcomputers. For the Apple II, Hollister offers a 6800 cross-assembler on disk and an EPROM- (erasable programmable read-only memory) programmer/EPROM card for programming 2716, 2732, 2732A, and 2764 EPROMs. Other products for the Apple include an EPROM/ROM simulator and a 24-bit parallel I/O card with high-level-drive and master/slave stacking capabilities.

For complete details on these and other products, contact Hollister Microsystems, 5081 Fairview, Hollister, CA 95023, (408) 637-0753.

Circle 529 on inquiry card.



## No More Waiting

If you're tired of waiting for your printer, plotter, or other peripheral to finish its job so you can get back to your computer, the Microcuc may be what you've been waiting for. Microcuc, a programmable Z80-based first-in, first-out (FIFO) device, accepts data from your computer and drives the printer from its own memory, freeing the host computer for other chores. A multiport Microcuc can connect multiple printers and computers and select between them from switches or software control.

The Microcuc SP has serial and parallel ports and can convert from one to the other.

In addition to buffering, all Microcucs are download-programmable, which allows for poll and select, code conversions, data formatting, modem operation, and interfacing to other systems. Present models have from two to eight ports and 16K to 32K bytes of memory. Prices start at \$299. Contact Microcompatible, POB 7624, Atlanta, GA 30357, (404) 874-8366. Circle 530 on inquiry card.

## Apple Cat II

The Apple-Cat II is a large-scale integration (LSI) modem that converts your Apple II or II Plus computer into a functional telephone, complete with a handset. It can automatically answer, dial, re-dial, and disconnect a telephone call. Both Baudot and ASCII code are combined in this single add-on product. For the deaf and hearing impaired, a special 45.5-bit-per-second (bps)

Baudot-coded Weitbrecht modem is provided for use with teletypewriters (TTYs).

Data-transmission rates range from 50 to 1200 bps. Software is supplied on a floppy disk. A separate RS-232C serial port is provided, and the Apple Cat II also offers a 26K-byte memory-storage area and software controls that assure the accurate transmission of data.

An optional program chip provides compatibility

# What's New?

with many languages and operating systems, including BASIC, Pascal, and CP/M. The Apple-Cat II costs \$389 and is available from authorized Novation distributors. Contact Novation Inc., 18664 Oxnard St., Tarzana, CA 91356, (213) 996-5060.  
Circle 531 on inquiry card.

## 80-Column PET Adapter

Execom's 80-column adapter, circuit board, and ROM combination lets you switch the Commodore PET's 40-column display to an 80-column display from the keyboard or through program control. The kit contains a dual 24-pin socket, a circuit board that replaces the existing screen programmable memory, and an 80-column reference ROM that plugs into an expansion slot.

The circuit board and ROM combination is designed for the 2000, 3000, and 4000 series of PET/CBM computers that are designed for version 3.0 or 4.0 BASIC but do not have a video-display or a display-controller chip. The kit costs \$275; Execom will install the adapter for an additional \$75. An optional board that allows the ROM to be used with any other 2K-byte ROM in any expansion socket is available for \$25. For details, contact Execom Corp., 1901 Polaris Ave., Racine, WI 53404, (414) 632-1004.  
Circle 532 on inquiry card.

## Z65: Database Processor

The Z65 Database Processor is an applications development tool for the Apple II. It consists of a Z80 microprocessor, a 6502-to-Z80 software interface, and a Z80 implementation of the MDBS database-management program, which is based on an extended-network data model. With the Z65, all applications development is performed within the Apple disk operating system using Applesoft BASIC. Database manipulations are handled by the Z80, which increases the 6502's speed.

With documentation, the Z65 package is available through a single-user license for \$1600. Without the Z80 card, the Z65 software costs \$1500, including documentation. Manuals can be purchased separately. For details, contact Micro Data Base Systems Inc., POB 248, Lafayette, IN 47902, (317) 448-1616.  
Circle 533 on inquiry card.

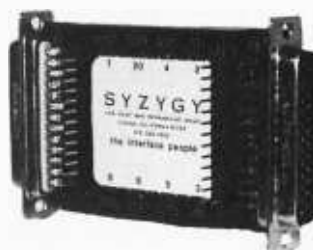
## MISCELLANEOUS

### Video Attributes Controller

The CRT 8021 Video Attributes Controller (VAC) works in conjunction with a character-generator ROM to provide video attributes and graphics for a display screen. An n-channel MOS/LSI (metal-oxide semiconductor/large-scale integrated) circuit, the 8021 processes and serializes

parallel data from the character generator for direct connection to the video input of a display-screen monitor. Attributes are added to alphanumeric data as you choose. The 8021 features both field and character attributes graphics modes, a 20-MHz video shift register, cursor, and separate data and attributes latches. Attributes include reverse video, character blink and blank, underline, and strike through. For more details, contact Standard Microsystems Corp., 35 Marcus Blvd., Hauppauge, NY 11787, (516) 273-3100.

Circle 534 on inquiry card.



### Patch Set Monitors Line Signals

Syzygy's RS-232 Patch Set is a handheld device that connects inline with an interface cable, terminal, or modem. Designed for engineers and field-service personnel working with custom or nonstandard interfaces, the Patch Set's two 26-pin headers and jumpers permit line monitoring and full configuration of all 25 line signals. This lets the user completely define the configuration by means of

jumper cables. The unit does not affect communications and is transparent to the line.

About the size of a business card, the Patch Set conforms to RS-232C standards and comes with ten 2-pin, four 3-pin, and one 4-pin jumper assemblies. The RS-232 Patch Set costs \$111. Contact Syzygy, 256 West San Bernardino Rd., Covina, CA 91723 (213) 332-3320.

Circle 535 on inquiry card.

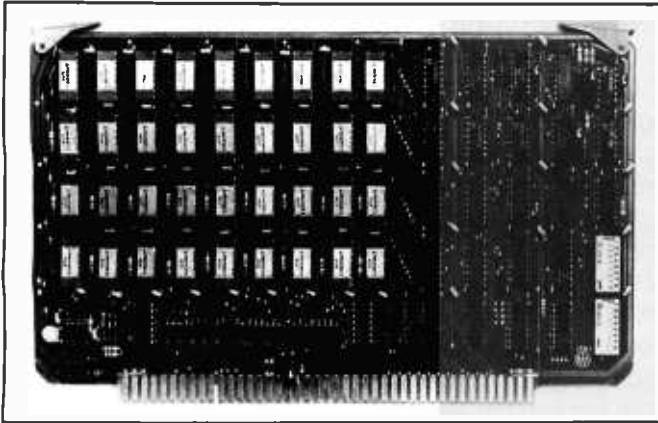
### Flipper Flips Signals

A software-controllable switch that lets you switch voltage signals with simple software commands, the Flipper can be used between alternate video signals such as those generated by the Apple and an 80-column video board. The device plugs into the game port on the Apple and makes use of annunciator output zero (ANO). It allows unobstructed use of all the remaining functions for game I/O by providing a parallel game I/O connector.

The Flipper has two RCA phono jacks for input and one for output, and it can be arranged to have one jack for input and two for output. The board drains 30 milliamperes when the relay is energized. The Flipper costs \$50 and is available from Aurora Systems Inc., 2040 East Washington Ave., Madison, WI 53704, (608) 249-5875.

Circle 536 on inquiry card.

# What's New?



## Dynamic Memory Board

The CI-6800-2 dynamic-memory board for the Exorcisor I and II and Rockwell International's System 65 plugs directly into existing Exorcisor connectors. Available in 16K-, 48K-, and 64 K-byte configurations, the board allows maximum processor throughput with the use of hidden-refresh control logic onboard. Data-access time is 225 nanoseconds (ns) and cycle time is 400 ns, which allows the board to operate as a static programmable memory at clock rates in excess of 1.5 MHz. For 2-MHz operation, the board can be configured to use a cycle-steal-

ing refresh operation.

Onboard memory-select is available in 4K-byte increments to up to 64K bytes of memory. Another feature is onboard even parity with output jumper-selectable to the system bus as a parity error or non-maskable interrupt. The board's power consumption is under 7 watts.

Prices range from \$475 for the 16K-byte by 8-bit version to \$575 for the 64K-byte by 8-bit version. Contact Chrislin Industries Inc., 31352 Via Colinas #102, Westlake Village, CA 91361, (213) 991-2254. Circle 537 on inquiry card.

## Remote Transmitter Controls Appliances

The BSR System X-10 Model TR274 remote telephone transmitter is a portable, calculator-size transmitter that is used in conjunction with a personal computer and your telephone. With the TR274, you can control any lights and appliances that are hooked up to your base station from any telephone, anywhere. The TR274

works with answering machines as well. The transmitter must be used with the TR270 telephone responder/controller. The Model TR274 telephone transmitter costs \$29.99. As a set, the TR274 and the TR270 cost \$99.99. Contact BSR Ltd., Rte. 303, Blauvelt, NY 10913, (914) 358-6060. Circle 538 on inquiry card.

## SOFTWARE

### Package of Mysteries

The Applied Mysteries Package consolidates the information in H. C. Pennington's TRS-80 Disk & Other Mysteries into easily understood concepts. The package includes disassembled listings of bootstrap loaders with comments, descriptions of encoding methods that render floppy disks difficult to copy, a utility program for viewing a file's device-control block, and procedures for disassembling system files. The Applied Mysteries package (booklet and floppy disk) costs \$17.95, plus \$2 postage. Contact Applied Softwares, 4316 Vermont Court, Virginia Beach, VA 23456.

Circle 539 on inquiry card.

### Print Diagrams of Your Projects

The expanded PMS-II project-management system has the ability to prepare net-change reports that compare the current status of a project to a previous status. In addition to critical-path analysis, data-management, and reporting capabilities, PMS-II can calculate gains and losses that can be displayed in both calendar and net working days format. Accommodating more than 1000 simultaneous activities for each project, PMS-II can calculate a critical-path schedule

based upon a three- to seven-day week, while omitting holiday periods.

PMS-II will operate with any microcomputer running under Digital Research's CP/M 2.2 operating system and Compiler Systems' CBASIC 2.07. Two 8-inch disk drives and a 132-column printer are required. PMS-II costs \$995. Contact North America Mica Inc., Suite 240, 11772 Sorrento Valley Rd., San Diego, CA 92121, (714) 481-6998.

Circle 540 on inquiry card.

### Level II COBOL

Mainframe applications programs written to ANSI 74 COBOL standards can now be transported to microcomputers with minimal conversion thanks to Micro Focus Inc.'s Level II COBOL. The easy-to-install language fully meets the specifications set forth by the American National Standards Institute (ANSI) for Level II COBOL modules, including nucleus, table handling, sequential I/O, relative and indexed I/O, interprogram communication, and sort/merge operations.

Level II COBOL is available for 8086-based computers and any computer with a C language compiler, such as the Z8000, the 68000, and the PDP-11. Contact Micro Focus Inc., 1601 Civic Centre Dr., Santa Clara, CA 95050, (408) 496-0176. Circle 541 on inquiry card.



# What's New?

## Get In Synch

Synch is a 2780/3780 IBM binary synchronous software communications package for the Radio Shack TRS-80 Model II. Emulating 2770-, 2780-, and 3780-type bisynchronous work stations at data rates of up to 9600 bits per second, Synch supports transparency, buffer expansion from 128K bytes to 512K bytes, space compression, RVI (processor interrupt), and multipoint circuits. Synch provides low-cost RJE (remote job entry) capabilities and automatic features that allow up to 100 files to be arranged for unattended operations.

Including documentation, Synch costs \$500. Contact Westico Inc., 25 Van Zant St., Norwalk, CT 06855, (203) 853-6880. Circle 542 on inquiry card.

## Quic-N-Easi Program Development

The Quic-N-Easi programming system ties together formatted and edited data entry with processing, printing, and file-handling capabilities including index-sequential, sequential, and random-access methods. The system features a screen builder, parameter-driven content editor, an interpreter language, and a print-format handler.

Quic-N-Easi will operate with most CPM, Z80-based microcomputers with a minimum of 48K bytes and one disk drive. It costs \$395, including a self-

teaching guide, reference manual, and reference card. Contact Standard Microsystems Inc., 136 Granite Hill Court, Langhorne, PA 19047, (215) 968-0689.

Circle 543 on inquiry card.

## Communications Software for Osborne

The Micro-Link communications package is designed exclusively for the Osborne 1's video-display screen. It uses the Osborne's RS-232C port with a standard modem to communicate over telephone lines with other computer users as well as with computerized bulletin boards and information-retrieval services. One such service, The Source, has organized an electronic mailbox for members of the Osborne Users Group. Originate and answer modes as well as full- and half-duplex operation are supported. Operating at 300 bits per second (bps), Micro-link allows files to be transmitted in character, line, or memory-block protocols. Files can be prepared in advance and transmitted automatically, and a complete two-way record of communication can be recorded in memory and on disk.

With documentation and software on disk, Micro-Link costs \$89. Contact Osborne Computer Corp., 26500 Corporate Ave., Hayward, CA 94545, (415) 887-8080. Circle 544 on inquiry card.

## Microline Graphics Package

Okidata's all-points-addressable graphics software package lets you create flowing lines and illustrations with any Microline printer. Each dot in the 60- by 66-dot-per-square-inch field is under your control. A software algorithm, supplied on floppy disk, lets you translate data displayed by an Apple computer into parallel data that can be used by the Microline printer. The Apple displays data in a 280 by 192 dot format, and the software sets it up proportionally for printing on a one-to-one basis.

The package consists of two programmable read-only memories (PROMs) and a floppy disk. It's available for the Microline Models 82A and 83A for \$100 at local dealers. As a standard feature on the Microline Model 84, the package provides a 72- by 72-dot-per-square-inch format. Contact Okidata Corp., 111 Gaither Dr., Mt. Laurel, NJ 08054.

Circle 545 on inquiry card.

## FORTH Source Code

A variety package of FORTH source code containing many previously unpublished FORTH definitions is available on an 8-inch disk from Timin Engineering. The package includes data structures, software-development aids, string manipulators, an expanded 32-bit vocabulary, a screen calculator, a typ-

ing practice program, and a menu generation/selection program. Also provided are examples of recursion, <BUILDS. .DOES> usage, output number formatting, assembler definitions, conversational programs, 100 screens of software, and 100 screens of instructional documentation. The screens can be used with Timin FORTH or any other FIG (FORTH Interest Group) FORTH.

The variety package of FORTH source code costs \$75. Contact Timin Engineering Co., Suite E-2, 9575 Genesee Ave., San Diego, CA 92121, (714) 455-9008.

Circle 546 on inquiry card.

## Entertainment Products

Arcade Machine, Red Alert, Track Attack, and Midnight Magic are four new entertainment products from Broderbund Software.

Arcade Machine lets you create arcade games for one or two players, featuring monsters, sound effects, automatic scoring, fast loading, and automatic boot to a title page with your name and your game's title in large graphic letters.

Red Alert requires a joystick, which helps you wield radar, ack-ack, and rockets to protect your base against an alien menace. Track Attack is a fast-paced, high-resolution game with color graphics, large-scale animation, and three train-robbery scenar-

# What's New?

ios from which to choose. The Midnight Magic high-resolution pinball game has dual flipper controls, upper and lower playing levels, and a host of other effects.

The products range in price from \$29.95 to \$49.95. Each requires a 48K-byte Apple II with DOS 3.2 or 3.3. For details, contact Broderbund Software, 1938 Fourth Ave., San Rafael, CA 94901, (415) 456-6424. Circle 547 on inquiry card.

## Depreciation Planner

Designed for the Apple computer, the Depreciation Planner keeps track of depreciable assets for accounting and tax-planning purposes. Incorporating both pre-January 1981 depreciation methods and the new post-January 1981 depreciation methods, the Planner automatically calculates current-month depreciation, year-to-date, and life-to-date amounts. A modeling feature lets you experiment with all forms of depreciation for each asset. Lists of

items potentially eligible for investment tax credit in each fiscal year can be printed, as well as a depreciation-projection report listing current and following-year depreciation for individual assets. The Planner can provide a printed list of assets in five formats: tag numbers, location, depreciation type, depreciation method, and asset life.

Contact Dakin5 Corp., 7475 Dakin St., Denver, CO 80221, (303) 426-6090. Circle 548 on inquiry card.

## HP 83/85 File Manager

The Hewlett-Packard File Manager Software Pac gives owners of HP 83/85 computers electronic file-management capabilities. The File Manager lets you create your own forms for entering data into the filing system. Data can be updated, searched, sorted, or even translated to a string data file for use with other software packages, such as Visicalc Plus. Other fea-

tures include report and graphics capabilities, built-in error trapping and recovery routines, and comprehensive data-integrity checks. Each File Manager file can contain up to 1000 forms; each form can contain up to

1000 alphanumeric characters.

The HP 83/85 File Manager Software Pac is supplied on 5 1/4-inch floppy disks and is available for \$200 at local Hewlett-Packard sales offices. Circle 549 on inquiry card.

## Where Do New Products Items Come From?

The information printed in the new products pages of BYTE is obtained from "new product" or "press release" copy sent by the promoters of new products. If in our judgment the information might be of interest to the personal computing experimenters and homebrewers who read BYTE, we print it in some form. We openly solicit releases and photos from manufacturers and suppliers to this marketplace. The information is printed more or less as a first-in first-out queue, subject to occasional priority modifications. While we would not knowingly print untrue or inaccurate data, or data from unreliable companies, our capacity to evaluate the products and companies appearing in the "What's New?" feature is necessarily limited. We therefore cannot be responsible for product quality or company performance.

# TEST YOUR E.Q.

(Economics Quotient)

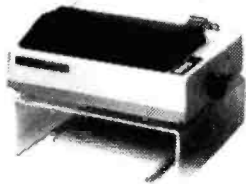
Write for a free booklet. "Economics." Pueblo, Colorado 81009.

The American Economic System. We should all learn more about it.

**Ad Council** A public service message of This Magazine & The Advertising Council & US Department of Commerce.

TANTALUM CAPACITORS	LINEAR CIRCUITS	CRYSTALS
4.7UF 20V \$1.00 10UF 20V \$1.20 22UF 20V \$1.40 47UF 20V \$1.60 100UF 20V \$1.80 220UF 20V \$1.95	LM323T - 30 LM324T - 30 741C - 25 742 - 90 1456 - 80 4558 - 80 4138 - 85 3000 - 25 LM307 - 35 LM309 - 35 LM311 - 35 LM312 - 35 LM313 - 35 LM314 - 35 LM315 - 35 LM316 - 35 LM317 - 35 LM318 - 35 LM319 - 35 LM320 - 35 LM321 - 35 LM322 - 35 LM323 - 35 LM324 - 35 LM325 - 35 LM326 - 35 LM327 - 35 LM328 - 35 LM329 - 35 LM330 - 35 LM331 - 35 LM332 - 35 LM333 - 35 LM334 - 35 LM335 - 35 LM336 - 35 LM337 - 35 LM338 - 35 LM339 - 35 LM340 - 35 LM341 - 35 LM342 - 35 LM343 - 35 LM344 - 35 LM345 - 35 LM346 - 35 LM347 - 35 LM348 - 35 LM349 - 35 LM350 - 35 LM351 - 35 LM352 - 35 LM353 - 35 LM354 - 35 LM355 - 35 LM356 - 35 LM357 - 35 LM358 - 35 LM359 - 35 LM360 - 35 LM361 - 35 LM362 - 35 LM363 - 35 LM364 - 35 LM365 - 35 LM366 - 35 LM367 - 35 LM368 - 35 LM369 - 35 LM370 - 35 LM371 - 35 LM372 - 35 LM373 - 35 LM374 - 35 LM375 - 35 LM376 - 35 LM377 - 35 LM378 - 35 LM379 - 35 LM380 - 35 LM381 - 35 LM382 - 35 LM383 - 35 LM384 - 35 LM385 - 35 LM386 - 35 LM387 - 35 LM388 - 35 LM389 - 35 LM390 - 35 LM391 - 35 LM392 - 35 LM393 - 35 LM394 - 35 LM395 - 35 LM396 - 35 LM397 - 35 LM398 - 35 LM399 - 35 LM400 - 35	2.000 3.000 5.000 8.000 15.000 20.000 30.000 45.000 60.000 75.000 90.000 100.000 120.000 150.000 200.000 300.000 400.000 500.000 600.000 700.000 800.000 900.000 1000.000 1200.000 1500.000 2000.000 3000.000 4000.000 5000.000 6000.000 7000.000 8000.000 9000.000 10000.000 12000.000 15000.000 20000.000 30000.000 40000.000 50000.000 60000.000 70000.000 80000.000 90000.000 100000.000 120000.000 150000.000 200000.000 300000.000 400000.000 500000.000 600000.000 700000.000 800000.000 900000.000 1000000.000 1200000.000 1500000.000 2000000.000 3000000.000 4000000.000 5000000.000 6000000.000 7000000.000 8000000.000 9000000.000 10000000.000 12000000.000 15000000.000 20000000.000 30000000.000 40000000.000 50000000.000 60000000.000 70000000.000 80000000.000 90000000.000 100000000.000 120000000.000 150000000.000 200000000.000 300000000.000 400000000.000 500000000.000 600000000.000 700000000.000 800000000.000 900000000.000 1000000000.000 1200000000.000 1500000000.000 2000000000.000 3000000000.000 4000000000.000 5000000000.000 6000000000.000 7000000000.000 8000000000.000 9000000000.000 10000000000.000 12000000000.000 15000000000.000 20000000000.000 30000000000.000 40000000000.000 50000000000.000 60000000000.000 70000000000.000 80000000000.000 90000000000.000 100000000000.000 120000000000.000 150000000000.000 200000000000.000 300000000000.000 400000000000.000 500000000000.000 600000000000.000 700000000000.000 800000000000.000 900000000000.000 1000000000000.000 1200000000000.000 1500000000000.000 2000000000000.000 3000000000000.000 4000000000000.000 5000000000000.000 6000000000000.000 7000000000000.000 8000000000000.000 9000000000000.000 10000000000000.000 12000000000000.000 15000000000000.000 20000000000000.000 30000000000000.000 40000000000000.000 50000000000000.000 60000000000000.000 70000000000000.000 80000000000000.000 90000000000000.000 100000000000000.000 120000000000000.000 150000000000000.000 200000000000000.000 300000000000000.000 400000000000000.000 500000000000000.000 600000000000000.000 700000000000000.000 800000000000000.000 900000000000000.000 1000000000000000.000 1200000000000000.000 1500000000000000.000 2000000000000000.000 3000000000000000.000 4000000000000000.000 5000000000000000.000 6000000000000000.000 7000000000000000.000 8000000000000000.000 9000000000000000.000 10000000000000000.000 12000000000000000.000 15000000000000000.000 20000000000000000.000 30000000000000000.000 40000000000000000.000 50000000000000000.000 60000000000000000.000 70000000000000000.000 80000000000000000.000 90000000000000000.000 100000000000000000.000 120000000000000000.000 150000000000000000.000 200000000000000000.000 300000000000000000.000 400000000000000000.000 500000000000000000.000 600000000000000000.000 700000000000000000.000 800000000000000000.000 900000000000000000.000 1000000000000000000.000 1200000000000000000.000 1500000000000000000.000 2000000000000000000.000 3000000000000000000.000 4000000000000000000.000 5000000000000000000.000 6000000000000000000.000 7000000000000000000.000 8000000000000000000.000 9000000000000000000.000 10000000000000000000.000 12000000000000000000.000 15000000000000000000.000 20000000000000000000.000 30000000000000000000.000 40000000000000000000.000 50000000000000000000.000 60000000000000000000.000 70000000000000000000.000 80000000000000000000.000 90000000000000000000.000 100000000000000000000.000 120000000000000000000.000 150000000000000000000.000 200000000000000000000.000 300000000000000000000.000 400000000000000000000.000 500000000000000000000.000 600000000000000000000.000 700000000000000000000.000 800000000000000000000.000 900000000000000000000.000 1000000000000000000000.000 1200000000000000000000.000 1500000000000000000000.000 2000000000000000000000.000 3000000000000000000000.000 4000000000000000000000.000 5000000000000000000000.000 6000000000000000000000.000 7000000000000000000000.000 8000000000000000000000.000 9000000000000000000000.000 10000000000000000000000.000 12000000000000000000000.000 15000000000000000000000.000 20000000000000000000000.000 30000000000000000000000.000 40000000000000000000000.000 50000000000000000000000.000 60000000000000000000000.000 70000000000000000000000.000 80000000000000000000000.000 90000000000000000000000.000 100000000000000000000000.000 120000000000000000000000.000 150000000000000000000000.000 200000000000000000000000.000 300000000000000000000000.000 400000000000000000000000.000 500000000000000000000000.000 600000000000000000000000.000 700000000000000000000000.000 800000000000000000000000.000 900000000000000000000000.000 1000000000000000000000000.000 1200000000000000000000000.000 1500000000000000000000000.000 2000000000000000000000000.000 3000000000000000000000000.000 4000000000000000000000000.000 5000000000000000000000000.000 6000000000000000000000000.000 7000000000000000000000000.000 8000000000000000000000000.000 9000000000000000000000000.000 10000000000000000000000000.000 12000000000000000000000000.000 15000000000000000000000000.000 20000000000000000000000000.000 30000000000000000000000000.000 40000000000000000000000000.000 50000000000000000000000000.000 60000000000000000000000000.000 70000000000000000000000000.000 80000000000000000000000000.000 90000000000000000000000000.000 100000000000000000000000000.000 120000000000000000000000000.000 150000000000000000000000000.000 200000000000000000000000000.000 300000000000000000000000000.000 400000000000000000000000000.000 500000000000000000000000000.000 600000000000000000000000000.000 700000000000000000000000000.000 800000000000000000000000000.000 900000000000000000000000000.000 1000000000000000000000000000.000 1200000000000000000000000000.000 1500000000000000000000000000.000 2000000000000000000000000000.000 3000000000000000000000000000.000 4000000000000000000000000000.000 5000000000000000000000000000.000 6000000000000000000000000000.000 7000000000000000000000000000.000 8000000000000000000000000000.000 9000000000000000000000000000.000 10000000000000000000000000000.000 12000000000000000000000000000.000 15000000000000000000000000000.000 20000000000000000000000000000.000 30000000000000000000000000000.000 40000000000000000000000000000.000 50000000000000000000000000000.000 60000000000000000000000000000.000 70000000000000000000000000000.000 80000000000000000000000000000.000 90000000000000000000000000000.000 100000000000000000000000000000.000 120000000000000000000000000000.000 150000000000000000000000000000.000 200000000000000000000000000000.000 300000000000000000000000000000.000 400000000000000000000000000000.000 500000000000000000000000000000.000 600000000000000000000000000000.000 700000000000000000000000000000.000 800000000000000000000000000000.000 900000000000000000000000000000.000 1000000000000000000000000000000.000 1200000000000000000000000000000.000 1500000000000000000000000000000.000 2000000000000000000000000000000.000 3000000000000000000000000000000.000 4000000000000000000000000000000.000 5000000000000000000000000000000.000 6000000000000000000000000000000.000 7000000000000000000000000000000.000 8000000000000000000000000000000.000 9000000000000000000000000000000.000 10000000000000000000000000000000.000 12000000000000000000000000000000.000 15000000000000000000000000000000.000 20000000000000000000000000000000.000 30000000000000000000000000000000.000 40000000000000000000000000000000.000 50000000000000000000000000000000.000 60000000000000000000000000000000.000 70000000000000000000000000000000.000 80000000000000000000000000000000.000 90000000000000000000000000000000.000 100000000000000000000000000000000.000 120000000000000000000000000000000.000 150000000000000000000000000000000.000 200000000000000000000000000000000.000 300000000000000000000000000000000.000 400000000000000000000000000000000.000 500000000000000000000000000000000.000 600000000000000000000000000000000.000 700000000000000000000000000000000.000 800000000000000000000000000000000.000 900000000000000000000000000000000.000 1000000000000000000000000000000000.000 1200000000000000000000000000000000.000 1500000000000000000000000000000000.000 2000000000000000000000000000000000.000 3000000000000000000000000000000000.000 4000000000000000000000000000000000.000 5000000000000000000000000000000000.000 6000000000000000000000000000000000.000 7000000000000000000000000000000000.000 8000000000000000000000000000000000.000 9000000000000000000000000000000000.000 10000000000000000000000000000000000.000 12000000000000000000000000000000000.000 15000000000000000000000000000000000.000 20000000000000000000000000000000000.000 30000000000000000000000000000000000.000 40000000000000000000000000000000000.000 50000000000000000000000000000000000.000 60000000000000000000000000000000000.000 70000000000000000000000000000000000.000 80000000000000000000000000000000000.000 90000000000000000000000000000000000.000 100000000000000000000000000000000000.000 120000000000000000000000000000000000.000 150000000000000000000000000000000000.000 200000000000000000000000000000000000.000 300000000000000000000000000000000000.000 400000000000000000000000000000000000.000 500000000000000000000000000000000000.000 600000000000000000000000000000000000.000 700000000000000000000000000000000000.000 800000000000000000000000000000000000.000 900000000000000000000000000000000000.000 1000000000000000000000000000000000000.000 1200000000000000000000000000000000000.000 1500000000000000000000000000000000000.000 2000

## PRINTER SOLUTION



Handsomely crafted of heavy-duty 1/4" Plexiglas. Permits easy, convenient storage of paper checks, invoice forms, plus direct feed from shelf or surface below. A Programs Unlimited exclusive!

Regular Size 13" x 15" (Epson MX-80, Okidata u82, u83) \$29.95  
 Large Size 13" x 17" (Epson MX-100, Okidata u84) \$39.95  
 X-Large Size (Includes Shelf) 13" x 22" (Dataroyal, Paper Tiger) \$59.95  
 Optional Shelf \$14.95



**PROGRAMS UNLIMITED**  
 COMPUTER CENTERS  
 800-645-6038 In NY 516-997-8668

Circle 345 on Inquiry card.

## SUPER E-Z80 KIT

### 64K-Z80A-CP/M™ Compatible Micro-Computer

Features: Z80A CPU/CTC and PIO • 64K Dynamic Ram • 4K Monitor EProm • 54 Key Keyboard (Detachable) • 3 Fully Buffered S-100 Spaces • Intergrated Circuit Sockets • RS232-C Asynch. Modem Control (Programmable Baud Rate) • Composite Video • CP/M™ Operating System Compatible • Epson or Centronics Printer Compatible Parallel Port • 8272 Floppy Controller Device - 3740 and 3741 Comp. - 8" & 5 1/4" Drives - up to 4 Drives • Z80 Programming Card • Assembly Instructions • Monitor Listing • Block Diagram.

**PRICE: \$1195.00**  
**TERMS: Certified check or money order**  
 (Texas Res. Add Sales Tax)

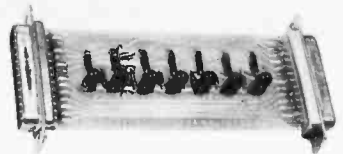
### KIT-80 INC.

18601 LBJ Fwy. • Mesquite, Texas 75150  
 • 800-527-1593

™ Trademark of Digital Research

Circle 230 on Inquiry card.

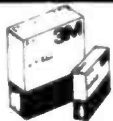
## RS-232 PROBLEMS?



LET THE RS-232 TESTER HELP YOU SOLVE YOUR COMPUTER INTERFACE PROBLEMS. DESIGNED TO CONNECT IN SERIES WITH ANY RS-232 INTERFACE, IT DISPLAYS THE STATUS OF SEVEN OF THE MOST IMPORTANT LINES: TRANSMIT DATA, RECEIVE DATA, REQUEST TO SEND, CLEAR TO SEND, DATA SET READY, CARRIER DETECT, AND DATA TERMINAL READY. THE RS-232 TESTER REQUIRES NO POWER AND MAY BE LEFT IN THE LINE PERMANENTLY.

**\$39.95 POST PAID**  
**B & B ELECTRONICS**  
 BOX 475/MENDOTA, IL 61342

Circle 37 on Inquiry card.



**Scotch**  
 DISKETTES

**SAVE 40%** Write for our complete list.

**5 1/4"** Specify soft, 10 or 16 sector Price/10  
 #744 1 side/sgl dens. \$26.70  
 #744D 1 side/dbl dens. 31.20  
 #745 2 sides/dbl dens. 38.40

**8"** Specify soft or 32 sector  
 #740 1 side/sgl dens. 27.30  
 #741 1 side/dbl dens. 35.80  
 #743 2 sides/dbl dens. 43.60

CHECKS - VISA - MC - C.O.D.  
 (313) 777-7780 ADD \$2 SHIPPING

LYBEN COMPUTER SYSTEMS  
 27204 Harper Ave.  
 St. Clair Shores, MI 48081

Authorized Distributor  
 Information Processing Products



Circle 244 on Inquiry card.

## THE MISSING LINK



Adapt IBM ET50, 60, or 75 to Apple II or III with our Missing Link for word processing quality output.

- Does not affect normal typewriter operation
  - Typewriter still qualified for IBM maintenance contract
  - Interface isolates the Apple from the typewriter
- See our full page ad in May 1980 BYTE  
 Check with your local Apple dealer or to order call: 1-800-845-2712 (In S.C., call 1-800-922-5528)

If you need word processing software, we offer Manuscripter in two versions: Beginner \$95, Advanced \$195

\*S.C. residents add 4% sales tax



**CompuSystems**

2301 DEVINE STREET • PO BOX 5144  
 COLUMBIA, S.C. 29250 • 18031 254-0804

Circle 89 on Inquiry card.



**ATARI**

Entertainer Kit . . . . . 88.00	Atari 800 16K . . . . . 710.00
Programmer Kit . . . . . 56.00	Atari 400 16K . . . . . 359.00
Communicator Kit . . . . . 320.00	Atari 410 Cassette . . . . . 80.00
Microsoft Basic . . . . . 72.00	Atari 810 Disk . . . . . 480.00

**ALL ATARI SOFTWARE 20% OFF**  
 Plus Loads of 3rd Party Software!  
**VOTRAX TYPE'N'TALK: 340.00**  
**ALSO EPSON & CENTRONICS PRINTERS**  
**ZENITH & TELEVIDEO TERMINALS**

BBI Mail Order is a company made up of computer professionals. We are able to provide low prices as well as technical support. Give us a call and find out why we consider the Atari the best home computer on the market today. You won't be disappointed.



### BBI Mail Order

Specializing in Atari Home Computers  
 P.O. Box 365  
 Newton Highlands, MA 02161  
 (617) 964-3080

Circle 42 on Inquiry card.

ATLANTIC CABINET  
 P.O. Box 100,  
 Williamsport,  
 Maryland 21795

## Design Line Micro Work Stations



- A range of work stations designed specifically to house all micro-computers.
- Delivered heavily packed. In self-assembly form needing only a Phillips screwdriver and a few minutes of your time to assemble.
- Manufactured from 1" all wood particleboard surfaced with hard-wearing melamine veneer, in either Oak or Walnut.

DEALER AND DISTRIBUTOR PRICES ON REQUEST  
 FOR MORE INFORMATION WRITE OR CALL 301-223-8900

Circle 33 on Inquiry card.

## PERSONAL COMPUTER SOFTWARE

### for EXECUTIVES and MANAGERS

- Name/Address/Key Information
- Personal Schedule
- Corporate Schedule
- Document Tracking
- File Indexing Schema
- Tickler File
- Questionnaire Tabulating

Any three for \$150 - All seven for \$250.  
 Functional, well engineered software in the Pascal programming language for Apple II and TRS-80 Model II computers.

### SOFTWARE CONSULTING SERVICES

901 Whittier Drive, Allentown, Pa. 18103  
 (215) 797-9690  
 ATT. Martha Cichelli

\* (TM) Apple Computer Co. \*\* (TM) Tandy Corp.

Circle 383 on Inquiry card.

HERE IT IS  
 AT LAST!



"SUPERNET"

THIS IS THE MOST UNIQUE S-100 COMPUTER BOARD:  
 64K of memory, Z80A CPU, Double Density Floppy Disk Controller, 2 Serial & Parallel I/O, monitor (EPROM) ALL on a single S-100 Computer Board from ADVANCED Micro Digital Corp. ©

SUPERNET . . . . .	\$900.
Serial Adaptor Cable . . . . .	\$ 35.
Parallel Adaptor Cable . . . . .	\$ 40.
Shugart SA801R . . . . .	\$ 455.
Televideo 912C . . . . .	\$ 750.
Enclosure with 10 slots, power supply, cut outs for two 8" floppies . . . . .	\$ 650.
Z-80A CPU . . . . .	\$5.50
4164 RAM Chips . . . . .	\$10.00
Z-80A CTC . . . . .	\$5.50
2716 EPROM . . . . .	\$5.50

### • MICRO SPOT ELECTRONICS

14221 Edwards, Suite 72  
 Westminster, CA 92683  
 (714) 891-0382

#### TERMS:

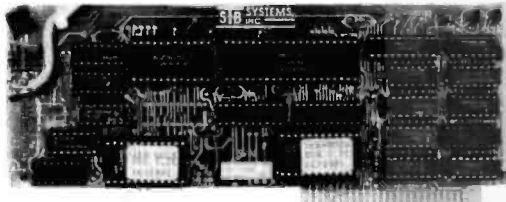
Pre-Payment or C.O.D. up to \$250. (Cashier's check). Allow one week for checks to clear before shipping. Add \$5 shipping and handling charge to your order. Calif. Residents add 6% sales tax.

Circle 274 on Inquiry card.



# IBM and APPLE COMPATIBLE BOARDS!

## STB-80™ APPLE VIDEO BOARD



### FEATURES:

- ★ 24 x 80 Display
- ★ Direct Keyboard Entry for Lower Case and Special Characters
- ★ Line Graphics
- ★ Software Screen Switch to Standard Apple
- ★ Emulates all Basic Screen Formatting Commands
- ★ Compatible with PASCAL & CP/M
- ★ Software Controllable Inverse Video by Character & Screen

**\$259**  
ASSEMBLED  
& TESTED

### SOFTWARE

#### #1 DOS TOOL KIT PATCH DISKETTE

This patches the APPLE EDITOR & ASSEMBLER for use with the STB-80.  
**\$24.95**

#### #2 APPLE WRITER PATCH DISKETTE

This patches the APPLE WRITER WORD PROCESSOR package for use with the STB-80.  
**\$24.95**

*New*

## APPLE MEMORY EXPANSION BOARDS

### STB-16™ 16K BOARD

- ★ Assembled & Tested
- ★ Increases 48K to 64K
- ★ Compatible with PASCAL, CP/M DOS 3.3, PILOT, COBOL, FORTRAN, VISICALC, INT. BASIC, APPLE SOFT BASIC, etc.
- ★ Easy to Install. Plug in and Go. No Cables. No chips to Remove.
- ★ Expandable to 64K

**\$139**

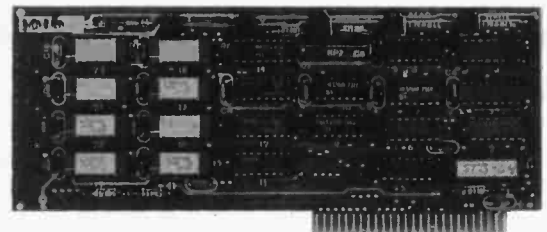
16K A & T  
(64K UPGRADE FOR STB-16 IS \$189)

### STB-64™ 64K BOARD

**\$299**

64K A & T

*New*



- ★ Assembled and Tested
- ★ Uses 64K RAMS
- ★ Four STB-16's on one Card
- ★ Software Bank Selectable
- ★ Compatible with 16K RAM Card Software
- ★ DOS 3.3 Support Disk FREE with Purchase

### STB-128™ 128K APPLE BOARD

#### MULTI-PURPOSE MEMORY BOARD & DISK EMULATOR

- ★ 128K of Expansion Memory
- ★ Includes DOS 3.3 Support Disk
- ★ Eight STB-16's on one Card
- ★ Processor Port for Direct Access Control
- ★ Uses 64K RAMS

**\$549**

128K A & T

COMING SOON: VISICALC  
EXPANSION SOFTWARE

### STB DOS 3.3 SUPPORT PROGRAM DISK

- ★ Disk Emulator (1 STB-128 or 2 STB-64 Req)
- ★ Disk "Cache" (1 STB-128 or 2 STB-64 Req)
- ★ Fast Basic Loader
- ★ Memory Tester
- ★ DOS Relocater (Free 8K for Basic)
- ★ Picture Flipper/Saver

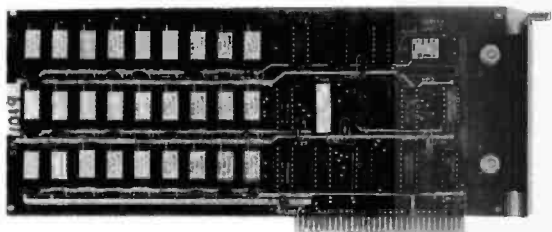
**\$29.95**

(FREE with STB-64 or STB-128)

*New*

## IBM PC MEMORY EXPANSION BOARDS

*New*



PUT UP TO 256K ON LINE  
IN YOUR IBM P.C.!

64K — \$399 (STB-I64)

128K — \$649 (STB-I128)

192K — \$799 (STB-I192)

ALL ASSEMBLED & TESTED

EXPANSION KIT TO GO FROM 64K  
TO 192K IS \$450

- ★ Expand Your IBM to 256K Using Only one Slot.
- ★ Available in 64, 128, or 192K Sizes
- ★ Easy to Install, Use in Any of the 5 Expansion Slots
- ★ Mounting Bracket, Included for Secure, Reliable Operation
- ★ Parity — All Three Models Support Parity Error Testing
- ★ One Year Limited Warranty on all Boards

IBM PC TM OF IBM CORP. APPLE AND APPLEWRITER TM OF APPLE COMPUTERS, CP/M TM OF DIGITAL RESEARCH. VISICALC TM OF VISICORP.

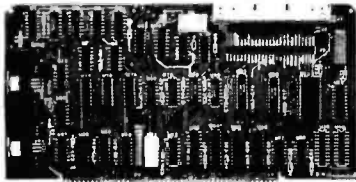
DIGITAL RESEARCH COMPUTERS IS PROUD TO BE ANNOUNCED AS THE NATIONAL MAIL ORDER OUTLET FOR THE FINE LINE OF S.T.B. "SIMPLY THE BEST" BOARDS.

**Digital Research Computers**  
(OF TEXAS)

P.O. BOX 401565 • GARLAND, TEXAS 75040 • (214) 271-3538

TERMS: Shipments will be made approximately 3 weeks after we receive your order. VISA, MC, cash accepted. We will accept COD's with a \$75 deposit. Balance UPS COD. Add \$4.00 shipping.  
USA AND CANADA ONLY

## FEEL TRAPPED BETWEEN CAPACITY AND COST?



Processor Interface introduces the Cartridge Disk Controller for the S-100 bus. Configurable for 12 sector 2315 and 5440 type disk drives (1.25 - 10 Mbytes per drive) Complete with CPM\* CBIOS, disk formatter diagnostics and technical manual low cost \$595.00

Manual only \$25.00  
The performance you need at a cost you can afford



Special Introductory price \$499.00 (until 5/30/82)

Processor Interfaces, Inc. P.O. Box 154A Elm Grove, WI 53122  
414-785-1245

Circle 343 on Inquiry card.

## PC/FORTH

Complete FORTH program development systems for the IBM® Personal Computer. Packages include interpreter/compiler with virtual memory management, line editor, custom screen editor, assembler, decompiler, utilities, file and record access modules, and many demonstration programs. 100 page user manual . . . \$100.00

Floating point arithmetic extensions and cross compiler available at additional cost.

Ready to run under PC-DOS or CP/M-86® Standalone version available soon. 64 kbytes RAM and two disk drives recommended. (IBM is a registered trademark of International Business Machines Corp. CP/M is a registered trademark of Digital Research, Inc.)

### Laboratory Microsystems

4147 Beethoven Street  
Los Angeles, CA 90066  
(213) 306-7412

Circle 233 on Inquiry card.



## DESK TOP VIDEO-PRINTER STAND

Get the benefits of specialized computer furniture at a fraction of the cost.



- Keyboard slides under TV increasing work space. (Works the same with printer, disk drives, and other devices, or fanfold paper.)
- For use on your present desk or table
- Places all components at your fingertips
- Designer styling, sturdy metal construction in Black or Beige
- For use with most micros and printers

Introductory Price  
**\$39.95 ea.**  
Fla. add 4%

Dim: 19 1/2" x 12" x 6 3/4"  
Send CK or MO  
Including \$4.00  
Shipping & handling

**E-S** Advanced EFFORT-SAVER Products, Inc.

P.O. BOX 5001  
HIALEAH, FL 33014

Circle 8 on Inquiry card.

## SCR SUPER-BUYS

\$10.00 MIN. ORDER HANDLING/SHIPPING \$2.50  
UPS ANYWHERE IN CONTINENTAL U.S.

**1982 BUYERS GUIDE NOT JUST ANOTHER CATALOGUE BUT A BUYERS GUIDE "OF THE FUTURE"** FREE

1. **UHF-VHF CONVERSION KIT.** \$119.95  
Completes with PC board, all required components, jumper wire, cabinet with speaker, and comprehensive brochure incl. schematic, board layout, mounting and hook-up diagrams, parts list, and assembly and set-up instructions. All parts are industrial prime quality.

2. **NEW ZENITH ZVM-121 HIGH-LEGIBILITY CRT MONITOR.** \$117.95  
Features 12" green phosphor CRT, with 15 MHz Bandwidth, 40 or 80 character widths are operator switch-selectable. Fully compatible with 80-column Apple cards, etc.

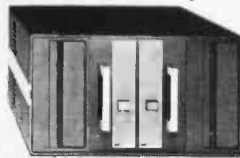
OUTSIDE CAL. 800-854-8660  
INSIDE CAL. (714) 527-2554

### SCR ELECTRONICS INC.

VISIT OUR NEW SUPER CENTER  
5303 Lincoln Ave., Cypress, CA 90630  
Pay by CHECK, M.O., VISA, M/C

Circle 373 on Inquiry card.

## Sprint 68 Microcomputer



### CONTROL COMPUTER DEVELOPMENT SYSTEM

6800 MPU, serial I/O, 48K RAM, dual 8" drives, WIZRD multitasking DOS, editor, assembler, 16K BASIC, all for \$3949.

#### OPTIONS

C, PL/W, PASCAL, FORTRAN, EROM programmer, analog I/O, parallel I/O, 488 GPIB interface, CMOS RAM/battery, power fail detect/power on reset



**WINTEK**

Wintek Corp.  
1801 South Street  
Lafayette, IN 47904  
317-742-8428

Circle 438 on Inquiry card.

## CROSS REF. PROGRAM

for  
**MBASIC & BASCOM**  
Source Files  
**M80 and CP/M's ASM**

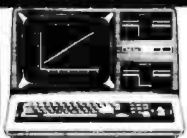
MXREF will list all program variables, functions, key words, strings, constants and line number references in alphabetical order. 1000 variable names allowed. Requires an 8080 or Z80 running CP/M ver. 1.4 or later and at least 48K RAM. Price \$96.00. Manual only \$15.00. Add \$5.00 COD. MXREF available in CP/M format on 5" NorthStar or 8" single or double density soft sector.

### COMPUTER TOOLBOX INC.

1325 East Main St.  
Waterbury, CT. 06705  
(203) 754-4197

Circle 104 on Inquiry card.

## YOU CAN PAY MORE BUT YOU CAN'T GET MORE!



Model III 16K  
**\$839**  
Model III 48K  
2 disc & RS232C  
**\$2059**

BUY DIRECT. These are just a few of our great offers which include Printers, Modems, Computers, Peripherals, Disc Drives, Software and more. call TOLL FREE 1-800-343-8124

We have the lowest possible fully warranted prices and a full complement of Radio Shack Software.



Color Computer 4K  
**\$310**  
w/16K Ext. Basic  
**\$459**  
w/32K Ext. Basic  
**\$525**

**computer plus**  
Write for your free catalog.

245A Great Road  
Littleton, MA 01460  
617-486-3193

Circle 98 on Inquiry card.

## 5 1/4" Floppy Disk Drives

(single side-single or double density)

**TANDON Model TM 100-1** } \$219.95 ea.  
**CDC Model 9409**

2 or more — \$214.95 ea.\*

Floppy Drive Power Connector Kit . . . . . \$2.00\*  
5 1/4" Memorex Floppy Disks - single side soft sector, single or double density - Box of 10 . . . . . \$28.00\*

### CALL NOW - TOLL FREE

800-824-7888 all states except CA.  
800-852-7777 for CA residents.  
Ask for Operator #99.

MC/VISA or C.O.D. with certified check or money order. Kansas residents add 3% sales tax.

\*Plus shipping.  
For info call: 316-683-9225  
316-685-9445

**gb computer systems**

923 Longfellow Street  
Wichita, KS 67207

Circle 178 on Inquiry card.

## Maxell Floppy Disks

The Mini-Disks  
with maximum quality.



Dealer inquiries invited. C.O.D.'s accepted. Call FREE (800) 235-4137.



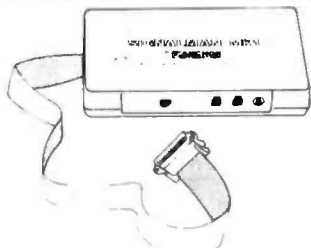
**PACIFIC EXCHANGES**  
100 Foothill Blvd., San Luis  
San Luis Obispo, CA 93401.  
In Cal. call (800) 592-5935 or  
(805) 543-1037.

Circle 320 on Inquiry card.

**SPECIALS ON INTEGRATED CIRCUITS**

6502	7.45	10/6.95	50/6.55	100/6.15
6502A/6512A	8.40	10/7.95	50/7.35	100/6.90
6520 PIA	5.15	10/4.90	50/4.45	100/4.15
6522 VIA	6.45	10/6.10	50/5.75	100/5.45
6532	7.90	10/7.40	50/7.00	100/6.60
2114-L200		3.75	25/3.50	100/3.25
2114-L300		3.15	25/2.90	100/2.65
2716 EPROM		7.00	5/6.45	10/5.90
2532 EPROM				14.50
8116 Hitachi 2K x 8 CMOS RAM				14.50
4116				8 for 17
Zero Insertion Force 24 pin Socket				2.00
6550 RAM (PET 8K)				12.70
S-100 Wire Wrap Socket				2.40

**A P Products 15% OFF**  
**A P Hobby-Blox 15% OFF**



**MODEM SPECIAL \$99**

**SIGNALMAN Mk1** from Anchor Automation  
 DIRECT CONNECT Modem with RS232 Cable and Connector included. Fully compatible with all Bell 103 modems. 0 to 300 bps. Full duplex. Frequency shift keyed modulation. automatic ANSW/ORIG selection. direct connect. audible tone carrier detect indicator. self-contained battery powered.

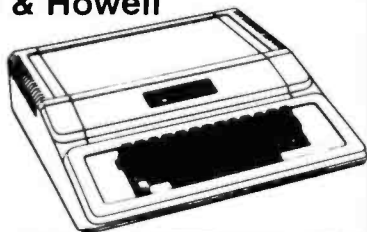
**PET/CBM Version (Mk1P) \$169**

For Commodore Computers, the Signalman Mk1P includes connector, cable, and machine language software

**STAR MODEM** Prentice/Livermore Data Systems

RS232 MODEM	SALE	\$128
IEEE 488 MODEM	SALE	\$199
RS232 CCITT		\$170
IEEE 488 CCITT		\$270

**We carry Apple II+ from Bell & Howell**



**16K RAM for Apple 95**

**CASH MANAGEMENT SYSTEM \$45**

Easy to use. Keeps track of cash disbursements, cash receipts, cash transfers, expenses for up to 50 categories.

**FORTH for PET by Cargile/Riley \$50**

Full FIG model with all 79 Standard extensions.  
**Metacompiler for FORTH** for independent object code 30

**KMMM PASCAL for PET/CBM \$85**

Includes translator for true machine language object code.

**EARL for PET/CBM 65**

Editor, Assembler, Relocator, Linkeditor.

**SuperGraphics - BASIC Language Extensions 40**

Fast Machine Language Graphics routines for PET/CBM.

**commodore**



**CBM-PET SPECIALS**

8023 Printer - 136 col, 150cps bi-directional	(995)	775
8300 Daisy Wheel - 40 cps bi-directional	(2250)	1750
8032 80 x 25 CRT, business keyboard	(1495)	1100
Super Pet	(1995)	1650
8096 Board (extra 64K RAM for 8032)	(500)	400
8050 Dual Disk Drive - 1 megabyte	(1795)	1345
8250 Dual Disk Drive - 2 megabyte	(2195)	1760
CBM IEEE Modem	(395)	199
4016 full size graphics keyboard	(995)	795
4032 full size graphics keyboard	(1295)	999
4040 Dual Disk Drive - 330,000 bytes	(1295)	999
2031 Single Disk Drive - 165,000 bytes	(695)	550
4022 Tractor Feed Printer	(795)	630
C2N External Cassette Deck	(75)	65
VIC 20 Color Computer	(299)	259
VIC 1515 Graphic Printer	(395)	335
Used CBM/PET Computers		CALL
8024-7 High Speed Printer	(1995)	1345

**WE WILL MATCH ANY ADVERTISED PRICE**

**\*\*\* EDUCATIONAL DISCOUNTS \*\*\***

Buy 2 PET/CBM Computers, receive 1 FREE

**PETSCAN I \$345 base price.**

Allows you to connect up to 20 CBM/PET Computers to shared disk drives and printers. Completely transparent to the user. Perfect for schools or multiple word processing configurations.

VIC 20	259	VIC Superslot	24
VIC 1515 Printer	335	VIC Super Alien	24
VIC 3K RAM	36	VIC Maze in 3-D	12
VIC 8K RAM	54	VIC Cosmic Debris	9
VIC 16K RAM	112	VIC Amok (UMI)	17
VIC 1540 Disk Drive	500	VIC Snakman	13
VIC Invaders	24	VIC Rubik's Cube	13
VIC Jupiter Lander	24	VIC Night Rider	11

TNW 1000 Serial Interface	110
TNW 488/103 with DAA	450
Computer's First Book of PET /CBM	11
WordPro 3 Plus - 32K CBM, disk, printer	195
WordPro 4 Plus - 8032, disk, printer	300
OZZ Data Base System for CBM 8032	335
VISICALC for PET, ATARI, or APPLE	190
SM-KIT - PET ROM Utilities	40
Programmers Toolkit - PET ROM Utilities	35
PET Spacemaker II ROM Switch	36
2 Meter PET to IEEE or IEEE to IEEE Cable	40
Oust Cover for PET	8
IEEE-Parallel Printer Interface for PET	110
IEEE-RS232 Printer Interface for PET	120
The PET Revealed	12
Library of PET Subroutines	12

**RAM/ROM for PET/CBM**

4K or 8K bytes of soft ROM with optional Battery Backup.  
 Adds extra RAM which can be write protected like ROM.  
**4K Version - \$85 .8K Version - \$120 Battery Backup - \$30**

**EPROM Programmer for CBM/PET 79**

Branding Iron with software/hardware for 2716 and 2532.

**DISK SPECIALS**



SCOTCH (3M) 5"	10/2.45	50/2.35	100/2.30
SCOTCH (3M) 8"	10/2.60	50/2.45	100/2.40

**WE STOCK VERBATIM DISKS**

Try the new Verbatim Head Cleaner Kits

BASF 5" or 8"	10/2.00	20/1.95	100/1.85
Wabash 5"	10/2.00	20/1.95	100/1.85
Wabash 8"	10/2.00	20/1.95	100/1.85

**WE STOCK MAXELL DISKS**

Diskette Storage Pages			10 for 3.95
Disk Library Cases	8" - 2.85	5" - 2.15	
Disk Hub Rings	8" - 50 for 7.50	5" - 50 for 6.00	

**CASSETTES - AGFA PE-611 PREMIUM**

High output, low noise, 5 screw housings.

C-10	10/56	50/50	100/48
C-30	10/73	50/68	100/66

All other lengths available. Write for price list.

**SPECIALS**

<b>EPSON MX-80 Printer</b>	
<b>EPSON MX-80 F/T Printer</b>	
<b>EPSON MX-70 Printer</b>	
<b>EPSON MX-100 Printer</b>	
Centronics 739 Printer with dot graphics	575
<b>STARWRITER Daisy Wheel Printer</b>	1445
Zenith ZVM-121 Green Phosphor Monitor	119
Amdek Color Monitor	355
DC Hayes Smartmodem	240
Watanabe Intelligent Plotter 1195 6-Pen	1445
BMC BM12A Green Phosphor Monitor	105
BMC BM1400BLUC 13" Color Monitor	285

**ALL BOOK and SOFTWARE PRICES DISCOUNTED**

**Synertek Systems**

<b>SYM-1 Microcomputer</b>	SALE	199
SYM BAS-1 BASIC or RAE 1/2 Assembler		85
KTM-2/80 Synertek Video and Keyboard		349
KTM-3/80 Synertek Tubeless Terminal		385

**ZENITH data systems**

Z90-80 64 K	2170
Z90-82 64K, 1 double dens. drive	2395
Z89-0 48K	1950
Z89-1 48K, 1 drive	2150
Z67 10 Megabyte + Floppy Drive	4495
Z37 1.3 Megabyte Dual Floppy	1495
Z25 High Speed Printer	1195
Z19 Video Terminal (VT-52 compatible)	670
ZVM-121 Green Phosphor Monitor	119

All Zenith Software discounted



**ATARI SPECIALS**

800 Computer	695	Microsoft BASIC	72
400 - 16K	339	<b>MISSILE COMMAND</b>	32
810 Disk Drive	449	<b>ASTEROIDS</b>	32
825 Printer	629	<b>STAR RAIDERS</b>	32
850 Interface	175	Space Invaders	36
Inside Atari DOS	18	Music Composer	45
Paddle Pair	19	Chess	30
Joystick Pair	19	Super Breakout	30
16K RAM	69	<b>PAC-MAN</b>	36
32K RAM	99	<b>CENTPEDE</b>	36
Pilot	68	First Book of Atari	11

Write for prices on other Atari items.

**WRITE FOR CATALOG**

Add \$1.25 per order for shipping. We pay balance of UPS surface charges on all prepaid orders. Prices listed are on cash discount basis. Regular prices slightly higher. Prices subject to change.

252 Bethlehem Pike  
 Colmar, PA 18915

215-822-7727

**A B Computers**

Circle 4 on Inquiry card.



**IPEX** **NEW!**

**"ELF" Interface Converts Your Typewriter Into Printer**



- Finest print quality
- Low cost
- Easy Installation
- Quick delivery
- Fits IBM Selectric® and Electronic Typewriters
- Models for all popular computers
- Call or write for more information, today!

**We export to all countries -**

**IPEX INTERNATIONAL INC.**  
5115 Douglas Fir Rd.  
Calabasas, CA 91302 U.S.A.  
Tel: (213) 710-1444 TLX/TWX: 910 494 2100

Circle 215 on Inquiry card.

**EPROM-32**

The only EPROM programmer you need!

- IEEE 696 (S-100) EPROM programmer for single-supply (+5V) EPROMs.
- Programs current 1K through 8K (byte) EPROMs plus future 16K and 32K EPROMs.
- Personality Modules adapt board to different EPROM types:
  - PM-1—2508, 2758 PM-4—2564
  - 2516, 2716 PM-5—2764
  - PM-2—2532 PM-6—68764
  - PM-3—2732 PM-7—2528(TI-16K)
- Zero-insertion-force socket accommodates both 24-pin and 28-pin EPROM packages.
- DIP switch selection of programming ports and EPROM address for verification and/or use.
- On-board DC-to-DC converter with adjustable regulator for programming voltage.
- Programming voltage switched by software.
- Double-sided PC board with solder masks, silkscreen and gold-plated contact fingers.
- Documentation includes source listing of 8080/Z80 software for programming and verification.

**MicroDynamics** **\$269.95**  
(assembled & tested)

Price includes EPROM-32, documentation and two personality modules (specify). Additional modules — \$79.95. Programming/verification software on 8 inch single density CP/M-compatible diskette — \$9.95.

**Corporation**  
P.O. Box 17577  
Memphis, TN 38117  
(901) 755-0619

MASTERCARD & VISA—TN residents add 6% sales tax.

Circle 275 on Inquiry card.

**UV EPROM ERASER**



**\$49.95**

- ERASES ALL UV ERASABLE EPROMS (2708, 2716, 2504, etc.)
- QUICK FIFTEEN MINUTES ERASE TIME
- ERASES OVER FIFTEEN EPROMS AT A TIME
- LAMP LIFE, 7000 HOURS
- INDUSTRIAL MODEL 908-50
- INDUSTRIAL MODEL WITH TIMER & SAFETY INTERLOCK SWITCH \$97.50 (Rugged steel enclosure with bottom drawer)

**THE BEST 6809 SINGLE BOARD COMPUTER AVAILABLE**

- Ready Controller
- SARTIC Compatible
- Printer Port
- Built TSC Filter
- RS-232 Port
- Full Documentation

**PRICE: \$389.00**

FOR THE SS-50 AND \$100 BUS  
ASSEMBLED, TESTED, 90 HOUR BURN-IN, 90 DAY WARRANTY

**2718 EPROMS 250 ns \$4.95 DIRECT FROM FACTORY**

**SS-50 8809 CPU CARD: 1MHz \$149.00 2MHz \$189.00**

**RS-232 INTELLIGENT EPROM PROGRAMMER... \$489.00**  
Programs: 2718, 2516, 2532, 2732, 6748, 6749

**ANTISTATIC FOAM 4" x 8" \$3.95**

WE ACCEPT VISA, MASTERCARD, C.O.D., CHECKS  
**PHONE ORDERS (305) 776-5870**  
TWX: 510-965-8498 • Engineering Hot-Line: (305) 974-0067

**LOGICAL DEVICES INC.**  
781 W OAKLAND PARK BLVD • FT LAUDERDALE, FLORIDA 33311  
ADD \$3.00 SHIPPING \$2.00 C.O.D. CHARGES

Circle 240 on Inquiry card.

**BASF Flexy-Disks®**

**SAVE 40%** Write for our complete list.

**5 1/4" Specify soft, Price/10**  
10 or 16 sector

1 side/single density . . . . . \$26.70  
1 side/double density . . . . . \$31.90  
2 sides/double density . . . . . \$37.10

**8" Specify soft**  
or 32 sector

1 side/single density . . . . . 26.70  
1 side/double density . . . . . 31.90  
2 sides/double density . . . . . 41.60

CHECKS — VISA — MC — C.O.D.  
(313) 777-7780 ADD \$2 SHIPPING

**LYBEN COMPUTER SYSTEMS**  
27204 Harper Ave.  
St. Clair Shores, MI 48081

Circle 242 on Inquiry card.

*p-System\* + CPR = Word Processing*

**CPR The Vital Link**

CPR is an advanced text formatter offering fast, flexible word processing for the UCSD p-System.

CPR functions include pagination, underlining, proportional spacing and a lot more.

CPR is available now on 8" diskettes for p-System versions II and IV including 175 page users' manual . . . \$199.00.  
Users' manual alone . . . \$30.00

\*UCSD p-System™ is a trademark of the Regents of the University of California.

**Chapin ASSOCIATES** SOFTWARE FOR SYSTEMS AND APPLICATIONS

11568 Sorrento Valley Rd San Diego, CA 92121  
Suite 11 (714) 452-9340

Circle 70 on Inquiry card.

**\$GOLD DISKS**

**CP/M® Compatible**

**Z-80 Software**

**Z-80 DISASSEMBLER**

An easy to use program to create source (.ASM) files from executable (.COM) files **\$175**

**EZ-TEXT WORDPROCESSOR**

EZ-TEXT will format your text file the way you want it **\$75**

**Bower-Stewart & Associates**


POST OFFICE BOX 1389  
HAWTHORNE, CALIFORNIA 90250

**213-532-1237**

Trademark: Digital Research

Circle 52 on Inquiry card.

**Like-new products**



REI Sales Company is setting \$177 of like-new and electronic products for you.

**For free catalog, phone toll-free (800) 225-1008 In Massachusetts (617) 938-0900**

**GENSTAR REI SALES COMPANY**  
19527 Business Center Dr., Northridge, CA 91324

Circle 182 on Inquiry card.

**ZENITH/Heath Users**



**Double Your 5 1/4" disk storage capacity without adding a drive.**

Get twice as much from your H88 or H89 microcomputer. Our FDC-880H floppy disk controller, in conjunction with your 5 1/4" drives, for example, expands memory capacity from 256 bytes to 512 bytes per sector.

And it handles single and double-sided, single and double-density, 8" and 5 1/4" drives — simultaneously.

Call 714/275-1272 today or write for details.

**C.D.R. Systems Inc.**  
Controlled Data Recording Systems, Inc.  
7667 Vickers St., San Diego, CA 92111

Circle 67 on Inquiry card.

**IEEE-488 TO TRS-80\* INTERFACE**

Everything needed to add powerful BASIC GPIB-488 controller capability to TRS-80 Model 1 or 3, Level 2 or DOS with a minimum of 16K.



**488-80C For Model 3 Operation** **488-80B For Model 1 Operation**

Model 488-80B or 488-80C Price: \$375.  
+ shipping, insurance & tax  
**WHEN ORDERING SPECIFY DISK OR TAPE**

**SCIENTIFIC ENGINEERING LABORATORIES**  
11 Neil Drive • Old Bethpage, NY 11804  
Telephone: (516) 694-3370

\*Trademark of Tandy Corp.  
There is no affiliation between Scientific Engineering Laboratories and Tandy Corp. or Radio Shack.

Circle 369 on Inquiry card.

# Why use their flexible discs:

Athana, BASF, Control Data, Dysan, IBM, Maxell, Nashua, Scotch, Shugart, Syncom, 3M, Verbatim or Wabash

## when you could be using

# MEMOREX

## high quality error free discs?

Product Description	Part #	CE quant. 100 price per disc (\$)
8" SSSD IBM Compatible (128 B/S, 26 Sectors)	3062	2.09
8" SSSD Shugart Compatible, 32 Hard Sector	3015	2.09
8" SSDD IBM Compatible (128 B/S, 26 Sectors)	3090	2.74
8" DSDD Soft Sector (Unformatted)	3102	3.14
8" DSDD Soft Sector (128 B/S, 26 Sectors)	3115	3.34
8" DSDD Soft Sector (1024 B/S, 8 Sectors)	3104	3.34
8" DSDD Burroughs B-80 Comp., 32 Hard Sector	3092	3.34
5 1/4" SSSD Soft Sector (Unformatted)	3401	1.94
5 1/4" SSDD Soft Sector w/Hub Ring	3481	2.34
5 1/4" SSDD 10 Hard Sector w/Hub Ring	3483	2.34
5 1/4" SSDD 16 Hard Sector w/Hub Ring	3485	2.34
5 1/4" DSDD Soft Sector w/Hub Ring	3491	3.09
5 1/4" DSDD 10 Hard Sector w/Hub Ring	3493	3.09
5 1/4" DSDD 16 Hard Sector w/Hub Ring	3495	3.09

SSSD = Single Sided Single Density; SSDD = Single Sided Double Density  
DSDD = Double Sided Double Density

### Memorex Flexible Discs...The Ultimate in Memory Excellence

#### Quality

Memorex means quality products that you can depend on. Quality control at Memorex means starting with the best materials available. Continual surveillance throughout the entire manufacturing process. The benefit of Memorex's years of experience in magnetic media production, resulting, for instance, in proprietary coating formulations. The most sophisticated testing procedures you'll find anywhere in the business.

#### 100 Percent Error Free

Each and every Memorex Flexible Disc is certified to be 100 percent error free. Each track of each flexible disc is tested, individually, to Memorex's stringent standards of excellence. They test signal amplitude, resolution, low-pass modulation, overwrite, missing pulse error and extra pulse error. They are torque-tested, and competitively tested on drives available from almost every major drive manufacturer in the industry including drives that Memorex manufacturers. Rigid quality audits are built into every step of the manufacturing process and stringent testing result in a standard of excellence that assures you, our customer, of a quality product designed for increased data reliability and consistent top performance.

#### Customer-Oriented Packaging

Memorex's commitment to excellent does not stop with a quality product. They are proud of their flexible discs and they package them with pride. Both their packaging and their labeling have been designed with your ease of identification and use in mind. The desktop box containing ten discs is convenient for filing and storage. Both box labels and jacket labels provide full information on compatibility, density, sectoring, and record length. Envelopes with multi-language care and handling instructions and color-coded removable labels are included. A write-protect feature is available to provide data security.

**Full One Year Warranty—Your Assurance of Quality**  
Memorex Flexible Discs will be replaced free of charge by Memorex if they are found to be defective in materials or workmanship within one year of the date of purchase. Other than replacement, Memorex will not be responsible for any damages or losses (including consequential damages) caused by the use of Memorex Flexible Discs.

#### Quantity Discounts Available

Memorex Flexible Discs are packed 10 discs to a carton and 10 cartons to a case. Please order only in increments of 100 units for quantity 100 pricing. We are also willing to accommodate your smaller orders. Quantities less than 100 units are available in increments of 10 units at a 10% surcharge. Quantity discounts are also available. Order 500 or more discs at the same time and deduct 1%; 1,000 or more saves you 2%; 2,000 or more saves you 3%; 5,000 or more saves you 4%; 10,000 or more saves you 5%; 25,000 or more saves you 6%; 50,000 or more saves you 7% and 100,000 or more discs earns you an 8% discount off our super low quantity 100 price. Almost all Memorex Flexible Discs are immediately available from CE. Our warehouse facilities are equipped to help us get you the quality product you need, when you need it. If you need further assistance to find the flexible disc that's right for you, call the Memorex compatibility hotline. Dial 800-538-8080 and ask for the flexible disc hotline extension 0997. In California dial 800-672-3525 extension 0997. Outside the U.S.A. dial 408-987-0997.

#### Buy with Confidence

To get the fastest delivery from CE of your Memorex Flexible Discs, send or phone your order directly to our Computer Products Division. Be sure to calculate your price using the CE prices in this ad. Michigan residents please add 4% sales tax. Written purchase orders are accepted from approved government agencies and most well rated firms at a 30% surcharge for net 30 billing. All sales are subject to availability, acceptance and verification. All sales are final. Prices, terms and specifications are subject to change without notice. Out of stock items will be placed on backorder automatically unless CE is instructed differently. Minimum order \$50.00. International orders are invited with a \$20.00 surcharge for special handling in addition to shipping charges. All shipments are F.O.B. Ann Arbor, Michigan. No COD's please. Non-certified and foreign checks require bank clearance.

Mail orders to: Communications Electronics, Box 1002, Ann Arbor, Michigan 48106 U.S.A. Add \$6.00 per case or partial case of 100 8-inch discs or \$6.00 per case or partial case of 100 5 1/4-inch mini-discs for U.P.S. ground shipping and handling in the continental U.S.A. If you have a Master Card or Visa card, you may call anytime and place a credit card order. Order toll-free in the U.S. Call anytime 800-521-4414. If you are outside the U.S. or in Michigan, dial 313-994-4444. Order your high quality, error free Memorex discs today.

Copyright ©1982 Communications Electronics™

## High Quality Error Free



Order Toll-Free!  
**(800) 521-4414**  
In Michigan (313) 994-4444



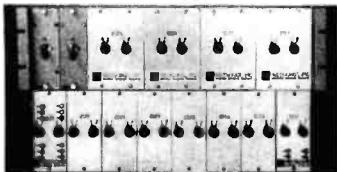
For Data Reliability—Memorex Flexible Discs

# COMMUNICATIONS ELECTRONICS™

## Computer Products Division

854 Phoenix □ Box 1002 □ Ann Arbor, Michigan 48106 U.S.A.  
Call TOLL-FREE (800) 521-4414 or outside U.S.A. (313) 994-4444

## Got to expand?



### Get a Giltronix Dual Switching System.

Expand and upgrade your 19" rack mounted dual switching system with a Giltronix Switching System #GDnS24. Superior design features: PCB technology for increased reliability... Vertically mounted connectors for easy access... Optional 3rd position and monitoring functions. For only \$139. Quantity discounts available. Dealer inquiries invited.

**SWITCH TO GILTRONIX.**



970 San Antonio Ave., Palo Alto, CA 94303

Circle 183 on Inquiry card.

## Got a computer?



### Get a Giltronix Selector Switch.

Eliminate unplugging and re-plugging your CPU's, peripherals, and modems. Eliminate expensive duplication of interconnection hardware. Connect three components to Giltronix Selector Switch #S8AB. Then select your connection with a simple turn of the dial. Only \$79 in OEM quantities. Monitoring options available. Full 5 year warranty on all Giltronix units.

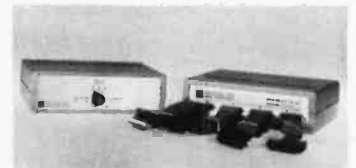
**SWITCH TO GILTRONIX.**



970 San Antonio Ave., Palo Alto, CA 94303

Circle 184 on Inquiry card.

## Get Greedy!



### Get your TRS-80 a Giltronix Switching Unit.

Maximize price/performance by connecting your TRS-80 and two peripherals to Giltronix Switching Unit #GTRS-2AB-AP2. Then select your connection with a single turn of the dial. Eliminate duplicate interconnection hardware. Eliminate wasted time spent unplugging and replugging components. Off-the-shelf availability with a wide selection of I/O configurations. Call for your FREE product catalog.

**SWITCH TO GILTRONIX.**



970 San Antonio Ave., Palo Alto, CA 94303

Circle 185 on Inquiry card.

## CHIPS & DALE

THE INFLATION FIGHTERS!

4116 300ns 8/\$11.00  
 4116 250ns 8/\$12.00  
 4116 200ns 8/\$13.00  
 4116 150ns 8/\$16.00  
 2114L 300ns 8/\$16.25  
 2114L 200ns 8/\$17.00  
 \*4164 150ns \$7.90  
 \*6116 150ns \$8.00

280A CPU \$5.50 ea.  
 8251A \$4.75 ea.  
 2716-1 (5V)350ns 8/\$7.00 ea. \$7.50 ea.  
 2716 (5V)450ns 8/\$3.75 ea. \$4.15 ea.  
 \*2732 (5V)450ns 8/\$7.25 ea. \$9.00 ea.  
 2532 (5V)450ns 8/\$9.75 ea. \$10.00 ea.

Allow up to 3 wks. for personal checks to clear. Please include phone number. Prices subject to change without notice.  
 Add \$3.50 Shipping & Handling  
 Wash. residents add 6.6% Sales Tax

CHIPS & DALE P.O. Box 31607  
 Seattle, Wash. Zip 98103  
 1-206-524-9126  
 Master Charge VISA accepted.

Circle 74 on Inquiry card.

## A PROFESSIONAL MICROCOMPUTER



THE BEST VALUE ON THE MARKET

- 280 4MHZ
- 64K RAM
- DUAL 8" DRIVES
- 1.2 MB STORAGE
- 2 SERIAL I/O
- 2 PARALLEL I/O
- OPERATING SYSTEM AND UTILITIES

MICRO BUSINESS ASSOCIATES, INC.  
 460 THIRD STREET  
 OAKLAND, CA 94607  
 415-839-5464

Circle 264 on Inquiry card.

## PLOTTING SOFTWARE

Calcomp compatible, for

EPSON and HILOT with CPM, FORTRAN, and BASIC

PLOTWARE-z 8" seed .....399  
 Manuals only .....35  
 PLOTWARE-z samples .....6  
 \* Refundable on order

ENERCOM P  
 P.O. BOX 28014  
 Lakewood, Colo.  
 80228  
 303-988-1648



VALUE & EASE



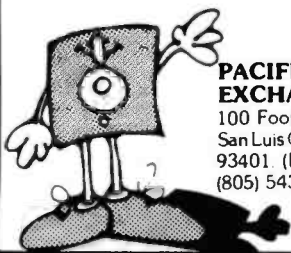
OPTIONAL  
 Maps, Charts  
 Drafting  
 Scientific  
 Characters  
 Terminal  
 Emulation

PLOTWARE-z drew this ad

Circle 162 on Inquiry card.

## Dysan CORPORATION

Solve your disc problems, buy 100% surface treated Dysan diskettes. All orders shipped from stock, within 24 hours. Call toll FREE (800) 235-4137 for prices and information. Visa and Master Card accepted.



PACIFIC EXCHANGES  
 100 Foothill Blvd.  
 San Luis Obispo, CA  
 93401. (In Cal. call  
 (805) 543-1037.)

Circle 320 on Inquiry card.

## LABELS

# 299

perM

15/16"x3 1/2" white pressure  
 1 up - pin feed sensitive

PRICE INCLUDES SHIPPING

Packed 5M per box - Min. order 1 box -\$14.95  
 Check with order - Mass Residents add 5% Sales Tax



CHECK-MATE

P.O. Box 103, Randolph, MA 02368  
 Telephone: 617-963-7694  
 CALL TOLL FREE 1-800-343-7706

Circle 71 on Inquiry card.



400 16K .....\$319.00  
 400 YOURS to 32K or 48K .....CALL  
 800 (16K) .....659.00  
 410 RECORDER .....84.00  
 810 DISK DRIVE .....449.00  
 850 INTERFACE .....169.00  
 830 MODEM .....149.00  
 825 PRINTER .....575.00  
 481 ENTERTAINER KIT .....85.00  
 482 EDUCATOR KIT .....125.00  
 483 PROGRAMMER'S KIT .....60.00  
 484 COMMUNICATOR KIT .....309.00

Prices subject to change without notice.  
 Shipping extra. No tax out of state.  
 Ca. residents add appropriate taxes.

WE ARE AN AUTHORIZED ATARI SALES AND SERVICE CENTER



COMPUTERTIME, INC.

P.O. Box 216  
 Kentfield, CA 94914

CALL TOLL-FREE 800-227-2520  
 In California 800-772-4064

Circle 108 on Inquiry card.



# WE WILL NOT BE UNDERSOLD

CP/M® Software	Software/Manual only
<b>Digital Research</b>	
PL/I-80	\$459/\$35
BT-80	\$179/\$30
Mac	\$ 85/\$15
Sid	\$ 65/\$15
Z-Sid	\$ 90/\$15
Tex	\$ 90/\$15
DeSpool	\$ 50/\$10
<b>Micropro</b>	
WordStar	\$319/\$60
Customization Notes	\$489/\$na
Mail-Merge	\$109/\$25
WordStar/Mail-Merge	\$419/\$85
DataStar	\$249/\$60
WordMaster	\$119/\$40
SuperSort I	\$199/\$40
Spell Star	\$175/\$40
<b>Microsoft</b>	
Basic-80	\$289/\$na
Basic Compiler	\$329/\$na
Fortran-80	\$349/\$na
Cobol-80	\$574/\$na
M-Sort	\$124/\$na
Macro-80	\$144/\$na
Edit-80	\$ 84/\$na
MuSimp/MuMath	\$224/\$na
MuLisp-80	\$174/\$na
<b>Organic Software</b>	
Milestone	\$269/\$30
<b>Supersoft</b>	
Diagnostic I	\$ 49/\$20
Diagnostic II	\$ 84/\$20
Disk Doctor	\$ 84/\$20
Forth (8080 or Z80)	\$149/\$30
Fortran	\$219/\$30
Fortran w/Ratfor	\$289/\$35
<b>Unicorn</b>	
Mince	\$149/\$25
Scribble	\$149/\$25
Both	\$249/\$50
<b>Data Base</b>	
FMS-80	\$649/\$45
dBASE II	\$595/\$50
Access/80	\$699/\$50
<b>Pascal</b>	
Pascal/MT+	\$429/\$30
Pascal/M	\$189/\$20
<b>Miscellaneous</b>	
SpellGuard	\$299/\$25
SuperCalc	\$269/\$50
CBASIC-2	\$ 98/\$20
MicroStat	\$224/\$25
StatPak	\$449/\$40
Micro B+	\$229/\$20
<b>Apple Software (Business)</b>	
<b>Micropro</b>	
Wordstar	\$289
MailMerge	\$119
Wordstar/MailMerge	\$389
SuperSort I	\$189
Spellstar	\$139
<b>Personal Software</b>	
Visicalc 3.3	\$229
CCA Data Mgr	\$ 84
Desktop/Plan II	\$229
Visiterm	\$139
Visidex	\$229
Visiplot	\$185
Visitrend/Visiplot	\$275
Zork	\$ 34
<b>Miscellaneous</b>	
Micro Courier	\$219
Super-Text II	\$127
ASCII Express	\$ 59



Apple Software (Entertainment)	
Wizard & Princess	\$ 28
Mystery House	\$ 24
Flight Simulator	\$ 32
Raster Blaster	\$ 29
Space Eggs	\$ 26
Sargon II	\$ 29
ABM	\$ 22
Pool 1.5	\$ 26
Beer Run	\$ 28
Epoch	\$ 32
Sneakers	\$ 27
Midnight Magic	\$ 32
Wizardry	\$ 45



Apple Accessories	
Z-80 Softcard by Microsoft	\$ 299
Keyboard Enhancer	\$ 119
T & G Joystick	\$ 49
Sup-r Mod	\$ 25
CPS Multifunction Card	\$ 199
Videoterm by Videx	\$ 249
16K Card by Microsoft	\$ 159
Sup-r Fan	\$ 39
ALF9 Voice Board	\$ 149
CCS Cards	\$ Call
CCS Parallel Model 7720	\$ Call
CCS Serial Model 7710D	\$ Call
CCS Centronics Model 7728	\$ Call

Disk Drives	
For TRS-80* Model 1	
CCI-100 5 1/4", 40 Track	\$ 299
Add-ons for Zenith Z-89	
CCI-189 5 1/4", 40 Track	\$ 455
Z-87 Dual 5 1/4" system	\$ 995
Drives for Z-90	\$ Call

External card edge and power supply included. 90 day warranty/one year on power supply.	
<b>Corvus 5M</b>	\$ 3089
<b>Corvus 10M</b>	\$ 4489
<b>Corvus 20M</b>	\$ 5429
<b>Corvus Mirror</b>	\$ 699
Shugart 8" 801R Raw Drive	\$ 399
TANDON 5 1/4" Raw Drive	\$ Call
Power Supplies	\$ Call

<b>Diskettes—Box of 10</b>	
Maxell 5 1/4"	\$ 40
Maxell 8"	\$ 45
BASF/Verbatim 5 1/4"	\$26.95
BASF/Verbatim 8"	\$ 36
Plastic File Box—Holds 50 5 1/4" dskts.	\$ 19
Plastic Library Case 5 1/4"	\$ 3
Plastic Library Case 8"	\$ 4
Head Cleaning Diskette	\$ 25
Floppy Saver	\$10.95
Floppy Saver Rings	\$ 6.95
<b>16K RAM Kits</b>	
One Kit	\$19.00
Two Kits	\$37.00

200ns for TRS-80\*, Apple II, (specify): Jumpers \$ 2.50

Computer Systems	
Atari 400	\$ 359
Atari 800	\$ 699

Call for other Atari products  
 Zenith Z89, 48K \$ Call  
 Zenith Z90, 64K \$ Call  
 Call for other Zenith products

For fast delivery, send certified checks, money orders or call to arrange direct bank wire transfers. Personal or company checks require one to three weeks to clear. All prices are mail order only and are subject to change without notice. Call for shipping charges.

Terminals	
<b>ADDS Viewpoint</b>	\$ Call
Zenith Z-19	\$ 699
Televideo 910	\$ 595
Televideo 920C	\$ 769
Televideo 950	\$ 969



S-100 California Computer Systems	
Mainframe	\$ 349
Z80 CPU	\$ 239
64K RAM	\$ 569
Floppy Disc Cntrl	\$ 339
Integrated Sys. w/int. cables, tstd.	\$1975
2P + 2S I/O	\$ 269
4 Port Serial I/O	\$ 249
4 Port Parallel I/O	\$ 179

Casio Calculators	
Pocket Comp. FX702	\$185.00
Desk Printr/Calc. FR100	\$ 79.95
Scientific Calc. FX8100	\$ 49.95
Game Watch CA90 Plastic	\$ 49.95
Game Watch CA901 Steel	\$ 69.95
Calendar Watch AX210	\$ 59.95

Printers	
<b>NEC Spinwriter</b>	
7710 R.O. Ser	\$2395
7710 Ser w/tr.	\$2595
7720 KSR w/tr.	\$2795
7730 R.O. Par	\$2395
7730 R.O. Par w/tr.	\$2595
<b>NEW 3500 Series</b>	\$ Call

<b>Epson MX-70</b>	\$ Call
<b>Epson MX-80</b>	\$ Call
<b>Epson MX-80FT</b>	\$ Call
<b>Epson MX-100</b>	\$ Call

<b>Epson Grafrax</b>	\$ Call
PaperTiger 560 Gr. & 2K	\$ Call
IDS Prism 80	\$ Call
IDS Prism 132	\$ Call
PaperTiger Access.	\$ Call
Anadex DP-8000	\$ 949
Anadex DP-9500/01	\$1465
Okidata Microline 80 Fric. & pin feed	\$ Call
Okidata Microline 82A Fric. & pin feed	\$ Call
Okidata Microline 83A 120 cps	\$ Call
Okidata 84 200 cps	\$ Call
Centronics 739	\$ 739
Data South 180 cps	\$ Call

Monitors	
Leedex 12" B & W	\$ 119
Leedex 12" Green Screen	\$ 129
Leedex 13" Color	\$ 329
Sanyo 9" B & W	\$ 149
Sanyo 9" Green Screen	\$ 189
Sanyo 12" Green Screen	\$ 249
Sanyo 12" B & W	\$ 239
Sanyo 13" Color	\$ 449
Zenith 12" Green Screen	\$ 129
Zenith 13" Color	\$ 349

\*\*\*\*\* Special of the Month \*\*\*\*\*  
 Olivetti DY 211 Daisy Wheel  
 \$Call

Telecommunications	
Prentice Star Modem 1-yr. guar.	\$ 125
Univ. Data System UDS103LP	\$ 135
Univ. Data System UDS103JP	\$ 189
Novation Cat	\$ 139
Novation D-Cat	\$ 149
Novation Auto-Cat	\$ 199
Novation Apple Cat II	\$ 299
Hayes Smart Modem™	\$ 249
Hayes Micro-Modem II™	\$ 310
Hayes Chronograph™	\$ 225
CCI Telnet Com. Package	\$ 135

DEALER (NATIONAL/INTERNATIONAL) INQUIRIES INVITED

Send for FREE Catalogue

## The CPU SHOP

TO ORDER CALL TOLL FREE 1-800-343-6522

TWX: 710-348-1796 Massachusetts Residents call 617/242-3361

420-438 Rutherford Ave., Dept. B05M  
 Charlestown, Massachusetts 02129  
 Hours 9 AM-9 PM (EST) Mon.-Fri. (Sat. till 6)

Technical Information call 617/242-3361  
 Massachusetts Residents add 5% Sales Tax  
 Tandy Corporation Trademark® Digital Research



# ELIZA IS HERE!

AT LAST! A FULL IMPLEMENTATION of the original ELIZA program is now available to run on your microcomputer.

Created at MIT in 1966, ELIZA has become the world's most celebrated artificial intelligence demonstration program. ELIZA is a non-directive psychotherapist who analyzes each statement as you type it and then responds with her own comment or question — and her remarks are often startlingly appropriate!

Designed to run on a large mainframe, ELIZA has hitherto been unavailable to personal computer users except in greatly stripped down versions lacking the sophistication which made the original program so fascinating.

Now, our new microcomputer version possessing the FULL power and range of expression of the original is being offered at the introductory price of only \$25. And if you want to find out how she does it (or teach her to do more) we will include the complete Source Program for only \$20 additional.

Order your copy of ELIZA today and you'll never again wonder how to respond when you hear someone say "Okay, let's see what this computer of yours can actually do!"

**ELIZA IS AVAILABLE IN THE FOLLOWING DISK FORMATS:**

1. Standard 8 Inch single density for all CP/M based computers \$25 for ELIZA.COM — add \$20 for Microsoft BASIC-80 Source
2. 5 1/4 Inch CP/M for Apple II equipped with Z-80 SoftCard \$25 for ELIZA.COM — add \$20 for Microsoft BASIC-80 Source
3. 5 1/4 Inch for 48K Apple II with Applesoft ROM and DOS 3.3 \$25 for Protected File — add \$20 for Unprotected Source

**ARTIFICIAL INTELLIGENCE RESEARCH GROUP**

921 NORTH LA JOLLA AVENUE  
LOS ANGELES, CALIFORNIA 90046  
(213) 656-7368 (213) 654-2214  
MC, VISA and CHECKS ACCEPTED



Circle 28 on inquiry card.

## now you can command your own STARSHIP

with  
**Fleet Maneuvers**

1982's hottest new  
play by mail game.

by  
**FANTASTIC SIMULATIONS**

p. o. box 24566  
denver colorado 80224

Circle 170 on inquiry card.

# OMEGA

## The Last Disassembler You Will Ever Need!

Mnemonics Externally Defined

Zilog, Intel, PASM Supplied

ASCII/HEX Preconditioner

Can Externally Def. Equates

Optional Address Listing

ASM/PASM/M80 Compatible

DB statements forcible over user  
specified range

\$150. complete/\$25. manual only  
for further information contact

**COMPUTER TOOLBOX, INC.**

1325 East Main St.  
Waterbury, Ct. 06705  
Phone (203) 754-4197

Circle 105 on inquiry card.

# WANTED:

## APPLE, IBM, TRS-80, CP/M SOFTWARE

Westico is a publisher and distributor of professional software for microcomputers. If you have a new program ready for distribution or want your existing programs to reach a larger market, contact:

Phillip Woelhof, V.P. Mktg.  
Westico, Inc.  
25 Van Zant Street  
Norwalk, CT 06855  
(203) 853-6880

To increase your profits, take advantage of Westico's worldwide promotion and distribution.

**WESTICO**  
The Software Express Service

Circle 11 on inquiry card.

## ANALOG ↔ DIGITAL DIGITAL ↔ ANALOG

CONVERSION MODULES  
SOFTWARE  
GAIN CONTROL

high resolution 12-bit digital to analog converter  
programmable gain instrumentation amplifier  
16-channel programmable gain instrumentation amplifier  
18-bit sample and hold amplifier  
8-channel differential high accuracy analog to digital converter

For additional details about the AD-100-4 and other fine California Data Corporation 100% individually tested, high reliability products, circle the reader service card number below or for faster response write or call us.

**CALIFORNIA DATA CORPORATION**  
3475 Old Conejo Road, Suite C-10  
Newbury Park, CA 91320  
(805) 498-3651

Circle 82 on inquiry card.

# Verbatim®

## Floppy Discs

**SAVE 40%** Write for our complete list.

5 1/4" Specify soft, 10 or 16 sector	Price/10
MD525 1 side/dbl dens. . . . .	\$27.30
MD560 2 sides/dbl dens. . . . .	44.20
MD577 1 side/77 track . . . . .	32.50
MD557 2 sides/77 track . . . . .	44.20

8" Critically Certified Soft sector	
FD34-9000 1 side/sgl dens. . . . .	33.80
FD34-8000 1 side/dbl dens. . . . .	39.00
FD34-4001 2 side/dbl dens. . . . .	46.20

CHECKS — VISA — MC — C.O.D.  
(313) 777-7780 ADD \$2 SHIPPING

**LYBEN COMPUTER SYSTEMS**  
27204 Harper Ave.  
St. Clair Shores, MI 48081

Circle 243 on inquiry card.

## SOFTWARE FOR CP/M®

dBASE II Ashton-Tate  
Copyright 1981

**DATABANK™**  
AND  
**DATAFLEX™**  
TM-DATA ACCESS CORPORATION

FOR YOUR **FREE CATALOG**  
HARDWARE AND SOFTWARE

FETCH COMPUTER PRODUCTS DIVISION OF:  
ALMALY TRADING CORPORATION  
8135 S.W. 17 STREET, MIAMI, FL 33155  
TELEX: 51-9602 "ALMALY MIA"

CALL TOLL FREE 800-327-2251

Apple is a Registered Trademark of Apple Computers  
CP/M is a Registered Trademark of Digital Research

Circle 11 on inquiry card.

RAM: 64K-200ns (128 refresh) — 8/ \$69

Color R.F. Modulator Kit: — \$9.95

14A S-100 Power Supply Kit—\$29.95

(for line cord and circuit breaker, add \$8.95)  
47-63 Hz, 95-250 VAC with RFI filter included. ± 16V @ 2A

Enclosed versions now available for: NEC, IBM, Apple III (your choice). Call for Data.

## New! RGB Displays

Now Higher Resolution!

- High Contrast Black-Silrpe Tube
- Ultra Stable Convergence
- 90 Day Warranty
- 15.7 KHz

Microangelo  
CAT-100, IBM

13" . \$359<sup>00</sup>

525 x 420 lines, 32 lbs

19" . \$389<sup>00</sup>

525 x 620 lines, 48 lbs.

(Displays 80 characters on IBM)  
Active 12" Cable to IBM with "Intensity" Input—\$75.00

Anti shipping, and insurance. We are philosophically against VISA & M.C. (for \$% who wouldn't be?)

**Dealin' Electronics**

735 Loma Verde, Palo Alto, CA 94303 • 415-493-5930

Dealerships Available

Circle 134 on inquiry card.

# DISKETTES CASSETTES

Error-Free 5 1/4-inch Diskettes (MD-5) single-sided, soft sector, single or double density, reinforced hub.

Item	Qty 10	Qty 50
MD-5	\$25.00	\$110.00
C-10	\$ 7.50	\$ 32.50
C-20	9.00	39.00
C-60	11.50	50.00
C-90	15.00	70.00

UPS SHIPPING INCLUDED  
in Continental USA  
CA Customers add taxes

# MICROSETTE

475 Ellis St., Mt. View,  
CA 94043 (415) 968-1404

Circle 279 on inquiry card.

**CRT CONTROLLER**



This Intelligent CRT Controller uses an 8085A CPU & an 8275 integrated CRT Controller. It features:

- 25 lines (80 char./line)
- 5x7 dot matrix
- Upper & lower case
- Two 2716's (controller & char. generator)
- Serial interface RS232 & TTL
- Baud rates of 110, 150, 300, 600, 1200, 2400, 4800 and 9600
- Keyboard scanning system
- Unencoded keyboard required
- Uses +5V & ±12V Power Supplies
- Does not have graphic capabilities.

Documentation includes program listing and composite video circuit.

Bare Board only (with doc) **\$39.95**  
 2716 Char. Gen. A7 **\$19.95**  
 2716 Program A12 **\$19.95**

**6522 APPLE II INTERFACE**



The JBE 6522 Parallel Interface for the Apple II Computer, plugs directly into any slot 1 through 7 in the Apple. This card has 2 6522 VIA's that provide:

- Four 8 bit bi-directional I/O ports
  - Four 16 bit programmable timer/counters
  - Serial shift registers
  - Handshaking
- A 74LS05 is for timing. Four 16 pin sockets provide easy connections to other peripheral devices. (Dip jumpers with ribbon cables are also available from JBE) The 6522 Parallel I/O card interfaces to the JBE EPROM programmer.

Understanding of machine language required to use this board. Inputs and outputs are TTL compatible.

79-295A **\$69.95** Assembled  
 79-295K **\$59.95** Kit  
 79-295B **\$19.95** Bare Board

**81-260 "SLIM"**



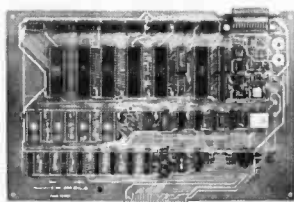
Single board large scale Integration Microcomputer. This 4.5 x 6.5 board uses the 6502 Microprocessor, two 6522 VIA's, four 2114 RAM's, 2516, 2716 or 2532 EPROM. The fully buffered 22/44 pin bus is similar to the KIM<sup>®</sup>, SYM<sup>®</sup>, and AIM<sup>®</sup> expansion connector. The four 8 bit I/O ports connect through 16 pin dip sockets. This board was designed for control and is ideal for Personal and OEM use.

- 6502 MPU
- Two 6522 VIA's
- Four 2114 RAM's (2K bytes)
- One EPROM 2516 or 2532
- Crystal clock 1 Mhz
- Requires 5V 1AMP Power
- 4.5 x 6.5 card
- Power on reset
- Fully buffered-expandable
- Solder mask-both sides

Use your Apple II Computer, JBE 6522 Parallel Interface card and EPROM Programmer as a development system for SLIM.

Prices:  
 81-260A **\$199.95** Assembled  
 81-260K **\$149.95** Kit  
 81-260B **\$ 39.95** Bare Board

**JBE I MICROCOMPUTER**



JBE's 7.75 x 11.75 6502 base Microcomputer has the capacity for 16K of EPROM, 4K of RAM, 8 Parallel Ports and 1 Serial Port. Monitor and Tiny Basic are also available. The fully populated version includes:

- 1 6502 CPU
- 4 6522 VIA (8 Parallel I/O Ports)
- 1 AY5-1013 (Serial I/O Ports)
- 8 2114 RAM (4K)
- 2 2716 EPROM (Monitor & Tiny Basic)

The partially populated version includes:

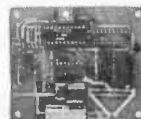
- 1 6502 CPU
- 1 6522 VIA (2 Parallel I/O Ports)
- 1 AY5-1013 (Serial I/O Port)
- 2 2114 RAM (1K)
- 1 2716 EPROM (with Monitor)

Both versions include sockets for 2716s or 2532s, 8 16 pin sockets for I/O interfacing and a DB25 connector for RS232.

All address and data lines are brought off the board to the 50 pin edge connector. (similar to the Apple II bus)

This board also features power on reset and cassette interface.

81-030 C Fully Populated **\$349.95**  
 81-030M Partially Populated **\$249.95**  
 81-030B Bare Board **\$ 89.95**  
 2716 EPROM (with Monitor) **\$ 19.95**  
 2715 EPROM (with Tiny Basic) **\$ 19.95**



**A-D CONVERTER**



JBE's 16 channel A-D Converter plugs into your Apple II computer. It uses an ADC0817 which incorporates a 16 channel multiplexer and an 8 bit A-D Converter. The 16 inputs are high impedance and the voltage range is 0 to 5.12 volts. Conversion time is <100µsec. The resolution is 8 bits or 256 steps, linearly is ± 1/2 step. Two 16 pin DIP sockets are used for input, GND & reference voltage connections. There are 3 single bit TTL inputs. Doc. Includes sample program.

81-132A Assm. **\$89.95**  
 81-132K Kit **\$69.95**  
 81-132B Bare Board **\$29.95**

**SPEECH SYNTHESIZERS**



JBE's Speech Synthesizers use the Votrax SC-01 Phoneme Synthesizer chip. The SC-01 phonetically synthesizes continuous speech of unlimited vocabulary. The SC-01 contains 64 different phonemes and 4 levels of inflection accessed by an 8 bit code. It requires 10 Bytes per second for continuous speech. Both boards have an audio amp for direct connection to an 8 ohm speaker.

Documentation includes basic user programs, a phoneme chart and listing of coded words to help you get started. Documentation for the Apple II<sup>®</sup> Speech Synthesizer includes a disk with many user programs.

81-088 Apple II Speech Synthesizer **\$139.95**  
 81-120 Parallel Input Speech Synthesizer **\$149.95**  
 Prices include the SC-01 Chip SC-01 sold separately for **\$ 75.95**

**6502 MICROCOMPUTER**



6502 MPU, 6522 VIA, 2716 EPROM, 2114 RAM single board computer. Single 5 volt power supply at 400 Ma. Two independent 8 bit I/O ports with handshake lines. RC controlled 1 Mhz clock.

Complete documentation. I/O lines use 50 pin edge connector. Data and address lines are not accessible. Mod. for 2532 is included. EPROM is not included. 1K RAM, 2K EPROM, 2 I/O ports.

80-153 Assm. **\$110.95**  
 80-153 Kit **\$ 89.95**  
 80-153 Bare Board **\$ 19.95**

**EPROM PROGRAMMER**



JBE's EPROM Programmer is designed to program 5V 2516's, 2532's & 2716's. It interfaces to the JBE Parallel I/O card using four ribbon cables. An LED indicates when the EPROM is being programmed. A textool zero insertion force socket is used for the EPROM. Comes with complete documentation for writing and reading EPROM's in the Apple II or Apple II Plus. Cables available separately.

80-244A Assm. **\$49.95**  
 80-244K Kit **\$39.95**  
 80-244B Bare Board **\$24.95**

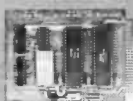
**EPROM EXPANSION CARD**



JBE EPROM Expander for the Apple II holds six 5V 2716s for a total of 12K bytes of EPROM. This board takes the place of the on board ROM in the Apple. It is software switchable by the same technique used by the Apple II firmware card. Solder jumpers are for reset to the Apple ROM or EPROM Expansion Card. Use JBE EPROM Programmer and Parallel I/O to program your EPROMs. EPROMs sold separately.

81-085A Assm. **\$59.95**  
 81-085K Kit **\$49.95**  
 81-085B Bare Board **\$39.95**

**Z-80 MICROCOMPUTER**



Z-80 MPU, Z-80 PIO, 2716 EPROM, 2114 RAM single board computer. Single 5 volt power supply at 300 Ma. Two independent 8 bit I/O ports with handshake lines. RC controlled 2Mhz clock.

Complete documentation. I/O lines use 50 pin edge connector. Data and address lines are not accessible. Mod. for 2532 is included. EPROM is not included. 1K RAM, 2K EPROM, 2 I/O ports.

80-280 Assm. **\$129.95**  
 80-280 Kit **\$119.95**  
 80-280 Bare Board **\$ 19.95**

**PARTS**

6502 MPU **\$9.95**  
 6522 VIA **\$9.95**  
 Z-80 MPU **\$9.95**  
 Z-80 PIO **\$9.95**  
 TWO 2114 RAM **\$9.95**  
 2716 **\$14.95**  
 50 pin conn. **\$5.95**  
 Dip Jumper 2ft. **\$4.95**



**JOHN BELL ENGINEERING, INC.**

ALL PRODUCTS ARE AVAILABLE FROM JOHN BELL ENGINEERING, INC. • 1014 CENTER ST., SAN CARLOS, CA 94070

ADD SALES TAX IN CALIFORNIA • ADD 5% SHIPPING & HANDLING 3% FOR ORDERS OVER \$100

**(415) 592-8411**

10% OUTSIDE U.S.A.

MC

SEND FOR CATALOG

VISA

WILL CALL HOURS: 9am - 4pm



**ATTENTION  
SINGLE BOARD  
COMPUTER OWNERS**

Complete your system with these fine products at savings from 15 to 25%.

**Clock/Calendar** for Digital Research's Big Board. Full time & date functions. Eight interrupts & battery backup. Bare board—\$25, Kit—\$54.95, Asm—\$67.95, Program diskette—\$5. Add \$2.50 postage.

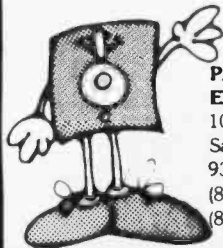
**Enclosures** — Will house a computer board, keyboard, power supply, 12" monitor and 5" disk. 21" D X 19" W X 16" H. List \$105 Now Only \$89 + \$7 shipping

**Monitors** — 12" Motorola, 15 MHz, 800 line resolution. Separate video & sync. List \$200 Now Only \$150 + \$4 shipping.

Call or write for other great specials.  
**AB COMPUTER PRODUCTS, P.O. BOX 571-B  
JACKSON, N.J. 08527, (201) 370-9889**

**MEMOREX  
FLEXIBLE DISCS**

**WE WILL NOT BE UNDER-  
SOLD!** Call Free (800)235-4137  
for prices and information. Dealer  
inquiries invited and C.O.D.'s  
accepted.



**PACIFIC  
EXCHANGES**  
100 Foothill Blvd.  
San Luis Obispo, CA  
93401. In Cal. call  
(800)592-5935 or  
(805)543-1037

**Personal  
Publishing™**

If you have ever thought about publishing your memoirs, the Great American Novel, your PhD thesis, documentation for a computer program, or whatever; think about Intergraphics' **Personal Publishing** service. It is the lowest cost method yet devised to get your words into print. Your Personal Computer, a modem, and a little "do-it-yourself" spirit are all that is necessary to access our fully automated computerized typesetting service.

For further information, write to:

**Intergraphics Inc.**

106A South Columbus Street  
Alexandria, Virginia 22314

Circle 3 on Inquiry card.

Circle 320 on Inquiry card.

Circle 212 on Inquiry card.



**NOW!  
176K  
TOTAL  
RAM**

For the '89  
• 3 MP/M II® Compatible Banks  
• "Invisible Disk" CP/M®  
Software Included

Only **\$595.00**  
**MAGNOLIA**  
**MICROSYSTEMS**

2264 - 15th AVE. W • SEATTLE, WA 98119  
(206) 285-7266 (800) 426-2841

CP/M® & MP/M II® are registered trademarks of Digital Research, Pacific Grove, CA.



**STARTJOB**

KEY BE ALARM FOR YOUR COMPUTER  
AND SLEEP WHILE IT DOES THE WORK!

22:00:00  
**STARTJOB VERS 1.1**  
These Jobs Will Start At  
22:00:00

Receive B:  
Transmit C:Test.txt  
Crun2 Update  
Submit Payroll

Starting Delayed Jobs

FOR ANY 8-105 OR APPLE II/III/5/6/7/8  
STARTJOB AND C.T. CALENDAR CLOCK ..... \$130.00  
PROGRAM SOFTWARE ONLY ..... \$75.00  
SOURCE CODE FOR STARTJOB PROGRAM ..... \$100.00  
DISKETTE/ACCIDENTS/PLATE AND 1/8" SALES TAX  
\* WRITE FOR OUR FREE CATALOG OF 8-105 & APPLE PRODUCTS \*

**SYSTEM SOLUTIONS**

P.O. BOX 35  
2108 ROSTER, RD., 15334  
HARTSEYCARD AND VISA CALL  
1-813-673-7883



APPLE II is a registered trademark of Apple Computer, Inc.  
CP/M is a registered trademark of Digital Research, Inc.

**NEC America**



**PC-8000 Series  
Microcomputer  
System.**

- SYSTEMS
- COMPONENTS
- PRINTERS
- SOFTWARE
- SERVICE
- ADD-ONS

For Pricing and Catalog Call or Write



**Development Systems Co.**  
2100-A Walsh Ave.  
Santa Clara, CA 95050  
Phone: (408) 727-1549

Circle 248 on Inquiry card.

Circle 399 on Inquiry card.

Circle 139 on Inquiry card.

**ANNOUNCING THE  
FOX & GELLER  
dBASE II  
PROGRAM  
GENERATOR!  
QUICKCODE™**

Now, without any programming,  
you can create these in seconds:

- MAILING LABELS
- WORDSTAR FORM LETTERS
- DATA ENTRY/RETRIEVAL PGMS.
- dBASE FILES

**\$295**

**INTRODUCING DUTIL™**

The dBASE II utility program.  
Automatically improves and comments  
your programs. Many other features.

**\$99**

**Fox & Geller** Teaneck, NJ 07666  
P.O. Box 1053 (201) 837-0142  
dBASE II™ Ashton-Tate  
Wordstar™ Micropro Int'l

**SLIDER**  
**CompuPro™** from **GODBOUNT  
ELECTRONICS**

8086 CPU A&T 394, 8085/88 CPU A&T 319.  
CPU Z A&T 199, CPU Z 6MHz CSC 308,  
DISK II&III 8-16 CALL DISK I A&T 371,  
INTERFACER 3 (5) 449, RAM 16 A&T 64K 671.

**LOMAS DATA PRODUCTS**

LIGHTING 1 8086 399, LDP72 DISK CONTR. 220,  
HAZITAL 2SER. 2P 260, MSDOS OR CPM™'86 195,  
RAM 128K A&T 650, RAM 256K A&T 1099.

**SEATTLE COMPUTER**

8086 SUPPORT CARD & 86DOS ONLY 629,  
RAM 64K STATIC 746, IBM 256K ADD-ON 699.

**MORROW DESIGNS**

DECISION 1 BASIC 1295, DPA DJ W/CPM™ 356,  
RAM 65K STATIC 581, MULTI IO 269,  
DUAL 8" 801 & CAB 1056, DUAL 8" 850 & CAB 1496.

ALL PRICES SUBJECT TO CHANGE SHIPPING MIN 3.  
CPM IS A TRADEMARK OF DIGITAL RESEARCH OF CA.  
PO 951 WESTMINSTER CA 92683-0751  
714 845-1746

Circle 461 on Inquiry card.

Circle 380 on Inquiry card.

Circle 195 on Inquiry card.

**TRS-80™ Models 1 & 3**

**SMART TERMINAL.....\$69.95**  
**Model 2 (CP/M) Version ... \$79.95**

Enables your TRS-80 to be used as a data communications terminal to a time-sharing system or to another computer. Automatic transmission or storage of data to/from other computer. Control keys, character mapping, true BREAK key. Cassette and disk files compatible with Electric Pencil™ and Scripsit™. Transmit/receive with verification.

**SYSTEM DIAGNOSTIC ..... \$94.95**

Complete diagnostics for every component of your TRS-80. Separate tests for ROM, RAM, video display, keyboard, line printer, cassette recorder, disk drives, RS-232-C interface.

Add \$5.00 for program supplied on diskette, \$3.00 postage and handling.

S.A.S.E. for FREE catalogue.

**HOWE SOFTWARE**

14 Lexington Rd., New City, NY 10956  
**(914) 634-1821**

P.O. Box 4430X  
Santa Clara, CA 95054  
Will calls: 2322 Walsh Ave.  
(408) 988-1640

Same day shipment. First line parts only. Factory tested. Guaranteed money back. Quality IC's and other components at factory prices.

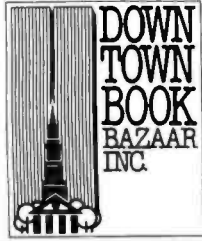
INTEGRATED CIRCUITS Phone orders only (800) 538-8196

74001T	LM317T	1.65	CD4017	1.05	8736	1.69	UART-RPO	DE95	1.35
74001N	LM317K	3.75	CD4018	34	8728	1.33	AVS-1013	DA19P	2.10
7402N	LM319	1.49	CD4019	45	8752	99	AVS-1014	DA19S	3.10
7404S	LM320S	1.35	CD4020	95	8938	99	3341	Complete Set	8.50
7409N	LM320K-15	1.35	CD4021	95	8938	99	3341	Complete Set	8.50
7410N	LM320K-15	1.35	CD4022	110	2101-1	1.95	1707A	26.50	Auto Clock Kit 18.95
7414A	LM320K-15	1.35	CD4023	75	2102-1	1.25	2708	2.55	Digital Clock Kit 18.75
7420N	LM320T-8	85	CD4024	75	2102-2	1.25	2708	2.55	
7430N	LM320K-12	85	CD4025	23	2102A-1	1.65	2716-1	8.50	
7432A	LM320K-15	85	CD4026	45	2102A-2	1.65	2716-2	8.50	
7445H	LM320K-5	4.95	CD4027	65	2107B-4	3.75	2716-5 Volt	5.00	
7447N	LM320K-5	4.95	CD4028	65	2111-1	2.99	2732	7.50	
7448N	LM320K-5	4.95	CD4029	65	2111-2	2.99	2732	7.50	
7474N	LM340K-5	1.35	CD4030	45	2114	2.24	3111A	39.95	
7475N	LM340K-5	1.35	CD4031	45	2114-100s	2.50	3111A	39.95	
7485A	LM340K-12	1.35	CD4032	45	2114-400s	2.50	3111A	39.95	
7488A	LM340K-15	1.35	CD4033	45	2114-200s	2.50	3111A	39.95	
7490N	LM340K-15	1.35	CD4034	45	2114-400s	2.50	3111A	39.95	
7495N	LM340K-5	75	CD4034	45	2114-200s	2.50	3111A	39.95	
74100N	LM340K-5	75	CD4035	45	2114-400s	2.50	3111A	39.95	
74107N	LM340K-5	75	CD4036	45	2114-200s	2.50	3111A	39.95	
74123N	LM340K-5	75	CD4037	45	2114-400s	2.50	3111A	39.95	
74125N	LM340K-5	75	CD4038	45	2114-200s	2.50	3111A	39.95	
74145N	LM340K-12	1.35	CD4039	45	2114-400s	2.50	3111A	39.95	
74150N	LM340K-15	1.35	CD4040	45	2114-200s	2.50	3111A	39.95	
74151N	LM340K-15	1.35	CD4041	45	2114-400s	2.50	3111A	39.95	
74152N	LM340K-15	1.35	CD4042	45	2114-200s	2.50	3111A	39.95	
74153N	LM340K-15	1.35	CD4043	45	2114-400s	2.50	3111A	39.95	
74154N	LM340K-15	1.35	CD4044	45	2114-200s	2.50	3111A	39.95	
74155N	LM340K-15	1.35	CD4045	45	2114-400s	2.50	3111A	39.95	
74156N	LM340K-15	1.35	CD4046	45	2114-200s	2.50	3111A	39.95	
74157N	LM340K-15	1.35	CD4047	45	2114-400s	2.50	3111A	39.95	
74158N	LM340K-15	1.35	CD4048	45	2114-200s	2.50	3111A	39.95	
74159N	LM340K-15	1.35	CD4049	45	2114-400s	2.50	3111A	39.95	
74160N	LM340K-15	1.35	CD4050	45	2114-200s	2.50	3111A	39.95	
74161N	LM340K-15	1.35	CD4051	45	2114-400s	2.50	3111A	39.95	
74162N	LM340K-15	1.35	CD4052	45	2114-200s	2.50	3111A	39.95	
74163N	LM340K-15	1.35	CD4053	45	2114-400s	2.50	3111A	39.95	
74164N	LM340K-15	1.35	CD4054	45	2114-200s	2.50	3111A	39.95	
74165N	LM340K-15	1.35	CD4055	45	2114-400s	2.50	3111A	39.95	
74166N	LM340K-15	1.35	CD4056	45	2114-200s	2.50	3111A	39.95	
74167N	LM340K-15	1.35	CD4057	45	2114-400s	2.50	3111A	39.95	
74168N	LM340K-15	1.35	CD4058	45	2114-200s	2.50	3111A	39.95	
74169N	LM340K-15	1.35	CD4059	45	2114-400s	2.50	3111A	39.95	
74170N	LM340K-15	1.35	CD4060	45	2114-200s	2.50	3111A	39.95	
74171N	LM340K-15	1.35	CD4061	45	2114-400s	2.50	3111A	39.95	
74172N	LM340K-15	1.35	CD4062	45	2114-200s	2.50	3111A	39.95	
74173N	LM340K-15	1.35	CD4063	45	2114-400s	2.50	3111A	39.95	
74174N	LM340K-15	1.35	CD4064	45	2114-200s	2.50	3111A	39.95	
74175N	LM340K-15	1.35	CD4065	45	2114-400s	2.50	3111A	39.95	
74176N	LM340K-15	1.35	CD4066	45	2114-200s	2.50	3111A	39.95	
74177N	LM340K-15	1.35	CD4067	45	2114-400s	2.50	3111A	39.95	
74178N	LM340K-15	1.35	CD4068	45	2114-200s	2.50	3111A	39.95	
74179N	LM340K-15	1.35	CD4069	45	2114-400s	2.50	3111A	39.95	
74180N	LM340K-15	1.35	CD4070	45	2114-200s	2.50	3111A	39.95	
74181N	LM340K-15	1.35	CD4071	45	2114-400s	2.50	3111A	39.95	
74182N	LM340K-15	1.35	CD4072	45	2114-200s	2.50	3111A	39.95	
74183N	LM340K-15	1.35	CD4073	45	2114-400s	2.50	3111A	39.95	
74184N	LM340K-15	1.35	CD4074	45	2114-200s	2.50	3111A	39.95	
74185N	LM340K-15	1.35	CD4075	45	2114-400s	2.50	3111A	39.95	
74186N	LM340K-15	1.35	CD4076	45	2114-200s	2.50	3111A	39.95	
74187N	LM340K-15	1.35	CD4077	45	2114-400s	2.50	3111A	39.95	
74188N	LM340K-15	1.35	CD4078	45	2114-200s	2.50	3111A	39.95	
74189N	LM340K-15	1.35	CD4079	45	2114-400s	2.50	3111A	39.95	
74190N	LM340K-15	1.35	CD4080	45	2114-200s	2.50	3111A	39.95	
74191N	LM340K-15	1.35	CD4081	45	2114-400s	2.50	3111A	39.95	
74192N	LM340K-15	1.35	CD4082	45	2114-200s	2.50	3111A	39.95	
74193N	LM340K-15	1.35	CD4083	45	2114-400s	2.50	3111A	39.95	
74194N	LM340K-15	1.35	CD4084	45	2114-200s	2.50	3111A	39.95	
74195N	LM340K-15	1.35	CD4085	45	2114-400s	2.50	3111A	39.95	
74196N	LM340K-15	1.35	CD4086	45	2114-200s	2.50	3111A	39.95	
74197N	LM340K-15	1.35	CD4087	45	2114-400s	2.50	3111A	39.95	
74198N	LM340K-15	1.35	CD4088	45	2114-200s	2.50	3111A	39.95	
74199N	LM340K-15	1.35	CD4089	45	2114-400s	2.50	3111A	39.95	
74200N	LM340K-15	1.35	CD4090	45	2114-200s	2.50	3111A	39.95	
74201N	LM340K-15	1.35	CD4091	45	2114-400s	2.50	3111A	39.95	
74202N	LM340K-15	1.35	CD4092	45	2114-200s	2.50	3111A	39.95	
74203N	LM340K-15	1.35	CD4093	45	2114-400s	2.50	3111A	39.95	
74204N	LM340K-15	1.35	CD4094	45	2114-200s	2.50	3111A	39.95	
74205N	LM340K-15	1.35	CD4095	45	2114-400s	2.50	3111A	39.95	
74206N	LM340K-15	1.35	CD4096	45	2114-200s	2.50	3111A	39.95	
74207N	LM340K-15	1.35	CD4097	45	2114-400s	2.50	3111A	39.95	
74208N	LM340K-15	1.35	CD4098	45	2114-200s	2.50	3111A	39.95	
74209N	LM340K-15	1.35	CD4099	45	2114-400s	2.50	3111A	39.95	
74210N	LM340K-15	1.35	CD4100	45	2114-200s	2.50	3111A	39.95	
74211N	LM340K-15	1.35	CD4101	45	2114-400s	2.50	3111A	39.95	
74212N	LM340K-15	1.35	CD4102	45	2114-200s	2.50	3111A	39.95	
74213N	LM340K-15	1.35	CD4103	45	2114-400s	2.50	3111A	39.95	
74214N	LM340K-15	1.35	CD4104	45	2114-200s	2.50	3111A	39.95	
74215N	LM340K-15	1.35	CD4105	45	2114-400s	2.50	3111A	39.95	
74216N	LM340K-15	1.35	CD4106	45	2114-200s	2.50	3111A	39.95	
74217N	LM340K-15	1.35	CD4107	45	2114-400s	2.50	3111A	39.95	
74218N	LM340K-15	1.35	CD4108	45	2114-200s	2.50	3111A	39.95	
74219N	LM340K-15	1.35	CD4109	45	2114-400s	2.50	3111A	39.95	
74220N	LM340K-15	1.35	CD4110	45	2114-200s	2.50	3111A	39.95	
74221N	LM340K-15	1.35	CD4111	45	2114-400s	2.50	3111A	39.95	
74222N	LM340K-15	1.35	CD4112	45	2114-200s	2.50	3111A	39.95	
74223N	LM340K-15	1.35	CD4113	45	2114-400s	2.50	3111A	39.95	
74224N	LM340K-15	1.35	CD4114	45	2114-200s	2.50	3111A	39.95	
74225N	LM340K-15	1.35	CD4115	45	2114-400s	2.50	3111A	39.95	
74226N	LM340K-15	1.35	CD4116	45	2114-200s	2.50	3111A	39.95	
74227N	LM340K-15	1.35	CD4117	45	2114-400s	2.50	3111A	39.95	
74228N	LM340K-15	1.35	CD4118	45	2114-200s	2.50	3111A	39.95	
74229N	LM340K-15	1.35	CD4119	45	2114-400s	2.50	3111A	39.95	
74230N	LM340K-15	1.35	CD4120	45	2114-200s	2.50	3111A	39.95	
74231N	LM340K-15	1.35	CD4121	45	2114-400s	2.50	3111A	39.95	
74232N	LM340K-15	1.35	CD4122	45	2114-200s	2.50	3111A		

## Save \$ on Computer Books!

We offer a 10% discount on computer books from Addison-Wesley, Wiley, Sybex, and Murach.

Fast, reliable service and low shipping charges for mail orders. Write for FREE catalog (or stop in to see us in lower Manhattan).



**DOWNTOWN BOOK BAZAAR, Dept. B**

172 Fulton St. (near World Trade Ctr.) New York, N.Y. 10007

Circle 144 on inquiry card.

## FLOPPY DISKS

NEW Shugart SA400L.....	\$233.00
NEW Shugart SA450.....	325.00
NEW Shugart SA801R.....	389.00
NEW Shugart SA851R.....	520.00
Dual 8" enclosure, wired, power, neck mount slides, remote AC power control.....	649.00
Enclosure, 8" desk top, bare, unwired	75.00
ENCLOSURE DUAL MINI WITH POWER, DESK TOP.....	90.00
FD206 power supply.....	95.00

### DISKETTES

1 year warranty, 10 per plastic library case, 8" ..single side-single density	28.40
8" ..single side-double density	39.90
8" ..double sided-double density	45.70
5 1/4" REINFORCED HUB 10/PLASTIC LIBRARY CASE SOFT SECTORED, 10 OR 16 HOLES	
single side-single density	29.70
single side-double density	36.10
double sided-double density	43.90

### TRACTOR FEED PAPER

9 1/2 x 11 blank, 3700 sheets, perf	27.22
8 1/2 x 11 blue bar, 3700 sheets	24.72

OTHER TYPES OF MEDIA AVAILABLE... CALL FOR PRICE



**METAVAN, INC.**  
1805 East Dyer Road, Suite 307  
Santa Ana, CA 92705  
(714) 540-2427

Circle 260 on inquiry card.

## Build and Enhance



your Apple software library at affordable prices. For the FIRST time — PACKED disks with 60 outstanding programs. Your Apple needs programs! At last you have an opportunity to use your Apple to its fullest capacity!

**APPLEWARE INC.** offers on each disk an extensive variety of programs including:

- |           |               |   |
|-----------|---------------|---|
| Business  | • Printer     | • Graphics  |
| Games     | • Text        | • Music   |
| Utilities | • Data Base   | • Finance   |
| Science   | • Engineering | • and many others with 3.3 DOS for easy demuffling. |

First 3 disks available at \$59.95 each. Order all 3 for a free bonus disk. Call now toll free: 1-800-327-8664. Fla. Residents: 305-584-7004. Please add \$3 for postage & handling.

6400 Hayes St.  
Hollywood, FL 33024



\*TM Apple is a registered trademark of Apple Computer Co.

Circle 23 on inquiry card.

### — Mod II Owners — Program Modifications Now A Snap With Basic IDEAS™

If you know what it's like to write programs on a mainframe computer with a well human-engineered programming facility (like SPF), then you're probably frustrated with the limitations of the BASIC Line Editor of your TRS-80® Mod II.

If you've never experienced mainframe programming power at its best, you don't know what you've been missing. Tedious line-by-line editing is now a thing of the past with Basic IDEAS™ and its powerful Full-Screen Text Editor.

- **Changes Made Easy.** Move the cursor anywhere on the screen & simply type in your revisions.
  - **Multi-Line Insert & Delete:** Just position the cursor and insert/delete lines at will.
  - **Text Insert & Delete Within A Line:** Again, just position the cursor anywhere on the line and insert or delete text with instantaneous visual feedback.
  - Also includes: **Global Search & Replace, Automatic Prompting, Print,** and much more.
- That's not all. Basic IDEAS™ has a full array of advanced programming tools that make Mod II BASIC **Easier To Write, Easier To Read, Easier To Modify.**

Send for our FREE brochure for complete details and actual examples of the power of Basic IDEAS™. Complete system, fully documented, only \$299.

Computer IDEAS Corporation  
4229 Hall St. • Dallas, Texas 75219

Circle 95 on inquiry card.

## Introducing...



## Frog Prince Software

**PROGRAMMERS:** We are seeking outstanding entertainment programs for publication. Unique, challenging programs for the IBM PC, the TRS-80 Color Computer and other computers with high-resolution color graphics capabilities. Write for our submissions kit.

Frog Prince Software  
P.O. Box 970  
Bowling Green Station  
New York, New York 10274

Circle 175 on inquiry card.

## For CP/M-80® Users

### DATA ENCRYPTION

- \$49.95 FAST-LOCK/1 — Fast File and Disk Encryption/Decryption.
- Very Fast, encrypts files or an entire disk (SS/SD 374D)
- Provides security for all but the most sensitive data • Combination of transposition, substitution, and algebraic cyphers
- Any bit change in KEY or DATA drastically alters results
- 64 bit key

• \$149.95 POWER-CRYPT/1 — U.S. Government's Data Encryption Standard.

- Software implementation, that doesn't require costly hardware, of the National Bureau of Standards FIPS pub. 46 (Jan. '77) Data Encryption Standard • Includes FAST-LOCK/1 • Provides high level of security for the most sensitive data • Encrypts files for entire disks with FAST-LOCK/11 • Provides multiple/combination encryption • "Electronic Code Book Mode" • 64 bit key
- Combination of multiple complex permutations, product transformations, block ciphering • Multiple encryptions are virtually UNBREAKABLE by ANYONE, no matter how large or sophisticated the computer/cryptologic equipment.

### SPREAD SHEET/STACK CALCULATOR

- \$49.95 SHEET-CALC/1 — Easy to use SPREAD SHEET calculator.
- Uses RPN (Reverse Polish Notation) like scientific calculators
- Symbolic names for ROW/COL's • Three calculators: Accumulator, Stack, Spread sheet • Decimal Floating Point (12 Digits, ±99 exp.)

Send Orders, and requests for FREE information to:

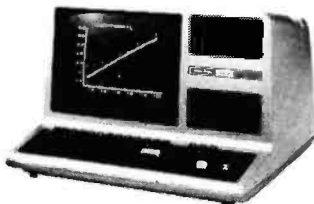
### UNIVERSAL INFORMATION SYSTEMS

26453 SKY Drive  
Escondido, California  
92025

Call: residents add 6% sales tax.  
CP/M — Reg TM of Digital Research Inc.

Circle 422 on inquiry card.

TRS-80® Model III  
48K RAM & 2 Drives



**\$1799<sup>88</sup>** DELIVERED  
Non Radio Shock Warranty

HIGH TECHNOLOGY AT AFFORDABLE PRICES

**THE BOTTOM LINE**

Orders & Information  
(603) 673-8857

Orders Only  
(800) 343-0726

12 Johnson Street, Milford NH 03055-0423

Circle 51 on inquiry card.

## Beech Enterprises

6109 South I Street  
Tacoma, Washington 98408  
(206) 472-1094

Printers — Epson, Okidata, Nec, Anadex, Others

Epson MX-70 .....	315.00
Epson MX-80 .....	445.00
Epson MX-100 .....	745.00
Anadex DP9500, DP9501 .....	1265.00
IDS 560 .....	1104.00

Boards — Microsoft, Vindex

Z80 Softcard by Microsoft .....	287.00
16K Ramcard by Microsoft .....	146.75

Computer systems — Altos, Televideo, NEC

NEC — 64K Ram, 2 Disk, 7 Expansion Slots CRT .....	2379.00
--	---------

Other Products & Software Available. \$ Call

Hard Disk, Visicalc, Modems, Monitors, Furniture

Terms: Certified checks, personal checks, money orders. Allow 2 weeks for personal checks to clear. Equipment is subject to price change and availability.

Circle 43 on inquiry card.

**daisy\*typer®**



## LETTER QUALITY PRINTERS

Olivetti PRAXIS Electronic Daisywheel Model 30/35 Typewriter-Printer

non-ASCII interface versions from \$649  
Buffered Centronics version  
Buffered RS-232C Terminals

Brand new units with 90 day warranty and case. We supply ribbons and printwheels.

Dealer Inquiry Welcome

**SYSTEMED CORPORATION**

P.O. Box 18, Mountain City, Tennessee 37683  
Phone (615) 727-6000

Circle 400 on inquiry card.



# INCREDIBLE? BELIEVE IT!

## Washington Computer Services

an affiliate of **WASHINGTON ELECTRIC COMPANY** est. 1912

CUSTOM COMPUTER ROOM WIRING SINCE 1960

97 Spring Street, New York, New York 10012

TO ORDER: CALL OUR TOLL-FREE NUMBER: (800) 221-5416 In N.Y. State and for technical information: (212) 226-2121

HOURS: 9 AM-5:30 PM (EST) Monday-Friday TELEX: 12-5606 CABLE: WASHCOMP NYK

### PRINTERS



150 cps bidirectional - 9x9 dot matrix, quietized case, 136 col, vertical form control and many other functions **NOW \$950**

The best price/performance ratio available.

RS-232 serial to 19,200 baud x-on, x-off add \$25

**Teletype 40.** 300 LPM-typewriter quality, RS-232 interface. This quality printer is available in many configurations including forms access, quietized case, etc. **from Only \$3200**

**Teletype 43** **from \$995**

**Teletype AP-200.** 340 cps dot matrix (similar to Data Prod. M-200) **\$2799**

**NEC Spinwriter-55** cps, bidirectional, letter quality R.O. 7710 **\$2560** KSR 7720

**DIABLO 630-40** cps, bidirectional, daisy wheel, plot/graph **\$2799**

**QUME Sprint 9/35** cps, daisy wheel **\$2349**

**C. ITOH Starwriter.** 40 cps, daisy wheel, F10 **\$1944**

**EPSON MX-80, 100, 80** cps, 9x9 dot matrix **\$1550**

**ANADIX 9500/9501,** up to 200 cps, high resolution dot **SCALL**

**OKI/OATA Microline 82A,** bidirectional, friction/pin feed **\$1325**

**Microline 83A,** bidirectional, 120 cps, uses 15" paper **\$525**

**TI-810,** 150 cps, Basic **\$799**

Package-Compressed print, vertical form control **\$1449**

**MANNESMANN MT 1705** 200 cps, 7x9, 132 col **\$1630**

**TALLY MT 1805** 200 cps, 7x9 + NLQ 40x18 matrix **SCALL**

**CENTRONICS** **SCALL**

739 100 cps, nx9 dot matrix, Full Graphics **\$567**

122 120 cps, International set, Full Graphics **\$899**

**DEC LA-34** **\$1085**

**IDS PRISM,** 132 col., color **\$1785**

**TERMINALS** PMMI MODEM **\$359**

**AMPEX DIALOGUE 30, 80, 81** **SCALL**

**TELEVIDEO 910 C** (multi-terminal) **\$610**

925C **\$795**

950C **\$950**

**SOROC IQ 120** **\$729**

**HAZELTINE ESPRIT** **\$669**

**DEC VT-100** **\$1575**

**WYSE WY-100 (ALTOS 1)** **NEW! SCALL**

Similar savings for our HAZELTINE and LEAR SIEGLER lines

### SOFTWARE

**MBASIC-80** **\$275** **WORDSTAR** **\$300**

**MBASIC COMPILER** **\$285** **MAILMERGE** **\$110**

**FORTRAN-80** **\$349** **DATASTAR** **\$230**

**COBOL-80** **\$574** **OBASE II** **\$525**

**PL/1-80** **\$425** **CONDOR III** **\$716**

**PASCAL MT + V5.5** **\$398** **MILESTONE** **\$235**

**WHITESMITH'S C** **\$660** **SUPERCALC** **\$221**

**BSTAM, BSTMS** **\$200** **FMS-80** **\$649**

**CB-80** **\$420** **SELECTOR V** **\$396**

**PEARL (LEVEL 3)** **\$549** **SPELLGUARD** **\$236**

**LIFEBOAT SOFTWARE** **SCALL** **SUPERSOFT** **SCALL**

**PEACHTREE** **SCALL** **AMERICAN BUS. SYST.** **SCALL**

**GRAHAM-DORIAN** **SCALL** **ACCOUNTING PLUS** **SCALL**

**STRUCTURED SYST.** **SCALL** **TURBOODS (MULTI)** **\$500**

**VANDATA/OSBORNE** **\$500** **TURBOODS (1 USER)** **\$220**

### 8" DISK DRIVE SALE

8" SHUGART SA801R \$450 8" SHUGART SA 851R \$669 2 for \$1289

QUME DATATRACK 8 \$589 2 for \$1110

Enclosure, power supply for 2 8" drives A & T \$350

MORROW DISCUS 20 + CP/M®, MICROSOFT BASIC, CONT. \$950

### HARD DISK SPECIALS

**CORVUS 5MB, 10MB, 20MB Constellation Multiplexer and Mirror Backup**

**MORROW 26MB + controller + CP/M 2.2®, M basic** **\$4495 \$3821**

**controller, CDC Hawk Drive (5 fix, 5 rem)** **\$7995 \$6795**

**controller, Western Dynex (5 fix, 5 rem)** **\$5995 \$5099**

Winchester 5 1/4 drives complete with case, cable, software, S-100 controller. Adapter avail. for use with any Z-80 system. Cartridge drive controllers avail.

**5MB APPLE S-100** **Z-89 \$2898**

**10MB XEROX ALTOS** **OEM discounts available! R.S. MOD. II \$3398**

**ADDS & KONAN** 5 1/4", 8" and 14" Winchester/tape subsystems avail.

**FULLY CONFIGURED BUSINESS SYSTEMS**

The following are some examples of the fully assembled and tested business and scientific computer systems which we offer.

**IMS INTERNATIONAL 8000 SX,** multi-user, multi-processor, turbo DOS **SCALL**

**CPM 2.2. FULL 2 YEAR WARRANTY!**

**DELTA 68000** 16 bit multi-user UNIX V.7 **SCALL**

**SEATTLE COMPUTER 8086** 16 bit, 128K RAM, Syst. #2 **\$3499**

**Systems Group** Call us for best prices on these high quality 2nd generation boards and systems.

**California Computer Systems** These high quality, reliable products have made CCS defacto industry standard for S-100 products

Assembled and tested:

**2200 H.D. Mainframe** **\$517** **2810AZ-80 CPU,** serial port **\$316**

**2065C64K dynamic RAM** **\$409** **2422AFloppy Cont,** CP/M 2.2 **\$427**

**CCS 2210A w/floppy controller,** 1 serial port **\$2116**

**CCS 300-1A w/1.2 MB floppy drives,** 2 serial, 2 parallel ports **SCALL**

**DIGIAC** Fine Computers **SCALL**

**GODBOUNT** We offer generous discounts on the Compupro line of fast, quality 8 and 16 bit boards

**NorthStar** **AVANTAGE & HORIZON** **SCALL**

**NEC** Low prices on PC-8000 series **SCALL**

**DELTA S-4500** 10 User, Multi-Processor, 40 MB hard 17 MB tape **SCALL**

**ALTOS** single and multi-user systems **SCALL**

**MORROW DESIGN** Decision 1, CP/M Microsoft Basic, UNIX **SCALL**

**XEROX** 820 Desktop computer-64K, 2 floppys. (CP/M avail.) **SCALL**

Similar savings on the full lines of CCS, SSM, NNC, MORROW, DELTA, NDRTHSTAR, ITHACA INTERSYSTEMS, GODBOUNT, NEC, TELEVIDEO, IMS

ZENITH, ADDS, DEC, DATA GEN., ATARI, DYNABYTE, TECMAR, DUAL

**LOOK HERE!** **AMPEX Dialogue 80"**

Call us for ALL your softwair needs **Dialogue 80"**

Systems Houses, Educational Institutions, & Government Agencies Given Special Consideration



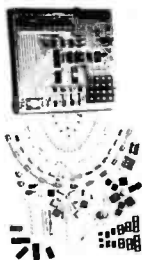
ALL OF OUR PERIPHERALS CAN BE CONFIGURED FOR RADIO SHACK® MODEL II

## DEALER and INTERNATIONAL INQUIRIES WELCOME

For fast delivery, send certified check, money order or call to arrange direct bank wire transfer. Personal or company checks require two to three weeks to clear. All prices are mail order only. Prices subject to change without notice; call for latest prices. Prices include 3% cash discount. N.Y. residents add sales tax. Qantex is a trademark of North Atlantic Industries, Inc. Radio Shack® is a trademark of the Tandy Corp. CP/M® is a trademark of Digital Research. All sales subject to our standard sale conditions (available on request).



## KIT-80 INC.



### E-Z-80 ENTRY KIT

A Z-80 Micro Computer with CPU: CTC:  
PIO: Prom Programmer: Read Outs: Key  
Pad: Onboard ROM & RAM: Wire Wrap:  
DC Regulator: Manual & Instructions.

**Kit Price \$390.00**

18601 LBJ Fwy • Mesquite, Texas  
75150 • 800-527-1593

Circle 231 on Inquiry card.

## RIBBONS at GREAT DISCOUNTS

Multistrike ribbons (black) for:

	New Ribbons	Reloaded Cartridges	Refill* Ribbon Pancakes
Qume (Ours)	\$3 ea.	\$2 ea.	\$1 ea.
Diablo (Univ.)	\$4 ea.	\$3 ea.	\$2 ea.
NEC (Orig.)	\$4 ea.	\$3 ea.	\$2 ea.
Wang (Ours)	\$4 ea.	\$3 ea.	\$2 ea.
Ricoh (Orig.)	\$6 ea.	\$4 ea.	\$3 ea.

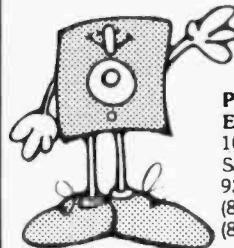
(Cloth ribbons will be available shortly.)  
\*Minimum order 3 pancakes with instructions.  
Add 25 percent for orders of less than 1 doz.  
We "trade" for RELOADABLE used cartridges.  
Write for price lists on diskettes, printwheels  
and other ribbons. Order our new 150 page book  
**HOW TO RELOAD MULTI-STRIKE DAISY WHEEL  
WORD PROCESSING RIBBONS.** \$49. This book puts  
you in business reloading ribbons at home.

WILLIAM WALKER  
Word Processing Supplies  
306 West 46th St.  
New York, NY 10036

Circle 431 on Inquiry card.

## Verbatim flexible disks

Call Free (800) 235-4137 for  
prices and information. Dealer  
inquiries invited. C.O.D. and  
charge cards accepted.



VISA

PACIFIC EXCHANGES  
100 Foothill Blvd.  
San Luis Obispo, CA  
93401. In Cal. call  
(800) 592-5935 or  
(805) 543-1037.

Circle 320 on Inquiry card.

## PRICE BREAK

### EPSON MX-80 CARTRIDGE RIBBONS

**\$9.95** EA.

**\$107.46 per dozen**  
Minimum Order 3 Ribbons  
Price Includes Shipping  
We accept Mastercard and Visa

**CHECK-MATE™**  
P.O. BOX 103, RANDOLPH, MA 02368  
Call Toll Free - 1-800-343-7706  
In Massachusetts - 617-963-7694

Circle 72 on Inquiry card.

## VOLTAGE SURGE & TRANSIENT SUPPRESSOR



Protects  
Most  
Electronic  
Equipment

The SUPPRESSOR electronically removes  
or reduces sudden voltage changes. It  
simply plugs into a power receptacle on  
the same circuit as the equipment being  
protected.

END POWER LINE SPIKES, SURGES,  
HASH... Only \$29.95 ea. Dealer Inquiries  
Invited.



CUESTA SYSTEMS, INC.  
3440 Roberto Court  
San Luis Obispo, California 93401  
(805) 541-4160

Circle 128 on Inquiry card.

## DMB 6400

### LOOK ALIKE

**\$399**

One Year Full Warranty  
Delivery from stock

Sonics  $\mu$  sys

1500 NW. 62 Street  
Ft. Lauderdale FL.  
33309 Suite 409

305-776-7177

Circle 384 on Inquiry card.

## EPSON

DOT MATRIX PRINTERS  
SUPER DISCOUNTS ON  
MX-80F/T NOW  
MX-80 IN  
MX-100 STOCK

We also stock direct connect  
cables for TRS-80, Apple, IBM,  
Atari, Pet or RS 232

TO ORDER  
(209) 667-2888 or 634-8888



GRAPHICS ROM'S  
AVAILABLE

MACROTRONICS, inc.  
1125 N. Golden State Blvd.  
Turlock, California 95380



Circle 246 on Inquiry card.

## ADDS VIEWPOINT

\$495 Qty. 1

Modem 300/1200 \$699

### DEC COMPATIBLE

Datamedia  
Excel 12 \$1,295  
Excel 22 \$995

Economy  
Peripherals  
(404) 952-0213

Circle 462 on Inquiry card.

## SUPER SALE

### EPROM

	1-7	8 up	50 up
2716	4.15	3.90	CALL
2732	9.70	8.85	CALL

### 16K RAM EXPANSION KIT

For TRS-80 Model III  
Set of 8 pieces UPD416-2 (200nS)

Data furnished with purchase on request. **\$13.95**

### WRITE FOR FREE CATALOG



SUNTRONICS CO., INC.

12621 CRENSHAW BOULEVARD  
HAWTHORNE, CALIFORNIA 90250  
(LOCATED NEXT TO FORMULA INTERNATIONAL)

STORE HOURS: Mon-Fri 10am to 8:30pm - Sat 10am to 5pm

IN CALIFORNIA OUTSIDE CALIFORNIA TOLL FREE

(213) 644-1149 1-800-421-5775

Mail Order—Minimum Order: \$10. Send Money Order or Check to:  
P.O. BOX 1957—Dept. B HAWTHORNE, CA 90250. Use your  
VISA or Mastercard (please include expiration date). Add \$2.00  
postage and handling to order. California residents add 6% sales tax.

Circle 395 on Inquiry card.

# Best prices anywhere. We beat 'em all!

## COMPUTERS

INTERSYSTEMS



DPS1 DPS1A DPS2A CALL FOR PRICES

**DYNABYTE** List ..... Less 30%

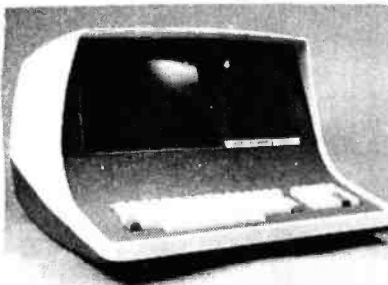
**ALTOS** List ..... Less 20%

**NORTHSTAR**

Horizons & Advantages ..... CALL

**TELEVIDEO COMPUTER SYSTEMS** ..... CALL

## SUPERBRAIN



64K DD. .... \$2639

64K QD. .... \$2949

DSS-10MEG Hard Disk. .... \$3195

## CROMEMCO

CS-1 List. \$3995 ..... OUR PRICE \$3195

CS-2 List. \$4695 ..... OUR PRICE \$3549

CS-3 List. \$7995 ..... OUR PRICE \$6349

Z2H List. \$9995 ..... OUR PRICE \$7995



**data systems**



Z-89 List \$2895  
OUR PRICE \$2099

## TERMINALS

TeleVideo



Televideo 910C. .... CALL  
912C. .... CALL  
920C. .... CALL  
925C. .... CALL  
950C. .... CALL

INTERTUBE. .... \$725  
Emulator. .... \$725

### OKIDATA

Microline 81J ..... \$359  
Microline 82A ..... \$469  
Microline 83A ..... \$749

C.I.TOH. .... CALL FOR PRICES

## SOROC

Soroc IQ120. .... \$679  
IQ130. .... \$585  
IQ135. .... \$719  
Q135 w graphics. .... \$789  
IQ140. .... \$995

## HAZELTINE

1420. .... CALL  
1500. .... SAVE  
1510. .... CALL

**ZENITH Z19** ..... \$639

Prices are for pre-paid orders only, and reflect a cash discount. C.O.D.'s and charge cards slightly higher.

Most items in stock for immediate delivery. Factory sealed cartons w/ full factory warranty. NYS residents and audio-visual sales tax. Prices do not include shipping. C.O.D. orders require 25% deposit. Prices subject to change without notice.

## PRINTERS

CENTRONICS



749-1 PAR. .... \$699  
739-3 SER. .... \$619  
704-11 parallel. .... \$1569  
704-9 (RS232). .... \$1519

## TI 810

810 Basic. .... \$1289  
810 Full Option. .... \$1599  
820 RO Basic. .... \$1545  
820 KSR Basic. .... \$1739  
NEC 7710 (RS232) SERIAL. .... \$2395  
7730 PARALLEL. .... \$2395

Qume. .... CALL FOR PRICE

Diablo 630 RO. .... \$2049  
1640 KSR. .... \$3495  
1640 RO. .... \$3095

Paper Tiger 445G. .... \$739  
460. .... \$799  
460G. .... \$839  
560G. .... \$1099

Prism 80. .... \$895  
132 w/ color. .... \$1495

### Epson

MX 80 ..... \$465  
MX 80F I ..... \$548  
MX 100 ..... \$745

## DISK SYSTEMS

### MORROW

Discus 2D ..... \$835  
Dual Discus 2D ..... \$1385  
Discus 2 + 2 ..... \$1199  
M 5 5meg Hard Disk ..... \$1995  
M 10 10 meg Hard Disk ..... \$2995  
M26 26 meg Hard Disk ..... \$3349

CORVUS 5 meg Hard Disk ..... \$2999  
CORVUS 10 meg Hard Disk ..... \$4279  
CORVUS 20 meg Hard Disk ..... \$5159

# COMPUTERS WHOLESALE

P.O. Box 144 Camillus, N.Y. 13031

## 315-472-2582

Prices subject to change without notice



SLIDER QUALITY

**CompuPro™** from **GOBBOUT ELECTRONICS**

6MHz CPU Z, 64K, (2) 8" DRS SYSTEM \$2795.  
 6MHz CPU 85/88, 64K, (2) 8" DRS. SYSTEM 2795.  
 8MHz CPU 8086, 64K, (2) 8" DRS. SYSTEM 2995.  
 INCLUDES INTEGRAND CAB 10 SLOT & CPM™80 or 86  
 CPM 6MPM ARE TRADEMARKS OF DIGITAL RESEARCH  
**LOMAS DATA PRODUCTS**

10MHz 8086, 128K, (2) 8" DRS SYSTEM \$2995.  
 MPM™86 8086, FLOPPY SYSTEM 128K 3495.  
 (FOR SB86 FOR GOBBOUT DUAL PROCESSOR CALL)

**SEATTLE COMPUTER**

SYSTEM I 64K \$2549. SYSTEM II 128K \$3325.  
 (2) 8" 801's IN MORROW CABINET w/PS 1056.  
 5086 IS TRADEMARK OF LIFEBOAT ASSOCIATES

**MORROW DESIGNS**

DECISION I w/DUAL 5 1/4" DRS., 65K, CPM, \$3150.  
 WIN A GOBBOUT DUAL PROCESSOR 85/88 WRITE  
 ALL GOBBOUT, LOMAS, OR SEATTLE SYSTEMS AVAIL-  
 ABLE IN BUDGET SYSTEMS ABOVE OR LUXURY SYSTEM  
 WITH CONSTANT VOLTAGE TRANSFORMER ON MAINFRAME  
 AND DRIVE CABINET STARTING AT \$3595.  
 ALL PRICES SUBJECT TO CHANGE  
 PO 951 WESTMINSTER CO 92693-0951  
 714 645-1746

Circle 381 on inquiry card.

**wabash®**

When it comes to  
Flexible Disks, nobody  
does it better than  
**Wabash.**


MasterCard. Visa Accepted.  
Call Free: (800) 235-4137



**PACIFIC EXCHANGES**  
 100 Foothill Blvd.  
 San Luis Obispo, CA  
 93401 (In Cal. call  
 (805) 543-1037)

Circle 320 on inquiry card.

**MEMORY EXPANSION FOR APPLE®** The company that brought you the first 32K RAM board for Apple II® and Apple II+® now offers:

- **128K RAM ALL FOR ONLY \$599**  
 includes 1. MOVEDOS (relocates DOS)  
 5 comprehensive 2. FRAMEXPAND (for Applesoft®, Integer®)  
 software 3. PSEUDO-DISK for DOS 3.3 or 3.2  
 packages 4. PSEUDO-DISK for CPM®  
 5. PSEUDO-DISK for PASCAL.
- **64K RAM \$425**  
 A medium range memory expansion board which can be upgraded to 128K at a later date. (Upgrade kit sold for \$175) includes all 5 software packages offered with the 128K board.
- **32K RAM STILL ONLY \$239**  
 The old favorite for Apple users. Includes our first 3 software packages (above) with CPM® and PASCAL pseudo-disks now offered as options (\$39 each).
- **VC-EXPAND™ MEMORY EXPANSION ONLY \$100 FOR VisiCalc®**  
 Expand memory available to Personal Software's 16 sector VisiCalc®. Add 32K, 64K, or even 128K to your present workspace (even if you already have a 16K card in use!) with this program plus one or more Saturn boards.  
  
**313/973-8422**

Circle 368 on inquiry card.

**Cables**  
**EIA RS 232-C**  
 Quality cables with immediate delivery and low prices.

Conductor	Price
1-4	\$11.50 + .15/ft.
5-7	12.00 + .25/ft.
8-12	13.00 + .30/ft.
13-16	14.00 + .40/ft.
17-25	16.00 + .50/ft.

Specify: Male or female connectors, length of cable and pins to be connected. OEM & quantity discounts available to qualified customers. On prepaid orders add \$4.50 for shipping/handling.

We also supply DEC and IBM Compatible cables.

**Communication Cable Company**  
 319 Louella Ave. Wayne, PA 19087  
 215-964-9404

Circle 83 on inquiry card.

**Hey CANADIANS!**

New and Refurbished Equipment

8" Disc Drives .....	\$400.00
Letter Quality Printers Gume & Diablo .....	\$1600.00
Oscilloscopes Dual Trace, 15Mhz. ....	\$900.00
Computer Systems, CP/M with 2 8" disc drives, CRT 64K, letter quality printer .....	\$7500.00

All Sales Final  
 Ontario Residents add PST  
 All items warranty 90 days, parts & labour  
 All prices in Canadian Funds

**TSA PROFORMA INC.**  
 154 Fulton Ave.  
 Toronto, Ontario  
 M4K 1Y3  
 (416) 922-1139 425-9058

Circle 463 on inquiry card.

YOU'VE JUST FOUND



**THE MISSING LINK!**

Computer Shopper is your link to individuals who buy, sell and trade computer equipment and software among themselves nationwide. No other magazine fills this void in the marketplace chain.

Thousands of cost-conscious computer enthusiasts use Computer Shopper every month through hundreds of classified ads. And new equipment advertisers offer some of the lowest prices in the nation.

Subscribe to Computer Shopper with a **6 month trial for only \$6.** MasterCard or VISA call **TOLL FREE 800-327-9920**

**COMPUTER SHOPPER**  
 P.O. Box F307 • Titusville, FL 32780  
 305-269-3211

Circle 101 on inquiry card.

**MAGIC**  
**Telecommunication Software**

1. MAGIC is compatible with any Host Computer Full or Half Duplex.
2. Use your CP/M computer system as an intelligent terminal on your modem.
3. Send disk files of text, programs, or keyboard input to host computer.
4. Record in a disk file all or part of the conversation with the host.
5. Send and Record disk files on your CP/M system without logging off of the host system.
6. Modular software is easily configured for various types of terminals computers, and modems.


**HARDWARE REQUIREMENTS**

1. CP/M computer with 32K memory min.
2. Integral modem or RS-232 port and stand alone modem.

**AVAILABLE IN THE FOLLOWING FORMATS**

5 1/4" Apple CPM requires Z80 SoftCard  
 5 1/4" Zenith H-89 requires CP/M 2.2  
 5 1/4" Xerox 820 single density format  
 8 inch single density general release

MAGIC \$95.00 Users Manual only \$10.00  
 Terms certified check or money order  
 Allow two weeks for personal check  
 Nebraska resident add 3% sales tax

 Technical Engineering Labs  
 7016 N 107 CT Omaha Nebraska 68142  
 Phone 402-493-9580

Circle 407 on inquiry card.

**Switch box runs 2 printers from one CPU port.**

- Change printers without unplugging cables.
- Centronics compatible I/O parallel model.
- RS 232C serial model.
- All solid state electronics
- Attractive styling, compact size

only **\$129.95**

**ACS**    
**automated control systems, inc.**  
**UCZ** 14218 N.E. 21st St., Bellevue, WA 98007  
 Or call Tracy Martin at (206) 881-0177.

Circle 34 on inquiry card.

**COMPUTER CLASSIFIEDS™**

Buy - Sell - Employment - Etc.

National on-line classified system for all types of advertisements.

Sell your unneeded equipment, or upgrade with good used gear.

There is no charge to read the listings. Club listings, reader to reader messages, and letters to the editor may be placed at no charge. Ads are \$10.00 for 90 days, payable by Visa, MasterCard or check. Ads are up to 1200 characters long. Ads may also be sent in written form to the address below. Ads are not limited to computer related subjects. No delay, your ad is working for you the minute you enter it!!!

512 346-4495 @ 300 baud  
 24 hours, multiple lines

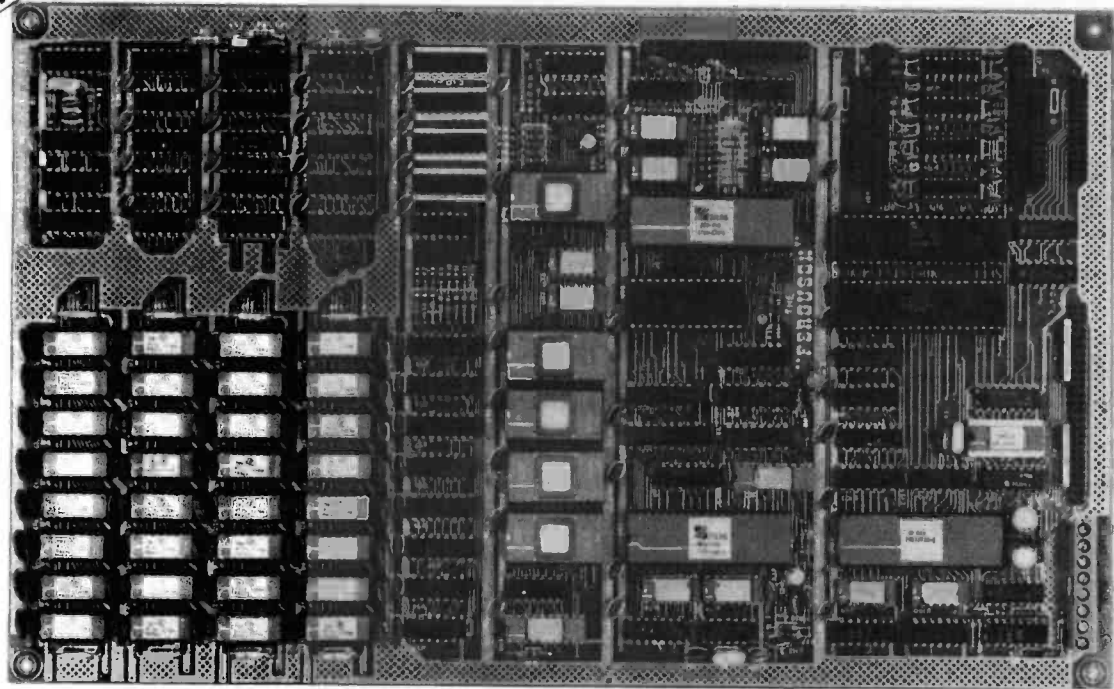
**COMPUTER CLASSIFIEDS**  
 8348 Summerwood Austin, Tx 78759

U.K. AND EUROPE: CONTACT VINCELOD LTD. 47 GOLDHURST TERRACE LONDON NW6

**NEW LOWER PRICES**

**"THE BIG BOARD"**  
 OEM - INDUSTRIAL - BUSINESS - SCIENTIFIC  
**SINGLE BOARD COMPUTER KIT!**  
 Z-80 CPU! 64K RAM!

**NEW!**



**PARTIALLY ASSEMBLED KITS**  
 For All Sockets Installed  
 And Soldered Add \$50.

**WANT MORE INFO?**  
 Full Documentation and  
 Schematics — \$5.

**THE BIG BOARD PROJECT:** Three years in the works, and maybe too good to be true. A tribute to hard headed, no compromise, high performance, American engineering! The Big Board gives you all the most needed computing features on one board at a very reasonable cost. The Big Board was designed from scratch to run the latest version of CP/M\*. Just imagine all the off-the-shelf software that can be run on the Big Board without any modifications needed! Take a Big Board, add a couple of 8 inch disc drives, power supply, an enclosure, C.R.T., and you have a total Business System for about 1/3 the cost you might expect to pay.

**\$499<sup>00</sup>\*\*** (64K KIT BASIC I/O)

SIZE: 8 1/2 x 13 3/4 IN.  
 SAME AS AN 8 IN. DRIVE.  
 REQUIRES: +5V @ 3 AMPS  
 + - 12V @ .5 AMPS.

**FULLY SOCKETED! FEATURES: (Remember, all this on one board!)**

**64K RAM**

Uses Industry standard 4116 RAM'S. All 64K is available to the user. our VIDEO and EPROM sections do not make holes in system RAM. Also, very special care was taken in the RAM array PC layout to eliminate potential noise and glitches.

**Z-80 CPU**

Running at 2.5 MHZ. Handles all 4116 RAM refresh and supports Mode 2 INTERRUPTS. Fully buffered and runs 8080 software.

**SERIAL I/O (OPTIONAL)**

Full 2 channels using the Z80 SIO and the SMC 8116 Baud Rate Generator. FULL RS232! For synchronous or asynchronous communication. In synchronous mode, the clocks can be transmitted or received by a modem. Both channels can be set up for either data-communication or data-terminals. Supports mode 2 Int. Price for all parts and connectors: \$65.

**BASIC I/O**

Consists of a separate parallel port (Z80 PIO) for use with an ASCII encoded keyboard for input. Output would be on the 80 x 24 Video Display.

**BLANK PC BOARD — \$175**

The blank Big Board PC Board comes complete with full documentation (including schematics), the character ROM, the PFM 3.3 MONITOR ROM, and a diskette with the source of our BIOS, BOOT, and PFM 3.3 MONITOR.

**24 x 80 CHARACTER VIDEO**

With a crisp, flicker-free display that looks extremely sharp even on small monitors. Hardware scroll and full cursor control. Composite video or split video and sync. Character set is supplied on a 2716 style ROM, making customized fonts easy. Sync pulses can be any desired length or polarity. Video may be inverted or true. 5 x 7 Matrix - Upper & Lower Case

**FLOPPY DISC CONTROLLER**

Uses WD1771 controller chip with a TTL Data Separator for enhanced reliability. IBM 3740 compatible. Supports up to four 8 inch disc drives. Directly compatible with standard Shugart drives such as the SA800 or SA801. Drives can be configured for remote AC off-on. Runs CP/M\* 2.2.

**TWO PORT PARALLEL I/O (OPTIONAL)**

Uses Z-80 PIO. Full 16 bits, fully buffered, bi-directional. User selectable hand shake polarity. Set of all parts and connectors for parallel I/O: \$19.95

**REAL TIME CLOCK (OPTIONAL)**

Uses Z-80 CTC. Can be configured as a Counter on Real Time Clock. Set of all parts: \$9.95

**CP/M\* 2.2 FOR BIG BOARD**

The popular CP/M\* D.O.S. to run on Big Board is available for \$159.00.

**PRICE CUT!**

**PFM 3.3 2K SYSTEM MONITOR**

The real power of the Big Board lies in its PFM 3.3 on board monitor. PFM commands include: Dump Memory, Boot CP/M\*, Copy, Examine, Fill Memory, Test Memory, Go To, Read and Write I/O Ports, Disc Read (Drive, Track, Sector), and Search. PFM occupies one of the four 2716 EPROM locations provided. Z-80 is a Trademark of Zilog.

**Digital Research Computers**  
 (OF TEXAS)  
 P.O. BOX 401565 • GARLAND, TEXAS 75040 • (214) 271-3538

**TERMS:** Shipments will be made approximately 3 to 6 weeks after we receive your order. VISA, MC, cash accepted. We will accept COD's (for the Big Board only) with a \$75 deposit. Balance UPS COD. Add \$4.00 shipping.  
 USA AND CANADA ONLY

\*TRADEMARK OF DIGITAL RESEARCH. NOT ASSOCIATED WITH DIGITAL RESEARCH OF CALIFORNIA, THE ORIGINATORS OF CPM SOFTWARE  
 \*\*1 TO 4 PIECE DOMESTIC USA PRICE.

**IBM PC  
TRS-80 \* MODEL II**

**ADVANCED PRODUCTIVITY SYSTEM**

APS is a productivity booster that can be compared with IBM's SPF system. The sophisticated user will settle for nothing less. Note these features:

- Menu driven, user friendly general purpose architecture
- Dual screen operation
- Primary, Line and Function key commands
- Separate Edit and Browse subsystems
- Dynamically adjustable scrolling in all four directions
- External datasets merge and create
- Text formatter, similar to IBM's SCRIPT/GML formatter, is designed for large documents
- Built-in utilities allow dataset format conversions

All registered users of our products receive full maintenance support. For more information contact:

**ARRIX LOGIC SYSTEMS INC.**  
P.O. BOX 142  
DON MILLS, ONTARIO  
CANADA M3C 2R6

\* Registered Trademark of Tandy Corporation

Circle 27 on inquiry card.

**FORECASTING**

**EASI/ARIMA** — The first and only microcomputer program to develop and run ARIMA (Box-Jenkins) models...all automatically. Designed for the stock or commodity trader. Create a database or read Compu Trac files directly. Requires no knowledge of statistics. Recommended by Chase Econometrics. \$300.

**TWG/ARIMA** — The statistician's version of EASI/ARIMA. Complete control and more options, such as seasonal models and Box-Cox transformations. \$300.

**ELF** is our general purpose statistical package. \$200.

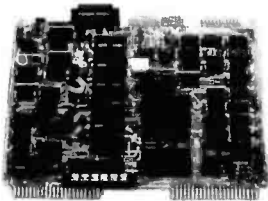
All are for the Apple II\* with 48K of memory, Applesoft\* and DOS 3.3. Visa and MasterCard accepted. Call or write:

*The Winchendon Group*  
3907 Lakota Road  
P.O. Box 10114  
Alexandria, VA 22310  
(703) 960-2587

\*Trademarks of Apple Computer, Inc.

Circle 436 on inquiry card.

**MULTI-FUNCTION MICROCOMPUTER**



**FLEXI PLUS** is a 6809 E microprocessor with built-in controllers for:

- 8" and 5 1/4" IBM compatible Floppy Diskettes
- IEEE-488 Instrumentation Bus
- RS-232/20MA Communication at 50-19.2K Baud Parallel/Serial I/O and Cassettes
- Up to 56K on board RAM, ROM, EPROM
- Advanced Debugging Monitors

The most complete single board microcomputer. Special price: only \$695 with all options and 2K RAM/2K EPROM.

Quantity discounts available.

See us at *Comdex/Spring '82, June 28-30, booth #1369.*

**The Computerist, Inc.**  
34 Chelmsford St.  
Chelmsford, MA 01824  
617/258-3649

Circle 106 on inquiry card.

**SOFTWARE  
AUTHORS**

Cash in on your creative energies, join InfoSoft Computer Systems' SOFTWARE DEVELOPMENT PROGRAM. Get all of your R&D hardware at our distributor cost plus

**20% Royalty!**

We give you personalized service, offer a non-exclusive marketing agreement, plus other specialized services. We seek: high level language compilers, cross-assemblers, utilities, DBMS, new OS, educ. and business applications, and any other marketable program. We offer full development and documentation. Don't hesitate, contact us immediately.

Michael L. Dean, V.P. R&D  
**InfoSoft Computer Systems**

2699 Clayton Rd.  
Concord, CA 94519



(415) 680-0202

Single Source Solution

Circle 203 on inquiry card.

**PROFESSIONAL COMPUTER  
CASSETTES**

TRS-80\* APPLE - COMMODORE-ATARI  
Instant Play Sliding Lock Out Doors



Micro-comp Cassettes Head Cleaner to keep your Quality Computer tape recorder at peak performance.

**CERTIFIED AT 1600 FCI ONE YEAR WARRANTY**  
List price Micro-comp starting at \$3.95; Head Cleaner: \$3.95

**SPECIAL INTRODUCTORY OFFER!**

MICRO-COMP MODEL	UNIT PRICE	10 PACK
C-10 (50 feet)	\$2.95 <input type="checkbox"/>	\$20.00 <input type="checkbox"/>
C-20 (TRS-80*) (100 feet)	3.15 <input type="checkbox"/>	22.00 <input type="checkbox"/>
C-30 (150 feet)	3.35 <input type="checkbox"/>	24.00 <input type="checkbox"/>
C-60 (300 feet)	3.55 <input type="checkbox"/>	26.00 <input type="checkbox"/>
Head Cleaner	2.95 <input type="checkbox"/>	20.00 <input type="checkbox"/>

\*TRS-80-trademark of the Tandy Corp.

CHECK  MASTERCHARGE  VISA

Minimum order for credit cards \$10.00

Card Account No. \_\_\_\_\_ Expiration Date \_\_\_\_\_

Name \_\_\_\_\_

Address \_\_\_\_\_

City \_\_\_\_\_ State \_\_\_\_\_ Zip \_\_\_\_\_

Mail to P.O. Box 806, Shelton, CT 06484

Dealer's Inquiries Welcomed

Circle 247 on inquiry card.

**ATARI®**

<b>VIC-20 \$249</b>	<b>800 (16K)</b>	<b>649</b>
	<b>400 (16 K)</b>	<b>319</b>
	<b>410 Recorder</b>	<b>74</b>
	<b>810 Disk Drive</b>	<b>439</b>
	<b>822 Printer (THERMAL)</b>	<b>269</b>
	<b>825 Printer (80 COLUMN)</b>	<b>589</b>
	<b>830 Modem</b>	<b>149</b>
	<b>850 Interface</b>	<b>164</b>
	<b>853 Memory (16K)</b>	<b>79</b>

**ATARI SOFTWARE**

4002 BASIC CARTRIDGE	45	483 THE PROGRAMMER	52
4003 ASSEMBLER EDIT	45	484 THE COMMUNICATOR	299
4006 SUPER BREAKOUT	33	404 WORD PROCESSOR	110
4007 MUSIC COMPOSER	45	405 PILOT (EDUC)	99
4008 SPACE INVADERS	33	4106 PROGRAMMING 2	21
4009 COMPUTER CHESS	33	4117 PROGRAMMING 3	21
4011 STAR RAIDERS	37	8126 MICROSOFT BASIC	66
4012 MISSILE COMMAND	33	8121 MACRO ASSEMBLER	66
4013 ASTEROIDS	33	813 CAVERNS OF MAR'S	29

CALL OR WRITE FOR FREE CATALOG

**COSMIC COMPUTERS**

228 N. PROSPECTORS RD. UNLIMITED  
DIAMOND BAR, CA. SHIPPING EXTRA \$2 MINIMUM  
91765 PRICES SUBJECT TO CHANGE  
CALIF. RESIDENTS ADD TAX

**(714) 861-1265**

Circle 122 on inquiry card.

**E-PROMS**

1702A	256x8	3.95ea.
2708	1024x8	2.65ea.
2758 (5V)	1024x8	5.95ea.
2716 (5V)	2048x8	4.75ea.
2732 (5V)	4096x8	8.95ea.

**RAMS**

4116-200NS	16k x1	1.55ea.
4164-200NS	64k x1	9.95ea.
2114L-200NS	1024x4	1.75ea.

**LEDs**

Jumbo Red	.10ea. Min. 10pcs.
Jumbo Yellow	.10ea. Min. 10pcs.

**SOCKETS**

8 Pin Tin L.P.	.08ea.	4 Pcs.	.60ea.
14 Pin Tin L.P.	.12ea.	7 Pcs.	.90ea.
16 Pin Tin L.P.	.13ea.	8 Pcs.	.90ea.
24 Pin Tin L.P.	.24ea.		
40 Pin Tin L.P.	.41ea.		

**FANS & MIBs**

4" Muffin Fans	7.88ea.
8080A	2.10ea.
MC6821P	2.95ea.

All merchandise is 100% Guaranteed. If not completely satisfied return for a full cash refund.

TERMS: CDD, VISA, or MASTERCARD accepted. Allow 2 weeks for personal checks to clear.

SHIPPING: 2.50 UPS ground Min. Order \$10.00  
3.50 UPS BLUE

Call Or Write  
**Electronic Super-Mart Inc.**  
587 Bay Road  
Hamilton, Mass. 01936  
(617) 468-3046

Circle 202 on inquiry card.

**Votrax® SC-01A  
SPEECH SYNTHESIZER**

**\$70 Each**  
(5 or more,  
**\$55 each)**

**Order in Ones or Thousands**

The SC-01A Speech Synthesizer is a completely self-contained solid state device. This single chip phonetically synthesizes continuous speech of unlimited vocabulary.

The SC-01A contains 64 different phonemes which are accessed by a 6-bit code. Computer interfaces and text-to-speech algorithms also available for product development.

Votrax is a trademark of Federal Screw Works

Call 1-800-645-3479, in N.Y. 1-516-374-6793

**MICROMINT INC.**

917 Midway  
Woodmere, N.Y. 11598



Call for quantity pricing.

Circle 464 on inquiry card.

**Bill Cosby  
says:**  
"When you  
learn CPR,  
you're  
ready to  
save lives—  
anywhere."

**American  
Red Cross**



# CALIFORNIA Digital

Post Office Box 3097 B • Torrance, California 90503

## NEW! Ampex D81 Terminal Only \$895

AMPEX

AMPEX

PRINT SEND LINE SEND PAGE  
SEND TAB TAB CLR PAGE CLEAR  
LINE READY CLEAR  
LINE

## D81 buffered editing terminal with detached Selectric-style keyboard.

Operates in conversational or block mode at synchronous rates to 19.2Kbps. RS232C interface. Operates in either full or half duplex. Parallel printer interface is standard. The D81 offers ergonomic design, sculptured profile and award-winning styling plus these features:

- Familiar Selectric-style detached keyboard
- Amber, green or white phosphors
- Non-glare 12" display formatted as 24 lines by 80 columns of data with 25th status line
- Standard memory two 1920 character pages with third and fourth pages optional
- Standard editing functions include erase, insert and delete character and line operations
- Full range of visual attributes

- Half-intensity protected fields
- 128 displayable symbols, including 96 ASCII characters, 21 control characters and 11 line drawing characters
- Twenty function keys with 10-key numeric pad. Function keys supported by standard 256KB memory expandable to 2MB
- Function key memory down-loadable from host.

### Also from Ampex!

**D80 Terminal.** Similar features to D81 but with detached programmer-type keyboard. **D30 Terminal.** Strictly inter-active terminal. Detached keyboard. Operates in on-line, local or monitor modes. Economy and ease of operation make it ideal for basic data communications.



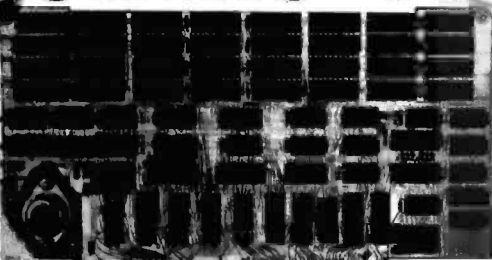
All merchandise sold by California Digital is premium grade. Shipping: First five pounds \$2.00; each additional add \$.40 Foreign orders 10% shipping. Excess will be refunded. California residents add 6% sales tax. COD's discouraged. Open accounts extended to state supported educational institutions and companies with a "Strong Dun & Bradstreet." Warehouse: 15608 Inglewood Blvd. Visitors by appointment.

TOLL FREE ORDER LINE  
**(800) 421-5041**  
TECHNICAL & CALIFORNIA  
**(213) 679-9001**

# CALIFORNIA DIGITAL

Post Office Box 3097 B • Torrance, California 90503

## California Digital STATIC • 64



RELIABILITY OF STATIC ... PRICE OF DYNAMIC

### Sixteen Bit Memory \$595

February Price \$850  
30% Price Reduction

Utilizing the new Hitachi 6167/2167 ram chip, the Static 64 is the most current technology available in S-100 memory products. 24 bit extended addressing, 8 or 16 bit data paths along with 16 bit request and acknowledge make this unique board completely compatible with the IEEE 696 S-100 bus standard.

The Static 64 has been engineered to allow each 16K segment of memory to be bank selectable supporting multiuser systems. Other selectable features allow the board to fully integrate with all current bank selecting schemes including Cromex and Alpha-Micro. Operates with all 18 bit computers including Seattle Computers, Temmar and Lomas. Designed for DMA operations at clock frequencies in excess of 10 MHz. Standby power consumption less than one Amp.

To add to the total integrity of the product, each board is subjected to extensive high temperature burn-in and test procedures. CAL-6400



## ZENITH \$119

### GREEN PHOSPHOR MONITOR

The new Zenith ZVM-121 monitor features a P-31 green phosphor tube along with 15 MHz bandwidth.

Switch selectable for 40 and 80 character per line screen formats.

Accepts composite video and is fully compatible with 80 column Apple cards. VDM-121 20 lbs.



IBM Direct Price \$1395

California Digital

discount \$1295  
price



AMPEX  
DIALOGUE 80  
REDUCED PRICE

\$795

New from the Amplex Corporation. The Dialogue 80 features removable keyboard, displayable two pages (four optional) dual program keys, half intensity protected fields and status line. Transmits data either block, line or character mode. Excellent value, VDT-D80 shipping 47 lbs.

### ACCESSORIES FOR THE APPLE COMPUTER

CALIFORNIA COMPUTER SYSTEMS  
Arithmetic Processor 7811 B/C \$319  
Asynchronous serial interface 7710 129  
Centronics interface card 7728 05  
12K PROM Module 7114 69  
Calendar/Clock, Bat-back-up 7424 99  
Parallel Interface 7720A 99  
Programmable Timer 7140A 99  
Analog/Digital converter 7470A 99

MICROSOFT PRODUCTS  
Apple to Z-80 CPU card 379  
D. C. HAYES PRODUCTS  
Micromodem for Apple 319  
COMPUTER STOP PRODUCTS  
Double Vision/80 Column Video 250  
INTERACTIVE STRUCTURES  
16 Channel A/D card AIO/2 275

MOUNTAIN COMPUTER PRODUCTS  
Intro X-10 system for MSK 1239  
Intro X-10 card only 165  
16 channel AD/DA 8 bit 310  
Apple Clock with battery back-up 223  
Supertaker SD200 245  
ROM Plus with filter 185  
ROM Writer/Programmer 119  
APPLE BRAND PRODUCTS  
Apple Language card 450  
Floppy disk with controller 370  
Floppy disk without controller 495  
Apple parallel interface 165  
SSI MICROCOMPUTER  
Dual serial parallel interface AIO 570  
SORRENTO VALLEY ASSOCIATES  
8" floppy controller (Pascal) 360



EPSON MX80

\$450

Epson MX80FT friction/fit \$595.00  
Epson MX100 132 column 70.00  
Grantrax 80 option 70.00  
Apple I/O cable (8131) 129.00  
Serial Interface (8141) 70.00  
Serial Inter., 2K buf. (8151) 145.00  
Cable for TRS-80 35.00  
IEEE 488 interface (8161) 65.00  
Replacement head 45.00  
Replacement Ribbon 14.00  
Paper 3500 sheets 9 1/2" 35.00



NEC PC-8023A

\$535

Dot-matrix, bi-directional, logic-seeking, friction or tractor feed, Impact printer. Complete graphics, upper and lower case ASCII, Greek, mathematics along with the ability to print dot graphic screen images directly onto paper. Proportional spacing and 132 column compressed print make this low cost machine the best value in today's printer market.

### PRINTRONIX

P-300 \$4500

P-600 \$6150



## PRINTERS

Epson MX80	PREMX80	5475	NEC/Setium 1	PRN5510ps	2695
Epson MX80FT	PREMX80F	595	NEC/Sm 16K	PRN5510ps	2795
Epson MX100	PREMX100	1295	TEC/Starwrit	PRV300	1395
Anadex 9500	PRA9500	1295	Okidata 80	PRO80	419
Anadex 9501	PRA9501	1295	Okidata 83	PRO83	895
Anacom 150	PR150	1075	Teletype 43K	PTT4320K	1095
IDS Paper Tgr.	PRG460C	1095	Texas Ins. 810	PRT810C	1450
IDS Tiger 560	PRG560C	1350	Tex. Ins 810C	PRT810C	1795
Diablo 630	PRD630	2150	Centronics 730	PRC730P	529
Diablo 1550	PRD1550	2850	Centronics 737	PRC737P	685
Diablo 1640	PRD1640	2495	Centronics 739	PRC739P	795
Datasouth 180	PRD180	1350	Centrx 704-9	PRC704-9	
Printronix 300	PRP300	4500	Centrx 704-11	PRC704-11	
Printronix 600	PRP600	6150			

## VIDEO TERMINALS

ADDS Viewpoint	VDT-RVP	595
ADDS Regent 25 numeric cluster	VDT-R25	850
ADDS Regent 30 25th status line	VDT-R30	950
ADDS Regent 40 limited graphics	VDT-R40	1195
ADDS Regent 60 Block mode	VDT-R60	1495
Amplex Dialogue 80 two page, detach	VDT-D80	
Digital Equipment VT-100	VDT-V100	1595
IBM 3101-10 character mode green	VDT-V132	1895
IBM 3101-20 block mode	VDT-3101	1195
Visual 200	VDT-31012	1395
Televideo 910C (new)	VDT-V200	995
Televideo 912C	VDT-T910	595
Televideo 920C	VDT-T912	665
Televideo 950C detachable keybd.	VDT-T920	745
Zenith Z-19	VDT-T950	985
	VDT-Z-19	

## VIDEO MONITORS

BMC KG-12C 20 MHz	
P31 green phosphor	\$169
NEC gm. 1201	189
Zenith gm ZVM121	119
BMC color composit	339
Zenith color 13"	395
NEC RGB 1202DH	895

EPROM ERASER  
Ultra Violet Products

\$65

UVP-11E



### Rotron Muffin Fan

\$14.77

\$12.00 @ 100

10.50 @ 1000

115 VAC, 7 Watts WR2A1  
Factory fresh Muffin fans  
NOT pull-outs. EMF-4M



## SYSTEMS

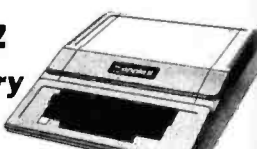


HEWLETT  
PACKARD  
HP 85 COMPUTER

BELOW OUR COST

\$2295

Apple  
48K Memory  
\$1150



VISA

master charge

All merchandise sold by California Digital is premium grade. Shipping: First five pounds \$2.00; each additional add \$4.00 Foreign orders 10% shipping. Excess will be refunded. California residents add 6% sales tax. COD's discouraged. Open accounts extended to state supported educational institutions and companies with a "Strong Dun & Bradstreet." Warehouse: 15608 Inglewood Blvd. Visitors by appointment.

TOLL FREE ORDER LINE  
**(800) 421-5041**  
TECHNICAL & CALIFORNIA  
**(213) 679-9001**  
TWX 910 325-6212

# CALIFORNIA DIGITAL

Post Office Box 3097 B • Torrance, California 90503

## DISKETTES

FREE PLASTIC LIBRARY CASE INCLUDED WITH THE PURCHASE OF EVERY BOX OF DISKETTES

**\$24.95**

Private labeled for California Digital by one of the most respected producers of magnetic media. Each diskette is certified double density at 40 tracks. To insure extended media life each diskette is manufactured with a reinforced hub-hole. And of course, a plastic library case is included with every box of diskettes. MMD-CDS01K101 Please specify computer or required sectors.

Ten boxes \$22.75 One hundred boxes \$21.50

**5 1/4" DISKETTES WITH LIBRARY CASE \$26.50**

Your Choice **SCOTCH MEMOREX VERBATIM**

	Soft Sector	10 Sector	16 Sector	
SCOTCH	744-0	744-10	744-16	\$26.50
MEMOREX	3401	3403	3405	26.50
VERBATIM	525-01	525-10	NA	26.50
DYSAN	104/1	107/1	NA	39.50

Single Side Double Density

DYSAN	104/1D	107/1D	NA	45.00
-------	--------	--------	----	-------

Double Side Double Density

SCOTCH	745-0	745-10	745-16	42.50
DYSAN	104/2D	107/2D	NA	49.50
DYSAN 96	204/2D	NA	NA	59.50

### EIGHT INCH DISKETTES

Single Side Single Density			Single Side Double Density		
SCOTCH	740-0	29.50	SCOTCH	741-0	39.00
MEMOREX	3060	29.50	MEMOREX	3090	35.00
DYSAN	3740/1	39.50	DYSAN	3740/D	57.50

Thirty Two Sector			Double side Double Density		
SCOTCH	740-32	29.50	SCOTCH	743-0	47.50
Memorex	3114	39.50	DYSAN	3740/2D	65.00

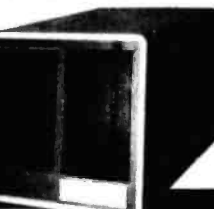
PLEASE PHONE FOR VOLUME PRICING.



**BSR SYSTEM X-10**

The new BSR timer runs your home just like clockwork. Turn on lamps and appliances while you're away from home. Completely compatible with your existing System X-10 devices.

BSR Timer eight channel \$65.00  
Master control console 34.00  
Ultra-sonic Controller 19.95



**\$1250**

Includes seven megabyte Winchester hard disk, dual enclosure and power supply. Floppy backup drive \$199.00 additional.



## MEMORY

64K DYNAMIC \$9.95	16K STATIC \$13.95
4164 100-	2167 70ns.
16K DYNAMIC \$2.10	2716 EPROM \$4.95
4116 100-1185	100-4.50 1K-4.00



**2732 EPROM SALE \$7.95**

### STATIC

	ea.	32+	100+	1K+
21L02 1K	1.19	1.09	1.05	.99
2114 300ns.	2.95	2.75	2.50	1.89
4044-4 450ns.	4.50	4.19	4.00	3.75
4044-2 250ns.	4.95	4.65	4.50	4.25
6116 16k 24 pin	7.95	7.50	6.75	5.43
2167/6167 20 pin	11.95	10.75	9.65	8.25

### EPROM

2708 450ns.	3.95	3.50	3.25	3.00
2716 5V.	4.95	4.00	3.75	3.50
2716 tri-volt	8.50	7.95	7.65	7.25
2732 Intel/Hitac.	7.95	7.50	7.00	6.65
2532 Texas Inst	12.95	11.50	10.00	9.50
2764 64K Eprom	29.95	27.00	25.00	23.50



**direct connect MODEM Your Choice \$169**

Direct connect modems eliminate loss of information due to the carbon compression associated with acoustic modems. Choose either of these two great units.

The Universal Data Systems 103LP is switch selectable between answer and originate modes. Fully Bell 103 compatible. Directly connects to the new modular telephone jack. 100% powered from the telephone line. No need to locate modem in proximity to A.C. power receptacle. MOU-103LP 2 pounds.

Novation 'D' Cal connects to most of the new "Bell" modular handsets. Ideal for multiple line office telephones. Requires external A.C. power. MOU-DCAAT 2 Lb.

## SWITCHES

DIP SWITCHES				TOGGLE			
pos.	ea.	100+	1K+	pos.	ea.	100+	1K+
4	.88	.75	.69	7101 on/on	1.19	.99	
7	.99	.83	.79	7103 on/off/on	1.39	1.19	
8	1.05	.91	.87	7107 mnt. on	1.39	1.19	
12	1.19	.99	.91	7108 mnt. on	1.39	1.19	
				7205 dip-mnt	1.85	1.63	

## CONNECTORS



GOLD EDGE CONNECTORS			
S-100 .125" centers	each	100+	
Imasal solder wrap (TI)	row	\$2.95	\$2.50
Imasal wire wrap (TI)		3.85	3.50
Sullins Hi-Rel. .250"		4.50	4.00
Sullins Hi-Rel. W/W		5.35	4.90
Sullins /Alisr. .140"		4.95	4.50
.156" Centers (standard)			
22/44 Kim Eyelet		2.50	2.15
36/72 Digital Group S/T		3.25	3.50
36/72 Digital Group W/W		6.60	6.15
43/86 Motorola 6800 S/T		6.60	6.15
43/86 Motorola 6800 W/W		7.00	6.85

INTEGRATED CIRCUIT SOCKETS			
Low Profile	each	100+	Wire Wrap
8 pin	\$1.00	\$2.00	\$4.66
14 pin	.10	.09	.45
16 pin	.12	.11	.50
18 pin	.15	.13	.60
24 pin	.26	.24	.94
40 pin	.42	.40	1.60

'D' Type			
DE3P male	\$1.60	\$1.40	\$1.30
DE5P female	2.25	2.00	1.90
DE hood	1.50	1.35	1.20
DA15P male	2.35	2.15	2.00
DA15S female	3.25	3.00	3.00
DA hood 2/P	1.40	1.25	1.30
DB25P male	2.50	2.35	2.25
DB25S female	3.35	3.15	3.05
DB hood 2/P	1.35	1.15	1.05
DC37P male	4.20	4.00	3.70
DC37S female	6.00	5.75	5.50
DC hood 2/P	2.25	2.00	1.75
DD50P male	5.50	5.10	4.75
DD50S female	9.40	8.60	8.00
DD50 hood 2/P	2.60	2.40	2.10

CENTRONICS			
57-30360	7.95	6.75	5.75

HIBBON CABLE CONNECTORS			
17/04 "diak	4.95	4.15	3.95
20/40 TRS-80	5.65	5.05	4.70
25/50 "diak	5.90	5.15	4.90



**NEW OLIVETTI 801 \$295**

Eight Inch Disk Drive

		ONE	TWO	TEN
★ OLIVETTI 801	single	\$319	309	295
★ OLIVETTI 802/851	double	425	419	410
SHUGART 801/R	single	395	385	375
SHUGART 851/R	double	525	495	475
QUME DATA TRACK 8	double	525	495	475

\* The 8" Olivetti drives are approx. 1/2" wider than the Shugarts.

### Five Inch Disk Drives

OLIVETTI 501/400	single	199	185	175
OLIVETTI 502/451	double	235	225	215

Upon request, all drives are supplied with power connectors and one manual per order.

230 volt 50Hz. 8" add \$50.00 per drive.



**\$995 Eight Inch Subsystem**

Two Olivetti 801 disk drives with power supply, 4" exhaust fan complete in dual enclosure with all necessary power cables. Documentation included. 50 Lbs. CAL-2801

Signal cable add \$35.00 WCA-6500

Same as above but with:

Shugart 801R	MSD2801	\$1195	Olivetti 802	CAL2802	\$1250
Shugart 851R	MSD2851	1450	Dume 078	MSD6DT	1450

**SPECIAL \$895**

**Seagate Compatible 7.5 MEGABYTE Winchester Hard Disk Drive**

We have priced this so low that the manufacturer has asked not to use their brand name in our advertising. Industry standard Seagate plug compatible. Drive fits into the same space as a 5 1/4" floppy disk drive. CAL-561/2

**S-100 MOTHER BOARD**

**\$35**

The quietness from California Digital is quality engineered. No short cuts have been taken to produce this mother board. Active termination circuitry prevents noise and crosstalk, manufactured from ultra heavy epoxy glass.

MSAI 18 Slot CAL-M18

**TOLL FREE ORDER LINE (800) 421-5041**

**TECHNICAL & CALIFORNIA (213) 679-9001**

TWX 910 325-6212

All merchandise sold by California Digital is premium grade. Shipping: First five pounds \$2.00; each additional add \$4.00 Foreign orders 10% shipping. Excess will be refunded. California residents add 6% sales tax. COD's discouraged. Open accounts extended to state supported educational institutions and companies with a "Strong Dun & Bradstreet." Warehouse: 15600 Inglewood Blvd. Visitors by appointment.



### FLOPPY DISK DRIVES



**SPECIAL!!!!!!! QUME DATATRAK 8**  
 Virtually the industry standard. High quality/  
 reliability. Full featured, double, sided, double  
 density.  
 Tandon TM 848 ..... \$545  
 \$525 quantity 1, \$499 quantity 2 up.

- TANDON DOUBLE SIDED, DOUBLE DENSITY MINIS**  
 TM100-2 . . . . 48 TPI (500 KBYTES) ..... \$325  
 Compatible with Northstar, Cromemco, TRS-80  
 TM100-4 . . . . 96 TPI (1000 KBYTES) ..... \$425  
 Compatible with Zenith, Heath, etc.  
**TANDON 5 1/4" HARD DISKS**  
 TM 602 (5MB) ..... \$1195  
 TM 603 (10MB) ..... \$1295

### CONTROLLERS

- Tarbell single density kit ..... \$195  
 Tarbell single density A & T ..... \$310  
 Tarbell double density A & T ..... \$425  
 CCS 2422 w/CPM 2.2 ..... \$350  
 Godbout Disk 1 ..... \$450  
 MDA MXV-21 LSI-11 controller (RX-01, RX-02 compatible) ..... \$1050



### MISCELLANEOUS

- 2 Disk drive enclosure ..... \$ 95  
 (fits Siemens, Shugart, Qume)  
 CP-206 power supply ..... \$110  
 (powers two floppies)

- Cable Kits 2 drives ..... \$ 35  
 3 drives ..... \$ 40  
 4 drives ..... \$ 45  
 Diskettes ss \$39/10 - ds \$59/10

- Mini-Enclosure with power supply  
 1 drive ..... \$ 85  
 2 drives ..... \$120

## Electrolabs

POB 1608, Palo Alto, CA 94302 (415) 965-7040

### CPU

- CCS 2810 ..... \$ 275  
 Godbout Z-80A ..... \$ 275  
 Godbout 8085A ..... \$ 295

### MEMORY

- CCS 2065 64K dynamic ..... \$ 595  
 CCS 2116 32K static ..... \$ 625  
 Godbout RAM 17 64K ..... \$ 675

### I/O

- CCS 2710 4 SIO ..... \$ 325  
 Godbout Interfacer 1 ..... \$ 225  
 Godbout Interfacer 2 ..... \$ 225

### NEW !!!!

**Qume Sprint 9**  
**DAISY WHEEL PRINTER . . \$2395**  
 45 CPS, RO. Available in KSR version.  
 Call for further particulars.  
 Ribbons: \$125/case  
 Bidirectional tractor feed \$225

### NEW !!!!

**ABM 85 Video Terminal . . \$ 895**  
 - Detachable keyboard  
 - Televideo 920, ADM 3A compatible  
 - High resolution green phosphor (23 MHZ)  
 - Extra multi-bus or S-100 slot for stand-alone capability

Terms of sale: cash or checks, MC/  
 VISA. Min. order \$25. CA residents  
 add 6% tax. Prices subject to change  
 without notice. All goods subject to  
 prior sale.

# General Software

**Main Offices:**  
**9060 Arrowood Ct.**  
**Terre Haute, IN 47802**  
 WE HONOR  
**VISA and MASTERCHARGE**  
**TOLL FREE - Outside Indiana**  
**1-800-457-0517**  
**ORDER DESKS**  
**(812) 299-2484**  
 Best Selection Best Service

Write for our famous CATALOG.  
 Contains many items not in ad.

Outside US add \$10 plus additional postage. Add \$3.50 postage and handling per each item. Indiana residents add 4% sales tax. Allow 2 weeks on checks. COD ok. Prices subject to change without notice. All items subject to availability.

- ARTIFICIAL INTELLIGENCE**  
 Disk Manual with Only  
 Dental (PAS-3) ..... \$849/40  
 Medical (PAS-3) ..... \$849/40  
**ASHTON-TATE** ..... \$575/50  
**\*dBASE II**  
**BUSINESS PLANNING SYSTEMS**  
 Plan-80 ..... 269/30  
**BYRON SOFTWARE**  
 \*BSTAM ..... \$149/15  
 \*BSTMS ..... \$149/15

- COMPUTER CONTROL**  
 \*Fabs (B-Tree) ..... \$159/25  
 Ultrasort ..... \$159/25  
**CONDOR COMPUTER**  
 Condor II ..... \$549/50  
 Condor III ..... \$899/50  
**DIGITAL RESEARCH**  
 CP/M  
 2.2 Intel MDS-800 ..... \$149/25  
 Northstar (Horizon) ..... \$149/25  
 Micropolis ..... \$169/25  
 TRS Model II ..... \$159/35  
 CB-80 ..... \$459/35  
 CBasic2 ..... \$ 98/20  
**ERIC COMPUTER**  
 \*Super vyx ..... \$ 89/15  
**FAIRCOP**  
 \*Micro B+  
 (Specify language) ..... \$229/20  
**FINANCIAL PLANNING**  
 \*Mini Model ..... \$449/50  
**FRIENDS**  
 ACCESS 80 I ..... \$249  
 ACCESS 80 II ..... \$429  
**FRONTIER SOFTWARE**  
 Professional  
 Time Accounting ..... \$549/40  
 General Subroutine ..... \$269/40  
 Application Utilities ..... \$439/40  
**ISA**  
 Spellguard ..... \$229/25  
 SPLaw ..... \$109  
**PASCAL LANGUAGE**  
 Pascal Z ..... \$349/30  
 Pascal MT + V5.5 ..... \$429/30  
 Compiler ..... \$316/20  
 SPP Only ..... \$140/15  
**KEY BITS**  
 Wordsearch ..... \$179/50  
 String 80 ..... \$ 84/20  
 String 80 (Source) ..... \$279  
 String Br ..... \$ 65  
**LEXISOFT**  
 \*Spellbinder ..... \$349/45  
**MICRO AP**  
 Selector IV ..... \$269/35  
 Selector V ..... \$469/50  
 SBasic ..... \$269/25

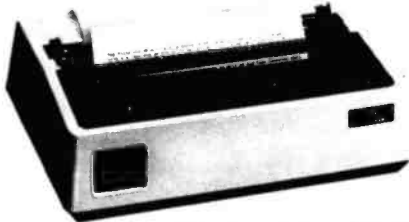
- MICRO TAX**  
 \*Level I ..... \$249  
 \*Level II ..... \$995  
 \*Level III ..... \$749  
 \*Combo II + III ..... \$1495  
 Microsoft 5.3 ..... 49  
 Run time module  
**MICRO PRO**  
 Wordstar ..... \$309/60  
 WS Training Guide ..... 20  
 WS Custom Notes ..... \$429/na  
 MailMerge ..... \$109/25  
 WS-Mailmerge ..... \$419/85  
 Datastar ..... \$249/60  
 DS Custom Notes ..... \$429/na  
 Calcstar ..... \$259/na  
 Supersort I ..... \$199/40  
 Spellstar ..... \$175/40  
**MICROSOFT**  
 Basic-80 ..... \$298  
 Basic Compiler ..... \$329  
 Fortran-80 ..... \$349  
 Cobol-80 ..... \$629  
 M-Sort ..... \$124  
 Macro-80 ..... \$144  
 Edit-80 ..... \$ 84  
 MuSimp/muMath ..... \$224  
 MuLisp-80 ..... \$174  
**NORTHWEST ANALYTICAL**  
 \*Statpak ..... \$439/40  
**OASIS**  
 \*The Word\* ..... \$ 75  
**ORGANIC SOFTWARE**  
 \*Textwriter III ..... \$111/25  
 \*Datebook ..... \$269/25  
 \*Milestone ..... \$269/30  
**PEACHTREE SOFTWARE**  
 General Ledger ..... \$399/40  
 Accounts Receivable ..... \$399/40  
 Accounts Payable ..... \$399/40  
 Payroll ..... \$399/40  
 Inventory ..... \$399/40  
 Mailing Address ..... \$399/40  
 for P5 Version ..... add \$119  
 Series 6-Peachtree ..... \$799/40  
 CPA ..... \$799/40  
 Property Mgt ..... \$799/40  
 Passive Payroll ..... \$449/40  
 Series 7-Peachtree ..... \$3049/55  
 Sales Tracker ..... \$1299/50  
 AR-Sales Analysis

- Inventory ..... \$799/40  
 Order Entry ..... \$699/40  
**REDDING GROUP**  
 \*Lynx ..... \$199/20  
**SOHO GROUP**  
 Matchmaker ..... \$ 97/20  
 Worksheet ..... \$177/20  
**SORCOM**  
 \*PascalM 280 ..... \$349/40  
 PascalM 86/88 ..... \$449/40  
 \*Act 65 ..... \$149/20  
 \*Act 68 ..... \$149/25  
 \*Act 69 ..... \$149/25  
 \*Act 86/88 ..... \$119/25  
 \*Trans 86 ..... \$269  
 \*Supercalc ..... \$269  
**SOUTHERN COMPUTERS**  
 \*Raid ..... \$224/35  
 \*Raid FP ..... \$349/35  
 \*FFF ..... \$224/15  
 \*Recover ..... \$ 75  
 \*RADAR ..... \$449/25  
 ISIS ..... \$224/20  
**STRUCTURED SYSTEMS GROUP**  
 General Ledger ..... \$849/40  
 Accounts Receivable ..... \$849/40  
 Accounts Payable ..... \$849/40  
 Payroll ..... \$849/40  
 Inventory ..... \$849/40  
 Order Entry ..... \$849/40  
 Analyst ..... \$224/25  
 Letteright ..... \$159/20  
 NAD ..... \$ 89/20  
 Qsort ..... \$ 89/20  
**SUPERSOFT**  
 \*Diagnostic II ..... \$ 84/20  
 \*Forth ..... \$149/30  
 \*SSS Fortran ..... \$219/30  
 \*Fortran w/RATFOR ..... \$289/35  
 \*C Compiler ..... \$175/20  
 \*Disk Doctor ..... \$ 84/20  
 \*Term I ..... \$129/25  
 Term II ..... \$169/25  
 Z8000 Xassembler ..... \$449/35  
 Others less 10%  
**WHITESMITHS**  
 C Compiler ..... \$600/30  
 Pascal (incl C) ..... \$850/45  
 Call for catalog and other listings

\* Available for Apple with Softcard

# Orange County ● Sunnyvale San Diego ● Los Angeles San Fernando Valley ● Dallas

## BETTER THAN EPSON! - Okidata



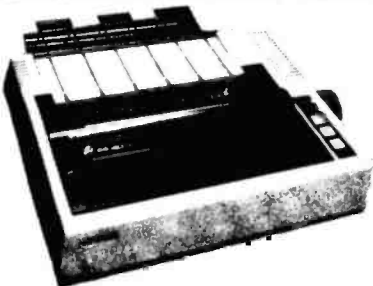
**Microline 82A** 80 132 column, 120 CPS, 9 x 9 dot matrix, friction feed, pin feed, adjustable tractor feed (optional), handles 4 part forms up to 9.5" wide, rear & bottom feed, paper tear bar, 100% duty cycle/200,000,000 character print head, bi-directional/logic seeking, both serial & parallel interfaces included, front panel search & program control of 10 different form lengths, uses inexpensive spool type ribbons, double width & condensed characters, true lower case descenders & graphics  
PRM-43082 Friction & pin feed ... \$499.95

**Microline 83A** 132 232 column, 120 CPS, handles forms up to 15" wide, removable tractor, plus all the features of the 82A.  
PRM-43083 with FREE tractor ... \$744.95

**Microline 84** 132 232 column, 200 CPS, full dot graphics built in, handles forms up to 15" wide, plus all the features of the 83A.  
PRM-43083 with FREE tractor ... \$1149.95

PRA-27081 Apple card ..... \$39.95  
PRA-27082 Apple cable ..... \$19.95  
PRA-27087 TRS-80 cable ..... \$24.95  
PRA-43081 2K hi spd serial card ... \$169.95  
PRA-43082 Graphics ROMs 82A .... \$79.95  
PRA-43083 Graphics ROMs 83A .... \$79.95  
PRA-43088 Tractor option 82A .... \$39.95  
PRA-43080 Extra ribbons pkg. of 2 ... \$9.95

## INEXPENSIVE PRINTERS - Epson



**MX-70** 80 column, 80 CPS, 5 x 7 dot matrix, adjustable tractor feed, & graphics  
PRM-27070 List \$459 ..... \$389.95

**MX-80** 80 column, 80 CPS, bi-directional/logic seeking printing, 9 x 9 dot matrix, adjustable pin feed, & 64 graphics characters  
PRM-27080 List \$615 ..... \$429.95

**MX-80FT** same as MX-80 with friction feed added.  
PRM-27082 List \$745 ..... \$529.95

**MX-100** 132 column, correspondence quality, graphics, up to 15" paper, friction feed & adjustable pin feed, 9 x 9 dot matrix, 80 CPS.  
PRM-27100 List \$945 ..... \$724.95

PRA-27084 Serial interface ..... \$54.95  
PRA-27088 Serial intf & 2K buffer ... \$144.95  
PRA-27081 Apple card ..... \$39.95  
PRA-27082 Apple cable ..... \$19.95  
PRA-27086 IEEE 488 card ..... \$52.95  
PRA-27087 TRS-80 cable ..... \$24.95  
PRA-27085 Graftrax II ..... \$75.00  
PRA-27090 Extra print head ..... \$44.95  
PRA-27083 MX-80 ribbon cart. .... \$13.95  
PRA-27101 MX-100 ribbon only ..... \$9.95

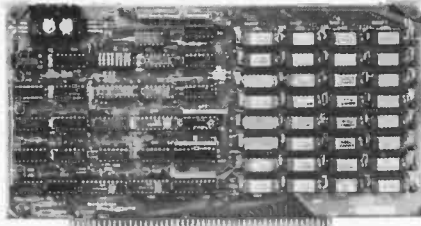
## 16K RAM Card for Apple II was \$175, Now Only \$74.95

Expand your Apple's memory from 48K to 64K with this assembled & tested RAM Card that just plugs right into your Apple. Take advantage of this half price sale !!!

MEX-16700A 16K RAM Card ..... \$74.95

## SD Systems ExpandoRAM III

64K to 256K expandable RAM board



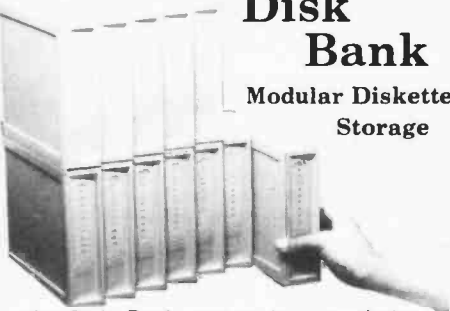
SD Systems has duplicated the famous reliability of their ExpandoRAM I and II boards in the new ExpandoRAM III, a board capable of containing 256K of high speed RAM. Utilizing the new 64K x 1 dynamic RAM chips, you can configure a memory of 64K, 128K, 192K, or 256K, all on one S-100 board. Memory address decoding is done by a programmed bipolar ROM so that the memory map may be dip-switch configured to work with either COSMOS/MPM-type systems or with OASIS-type systems.

Extensive application notes concerning how to operate the ExpandoRAM III with Cromemco, Intersystems, and other popular 4 MHz Z-80 systems are contained in the manual.

MEM-65064A 64K A & T ..... \$424.95  
MEM-65128A 128K A & T ..... \$494.95  
MEM-65192A 192K A & T ..... \$559.95  
MEM-65256A 256K A & T ..... \$595.00

## Disk Bank

Modular Diskette Storage



The Disk Bank system is a revolutionary diskette storage concept designed to handle all your diskette storage needs no matter how small or large.

The Disk Bank system can grow as your storage needs grow. Its modular interlocking design allows you to add to your system horizontally or vertically. And Disk Bank's design allows easy access to your diskettes. Just open the drawer and slide it out. The diskette retaining gate falls forward automatically for easy access to any of the 10 diskettes, without fear of bending or crimping. Shipping weight 1 lb.

MMA-405 5 1/4" Disk Bank ..... \$4.95  
MMA-408 8" Disk Bank ..... \$5.95

## Modems on Sale !!!!

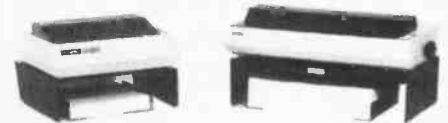


**SIGNALMAN - Anchor**  
Direct-connect automatic answer/originate selection, 300 Baud full duplex, Bell 103, includes RS-232 cable  
IOM-5600A Signalman ..... \$98.50

**SMARTMODEM - Hayes**  
Sophisticated direct-connect auto-answer/auto-dial modem, touch-tone or pulse dialing, RS-232C interface, programmable  
IOM-5400A Smartmodem ..... \$249.95  
IOK-1500A Hayes Chronograph ... \$219.95  
IOM-2010A Micromodem II ..... \$329.95  
IOM-1100A Micromodem 100 ..... \$375.00

**Apple-CAT - Novation**  
Software selectable 1200 or 300 Baud, direct connect, auto-answer/auto-dial/dialing, auxiliary 3-wire RS-232C serial port for printer  
IOM-5232A Save \$50.00 ..... \$325.00

## FMJ Inc Printer Pal Model P80 & P100



P80 dimensions: 14 1/2" wide, 13" deep, 4 1/2" high •  
P100 dimensions: 21" wide, 13" deep, 5 1/2" high •  
Stores paper below printer • Constructed of 16 gauge steel • Attractive textured finish • Plastic trim and rubber feet • Adjustable paper support brackets.

The Printer Pal is a very simple, but convenient paper rack and printer stand. The Model P80 will support an 80 column printer such as the Epson MX80/MX80FT or the Okidata 82A. The Model P100 supports the larger 132 column printers like the Epson MX100 or the Okidata 83A. Either model performs the same function; to act as a stand for your printer while keeping your paper straight and tidy so you can spend your time computing instead of realigning your printer paper.

PRA-99080 P80, 10 lbs ..... \$24.95  
PRA-99100 P100, 12 lbs ..... \$29.95

## Place Orders Toll Free

Continental U.S. Inside California  
800-421-5500 800-262-1710

For Technical Inquires or Customer Service call:  
213-973-7707

## JADE Computer Products

4901 W. Rosecrans, Hawthorne, Ca 90250

TERMS of SALE: Cash, checks, credit cards, or Purchase Orders from qualified firms and institutions. Minimum Order \$15.00. California residents add 6% tax. Minimum shipping & handling charge \$3.00. Pricing & availability subject to change

Circle 222 on Inquiry card.

# JADE

Computer Products

3313 S. Bristol St.  
Santa Ana, Calif.  
714-549-7108

## PLACE ORDERS TOLL FREE.

# JADE

Computer Products

1291 W. El Camino Real  
Sunnyvale, Calif.  
415-965-7980

Continental U.S. - 800-421-5500  
Inside California - 800-262-1710  
Los Angeles Area - 213-973-7707

# JADE

Computer Products

4344 Convoy Street  
Kearny Mesa, Calif.  
714-268-4661

## JADE Disk Sub-Systems

Shugart, Siemens, Qume



Handsome metal cabinet with proportionally balanced air flow system • Rugged dual drive power supply • Power cable kit • Power switch, line cord, fuse holder, cooling fan • Never-Mar rubber feet • All necessary hardware to mount 2-8" disk drives, power supply, and fan • Does not include signal cable

### Dual 8" Subassembly Cabinet

END-000420 Bare cabinet .....	\$59.95
END-000421 Cabinet kit .....	\$225.00
END-000431 A & T .....	\$359.95

### 8" Disk Drive Subsystems

#### Single Sided, Double Density

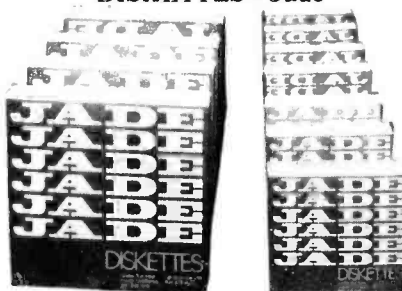
END-000423 Kit w 2 FD100-8Ds .....	\$924.95
END-000424 A & T w 2 FD100-8Ds .....	\$1124.95
END-000433 Kit w 2 SA-801Rs .....	\$999.95
END-000434 A & T w 2 SA-801Rs .....	\$1195.00

### 8" Disk Drive Subsystems

#### Double Sided, Double Density

END-000426 Kit w 2 DT-8s .....	\$1224.95
END-000427 A & T w 2 DT-8s .....	\$1424.95
END-000436 Kit w 2 SA-851Rs .....	\$1295.00
END-000437 A & T w 2 SA-851Rs .....	\$1495.00

### DISKETTES - Jade



We proudly put our name on these high quality diskettes guaranteed to satisfy you or your money back.

### 5 1/4" Diskettes, Box of Ten

MMD-5110103 SS, SD, 01S .....	\$29.00
MMD-5111003 SS, SD, 10S .....	\$29.00
MMD-5111603 SS, SD, 16S .....	\$29.00
MMD-5120103 SS, DD, 01S .....	\$31.00
MMD-5121003 SS, DD, 010 .....	\$31.00
MMD-5121603 SS, DD, 16S .....	\$31.00

### 8" Diskettes, Box of Ten

MMD-8110103 SS, SD, 01S .....	\$31.00
MMD-8120103 SS, DD, 01S .....	\$39.00
MMD-8220103 DS, DD, 01S .....	\$48.00

### EPROM ERASER - Spectronics

Ultra-violet EPROM erasers

XME-3100A With out timer .....	\$69.50
XME-3101 With timer .....	\$94.50
XME-3200 Economy Model .....	\$39.95

### 16K MEMORY UPGRADE

Add 16K of RAM to your TRS-80, Apple, or Exidy in just minutes. We've sold thousands of these 16K RAM upgrades which include the appropriate memory chips (as specified by the manufacturer), all necessary jumper blocks, fool-proof instructions, and our 1 year guarantee.

MEX-16100K TRS-80 kit .....	\$25.00
MEX-16101K Apple kit .....	\$25.00
MEX-16102K Exidy kit .....	\$25.00

### 16K RAM CARD - for Apple II

Expand your Apple to 64K. 1 year warranty

MEX-16700A Save \$125.00 !!! .....	\$74.95
------------------------------------	---------

### Z-80\* CARD for APPLE

Two computers in one. Z-80 & 6502, more than doubles the power & potential of your Apple, includes Z-80\* CPU card, CP/M 2.2, & BASIC-80

CPX-30800A A & T .....	\$299.95
------------------------	----------

### 8" DISK CONTROLLER

New from Vista Computer, single or double sided, single or double density, compatible with DOS 3.2/3.3, Pascal, & CPM 2.2. Shugart & Qume compatible

IOD-2700A A & T .....	\$499.95
-----------------------	----------

### 2 MEGABYTES for Apple II

Complete package includes: Two 8" double-density disk drives, Vista double-density 8" disk controller, cabinet, power supply, & cables. DOS 3.2/3.3, CP/M 2.2, & Pascal compatible.

1 MegaByte Package (Kit) .....	\$1495.00
1 MegaByte Package (A & T) .....	\$1695.00
2 MegaByte Package (Kit) .....	\$1795.00
2 MegaByte Package (A & T) .....	\$1995.95

### Apple-CAT - Novation

Software selectable 1200 or 300 baud, direct connect, auto-answer/auto-dial, auxiliary 3-wire RS232C serial port for printer.

IOM-5232A Save \$50.00!!! .....	\$334.95
---------------------------------	----------

### DISK DRIVES - Micro Sci

Inexpensive disk drives for your Apple

A2 Direct replacement for Apple Disk II, works with Apple II controller as first or second drive.

MSM-123101 Micro Sci A2 .....	\$429.95
MSM-123101C A2 with contrlr .....	\$499.95

A40 40 track drive for Apple II. Improved storage capacity and speed over Apple Brand drives - requires Micro Sci controller.

IOD-2340A Micro Sci A40 .....	\$399.95
-------------------------------	----------

A70 70 track drive for Apple II. Twice the storage capacity and three times faster than Apple Brand drives - requires Micro Sci controller

IOD-2370A Micro Sci A70 .....	\$499.95
-------------------------------	----------

Micro Sci Controller Disk controller for up to two Micro Sci A40 or A70 disk drives, DOS 3.2, 3.3, Pascal, and Z-80 SoftCard compatible, includes utility disk and 40/70 track patch.

IOD-2300A Micro Sci controller .....	\$95.00
--------------------------------------	---------

### VISION 80 - Vista Computer

80 column x 24 line video card for Apple II. 128 ASCII characters, upper and lower case, 9 x 10 dot matrix with 3 dot descenders, standard data media terminal control codes, CP/M Pascal & Fortran compatible. 50/60 Hz

IOV-2400A Vista Vision 80 .....	\$375.00
---------------------------------	----------

### Joystick - T G Products

A better joystick for your Apple II

SYA-1512A A & T .....	\$49.95
-----------------------	---------

### CPS MULTICARD - Mtn. Computer

Three cards in one! Real time clock, calendar, serial interface, & parallel interface - all on one card.

IOX-2300A A & T .....	\$179.95
-----------------------	----------

## Commodore VIC-20 Computer



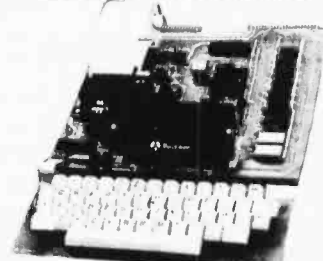
Complete personal computer with 5K RAM, full color, 61 key keyboard, 4 dual special-function keys, serial ports, cassette port, composite video output (connects to standard color TV set), BASIC language, & expansion port.

COM-VIC20 VIC-20 .....	\$279.95
------------------------	----------

### Z-80 STARTER KIT - SD Systems

Complete Z-80 microcomputer with RAM, ROM, I/O, keyboard, display, kludge area, manual, & workbook

CPS-30100K KIT .....	\$299.95
CPS-30100A A & T .....	\$469.95



### AIM-65 - Rockwell

6502 computer with alphanumeric display, printer, & keyboard, and complete instructional manuals

CPK-50165A 1K AIM-65 .....	\$424.95
CPK-50465A 4K AIM-65 .....	\$474.95
SFK-74600008E 8K BASIC ROM .....	\$64.95
SFK-64600004E 4K Assembler ROM .....	\$43.95
PSX-030A Power Supply .....	\$64.95
ENX-00002 Enclosure .....	\$54.95
SFK-74600020E PL/65 ROM .....	\$84.95
SFK-74600010E Forth ROM .....	\$64.95
SFK-74600030E Instant Pascal .....	\$99.95

### Special Packages

1K AIM-65, 8K BASIC, power supply & enclosure Special Package Price .....	\$649.95
--	----------

## Video Monitors

### HI-RES 12" GREEN - Zenith

15 MHz bandwidth, 700 lines inch, P31 green phosphor, switchable 40 or 80 columns, small, light-weight & portable.

VDM-201201 List price \$150.00 .....	\$118.95
--------------------------------------	----------

### 12" GREEN SCREEN - NEC

20 MHz, P31 phosphor video monitor with audio, exceptionally high resolution - A fantastic monitor at a very reasonable price

VDM-651200 Special Sale Price .....	\$169.95
-------------------------------------	----------

### 12" COLOR MONITOR - NEC

Hi-res monitor with audio & sculptured case

VDC-651212 Color Monitor .....	\$479.95
NEC-1202D RGB color monitor .....	\$1045.00

### Leedex / Amdek

Reasonably priced video monitors

VDC-801310 13" Color I .....	\$379.95
VDC-801320 Color II .....	\$895.00
IOV-2300A DVM board for Apple ..	\$199.95

Prices may be slightly higher at our retail locations. Please call the store nearest you for local price and availability.

Circle 223 on inquiry card.



# JADE

Computer Products

13440 S. Hawthorne Blvd.  
Hawthorne, Calif.  
213-973-7330

# JADE

Computer Products

21800 Ventura Blvd.  
Woodland Hills, Calif.  
213-716-6120

# JADE

Computer Products

4950 Bellline Road  
Addison, Texas  
214-458-2782

## PLACE ORDERS TOLL FREE.

## Continental U.S. - 800-421-5500 Inside California - 800-262-1710 Los Angeles Area - 213-973-7707

### SBC-200 - SD Systems

4 MHz Z-80A CPU with serial & parallel I/O. 1K RAM. 8K ROM space, monitor PROM included.  
CPC-30200A A & T ..... \$299.95

### THE BIG Z\* - Jade

2 or 4 MHz switchable Z-80\* CPU with serial I/O. accommodates 2708, 2716, or 2732 EPROM. baud rates from 75 to 9600  
CPU-30201K Kit ..... \$139.95  
CPU-30201A A & T ..... \$189.95  
CPU-30200B Bare board ..... \$35.00

### 2810 Z-80\* CPU - Cal Comp Sys

2 4 MHz Z-80A\* CPU with RS-232C serial I/O port and on-board MOSS 2.2 monitor PROM. front panel compatible.  
CPU-30400A A & T ..... \$269.95

### CB-2 Z-80 CPU - S.S.M.

2 or 4 MHz Z-80 CPU board with provision for up to 8K of ROM or 4K of RAM on board. extended addressing. IEEE S-100. front panel compatible.  
CPU-30300K Kit ..... \$239.95  
CPU-30300A A & T ..... \$299.95

### 16K STATIC RAM - Mem Merchant

4 MHz 16K static RAM board. IEEE S-100, bank selectable. Phantom capability. addressable in 4K blocks. "disable-able" in 1K segments. extended addressing. low power  
MEM-16171A A & T ..... \$154.95

### 32K STATIC RAM - Jade

2 or 4 MHz expandable static RAM board uses 2114L's  
MEM-16151K 16K 4 MHz kit ..... \$169.95  
MEM-32151K 32K 4 MHz kit ..... \$299.95  
Assembled & tested ..... add \$50.00

### MEMORY BANK - Jade

4 MHz. S-100. bank selectable. expandable from 16K to 64K  
MEM-99730B Bare Board ..... \$49.95  
MEM-99730K Kit no RAM ..... \$199.95  
MEM-32731K 32K Kit ..... \$239.95  
MEM-64733K 64K Kit ..... \$279.95  
Assembled & Tested ..... add \$50.00

### 64K RAM - Calif Computer Sys

4 MHz bank port / bank byte selectable. extended addressing. 16K bank selectable. PHANTOM line allows memory overlay. 8080 / Z-80 / front panel compatible.  
MEM-64565A A & T ..... \$575.00

### 64K STATIC RAM - Mem Merchant

64K static S-100 RAM card. 4-16K banks. up to 8MHz  
MEM-64400A A & T ..... \$594.95

### 64K STATIC RAM - SSM

IEEE 696/S-100 standard. up to 6MHz/8 Bit, 12MHz/16 Bit. 24 Bit extended addressing. disable-able in 2K increments  
MEM-64330A A & T ..... \$749.95

### 64K STATIC - Lab Standard

Absolute IEEE 696/S-100 compliance. 8 or 16 Bit data paths. 16 bit request/acknowledge properly implemented, supports DMA at 8MHz, switchable bank select system for use with Cromemco & Alpha Micro  
MEM-64900A A & T ..... \$699.95

### BUS PROBE - Jade

S-100 diagnostic analyzer board. dynamic visual display of all 96 IEEE S-100 signals. aids in real time analysis of faulty hardware and software  
TSX-200B Bare Board ..... \$59.95  
TSX-200K Kit ..... \$119.95  
TSX-200A A & T ..... \$149.95

### VERSAFLOPPY II - SD SYSTEMS

Double density disk controller for any combination of 5 1/4" or 8" single or double sided disk drives. analog phase-locked loop data separator. vectored interrupt. CP/M 2.2 & OASIS compatible. control diagnostic software PROM included  
IOD-1160A A & T ..... \$359.95  
SFC-55009047F CP/M 2.2 for VF II ..... \$99.95

### DOUBLE-D - Jade

Double density controller with the inside track. on-board Z-80A\*. printer port. IEEE S-100. can function on an interrupt driven buss  
IOD-1200K Kit ..... \$299.95  
IOD-1200A A & T ..... \$375.00  
IOD-1200B Bare board ..... \$59.95

### DOUBLE DENSITY - Cal Comp Sys

5 1/4" and 8" disk controller. single or double density. with on-board boot loader ROM. and free CP/M 2.2\* and manual set.  
IOD-1300A A & T ..... \$374.95

### MPC-4 - SD Systems

Intelligent 4-port serial I/O card. on-board Z-80A. 2K RAM. 4K PROM area. on-board firmware. fully buffered, vectored interrupts. four CTC channels. add to SD Board set for powerful multi-user system  
IOI-1504A A & T w/software ..... \$495.00

### I/O-4 - S.S.M.

2 serial I/O ports plus 2 parallel I/O ports

IOI-1010K Kit ..... \$179.95  
IOI-1010A A & T ..... \$249.95  
IOI-1010B Bare board ..... \$35.00

### I/O-5 - SSM Microcomputer

Two serial & 3 parallel I/O ports. 110-19.2K Baud  
IOI-1015A A & T ..... \$279.95

### I/O-8 - SSM Microcomputer

Eight software programmable serial I/O ports. 110 -19.2K Baud. ideal for multi-user systems  
IOI-1018A A & T ..... \$449.95

### PROM-100 - SD Systems

2708, 2716, 2732 EPROM programmer w/software  
MEM-99520K Kit ..... \$189.95  
MEM-99520A A & T ..... \$249.95

### PB-1 - S.S.M.

2708, 2716 EPROM board with built-in programmer  
MEM-99510K Kit ..... \$154.95  
MEM-99510A A & T ..... \$219.95

### EPROM BOARD - Jade

16K or 32K uses 2708's or 2716's, 1K boundary  
MEM-16230K Kit ..... \$79.95  
MEM-16230A A & T ..... \$119.95

### ISO-BUS - Jade

Silent, simple, and on sale - a better motherboard

6 Slot (5 1/4" x 8 3/4")  
MBS-061B Bare board ..... \$19.95  
MBS-061K Kit ..... \$39.95  
MBS-061A A & T ..... \$49.95  
12 Slot (9 3/4" x 8 3/4")  
MBS-121B Bare board ..... \$29.95  
MBS-121K Kit ..... \$69.95  
MBS-121A A & T ..... \$89.95  
18 Slot (14 1/2" x 8 3/4")  
MBS-181B Bare board ..... \$49.95  
MBS-181K Kit ..... \$99.95  
MBS-181A A & T ..... \$139.95

## Single User System

SBC-200, 64K ExpandoRAM II, Versafloppy II, CP/M 2.2

# \$1095.00

4 MHz Z-80A CPU, 64K RAM, serial I/O port, parallel I/O port, double-density disk controller, CP/M 2.2 disk and manuals, system monitor, control and diagnostic software.

Board set with 256K of RAM .... \$1295.00

-All boards are assembled and tested-

## 8" Disk Drives



Shugart SA801R single-sided double-density MSF-10801R .. \$394.95 ea 2 for \$389.95 ea

Shugart SA851R double-sided double-density MSF-10851R .. \$554.95 ea 2 for \$529.95 ea

Qume DT-8 double-sided double-density MSF-750080 .. \$524.95 ea 2 for \$499.95 ea

Siemens FDD 100-8 single-sided double-density MSF-201120 .. \$384.95 ea 2 for \$349.95 ea

## 5 1/4" Disk Drives

Shugart SA400L single-sided double-density 40 track MSM-104000 .. \$234.95 ea 2 for \$224.95 ea

Shugart SA450 double-sided double-density 70 track MSM-104500 .. \$349.95 ea 2 for \$329.95 ea

Qume DT-5 double-sided double-density 80 track MSM-750050 .. \$359.95 ea 2 for \$349.95 ea

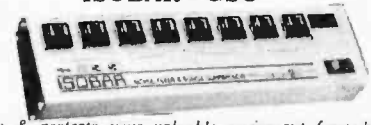
MPI B-51 single-sided double-density 40 track MSM-155100 .. \$234.95 ea 2 for \$224.95 ea

MPI B-52 double-sided double-density 40 track MSM-155200 .. \$344.95 ea 2 for \$334.95 ea

MPI B-91 single-sided double-density 77 track MSM-155300 .. \$369.95 ea 2 for \$359.95 ea

MPI B-92 double-sided double-density 77 track MSM-155400 .. \$469.95 ea 2 for \$459.95 ea

### ISOBAR - GSC



Isolates & protects your valuable equipment from high voltage spikes & AC line noise, inductive isolated ground. 15 amp circuit breaker, U.L. listed

EME-115103 3 socket ..... \$39.50  
EME-115105 4 socket ..... \$49.50  
EME-115100 8 socket ..... \$54.50  
EME-115110 9 socket rackmount ..... \$74.50

Prices may be slightly higher at our retail locations. Please call the store nearest you for local price and availability.

Circle 223 on inquiry card.

www.americanradiohistory.com

# PALOMAR TAKES THE RISK

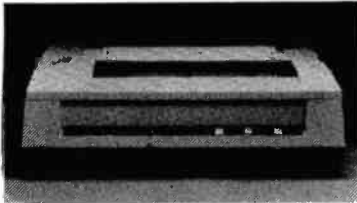
...Join the thousands of satisfied customers who buy from  
fast response, expert technical help, and



**NEC-8023 A**

High-resolution dot graphics. Proportional spacing. Correspondent quality printing. Bidirectional tractor and friction feed. 80, 132 col. Greek and math symbols. 100 cps matrix printer.

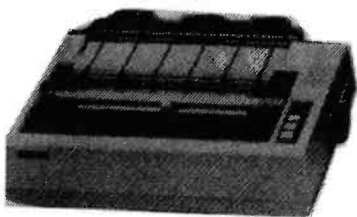
List \$780 Parallel ..... \$599



**C. ITOH**

Pro/Writer offers 8 character sizes, 5 different alphabets, and high proportional spacing, bidirectional, vert. and horiz. tabs, resolution graphics, nx9 matrix, 100 cps 136 col. max. Friction and tractor feed.

8510R Parallel ..... \$549  
8510R Serial ..... \$599



## EPSON—COMPLETE STOCK!

Features disposable print heads. Graphtrax. All models except MX-70 print text in two directions. MX-80F/T and MX 100 have both friction and tractor feed. Unparalleled dot placement accuracy.

MX-70 (80 col.) ..... CALL  
MX-80 (80 col.) ..... CALL  
MX-80F/T (80 col.) ..... CALL  
MX-100 (136 col.) ..... CALL  
Interface Cards ..... CALL  
Cables ..... CALL

## VIDEO TERMINALS, MONITORS

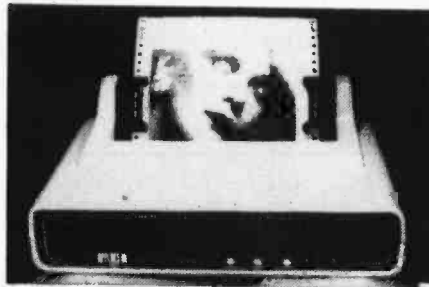
Ampex Dialog 80 ..... \$995  
Ampex Dialog 30 ..... \$795  
Televideo 920C ..... \$845  
Televideo 950 ..... \$995  
SOROC IQ 120 ..... \$699  
Zenith 12" Green ..... \$119  
NEC 12" Green ..... \$169  
Amdex 12" B/W (Leedex) ..... \$99  
Amdex 13" Color Lo-Res ..... \$439



## LOW, LOW PRICE ON NOVELL!

Heavy duty, 150 CPS, bidirectional, tractor feed, 9x9 dot matrix, 6 or 8 lines per inch, 10, 13.6 or 16.5 CPI, EIA RS-232C or parallel interface.

IMAGE 800 ..... \$995



## MPI 88G/99G MATRIX

High resolution dot-addressable graphics for Apple. Enhanced "correspondence quality" printing. Tractor and friction feed. Serial and Parallel Input. 100 cps Bi-directional printing.

88 G (132 col.) List \$749 ..... \$549  
99 G (132 col.) List \$849 ..... \$599  
Apple parallel I/O Card/Cable/Disk ..... \$110  
with Graphics Prom (Ap-Pak) ..... \$145  
IEEE I/O Card ..... \$55  
Single Sheet Feeder ..... \$25  
QT Cover ..... \$35

## OKIDATA

UP TO 200 CPS!

Microline 82A—80/132 col., 120 CPS, 9x9 dot matrix, friction, pin feed or tractor feed (removeable) rear and bottom feed. Includes bi-directional/logic seeking, serial and parallel interfaces. Double width and condensed characters, true lower case descenders and graphics.

82A ..... \$545

Microline 83A—132/232 col., 120 CPS, handles forms up to 15 in. wide, plus all the features of the 82A.

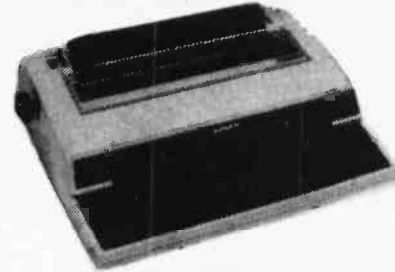
83A ..... \$775

Microline 84—132/232 col., 200 CPS, with full dot graphics built-in. Takes forms up to 15 in. wide, plus all the features of the 83A.

84SP ..... \$1250

## MODEMS

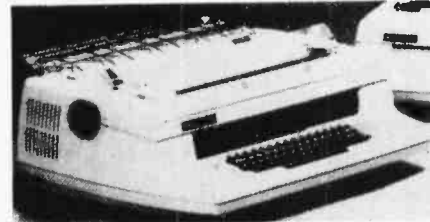
UIDS 103 LP, direct ..... \$169  
103 JLP Auto Answer ..... \$209  
202 LP 1200 BAUD ..... \$259  
NOVATION CAT, acoustic ..... \$145  
D-CAT, direct ..... \$155  
Auto Cat ..... \$219  
Apple Cat ..... \$329  
HAYES S100 Micromodem ..... \$349  
Apple Micromodem ..... \$299  
Smart Modem ..... \$245



**ADLER**

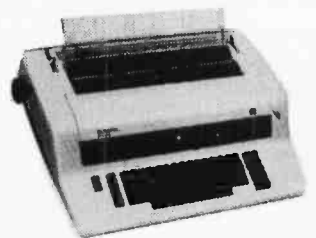
17.5 CPI, 10, 12, 15 and proportional spacing, line correcting memory, inter-changeable print wheels.

SE1010 List \$1295 ..... SAVE \$30  
Interface Card ..... ADD \$35



## NEC SPINWRITERS

7710/7730 RO w/tractor ..... \$255  
7720 KSR w/tractor ..... \$294  
3510/3530 RO ..... \$177  
Bidirectional tractor ..... \$21  
Push tractor ..... \$35



**OLYMPIA**

Letter quality. Daisy wheel printer typewriter interfaces to Apple, Atari, NEC, TRS80 and RS232 Serial ports.

ES 100 RO Computer printer  
List \$1690 ..... SAVE \$3  
ES100 Typewriter only List \$1195 SAVE \$1  
Interface Card Only ..... \$2  
(specify serial or parallel)  
I/O Cable (specify serial or parallel) ..... \$1  
Apple Serial Card ..... \$1

## MODEMS

BIZCOMP Super low introductory price. Superior over other modems! Apple—direct connect game port. No serial card needed. Save \$13 more. Atari—direct connect via inter module and telink cartridge. Commodore the only modem available. Each pkg. contains cable with connectors and phone T-adapt  
Apple Comm Pkg ..... \$1  
VIC Comm Pkg ..... \$1  
Atari Comm Pkg ..... \$1

Circle 326 on inquiry card.

www.americanradiohistory.com

# OUT OF MAIL ORDER BUYING!

Buy with confidence and know you'll receive the same **guaranteed satisfaction — at UNBEATABLE PRICES!**

## APPLE SOFTWARE

### BUSINESS

Financial Partner	\$191.99
Pascal Tutor	\$97.99
Pro Easy Writer	\$196.99
Easy Writer 40 col.	\$78.99
Ward Star (Req. Softcard)	\$241.99
Super Sort (Req. Softcard)	\$129.99
Mail Meger (Req. Softcard)	\$80.99
Data Star (Req. Softcard)	\$192.99
Spell Star (Req. Softcard)	\$129.99
Call Star (Req. Softcard)	\$129.99
Super Tex II	\$117.99
The Address Book	\$38.99
Form Letter Module	78.99
Visifiles	\$229.99
Desktop Plan III	\$275.99
Desktop Plan II	\$229.99
Visiplot	\$185.99
Visitrend/Visiplot	\$275.99
Visidex	\$229.99
Visiterm	\$89.99
Visicalc 3.3	\$229.99
Infotory	\$199.99
Superspell (Req. Softcard)	\$435.99
Word Processor (Req. Softcard)	\$255.99

### PERSONAL/HOME

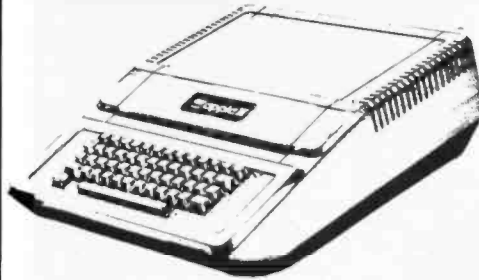
Typing Tutor	\$19.99
Elementry Math	\$31.99
Personal Filing System	\$74.99
Personal Report System	\$74.99
Algebra I	\$31.99
Compu-Math: Arithmetic Skill	\$39.99
Compu-Math: Fractions	\$31.99
Compu-Math: Decimals	\$31.99
Compu-Spells: (Req. Data Disk)	\$23.99

### MISC

Applesoft Compiler	\$165.99
Basic Compiler	\$315.99
Apple-Doc	\$41.99
D.B. Master	\$189.99
D.B. Utility Pack	\$81.99

### GAMES

Raster Blaster	\$24.99
Air Traffic Controller	\$9.99
Temple of Apschai	\$31.95
Datstones of Ryn	\$15.99
Morloc's Tower	\$15.99
Rescue at Rigel	\$23.99
Tell Fire Warrior	\$31.99
Star Warrior	\$31.99
Crash, Crumble and Chomp	\$23.99
Jpper Reaches of Apschai	\$15.99
The Keys to Acheron	\$15.99
Snack Attack	\$23.99
The Prisoner	\$23.99
Conk I	\$31.99
Conk II	\$31.99
Robot Wars	\$31.99
Three Mile Island	\$31.99
A.B.M.	\$19.99
Castle Wolfenstein	\$23.99
Wizard and Princes	\$25.99
Missile Defense	\$23.99
Transton Manor	\$27.99
Varp Destroyer	\$23.99
Cyber Strike	\$31.99
Phantoms Five	\$23.99
Space Eggs	\$23.99



## APPLE ACCESSORIES

### MICROSOFT

Z80 Softcard	\$299.99
16K RAMcard	\$158.99

### CCS

Parallel Card	\$119.99
ASYNC Serial Card	\$148.99
Clock Calendar Card	\$99.99
IEEE Card	\$249.99
A-D Card	\$99.99

### MOUNTAIN COMPUTERS

Romulus	\$129.99
Keyboard Fitter Rom	\$49.99
CPS Multifunction Card	\$189.99
Super talker	\$229.99

### PAYMAR

L/C Adapter-New	\$35.99
L/C Adapter-Old	\$45.99
Videx-Video Term	\$299.99

### ADVANCE BUSINESS TECH

13 Key pad for Apple (New KBD)	\$110.99
13 Key pad for Apple (Old KBD)	\$110.99
BAR Code Reader	\$189.99
Dana-Cooling Fan	\$39.99
Lazer-Lower Case Adapter	\$55.99

### T.G. PROD.

Game Paddles	\$31.99
Joy Stick	\$46.99
Select A Port	\$46.99
Wizard-80 (80 col.)	\$278.99

## RS232 CABLES

4 wire male-male 10 ft.	\$19.99
9 wire male-male 10 ft.	\$21.99
4 wire male-female 10 ft.	\$19.99
9 wire male-female 10 ft.	\$21.99
RS232 Switch Box (Use 2 terminals or printers from one output port)	\$109.99

## FAN FOLD PAPER

(Prices F.O.B. S.P.)

9 1/2 x 11-20# Bond White (2700 ct.)	\$30.10
14 7/8 x 11-20# Bond White (2400 ct.)	\$37.10
14 7/8 x 11-20# Bond 1/2" Green Bar (2400 ct.)	\$37.10

## RIBBONS

NEC	\$77/Doz.
Qume	\$45/Doz.
Diablo	\$66/Doz.
Anadex	\$135/6 ea.
Tritel	\$95/Doz.
TI/DEC/TTY	\$45/Doz.
Epson	\$13.95/ea.
MPI/Axiom/Base 2	\$13.95/ea.

## MAGNETIC MEDIA

Premium Quality At Bargain Prices  
100% Certified with hub rings, box of 10

### Economy Diskettes

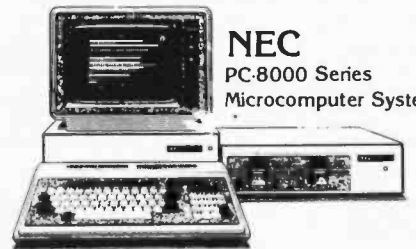
5 1/4" SSSD Soft, 10 or 16 sector	\$25.00
SSSD Soft, 10 or 16 sector	\$28.50
DSDD Soft, 10 or 16 sector	\$36.00

### Quality Diskettes

5 1/4" SSD, Soft 10 or 16 sector	\$27.00
SSDD, Soft 10 or 16 sector	\$32.00
DSDD, Soft 10 or 16 sector	\$38.50
8" SSSD, Soft or 32 hard sector	\$28.50
DSDD, Soft or 32 hard sector	\$45.50

CALL for prices on name brand diskettes:

VERBATIM DYSAN 3M SCOTCH  
MEMOREX WABASH MAXELL



## NEC

PC-8000 Series  
Microcomputer System

- z-80A CPU 4 MHz
- 5 user programmable function keys
- 82 Keys with numeric keypad
- 160 x 100 resolution
- 80 character screen

PCX-8001A Microcomputer w/32K RAM \$899

PC-8012A I/O Unit w/32K RAM

Expansion slots \$599

PC-8031A Dual Mini-Disk Drive Unit \$899

PC-8032A Add-On Dual Mini Disk Drive Unit \$799

## ATARI SOFTWARE

Adventure #1,2,3, (D)	\$31.99
Adventure #4,5,6, (D)	\$31.99
Adventure #7,8,9 (D)	\$31.99
Adventure #10,11,12 (D)	\$31.99
Adventure 1-12 (D)	\$79.99
Atari Mailing List (D)	\$19.99
Text Wizard (D)	\$79.99
Compu-Math/Fractions (D)	\$31.99
Compu-Math/Decimals (D)	\$31.99
Compu-Math/Fractions (D)	\$23.99
Compu-Math/Decimals (C)	\$23.99
Letter Perfect (D)	\$119.99
Mail Merge/Utility (D)	23.99

TO PLACE YOUR ORDER CALL:

TELEPHONE (714)744-7314 CODE: BApr82 or write to: 697120 TELEX

# PALOMAR

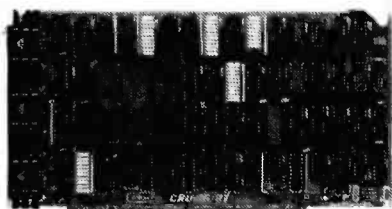
Computer Products

910-105 W. San Marcos Blvd., San Marcos, CA 92069

TERMS OF SALE: Cash, check, money order, bank wire transfer, credit card or purchase orders from qualified firms and institutions. Please include telephone number with order and expiration date on credit card orders. California residents add 6% sales tax. Advertised prices are for prepaid orders F.O.B. shipping point. Add 3% for shipping in U.S. Pricing and availability subject to change without notice.



## S-100 CPU



CO-PROCESSOR 8086 - 8087 COMPUPRO  
Math co-processor

PART NO.	DESCRIPTION	LIST PRICE	OUR PRICE
BEGBT106A	A&T 8086 Only	\$695.00	\$825.00
BEGBT106C	CSC 8086 Only	\$850.00	\$785.00
BEGBT0087	8087 Chip		CALL

### CPU-Z - GODBOUT

2/4 MHZ Z80 CPU 24 Bit Addressing

BEGBT 180A	A & T	\$295.00	\$280.00
BEGBT 180C	CSC 3-6 MHZ	\$395.00	\$375.00

### DUAL PROCESSOR 8085-8088 - COMPUPRO

6 or 8 MZ Provides true 16 Bit Power with a standard 8 bit S-100 bus.

BEGBT 1612A	A & T	\$425.00	\$390.00
BEGBT 1612C	CSC	\$525.00	\$498.00

### MPM (8) - COMPUPRO

Runs CPM 80™, CPM 86™, And MPM86™ AT THE SAME TIME! 8 AND/OR 16 BIT TOGETHER! WOW!

BEGBTMPM810	Software		\$995.00
-------------	----------	--	----------

See Compupro AD in May BYTE for details

### SOLID STATE DISK DRIVE, 3500% FASTER!

Not Really, But the Next Best Thing For Compupro 80B5/88 Users. Call for Details on M-Drive.

BEGBT MD 128K			\$1,550.00
BEGBT MD 256K			\$3,000.00

### 2810 Z80 CPU-CA. COMP. SYST.

2/4 MHZ Z80A CPU with RS232C Serial I/O Port complete with Monitor PROM for 2422 Disk Controller

BEGCS 2810A	A & T	\$350.00	\$280.00
-------------	-------	----------	----------

### CB2 Z80 CPU - S.S.M.

2/4 MHZ will accept 2716, or 2732, or RAM

BEGSSM82K	Kit		\$260.00
BEGSSM82A	A & T	\$344.00	\$310.00
BEGSSM260M	SSM Z80 Monitor		\$89.00

## S-100 I/O BOARDS

### SYSTEM SUPPORT I - GODBOUT

Serial port (software prog baud), 4K EPROM OR RAM provision, 15 levels of interrupt, real time clock, optional math processor

PART NO.	DESCRIPTION	LIST PRICE	OUR PRICE
BEGBT102A	Assembled & Tested	\$399.00	\$360.00
BEGBT102C	CSC	\$495.00	\$460.00
BEGBT0231	Math Chip		\$195.00
BEGBT0232	Math Chip		\$195.00
BEGBT102AM1	A&T with 8231 Math Chip		\$555.00
BEGBT102CM1	CSC with 8231 Math Chip		\$655.00
BEGBT102AM2	A&T with 8232 Math Chip		\$655.00
BEGBT102CM2	CSC with 8232 Math Chip		\$655.00

### MPX CHANNEL BOARD - COMPUPRO

I/O Multiplexer, using 8085A-2 CPU on board With 4K RAM

BEGBT106AA	A & T	\$495.00	\$445.00
BEGBT106C4	CSC	\$595.00	\$535.00

### With 16K RAM

BEGBT106A16	A & T	\$649.00	\$585.00
BEGBT106C16	CSC	\$749.00	\$675.00

### INTERFACER I - COMPUPRO

Two Serial I/O

BEGBT133A	A & T	\$249.00	\$219.00
BEGBT133C	CSC	\$324.00	\$298.00

### INTERFACER II - COMPUPRO

Three parallel, one serial I/O board

BEGBT150A	A & T	\$249.00	\$219.00
BEGBT150C	CSC	\$324.00	\$299.00

### INTERFACER III - COMPUPRO

Eight channel multi-use serial I/O board

BEGBT1746A	A & T	\$699.00	\$629.00
BEGBT1746C	CSC 200 hr. 8 Port	\$849.00	\$790.00
BEGBT1745A	A & T	\$599.00	\$559.00
BEGBT1745C	CSC 200 hr. 5 Port	\$699.00	\$629.00

### MULTI I/O - MORROW DESIGNS

Three Serial, Two parallel

BEMOSMB3200	A & T	\$399.00	\$329.00
-------------	-------	----------	----------

### SWITCHBOARD - MORROW DESIGNS

Two serial I/O, four parallel I/O, one status port, one strobe port

BEMOSSB2411		\$299.00	\$269.00
-------------	--	----------	----------

### I/O4 - SSM

Two serial I/O, two parallel I/O

BESSMI04K	Kit		\$210.00
BESSMI04A	A & T	\$290.00	\$260.00

### I/O 5 - SSM

2 Serial, 3 Parallel including 1 Centronics

BESSMI051	A & T	\$329.00	\$309.00
-----------	-------	----------	----------

### I/O 8 - SSM

8 Port Serial I/O with Timer

BESSMI08A	A & T	\$550.00	\$495.00
-----------	-------	----------	----------

### 2710 4 PORT SERIAL - CCS

4 Full handshaking RS232 ports and optional 2K ROM

BEGCS271001	A & T	\$360.00	\$310.00
-------------	-------	----------	----------

### 2719 2 SERIAL & 2 PARALLEL - CCS

2 RS232 C ports, 2 8 bit parallel ports, & optional 2K ROM

BEGCS271901	A & T	\$360.00	\$325.00
-------------	-------	----------	----------

### 2720 4 PORT PARALLEL - CCS

4 8 bit parallel ports and optional 2K ROM

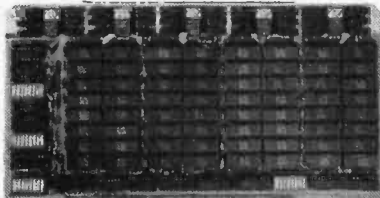
BEGCS272001	A & T	\$250.00	\$225.00
-------------	-------	----------	----------

## S-100 10 MHZ STATIC RAM

NEW LOW PRICES!

## RAM 20 - 32K

CompuPro™



### 32K STATIC RAM - COMPUPRO

RAM 20 10 MHZ, 4K byte block disable, bank select or 24 bit addressing available 8, 16, 24 or 32K

PART NO.	DESCRIPTION	LIST PRICE	OUR PRICE
BEGBT104AA8	8K A&T	\$210.00	\$190.00
BEGBT104AC8	8K CSC	\$280.00	\$260.00
BEGBT104AA16	16K A&T	\$285.00	\$260.00
BEGBT104AC16	16K CSC	\$355.00	\$325.00
BEGBT104AA24	24K A&T	\$355.00	\$325.00
BEGBT104AC24	24K CSC	\$425.00	\$385.00
BEGBT104AA32	32K A&T	\$425.00	\$385.00
BEGBT104AC32	32K CSC	\$495.00	\$450.00

### CMOS STATIC RAM

For a complete analysis of the advantages of CMOS memory, see the "Product Description" on page 416 of the January Issue of BYTE.

### 64K CMOS STATIC RAM - COMPUPRO

RAM 17, 10 MHZ, 2 Wait, DMA Compatible 24 Bit Addressing

BEGBT175AB4	64K A&T	\$599.00	\$550.00
BEGBT175CB4	64K CSC 200hr.	\$699.00	\$650.00

### NEW! 32K x 16 BIT CMOS STATIC RAM - COMPUPRO

8 and/or 16 Bit

BEGBT175AB4	64K A&T	\$599.00	\$550.00
BEGBT175CB4	64K CSC 200hr.	\$699.00	\$650.00

### NEW! 128K NMOS STATIC RAM - COMPUPRO

RAM 21 15MHz, 128K X 8 OR 64K X 16

BEGBT190A	128K A&T	\$1695.00	\$1810.00
BEGBT190C	128K CSC	\$1895.00	\$1795.00

## S-100 PROM

### FBI PROM PROGRAMMER - SSM

Programs 2708 or 2716's, operates as a 4K/8K EPROM BOARD AS WELL.

BEGSSMPB1K	Kit		\$179.00
BEGSSMPB1A	A & T	\$265.00	\$220.00

### ICONOROM 2708 - COMPUPRO

16K x 8 EPROM Board using 2708, Power on jump to any 256 byte

BEGBT125A	A & T	\$135.00	\$120.00
BEGBT125C	CSC	\$195.00	\$175.00

### MB8A - SSM

1K/16K 2708 EPROM board, disable in 1K increments

BESSM8BAK	Kit		\$114.00
BESSM8BA	A & T	\$179.00	\$169.00

## S-100 VIDEO BOARDS

### SPECTRUM - COMPUPRO

Color Graphics board with Parallel I/O

BEGBT144A	A & T	\$399.00	\$349.00
BEGBT144C	CSC	\$449.00	\$399.00

BEGBT20	Sublogic Universal Graphics Interpreter Software		\$35.00
---------	--	--	---------

### VB - 3 S.S.M.

80 x 25 or 50 character video display Memory

BESSMVB3K24	80 x 24 Kit		\$425.00
BESSMVB3A24	80 x 24 A&T	\$499.00	\$440.00
BESSMVB3UP	80 x 50 Line Upgrade		\$ 39.00

### VB2-S.S.M.

I/O Mapped Video Board, with Parallel Keyboard port 64 x 16

BESSMVB2K	Kit		\$199.00
BESSMVB2A	A & T	\$269.00	\$229.00

### VBBB - S.S.M.

Memory Mapped Video Board 64 x 16 character display or 64 x 16 graphics display

BESSMVB1K	Kit		\$179.00
BESSMVB1A	A & T	\$242.00	\$220.00

### S-100 CLOCK CALENDAR

Assembled & Tested

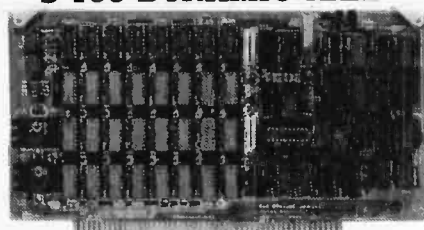
BEGTCCCSA			\$150.00
-----------	--	--	----------

### S-100 MOTHERBOARDS - COMPUPRO

Active termination, 6-12-20 slot

BEGBT153A	A&T 6 slot, 2 lbs	\$140.00	\$128.00
BEGBT153C	CSC 6 slot, 2 lbs.	\$190.00	\$175.00
BEGBT154A	A&T 12 slot, 3 lbs.	\$175.00	\$155.00
BEGBT154C	CSC 12 slot, 3 lbs.	\$240.00	\$220.00
BEGBT155A	A&T 20 slot, 4 lbs.	\$265.00	\$235.00
BEGT155C	CSC 20 slot, 4 lbs.	\$340.00	\$310.00

## S-100 DYNAMIC RAM



### THE EXPANDABLE I

### PRIORITY 1 ELECTRONICS

THE EXPANDABLE 1" 64K Dynamic Ram board provides your S-100 system with 64K of reliable, high-speed dynamic RAM. Compatible with most of the major S-100 systems on the market, including those with front panels, it supports DMA operations and requires no Wait states with current microprocessors.

- User expandable from 16 to 64K
- Supports DMA
- Designed to IEEE proposed S-100 bus standards
- 2 or 4 Mhz operation
- Operates with either an 8080 or Z-80 based S-100 system, providing processor-transparent refreshes with both
- Supports IMSA1-type front panels
- Jumper-selectable Phantom input
- Uses Popular 4116 RAMS
- All ICs in sockets
- Any 16K block can be made bank-independent
- Fully buffered address and data lines
- Fail-safe refresh circuitry for extended Wait states
- Board configuration with reliable, easy-to-configure Berg jumpers

## S-100 DISK CONTROLLERS

### 2422A - CA. COMP. SYST.

I/O Mapped, controls 8", single or double density A&T with CPM 2.2 8" S.D.

	LIST PRICE	OUR PRICE
BEGCS2422A	\$475.00	\$375.00

### DISK JOCKEY 2D - MORROW

Memory Mapped, controls 8", single or double density, serial I/O

BEMO10J2208	A&T with CP/M 2.2	\$399.00	\$375.00
-------------	-------------------	----------	----------

## S-100 DISK SUBSYSTEMS

### DJ2B DISCUS SINGLE SIDED MORROW

8" DBL Density drives with cabinet, power supply controller, with CP/M 2.2 and Microsoft Basic

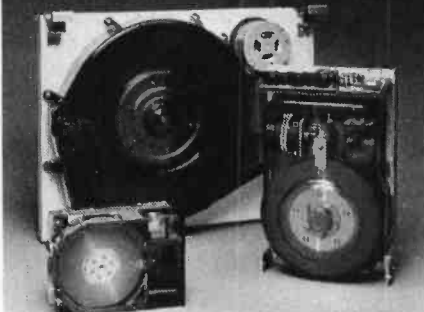
BEMOSF1216	Single Drive System	\$1095.00	\$950.00
BEMOSF1226	Dual Drive System	\$1875.00	\$1598.00

### DJ2B DISCUS DOUBLE SIDED - MORROW

8" DBL Density/sided drives with cabinet Power supply controller, with CP/M 2.2 and Microsoft Basic

BEMOSF2216	Single Drive System	\$1395.00	\$1250.00
BEMOSF2226	Dual Drive System	\$2495.00	\$2050.00

## S-100 HARD DISK - MORROW



5.25" 5MB, 8" 10 & 20MB, 14" 26MB formatted hard disk complete with cabinet, P.S., Controller, CP/M 2.2 and Microsoft MBASIC 80

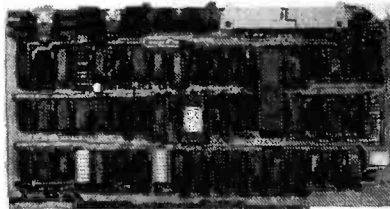
	LIST PRICE	SALE PRICE
BEMOSDMAMS	5 MB	\$2495.00
BEMOSDM10S	10 MB	\$3695.00
BEMOSDM20S	20 MB	\$4795.00
BEMOSDM26S	26 MB	\$4495.00

WOW! \$1995.00

\$2950.00

\$3625.00

## COMPUPRO DMA DISK 1 WITH FREE CP/M 2.2 SALE \$450.00



**SAVE \$220.00**

Priority 1 Electronics is pleased to offer the COMPUPRO DISK 1 High Performance Disk Controller at our regular low price with CP/M 2.2 and BIOS at no additional cost. That's a savings of \$220.00 of the manufacturer's list price.

- Third generation INTEL 8272/NEC 765A LSI floppy disk controller.
- High speed cycle stealing DMA interface for processor independent data transfer between system memory and flexible disk.
- Handles up to four 8 or 5.25 inch floppy disk drives
- Single or double density/single or double sided capability.
- Supports IBM 3740 soft sectored formats.
- 24 bit DMA addressing with data transfer across 64K boundaries for data transfer throughout the 16Mbyte memory map.

PART NO.	DESCRIPTION	LIST PRICE	OUR PRICE
BEPOB171ACPM	A&T w/CP/M 2.2 & BIOS	\$670.00	\$450.00
BE0BT171C	CSC	\$595.00	\$555.00
BE0BTCPM80*	CP/M 2.2 for 280/8085 with manuals & BIOS 8" S/D disk	\$175.00	
BE0BTDAS8	Oasis 8 bit single user 8" S/D disk	\$500.00	
BE0BTDAS8M	Oasis 8 bit multiuser, 8" S/D disk	\$450.00	

## S-100 SYSTEMS

### SUPERSIXTEEN - COMPUPRO

HERE IS WHAT EACH PACKAGE INCLUDES:

- BE0BT1812A 6 MHz 8085/8088 Dual Processor Board
  - BE0BT171A High Speed DMA Disk Controller
  - BE0BT182A System Support 1 Multi-Function Board
  - BE0BT133A Interfacer 1 Dual Serial I/O
  - BE120K 10MHz Low Power Static Ram
  - BE0BTC/PM 88 16 Bit Operating System Ready to Load & Go
- Cables and Documentation Three interlacer cables one disk I/O cable, complete documentation for all hardware, and manuals for both CP/M operating systems.
- Comp Pro's famous 1 Year limited warranty.

Now to the best part of all. If purchased separately, these quality components would list for \$4,344.00. BUT SuperSixteen's low package price is an amazing \$3,495.00. You save \$849.00! (For boards qualified under the Certified System Component high-reliability program - with extended 2 year warranty, 200 hour burn-in and 6/8 MHz processors - add \$600.00 to the package price. Sh. Wt. 15 lbs.)

BEPOB68TSJ	SuperSixteen A&T	\$3495.00
BEPOB68TSC	SuperSixteen CSC	\$4095.00

## PRINTERS

**BEST PRICE!**



## MICROLINE - OKIDATA WITH FRICTION AND TRACTOR FEED

- BI-DIRECTIONAL - 120 CPS
- 9x9 Matrix (Alphanumeric)
- 6x9 or 12 Matrix for Graphics
- 5,8,3, 10, 16 Characters/Inch
- 6 or 8 Lines per Inch
- 80 CPL @ 10 CPI for 82A
- 132 CPL @ 10 CPI for 83A
- Parallel and Serial I/O
- 100 Thru 1200 Baud
- Self Test
- Out of Paper Switch
- Friction or Tractor Feed
- 3" to 14" Top of Form (Switch Selectable)
- 10 Different Character Sets

PART NO.	DESCRIPTION	LIST PRICE	SALE PRICE
BEOKIOA82AT(26 lbs)	80 CPL @ 10 CPI's	799.00	\$539.00
BEOKIOA83AT (37 lbs)	132 CPL @ 10 CPI	\$1195.00	\$750.00
BEOKISER2K8F	9600 baud with 2K Serial		\$150.00
BEOKIGRAPH	Buffer upgrade with X-on Y-off High Resolution Graphics Prom		\$99.00

## MX80 - EPSON NEED WE SAY MORE?

BEEMPMX80	Tractor Feed 17 lbs	\$645.00
BEEMPMX100	132 Col. Tractor Feed 24 lbs	\$725.00
BE0BMSSE11	A & T Apple Centronics 8 bit parallel interface for Centronics, Epson & OKIDATA printers	\$55.00
BE0BMSAE11	A & T Cable for above	\$55.00
BE0BMSAE11	Cable for above	\$14.95

Printer interlaces & cables sold only with printer purchase

## S-100 MAINFRAMES



### S-100 MICROFRAME - TEI

110V 60HZ CVT Mainframes, the best money can buy!  
12 Slot ±8V 17A±16V @ 2A  
22 Slot ±8V @ 30A±16V @ 4A

PART NO.	DESCRIPTION	LIST PRICE	1-9	10-24
BE1EIMCS 112	12 Slot Desk	\$685.00	\$615.00	\$570.00
BE1EIMCS 122	22 Slot Desk	\$825.00	\$760.00	\$705.00
BE1EIRAM 12	12 Slot Rackmount	\$725.00	\$720.00	\$619.00
BE1EIRAM 22	22 Slot Rackmount	\$875.00	\$850.00	\$750.00

Shipping Weight: On 12 Slot Mainframe 45 lbs.  
On 22 Slot Mainframes 55 lbs.

### TEI S-100 FRAMES

#### 3 - 5" DISK CUTOUPS

±8V @ 17±16V @ 1.2A, Internal Cables

PART NO.	DESCRIPTION	LIST PRICE	1-9	10-24
BE1EITF12	12 Slot desk	\$675.00	\$625.00	\$580.00
BE1EIRF12	12 Slot Rackmount	\$795.00	\$715.00	\$665.00

Shipping Weight: On 12 Slot Desk 40 lbs.  
On 12 Slot Rackmount 45 lbs.

### DUAL 8" DISK DRIVE CHASSIS - TEI

For Shugart 800/801R or 850/851R with internal power cables provided  
+24V @ 1.5A+5V @ 1.0A - 5V @ .25A

PART NO.	DESCRIPTION	LIST PRICE	1-9	10-24
BE1EBCFDD	Desk Top	\$535.00	\$485.00	\$455.00
BE1EIRFDD	Rack Mount	\$720.00	\$670.00	\$630.00



### S-100 MAINFRAME - COMPUPRO

110V 60HZ CVT Mainframe uses famous 20 slot COMPUPRO Motherboard. 55 lbs.  
BE0BTENC20RM 20 Slot Rack Mount \$895.00 \$825.00  
BE0BTENC20DK 20 Slot Desk Top \$825.00 \$760.00

### S-100 MAINFRAME - CCS

12-slot motherboard with removable termination card  
BECCS220001 Office Cream 35 lbs \$575.00 \$535.00  
BECCS220002 Blue 35 lbs \$575.00 \$535.00

### SOFTWARE - MICROPRO

All software is supplied on 8" Single Density IBM 3740 CP/M Compatible Diskettes

Screen-Oriented, integrated word processing system specifically designed for non-technical personnel  
BE0MPWROSTAI \$495.00 \$300.00

### MAIL MERGE WORD STAR OPTION

Powerful file merging tool  
BE0MPMLRGA1 (Requires Word Star 2.1 or later) \$250.00 \$100.00

### SPELLSTAR WORD STAR OPTION

One Step "Proofreader" with compressed 20,000 word dictionary and user-created supplemental dictionaries  
BE0MPSPSTA1 (Requires Word Star 3.0 or later) \$250.00 \$150.00

### SUPER SORT

Sophisticated program that will select and re-arrange variable length information from data files  
BE0MPSPSRA1 \$250.00 \$150.00

### CALC STAR

Sophisticated, easy-to-use, electronic spread sheet and financial planner  
BE0MPRLCSTA1 \$295.00 \$200.00

### DATA STAR

Office-Oriented Data Entry, retrieval, and updating system  
BE0MPROATSTA1 \$350.00 \$200.00

Turn to pages 12 and 13 for our Full Color, 2-Page Ad Announcing Our Fall 1982 Engineering Selection Guide



**PRIORITY ONE ELECTRONICS**

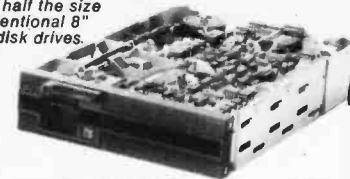
9161 B DEERING AVE • CHATSWORTH, CA 91311

**ORDER TOLL FREE (800) 423-5922 CA, AK, HI CALL (213) 709-5464**

Terms U.S. VISA, MC, BAC, Check, Money Order, U.S. Funds Only. CA residents add 6% Sales Tax. MINIMUM PREPAID ORDER \$15.00. Include MINIMUM SHIPPING & HANDLING of \$2.50 for the first 3 lbs. plus 25¢ for each additional pound. Orders over 50 lbs. sent freight collect. Just In case, please include your phone number. Prices subject to change without notice. We will do our best to maintain prices through May, 1982. Credit Card orders will be charged appropriate freight. If you don't already have your Spring '82 Engineering Selection Guide, send \$1.00 for your copy, today. Sale prices are for prepaid orders only.

## FLOPPY DISC DRIVES

Tandon TM-800 Thinline is exactly half the size of conventional 8" floppy disk drives.



**1 ONE**

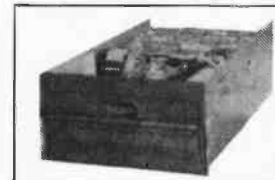
Exactly one-half the height of any other model. Proprietary, high-resolution, read-write heads patented by Tandon. D.C. only operation - no A.C. required. Industry standard interface.

Three millisecond track-to-track access time 9 lbs.  
BE1NDTM8481 Single Sided \$425.00 2 or more \$395.00  
BE1NDTM8482 Double Sided \$475.00 2 or more \$550.00  
BE1NDTM8M Manual - not included with drive \$10.00

### 801R - SHUGART

Single sided double density most popular 8" drive  
BE1SHUG01R \$425.00 ea or 2 or more (16 lbs) for \$395.00 ea.  
BE1SHUG01RM Manual for 801R drives \$10.00

## MITSUBISHI ELECTRIC



**Better Than QUME!  
Better Than SHUGART!**

8 Inch double-sided, double density  
BE1MITM289463 Sh. Wt. 16 lbs. \$550.00  
BE1MITM289463M Manual \$10.00

2 or more \$525.00 each

PART NO.	DESCRIPTION	PRICE
BE1NDTM1001	5 1/4" DRIVES - TANDON Single Sided, 250KB (5 lbs)	\$249.00 ea.
BE1NDTM1002	2 or More \$220.00 Double Sided, 500KB	\$325.00 ea.
BE1NDTM1003	2 or More \$299.00 Single Sided, 500KB	\$325.00 ea.
BE1NDTM1004	2 or More \$299.00 Double Sided, 1000KB	\$449.00 ea.
BE1NDTM5M	2 or More \$420.00 Manual, not included with drive	\$10.00

\*As used in the IBM P.C.

## DISK CABINETS

### V-100 - VISTA

• Desk or rack mountable • Internal power and data cables  
• Drives pull out for easy service and maintenance  
BE1VIS100 Disk Drive Cabinet (43 lbs) \$495.00 \$449.00

### SINGLE 8" - G.T.

Single 8" cabinet with power supply  
BE1QTC00C8 (22 lbs) \$249.00 \$225.00

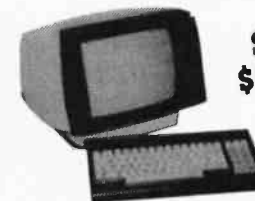
### DUAL 8" - G.T.

Dual 8" cabinet with power supply  
BE1QTC00C88 (24) \$395.00 \$349.00

### 5" CABINETS - VISTA

BE1VIS 9801 Single 5" with P.S. \$75.00  
BE1VIS 9802 Dual 5" with P.S. \$95.00

## TERMINALS



**SALE!  
\$525.00**

### VIEWPOINT - ADDS

Detachable keyboard, RS232C interface and auxiliary port, 80 x 24 display, tiltable screen  
BE1ADDVWPR Shipping Weight 30 lbs \$699.00 \$525.00

**VT200 - VISUAL TECHNOLOGY**  
THE MOST RELIABLE TERMINAL WE'VE EVER USED!  
Detachable keyboard, RS232C or 20MA interface, 110 to 19200 baud, 12" non glare 80 x 24 display, RS232C Aux. port and composite video out.  
BE1VSL200 Shipping Weight 55 lbs. \$995.00



# 16K Memory

4116-200ns

# 8/15.95

ALL MERCHANDISE 100% GUARANTEED!

CALL US FOR VOLUME QUOTES

## EPROMS

			Each	8 pcs
1702	256 x 8	(1ns)	4.95	4.50
2708	1024 x 8	(450ns)	2.99	2.75
2758	1024 x 8	(5V) (450ns)	9.95	8.95
TMS2516	2048 x 8	(5V) (450ns)	6.95	5.95
2716	2048 x 8	(5V) (450ns)	5.50	4.95
2716-1	2048 x 8	(5V) (350ns)	9.00	8.50
TMS2716	2048 x 8	(450ns)	9.95	8.95
TMS2532	4096 x 8	(5V) (450ns)	12.95	11.95
2732	4096 x 8	(5V) (450ns) (200ns)	CALL	CALL
2764	8192 x 8	(5V) (450ns)	CALL	CALL

## DYNAMIC RAMS

				100 pcs
4027	4096 x 1	(250ns)	2.50	2.00
4116-120	16,384 x 1	(120ns)	8/29.95	CALL
4116-150	16,384 x 1	(150ns)	8/18.95	1.95
4116-200	16,384 x 1	(200ns)	8/15.95	1.80
4116-300	16,384 x 1	(300ns)	8/14.95	1.75
4164	64,536 x 1	(200ns)	CALL	CALL

## STATIC RAMS

				100 pcs
2101	256 x 4	(450ns)	1.95	1.85
2102-1	1024 x 1	(450ns)	.89	.85
21L02-4	1024 x 1	(LP) (450ns)	1.29	1.15
21L02-2	1024 x 1	(LP) (250ns)	1.69	1.55
2111	256 x 4	(450ns)	2.99	2.49
2112	256 x 4	(450ns)	2.99	2.79
2114	1024 x 4	(450ns)	8/16.95	1.95
2114L-2	1024 x 4	(LP) (200ns)	8/19.95	2.35
2114L-3	1024 x 4	(LP) (300ns)	8/18.95	2.25
2114L-4	1024 x 4	(LP) (450ns)	8/17.95	2.10
2147	4096 x 1	(5ns)	9.95	CALL
TMS4044-4	4096 x 1	(450ns)	3.49	3.25
TMS4044-3	4096 x 1	(300ns)	3.99	3.75
TMS40L44-2	4096 x 1	(LP) (200ns)	4.49	4.25
TMM2016	2048 x 8	(200ns) (150ns)	CALL	CALL
HM6116	2048 x 8	(200ns) (150ns) (120ns)	CALL	CALL

LP = LOW POWER

## CRYSTALS

32.768 KHZ	3.95
1.0 MHZ	4.95
1.8432	4.95
2.0	3.95
2.097152	3.95
2.4576	3.95
3.2768	3.95
3.579545	3.95
4.0	3.95
5.0	3.95
5.0688	3.95
5.185	3.95
5.7143	3.95
6.5536	3.95
8.0	3.95
10.0	3.95
14.31818	3.95
18.0	3.95
18.432	3.95
20.0	3.95
22.1184	3.95
32.0	3.95

## MISC.

AY5-2376	12.50
11C90	13.95
XR2206	4.95
3242	7.95
3480	9.00
MC4024	3.95
MC4044	4.50
7103	9.50
7106	9.95
7107	12.95
76477	3.95
8038	3.95
95H90	7.99
9602	1.50

## DISC CONTROLLERS

1771	24.95
1791	36.95
1793	44.95
1797	54.95
UPD765	39.95

## UARTS

AY3-1014	6.95
AY5-1013	3.95
TR1602	4.95
IM6402	7.95

## INTERFACE

8T26	1.69
8T28	2.49
8T95	.99
8T96	.99
8T97	.99
8T98	.99
DM8131	2.95
DS8836	1.29

## CLOCK CIRCUITS

MM5369	3.95
MM5375	3.95
MSM5832	7.45
7207	7.50
7208	15.95

## CONVERTERS

MC1408 LB	4.95
DAC-0800	4.95
ADC-0804	4.95

## MAY SPECIALS

### 16K APPLE\* RAM CARD

\* Upgrade your 48K Apple II to full 64K.

\* Fully software and hardware compatible with Apple language card and microsoft Z80 card.

\* Eliminates the need for Applesoft or Integer Basic ROM card when used in conjunction with DOS 3.3.

\* Allows you to run Apple Fortran or Pascal.

\* Available as bare board, kit, or completed and tested board.

BARE BOARD ..... \$ 40.00

KIT ..... 89.95

ASSEMBLED & TESTED ..... 109.95

6883 SAM 24.95

RS232 FEMALE 3.49

RS232 RIGHT ANGLE FEMALE 4.95

RS232 MALE 2.99

RS232 HOOD .99

Specials end May 31, 1982. Please state "May Specials" when ordering.

## 6502

6502	6.95
6502-A	12.95
6504	6.95
6505	8.95
6507	9.95
6520	4.35
6522	9.95
6532	14.95
6551	11.85

## Z80

Z80-CPU	8.95
Z80A-CPU	6.00
Z80-P10	6.50
Z80A-P10	6.00
Z80-CTC	5.95
Z80A-CTC	8.65
Z80-DART	15.25
Z80A-DART	18.75
Z80-DMA	17.50
Z80A-DMA	27.50
Z80-S10/0	23.95
Z80A-S10/0	28.95
Z80-S10/1	23.95
Z80A-S10/1	28.95
Z80-S10/2	23.95
Z80A-S10/2	28.95
Z80-S10/9	17.95
Z80A-S10/9	22.95

Z80B-CPU	18.95
Z80B-CTC	17.95
Z80B-P10	17.95
Z8671	39.95
Z6132	34.95

## CMOS

74C00	.35	74C374	2.75	4019	.45	4098	2.49
74C02	.35	74C901	.80	4020	.95	4099	1.95
74C04	.35	74C902	.85	4021	.95	14409	12.95
74C08	.35	74C903	.85	4022	1.15	14410	12.95
74C10	.35	74C905	10.95	4023	.35	14411	11.95
74C14	1.50	74C906	.95	4024	.75	14412	12.95
74C20	.35	74C907	1.00	4025	.35	14419	4.95
74C30	.35	74C908	2.00	4026	1.65	4502	.95
74C32	.50	74C909	2.75	4027	.65	4503	.65
74C42	1.75	74C910	9.95	4028	.80	4508	1.95
74C48	2.10	74C911	10.00	4029	.95	4510	.95
74C73	.65	74C912	10.00	4030	.45	4511	.95
74C74	.85	74C914	1.95	4034	2.95	4512	.95
74C76	.80	74C915	2.00	4035	.85	4514	1.25
74C83	1.95	74C918	2.75	4040	.95	4515	2.25
74C85	1.95	74C920	17.95	4041	1.25	4516	1.55
74C86	.95	74C921	15.95	4042	.75	4518	1.25
74C89	4.50	74C922	5.95	4043	.85	4519	1.25
74C90	1.75	74C923	5.95	4044	.85	4520	1.25
74C93	1.75	74C925	6.75	4046	.95	4522	1.25
74C95	1.75	74C926	7.95	4047	.95	4526	1.25
74C107	1.00	74C927	7.95	4049	.55	4527	1.95
74C150	5.75	74C928	7.95	4050	.55	4528	1.25
74C151	2.25	74C929	19.95	4051	.95	4531	.95
74C154	3.25	74C930	19.95	4053	.95	4532	1.95
74C157	1.75	4000	.35	4060	1.45	4538	1.95
74C160	2.00	4001	.35	4066	.75	4539	1.95
74C161	2.00	4002	.25	4068	.40	4543	2.70
74C162	2.00	4006	.95	4069	.35	4555	.95
76C163	2.00	4007	.29	4070	.35	4556	.95
74C164	2.00	4008	.95	4071	.30	4581	1.95
74C165	2.00	4009	.45	4072	.30	4582	1.95
74C173	2.00	4010	.45	4073	.30	4584	.95
74C174	2.25	4011	.35	4075	.30	4585	.95
74C175	2.25	4012	.25	4076	.95	4702	12.95
74C192	2.25	4013	.45	4078	.30	4724	1.50
74C193	2.25	4014	.95	4081	.30	80C07	.95
74C195	2.25	4015	.95	4082	.30	80C95	.85
74C200	5.75	4016	.45	4085	.95	80C96	.95
74C221	2.25	4017	1.15	4086	.95	80C97	.95
74C373	2.75	4018	.95	4993	.95	80C98	1.20

HOURS: Mon. - Fri., 9 to 5; Sat., 11 to 3

VISIT OUR RETAIL STORE!



JDR MICRODEVICES, INC.

1224 So. Bascom Ave.

San Jose, CA 95128

800-538-5000 • 800-662-6279 (CA)

(408) 995-5430 • Telex 171-110

TERMS: For shipping include \$2.00 for UPS ground, \$3.00 for UPS Blue Label air. \$10.00 minimum order. Bay Area residents add 6 1/2% sales tax. California residents add 6% sales tax. We reserve the right to limit quantities and substitute manufacturer. Prices subject to change without notice. Send SASE for complete list.



# 2716 EPROMS 450NS (5V)

# 8/4.95 ea.

ALL MERCHANDISE 100% GUARANTEED!

CALL US FOR VOLUME QUOTES

## 8000

8035	16.95
8039	19.95
8080A	3.95
8085	12.95
8085A-2	16.95
8086	99.95
8088	39.95
8155	11.95
8156	11.95
8185	29.95
8185-2	39.95
8741	39.95
8748	29.95
8755	44.95

## 8200

8202	45.00
8205	3.50
8212	1.85
8214	3.85
8216	1.80
8224	2.50
8226	1.80
8228	4.90
8237	19.95
8238	4.95
8239	4.85
8243	4.45
8250	14.95
8251	4.75
8253	9.25
8253-5	9.85
8255	4.75
8255-5	5.25
8257	8.75
8259	6.90
8272	39.95
8275	29.95
8279	9.50
8279-5	10.50
8282	6.65
8283	6.65
8284	5.70
8286	6.65
8287	6.50
8288	25.00
8289	49.95

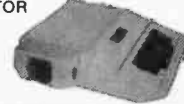
## TV CIRCUITS

MC1330	1.89
MC1350	1.29
MC1358	1.79
LM380	1.29
LM386	1.50
LM565	.99
LM741	.29
LM1310	2.90
LM1800	2.99
LM1889	2.49



## APPLE\* FAN \$69.00

- EXTRA PLUG-IN CARDS CAN CAUSE YOUR APPLE TO OVERHEAT
- ULTRA-QUIET APPLE FAN DRAWS COOL AIR THROUGH YOUR COMPUTER
- ELIMINATES DOWN TIME
- SAVES REPAIR CHARGES
- INCREASES RELIABILITY
- CLIPS ON — NO HOLES OR SCREWS
- COLOR MATCHES APPLE
- LONG LIFE, LOW NOISE MOTOR



\*APPLE IS A TRADEMARK OF APPLE COMPUTER INC.

## EPROM ERASERS

PE-14	78.50
PE-14T (with timer)	108.50
PE-24T (with timer)	154.50

ALL ARE HIGH QUALITY UNITS ENCLOSED IN A BLACK ANODIZED ALUMINUM ENCLOSURE.

# 800-538-5000

# 800-662-6279

(CALIFORNIA RESIDENTS)

CALL JDR BEFORE YOU BUY!  
WE WILL BEAT ANY COMPETITORS' PRICES

## 6800

6800	5.70
6802	10.95
6808	9.95
6809	24.95
6809E	29.95
6810	4.60
6820	4.95
6821	4.95
6828	14.95
6834	16.95
6840	14.95
6843	42.95
6844	44.95
6845	16.95
6847	15.95
6850	4.75
6852	5.75
6860	10.95
6862	11.95
6875	6.95
6880	2.95
68B00	10.95
68B21	12.95
68B50	12.95

## VOLTAGE REG'S

7805T	.79	7905T	.89
7808T	.99	7912T	.89
7812T	.79	7915T	1.19
7815T	.99	7924T	1.19
7824T	.99		
7805K	1.39	7905K	1.49
7812K	1.39	7912K	1.49
7815K	1.39	7915K	.79
7815K	.69	7912L	.79
7815K	.69	7915L	.79
7815K	.69		
LM309K	1.49	LM317K	3.95
LM317T	1.95	LM323K	4.95
		LM337K	3.95

T = TO-220 K = TO-3 L = TO-92

## LINEAR

LM301V	.34
LM308V	.98
LM309K	1.49
LM311	.64
LM317T	1.95
LM317K	3.95
LM318	1.49
LM323K	4.95
LM324	.59
LM337K	3.95
LM339	.99
LM377	2.29
LM380	1.29
LM386V	1.50
LM555V	.39
LM556	.69
LM565	.99
LM566V	1.49
LM567V	1.29
LM723	.49
LM733	.98
LM741V	.29
LM747	.79
LM748V	.59
LM1310	2.90
MC1330V	1.89
MC1350V	1.29
MC1358	1.79
LM1414	1.59
LM1458V	.69
LM1488	.99
LM1489	.99
LM1800	2.99
LM1889	2.49
LM3900	.59
LM3909V	.98
LM3914	3.95
LM3915	3.95
LM3916	3.95
75451V	.39
75452V	.39
75453V	.39

## TRANSISTORS

PN2222	10/1.00	100/ 8.99
2N2222	.25	50/10.99
2N2907	.25	50/10.99
2N3055	.79	10/ 6.99
2N3904	10/1.00	100/ 8.99
2N3906	10/1.00	100/ 8.99
1N4148 (1N914)		25/ 1.00
1N4004		10/ 1.00

## IC SOCKETS

	1-99	100
8 pin ST	.13	.11
14 pin ST	.15	.12
16 pin ST	.17	.13
18 pin ST	.20	.18
20 pin ST	.29	.27
22 pin ST	.30	.27
24 pin ST	.30	.27
28 pin ST	.40	.32
40 pin ST	.49	.39

ST = SOLDDERTAIL

8 pin WW	.59	.49
14 pin WW	.69	.52
16 pin WW	.69	.58
18 pin WW	.99	.90
20 pin WW	1.09	.98
22 pin WW	1.39	1.28
24 pin WW	1.49	1.35
28 pin WW	1.69	1.49
40 pin WW	1.99	1.80

WW = WIREWRAP

## CONNECTORS

RS232 MALE	3.25
RS232 FEMALE	3.75
RS232 HOOD	1.25
S-100 ST	3.95
S-100 WW	4.95

## DIP SWITCHES

4 POSITION	.85
5 POSITION	.90
6 POSITION	.90
7 POSITION	.95
8 POSITION	.95

## 7400 SERIES

7400	.19	7451	.23	74136	.50	74186	18.50
7401	.19	7453	.23	74141	.65	74190	1.15
7402	.19	7454	.23	74142	2.95	74191	1.15
7403	.19	7460	.23	74143	2.95	74192	.79
7404	.19	7470	.35	74144	2.95	74193	.79
7405	.22	7472	.29	74145	.60	74194	.85
7406	.22	7473	.34	74147	1.75	74195	.85
7407	.22	7474	.35	74148	1.20	74196	.75
7408	.24	7475	.49	74150	1.35	74197	.75
7409	.19	7476	.35	74151	.65	74198	1.35
7410	.19	7480	.59	74152	.65	74199	1.35
7411	.25	7481	1.10	74153	.55	74221	1.35
7412	.30	7482	.95	74154	1.40	74246	1.35
7413	.35	7483	.50	74155	.75	74247	1.25
7414	.55	7485	.65	74156	.65	74248	1.85
7416	.25	7486	.35	74157	.55	74249	.95
7417	.25	7489	4.95	74159	1.65	74251	1.75
7420	.19	7490	.35	74160	.85	74259	2.25
7421	.35	7491	.40	74161	.70	74265	1.35
7422	.29	7492	.50	74162	.85	74273	1.95
7423	.29	7493	.49	74163	.85	74276	1.25
7425	.29	7494	.65	74164	.85	74279	.75
7426	.29	7495	.55	74165	.85	74283	2.00
7427	.29	7496	.70	74166	1.00	74284	3.75
7428	.45	7497	2.75	74167	2.95	74285	3.75
7430	.19	74100	1.00	74170	1.65	74290	.95
7432	.29	74107	.30	74172	5.95	74293	.75
7433	.45	74109	.45	74173	.75	74298	.85
7437	.29	74110	.45	74174	.89	74351	2.25
7438	.29	74111	.55	74175	.89	74365	.65
7440	.19	74116	1.55	74176	.89	74366	.65
7442	.49	74120	1.20	74177	.75	74367	.65
7443	.65	74121	.29	74178	1.15	74368	.65
7444	.69	74122	.45	74179	1.75	74376	2.20
7445	.69	74123	.55	74180	.75	74390	1.75
7446	.59	74125	.45	74181	2.25	74393	1.35
7447	.69	74126	.45	74182	.75	74425	1.35
7448	.69	74128	.55	74184	2.00	74426	.85
7450	.19	74132	.45	74185	2.00	74490	2.55

# SHUGART SA-400

- Raw drive for use in TRS-80, Atari, Apple and other computers\*.
- NEW - in original carton. Includes test certification.
- LIMITED SUPPLY - they won't last long at this price.

# \$199.<sup>95</sup> ea.

CALL FOR VOLUME QUOTE

\*Some computers require modification of board.

HOURS: Mon. - Fri., 9 to 5; Sat. 11 to 3



## JDR MICRODEVICES, INC.

1224 S. Bascom Ave.

San Jose, CA 95128

800-538-5000 • 800-662-6279 (CA)

(408) 995-5430 • Telex 171-110

VISIT OUR RETAIL STORE!

TERMS: For shipping include \$2.00 for UPS Ground, \$3.00 for UPS Blue Label Air. \$10.00 minimum order. Bay Area residents add 6 1/2% sales tax. California residents add 6% sales tax. We reserve the right to limit quantities and substitute manufacturer. Prices subject to change without notice. Send SASE for complete list.

# ADVANCED COMPUTER PRODUCTS

TOLL FREE ORDER LINE  
**800-854-8230**



## apple computer

Sales and Service

COMPUTERS	LIST	ACP
Apple II 16K	\$1330.00	\$1029.00
Apple II 48K	1530.00	1099.00
Apple II 64K	1729.00	1225.00
Apple II 64K	2519.00	1775.00
* w/280 Softcard & Vision 80	3495.00	*2895.00

APPLE HARDWARE	LIST	ACP
Apple Disk II w/interface	\$ 645.00	\$ 529.00
Apple Disk II w/o	525.00	449.00
SmartType Printer	395.00	355.00
Photocopy Card	74.00	21.95
IEEE 488 Interface	450.00	375.00
1 year 801 warranty	225.00	175.00
Parallel Printer Interface	180.00	159.95
Communications Card	225.00	189.00
Pascal Language System	495.00	425.95
High Speed Serial Interface	195.00	174.95
Apprentice II ROM Card	200.00	159.95
Language Card	195.00	174.95
12" Green Monitor III	320.00	273.00
* Protie Hard Disk Subsystem	3495.00	2995.00
Graphics Tablet	795.00	695.00

APPLE COMPATIBLE HARDWARE	LIST	ACP
Microsoft 280 Softcard D	\$249.00	
Microsoft 16K Ramcard	128.00	
SSM A10 Serial/Parallel	166.00	
The Keyboard Company		
Joystick	45.00	
Numeric Pad	119.00	
Mountain Computer		
ROM Plus	169.00	
ROM Writer	159.00	
RAMP Plus	225.00	
CPS Multiplexer	169.00	
Expansion Chassis	699.00	
Thunderclock	125.00	
3-10 option	49.00	
Pascal option	29.00	
Veracard 4 in 1	225.00	
CCS Serial I/O	139.00	
Parallel I/O	99.00	
M & R Enterprises		
Apple Fan	45.00	
Sup'RMod	29.95	
Auto Switcher Supply	199.00	
Sup'RTerm	299.00	
ALS Smarterm	299.00	
Corvus 5MB Hard Disk	2995.00	
5MB	425.00	
20MB	524.00	
Apple 16K Upgrade Kit	12.95	
Voxra Voice Box	call	
Scott Voice Recognition	call	

APPLE SOFTWARE	LIST	ACP
Viscalc	\$ 169.00	
SuperCalc	199.00	
VisiTerm/VisiPlot	239.00	
VisiDex	169.00	
VisiTerm	129.00	
BPI General Ledger	329.00	
Accounts Receivable	329.00	
Inventory	329.00	
Microcruiser	229.00	
Micro Telegraph	229.00	
Accounting Plus	119.00	
DB Master	259.00	
Wordstar	149.00	
Super Sort	89.00	
Mail Merger	89.00	
Data Star	199.00	
Sport Star	169.00	
VTS-80 CP/M	319.00	
Fortran 80	195.00	
Code90	699.00	
PFS Ring System	75.00	
PFS Report	75.00	

**SUPERCALC**  
for Apple  
only \$199.00

### FLOPPY DISK DRIVES QUME DT/8 D/D D/S

Qume DT/8 D/D D/S	LIST	ACP
Tandem TM100-1 5 1/4" Disk Drive	\$ 569.95	279.00
MPI 05-5 1/4" 40 Tracks	279.00	
Shugart SA400-5 1/4" 35 Tracks	295.00	
Shugart 800/801R 8"	449.00	
Siemens Shugart Compatible Model FDD-120-80	429.00	
PERSCO Model 277 Dual	699.00	
MPI 052 5 1/4" Dual	346.00	
WANG/OSIEMENS 2	290.00	
MPI 91 Double Track Density Single Side	375.00	
80 Tracks		
MPI 92 Double Track Density Double Side	475.00	
160 Track		

**16K RAMCARD**  
• Apple II compatible  
List \$195.00 ACP \$74.95  
DEALER PRICING AVAILABLE

## Vista

VISTA COMPUTER	LIST	ACP
* Vision 80 8" 80x24 display card	\$395.00	\$299.00
Vision 400 40 cpi enhancement	199.00	149.00
Vision 20 8" lower case ROM	29.95	25.00
* A800 Double Density 8" Controllers	595.00	*499.00
MM9 9 voice music	195.00	99.00
GD25 (384 Regent) Apple I/O	195.00	169.00
PDS PROM development	595.00	399.00
TYPE AHEAD BUFFER	49.95	35.00



**Vision 80**  
\$299.00

### VISTA V-DRIVE

VISTA V-DRIVE	LIST	ACP
Model W-1000 8" floppy disk enclosures with Qume Datatrak 8		
CABINET	\$ 459.95	
w/2 single-sided drives, ps/ac	\$ 1495.00	
w/7 double-sided drives, ps/ac	\$ 1995.00	
A800 Double density controller (for Apple computer)	\$ 499.00	

### APPLE COMPATIBLE DRIVES (MicroSci)

A2 series is plug-compatible	LIST	ACP
Save \$300 on dual drive system		
DOS software not included		
* A2 5 1/4" 162K Drive	\$478.00	*339.00
A2C controller	100.00	89.00
A405 1/4" 160K Drive	449.00	365.00
A70 5 1/4" 285K Drive	599.00	480.00
A400 controller for A40/A70	100.00	79.00

### DISKETTES

VERBATIM & Maxell Diskettes	PRICE BOX 10
* 5 1/4" TRACKS DOUBLE DENSITY SINGLE-SIDED 5 1/4" DISK	
5/5 01 Soft Sealed TRS 80 etc.	\$29.95
5/5 02 10 Hole Hard MS Apple etc.	\$29.95
5/5 16 16 Hole Hard Micro	\$29.95
* 40 & 72 TRACK DOUBLE DENSITY - SINGLE SIDED 5 1/4" DISK, REINFORCEMENT ANGLE	
5/7 01 Soft Sealed TRS 80 etc.	\$32.75
5/7 02 10 Hole Hard MS Apple etc.	\$32.75
5/7 16 16 Hole Hard Micro	\$32.75
* 48 TRACKS DOUBLE SIDED DOUBLE DENSITY 5 1/4" DISK	
5/8 01 Soft Sealed 5 1/4" MS 5 1/4"	\$39.95
5/8 02 10 Hole Hard 5 1/4" WANG/CCD	\$39.95
5/8 16 16 Hole Hard Micro	\$39.95
* 8" 100% DENSITY DISKETTES	
10800 01 Soft Single Density 3 1/2"	\$33.50
10800 02 3 1/2" Hard Single Density Shell	44.80
10800 01 Soft Double Density 3 1/2"	44.80
10800 02 Soft Double Sided Double Density 3 1/2"	49.60

### ROBOTIC ARM

Automation or Robotic Assembly	Education in Robotic Principles	Artificial Intelligence Experiments	Computer Art and Games
Microbot MiniMover-5	Completely Assembled w/Applications Manual	\$1695.00	
ARM-BASIC Software For TRS-80		39.95	
Application/Reference Manual		16.95	

## USI Computer Products

### VIDEO MONITOR (Sanyo Look Alike)

Model P1 18" Green	\$159.95
Model P1 2 12" Green	159.95
Model P1 3 12" Orange	199.95



\$429.00

### PRINTERS

EPSON/VISTA	LIST	ACP
MX-80 Dot Matrix	\$645.00	\$429.00
MX-100	745.00	529.00
Apple I/O & cable	110.00	89.00
Graftrax option	95.00	89.00
IEEE I/O & cable	130.00	95.00
Serial I/O & cable	130.00	95.00
Serial w/2K & cable	175.00	149.00
Universal Graphics Utility	39.95	35.95
NEC 8023 Dot Matrix	795.00	649.00
DIABLO 830 Daisywheel Tractor	2965.00	*2295.00
249.00	169.95	
* ITH/VISTA Starwriter/V300	25 cps	1895.00
45 cps	2195.00	
100 cps	2499.00	
8510	749.00	* 675.00
AMDEK 9500/9501	1650.00	1350.00
QUME 9445	3295.00	2995.00
IDS 460G w/Graphics 500G 14.75" carriage	1395.00	899.00
1695.00	1199.00	



**BROTHER**  
Daisywheel Printer  
Only  
\$895

### TERMINALS

TELEVIDEO	LIST	ACP
910	\$ 699.00	\$ 599.00
912C	950.00	699.00
920C	995.00	799.00
950C	1195.00	999.00
SOROC		
IO120		699.00
IO135		899.00
IO140		1149.00

## SANYO

### MONITORS

SANYO	LIST	ACP
9" B&W	\$225.00	\$169.95
9" Green	259.00	199.95
12" B&W	340.00	249.00
12" Green	360.00	279.00
13" Color	530.00	429.00
13" RGB	1195.00	995.00

### Novation

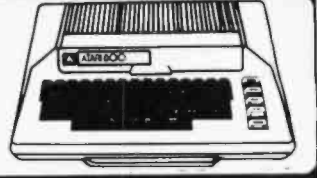
### MODEMS

NOVATION	LIST	ACP
Cat	\$199.95	\$149.00
D-Cat	199.95	169.00
Apple-Cat	349.95	309.00
Auto-Cat	299.95	239.95
HAYES		
Micromodem	\$379.00	\$299.00
Smartmodem	278.00	249.00

## IBM

### IBM COMPATIBLE BOARDS

MAX-OUT YOUR IBM PC	LIST	ACP
Vista 576K RAM CARD 250K populated	\$1199.00	
576K populated	1739.00	
512K populated	1849.00	
Vista 192K ADD-ON w/SUPERCALC		
WOW! Superdeal @ That's for both	799.00	
IBM Wire Wrap Board	69.00	
IBM Extender Board	19.95	



## ATARI

ATARI COMPUTER	LIST	ACP
400 w/16K RAM	\$399.00	\$339.95
-400 Basic Language Module	49.00	47.00
800 w/16K RAM	899.00	699.00
410 Prog Recorder	90.00	80.00
825 Printer	799.95	699.00
830 Acoustic Modem	199.95	159.00
850 Interface Module	219.95	165.85
MTK 16K RAM	99.50	74.00
MTK 32K RAM	199.50	139.00
ATARI VisiCalc	200.00	160.00
ATARI Pac-Man	44.95	36.95

### ADD-ON MEMORY

Atari 16K	LIST	ACP
Atari 32K	\$ 99.50	\$ 74.00
Vic 20 16K	199.50	149.00

### XEROX 820

"The Personal Computer"  
FREE TCS BUSINESS SOFTWARE  
w/purchase A/R G/L A/P Payroll Inventory  
\$100.00 VALUE 8" only

820-1	5 1/4" system	\$2995.00	\$2496.00
820-2	8" system	3795.00	*3195.00
CP/M		200.00	169.95
SuperCalc		295.00	239.95
Word Processing		500.00	429.95



## HEWLETT PACKARD

### HEWLETT-PACKARD COMPUTERS

HP-87	LIST	ACP
HP-85A	\$2495.00	\$1895.00
HP-83	2750.00	2095.00
HP-125	2395.00	1050.00
HP-125	2750.00	2095.00
8250IM 5 1/4" Dual Floppy	1875.00	
8135A 5 1/4" Floppy w/Winchester	4765.00	
9895 A 8" Dual Floppy	5135.00	
7470A Plotter	1375.00	
82907A 32K Module	249.00	
82908A 64K Module	379.00	
82909A 128K Module	675.00	
82900A CP/M w/64K	425.00	

### CALCULATORS

HP-41C w/2 2K memory	NEW!	325.00	256.00
HP-41C Calculator		250.00	189.95
Memory Module for 41C		26.00	
Quad RAM		95.00	83.95
Card Reader for 41C CV		219.00	169.95
Printer for 41C CV		385.00	291.95
Optical Wand for 41C CV		125.00	99.95
HP-11C Advanced Scientific	NEW!	135.00	149.95
HP-12C Financial		150.00	129.95
HP-34C Prog. Scientific		150.00	119.00
HP-38C Prog. Business		150.00	119.00
HP-97 Programmable Printer		750.00	595.00

NOTE: WE STOCK ACCESSORIES  
HPIL Interface Loop \$119.95  
Turns your calculator into a complete computer system.  
82182A Time Module 75.00 64.95

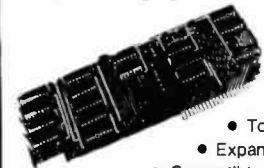
# ★ SUPER SPECIALS ★

MOUNTAIN COMPUTER	SAVE \$300	ELPAC FD206 8"	AMDEK
CPS Multifunction Card \$239.00	Apple Board Set \$395.00 Z80 Softcard (Microsoft) \$195.00 16K Ramcard \$1		

# ADVANCED COMPUTER PRODUCTS

SEND \$2.00 for 104 PAGE CATALOG

## 16K Apple™ Ramcard



**LIST 195 ACP \$74.95**

- Full 1 year warranty
- Top quality — gold fingers
- Expand Apple II 48K to 64K
- Compatible with Z-80 Softcard™
- Allows system to run with CP/M™, PASCAL, DOS 3.3, COBOL, Visicalc, etc.
- Supplied with extra 16K RAM & has (2) LED's

## 32K STATIC RAM

**2 or 4 MHz Expandable Uses 2114's \$159.95**

- 16K 4 MHz Kit 217.95
- 32K 4 MHz A&T 217.95
- 32K 4 MHz A&T 199.95
- 32K 4 MHz A&T 339.00
- BARE BOARD 39.95
- Bare Bd w/ all parts less mem. 99.95

## Astec RF Modulator

**for COLOR & B/W**

P/N 1082 Channel 3 or 4 \$6.95  
P/N 4151 UHF Channel 33 8.95

## MOSTEK 4K RAMS

**29¢ ea.**

200,000 pieces in stock — priced to move. Same as MK4027 except 1ms refresh MK4015 4Kx1 RAM

## BARE BOARDS

5-100 Sound Board \$34.95  
8080A CPU 34.95  
32K Static RAM (2114) 34.95  
8K EPROM (2708) 34.95  
2708/2716 EPROM 24.95  
ACP Proto Board 22.95  
Vector 8800 Proto 22.20  
Vector 8803 11 slot MB 29.95  
ACP Extender with connector 18.95  
13 Slot Mother Board (WMC) 32.95  
9 Slot Mother Board (WMC) 29.95  
9 Slot Mother Bd (Expandable) 34.95  
Floppy PCB (6" SUGART) 39.95  
S100 (A5-8910) Sound Board 34.95  
Apple Sound Board 24.95

## 300 PROMS

2764 (8Kx8) TS \$69.95 2708 (450S) SI \$5.75  
2732 (4Kx8) TS 12.95 2702A (600S) A 5.25  
2716/2516, 5V 7.95 MM5030A0 14.50  
TMS2716, 5V, 12V 17.95 MM52040 9.95  
2765, 5V, (450S) 3.50

## UV "EPROM" ERASER

**Model S-52T \$325.00**

Model S-52T \$325.00

Model S-52T \$325.00

## PMI "Super Beta" LOW POWER AMPLIFIER

**INTERNALLY COMPENSATED P/N OP12GJ**

V<sub>offset</sub> = 1.0 mV  
I<sub>bias</sub> = 5.0 mA  
Gain = 40V/mV (quantity limited)

## 16K Memory Expansion Kits for Apple/TRS-80

8 pcs 4116 16K 200/250S \$12.95  
Specify computer  
CALL FOR VOLUME PRICING

## 4K STATIC RAM SELL-OFF

**10/\$95.00**

Same as TMS4044 but designed specifically for Z-80 based systems. This is a full-spec 4Kx1 RAM, 450nS. Order P/N Zilog 6104-4 while supply lasts.

## "D" SUB CONNECTORS

Unreal price. DB37 male, DB25 female. Gold PC mount with mounting holes. Mig. AMP. Specify 25 or 37 pins.

DB37 \$2.50 DB25 \$1.95

## Zilog Z8 CPU with TINY BASIC

**Debug prog. \$49.95**

Plus 6132 companion quasi-static RAM 29.95

## Stepper Motor

USED IN DATA PRODUCTS PRINTER \$19.95 ea.

## "BLINKER" LED's

Respond to sound. Complete, ready to wear. ("2" x 2"). Sold at Nieman Marcus for 69.95. ACP \$49.95 red, yellow, green LED's

## 12 VOLT BUZZER/HORN

2" DIAMETER ALL METAL 2/\$1.99

## CONNECTORS

DB25P (RS232) \$3.25  
DB25S Female 3.75  
Hood 1.25  
Set with Hood, Sale 7.50  
22/44 S/T, KIM 2.95  
43/86 S/T, MOT 6.50  
50/100 S-100 Connector W/W 4.95  
50/100 S-100 Connector S/T 3.95

## GE D43C3

PNP power HFE = 40-120 VCEO = 30 IC = 3A 6,000 pcs available 69¢ ea.

## Full ASCII Encoded Keyboards

RCA 128-Character, 58-Key Typewriter Form for Alphanumeric Entry VP-606 A Sync Serial Output, Reg. \$99.00 ACP SALE ... \$69.95

## MICROPROCESSORS

Z8001	\$90.00	8008-1	\$14.95	6802P	14.95
Z8002	69.00	8008-2	8.95	8005	14.95
Z80	9.95	2901A	14.95	8038	12.95
Z80A	11.95	9900UL	49.95	8073N	34.95
F-8 (Z850)	19.95	6502	8.95	8765	49.95
2650	19.95	6502A	18.95	8748	49.95
180A	9.75	IM6100	29.95	8909	30.00
6808A	4.75	6800	11.75	8068	49.95
6805	14.95	6803B	19.95	68020	139.95

## RAMS

6116/2016	\$7.95	2147	\$5.99	5230	\$1.99
6264-64K	8.50	411	5.99	5298	1.49
4116-2	1.99	414	4.60	6504	4.50
4116-2	8/12.95	1101	9.99	6518	7.49
2101	3.99	1103	9.99	6561	3.79
2102	7.99	4027	4.69	6604	3.99
21L02-2	1.49	4044	3.99	6605	7.99
21L02-4	1.29	4050	4.69	9130	7.99
2111	3.49	4080	4.69	9140	8.99
2112	3.49	4098	3.99	93415	8.99
2114	1.99	4115	1.49	93425	8.99
2114L-2	3.25	4200	7.95		
2114L-4	2.29	4402	1.99		
2125	6.99	5280	4.60		

## SUPPORT

8155	\$9.95	8259	\$8.95	68047	\$22.95
8156	9.95	8275	19.95	68488	19.95
8202	29.95	8279	9.50	46505	22.95
8305	2.59	6810	4.75	6520	6.95
8212	2.75	6820	6.50	6522	9.95
8214	4.95	6821	6.50	6530-X	24.95
8216	2.75	6828	10.50	6532	17.95
8224	2.95	6834	16.95	6551	19.95
8226	2.95	6845	22.95	Z80-PIO	6.50
8228	3.95	6847	7.75	Z80-PIO	6.50
8243	9.50	6850	5.25	Z80-CTC	6.50
8250	14.95	6852	5.25	Z80A-CTC	9.50
8251	6.50	6860	10.95	Z80A-DMA	19.95
8253	11.95	6862	10.95	Z80A-DMA	27.95
8255	4.50	6875	5.95	Z80A-SIO	24.95
8257	9.50	6880	2.49	Z80A-SIO	29.95

## HI-TECH

2513-001 (5V) Upper	99.50	DA6C6	59.95
2513-005 (5V) Lower	89.50	DA1C0	9.95
2513-AD03 (5V) Lower	14.95	8038 Function Generator	4.50
MC666710 A/SCL Shifter 13x5	13.95	MC424 VCO	2.95
MC666740 Math Symbol 13x5	13.95	MC566 VCO	1.95
MC666750 Alpha Control 13x45	39.25	XR2206 Function Generator	5.25
1771 (1" B) Microtypo	24.95	TR1612 (5V, 12V)	3.95
1781 Dual Floppy	29.95	AY51013 (5V, 12V)	4.95
1791-01 Dual Floppy	36.95	AY51014 (1612 G-14V)	6.95
1791-02 Dual Floppy	44.95	AY51015 (1863 G5)	6.95
1780 DD, 05 Floppy	44.95	IM5402	7.95
1791 DD, 05 Floppy	54.95	IM6413	8.95
1691 Data Separator	18.95	2330 SIOA	13.95
2143 Clock Generator	19.95	18718 ASIR	24.95
6700 10 bit Binary	13.50	MC14111	11.95
6700 10 bit Binary	22.00	4702	14.95
6703 8 bit TS	13.50	WD191A	9.95
9400 Volt to Freq Conv.	7.25	OW5016	16.95
8760 3's Dcm 8CD	13.95	IM58250	13.95
1048L 6 bit	3.95	AY5-2376	13.75
1048L 8 bit	5.95	AY5-3600	13.75
DA061 D to A	5.95	MM572DAC	8.95

## SOCKETS

8 pin LP	16	15	14
14 pin LP	20	19	18
16 pin LP	22	21	20
18 pin LP	29	28	27
20 pin LP	34	33	32
20 pin LP	29	27	26
24 pin LP	38	37	36
28 pin LP	45	44	43
40 pin LP	60	59	58

## LOW PROFILE SOCKETS (TIN)

1-24	25-49	50-100	
8 pin LP	16	15	14
14 pin LP	20	19	18
16 pin LP	22	21	20
18 pin LP	29	28	27
20 pin LP	34	33	32
20 pin LP	29	27	26
24 pin LP	38	37	36
28 pin LP	45	44	43
40 pin LP	60	59	58

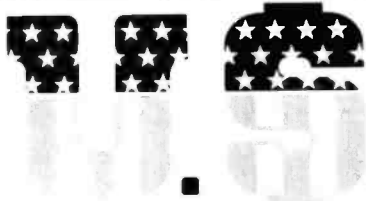
## 3L WIREWRAP SOCKETS (GOLD)

8 pin WW	55	54	49
10 pin WW (Tin)	65	63	58
14 pin WW	75	73	67
16 pin WW	80	77	70
18 pin WW	95	90	81
20 pin WW	1.15	1.08	91
22 pin WW	1.45	1.38	1.23
24 pin WW	1.35	1.26	1.14
28 pin WW	1.99	1.83	1.69
40 pin WW	2.20	2.09	1.89

## LINEAR

78H05K	\$5.95	LM1414N	\$1.90	7400 S 19	7475 S 38	74161 S 1.89
78M06	1.49	LM1458CN/N	.49	7401 22	7476 34	74162 8.99
78M 0.1	1.49	MC1488N	.99	7402 22	7479 4.60	74163 .87
LM1084H	2.95	MC1489N	.99	7403 22	7480 4.49	74164 .87
LM300H	.99	LM1498N	.89	7404 22	7482 95	74165 .87
LM301CN	1.98	LM1556N	1.50	7405 23	7483 55	74166 1.20
LM304H	1.98	LM1800N	.95	7406 23	7484 65	74167 1.69
LM305H	1.89	LM1850N	.95	7407 35	7486 35	74170 1.60
LM306H	3.25	LM1889N	3.10	7408 26	7489 1.75	74172 4.75
LM307CN	.29	LM2111N	1.75	7409 23	7490 39	74173 7.78
LM308CN	.98	LM2900N	.99	7410 22	7491 57	74174 8.99
LM309H	1.49	LM2931N	1.49	7411 23	7492 45	74175 1.89
LM310CN	1.25	LM2917N	2.95	7412 29	7493 45	74176 7.75
LM311D/CN	6.99	CA3013T	1.82	7413 39	7494 8.99	74177 7.75
LM312H	1.75	CA3018T	1.99	7414 59	7495 65	74179 1.34
LM317T	1.70	CA3021T	3.49	7416 29	7496 69	74180 1.75
LM319H	1.49	CA3023T	2.99	7417 29	7497 2.90	74181 1.75
LM320T-XX*	1.25	CA3035T	2.40	7420 20	74100 2.90	74182 1.00
LM320T-XX*	1.35	CA3039T	1.28	7421 35	74107 32	74184 2.25
LM320T-XX*	1.39	CA3046N	1.29	7422 29	74109 37	74185 2.25
LM320T-XX*	1.25	LM3053CN	1.49	7423 29	74116 1.95	74188 9.95
LM323K	4.86	CA3059N	3.19	7425 29	74121 29	74188 3.90
LM324N	1.25	CA3092N	3.19	7426 39	74122 6.79	74189 1.89
LM337K	5.95	CA3082N	4.95	7427 25	74123 59	74181 1.15
LM339K	6.95	LM3065N	1.49	7429 45	74125 39	74192 8.5
LM339N	6.95	CA3080T	1.29	7430 23	74126 44	74193 8.5
LM340K-XX*	1.75	CA3081N	1.89	7432 26	74128 59	74194 8.5
LM340K-XX*	1.25	CA3082N	1.69	7437 25	74132 89	74195 8.8
LM340H-XX*	1.95	CA3083N	1.55	7438 29	74134 1.75	74196 1.89
LM344H	1.85	CA3086N	8.0	7439 29	74139 95	74197 8.5
LM348N	1.20	CA3089N	2.99	7440 19	74141 79	74198 1.39
LM350K	5.60	CA3096N	3.49	7441 79	74142 2.95	74199 1.39
LM358CN	.98	CA3097N	1.99	7442 57	74143 2.95	74221 1.19
LM350N	1.49	CA3130T	1.30	7443 95	74144 2.95	74251 9.5
LM372N	1.25	CA3140T	1.19	7444 79	74145 1.82	74252 1.00
LM376N	2.75	CA3146N	2.49	7445 79	74147 1.95	74276 1.89
LM380CN/N	1.25	CA3160T	1.19	7446 79	74148 1.20	74279 7.5
LM381N	1.79	CA3190N	1.95	7447 65	74150 0.99	74283 1.40
LM381N	1.25	CA3410N	.59	7448 79	74151 67	74284 3.90
LM382N	1.95	MC3423N	3.19	7450 15	74152 6.79	74285 1.89
LM386N	1.40	MC3460N	3.95	7451 19	74153 67	74290 1.25
LM387N	1.40	SG3524N	3.95	7453 19	74154 1.19	74298 9.5
LM390N	1.95	CA3600N	3.39	7454 19	74155 7.8	74365 6.8
NE531V-T	3.75	LM3900N	.59	7459 25	74156 78	74366 6.8
NE555V	.39	LM3905N	1.19	7460 23	74157 69	74367 6.8
NE555N	.98	LM3920N	1.19	7470 25	74158 1.89	74368 6.8
NE551T	19.95	LM3914N	3.75	7472 29	74159 4.29	74390 1.45
NE565H/V	1.25	LM3915N	3.95	7473 34	74160 88	74393 1.90
NE566H/V	1.75	LM3916N	3.75	7474 34		74490





# MICRO SALES

15381 CHEMICAL LANE ★ HUNTINGTON BEACH, CA 92649

★ (714) 891-2677 ★

## ★ SPECIALS OF THE MONTH ★



**ONLY \$25.00**



**ONLY \$55.00**

WOW! LOOK!  
Brand new fully encoded ASCII keyboards.  
Guaranteed to work. With all documentation.  
SUPER DEAL! 40 pin dual .100 cable.  
+5V @ .500MA

Perfect for 8" or 5" drive power. Comes with Shugart type connectors but 5" type can be put on. These are overstock from our Horizontal Cabinet shown below.  
+5V @ 4A ● +24V or +12V @ 3A ● -12V @ 1A

## BREAK THE COST BARRIER!

THIS OFFER ONLY GOOD THRU MAY 1982  
NOW IS YOUR CHANCE TO GET THAT COMPUTER  
LOOK AT THESE FEATURES!

- 4MHZ Z-80 CPU with 2 Programmable Serial and 3 Parallel Ports
- 64K Dynamic Ram w/Extended Addressing to 1MB
- Floppy Disk Controller with WD1795. Runs 8" or 5" Floppys Error Free
- 30 Amp Power Supply with S-100 MOD 12 Slot Mother with Regulated Floppy Supplies as Shown Below
- Tan and Charcoal Sturdy Steel Cabinet with Space for 2 Floppy Drives at Left (8" or 5")

## ★ DUAL DRIVE SUBSYSTEMS ★



HORIZONTAL



VERTICAL



MINI

- Power Supply for 2 801/851 DT8 etc.
- 50 Pin Ribbon Cable, 36"
- AC Cord, Fuse, Internal Wiring and Connectors

w/2 801R Shugart	<b>\$1045.00</b>
w/2 851R Shugart	<b>\$1395.00</b>
w/2 QUME DT-8	<b>\$1295.00</b>
w/2 MPI B-51	<b>\$ 675.00</b>
w/2 MPI B-52	<b>\$ 830.00</b>
w/2 MPI B91	<b>\$ 850.00</b>
w/2 MPI B92	<b>\$ 995.00</b>
w/2 Empty 5"	<b>\$ 87.00</b>
w/2 Empty 8"	<b>\$ 95.00</b>

## ★ MODEMS ★



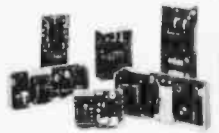
Ask About  
Our Low Cost  
Modem Software



Hayes - Micro Modem	<b>\$275.00</b>
Hayes - Smart Modem	<b>\$250.00</b>
NOV. - DCAT 300 Baud Direct Con. Ans./Orig.	<b>\$165.00</b>
NOV. - AUTOCAT Auto/Ans./Orig. Direct Con.	<b>\$235.00</b>
NOV. - APPLICAT 300/1200 Baud Direct Con.	<b>\$350.00</b>
PMMI - MM103 300/600 Baud (S-100)	<b>\$359.00</b>

## OPEN FRAME POWER SUPPLIES

DISK POWER SUPPLIES				
PRIAM - SHUGART - CENTURY - MICROPOLIS				
+5V @ 9A	-5V @ .8A	+24V @ 4.5A	US-384	89.00
SHUGART - SIEMANS - MPI 5 1/2"				
+5V @ 5A	+12V @ .9A		US-340	33.50
+5V @ 2A	+12V @ 4A		US-323	56.25
SHUGART - SIEMANS - CDC 8"				
+5V @ 1A	-5V @ .5A	+24V @ 1.5A	US-205	52.50
+5V @ 2A	-5V @ .5A	+24V @ 3A	US-206	69.00
+5V @ 3A	-5V @ .6A	+24V @ 5A	US-162	89.00
+5V @ 1.7A	-5V @ 1.5A	+24V @ 2A	US-272	69.00
+5V @ 2A	+12V @ .4A	-12V @ .4A	US-HTAA	37.50



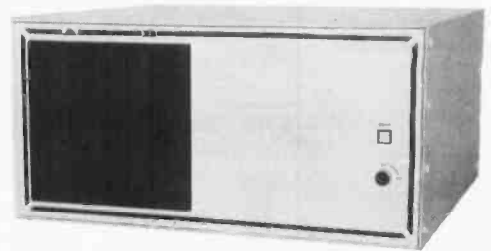
If you can beat these prices we will be truly amazed. OEM's at 500 lot pay more than this. Call or write for full spec. sheets.

## COMING NEXT MONTH — HARD DISK!

**\$100-12**

\$1750 Retail  
**ONLY \$975.00**

CP/M\* \$150  
MP/M \$350  
CABLE SET \$30



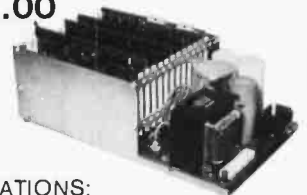
(Less Drives, Cables Pick-up Price)

\*CP/M is a Trademark of Digital Research

## ★ XOR ★

**S-100 MOD KIT \$199.00**  
BY XOR

For test or hobby applications complete S-100 12 Slot Sub-System power for up to 4 Floppy Disk Drives.

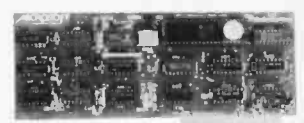
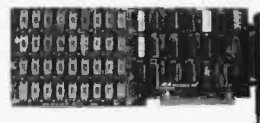


SPECIFICATIONS:

UNREGULATED	REGULATED
• 12 Slots S-100	+5 at 5 Amps
• +8VDC at 30Amps	+24 at 4 Amps
• ±16VDC at 6 Amps	-5 at 1 Amp

XOR-CPU Z-80 4MHZ, Prom 2 Serial 3 Par	<b>\$255</b>
XOR-DSK WD-1795 MINI and 8"	<b>\$275</b>
XOR-64K Bank SW Memory up to 1 Meg	<b>\$389</b>
XOR-32K Static Ram (Kit)	<b>\$199</b>
XOR-MPM IO MPM Interface Card	<b>\$335</b>
XOR-DTC Hard Disk and DTC Tape	<b>\$225</b>
XOR-SMS Hard Disk Controller	<b>\$750</b>

## ★ IBM AND APPLE ★



APPLE - 16K Ram Expansion Card, works with Microsoft Basic	<b>\$99.50</b>
APPLE - Z-80 CPU Direct replacement for Z-80 Softcard	<b>\$149.50</b>
IBM-PC Ram Expansion Card with 64K (256K available)	<b>\$475.00</b>

Circle 419 on inquiry card.

## California Computer Systems



- 2810 CPU Only — \$255.00
- 2422 Dsk Cont Only — \$330.00
- 2065C 64K Only — \$510.00
- 2200A Mainframe Only — \$450.00
- CCS Apple Boards Call for prices
- CCS 2200 System Tested and Assembled Only — \$1,695.00

★ SPECIAL ★ SPECIAL ★ SPECIAL ★

### CCS SYSTEM 2410

#### \*FEATURES\*

- \* DMA Disk Controller
  - \* 2-Real Time Clocks
  - \* 2-Serial/1-Parrell Port
  - \* Hardware Vectored Interrupts
  - \* Supports C/PM, M/PM, OASIS
  - \*\*\*Comes with C/PM\*\*\*
- only-\$2200.00



CB2-CPU .....	\$295.00
MB10A-16K .....	\$295.00
MB64-64K .....	\$845.00
I/O5-2SER 3PAR .....	\$329.00
I/O8-8SER .....	\$550.00
Apple	
A-I/O II .....	\$225.00
A-S/I/O .....	\$149.00

#### COMMUNICATIONS PACKAGES

TRACEND I .....	\$89.00
TRACEND II .....	\$149.00

**commodore**  
computer systems  
CALL FOR PRICES



SYSTEMS 200, 300, 400  
CALL FOR PRICES



**data systems**

CALL FOR PRICES



**Cromemco**  
INCORPORATED

CALL FOR PRICES



**TeleVideo**  
SYSTEMS

CALL FOR PRICES



11 EDISON DRIVE ★ NEW LENOX ★ ILLINOIS 60451  
CALL TOLL FREE: 1-800-435-9357 ★ MONDAY thru SATURDAY  
(ILLINOIS RESIDENTS CALL: 815-485-4002) ★ 8:00 a.m. to 6:30 p.m.

TERMS: Prepayment — C.O.D. up to \$100.00 — M/C Visa  
\$5.00 Processing and Handling added to each order PLUS  
Shipping Charges. Please allow personal check to clear before shipment.  
15% Restocking Charge for Non-Defective, Returned Merchandise.

## FEATURES! TERMINAL

- Feather Touch Capacitance Keyboard
- 60 Key Standard ASCII PLUS + Hex Keypad PLUS + 8 Special Function Keys PLUS + 20 Screen Editing Keys
- SOROC Type Screen Attribute Set
- Half Intensity

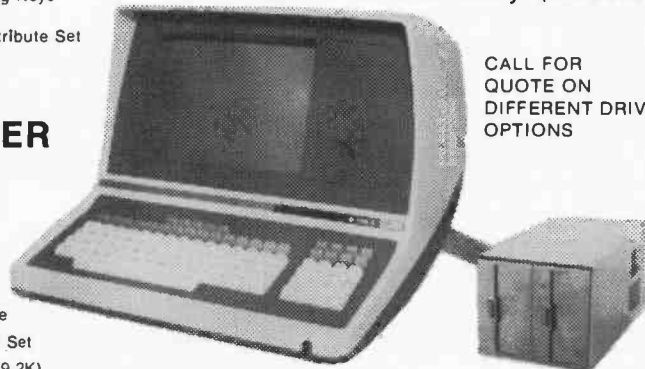
## COMPUTER

- 8 Slot S-100
- 64K Dynamic Ram
- 4MHZ Z-80
- Double Density Disk Controller
- Programmable Baud Rate
- Programmable Keyboard Set
- Serial Printer Port (150-19.2K)

## S-100-8

INCLUDING C/P/M 2.2®  
AND WORDSTAR®

WITH: 8" SS/DD Drives Only \$2850.00  
5 1/4" SS/DD Drives Only \$2700.00



CALL FOR QUOTE ON DIFFERENT DRIVE OPTIONS

WORDSTAR is a TM of Micropro Inc. — C/P/M 2.2 is a TM of Digital Research Inc.

## MONITORS

ZENITH VIDEO MONITOR—  
ZVM .....

AMDEK MONITORS—  
AMDEK Color 1 .....

## DISK DRIVES

- Shugart 801's — \$395.00
- Shugart 851's — \$575.00
- Qume DT-8's — \$540.00
- Shugart 400's — \$255.00
- Tandom 5 1/4 — \$255.00

## TERMINALS

- Adds Regent 20 — \$570.00
- Televideo 910 — \$575.00
- Televideo 912C — \$665.00
- Televideo 925C — \$740.00
- Televideo 950 — \$950.00
- Ampex Dialog 80 — \$895.00
- Zenith Z19 — \$745.00

## PRINTERS

- C-ITOH PROWRITER .....
- C-ITOH Comet I 9 x 7 Dot Matrix .....
- C-ITOH Comet II 132 Column Printer 9 x 7 Dot Matrix .....
- MPI-88G .....
- EPSON MX 80 .....
- EPSON MX 100 .....
- Anadex 9501 Graphic Printer .....
- OKIDATA 82A .....
- Microline 80 .....

WE HAVE NEC SPINWRITERS  
CALL FOR PRICES



- Apple 8" Disk Controller Card
- ZVX4 Dual Density, Single & Double Sided - Auto Boot .....
- Disk 2 + 2 Single Density Single or Dual Sided .....

Circle 419 on Inquiry card.

www.americanradiohistory.com





SN7400N	.20	SN7472N	.29	SN74156N	.79
SN7401N	.20	SN7473N	.35	SN74157N	.69
SN7402N	.25	SN7474N	.35	SN74160N	.89
SN7403N	.25	SN7475N	.35	SN74161N	.89
SN7404N	.25	SN7476N	.35	SN74162N	.89
SN7405N	.29	SN7479N	5.00	SN74163N	.89
SN7406N	.35	SN7480N	.50	SN74164N	.89
SN7407N	.35	SN7482N	.99	SN74165N	.89
SN7408N	.29	SN7483N	.99	SN74166N	.29
SN7409N	.29	SN7485N	.99	SN74167N	2.79
SN7410N	.29	SN7486N	.35	SN74170N	1.95
SN7411N	.29	SN7489N	1.75	SN74172N	4.95
SN7412N	.25	SN7490N	.49	SN74173N	1.39
SN7413N	.49	SN7491N	.49	SN74174N	.99
SN7414N	.69	SN7492N	.45	SN74175N	.85
SN7416N	.29	SN7493N	.45	SN74176N	.79
SN7417N	.29	SN7494N	.69	SN74177N	.79
SN7420N	.25	SN7495N	.69	SN74178N	1.69
SN7421N	.29	SN7496N	.69	SN74180N	.79
SN7422N	.45	SN7497N	3.00	SN74181N	2.25
SN7423N	.29	SN74100N	1.49	SN74182N	.79
SN7424N	.29	SN74101N	.89	SN74184N	2.49
SN7425N	.29	SN74102N	.89	SN74185N	.79
SN7426N	.25	SN74107N	.35	SN74190N	1.25
SN7427N	.49	SN74109N	.39	SN74191N	1.25
SN7430N	.25	SN74112N	1.95	SN74192N	.89
SN7432N	.29	SN74113N	.29	SN74193N	.89
SN7433N	.25	SN74122N	.35	SN74194N	.89
SN7434N	.40	SN74123N	.59	SN74195N	.69
SN7435N	.25	SN74125N	.49	SN74196N	.89
SN7440N	.20	SN74126N	.49	SN74197N	.89
SN7441N	.89	SN74138N	.75	SN74199N	1.49
SN7442N	.89	SN74139N	.75	SN74199N	1.49
SN7443N	1.10	SN74141N	.99	SN74211N	1.25
SN7444N	1.10	SN74142N	3.25	SN74211N	.99
SN7445N	.89	SN74143N	3.49	SN74216N	1.95
SN7446N	.89	SN74144N	.79	SN74217N	.79
SN7447N	.69	SN74145N	.79	SN74218N	1.49
SN7448N	.79	SN74147N	1.95	SN74248N	3.95
SN7449N	.79	SN74148N	1.29	SN74248N	3.95
SN7451N	.20	SN74150N	1.25	SN74365N	.89
SN7452N	.20	SN74151N	1.25	SN74366N	.89
SN7453N	.20	SN74152N	1.25	SN74367N	.69
SN7454N	.25	SN74153N	.79	SN74368N	.69
SN7455N	.20	SN74154N	1.25	SN74390N	1.49
SN7456N	.20	SN74155N	.79	SN74393N	1.49

74LS00	.29	74LS152	1.15	74LS312	1.15
74LS01	.29	74LS153	.75	74LS313	1.15
74LS02	.29	74LS154	.75	74LS314	1.15
74LS03	.29	74LS155	.75	74LS315	1.15
74LS04	.29	74LS156	1.15	74LS316	1.15
74LS05	.29	74LS157	.75	74LS317	1.15
74LS06	.29	74LS158	1.15	74LS318	1.15
74LS07	.29	74LS159	.75	74LS319	1.15
74LS08	.29	74LS160	1.15	74LS320	1.15
74LS09	.29	74LS161	1.15	74LS321	1.15
74LS10	.29	74LS162	1.15	74LS322	1.15
74LS11	.29	74LS163	1.15	74LS323	1.15
74LS12	.29	74LS164	1.15	74LS324	1.15
74LS13	.29	74LS165	1.15	74LS325	1.15
74LS14	.29	74LS166	1.15	74LS326	1.15
74LS15	.29	74LS167	1.15	74LS327	1.15
74LS16	.29	74LS168	1.15	74LS328	1.15
74LS17	.29	74LS169	1.15	74LS329	1.15
74LS18	.29	74LS170	1.15	74LS330	1.15
74LS19	.29	74LS171	1.15	74LS331	1.15
74LS20	.29	74LS172	1.15	74LS332	1.15
74LS21	.29	74LS173	1.15	74LS333	1.15
74LS22	.29	74LS174	1.15	74LS334	1.15
74LS23	.29	74LS175	1.15	74LS335	1.15
74LS24	.29	74LS176	1.15	74LS336	1.15
74LS25	.29	74LS177	1.15	74LS337	1.15
74LS26	.29	74LS178	1.15	74LS338	1.15
74LS27	.29	74LS179	1.15	74LS339	1.15
74LS28	.29	74LS180	1.15	74LS340	1.15
74LS29	.29	74LS181	1.15	74LS341	1.15
74LS30	.29	74LS182	1.15	74LS342	1.15
74LS31	.29	74LS183	1.15	74LS343	1.15
74LS32	.29	74LS184	1.15	74LS344	1.15
74LS33	.29	74LS185	1.15	74LS345	1.15
74LS34	.29	74LS186	1.15	74LS346	1.15
74LS35	.29	74LS187	1.15	74LS347	1.15
74LS36	.29	74LS188	1.15	74LS348	1.15
74LS37	.29	74LS189	1.15	74LS349	1.15
74LS38	.29	74LS190	1.15	74LS350	1.15
74LS39	.29	74LS191	1.15	74LS351	1.15

74S00	.45	74S124	3.95	74S243	3.25
74S01	.45	74S133	.65	74S244	3.25
74S02	.45	74S134	.65	74S251	1.45
74S03	.45	74S135	.65	74S252	1.45
74S04	.45	74S136	.65	74S253	1.45
74S05	.45	74S137	.65	74S254	1.45
74S06	.45	74S138	.65	74S255	1.45
74S07	.45	74S139	.65	74S256	1.45
74S08	.45	74S140	.65	74S257	1.45
74S09	.45	74S141	.65	74S258	1.45
74S10	.45	74S142	.65	74S259	1.45
74S11	.45	74S143	.65	74S260	1.45
74S12	.45	74S144	.65	74S261	1.45
74S13	.45	74S145	.65	74S262	1.45
74S14	.45	74S146	.65	74S263	1.45
74S15	.45	74S147	.65	74S264	1.45
74S16	.45	74S148	.65	74S265	1.45
74S17	.45	74S149	.65	74S266	1.45
74S18	.45	74S150	.65	74S267	1.45
74S19	.45	74S151	.65	74S268	1.45
74S20	.45	74S152	.65	74S269	1.45
74S21	.45	74S153	.65	74S270	1.45
74S22	.45	74S154	.65	74S271	1.45
74S23	.45	74S155	.65	74S272	1.45
74S24	.45	74S156	.65	74S273	1.45
74S25	.45	74S157	.65	74S274	1.45
74S26	.45	74S158	.65	74S275	1.45
74S27	.45	74S159	.65	74S276	1.45
74S28	.45	74S160	.65	74S277	1.45
74S29	.45	74S161	.65	74S278	1.45
74S30	.45	74S162	.65	74S279	1.45
74S31	.45	74S163	.65	74S280	1.45
74S32	.45	74S164	.65	74S281	1.45
74S33	.45	74S165	.65	74S282	1.45
74S34	.45	74S166	.65	74S283	1.45
74S35	.45	74S167	.65	74S284	1.45
74S36	.45	74S168	.65	74S285	1.45
74S37	.45	74S169	.65	74S286	1.45
74S38	.45	74S170	.65	74S287	1.45
74S39	.45	74S171	.65	74S288	1.45
74S40	.45	74S172	.65	74S289	1.45
74S41	.45	74S173	.65	74S290	1.45
74S42	.45	74S174	.65	74S291	1.45
74S43	.45	74S175	.65	74S292	1.45
74S44	.45	74S176	.65	74S293	1.45
74S45	.45	74S177	.65	74S294	1.45
74S46	.45	74S178	.65	74S295	1.45
74S47	.45	74S179	.65	74S296	1.45
74S48	.45	74S180	.65	74S297	1.45
74S49	.45	74S181	.65	74S298	1.45
74S50	.45	74S182	.65	74S299	1.45
74S51	.45	74S183	.65	74S300	1.45
74S52	.45	74S184	.65	74S301	1.45
74S53	.45	74S185	.65	74S302	1.45
74S54	.45	74S186	.65	74S303	1.45
74S55	.45	74S187	.65	74S304	1.45
74S56	.45	74S188	.65	74S305	1.45
74S57	.45	74S189	.65	74S306	1.45
74S58	.45	74S190	.65	74S307	1.45
74S59	.45	74S191	.65	74S308	1.45

CA3010H	.99	CA3096N	3.75	CD4098	2.49
CA3011H	2.15	CA3097N	3.95	CD4099	2.49
CA3012H	3.25	CA3100H	1.39	CD4100	2.49
CA3013H	2.49	CA3101H	1.59	CD4101	2.49
CA3014H	1.35	CA3102H	1.69	CD4102	2.49
CA3015H	1.30	CA3103H	1.59	CD4103	2.49
CA3016H	1.30	CA3104H	1.59	CD4104	2.49
CA3017H	1.30	CA3105H	1.59	CD4105	2.49
CA3018H	1.30	CA3106H	1.59	CD4106	2.49
CA3019H	1.30	CA3107H	1.59	CD4107	2.49
CA3020H	1.30	CA3108H	1.59	CD4108	2.49
CA3021H	1.30	CA3109H	1.59	CD4109	2.49
CA3022H	1.30	CA3110H	1.59	CD4110	2.49
CA3023H	1.30	CA3111H	1.59	CD4111	2.49
CA3024H	1.30	CA3112H	1.59	CD4112	2.49
CA3025H	1.30	CA3113H	1.59	CD4113	2.49
CA3026H	1.30	CA3114H	1.59	CD4114	2.49
CA3027H	1.30	CA3115H	1.59	CD4115	2.49
CA3028H	1.30	CA3116H	1.59	CD4116	2.49
CA3029H	1.30	CA3117H	1.59	CD4117	2.49
CA3030H	1.30	CA3118H	1.59	CD4118	2.49
CA3031H	1.30	CA3119H	1.59	CD4119	2.49
CA3032H	1.30	CA3120H	1.59	CD4120	2.49
CA3033H	1.30	CA3121H	1.59	CD4121	2.49
CA3034H	1.30	CA3122H	1.59	CD4122	2.49
CA3035H	1.30	CA3123H	1.59	CD4123	2.49
CA3036H	1.30	CA3124H	1.59	CD4124	2.49
CA3037H	1.30	CA3125H	1.59	CD4125	2.49
CA3038H	1.30	CA3126H	1.59	CD4126	2.49
CA3039H	1.30	CA3127H	1.59	CD4127	2.49
CA3040H	1.30	CA3128H	1.59	CD4128	2.49

## Bulova Quartz Ladies Watches

ONE YEAR FACTORY WARRANTY

Leads LCD Round Digital Games Clock with Leather Strap \$299.97 - Sugg. Retail \$140.00

Leads LCD Square Digital Games Clock with Gold Metal Strap \$299.97 - Sugg. Retail \$110.00

Leads LCD Round Digital Games Clock with Gold Metal Strap \$299.97 - Sugg. Retail \$140.00

Leads LCD Square Digital Games Clock with Leather Strap \$299.97 - Sugg. Retail \$110.00

### Your Choice — \$69.95 ea. any Model

CALL OR SEND ORDER IN REFERENCE TO THIS AD FOR SPECIAL PRICE  
Because of Limited Supply, please provide a second and third choice

### LITRONIX Stick Display Sale

MULTI-DIGIT REFLECTOR ARRAYS FOR CLOCKS

Part No.	Description	Price
LD-100	10-Digit 10mm 1/2" High	2.95
LD-100A	10-Digit 10mm 1/2" High with 10mm 1/2" High	2.95
LD-100B	10-Digit 10mm 1/2" High with 10mm 1/2" High	2.95
LD-100C	10-Digit 10mm 1/2" High with 10mm 1/2" High	2.95
LD-100D	10-Digit 10mm 1/2" High with 10mm 1/2" High	2.95
LD-100E	10-Digit 10mm 1/2" High with 10mm 1/2" High	2.95
LD-100F	10-Digit 10mm 1/2" High with 10mm 1/2" High	2.95
LD-100G	10-Digit 10mm 1/2" High with 10mm 1/2" High	2.95
LD-100H	10-Digit 10mm 1/2" High with 10mm 1/2" High	2.95
LD-100I	10-Digit 10mm 1/2" High with 10mm 1/2" High	2.95
LD-100J	10-Digit 10mm 1/2" High with 10mm 1/2" High	2.95
LD-100K	10-Digit 10mm 1/2" High with 10mm 1/2" High	2.95
LD-100L	10-Digit 10mm 1/2" High with 10mm 1/2" High	2.95
LD-100M	10-Digit 10mm 1/2" High with 10mm 1/2" High	2.95
LD-100N	10-Digit 10mm 1/2" High with 10mm 1/2" High	2.95
LD-100O	10-Digit 10mm 1/2" High with 10mm 1/2" High	2.95
LD-100P	10-Digit 10mm 1/2" High with 10mm 1/2" High	2.95
LD-100		

# Unclassified Ads

**FOR SALE:** Synertek SYM-1 with 4 K monitor ROM and 1 K RAM. Excellent condition, with all manuals. \$150 plus postage. Robert Perstein, 142 Dumas Rd., Cherry Hill, NJ 08003, (609) 428-7282.

**WANTED:** Used computer-science books. Reasonably priced, in good condition for personal use—only one copy of a title wanted. Examples: programming languages, Knuth (Vol. 2), programming techniques, compiler design, applications, etc. M. Berman, Mathematics Dept., Room GT-113, Bronx Community College, Bronx, NY 10453.

**FOR SALE:** Programmer's Toolkit (3.0) for PET (8/16/32 K) and Commodore W/P2 (16/32 K) and Temple of Apsah programs (32 K). Originally \$170. Asking \$70 for total package. MTU 8-bit D/A converter for PET. \$35 or best offer. Philip Chao, POB 387, Rochester, NY 14642, (716) 442-0903.

**FOR SALE:** 32 K Sorcerer with Vista V200 5-inch dual disks, S-100 expansion box, music DAC, and video CRT. CP/M, Z80 assembler, BASIC and Development ROM PACS, and some Adventure games. Cost me \$2800; will sell for \$1600. Drop a card with quote and I'll call you. Gerald Owens, c/o S.M.C., Collegedale, TN 37315, (615) 396-3524 after 9 p.m.

**FOR SALE:** National Semiconductor Digitaltalker DT-1050 3-chip set. Never used, still in box. \$40. Jeffrey M. Craig, 3001 South King Dr. Apt. 912, Chicago, IL 60616.

**FOR SALE:** Jade double-density disk controller, S-100 bus compatible. Reads and writes single- or double-density, 5- or 8-inch, single- or double-sided. Uses on-board Z80A. Has serial printer port. \$200. Jim Burrett, 5-629 Rubidge St., Peterborough, Ontario, Canada, (705) 742-4831.

**FOR SALE OR TRADE:** Assembled and tested Disk-80 (BYTE, March 1981) substitute for RS expansion interface. Originally cost \$429.95. Two months old. For sale at \$250 or trade for database/business programs, printers, or hardware. Includes: 32 K RAM, disk controller for four drives, real-time clock, printer port, power supply, cable to TRS-80, case, and documentation. A. Keung, 761 Fieldstone Rd., Mississauga, Ontario, L5C 3K7 Canada, (416) 279-4613 after 6 p.m.

**WANTED:** Manuals covering the electronic portions of the Savin 900 Wordmaster and the Holmes Tycom KSR38 Selectric typewriter modification. I have the baseplate information available, if anyone needs it, but need maintenance manual or at least schematic for the digital electronics parts of both units, particularly the circuit boards of the Savin 900. Will pay for originals or copies. Please call collect. Bob Howard, 1234 South First Ave., Arcadia, CA 91006, (213) 446-3302.

**FOR SALE:** OSI C/P Challenger with 32 K memory, mini-disk drive with DOS, APF 9-inch monitor, manuals, and repair manual. Barry Hammer, (608) 725-5114.

**WANTED:** The following back issues of Microsystems: 1-1, 1-3, 1-6, and 2-2. DJC, POB 4163, Spartanburg, SC 29303, (803) 583-6106.

**FOR SALE:** IEEE Computer, 35 issues from 9/71 to 2/78 (some missing). Communications of the ACM, Vol. 23: #3, 5, 6, 9, 11 and Vol. 24: #1, 3, 7, 2/76 to 4/76. IEEE Spectrum, 89 issues from 2/68 to 2/76 (some missing). Everything for \$150 or best offer. You pay postage. David Wolverton, 301 C Nubes, Irvine, CA 92715, (714) 752-7303.

**FOR SALE:** Tektronix 4051 graphics computer system. Includes 4662 digital plotter, 4924 tape drive, 4952 joystick, data-communications interface, Extended BASIC, editor, binary loader, ROM pack expander, manuals, and more. Software included: Mathematics Vol. 1 & 2, Stat Vol. 1-4, Mgmt Vol. 1 & 2, Plotter, and Graphics programs. More than 30 tapes. Can be used as stand-alone or terminal. Present price is over \$20,000, but will sell for \$5000. Ron Bremer, 19645 Southwest Wright St., Aloha, OR 97007, (503) 642-1048, 629-1859.

**UNCLASSIFIED POLICY:** Readers who are soliciting or giving advice, or who have equipment to buy, sell or swap should send in a clearly typed notice to that effect. To be considered for publication, an advertisement must be clearly noncommercial, typed double spaced on plain white paper, contain 75 words or less, and include complete name and address information.

These notices are free of charge and will be printed one time only on a space available basis. Notices can be accepted from individuals or bona fide computer users clubs only. We can engage in no correspondence on these and your confirmation of placement is appearance in an issue of BYTE.

Please note that it may take three or four months for an ad to appear in the magazine.

## **BOMB** **BYTE's Ongoing Monitor Box**

Article #	Page	Article	Author(s)
1	34	Everyone Can Know the Real Time	Ciarcia
2	60	Six Personal Computers from Japan	Kocher, Keith Haas Leemons
3	106	Japan Update	Zipnick
4	114	The Machines Behind the Machines	Manuel
5	118	The Japanese Manufacturers, How Successful Will They Be?	Pitta, Winner
6	140	Japan Maps Computer Domination	Barden
7	148	The Atari Tutorial, Part 9: Even More Colors!	Leibson Latocha
8	162	Ports of Entry and Soft Breezes for the Color Computer and Model III	Pournelle
9	202	The Input/Output Primer, Part 4: The BCD and Serial Interfaces	Lehman
10	224	Alien Typhoon	Howland
11	226	Supercalc, Spelling Programs, Basic Compilers, and Home-Grown Accounting	Williams Neldner
12	246	PL/I for Microcomputers	Leininger Williams
13	252	Apple II 80-Column Video Boards, Five Popular Units	Tesler
14	266	More Apple 80-Column Boards	Walters Sweet
15	274	More Maze Building	Blanken- ship Zimmer- man, Conrad
16	286	Colne Robotics Armdroid, The Small-Systems Robot	Calaway, Hill
17	296	Super FORTH Isn't	
18	318	TRS-80 BASIC Program Hang-ups: The Reasons and Some Solutions	
19	334	Anatomy and Development of a Batch-Processing System	
20	426	CHEDIT: A Graphics-Character Editor	
21	446	Give Your Apple a Voice: A Speech Development System Using the Radio Shack Speech Synthesizer	
22	465	Programming PERT in BASIC	
23	479	CP/M, Your Time Has Come: A Real-Time Clock for the Most Popular Microcomputer Operating System	

### First Place Tie

The February BOMB results ended in a tie for first place between Steve Ciarcia for "Build a Computerized Weather Station" and Steve Leibson for "The Input/Output Primer, Part 1: What is I/O?" Each will receive \$100. Neal Atkins and Enrique Castro-Cid captured the second-place prize of \$50 for their description of "A Homebrew Graphics Digitizer." Our readers evidently appreciated the tax advice offered by Melvyn Feuerman and Melvyn Moller as their article "Tax Tips for Computer Owners" placed third. Our congratulations to these authors.

# Reader Service

Inquiry No.	Page No.	Inquiry No.	Page No.	Inquiry No.	Page No.	Inquiry No.	Page No.
1	47th STREET PHOTO 413	86	COMPULINK CORP. 218	169	EXXON OFFICE SYS.CO. 301	*	MBP SFTF.&SYS.TECH. 283
2	A.S.T. RESEARCH 17	*	COMPUMART 52	170	FANTASTIC SIMULATIONS 512	254	MCGRRAW-HILL BOOK CO. 367
3	AB COMP.PROD. 514	*	COMPUPRO/GODBOU 135	171	FIBERFAB,INC. 454	*	MCGRRAW-HILL RESEARCH 271
4	AB COMPUTERS 507	87	COMPUPRO/GODBOU 136, 137	172	FORETHOUGHT PRODUCTS 460	*	MCMILLAN BOOK CLUBS 449
5	ABM PRODUCTS 452	88	COMPUSERVE 478	461	FOX & GELLER ASSOC. 514	256	MEDIA DISTRIBUTING 416
6	ACTION COMPUTER 73	89	COMPUSYSTEMS Inc. 504	*	FRANKLIN MINT CORP. 192, 193	257	MEMORY MERCHANT 231
7	ADV.COMP.PROD. 536, 537	448	COMPUTE MAGZ.N.&BOOKS 311	173	FREDERICK COMP.PROD. 250	35	MEMOTECH 163
8	ADV. EFFORT-SAVER 506	111	COMPUTEX CORP. 324	258	FREE COUPONS 467	259	METAMORPHIC SYS.INC. 247
9	ADV.MICRO DIGITAL CORP. 289	112	COMPUTORIAL 445	174	FREEDOM TECH.N.INT'L. 445	280	METAVAN INC. 516
*	ALF PRODUCTS, INC. 242	113	COMPUVIEW PROD.INC. 10, 11	175	FROG PRINCE,THE 516	118	METROTECH 291
10	ALL ELECTRONICS CORP 310	90	COMPUTER CHANNEL 437	176	FRYE ELECTR. 439	261	MFJ ENTERPRISES INC 142
11	ALMALY TRADING CORP. 512	*	COMPUTER CLASSIFIEDS 520	177	FYI INC. 345	282	MICRO AGE COMP.STORE 41
12	ALPHA BYTE COMP.PROD. 38, 39	452	COMP COMPNTS.UNLTD. 485	459	G & G ENGINEERING 133	263	MICRO BUSINESS WORLD 343
13	ALPHA BYTE COMP.PROD 335	92	COMPUTER EXCHANGE 391	178	G-H COMPUTER SYS. 506	264	MICRO BUSN.ASSOC 510
14	ALPHACOM 340	93	COMPUTER FURN.& ACCSS. 134	179	GENERAL ELECTRIC CO. 171	265	MICROCOM 173
15	ALPS 444	94	COMPUTER HORIZON 464	180	GENERAL SOFTWARE INC. 526	266	MICRO DEVELOPMENTS 248
16	ALSPA COMP.SYS. 263	95	COMPUTER IDEAS CORP. 516	181	GENSTAR REI SALES CO. 109	267	MICRO FOCUS 165
17	ALTOS COMP.SYS. 112, 113	96	COMPUTER INNOVATIONS 429	182	GENSTAR REI SALES CO. 508	268	MICRO MAGAZINE 402
18	AMDEK CORP. 23	97	COMPUTER MAIL ORDER 424, 425	183	GILTRONIX,INC. 510	269	MICRO MANAGEMENT SYS. 307
19	AMER.SMALL BUSN.COMP 132	98	COMPUTER PLUS 506	184	GILTRONIX,INC. 510	456	MICRO MINT 182
20	AMER.SQUARE COMP. 188, 189	99	COMPUTER RESOURCES 221	185	GILTRONIX,INC. 510	464	MICRO MINT 522
21	ANSWER CORP. 50	446	COMPUTER SHOPPER 460	330	GNT AUTOMATIC INC 210	271	MICRO PRINTER MKRGTG 149
22	APPARAT INC 285	101	COMPUTER SHOPPER 520	466	GR ELECTRONICS 210	272	MICRO PRO INT'L. 339
23	APPLEWARE,INC. 516	102	COMP SHOPPING CTR. 419	187	GREAT PLAINS SOFTWARE 95	273	MICRO WORKS, THE 441
24	A.M.T. 58	103	COMPUTER SPLCTIES. 179	188	H&E COMPUTRONICS 393	274	MICRO-SPOT ELECTR. 504
25	APPLIED SOFTWARE TECH 387	104	COMPUTER TOOLBOX,INC. 506	189	HAYES MICROCOMP.PROD. 191	275	MICRODYNAMICS 508
26	ARBA 20	105	COMPUTER TOOLBOX,INC. 512	190	HAYES MICROCOMP.PROD. 295	277	MICROHOUSE 222, 223
27	ARCHIVE 377	*	COMPUTER WRHSE. 155	191	HAYES MICROCOMP.PROD. 316	278	MICROMAIL 254
28	ARRIX LOGIC SYS.INC. 522	106	COMPUTERIST,THE 522	*	HEATH COMPANY 129	279	MICROSETTE INC. 512
29	ARTIFICIAL INT'L.RESRCH 512	107	COMPUTERS WHOLESALE 519	192	HERTZ CORP,THE 235	280	MICROSOFT (CPD) 87
30	ASAP COMPUTER PROD 332, 333	108	COMPUTERTIME INC. 510	193	HEWLETT-PACKARD 143	281	MICROSOFT (CPD) 305
31	ASAP COMPUTER PROD 411	109	COMPUTERWARE 464	194	HIGH TECH.SFTW.PROD. 183	282	MICROSTUF,INC. 209
32	ASHTON-TATE 341	110	COMPUTERWORLD INT'L. 319	*	HILTON HOTEL CORP. 77	283	MICROTECH EXPORTS 427
*	ASPEN SFTW.CO. 26	114	CONCORD COMP.PROD. 427	195	HOWE SOFTWARE 514	284	MIKOS 346
33	ATARI 152, 153	115	CONCURRENT CORP. 477	197	HYPERTEK, INC 298	285	MILLER MICROCOMP.SERV. 434
34	ATLANTIC CABINET CORP. 504	116	CONSUMER COMP. 275	198	I.B.C. 57	286	MILWAUKEE COMP.INC. 363
35	AUTOMATED CONTROL SYS. 520	117	CONSUMER COMP. 486	199	I.Q.SYSTEMS 101	287	MINI COMP.SUPPLIERS 427
*	AVOCET 436	*	CONTEXT INC. 49	200	IMS INTERNATIONAL 297	288	MINI MICRO MART 317
36	AXIOM CORP 395	119	CONTEXT MANGMNT.SYS. 24	201	INDIGO TECHNOLOGY 302	289	MOORE BUSN. FORMS 474
37	B&B ELECTR. 504	120	CONTEXT MANGMNT.SYS. 25	203	INFOSOFT COMP.SYS. 522	290	MORROW DESIGNS 168, 169
38	BASF SYSTEMS 389	121	CORONA DATA SYS. 111	204	INNOVATIVE SOFTWARE 237	291	MOUNTAIN VIEW PRESS 357
*	BASIC BOOKS 304	122	COSMIC COMP.UNLTD. 522	205	INT'L.INST.OF APPLD.TECH 306	293	MPI 379
39	BAUSCH & LOMB INSTR.SYS. 233	123	CPU SHOP, THE 511	206	INT'L.MICRO SYS. 309	294	MTI,INC. 440
40	BAUSCH & LOMB INSTR.SYS. 233	126	CROMEMCO C II, 1	207	INTEGRAL DATA SYS. 281	295	MULTI BUSN.COMP.INC. 428
41	BAY TECHNICAL ASSOC. 396	127	CROMEMCO 2	208	INTEGRAND 430	296	MULTITECH ELECTR.INC. 99
42	BBI MAIL ORDER 504	128	CUESTA SYSTEMS 518	209	INTERACTIVE MICROWRE. 262	297	NAT'L.GRAPHICS OF CO. 422
43	BEECH ENTERPRISES 516	128	CYBERNETICS INC 385	210	INTERACTIVE STRUCTURES 292	298	NEBS 268
*	BELL JOHN ENGR. 513	*	DATA DISCOUNT CTR 352	211	INTERCONT'L MICRO SYS. 284	299	NEC HOME ELECTR.USA 43
44	BIBLE RESEARCH SYSTEMS 230	*	DATA-ED 28	212	INTERFACE INC. 474	300	NEC INFORMATION SYS. 361
45	BISON PRODUCTS 277	129	DATA-RX INC. 310	213	INTERGRAPHICS 514	301	NECO 397
46	BIT 3 COMP.CORP. 314	*	DATA SOURCE SYS.CORP. 234	213	INTERTEC DATA SYS. 272, 273	302	NET PROFIT COMP. 432
47	BLAT RESRCH & DEVELP. 394	130	DATAFACE 30	215	IPEX INT'L. 508	302	NETRONICS 450, 451
48	BMC INTL 119	131	DATAMAC COMP.SYS. 117	216	ISE 126, 127	303	NETWORK CONSULTING CORP 130
49	BORLAND LIMITED 194	132	DATASOUTH COMP.CORP. 83	217	ISE 303	304	NEW GENERATION SYS. 455
50	BOTTOM LINE,THE 326	133	DAY STAR TECHNOLOGY 85	218	ISOTECH,INC. 120	305	NORPAC LIMITED 241
51	BOTTOM LINE,THE 516	134	DEALIN' ELECTR. 512	219	ITHACA INTERSYSTEMS 8	306	NORTH STAR COMPUTERS 442
52	BOWER-STEWART 508	135	DELMART-DELLUX CHK.PRNTRS. 456	220	ITHACA INTERSYSTEMS 9	307	NOVATION 403
53	BRIDGE COMPUTER 238	136	DELPHIC SYSTEMS 158	186	J.C.SYSTEMS 466	*	NRI SCHOOLS ELECTR.DIV. 353
54	BUSINESS & PROF.SFTW. 81	*	DELTA PRODUCTS 146	222	JADE COMP.PROD. 527	*	OASIS SYSTEMS 174
55	BUSINESS OPERATING SYS 255	138	DELTA PRODUCTS 147	223	JADE COMP.PROD. 528, 529	308	OLYMPIC SALES 445
56	BYTE BOOKS 225	139	DEVELOPMENT SYSTEMS 514	224	JAMECO ELECTR. 540, 541	309	OMEGA SALES 415
57	BYTE BOOKS 294	445	DIGITAL EQUIP. CORP 336, 337	225	JDR MICRODEVICES 534, 535	311	OPTICAL TECHNOLOGY 418
58	BYTE BOOKS 315	140	DIGITAL MARKETING 6	226	JIMSCOT,INC. 431	313	ORANGE MICRO 261
59	BYTE BOOKS 417	141	DIGITAL MICROSYSTEMS 253	227	KADAK PRODUCTS 349	314	ORYX SOFTWARE 212
60	BYTE BOOKS 423	*	DIGITAL RESEARCH COMP. 505	450	KEELE CODES LTD. 443	315	ORYX SOFTWARE 447
*	BYTE BACK ISSUES 378	*	DIGITAL RESEARCH COMP. 521	228	KERN PUBLISHING 18	*	OSBORNE COMPUTERS 359
*	BYTE SUBSCRIBER 243	142	DISCOUNT SOFTWARE 348	229	KERN PUBLISHING 19	316	OSBORNE/MCGRAW-HILL 167
61	BYTEK COMP. SYS. 468	143	DMA 444	230	KIT 80 INC. 504	317	OSBORNE/MCGRAW-HILL 299
460	BYTEWRITER 461	*	DOW JONES 145	231	KIT 80 INC. 518	318	OSM COMPUTER 51
62	CALIF DATA CORP 512	144	DOWNTOWN BOOK BAZAAR 516	232	KRAMER SYS INT'L. 433	*	OWENS ASSOC. 228, 229, 243
63	CALIF. DIGITAL 524, 525	145	DRAKE MICRO SYS. 456	233	LABORATORY MICROSYS. 506	320	PACIFIC EXCHANGES 422, 506, 510
64	CALIF. DIGITAL 523	146	DUAL SYS.CONTROL CORP. 351	234	LEADING EDGE PROD CIII	320	PACIFIC EXCHANGES 514, 518, 520
65	CALIF. COMP.SYS. 107	148	DYMARC IND. 439	235	LEHIGH VALLEY LOGIC INC. 431	326	PALOMAR COMP.EQUIP. 530, 531
*	CALIF.MICRO COMP. 412	150	DYSAN CORP. 328, 329	236	LEO ELECTRONICS 422	327	PAN AMERICAN ELEC INC. 443
66	CAMBRIDGE DEVEL LABS 320	462	ECONOMY PERIPHERALS 518	*	LIFEBOAT ASSOC. 141	328	PANASONIC 59
67	CDR SYSTEMS 508	151	ECOSOFT 472	237	LIFEBOAT ASSOC. 181	329	PCD SYSTEMS INC. 124
68	CENTENNIAL SOFTWARE 476	152	EDMOND SCIENTIFIC CO. 441	238	LJK ENTERPRISES INC. 331	*	PERCOM DATA 7
69	CERMETEK 390	449	ELCOMP PUBLISHING INC 473	239	LNW RESEARCH 279	332	PERCOM DATA 177
70	CHAPIN & ASSOCIATES 508	153	ELECTROHOME 215	240	LOGICAL DEVICES 508	333	PERCOM DATA 177
71	CHECK-MATE 510	154	ELECTROLABS 526	241	LOMAS DATA PRODUCTS 197	334	PERCOM DATA 177
72	CHECK-MATE 518	156	ELECTRONIC SPLISTS 472	244	LYBEN COMP.SYS. 504	335	PERSONAL COMP.SYS. 453
73	CHECKS-TO-GO 240	202	ELECTRONIC SUPER-MART 522	242	LYBEN COMP.SYS. 508	336	PHASE ONE SYS.INC. 227
74	CHIPS & DALE 510	157	ELECTRONIC SYS.FURN 384	243	LYBEN COMP.SYS. 512	337	PHONE I,INC. 338
75	CHRISLIN INDUSTRIES 409	158	ELEK-TEK 410	447	MACROTECH COMP 16	338	PICKLES & TROUT 216
76	CMC,INT'L. 211	159	ELLIS COMPUTING 207	467	MACROTECH INT'L. 313	*	POPULAR COMPUTING 161
77	CMC,INT'L. 287	160	EMERGING TECH.CONSLT. 431	468	MACROTECH INT'L. 313	*	POTOMAC MICRO-MAGIC 462
79	COLONIAL DATA SERV. 116	161	EMPIRICAL RESRCH GRP. 454	469	MACROTECH INT'L. 313	339	PRACTICAL PERIPH. 15
80	COLONIAL DATA SERV. 170	162	ENERCOMP 510	246	MAGNETRONICS 518	340	PRACTICAL PERIPH. 199
453	COLONIAL DATA SERV. 322	163	EPIC COMP.CORP. 139	247	MAGNETIC INFORMATION 522	341	PRIORITY ONE 12, 13
81	COLUMBIA DATA PROD. 89	164	EPIC COMP.CORP. 435	248	MAGNOLIA MICROSYS. 514	342	PRIORITY ONE 532, 533
82	COMMODORE BUSN.MACH. 383	165	EPSON AMERICA 406, 407	249	MANNESMANN TALLY 103	343	PROCESSOR INTERFACES INC. 506
83	COMMUNICATION CABLE 520	166	ESSEX PUBLISHING 429	250	MARK OF THE UNICORN 203	344	PROFESSIONAL DATA SYS. 373
84	COMMUNICATIONS ELECTR. 509	167	EXECUTIVE SCANCARD SYS. 371	251	MARYMAK INDUSTRIES 392	345	PROGRAMS UNLTD. 504
451	COMPUCO BUSN. SYS 485	168	EXPOTEC 236	252	MATEX 418	346	PROMETHEUS PRODUCTS 91

To get further information on the products advertising in BYTE, fill out the reader service card with your name and address. Then circle the appropriate numbers for the advertisers you select from the list. Add an 18-cent stamp to the card, then drop it in the mail. Not only do you gain information, but our advertisers are encouraged to use the marketplace provided by BYTE. This helps us bring you a bigger BYTE. The index is provided as an additional service by the publisher, who assumes no liability for errors or omissions. \*Correspond directly with company.



## Reader Service

Inquiry No.	Page No.	Inquiry No.	Page No.	Inquiry No.	Page No.	Inquiry No.	Page No.
292	RCA SOLID STATE 97	* SINCLAIR RESEARCH 200, 201	402	SYSTEMS GROUP. THE 29	424	VECTOR ELECTR. 138	
360	RCE 429	380 SLUDER 514	403	SYSTEMS PLUS INC. 131	425	VECTOR GRAPHICS 79	
312	RED BARON COMP.PROD. 184, 185	381 SLUDER 520	404	TAB BOOKS 401	426	VERBATIM CORP 75	
361	REITH,WALCOTT ENG. 433	* SOF/SYS.INC. 365	405	TARBELL ELECTR. 219	427	VIDEX 21	
363	REMOTE EVOLUTIONARY COMP. 264	382 SOFTECH MICROSYS 347	407	TECHNICAL ENGINEERING 520	428	VISIBLE COMP.SUPPLY 463	
364	RENAISSANCE TECHN. 220	383 SOFTWARE CONSLTG.SERV. 504	408	TECMAR INC 175	* VISICORP INC. 249		
365	ROCKWELL INT'L. 405	* SOLID STATE SALES 503	409	TECMAR INC 251	* VR DATA 45		
455	RUPERT NEVE INC. 239	384 SONICS MICRO SYS. 518		* TEKTRONIX INC. 55	429	VISTA COMPUTER CO 93	
366	S C DIGITAL 477	385 SORRENTO VALLEY ASSOC 232		* TEKTRONIX INC. 258			
454	S.P.C. TECH.INC. 304	386 SOURCE TELECOMP.CORP. 285		* TEKTRONIX INC. 260	430	VYNET CORP. 270	
* S-100 INC 437		387 STANDARD SFTW.CORP. 160		410	431	WALKER,WILLIAM 518	
367	SAGE COMP. TECH. 27	388 STATE OF ALABAMA 159		411	432	WARNER ROBINS AFB 308	
368	SATURN SYSTEMS INC. 520	389 STATIC MEMORY SYS 381		412	433	WASHINGTON COMP.SERV. 517	
369	SCIENTIFIC ENG. 508	390 STELLATION TWO 439		413	* WESTICO INC. 204, 205, 512		
370	SCION CORP 5	391 STRAWBERRY TREE COMP. 441		414	* WHITESMITHS LTD 269		
371	SCITRONICS 435	392 STRICTLY SOFTWARE 195		* TINNEY,RBT.GRAPHICS 400	* WICAT SYSTEMS 31		
372	SCOTIA SOFTWARE 208	393 STROBE 121		415	434	WILDFIRE PUBLISHING 404	
* SCOTTSDALE SYSTEMS 259		* SUBARU OF AMERICA 421		416	435	WILDHARE COMP.SYS. 399	
373	SCR ELECTR. 506	394 SUBLOGIC 190		417	436	WINCHENDON GRP,THE 522	
374	SEATTLE COMP PRODS 327	395 SUNTRONICS 518		418	437	WINTERHALTER & ASSOC. 420	
375	SEIKO-SHA CORP. 37	396 SUPERSOFT 32, 33		419	438	WINTTECH CORP. 506	
376	SFTW.TECH FOR COMP. 157	397 SYBEX 125		420	439	WINTERHALTER & ASSOC. 420	
377	SHAPE INC. 420	398 SYNCOM 128		421	440	X COMP 47	
378	SIERRA COMP.PROD. 435	399 SYSTEM SOLUTIONS 514		422	441	XAVAX CORP. 438	
379	SIERRA DATA SCIENCES 53	400 SYSTEMED 518		423	442	XEDEX CORP. 244, 245	
		401 SYSTEMS GROUP, THE 29			443	ZOBEX 187	

\*Correspond directly with company.

### National Advertising Sales Representatives:

#### Northeast (617) 444-3946

ME, NH, VT, MA, CT, RI, DE, MD,  
VA, WV, OK, TX, Upstate NY,  
Eastern Canada

Hajar Associates  
280 Hillside Ave.  
Needham Heights, MA 02194

#### Mid Atlantic (201) 741-7744

NY, NYC, NJ, PA

Hajar Associates  
321 Broad St.  
Red Bank, NJ 07701

#### Southeast (305) 628-3525

NC, SC, GA, FL, AL, MS, TN, KY

Hajar Associates  
Diplomat Bldg.  
5400 Diplomat Circle  
Suite 272  
Orlando, FL 32810

#### Midwest (312) 966-0160

MN, WI, MI, IA, IL, IN, OH,  
MO, NE, KS, ND, SD, AR

Hajar Associates  
5225 Old Orchard Rd.  
Suite 50  
Skokie, IL 60076

#### Northwest (415) 964-0706

AK, HI, WA, OR, ID, MT, WY,  
Northern California, Nevada Except  
Las Vegas, Western Canada

Hajar Associates  
1000 Elwell Ct.  
Suite 124  
Palo Alto, CA 94303

#### Southwest (714) 540-3554

UT, CO, AZ, NM, Las Vegas,  
Southern California

Hajar Associates  
3303 Harbor Blvd.  
Suite H-4A  
Costa Mesa, CA 92626

### European Advertising Sales Representatives:

Mr. Simon Smith  
McGraw-Hill Publishing Co.  
34 Dover St.  
London W1X 3RA  
England 1-493-1451

Mr. Andrew Karnig  
Andrew Karnig & Associates  
Kungsholmsgatan 10  
112 27 Stockholm, Sweden  
08/51-68-70

Mr. Hans Csokor  
Publimedia  
Reisnerstrasse 61  
A-1037 Vienna, Austria

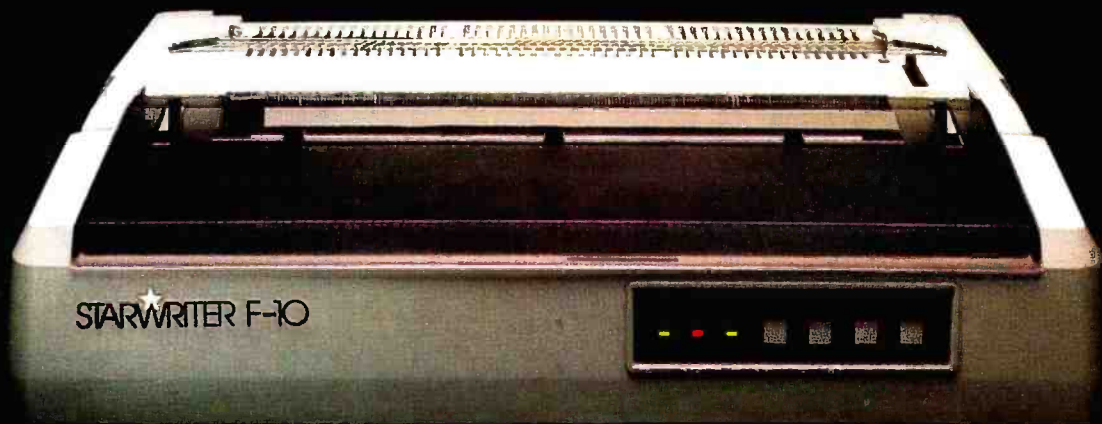
Mr. Fritz Krusebecker  
McGraw-Hill Publishing Co.  
Liebigstrasse 27C  
D-6000 Frankfurt/Main 1  
West Germany  
72-01-81

Mr. Michael Sales  
McGraw-Hill Publishing Co.  
17 rue Georges Bizet  
F 75116 Paris  
France  
720-33-42

Mr. A. Fabio Guarneri  
McGraw-Hill Publishing Co.  
Via Bracchini 1  
20123 Milan, Italy  
88-90-617

Mrs. Gurit Gepner  
McGraw-Hill Publishing Co.  
115 Yosephthal St.  
Bat Yam, Israel  
866-561

# SAVE 6 INCHES, 10 POUNDS, AND \$800.



On the new, slicked-up, trimmed-down Starwriter F-10.

It's C. Itoh's latest generation of letter-quality printers.

It cranks out flawless copy at 40 cps; and its full 15" carriage lets it double in brass for both letter processing and business applications. You can plug it into almost any micro on the market (serial or parallel) simply by plugging it in. And then make it keep on trucking with inexpensive, easily available Diablo com-

patible daisy wheels and ribbons.

In its serial mode, it can print just about anything (including boldface, underlines, subscripts and superscripts), and snap the carriage back to start the next line in less than a second. In its line mode, it prints in both directions, for even faster throughput.

(While making about as much noise as a cat walking on Kleenex.)

It's a nice, portable 30 pounds—about 10 pounds

lighter than the Starwriters before it. And it stands exactly as tall (or precisely as small) as a dollar bill.

Speaking of which:

Incredibly, the Starwriter F-10 sells for about the same preposterously low price as its predecessors. Which is to say, about \$800 less than a lot of other printers that don't even come close to measuring up. Or even better...

Measuring down.

*Distributed Exclusively by Leading Edge Products, Inc., 225 Turnpike Street, Canton, Massachusetts 02021. Call: toll-free 1-800-343-6833; or in Massachusetts call collect 1617/828-8150. Telex 951-624.*

**LEADING  
EDGE.**

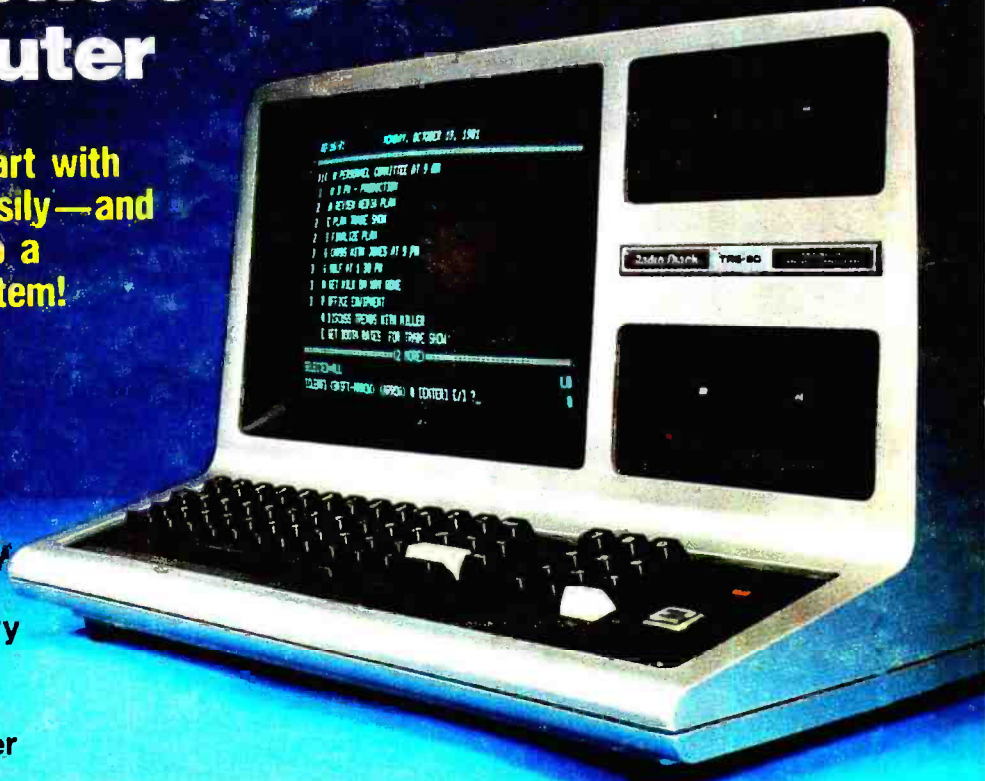
Circle 234 on inquiry card.



# Radio Shack's TRS-80® is Your Best Choice in a First Computer

**Why? Because you can start with our \$999 Model III and easily—and economically—expand into a powerful, professional system!**

- Add Up to 4 Double-Density Disk Drives—2 Internally
- Go from 16K to 48K Memory
- Add RS-232-C Interface
- Or Get It All with Our \$2495 Model III Desktop Computer



A Radio Shack Model III is a versatile, self-contained computer that can grow with you. Whether you're a beginner or a pro, there's one that fits your budget and intended use. And features you'd expect to pay extra for are standard on Model III.

**The built-in "extras".** Our \$999 system includes: a 65-key keyboard with 12-key data pad, a 12" high-resolution monitor, and a parallel printer interface.

**You get much more,** including 16K memory, powerful Model III BASIC language, 500 and 1500 baud cassette operation, 16 lines of 64 or 32 upper and lower case characters, repeating keys, special graphics characters, program editor and real time clock.

**Model III is ready** for a wide range of professional and personal uses. Choose from our large library of user-proven programs or develop your own applications in easy-to-learn BASIC. Just add a cassette recorder to store and run programs and data. Cat. No. 26-1062. **\$999**

**Choose our professional Model III Desktop Computer** for more sophisticated applications. You get the same basic features as the smaller model, but with 48K internal memory, two built-in double-density mini disk drives for 368K of program and data storage and a built-in RS-232 Serial Interface to communicate with other computers using an optional telephone coupler, like our new Modem II (right). Our powerful disk operating system (TRSDOS) is included along with an expanded Disk BASIC language. And we have optional programming languages to meet specific needs—choose from COBOL, Assembler, Compiler BASIC and FORTRAN. And of course the smallest Model III can be upgraded to this top of the Model III line. Cat. No. 26-1066. **\$2495**

**Get a "hands-on" demonstration** of the TRS-80 Model III today at more than 240 Radio Shack Computer Centers and 6200 Radio Shack stores and participating dealers nationwide. Ask about our service and leasing plans, too.

## NEW! Direct-Connect Modem II Automatically Dials and Answers Phone



**Connects Directly to Phone Line And Any RS-232-Equipped TRS-80**

Now your TRS-80 can access and transfer data by telephone. Program the Modem II to dial and answer, receive and transmit, even hang-up. 300 baud. FCC registered. Cat. No. 26-1173. **\$249**

Send me a free TRS-80 catalog.

Mail To: Radio Shack  
Dept. 82-A-130  
1300 One Tandy Center  
Fort Worth, TX 76102

NAME \_\_\_\_\_  
COMPANY \_\_\_\_\_  
ADDRESS \_\_\_\_\_  
CITY \_\_\_\_\_  
STATE \_\_\_\_\_ ZIP \_\_\_\_\_

Retail prices may vary at individual stores and dealers.

**Radio Shack®**  
The biggest name in little computers™  
A DIVISION OF TANDY CORPORATION

Send for a TRS-80 computer catalog. Includes a full line of Radio Shack computers and software.

Circle 357 on inquiry card.

[www.americanradiohistory.com](http://www.americanradiohistory.com)