

DECEMBER 1980 Volume 5, Number 12 \$2.50 in USA/\$2.95 in Canada

A MCGRAW-HILL PUBLICATION

BYTE

the small systems journal

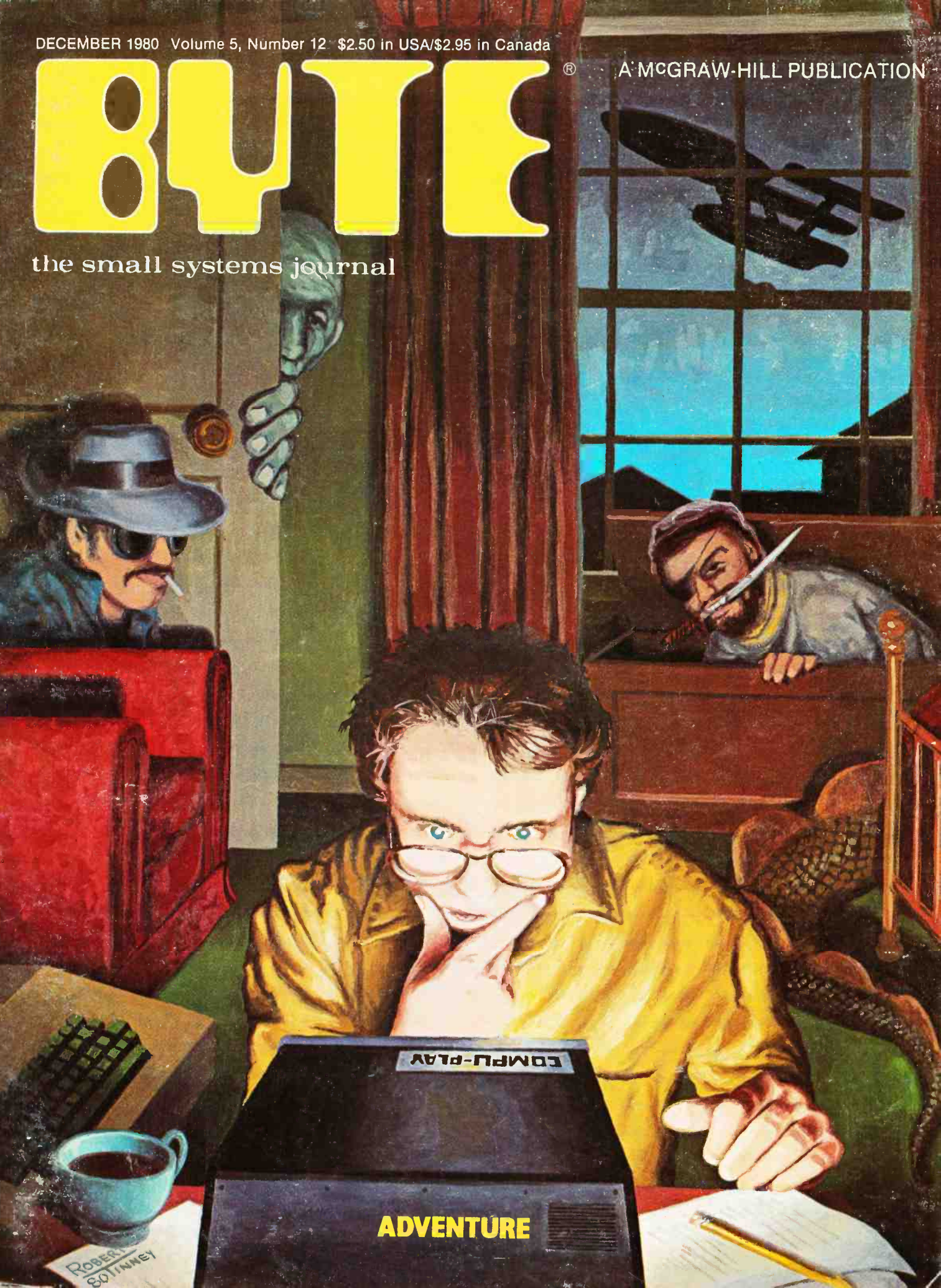

ROBERT
GOTTINNEY

WHAT ARE YOU LOOKING FOR IN A SYSTEM?

VERSATILITY — Data bus—motherboard design allows you to configure a system to the end users exact needs.

EXPANDABLE — Minimum RAM capacity 56K Expandable to 768K. Two I/O ports — Expandable to seventeen.

MASS STORAGE— 3.0 M/bytes on 5¼" flexible disks. (4 drives) 5.0 M/bytes on 8 inch flexible disks—(4 drives)
40 M/bytes on "Winchester" fixed disk.

SOFTWARE — Operating System — Multitasking, multiuser with memory management.

Languages — FORTRAN, Pascal, BASIC, PILOT

Utilities — Debug, Sort-Merge, Diagnostics — over 40 others.

Data Processing — General Ledger, Receivables, Payables, Payroll, Jobcost, Mail List,
Inventory, Record Management System.

Word Processing — Text Editor and Processor — device independent with proportional spacing
bidirectional printing.

COST EFFECTIVE—System consisting of 128K processor, terminal, and 2.4 M/byte dual eight-inch disk drives —
less than \$6,000.00 (O.E.M. 100 quantity)



SOUTHWEST TECHNICAL PRODUCTS CORPORATION

219 W. Rhapsody

San Antonio, Texas 78216

(512) 344-0241

Cromemco accepts your challenge, Data General

Yes, Data General, we saw your ad.

So we realize you hope to win over some of our computer business.

And we can see you have reason to be pleased about your line of minicomputers. They are MINIs though.

But Cromemco produces state-of-the-art MICROcomputers.

Powerful ones.

And our micros have some outstanding advantages.

For example, Cromemco is the only microcomputer manufacturer to support a broad range of microcomputers with (a) 5-inch

double-sided, double-density floppy disk drives and with (b) 8-inch double-sided, double-density floppy disk drives AS WELL AS (c) 8-inch Winchester hard disk drives.

That means, of course, that our customers have a wide choice of disk storage capability.

UNEQUALLED SOFTWARE SUPPORT

OK. That was one point.

Here's another: our stunning selection of software support. Cromemco is the only micro manufacturer to produce both single-user and multi-user multi-tasking computers with software like this:

SYSTEM SOFTWARE

- CDOS (a CP/M-like operating system)
- CROMIX (a UNIX-like operating system)
- RPG-II (IBM-compatible)
- COBOL
- BASIC
- FORTRAN IV
- RATFOR
- LISP
- C
- Macro Assembler

APPLICATION SOFTWARE

- Word Processing System
- Data-Base Management
- General Ledger
- Accounts Receivable
- Accounts Payable
- Inventory

All of this is available now with more coming all the time.

So there you are, D.G.

You can see why we know our microcomputers will stand the test.

Cromemco eagerly accepts the challenge.

WE'RE BUSTING THE COMPETITION'S BOARDS AGAIN.

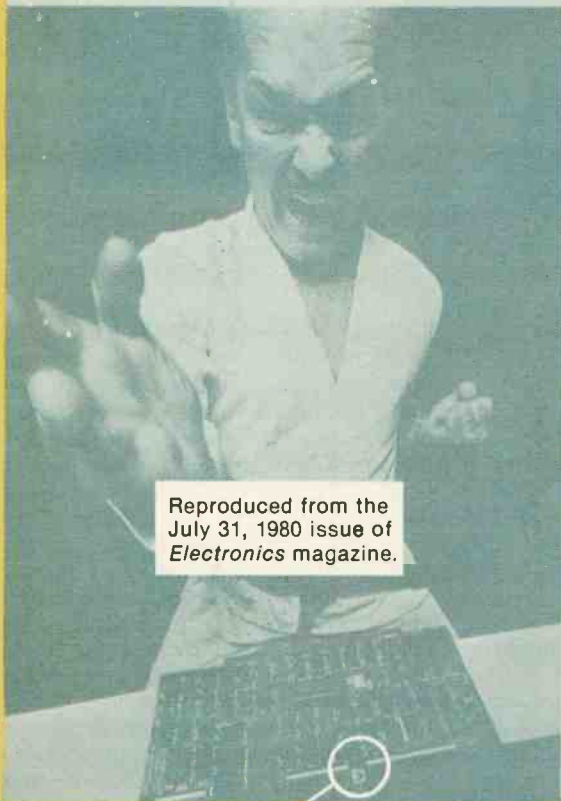

Reproduced from the July 31, 1980 issue of *Electronics* magazine.

Announcing MBC/2 and MBC/3, the newest members of Data General's growing family of microNOVA™ board computers. They're the best computers on a board money can buy. You get up to 64K bytes of memory, serial and parallel I/O lines, and software support from MP/OS, our famous micro operating system. You even get supporting languages like MP/PASCAL and MP/FORTRAN IV. See for yourself.

	MBC/1	MBC/2	MBC/3	LSU	58C/1
RAM Bytes	2K	8K	32K	4K	32K
MP/OS I/O Lines	4K	32K	32K	-	16K
Serial Lines	3	2	3	-	1
Orig. I/O Lines	10	ASAPC/ SYMC	ASAPC/ SYMC	-	24
# Boards	1	1	1	2	1
Board Size	7.25" x 5.5"	7.25" x 5.5"	7.5" x 5.5"	4.5" x 5.2"	6.75" x 7.1"

The competition will always sing the praises of their little single board computers. But from now on they'll be doing it falsetto.

Data General Corporation, Westboro, MA 01580, (617) 356-8911
microNOVA is a trademark of Data General. ©Data General Corporation, 1980.

Data General
Mail to: Data General Corporation, Westboro, MA 01580
☐ for these items only. Send complete information on the micro product line. ☐ I have sent a subscription ASAP.



Cromemco logo on computer board shown in original ad



Cromemco™
Incorporated
Tomorrow's Computers Today

280 BERNARDO AVE. MOUNTAIN VIEW, CA 94043
(415) 964-7400 • TWX 910-379-6988



Management Information Display

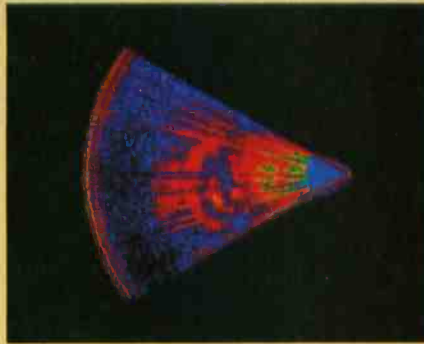

Ultrasonic heart sector scan



High-resolution display with alphanumerics

Get the professional color display that has BASIC/FORTRAN simplicity

LOW-PRICED, TOO

Here's a color display that has everything: professional-level resolution, enormous color range, easy software, NTSC conformance, and low price.

Basically, this new Cromemco Model SDI* is a two-board interface that plugs into any Cromemco computer.

The SDI then maps computer display memory content onto a convenient color monitor to give high-quality, high-resolution displays (756 H x 482 V pixels).

When we say the SDI results in a high-quality professional display, we mean you can't get higher resolution than this system offers in an NTSC-conforming display.

The resolution surpasses that of a color TV picture.

BASIC/FORTRAN programming

Besides its high resolution and low price, the new SDI lets you control with optional Cromemco software packages that use simple BASIC- and FORTRAN-like commands.

Pick any of 16 colors (from a 4096-color palette) with instructions like DEFCLR (c, R, G, B). Or obtain a circle of specified size, location, and color with XCIRC (x, y, r, c).

*U.S. Pat. No. 4121283

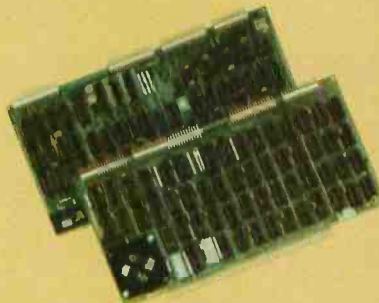

Model SDI High-Resolution Color Graphics Interface

HIGH RESOLUTION

The SDI's high resolution gives a professional-quality display that strictly meets NTSC requirements. You get 756 pixels on every visible line of the NTSC standard display of 482 image lines. Vertical line spacing is 1 pixel.

To achieve the high-quality display, a separate output signal is produced for each of the three component colors (red, green, blue). This yields a sharper image than is possible using an NTSC-composite video signal and color TV set. Full image quality is readily realized with our high-quality RGB Monitor or any conventional red/green/blue monitor common in TV work.

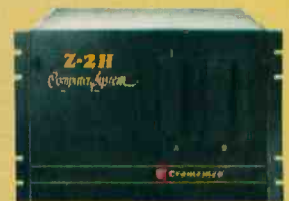

Model SDI plugs into Z-2H 11-megabyte hard disk computer or any Cromemco computer

DISPLAY MEMORY

Along with the SDI we also offer an optional fast and novel two-port memory that gives independent high-speed access to the computer memory. The two-port memory stores one full display, permitting fast computer operation even during display.

CONTACT YOUR REP NOW

The Model SDI has been used in scientific work, engineering, business, TV, color graphics, and other areas. It's a good example of how Cromemco keeps computers in the field up to date, since it turns any Cromemco computer into an up-to-date color display computer.

The SDI has still more features that you should be informed about. So contact your Cromemco representative now and see all that the SDI will do for you.

 **Cromemco**
incorporated
280 BERNARDO AVE., MOUNTAIN VIEW, CA 94040 • (415) 964-7400
Tomorrow's computers today

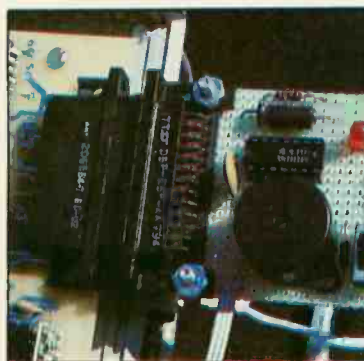

page 44



page 90

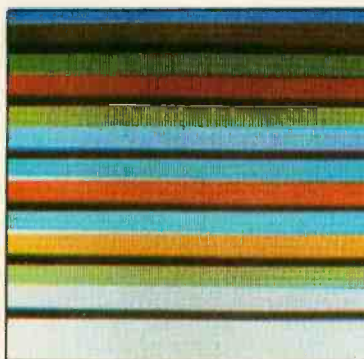

page 142

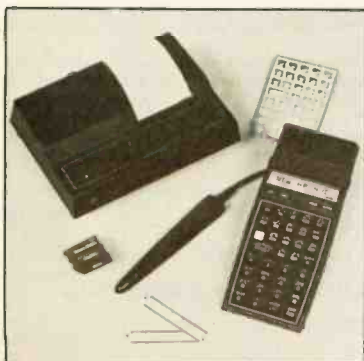

page 244

Foreground

- 24 MULTIMACHINE GAMES** by Ken Wasserman and Tim Stryker
The most exciting computer games are those with two machines and two or more players.
- 44 COMPUTERIZED TESTING** by Steve Ciarcia
A computer is useful for automating any process—even hardware testing.
- 96 GRAPHIC COLOR SLIDES, PART 2** by Alan W Grogono
This month we demonstrate the use of subroutines to generate equation plots, histograms, regression and monthly analysis graphs.
- 120 MICROGRAPH, PART 2: VIDEO-DISPLAY PROCESSOR**
by E Grady Booch
Part 2 details more about this surprisingly simple high-resolution video display.
- 192 PIRATE'S ADVENTURE** by Scott Adams
The man who first brought Adventure games to microcomputers gives us an entire listing of one of his most enjoyable games.
- 244 A POCKET COMPUTER? SIZING UP THE HP-41C** by Bruce Carbrey
This device comes close to being the world's first pocket-sized personal computer.
- 268 LOST DUTCHMAN'S GOLD** by Bob Liddil and Teri Li
Applesoft BASIC is well suited to the writing of games, as this program shows.

Background

- 142 A SIMPLIFIED THEORY OF VIDEO GRAPHICS, PART 2**
by Allen Watson III
Explanations of color-video techniques and some of the quirks of microprocessor systems are provided.
- 158 ON THE ROAD TO ADVENTURE** by Bob Liddil
Along with a survey of the major Adventure games, here's an explanation of how to play them.
- 172 ZORK AND THE FUTURE OF COMPUTERIZED FANTASY SIMULATIONS** by P David Lebling
One of the authors of Zork describes his game and how similar games may appear in the future.
- 186 CHARACTER VARIATION IN ROLE-PLAYING GAMES** by Jon Freeman
A variable set of character traits can be used to create a game of high adventure that is different every time you play it.

Product Reviews: Games

- 74 DUNGEON CAMPAIGN; 78 A STELLAR TREK; 84 MORLOC'S TOWER; 90 ODYSSEY: THE COMPLEAT APVENTURE; 114 SARGON II; 264 MICROSOFT ADVENTURE; 282 COMPUTER BISMARCK**

Nucleus

- | | |
|---|---------------------------|
| 6 Editorial: What's Wrong With Technical Writing Today? | 296, 325, 326 BYTE's Bits |
| 14 Letters | 306 Clubs and Newsletters |
| 94 Technical Forum: The Twelve Computerized Days of Christmas | 314 Event Queue |
| 214 BYTELINES | 318 Ask BYTE |
| 222 User's Column | 322 Books Received |
| 288 Programming Quickies: Monster Combat | 324 Software Received |
| 294 BYTE's Bugs | 342 What's New? |
| | 398 Unclassified Ads |
| | 399 BOMB, BOMB Results |
| | 400 Reader Service |

Publishers

Virginia Londoner,
Gordon R Williamson
Associate Publisher
John E Hayes
Assistant
Cheryl A Hurd

Founding Editor
Carl T Helmers Jr

Editor-in-Chief
Christopher P Morgan

Editors
Richard S Shuford, Gregg Williams,
Curtis P Feigel, Harold Nelson
Stan Miastkowski

Consulting Editor
Mark Dahmke

Book Editor
Bruce A Roberts

Chief Copy Editor
David W Hayward

Copy Editors
Faith Hanson, Warren Williamson,
Robin M Moss, Anthony J Lockwood
Assistant to the Editors

Faith Ferry
Assistants

Debe Wheeler, Karen A Cilley
New Products Editor

Clubs, Newsletters
Charles Freiberg

Drafting
Jon Swanson

Production Director
Nancy Estle
Assistant Production Director
Christine Dixon
Production/Advertising Coordinator
Wal Chiu Li

Production Art
Holly Carmen LaBosiere,
Deborah Porter

Chief Typographer
Sherry McCarthy
Typographers
Debi Fredericks, Donna Sweeney,
Valerie Horn

Advertising Director
Thomas Harvey
Assistants
Ruth M Walsh, Ms. Marion Gagnon
Barbara J Greene, Rob Hannings

Special Projects Coordinator
Jill E Callihan

Marketing Coordinator
Laura A Hanson

Circulation Manager
Gregory Spitzfaden
Assistant Circulation Manager
Andrew Jackson

Assistants
Agnes E Perry, Barbara Varnum,
Louise Menegus, David Overbeck
Dealer Sales
Melanie Bertoni

Controller
Daniel Rodrigues
Assistant
Mary E Fluhr
Accounts Receivable Specialist
Karen Burgess
Accounts Receivable Assistant
Jeanne Cilley

Receptionist
Jacqueline Earnshaw
Traffic Department
Mark Sandagata, N Scott Gagnon



In This Issue

Although the mysteries and menaces lurking in the shadows of this issue's cover may exist only in the minds of an imaginative Adventure player or the cover artist, Robert Tinney, that doesn't make them any less real to the person playing the game. This issue explores the many aspects of Adventure and Adventure-like games. It includes two complete Adventures in BASIC, an excellent introductory article ("On the Road to Adventure," by Bob Liddil), two articles on the state of the art in Adventure games, and a handful of game reviews.

This issue also contains "Computer Testing," an article by Steve Ciarcia, as well as the second parts of several articles continued from the November graphics issue: "Micrograph," "Graphic Color Slides," and "A Simplified Theory of Video Graphics."

Officers of McGraw-Hill Publications Company: Paul F McPherson, President; Executive Vice Presidents: James E Boddorf, Gene W Simpson; Group Vice President: Daniel A McMillan; Senior Vice President-Editorial: Ralph R Schultz; Vice Presidents: Kemp Anderson, Business Systems Development; Stephen C Croft, Manufacturing; Robert B Doll, Circulation; James E Hackett, Controller; William H Hammond, Communications; Eric B Herr, Planning and Development; John W Patten, Sales; Edward E Schirmer, International.

Officers of the Corporation: Harold W McGraw Jr, President, Chief Executive Officer and Chairman of the Board; Robert F Landes, Senior Vice President and Secretary; Ralph J Webb, Treasurer.

BYTE is published monthly by BYTE Publications Inc, 70 Main St, Peterborough NH 03458, a wholly-owned subsidiary of McGraw-Hill, Inc. Address all mail except subscriptions to above address: phone (603) 924-9281. Address subscriptions, change of address, USPS Form 3579, and fulfillment questions to BYTE Subscriptions, PO Box 590, Martinsville NJ 08836. Controlled circulation postage paid at Waseca, Minnesota 56093 - USPS Publication No. 528890 (ISSN 0360-5280). Canadian second class registration number 9321. Subscriptions are \$18 for one year, \$32 for two years, and \$46 for three years in the USA and its possessions. In Canada and Mexico, \$20 for one year, \$36 for two years, \$52 for three years. \$32 for one year air delivery to Europe. \$32 surface delivery elsewhere. Air delivery to selected areas at additional rates upon request. Single copy price is \$2.50 in the USA and its possessions, \$2.95 in Canada and Mexico, \$4.00 in Europe, and \$4.50 elsewhere. Foreign subscriptions and sales should be remitted in United States funds drawn on a US bank. Printed in United States of America.

Address all editorial correspondence to the editor at the above address. Unacceptable manuscripts will be returned if accompanied by sufficient first class postage. Not responsible for lost manuscripts or photos. Opinions expressed by the authors are not necessarily those of BYTE. Entire contents copyright © 1980 by BYTE Publications Inc. All rights reserved. Where necessary, permission is granted by the copyright owner for libraries and others registered with the Copyright Clearance Center (CCC) to photocopy any article herein for the base fee of \$1.00 per copy of the article or item plus 25 cents per page. Payment should be sent directly to the CCC, 21 Congress St, Salem MA 01970. Copying done for other than personal or internal reference use without the permission of McGraw-Hill is prohibited. Requests for special permission or bulk orders should be addressed to the publisher.

BYTE® is available in microform from University Microfilms International, 300 N Zeeb Rd, Dept PR, Ann Arbor MI 48106 USA or 18 Bedford Row, Dept PR, London WC1R 4EJ England.



Subscription WATS Line: (800) 258-5485

Office hours: Mon-Thur 8:30 AM - 4:30 PM, Friday 8:30 AM - Noon, Eastern Time

NATIONAL ADVERTISING SALES REPRESENTATIVES:

NORTHEAST (617) 444-3946
Hajar Associates
280 Hillside Ave
Needham Heights MA 02194

MIDWEST (312) 864-3467
Hajar Associates
2405 Lawndale
Evanston IL 60201

EAST & SOUTH (212) 682-5844
Hajar Associates
521 Fifth Ave
New York NY 10017

SOUTHWEST (714) 540-3554
NORTHWEST (415) 964-0706
Hajar Associates
1000 Elwell Ct, Suite 227
Palo Alto CA 94303

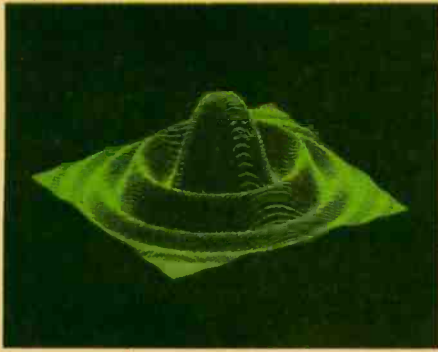

MICROANGELO

HIGH RESOLUTION GRAPHICS SINGLE BOARD COMPUTER

by

SCION
CORPORATION

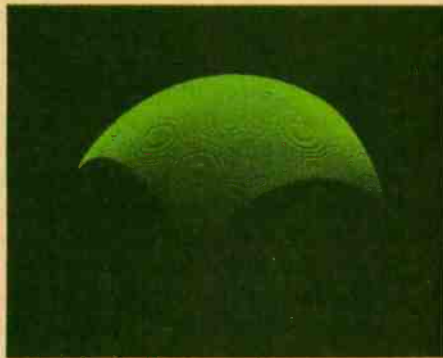
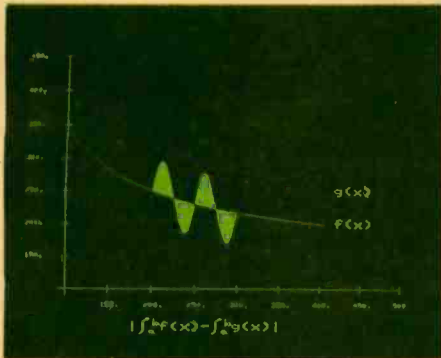

RS-170 composite or direct drive output

Local or external sync generation

4 or 5 Mhz Z80 micro-processor

60 hertz real-time clock

8 level interrupt tie-in

IEEE S100 bus compatible

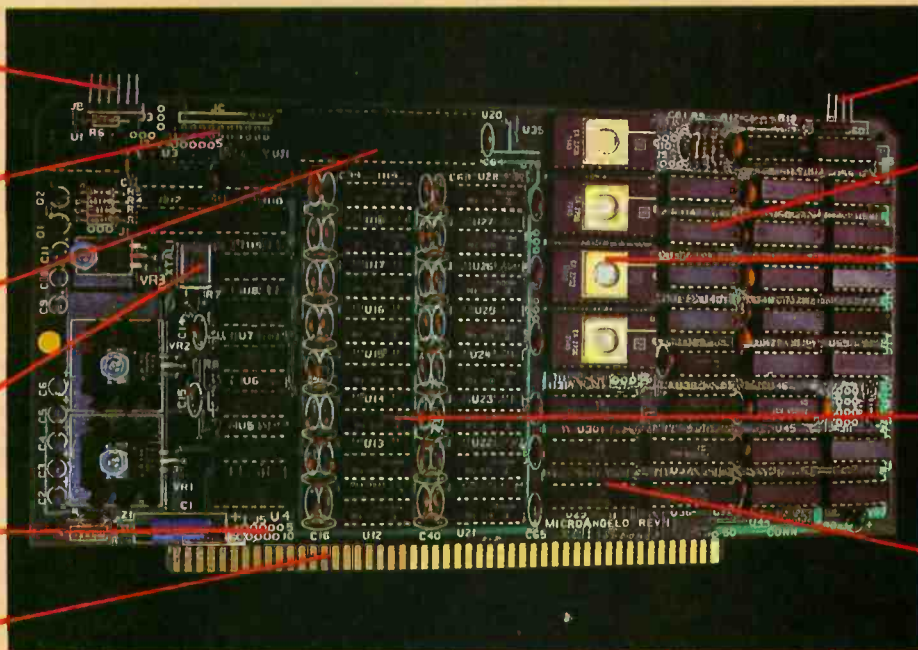

Light pen interface

Time multiplexed refresh

4K resident Screenware™ Pak I operating system

32K RAM isolated from host address space

High speed communications over parallel bus ports

Screenware™ Pak I

A 4K byte operating system resident in PROM on MicroAngelo™ Pak I emulates an 85 character by 40 line graphics terminal and provides over 40 graphics commands. Provisions exist for user-defined character sets and directly callable user extensions to Screenware Pak I.

Host Resident Terminal Software

An interface software package that coordinates input/output from the MicroAngelo™ graphics board, the MicroAngelo™ keyboard, and your computer. The result is a flexible, yet sophisticated graphics terminal.

SCION Corporation
8455-D Tyco Road
Vienna, Va. 22180
(703) 827-0888

European Distributor:
Micro Diversions UK Ltd.
17/19 Mesnes Street
Wigan, England WN1 1QP
09-423 4311

UCSD*

PASCAL

FORTRAN

PORTABLE

Develop on a Z-80†, run on LSI-11‡, T. I. 990, 6800 or vice versa

EFFICIENT

Structured, readable
Speeds development X5
Easy maintenance

POWERFUL

Full standard Pascal or ANSI '77 FORTRAN plus extensions.
Concurrency, multiple users soon.

COST-EFFECTIVE

Complete system with compiler, editors, Interpreter, assembler and utilities from \$350.

NOW AVAILABLE

Operating System
Compilers
Programmer Utilities
Data Base Management
Word Processing
Business and
Medical Software
Games, Home & Hobby

POPULAR MICROS SUPPORTED

DEC, Radio Shack, Apple, Microengine, CP/M§ based and others

PCD SYSTEMS

P. O. Box 143
Penn Yan, NY 14527
315-536-3734

*TM Univ. of Calif.
†TM of Zilog
‡TM of Digital Equipment
§TM Digital Research

Editorial

What's Wrong with Technical Writing Today?

Chris Morgan
Editor-in-Chief

In going through the scores of articles that cross my desk each month, I've begun to notice that many of them are poorly written. I'm talking here not so much about incompetent writing (although the number of spelling and syntax errors is alarming), but rather about *misguided* writing, writing that is difficult to read, unclear, or wasteful of the reader's time. The problem is certainly not BYTE's alone. Editors of other magazines have told me much the same story. Thinking about possible solutions to the problem led me to write this editorial.

The quality of technical writing affects all of our readers in one way or another. Whether you program for a living or just for fun, you need to write clear, concise documentation to accompany your programs. And you undoubtedly have to write reports as part of your job or your studies.

There are tricks to good technical writing. I'd like to describe some of them here, and list some sources of information that have proved helpful to us in our writing work. I've also included a list of recommended reading at the end of the editorial.

Ask someone on the periphery of our field what the problem is with our prose, and he or she will probably say, "There's too much jargon." Things like: I/O, ASCII, byte, CPU, compiler, nonvolatile memory, BASIC, NAND gate, modem, macro, Pascal, floppy disk, Z80, 8080, 8086, 6809, 6502, 68000, Z8000, BCD, CP/M, Unix, Xenix, bootstrap, OS, DOS, DMA, CAI, CAD, CAM, vectored interrupt, monitor, RS-232C, S-100 bus, global variable, checksum, NOP, SWI, VOM, and so on, and so on.

It's a lexical maze for the uninitiated. But is jargon really our downfall? I think not. We need jargon in the same way that doctors and psychologists do — as a convenient form of shorthand. Programmers have traditionally wrestled with the problem of fitting the most program into the least amount of memory space, so it's only natural that their everyday speech has been condensed down to a sort of technical "alphabet soup." Jargon isn't intrinsically bad — it's how you use it that counts.

Knowing Your Audience: The Seesaw Effect

Outside of grammar, syntax, and spelling (all of which I'll deal with later), there is the major consideration of your intended audience.

Imagine your readers to be sitting at irregular intervals along a large seesaw. At one end are the most technically astute members of your audience; at the other, the interested novices. In the middle are people with varying degrees of knowledge in the subject you are writing about. Your job is to keep the seesaw as level as possible by attending to the various groups in proportion. If there are many novices involved, you must "hold up" their side by providing them with a lot of introductory material. But if you go too far in this direction, the experts will get bored, dismount, and leave you hanging with a partial audience. It's a quandary, one that has no simple answer. Some topics are so technical that even the most intelligent novice will be left in your wake. You can't understand the workings of a compiler, for instance, until you know a lot about computer languages in general.

Some seesaws can't be balanced despite the best intentions of the writer. It is the job of the writer to know this. Nevertheless, within limits, a lot can be

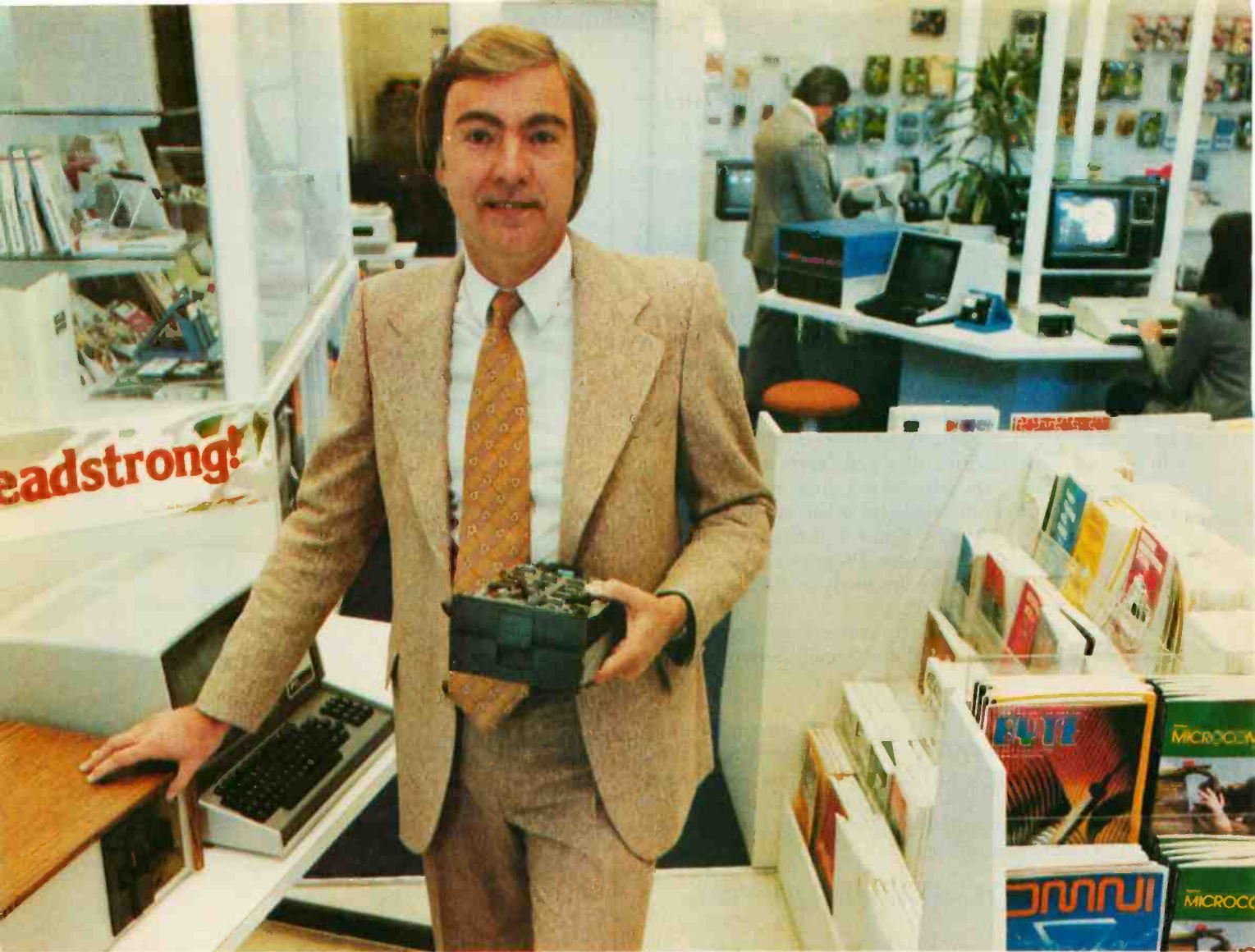

**“For reliable data storage,
you can’t beat Shugart’s
Minifloppy.”**TM Raymond Schlitzer, Owner—
Computerland, San Francisco

“I sell systems my customers can depend on. That’s why most of the personal and small business computer systems sold here feature Minifloppy disk drives. I know from experience I can rely on the Minifloppy.”

Since 1976 Shugart’s Minifloppy has been used by more small computer system manufacturers than any other drive. In fact, more than half-a-million Minifloppys

have been installed. The Minifloppy looks small—but it stores a lot of data. 250 kilobytes on one side, or up to 500 kilobytes in the double-sided model. That’s about 50 pages of printed information on a single-sided Minidiskette, and twice that on the double-sided version. You’ll have plenty of storage capacity for your programs, letters, forms, or ledger entries. And you find your data fast, too, because the Minifloppy is a random access device

that eliminates the need to search for your data serially as you must with a tape cassette unit.

No matter what problem you’re solving with your computer system, you can rely on Shugart’s Minifloppy for data storage. We’re known as the Headstrong company for good reason. We’re Headstrong about reliability, quality, and value. Ask your dealer. He knows us.

**Rely on the
Headstrong Company.**

Shugart

TM—Minifloppy is a trademark of Shugart Associates.

475 Oakmead Parkway, Sunnyvale, California 94086

done to encourage those readers who are interested in your topic, but who may need some extra clarification. This leads me to the first of what I immodestly refer to as *Morgan's Laws of Writing* (not to be confused with DeMorgan's Law):

Morgan's Law #1: No Writer Ever Got Shot Down for Writing Too Clearly.

How do you write clearly? A good first step is to buy a copy of *The Elements of Style* by Strunk and White. There is more wisdom contained in this slim volume than in many a three-pound guide to English Usage.

Next, find some good technical writing and study it. I've included a bibliography of good technical books at the end of this editorial. We can learn a lesson from painters and musicians who take it for granted that good paintings and pieces of music by other artists should be carefully studied. Donald Knuth's three-part series of books, *The Art of Computer Programming*, contains some of the best writing you're likely to find in our field — and he's funny, to boot!

Another excellent writing tip comes from Peter Jacobi, a professor of journalism at the Medill School of Journalism:

Read your writing out loud.

How does it sound? Is it awkward, circumlocutory, pedantic? If so, rewrite it. There's something about reading a piece out loud that lays bare its weaknesses. You can be clear without turning off the majority of your audience. See the accompanying text boxes for some Do's and Don'ts of clear writing.

Morgan's Law #2: The Beginning Is Half the Thing.

Actually, this is an old Roman saying I borrowed. The main point of it is that the first few paragraphs of an article are crucial to the rest of the text. The chances are you'll win or lose your readers at the beginning. Still, it's the one part of an article that fledgling writers gloss over in their eagerness to write the main body of the text. One very good writer I know told me he spends up to *half* of his article-writing time creating the first few paragraphs!

Morgan's Law #3: Avoid the Penguin Syndrome.

A famous story made the rounds a few years ago involving a publisher of children's books. A copy of one of the company's books about penguins appeared in the publisher's mailbox along with a letter from an eight-year-old girl that read, "Dear Sirs: I am returning your book, because it told me more about penguins than I wanted to know."

The moral? Tell your readers what they need to know, and no more. If you're zealous about a given topic, tell the reader how to get more information by including a comprehensive list of references. Don't waste space.

Morgan's Law # 4: Writing Is Nonlinear.

Article ideas don't come in an orderly sequence. Be prepared to jot down your ideas as they come, as writer John McPhee does. McPhee is blessed with a short-term memory that permits near-total recall. Even so, he writes



PASCAL/Z™ - Q.E.D.

Ithaca Intersystems PASCAL/Z is the most powerful CP/M™ compatible Z-80™ Pascal compiler ever . . . and here's why:

PASCAL/Z generates true Z-80 native code — ROMable and re-entrant — 5-10X faster than P-code interpreters; permits separate compilation; supports Direct File Access and variable length STRINGS; utilizes fast one-pass recursive descent organization; the macro-assembler generates relocatable object modules; and much, much more.

Complete package includes compiler, macro-assembler, linker/loader and source for the full library on one disk; with free copy of Jensen/Wirth book and complete documentation. Only \$395.00.

IT'S DEMONSTRABLE!

Don't just take our word for it. Ask for a demonstration of these features and more today at Computerland® and other full-service computer stores.

Ithaca Intersystems Inc., 1650 Hanshaw Road
P.O. Box 91, Ithaca, N.Y. 14850. Phone (607) 257-0190

Computerland is a registered trademark of Computerland Corporation.
CP/M and Z-80 are trademarks of Digital Research Corp. and Zilog, Inc. respectively.
PASCAL/Z and InterSystems are trademarks of Ithaca Intersystems Inc.

InterSystems™
Ithaca Intersystems Inc.

Micros for bigger ideas.



Outside of the garden you need a computer that can grow.

For the average garden-variety home and hobby operation, a high quality personal computer is a real temptation. But let's face it: in the world of business, engineering and scientific applications you need a system that can keep up with bigger ideas.

Bigger ideas today mean the power and flexibility to move the micro up to and beyond the level of yesterday's minis. More memory to hold bigger data bases. More flexibility to handle a variety of data entry devices. More programming and computing power for numbercrunching and applications development. And easy upgrade to 16 bit operation when you need it.

Intersystems has that, and more. The power and flexibility of the versatile S-100 bus, with 20 slots of expandability for up to 16 individually-addressable DMA devices and up to 1 Megabyte of memory, fully accessible to all users via our unique memory management system. Plus reliable Intersystems design and manufacture, and the support of our PASCAL/Z™...the most powerful Z-80™ compiler ever.

For really serious computing, our front panel provides a powerful diagnostic tool for debugging or development. Combined with a scope, it allows you to look at any location in the circuitry, set breakpoints, trigger and view one-shot events, and many other activities usually possible only with expensive logic analyzers. No wonder it's fast becoming the tool of choice for repair technicians and custom hardware designers.

Intersystems Series II is the most complete line of fully IEEE 696 compatible S-100 boards...easily upgradeable to our MPU 8000™ or other 16 bit S-100 CPU's as they become available...so you're never locked out of rapid expansion, or locked into obsolescence, by dependency on a proprietary product line.

So if you've left those garden-variety applications behind, come to Intersystems and get a system that will grow as big as your next idea. Get it from the people who know small computers...your Computerland store...or other fine full service computer dealers.

Ithaca Intersystems Inc., 1650 Hanshaw Road
P.O. Box 91, Ithaca, N.Y. 14850.
Phone (607) 257-0190 TWX: 510 255 4346.

Z-80 is a trademark of Zilog, Inc.
PASCAL/Z, MPU 8000 and InterSystems are trademarks of Ithaca Intersystems Inc.

Circle 5 on inquiry card.

InterSystems™
Ithaca Intersystems Inc.

Micros for bigger ideas.

his ideas on index cards every day and pins them to a bulletin board where he can mix and match them. The actual writing of a piece might not occur until some time later. E B White recommends that writers use scissors and glue to cut and paste their efforts during the first-draft stage. Some of the more advanced word-processing programs can help to do this. Another great writing aid is to use a data-base-handling program that allows you to cross-index ideas and file them away.

Morgan's Law #5: (otherwise known as the Three-Foot Rule): *Don't Write Anything Unless You Have a Dictionary and a Thesaurus Within Three Feet of You.*

I know I'm being a little strict here, but it's important. Unless the dictionary is within easy reach, you probably won't bother to use it, and you may make a spelling error. Going without a thesaurus is a further way of handicapping yourself. Both these books are vital to every writer, and I needn't tell you that the average level of spelling accuracy these days is low. *The American Heritage Dictionary* is a good all-round choice because of its excellent usage notes.

There's nothing much I can say about improving grammar and syntax other than to suggest the reference books at the end of the editorial. *The Careful Writer* and Mrs. Thistlebottom's *Hobgoblins* by Theodore Bernstein both help to dispel many of the bugaboos that have haunted our language ever since the well-meaning Victorians got their hands on it. Bernstein correctly points out that it's all right to occasionally split an infinitive, or to use a preposition to end a sentence with. William Sloane's *The Craft of Writing*, although primarily aimed at the fiction writer, contains a valuable chapter on nonfiction. It's a beautifully written book.

Morgan's Law #6: *Don't Be Afraid to Be Interesting.*

This may be the most important law of all. Involve your reader by being specific. Generalities make for dull reading. Use humor if you can carry it off. Otherwise, don't! Add some personal observations and opinions. The reader will take them in stride.

All of this leads to the general conclusion that you should write about what you know well. William Sloane says, "There are no uninteresting subjects, only uninteresting writers."

In closing, I can think of no better quote than the following one from the same book (although Sloane is talking here about nonfiction books, the sentiment applies equally well to technical articles):

If a book has a beginning, it also has an end. Nonfiction develops by increment, builds on its own material, and ends when its material has been completely exploited. If the book fulfills its contract with the reader, the end will complete the book by fulfilling the promises it made at the start. And if the people who read that book feel continuously that they are added to and believe, at the end, that there is more to them than there was before, the work of nonfiction has succeeded. The same can be said of fiction. In both cases, the contract between the writer and the reader has been kept.

Clear Writing: Some Do's

DO: (1) Tell your audience what you're going to talk about, (2) Talk about it, and (3) Tell them what you talked about. This old saw from your creative-writing class in high school is as valid as ever. Not observing it is a common failing of much technical writing today.

DO: Include a theme sentence near the beginning of your writing that concisely sums up what you want to say in the piece.

DO: Tell your story in miniature in the captions to figures, photos, tables, listings, and other illustrations. Your readers may not have time to read all of your article: give them a quick summary and they'll thank you for it. Scientific American magazine does this sort of thing very well.

DO: Spell out acronyms and abbreviations when they first appear in text. How many times have you been stopped cold by an unfamiliar abbreviation in the middle of an interesting article?

DO: Use verbs. Avoid adjectives and adverbs. A verb in an article title can add a lot of spice. (See *Electronics* magazine for good examples of verbs in titles.) Adjectives and adverbs, to paraphrase Robert Benchley, are the spinach of technical prose. Everybody says they're vital, but few of us would miss them if the majority of them suddenly disappeared tomorrow. John McPhee (perhaps the best nonfiction writer in the country) has written several books on technical subjects (such as *The Curve of Binding Energy*) that illustrate these principles better than a hundred paragraphs from me.

DO: Break up your text into digestible chunks with subheadings.

DO: Remember the questions you had when you were first learning a subject.

Clear Writing: Some Don'ts

DON'T: Use the passive voice as your primary voice. Many of us were taught to use the passive voice when writing technical reports and the like. But the passive voice lends an air of coldness and formality to writing — the sort of thing you'd expect in technical transactions, but not in an article that's designed to be read. For example, "I ran the program" is more personal than "The program was run." Sometimes you need the passive voice for variety, but in general, own up: Say I, me, my, we, us or you.

DON'T: Make your reader search for information in an article. If you have a list of items in text, perhaps they could be set off in a table. If you have a glossary in your article, tell the reader at the beginning.

DON'T: Use big words when small words will do. A good example is utilize, a word that can almost always be replaced with use. Another popular word that should be avoided is implement. Don't implement when you can install, design, code, control, enable, connect, build, or operate; your readers will have a better idea of what you are doing.

DON'T: Use a clever title for an article if it fails to convey the article's content. Imagine that your title is all that the reader has to go on in deciding whether or not to read your work.

Text box continued on page 12

Why not kill two birds with one stone?

If you have an Apple* and you want to interface it with parallel and serial devices, we have a board for you that will do both. It's the AIO.TM

Serial Interface.

The RS-232 standard assures maximum compatibility with a variety of serial devices. For example, with the AIO you can connect your Apple* to a video terminal to get 80 characters per line instead of 40, a modem to use time-sharing services, or a printer for hard copy. The serial interface is software programmable, features three handshaking lines, and includes a rotary switch to select from 7 standard baud rates. On-board firmware provides a powerful driver routine so you won't need to write any software to utilize the interface.

Parallel Interface.

This interface can be used to connect your Apple* to a variety of parallel printers. The programmable I/O ports have enough lines to handle two printers simultaneously with handshaking control. The users manual includes a software listing for controlling parallel printers or, if you prefer, a parallel driver routine is available in firmware as an option. And printing is only one application for this general purpose parallel interface.

Two boards in one.

The AIO is the only board on the market that can interface the Apple to both serial and parallel devices. It can even do both at the same time. That's the kind of innovative design and solid value that's been going into SSM products since the beginning of personal computing. The AIO comes complete with serial PROM's, serial and parallel cables, and complete documentation including software listings. See the AIO at your local computer store or contact us for more information.



2190 Paragon Drive
San Jose, California 95131
(408) 946-7400

*Apple is a
TM of Apple
Computers,
Inc.

Maybe we can save you a call.

Many people have called with the same questions about the AIO. We'll answer those and a few more here.

Q: Does the AIO have hardware handshaking?

A: Yes. The serial port accommodates 3 types—RTS, CTS, and DCD. The parallel port handles ACK, ACK, BSY, STB, and STB.

Q: What equipment can be used with the AIO?

A: A partial list of devices that have actually been tested with the AIO includes: IDS 440 Paper Tiger, Centronics 779, Qume Sprint 5, NEC Spinwriter, Comprint, Heathkit H14, IDS 125, IDS 225, Hazeltine 1500, Lear Siegler ADM-3, DTC 300, AJ 841.

Q: Does the AIO work with Pascal?

A: Yes. The current AIO serial firmware works great with Pascal. If you want to run the parallel port, or both the serial and parallel ports with Pascal, order our "Pascal Patcher Disk."

Q: What kind of firmware option is available for the parallel interface?

A: Two PROM's that the user installs on the AIO card in place of the Serial Firmware PROM's provide: Variable margins, Variable page length, Variable indentations, and Auto-line-feed on carriage return.

Q: How do I interface my new printer to my Apple using my AIO card?

A: Interconnection diagrams for many popular printers and other devices are contained in the AIO Manual. If your printer is not mentioned, please contact SSM's Technical Support Dept. and they will help you with the proper connections.

Q: I want to use my Apple as a dumb terminal with a modem on a timesharing service like The Source. Can I do that with the AIO?

A: Yes. A "Dumb Terminal Routine" is listed in the AIO Manual. It provides for full and half duplex, and also checks for presence of a carrier.

Q: What length cables are provided?

A: For the serial port, a 12 inch ribbon cable with a DB-25 socket on the user end is supplied. For the parallel port, a 72 inch ribbon cable with an unterminated user end is provided. Other cables are available on special volume orders.

The AIO is just one of several boards for the Apple that SSM will be introducing over the next year. We are also receptive to developing products to meet special OEM requirements. So please contact us if you have a need and there is nothing available to meet it.



SSM Microcomputer Products
2190 Paragon Drive
San Jose, California 95131
(408) 946-7400



DON'T: Use it or other pronouns if the meaning is obscured. Vague pronoun references in an article slow the reader down. What does the it mean?

Writing for BYTE

If you'd like to write for BYTE, we offer the following guidelines:

Knowing the reader: Over three-quarters of BYTE's readers are involved professionally with computers as programmers, systems analysts, engineers, or technicians. Most of them are dyed-in-the-wool hobbyists at heart and spend a lot of time with their systems. The majority have college degrees or higher, although we also have many student readers. They are interested in virtually every aspect of personal computing, including high-level languages, original hardware designs, reviews of software and hardware (we are especially interested in these), graphics, artificial intelligence, using computers to control the home, games, robots, etc, etc.

Although many of our articles contain highly technical information, we also encourage the submission of lower-level tutorial articles to enable readers to brush up on the basics. BYTE's readers like to have fun with their systems, too — a fact that should not be overlooked.

Form of the Submitted Article

● All submissions should be double-spaced and typewritten on 8½ by 11 inch paper, with the narrow dimension vertical. Double-spacing is important, since proofreader's marks and other additions must be made to the manuscripts.

● Take the time to write complete, descriptive captions for all figures, tables, listings, and photos.

● Schematic diagrams should be neatly drawn, using the schematics in BYTE as a guide. Note that we prefer a certain type of connector designation, and that power connections to integrated circuits are usually listed in a separate power-wiring table rather than being included in the schematic. The direction of flow in a flowchart is assumed to be downward and to the right. No directional arrows should be used unless the flow is contrary to the aforementioned directions. Again, see the magazine for examples.

● We prefer not to typeset listings, but rather to photograph them for the magazine in order to eliminate the possibility of typographical errors. Because of this, we ask authors to submit listings printed on white paper with a dark ribbon (preferably new).

● Photographs can be either color or black and white, but should be as sharp as possible. We prefer color slides to color prints.

● All submissions should be accompanied by a stamped, self-addressed envelope with sufficient postage affixed. We acknowledge all manuscripts upon arrival, and make a final determination within 8 to 12 weeks.

Reference Books

Rathbone, Robert R. *Communicating Technical Information*. Reading MA: Addison-Wesley, 1972. A good source of information about technical writing.

Ralston, A, and Meek, C, eds. *Encyclopedia of Computer Science*. New York: Petrocelli/Charter, 1976. Although this book is oriented more toward large computers, it contains a wealth of information about high-level languages, assembly language, data processing, and hundreds of other topics, all presented in lucid fashion. Every serious computer science library should have a copy.

Bernstein, Theodore M. *The Careful Writer: A Modern Guide to English Usage*. New York: Atheneum Press, 1977. Highly recommended, along with the author's other book, Mrs. Thistlebottom's *Hobgoblins*.

Burton, Philip E. *A Dictionary of Microcomputing*. New York: Garland Publishing Company, 1976. Still the best dictionary in the microcomputing field.

Turner, R P. *Technical Writer's and Editor's Stylebook*. New York: Howard W Sams and Company, 1964.

Todd, Alden. *Finding Facts Fast*. Berkeley CA: Ten
Editorial continued on page 294

DEALERS...OEM USERS.

Call on Monday...
your North Star
computer
will be
delivered by
Thursday.



WHOLESALE PRICES AVAILABLE.

GBC maintains ready stock on the following products and software:

- North Star
- Centronics
- Perkin-Elmer
- Epson

- NEC Spinwriter
- Turnkey North Star Business Software

(609) 424-0465

GBC inc.
General Business Computers

2020 Fairfax Avenue
Cherry Hill, New Jersey 08003



Edison had over 1,800 patents in his name, but you can be just as inventive with an Apple.

Apple is the company with the brightest ideas in hardware and software *and* the best support — so you can be as creative with a personal computer system as Edison was with the incandescent bulb.

How Apple grows with you.

With Apple's reliable product family, the possibilities of creating your own system are endless. Have expansion capabilities of 4 or 8 accessory slots with your choice of system.

Expand memory to 64K bytes or 128K bytes. Add an A to D conversion board. Plug into time sharing, news and electronic mail services. Use an IEEE 488 bus to monitor lab instruments. Add 4 or 6 disk drives — the 5¼", 143K bytes, high-speed, low-cost drive that's the most popular on the market.

Apple speaks many languages.

Since more than 100 companies create software for Apple, you'll have the most extensive library in the personal

computer world. Want to write your own programs? Apple is fluent in BASIC, Pascal, FORTRAN, PILOT and 6502 assembly language.

There's even a series of utility programs called the DOS Tool Kit that not only lets you design high-resolution graphic displays, but lets you work wonders with creative animation.

More illuminating experiences in store.

You won't want to miss all the Apple products being introduced at your computer store all the time. Don't let



history pass you by. Visit your nearest Apple dealer or call 800-538-9696. In California, 800-662-9238. Or write: Apple Computer, 10260 Bandy Drive, Cupertino, CA 95014.

apple computer inc.



Letters

Heath Faces Horizon

John Dye remarked in his letter (August 1980 BYTE, page 18) that he cannot run his Heathkit H-14 printer with a North Star Horizon at any data transfer rate over 110 bps (bits per second). A simple reconfiguration of the Horizon headers, as designed by Don

Baker, will allow it to recognize the BUSY from the H-14.

I have assembled three H-14s and interfaced them with Horizon systems at 4800 bps with no problems. Heathkit supplies a modification-instruction pamphlet which allows you to obtain a BUSY signal on the printer's connector pin 4. This pin translates to pin 15,

DB:XMIT CLK (DCE), on the Horizon motherboard. To accomplish the handshaking, jumper the right configuration-header at location 4D as follows:

- Connect pin 2 to pin 16
- Connect pin 4 to pin 14
- Connect pin 5 to pin 11
- Connect pin 7 to pin 8
- Connect pin 9 to pin 10 and
- Connect pin 12 to pin 12 of the right special-clock header at location 2C.

David M Koehler
306 Timber Trl
Lafayette IN 47905

After you play the Temple of Apshai, you can play Sticks and Stones for free.

Within the 200 rooms and catacombs of the Temple of Apshai, untold treasures await you — the hero. All you have to do is elude, outsmart and outwit the beasts, monsters and demons lurking in the dark labyrinth. Spend minutes or hours on this role-playing fantasy — the boldest computer game in our Dunjonquest™ series.

Now, when you order the "Temple of Apshai," you get the "Sticks & Stones" board game

for no extra charge. In fact, if you're not satisfied with the "Temple of Apshai," you can return it within 10 days and still keep "Sticks & Stones!"

But don't wait, this special offer is limited. (We'll also send you a catalog outlining our other exciting computer games.)



Automated Simulations, Department BY
P.O. Box 4247, 1988 Leghorn Street
Mountain View, California 94040

Please send me the "Temple of Apshai" for:

	Cassette (\$24.95)	Disk (\$29.95)
TRS-80	<input type="checkbox"/> 16K, Level II	<input type="checkbox"/> 32K TRSDOS
APPLE	Not available	<input type="checkbox"/> 48K Applesoft in ROM
PET	<input type="checkbox"/> 32K	Not available

(Add \$1.00 shipping and handling charge; plus 6% or 6½% tax for California residents.)

Name _____

Address _____

City, State, Zip _____

Check enclosed. Charge to: VISA MasterCard

Amount \$ _____ # _____ Expiration date _____

Or charge by phone: (800) 824-7888, operator 861. In California: (800) 852-7777, operator 861. If you prefer, call these numbers for a list of the computer stores near you.

D

The APL Plot

I was very pleased to see BYTE's August 1980 FORTH issue, since I am working part-time with FORTH doing a computer-aided design package to be used with the fine Mauro Engineering Proac plotter. Incidentally, the new product announcement for this plotter in the August 1980 BYTE (page 249) referred erroneously to the unit as a printer in the heading.

The self-replicating programs in "Programming Quickies" (see "Self-Reproducing Programs," by Burger, Brill, and Machi, August 1980 BYTE, page 72) are a challenge that APLers cannot pass up. I have a 22-character line of APL that reproduces itself when executed, which was published a few years ago in *APL News*, a free publication of APL Press (not to be confused with *Personal APL News*, my publication, which is now part of the *APL Market Newsletter* from Southwater Corporation). Anyone who is interested should contact Eugene McDonnell of I P Sharp in Palo Alto, California.

If we take the character string:

```
A←'1+23p11p''''1+23p11p''''''
```

and then print it and execute it, we get:

```

      A
1+23p11p''''1+23p11p''
      A
1+23p11p''''1+23p11p''

```

The key to this line is the fact that the reshape function wraps around to the beginning of the right argument. I hope that the following makes it clear what is happening:

```

      ''1+23p11p''
'1+23p11p'
11p''1+23p11p''
'1+23p11p''

```

Store Up to 350 Kbytes on a 5" Disk

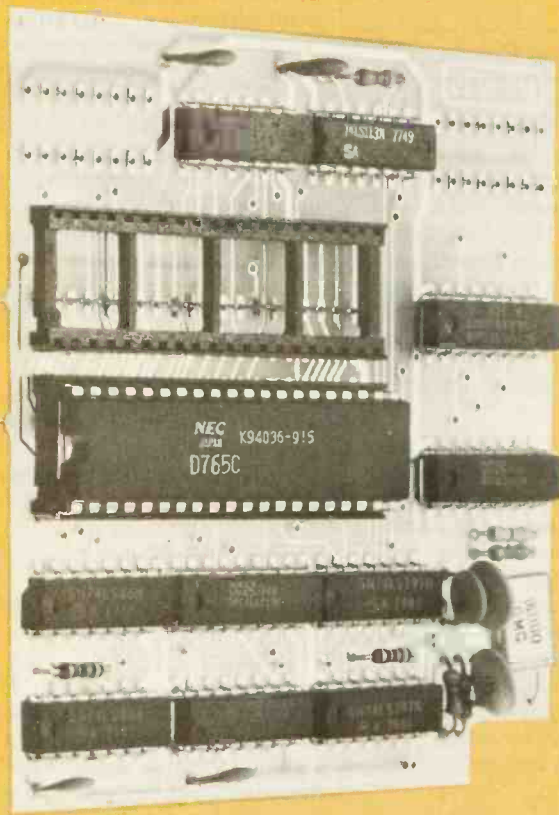

FORMATTED DISK STORAGE CAPACITY
IN
KBYTES

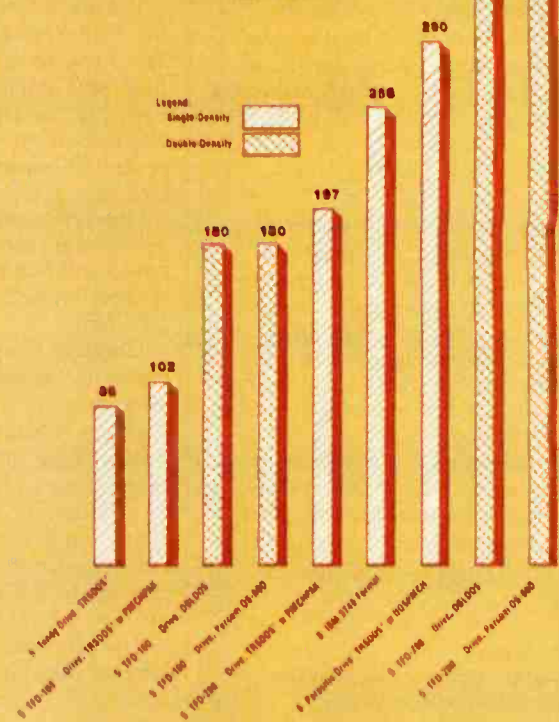

The DOUBLER™. It packs almost twice the data on a disk track as your single-density system. Depending on the type of drive, you can store up to **four** times more data on one side of a minidiskette than you can store using a standard Model I mini-disk drive.

- The DOUBLER™ reads, writes and formats **either** single- or double-density minidiskettes.
- Proprietary design allows you to continue to run TRSDOS*, NEW-DOS‡, Percom OS-80™ or other single-density software **without making any changes** to software or hardware. Switch to double-density operation at any convenient time.
- Includes DBLDOS™, a TRSDOS* compatible double-density disk operating system.

- CONVERT utility, on DBLDOS™ minidiskette, converts files and programs from single- to double-density or double- to single-density.
- The DOUBLER™ circuit card includes **high performance data separator, write precompensation** circuits for reliable disk read operations — even with 80-track drives.
- **Plug-in Installation** — The DOUBLER simply plugs into the disk controller socket of your Ex-

- pansion Interface, requiring no strapping or trace cutting. Expansion Interface disk controller may be completely restored to original configuration by simply removing the DOUBLER™ and re-installing the original disk controller chip.
- Works with standard 35-, 40-, 77- and 80-track mini-disk drives rated for double-density operation.
- Introductory price, including DBLDOS™ and format conversion utility on minidiskette, **only \$219.95.** Use the coupon for even greater savings.

Mini-Disk Systems



More storage capacity, higher reliability — from Percom, the industry leader. One-, two- and three-drive configurations in either 40- or 77-track format. Fully burned-in. From only \$399.

\$20 PERCOM DISCOUNT \$20
COUPON
worth \$20
toward
The Purchase of a
DOUBLER™
Coupon No. B10101
Expires December 30, 1980
Void where prohibited by law.
LIMIT ONE COUPON PER DOUBLER

Call toll-free, 1-800-527-1592, for the address of your nearest authorized Percom dealer, or to order directly from Percom.



PERCOM DATA COMPANY, INC.
211 N. KIRBY GARLAND, TEXAS 75042
(214) 272-3421

™ trademark of Percom Data Company, Inc.
* trademark of Tandy Radio Shack Corporation which has no relationship to Percom Data Company.
‡ trademark of Apparat Company, Inc.

PRICES AND SPECIFICATIONS SUBJECT TO CHANGE WITHOUT NOTICE.
PRICES DO NOT INCLUDE SHIPPING AND HANDLING CHARGES.

23p11p''1+23p11p''
 '1+23p11p''1+23p11p''

This is much shorter and also much simpler in conception than the other self-replicating programs given. It is not, however, a defined function, but an expression. I don't think it would be difficult to write an APL function that would produce its own visual representation, even without using the visual representation function which makes the question trivial:

```

VR+MYSELF
[1] R+VR 'MYSELF'
  
```

This function returns its character form as a value, and only prints by default if that value is not assigned to a variable; the expression given earlier also yields a value and not just printing. Only LISP can improve on that, by returning a function as its value, rather than a character vector (character string to the rest of you).

Other variants of this amusement have been worked out in APL before. Try creating two expressions, each of which gives the other as its value or its printed result, or a cycle of three or more.

Mokurai Cherlin
 Director, Micro Systems Development
 APL Business Consultants Inc

APL Computer Language Specialists
 POB 1131
 Mt Shasta CA 96067

Thlef-Reproduthing Programth

We are rather amazed and amused by the "Self-Reproducing Programs" (see the "Programming Quickie," by Burger, Brill, and Machi, August 1980 BYTE, page 72). We were amazed by the elegance of the "optimal" C program presented (especially given C's notable lack of expressive power), and amused by the proposed LISP solution (which, by the way, won't work. What was proposed will not evaluate to a function — it needs an enclosing *DEFUN* or *DEFINE*).

Consider the problem of creating an expression which evaluates to itself. A microsecond's thought usually yields a constant, usually 1. Indeed, any friendly APL or LISP interpreter would be more than happy to return 1 when 1 is typed to it. However, many people would claim that 1 is data, and not a program. For the sake of this letter, we will pay homage to this unfounded prejudice, and go "up" a level in our analysis.

The canonical "program" in the lambda calculus which reduces to itself is:

$(\lambda x.xx)(\lambda x.xx)$.

The first $(\lambda x.xx)$ is the "program" and the second $(\lambda x.xx)$ is data to the program. When this "program" is "executed" the formal parameter x is bound to $(\lambda x.xx)$ parameter of the program (x), then x is concatenated with itself once (this is what xx means), and then this value is returned. (You may find it instructive to compare this with the "optimal" C program.)

We shall try to emulate this in LISP. The first attempt yields:

```
((lambda (x) (list x x))(lambda (x)
(list x x)),
```

however, this fails because the data part will get evaluated. We can try:

```
((lambda (x) (list x x))'(lambda (x)
(list x x)))
```

but this only yields:

```
((lambda (x) (list x x))(lambda (x)
(list x x)),
```

which is missing the quote mark. An interesting hack is to change the way *lambda* evaluates by executing (macro *lambda* form (list 'quote form)). The first attempt above will now work because when $(\lambda x)(\text{list } x \ x)$ is evaluated it will return a copy of itself, which is what we want. However, there are those that would claim this is cheating because we have implicitly changed the behavior of the evaluator. We will admit this objection and continue with our analysis.

After much musing around trying to get the quote mark back in we stumble upon:

```
((LAMBDA (LAMBDA)(LIST(LIST
'LAMBDA '(LAMBDA)
LAMBDA)(LIST 'QUOTE
LAMBDA)))
'(LIST (LIST 'LAMBDA
'(LAMBDA)
LAMBDA)(LIST'QUOTE
LAMBDA)))
```

which does what we want. Note that this uses no *PROG*, *SETQ*'s or *REPLACX*'s. Also note that the lambda variable need not be named *lambda*, this is merely a hack. It is trivial to make a program out of this expression by throwing up the necessary *DEFUN*'s:

```
(DEFUN PRINTME()
((LAMBDA (LAMBDA)(LIST
'DEFUN
'PRINTME')(LIST(LIST'LAMBDA
'(LAMBDA) LAMBDA) (LIST
'QUOTE LAMBDA))))
'(LIST 'DEFUN
'PRINTME')(LIST(LIST LAMBDA
```



PUT TIME AND BSR CONTROL IN YOUR APPLE II

THUNDERCLOCK PLUSTM

AN INTERFACE FOR THE BSR X-10

- Control AC outlets with your BSR Command Console and APPLE II
- All 22 BSR commands at your program's fingertips
- Up to 128 separate dim/bright levels
- THUNDERWARE'S Scheduler software will control AC outlets in the background, while you run another program in the foreground

A REAL-TIME CLOCK/CALENDAR

- Provides month, date, day-of-week, hour, minute, and second
- Software selectable time formats: 24 hour or AM/PM ASCII string, or as numeric values
- Provides interrupts which can be enabled or disabled under software control
- On board battery allows accurate time-keeping for up to 2 years even with your APPLE turned off

BOTH FEATURES ON ONE CARD

- On-board firmware makes the THUNDERCLOCK PLUSTM exceptionally easy to use
- Read or set time, control interrupts, and send BSR commands with simple BASIC 'INPUT' and 'PRINT' statements
- Completely APPLE II compatible: INT and FP BASIC or PASCAL with Unit support
- Special introductory prices end Jan 15, 1981

THUNDERCLOCK PLUSTM.....\$119.00
 Clock, BSR interface, and User's manual

THUNDERWARE SCHEDULER.....\$24.95
 Diskette with Scheduler, examples, demos, and Scheduler manual

PASCAL SOFTWARE.....\$19.95
 Diskette with PASCAL Unit for clock and BSR interface

TO ORDER TOLL FREE (VISA/MC) CALL:
 800-227-6204 Ext. 307 (Outside California)
 800-632-2131 Ext. 307 (California Only)

California residents add 6% sales tax
 BSR X-10 is a trademark of BSR (USA) LTD. APPLE II is a trademark of APPLE COMPUTER, INC

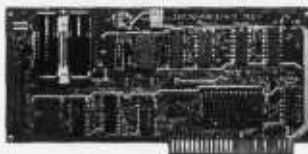

SEE YOUR DEALER

OR WRITE FOR INFORMATION:
 THUNDERWARE INCORPORATED
 P.O. Box 13322, Oakland, CA 94661

FIDELITY



SAN JOSE, CALIFORNIA
September 5, 6, 7
1980

LONDON, ENGLAND
September 4, 5, 6
1980

WINS BOTH WORLD AND NORTH AMERICAN MICROCOMPUTER CHESS CHAMPIONSHIPS!

The same engineers who helped win the "First World Microcomputer Chess Championship" under the auspices of the World Chess Federation on September 4, 5, and 6, 1980 in London, England – five straight wins with no loss or draw – and the "First Official North American Microcomputer Chess Championship" on September 5, 6, and 7, 1980 in San Jose, California – four straight wins without a loss or draw – are proud to announce Fidelity's newest chess product...

VOICE SENSORY CHESS CHALLENGER[®]

*The Perfect
Chess Opponent!
It Thinks... It Talks...
It "Sees"
Every Move
You Make!*

Voice Sensory Chess Challenger senses every move and automatically enters it into its computer brain. Fifty-word vocabulary calls out moves, describes captures, announces errors. Plays at ten levels of difficulty. Analyzes over 3,000,000 moves – it's faster and smarter than ever. Speaks English, Spanish, French or German language.

- Chess Clock tells time remaining, elapsed time, time used per move.
 - Duplicates 64 of the world's greatest games – you play against the Master.
 - Plays 64 book openings, average 15 moves into the game.
 - Many other features include: Problem Mode, Mate-in-Two solutions, change sides in mid-game, and much more.
- For the beginner or serious player. Available in fine stores everywhere.

* Spanish, French or German optional.



The world's largest manufacturer of self-contained, microprocessor based, board games.



FIDELITY ELECTRONICS, LTD.

8800 N.W. 36th STREET, MIAMI, FLORIDA 33178

Quality made in U.S.A.

read cards... economically!



The new HEI Model 121-4 card reader handles marked and punched cards interchangeably, including many colors of pen or pencil. Absolutely no operator adjustment required. Includes a number of switch-selectable features for application tailoring without extra cost.

- Reads strobe marks right or left, or self-clocking on both 80 column punch and mark-sense cards.
- RS-232 ASCII output (with Hollerith to ASCII conversion if necessary), or parallel TTL output.
- Six in-per-sec. card feedthru, or auto return to the front after read.

A built-in self test feature checks all 13 channels with a diagnostic card. The Model 121-4 operates on 50/60 CPS. Specify voltage as either 110 or 230 VAC.

The Model 121-4 is the most flexible and capable hand-fed card reader on the market at any price, and the price is right. You'll find it to be ideal for a variety of inventory control and data collection tasks. Call or write for more information on the latest optoelectronic solution from HEI.

The Optoelectronic Specialists

 **HEI inc.**

Jonathan Industrial Center • Chaska, MN 55318 • 612/448-3510

Circle 13 on inquiry card.

'(LAMBDA) LAMBDA) (LIST
'QUOTE LAMBDA)))))

However, neither of these two solutions would be written that way in a modern LISP (eg: MacLISP or Lisp-MachineLISP, instead using the *back-quote facility* they would be written:

```
((lambda (x) '(,x ',x)) '(lambda (x) ',(x',x)))
```

and:

```
(DEFUN PRINTME()  
  ((LAMBDA (X) '(,@X',X)))  
  '(DEFUN PRINTME ()((LAMBDA  
  (X) '(,@X',X))))))
```

The real way it would be written in MacLISP is (DEFUN PRINTME () (GRINDEF PRINTME)). This whole exercise really isn't very interesting in LISP because this sort of thing is done routinely. Routines are constantly being *consed* up by other routines, and macros which write their own macros are becoming a standard tool. LISP doesn't discriminate against something just because it is code.

Daniel Weise
NE43-838
MIT Laboratory for Computer Science
545 Technology Sq
Cambridge MA 02139

Leedex / Sup'R' Terminal Incompatibility

Any BYTE reader who owns an Apple II system and is considering expanding to 80 columns may be interested in my experience with the Leedex monitor and the Sup'R' Terminal RF (radio-frequency) modulator board. While the Leedex monitor is an excellent value and performs well with the standard 40-column Apple II, I found it impossible to get a clear display while using it in conjunction with the Sup'R' Terminal board. Repeated efforts at adjusting both the board and the monitor failed to produce a legible display. The only solution proved to be using another monitor, namely a Hitachi.

Sunil Subbkrishna
Shakti Systems
Wilmette IL 60091

Bar-Code Reader as Light Pen?

Before reading Carl Helmers's editorial "Bar Codes, Revisited . . ." (April 1980 BYTE, page 6) on the Hewlett-Packard HEDS-3000 bar-code data-entry wand, I considered the possibility of buying a light pen for my Apple II. Afterwards, I couldn't see buying two pieces of equipment when one might do both jobs.

Circle 14 on inquiry card. →

Mountain Computer makes more peripherals for the Apple Computer than Anybody.

and . . . a place to put them

INTROL X-10

Intelligent Home Controller for lights and appliances. Real-time schedules and energy conservation. Complete applications software package. Home security with random scheduler. Power usage accounting package for home energy cost control. No wiring required.

APPLE CLOCK

Real-time and date information. Interrupts permit Foreground/Background operation of two programs simultaneously. Battery back-up. Crystal-controlled for $\pm .001\%$ accuracy. Onboard ROM for easy access from BASICs. Supports PASCAL. Time from one millisecond to one year.

SUPERTALKER SD200

Input/Output Speech Digitizer. Permits talking programs. I/O capability allows interactive programs with speech-prompted inputs. Use output for speech directed activities in business systems, announcements in a control-room, or sound effects in entertainment programs. Easy to use because input as well as output is under user control with special software operating system.

ROMWRITER

Program your own EPROMs. Create your own firmware. Programs 2K, 2716 5V EPROMs. Disk software package provides easy EPROM programming. EPROMs are verified after BURN. RUN your programs from on-board socket or install them on ROMPLUS.

ROMPLUS+

More power for your system through firmware. Six sockets accept 2716 EPROMs or ROM equivalents. Six or any combination can be used at once. Scratch-pad RAM and two TTL connectors. Special 2K ROMs available for powerful system enhancement: Keyboard Filter ROM—COPYROM—Others coming soon.

MusicSystem

Sophistication previously available only on experimental mini and mainframe computer synthesizers. Digital instrumental music synthesizer system. 16 voices in stereo. Instrument definitions simulate the sound of real instruments—and more. Fully programmable waveforms. Envelope Control. Composition system—sheet music input using standard music notation. Chords and multi-part scoring up to 16 voices. A true instrument that anyone with an Apple can play.

A/D+D/A

16 channels analog to digital input. 16 channels digital to analog output. Eight bit resolution. Super-fast 9 μ sec. conversion time. Monitor and output to the real world. All on one card.



EXPANSION CHASSIS

By popular demand! Eight more slots for your Apple. Attractive sturdy enclosure. Its own heavy duty power supply. Easy to use. Address cards in Expansion Chassis the same way as in your Apple. Only one additional command to specify in Apple or in Expansion Chassis. Compatible with all Apple peripherals.



Card Reader

At last! An intelligent, high-quality device for data entry from user-marked cards. Implement BASIC programming, examination scoring, inventory maintenance and other applications requiring off-line data preparation for batch entry later. Connects to any computer having RS-232 interface. Software and cards are available for jobs in business, science and education.

MOUNTAIN COMPUTER has the most comprehensive line of Apple peripherals available. Anywhere. From anybody. We know the Apple inside and out and are committed to providing the most innovative and unique products to expand and enhance its capabilities and use. After all, we were the first company to make an Apple peripheral—except Apple Computer.

Available at Apple Dealers worldwide.



Mountain Computer
INCORPORATED

300 Harvey West Blvd., Santa Cruz, CA 95060
(408) 429-8600 TWX 910 598-4504

*Based on Manufacturer's published catalogs—Apr. 1980
Apple is a trademark of Apple Computer Inc.

That is, can the wand be altered so as to become a light pen?

John Gibbs

If you don't activate the infrared LED (light-emitting diode) in the HEDS-3000, you can certainly sense light coming into the wand from an external source, such as the video display's CRT (cathode-ray tube). There might be problems in matching the wave length of the light from the CRT to the spectral sensitivity of the infrared phototransistor in the wand . . . CH

Telecommunication Options

I enjoyed Carl Helmers's June editorial very much. (See "The Grass Roots Electronic Post Office, or, How Electronic (and Private) Mail Is Already Here," June 1980 BYTE, pages 6 thru 10.) The prospect of using my terminal for rapid and inexpensive communication is very exciting.

The costs you mention for sending computer messages using voice telephone lines can be greatly reduced by taking advantage of the digital communication provided by Telenet or Tymnet. This is easily done by means of The Source or MicroNet information services. Electronic mail can be sent with The Source for \$8.50 per hour of connection time counting both send and receive time during "nonprime" hours, but not counting the initial charge. Similarly, MicroNet charges \$10 per hour (for both send and receive) and has a lower initial charge. In addition, both systems permit users to chat on-line with other users through their respective terminals.

Robert W Hosken
Avatar Exports
21515 Hawthorne Blvd #432
Torrance CA 90503

According to my table of telephone rates, the cost for a one-hour telephone call from New Hampshire to California during the 60% discount time period (which Carl Helmers used as an example) would be \$9.65. The cost would be less, of course, for a call over a shorter distance.

Using The Source or MicroNet has the benefit that the two correspondents do not have to send and receive simultaneously and opens the possibility for multiple recipients of the same communication . . . RSS

Info on Micropolis Software Wanted

The Micropolis Users Group (MUG) is an association whose desire is maximizing the use of the Micropolis-supplied

software. As part of this endeavor, we are compiling a directory of all software that runs on MDOS or Micropolis BASIC without requiring a second operating system (such as CP/M). I would appreciate suppliers of such software informing me of their products.

Of course we are always interested in new members. Membership is \$12 per year for twelve monthly newsletters.

Buzz Rudow
Micropolis Users Group
604 Springwood Cr
Huntsville AL 35803

6809 Time-Sharing

Don Kinzer's article in the June 1980 BYTE ("A Time-Sharing/Multi-User Subsystem for Microprocessors," page 122) describes how a sixteen-user time-sharing system can be implemented. The system, based on a 6800 microprocessor, uses a minimum of hardware and software. However, using the new 6809 processor, even less hardware and software is required.

The first savings of hardware occurs at power-up/reset. Most processors, including the 6800, accept a nonmaskable interrupt (NMI) at any time—even at reset. Obviously, if an NMI occurs before the stack is initialized correctly, the program will bomb. The problem is usually solved by adding a special circuit that disables all interrupts until the processor is properly initialized (as shown in figure 4 of Kinzer's article).

On the 6809, the NMI is blocked until the first load of the system stack pointer (SP). Thus, no special reset circuitry is needed. After initialization is complete, the stack pointer is loaded to enable the NMI. Note that most interrupt timers must still be initialized; when using the 6809, simply use the RESET signal to clear the timer to a known state.

The 6809 allows direct addressing anywhere in the memory map. By use of a direct page (DP) register, the 64 K-byte addressing range is divided into 256 pages. In a time-sharing environment, the DP register could be loaded with a different value for each user, resulting in each user accessing a different 256 bytes of temporary storage.

An alternate method of implementing a time-sharing/multi-user system is with the 6829 memory-management unit (MMU). The MMU expands the address space of the 6809 from 64 K bytes to 2 megabytes. Each MMU can handle four concurrent tasks; the address space of each task can be fully protected from other tasks. In addition, a total of eight MMUs can be used in a system,

Letters continued on page 298

A growing line of tools to expand the Apple.

7440A Programmable Interrupt Timer Module. Time events in four operating modes—continuous, single shot, frequency comparison, and pulse width comparison. Includes three 16-bit interval timers, plus flexible patch area for external interface. Programmable interrupts, on-board ROM, and much more.

7720A Parallel Interface. Two bi-directional 8-bit I/O ports will connect your Apple to a variety of parallel devices, including printers, paper tape equipment, current relays, external on/off devices. Full featured, programmable interrupts, supports DMA daisy chaining.

7811B Arithmetic Processor. Interfaces with Applesoft, so you just plug in and run. Based on the AM 9511 device, provides full 16/32-bit arithmetic, floating point, trigonometric, logarithmic, exponential functions. Programmed I/O data transfer, much, much more.

7710A Asynchronous Serial Interface. Conforming to RS-232-C A thru E 1978 standard, this card will drive a variety of serial devices such as CRT terminals, printers, paper tape devices, or communicate with any standard RS-232 device, including other computers. Full hand-shaking, and fully compatible with Apple PASCAL!

7470A 3% BCD A/D Converter. Converts a DC voltage to a BCD number for computerized monitoring and analysis. Typical inputs include DC inputs from temperature or pressure transducers. Single channel A/D, 400 ms per conversion.

7490A GPIB IEEE 488 Interface. A true implementation of the IEEE 488 standard—the standard protocol for instrumentation and test devices. Control and monitor test instruments such as digital voltmeters, plotters, function generators, or any other device using the IEEE 488.

7114A PROM Module. Permits the addition or replacement of Apple II firmware without removing the Apple II ROMs. Available with on-board enable/disable toggle switch.

7500 A Wire Wrap Board. For prototyping your own designs.

7510A Solder Board.

7590A Extender Board.

7018A 18K Dynamic Memory Add-On.

Watch this space for new CCS products for the Apple. We've got some real surprises in the works. To find out more about the CCS product line, visit your local computer retailer. The CCS product line is available at over 250 locations nationally, including most that carry the Apple. Or circle the reader service number on this ad.

Apple II, Apple II Plus, and Applesoft are trademarks of the Apple Corporation.

CCS makes the difference.

We see the Apple a little differently.

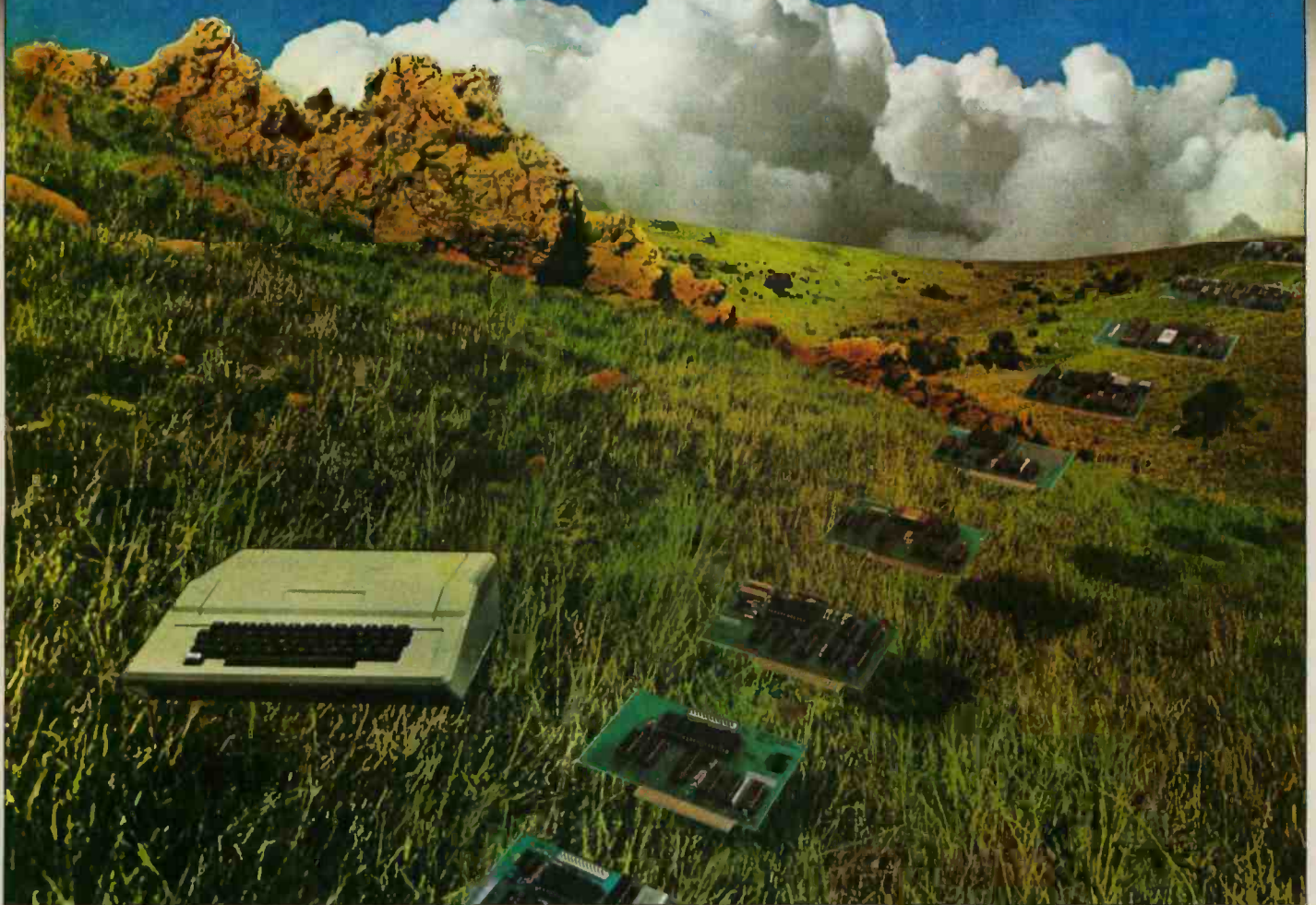

We see it as a good way to get things done.

Apple has built a great computer. We at CCS have built a great line of peripherals and components to expand the Apple. To do almost anything you want to get done with a computer.

If you want to do business with an Apple, we've got tools to connect the Apple to standard business printers and terminals. Or to modems, for communications over telephone lines, with other computers, even with other Apples.

If you want to apply your Apple to engineering, scientific, or graphic projects, we've got tools for high-powered,

high-speed math functions, and fast, high resolution graphics. And tools to connect the Apple to lab test equipment like function generators or plotters.

And we have tools to connect the Apple to the outside world, including A/D converters and interval timers with external interface.

We make components for the S-100 bus, the PET, and the TRS-80, too. We built our products to deliver hard-nosed value to the OEM, and to the inventor who knows the best, at prices that are unbeaten.

To find out how much computer your Apple II can be, see things our way. Because for serious users with serious uses for the Apple, we've got the tools.



California Computer Systems

250 Caribbean Sunnyvale, CA 94086 (408) 734-5811

Your vehicle for com The Challenger 8P DF.

The general purpose microcomputer was first introduced as a computer for hobbyists and experimenters. However, as the industry has grown, microcomputers have become specialized for personal use or for small business use. There is virtually no computer for the serious experimenter with one important exception, the Ohio Scientific Challenger 8P.

The C8P is unique in that it incorporates the features of state-of-the-art personal computers, with the memory and disk storage capacity of business computers, along with the "mainframe" bus architecture and open ended expansion capability of industrial control computers.

Personal Computer Features

The C8P DF's specs beat all personal computers hands down. It executes instructions two to three times faster, and displays more alphabetic characters on its screen than other

models. It has upper and lower case and graphics in 16 colors. The C8P's *standard I/O* capabilities are far more extensive than any other computer, with joystick and keypad interfaces, sound output, an 8-bit D/A converter, 16 parallel I/O lines, modem and printer interfaces, AC remote control and security monitor interfaces and a universal accessory port that accepts a prom blaster, 12-bit analog I/O module, solderless prototyping board and more.

Ohio Scientific offers a large library of personal applications programs, including exciting action games such as *Invaders* and *Star Trek*, sports simulations, games of logic

and educational games, personal applications such as biorhythms, calorie counter, home programs such as checking and savings account balancers and a home budgeter just to name a few. A new Plot BASIC makes elaborate animations easy, and music composition program allows you to play complex multi-part music through the computers DAC.

At the systems level the machine comes standard with OS-65D, an advanced disk operating system with Microsoft BASIC and an interactive Assembler Editor. Optional software includes UCSD PASCAL and FORTRAN and an Information Management System (OS-MDMS). Dozens of independent software suppliers now also offer personal programs for the C8P.



puter explorations.

Business Computer Features

The C8P DF utilizes dual 8" floppy disk drives which store up to eight times as much information as personal computer mini-floppies, and an available double-sided option expands capacity to 1.2 megabytes of on-line storage. The C8P DF is compatible with Ohio Scientific's business computer software, including OS-65U an advanced operating system, and an Information Management System (OS-DMS) with supplementary inventory, accounting, A/R-A/P, payroll, purchasing, estimation, educational grading and financial modeling packages. The system also supports word processing (WP-3) and a fully integrated small business accounting system (OS-AMCAP V1.6). The C8P DF's standard modem and printer ports accept high-speed matrix printers and word-processing printers directly.

Home Control and Industrial Control

The C8P DF has the most advanced home monitoring and control capabilities ever offered in a computer system. It incorporates a real time clock and a unique FOREGROUND/BACKGROUND operating system which allows the computer to function with normal BASIC programs, at the same time it is monitoring external devices. The C8P DF comes standard with an AC remote control interface, which

allows it to control a wide range of AC appliances and lights remotely, without wiring, and an interface for home security systems which monitors fire, intrusion, car theft, water levels and freezer temperature, all without messy wiring. In addition, the C8P DF can accept Ohio Scientific's Votrax voice I/O board and/or Ohio Scientific's new universal telephone interface (UTI). The telephone interface connects the computer to any telephone line. The computer system is able to answer calls, initiate calls and communicate via touch-tone signals, voice output or 300 baud modem signals. It can accept and decode touch-tone signals, 300 baud modem signals and record incoming voice messages. These features collectively give the C8P DF capabilities to monitor and control home functions with almost human-like capabilities.

For process control applications, a battery back up calendar clock with automatic computer restart capabilities is available. Ohio Scientific's unique accessory ports allow the connection of a nearly unlimited number of 48 line parallel I/O cards and 12-bit high speed instrumentation quality analog I/O modules to the computer by inexpensive 16-pin ribbon cables.

Exploring New Frontiers

Ohio Scientific's vocalizer software processes normal BASIC print statements with conventional spellings and speaks them clearly in real-time

on computers equipped with the UTI (CA-15B or CA-14A). This voice output capability, combined with the C8P's remote control, remote sensing, telephone interface capabilities and reasonable cost open up new frontiers for computer applications.

Documentation

The C8P DF is not a beginner's computer and doesn't come with beginner's documentation. However, Ohio Scientific does offer detailed documentation on the computer which is meaningful for experts, including a Howard Sams produced hardware service manual that includes detailed block diagrams, schematics, parts placement diagrams and parts lists. Ohio Scientific is now also offering fully documented Source Code in machine readable form for OS-65D, the Challenger 8P's operating system allowing experimenters and industrial users to customize the system to their specific applications.

What's Next?

Ohio Scientific is working on a speech recognizer to complement the UTI system, with a several hundred word vocabulary. The company is also developing an 8 megabyte low-cost, add-on hard disk for use in conjunction with natural language parsing to further advance the state-of-the-art in small computers. The modular bus architecture of the C8P assures system owners of being able to make use of these new developments as they become available just as the owner of a 1976 vintage Challenger can directly plug in voice output, the UTI and other current state-of-the-art OSI products.

The C8P DF with dual 8" floppies, BASIC and two operating systems costs about \$3000, only slightly more than you would pay for a dual mini-floppy equipped personal computer with only a fraction of the capabilities of the C8P.

For more information and the name of the dealer nearest you, call 1-800-321-6850 toll free.

OHIO SCIENTIFIC
1333 SOUTH CHILLICOTHE ROAD
AURORA, OH 44202 • [216] 831-5600



Multimachine Games

Ken Wasserman and Tim Stryker
Mach 2 Software
96 Hammersmith Apts
Danbury CT 06810

There you are, staring into a poor dumb tube, spending hours trying to wheedle, cajole, flatter and coax your machine into coughing up a few more points, or maybe into reluctantly admitting every now and then: "YOU WIN!!!(bell)(bell)!!!" How much satisfaction is there in that, really? How much challenge? So you beat the computer. So what? So the computer beat you. Who cares? Do you ever long for a scenario something like the following? . . .

Tonight will be the final, deciding match of the battle series—the winner will have won the regional computer-club title and will be eligible for the national playoffs next month in San Diego. As you and your worthy opponent, both dressed in black, enter the room, a hush falls over the gathered assembly. You approach your respective consoles, and, at a prearranged signal from the presiding judge, the game begins.

The screen before you contains a wealth of information about the status and positioning of your various forces. You have two "windows" onto the field of play, one centered on your base, the other on your current tank. You see no sign of your opponent or his base in either window, for the field of play is very large: you know that he is out there somewhere, but, as the game begins, you have no idea where.

As you begin to move your tank out of your base, you find that it stays centered in its own window, thereby making previously unseen portions of the field visible to you, while, from the point of view of your base (which is immobile) your tank appears to move away from window center until shortly it disappears off the edge. Quickly reconnoitering your base perimeter, you begin to lay down mines to protect it from invasion. (These mines are visible to you but not to your opponent, to whom a

Quickly reconnoitering your base perimeter, you begin to lay down mines to protect it from invasion.

square filled with one of your mines looks just like a stretch of virgin grassland.) As you do this, the steady clickety-click you hear from your opponent's keyboard tells you that he is not exactly idle either—he is probably mining the area around his base.

Or perhaps his base is well protected by mountain ranges, and he is now already actively seeking yours? Or maybe he has decided on the decoy ploy, and is building and mining an entirely false base to confuse you? You have no way of knowing!

Running out of mines, you frantically return to your base to restock, then rush out again to complete the mining operation. Suddenly you hear the sound of a mine exploding. Has your opponent run across your mine field already? Or did he, in his own haste, run afoul of one of his own mines? Thankful you had the foresight to make your mine fields orderly, you investigate: one of them is missing! Your opponent's tank is now badly damaged, but there are still four more where that one came from, and, more important, he now has some idea as to where your base is.

Out of mines again, and unwilling to return to base to restock, you are unable to patch the breach—instead, you take off after the intruder, and suddenly—there he is! His tank appears within your tank window! You fire—and miss—he maneuvers, fires—and hits you!

Your tank goes into condition yellow—you maneuver, fire—and miss—fire again—a hit! His tank, which was in condition red from having hit the mine, is completely destroyed, but you know that the second of his supply of five tanks has now been made available to him back at his base, wherever that is. Quickly slipping into a nearby forest to survey the area, you suddenly run across what can only be his second tank!

You reason as follows: in order for his second tank to have gotten back to this area as fast as it did, his base

Cassettes containing Flash Attack for the PET, at \$15 each, and kits containing all the hardware needed to run Flash Attack and other games on the PET, including CB2 sound, at \$15 each, are available from: Mach 2 Software, 96 Hammersmith, Danbury CT 06810.

ATARI® PERSONAL COMPUTER SYSTEMS THAT GROW WITH YOU



modulator and FCC approval for connection to any TV. Plus, nationwide Atari Authorized Service Centers. And more.

Add memory. The ATARI 800™ is supplied with 16K of memory. You can expand up to a full 48K of RAM with 8K or 16K Memory Modules™ you install yourself. In less than a minute. The ATARI 400's™ 8K of RAM may be expanded to 16K at Authorized Service Centers. Both may be expanded to 26K of ROM with slip-in ROM cartridge programs.

Add peripherals. The ATARI 40™ audio-digital program recorder. Single or dual density* disk drives. The ATARI 800 individually addresses up to four drives. Add the ATARI 850™ RS232 Interface Module. Add high speed 40 or 80-column printers. Add an acoustic modem for remote data access. Add a light pen.* And there are more Atari peripherals on the way.

Add programs. Choose among dozens of programs in Atari's rapidly expanding software library. Programs categories include:

- Personal Finance & Record Keeping
- Personal Interest & Development
- Professional Applications
- Education
- Information & Communication
- Entertainment
- Programming Languages
- Small Business Accounting

Add it up. With Atari, you start with more. And you can build to more. Because Atari offers you personal computer systems that grow with you. Ask your Atari retailer to give you a full demonstration of Atari computers, peripherals and programs. Complete systems. Because when other people were thinking hardware and software, Atari was thinking systems.



*Available Fall, 1980

Start with a better computer.

Atari computers have built-in capabilities you can't even add onto many other personal computers. Three programming formats (ROM cartridge, disk and cassette). A 57 key upper/lower case ASCII keyboard with 29 keystroke graphics symbols. 128 colors and hues. Four separate sound channels and a built-in speaker. Four controller ports. A built-in RF

©1980, Atari, Inc.

Ⓜ A Warner Communications Company

Atari reserves the right to make changes to products or programs without notice.

PERSONAL COMPUTERS

1265 Borregas Avenue, Sunnyvale, CA 94086

Call toll-free (800) 538-8547 (Except Alaska and Hawaii)

(In California: (800) 672-1404) for the name of your nearest Atari retailer.



must be nearby. Accordingly, you ignore the fact that his tank begins firing at you, opting instead to try to catch a glimpse of his base in your tank window before your tank is destroyed.

You maneuver—are hit!—your tank is now in condition red, and you find it difficult to move properly—nevertheless you forge ahead—there is his base! You move again, and hit a mine—your tank is destroyed! However, remembering the coordinates your tank was at when you saw his base, you make a lightning mental conversion from rectangular to polar coordinates, and, shouting insults across the room to distract your opponent's attention, you swiftly key the polar data into your angle and range registers and fire off an intercontinental ballistic missile from your base. A high, falling whistle is heard, followed by a colossal explosion.

A deathly quiet ensues: your condition display glows with the word "SUPREME," while on your opponent's screen you know the condition to be "DEFUNCT." You have triumphed in the first game of tonight's seven-game match—as you glance across to see the look of fierce determination on the face of your opponent, you realize that the remaining games may not be won so easily. The judge, looking at both players, slowly raises his hands, and the second game begins. . . .

Creating a Game

The creation of such a game may not be as far beyond your capabilities as you might think: the above game, including all features mentioned, and more, has already been implemented for use on a pair of lowly 8 K-byte

Commodore PET computers, under the name of *Flash Attack*. (See photos 1a and 1b.)

A pair of 16 K-byte PETs, TRS-80s, or Apple IIs should allow the development of even more outrageous games of this general type, perhaps involving quicksand pools, laser weaponry, or aerial reconnaissance, to name a few possibilities. The game could even conceivably be generalized to include more than two players, leading to situations in which teamwork and treachery could become determining factors in a game's outcome.

(1a)

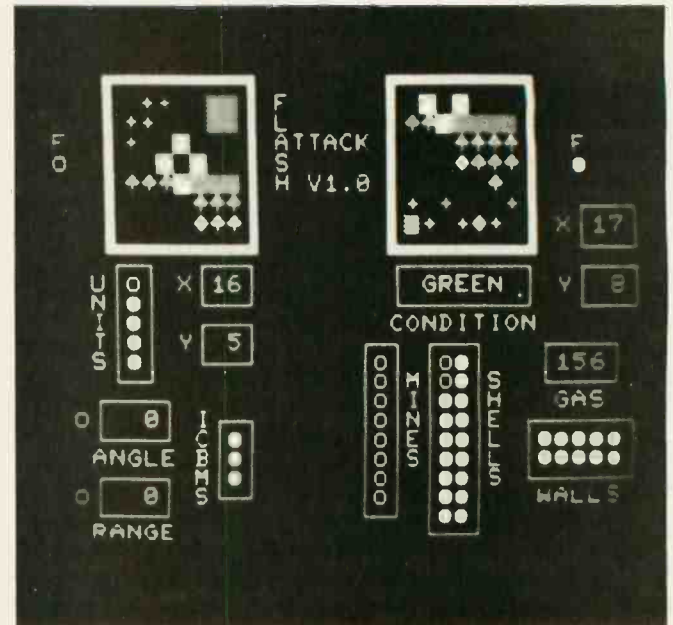

(1b)

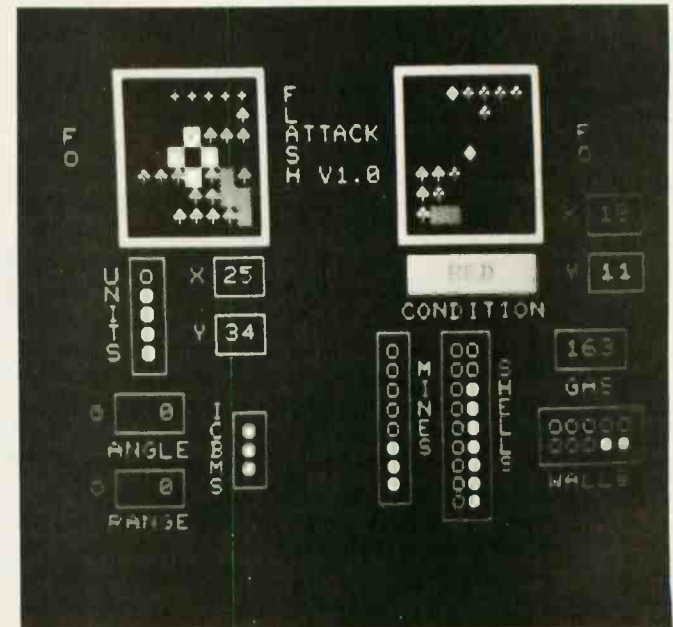
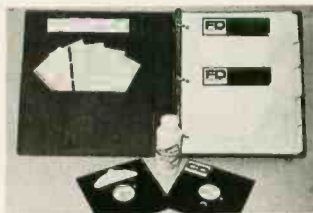

Photo 1: A typical game of *Flash Attack* fully underway. The photos 1a and 1b show the display screens seen by each of the two players. The two rectangular "windows" seen on each screen represent a limited view of each player's base and the view from his active tank. By presenting only incomplete information to each player, the skill necessary (along with the corresponding sense of accomplishment) is increased.

FLOPPY DISK FACTORY DIRECT FLOPPY DISK FACTORY

FACTORY DIRECT FLOPPY DISK FACTORY DIRECT FLOPPY DISK FACTORY



- Buy factory direct from the manufacturer of floppy disks sold exclusively under other well-known brand names.
- Save distribution costs on reversible 5.25" floppy disks, which are 100% certified for 40 track, dual side, double density and all other standard applications.
- 50% savings on 5.25" floppy disks with new factory-direct 2.2 megabyte capacity "Diskit".
- Factory-direct "Diskit", includes twelve floppy disks and accessories, plus a head cleaner disk and solution packaged in a bookcase binder for easy access, handling and storage. "Diskit" complete for the introductory price of only \$49.50 plus \$2.50 freight and handling. Normal price \$59.50. **Order now and save \$10.00** (CA residents add 6 1/2% sales tax).
- Available in hard and soft sector configurations; when ordering indicate number of sectors — 1, 10 or 16.
- Send check or money order to:

Factory Direct

P.O. Box 60759
Sunnyvale, CA 94088

For VISA or MasterCard call toll-free

(800) 824-7888

In Calif. (800) 852-7777

In Alaska & Hawaii (800) 824-7919

Ask for Operator 98

FACTORY DIRECT FLOPPY DISK FACTORY DIRECT FLOPPY DISK FACTORY



QDP 100 is quiet
 QDP 100 is quietly beautiful
 QDP 100 quietly works and works and works
 beautifully

\$4695

- Z-80 4 Mhz CPU
- Two 8" Double Sided Double Density Floppies
- Four Ports - 2 Serial - 2 Parallel
- 64 K Memory
- Disk Controller - Double Sided Double Density - up to 4 M.B.
- Monitor in Prom
- CP/M 2.2 DOS
- S-100 (1-€€€) Motherboard
- Basic Language Included
- Real Time Clock

Quasar Data Products

10330 Brecksville Rd., Brecksville, Ohio 44141

216 - 526 - 0838 216 - 526 - 0839



The game hinges on the players' judicious use of incomplete information.

The basic factors that go into making a game like this interesting are threefold:

1. More than one human player is involved in the game. Rather than having the user compete against the machine, the machine is *utilized* to permit two or more people to compete with *each other* in ways that would be impossible without the aid of the machine.
2. Success in the game hinges on the players' judicious use of *incomplete information*. Although the game may, in fact, be entirely deterministic in the sense that each legal move a player proposes gets put into effect without the intervention of any randomizing influence, the fact that each player has only a limited notion as to what his opponents are up to lends a definite element of suspense and calculated risk-taking to the game.
3. The game is played in *real time*: one's options are constrained not so much by the rules of the game as by one's own fleetness of hand and mind (or lack thereof).

Many conventional board games, and virtually all conventional card games, embody factors 1 and 2. Many video pinball parlor games, such as Atari's *Pong* and

Tank, embody factors 1 and 3, while most of the rest of the available microcomputer game software embodies either none of these factors (computer chess, backgammon, etc), factor 2 alone (*Star Trek*, *Adventure*, etc), or, in exceptional cases, factors 2 and 3 together (real-time *Star Trek*, etc).

It is interesting to note that, of all the major league sports, the one that embodies all three of these factors most fully is football—this may be the reason why the sport is so overwhelmingly popular.

Bringing all three of these factors together in a single computer game virtually *requires* that more than a single console be used. Since, to most of us, a requirement for multiple consoles is equivalent to a requirement for multiple machines, the issue that will be addressed here is: what is needed in the way of hardware and software to support the implementation of multimachine games?

Two-Machine Games

In the case of two-machine games, the answer turns out to be surprisingly simple and inexpensive. Most microcomputers come already supplied with a general-purpose, 8-bit, parallel I/O (input/output) port poking out the back someplace. For those that do not, an add-on port of this type can generally be purchased at nominal expense. As in the PET, the port should ideally have the property that, even though configured for output, it will still return a correct reading of the states of the pins involved when a "read" operation is performed on it.

Also, as with the PET, the port should represent the *high* state upon output by means of a passive pull-up resistor. Ports not satisfying these conditions may still be

ECTTM

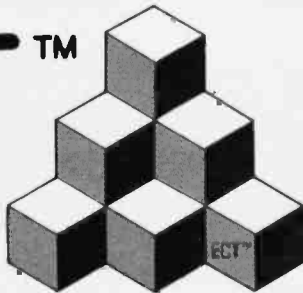

Building Blocks for Microcomputer Systems, Dedicated Controllers and Test Equipment.

R²I/O S-100 ROM, RAM & I/O BOARD

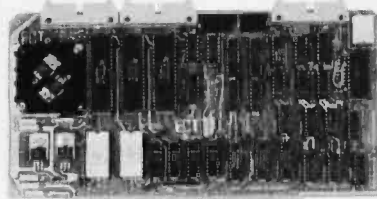

ECT's R²I/O is an S-100 Bus I/O Board with 3 Serial I/O Ports (UART's), 1 Parallel I/O Port, 4 Status Ports, 2K of ROM with the 8080 Apple Monitor Program and 2K of Static RAM.

\$295.00

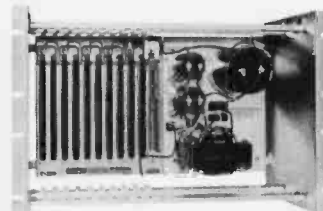

RM-10 S-100 RACK MOUNT CARD CAGE

ECT's RM-10 is a rack mount 10 slot Card Cage with Power Supply, consisting of an ECT-100 rack mount Card Cage (19"W x 12.25"H x 8"D), the MB-10 Mother Board (with ground plane and termination) all 10 connectors and guides and the PS-15A Power Supply (15A @ 8V, 1.5A @ ± 16V).

\$295.00

Specializing in Quality Microcomputer Hardware
Industrial • Educational • Small Business • Personal

Card Cages, Power Supplies, Mainframes, CPU's, Memory, I/O, OEM Variations

ECTTM ELECTRONIC CONTROL TECHNOLOGY (201) 686-8080

763 Ramsey Ave., Hillside, NJ 07205

THE UNBEATABLE S-100 MEMORY

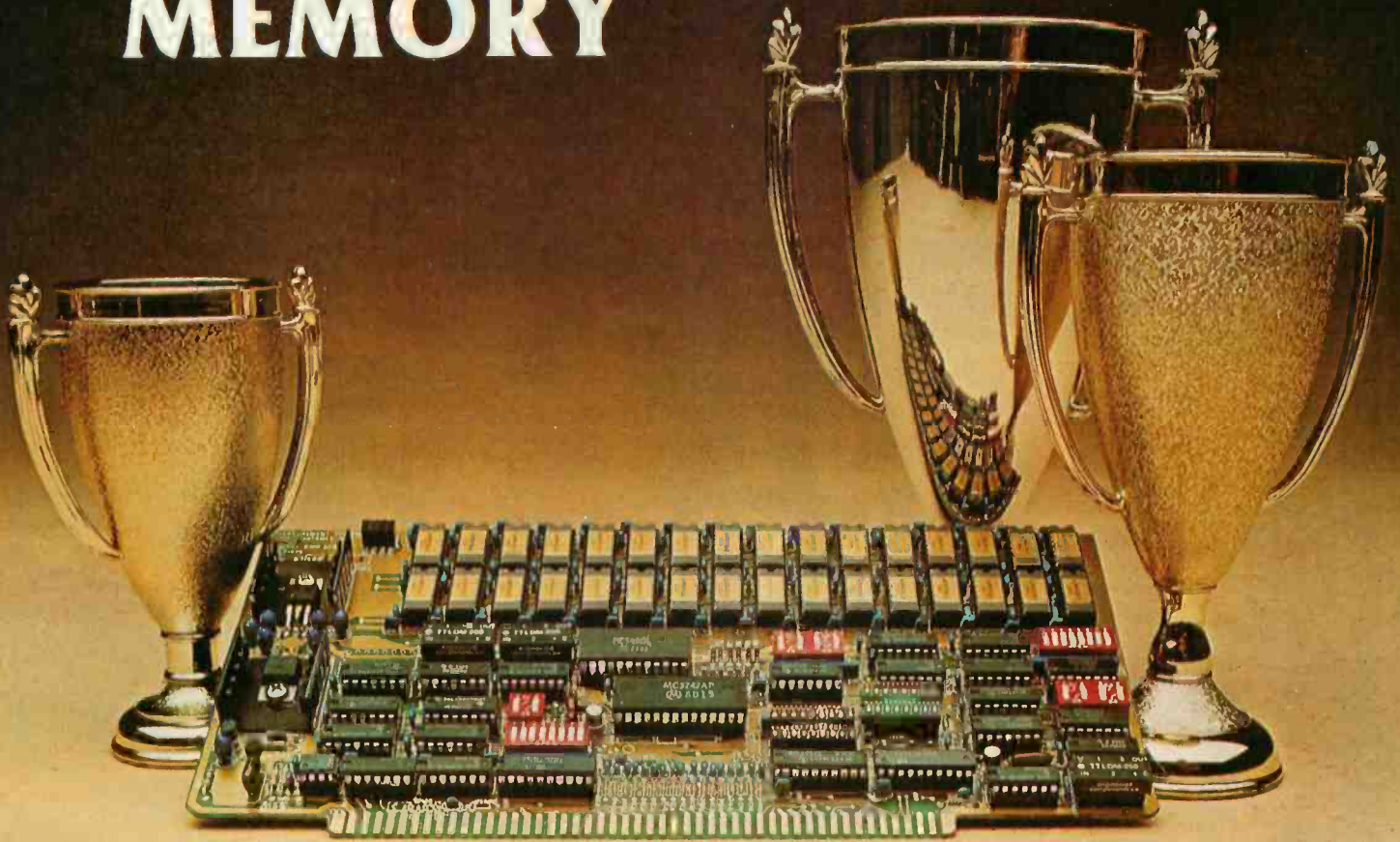

That's the MEASUREMENT systems & controls DMB Series of S-100 bus memory modules, fully compatible with **ALPHA MICRO, CROMEMCO, DYNABYTE, NORTH STAR, MP/M,** and most other S-100 systems.

Definitely a winner, the DMB Series is available with Bank Select (DMB6400) or without (DM6400) and utilizes industrial quality construction, provides outstanding reliability, and is backed by dedicated customer service and a one year guarantee.

The DMB6400 uses I/O port addressing for the bank select feature. A switch provides the ability to select any one of the 256 I/O ports for addressing the memory banks. The memory is configured as four totally independent 16K software selectable banks, with each bank addressable on any 16K boundary.

Outstanding features such as those listed below make the DMB series the UNBEATABLE S-100 Memory:

- Four independent 16K software selectable banks.
- Each bank is independently addressable on any 16K boundary.
- Switch selectable bank sizes — from 16K to 64K in 16K increments.
- Eight banks (512K) per I/O port for each of the 256 ports.
- Z-80 4MHz operation with no wait states using transparent refresh.
- On-board diagnostic LED's.
- Low power — 8 watts maximum.
- Reliable, tested and burned-in memory.
- IEEE S-100 compatible timing.
- One year guarantee.
- Attractive Dealer & OEM Prices.

See your nearest computer dealer, or contact us for the complete story on the UNBEATABLE S-100 Memory.

Systems Group

A Division of MEASUREMENT systems & controls
Incorporated

867 North Main St. / Orange, Calif. 92668 / (714) 633-4460
TWX/TELEX: 678 401 TAB IRIN

"Here's the best news yet about Fluke Digital Multimeters.

Now you can carry one home."

Right now, in selected electronics supply stores across the country, Fluke is introducing a new line of low-cost DMM's: the Fluke Series D. With their distinctive dark cases and full range of accessories, these five DMM's are designed to meet the test and measurement needs of the uncompromising service technician, home hobbyist, student or working engineer.

Fluke perfected the handheld DMM and set tough standards for accuracy and reliability that have made analog meters obsolete, and other digitals seem clumsy by comparison.

You've probably heard about their superior electrical performance, mechanical

ruggedness and environmental endurance. And now you can see for yourself at your favorite electronics dealer why Fluke DMM's have become the professional's choice the world over.

Series D Handheld Models.

D 800: Fluke's lowest-priced DMM, easy to operate, with six functions, 24 ranges and 0.5% dc voltage accuracy. Guaranteed a full year by Fluke. A sure-fire solution to basic measurement needs. \$125.*

D 802: Basic dc accuracy of 0.1% and conductance for high resistance measurements to 10,000 M Ω make this multimeter a solid price/performance value. \$179.*



If your dealer doesn't carry Series D Multimeters yet, call this number. We'll be happy to tell you who does. 1-800-426-9182

D 804: A powerful, versatile handheld DMM with nine functions, 26 ranges, 0.1% basic dc accuracy and more. Direct temperature readings in °C with K-type thermocouples; peak hold on voltage and current functions; even an audible indicator for instant continuity and logic level detection. Available January 1981. \$229.*

Series D Bench/Portables.

D 810: By means of a Fluke-built hybrid converter, this multi-purpose DMM delivers True RMS measurements of ac voltage and current with speed and precision. Also features conductance, 0.1% basic dc accuracy, an extra 10A range and diode test. \$259.*

D 811: Same performance features as the D 810 with the added convenience of battery power. Rechargeable "C" size Ni-Cad batteries deliver up to 40 hours continuous operation. \$299.*

Series D Accessories.

A wide range of accessories to extend the measurement capabilities of your Series D Multimeter is available, including temperature and current probes, carrying cases, deluxe test leads and thermocouples.

With Series D Multimeters so easy to find and economical to own, Fluke has made selecting the right DMM much simpler. This is your opportunity to own a Fluke.



From the world leader in DMM's. Now we've designed one for you.



*suggested U.S. list price.
For technical data circle no.
Circle 21 on Inquiry card.



Listing 1: Listing of the program used to test the cable described in figure 1.

```

100 REM*** PROGRAM TO TEST INTER-
110 REM*** MACHINE COMMUNICATIONS
120 REM***
200 GOSUB 10000
210 IF PEEK(59471) AND 16 THEN 260
220 GET S$
230 IF S$ = "" THEN S$ = CHR$(0)
240 GOSUB 10200
250 IF S$ = "●" THEN 999
260 GOSUB 10400
270 PRINT R$;
280 IF R$ <> "●" THEN 220
999 END
10000 REM***
10010 REM*** ROUTINE TO INITIALIZE PORT
10020 REM*** INPUTS: NONE
10030 REM*** OUTPUTS: NONE
10040 REM***
10050 POKE 59471,255
10060 POKE 59459,255
10070 RETURN
10200 REM***
10210 REM*** ROUTINE TO SEND BYTE
10220 REM*** INPUT: S$ = BYTE TO BE
10230 REM*** SENT
10240 REM*** OUTPUTS: NONE
10250 REM***
10260 HN = INT(ASC(S$)/16)
10270 LN = ASC(S$)-HN*16
10280 POKE 59471,LN+128+32
10290 IF PEEK(59471) AND 128 THEN 10290
10300 POKE 59471,HN+128+64
10310 IF PEEK(59471) AND 128 THEN 10330
10320 GOTO 10310
10330 POKE 59471,255
10340 RETURN
10400 REM***
10410 REM*** ROUTINE TO RECEIVE BYTE
10420 REM*** INPUTS: NONE
10430 REM*** OUTPUT: R$ = BYTE RECEIVED
10440 REM***
10450 IF PEEK(59471) AND 64 THEN 10450
10460 LN = PEEK(59471) AND 15
10470 POKE 59471,127
10480 IF PEEK(59471) AND 32 THEN 10480
10490 HN = PEEK(59471) AND 15
10500 POKE 59471,255
10510 R$ = CHR$(HN*16+LN)
10520 RETURN

```

used as long as there is provision made within them for individually programming each bit position to be either input or output (examples of the use of such ports will not be given here).

What is needed, then, is an arrangement that will allow a byte at a time to be transferred from either machine to the other. Figure 1 gives the wiring diagram for the cable needed; as you can see, each bit position on each machine is simply directly connected to the corresponding bit position on the opposite machine. This is true for all bits except for the 2⁴ bit, labeled ASYM, which is grounded on one machine and left floating *high* on the other. The whole package, including connectors, should cost less than \$5.

Listing 1 contains a program designed to test the cable. It is designed for use on a pair of PETs, but, with minor modifications, it should be capable of supporting any pair of machines with ports satisfying the conditions discussed above. With the cable in place, and with both machines running this program, what should happen is that any keys hit on either machine should be displayed on the screen of the other. Type a shift-Q (not the STOP key) to exit the program and return to BASIC.

The three utility routines of interest here start at lines 10000, 10200, and 10400, respectively. The routine at line 10000 simply initializes the port: location 59471 is the PET's User Port I/O data register, while 59459 is the register used to configure the data pins for input and output. The POKE in line 10060 configures all eight pins as output.

The SEND routine at line 10200 may be called whenever it is desired to send a byte to the opposite

machine. However, the opposite machine must call its own RECEIVE routine, at line 10400, in order for the transfer to take place. There is a potential pitfall here: if, when writing your own code to use these routines, you create a situation in which both machines are trying to send a byte to the other at the same time, or if both machines try to receive a byte from the other at the same time, both will "hang."

The programs running on the two machines must be set up in such a way that whenever one of them decides to send a byte, the other realizes this and sets up to receive it. Given this fact, the purpose of the ASYM bit in figure 1 becomes evident: it guarantees that start-up problems will not arise when running identical copies of a single program in both machines. Consider yourself in the position of the program in listing 1 as you begin running; eventually you would reach the point where you would like to start up a dialogue with the other machine.

Question: should you send a byte to the other machine first, or receive one? You and the other machine had better come to complementary conclusions as to which to do first. Solution: you use the setting of the ASYM bit to decide. This is exactly what happens in line 210 in the listing. If, upon reading the port contents, you find that the 2⁴ bit is *high*, you receive first; otherwise you send first. From that point on, in this example, you simply alternate sending and receiving, and everything is fine.

Let's take a closer look at what is actually involved in transferring a byte using this scheme. The nine lines shown in figure 1 can be broken down into four groups:

- GND. This is a signal ground, which must be present in

ZORK™ is more than an adventure.

Zork™ is a computer fantasy of ultimate challenge. Unearthly creatures guard treasures beyond your imagination. Mazes confound your quest. So quicken your wits and pick your path carefully through the Great Underground Empire. The least likely object may be the only thing that can save your life.

Yet, you can succeed. Discover the 20 treasures of Zork, return them to the Trophy Case and leave alive. But bring all the cunning and courage you can muster. Because in Zork, they take no prisoners . . .

Zork, The Great Underground Empire, was created by Infocom, Inc., and is available for 32K Apple® II and II Plus and 32K TRS-80™ Model I Level II disk systems.

Also new from Personal Software is MONTY™ Plays Monopoly,™ which lets an Apple or TRS-80 play America's favorite board game with the family.

Arcade Classics is a new TRS-80 action game featuring Cosmic Raiders, Pinball, Ricochet and Blockade. A great way to have fun without feeding quarters into the machines.

Zork, MONTY Plays Monopoly and Arcade Classics—more fun and games with your computer, now joining our other Strategy Games: Microchess, Gammon Gambler, Checker King, Bridge Partner and Time Trek.

See these great strategy games at your Personal Software computer retailer. For the dealer nearest you, call Personal Software Inc. at 408/745-7841, or write 1330 Bordeaux Drive, Sunnyvale, CA 94086.

When you put your computer to work, use Personal Software™ Productivity Products: VisiCalc,™ DESKTOP/PLAN™ and CCA Data Management System.

PERSONAL SOFTWARE

Zork is a trademark of Infocom, Inc.; Apple is a registered trademark of Apple Computer, Inc.; TRS-80 is a trademark of Radio Shack Division of Tandy Corp.; MONTY is a trademark of Ritam Corp.; Monopoly is a trademark of Parker Brothers, Inc.; MONTY is not sponsored or endorsed by Parker Brothers, Inc.

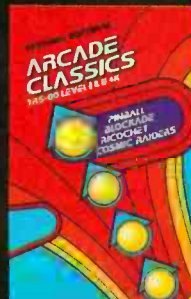
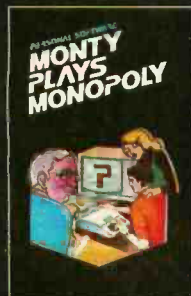

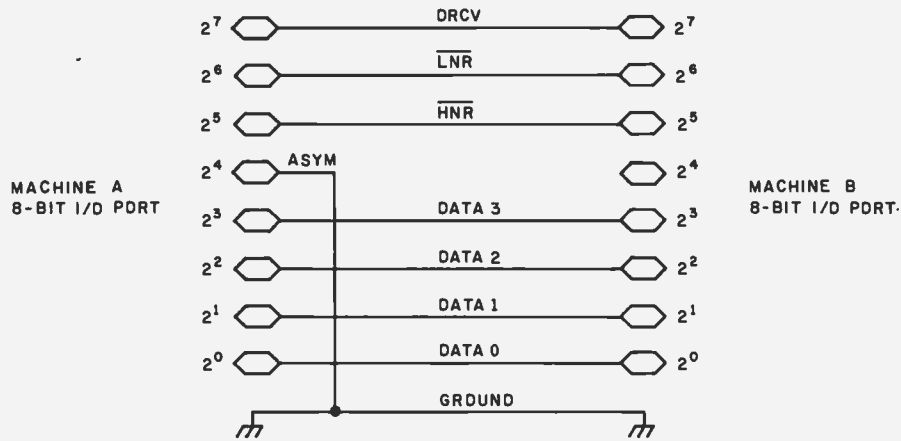

Figure 1: The cable arrangement needed for connecting two PETs in game-playing configuration. Each machine runs the same program, and exchanges relevant information, one byte at a time, with the opponent's computer. The bit labeled 2^4 determines the initial state of each machine and, thus, whether it first transmits or receives.



Figure 2: Timing diagram for information transfer using the cable scheme of figure 1. The transmitting computer puts information on the DATA lines, low-order nybble first, and brings the LNR line low. The receiving computer brings the DRCV line low when the information has been accepted. The process is repeated for the high-order nybble, but HNR is used to indicate the presence of new data. When DRCV is brought high, the transmitter and receiver functions reverse.

order for the two machines to have a common reference voltage.

- DATA 0 thru 3. These lines, which are controlled by the sender, carry the actual data being transferred, a nybble at a time (a nybble is half of a byte, or 4 bits).

- ASYM. This has already been discussed.

- DRCV, LNR, and HNR (data received, low-order nybble ready, and high-order nybble ready). These are the so-called "handshake" lines. LNR, which is a signal from the sender to the receiver, is brought low by the sender to indicate to the receiver that the low-order nybble of the byte being sent is now ready to be read off of the DATA lines. HNR, also a signal from the sender to the receiver, is brought low by the sender to indicate to the receiver that the high-order nybble of the byte being sent is now ready to be read off the DATA lines.

DRCV, which is a signal from the receiver to the sender, is brought low by the receiver once he has read the low-order nybble off of the DATA lines, to indicate to the sender that he is ready for the high-order nybble; DRCV is then brought high again by the receiver once he has

read the high-order nybble off of the DATA lines, to indicate to the sender that the high-order nybble has been received and that, as far as the receiver is concerned, the transaction is complete.

Figure 2 shows a timing diagram of the whole operation. Essentially, what happens is this:

The sender puts the low-order nybble on the DATA lines, and (by bringing LNR low) says, "Here is the low-order nybble." The receiver reads in the low-order nybble, and (by bringing DRCV low) says, "I've got it." The sender then puts the high-order nybble on the DATA lines, and (by bringing LNR high and HNR low) says, "Here is the high-order nybble." The receiver reads in the high-order nybble, combines it with the low-order one to make a complete byte, and (by bringing DRCV high again) says, "All set. Goodbye." The sender must then return all lines to the high state before returning to his caller.

All lines are left in the high state except when actually in use so that if one machine tries to send or receive while the other is off doing something else, the first machine will simply wait until the other is ready before proceeding

*"What You Don't Know
Won't Hurt You". Couldn't Be
Further From The Truth
When It Comes To Running Your
Own Business.*

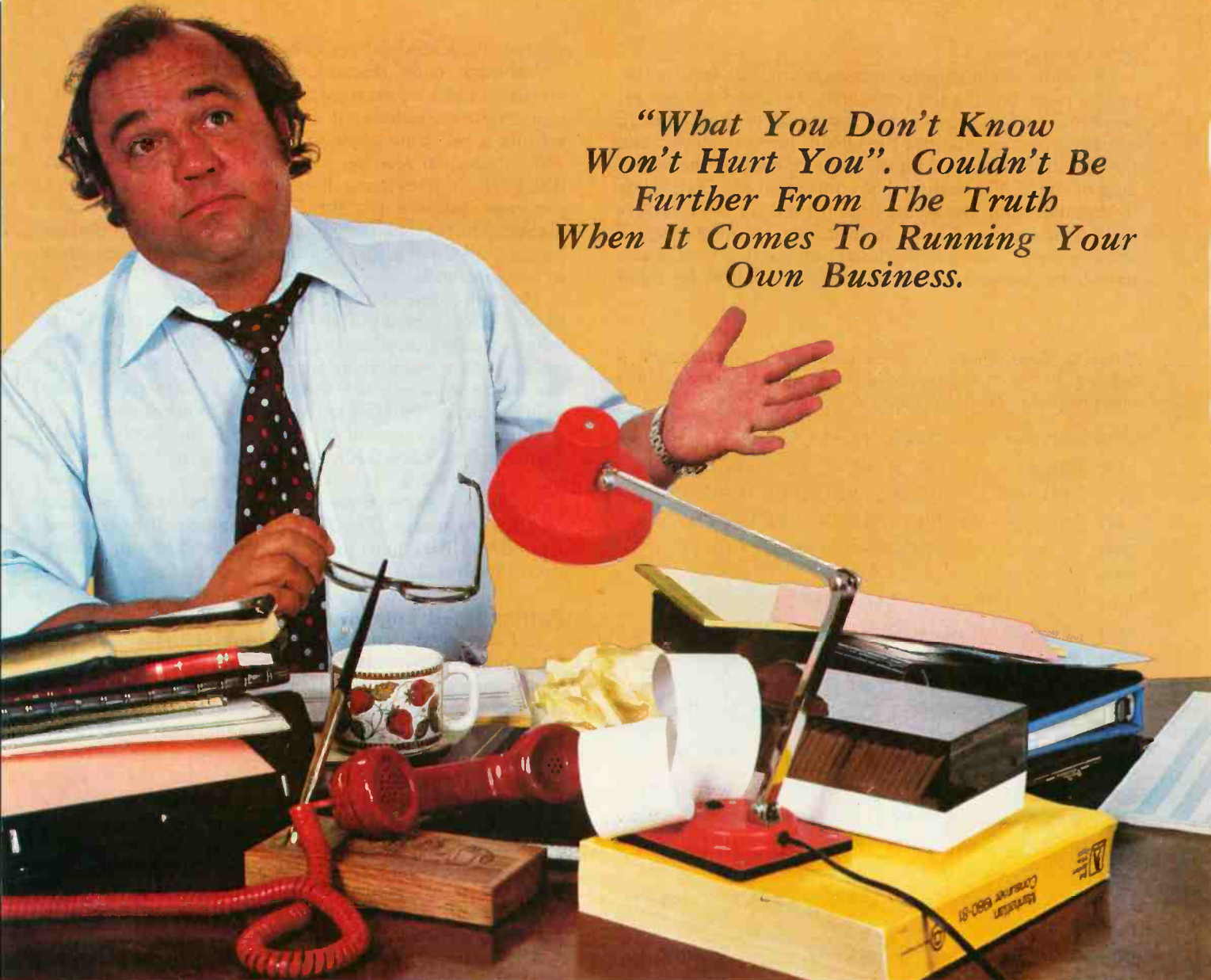

How far from the truth is the adage that says "What you don't know won't hurt you."

Systems II is designed to give you the advantage. Its updated methods and programming procedures will take you out of the "pencil pushing" age and into "today's technology".

The Reasons For Systems II

The number one reason is dependability.

At Applewest Inc. we have put the system through its paces. However no matter how much "in-house" testing is done the true test comes from the end user — like yourself. We listened to our customers and we learned.

Here Is What We Found Out

The small businessman wants big performance from his micro system, not micro performance. He wants complete documentation that is easy to use. He wants complete flexibility to grow into a

more advanced system. He wants the availability of additional programs so he won't be boxed in. Last, but not least, he wants support for any problems he may have.

Here Is How We Responded

To expand the performance of the already super Apple II, the KSAM (keyed sequential access method) was developed for fast access to any record on file, giving performance that even larger systems find hard to beat.

Our documentation is the most complete of any on the market. Our Operations Manual explains in depth the use of each module in the system, but we didn't stop there.

A Lesson Manual/User's Guide was developed taking the user through the system in a formatted, learning process.

SYSTEMS II is available on five and one quarter

diskettes, standard eight inch disk or a ten megabyte hard disk. Programs are continuously being developed to expand the usability of our system.

See your local dealer today. If he doesn't have SYSTEM II have him give us a call.

Systems II - Apple II - And You Moving Your Business Forward Faster.

2455 S.W. 4th Ave. Suite 2 Ontario, Oregon 97914
(503)889-8777



Applewest
Software Inc.

Apple II is a trademark of Apple Computers

with the transfer.

The only modifications necessary for this scheme (to handle ports lacking the previously discussed properties) would be: to have code at the beginning of the RECEIVE routine which configured the DRCV line for output and the remaining lines for input; to have code at the beginning of the SEND routine that configured the DRCV line for input and the remaining lines for output; and to have code at the ends of both routines for reconfiguring all lines as input. The port initialization routine would also have to be changed to initially configure all lines for input

Listing 2: Functionally the same as listing 1, this program is tailored for the PET computer and has several utility routines implemented in machine code.

```
100 REM*** PROGRAM TO TEST INTER-
110 REM*** MACHINE COMMUNICATIONS
120 REM*** USING MACHINE LANGUAGE
130 REM*** AND OTHER EFFICIENT
140 REM*** PROGRAMMING TECHNIQUES
150 REM***
200 GOSUB10000:SYS909
210 IFPEEK(59471)AND16THEN240
220 GETS$:S=0:IFLEN(S$)>0THENS=ASC(S$)
230 U=USR(S):IFS$="●"THEN999
240 R$=CHR$(USR(-1)):PRINTR$;
250 IFR$<>"●"THEN220
999 END
10000 REM*** THIS ROUTINE SETS UP THE
10010 REM*** FOLLOWING FACILITIES
10020 REM*** IN MACHINE LANGUAGE:
10030 REM***
10040 REM*** SYS909 ...INITS PORT
10050 REM***
10060 REM*** U=USR(+N) ...SENDS N
10070 REM***
10080 REM*** U=USR(-1) ...RECEIVES U
10090 REM***
10100 FORI=826TO917:READX:POKEI,X:NEXT
10110 POKE1,58:POKE2,3
10120 IFPEEK(50003)=0THENRETURN
10130 POKE827,154:POKE830,97:POKE834,98
10140 POKE869,109:POKE882,98:POKE903,98
10150 RETURN
11000 DATA 32,167,208,166,179,208,32
11010 DATA 165,180,72,9,240,41,191,141
11020 DATA 79,232,104,74,74,74,74,9
11030 DATA 208,44,79,232,48,251,141,79
11040 DATA 232,44,79,232,16,251,48,44
11050 DATA 32,103,3,76,120,210,44,79
11060 DATA 232,112,251,173,79,232,41,15
11070 DATA 133,180,169,127,141,79,232
11080 DATA 169,32,44,79,232,208,251,173
11090 DATA 79,232,10,10,10,10,5,180,168
11100 DATA 234,234,169,0,162,255,142,79
11110 DATA 232,142,67,232,96
```

so that the ASYM bit could be sensed properly.

Although code resembling that shown in listing 1 works, it executes excruciatingly slowly under most current implementations of BASIC. Anyone considering writing a real-time game using these routines would be well advised to rewrite, at a minimum, the SEND and RECEIVE routines in machine language. Listing 2 shows a program, tailored for the PET, which is functionally identical to the one in listing 1: the difference is that in listing 2 all three utility routines have been implemented in machine code.

The subroutine at 10000 now sets up the machine code in the PET's "tape-2 buffer"—the SYS to 909 in line 200 is what actually initializes the port. The USR function is invoked with a negative argument (as in line 240) to cause the machine to execute the RECEIVE software . . . the value returned by USR is that of the byte received.

When the argument to the USR function is non-negative (as in line 230), its value is turned over to the SEND software for transference to the other machine . . . under these conditions the value returned by USR is garbage. The ASYM bit must still be checked from BASIC to determine whether to send first or receive first. (See line 210.)

Putting It All Together

Just having the capability to transfer bytes back and forth between two machines does not guarantee success in writing multimachine games. We now need a general strategy for controlling the flow of information between the various machines in such a way that the moves made by each player are processed in a consistent manner by all machines involved. Among other things, the strategy used must ensure that all of the machines involved agree as to the order in which the various players' moves are to be processed. Only one such strategy, the key-oriented strategy, will be discussed here. Although many other approaches to the problem do exist, this one is particularly "clean" and therefore easily debugged; it is also reasonably efficient in both space and time.

The information transfers addressed by any general strategy of this kind fall into two groups: those that occur at initialization time and those that occur during the actual play of the game. The key-oriented strategy calls for all information pertinent to the initial state of the game, including information that may be kept secret from one or more players, to be made known to all machines at initialization time.

Then, during play, a continuous conversation is set up among the machines in which the only information changing hands consists of individual keystrokes generated by the players at their keyboards. If a player generates no keystroke to be sent on a given pass, a zero byte is sent out to the other machine(s) to indicate this fact. Every machine maintains the full status of every player but only displays the information its own player is supposed to see.

Listing 3 shows a program, Real-Time Two-Machine Hangman, designed to illustrate the use of the key-oriented strategy. To keep it short, such things as instructions, gruesome representations of gallows, and so on have been left out. The object of the game is not, as it is in normal Hangman, to guess your opponent's word within a set number of letter-guesses while he sits around telling you where your correct guesses fit in. Instead, both you and your opponent choose words that the other tries to

26 MEGABYTES

\$4995.

DRIVE A HARD BARGAIN!

Suddenly, S-100 microcomputer systems can easily handle 100 million bytes. Because Morrow Designs™ now offers the first 26 megabyte hard disk memory for S-100 systems—the DISCUS M26™ Hard Disk System.

It has 26 megabytes of useable memory (29 megabytes unformatted). And it's expandable to 104 megabytes.

The DISCUS M26™ system is delivered complete—a 26 megabyte hard disk drive, controller, cables and operating system—for just \$4995. Up to three additional drives can be added, \$4495 apiece.

The DISCUS M26™ system features the Shugart SA4008 Winchester-type sealed media hard disk drive, in a handsome metal cabinet with fan and power supply.

The single-board S-100 controller incorporates intelligence to supervise all data transfers, communicating with the CPU via three I/O ports (command, status, and data). The controller has the ability to generate interrupts at the completion of each command to increase system throughput. There is a 512 byte sector buffer on-board. And each sector can be individually write-protected for data base security.

The operating system furnished with DISCUS M26™ systems is the widely accepted CP/M* 2.0.

See the biggest, most cost-efficient memory ever introduced for S-100 systems, now at your local computer shop. If unavailable locally, write Morrow Designs™, 5221 Central Avenue, Richmond, CA 94804. Or call (415) 524-2101, weekdays 10-5 Pacific Time.

*CP/M is a trademark of Digital Research.

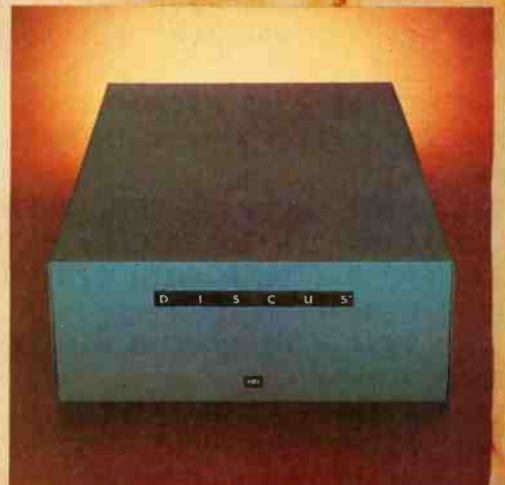
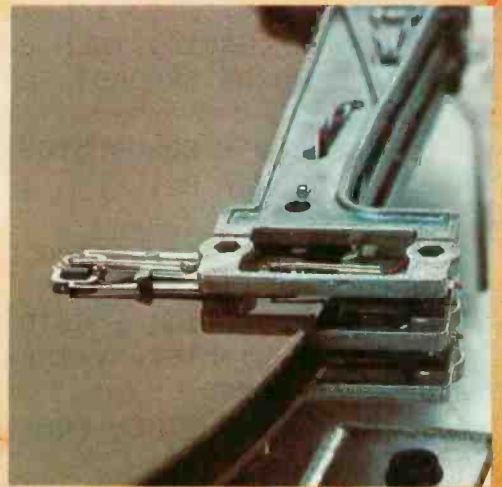

MORROW DESIGNS™
Thinker Toys™

guess—whoever guesses the other's word first wins.

The program as shown is, of course, only capable of running on a pair of PETs. However, with suitable alteration of the SEND/RECEIVE software, it should be possible to run it on any pair of common microcomputers

possessing the cabling arrangement described above.

Game Time

To play the *Hangman* game, attach the cable, type the program in, and RUN it on both machines. You and your

Listing 3: Real-time Two-Machine Hangman in which you attempt to guess your opponent's chosen word first.

```
10 REM*** REAL-TIME 2-MACHINE HANGMAN
20 REM***
30 REM*** W$... THE TARGET WORDS
40 REM*** F$... LETTERS FOUND SO FAR
50 REM*** T$... LETTERS TRIED SO FAR
60 REM***
90 DIM W$(2),F$(2),T$(2)
100 GOSUB 10000 : SYS 909
110 PRINT "WHAT IS YOUR WORD";
120 INPUT W$(1)
130 IF PEEK(59471) AND 16 THEN 190
140 LS=USR(-1) : U=USR(LEN(W$(1)))
150 IF LS<>LEN(W$(1)) THEN 210
160 GOSUB 5100 : GOSUB 5000
170 GOSUB 5200 : P=2 : GOTO 280
190 U=USR(LEN(W$(1))) : LS=USR(-1)
200 IF LS=LEN(W$(1)) THEN 230
210 PRINT "WORDS ARE NOT SAME LENGTH"
220 GOTO 110
230 GOSUB 5000 : GOSUB 5100
240 GOSUB 5200 : P=1
250 REM***
255 REM*** MAIN PROCESSING LOOP
260 REM***
270 M$=CHR$(USR(-1)) : GOTO 300
280 GET M$ : M$=MID$(M$+CHR$(0),1,1)
290 U=USR(ASC(M$))
300 IF M$=CHR$(0) THEN 500
310 FOR I=1 TO LS
320 IF M$<>MID$(W$(P),I,1) THEN 360
350 F$(P)=MID$(F$(P),1,I-1)+M$+MID$(F$(P),I+1,LS-I)
360 NEXT I : IF F$(P)=W$(P) THEN 1000
390 T$(P)=T$(P)+M$ : IF P=1 THEN 500
400 PRINT
410 PRINT "WORD SO FAR: ";F$(2)
420 PRINT "TRIED SO FAR: ";T$(2)
500 P=3-P : ON P GOTO 270,280
1000 REM***
1005 REM*** WE HAVE A WINNER
1010 REM***
1020 PRINT : IF P=1 THEN 1040
1030 PRINT "YOU WIN" : GOTO 1100
1040 PRINT "YOU LOSE"
1100 PRINT "THE MAGIC WORD WAS: ";W$(2)
1110 END

5000 REM*** ROUTINE TO SEND ENTIRE WORD
5005 REM*** TO OTHER MACHINE
5010 REM***
5020 FOR I=1 TO LS
5030 U=USR(ASC(MID$(W$(1),I,1)))
5040 NEXT I : RETURN
5100 REM***
5105 REM*** ROUTINE TO RECEIVE ENTIRE
5110 REM*** WORD FROM OTHER MACHINE
5115 REM***
5120 FOR I=1 TO LS
5130 W$(2)=W$(2)+CHR$(USR(-1))
5140 NEXT I : RETURN
5200 REM***
5205 REM*** ROUTINE TO INITIALIZE BOTH
5210 REM*** F$ ENTRIES TO ALL DASHES
5215 REM***
5220 FOR I=1 TO LS
5230 F$(1)=F$(1)+"-" : F$(2)=F$(2)+"-"
5240 NEXT I : RETURN
10000 REM*** THIS ROUTINE SETS UP THE
10010 REM*** FOLLOWING FACILITIES
10020 REM*** IN MACHINE LANGUAGE:
10030 REM***
10040 REM*** SYS909 ...INITS PORT
10050 REM***
10060 REM*** U=USR(+N) ...SENDS N
10070 REM***
10080 REM*** U=USR(-1) ...RECEIVES U
10090 REM***
10100 FORI=826TO917:READX:POKEI,X:NEXT
10110 POKE1,58:POKE2,3
10120 IFPEEK(50003)=0THENRETURN
10130 POKE827,154:POKE830,97:POKE834,98
10140 POKE869,109:POKE882,98:POKE903,98
10150 RETURN
11000 DATA 32,167,208,166,179,208,32
11010 DATA 165,180,72,9,240,41,191,141
11020 DATA 79,232,104,74,74,74,74,9
11030 DATA 208,44,79,232,48,251,141,79
11040 DATA 232,44,79,232,16,251,48,44
11050 DATA 32,103,3,76,120,210,44,79
11060 DATA 232,112,251,173,79,232,41,15
11070 DATA 133,180,169,127,141,79,232
11080 DATA 169,32,44,79,232,208,251,173
11090 DATA 79,232,10,10,10,10,5,180,168
11100 DATA 234,234,169,0,162,255,142,79
11110 DATA 232,142,67,232,96
```

In this age of runaway inflation...

Look what \$795* will buy



The HIPAD™ digitizer

Inexpensive input to your computer

The HIPAD™ digitizer can be used for both converting graphic information into digital values and as a menu. Utilizing either the stylus or the optional cursor, the operator can input graphic data into the computer by locating individual points on the digitizers 11" x 11" (28cm x 28cm) active area. In the "stream mode" a continuous of placements of coordinate pairs may be input.

Not a kit, the HIPAD™ comes complete with both RS-232C and parallel interfaces and has its own built-in power source. The origin is completely relocatable so coordinates may be positive or negative for a true reference value and oversized material may be input by simply resetting the origin.

Accurate positional information, free form sketches, even keyboard simulation

All can be entered using the multi-faceted HIPAD™ digitizer. Its capabilities and low price make the UL listed HIPAD™ a natural selection over keyboard entry, inaccurate joysticks, or expensive approximating light pens. It's perfect for inputting isometric drawings, schematics, X-rays, architectural drawings, business graphs, and many other forms of graphic information, as well as creating your own graphics.

Use it with Apple II™, TRS-80 Level II™, PET™ or other popular computers

The HIPAD's™ built-in RS-232C and parallel 8 bit interfaces make it all possible. (For Apple II order DT-11A, for TRS-80 or PET order DT-11). Furthermore, you get English or metric scaling, data format (Binary/BCD/ASCII), selectable baud rates, and resolution of either .005" or .01".

For complete information contact Houston Instrument, One Houston Square, Austin, Texas 78753. (512)837-2820. For rush literature requests, outside Texas call toll free 1-800-531-5205. For technical information ask for operator #5. In Europe contact Houston Instrument, Rochesterlaan 6, 8240 Gistel, Belgium. Telephone 059/27-74-45.



The ideal input device for the small system user.

MODEL	LIST	MODEL	LIST	MODEL	LIST
HI111-A	\$65.00	HI112-A	\$75.00	HI113-A	\$85.00
HI111-B	\$68.00	HI112-B	\$78.00	HI113-B	\$88.00
HI111-C	\$68.00	HI112-C	\$78.00	HI113-C	\$88.00
HI111-D	\$68.00	HI112-D	\$78.00	HI113-D	\$88.00
HI111-E	\$68.00	HI112-E	\$78.00	HI113-E	\$88.00
HI111-F	\$68.00	HI112-F	\$78.00	HI113-F	\$88.00
HI111-G	\$68.00	HI112-G	\$78.00	HI113-G	\$88.00
HI111-H	\$68.00	HI112-H	\$78.00	HI113-H	\$88.00
HI111-I	\$68.00	HI112-I	\$78.00	HI113-I	\$88.00
HI111-J	\$68.00	HI112-J	\$78.00	HI113-J	\$88.00
HI111-K	\$68.00	HI112-K	\$78.00	HI113-K	\$88.00
HI111-L	\$68.00	HI112-L	\$78.00	HI113-L	\$88.00
HI111-M	\$68.00	HI112-M	\$78.00	HI113-M	\$88.00
HI111-N	\$68.00	HI112-N	\$78.00	HI113-N	\$88.00
HI111-O	\$68.00	HI112-O	\$78.00	HI113-O	\$88.00
HI111-P	\$68.00	HI112-P	\$78.00	HI113-P	\$88.00
HI111-Q	\$68.00	HI112-Q	\$78.00	HI113-Q	\$88.00
HI111-R	\$68.00	HI112-R	\$78.00	HI113-R	\$88.00
HI111-S	\$68.00	HI112-S	\$78.00	HI113-S	\$88.00
HI111-T	\$68.00	HI112-T	\$78.00	HI113-T	\$88.00
HI111-U	\$68.00	HI112-U	\$78.00	HI113-U	\$88.00
HI111-V	\$68.00	HI112-V	\$78.00	HI113-V	\$88.00
HI111-W	\$68.00	HI112-W	\$78.00	HI113-W	\$88.00
HI111-X	\$68.00	HI112-X	\$78.00	HI113-X	\$88.00
HI111-Y	\$68.00	HI112-Y	\$78.00	HI113-Y	\$88.00
HI111-Z	\$68.00	HI112-Z	\$78.00	HI113-Z	\$88.00

Available with stylus or optional cursor.



Available with optional display.

*U.S. Suggested retail price

TM HIPAD is a trademark of Houston Instrument
 TRS-80 is a trademark of Tandy Corporation
 APPLE is a trademark of Apple Computer Inc.
 PET is a trademark of Commodore Business Machines, Inc.

Circle 24 for literature
 Circle 25 to have representative call

houston instrument

GRAPHICS DIVISION OF

BAUSCH & LOMB



opponent will each be asked to enter a word—if the words entered are of different lengths, the program prints an error message and reprompts both players for new words. Once the program has accepted the two words, any key you strike is taken to be a letter-guess directed at your opponent's word.

Each time you hit a key, your machine displays the results of your guess—that is, your target word so far, with dashes in the positions corresponding to letters not yet guessed, and a tabulation of the letters you have tried so far. The program automatically detects when one player has guessed every letter in his opponent's word, and declares the winner accordingly.

The initialization phase of listing 3 encompasses lines 10 thru 240 and all of the subroutines appearing from line 5000 on up. During this phase, the program POKes the machine-language software into place, initializes the port to the other machine, and then (in line 110) prompts its own player for input and reads the reply into W\$(1).

Then, using the ASYM bit as usual to determine whether to send first or receive first, it essentially exchanges word lengths with the other machine and checks to make sure that the two word lengths are equal. Once satisfied that they are, the program proceeds to exchange words with the other machine (using the subroutines at 5000 and 5100), placing the other player's word into W\$(2). Both machines now know both players' words. Each machine has its own player's word in its own copy of W\$(1) and the opposing player's word in its own copy of W\$(2).

The Play Phase

At this point, the program is ready to enter the play phase, but first it must set the initial value of the *player select* variable P to either 1 or 2, depending on the setting of the ASYM bit. The reason for this is that the section of code from line 300 to line 500 is used to process proposed letters, or moves originating from *both* players—this is the essence of the key-oriented strategy. The variable P, which flips back and forth during play between 1 and 2 via the statement "P=3-P" in line 500, is used on each pass to determine whether to attempt to get a keystroke from one's own keyboard (which is what the GET statement in line 280 does) or to receive from the other machine the result of its attempt to get a keystroke from its own keyboard (which is what the assignment in line 270 does).

The value of P is also used in the main processing loop as the index into each of the two-element arrays W\$, F\$, and T\$, to ensure that the proper player's status is updated as a result of the processing of the keystroke. The net implication is that P must be initialized to 1 on one machine and to 2 on the other so that the play phase will begin correctly.

During the play phase, then, the program simply circulates in the main processing loop shown, alternating the value of P back and forth between 1 and 2 on each pass. When P is 2, the machine's own keyboard is interrogated, the resulting keystroke (or a zero if the resulting keystroke was null) is sent off to the other machine, and the keystroke is processed by examining W\$(2) for occurrences of it. F\$(2) and T\$(2) are updated accordingly and, in lines 410 and 420, are printed out.

When P is 1, the keystroke to be processed comes from the other machine (in order for this to happen the other machine's copy of P will at this point be equal to 2). The keystroke is processed by examining W\$(1) for occurrences of it, and F\$(1) and T\$(1) are updated but not printed out, since they are of interest only to the player on the other machine.

Checking for the end-of-game is thus very simple: as soon as F\$(P) becomes equal to W\$(P), the game is over, and the value of P for which this was the case can be used (as it is in line 1020) to determine who won.

This is how a typical real-time two-machine game involving incomplete information is implemented. Other good candidates for implementation in this manner would be *Star Trek*, *Kriegspiel* (a version of chess in which neither player is ever entirely sure just where his opponent's pieces are located), and *Stratego*. You can easily design entirely new Adventure games, a submarine battle for example, using the basic approaches given here. The possibilities are certainly more exciting and creative than playing *Battleship* with pencil and graph paper. ■

MARK GORDON COMPUTERS

DIVISION OF MARK GORDON ASSOCIATES, INC.

P.O. BOX 77, CHARLESTOWN, MASSACHUSETTS 02129
(617) 491-7505

SD SYSTEMS COMPUTER KITS

- ★ EXPANDORAM I (No RAMS) 169.00
- ★ VERSAFLOPPY CONTROLLER I . . 189.00
- ★ SBC-100 Single Board Kit 239.00
- ★ Z80 Starter 269.00

OTHER SPECIALS

- ★ 16K Memory Kit 49.00
- ★ CAT Modem 151.00
- ★ Leedex Monitor 109.00
- ★ 16K Model III TRS-80 859.00*
- ★ Atari 800 779.00
- ★ Hazeltine 1410 699.00

To Order Call Toll-Free 1-800-343-5206

*TRS-80 is a Trademark of Tandy Corp.

ORDERING INFORMATION

We accept Visa and Mastercharge. We will ship C.O.D. certified check or money order only. Massachusetts residents add 5 percent sales tax.

The Company cannot be liable for pictorial or typographical inaccuracies.

Need help? Call us. Want to help?

Call us.



Red Cross is
counting on you.



Give Your Computer the Best

The Microline 80

You can't find a better small printer. The Microline 80 will outperform and outlast every competitor. It will run all day at 80 cps with no duty cycle limitations, producing letter perfect printing on plain paper. And the head is warranted for 200,000,000 characters.

You can't find a better value either. The Microline 80 includes upper and lower case characters, double width and condensed printing, friction and pin feed, six and eight line per inch spacing and block graphics for charts, graphs and diagrams. And it operates with TRS-80™, Apple® and other popular small computers. The only extras are snap-on tractor and a buffered RS232 interface. Give your computer the best, the Microline 80.

TRS-80 is a registered trademark of Radio Shack, a division of Tandy Corp.

OKIDATA

Okidata Corporation
111 Gaither Drive
Mount Laurel, New Jersey 08054
609-235-2600

TOGETHER...A New Beginning

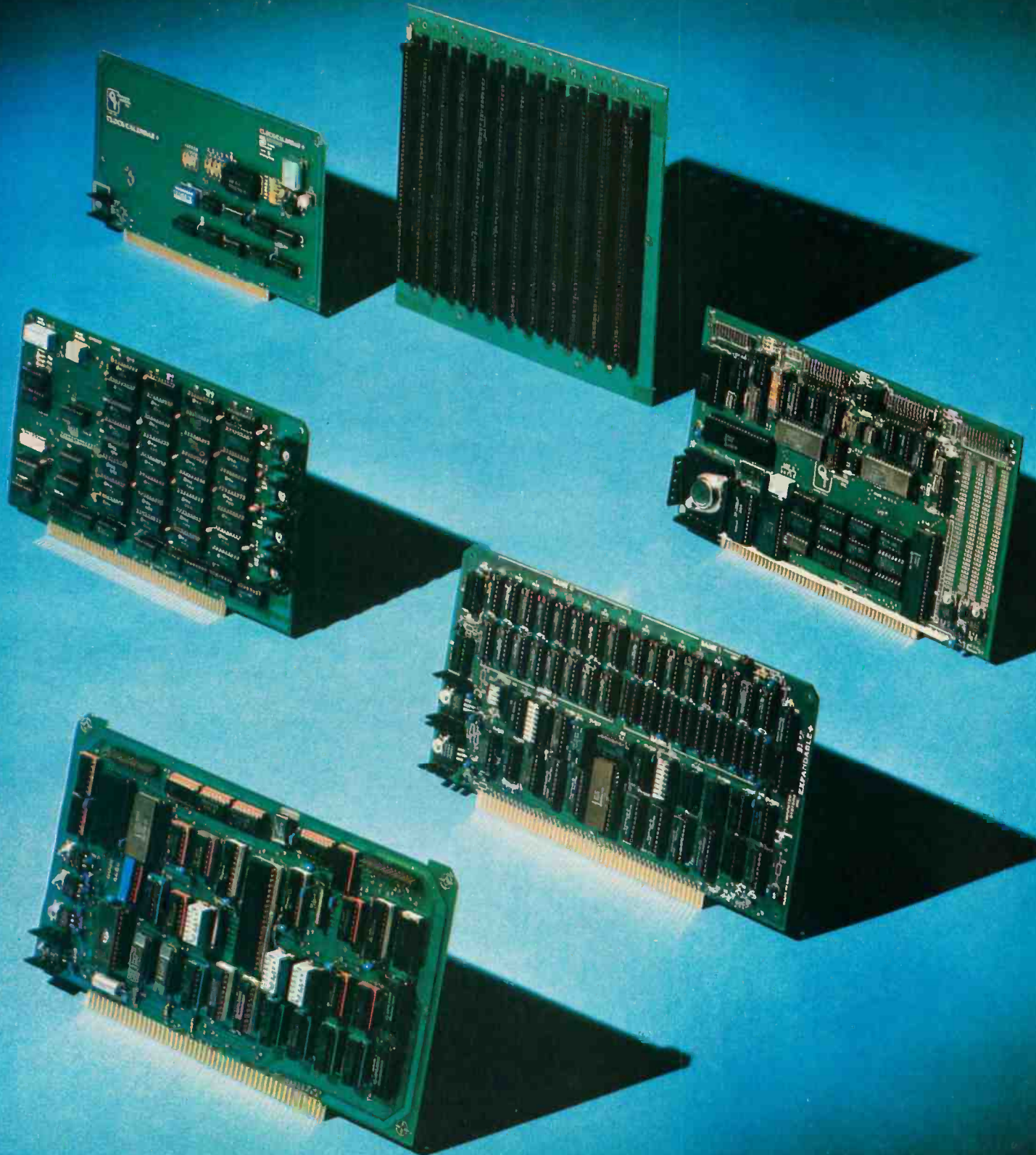

nning!

Manufacturing and marketing micro products is our only business.

QT is committed to building uncommon features and quality into each of its micro user products. We're offering you the lowest prices on the QT System+ and other fine products. It's our new beginning.

Open Accounts: Minimum order \$25.00. We gladly accept purchase orders from government agencies, educational institutions and firms with a favorable D & B rating. All prices are FOB Lawndale, California.

■ **Look At These QT System + Features:**
 2 Megabyte storage (standard)
 • Up to 16 Megabytes storage available • Mainframe with power supply and fan • Televideo 920C terminal • CPU-Z80-4MHZ • Two 8" disk drives • Floppy disk controller (double density) • Dynamic Memory (48K—expandable to 64K) • 2K Monitor program and Disk Bios on 2716 EPROM • RAM/ROM/PROM, up to 8K in any combination on CPU • Hard Disk Compatible • 2 Serial/2 Parallel Ports • Real Time Clock • EPROM Programmer • CP/M® 2.2 or 1.4 Operating System • MP/M® Compatible • Full line of business software available.

SYSTEM + SS (1 Megabyte)
 Sgl Side/DbI Den \$4295.00,
SYSTEM + DS (2 Megabytes)
 DbI Side/DbI Den \$4995.00



■ **Silence + Mother Boards**
 No need for termination • Very high crosstalk rejection • 6, 8, 12 and 18 slots available • Has operated to 14 MHz quietly.

Bare Bd.	6-Slot	8-Slot	12-Slot	18-Slot
	\$24.95	\$26.95	\$29.95	\$49.95
Kit	\$39.95	\$54.95	\$69.95	\$99.95
A&T	\$49.95	\$69.95	\$89.95	\$139.95

■ **SBC + 2/4**
 1K RAM On Board • 2 Programmable Timers • Power On Jump to On-Board 1K or 2K EPROM (2708-2716) • 2 Separate Parallel Ports • Programmable Baud Rate Selection (110 to 9600) • Serial I/O Port (RS-232).

Bare Board	\$60.00	Kit	\$190.00
1K Mem. Kit	\$12.00	A&T	\$280.00

■ **Expandable + Dynamic Memory (16K to 64K)**
 Uses 3242 Refresh Chip with delay line • Quiet four layer PC Bd • Supports 16K, 32K, 48K or 64K of memory • 24 Address lines per IEEE specifications • Bank on/off signal selected by I/O port 40 (Hex) per industry standard.

Bare Board	\$70.00	48K Kit	\$480.00
16K Kit	\$280.00	48K A&T	\$550.00
16K A&T	\$325.00	64K Kit	\$525.00
32K Kit	\$360.00	64K A&T	\$625.00
32K A&T	\$425.00		

■ **I/O +**
 Two Independent SYNC/ASYN Serial Ports • One Strobed 8-Bit Parallel Input Port With Handshaking • Three 8-Bit Parallel Ports (Undedicated, User Configured) • Three Independent 16-Bit Timers • 8 Level Priority Interrupt Controller.

Bare Board	\$69.00	A&T	\$375.00
Kit	\$275.00		

■ **RAM + 65**
 2 or 4MHZ • 16K Static RAM • Uses 2114L static RAMS • Addressable in 4K steps • Memory protection in 1K increments • Features bank selection.

	2MHZ	4MHZ	
Bare Board	\$20.00	Kit	\$225.00
Kit	\$200.00	A&T	\$250.00
A&T	\$240.00		

■ **Clock/Calendar +**
 Day, Week, Month, Year • 24 Hour Time, or 12 Hour AM PM (selectable) • Interval Interrupt Timer: 1024 Hz (approximately 1 millisecond), 1 Sec, 1 Min, 1 Hour • On Board Battery Backup • Available for Apple & TRS-80.

Bare Board	\$45.00	A&T	\$150.00
Kit	\$100.00		

■ **Mainframe + MF +**
 • Cabinet • 30A Pwr Supply • 12 or 18 Slot Motherboard • Fan-cooled • AC Line Filter to eliminate EMI • A&T • Power and Reset Switches on front panel.

MF + 12	\$450.00
MF + 18	\$500.00
MF + W/O Motherbrd	\$400.00

■ **Mainframe + MF + MD**
 Accepts 2 Each 5 1/4" Disk Drives • 18A Pwr Supply • 6-12 Slot Motherboard • Dual-mini-disk provision • Disk Drive Power Supply • AC line filter to eliminate EMI • Power and reset switches on front panel.

MF + MD12	\$500.00
MF + MD6	\$450.00
MF + MD W/O Motherbrd	\$400.00

■ **DDC-8 +**
 Available in Brown or TRS 80 Colors • Disk Cabinet for Single 8" Drive • Data Cable • Fan • Accepts Persci, Shugart, Siemens, Remex, QUME.
 DDC-8 + \$250.00

Also Available: S-100 (Smart) Proto Board +. Ask for our catalog.

WARRANTY: 1 year against defects in material and workmanship from date of shipment on all OT products.

Apple is a trademark of Apple Computer, Inc. CP/M™ and MP/M™ are trademarks of Digital Research. TRS-80 is a trademark of Radio Shack.



15620 South Inglewood Avenue
 Lawndale, CA 90260
 (213) 970-0952
 Call TOLL FREE: 800-421-5150
 (Except Alaska, California and Hawaii)



Computerized Testing

Steve Ciarcia
POB 582
Glastonbury CT 06033

Suppose for a moment that you are a custom-electronics manufacturer. You have accepted a job to produce 1000 sequential-controller boards for a major photocopier manufacturer. (It is not unusual for large companies to farm out control subassemblies.) For all practical purposes, the controller board is a microcomputer that has various output combinations in response to designated inputs. As a subassembly manufacturer, you have the responsibility for testing the controller boards as well as building them.

The controller board in question has ten inputs and ten outputs. When a particular input signal is received (perhaps from the copy button), the controller activates one or more outputs, waits a preset time limit, and then changes the output. Depending upon the input-signal combination, the sequence may have one to five steps. The timing intervals can also vary within each sequence.

Without going into too much detail, it is easy to see that what we are discussing could prove to be a nightmare to test. It could conceivably be done manually in perhaps 2 or 3 hours with a maze of switches, indicators, and wires. With 1000 of them to build, it would take the services of two workers, and only six units could be shipped a day. (If you are lucky, you won't have to deliver 1000 controllers in 3 months.)

If you have any business sense at all, you know that such a situation is worth avoiding. (Customers have a

The general industry practice of estimating software cost results in a cost of \$20 to \$40 per line of finished code.

habit of changing schedules just when the only technician who knows the test procedure goes on vacation.) The obvious solution is automatic testing, or more explicitly, computerized testing.

Automated Testing by Computer

Automated testing is an activity where a machine simultaneously activates and monitors signals according to a prescribed test plan. While it is not a necessity, most automatic testers incorporate microcomputers because of the cost advantages and flexibility they impart to the tester. Microcomputers replace bulky relays and hardwired logic in older designs. The latest economically priced units are in fact nothing more than a basic computer with some specialized front-end interfacing.

In many applications, it is cheaper to configure your own test system and program it for a specific application rather than buy a "board tester." In our photocopy-board example, the hardware for ten input and ten output bits is relatively inexpensive. The application program to do the testing re-

quires some thought, however.

There are two ways to write software for automatic test and controller applications. One is to use assembly language, and the other is to use a high-level language such as BASIC, tiny-c, or FORTH.

Companies that manufacture electronic devices in 1000-quantity are quite concerned about memory size and costs. High-level languages take considerably more memory space for a given application than straight assembly code. Every extra 1 K bytes costs \$10. This results in \$10,000 difference for each 1 K increment on 1000 photocopier controllers. In high-volume applications where cost is the most important factor, assembly language is used to save space.

As a custom-electronics manufacturer, you have similar decisions to make concerning computer hardware. You must design an automated device to efficiently test the photocopier controller. Unfortunately, you are building only one unit and will not have the large production volume over which to amortize the software-development costs. Your only choice is to risk becoming uncompetitive by raising the price of assembling each controller board. Therefore, it is in your best interests to keep these testing costs low.

High-Level Languages in Control Applications

The cost for developing a program is much higher than you probably thought. (Many business profes-

Make your micro

MIGHTY!



Get the most out of your microcomputer with Graham-Dorian Business software.

At any given time, your hardware is only as useful as the software you insert in it.

So it pays to rely on Graham-Dorian, the software that gets your micro performing to its fullest — almost like a mini.

Graham-Dorian, the industry leader, offers highly detailed and well-documented programs. All pretested on the job. Each so comprehensive that it takes little time to learn to run a program — even for someone who's never operated a computer before.

Programs are compatible with most major computers using CP/M disk operating systems, and come in standard 8" or on various mini-floppy disks. Each package contains the software program in INT and BAS file form plus a user's manual and hard copy source listing. Graham-Dorian stands behind dealers with technical advice.

Yes, there's a world of difference in business software. Graham-Dorian has more per-package capabilities and more packages. (With new ones added every few months.)

The Graham-Dorian line now includes these packages:

- Medical
- Dental
- Surveying
- Inventory
- Payroll
- Apartment Management
- Construction Job Costing
- Accounts Receivable
- Accounts Payable
- General Ledger
- Cash Register
- CBASIC-2

Ask your dealer for a demonstration soon.



**Graham-Dorian
Software Systems, Inc.**

211 North Broadway / Wichita, KS 67202 / (316) 265-8633

sionals discover this only after buying computers.) The general industry practice of estimating software is to charge at the rate of one line of code per hour regardless of the language used. This results in a cost of \$20 to \$40 per line. You may write ten lines of code in the first hour, but with all the documentation, debugging, and testing involved, one per hour is realistic by the time the application is thoroughly finished.

For a high-level language such as BASIC, the average line-for-line coding-time comparison is about 10

to 1 over assembly language. As much can be accomplished with a single IF . . . THEN . . . ELSE statement as ten or fifteen assembly-language instructions. For limited production items, or one-of-a-kind applications, where one line of high-level code costs no more than one line of assembly code, it is more reasonable to consider the former.

The major limitation of high-level languages such as BASIC is that they are interpretive and slow (2 to 5 ms per line). They require a fixed block of code (2 K bytes for a tiny BASIC to

24 K bytes for a fully extended disk version) to interpret and execute any amount of program statements in addition to the memory containing the user program. The size of the interpreter depends upon the sophistication of the instruction repertoire.

"Slow" is a relative term. If you need to activate a signal only 10 times a second, then there is no conflict. Doing something 500 times a second is more involved. As the interpreter code is reduced in size and complexity, the processing speed is increased. In its bare-bones state, a tiny BASIC has only integer arithmetic, no alphanumeric string-handling capability, limited array-handling capability, and limited math functions. But it is fast by comparison to fully extended high-level languages. If full processor speed is required in some portions of the application, one or more special assembly-language subroutines can be called and executed from the high-level language program, which takes over again at the conclusion of the assembly-language subroutine.

An Actual Automatic Tester Application

In "I/O Expansion for the TRS-80," Parts 1 and 2 (Ciarcia's Circuit Cellar in the May and June 1980 BYTE, pages 22 and 42, respectively), I presented an article on the design of a serial/parallel I/O (input/output) interface for the TRS-80 called the COMM-80. (A block diagram of the interface is shown in figure 1.) I have received an influx of reader inquiries concerning component sources and terminal software. This leads me to believe many people are building the interface.

This assumption, as well as a need to have a good diagnostic program for any computer peripheral in production, prompted me to design the hardware and software necessary to automatically test a COMM-80. In addition to providing anyone who has constructed the interface with a useful test program, the resulting effort fully demonstrates use of a high-level language in a test/control application.

Reviewing quickly, the COMM-80 is an interface designed specifically for the TRS-80 (it can be attached to any 8-bit computer with a bidirec-

Text continued on page 50

NEW OPEN FRAMES AND SWITCHERS...

at our same old low prices!



More new open frames to choose from - plus new special-purpose models for specific applications such as Microprocessor and Floppy-Disk systems. Also, Power-One now offers a growing line of switching D.C. Power supplies with the same high quality and reliability as our open frame models.

FREE!

New 1980-81 Product Catalog... plus our new Tour Guide.

Phone or write for your copies today!



1 POWER-ONE D.C. POWER SUPPLIES

Power-One, Inc. • Power One Drive • Camarillo, California 93010
Phone: (805) 484-2806 • (805) 987-3891 • TWX: 910-336-1297

When It Comes To Add-on Memory...

LOBO Has It All.

LOBO DRIVES manufactures a full line of S-100 computer compatible disk drives. All drives are software compatible with most S-100 disk operating systems and applications software programs. Only LOBO DRIVES offers you the variety and choice of floppy and fixed disk drives. Choose from 5¼ and 8-inch floppies, 5¼ and 8-inch Winchester technology fixed disk drives, and several Floppy/Fixed disk combinations. Each LOBO DRIVES system is thoroughly tested and burned-in and has the famous LOBO DRIVES One Year, 100% Parts/Labor Warranty.



MODEL 400 5¼-INCH FLOPPY DISK MEMORY SYSTEM

A high-speed (298) Msec Access), high-reliability (8000 hrs MTBF), low-cost floppy disk memory system. It is available in both soft and hard sector formats, and a choice of single or double density configurations.

- Up to 220 KBytes Capacity
- Single/Double Density
- Soft Sector Format
- Complete Software Compatibility

MODEL 800/850 DUAL FLOPPY DISK DRIVE MEMORY SYSTEM

LOBO DRIVES offers you a choice of single-sided, single or double density (Model 800) or double-sided, single or double density (Model 850) dual 8-inch memory subsystems. Each system comes complete with chassis and power supply, cables, controller and interface.

- Compatible with Most S-100 DOS Systems
- Up to 3.2 MByte Capacity

MODEL 1850 DUAL FLOPPY/FIXED DISK MEMORY SYSTEM

No more worries about back-up. LOBO DRIVES has combined the latest state-of-the-art Winchester technology with the proven reliability and dependability of its Model 850 8-inch floppy disk drive to bring you the ultimate in memory expansion for your S-100 computer. The Model 1850 is the ideal memory system for small business and word processing applications.

- 5 or 10 MByte Fixed Disk Capacity
- 1.6 MByte Floppy Disk Capacity
- Software Compatibility
- Sealed Environment
- Winchester Reliability
- 70 Msec Average Access Time

MODEL 950 DUAL FLOPPY/FIXED DISK MEMORY SYSTEM

All the advantages of Winchester technology fixed disk memory: large capacity (6.38 MBytes), high speed (170 Msec avg. access time), and extended reliability, combined with the convenience of a built-in floppy disk back-up in one cabinet. Only LOBO can bring you the storage capacity of 16 mini-floppies at a fraction of the price.

- The Storage Capacity of 16 Mini-Floppies
- Built-in Back-up
- 170 Msec Access (Avg)
- Software Compatibility

See your nearest dealer, call, or write for the complete LOBO DRIVES story... find out just how competitively priced a quality drive can be.



935 Camino Del Sur
Goleta, California 93017
(805) 685-4546
Telex: 658 482

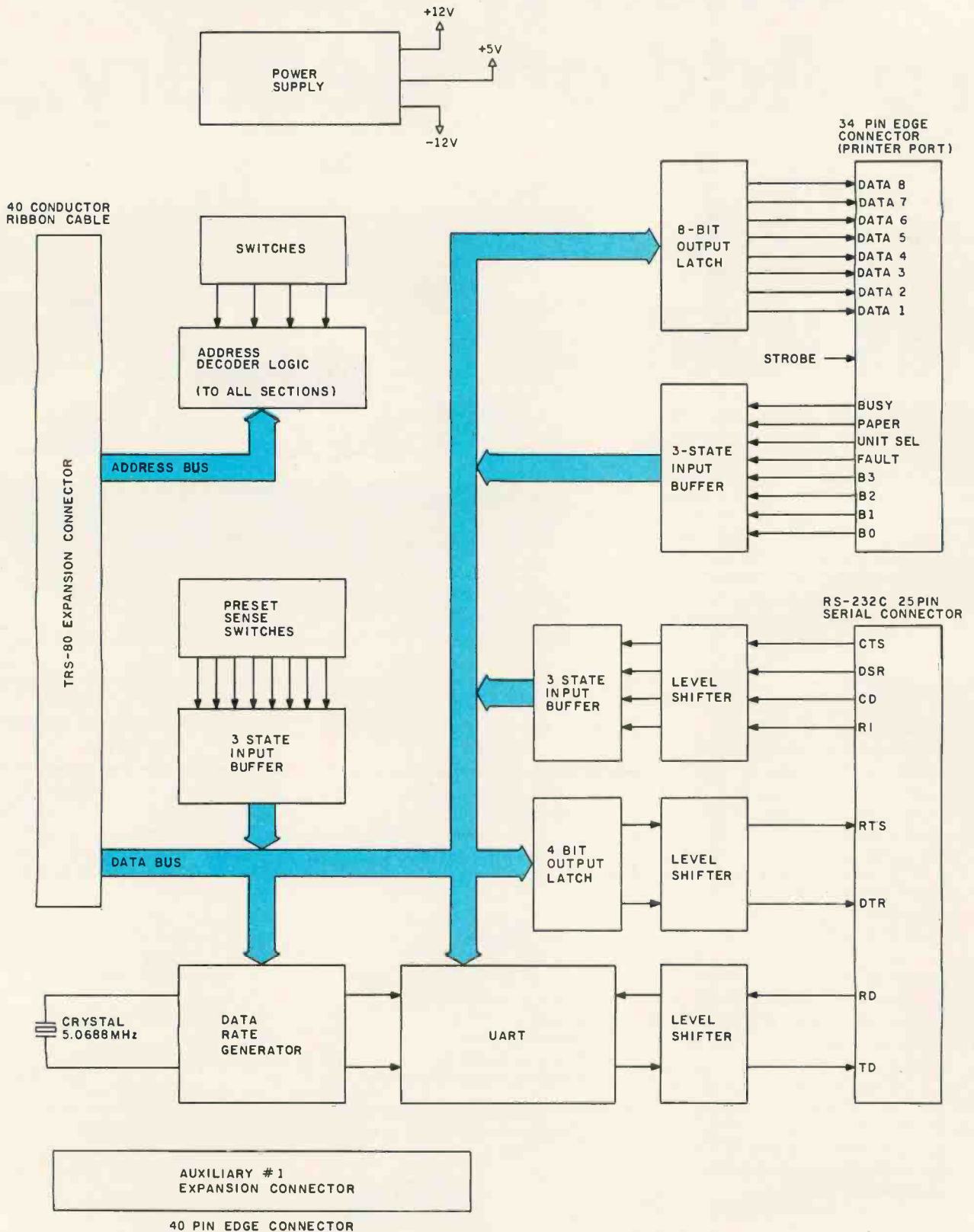
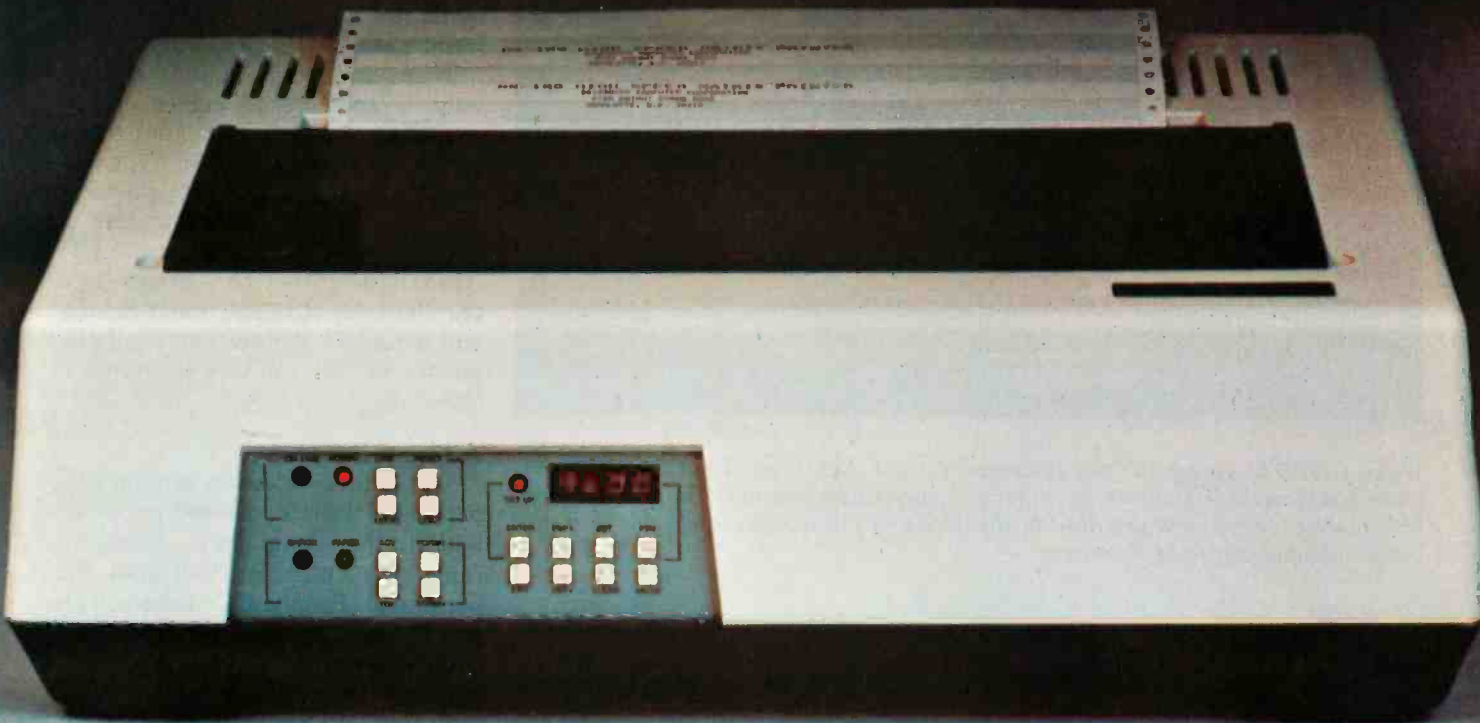

Figure 1: Block diagram of the COMM-80 I/O interface showing the interrelationship of the signals.

datasouth announces... **THE TOTAL PRINTER PACKAGE!**



With so many matrix printers on the market today, it may seem tough to find exactly the right one for your application. Some models may offer the speed you need, others the communications flexibility and still others the forms handling capability. But no printer offers all the features you need...until now.

The DS180 matrix printer provides the total package of performance features and reliability required for applications such as CRT slave copy, remote terminal networks and small to mid-range systems. Not a "hobby-grade" printer, the DS180 is a real work-horse designed to handle your most demanding printer requirements. And pricing on the DS180 is hundreds of dollars below competitive units.

High Speed Printing—Bidirectional, logic-seeking printing at 180 cps offers throughput of over 200 lpm on average text. A 9-wire printhead life-tested at 650 million characters generates a 9x7 matrix with true lower case descenders and underlining.

Non-volatile Format Retention—a unique programming keypad featuring a non-volatile memory allows the user to configure the DS180 for virtually any application. Top of form, horizontal and vertical tabs, perforation skipover, communications parameters

and many other features may be programmed and stored from the keypad. When your system is powered down, the format is retained in memory. The DS180 even remembers the line where you stopped printing. There is no need to reset the top of form, margins, baud rate, etc...it's all stored in the memory. If you need to reconfigure for another application, simply load a new format into the memory.

Communications Versatility—The DS180 offers three interfaces including RS232, current loop and 8-bit parallel. Baud rates from 110-9600 may be selected. A 1K buffer and X-on, X-off handshaking ensure optimum throughput.

Forms Handling Flexibility—Adjustable tractors accommodate forms from 3"-15". The adjustable head can print 6-part forms crisply and clearly making the DS180 ideal for printing multipart invoices and shipping documents. Forms can be fed from the front or the bottom.

If you would like more information on how the DS180's low-cost total printer package can fill your application, give us a call at Datasouth. The DS180 is available for 30-day delivery from our sales/service distributors throughout the U.S.

datasouth
computer corporation

Text continued from page 46:

tional data bus). It contains a software-programmable serial port and an 8-bit parallel I/O printer port. It has variable-address selection and full RS-232C handshaking capability. The variety of options makes for a

lengthy test when done manually.

The Test Sequence

As I previously mentioned, most automatic testers consist of a microcomputer and some front-end interfacing hardware. In this applica-

tion, I chose to use the TRS-80 as the test computer for obvious reasons, but the software is written so that it can be executed on most similar BASICs. The front-end equipment, consisting of a serial and parallel port, is coincidentally another COMM-80 that is set at an address different (hexadecimal 37F8) from the test unit. When the test unit is exercised, the computer reads the results through the second (master) unit. The entire computer configuration is shown in photo 1. The second unit is required only to provide the automatic test computer with the proper serial/parallel I/O capability.

There are four major tests involved, and special cables are required to attach the test unit to the master unit (see photo 2). When attached, they appear as in photo 3. The sequence of tests includes in order: address decoding, TTL (transistor-transistor logic)-level parallel I/O, RS-232C handshaking, and serial I/O. A flowchart for the sequence of test routines is shown in figure 2.

Address Decoding

The address-selection section of a peripheral device determines where within the computer's addressing range the computer will find this peripheral. For the COMM-80, there are sixteen locations between hexadecimal locations 3708 and 37F8 to which it can be set. To be compatible with standard Radio Shack software, the setting should be 37E8. Generally speaking, the failure in address decoders is usually the *switch* and not the *logic*. It is not enough to set the unit for address 37E8 and presume that, if it works, the rest of the addresses will. All sixteen addresses need not be checked, but each one of the 4 selectable address bits should be cycled. My preference is to check six combinations: all on, all off, and one on at a time. The only way to determine if they work is to successfully accomplish I/O communication at each address.

Figure 3b is a diagram of a circuit that facilitates this test. It is a simple one-quarter-second beeper that is activated by the 1 μ s printer output-strobe pulse. Only the address-decoder circuitry and the 74121 (IC16) strobe-pulse generator on the COMM-80 board are involved. If a test unit is set for an address of 37E8,



Photo 1: TRS-80 system and test equipment for the COMM-80. The COMM-80 unit under test is on the left with the cover removed and cables attached. The programming techniques employed and described in the testing of this unit are applicable to many other computer-control applications.

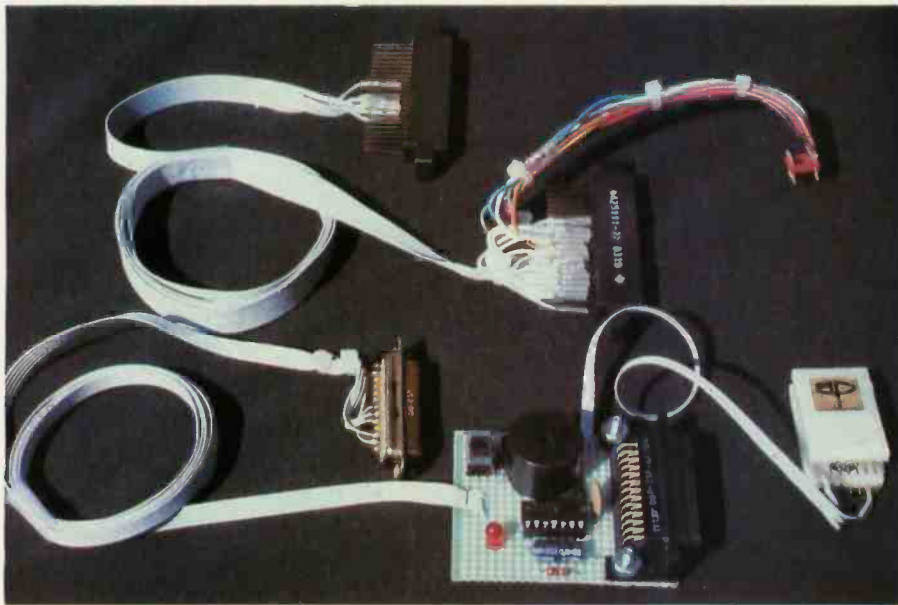
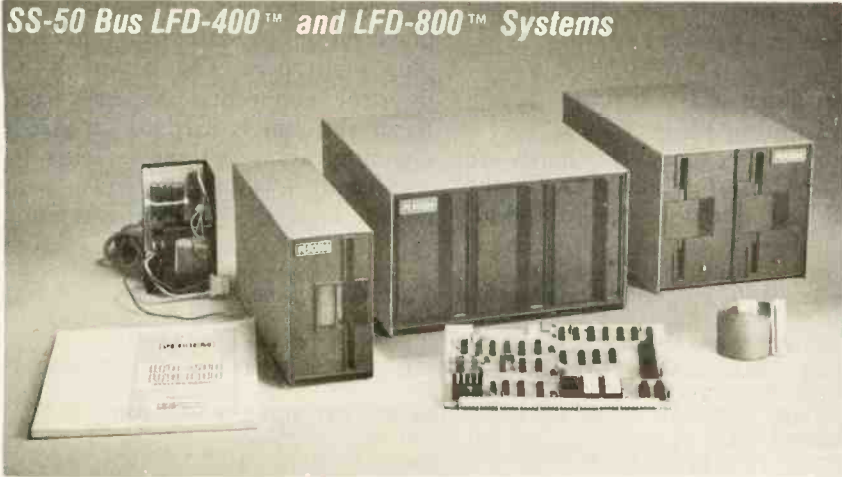

Photo 2: Test cables required to run diagnostics on a COMM-80 serial/parallel I/O interface. The cable on the top (from figure 3) connects the test-unit printer port to the master-unit printer port. The 8-bit parallel output is also wired to a sixteen-pin dual-inline plug header to test the programming-plug input.

The cable on the bottom (from figure 6) connects the test unit RS-232C signals to the master unit's RS-232C port. The prototyping board contains a beeper that is triggered when the computer outputs data through the test-unit printer port.

A Few Extraordinary Products for Your 6800/6809 Computer

SS-50 Bus LFD-400™ and LFD-800™ Systems



From Percom . . .

Low Cost Mini-Disk Storage in the Size You Want

Percom mini-disk systems start as low as \$599.95, ready to plug in and run. You can't get better quality or a broader selection of disk software from any other microcomputer disk system manufacturer — at any price!

Features: 1-, 2- and 3-drive systems in 40- and 77-track versions store 102K- to 591K-bytes of random access data on-line • controllers include explicit clock/data separation circuit, motor inactivity time-out cir-

cuit, buffered control lines and other mature design concepts • ROM DOS included with SS-50 bus version — optional DOSs for EXORciser* bus • extra PROM sockets on-board • EXORciser* bus version has 1K-byte RAM • supported by extended disk operating systems; assemblers and other program development/debugging aids; BASIC, FORTRAN, Pascal and SPL/M languages; and, business application programs.

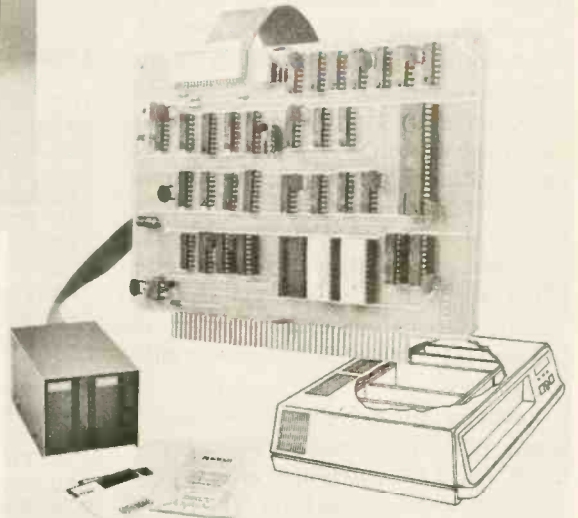

EXORciser* Bus LFD-400EX™ -800EX™ Systems

Versatile Mother Board, Full-Feature Prototyping Boards

Printed wiring is easily soldered tin-lead plating. Substrates are glass-epoxy. Prototyping cards provide for power regulators and distributed capacitor bypassing, accommodate 14-, 16-, 24- and 40-pin DIP sockets. Prototyping boards include bus connectors, other connectors and sockets are optional.

MOTHERBOARD — accommodates five SS-50 bus cards, and may itself be

plugged into an SS-50 bus. Features wide-trace conductors. Price: \$21.95

SS-50 BUS CARD — accommodates 34- and 50-pin ribbon connectors on top edge, 10-pin Molex connector on side edge. Price: \$24.95.

SS-30 BUS CARD — 1¼-inch higher than SWTP I/O card, accommodates 34-pin ribbon connector and 12-pin Molex connector on top edge. Price: \$14.95.

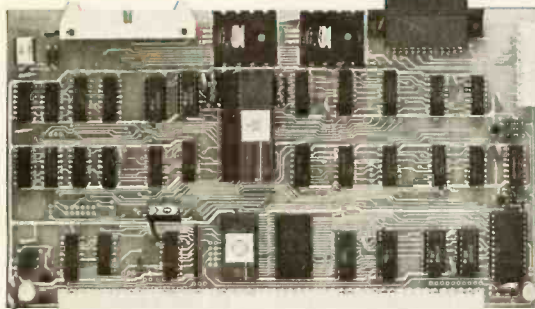

The SBC/9™. A "10" By Any Measure.

The Percom SBC/9™ is an SS-50 bus compatible, stand-alone Single-Board Computer. Configured for the 6809 microprocessor, the SBC/9™ also accommodates a 6802 without any modification. You can have state-of-the-art capability of the '09. Or put to work the enormous selection of 6800-coded programs that run on the '02.

The SBC/9™ includes PSYMON™, an easily extended 1-Kbyte ROM OS. Other features include:

- Total compatibility with the SS-50 bus. Requires no changes to the motherboard, memory or I/O.
- Serial port includes bit-rate generator. RS-232-C compatible with optional subminiature 'D' connector installed. 10-pin Molex connector provided.
- Eight-bit, non-latched, bidirectional parallel port is multi-address extension of system bus. Spans a 30-address field; accommodates an exceptional variety of peripheral devices. Connector is optional.
- Includes 1-Kbyte of static RAM.
- Costs only \$199.95 with PSYMON™ and comprehensive users manual that includes source listing of PSYMON™.

™ trademark of Percom Data Company, Inc.
* trademark of the Motorola Corporation.

Prices and specifications subject to change without notice.

The Electric Window™: Instant, Real-Time Video Display Control

Memory residency and outstanding software control of display format and characters make this SS-50 bus VDC card an exceptional value at only \$249.95. Other features:

- Generates 128 characters including all ASCII displayable characters plus selected Greek letters and other special symbols.
- Well-formed, easy-to-read 7x12-dot characters. True baseline descenders.
- Character-store (display) memory included on card.
- Provision for optional character generator EPROM for user defined symbols.
- Comprehensive users manual includes source listing of Driver software. Driver — called WINDEX™ — is also available on mini-diskette through the Percom Users Group.

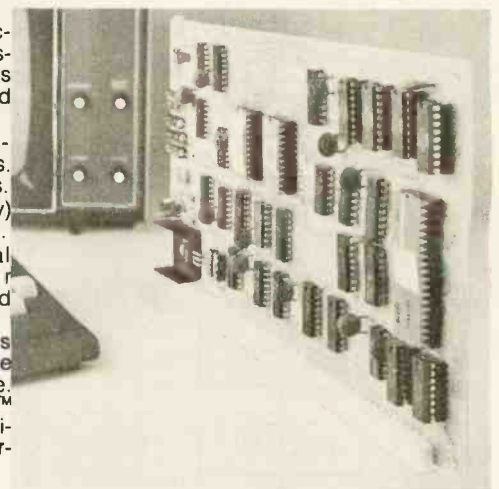

PERCOM DATA COMPANY, INC.
211 N. KIRBY GARLAND, TEXAS 75042
(214) 272-3421

Products are available at Percom dealers nationwide. Call toll-free, 1-800-527-1592, for the address of your nearest dealer, or to order direct.

Circle 44 on inquiry card.

the beeper will sound every time the computer writes data to that address. In addition to providing a method for testing the address decoder, the beeper serves as an audible indicator during other test sequences.

An integrated-circuit test clip facilitates access to +5 V (to power the beeper). It also conveniently picks up the strobe pulse and provides ground, even though they are available on the printer connector. The beeper circuit is completely independent of the other cables, but it is constructed on a board attached to the RS-232C connector, for convenience.

Figure 4 charts the test sequence, and listing 1 contains the actual code. This software, as well as that of the other tests, is designed as an independent subroutine to allow multiple passes.

Initially, all switches are set to the open position (hexadecimal address 37F8), and the computer attempts to write to the printer at port 37F8. If the address decoder works, the beeper should sound continuously. If not, there is a problem. Once continuous beeping is achieved, reset the address switches (as shown in photo 4) to hexadecimal address 3778 and press the @ key. This action tells the computer to try to write to printer port 3778. Once again the beeper should sound.

The sequence is repeated five times with the last address, hexadecimal 37E8, being left as the switch setting for all future tests. The master unit is permanently set at address 37F8 for all remaining tests. The test takes

whatever time it takes to flip the switches and press a key.

Printer Port and Programming Plug

Figure 3a outlines the hardware necessary to test parallel I/O. On the COMM-80, there is one full 8-bit

parallel I/O port for the printer and one 8-bit option-select programming-plug input port. The latter has no physical connection to the serial hardware, but is used to set serial-communication options under software control. With the interface set at hexadecimal 37E8 the programming

Text continued on page 58

Listing 1: BASIC program testing the address decoding of the COMM-80.

```

100 PRINT"***** ADDRESS CHECK *****"
105 REM THIS SUBROUTINE CHECKS EACH ADDRESS BIT OF THE ADDRESS
107 REM SELECTION SWITCH
130 PRINT"SET ALL ADDRESS SWITCHES TO THE OPEN POSITION"
140 GOSUB 510
150 POKE 14328,0
160 GOSUB 500
170 IF A$="@" THEN 180 ELSE 150
180 PRINT:PRINT"CLOSE SW1 ONLY" :GOSUB 510
190 POKE 14200,0
200 GOSUB 500
210 IF A$="@" THEN 220 ELSE 190
220 PRINT:PRINT"CLOSE SW2 ONLY" :GOSUB 510
230 POKE 14264,0
240 GOSUB 500
250 IF A$="@" THEN 260 ELSE 230
260 PRINT:PRINT"CLOSE SW3 ONLY" :GOSUB 510
270 POKE 14296,0
280 GOSUB 500
300 IF A$="@" THEN 310 ELSE 270
310 PRINT:PRINT"CLOSE SW4 ONLY" :GOSUB 510
320 POKE 14312,0
330 GOSUB 500
340 IF A$="@" THEN 350 ELSE 320
350 PRINT:PRINT"ADDRESS TEST CONCLUDED...LEAVE ADDRESS SWITCHES
    IN THIS SETTING";
360 PRINT"FOR REMAINDER OF TESTS AND SHIPPING"
370 GOSUB 2500
380 RETURN
500 A$=INKEY$ :RETURN
510 PRINT"IF YOU HEAR A BEEP THEN PRESS AN @ KEY" :RETURN
2500 PRINT:PRINT:PRINT"PRESS ANY KEY TO CONTINUE TEST"
2510 IF INKEY$<>" " THEN RETURN ELSE 2510

```

Listing 2: BASIC program testing the printer parallel port and programming plug of the COMM-80.

```

10 REM COMM-80 DIAGNOSTIC PROGRAM
20 REM
30 REM MASTER UNIT SET FOR ADDRESS F8-FB
40 REM
50 DATA 0,1,2,4,8,16,32,64,128,255
55 FOR X=1 TO 10 :READ Z(X) :NEXT X
1000 PRINT:PRINT:PRINT"***** PRINTER PORT AND PROGRAMMING PLUG
    TEST *****"
1010 FOR X=0 TO 9
1020 POKE 14312,Z(X) :REM SET DATA ON TEST UNIT PRINTER OUTPUT
1030 S=PEEK(14312) :REM READ TEST UNIT PRINTER INPUT
1040 S1=INP(233) :REM READ TEST UNIT PROGRAMMING PLUG
1050 S2=PEEK(14328) :REM READ MASTER UNIT PRINTER INPUT
1060 IF S+S1+S2<>3*Z(X) THEN 1200
1070 NEXT X
1080 PRINT"PROGRAMMING PLUG AND PRINTER PORT CHECK OK"
1090 RETURN
1200 IF S2<>Z(X) THEN PRINT"BAD PRINTER OUTPUT PORT --- FAILED O
    N ";Z(X);" DATA VALUE" :GOSUB 2500 :RETURN
1210 IF S1<>Z(X) THEN PRINT"BAD PROGRAMMING PLUG INPUT --- FAILE
    D ON ";Z(X);" DATA VALUE" :GOSUB 2500 :RETURN
1220 IF S<>Z(X) THEN PRINT"BAD PRINTER INPUT PORT --- FAILED ON
    ";Z(X);" DATA VALUE"
1230 GOSUB 2500 :RETURN
2500 PRINT:PRINT:PRINT"PRESS ANY KEY TO CONTINUE TEST"
2510 IF INKEY$<>" " THEN RETURN ELSE 2510

```

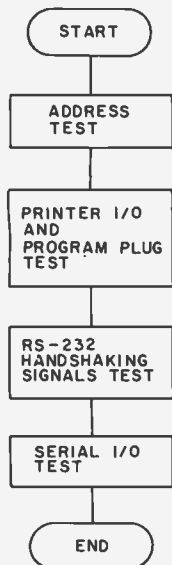

Figure 2: Flowchart of the four-step sequence employed to test the COMM-80.

WordPro Plus™ Word Processing Software

Turn your Commodore CBM/PET™ computer into a highly sophisticated word processing system

Everyone expected it would happen sooner or later... with WordPro Plus it already has! Now all the marvelous benefits of an advanced stand-alone wordprocessor are available with the WordPro Plus series of software and the systems they create.

If you've already been shopping for software in the crowded wordprocessing marketplace, you've probably determined the features you really want. You'll find WordPro Plus has them, and more.

And if you haven't begun to shop yet, we urge you to compare, because only by comparison will you fully appreciate how complete and sophisticated WordPro Plus software really is.

WORDPRO PLUS GIVES YOU THREE LEVELS TO CHOOSE FROM

WORDPRO 1 PLUS is ideal for hobbyists, students and organizations who can benefit from the advantages of a basic wordprocessor without the program refinements of a commercially oriented system. WordPro 1 Plus is recommended for use with the CBM/PET 8/16K, C2N cassette and interfaced printer.



WORDPRO PLUS SOFTWARE IS LOADED WITH THE LATEST INNOVATIONS

Sophisticated systems programmed with leading edge wordprocessing features, WordPro Plus is a series of programs designed specifically for use with the Commodore CBM/PET computers, peripherals and compatible typewriter quality printers.

WORDPRO 3 PLUS converts the CBM/2001 32K computer into a highly sophisticated 40-column screen wordprocessor. This program incorporates the advanced features considered important to effective wordprocessing, including nearly every entering, editing, memory and printing feature available today. WordPro 3 Plus is recommended for use with CBM/PET 32K (40-column) computer, CBM Dual Disk Drive, and a properly interfaced printer.

WHAT MAKES WORDPRO PLUS THE BEST?

Our research has shown that while many wordprocessing packages have comparable features to WordPro Plus, none can surpass WordPro Plus's EASE OF USE AND FLEXIBILITY. WordPro Plus operators need not be familiar with computer commands or functions. WordPro is easy to learn for anyone with ordinary typing skills.



WORDPRO 4 PLUS has it all! With this program, you will have everything you could want from a wordprocessor... and then some. WordPro 4 Plus includes every feature found on WordPro 3 Plus, but with the added advantage of an 80-column display screen. The 80-column display simplifies text editing and makes entering text in columnar formats effortless. And with a few simple keystrokes, you'll be able to visualize on the screen exactly how your document will look prior to printing it out. WordPro 4 Plus is designed for use with the Commodore CBM 8032 computer, CBM Dual Disk Drives, and a properly interfaced printer.

Call for complete product literature or for the name and address of a WordPro Plus dealer near you.

Professional Software Inc.

166 Crescent Rd., Needham, MA 02194

(617) 444-5224, Telex: 95-1579

*International Distributors and Domestic Dealer Inquiries Invited. *CBM is a registered trademark of Commodore Business Machines.
*WordPro Plus was developed by Steve Punter of Pro-Micro Software Ltd., and is marketed exclusively by Professional Software Inc.

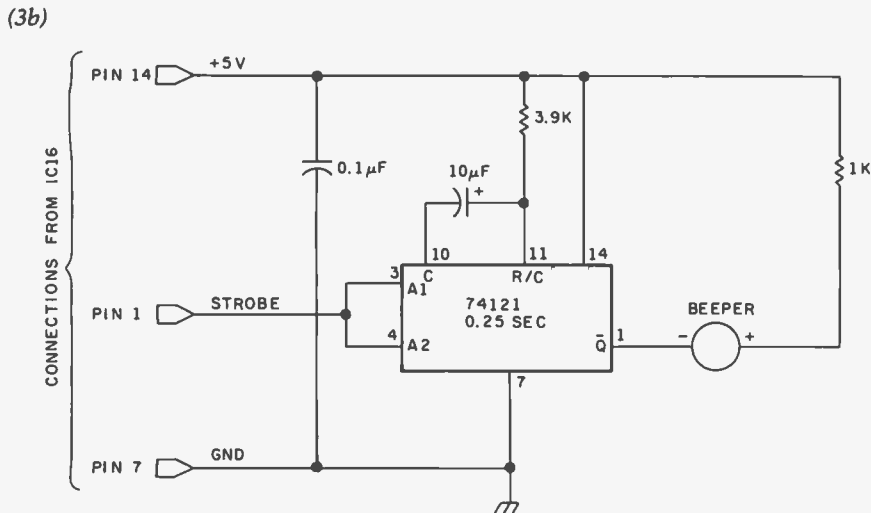
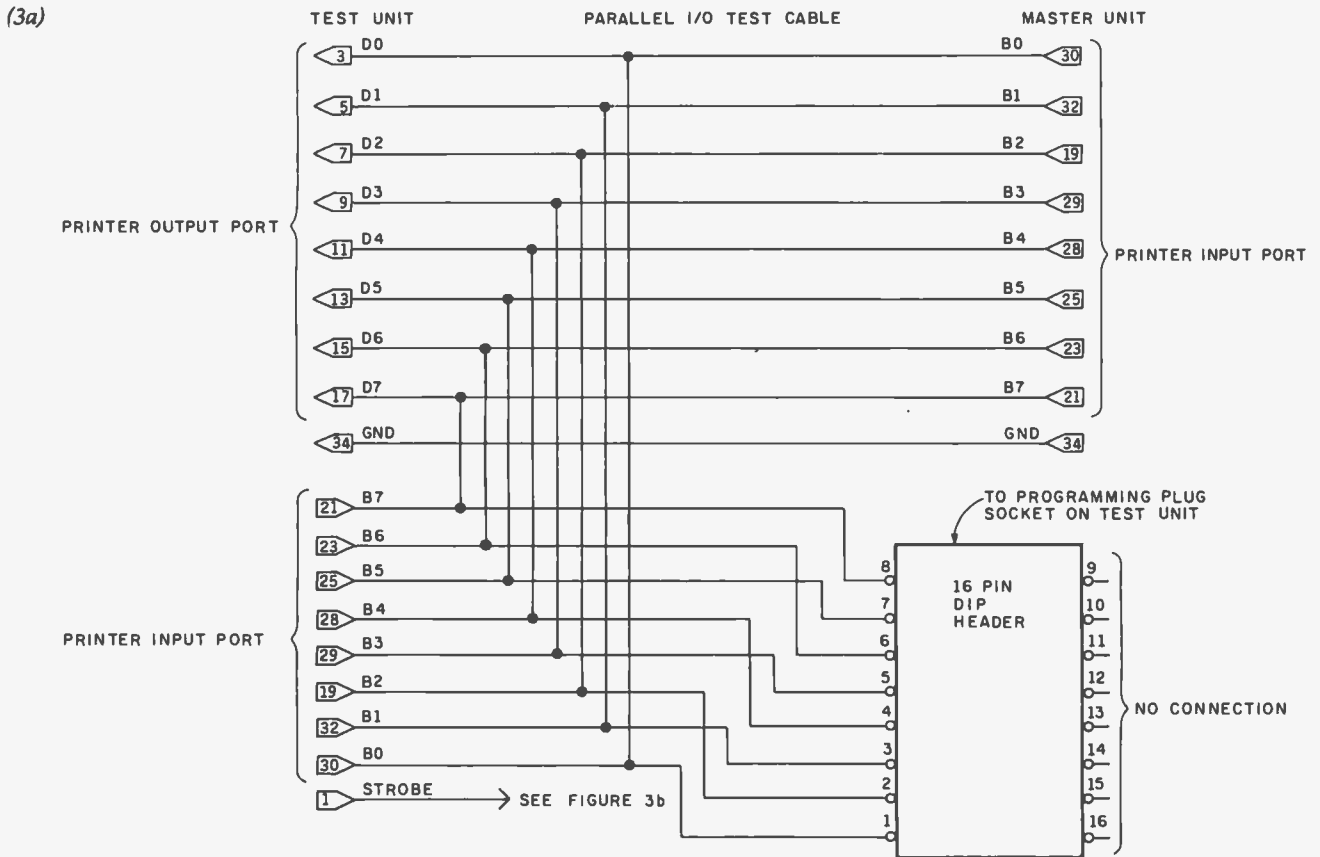

Figure 3: Hardware for testing the parallel I/O (figure 3a) and addressing (figure 3b) capabilities of the COMM-80. Figure 3a shows an I/O test cable that connects the master and test units. Figure 3b shows a beeper circuit that tests the address selection of the COMM-80.

UCSD p-System* for the INTERTEC SUPERBRAIN™

With UCSD Pascal* and FORTRAN

UCSD p-System includes: operating system, editor, filer, library, Z80 assembler, and documentation.

with Pascal	\$ 400
with FORTRAN	450
with Pascal and FORTRAN	600

NOESIS COMPUTING COMPANY

615 Third Street, San Francisco, CA 94107
Telephone: (415) 495-7440

VISA/Master Card Accepted

*UCSD p-System and UCSD Pascal are trademarks of the Regents of the University of California
™Trademark of Intertec Data Systems

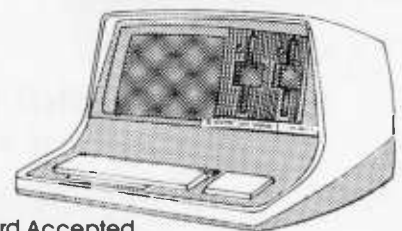

WHY OUR WINCHESTER HARD DISK BASED SYSTEMS ARE PICKED BY GROWING CONCERNS

Growing seasons. Those fruitful times when firms often find that their applications have outgrown their systems. Yet the costs of stepping up to a minicomputer can cause growing pains for many growing concerns.

Altos Computer Systems, a world leader in single board microcomputer technology, has packages of fresh ideas designed specifically for growing OEM's, the business sector, and many other end users. In fact, they're responsible for Altos' own rapid growth in the last three years.

Packages like Altos' ACS8000-6 microcomputer family that's loaded with features which provide mini-computer performance at affordable microcomputer prices. The advanced, proprietary double-sized single board contains fully socketed and reliable LSI circuitry that includes: the Z80A* CPU with high speed DMA; up to 208 KBytes of RAM; the sophisticated floppy disk and Winchester hard disk controller; six RS-232C serial and two 8-bit parallel ports; and an optional floating point processor.

The Altos hard disk family will support up to four users simultaneously with 48 KBytes of RAM each, as well as up to 58 MBytes of

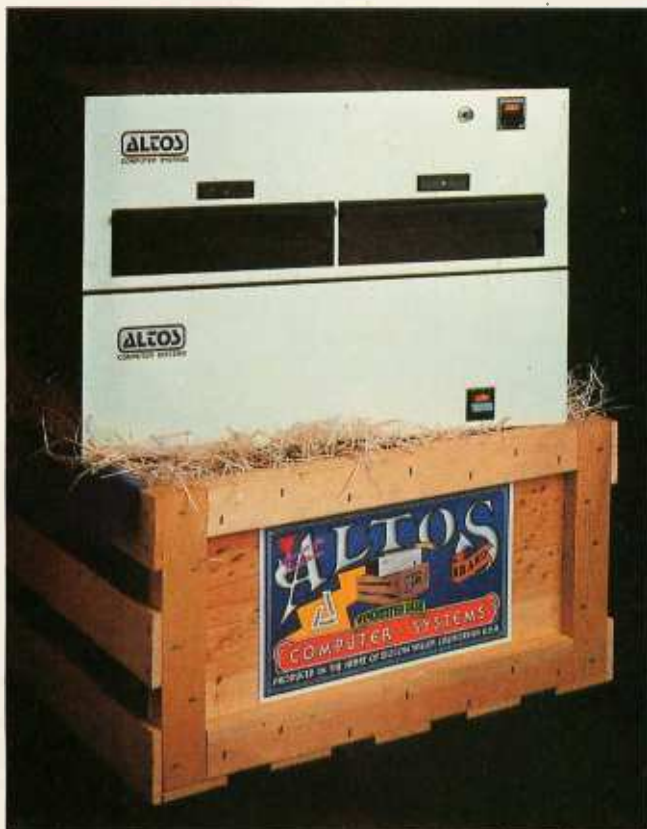

on-line quality Shugart Winchester hard disk storage, with tape cartridge back-up. And all this at microcomputer prices.

Altos also supports three industry standard operating systems: single/multi-user CP/M,** OASIS† and Altos' proprietary AMEX.™ Seven high level programming languages are offered which are CP/M or AMEX compatible.

Weed through the micro-computer system alternatives. No matter what your application, you'll pick Altos.

For specific details about pricing or performance, call or write: Altos Computer Systems, 2360 Bering Drive, San Jose, CA, 95131, (408) 946-6700, Telex 171562 ALTOS SNJ.

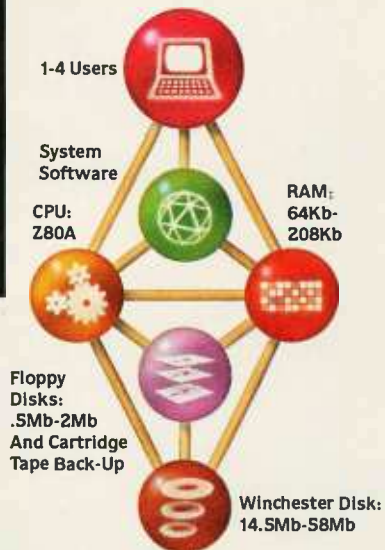

Packed with Fresh Ideas





OUR MEDIA IS

Over the past seven years we've earned a name for ourselves by making the best magnetic media in the business. Precision magnetic media — Diskettes, Mini Diskettes, Diagnostic Diskettes, Rigid Discs, Disc Packs, and Disc Cartridges — all certified to be 100% error free both on-track and between the tracks.

Now we're making it easier for you to buy the best. Just dial Dysan direct TOLL FREE at 800/538-8150 or 408/988-3472 (in California) or contact your local Dysan office listed below.

Precision magnetic media from Dysan. Our media says it all.



Dysan
CORPORATION

5440 Patrick Henry Drive
Santa Clara, CA 95050
408/988-3472



Call your local Dysan office:

Dysan Corporation
5440 Patrick Henry Drive
Santa Clara, CA 95050
408/988-3472

19600 Fairchild
Suite 150
Irvine, CA 92713
714/851-9462

13201 Bell Red Road
Suite 205
Bellevue, WA 98004
206/455-4725

OUR MESSAGE.

Text continued from page 52:

plug is read as input port hexadecimal E9.

The concept behind this is to have the test unit send a data byte from its own output port to both input ports. The master unit reads the same 8 bits to determine that they are set correctly. While we could have gone from input to output (sixteen wires) between master and test units, nothing

better would be accomplished. Figure 5 and listing 2 outline this activity in detail. The test takes about 1 second.

RS-232C Handshaking Test

A similar technique is employed to check the RS-232C handshaking signals. The necessary interface cable is outlined in figure 6. Figure 7 and listing 3 detail the logic flow.

There are two output (DTR, Data

Terminal Ready, and RTS, Request To Send) and four handshaking signals (RI, Ring Indicator; CD, Carrier Detect; DSR, Data Set Ready; and CTS, Clear to Send) on the RS-232C interface. Some are almost never used, but all must be checked and functioning. The test is accomplished by tying the input to the output on the test unit and monitoring the output lines again through the master unit. With two signal lines, there are four possible combinations, and all are checked. The test takes about 1 second.

Serial I/O Test

The serial section of the COMM-80 incorporates a COM5016 data-rate generator and a COM2017 UART (universal asynchronous receiver/transmitter). Both are programmable devices. Through them, it is possible to automatically set data rates, parity, word size, and stop-bit options completely through software. This makes testing much easier and eliminates the necessity of manually flipping switches. Figure 8 and listing 4 outline this test.

Upon initial examination, the software looks straightforward. Ten bytes of data (all on, all off, and each individual bit set) are sent from the master unit to the test unit at each of the sixteen data rates. The communication path is then reversed and 10 bytes are sent from the test unit to the master at each data rate to complete the test.

It may be surprising to note that a close examination reveals no assembly-language routine to transmit or receive the serial data. Even at 19,200 bps (bits per second), the serial communication and UART program interaction are accomplished completely in BASIC. (Remember that it takes less time to write a program in the higher-level language. So, if you don't need assembly-language routines, why bother?)

A UART is a hardware device that appears to the computer as a parallel port. To send data, we merely address this port and load 8 bits of data into it. At the conclusion of the output instruction, the UART automatically converts this byte to serial format and transmits it at a rate that is dependent only on the transmit-clock input to the UART. If this clock

Text continued on page 64

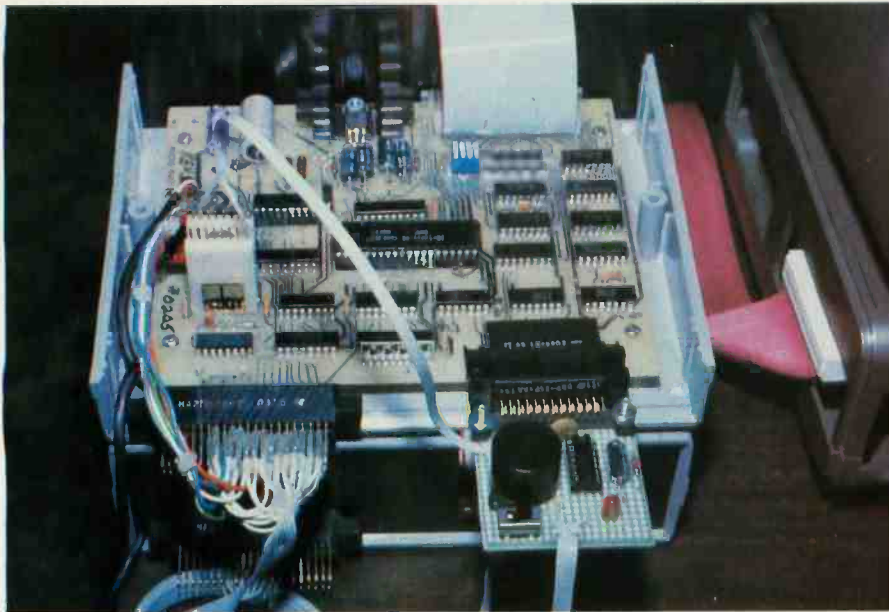

Photo 3: A production COMM-80 under test with cables attached. A second unit beneath it provides the computer with the necessary I/O capability to successfully interface to both a serial and parallel port. This capability is also available using a Radio Shack Expansion Interface with a RS-232C board installed.

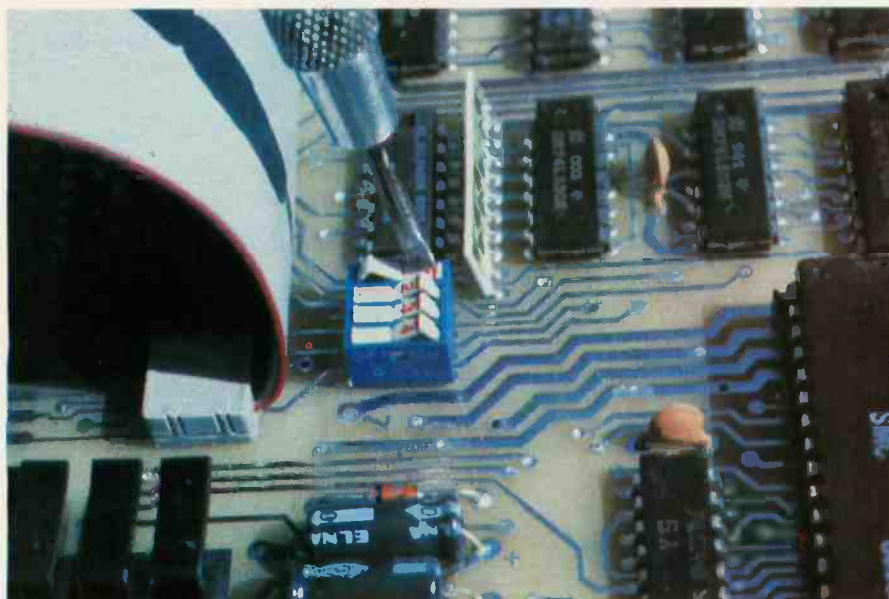

Photo 4: Address selection during test. When the beeper is heard, the proper address has been selected on the dual-inline plug switch.

COMPUTER WAREHOUSE

CALL TOLL FREE **1-800-528-1054**

ATARI

800 (24K)	\$748
400	\$445
810 Disk Drive	\$550
825 Printer	\$750
850 Interface	\$160
Star Raiders	\$ 47
Software	From \$ 10

Visicalc	Call
Kurta Digitizer	Call

MODEMS

Lexicon	
LEX-II	\$115
Novation	
CAT	\$150
D-CAT	\$160

MONITORS

APF - 9" Monitor	\$123
Sanyo - 9" Monitor	\$147

VIDEO TERMINALS

Hazeltine	
1500	\$848
1420	\$795
Soroc	
IQ 120	\$693
IQ 140	\$1099
Teletideo	
912 B	Call
912 C	Call
920 B	Call
920 C	Call
Zenith - Z - 19	\$789

PRINTERS

Centronics	
730 Serial	\$650
730 Parallel	\$598
737 Serial	\$875
737 Parallel	\$790

Diablo	
1640	Call
1650	Call

Epson-MX-80	Call
NEC	
5510	Call
5520	Call

Okidata - Microline 80	\$545
------------------------------	-------

Qume	
5/45	Call
5/55	Call

Teletype	
Model 40	Call
Model 43 w/Pinfeed	\$1005

Texas Instruments	
810 Basic	\$1516
810 Loaded	\$1724
820 KSR Basic	\$1732
820 KSR Package	\$1916



Prices & availability subject to change without notice

COMPUTERS

Aitos	Call
Cromemco	Call
Northstar	
HRZ II-32K D (Assm)	\$2300
HRZ II-32K Q (Assm)	\$2665
Zenith	
Z-89 48K	\$2210

DISKETTS

BASF	
5¼-0 Sector S/S D/D (Qty 10)	\$33
5¼-10 Sector S/S D/D (Qty 10)	\$33
5¼-10 Sector D/S D/D (Qty 10)	\$37
Memorex	
5¼-10 Sector S/S D/D (Qty 10)	\$27
Dysan	
5¼-10 Sector S/S D/D (Qty 10)	\$37
5¼-10 Sector D/S D/D (Qty 10)	\$42
Scotch	
5¼-0, 10, 16 Sector (Qty 100)	\$275
8"-0, 32 Sector (Qty 100)	\$275

USED

Experienced Equipment

Soroc IQ 120 ..	\$500	Centronics 779	\$600
TI 810 Basic ..	\$1200	Centronics 730	\$450
TVI 912	\$550	Teletype 40	Call
TVI 920	\$600	Comprint	\$400
Qume	Call	Z-89	Call
Diablo	Call	TI 99/4 Console	\$450



2222 E. Indian School Rd. Phoenix, Arizona 85016

Store Hours: Tues. - Friday 10-6 MST
Saturday 10-5 MST

Have some great memories.

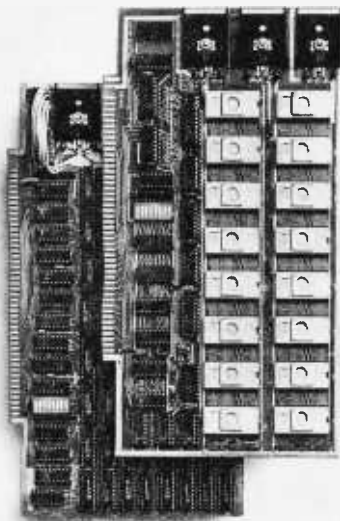

16K PROM boards.

- PROM card has 2708-type memory
 - Quality board construction
 - 0-4 wait states
 - Address any 4K group to any 4K boundary
 - Control up to 8 banks of memory
 - Fully assembled and tested
 - PRICE—\$300
- (California residents add 6% sales tax)

Expandable 5 MHz RAM boards.

- 8—32K expandable RAM board uses TI 4044 memory runs at 5MHz
 - Fast 250 ns access time
 - Bank select
 - Address any 4K block to any 4K boundary
 - Quality board construction
- PRICE—8K—\$175; 16K—\$315; 24K—\$475; 32K—\$620; 8K add-on kits—\$135
- (California residents add 6% sales tax)

Call or write Artec for details

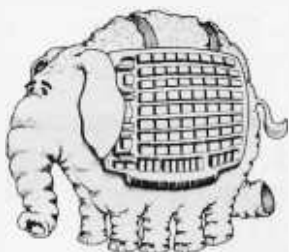

ARTEC ELECTRONICS, INC.

605 Old County Rd., San Carlos, CA 94070
Telephone (415) 592-2740

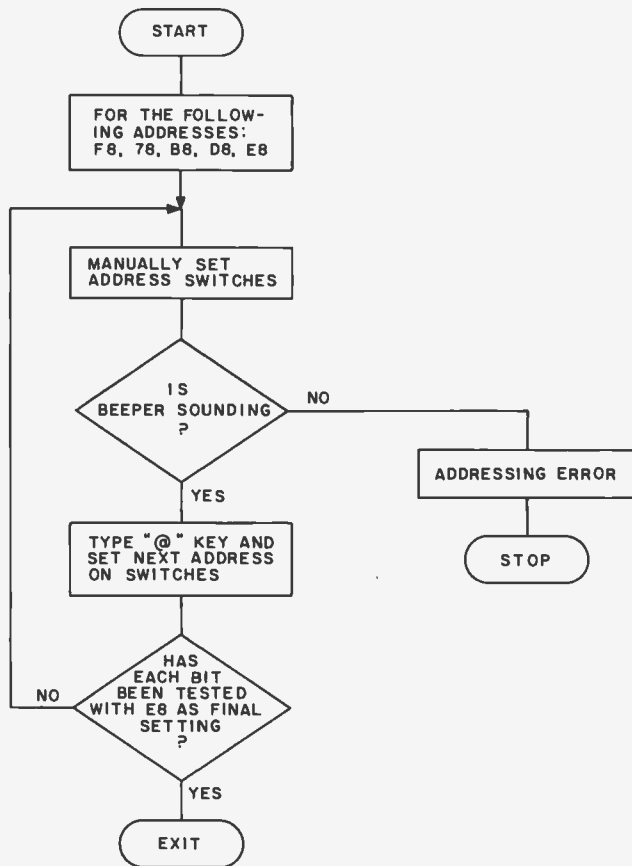

Figure 4: Flowchart showing the sequence of the address-decoder test program.

Listing 3: BASIC program testing the RS-232C handshaking signals of the COMM-80.

```

60 DATA 0,0,0,2,128,48,1,64,192,3,192,240
65 FOR X=0 TO 3 :READ A(X),B(X),C(X) :NEXT X
2000 REM THIS SUBROUTINE CHECKS THE RS-232 HANDSHAKE LINES
2002 REM THE DTR AND RTS SIGNALS ARE TIED TO RI,CD,DSR, AND CTS
2005 PRINT:PRINT:PRINT"***** RS-232 HANDSHAKE SIGNAL TEST **
*****"
2010 POKE 14312,0 :REM SOUND BEEPER
2020 FOR X=0 TO 3
2040 OUT 234,A(X) :REM SET DTR AND RTS ON TEST UNIT
2050 D=INP(248) :D=D AND 192 :REM READ CTS AND DSR ON MASTER
2060 IF D<>B(X) THEN 2200
2070 E=INP(232) :E=E AND 240 :REM READ TEST UNIT LINES
2080 IF E<>C(X) THEN 2300
2090 NEXT X
2100 PRINT" RS-232 HANDSHAKE SIGNALS CHECK OK"
2110 RETURN
2200 PRINT" MALFUNCTION ON DTR OR RTS OUTPUT SIGNALS" :RETURN
2300 PRINT"MALFUNCTION ON RI,CD,DSR,OR CTS INPUT SIGNALS":RETURN
    
```

Listing 4: BASIC program testing the serial input and output of the COMM-80.

```

50 DATA 0,1,2,4,8,16,32,64,128,255
55 FOR X=1 TO 10 :READ Z(X) :NEXT X
75 DIM N(16)
80 DATA 50,75,110,134.5,150,300,600,1200,1800,2000,2400
85 DATA 3600,4800,7200,9600,19200
90 FOR X=0 TO 15 :READ N(X) :NEXT X
2500 PRINT:PRINT:PRINT"PRESS ANY KEY TO CONTINUE TEST"
2510 IF INKEY$<>" " THEN RETURN ELSE 2510
3000 PRINT:PRINT:PRINT"***** SERIAL INPUT TEST *****"
3010 POKE 14312,0 :REM SOUND BEEPER AT START OF TEST
3020 GOSUB 3500
3030 FOR B=0 TO 15
    
```

Listing 4 continued on page 62

THEY INVENTED THE WHEEL . . .

During 1978 a set of four business systems was developed for sale in the CP/M environment under the name "Peachtree Software". Since then, this software has been used in over 3000 installations, and sold through more than 150 retail outlets. During this period, however, there was a split among the principals which resulted in a parting of the ways. It was decided one group would retain the "Peachtree Software" trademark and the second group would be restricted from competing with them for one year. We are now ready to market our business software to you under the name of "Insoft Accountant"

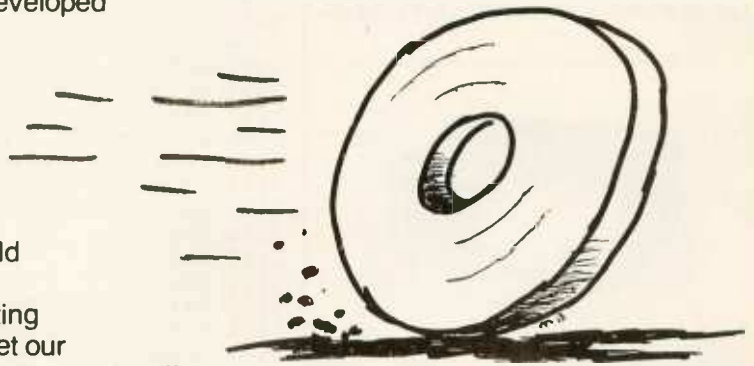

WE GAVE IT A NEW TWIST

Thanks to the Z-80 Softcard™ by Microsoft, this software is available to Apple owners for the first time. It uses the standard Apple 40 character display and unlike the Peachtree version, does not require an extra 16K memory card to run. All you need is an Apple II or Apple II Plus with 48K RAM, 2 drives, the Microsoft Z-80 Softcard™, DOS 3.3 and a 132 column printer. We supply all programs, manuals and sample company data files to get you up and rolling fast.

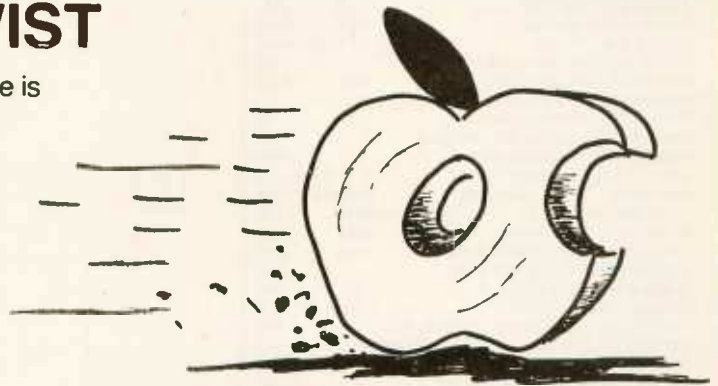

The deal of 1981!

EXACTLY WHAT IS IT?

This fully Integrated Business Software Package for \$365 includes:

- **GENERAL LEDGER** — Will automatically post end of month transactions from A/R, A/P, and Payroll. Prints detailed company and department reports, optional comparative financial statements with current, YTD, budget, and last year (month and YTD) giving values and percentages.
- **ACCOUNTS RECEIVABLE** — Instant customer account information (current and aged) with complete invoicing with open item and statement capabilities.
- **ACCOUNTS PAYABLE** — Tracks current and aged payables. Has extremely useful cash flow management reports.
- **PAYROLL** — Calculates payroll for every type of employee while maintaining monthly, quarterly and yearly totals for reporting purposes in multiple states. User modifiable tax tables. W-2, 941's, etc.
- **MANUALS** — Comprehensive user manuals for each module with start up aids, 290 pages.

ORDERING INFORMATION — Fill out and mail

- APPLE II 40 COLUMN SCREEN \$365
- APPLE II 80 COLUMN SCREEN \$365
- MICROSOFT Z-80 SOFTCARD™ \$320
- SINGLE DENSITY 8" VERSION \$365
For machines such as ALTOS

Signature.....
Name.....
Address.....
.....
Telephone.....
Visa or MC #.....

Certified Check or Money Order. Visa and MC welcomed. Personal checks require 2 weeks to clear. At this price software is sold as-is without support. Warranty limited to "good copies" of disks. Sale is to end users only for use on one computer. Call for sample reports. 80 column APPLE version requires SUP-R-TERM board or equivalent.

Apple II, CP/M, Peachtree Software and Microsoft are registered trademarks of Apple Computer, Inc., Digital Research, Retail Sciences, Inc., and Microsoft Consumer Products, Inc., respectively.

INSOFT CORPORATION

259 Barnett Rd., Unit 2 ■ Medford, Oregon 97501
503 / 779-2465

Circle 38 on inquiry card.

SAVE MORE THAN 20%!

**NORTH STAR — INTERTUBE — MICROTEK
ZENITH — RCA-COSMAC — ITHACA
THINKER TOYS — GODBOUT — SUPERBRAIN**

The smartest computers at the smartest price



FACTORY ASSEMBLED & TESTED	LIST	ONLY
HORIZON-1-32K-DOUBLE DEN	\$2895	\$1994
HORIZON-2-32K-DOUBLE DEN	3095	2274
HORIZON-2-32K-QUAD DENSITY	3595	2874
HORIZON-2-64K-QUAD+HARD DISK	9329	7149
HORIZON RAM ASSM SALE!	18K-#349	32K-#579
HORIZON RAM KIT SALE!	18K-#314	32K-#489
HORIZON DISK DRIVE SALE 00UB DEN SALE!		315
NORTH STAR HARD DISK 18 Mb	4999	3939
HORIZON PORTS, PARITYS, EDGE CONNECTORS, ETC.		
PASCAL FOR NORTH STAR ON DISK	199	190
PASCAL-PLUS 14, 18, or 38 DIGIT PRECISION		249
Powerful NORTH STAR BASIC...The Best		FREE
NSSE 1-22 & P01 TERRIFIC PROGRAMS		ONLY 10
NORTHWORD 294 MAILMAN 234 INFOMAN		384
RCA-COSMAC VP-111 99 GODBOUT SPECTRUM		289
MicroAngelo HI-RES GRAPHICS	1095	985
ITHACA FRONT PANEL COMPUTER 64K	3195	2895
Z-8002 CPU CARD 16-bit ITHACA S-100		1059
ITHACA MEMORY 8/16-bit 64K	995	845
PASCALIZ+ THE SPEED KING	395	375
SEATTLE 8086 CPU 16 bit 556 RAM 10K 8/16		358
SSM KITS Z-80 CPU 221 VIDEO BRD V83 4MHz		412
SYSTEMS GROUP RAM 64K A & T 4MHz		599
SYSTEMS GROUP RAM 64K BANK SELECT		789
ECONORAM XIV UNKIT 18K	279	249
CENTRAL DATA 64K RAM	885	599
DISCUS/2D A & T + CP/IM	1199	938
THINKER TOYS HARD DISK 28 Mb	4995	3995
DISCUS/2+ 2 1.2 Mbytes A & T	1545	1259
TARBELL DISK CONTROLLER OD	495	445
SUPERBRAIN	2995	2395
SUPERBRAIN QUAD DENSITY	3995	2995

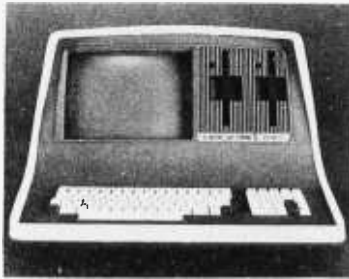

ZENITH-HEATH Z-89 40K	2895	2299
INTERTUBE III SMART TERMINAL	895	725
EMULATOR 4 IN 1 TERMINAL	895	725
ZENITH-HEATH SMART TERMINAL	995	739
CAT NOVATION MODEM	178	189
MICROTEK PRINTER	795	875
DIP-81 PRINTER FRICTION FEED!	499	425
ANADEX PRINTER DP-9501 1389 ANADEX DP-8000		885
NEC PRINTER Fast Typewriter Quality	2915	2799
SECRETARY WORD PROCESSOR The Best!	85	77
TEXTWRITER III Book Writing Program	125	112
GDFAST NORTH STAR BASIC Speeder Upper	79	71
ASSEMBLER PLUS DISASSEMBLER		ONLY! 39
A BASIC PROGRAM TRACER! + FANCY RENUMBERING		99
EZ-CODER Translates English to BASIC	79	71
ECOSOFT FULL ACCOUNTING PNG 315 MICROSTAT		225
BOX OF DISKETTES 29 EZ-80 Z8D TUTORIAL		25
Which Computers are BEST? BROCHURE		FREE
North Star Documentation refundable w/HRZ		20

ORDER 2 or more COMPUTERS... BIGGER DISCOUNTS
YES WE WILL BEAT OUR COMPETITION'S PRICE!
FACTORY ASSEMBLED & FACTORY WARRANTY

AMERICAN SQUARE COMPUTERS

KIVETT DR + JAMESTOWN NC 27282
(919)-889-4577

Listing 4 continued:

```

3040 GOSUB 3600
3050 PRINT"CHECKING ";N(B);" BITS PER SECOND"
3060 FOR X=1 TO 10
3070 OUT 251,Z(X) :REM LOAD MASTER UNIT WITH OUTPUT DATA
3075 IF B<5 THEN GOSUB 3950
3080 S=INP(234) :REM READ TEST UNIT STATUS REGISTER
3090 S1=S AND 56 : REM MASK OR,PE, AND FE
3100 IF S1>0 THEN 3800
3110 IF S AND 128=0 THEN 3850
3120 D=INP(235):IF D<>Z(X) THEN 3900
3130 NEXT X
3140 NEXT B
3145 RETURN
3150 PRINT:PRINT:PRINT"***** SERIAL OUTPUT TEST *****"
3155 POKE 14312,0 :REM SOUND BEEPER AT START OF TEST
3160 GOSUB 3500
3170 FOR B=0 TO 15
3180 GOSUB 3600
    
```

Listing 4 continued on page 64

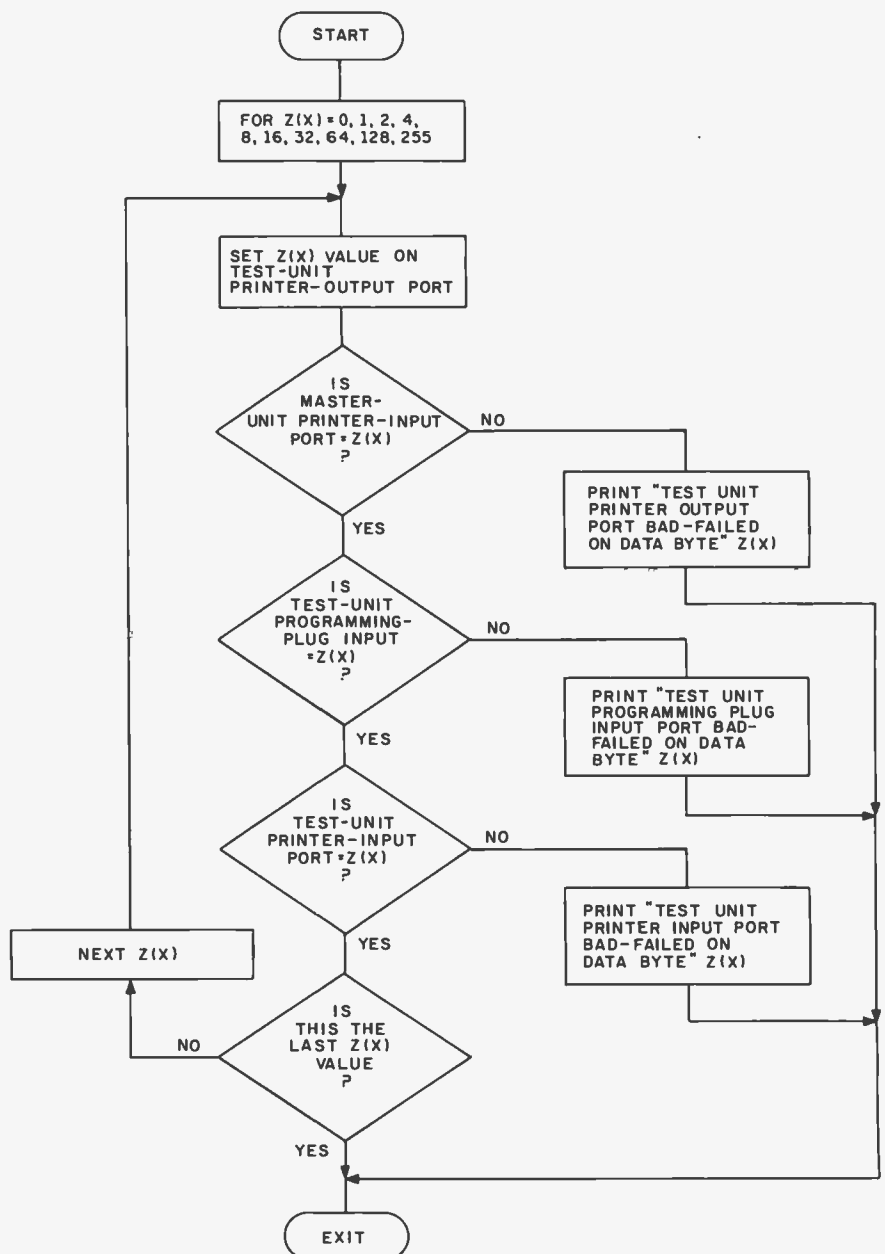

Figure 5: Flowchart showing the sequence of operations of the parallel I/O test program.

INTRODUCING THE EMULATOR™

The trouble with video terminals today is that most of the low-cost models just don't have the performance to handle your tough applications. And the few that do are usually not compatible with your existing system. But now, Intertec has resolved this age old dilemma with the introduction of its new Emulator™ Video Terminal.

The \$895* Emulator™ performs exactly as you command. With the depression of just a few keys, Emulator users can select terminal control codes of any one of four popular video terminals. The Lear-Siegler ADM-3A. The Soroc 1Q-120. The DEC VT-52. Or the Hazeltine 1500. Incredible! It's like having four terminals for the price of one.

But, best of all, not only does the Emulator replace these terminals, it outperforms them by offering enhanced user-oriented features. Features that those other terminals just don't have - at any price.

Standard Emulator™ features include: a sharp, crisp 12" non-glare screen with a full 24 line by 80 column display. Twin RS232C serial ports - one for the host computer and one for your printer. Four separate cursor control keys. A separate 18 key numeric pad. Keyboard selectable baud rates and operating modes. And, a host of visual attributes.

No matter which dumb or smart terminal you're using today, don't buy another until you check out our new Emulator™. You'll get the

performance of four terminals for the price of one. And you'll probably save hundreds of dollars over the price you paid for your last terminal. Plus, you'll get unparalleled reliability, nationwide service and quick delivery. Call or write us today for all the details. Intertec terminals are distributed worldwide and may be available in your area now.

 **INTERTEC
DATA
SYSTEMS®**

2300 Broad River Rd., Columbia, SC 29210
(803) 798-9100 TWX: 810-666-2115



*Quantity one - Dealer inquiries invited.

CHOOSE...

Choose an Apple Desk



A compact bi-level desk ideal for an Apple computer system. This 42" x 31½" desk comes with a shelf to hold two Apple disk drives. The top shelf for your TV or monitor and manuals can also have an optional paper slot to accommodate a printer.

Choose a Micro Desk



Get your micro computer off the desk top and into the micro shelf under our Designer Series desks. Suitable for the North Star, Dynabyte, Vector Graphics, and Altos computers. The desks come in a variety of sizes and colors.

Choose a Mini Rack



Mini racks and mini micro racks have standard venting, cable cut outs and adjustable RETMA rails. Choose a stand alone bay or a 48", 60", or 72" desk model in a variety of colors and wood tones. A custom rack is available for the Cromemco.

Choose a Printer Stand



The Universal printer stand fits the:

Centronics 700's	Diablo 1600's & 2300's
Dec LA 34	T.I. 810 & 820
NEC Spinwriter	Okidata Slimline
Lear Siegler 300's	Anadex 9500's

Delivery in days on over 200 styles and colors in stock. Dealer inquiries invited.

**ELECTRONIC SYSTEMS
FURNITURE
COMPANY**

17129 S. Kingsview Avenue
Carson, California 90746
Telephone: (213)538-9601

Listing 4 continued:

```

3190 PRINT"CHECKING ";N(B);" BITS PER SECOND"
3200 FOR X=1 TO 10
3210 OUT 235,Z(X) :REM LOAD TEST UNIT WITH OUTPUT DATA BYTE
3220 IF B<5 THEN GOSUB 3950
3230 S=INP(250) :REM READ MASTER UNIT STATUS REGISTER
3240 S1=S AND 56 :REM MASK OR,PE, AND FE
3250 IF S1>0 THEN 3800
3260 IF S AND 128=0 THEN 3850
3270 D=INP(251) :IF D<>Z(X) THEN 3900
3280 NEXT X
3290 NEXT B
3300 PRINT:PRINT:PRINT"TEST COMPLETE"
3310 RETURN
3500 OUT 232,0 :OUT248,0 :REM RESET MASTER AND TEST UNITS
3510 OUT 234,228 :OUT 250,228 :REM SET BOTH UNITS FOR 8 BITS,
3520 REM EVEN PARITY AND 1 STOP BIT
3530 RETURN
3600 OUT 233,B+B*16 :OUT 249,B+B*16 :REM SET EQUAL BAUD RATES
3610 RETURN
3800 PRINT"STATUS BIT ERROR":GOSUB 2500 :RETURN
3850 PRINT"NO DATA RECEIVED":GOSUB 2500 :RETURN
3900 PRINT"WRONG DATA RECEIVED":GOSUB 2500 :RETURN
3950 FOR A=0 TO 60 :NEXT A :RETURN
    
```

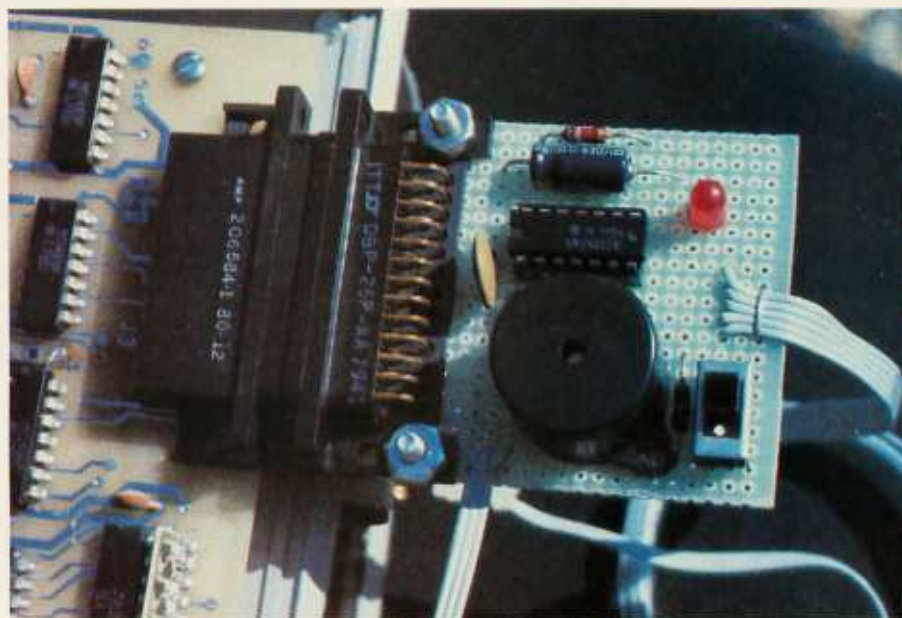

Photo 5: Close-up of RS-232C connector on the unit under test. The circuit on the perforated board is a 0.25-second monostable multivibrator (one-shot) activating a low-voltage beeper.

Text continued from page 58:

is 800 Hz, then the information will go out at 50 bps. If, on the other hand, the clock is 153,600 Hz, the information will go out at 9600 bps. The only difference to the programmer is that, at 9600 bps, he can transmit the next byte sooner.

To read the incoming data, the program periodically reads the UART-status register as would be done with any input port and checks to see if the DAV (data available) flag is set. When that occurs, the program reads the data from the UART and resets the DAV line. Similar I/O-port

manipulations accomplish error checking and option setting.

This can be done in BASIC just as well as in assembly code—only, not quite as often. We may be able to send data at 19,200 bps, but it can be sent by BASIC only at about 10 characters per second. Similarly, we may be able to read data from the UART in BASIC at 19,200 bps, but it also better not come any faster than 10 characters per second.

Since we can control the rate at which we send data, we can easily

Text continued on page 70

YOU WILL FIND WHAT WE DID!!

Specifications KG-12C

Input Signal: $1.0 \pm 0.2V$ P-P
composite Video sync.
negative, fully compatible.

Input Impedance: 75 ohms

CRT: 12", 90° deflection

CRT Color: Green P31 phosphor

Video Amplifier Bandwidth: 18 MHz

Display Format: 25 lines of 80 characters

Scan Frequency: Horizontal—15.75 KHz Vertical—60 Hz

Power Requirement: AC 117 volts 50/60 Hz

Size: 11½" high x 12½" wide x 12" deep

Weight: 16 Lbs



BMC INTERNATIONAL (USA), INC
SUITE 600, UNION BANK BLDG.,
11222 LA CIENEGA BLVD., INGLEWOOD, CA90304
TEL (213) 641-4588 TLX 182379 BMC USA ING

BMC INTERNATIONAL
No. 27, 5-CHOME, TANIMACHI, HIGASHI-KU,
OSAKA 540, JAPAN CABLE "BMCINT" OSAKA
PHONE: OSAKA 768-7791 TELEX: 64930 NISEMIC

S-100 Monitor/Control Modules . . .

Order these heavy duty industrial quality boards—best overall specs in the industry, finest components and workmanship, IEEE standard for S-100 bus.



Guaranteed to operate with Cromemco, North Star and most other S-100 systems. All manuals include applications programs in BASIC. DIP switch selectable port base address.

A/D MODULE

Dependable high-speed analog-to-digital conversion. 12-bit precision. 32 single-ended input channels, or 16 true differential inputs. High-speed sample and hold amplifier. 25 μ sec conversion time. Precision analog multiplexer. Vectored interrupt capability. Optional instrumentation amplifier with gain from 1 to 1,000. AIM-12, standard input module with instrumentation amplifier . . . \$725
AIM-12B, input module only . . . \$635
AIM-11B, 11-bit precision module . . . \$575

D/A MODULE

Four independent channels for digital-to-analog conversion. 12-bit precision over full 0° to 70°C range. Jumper selectable outputs. Binary or 2's complement digital inputs. Flexible bit-mapping jumpers allow compatibility with any existing I/O mapped software (either 12- or 8-bit). Super simple programming. AOM-12, output module . . . \$495

REAL TIME CLOCK

Features new OKI CMOS clock chip for day, date, hours, minutes, and seconds. 12 or 24 hour time format. On-board battery backup. Full year operation without battery replacement. Read or write time directly from I/O port. Vectored interrupt capability. CLK-24 . . . \$250

ALSO AVAILABLE: Industrial control output current module, 4-20 mA — \$395. Nonvolatile CMOS memory, 250 nsec, 4K bytes with battery backup — \$395. 8K CMOS memory — \$590. 16K CMOS memory — \$990. Thermocouple compensation module — \$350.

California; add 6% tax.
Money back guarantee. 10-day trial.
OEM and dealer inquiries invited.



system reliability/system integrity
DUAL SYSTEMS CONTROL CORP.
1825 Eastshore Hwy., Dept. B
Berkeley, CA 94710 (415) 549-3854

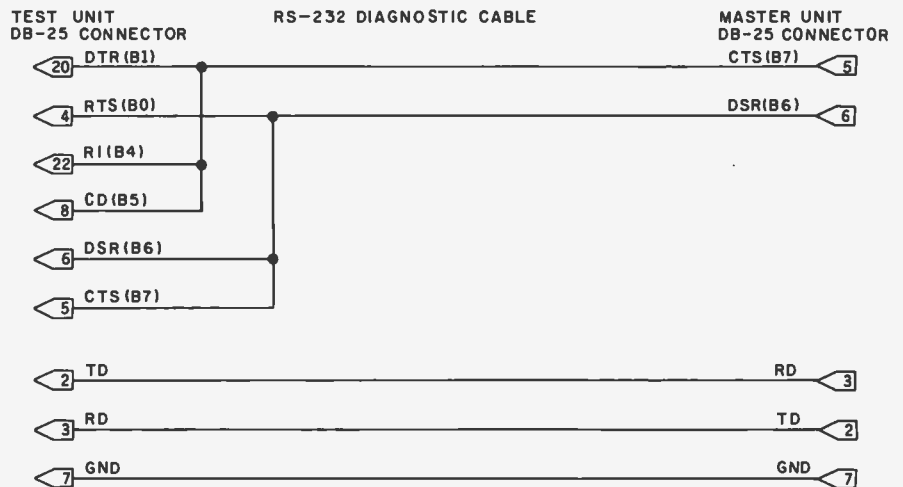

Figure 6: Schematic diagram of the RS-232C interconnection cable between the master and test units.

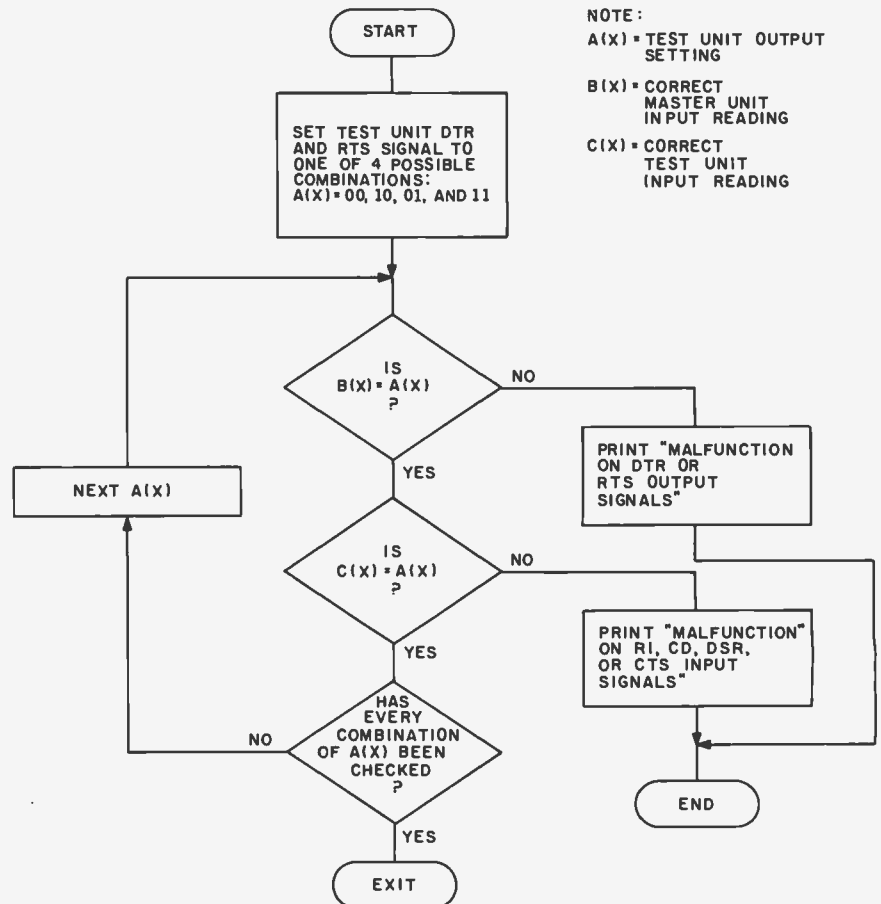

Figure 7: Flowchart showing the sequence of operations of the RS-232C handshaking test.

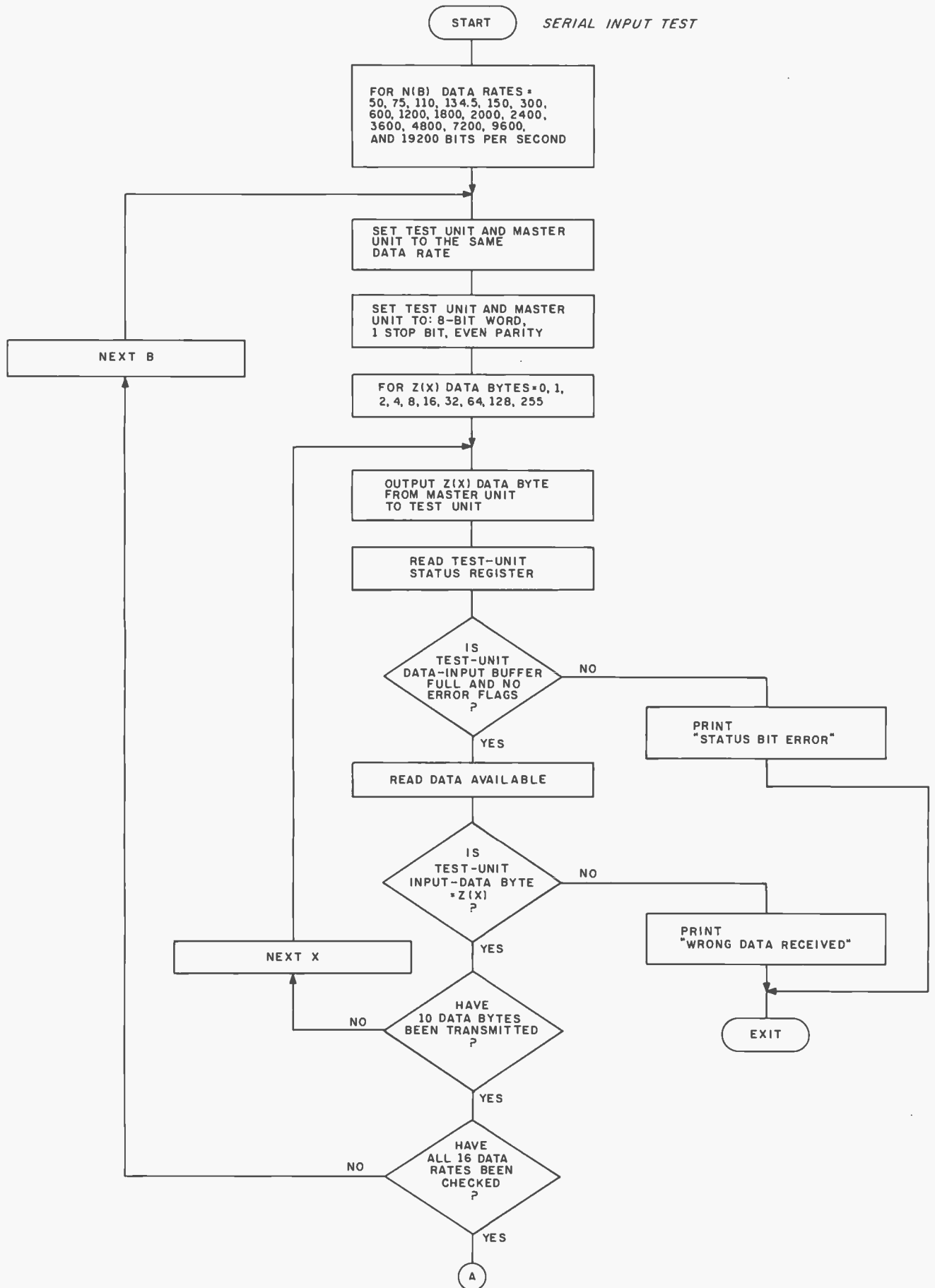
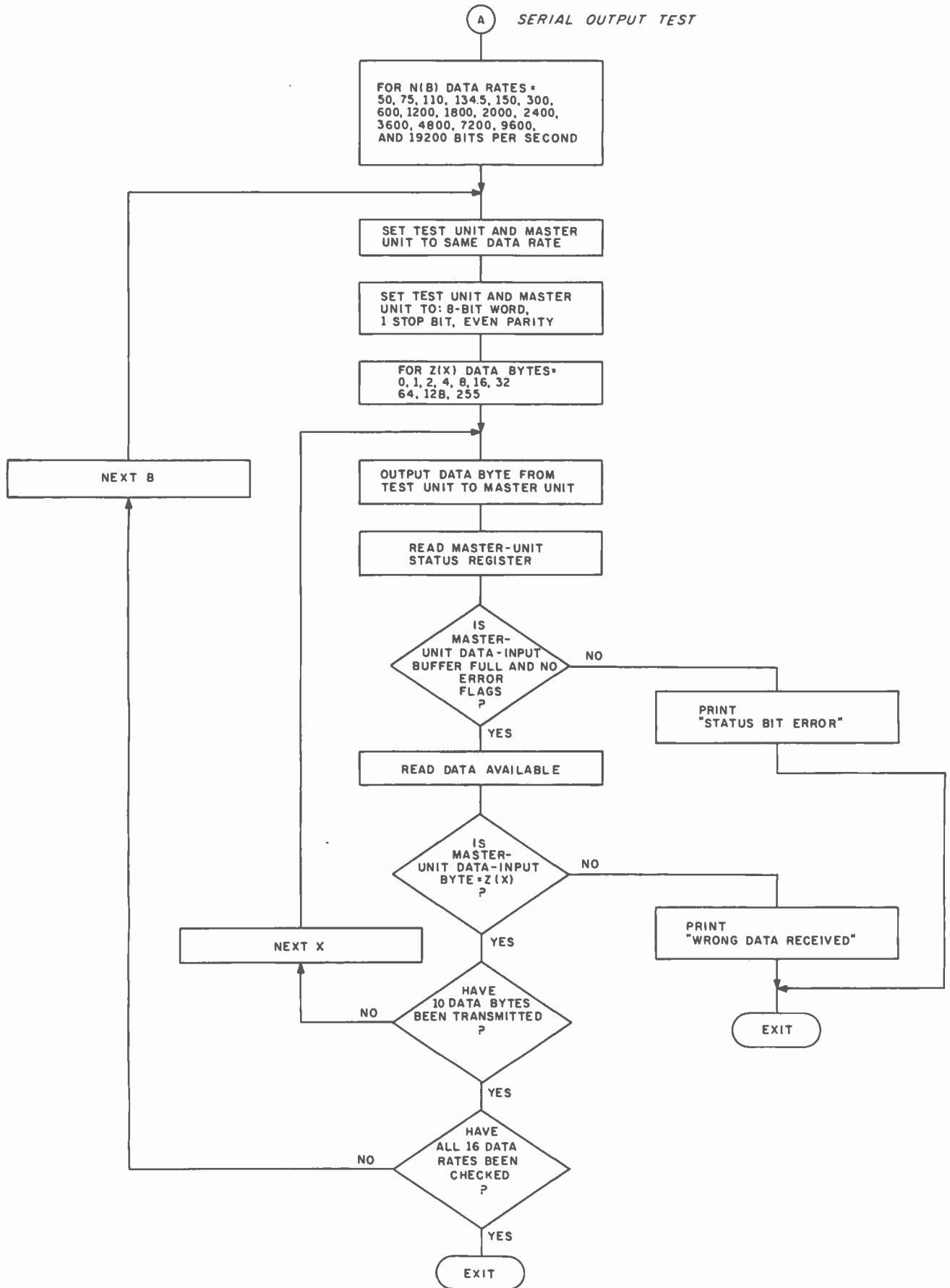

Figure 8: Flowchart of the sequence of operations of the serial input and output tests. Figure 8 continued on page 68

Figure 8 continued from page 67:



NEVER UNDERSOLD!

That's right. If you can find a lower price in this magazine for any of the items listed in this ad, we will reduce our price below our competitor's price. See each box below to determine how much EXTRA we will cut off of THEIR price if we're not lowest. Please consider the competitor's shipping charges, OUR SHIPPING IS FREE!*

FLOPPY DISKETTES & SUPPLIES

IF YOU CAN FIND A LOWER PRICE IN THIS MAGAZINE ON ANY OF THESE ITEMS, DEDUCT \$.50 FROM OUR COMPETITOR'S PRICE, THAT'S OUR PRICE!

Call For Quantity Discounts

Verbatim Diskettes (box of 10)	
5 1/4" MD525-01 soft, 10 or 16	\$26.50
5 1/4" MD577-01 quad soft, 10 or 16	\$33.00
8" FD34-1000 soft	\$30.00
8" FD32-1000 hard	\$30.00
8" FD34-8000 double density soft	\$44.00
8" FD32-8000 double density hard	\$44.00
Printwheels (specify style)	
Qume or Diablo	\$6.50
Labels	
3 1/2" x 15/16" (5000 labels)	\$18.75
Other sizes and quantities	CALL
Ribbons	
Diablo Hy Type I	\$4.95
Diablo Hy Type II	\$5.25
Qume Sprint	\$3.50
Centronics Zip Pack	\$3.95
MANY OTHERS	CALL

PRINTERS

IF YOU CAN FIND A LOWER PRICE IN THIS MAGAZINE ON ANY OF THESE PRINTERS, DEDUCT \$10 FROM OUR COMPETITOR'S PRICE, THAT'S OUR PRICE!

Paper Tiger IDS-440G	\$939
Paper Tiger IDS-460G	\$1193
Anadex DP-8000	\$855
Anadex DP-9500	\$1395
TI-810 Basic	\$1625
Centronics 737	\$825
NEC 5500 D w/ Bidrctnl Board	\$2695
NEC 5530	\$2595
VISTA Daisy Wheel Printer	\$1834
Qume 5/45,5/55	CALL
Escon IBM Interface	\$595

Call For Other Printers

HARDWARE

IF YOU CAN FIND A LOWER PRICE IN THIS MAGAZINE ON ANY OF THESE ITEMS, DEDUCT 5% FROM OUR COMPETITOR'S PRICE, THAT'S OUR PRICE!

Navation CAT Modem	\$145
Novation D-CAT Modem	\$185
16K Memory kit	\$46
Isolatars	\$49
Shugart 351r Drive	\$349
Percor or MPI 40tr Drive	\$359
Lobo Drives	CALL
Matchless Drives	CALL
Percom Doubler	\$209
Percom Separator	\$27
AIM-65 Computer	\$75
TI-99/4 Computer	\$925
California Computer Systems Bds	CALL
Symtec Computer Boards	CALL
Mountain Hardware Boards	CALL
Green Screen	\$11

Call for Other Hardware

4636 Park Granada
Calabasas, Ca. 91302



**Alpha
Byte
Storage**



For phone orders CALL:
(213) 883-8594

SPECIAL #1

If you purchase the "TRS-80
DISK AND OTHER MYSTERIES"
Book for the regular price
of \$22.50
You can buy 10 VERBATIM
DISKETTES AND a plastic library
case for **TOTAL \$44.50**

SPECIAL #2

If you purchase APPARAT
NEWDOS+ for the regular
price of \$99.95
you can buy 10 VERBATIM
DISKETTES AND a plastic library
case for **TOTAL \$104.95**

SPECIAL #3

If you purchase APPARAT
NEWDOS/80 for the regular
price of \$149.00
we will give you 10 VERBATIM
DISKETTES AND a plastic library
case **FREE**
TOTAL \$149.00

SPECIAL #5

If you purchase the new
"MICROSOFT BASIC REVEALED"
book for the regular
price of \$29.95
you can buy 10 VERBATIM
DISKETTES AND a plastic library
case for **TOTAL \$49.95**

SPECIAL #4

If you purchase the MICROSOFT
BASIC COMPILER for the
regular price of \$190.00
we will give you 10 VERBATIM
DISKETTES AND a plastic library
case **FREE**
TOTAL \$190.00

SPECIAL #6

SOFTWARE DEALS: If you want
to purchase any software (in-
cluding Utilities, Operating
Systems, Games, Business Pro-
grams, etc.) we will
automatically deduct from 10%
to 40% off the regular retail
price.

*FREE shipping on all orders over \$20. Visa and Master Card accepted. All never undersold offers good as supply lasts. Please add 2.00 for all COD orders. Please call for items not listed. We gladly answer any questions on all of our hardware, software, and supply needs. Quantity discounts available. School purchase orders accepted. Please remember to figure competitors shipping and handling charges when arriving at never undersold price.

Circle 32 on inquiry card.

ENTREPRENEURS NEEDED

MORE THAN EVER IN THE MICRO-COMPUTER INDUSTRY.

The shortage of knowledgeable dealers/distributors is the #1 problem of microcomputer manufacturers. Over 300 new systems houses will go into business this year, but the number falls short of the 1200 needed. It is estimated that the nationwide shortage of consultants will be over 3000 by 1981. The HOW TO manuals by Essex Publishing are your best guide to start participating in the continued microcomputer boom.

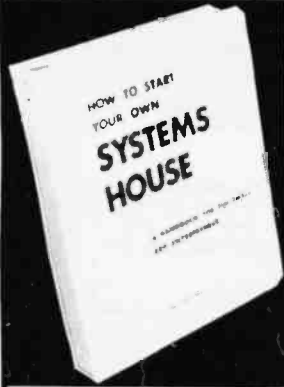

\$36. No. 10

Documentation • Solutions to the Service Problem Now? • How to Write a Good Business Plan • Raising Capital

HOW TO START YOUR OWN SYSTEMS HOUSE

6th edition, March 1980

Written by the founder of a successful systems house, this fact-filled 220-page manual covers virtually all aspects of starting and operating a small systems company. It is abundant with useful, real-life samples: contracts, proposals, agreements and a complete business plan are included in full, and may be used immediately by the reader.

Proven, field-tested solutions to the many problems facing the small systems house are presented.

From the contents:

- New Generation of Systems Houses
- The SBC Marketplace
- Marketing Strategies
- Vertical Markets & IAPs
- Competitive Position/Plans of Major Vendors
- Market Segment Selection & Evaluation
- Selection of Equipment & Manufacturer
- Make or Buy Decision
- Becoming a Distributor
- Getting Your Advertising Dollar's Worth
- Your Salesmen: Where to Find Them
- Product Pricing
- The Selling Cycle
- Handling the 12 Most Frequent Objections Raised by Prospects
- Financing for the Customer
- Leasing
- Questions You Will Have to Answer Before the Prospect Buys
- Producing the System
- Installation, Acceptance, Collection
- The Service Problem
- Protecting Your Product
- Should You Start

HOW TO BECOME A SUCCESSFUL COMPUTER CONSULTANT

by Leslie Nelson, May 1980

Independent consultants are becoming a vitally important factor in the microcomputer field, filling the gap between the computer vendors and commercial/industrial users. The rewards of the consultant can be high: freedom, more satisfying work and doubled or tripled income. **HOW TO BECOME A SUCCESSFUL COMPUTER CONSULTANT** provides comprehensive background information and step-by-step directions for those interested to explore this lucrative field:

- Established consulting markets
- How to get started
- Itemized start-up costs
- Are you qualified?
- Beginning on a part-time basis
- The Marketing Kit
- Should you advertise?
- Five marketing tips
- Getting free publicity
- How much to charge
- When do you need a contract?
- Sample proposals
- Which jobs should be declined
- Future markets
- The way to real big money
- Avoiding the legal pitfalls
- How consultants' associations can help you
- The National Register of Computer Consultants
- How others did it: real-life sample cases
- and much more.



\$28. No. 16

pitfalls • How consultants' associations can help you • The National Register of Computer Consultants • How others did it: real-life sample cases • and much more.

FREE-LANCE SOFTWARE MARKETING

3rd edition, June 1980

Writing and selling computer programs as an independent is a business where • you can get started quickly, with little capital investment • you can do it full time or part time • the potential profits are almost limitless. Since the demand for computer software of all kinds is growing at an explosive rate, the conditions for the small entrepreneur are outstanding.

This manual will show you how to sell your own computer programs using these proven techniques: • direct to industries • through consulting firms • through manufacturers of computer hardware • in book form • mail order • through computer stores. It will show you how to profitably sell and license all types of software ranging from sophisticated analytical programs selling for thousands of dollars, down to simple accounting routines and games for personal computers.

The book will guide you step by step through the process of marketing, advertising, negotiating a contract, installing software, training users and providing maintenance and support. It also contains sample software contracts that have been used in actual software transactions. Also included are tips on how to negotiate with a large corporation, ways of avoiding personal liability, techniques for obtaining free computer time and hints on how to run a free-lance software business while holding a full-time job.

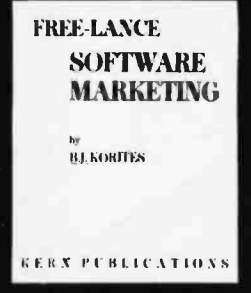

\$30. No. 32

training users and providing maintenance and support. It also contains sample software contracts that have been used in actual software transactions. Also included are tips on how to negotiate with a large corporation, ways of avoiding personal liability, techniques for obtaining free computer time and hints on how to run a free-lance software business while holding a full-time job.

ESSEX PUBLISHING CO. Dept. 2

285 Bloomfield Avenue • Caldwell, N.J. 07006

Order books by number. Send check, money order (U.S.\$), VISA or Master Charge #. Publisher pays 4th class shipping. For Air Mail shipping add \$2.50 per book in USA and Canada, \$5.00 in Europe, \$8.00 elsewhere. N.J. residents add 5% sales tax.

No. 10 No. 16 NO. 32 Check enclosed Credit card

Name _____

Address _____

City _____ State _____ Zip _____

Card # _____ Exp. _____

For faster shipment on credit card orders call (201) 783-6940 between 9 and 5 Eastern time.

Text continued from page 64:

send it at a rate that can be digested. The UART's function is primarily certified by the conversion/transmission and reception/reconversion process rather than the number of characters it can send through the wires. If it works for 1 character per minute, it will work for 100 characters per second. In truth, though, I decided to settle on 10 bytes which exercise each bit and to send each byte with parity enabled. The entire test, automatically checking thirty-two data rates, takes 39 seconds.

You might ask, as an afterthought, why I didn't just loop the input to the output on the test unit and check it that way, rather than utilizing a separate communications channel. The typical failure on a data-transfer-rate generator is that it sticks at one frequency for a group of data-rate settings. If this malfunctioning clock signal is simultaneously applied to both the transmit and receive sections of the UART under test, the data in and out will still be synchronized and no error will be detected. The only true test is to send data at a known rate from an external source and try to read it.

Conclusion

As you think about this presentation and consider possible applications, keep in mind that there are limitations as well as strengths in any high-level language. First, common sense should tell you that high-level languages suit only smaller applications. BASIC gets bogged down in both programming confusion and execution time as programs get larger than 4 K bytes.

On the other hand, appreciate it as a learning tool for understanding control applications with limited stress on the programmer. BASIC is an excellent language for becoming introduced to man-machine interfacing. A good programmer will not stop there and will soon become interested in more complete languages such as FORTH and tiny-c, which can be expanded to meet the specific problems.

You have to start somehow, and this way is fairly painless. ■

Next Month:

Are you blacking out the neighborhood with your computer? EMI (electromagnetic interference) will be discussed.

NOW THE SOFTCARD™ CAN TAKE YOU BEYOND THE BASICS.



You probably know about the SoftCard—our ingenious circuit card that converts an Apple II® into a Z-80® machine running CP/M®.

You may even know that with the SoftCard, you get Microsoft's powerful BASIC—extended to support Apple graphics and many other features.

Now, whenever you're ready to get beyond the BASICs, the SoftCard can take you into whole new realms. Starting with two advanced language packages from Microsoft.

FORTRAN AND COBOL TO GO.

Now you can run the world's most popular engineering/scientific language and the most popular business language on your Apple. Think what that means: you can choose from literally thousands of "off-the-shelf" applications programs, and have them working with little conversion. Or design your own programs, taking advantage of all the problem-solving power these specialized languages give you.

FORTRAN-80

A complete ANSI-standard FORTRAN (except COMPLEX type), with important enhancements. The extremely fast compiler performs extensive code

optimization, and, since it doesn't require a "P-code" interpreter at run time, your programs will typically execute 2-3 times faster than with Apple FORTRAN.

FORTRAN is easy to learn if you know BASIC, and the package includes a huge library of floating point, math, and I/O routines you can use in all your programs.

COBOL-80

Virtually the only choice for serious business data processing.

It's ANSI 1974 standard COBOL, with many user-oriented features added: formatted screen support for CRT terminals, simple segmenting of very large programs, powerful file handling capability, trace debugging, and much more. A separate Sort package is coming soon.

FORTRAN-80 and COBOL-80 are just two more reasons why the Apple with SoftCard is the world's most versatile personal computer. Get all the exciting details from your Microsoft dealer today. And start getting beyond the BASICs.

MICROSOFT Consumer Products, 400 108th Ave. N.E., Suite 200, Bellevue, WA 98004. (206) 454-1315.

SoftCard is a trademark of Microsoft. Apple II is a registered trademark of Apple Computer, Inc. Z-80 is a registered trademark of Zilog, Inc. CP/M is a registered trademark of Digital Research, Inc.

MICROSOFT

And now for the per

Introducing 7 data-shielding improvements from Verbatim for greater disk durability, longer data life.

Improvements to protect your data from head-to-disk abrasion. Improvements to shield your data against loss due to environmental conditions. Improvements that'll deliver a longer lifetime of trouble-free data recording, storage and retrieval than ever before possible.

It's all made possible by Verbatim, with these improvements:

1. A longer-lasting lubricant. Our new lubricant is more resistant to diffusion, to protect against data-destroying head-to-disk contact.

2. An improved liner. Our new liner cleans and

removes debris better. It also enables more lubricant to reach the recording head, protecting against head wear.

3. A thicker, more durable coating. Our disks have a more uniform oxide coating for more adhesive and cohesive strength. We've also made it thicker, providing 10% more protective lubricant and an optimized signal resolution for the new recording heads.

4. Advanced polishing techniques. Our burnishing makes our disks uniformly smooth, for better data transfer, less head wear.

5. Reinforcing hub rings. All Verbatim disks are available with hub rings to aid in registration, eliminate slippage, reduce errors, and give



Datalife™
Means 7 data-shielding improvements
for greater durability, longer life.

Ver

formance of a lifetime!

better alignment repeatability.

6. Testing standards that go far beyond industry standards. Every Verbatim disk meets or exceeds the most demanding of IBM, Shugart, ANSI, ECMA and ISO standards—because we insist on Verbatim being the industry standard of excellence.

We analyze raw materials down to their molecular content. We subject every coating batch to more than 70 chemical, magnetic and electrical tests. Two separate test groups employ life-cycle tests using more than 400 disk drives from every manufacturer. And we conduct "worst case" testing of every bit of every byte of every track of every single disk. All to insure that Verbatim disks always pass the ulti-

mate test: satisfying you.

7. A 100% Error-Free Certification that means more than just "100% error-free!" Our certification isn't based on random sampling, or statistical averaging. Rather, it's based on extensively testing every single disk. So we can state that our disks really are 100% error-free, and back it up with a **one year warranty.**

"Try new Verbatim for the performance of a lifetime."



flexible disks

Datalife
Means 2 data shuffling improvements
for greater durability. Longer life.

minidisks.

Verbatim

We play it back, Verbatim!

Product Review

Dungeon Campaign

Gregg Williams, Editor

One of my favorite games for the Apple II is *Dungeon Campaign*, from Synergistic Software (see "At a Glance" box for details). I cannot think of any game that causes such delight in playing, and I cannot think of a game that offers so much entertainment per unit of program. *Dungeon Campaign* is an example of fine game design and expert use of limited resources. Even though it does not use either game paddles or high-resolution graphics, it is far more entertaining than most games that do.

When the game begins, the computer draws four levels of mazes and erases them (this takes a minute or two). It has just created the maze that you will explore. After the full maze has been created, the program places you in the middle of a blank area that represents the top level of the maze. You use five 1-keystroke commands (U, D, R, L, and J) to move your explorer group (shown as a red square) up, down, right, or left (J for jump can precede any of these commands to jump over a square that might contain danger). As you move in the maze, adjacent walls become visible, allowing you to explore the level you are on. If you are lucky in your explorations, you will find some treasure, your group of explorers will not be totally destroyed, and you will leave the bottom level of the maze, thus winning the game.

The object, of course, is to find treasure; but in your explorations you may find stairways, pit traps, monsters, poison gas, man-eating dragons, and several other inhabitants; I will not tell you about these others to give you the surprise of discovering them. Combat with different kinds of monsters is resolved by die rolls for each side and subsequent computation (all done by the program); this gives the program an entertaining *Dungeons and Dragons*-like flavor.

The program is, at times, subtle. For example, sometimes the bottom level is drawn with the single exit blocked off (the maze is randomly created for each game). At first, I thought there was no way to leave the maze and win the game. But, in a later game, I discovered a "magic carpet" treasure that can be used only once to take your explorers over walls. This is an indication of the sophistication of this seemingly simple (but always enjoyable) game. ■

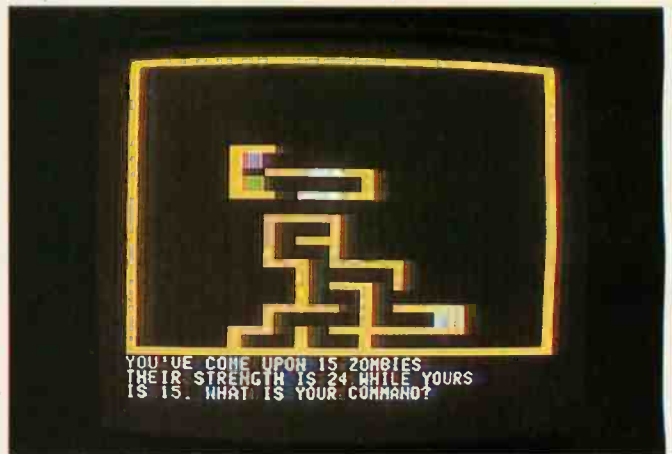

Photo 1: A partially explored maze in *Dungeon Campaign*. The red and green squares in the middle of the display are the explorers and a group of zombies, respectively, that are about to do battle. The thick white lines denote a stairway, while the light blue square near the bottom represents a hazard of unknown kind (at the moment).

At a Glance

Name <i>Dungeon Campaign</i>	versions supplied in each package)
Type Low-resolution color graphics game	Computer Apple II or Apple II Plus, with 32 K bytes of memory (16 K bytes for cassette Integer BASIC version)
Manufacturer Synergistic Software 5221 120th Ave SE Bellevue WA 98006 (206) 641-1917	Documentation Instruction sheet plus instructions in program
Price \$15 cassette, \$17.50 disk	Features Sound effects through Apple II speaker
Format Cassette tape or 5-inch disk	Audience Game enthusiasts of all ages (simple enough for children)
Language Applesoft and Integer BASIC versions (both	

The best news since CP/M... customizable full screen editing

North Star
Heath H8/H89
Super Brain

Sorcerer
TRS-80 Model I
TRS-80 Model II

Most other CP/M Systems with
CRT or Memory Mapped Displays.

Changes You Make On the Screen Become The Changes to the File.

Full screen editing is the fastest and easiest method of editing all types of text files. Straight forward enough for novices, yet also the choice of professionals. VEDIT is a proven full screen editor with unequalled features. You will appreciate that you can easily edit 10 times faster than with a command editor. Since VEDIT is customizable, it adapts to your applications and preferences, instead of requiring you to adapt to it.

VEDIT is ideally suited to program development and it's special features make it the most valuable development tool a programmer can have. VEDIT appeals to word processing users too. Many simple text editing tasks, such as mailing lists, are faster and easier to do with VEDIT than with more complex word processors.

Features of VEDIT:

Full screen editor with status line and cursor. The screen continuously displays the region of the file being edited. Changes are made by first moving the cursor to the text you wish to change. You can then overwrite, insert any amount of new text or hit a function key. These changes are immediately reflected on the screen and become the changes to the file.

Full array of cursor movements with single key movement to begin and end of lines and to tab positions.

Function keys for character delete, line delete and allowing line splitting and concatenating.

Text movement is very easy using a text register.

Flexible command mode allows global search and substitute, repetitive editing operations.

File handling allows files to be merged on input, split on output, drive selection and more. Blocks of text are readily copied from one file to another.

Disk buffering can automatically perform Read/Write for files larger than available main memory.

Tabs settable to any positions. Tab key inserts tab character or spaces to next tab position.

Extensive 60 page, clearly written manual with sections for both the beginning and experienced user.

You Customize the Fastest Editor for Word Processing, C-Basic, Fortran and Assembler:

Keyboard layout for all cursor and function keys.

Your screen size. (Up to 70 lines, 200 columns).

Default Tab positions and various parameters.

Scrolling methods.

Cursor type, blinking, reverse video.

Its ideal for diverse hardware, keyboards and applications.

For OEMs too.

Ordering: Specify your CRT terminal type, video board or microcomputer, the 8080/Z80 or Z80 code version, and disk format required.

Standard Package: Disk and manual \$110

Manual: Price refunded with software purchase \$ 15

PIICEON V-100: 24 X 80 Video display board . . \$445

VISA and MASTER CHARGE Welcome.
Attractive Dealer Terms.



Compuview Products, Inc.

618 Louise / Ann Arbor, Michigan 48103

Call Anytime - (313) 996-1299

SUPER

Now With Multi-Key Capabilities For Apple & Pet

Since KRAM™ was introduced in 1979 it has fast become known as the users. Now, after hundreds of requests we have added MULTI-KEY,

IBM/370 users have VSAM (Virtual Storage Access Method) to provide fast, flexible keyed-access to their data. Now SUPER KRAM (Keyed Random Access Method), from United Software of America, gives Apple and Pet users the same flexibility, substantially increasing the processing power of the Apple and Pet.

Until SUPER KRAM the only "random access" capability in the Apple and Pet consisted of a crude form of "relative record" processing. While this is usable for very simple applications, it falls far short of the needs of today's business and analytical applications. Using SUPER KRAM records may be processed by any one of multiple "Key" values, which may consist of any kind of data: numbers, letters, special characters, etc. Even Apples's long-awaited DOS 3.3 doesn't have anything like this!!

KRAM™ 2.0 Regular Features

- Written in 6502 machine code
- Basic compatible
- Create/Open a dataset
- Put record by key
- Add & delete records by key
- Get any record by Full/Partial key
- Access by any key in as little as .2 sec. (.1 sec. with Corvus disk)
- Supports multiple disks
- Read next or previous record
- Dynamic space allocation
- Dynamic space reclamation
- Dynamic index compression
- Files never need reorganization
- Compatible with language systems

KRAM™ 2.0 Only \$99.95

APPLE / ATARI

"Precise, humanized, well documented an excellent value" are the applauds being given

**3-D
ANIMATED
COLOR
GRAPHICS**

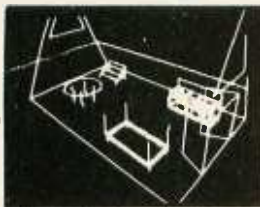

Written in machine code.

APPLE WORLD by Paul Lutus

The Program made famous on National TV!

Look for the RED-WHITE-BLUE
United Software Display at your local
computer dealer, or send check or
moneyorder, plus \$3.00 shipping to:

**USA UNITED
SOFTWARE
OF
AMERICA**

750 3RD Avenue,
New York NY 10017
(212) 682-0347 Telex 640055

DEALER INQUIRIES INVITED

APPLE WORLD turns your Apple into a sophisticated graphics system capable of creating animated three-dimensional color images, projecting them in true perspective on the screen, rotate them, move them closer, further away, and many other exciting and imaginative things.

Draws objects with 65,000 points per side.

A powerful screen-oriented text editor is included to facilitate image formation. This program was recently featured on Tom Snyder's Prime Time Saturday TV Show and is now available for sale.

APPLE WORLD'S powerful editor is so easy to use that children will love it. You can now "sketch" your dream house, boat, car, or fantasy empire. Then view it as it would be seen from 10,000 feet, or you can ZOOM in until the screen is filled with a doorknob. You could then go inside and move from room to room examining furniture placement as your screen rotates within the room. Images or specific parts of images can easily be saved to disk or printer.

Does all this sound like science fiction? You won't think so after you have visited Apple World.

Introductory Price \$59.95

36 page manual included

For 48K Apple II or Plus with Disk

KRAM™

By Ken Germann

You've Asked For It, Now You Got It!

quickest and most powerful access method for serious Apple and Pet MULTI-INDEX, functions, as well as increasing processing speed.

SUPER KRAM'S™ Added Features

- MULTIKEY SUPPORT — Allowing simultaneous access to a KRAM file by more than one key field.
- HI-SPEED READ — This feature allows increased I/O speed up to 60% faster during processing of SUPER KRAM read next, read previous, put and delete requests.
- IMPROVED INDEX ARCHITECTURE — Allowing faster index searches and more efficient disk space utilization.
- INTEGRATED BASIC COMMANDS — Allowing SUPER KRAM™ commands to be coded in-line with Basic, providing easier usage of KRAM than ever before.
- USER-SPECIFIABLE BUFFER POOL — Allowing the user to specify how many KRAM files are allowed open at one time; will support any number of KRAM files.

- LOGICAL RECORDS (KEYS MAY BE NON-UNIQUE) — Records added to the KRAM files are immediately accessible by any of the defined keys for the file (Automatic Upgrade).
- KRAM 2.0 files are totally compatible with SUPER KRAM

Requirements

Apple & Pet requirements - KRAM 2.0 and SUPER KRAM are designed to work with both Apple II's, Disk II, and Corvus Systems 10 Megabyte Winchester Disk, and Commodore's 2040, 3040, and 8050 Disk units. KRAM 2.0 and SUPER KRAM require 32K/48K Apple and a least on disk drive. (KRAM 2.0 requires Integer Basic in ROM). KRAM and SUPER KRAM work on any 40/80 column 16K/32K Pet.

SUPER KRAM™ Only \$175

BREAKTHROUGHS

these sophisticated programs designed to meet the stringent needs of individuals and business professionals.

NEW 3-D SUPERGRAPHICS & 3-D GAME DEVELOPMENT SYSTEM IN COLOR

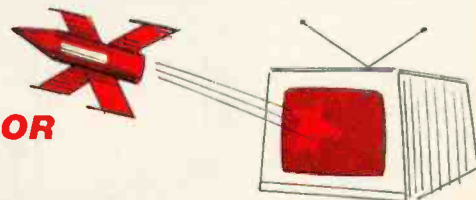

by Paul Lutus

Watch colorful butterflies, birds, fly across your Apple or Atari screen with true 3 dimensional perspective. Have rocket ships fly out at you in this incredible high speed graphics package. 3-D SUPERGRAPHICS™ is a 6502 machine language program that will interface to your Basic or machine language programs or games using simple "DOS-like" commands.

Features include:

- Simple image entry through editor
- Objects up to 256 points per side
- Uses all hi-res colors
- Allows mixed colored text & graphics for prompts and captions
- Translates on 3 axes
- Individual axis scales
- 21 different commands
- Rotate object by 1.4° to 360° increments at machine speeds

**For 48K Apple II or Plus with
Disk II \$39.95 for disk**

**For ATARI 800 with 40K memory
(disk optional) \$39.95 for tape**

FOR COMMODORE 16K/32K COMPUTERS

DATABASE MANAGEMENT SYSTEM — A comprehensive, interactive system like those run on mainframes! Six modules comprising 42K of programming allow you to; create, edit, delete, display, print, sort, merge, etc. - databases of up to 10,000 records. Printer routines automatically generate reports and labels on demand. 60 pages of concise documentation are included. Requirements - 16-32K PET and 2040 Dual Disk (printer optional) **COST \$125**

OTHER SOFTWARE

	Stock Analyzer	22.95	
	Mortgage	14.95	
	Space Intruders		
	("Best Game of 1979") ..	\$19.95	
Super Space Wars	\$ 9.95		
States & Capitals	9.95		
Moving Point		9.95	
Average	19.95		
Stock Options	24.95		
Finance	12.95		
Bonds	12.95		
	Kentucky Derby/Roulette	9.95	
	Alien I.Q./Tank	9.95	
	Tunnelvision/Maze Chase	14.95	
	Submarine Attack	9.95	
	Battle of Midway	7.95	
	Laser Tank Battle.....	9.95	
	Swarm	14.95	
Stock Options	24.95	Baseball	9.95
Finance	12.95	Super Startrek	14.95
Bonds	12.95	PET Music Box	29.95

Product Review

A Stellar Trek

Harold Nelson, Editor

You, captain of the starship *Enterprise*, begin your task of freeing the galaxy from the threat of the Klingon Empire and its Romulan allies by selecting the members of your crew. Next you must make some general strategy decisions.

There are two types of encounters (games) to choose from. Regular games are always different, while tournament games have identical outcomes if played in the same way. This is an interesting feature, because most games of this type are either *stochastic* (output from a given input is somewhat random) or *deterministic* (output from a given input is fixed). This feature of choice between these two kinds of games opens many possibilities for developing and practicing strategies, competing against other players, and still not "running out of game" as soon as a game has been successfully completed.

At a Glance

Name
A Stellar Trek

Type
High-resolution color graphics game

Manufacturer
Rainbow Computing Inc
9719 Reseda Blvd
Northridge CA 91324
(213) 349-5560

Price
\$24.95

Format
5-inch floppy disk

Language
BASIC

Computer
Apple II with 48 K bytes of memory, with Apple-soft floating-point BASIC, and a color display

Documentation
Photocopied, 8½ by 11 inch stapled packet with a table of contents for sections on game operation and descriptions of commands.

Audience
Star Trek fans and others 9 years old and up interested in Adventure-type games

THE FIRST TRS-80[®] COMPATIBLE COMPUTER WITH HIGH DENSITY COLOR GRAPHICS!

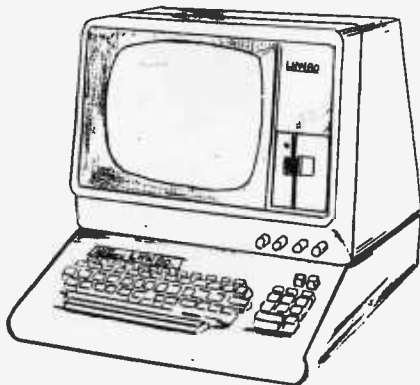

LNW80
PC BOARD **\$89.95**

Ask about our: Keyboard cabinet
Leadex VIDEO 100-80

LNW RESEARCH

LNW RESEARCH 3183-E AIRWAY AVE COSTA MESA CA 92626 714-562-8846

*Apple II is a TM of Apple Computer, Inc
TRS-80 is a TM of Tandy Corp

LNW RESEARCH introduces the LNW80, a high performance color computer, compatible with the TRS-80[™] Model I. The fully integrated LNW80 is a sophisticated and versatile microcomputer with the following powerful features.

COMPATIBILITY

Hardware and software compatible to the Radio Shack TRS-80[™] Model I computer, provides the widest software base of any microcomputer. cassette interface; expansion bus

DISPLAY

Quality upper and lower case display.

Two modes of color graphics, high resolution graphics, 384 x 192 in eight colors - higher density than the Apple II! Low density color graphics of 128 x 192 are also available in eight colors.

High resolution - black and white graphics - of 384 x 192 mixed with text and TRS-80[™] standard graphics.

Reverse video, composite video, RF output.

PERFORMANCE

The LNW80 utilizes the fast Z-80A microprocessor which executes at a speed of 4 MHz - over twice the speed of the TRS-80[™] Model I.

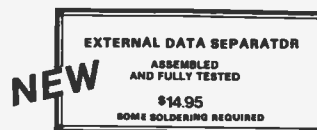

SYSTEM EXPANSION
AT **\$69.95** [PC BOARD & USER MANUAL]

- SERIAL RS232C/20-mA I/O
- FLOPPY CONTROLLER
- 32K BYTES MEMORY
- PARALLEL PRINTER PORT
- DUAL CASSETTE PORT
- REAL-TIME CLOCK
- SCREEN PRINTER BUS
- ONBOARD POWER SUPPLY
- SOFTWARE COMPATIBLE
- SOLDER MASK, SILK SCREEN

ORDERING INFORMATION

Add \$3 for postage and handling. CA residents add 6% sales tax.



a **WORD** to the wise...



IMM technology has developed a new innovative memory board with your future in mind. This compact static memory will operate in your present 8 bit S-100 system with built-in flexibility to handle 16 bit transactions when you are ready for it.

Sound engineering and common sense were the basic ingredients in our design parameters for the IMM-816. Your needs were our guidelines. The end result is a reliable memory with remarkable features at competitive prices.

MODEL IMM-816

- * FULL IEEE COMPLIANCE
- * LOW POWER 5257 STATIC MEMORIES
- * 8 BIT EXTENDED ADDRESS OPTION
- * ADDRESSABLE IN 2 SEPARATE BLOCKS OF 8K BOUNDARY
- * OPERATES IN 8 or 16 BIT S-100 SYSTEMS
- * IEEE OR NON IEEE SYSTEMS
- * PHANTOM LINE ENABLE
- * WAIT STATE ENABLE OPTIONS (0-2)
- * MWRT/PWR OPTION
- * 16 ENABLE

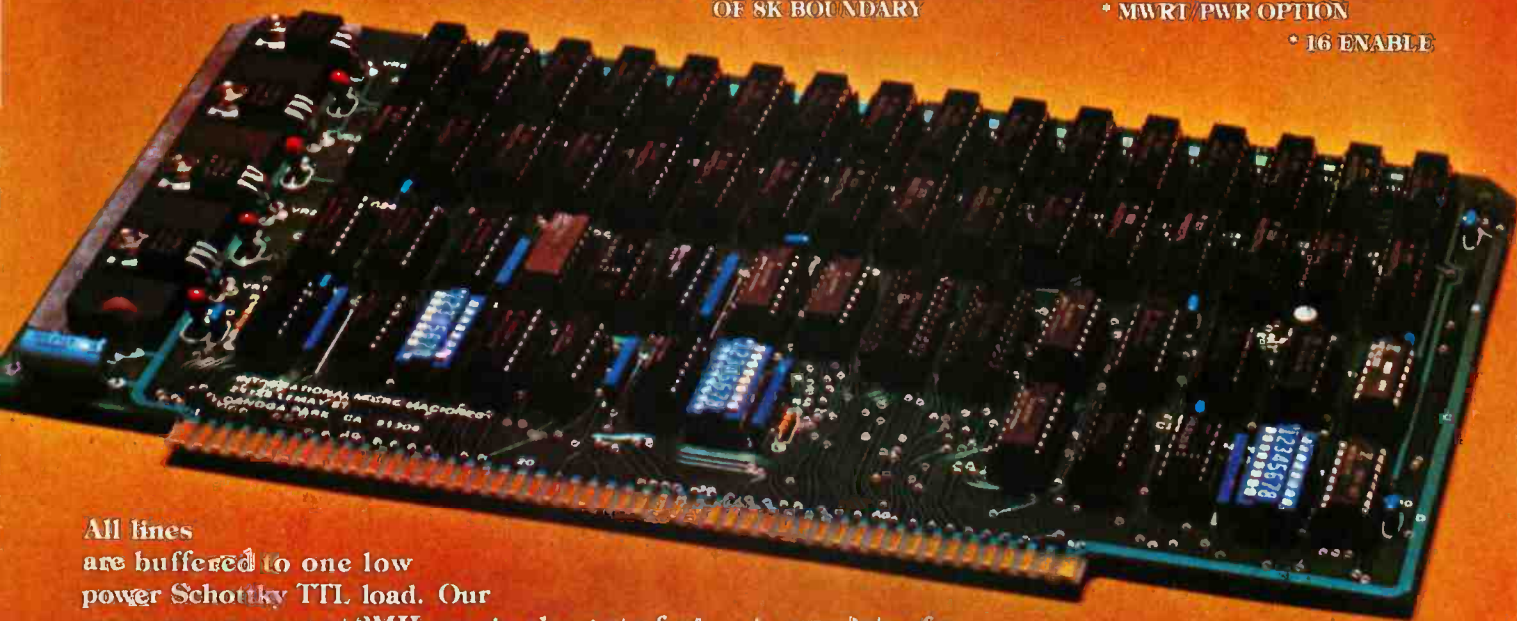

All lines are buffered to one low power Schottky TTL load. Our memory can coast at 2MHz or zip along at a fast 4MHz clip. All functions are DIP switch selectable without wire jumpers. We used high quality parts such as the Augat face-grip, low profile sockets to assure maximum component retention.

If your system employs Bank Select operation, our Memory Manager Card (Model IMM-900) may be used to emulate virtually any bank select format currently in existence; ie. Cromemco, Alpha Micro, Horizon, etc. The memory management card

consists of a simple I/O port, switch selectable to any 8 bit address. Data is written to 8 IEEE extended address lines (A16-A23) to set the desired active bank.

IMM 816K-45	2MHz KIT	\$ 290
IMM 816K-25	4MHz KIT	\$ 315
IMM 816A-45	2MHz Assembled & Tested	\$ 325
IMM 816A-25	4MHz Assembled & Tested	\$ 350
IMM 900K	KIT	\$ 65
IMM 900A	Assembled & Tested	\$ 95
Charge Cards are accepted		



INTERNATIONAL MICRO MACHINES

24125 Lamay Street

Canoga Park, California 91306 • (213) 887-5737



BW-2630 Battery Tool

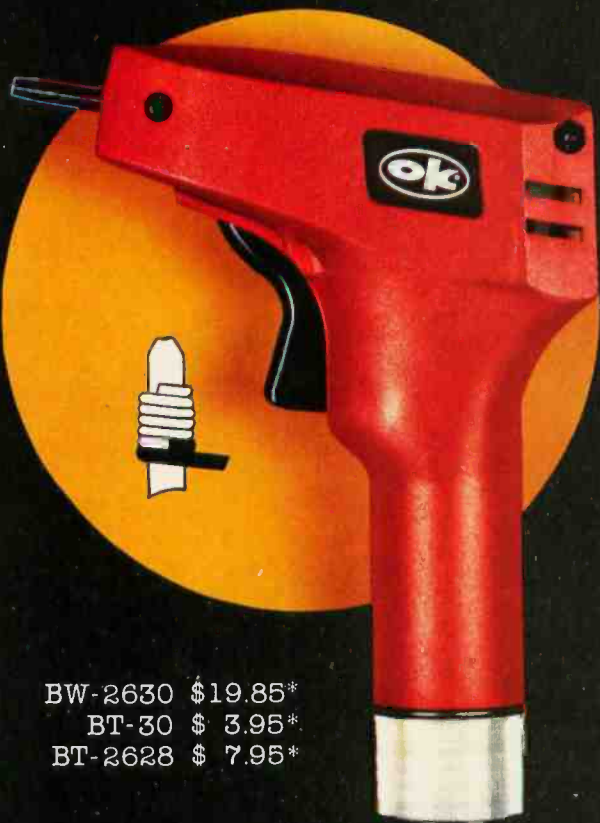

BW-2630 \$ 19.85*
 BT-30 \$ 3.95*
 BT-2628 \$ 7.95*

BW-2630 BATTERY TOOL

The new BW-2630 is a revolutionary battery powered wire-wrapping tool. The tool operates on 2 standard "C" size NiCad batteries (not included) and accepts either of two specially designed bits. Bit model BT-30 is for wrapping 30 AWG wire onto .025" square pins; BT-2628 wraps 26-28 AWG wire. Both produce the preferred "modified" wrap.

Designed for the serious amateur, BW-2630 even includes both positive indexing and anti-overwrapping mechanisms — features usually found only in industrial tools costing five times as much. Pistol grip design and rugged ABS construction assure performance and durability. In stock at local electronic retailers or directly from

OK Machine & Tool Corporation
 3455 Conner St., Bronx, N.Y. 10475 U.S.A.
 Tel. (212) 994-6600 Telex 125091

*Minimum billings \$25.00, add shipping charge \$2.00
 New York State residents add applicable tax



Photo 1: The Klingon ship in sector 9 (row), 9 (column) fires on the Enterprise in sector 5,2. In addition to the Enterprise and three Klingon ships, there are six stars in this quadrant. To the right of the quadrant display is important status information. Below that is a grid giving information on the quadrants surrounding the one currently occupied by the Enterprise, with the displayed quadrant in the center. In the space below the display you are given some messages and enter your commands.



Photo 2: A photon torpedo from the Enterprise is on its way to the Klingon ship in sector 3,1.

Your next decision is to determine the length of your trek (in stardates, not real time). The longer the game, of course, the more opponents you will have to overcome.

Finally, you will select the level of difficulty for your encounters. The choices range from Novice (quite easy), through Expert (extremely difficult), to Emeritus (perhaps not humanly possible).

Having made your choices, you are ready to begin your mission. From this point on, the format for playing *A Stellar Trek* is basically that of the standard *Star Trek* games. You can move about the galaxy of sixty-four "quadrants" seeking Klingons or visiting starbases for energy and repairs. The Move commands (manual or automatic) require some thought and care in execution, but the documentation explaining their use is quite clear.

When you encounter Klingons or Romulans, you can do battle using either phasers or photon torpedoes. Again, use of these commands requires some care but here, too, the documentation is very good (see box).

The Perfect Fit

The Micromodem II data communications system and the Apple II* computer. What better combination to maximize the capabilities of your personal computer!

This popular direct connect modem can transmit data between an Apple II and another Apple II, a terminal, another microcomputer, minicomputer or even a large time-sharing computer anywhere in North America. The Micromodem II has unique automatic dialing and answer capabilities which further increases the communications possibilities between the Apple II and another computer or terminal.

You can send and/or receive messages or data when you are out of your office, home or out of town. Your branch business locations can communicate with each other regarding inventory and other matters over the phone. Or you can communicate with friends across the country. And you can access information utilities like the SOURCE for various business and personal applications.

The Micromodem II consists of two parts. One part includes the printed circuit board which holds the Micromodem II, ROM firmware and the serial interface. The board plugs directly into the Apple II providing all the functions of a serial interface card plus programmable auto dialing and auto answer capabilities. The on-board ROM firmware enables the Micromodem II to operate in any of three modes to perform different tasks-terminal mode, remote console and program control mode.

The other part of the Micromodem II datacomm system is a Microcoupler which connects the Micromodem board and Apple II to a telephone line. The Microcoupler gets a dial tone, dials numbers, answers the phone and hangs up when a transmission is over. There are none of the losses or distortions associated with acoustic couplers. The Microcoupler is compatible with any North American standard telephone lines and is FCC-approved for direct connection in the U.S. It works with standard dial phone service or Touch-tone service.

The Micromodem II is completely compatible with Bell 103-type modems. Full and half-duplex operating modes are available as well as speed selectable transmission rates of 110 and 300 bps.

Why not increase your Apple II's capabilities by outfitting it with the sophisticated Micromodem II data communications system? The Micromodem II is available at retail computer stores nationwide. For the store nearest you, call or write:



Hayes Microcomputer Products Inc.

5835 Peachtree Corners East, Norcross, Georgia 30092 (404) 449-8791

™ Micromodem II is a trademark of Hayes Microcomputer Products, Inc.

* Apple II is a registered trademark of Apple Computer Inc.

The Micromodem II can also be used with the Bell & Howell computer.



\$99* For The GENERAL

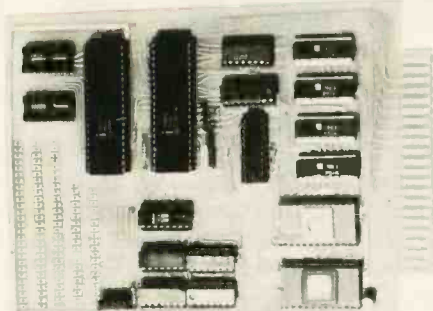

The Micro Computer General 85

FOR USE IN:

- OEM Industry
- Laboratory
- University
- Home

The **General** is a 4.5" x 6" single board micro computer, ideal for industrial control applications as well as for dedicated test monitoring systems, communication subsystems, small scale data processing and front end processing. Through its advanced design, it is adaptable for data logging, data acquisition, prototyping and experimenting.

Program development is facilitated through the General's "Expeditor" system monitor. The Expeditor has specialized commands for **automatic baud rate selection** — **uploading and downloading** which speed up development and cut down on "hidden" program costs. An optional assembler and disassembler on a 2716 will compliment the Expeditor and will further reduce programming time and cost.

The General comes complete with the Deluxe Users Manual which offers complete instructions on hardware and software usage.

THE GENERAL — ONE POWERFUL COMPUTER SYSTEM

HARDWARE FEATURES

- Board dimensions — 4.5" x 6"
- 8085 A CPU
- 4 Level programmable interrupt
- 3 Priority interrupts
- 2 Non-maskable interrupts
- 256 Bytes of programmable memory (expandable on board to 2 K bytes of either Static Ram or CMOS Ram with battery back-up)
- 2 K Bytes of EPROM — expandable on board to 4 K bytes
- 22 Programmable parallel I/O lines (ports)
- 8 Bit memory mapped port
- Programmable 14 bit binary counter and timer controlled through the system software
- Software compatible with the 8080

The GENERAL MCG-85 \$99.00

The GENERAL MCG-85 \$135.00

(Assembled & Tested)

2 K Expansion Rom \$30.00

2 K Expansion Ram \$30.00

SOFTWARE FEATURES

EXPEDITOR — 2 K SYSTEM MONITOR

- **Automatic Baud Rate Selection** (50-9600 Baud)
- **Downloading** — from a computer that supports an assembler. This will enable the user to develop programs on a time sharing service, a larger computer, and download directly to the Ram of the General.
- **Uploading** — Develop programs on the General and upload them to a computer that supports a disk drive for program storage.

Hex Keypad and Display \$69.00

2 K Basic In Rom \$59.00

2 K Assembler & Disassembler \$40.00

Expeditor Monitor Listings \$29.00

(Manual Form)

Send certified check (regular checks require 2 weeks to clear) or charge to Visa or Master Card. Add \$3.00 shipping. N.Y. residents add 8% sales tax.

* In Kit form, single quantity, introductory offer.

Dealer Inquiries Invited

ATLANTIS COMPUTERS

Division of

Atlantis Computerized Services

34-13 30 Ave. Astoria, NY 11103

(212) 728-6700

A *Stellar Trek* also has several interesting commands not present in standard versions of *Star Trek* games. For example, you can scan a nearby planet for dilithium crystals. If they are present, you can beam down to the planet, mine the crystals, and return them to the *Enterprise*. The dilithium crystals can then be used as an emergency source of energy, though they tend to be unstable. You can, if you are desperate enough, employ an experimental death ray. Even if the *Enterprise* is abandoned or destroyed, all is not necessarily lost.

An important feature, since games can take a very long time, is the Freeze command. This enables the player to save the game being played for later completion.

A *Stellar Trek* makes very fine use of the Apple II high-resolution graphics. (See photos 1 and 2.)

As indicated above, this game is not played in real time. The only annoying aspect of the game, in fact, is the amount of time it takes for displays to change, to enter new commands, and to be able to react to new situations. It also takes an awfully long time for a photon torpedo to find (or miss) its target.

Apart from the fact that this is not a fast-paced game, it is, in all other respects, an excellent version of an old standard. It requires thought, planning, and some luck. It provides engaging enjoyment (or frustration for the unwary). A *Stellar Trek* is a very fine game and makes good use of the capabilities of the computer. ■

Note: The documentation contained in the original package received did not explain all of the options available with the use of the phasers. However, a call to the people at Rainbow Computing Inc resulted in an updated version of the documentation. This new version nicely clarifies all possible uses of the phasers and a few other matters in addition. This immediate action based on our suggestions is very impressive. It seems that this company has a sincere interest in user satisfaction from its software.

BYTE's Bits

Call for Papers

The Software Engineering Technical Committee of the IEEE Computer Society is soliciting papers for the Software Engineering Standards Applications Workshop on August 18 thru 20, 1981, in San Francisco, California. Suggested topics include the selling of standards, process standardization versus product standardization, unrealizable standards, standards enforcement, factors in standards selection and tailoring, effectiveness of standards and the case against standards.

Five copies of presentation proposals are requested; they should consist of a 750-word summary. Final papers should be approximately 3000 words. Mail proposals by January 26, 1981. Acceptance notification and author kits will be sent by March 30, 1981. Send proposals to E Bersoff, CTEC Inc, 7777 Leesburg Pike, Falls Church VA 22043. For additional information, contact Robert M Poston, EAI, 185 Monmouth Pky, West Long Branch NJ 07764, (201) 229-1100. ■



BASIC SOFTWARE LIBRARY

NOW ★ 10 ★ Volumes and Growing

WHY Pay hundreds of dollars for Software that does Not work when WE offer the BEST available Software for only a few dollars a program. And what is better OURS WORKS!

We have over 100,000 in circulation since 1975 and we are still around and That's more than Anyone else can say. We used to sell hundreds of programs individually, the programs in Volume X were sold for several years at over \$10,000, in Volume III for over \$6,000 but a few years ago we decided to promote software to the mass public and it was an instant success.

For Homeowners, Businessmen, Engineers, Hobbyists, Doctors, Lawyers, Men and Women

Vol. I \$24.95	Vol. II \$24.95	Vol. III \$39.95	Vol. IV \$9.95	Vol. V \$9.95	Vol. VIII \$19.95	Vol. IX \$19.95	Vol. X \$69.95
Business & Personal Bookkeeping Programs	Animals Four Astronaut Bagel Bio Cycle Cannons Checkers Craps Dogflight Golf Judy Line Up Pony Roulette Sky Diver Tank Teach Me	Binomial Chi-Sq. Coeff. Confidence 1 Confidence 2 Correlations Curve Differences Dual Plot Paired Plot Plots Polynomial Fit Regression Stat 1 Stat 2 T-Distribution Unpaired Variance 1 Variance 2 XY.	Beam Conv. Filter Fit Integration 1 Integration 2 Intensity Lola Macro Max. Min. Navaid Optical Planet PSD Rand 1 Rand 2 Solve Sphere Trien Stars Track Triangle Variable Vector	Billing Inventory Payroll Risk Schedule 2 Shipping Stocks Switch	Jack Life Loans Mazes Poker Popul Profits Qubic Rates Retire Savings SBA Tic-Tac-Toe	1040-Tax Balance Checkbook Instol 78 Deprec 2 APPENDIX C Favorites	Intro. A/R A/P Mer Inv Check Assets Payroll Bal Sh P/L Year End Data Base Tax Up Basic St.
Bond Building Compound Cyclic Decision 1 Decision 2 Depreciation Efficient Flow Installment Interest Investments Mortgage Optimize Order Pert Tree Rate Return 1 Return 2 Schedule 1 Games & Pictures	A. Newman J.F.K. Linus Ms. Santa Nixon Noel Noel Nude Peace Policeman Santa's Sleigh Snoopy Virgin	APPENDIX A	Vol. VI \$49.95 Mini-Ledger Payroll A/R Inventory Peprec. Ledger	Andy Cap Baseball Compare Confid 10 Differ Engine Fourier Horse Integers Logic Playboy Primes Probab Quadrac Red Baron Regression 2 Road Runner Roulette Santa Stat 10 Stat 11 Steel Top Vary Xmas	APPENDIX B		

Almost every single program included in these volumes will run in every Computer system that operates in Basic. A few changes may be required for some Basics but most of these changes are covered in one of the Tables and Appendices included in Volumes III, V, VI, VIII, and X.

Volume VI — Disk programs are compatible with TRS-80 disk basic

The disk programs in Volumes VI, VII and X are written in (CP/M) M Basic and Disk Extended Microsoft Basic. Other programs written in 8K Basic.

SPECIAL BONUS ★ 15% discounts on single purchase of full set by December 31st, 1980

Unconditional Money Back Guarantee.

\$1.50 per volume handling, all domestic shipments sent U.P.S. except APO and O. Box which go parcel post. Foreign orders add \$6.00/volume for air shipment and are payable in U.S. dollars only.

AVAILABLE AT MOST COMPUTER STORES
Master Charge and Bank Americard accepted.
Our Software is copyrighted and may not be reproduced or sold.

Unlike others we have NOT raised our prices in five years

KEMCO, LTD.
P.O. Box 2096L Ashland, VA 23005
Sales HOT LINE 1-804-798-1147

IN GERMANY
Ing. W. Hofacker, GmbH
Holzkirchen, W. Germany

IN HOLLAND
Nanton Press B.V.
Bilthoven, Holland

OVER 116,000 IN USE TODAY

YOU'RE RIGHT! KEYED FILE ACCESSING

is essential to develop effective application programs under CP/M® for your 8080/Z80 machine. Your on-line, interactive systems demand the performance that only a professional keyed file accessing package can offer: fast random and sequential access to data by key values, on-line additions and deletions to your data files, elimination of lengthy sorting procedures.

BUT WHICH ONE?

Feature	MICRO B+™	The Other One
• Random Access by Key	YES	YES
• Wild Card Search	YES	YES
• Key-Sequential Access	YES	YES
• Multiple Keys	YES	YES
• Automatic Space Reclamation	YES	YES
• Eliminate Overflow Files	YES	NO
• Maximum Number of Entries	65,535 ¹	10,000
• Eliminate Index File Reorganization	YES	NO
• Guaranteed Optimal Index File Structure	YES	NO
• Maximum Disk Accesses To Reach Any of 10,000 Entries	3	?
• Duplicate Key Values	YES ²	NO

¹\$32,767 for the source code versions.

²Source code versions only.

IT'S OBVIOUS, GET MICRO B+™!

And search an index of over 10,000 key values in less than one second on a floppy disk system!

Assembly Language Version ...\$260.00
Specify MICROSOFT™, CBASIC™, PL/I-80™, S-BASIC™

Basic Source Code Version ...\$195.00
Specify MICROSOFT™ Basic or CBASIC™

Shipping \$2 USA / \$5 Foreign
We accept VISA and MASTERCARD

DEALER INQUIRIES INVITED

FAIR COM
Making Micro's work like Max!'s
© 1980 Fair Com

2606 Johnson Drive
Columbia, MO 65201
(314) 445-3304

CP/M and PL/I-80 are trademarks of Digital Research
MICROSOFT is a trademark of MICROSOFT, Inc.
CBASIC is a trademark of Compiler Systems, Inc.
S-BASIC is a trademark of Topaz Programming

Product Review

Morloc's Tower

Gregg Williams, Editor

The Automated Simulations' Dunjonquest games are as close to a computer-automated *Dungeons and Dragons*-type dungeon as I have seen. Naturally such games do not have the inventiveness or the vindictiveness of a human dungeonmaster. They do have the advantage of allowing you solitary play. And, in contrast to conventional Adventures which are essentially puzzles that, once solved, hold no interest, the Dunjonquest games are randomly configured at startup to give you a worthwhile game even if you have won the game before.

Morloc's Tower is a Dunjonquest of average complexity, simpler than *The Temple of Apshai*, yet more complicated than the beginner's *Datestones of Ryn*. Your character is Brian Hammerhand, and his self-imposed task is to kill Morloc the Mad before sunrise to prevent the destruction of Hagedorn, a village under Morloc's rule. The format of the game is simple: the screen shows an overhead outline of the room you (ie: Brian) currently are in (see photo 1). Your character, a small graphics figure in the center of the room, can be caused to move, fight, search, and perform other tasks by an appropriate 1- or 2-keystroke command. There are thirty rooms in the Tower, six levels of five rooms each, and they are drawn for you as you enter them through doors (secret and visible) and stairwells.

At a Glance

Name <i>Morloc's Tower</i>	Language BASIC
Type Graphic role-playing Adventure game	Computer Radio Shack TRS-80 (plus versions for Apple II and Commodore PET)
Manufacturer Automated Simulations Inc 1988 Leghorn St Mountain View CA 94043 (415) 964-8021	Documentation Sixteen-page booklet, 5½ by 8½ inches (14 by 21.5 cm)
Price \$14.95	Audience Game enthusiasts (10 years or older)
Format Cassette (also available on floppy disk)	

Standard & Poor's proudly announces STOCKPAK, a unique software and data system to help you meet your investment goals like a Wall Street professional.

STOCKPAK not only delivers a "stand-alone" Portfolio Management System but also gives you the software for Standard & Poor's monthly Common Stock Data Service (available to TRS-80 owners on a subscription basis). With STOCKPAK and the Data Service you command one of the most powerful and versatile investment tools available.

Here's How STOCKPAK Will Help You:

A 900 COMPANY DATA BASE SERVICE

Monthly Data Service subscribers receive a diskette containing 30 vital financial items on 900 of the most widely traded stocks (S&P "500" and 400 NYSE, ASE and OTC issues). Accompanying this monthly diskette is an Investor's Newsletter highlighting important financial news and investment strategies, with suggestions for maximizing the usefulness of the system.

STOCKPAK SELECTION SYSTEM

The heart of STOCKPAK is a powerful, analytical stock selection tool which enables investors to choose stocks which meet their investment criteria. For example, you may wish to select only those oil and gas stocks with price/earnings ratios of less than 7 and yields of 6% or more. Once a group of stocks has been selected, you can store it as a separate data file for continuing use.

REPORT WRITER

You can define the report formats you would like to see on those stocks meeting your investment objectives. Hundreds of calculations and ratios that you define can be sorted, averaged or totalled, and displayed on video screen or optional printer.



PORTFOLIO MANAGEMENT SYSTEM

Now you can effectively evaluate and manage your own stock portfolio of up to 100 securities with as many as 30 transactions for each. You can record "buy" and "sell" transactions, price and dividend information and stock splits for instant retrieval, for record keeping and tax purposes. You can measure actual performance or create hypothetical situations to help you make "buy" or "sell" decisions.

HOW TO ORDER STOCKPAK

STOCKPAK is designed exclusively for TRS-80 users with 32K business systems with two mini-disk drives. You can obtain the basic software and sample Data Base, plus a comprehensive User's Manual from your local Radio Shack Store for only \$49.95. The STOCKPAK Monthly Data Updating Service can be ordered directly from Standard & Poor's for \$200 annually, or from the order form provided in the basic package you purchase from Radio Shack.



Standard & Poor's Corporation

25 BROADWAY, NEW YORK, NY 10004 (212) 248-3994/3374

The game is similar to conventional Adventures in that there are several treasures in the Tower, some of which are necessary to kill Morloc, others of which will hinder or harm you in the attempt. And, of course, there are monsters that will try to kill you. As an example of commands in *Morloc's Tower*, fighting commands are A (attack), T (thrust), P (parry), F (fire a normal arrow), and M (fire a magic arrow). Each command has different effects on you and your attacker, usually trading off effectiveness of attack or defense with the degree of fatigue or wounds suffered by you. The game takes place in real time, which means you have to act quickly in fights. This makes the game a lot more interesting than most Adventures.

This game, like other role-playing games, takes a lot of time to play, and *Morloc's Tower* must be played at one sitting; there are no commands to save the state of the game. The version that I used, a cassette version for the TRS-80 Model I, is contained on both sides of the cassette. Side one is the program itself, while side two contains three sets of data statements, one of which is read to create a game in one of three levels of complexity. (I found that you *have* to leave the remote jack in the TRS-80 cassette recorder during loading; the program doesn't have enough time to "digest" the data if the tape runs uninterrupted.)

My only complaint against the game is one of speed; character movement is just a bit slow, and the delay of over a minute to redraw a fully explored level (when returning to it from another level) is quite annoying. Both these problems could be solved with a machine-language

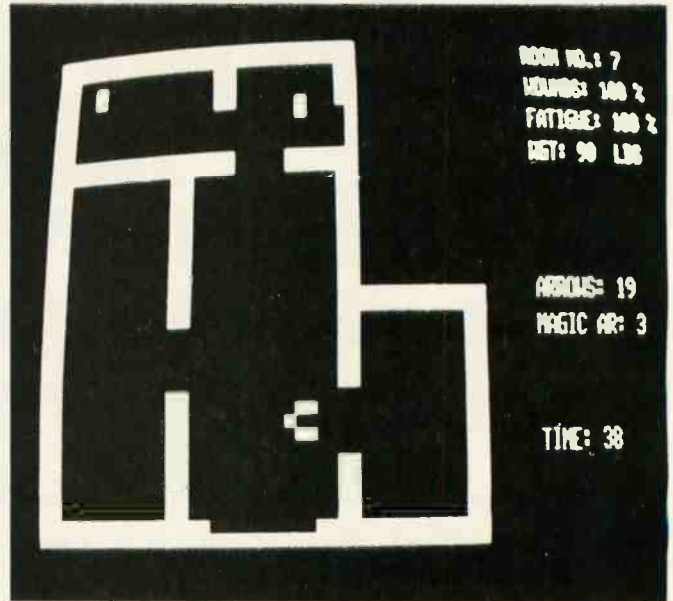

Photo 1: A game of *Morloc's Tower* in progress on the Radio Shack TRS-80. The three-block symbol near the bottom of the center room represents the player's character, and the two small rectangles are treasures. Information on the status of the game and the player is given on the right-hand side of the screen.

version of the game. This is the route that all the major Adventure writers (Scott Adams and Greg Hassett, in particular) have taken to improve the quality of their games. ■

★ CRYSTALWARE ★

Hires graphics - Crystalsonics - sophistication...Crystal is what is happening in fantasy and science fiction games! Tired of text games and wordy manuals? Have you been looking for games which are different each time you play? We offer you the results of three years of testing and research, what we believe to be the finest games available anywhere for the Apple Computer.

HOUSE OF USHER — Wander through a haunted house. Rooms and scenery in 15 color hi-res graphics. We offer a \$100.00 prize to the first person to solve the mystery. Over 200 monsters, objects, and perils. \$24.95

GALACTIC QUEST — Crystalsonics - hires graphics - the ultimate space adventure. Vegan warships attack and fire in real time simulation. Land on and trade with over 64 star systems in 3 galaxies. Allow 6-12 hours for play. \$24.95

SUMER — Travel back through time to ancient Sumeria in the middle east. You are given 10 years as king to restore this kingdom to prosperity. Plant wars, consult the astrologers - Very hard to beat! \$19.95

LASAR WARS — Crystalsonics - hires graphics - protect the planet earth from a full scale alien invasion. Over three types of invading craft and hundreds of approach simulations. The game speaks for itself. \$29.95

WORLD WAR III — Crystalsonics - hires graphics - for you war game freaks, this is it! Iran and Iraq, nuclear missiles - hires 3 screen battlefield - demolition squads - tanks - strategy. Custom designed for two, arm chair generals. Save the world from nuclear holocaust! \$29.95

BENEATH THE PYRAMID — Crystalsonics - hires graphics - brand new! Explore the pyramids and miles of winding secret tunnels beneath them. Enter at the Sphinx and find the hidden treasure chamber. All in hires with very aggressive monsters and many many perils. To win you must find the golden cat and your way out!! \$29.95

for Apple 48K with disc

Please send all correspondence to P.O. Box 206 San Jose, Calif. 95113

But no matter what the size, they all give you increased sales, greater security, and lower costs.

Choose from the VIP (315K bytes with optional add-ons up to 1.2M bytes), the Vector 2800 (2M bytes with 91 msec average access time), or the Vector 3030 (32M bytes with 34 msec average access time).

Each one gives you more disk speed and capacity than competitive models. So you can offer a less expensive system with more capacity than your competition, or one with much greater capacity for the same money.

Our multiple configurations with transportable software do not lock you into one level of system. For reliability, Vector builds industry standards into each Economy Sized Computer. Standard software and components include CP/M2[®] operating system, Microsoft BASIC-80[®], S-100 bus, 4 MHz, Z80A processor, RS-232C serial ports.

Our modular systems use common Vector 3 mainframes, boards, and printers. They save you time and money on inventory, service, staff, and training. Software transportability from one system to the next eliminates the cost of

rewriting or converting software and data. Our advanced software development tools reduce development time dramatically. And since we have such a wide range of models, we help you make more sales.

All this goes to prove one thing.

That is, no matter what size system you're building, an Economy Sized Computer can be a big help.

For more information, write Vector, 31364 Via Colinas, Westlake Village, CA 91362. Or call 213/991-2302.

Economy Sized Computers[™] now come in small, medium and large.



VECTOR

Economy Sized Computers[™]

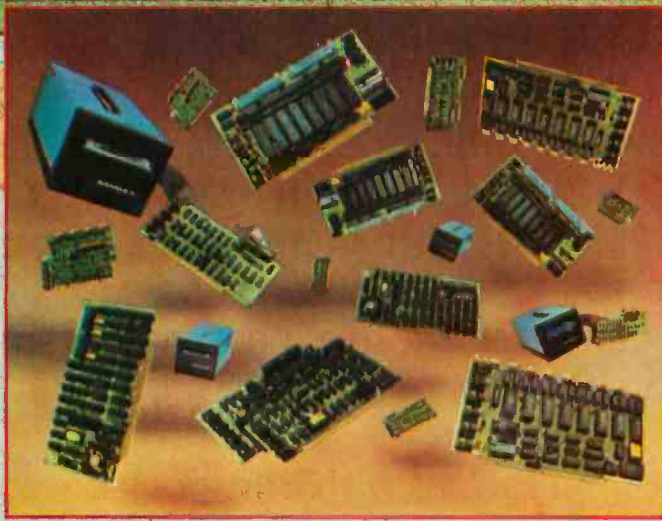

New power at your fingertips.

Konan presents Hard Disk Control, Tape Control, and Serial I/O Boards for S-100 computers. Konan, known throughout the industry for its leading, innovative, guaranteed controllers for S-100 systems, does it again. Now, it offers you more of the expanded capabilities you need.

First, there's Konan's complete line of hard disk mass storage subsystems and controllers. These high reliability products include the SMC-100™ storage module (SMD of CDC 9760 interface) hard disk controller for the S-100 Bus, DAT-100 Winchester type hard disk tape backup controller, the HARD TAPE™ system, and the new KNX-500™ hard disk controller which is software compatible with Alpha Micro AM-500*. Also, coming soon, Shugart technology mini hard disk controller and 9 track reel to reel tape controller.

Now, Konan introduces OCTOPLUS™ and OMNIPORT™, two new serial I/O boards. OCTOPLUS™, the 8-port board, offers a real time clock and full interrupt control. And the 16 port OMNIPORT™ offers you an efficient, economical board where more than 8 ports are needed.

With these and other quality products, Konan shows again that when it comes to S-100 systems, it is definitely in control. (And all at attractive O.E.M. and dealer prices.)

For complete information, call Konan's direct, toll-free information line, 800-528-4563.

Or write to: Konan Corporation, 1448 North 27th Avenue, Phoenix, AZ 85009, TWX/TELEX 9109511552

KONAN KONAN KONAN™

*Alpha Micro AM-500 is a trademark of Alpha Micro Systems.
IN CONTROL, SMC-100, HARD TAPE, KNX-500, OCTOPLUS, and OMNIPORT are trademarks of Konan Corporation.

I N C O N T R O L

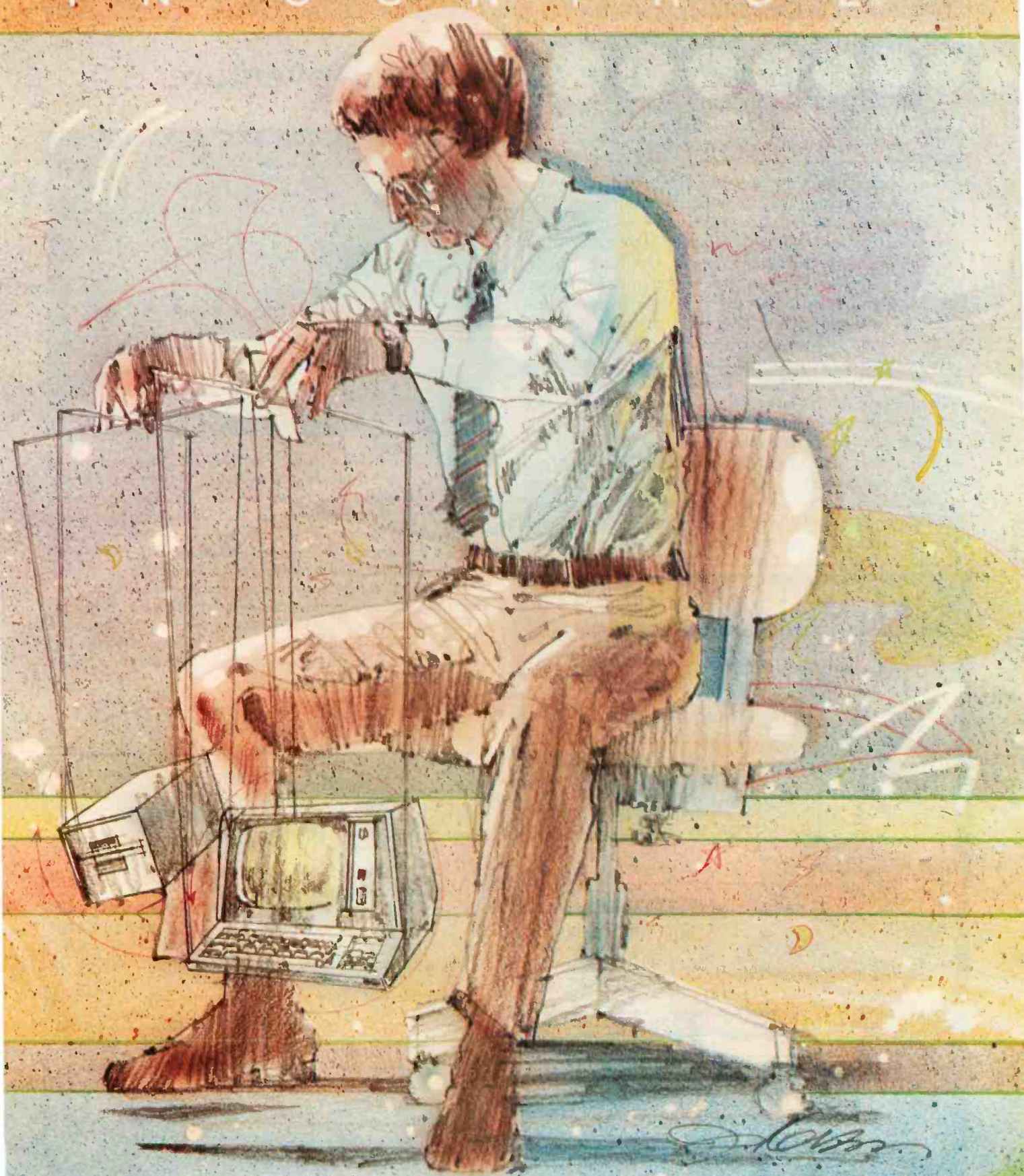

Handwritten signature

Product Review

Odyssey: The Compleat Adventure

Harold Nelson, Editor

One Friday afternoon recently, I decided to try my hand at a new game that sounded most intriguing. The evening before I had read over the game documentation pamphlet (I would urge any *Odyssey* adventurer to do the same before undertaking a game). On this particular Friday, I played one game which ended in less than success. A friend then joined me and we played a game together—one person at the keyboard and the other going through the documentation pamphlet. We must have begun this game around 4:30 PM. After thoroughly touring the island on which the game begins (see photo 1) and amassing a large army, a good deal of wealth, and considerable equipment, we decided to embark on a ship we had just purchased (very reasonably priced) for another island. Thinking it was about 6:30 PM, we decided to have something to eat before going to sea. We were astonished to discover that it was actually about 8:00 PM. We had been playing for nearly four hours, though it seemed like only half that time.



Photo 1: The island on which the *Odyssey* game begins. The crosses indicate villages containing markets where you can purchase supplies and equipment for your journey. The human shape shows the location of you and your followers (mostly mercenaries). The figure to your south is an ancient temple which is locked and can be opened and entered only with the appropriate devices. The figure to the northwest of you is a hut which is the dwelling of any one of an assortment of characters. Directions, hints, and questions are generally given below the map. Commands are, for the most part, single keystrokes (eg: E to move east). The major exception is typing numbers (eg: amounts of quadroons to bargain for a purchase or a bribe). Photo by Charles Freiberg.

SYNCHRO-SOUND



◀ **SOROC Technology**

IQ 120 **\$699⁰⁰**

IQ 140 **\$999⁰⁰**

ADDS
Regent 25
\$795⁰⁰



◀ **TELEVIDEO**
Data Terminals
Model 912 **\$825⁰⁰**
Model 920 **\$895⁰⁰**

We carry a full line of: **ADDS, LEAR-SIEGLER, HAZELTINE, QUME, TELETYPE, DEC, FLORIDA DATA SYSTEMS, TEXAS INSTRUMENTS**



SYNCHRO-SOUND ENTERPRISES, INC.

The Computer People

193-25 Jamaica Avenue
Jamaica, N.Y. 11423

PHONE ORDERS. CALL:

New York—212/468-7067
Los Angeles—213/628-1808
Chicago—312/641-3010
Dallas—214/742-6090

At a Glance

Name
Odyssey: The Compleat Adventure

Type
High-resolution color graphics game

Manufacturer
Synergistic Software
5221 120th Ave SE
Bellevue WA 98006
(206) 641-1917

Price
\$30

Format
5-inch floppy disk

Language
BASIC

Computer
Apple II with 48 K bytes of memory and Integer BASIC

Documentation
Sixteen-page 5½ by 8½ inch (14 by 22 cm) staple-bound pamphlet including a table of contents listing the various aspects of the game. Some directions, hints and questions are included in the program.

Audience
Almost anyone with sufficient time

Orange Micro

"SPECIALIZING IN PRINTERS
AND CRT'S"

CENTRONICS 737 (RADIO SHACK LINE PRINTER IV)

Word Processing Print Quality



- 18 x 9 dot matrix; suitable for word processing • Underlining • proportional spacing • right margin justification • serif typeface • 50/80 CPS • 9½" Pin Feed/Friction feed • Reverse Platen • 80/132 columns

CENTRONIC 737-1 (List \$995) **\$Call**

MALIBU

*The Small Business Printer;
Letter Quality & Speed.*



- 10 x 9 dot matrix • Letter quality print; Lower case descenders • High speed; 165 CPS, Bidirectional, Logic seeking • Wide carriage, Adjustable tractors to 16" • Vertical forms control • Variable line spacing • User programmable character set • Dot Resolution Graphics

MALIBU 165 (List \$2495) **\$2195**

EPSON MX80

*Low-Priced
Professional Print Quality*

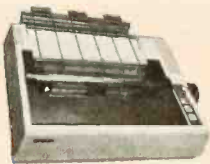

- 9 x 9 dot matrix • Lower case descenders • 80 CPS • Bidirectional, Logic seeking • 40, 66, 80, 132 columns per line • 64 special graphic characters: TRS-80 Compatible • Forms handling • Multi-pass printing • Adjustable tractors

EPSON MX80 (List \$645) **\$Call**

ANACOM

Low Cost, High Speed, Wide Carriage

- 9 x 9 dot matrix • Lower case descenders • Wide carriage • Adjustable tractors to 16" • 150 CPS, Bidirectional, Logic Seeking

ANACOM 150 (List \$1350) **\$Call**

EPSON TX80

- 5 x 7 dot matrix • 125 CPS • Double wide characters • Dot resolution graphics & 64 special graphic characters • 6/8 line per inch • Vertical forms control • Adjustable tractors • Heavy Duty — Highly reliable

EPSON TX80 (List \$799) **\$Call**

OKIDATA MICROLINE SERIES

TRS-80 Graphics Compatibility



- 9 x 7 dot matrix • 80 CPS • 80, 132 columns — 64 shapes for charts, graphs & diagrams • Double wide characters • 6/8 lines per inch • Up to 3 part copy • Friction & pin feed • 200 M character head warranty

OKIDATA MICROLINE 80 (List \$800) **\$599**

THE SMALL COMPUTER PRINTER by Brent Weston

This illustrated booklet provides the information you need about today's small printers. There are many printers available, each with different features and capabilities. *The Small Computer Printer* will guide you in determining which printer best fits your applications. A complete feature comparison chart is included representing over 40 small printers. A printer is a big investment — learn all about them before you buy one.

\$795

TELEVIDEO CRT'S PRICES SLASHED!



TVI 912C } Please Call Toll Free
TVI 920C } Prices are too low to
advertise

BASE 2

The Hobbyist Printer With The Most Features



- Graphics • Tractors/Friction Feed • 2K Input Buffer • RS-232 Serial, Centronics® Parallel, IEEE-488, 20 ma • TRS-80 Cable option • 100 CPS • Fast form feed • User programmable character set • 64, 72, 80, 96, 120, 132 Columns/line • Expanded characters • Automatic skip-over-perforation • Horizontal & Vertical tabs • Programmable vertical line spacing • Intel 8085 Microprocessor — over 40 software commands

BASE 2 800B (List \$699) **\$649**

PRINTERS

- CENTRONICS 730 Radio Shack Line Printer II (List \$795) **\$ 639**
- OKIDATA MICROLINE 82 & 83 **\$ Call**
- NEC 5530-5 letter quality, RO, parallel, tractors (List \$2970) **\$ 2599**
- PAPER TIGER IDS 440 . . . w/graphics and 2K buffer . . . (List \$1094) **\$ 939**
- PAPER TIGER IDS 460 w/graphics, 9 x 9 dot matrix . . . (List \$1295) **\$ Call**
- QUME 5/45 typewriter quality (List \$2905) **\$ 2559**

INTERFACE EQUIPMENT

- APPLE II - BASE 2 parallel graphics interface board & cable **\$ 160**
- APPLE II - EPSON TX80
parallel graphics interface board & cable **\$ 110**
- SSM AIO BOARD Apple Serial/parallel interface (List \$225) **\$ 175**
- MICROTRONICS Atari parallel interface **\$ 69**
- ATARI 850 Interface module, serial/parallel **\$ 199**
- TRS-80 CABLES to keyboard or Exp. interface **\$ Call**

TOLL FREE
(800) 854-8275
CA, AK, HI (714) 630-3322

At Orange Micro, we try to fit the right printer to your application.
Call our printer specialists for free consultation.

CALL FOR FREE CATALOG

Phone orders WELCOME. Same day shipment for VISA, MASTER CHARGE, and AMERICAN EXPRESS. Personal checks require 2 weeks to clear. Add 3% for shipping and handling. California residents add 6%. Manufacturer's warranty included. Prices subject to revision.

**Orange
Micro, Inc.** 
3148 E. La Palma, Suite E
Anaheim, CA 92806

Obviously, we decided, this is a game worthy of high praise. There is only one warning for the prospective player. The warning is simple: make sure you have sufficient time. It is obviously an engrossing game. It might be advisable to keep a clock handy or even set an alarm to your desired quitting time. Since a game in progress can be saved on any initialized disk and completed later, it is probably better to break off a game than risk the loss of family or job.

Upon returning to our game on that Friday evening, we set sail and were just getting the knack of handling our ship when we were lost in a fog bank and ran aground. We spent quite awhile trying, unsuccessfully, to get free. When we first went aground there was a brief message to the effect that local fishermen would help us for a price. This message appeared quite briefly and did not reappear.

In a case such as this, if the correct command is not found, it may seem as though there is a bug in the program causing it to go into a infinite loop. A call to Synergistic Software convinced us that this is not the case and that there is one command that can result in freeing a ship caught in this situation. (Hint: Use quadrooms.)

Some friends have said that they would like to see a little more detail in the documentation about how the outcome of battles with bandits and various monsters is determined. But, on the other hand, the element of uncertainty and chance that the user experiences may add to the excitement and enjoyment of the game. Also, the documentation does include the relative worth of the different offensive and defensive devices available. And, with some luck, one can increase his ability to avoid battle when its outcome appears doubtful.

The finest feature of this game is its use of high-resolution color graphics. It is the best use of color graphics in a game for the Apple that I have seen.

While this program does not operate in real time, certain features of the game give the user the illusion that it is doing just that. This is especially true of traveling on horseback, flying on a magic rug (should you encounter a

wizard inclined to give you one), and sailing.

Another strong feature of the game is the great number of possible encounters both on land and at sea and the variety of outcomes that can result from these encounters. These are too numerous to list or begin to describe in a brief review, and learning to deal with them is a major part of the enjoyment of this game.

It is also interesting that, as opposed to some Adventure games, it is virtually impossible to reproduce an *Odyssey* game. Each game starts at a randomly chosen point and the locations of castles, tombs, and other objects and creatures are also changed with each game. Hence, each game is unique.

Conclusions

● This is a very fine game for the Apple II computer. It makes excellent use of color graphics. Fans of Adventure and Dungeon games should find this to be an interesting and challenging addition, with some new twists, to their collections. For those just developing an interest in this type of game, *Odyssey* is such a good one that starting with it may greatly diminish the interest you have in other Adventure games.

● The documentation seems, at the very least, adequate. Some users may desire more detail on how various aspects of the program work. At any rate, there is enough information, presented in a clear and interesting manner, to allow virtually anyone to start playing the game.

● My only criticism of the program is that some of the messages offering hints on what to do next (such as that mentioned above about the local fishermen) appear so briefly that if their meaning is not clear at first or if you are momentarily distracted, they might as well not have been there at all.

● It is important to keep in mind that a well-played game of *Odyssey* is going to take a lot of time, but games can be saved and played in installments. The only short game is an unsuccessful game with an obvious outcome. ■

S-100 USERS: GIVE YOUR COMPUTER THE GIFT OF SIGHT!

The DS-80 Digisector® is a random access video digitizer. It works in conjunction with a TV camera (either interlaced or non-interlaced video) and any S-100 computer conforming to the IEEE standards. Use it for:

- Precision Security Systems
- Moving Target Indicators
- Computer Portraiture
- Fast To Slow Scan Conversion
- Robotics
- Reading UPC Codes, schematics, paper tape, musical scores



● IMAGE PROCESSED BY DS-80 ●

CHECK THESE FEATURES:

- High resolution** — a 256 × 256 picture element scan
- Precision** — 64 levels of grey scale
- Speed** — Conversion time of 14 microseconds per pixel
- Versatility** — scanning sequences user programmable
- Economy** — a professional tool priced for the hobbyist; comes fully assembled, tested and burned in, with fully commented portrait printing software.

Price: \$349.95 MasterCharge and Visa

THE
**MICRO
WORKS**

P.O. BOX 1110, DEL MAR, CA 92014 714-942-2400

“When you sell to small business, learn to speak their language. COBOL-80.”

Ron Mayberry
Mayberry Systems, Inc., Belleville, Illinois

“It’s amazing what a few key phrases will do for your sales record to small businesses. Words like “faster,” “cheaper,” and Microsoft’s “COBOL-80!”

I should know. I’m in the business of selling complete computer systems to one of the most demanding enterprises around: pharmacies. That means my programs have to solve the complex problems facing pharmacies today—the deluge of paperwork, regulations, and the need for immediate access to patient information.

I’ve sold a lot of mini-computer systems with programs written in DIBOL. Then I discovered microcomputers, and Microsoft’s COBOL-80. Together, they’re faster and less expensive than my old system, yet do all the same things. And more.

Like what? Like more flexibility and versatility. I use practically the whole range of COBOL-80 features, to speed inventory, billing, labeling, pricing, accounts receivable, patient profiles and



doctor lists. And I’ll be using a lot of the same features to write a program for travel agents too.

Believe me, we checked them all, and only COBOL-80 had all the necessary LEVEL II features, plus the new CHAIN feature, program segmentation and formatted screen ACCEPT/DISPLAY.

The CHAIN feature impressed even a veteran programmer like me. With my menu-driven systems, I have total control over which program will execute

next. And it was great to find that COBOL-80’s ACCEPT/DISPLAY statements give formatted screens that look the same as my old DIBOL screens. Yet with fewer lines of code.

With 300 different program modules, you can be sure I appreciate segmentation too. In one case, I collapsed seven DIBOL programs into one segmented COBOL-80 program. Now I can organize my system according to program function rather than memory size.

My compile times? Incredible. Over 1,500 lines compile and link in just five minutes.

I know what you’re thinking. ‘Sounds great, but I wouldn’t want to be in Mayberry’s shoes when he translated all those DIBOL programs to COBOL-80.’ Well, surprise. Since most DIBOL features translate into COBOL one-for-one, we converted the source code six times faster than originally scheduled.

So simply put, that’s how Mayberry Systems Inc. learned for itself that COBOL-80 is one language that makes a lot of sense to small businesses.

In my opinion, COBOL-80 is first-class. And I thought you should know about it too.”

COBOL-80 now supports Level II ANSI SORT/MERGE statements to interface with Microsoft’s new sort facility, M/SORT.

COBOL-80 with documentation, \$750.

Documentation purchased separately, \$20.

M/SORT, \$125.

MICROSOFT

10800 NE Eighth, Suite 819
Bellevue, WA 98004
206-455-8080 Telex 328945

We set the standard.

The Twelve Computerized Days of Christmas

Teri Li and Elizabeth Cooper, POB 481, Peterborough NH
03458

On the first day of Christmas, my computer gave to me
A glitch on the video screen.

On the second day of Christmas, my computer gave to
me
Two keyboard bounces,
And a glitch on the video screen.

On the third day of Christmas, my computer gave to me
Three loose plugs,
Two keyboard bounces,
And a glitch on the video screen.

On the fourth day of Christmas, my computer gave to me
Four garbled SAVES,
Three loose plugs,
Two keyboard bounces,
And a glitch on the video screen.

On the fifth day of Christmas, my computer gave to me
Five blank cassettes,
Four garbled SAVES,
Three loose plugs,
Two keyboard bounces,
And a glitch on the video screen.

On the sixth day of Christmas, my computer gave to me
Six I/O spasms,
Five blank cassettes,
Four garbled SAVES,
Three loose plugs,
Two keyboard bounces,
And a glitch on the video screen.

On the seventh day of Christmas, my computer gave to
me
Seven system resets,
Six I/O spasms,
Five blank cassettes,
Four garbled SAVES,
Three loose plugs,
Two keyboard bounces,
And a glitch on the video screen.

On the eighth day of Christmas, my computer gave to me
Eight worthless printouts,
Seven system resets,
Six I/O spasms,
Five blank cassettes,
Four garbled SAVES,

Three loose plugs,
Two keyboard bounces,
And a glitch on the video screen.

On the ninth day of Christmas, my computer gave to me
Nine burnt-out fuses,
Eight worthless printouts,
Seven system resets,
Six I/O spasms,
Five blank cassettes,
Four garbled SAVES,
Three loose plugs,
Two keyboard bounces,
And a glitch on the video screen.

On the tenth day of Christmas, my computer gave to me
Ten disk-drive lockouts,
Nine burnt-out fuses,
Eight worthless printouts,
Seven system resets,
Six I/O spasms,
Five blank cassettes,
Four garbled SAVES,
Three loose plugs,
Two keyboard bounces,
And a glitch on the video screen.

On the eleventh day of Christmas, my computer gave to
me
Eleven damaged diskettes,
Ten disk-drive lockouts,
Nine burnt-out fuses,
Eight worthless printouts,
Seven system resets,
Six I/O spasms,
Five blank cassettes,
Four garbled SAVES,
Three loose plugs,
Two keyboard bounces,
And a glitch on the video screen.

On the twelfth day of Christmas, my computer gave to
me
Twelve blown-out circuits,
Eleven damaged diskettes,
Ten disk-drive lockouts,
Nine burnt-out fuses,
Eight worthless printouts,
Seven system resets,
Six I/O spasms,
Five blank cassettes,
Four garbled SAVES,
Three loose plugs,
Two keyboard bounces,
And a glitch on the video screen. ■

HOT OFF THE PRESS!

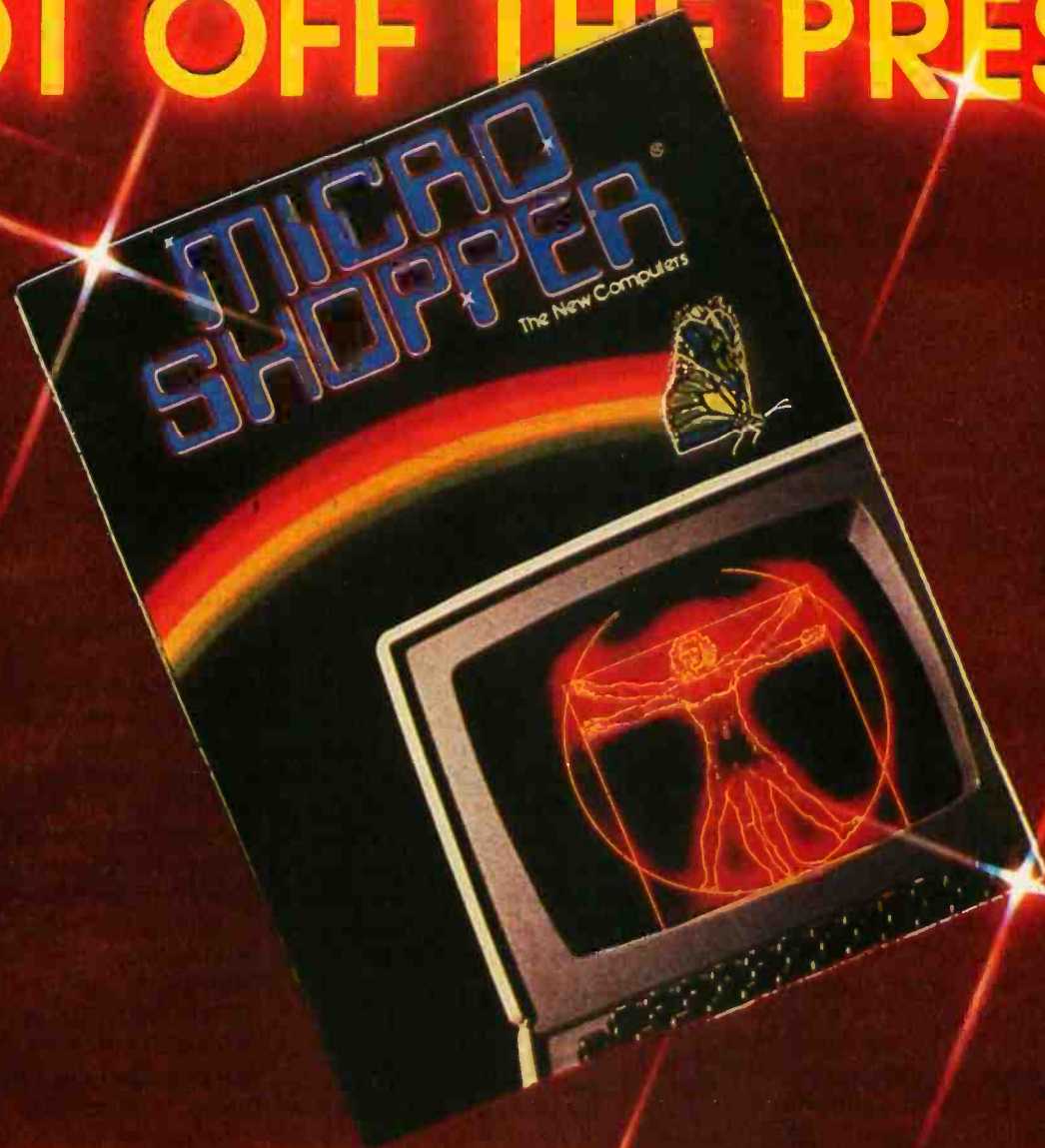

MICROSHOPPER the new Computers!

The most comprehensive consumers' guide to microcomputing ever published is hot off the press! The latest edition of the best-selling MicroShopper has been expanded to 192 pages, and is now in a convenient book form . . . includes nearly 200 photographs, illustrations and charts; dozens of hardware and software product reviews, and feature articles on topics from the history of computers to robotics. The new MicroShopper explains the often difficult-to-understand jargon of the computer industry, provides tips on selecting a system for business, professional, educational or personal use, and lets you take a look at the latest microcomputers and peripherals from industry-leading manufacturers!

To order the new edition of the MicroShopper, call toll-free 1-800-528-1418, or fill out and clip the coupon below today! Make checks or money orders payable to PGI Publishing. MasterCard and Visa orders welcomed.

TOLL FREE 1-800-528-1418

Please send me _____ MicroShopper(s) at \$9.95 each plus \$1.75 for postage and handling. Arizona residents add 5% sales tax.

Name _____

Address _____

City _____ State _____ Zip _____

Check or money order enclosed VISA
 MasterCard

Acct. No. _____

Expiration date

PGI
Publishing
1425 W. 12th Place * Tempe, Arizona 85281

Graphic Color Slides

Part 2

In "Graphic Color Slides, Part 1" (November 1980 BYTE, page 126), I demonstrated a series of subroutines for the CompuColor II that together can be used to plot a set of points, an equation, or horizontal or vertical bar graphs. The listings in this article, when added to the subroutines given in listing 1 of the cited article, will enable us to plot several new types of graphs. These listings also demonstrate the use of these subroutines in building special-purpose programs that generate a desired kind of graph. The programs listed here are designed to run on a CompuColor II with extended disk BASIC and at least 16 K bytes of programmable memory.

The first three graph programs have been written as part of a single program (see listing 1); the equation plotting, histogram, and regression routines all use the subroutines unaltered. Both the histogram and regression routines use a statistics subroutine at line 11400 that calculates the arithmetic average (program variable MEAN) and the standard deviation (variable DEVIAT). The monthly analysis chart routine, given in listing 2, illustrates how the graphics subroutines can be modified for a new application; the subroutine lines in listing 2 are the only lines being changed, not the entire subroutine. As before, the variable names used in these listings have been chosen to describe their function.

Alan W Grogono MD
Associate Professor
State University of New York
Upstate Medical Center
750 E Adams St
Syracuse NY 13210

Equation Plotting

The equation plotting routine is contained in lines 1000 thru 1086 of listing 1. This routine is similar to the one in last month's article in that it allows the user to change screen colors and to save a finished graph; but this routine allows you to graph a new equation, select a different type

Photo 1: Examples of equation plotting. Photos number 1a thru 1d show the same equation, $Y=X^4 - 4X^2$, plotted in different X- and Y-ranges and colors. Photo 1b shows a conventional plot of the equation; photos 1a, 1c, and 1d show the equation as the upper edge of a series of vertical bars.

(1a)

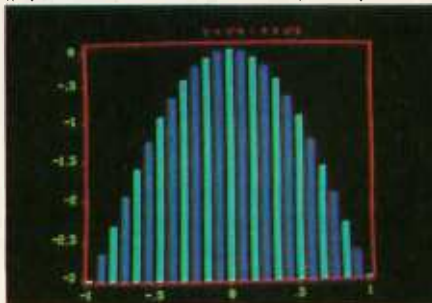

(1c)

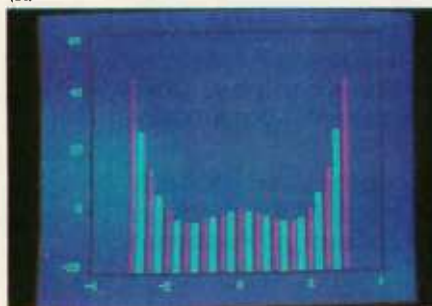

of plot (line or vertical bars), and choose different X- and Y-ranges. Photos 1a thru 1d illustrate the same equation, $Y=X^4 - 4X^2$, plotted in several different ways.

Histogram

The histogram plotting routine, lines 2000 thru 2390 in listing 1, allows the distribution of a given set of data to be displayed as a histogram. In addition, the theoretical Gaussian (bell-shaped) curve with the same mean and standard deviation is superimposed on the histogram; also, the areas under the curve and the histogram are the same.

Within the listing, the one-dimensional data to be plotted as part of the histogram is stored in ARRAY (N,0)—that is, in ARRAY (1,0), ARRAY (2,0), ARRAY (3,0), etc. The data is analyzed to determine the largest and smallest numbers to be graphed on the horizontal axis and the step size (variables HIGH (0), LOW (0), and JUMP (0), respectively). The user selects the number of bars in the histogram, and the value is stored in the variable COLUMNS. The data is classified as belonging to one of COLUMNS groups, and the tally of the number of data items belonging to group N (where N is between 1 and COLUMNS, inclusive) is stored in ARRAY (N,1). The height of the equivalent Gaussian curve is calculated in the statistical subroutine at line 11400, leading to the display of

(1b)

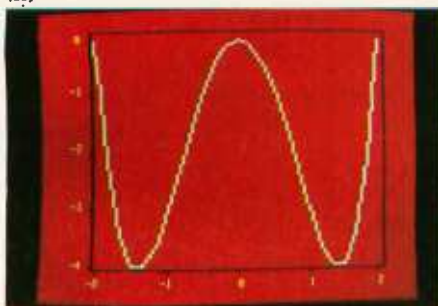

(1d)

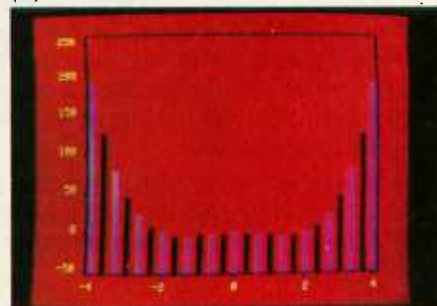

COMPARE SMARTS.

**INTEGRAL
MODEM NOW
AVAILABLE.***



- Reverse video
- Blinking/blank fields
- Upper/lower case char.
- Protected fields
- Underlining
- Non-glare screen
- 12 x 10 char. res.
- Blinking cursor

- 9 Baud rates (75-9600 Baud)
- Self test
- Auxiliary port

- Function/edit keys
- Typewriter/TTY keyboards

- Numeric pad

Model 920C shown.

Feature-for-feature our smart CRT terminals cost less than *their* dumb ones. Much less. Compare smarts. Then compare price. You'll pick TeleVideo.

Four different models to choose from. Each with features you'd expect to pay extra for. But with TeleVideo, they're standard.

We put a lot of engineering savvy into our CRTs. Their modular design means high reliability. It also lets us build in high volume. And sell to you at low prices.

Find out how you can make your next CRT buy a smart one. Contact TeleVideo today for information.

Nationwide Field Service is available from General Electric Co., Instrumentation and Communication Equipment Service shops.



TeleVideo, Inc., 2149 Paragon Dr.
San Jose, California 95131
Phone (408) 946-8500



*Optional, with models 912C and 920C only.

COMPARE PRICE.

CALIFORNIA Costa Mesa (714) 557-6095 • San Jose (408) 946-8500 • ILLINOIS Oak Grove Village (312) 981-1706
MASSACHUSETTS Boston (617) 668-6891 • NEW YORK/NEW JERSEY Paramus (201) 265-1321 • TEXAS Dallas (214) 980-9978

(2a)

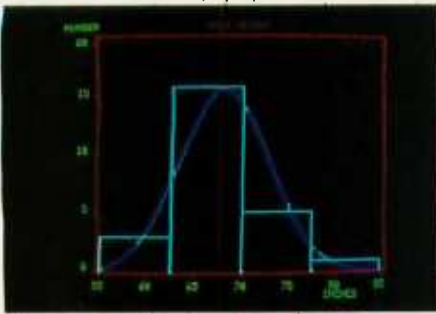

(2b)

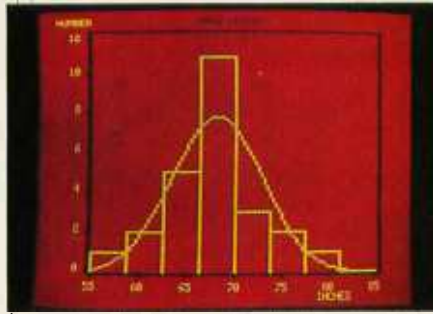

(2c)

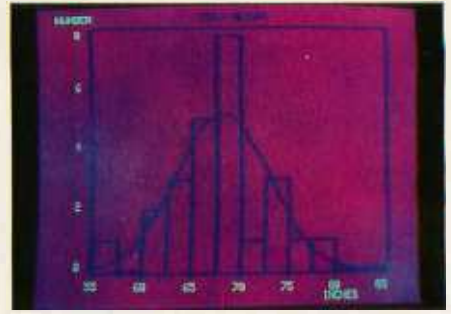

Photo 2: Examples of histograms. Here, a Gaussian (bell-shaped) curve having the same mean and area is superimposed on each of the histograms. Both the number of bars in the histogram as well as the colors used can be chosen by the user.

the histogram and Gaussian curve with labeled X- and Y-axes.

The same data, once entered, can be displayed with different colors and a different number of histogram bars. Photos 2a thru 2c show the same set of data displayed in different ways.

Regression

The regression routine, lines 4000 thru 4760 of listing 1, allows two sets of data to be plotted with a regression line for comparison. The two sets of data are graphed as X,Y pairs (with the X data being the independent variable and the Y data the dependent

variable). Then the computer finds the best line that describes a certain presumed relationship (linear, logarithmic, exponential, or reciprocal, as chosen by the user) for those points. If the chosen relationship is linear (if the user is performing a linear regression), the actual Y value is plotted with its given X value. If the relationship is logarithmic, exponential, or reciprocal, the dependent (Y) variable is replaced by the appropriate transformed value—that is, the X data point is plotted opposite $\ln Y$, e^Y , or $1/Y$, respectively.

After the data pairs and the regres-

sion type have been entered, the original Y data (stored in ARRAY [N,2]) is transformed according to the regression type, with the transformed Y values stored in ARRAY (N,1). At this point, the program makes the necessary calculations and displays the resulting graph, plotting the data points and the regression line that best fits them. (Actually, the regression line given by any regression except linear regression is not a straight line but rather a logarithmic, exponential, or reciprocal curve that best fits the data. These curves appear as straight lines because we are graphing X not against Y, but against a transform function of $Y - \ln Y$, e^Y , or $1/Y$, respectively.)

Once the data has been entered, it can be displayed in different colors with different kinds of regression. Photos 3a thru 3d show the same data graphed varying the colors and regression type. The data was taken from the following example: we have four test tubes (2, 3, 4, and 6) from a larger series of test tubes, and each one has a chemical solution in it; the independent (X) variable is the tube number, and the dependent (Y) variable is the measured strength of the solution in that tube. A linear regression on these data points (photo 3a) provides a poor fit, as does exponential regression (photo 3b). Logarithmic regression provides a better fit (photo 3c), but reciprocal regression provides the best fit of all (photo 3d).

Monthly Analysis Graph

The monthly analysis graph, shown in photos 4a and 4b, is a specific case of a graph that will plot the values of one or more variables over a given range of the independent variable. Here, income for 4 years is plotted for each month of the year. The

Text continued on page 110

Write in for this write-off.

Want to save taxes, travel expense and time?

Rockwell's Jetproposition — now with three Commander® Jetprops and new and expanded plans that make them even easier to own and operate — can show you how.



Member of GAMA



Rockwell International

...where science gets down to business

For full information on the many advantages of owning your own Commander Jetprop, call 800/654-4483.* Or write: Dept. 25, Commander Jetprop Information Center, Rockwell International, 5001 N. Rockwell Avenue, Bethany, Oklahoma 73008. TWX 910-830-6870. AEROCOM.

*In Oklahoma, call collect: 405/789-5000, Ext. 228. BY12

Name _____
 Title _____
 Company _____
 Street _____
 City _____ State _____
 Zip _____ Phone _____
 Present aircraft owned _____

Software Packages

Computerized Accounting & Tax Service
Taxman* US1040 tax return preparation. Can handle 29 schedules. **\$3000**

CMC
Legal Billing* Allows attorney to monitor charges based on hourly rates, costs, or flat fees. All AR functions. **\$2500**

Computer Management Systems
General Ledger & Payroll* Single diskette based, easy to use program. Writes checks, W-2's and 914's. Ideal for small retailer. **\$500**

Tek-Aids Industries, Inc.
BUS-I Original version, with GL, AR, AP, 6 diskettes with new docs. **\$99**

BUS/DMS* Most current version of BUS series. Special \$150 discount for P.O.'s submitted with original copies of Digital Technology BUS-II. **\$850**

MEMTEST/2 New edition of popular memory test for OSI hardware. 8" and 5" disk. **\$50**

fig-FORTH Stand-alone version of the FORTH Interest Group Model. **\$175**

DCS Software Products
WP/INT* Interface between WP-2 and any DMS file for form letters. **\$80**

Tra-Sta
Amway Distributors Package Order entry/inventory Package for direct Amway buyer. Maintains commission structure. **\$995**

BBS
Data Director* Powerful data base manager. Command oriented, very interactive. **\$995**

Tri-Comp
System Exerciser Self-prompting test routines for end user troubleshooting. **\$60**

Farragher and Assoc.
Med-Bill* Single doctor client billing. **\$995**

Frisch Computer Systems
Manufacturing Control System* Hard disk based. Standalone inventory with job costing and bill-of-materials. Extensively field tested. **\$3500**

DQFLS
WP-6502 OS65U version of popular word processor. **\$125**

UCSD System Users Society
USUS Software Exchange Library 6 diskette set of UCSD Pascal programs, includes USUS membership. **\$80**

Abacus Data Systems
Miller* Text processor plus key file/sort capability. Good mass mailer. **\$190**

Payroll* Thorough package for floppy or hard disk. End User Maintenance Service recommended. **\$495**

General Ledger* Multi-division/department support. Journal based, floppy or hard disk. **\$495**

Digital Technology
BUS-II Manufacturer's original version sold at trade-in price. **\$150**

*DMS Compatible

Affiliated Dealers

Abacus Data Systems Greensburg, PA 15601
 Taxman Salt Lake City, UT 84115
 Case Computer Bradley, IL 60915
 Business Computer of Joliet Cresthill, IL 60435
 Business Data Systems, Inc. Boulder, CO 80301
 Community Computers Arlington, VA 22201
 Computer Management Systems Mitchell, SD 57301
 CSB Houston, TX 77057
 Cybertronics Houston, TX 77084
 Data Buss Grayslake, IL 60038
 Data Services Computer Corp. Denver CO 80239
 Delta Data Distributors Memphis, TN 38118
 Farragher & Assoc. Milwaukee, WI 53213
 Frisch Computer St. Paul, MN 55113
 International Automation New Kensington, PA 15608
 KMH Galesburg, IL 61401
 MAP Systems Peoria Hts., IL 61614
 Practical Computer Springfield, IL 62703
 Specialized Computer Systems Jackson, MI 49204
 Tek-Aids Industries, Inc. Arlington Hts., IL 60004
 Tra-Sta Computer Shoppe Pueblo, CO 81005
 TriComp Inc. Denver, CO 80221
 Total Data Systems Ft. Collins, CO 80525
 Whitlock International, Inc. Detroit, MI 48219

EVERYONE WINS

The Ohio Scientific Software Game

Selecting software for your Ohio Scientific computer is a chancy task at best. There are few trustworthy vendors with a national reputation. There are no consistent quality standards and the documentation is often cryptic and inaccurate. If you are lucky enough to find a good package, there's no guarantee of ongoing support. A wrong choice results in months of wasted time, effort, and money.

With the Software Federation, you no longer take that risk. The Software Federation was formed by three of the largest Ohio Scientific hardware distributors to select and market quality software through reputable dealers nationwide.

DEALERS

The Software Federation solves the dealer's problems by providing low cost access to high quality software with the sort of demonstration packages, documentation, and support that the dealer needs to successfully sell machines.

AUTHORS

The Software Federation solves the independent vendor's problems

by providing a proprietary method of software protection, aggressive enforcement of software licenses, a strong dealer base, primary support, and national advertising.

END USERS

The Software Federation solves the user's problems by providing quality software, exceptional documentation, after-the-sale support, and optional software maintenance services.

Why risk making the wrong choice? With the Software Federation, everyone wins! See the dealer in your area for a complete turnkey demonstration.

Software Federation Inc.

44 University Drive
 Arlington Hts., IL 60004
 Phone: 312/259-1355



TM

! SOUND EFFECTS !

GUNSHOTS! PHASERS!
MUSIC! "OUTER SPACE
NOISES" AND MUCH MORE...

with

THE **ads**
NOISEMAKER ©
S-100 BUS

and

NOISEMAKER II ©
APPLE II BUS™

BOARDS USE THE
GI AY 3-8910 TO PRODUCE
SOUND EFFECTS UNDER
SOFTWARE CONTROL

- On board audio amp
- Breadboard area with +5, gnd
- Tone generators, noise source
- Envelope generator, I/O ports

FULL MANUAL INCLUDES:

Construction notes, software examples, full notes on AY 3-8910 schematic, parts list, etc. P.C. board soldermasked, gold contacts, parts silkscreen

NEW FEATURES!!!!

noisemaker (S-100 Bus)

Now, TWO on board audio amps for stereo, and on board wait state logic for 4MHz systems

ATTENTION APPLE II™ USERS!

Assembled & tested noisemaker II now available at \$79.95! plus \$1.50 shipping & handling

noisemaker P.C. board & manual \$34.95 + 50¢ shipping

noisemaker II P.C. board & manual \$34.95 + 50¢ shipping

Please specify *which* version when ordering.

Illinois residents add sales tax
*Apple is trademark of Apple Computer, Inc.

Write for details on the new ADS sound effects interpreter, the "Sound Writer"

ads

Ackerman Digital Systems, Inc.
110 N. York Rd., Suite 208
Elmhurst, Ill. 60126 (312) 530-8992

Listing 1: Menu-driven program to produce equation plots, histograms, or regression graphs. In order to run correctly, this program needs the subroutines from listing 1 of Part 1 of this article added to it.

```
5 REM KY 5 REM GRAPHS. (C) A.W.GROGONO. AUGUST 1979
6 REM HISTOGRAM, REGRESSION, EQUATION, V1
40 RESTORE :CLEAR 200:DIM I$(12)
50 DATA 1,2,6,4:FOR I= 1TO 4:READ COLOUR(I):NEXT I
90 PLOT 29,27,24,15,14,2,255,6,1,12,3,16,3:REM CLEAR PAGE
100 PRINT "S P E C I A L G R A P H S":PRINT
110 PRINT :PRINT ,, "1. CREATE HISTOGRAM"
120 PRINT :PRINT ,, "2. LINEAR REGRESSION"
130 PRINT :PRINT ,, "3. PLOT EQUATION"
140 PRINT :PRINT ,, "4. ERASE/REVIEW IMAGES"
150 PRINT :PRINT ,, "5. MAIN MENU"
190 PLOT 10,10,9,9,9,9:INPUT "ENTER #: ";CHOICE
200 ON CHOICEGOSUB 2000,4000,1000,7000,220:GOTO 5
220 LOAD "MENU":RUN
490 REM WRITE EQUATION AT 500, EG: 500 Y= X^2 - 3* X
510 RETURN
990 REM
991 REM
992 REM SUBROUTINE TO PLOT EQUATION
993 REM
1000 DIM ARRAY(25,1):REM PLOT EQUATION
1010 TITLE$= ""
1020 GOSUB 10100:REM EQUATION SUB
1030 PRINT :PRINT ,, :INPUT "X-BARS OR LINE: ";I$
1035 K= 1- (I$= "X")
1040 GOSUB 9000:ON KGOSUB 11100,11200:GOSUB 11900
1042 GOSUB 11800:IF K$= "C"THEN 1040:REM COLOR SELECT
1045 PLOT 3,0,31,6,4,11,3,15,31
1050 INPUT "NEW EQUATION, RANGE, SAVE OR MENU: ";I$
1060 IF I$= "E"THEN PLOT 12:GOTO 10132
1070 IF I$= "R"THEN 1020
1075 IF I$= "S"THEN GOSUB 11500
1085 IF I$= "M"THEN RETURN
1086 GOTO 1045
1190 REM
1191 REM
1192 REM SUBROUTINE TO ANALYSE DATA AND PLOT HISTOGRAM
1193 REM
2000 GOSUB 10000:REM HISTOGRAM
2010 AXIS= 0:GOSUB 10210:GOSUB 10310
2015 IF HIGH(0)> BIG(0)THEN 2020
2017 BIG(0)= BIG(0)+ JUMP(0)/ 2:GOSUB 10310
2020 PLOT 6,6,12,3,8,5:PRINT "THE HISTOGRAM WILL EXTEND FROM ";
2030 PRINT LOW(0);" TO ";HIGH(0):PRINT :PRINT
2040 PRINT ,"SELECT NUMBER OF COLUMNS IN HISTOGRAM: ":PRINT
2050 DATA " 4", " 6", " 8", "12", "16", "24"
2060 RESTORE 2050:PRINT :FOR I= 1TO 6:READ COLUMNS$
2070 PRINT ,, "";CHR$(64+ I);" ";COLUMNS$;" COLUMNS"
2080 PRINT :NEXT I
2110 PRINT ,, :INPUT "SELECT A - F: ";J$:J= ASC (J$)- 64:REM
2120 IF JK< 1OR J> 6THEN PLOT 28,11:GOTO 2110
2130 RESTORE 2050:FOR I= 1TO J:READ COLUMNS$:NEXT I
2140 COLUMNS= VAL (COLUMNS$)
```

Listing 1 continued on page 102



Please send your free software catalog.

(Check which software is of particular interest)

C COMPILER. Optimized native code for VAX 11/780, PDP-11, LSI-11, Z80, 8085, 8080. Full C language as defined in Kernighan and Ritchie, with comprehensive portable library. Cross compilers available. Runs under VMS, IAS, RSX-11D, RSX-11M, RSTS/E, RT-11, UNIX, Idris, CDOS, CP/M. From \$600

IDRIS OPERATING SYSTEM. System calls and file system identical to UNIX V6, including pipelines. Utilities include shell, editor, assembler, loader, archiver, compare, copy, grep, etc., plus system utilities for file system maintenance. Runs on LSI-11, PDP-11. From \$1000.

PASCAL COMPILER. Optimized native code for VAX 11/780, PDP-11, LSI-11, Z80, 8085, 8080. Full Pascal language as defined in Jensen and Wirth, with standard library. Includes C compiler and portable library, permitting intermixed C and Pascal. Cross compilers available. Runs under VMS, IAS, RSX-11D, RSX-11M, RSTS/E, RT-11, UNIX, Idris, CDOS, CP/M. From \$750.

Idris is a trademark of Whitesmiths Ltd.
UNIX is a trademark of Bell Laboratories.
CP/M is a trademark of Digital Research Co.

VMS, RSX-11, RT-11, RSTS/E, VAX,
PDP-11, LSI-11 are trademarks of Digital
Equipment Corporation.

Name _____

Company _____

Street _____

City _____ State _____ Zip _____

Whitesmiths, Ltd.
Software for grownups.
(212) 799-1200

P.O.B. 1132 Ansonia Station, New York, N.Y. 10023

By Netronics

ASCII/BAUDOT,
STAND ALONE



Computer Terminal

COMPLETE FOR ONLY \$149⁹⁵

The Netronics ASCII/BAUDOT Computer Terminal Kit is a microprocessor-controlled, stand alone keyboard/terminal requiring no computer memory or software. It allows the use of either a 64 or 32 character by 16 line professional display format with selectable baud rate, RS232-C or 20 ma. output, full cursor control and 75 ohm composite video output.

The keyboard follows the standard typewriter configuration and generates the entire 128 character ASCII upper/lower case set with 96 printable characters. Features include onboard regulators, selectable parity, shift lock key, alpha lock jumper, a drive capability of one TTY load, and the ability to mate directly with almost any computer, including the new Explorer/85 and ELF products by Netronics.

The Computer Terminal requires no I/O mapping and includes 1k of memory, character generator, 2 key rollover, processor controlled cursor control, parallel ASCII/BAUDOT to serial conversion and serial to video processing—fully crystal controlled for superb accuracy. PC boards are the highest quality glass epoxy for the ultimate in reliability and long life.

VIDEO DISPLAY SPECIFICATIONS

The heart of the Netronics Computer Terminal is the microprocessor-controlled Netronics Video Display Board (VID) which allows the terminal to utilize either a parallel ASCII or BAUDOT signal source. The VID converts the parallel data to serial data which is then formatted to either RS232-C or 20 ma. current loop output, which can be connected to the serial I/O on your computer or other interface, i.e., Modem.

When connected to a computer, the computer must echo the character received. This data is received by the VID which processes the information, converting to data to video suitable to be displayed on a TV set (using an RF modulator) or on a video monitor. The VID generates the cursor, horizontal and vertical sync pulses and performs the housekeeping relative to which character and where it is to be displayed on the screen.

Video Output: 1.5 P/P into 75 ohm (EIA RS-170) • Baud Rate: 110 and 300 ASCII • Outputs: RS232-C or 20 ma. current loop • ASCII Character Set: 128 printable characters—



BAUDOT Character Set: A B C D E F G H I J K L M N O P Q R S T U V W X Y Z . ? , * \$ % () , . 9 0 / 1 4 1 5 7 : 2 / 6 8 ~
Cursor Modes: Home, Backspace, Horizontal Tab, Line Feed, Vertical Tab, Carriage Return. Two special cursor sequences are provided for absolute and relative X-Y cursor addressing • Cursor Control: Erase, End of Line, Erase of Screen, Form Feed, Delete • Monitor Operation: 50 or 60Hz (Jumper selectable).

Continental U.S.A. Credit Card Buyers Outside Connecticut

CALL TOLL FREE 800-243-7428

To Order From Connecticut Or For Technical Assistance, Etc. Call (203) 354-9375

Netronics R&D Ltd., Dept. B12
333 Litchfield Road, New Milford, CT 06776

Please send the items checked below—

- Netronics Stand Alone ASCII Keyboard/Computer Terminal Kit, \$149.95 plus \$3.00 postage & handling.
- Deluxe Steel Cabinet for Netronics Keyboard/Terminal In Blue/Black Finish, \$19.95 plus \$2.50 postage and handling.
- Video Display Board Kit alone (less keyboard), \$89.95 plus \$3 postage & handling.
- 12" Video Monitor (10 MHz bandwidth) fully assembled and tested, \$139.95 plus \$5 postage and handling.
- RF Modulator Kit (to use your TV set for a monitor), \$8.95 postpaid.
- 5 amp Power Supply Kit In Deluxe Steel Cabinet (±8VDC @ 5 amps, plus 6-8 VAC), \$39.95 plus \$2 postage & handling.

Total Enclosed (Conn. res. add sales tax) \$ _____

By—
 Personal Check Cashiers Check/Money Order
 Visa Master Charge (Bank # _____)

Acct. # _____

Signature _____ Exp. Date _____

Print Name _____

Address _____

City _____

State _____ Zip _____

Send Me More Information

Listing 1 continued:

```

2150 FOR I= 1TO COLUMNS:ARRAY(I,1)= 0:NEXT I:REM ZERO SUMS
2160 JUMP= SCALE(0)/ COLUMNS:FOR ITEM= 1TO NUMBER
2170 GROUP= 1+ INT ((ARRAY(ITEM,0)- LOW(0))/ JUMP)
2180 ARRAY(GROUP,1)= ARRAY(GROUP,1)+ 1:NEXT ITEM
2200 PLOT 6, COLOUR(1),12:AXIS= 0:GOSUB 11400
2210 GOSUB 11900:AXIS= 1:GOSUB 10210:REM BIG(1)
2220 DEF FN E(I)= EXP (- ((MEAN(0)- I)^ 2/ (<2* DEVIAT(0)^ 2)))
2225 DEF FN F(I)= DEVIAT(0)* COLUMNS* 2.50663
2230 DEF FN G(I)= NUMBER* SCALE(0)* FN E(I)/ FN F(I):REM GAUSS
2240 IF FN G(MEAN(0))>> BIG(1)THEN BIG(1)= FN G(MEAN(0))
2250 GOSUB 9020:REM FRAME
2260 PLOT 6, COLOUR(4):REM GAUSSIAN CURVE
2270 FOR I= LOW(0)TO HIGH(0)STEP (HIGH(0)- LOW(0))/ 24
2280 AXIS= 0:PLACE= I:GOSUB 10700
2290 AXIS= 1:PLACE= FN G(I):GOSUB 10700
2300 ON 1- (I= LOW(0))GOSUB 11020,11010:NEXT I
2310 FOR AXIS= 0TO 1:PLACE= LOW(AXIS):GOSUB 10700:NEXT AXIS
2320 PLOT 6, COLOUR(3):GOSUB 11010:FOR I= 1TO COLOUMNS:REM HISTO
2330 AXIS= 1:PLACE= ARRAY(I,AXIS):GOSUB 10700:GOSUB 11020
2340 AXIS= 0:PLACE= LOW(AXIS)+ I* JUMP:GOSUB 10700:GOSUB 11020
2350 AXIS= 1:PLACE= LOW(AXIS):GOSUB 10700:GOSUB 11020:NEXT I
2355 GOSUB 11900:GOSUB 11800:IF K$= "C"THEN 2010:REM COLORS
2360 PLOT 3, 0, 31, 6, 4, 11, 3, 15, 31
2370 INPUT "NEW DATA, HISTOGRAM, SAVE OR MENU: "; I$
2375 IF I$= "M"THEN RETURN
2380 IF I$= "D"THEN 5
2385 IF I$= "S"THEN GOSUB 11500:GOTO 2355
2390 ON - (I$= "H")GOTO 2010:GOTO 2355
3990 REM
3991 REM
3992 REM SUBROUTINE TO ANALYSE DATA AND PLOT REGRESSION
3993 REM
4000 GOSUB 10000:REM DATA FOR LINEAR REGRESSION
4010 GOSUB 4400:REM BORDERS AND LINE
4030 GOSUB 11000:GOSUB 11900:REM POINT PLOT AND PAUSE
4035 GOSUB 11800:IF K$= "C"THEN GOSUB 4730:GOTO 4030:REM COLORS
4040 PLOT 3, 0, 31, 6, 4, 11, 3, 15, 31
4050 INPUT "NEW DATA, REGRESSION, SAVE OR MENU: "; I$
4060 IF I$= "D"THEN 5
4070 IF I$= "R"THEN 4010
4075 IF I$= "S"THEN GOSUB 11500:GOTO 4040
4085 IF I$= "M"THEN RETURN
4090 GOTO 4040
4400 PLOT 6, 47, 14, 12, 3, 17, 7:REM SELECT REGRESSION
4410 PRINT "S E L E C T R E G R E S S I O N":PRINT :PRINT
4420 DATA "LINEAR: Y = AX + B", ""
4430 DATA "EXPONENTIAL: 10^Y = AX + B", "10^"
4440 DATA "LOGARITHMIC: LOG10(Y) = AX + B", "LOG(10)"
4450 DATA "RECIPROCAL: 1/Y = AX + B", "1/"
4470 TITLES= 4
4480 RESTORE 4420:FOR I= 1TO TITLES:READ TITLE$, PREFIX$
4490 PLOT 10, 9, 9:PRINT I, TITLE$:NEXT I
4500 PRINT :PRINT , , :INPUT "SELECT REGRESSION: "; J
4510 IF J< 1OR J> TITLES THEN PLOT 28, 11, 28:GOTO 4500
4520 RESTORE 4420:FOR I= 1TO J:READ TITLE$, PREFIX$:NEXT I
4525 ON JGOTO 4530, 4540, 4550, 4560

```

Listing 1 continued on 106

Chief Relief

For years many small business system buyers thought that in order to get "real" performance and enough storage to be a "real" business system they would have to sacrifice the family jewels.

But with the introduction of the Smoke Signal Chieftain series office computers a lot of people's minds have been changed.

Because we designed the highly reliable Chieftain small business system with the most innovative combination of performance and efficiency around.

At your fingertips there are 64,000 characters of random access memory and you can address anywhere from 740,000 characters to 2 million characters with Smoke Signal's new double density controller. For larger concerns, there's a 20M byte hard disk available.

At a time when other small computer manufacturers tell you "you're on your own", Smoke Signal offers an abundance of easy-to-use software programs such as order entry, inventory control,

accounts receivable, invoice entry, payroll, word processing and much, much more. There's BASIC, COBOL and FORTRAN — even a multi-user BOS (Business Operating System) that allows for numerous users simultaneously.

Chieftain systems starting at under \$200.00 per month display performance on par with systems costing twice to three times as much.

So call (213) 889-9340 for your nearest authorized Smoke Signal dealer — he'll be glad to demonstrate the Chieftain's high reliability and ease of operation.

For dealers only, circle 68
All other inquiries, circle 67



SMOKE SIGNAL



BROADCASTING

31336 Via Colinas, Westlake Village, California 91361. (213) 889-9340



A FEW OF THE FEATURES THAT GIVE TERAK THE EDGE IN PRICE/PERFORMANCE

While some of the features of Terak's new 8600 can be found in other computer graphic systems, no other system in the \$5K-\$20K price class (and even those costing thousands more) provides a comparable combination of features and benefits. Features such as

Low Entry Cost The basic 8600 color system is priced at about \$15,000. It can be upgraded to higher resolution and a greater number of colors, but even fully expanded it still comes in at less than \$19,000.

Or, you can start with a black and white system for less than \$8,500 and upgrade to color at any time by the addition of a color processor and monitor.

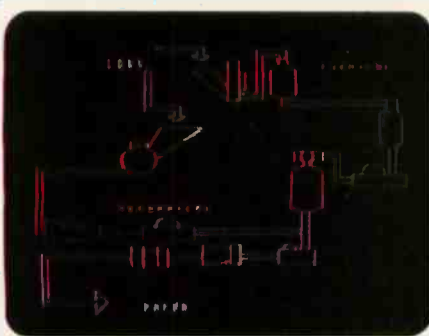

Simultaneous Graphic/Text Display

The 8600 offers outstanding control and formatting of both graphics and text. Completely under user control, the multiple memory planes permit simultaneous display and independent manipulation of text and graphics to achieve special effects such as overlays, scrolling and zoning. This capability, in conjunction with Terak's unique flexible character generation, enables the 8600 to present visual displays that are unequalled by any other system of its class.



Broad Spectrum of Color Selection

The number of color maps and the colors in each map is completely under software control. With a 6-plane memory (640 x 480 x 6), up to 64 colors can be displayed on the screen simultaneously. With a 3-plane memory (320 x 240 x 3), up to 8 simultaneous colors can be displayed from any one of eight color maps. The output of the color map produces eight levels each for red, blue and green. The result is the selection of 512 possible levels of intensity, saturation and hue. Switching from map to map is under software control.

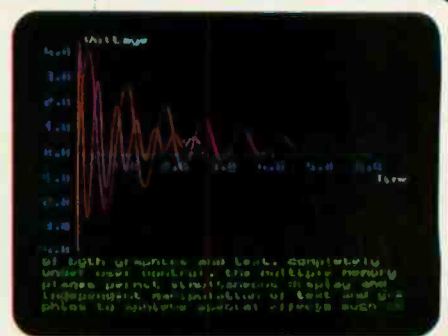

Zoning

The 8600 monitor screen can be divided into a maximum of four variable size zones. In a typical application, the upper three zones can display graphics while the lower zone displays text. The text can be scrolled or slow scrolled while the graphics are changing to coincide with the text changes.

Dual Processors For Speed and Flexibility The two 16-bit processors (each with its own memory) are assigned those tasks which they can accomplish most efficiently and with the fastest throughput. The result is more available user space in memory, faster processing and increased flexibility of operation.

DEC Based Hardware and Software The DEC based hardware and software includes the LSI-11 main processor, RT-11 operating system and Q bus compatibility. As a result, the 8600 will support a variety of software and easily integrates peripheral devices.

USCD Pascal, Too The 8600 also supports the easy to use USCD Pascal operating system for pro-

gram development, text editing, word processing and interactive applications.

Siggraph Core Standards, 2D1 Level Graphic support is provided for USCD Pascal and RT-11 for Fortran, Basic and Pascal.

The Other Reasons? Add such things as graphics display list processing, a high resolution quadrant, four modes of display blanking, emulation, remote on-line diagnostics, etc. The list goes on and on. But to fully appreciate the system you should see one in action. We'll be happy to set up an appointment. Just contact us.

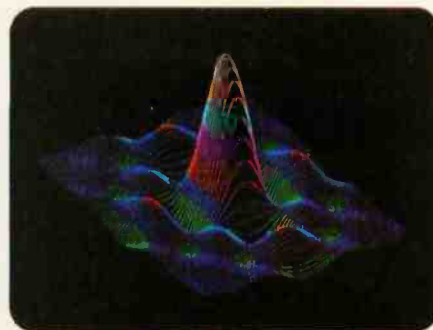

terak
CORPORATION

14151 North 76th Street
Scottsdale, Arizona 85260
(602) 998-4800

Circle 69 on Inquiry card.

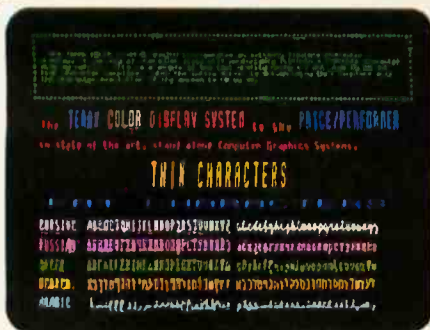

DYNAMIC FEATURES

The 8600 also offers several dynamic features that are impossible to illustrate and must be seen to fully appreciate.

Flexible Character Generation

Unlike the rigid cell sizes of many graphic display systems, the 8600 character generation is under software control. Characters can be programmed to any size or shape including the creation and display of foreign languages such as Arabic, Hebrew, Russian, etc., mathematical symbols, primitives, specially configured letters, characters or symbols and a host of others.

Fill Algorithms

Terak's fill algorithms are fast and allows you to fill the inside of simple or complex geometric figures without calculating points. This not only helps define charts, graphs, etc., but greatly enhances the appearance of presentation material.

Smooth or Line Scrolling

The speed of the vertical, bi-directional scrolling is under operator control. It can be slowed down for text editing or speeded up for search. And, unlike most terminals that jump a line at a time, the 8600 moves in increments of one scan line. The result is a smooth moving text that is easy to read.

External Video Synch

The 8600 can be synchronized to receive externally generated RGB signals or transmit 8600 signals to external video monitors. This lets you combine and/or overlay internally and externally generated characters and graphics onto a single screen if mixing hardware is incorporated in the system.

The days of complicated, unreliable, dynamic RAM are gone:

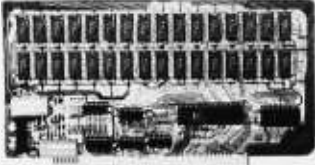

INTRODUCING JAWS

the ultrabyte memory board

\$199.95 (complete kit with 16K memory)

Netronics consistently offers innovative products at unbeatable prices. And here we go again — with JAWS, the ultrabyte 64K S100 memory board.

ONE CHIP DOES IT ALL

JAWS solves the problems of dynamic RAM with a state-of-the-art chip from Intel that does it all. Intel's single chip 64K dynamic RAM controller eliminates high-current logic parts . . . delay lines . . . massive heat sinks . . . unreliable trick circuits.

REMARKABLE FEATURES OF JAWS

Look what JAWS offers you: Hidden refresh . . . fast performance . . . low power consumption . . . latched data outputs . . . 200 NS 4116 RAMs . . . on-board crystal . . . 8K bank selectable . . . fully socketed . . . solder mask on both sides of board . . . designed for 8080, 8085, and Z80 bus signals . . . works in Explorer, Sol, Horizon, as well as all other well-designed S100 computers.

GIVE YOUR COMPUTER A BIG BYTE OF MEMORY POWER WITH JAWS — SAVE UP TO \$90 ON INTRODUCTORY LIMITED-OFFER SPECIAL PRICES!

UNDECIDED? TRY A WIRE 16K JAWS IN YOUR COMPUTER ON OUR 10-DAY MONEY-BACK OFFER (SPECIFY YOUR COMPUTER).

CONTINENTAL U.S. CREDIT CARD BUYERS: OUTSIDE CONNECTICUT CALL

CALL TOLL FREE 800-243-7428

From Connecticut Or For Assistance: (203) 354-8375 Dept. B12

NETRONICS RESEARCH & DEVELOPMENT LTD.
333 Litchfield Road, New Milford, CT 06776

Please send the items checked below:

- JAWS 16K RAM kit, No. 6416, \$199.95.*
- JAWS 16K RAM fully assembled, tested, burned in. No. 6416W, \$229.95.*
- JAWS 32K RAM kit, No. 6432, (reg. price \$329.95), SPECIAL PRICE \$299.95.*
- JAWS 32K RAM fully assembled, tested, burned in. No. 6432W, (reg. price \$369.95), SPECIAL PRICE \$339.95.*
- JAWS 48K RAM kit, No. 6464, (reg. price \$459.95), SPECIAL PRICE \$399.95.*
- JAWS 48K fully assembled, tested, burned in. No. 6448W, (reg. price \$509.95), SPECIAL PRICE \$449.95.*
- JAWS 64K RAM kit, No. 6464, (reg. price \$589.95), SPECIAL PRICE \$499.95.*
- JAWS 64K RAM fully assembled, tested, burned in. No. 6464W, (reg. price \$649.95), SPECIAL PRICE \$559.95.*
- Expansion kit, JAWS 16K RAM module, to expand any of the above in 16K blocks up to 64K, No. 16EXP, \$129.95.*

*All prices plus \$2 postage and handling. Connecticut residents add sales tax.

Total enclosed: \$

- Personal Check Money order or Cashiers Check
- VISA MASTER CHARGE (Bank No.)

Acct. No. _____ Exp. Date _____

Signature _____

Print Name _____

Address _____

City _____

State _____

Zip _____

Send me more information

Listing 1 continued:

```

4530 DEF FN F(I)= I:GOTO 4600:REM LINEAR
4540 DEF FN F(I)= 10^ I:GOTO 4600:REM EXPONENTIAL
4550 DEF FN F(I)= LOG (I)/ 2.30259:GOTO 4600:REM LOG BASE 10
4560 DEF FN F(I)= 1/ I:GOTO 4600:REM RECIPROCAL
4600 XYSUM= 0:REM PREPARE REGRESSION
4610 FOR ITEM= 1TO NUMBER:ARRAY<ITEM,1>= FN F<ARRAY<ITEM,2>>
4620 XYSUM= XYSUM+ ARRAY<ITEM,0>* ARRAY<ITEM,1>:NEXT ITEM
4625 LABEL$(1)= PREFIX$+ LABEL$(2):PLOT 6, COLOUR(1), 12
4630 FOR AXIS= 0TO 1:GOSUB 11400:NEXT AXIS
4640 I= NUMBER* XYSUM- SUM(0)* SUM(1)
4645 SLOPE= I/ (NUMBER* SQUARESUM(0)- SUM(0)^ 2)
4650 INCEPT= (SUM(1)- SLOPE* SUM(0))/ NUMBER
4660 COEFFICIENT= SLOPE* DEVIAT(0)/ DEVIAT(1)
4662 PLOT 3, 20, 17:PRINT "SLOPE: "; SLOPE
4664 PLOT 3, 20, 19:PRINT "INTERCEPT: "; INCEPT
4666 PLOT 3, 20, 21:PRINT "CORR. COEFF: "; COEFFICIENT
4668 GOSUB 11900
4670 GOSUB 10200:REM BIG & LITTLE
4680 ARRAY<NUMBER+ 1, 0>= LITTLE(0)
4690 ARRAY<NUMBER+ 1, 1>= INCEPT+ SLOPE* ARRAY<NUMBER+ 1, 0>
4700 ARRAY<NUMBER+ 2, 0>= BIG(0)
4710 ARRAY<NUMBER+ 2, 1>= INCEPT+ SLOPE* ARRAY<NUMBER+ 2, 0>
4720 NUMBER= NUMBER+ 2:GOSUB 10200:NUMBER= NUMBER- 2:REM LIMITS
4730 GOSUB 9020:PLOT 6, COLOUR(4):REM PREPARE GRAPH
4740 FOR ITEM= NUMBER+ 1TO NUMBER+ 2:FOR AXIS= 0TO 1:REM LINE
4750 PLACE= ARRAY<ITEM, AXIS>:GOSUB 10700:NEXT AXIS
4760 ON 2+ (ITEM= NUMBER+ 1)GOSUB 11010, 11020:NEXT ITEM:RETURN
11392 REM
11393 REM
11394 REM      SUBROUTINE TO ANALYZE ARRAY<NUMBER, AXIS>
11395 REM
11396 REM      CALCULATES      MEAN<AXIS>
11397 REM      AND PRINTS:      DEVIAT<AXIS>
11398 REM      ERR<AXIS>
11399 REM
11400 SUM<AXIS>= 0:SQUARESUM<AXIS>= 0:REM STATISTICS
11405 FOR ITEM= 1TO NUMBER
11407 SUM<AXIS>= SUM<AXIS>+ ARRAY<ITEM, AXIS>
11410 SQUARESUM<AXIS>= SQUARESUM<AXIS>+ ARRAY<ITEM, AXIS>^ 2
11415 NEXT ITEM
11420 MEAN<AXIS>= SUM<AXIS>/ NUMBER
11430 I= SQUARESUM<AXIS>- SUM<AXIS>^ 2/ NUMBER
11440 DEVIAT<AXIS>= SQRT (I/ (NUMBER- 1))
11450 ERR<AXIS>= DEVIAT<AXIS>/ SQRT (NUMBER)
11460 I= 20+ 20* AXIS:PLOT 3, I+ 3, 5:PRINT LABEL$(AXIS)
11465 PLOT 3, 0, 9:PRINT "MEAN:":PLOT 3, I, 9:PRINT MEAN<AXIS>
11470 PLOT 3, 0, 11:PRINT "STAN. DEV: "
11475 PLOT 3, I, 11:PRINT DEVIAT<AXIS>
11480 PLOT 3, 0, 13:PRINT "STAN. ERROR: "
11485 PLOT 3, I, 13:PRINT ERR<AXIS>:RETURN
11495 REM
11496 REM
11497 REM      ABBREVIATED SUBROUTINE
11498 REM      TO SAVE IMAGES
11499 REM
11500 PLOT 6, COLOUR(2), 3, 0, 31, 11:REM SAVE ON DISK
11540 PLOT 27, 4:PRINT "SAVE SCREEN. DIS 6000-6FFF":PLOT 27, 27
11550 RETURN

```

ENHANCED 'TINY' PASCAL

We still call it 'Tiny' but it's bigger and better than ever! This is the Famous Chung/Yuen 'Tiny' Pascal with more features including recursive procedures/functions & disk I/O.

'Tiny' Pascal is fast. Programs execute up to ten times faster than similar BASIC programs.

SOURCE TOO! We still distribute source, in 'Tiny' Pascal, on each discette sold. You can even recompile the compiler, add features or just gain insight into compiler construction.

'Tiny' Pascal is perfect for writing text processors, real time control systems, virtually any application which requires high speed. Requires: 36K CP/M. Supplied with complete user manual and source on discette: \$85.00 Manual alone \$10.00

StackWork's FORTH

A full, extended FORTH interpreter/compiler produces COMPACT, ROMABLE code. As fast as compiled FORTRAN, as easy to use as interactive BASIC.

SELF COMPILING: Includes every line of source code necessary to recompile itself.

EXTENSIBLE: Adds functions at will.

Z80 or 8080 ASSEMBLER included

Single license, OEM licensing available

Please specify CPU type: Z80 or 8080

Requires: 32K CP/M.

Supplied with extensive user manual and tutorial: \$150.00

Documentation alone: \$25.00

Protect your software investment by buying source! Prevent obsolescence, create custom versions, or use our systems as sources for 'library functions'!

The source code for all our programs, including the ones on this page, is available from us, either at additional cost, or if noted, included in the price. The programs on this page are distributed with machine readable source at no additional cost.

SUPERSOFT

Your Source for SOURCE

TFS—Text Formatting System

An extremely powerful formatter. More than 50 commands. Supports all major features including:

- left & right margin justification
- user defined macros
- dynamic insertion from disk file
- underlining and backspace

TFS lets you make multiple copies of any text. For example: Personalized form letters complete with name & address & other insertions from a disk file. Text is not limited to the size of RAM making TFS perfect for reports or any big job.

Text is entered using CP/M standard editor or most any CP/M compatible editor. TFS will link completely with Super-M-List making personalized form letters easy.

Requires: 24K CP/M

Source to TFS in 8080 assembler (can be assembled using standard CP/M assembler) plus user manual: \$250.00.

Object code only with user manual: \$85.00

Manual alone: \$20.00

TERM

A complete Intercommunications package for linking your computer to other computers. Link either to other CP/M computers or to large timesharing systems. TERM is comparable to other systems but costs less, delivers more and source is provided on discette!

With TERM you can send and receive ASCII and Hex files (COM too, with included conversion program) with any other CP/M computer which has TERM or compatible package. Allows real time communication between users on separate systems as well as acting as timesharing terminal.

- Engage/disengage printer
- error checking and auto retry
- terminal mode for timesharing between systems
- conversational mode
- send files
- receive files

Requires: 32K CP/M.

Supplied with user manual and 8080 source code: \$110.00

Manual alone: \$15.00



CP/M Formats: 8" soft sectored, 5" Northstar,
5" Micropolis Mod II, Vector MZ

*CP/M REGISTERED TRADEMARK DIGITAL RESEARCH

SUPERSOFT ASSOCIATES • P.O. BOX 1628 • CHAMPAIGN, IL 61820
(217) 359-2112

OUR PRICES ARE TOO LOW TO ADVERTISE!

CHECK THEM—CALL TOLL FREE!

800-243-7428

LOOK WHAT WE OFFER!

- **HAZELTINE**
Terminals
- **CENTRONICS**
Printers
- **LEAR-SIEGLER**
Terminals/Printers
- **DATA PRODUCTS**
Printers
- **ANADEX**
Printers

BE SMART- DON'T BUY UNTIL YOU CHECK OUR PRICES!

- ___ MASTERCHARGE
- ___ VISA ___ COD
- ___ PERSONAL CHECK
- ___ MONEY ORDER

NETRONICS

RESEARCH & DEVELOPMENT, LTD.
333 Litchfield Rd., New Milford, CT 06776

Listing 2: Programs for monthly analysis graph. Because this program modifies some of the previously written subroutines, this program should be added to the subroutines given in listing 1 of Part 1 of this article. (If the subroutines are added to this listing, the program will not run correctly.)

```

5 REM KY 5 REM      GRAPHS. (C) A. W. GROGONO.  AUG. 1979
6 REM      MONTHLY ANALYSIS FOR UP TO 7 YEARS
40 RESTORE :CLEAR 200:DIM I$(12)
50 DATA 1,2,1,2,4,6,3,5,7:FOR I= 1TO 9:READ COLOUR(I):NEXT I
90 PLOT 29,27,24,15,14,2,255,6,1,12,3,16,3:REM CLEAR PAGE
98 REM
99 REM
252 PRINT "M O N T H L Y   C O M P A R I S O N":PRINT
254 PRINT :PRINT ,, "THIS PROGRAM ALLOWS YOU TO"
255 PRINT :PRINT ,, "ENTER PROFITS OR INCOME ETC"
256 PRINT :PRINT ,, "MONTHLY FOR UP TO 7 YEARS. "
257 PLOT 10,10,10,9,9:PRINT "YOU CAN START AND FINISH"
258 PRINT :PRINT ,, "PART WAY THROUGH THE FIRST"
259 PRINT :PRINT ,, "AND LAST YEARS RESPECTIVELY"
260 PRINT :PRINT ,, "BY ENTERING THE NUMBERS OF"
261 PRINT :PRINT ,, "OF THESE MONTHS. "
264 PRINT :PRINT :PRINT ,, "1.  CREATE GRAPH":REM
266 PRINT :PRINT ,, "2.  ERASE/REVIEW OLD GRAPHS"
267 PRINT :PRINT ,, "3.  RETURN TO MAIN MENU":PRINT :PRINT ,,,
268 INPUT "ENTER 1 - 3: ";I:IF I= 2THEN GOSUB 7000:GOTO 5
270 IF I= 3THEN LOAD "MENU":RUN
272 PLOT 12,3,16,5:INPUT "ENTER # OF YEARS: ";N
274 FOR Y= 1TO N:PLOT 6,Y,10,9,9:PRINT "ENTER YEAR NUMBER":Y;
275 INPUT ": ";Y$(Y):NEXT Y:PLOT 10,9,6,1:PRINT "FOR YEAR ";
276 PRINT Y$(1):INPUT ", ENTER # OF FIRST MONTH, 1-12: ";FIRST
277 PLOT 10,9,6,N:PRINT "FOR YEAR ";Y$(N);
278 INPUT ", ENTER # OF LAST MONTH, 1-12: ";LAST
279 GOSUB 10000:FOR Y= 1TO N:GOSUB 10030:NEXT Y
280 LITTLE(0)= 0:BIG(0)= 12
281 LITTLE(1)= ARRAY(FIRST,2):BIG(1)= ARRAY(FIRST,2)
282 FOR Y= 1TO N:FOR ITEM= 1TO 12
283 ARRAY(ITEM,1)= ARRAY(ITEM,Y+ 1):REM COPY NEXT YEAR
284 NEXT ITEM:AXIS= 1:GOSUB 10215:NEXT Y:REM FIND BIG, LITTLE
285 GOSUB 600:REM SELECT ZERO END FOR Y-AXIS
286 GOSUB 10500:REM FRAME
287 FOR Y= 1TO N:F= 1:IF Y= 1THEN F= FIRST
288 L= 12:IF Y= NTHEN L= LAST
300 FOR ITEM= FTO L:ARRAY(ITEM,1)= ARRAY(ITEM,Y+ 1)
302 NEXT ITEM
320 GOSUB 11100:REM LINE
322 PLOT 3,59,20+ N- Y* 3:PRINT Y$(Y):REM YEAR IN GRAPH-COLOR
324 NEXT Y:GOSUB 11500:REM SAVE
325 GOSUB 11800:IF K$= "C"THEN GOTO 286:REM COLORS
330 PLOT 3,15,31:INPUT "ENTER A TO ALTER Y-AXIS ZERO: ";I$
340 IF I$= "A"THEN 280:REM NEW ZERO
350 GOTO 5
600 PLOT 6,6,14,12,3,16,5:PRINT LABEL$(1):PLOT 15,6,1,10,10
602 PRINT ,, "SELECT LENGTH OF SCALE":PRINT
610 PRINT :PRINT ,, "1.  WITH ORIGIN STARTING AT ZERO"
620 PRINT :PRINT ,, "2.  MAXIMUM ENLARGEMENT"
630 PRINT :PRINT ,,, :INPUT "SELECT 1 OR 2: ";I
640 IF I= 1THEN LITTLE(1)= 0
650 GOSUB 10300:RETURN :REM SCALE VALUES

```

Listing 2 continued on page 110

Make Your Dreams Come True

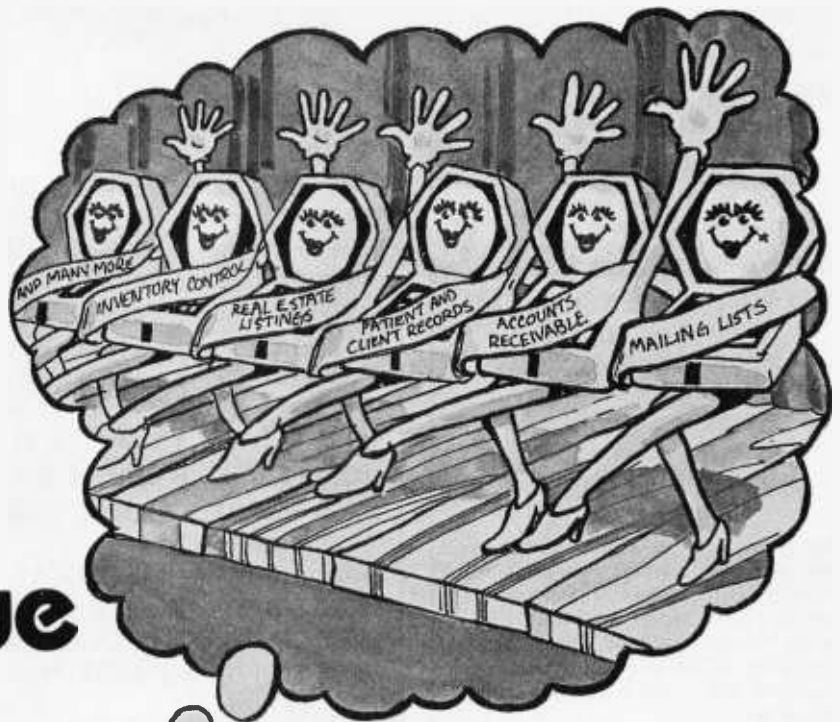

Imagine sitting down at your computer system and developing that specialized application you've always dreamed about — with absolutely **no programming!**

Now you can with **PRISM™** — the first Data Base Management System that provides the Total Solution to your information management needs. With **PRISM™**, you can have your application up and running in a matter of minutes — not months.

PRISM requires CP/M and CBASIC. (CP/M is a registered trademark of Digital Research. CBASIC is a trademark of Complier Systems.)

PRISM's flexibility and ease of use are combined with its full spectrum of features and capabilities to make it the ideal DBMS for a wide range of business applications. Mailing Lists, Patient Records, Real Estate Listings, and Client Billings are just a few of the possibilities. And **PRISM™** provides the quality, performance, and affordability you have come to expect from MAG software products.

To find out how **your** dreams can become realities, see your **PRISM™** dealer today.

Micro Applications Group, 7300 Caldas Avenue, Van Nuys, California 91406, (213) 881-8076.

PRISM™

"The Total Solution" **MAG**

© MAG 1980

Now-Break Through The 64K
Micro-Memory Limit!

SWEET SIXTEEN

Bank Selectable 16K Static RAM

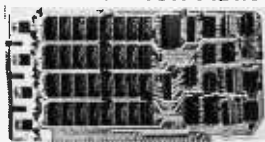

SAVE \$50.00
LIMITED TIME OFFER

Don't buy any more antique RAMs (RAM without bank select) — now there's Netronic's new SWEET SIXTEEN board featuring a universal software bank select system. SWEET SIXTEEN is capable of addressing 2,048 different banks. With SWEET SIXTEEN boards you can add memory beyond the 64K limit, or expand to a multi-terminal system.

LOOK AT THESE FEATURES:

- 300 NS, low power 2114's.
- **Software Bank Selector** — Universal decoder works with Cromenco, Alpha Micro, Netronics, most other systems, or your design. Onboard dip switches: Bank Select Enable; Reset Enable; Reset Disable; Port Address; Port Data.
- **All Inputs And Outputs** meet the proposed IEEE standards for the S-100 bus.
- 4.0 MHz Operation.
- **Schmitt Trigger Buffer** on all signals for maximum noise immunity.
- **Addressable On 16k Boundaries**, 0-64k, dip switch selectable.
- **Phantom Option**, dip switch selectable.
- **PWR/MWRITE Option**, dip switch selectable.
- **LED Indicator** to display status.
- **Glass Epoxy PC Board** with gold-plated contacts and double-sided solder mask.
- **Fully Socketed.**
- **Four Separate Regulators** for maximum stability.

10-Day Money-Back Policy For Wired & Tested Unit: Try a fully wired board — then either keep it, return it for kit, or simply return it in working condition.

Continental U.S.A. Credit Card Buyers
Outside Connecticut:

CALL TOLL FREE:

800-243-7428

From Connecticut Or For Assistance:
(203) 354-9375

Please send the items checked below:

- SWEET SIXTEEN kit; No. S-16** ... (reg. price \$249.95) now \$199.95*
- SWEET SIXTEEN, fully assembled, tested, burned in; No. S-16W** ... (reg. price \$289.95) now \$239.95*

*Plus \$2 postage & insurance. Connecticut residents add sales tax.

Total Enclosed: \$ _____
 Personal Check Money Order/Cashier's Check
 VISA Master Charge (Bank No. _____)
 Acct. No. _____ Exp. Date _____

Signature _____
 Print _____
 Name _____
 Address _____
 City _____
 State _____ Zip _____

NETRONICS

RESEARCH & DEVELOPMENT, LTD.
333 Litchfield Rd., New Milford, CT 06776

Listing 2 continued:

```

9990 REM
9991 REM
9992 REM      ALTERATIONS TO SUBROUTINES:
9993 REM
9994 REM      10000 DATA ENTRY
9995 REM      10200 FIND BIG AND LITTLE
9996 REM      10500 DRAW BORDERS ETC.
9997 REM      11000 PLOT POINTS AND LINES
9998 REM      11800 COLOR SELECTION
9999 REM
10000 PLOT 6, 1, 12, 14, 3, 18, 13:REM DATA ENTRY
10010 PRINT "D A T A   E N T R Y"
10015 PLOT 10, 9, 9:INPUT "GRAPH TITLE: ";TITLE$
10020 NUMBER= 12
10021 DIM ARRAY(NUMBER, N+ 1)
10022 LA$(0)= "JAN FEB MAR APR MAY JUN JLY AUG SEP OCT NOV DEC"
10025 IF CHOICE= 1THEN LABEL$(1)= "NUMBER":GOTO 10030
10026 PLOT 10, 9, 9:INPUT "Y-AXIS UNITS: ";LABEL$(1)
10028 RETURN
10030 F= 1:IF Y= 1THEN F= FIRST:REM ENTER DATA
10032 L= 12:IF Y= NTHEN L= LAST
10035 FOR ITEM= FTO L:REM ENTER POINTS
10040 IF ITEM> FTHEN 10060
10045 PLOT 12, 3, 17, 0:PRINT Y$(Y)
10050 PRINT :PRINT "POINT",, "MONTH":REM
10055 IF CHOICE< > 1THEN PLOT 28:PRINT ,,, ,";LABEL$(1)
10060 IF ITEM- 1= 6* INT ((ITEM- 1)/ 6)THEN PLOT 10:REM SPACE
10065 I$= MID$( LABEL$(0), ITEM* 4- 3, 3)
10070 PRINT :PRINT " "; ITEM, , " "; I$:ARRAY(ITEM, 0)= ITEM- . 5:REM
10075 IF CHOICE= 1THEN NEXT ITEM:RETURN
10080 PLOT 28, 18, 9, 9, 9:INPUT " "; ARRAY(ITEM, Y+ 1)
10085 NEXT ITEM:RETURN
10215 F= 1:IF Y= 1THEN F= FIRST
10216 L= 12:IF Y= NTHEN L= LAST
10217 FOR ITEM= FTO L
10498 REM
10499 REM
10557 IF AXIS= 0THEN NEXT AXIS
10662 PLOT 3, MAXSCREEN(0)/ 2- LEN (LABEL$(0))
10664 PLOT 33- MINSCREEN(1)/ 4:PRINT LABEL$(0)
10998 REM
10999 REM
11150 PLOT 6, COLOUR(2+ Y):FOR ITEM= FTO L:FOR AXIS= 0TO 1
11170 ON 2+ (FLAG= 1OR ITEM= F)GOSUB 11010, 11020
11798 REM
11799 REM
11845 DATA "GRAPH3", "GRAPH4", "GRAPH5", "GRAPH6", "GRAPH7"
11850 FOR J= 1TO N+ 2:READ I$:PLOT 3, 16, 9+ 2* J:PRINT "FOR "; I$;

```

Text continued from page 98:

independent (X) variable is the month of the year, while the dependent (Y) variable is the income in dollars for 1 month; four variables (the income in each of 4 years) are plotted on this graph.

When you run the monthly analysis graph program (by adding listing 2

to the subroutine lines of listing 1 in last month's article), you are asked for the numbers of the years to be graphed, followed by the beginning month for the first year and the ending month of the last year to be graphed. (This program is written to account for the possibility that you may not have all the data for the



At \$795*, how tough can these new Tigers be?

Introducing the new Paper Tiger™ 445 with the most rugged printing mechanism ever put in a low-cost matrix printer.

The 445 comes with a reliable ballistic-type print head and an advanced cartridge ribbon that lasts four times longer than many cassette or spool ribbons. Two separate heavy duty motors drive the print head and advance the paper. Plus you get true tractor paper feed.

And the new 445 gives you the performance you expect from the Paper Tiger family of printers. You can software-select character sizes, print 80- and 132-column formats, adjust paper width and length, even generate six-part business forms. All at unidirectional print speeds to 198 characters per second.

Need more stripes? Specify DotPlot™, a sophisticated raster graphics option.

If you've got an Apple**, TRS-80*** or other personal computer, get your paws on the tough new Paper Tiger™ 445 from IDS.

The people who invented low-cost matrix printing just growled.

Call TOLL FREE 800-258-1386 (in New Hampshire, Alaska and Hawaii, call 603-673-9100.)

Or write:
Integral Data Systems, Inc.,
Milford, New Hampshire
03055.



Paper Tiger 445

 Integral Data Systems, Inc.

*Suggested U.S. retail price.

**Apple is a trademark of Apple Computer Inc.

***TRS-80 is a trademark of Radio Shack, a division of Tandy Corp.

beginning and ending years.) After the title, Y-axis label, and monthly data values have been entered, the program calculates and displays the data on the color video display screen. The Y-axis can start at zero (as in photo 4a), or it can start at some nonzero value to allow maximum use of the Y-axis (as in photo 4b). As before, the colors used in the graph may also be changed.

Summary

The programs were written with readability as the main objective. You may wish to decrease the memory needed to store these subroutines by omitting REMark statements and putting multiple statements on a line. Care should be exercised, however, when compressing statement lines because some subroutines are written to be entered at more than one point.

The CompuColor PLOT statement was more fully explained in last month's article.

The four kinds of graphs described in this article demonstrate how the graphics subroutines can be combined (with or without modification) to form complex programs that produce specialized graphs. These subroutines can be used to substantially reduce the time required to create a given graph. In addition, the use of photographed color images (as opposed to color slides of conventionally produced graphs) can significantly decrease both the time and cost necessary to add color graphs to a slide presentation. ■

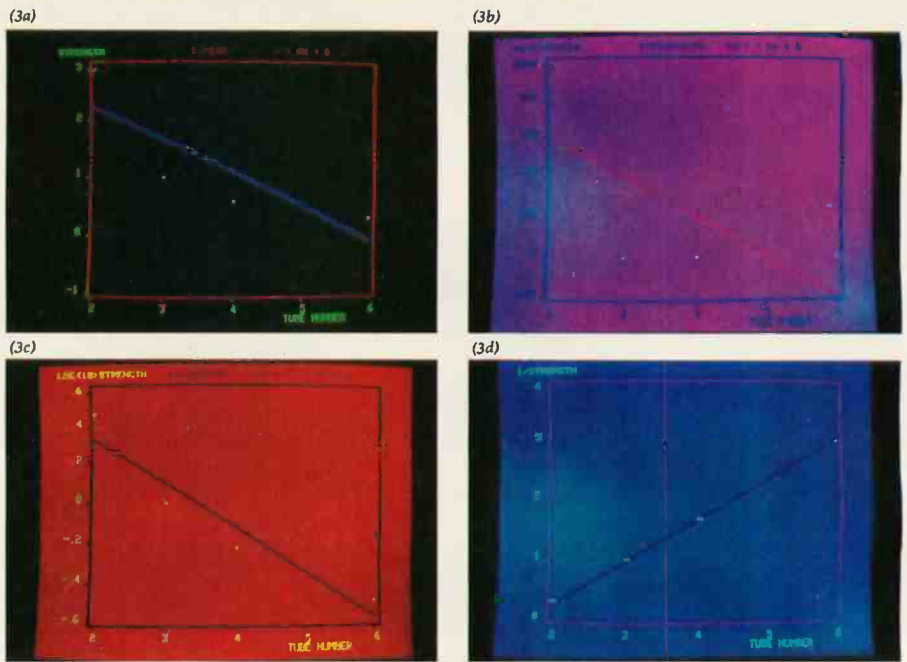

Photo 3: Examples of regression charts. The program in listing 1 allows the entered data to be graphed using different colors and different types of regression—linear (photo 3a), exponential (photo 3b), logarithmic (photo 3c), or reciprocal (photo 3d).

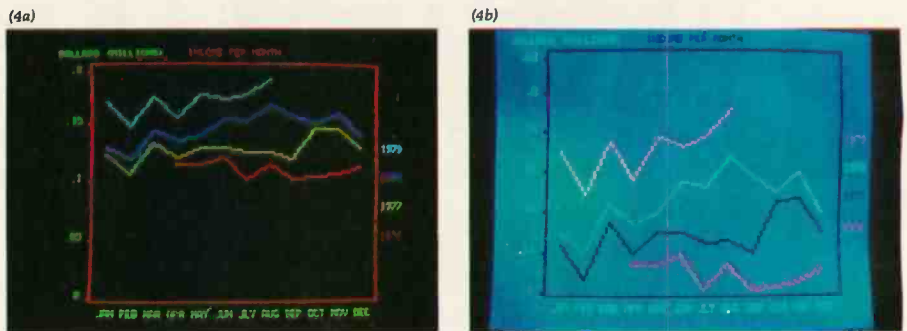
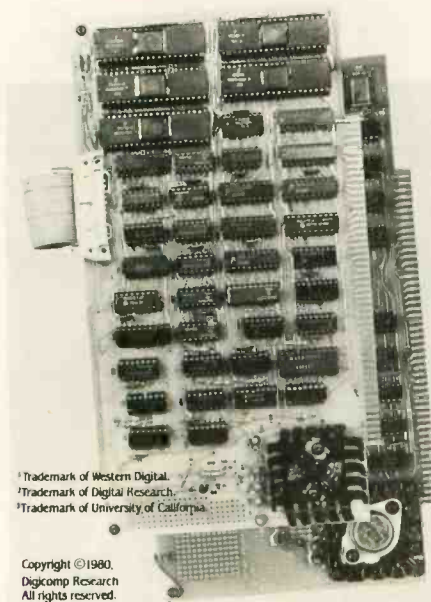

Photo 4: Examples of monthly analysis graphs. These graphs superimpose a variable plotted over a 12-month span for up to seven 12-month graphs. The Y-axis can start either at zero (photo 4a) or at some predefined value (photo 4b).



New PASCAL-100™ CPU mates today's popular UCSD Pascal language to your S-100 system. With both a Z80 processor and the Pascal Microengine¹ aboard, PASCAL-100 gives you the power of software data structuring without sacrificing speed, memory space—or even your current Z80, 8080 and CP/M² software.

Greater Speed. Up to 5 to 10 times faster than usual S-100

implementations of UCSD Pascal.³

More Memory. Up to 128K bytes of memory, plus an optional 1M extended address feature.

Better Performance. Complies with the new IEEE standard—PASCAL-100 has upward compatibility built in.

For complete information—fast—mail this ad or call us.

Name _____ Title _____
 Company _____ Phone _____
 Address _____
 State _____ Zip _____



Digcomp Research Terrace Hill, Ithaca N.Y. 14850 (607) 273-5900



Dealer/OEM Inquiries welcomed

¹Trademark of Western Digital.
²Trademark of Digital Research.
³Trademark of University of California.

Copyright ©1980, Digcomp Research. All rights reserved.

New on the North Star Horizon: 18Mb Hard Disk Drive!

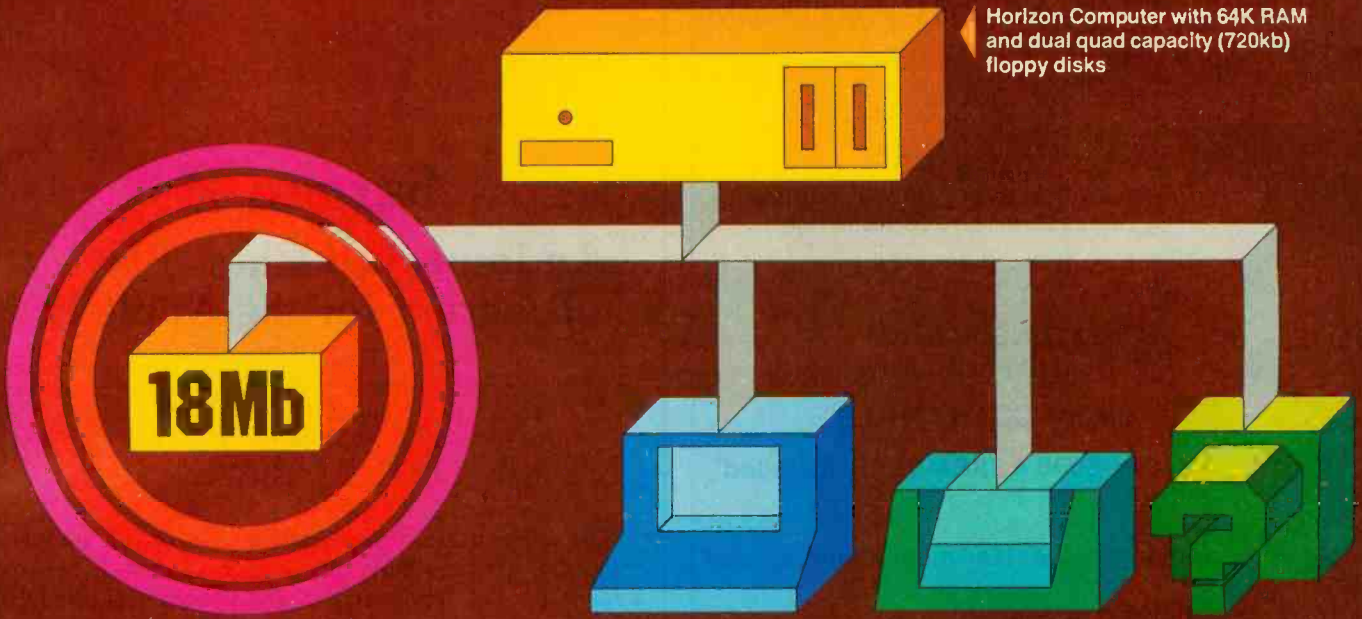

Up to four 18Mb Winchester-type hard disk drives

Display terminal

Letter-quality or dot matrix printer

Horizon I/O flexibility allows expansion to meet your needs

Unsurpassed Performance and Capacity!

North Star now gives you hard disk capacity and processing performance never before possible at such a low price! Horizon is a proven, reliable, affordable computer system with unique hardware and software. Now the Horizon's capabilities are expanded to meet your growing system requirements. In addition to hard disk performance, the Horizon has I/O versatility and an optional hardware floating point board for high-performance number crunching. The North Star large disk is a Century Data Marksman, a Winchester-type drive that holds 18 million bytes of formatted data. The North Star controller interfaces the drive(s) to the Horizon and takes full advantage

of the high-performance characteristics of the drive. Our hard disk operating system implements a powerful file system as well as backup and recovery on floppy diskette.

Software Is The Key!

The Horizon's success to date has been built on the quality of its system software (BASIC, DOS, PASCAL) and the very broad range and availability of application software. This reputation continues with our new hard disk system. Existing software is upward compatible for use with the hard disk system. And, with the dramatic increase in on-line storage and speed, there will be a continually expanding library of readily available application software. For more information, see your North Star dealer!

NorthStar 

North Star Computers, Inc.
1440 Fourth St.
Berkeley, CA 94710
(415) 527-6950 TWX/Telex 910-366-7001

HORIZON-HD-18

Horizon computer with 64K RAM, 2 quad capacity mini drives and one HDS-18 hard disk drive **\$9329**

HDS-18

Additional 18Mb hard disk drive for expansion of Horizon HD-18, or your present Horizon **\$4999**

SYS-1N

Complete Horizon HD-18 plus 80 x 24 display terminal and NEC Spinwriter printer **\$13,239**

SYS-1A

Complete Horizon HD-18 with 80 x 24 display terminal and Anadex printer **\$11,319**

FORTH

A full, extended FORTH interpreter/compiler produces COMPACT, ROMABLE code. As fast as compiled FORTRAN, as easy to use as interactive BASIC.



SELF COMPILING
Includes every line of source necessary to recompile itself.

EXTENSIBLE
Add functions at will.

CP/M* COMPATIBLE
Z80 or 8080 ASSEMBLER included

Single license
Supplied with extensive user manual and tutorial:
\$150.00
Documentation alone: \$25.00

OEM's, we have a deal for you!

CP/M Formats: 8" soft sectored,
5" Northstar, 5" Micropolis Mod II,
Vector MZ, TRS-80 Mod II

Please specify CPU type.
Z80 or 8080

All Orders and General Information:
SUPERSOFT ASSOCIATES
P.O. BOX 1628
CHAMPAIGN, IL 61820
(217) 359-2112
Technical Hot Line: (217) 359-2691
(answered only when technician is available)



SuperSoft
First in Software Technology

*CP/M registered trademark Digital Research

Product Review

Sargon II

An Improved Chess-Playing Program for the Apple II

John Martellaro
2929 Los Amigos, Apt B
Las Cruces NM 88001

The advertising literature for Sargon II quotes a magazine article: "Buy this program when it becomes available. . . ." My reaction: the program is available; buy it. Sargon II is everything Sargon I should have been. It is a mature effort. The program is clean, strong, and debugged. Nearly every deficiency of Sargon has been corrected:

- Sargon II has book openings. . .
- Sargon II recognizes stalemates.
- The levels of play are geared to clock time instead of ply search. As the pieces disappear, the ply search goes deeper, keeping the *time* relatively constant.
- Setting up a board position is easier.
- The program shows the move it is thinking of making.
- It will suggest a move for you.
- The graphics are new and very handsome.
- There is the much-asked-for asterisk prompt to indicate that the program is thinking.
- Every check is logged on the screen.
- Move entry is easier, but still not as easy as in Microchess 2.0.
- The playing strength is vastly improved.

Sargon II plays well. I play at an unofficial 1700+ United States Chess Federation (USCF) rating and have never lost a serious chess game to any microcomputer program (Boris 1978, Microchess 2.0, Sargon I), but I lost the first two trial games against Sargon II — mostly from being taken by surprise at its unwillingness to be bullied. Carelessness? Impatience?

After this appalling result, I promptly invited two friends over. They have official USCF ratings of 1650 and 1714, and the former player is extremely familiar with the openings.

We set Sargon II at level 3, the highest level that makes moves in tournament time. By our combined efforts, we cleaned Sargon II off the board — mostly by our

Our Printers

MEAN BUSINESS!



ANACOM 150

DOT MATRIX PRINTER

FEATURES:

- 150 Characters per second
- Bidirectional printing, logic seeking
- 9 x 9 Dot matrix
- Upper and lower case with descenders
- Double width characters
- 10 Characters per inch – horizontal
- 6 or 8 Lines per inch – vertical
- Adjustable tractors
- Original and 4 copies

OPTIONS:

- Extended life head
- Paper out sensor
- Bell, programmable
- 240 Vac 50 Hz
- Extended Factory Service

The ANACOM - 150 is a highly dependable receive only printing terminal. It's modular construction combines rugged quality with convenient serviceability. It is factory warranted for 90 days with an extended service contract available for continued customer protection.

Suggested list price

\$1,350.00

Includes:

Serial or parallel interface

**ANACOM GENERAL
CORPORATION**

1116 E. Valencia Dr.

Fullerton, Calif. 92631

(714) 992-0223

DEALER INQUIRIES INVITED

familiarity with the standard opening moves.

The 1650-rated player, whose lifetime high rating is 1850, has played every available computer chess game, including large mainframe computers. None has ever survived his "fried-liver attack." [The fried-liver attack involves placing the White King's Bishop on c4 and a White Knight on g5, attacking the weak King's Bishop pawn; or the equivalent setup for Black....RSS] Sargon II fared no better and succumbed in 13 moves.

Convinced now that Sargon II could be beaten, I rolled up my sleeves, got very mean, and again set the program for level 3. After 90 minutes of trekking through a bloody, grim Ruy Lopez opening, fending off a Queen-side attack, and using my mobility on the Kingside, I broke through. On move 40, Sargon made a mistake (failure to look far enough ahead), and I blew its position wide open. But for that one mistake, the game would have been a draw.

During the dozen or so games I have played against Sargon II, I have lost only one more game and have made the following observations. Sargon II has much needed and clearly visible improvements over Sargon I. It castles at the most propitious time and actually seeks an opponent's weaknesses and tries to gain tactical advantages.

The pawn play is much improved. Sargon II senses the worth of passed pawns and actively tries to promote them. Sargon I had little use for pawns.

After our three-game "tournament" mentioned above, we set up an endgame position out of curiosity. We took White with King at c1 and pawns at c2, b2, and h2. We gave Sargon II a King at g8 and pawns at g7, h7, a7, and b7. This should be a won game for Black with careful

White (Sargon II)	Black (Three humans, rated 1700 +, 1714, and 1650)
----------------------	--

- | | |
|-----------|--------|
| 1. e2-e4 | e7-e5 |
| 2. Ng1-f3 | Nb8-c6 |
| 3. Bf1-b5 | Ng8-f6 |
| 4. Nb1-c3 | Nc6-d4 |
| 5. d2-d3 | ... |

This looks like a good developing move, but Sargon II needed to play a little more sharply here. 5.Nf3xe5 leads to a much better game for White.

- | | |
|-----------|-------|
| 5. | c7-c6 |
| 6. Bb5-a4 | d7-d6 |
| 7. O-O | |

It looks safe enough for Sargon II. He has castled and mobilized his pieces by move 7. Sargon I never managed that.

- | | |
|-----------|--------|
| 7. | Bc8-g4 |
| 8. Bc1-e3 | |

A critically weak move. The Black Knight is going to capture anyway. Why not Bc1-g5?

- | | |
|------------|--------|
| 8. | Nd4xf3 |
| 9. g2xf3 | Bg4-h3 |
| 10. Rf1-e1 | |

An unfortunate move to have to make. If White could have seen what was in store, he might have abandoned the Rook and moved the King to h1.

- | | |
|----------|--------|
| 10. | Nf6-h5 |
|----------|--------|

This clears the way for the Queen. An important move in the attack.

- | | |
|------------|--|
| 11. Qd1-d2 | |
|------------|--|

A clever and amusing trap by White. If we had played 11. Qd8-h4 to pour it on, then 12.Be3-g5, and we lose our Queen. We very nearly fell for it. So far, Sargon II has played like an intelligent, but inexperienced, player. This is the first "trap" I have seen set by a microcomputer chess program.

- | | |
|----------|--------|
| 11. | Qd8-f6 |
|----------|--------|

But at the last second, we don't fall for the trap and attack the weak pawn at f3 instead.

- | | |
|-------------|--|
| 12. Nc3-d5? | |
|-------------|--|

A desperation move; White ignores the weak pawn at f3, but probably saw 12.Qd2-e2, Qf6-g6 check, and is ready to try anything.

- | | |
|----------|--------|
| 12. | Qf6xf3 |
|----------|--------|

It's all over now for White.

- | | |
|------------------|--------|
| 13. Nd5-c7 check | Ke8-d7 |
| 14. Ba4xc6 check | Kb7xc6 |

The horizon effect, trying to avoid fate: any human would have done the same.

- | | |
|------------|------------------|
| 15. Nc7xa8 | Qf3-g2 checkmate |
|------------|------------------|

Table 1: Score of a game played between Sargon II (with the White pieces) and three humans (with the Black pieces), one of whom is an openings expert. While Sargon lost the game, it went down fighting. This contest shows the style and limitations of the program, which played at level 3. The notation is algebraic.

Desk Main/Frame

Desk Main/Frame

LOW COST & ATTRACTIVE STYLING

- MAINFRAME INTEGRATED INTO FURNITURE QUALITY DESK
- ELECTRONICS PACKAGE SLIDE MOUNTED FOR EASY ACCESS
- SUPPORTS TWO 8" FLOPPY DRIVES FROM SEVERAL MANUFACTURERS (DRIVES NOT INCLUDED)
- 10 SLOT MOTHERBOARD INCLUDES CONNECTORS
- POWER SUPPLY FOR DRIVES AND CARDS
- DESK AND MAINFRAME AVAILABLE SEPARATELY
- MATCHING PRINTER DESK AVAILABLE



WRITE OR CALL FOR OUR BROCHURE WHICH INCLUDES OUR APPLICATION NOTE: 'BUILDING CHEAP COMPUTERS'

INTEGRAND

8474 Ave. 296 • Visalia, CA 93277 • (209) 733-9288
We accept BankAmericard/Visa and MasterCard

MICROWORLD®

TOLL FREE 1-800-528-1418



ATARI 800 SYSTEM

MicroWorld now offers complete systems based around the Atari 800 Personal Computer! Easier to operate, easier to own. In addition to features like 16-color graphics and a memory expandable to 48K, a full line of peripherals and comprehensive software library are now available for the Atari 800! Choose between two models of floppy disk drives, program recorder, three models of printers, modem, RS232 Interface module, and software designed for personal, professional and educational use! And now, MicroWorld offers FREE 8K RAM, FREE joysticks and FREE Star Raiders game with the purchase of an Atari 800 Personal Computer!

CALL FOR SPECIAL PRICE!



DIABLO 630 RO

Letter-quality, up to 40 cps printer offers complete interchangeability between metal and plastic print wheels! Universal Interface, baud rates to 9600, optional forms tractor.

CALL FOR PRICE!



LEXICON LX-11

Priced lower than Novation, lower than Livermore! New Bell 103A-compatible, RS232-compatible modem has special battery-powered option!

CALL FOR PRICE!



MICROSHOPPER

New edition of the best selling computer consumer guide! Includes more than 100 photos, dozens of hardware and software product reviews...feature articles, glossary, and more!

\$10.00 POSTAGE PAID



OKIDATA M-80

Reliable low-cost, 80 cps dot matrix printer. Program selectable 80 or 132 columns; friction, pin or tractor feed! Block graphics, too!

CALL FOR PRICE!



ATARI 400

Complete systems based around the Atari 400 from MicroWorld... excellent software selection for home and educational use! Plenty of options and accessories, too!

CALL FOR PRICE!

FREE FREIGHT

Best mail order offer in the industry! MicroWorld will pay the surface freight on any item featured in this ad! Free freight to 18,000 locations on selected NorthStar, Cromemco, Dymabyte, Archives, Centronics, Soroc and Texas Instruments products, too! Call MicroWorld today for the nation's largest microcomputer inventory and rapid, automated ordering processing! We pass our savings on to you!

Prices are subject to change and offers subject to withdrawal without notice.

MICROWORLD

1425 W. 12th Place, Tempe, AZ 85281

Master Card and Visa orders welcomed!

SYNCHRO-SOUND THE COMPUTER PEOPLE

A PERFECT
SUPER SPECIAL MATCHED PAIR!

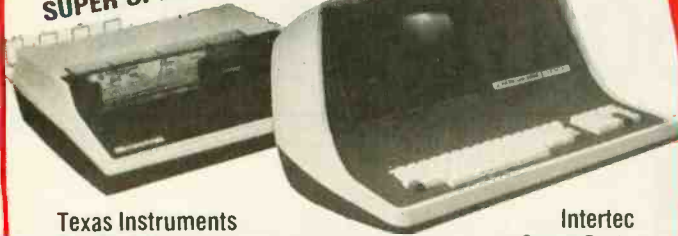

Texas Instruments
810 Multi Copy
Impact Printer

Intertec
Super Brain
Computer Terminal

ONLY \$4295.



Lear Siegler
ADM 3A
ADM 3A+



Soroc
Technology
IQ 120
IQ 140



DECwriter IV
LA34

Okidata
Microline 80

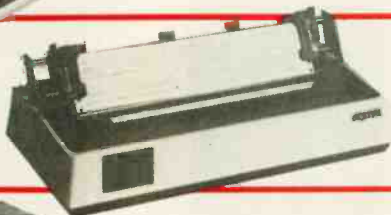

Northstar
Horizon II
Horizon II Quad

Many of our prices are too low to advertise!
PLEASE CALL OR WRITE

We carry a full line of: ADDS, QUME, TELETYPE,
CROMEMCO, FLORIDA DATA SYSTEMS, SCOTCH,
MAXELL, VERBATIM, ALPHA-MICRO, ATARI,
INTEGRAL DATA, LIVERMORE COUPLERS,
HAZELTINE, TEXAS INSTRUMENTS,
DIGITAL MICRO SYSTEMS and others.



SYNCHRO-SOUND

ENTERPRISES, INC.
THE COMPUTER PEOPLE

193-25 Jamaica Ave.
Jamaica, New York 11423
TWX 710-582-5886

PHONE ORDERS CALL:
New York 212/468-7067
Los Angeles 213/628-1808
Chicago 312/641-3010
Dallas 214/742-6090

play. At times, Sargon II pushed its look-ahead procedure to level 8. (This cannot be set from the keyboard.)

Sargon pushed its pawns carefully, but blundered by trying to fight on both fronts for too long. The program finally made a critical mistake and allowed us a draw. We wound up with just the two Kings on the board. Curiously at that point, instead of calling a draw Sargon's King started advancing toward our King, perhaps thinking that with a hidden dagger up its sleeve, it could finish us off. Such violence would be a patent violation of chess law.

Sargon II is the first chess program I have seen which has doubled its Rooks on a file with malice obviously intended. It is also the first program I've played that has actually set a trap. Perhaps this is a glimmer of artificial intelligence!

The program will suggest a move for you if you type control-K. You would be wise to ignore this advice if you are an experienced player. Why? These programs play well tactically but with poor strategy. Any suggested move will be devoid of the strategic thought which you, as a human, ought to be applying.

Sargon II may be the strongest chess program you can buy, dedicated chess-playing devices included. I am impressed beyond all expectation. If I were to estimate its Elo rating, I would say it is possibly 1500 at level 3.

However, as with any software product, there are some minor complaints. If you bought Sargon I for \$20, you may flinch at buying Sargon II for \$30 (\$35 on floppy disk). Such a price seems hard to justify, and you would expect that for a \$30 program, the packaging would be a little better. For example, the shell of the cassette I received was the glued-together type, instead of the higher-quality shell with screws.

Also, the instruction book is not what you would expect of a \$30 program. The book was not carefully produced and assumes too much prior knowledge on the part of the user. There is an error on page 4 where it says to type a control-R followed by a Return. If you hit the Return, you'll find yourself helplessly transferred into the monitor, and since the program is locked and protected, you'll have to reload it.

Another possibility for grief lies in the use of a printer to record the game. If Sargon II changes its decision about a move, it will overwrite the previous move. This works fine for a video display, but on a printer there would be a blob after two or more move changes.

About the only other request you might make of Sargon II is to have the listing of the entire game in memory instead of letting lines scroll off the top of the screen. Often a user gets too busy playing to record the game by hand. Not everyone can afford a printer; but this is a minor affair.

In summary, Sargon II is about all we computer chess players could wish for in 1980. No doubt, stronger programs will be written (Sargon III is still in an experimental stage), but this one will keep your attention unless you are a wizard in the openings. Dan and Kathe Spracklen are to be commended for a superb implementation on the 6502 microprocessor: in fact, I give them an A+ rating for the implementation. The Spracklens and the Hayden Book Company also get a A+ for correcting the problems in Sargon I, but unfortunately, Hayden gets a C on the packaging. ■

[Next month the author reviews Sargon 2.5...ed]

Pump Up Your TRS-80 with the ES/F Mass Storage System



THESE FACTS SPEAK FOR THEMSELVES!

	CASSETTE	ES/F	MINI-DISK
SPEED (Seconds to load "Blackjack")	56	6 (5' wafer)	6½
CAPACITY (thousands of bytes)	38 (C-20)	64 (75' wafer)	59 (TRSDOS)
RELIABILITY (Designed for digital data?)	NO	YES	YES
SYSTEM COST (First unit plus interface)	\$60	\$250	\$800
MEDIA COST (in quantities of ten)	\$3.10 cassette	\$3.00 wafer	\$3.20 disk

Let's face it. Cassette players were not designed to store digital data and programs. That's why we designed a digital storage system using a continuous tape loop: the Exatron Stringy/Floppy (ES/F) and the Wafer. There's no expensive interface to buy—the ES/F comes ready to pump up your TRS-80.*

Once your TRS-80* is pumped up by our ES/F . . . you won't want to deflate it. We're so sure, that we offer an unconditional 30-day money-back guarantee and a one-year limited warranty. Over 2,000 TRS-80* owners have met the wafer . . . why don't you? *

EXATRON'S STRINGY/FLOPPY...

SPEED, CAPACITY AND RELIABILITY FOR ONLY \$249.50



**CALL
OUR HOTLINE
(800)-538-8559**

**IN CALIFORNIA,
CALL (408)-737-7111**

exatron, inc.
181 Commercial Street
Sunnyvale, Calif. 94086

*TRS-80 is a registered trademark of Tandy Corp.

Micrograph

Part 2: Video-Display Processor

E Grady Booch
4314 Driftwood Dr
Colorado Springs CO 80907

Part 1 of this article (BYTE, November 1980, page 64) presented some background on interactive computer-graphics systems, with an emphasis on the characteristics of display processors (the portion of the graphic system that produces the actual image). The instruction set for a color raster-scan graphics-display processor was also presented. Part 2 will feature the hardware for a low-cost display processor, called Micrograph, which implements this instruction set. You can find the essential characteristics of Micrograph listed in table 1. The processor's hardware, including a circuit description, construction hints,

and enhancement ideas, will be the topic of the latter portion of this part of the series.

Block Diagram

As figure 1 indicates, Micrograph is relatively simple in terms of hardware: there is nothing tricky about its design. Micrograph is built around a Zilog Z80 microprocessor, which shares a bus with a video-display generator. The bus control arbitrates between the microprocessor and the display generator so that only one

device is allowed to access the bus at a time.

Also connected to the system bus are several I/O (input/output) ports, which are used to communicate with a host computer. The I/O interface includes ports for transmission of data and instructions from the host computer and ports for the transmission of data and status to the host computer. Micrograph thus appears to the host computer as an intelligent peripheral. With this architecture, the display processor does not tie up the

Features:

64 by 64, 128 by 128, and 256 by 192 pixel resolutions available.

Up to eight different colors displayed at one time.

Single-board processor, based on Zilog Z80 and Motorola MC6847 Video-Display Generator.

Costs approximately \$275 to construct.

Supported by high-level graphics primitives to produce images efficiently.

Supports graphics and alphanumerics.

Interfaces to a host microcomputer via three 8-bit I/O ports (status, input, and output) and by radio frequency or video entry to a standard, unmodified color television.

Table 1: Summary of the characteristics of the Micrograph color-display system.

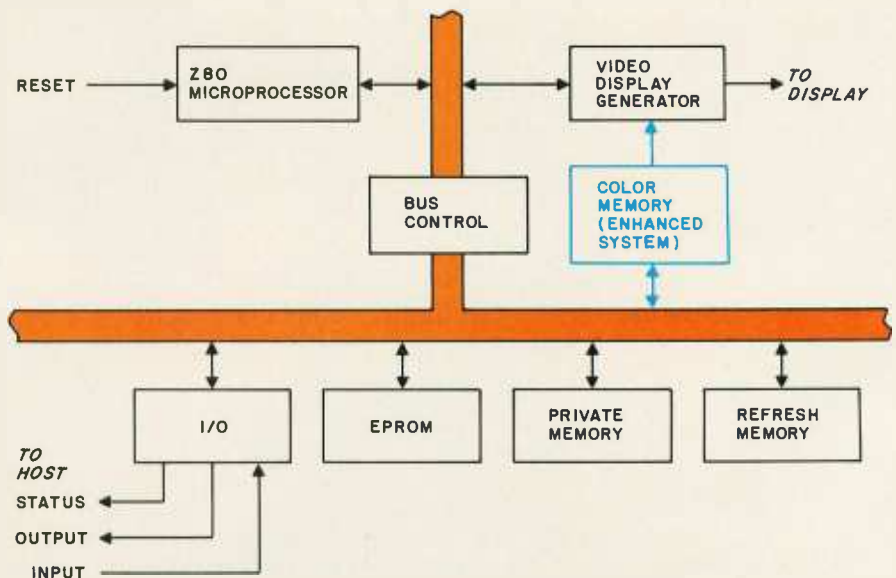

Figure 1: Block diagram of Micrograph hardware. The Z80 microprocessor provides an active element for implementing the instruction set described in Part 1 of this article. By using a video-display generator device developed by Motorola, the hardware is simplified. The processor and display generator share a common bus that is separate from the host system's bus, so that Micrograph is a truly intelligent peripheral.

Radio Shack's \$399* TRS-80™ Color Computer-- Innovation at it's Very Best!

The Family Christmas Gift That's Functional, Fun and Educational! Tremendous versatility and value at a breakthrough price. Something for everyone in your home! The TRS-80 Color Computer can be used with our plug-in ROM Paks, or write your own programs in BASIC. Mom and Dad can use it for any number of applications, such as keeping track of personal finances; youngsters can learn the basics of computer programming—the whole family will enjoy playing exciting color action games. It's expandable, so its capability grows with yours. Attaches to any color TV quickly and easily or get our optional TRS-80 Color Video Receiver (works as an extra TV too!).



Put a computer in your life this Christmas. Get the full story and specs from your nearest Radio Shack store, dealer or Computer Center. Over 6,000 locations, nationwide. Or write for a free TRS-80 catalog: Radio Shack, Dept. 81-A-60, 1300 One Tandy Center, Fort Worth, TX 76102.

*Retail prices may vary at individual stores and dealers.

Radio Shack
The biggest name in little computers™

Mode Number	Control Signals							Colors	Border	Resolution
	\bar{A}/G	\bar{A}/S	GM1	GM2	GM3	CSS	INV			
1	0	0	x	x	x	0	0	green on black	black	32 characters by 16 lines
	0	0	x	x	x	0	1	black on green	black	
	0	0	x	x	x	1	0	orange on black	black	
	0	0	x	x	x	1	1	black on orange	black	
2	0	1	x	x	x	x	x	black, green, yellow, blue, red, buff, cyan, magenta, or orange (depends on color code)	black	64 by 32, eight colors
	1	x	0	0	0	0	x	green, yellow, blue, red	green	
3	1	x	0	0	0	1	x	buff, cyan, magenta, orange	buff	64 by 64, four colors
	1	x	0	0	1	0	x	black, green	green	
4	1	x	0	0	1	0	x	black, buff	buff	128 by 64, two colors
	1	x	0	0	1	1	x	same as 3	green	
5	1	x	0	1	0	0	x	same as 3	buff	128 by 64, four colors
	1	x	0	1	0	1	x	same as 4	green	
6	1	x	0	1	1	0	x	same as 4	buff	128 by 96, two colors
	1	x	0	1	1	1	x	same as 4	green	
7	1	x	1	0	0	0	x	same as 3	buff	128 by 96, four colors
	1	x	1	0	0	1	x	same as 3	green	
8	1	x	1	0	1	0	x	same as 4	buff	128 by 192, two colors
	1	x	1	0	1	1	x	same as 4	green	
9	1	x	1	1	0	0	x	same as 3	buff	128 by 192, four colors
	1	x	1	1	0	1	x	same as 3	green	
10	1	x	1	1	1	0	x	same as 4	buff	256 by 192, two colors
	1	x	1	1	1	1	x	same as 4	green	

Table 2: Summary of the modes available to the Micrograph user. The Motorola MC6847 Video-Display Generator integrated circuit supports other resolutions, which are not available in the systems presented here. The 6847 control signals include: two lines to select between alphanumeric, semigraphics, and graphics; three lines to select the graphics-mode resolution; a color-set select line; and an inverse-video select line.

host computer's time but rather handles its own display refreshing.

EPROM (erasable programmable read-only memory) is required to store the approximately 2.6 K bytes of software that implements the Micrograph instruction set. (A discussion of this software will be presented next month in Part 3.) Finally, 2 K bytes of programmable memory are used to store software variables and data for a programmable character generator, and 6 K to 8 K bytes of programmable memory are used for the display buffer.

Note that there is a reference to "System II": this is an improvement to the basic Micrograph system that will be discussed later in this article.

Video-Display Generator

The secret to Micrograph's simplicity is Motorola's MC6847 video-display generator. This forty-pin integrated circuit performs all the necessary video timing and refresh functions needed to produce a truly inexpensive color-graphics display. The 6847 was actually designed for the 6800 family of microprocessors, but its control, address, and data structures are generalized enough to allow its use with almost any

microprocessor. I chose the Z80 because it was convenient in terms of the software development tools I had available.

The 6847 has several modes of operation, including alphanumeric, semi-alphanumeric, and full graphics modes. The device offers several different graphics-display resolutions, including sixteen lines of thirty-two alphanumeric characters and 64 by 64 pixel, 128 by 64 pixel, 128 by 96 pixel, 128 by 192 pixel, and 256 by 192 pixel graphics. The circuit also produces up to eight different colors that can be displayed at one time. Of course, with memory size held constant as the resolution increases, the number of colors that can be displayed at one time decreases. For example, the 128 by 192 pixel resolution has four colors, and the 256 by 192 pixel resolution has two colors. (Table 2 summarizes the modes available to the Micrograph user.)

Ready for use with the 6847 is a companion device, the MC1372 color television video modulator. This circuit interfaces directly to the MC6847 to provide either an RF (radio-frequency) or composite-video television signal. This allows Micrograph to be connected directly to an un-

modified color television. Both of these devices are obtainable from most Motorola distributors; and in single quantities, the MC6847 costs around \$35 and the MC1372 costs around \$5.

For those readers who would rather avoid the expense of building a complete version of Micrograph, the MC6847 will still offer a very inexpensive way to produce a color-graphics display. In the event that you wish to connect the video-display generator to an existing microcomputer, the following discussions are still applicable. However, the advantage of dedicating a microprocessor to control the video display is that the host computer doesn't have to wait while the video generator accesses display-refresh memory. Furthermore, the Micrograph instruction set allows the host processor to deal with manipulating images, rather than worrying about the overhead of scan-line conversion and otherwise maintaining the display.

Circuit Description

Figure 2 provides the complete schematics for Micrograph. As we noted in the block diagram, the Z80

Text continued on page 126

Speed up your PET programming with The BASIC Programmer's Toolkit™ now only \$39.95.

Don't waste valuable programming time if there's an easier way to go. Here it is: The BASIC Programmer's Toolkit, created by Palo Alto ICs, a division of Nestar. The Toolkit is a set of super programming aids designed to enhance the writing, debugging and enhancing of BASIC programs for your PET.

The BASIC Programmer's Toolkit has two kilobytes of ROM firmware on a single chip.

This extra ROM store lets you avoid loading tapes or giving up valuable RAM storage. It plugs into a socket inside your PET system, or is mounted on a circuit board attached on the side of your PET, depending on which model you own.

There are basically two versions of PET. To determine which Toolkit you need, just turn on your PET. If you see *****COMMODORE BASIC*****, your PET uses the TK-80P Toolkit. If you see **###COMMODORE BASIC###**, your PET uses the TK-160 Toolkit. Other versions of the BASIC Programmer's Toolkit are available for PET systems that have been upgraded with additional memory.

How Toolkit makes your programming easier:

FIND locates and displays the BASIC program lines that contain a specified string, variable or keyword.

If you were to type **FIND A\$,100-500**, your PET's screen would display all lines between line numbers 100 and 500 that contain **A\$**.

RENUMBER rennumbers the entire program currently in your PET.

You can instantly change all line numbers and all references to those numbers. For instance, to start the line numbers with 500 instead of 100, just use **RENUMBER 500**.

HELP is used when your program stops due to an error. Type **HELP**, and the line on which the error occurs will be shown. The erroneous portion of the line will be indicated in reverse video on the screen.

These simple commands, and the other seven listed on the screen, take the drudgery out of program development work. And for a very low cost. The BASIC Programmer's Toolkit costs as little as \$39.95, or at most, \$59.95.

Get the BASIC Programmer's Toolkit and find out how quick and easy program development can be. See your local PET dealer or send this coupon in today.

Increase your PET's IQ for \$39.95

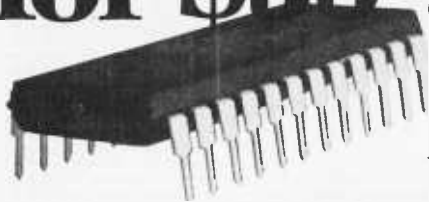

PALO ALTO ICs
A Division of Nestar Systems, Incorporated

PET™ is a trademark of Commodore Business Machines, Inc. The BASIC Programmer's Toolkit™ is a trademark of Palo Alto ICs, a division of Nestar Systems, Inc.

The Toolkit is fully assembled. It is not a kit and requires no special tools to install.

I want to save programming time and money. Send me The BASIC Programmer's Toolkit that will give my PET 10 new and useful commands. Fill in the appropriate line below:

Qty. _____ TK-160 Toolkit(s) @ \$39.95 each

Qty. _____ TK-80P Toolkit(s) @ \$59.95 each

Want to charge it? Call (415) 493-TOOL, or fill out the form below.

Enclosed is a money order check

(If charging): Bill VISA Bill Master Card.

Charge Card _____ Exp. Date _____

Master Card Interbank Number _____

Signature _____

Please include the amount of the Toolkit, plus \$2.50 for shipping and handling. Please allow 4-6 weeks for delivery. **SATISFACTION GUARANTEED, OR SEND IT BACK WITHIN 10 DAYS OF RECEIPT AND PALO ALTO ICs WILL REFUND YOUR MONEY.**

SEND TO:

Name _____

Address _____

City _____ State _____ Zip _____

Phone _____

MAIL TO: Palo Alto ICs
A Division of Nestar Systems, Inc.
430 Sherman Avenue
Palo Alto, CA 94306
(415) 493-TOOL

Dealer inquiries invited.

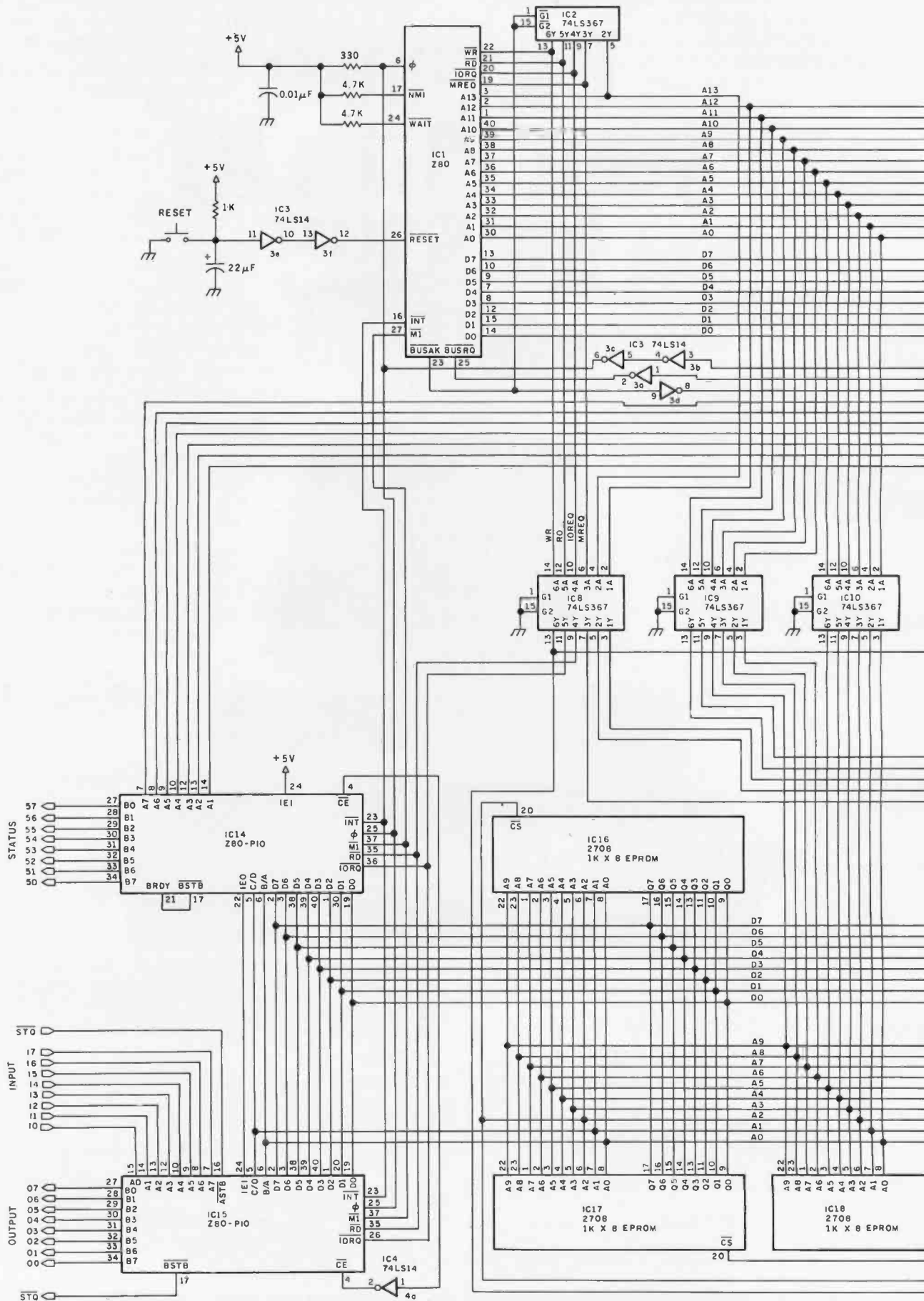

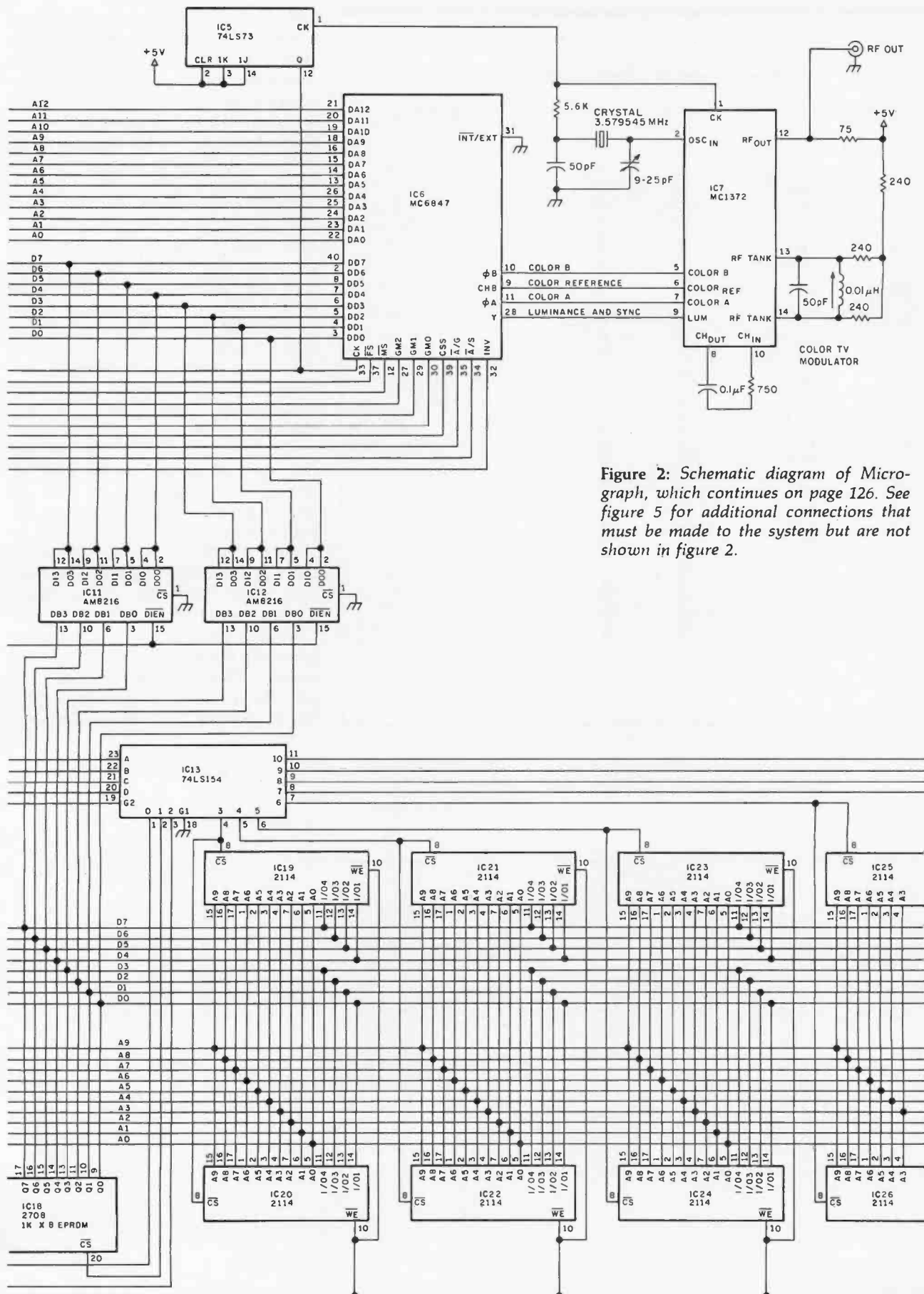

Figure 2: Schematic diagram of Micrograph, which continues on page 126. See figure 5 for additional connections that must be made to the system but are not shown in figure 2.

Text continued from page 122:

and the MC6847 share the same bus. Since both of these devices have three-state address and data lines, they can simply be wired to the same physical bus. The only problem that must be dealt with is the selection of a single device to use the bus at a given time. This problem is simplified by the bus-control lines of the Z80 (the $\overline{\text{BUSRQ}}$ and $\overline{\text{BUSAk}}$ control lines) and the MC6847 (with the $\overline{\text{FS}}$ and $\overline{\text{MS}}$ control lines). On the Z80, whenever the $\overline{\text{BUSRQ}}$ line is pulled low, the $\overline{\text{BUSAk}}$ line will go low later, indicating that a request to use the bus has been acknowledged. At that time, the processor's address and data lines enter a high-impedance mode, the processor essentially "disappears," and another system can control the bus.

On the MC6847, there are similar lines to control bus access. The $\overline{\text{FS}}$ line goes low during the vertical retrace period. The $\overline{\text{MS}}$ line on the MC6847 can then be brought low to allow the Z80 access to the bus while the video-display generator's address and data lines are in a high-impedance condition.

In this design, the video-display generator has priority for memory accesses. This approach limits the amount of time the microprocessor has to execute, but since we have a

Power Connections for Figure 2

Number	Type	+5 V	GND	-5 V	+12 V
IC1	Z80	11	24		
IC2	74LS367	16	8		
IC3	74LS14	14	7		
IC4	74LS14	14	7		
IC5	74LS73	20	10		
IC6	MC6847	17	1		
IC7	MC1372	11	4		
IC8	74LS367	16	8		
IC9	74LS367	16	8		
IC10	74LS367	16	8		
IC11	AM8216	16	8		
IC12	AM8216	16	8		
IC13	74LS154	24	12		
IC14	Z80-PIO	26	11		
IC15	Z80-PIO	26	11		
IC16	2708	24	12	21	19
IC17	2708	24	12	21	19
IC18	2708	24	12	21	19
IC19	2114	18	9		
IC20	2114	18	9		
IC21	2114	18	9		
IC22	2114	18	9		
IC23	2114	18	9		
IC24	2114	18	9		
IC25	2114	18	9		
IC26	2114	18	9		
IC27	2114	18	9		
IC28	2114	18	9		
IC29	2114	18	9		
IC30	2114	18	9		
IC31	2114	18	9		
IC32	2114	18	9		
IC33	2114	18	9		
IC34	2114	18	9		

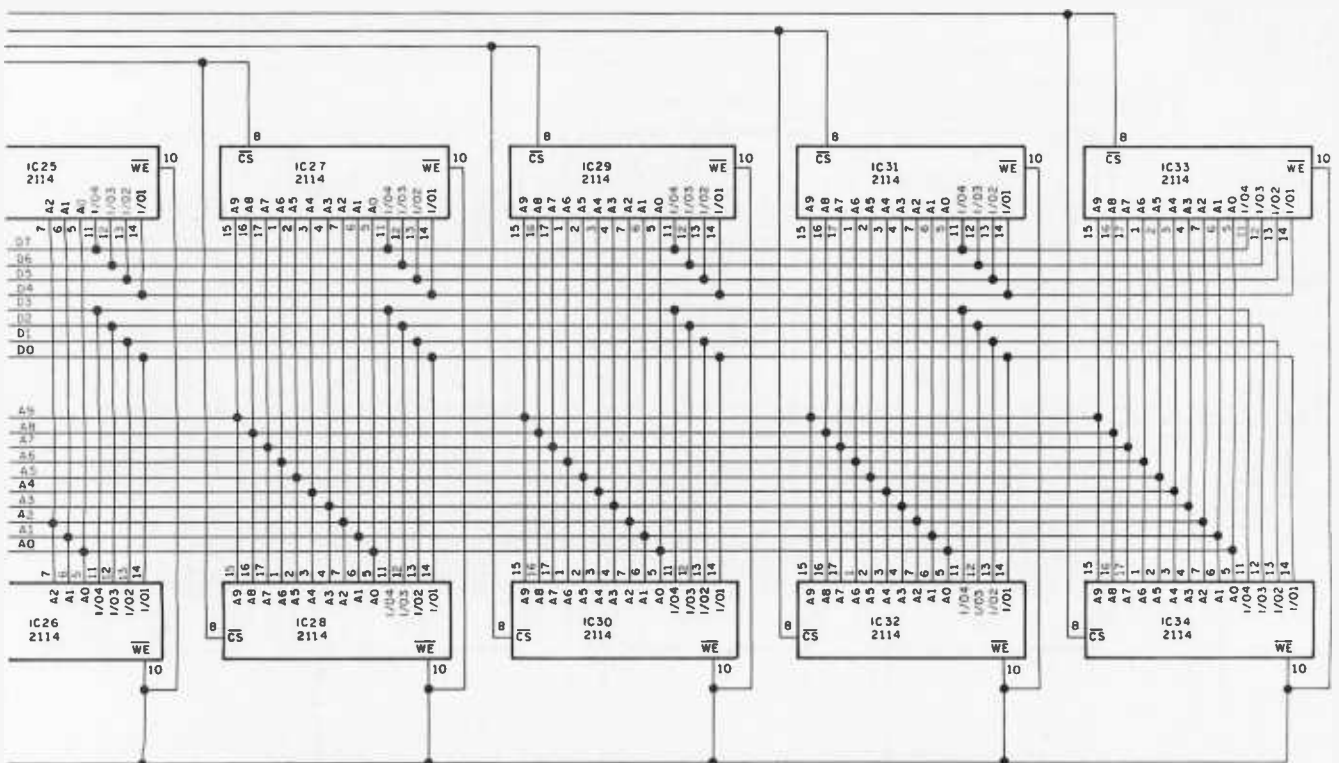

This Christmas,
don't give a toy...

Give a Microtek



The market is flooded with low-cost printers that look and last more like toys.

On the other hand, the Microtek MT-80, our versatile alphanumeric line printer, has a high quality mechanism that gives you solid value for your dollar. We stand behind every printer we make because we build quality into each one. So stop tinkering with toys and get serious. The Microtek decision assures you 100% value.

Available from Microtek or your nearest computer dealer.

LOADED WITH INNOVATIONS

- 40, 80 or 132 columns
- Non-thermal paper, pin feed
- 125 CPS, 70 lines per minute
- 9 x 7 dot matrix
- Vertical format unit
- 96-character ASCII (upper and lower case)
- Adjustable forms width to 9½"
- Parallel and serial (RS-232C) interfaces available
- One year warranty



9514 Chesapeake Drive
San Diego, CA 92123
Tel. (714) 278-0633
TWX 910-335-1269
Outside California
call toll free: 800-854-1081

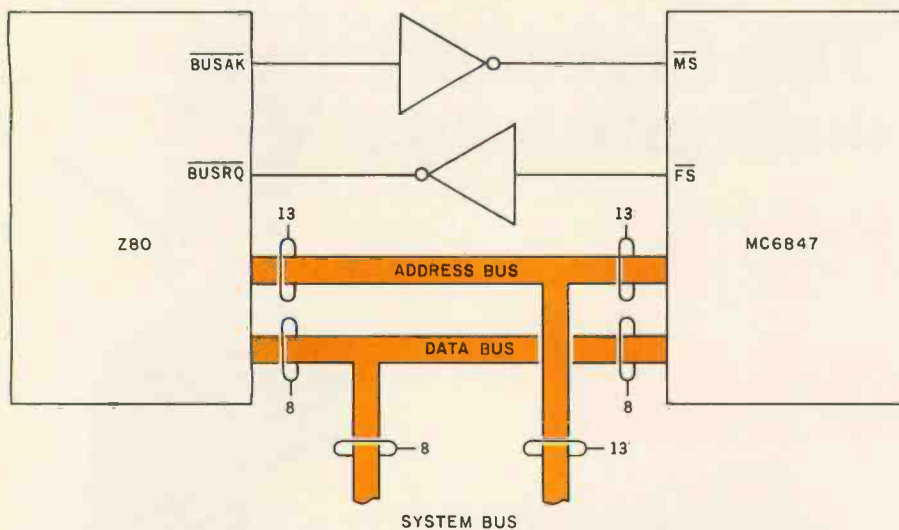

Figure 3: Bus control. Since both the processor and the display generator must access memory, this simple arbitration scheme was devised to eliminate contention. The display generator is given priority. This approach limits the amount of time available to the processor for executing display "primitive" instructions, but it does help to maintain a stable display without the "tearing" effect that occurs when the display generator cannot read from memory when it needs to.

dedicated processor, this is not really a problem. This approach also provides a stable display that will not "tear" since the video-display generator has the bus the entire time it needs it. As we see in figure 3, the bus control can be handled by two inverters, which are part of the 74LS14 Schmitt-trigger inverters in figure 2.

The Microprocessor

The discrete components shown near the Z80 in figure 2 are required for clock-line pull-up, as specified by Zilog. The nonmaskable interrupt (NMI) and wait (WAIT) lines are pulled high, since Micrograph operation requires neither wait states nor nonmaskable interrupts.

The Shared Bus

The Z80 and MC6847 address and data lines are simply tied together. The leftmost 74LS367 bus driver circuit is used to provide additional address (A13) and control (WR, RD, IOREQ, and MREQ) lines, which are active only when the MC6847 has control of the bus. These lines are needed since the MC6847 does not supply these signals. In this case, the address line (A13) is tied high to force addressing of the refresh memory in the 8 K to 16 K range of the Z80 microprocessor's address space.

The next integrated circuit, a 74LS14, is used to provide a manual

and power-up reset circuit and also to drive the clock line to the microprocessor. The 74LS73 JK flip-flop is used to derive the Z80 clock signal from the video-display-generator clock output.

The Modulator and Display Generator

Note that the connections to the MC6847 are simple: the address lines (A0 thru A12) and data lines (D0 thru D7) go to the shared bus. At the bottom of the schematic, there are seven control lines that determine the display mode. These lines are controlled by one of the four I/O ports.

The MC6847 and MC1372 connect directly together. In this configuration, the MC1372 is wired to provide an RF output, so that Micrograph may be tied to the antenna leads of a television through a matching transformer. (See figure 4 for the wiring option to provide direct video output.)

Also tied to the modulator is the clock circuitry, which provides a 3.579545 MHz signal, which is the standard color-burst frequency. This clock is routed to both the video-display generator and the modulator.

The variable capacitor in the timing circuit is used to fine-tune the displayed colors. On the right side of figure 2 is the RF tank circuit, which can be tuned to station 3 or 4.

Every ISC computer is backed by a worldwide network of representatives and service centers.

AL: W A BROWN INST 205/883-8660. **AR:** (OK) USDATA Assoc 918/252-9646. **AZ:** BFA Corp 602/994-5400. **CA:** Thorson Co. So. Ca. Alhambra 213/281-2280. Goleta 805/964-8751. Irvine 714/557-4460. Los Angeles 213/476-1241. Thorson Co. San Diego 714/292-8525. Jay Stone Assoc. Los Altos 415/948-4563. No. Ca. Service Ctr. 408/732-4502. **CD:** PAR Assoc 303/371-4140. **CT:** J&J Assoc 203/624-7800. **DE:** (PA) Denco Data Equip. 215/542-9876. **DC:** (VA) Intron Corp 703/569-1502. **FL:** W A Brown Inst. Ft. Lauderdale 305/776-4800. Melbourne 305/723-0766. *Orlando 305/425-5505. Tallahassee 904/878-6642. **GA:** W A Brown Inst 404/455-1035. **HI:** Thorson Co 808/524-8633. **ID:** PAR Assoc 801/292-8145. **IL:** (No.) Resource Data Sys 312/564-5440. (So.) Digital Sys Sales 816/765-3337. **IN:** Resource Data Sys 312/546-5440. **IA:** (MO) Digital Sys Sales 816/765-3337. (IL) Scott Co. Only. Resource Data Sys 312/564-5440. **KS:** (MO) Digital Sys Sales 816/765-3337. **KY:** Lowry & Assoc 606/273-3771. **LA:** W A Brown Inst 504/626-9701. **ME:** (MA) J&J Assoc 617/729-5770. **MD:** (VA) Intron Corp 703/569-1502. **MA:** J&J Assoc 617/729-5770. **MI:** Lowry & Assoc - Brighton 313/227-7067. Grand Rapids 616/363-9839. **MN:** Dytac No 612/645-5816. **MS:** (AL) W A Brown Inst 205/883-8660. **MO:** Digital Sys Sales 816/765-3337. **MT:** (CO) PAR Assoc 303/355-2363. **NB:** (MO) Digital Sys Sales 816/765-3337. **NH:** (MA) J&J Assoc 617/729-5770. **NJ:** (No.) Tech Mktg Assoc 201/224-6911. (So.) (PA) Denco Data Equip. Corp 215/542-9876. **NM:** BFA Corp - Albuquerque 505/292-1212. Las Cruces 505/524-9593. **NV:** (AZ) BFA Corp 602/994-5400. **NY:** Naco Elect Corp Fairport 716/223-4490. No. Syracuse 315/699-2651. Uta 315/732-1801. Metro LI, (NJ) Tech Mktg Assoc 201/224-6911. **NC:** W A Brown Inst 919/683-1580. **ND:** (MN) Dytac No 612/645-5816. **OH:** Lowry & Assoc - Cleveland 216/398-9200. Dayton 513/435-7684. **OK:** USDATA Assoc 918/252-9646. **OR:** Thorson Co 503/644-5900. **PA:** (E) Denco Data Equip. 215/542-9876. Lowry & Assoc 412/922-5110. **RI:** (MA) J&J Assoc 617/729-5770. **SC:** W A Brown Inst 803/798-8070. **SD:** (MN) Dytac No 612/645-5816. **TN:** W A Brown Inst 615/482-5761. **TX:** Austin USDATA Engrg 512/454-3579. *Dallas 214/661-9633. *El Paso (NM) BFA Corp 505/524-9693. *Houston USDATA Assoc 713/681-0200. **UT:** PAR Assoc 801/292-8145. **VT:** (MA) J&J Assoc 617/729-5770. **VA:** Intron Corp 703/569-1502. **WA:** Thorson Co 206/455-9180. **WV:** (PA) Lowry & Assoc 412/922-5110. **WI:** (IL) Resource Data Sys 312/564-5440. **WY:** (CO) PAR Assoc 303/355-2363.

*Service contract available in these cities plus San Francisco, Ca. Consult factory for additional information.

INTERNATIONAL DISTRIBUTORS

EUROPE: Techexport, Cambridge, MA 617/661-9424. **BELGIUM:** Noron S A, Brussels 02-24236-04. **DENMARK:** Nordland Comm, Kobenhavn 02-913255. **FRANCE:** Techdata Sarl, Rueil Malmaison 749-47-65. Informatic/ISTC, Paris 33-1-306-4606. **GREECE:** Infodata, Athens 642-1368. **ITALY:** E.F.E., Milano 02-600733. **THE NETHERLANDS:** Schreiner Elect, Poeldijk 01749-47640. Compu 2000, Amsterdam 020-360904. **SPAIN:** Mecorsa, Barcelona TELEX/813-53908. **SWEDEN:** Tele-Instruments AB, Vallingby 08-380-370. **SWITZERLAND:** W. Stolz Ag, Mutschellen 057-546-55. **UK:** Techex, Ltd. Bournemouth 0201671181. **ICELAND:** Benco, Ltd. Reykjavik 091-21945. **WEST GERMANY:** Techdata GmbH, Koblenz 01149-31025. **AUSTRALIA:** Anderson Digital Equip., Melbourne 03-543-2077. Canberra 58-1811. Sydney 02-808-1444. Brisbane 07-350-2611. **NEW ZEALAND:** Anderson Digital Equip., Waimuomata, 644-585. Auckland 876-570. Christchurch 796-210. **CANADA:** Datamex, Ltd. Dorval, PQ 514/636-9774. Ottawa, Ont. 613/224-1391. Toronto, Ont 416/787-1208. Vancouver, B.C. 604/684-8625. **CENTRAL & SOUTH AMERICA & CARIBBEAN:** (GA) Amer Bus Sys 404/394-9603. **MEXICO:** Intercomex, Monterrey 564-876. **FAR EAST:** Computers Int'l, Los Angeles 213/382-1107. **CHINA:** Syscom Computer Engrg., Taipei 02 7022156. **HONG KONG:** Compex, Hong Kong, 03-463-9921. **INDIA:** Pairs Computer Sys., Bombay 230-314. **JAPAN:** Computers Int'l, Tokyo 03-463-9921. **TAIWAN:** Sys. Computer Engrg., Taipei 02-7026284. **MIDDLE EAST:** (GA) ISC Middle East 404/581-0243. **EGYPT:** United Elect. Alexandria 809933. **KUWAIT:** W J Towell, Safat 438 180. **LEBANON:** Computer Info Sys., Beirut 260110. **SAUDI ARABIA:** Jampoom Int'l, Jeddah 27790. Riyadh 25083-39732. **REPUBLIC OF SOUTH AFRICA:** Fulmen Africa, Germiston (Elandsfontein) (011) 36-5201.

For sales and service in other countries contact ISC headquarters in Norcross, Ga. U.S.A.

Computer Dealers: Contact your local ISC rep to find out how you too can carry the ISC product line.

Intelligent Systems Corp.



ISC's new 3650 Series: No other desktop computers have such a colorful past.

- **Eight-Color 128x128 Graphics**
- **Expandable from Standard 92K to 2.6M Byte Disk Storage**
- **Color Business Graphics and Word Processing Software**
- **Microsoft® BASIC in ROM**
- **RS-232C Communications Port**

Now from ISC, the world leader in low-cost color since 1973, comes a line of computers that give you the powerful color-graphics capability you need, with the expanded interface capability you want. For further information and the name of your nearest authorized dealer, call ISC toll-free at **800-241-4310** and ask for Ron Hinkley.

**Color
Communicates
Better**SM



Intelligent Systems Corp.

Intecolor Drive • 225 Technology Park Atlanta • Norcross, Georgia 30092
Telephone 404/449-5961 • TWX 810-766-1581

Unretouched photo of screens. Price is U.S. domestic.

Intecolor® 3651
\$2945

Features built-in 92K mini-disk, 16K user RAM (expandable to 32K), Microsoft® Extended Disk BASIC (FORTRAN available), 72-key keyboard. Shown with optional Trendspotter package and 117-key keyboard.



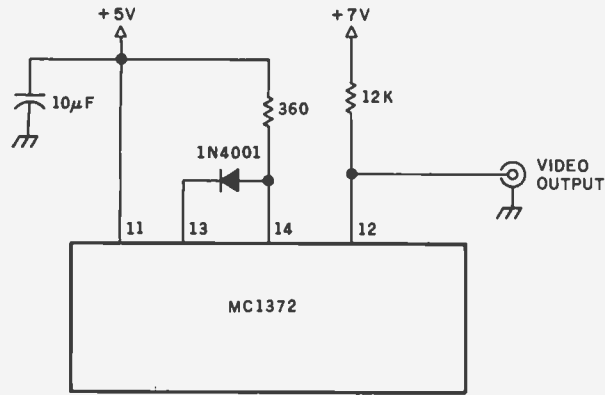

Figure 4: Optional wiring for direct video output. The Motorola MC1372 can be used to provide direct (composite) video to a video monitor, if it is available. As shown in figure 2, the MC1372 may also be used to provide an RF (radio-frequency) output for use with television set tuned to channel 3 or channel 4.

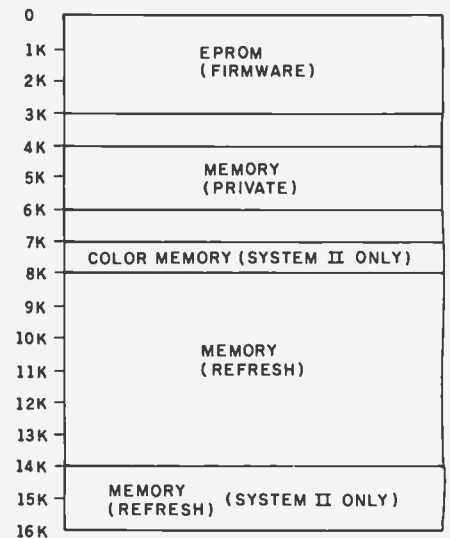

Figure 6: Memory map for the Micrograph board.

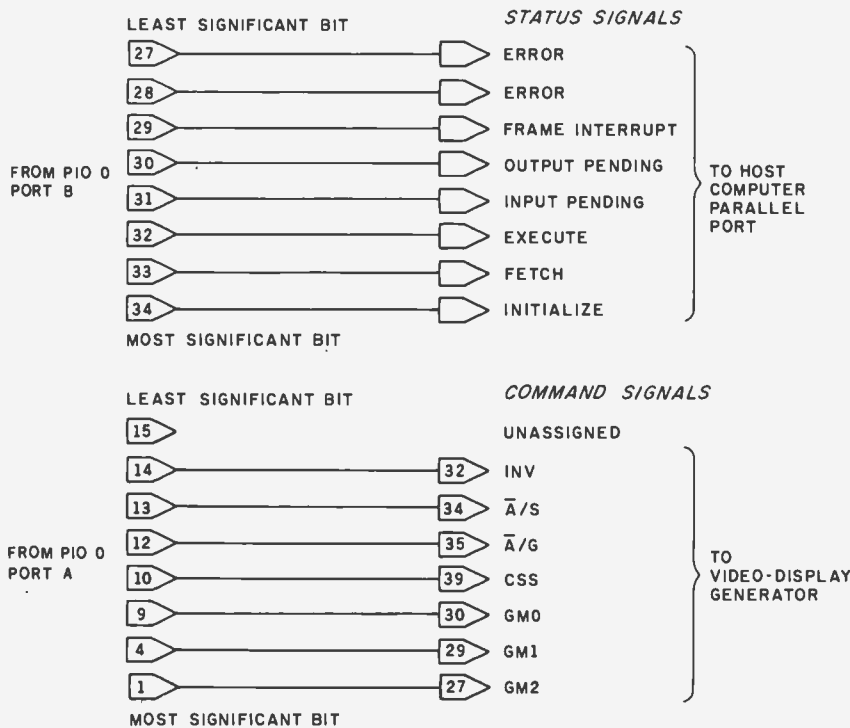

Figure 5: Status-port and command-port pin assignments and control-byte formats. One PIO (peripheral input/output) port is used to communicate status information to the host processor and also to control the video-display generator. These connections must be added to figure 2.

Bus Control

The address and control lines are routed to 74LS367 bus drivers, where they are then passed to the memory and I/O circuitry. The top four address lines are also routed to a 74LS154 four-to-sixteen-line decoder to provide memory chip-select decoding. Finally, the two 8216 bus drivers buffer the data lines. Their direction is controlled by the DBIN signal from the shared bus.

I/O Circuitry

Only two PIO (peripheral-input/output) circuits are needed. PIO 0 provides a status indication to the host through one port. (See figure 5 for the format of the status byte). The other PIO 0 port is routed to the video-display generator to select the proper display format. (Figure 5 also provides the format of this control byte.) The second PIO circuit is used to communicate with the host com-

puter.

One of the ports is used to receive data and instructions from the host (the input port), and the other port is used to transmit data back to the host (the output port). In either case, the strobe lines for both of these ports are controlled by the host to indicate that Micrograph is being sent an instruction or that the host has just received a data byte. The protocol for communicating with the host computer will be further discussed in Part 3 of this article. Refer to tables 3 and 4 on page 132 for the port assignments in the microprocessor address space.

Firmware and Frame Buffer

Three 2708 EPROMs (erasable programmable read-only memories) are used to hold the 2.6 K bytes of the object code required to control Micrograph. Four type-2114 1024 by 4-bit static-memory devices provide the 2 K bytes needed by the firmware for variables and data for the programmable character generator. Refer to figure 6 for a memory map and to tables 3 and 4 for memory and port assignments.

In the frame buffer, 6 K bytes of memory are required, and 2114s are used to keep the device count low. Figure 6 provides the map for the frame-buffer memory also.

That is all the hardware needed to produce a color-graphics display. Thanks to the MC6847, Micrograph can be built with only thirty-four

5,000,000 Reasons to replace your 5-inch Floppies with a low-cost, high-performance Hard-Disk.

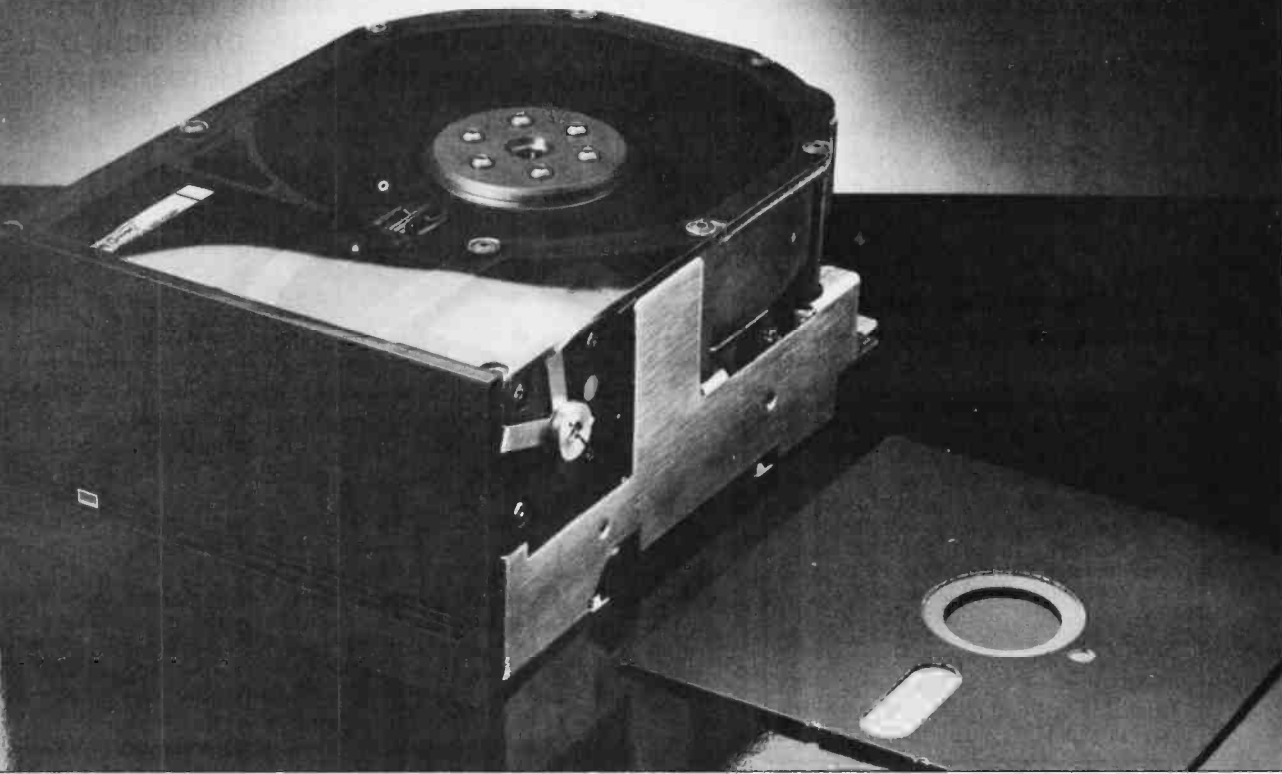

5 megabytes instantly expand the program and data storage horizons on your H-89, TRS-80, or S-100 microcomputer system.

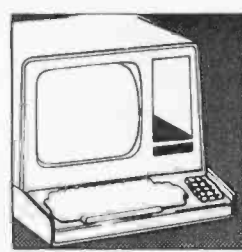

Just slip 5 megabytes of on-line data storage into place in your standard 5-inch floppy disk openings, and suddenly your capability horizons have dramatically shifted. Upwards. Now your CP/M* S-100 microcomputer system, or H-89 Heathkit (HDOS or CPM 2.2) computer system can utilize the kind of high-reliability and rapid-access mass storage which today's sophisticated programming demands. A company named

ACT has created a complete package at a price so good, you couldn't walk away from it. The 5-Inch package includes the remarkable Shugart Technology ST 506 hard-disk drive with 6.3 megabytes of unformatted mass storage and a micro-sequencing controller card with complete floppy disk-like interfacing. Hard-disks have never been more affordable. If you are wondering just how these ultra-fast, high throughput hard-disk drives will work with your multi-terminal or real-time transaction oriented systems: now you can get some straight answers. Clip and mail the coupon for quick response to all your questions. Or better yet, give us a call today at (703) 471-6288 for some no-nonsense reasons why your system needs to ACT now. Quantity pricing is available to meet the needs of Original Equipment Manufacturers; check the box on the coupon.

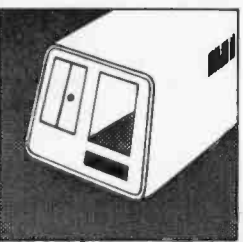

American Computer and Telecommunications Corporation

Circle 84 on inquiry card.

Clip and mail coupon to:
11301 Sunset Hills Road
Suite A-4, Reston, VA 22090
(703) 471-6288

Tell me more about the ACT 5-inch hard-disk drive package:

My present 5-inch hard-disk drive interests center around:

- S-100 Microcomputer Systems
- H-89 Heathkit Computer Systems
- TRS-80 Radio Shack Computer Systems
- Send me quantity price schedule

Name _____
 Title _____
 Company _____
 Address _____
 City, State, Zip _____
 Phone (____) _____

COPYRIGHT © 1981 AMERICAN COMPUTER AND TELECOMMUNICATIONS CORPORATION

DIPs (dual-in-line packages) and a handful of discrete components. Micrograph can be constructed on a single board and requires only a +5 V, +12 V, and -5 V power supply.

Construction

Photos 1a and 1b show my prototype Micrograph. I used a universal wirewrap board, and as the photo indicates, a spacious layout was possible as a result of the low device count. In the leftmost section of photo 1a are the Z80 and the two PIO devices. In the next section are part of the bus drivers and the EPROMs. In the middle section are the rest of the bus drivers and some of the 2114 memory circuits. In the next and final sections are the rest of the memory integrated circuits and the video-display circuitry. Note the few discrete components required: most are decou-

Type of memory	Address (decimal)
EPROM	0 to 3071
private memory	4096 to 6143
color memory 0	7168 to 7183
color memory 1	7184 to 7199
color memory 2	7200 to 7216
refresh memory	8192 to 14335 (for System I) 8192 to 16383 (for System II)

Table 3: Type and location of memory used in the Micrograph board.

Port Number	Device Name	Use	Type of Port
port 0	PIO 0, port A	display control	output
port 1	PIO 0, port A	port control	output
port 2	PIO 0, port B	status	output
port 3	PIO 0, port B	port control	output
port 4	PIO 1, port A	input	input
port 5	PIO 1, port A	port control	output
port 6	PIO 1, port B	output	output
port 7	PIO 1, port B	port control	output

Table 4: Port numbers and their usage by Micrograph.

"The MDBS data base system is fantastic!"



That's the essence of this letter from Leonard L. Overton, Jr., president of LS Business Systems, Inc. Here's what he says...

"The MDBS data base system has made a fantastic improvement in the productivity of our custom programming operation. The implementation of this system in our business has allowed us to change to a completely different concept of producing custom microcomputer based software. The old system of a myriad of files, pointers, updates, and file structures has been changed to a simple graphical representation of the data network and its logical relationships (the schema).

"Representing an application with a schema that can readily be transferred to the computer through the data definition language has increased our software productivity in the following ways:

1. The system designer gets a much clearer picture of how clean, efficient, and effective his design is. Improvements are made easily and rapidly.
2. The programmer can spend his time producing the calculational and interactive parts of the system rather than getting bogged down in the intricacies of the data structure. This not only reduces the amount of code generation but also reduces programmer fatigue due to tedious repetition.
3. Communication with the end-user is much more effective when he can see an easily understood, graphical depiction of how his data will be handled. A good understanding by the end-user in the early stages of the design can eliminate costly program changes or data restructuring later.
4. Debugging time is greatly reduced and so are calls from customers who find the hidden bugs that always show up in a complex data structure written on a file basis.

"In short, the MDBS data base system is not only a very effective software development tool but has become the foundation on which we are building our future applications software. This change has enabled us to produce quicker, cleaner, and more flexible applications software at a lower cost to our end-users."

To find out what a fantastic job the MDBS system can do for you, see the facing page and then contact us without delay!

**Micro
Data Base
Systems, inc.**

Box 248, Lafayette, Indiana 47902

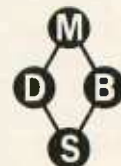

Micro-computer data base management at its best!

Get the most out of your micro-computer. Use our advanced and productive data management system.

HDBS is an extended hierarchical data base system offering

- fixed length records
- file-level read/write protection
- one-to-many set relationships

MDBS is a full network data base system offered as an upgrade from HDBS... or it may be ideal as your initial system. **Unique and versatile**, it adds these features:

- full network CODASYL-oriented data structures
- variable length records
- multiple levels of read/write protection
- one-to-one, many-to-one, and many-to-many sets
- non-redundancy of data, easy updating
- occurrences of a record type may own other occurrences of the same type
- a single set may have multiple owner and member record types

MDBS-DRS. As an add-on to MDBS, the DRS system offers extraordinary flexibility in data base restructuring to meet new needs.

- Item, record, and set types can be added, deleted, or renamed in an existing data base as well as other data base characteristics. You can redesign the data base after it is already on-line!

MDBS-RTL. As an add-on to MDBS, the RTL (Recovery Transaction Logging) logs all data base transactions, so that in the event of a system failure, the data base can be recovered with minimal loss of information.

- The recovery processor permits selective reloading of the data base from the transaction file. Users can log messages, indicate complex transaction sequences, and effect selective control over the recovery process.

MDBS-QRS. An interactive Report-Writer/Query-System for HDBS/MDBS data bases. Features...

- may be customized for non-technical users
- complex retrieval conditions may be specified
- detailed reports can be quickly generated
- wildcard and "match-one" string specifications included

HDBS and MDBS Packages Include:

- DDL data definition language analyzer/editor
- 260-page users manual
- DMS data management routines callable from host language
- Sample application program and DDL files
- Relocator to re-org all routines
- System specific manual for bringing up our software

Both HDBS and MDBS Systems . . .

- Run under . . .
CP/M® with CBASIC; Microsoft BASICs, FORTRAN or COBOL; InterSystem PASCAL/Z; Sorcim PASCAL/M; Micro Focus CIS COBOL; Digital Research PL/I OASIS
TRSDOS and NEWDOS (Models I and II) with Disk BASIC
North Star DOS with North Star BASIC
Apple DOS and Applesoft BASIC
Machine Language Interface available on all above systems.
- Up to 254 record-types definable in the data base; each record-type may contain up to 255 item-types; each item-type may be up to 9,999 bytes in length.
- Names of data items, records, sets, and files are wholly user definable.
- Commands to add, delete, update, search, and traverse the data base.
- Straightforward use of ISAM-like structures.
- Records can be maintained in several sorted orders.
- Written in machine language for maximum execution efficiency and minimal memory usage.
- Independent of types and sizes of disk drives. Support data base spread over several disk drives (max.8); disks may be mini- or full-sized floppies or hard disks.
- Available versions: Z80 (requires approx. 18K), 6502 (approx. 30K), 8080 (approx. 22K)
Total memory requirement must allow for buffer areas. For Apple users, a language card is recommended.
- 8086 version available. (Call or write for details and prices.)

Ordering Information (applicable to Z80, 8080 and 6502 versions):

HDBS (Version 1.04)	\$ 300.00	When ordering, specify intended use with . . . 1. North Star DOS and BASIC 2. CP/M* - CBASIC 3. CP/M* - Microsoft BASIC 4.XX 4. CP/M* - Microsoft BASIC 5.XX 5. CP/M* - Microsoft BASIC or FORTRAN Compiler 6. CP/M* - Microsoft COBOL-80 7. CP/M* - InterSystem PASCAL/Z 8. CP/M* - Sorcim PASCAL/M 9. CP/M* - Digital Research PL/I 10. CP/M* - Micro Focus CIS COBOL 11. TRSDOS/NEWDOS and TRS Disk BASIC (Models I and II) 12. Apple DOS and Applesoft BASIC 13. OASIS 14. Machine Language Programs - (Specify operating system.)
MDBS (Version 1.04)	900.00	
DRS	300.00	
RTL	300.00	
QRS	300.00	
HDBS upgrade to MDBS	650.00	
MDBS with DRS, RTL, and QRS	1500.00	
HDBS/MDBS Manual	35.00	
DRS Manual	5.00	
RTL Manual	5.00	
QRS Manual	5.00	
System Specific Manuals (each)	5.00	

Within a given operating system, add \$125.00 for each additional language selected.

For prices outside the U.S. and Canada, please ask for price lists.

Add \$2.50 handling fee for non-cash order (\$5.00 outside U.S.).

Indiana residents add 4%.
We accept Visa and Master Charge.



54-page "primer" on data base systems for micro-computers — only \$10.00 per copy.

Dealer Demo-Package (\$60.00) includes Primer, HDBS/MDBS Manuals, Demo-Disk, etc.

Setting standards of excellence for data base software . . . worldwide.

Micro Data Base Systems, inc.

Dept. B, Box 248, Lafayette, IN 47902
317-448-1616



pling capacitors. This physical layout follows the schematic layout almost exactly.

In photo 1b (page 136) is a view of the wirewrap side. It took me two weekends to wrap the board, using a Slit N' Wrap tool marketed by Vector and also an electric wirewrap tool. I used Slit N' Wrap techniques for the bus and, as best as I could, tried to color-code the whole device.

Any construction technology can be used to build this board, but there are a few hints I might pass along. To begin, insure that the video-modulator circuitry is well isolated from the rest of the system: keep the wiring as short as possible in this section. Furthermore, because of the relatively high frequencies used, be sure to minimize stray capacitance: a shielded board will help reduce interference.

Micrograph is best built in stages. I suggest you start with the video-display generator and modulator circuit. Wire this area first, then temporarily wire some memory on the 6847's bus. You can go ahead and supply power to this circuit to verify that your display is working properly.

ly. The various modes can then be tested. At this time, you can connect the modulator to your television (use coaxial cable, and don't forget a matching transformer). When you apply power, a random pattern that reflects the mode you have selected should appear. The variable capacitor in the timing circuit can then be adjusted to produce the most pleasing colors.

Once the video display is working properly, you should install the rest of the refresh memory and bus drivers. Again, repeat the checkout of the display, this time using all the refresh memory. Note that the 256 by 192 or 128 by 192 resolution modes will utilize all the memory. You might even connect an oscilloscope to the address lines to check that the lines are cycling through the entire 6 K bytes of memory.

Once this portion is working, the EPROMs, Z80, and PIOs can be wired in. From this point, there is little testing to do without the necessary software, which will be discussed in Part 3.

Troubleshooting a system without good tools is almost impossible. I

found that I needed no more than a good oscilloscope to check out the system, even though I had a Hewlett-Packard 1611 Microprocessor Analyzer available. The Micrograph system has an excellent test device built in: the color display. Since the video-display generator scans all of the refresh memory, you have a visual means of checking a large portion of your wiring. To track down a bad memory circuit, you might selectively remove integrated circuits and watch how the display is affected.

One final word concerning the construction. The system draws +5 V at about 1.5 A, so don't make your power bus small. The other supplies, since they are mainly for the EPROMs, require only a few hundred milliamperes. When powering up the system, if your supplies are independent, be certain the -5 V supply powers up first and powers down last, if it can't be done simultaneously with the rest of the power. (I didn't do it that way and, consequently, destroyed six EPROMs; then I read an obscure warning in an Intel data book.)

Enhancements: System II

There are a number of enhancements to the system that will increase the system performance, although I have not implemented them. The first obvious improvement is to use a Z80A (capable of using a 4 MHz clock) and run the system on the color-burst clock. This will immediately double the speed of the display processor. Of course, be sure that your memory is fast enough to handle the extra speed.

You might also try to use dynamic memory. I used static memory to reduce the development risk and make the design and testing of the board easier, but if the timing works out, the use of dynamic memory would significantly reduce the cost of the system.

These are some basic improvements that can be made, and I'll offer some more radical changes, which I call System II. When I first designed Micrograph, I created a system consisting of over 100 DIPs for the video section alone. This design supported two formats: 128 by 128 with sixteen colors and 256 by 256 with two colors. The system also supported a color-look-up table, to allow a set of 2^{12} (or 4096) possible

A CREATION OF COMPUTER HEADWARE

WHATSIT?

(Wow! How'd All That Stuff get In There?)

A sophisticated, self-indexing filing system—flexible, infinitely useful and easy to use, that adapts to your needs.

WHATSIT's unique capabilities:

Multiple Entries allowed per field: For example, a bibliographic file can associate each work with any number of authors. WHATSIT allocates file space as needed for each.

New Data Fields added "on the fly": You're not confined to a particular "record layout" that must be declared in advance. Your file evolves to fit your needs.

P.O. Box 14815 • San Francisco, CA 94114 • Tel: (415) 621-2106

Immediate Response: Even in the largest files, WHATSIT responds in seconds, thanks to pointer linkages and hash coding.

Conversational Dialogue: Query and update requests may be intermixed in any order, without returning to a "menu selector."

NEW
Apple II Plus
WHATSIT at special
introductory price:
\$95

(Regular price, \$150
after December 31, 1980.)

WHATSIT comes ready to run on your Apple, Apple II Plus, AlphaMicro NorthStar, or CP/M computer. See your dealer for a full demonstration... or write or call:

HARDHAT Software

THE SOLUTION STORE SM



... Makes The Difference!

MicroAge Computer Stores sell solutions to your professional, business and household-management problems, not just hardware. That's what makes the MicroAge difference! From systems integration to easy-to-understand application software, research and development to warranty service and repair, systems consulting to training and installation. In all these, we offer the latest, most innovative approaches. That's why we are the forerunners . . . the pioneers in the microcomputer industry.

But don't just take our word for it. Visit the MicroAge Computer Store nearest you and see the difference solutions make. We have differences you'll experience with every time and money-saving idea. The difference that will keep you satisfied now and for years to come!

MicroAge.
COMPUTER STORE

"Where Vision Becomes Reality"

611 Rockville Pike
Rockville, Maryland
(301) 840-9315

1707 Monroe Avenue
Rochester, New York
(716) 244-9000

2065B El Camino Real West
Mountainview, California
(415) 964-7063

83 South 10th Street
Minneapolis, Minnesota
(612) 338-1777

24 W. Camelback
Phoenix, Arizona
(602) 265-0065

2591 Hamilton Road
Columbus, Ohio
(614) 868-1550

5742 E. Broadway
Tucson, Arizona
(602) 790-8959

1220 Melbourne Drive
Hurst, Texas
(817) 284-3413

2525 N. Scottsdale Road
Scottsdale, Arizona
(602) 941-8794

1490 W. Spring Valley Road
Richardson, Texas
(214) 234-5955

4550-50 E. Cactus
Phoenix, Arizona
(602) 996-2910

Coming soon to:
El Paso, Texas
Denver, Colorado

FOR FRANCHISE OPPORTUNITY INFORMATION CALL (602) 967-1421

(1a)

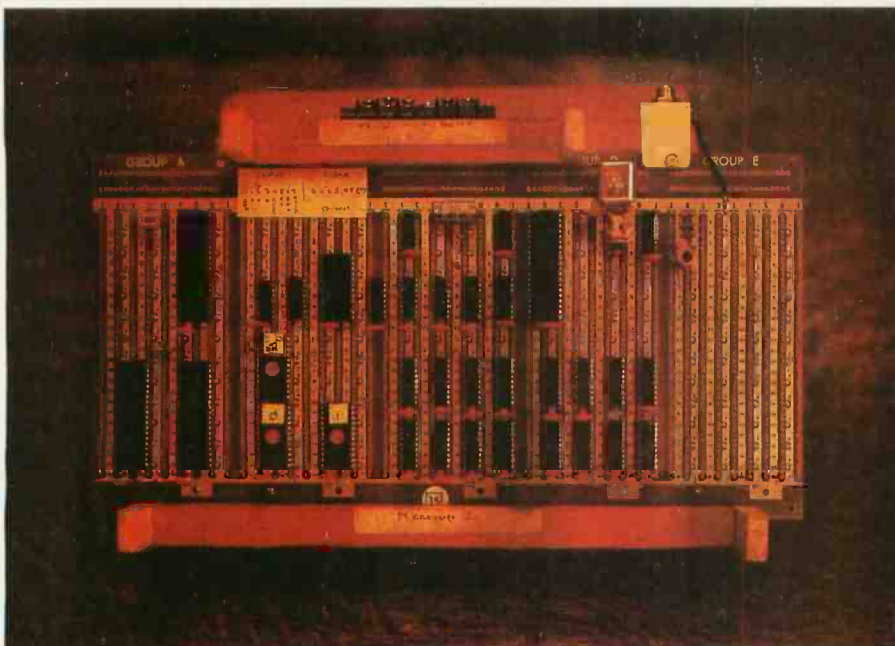

(1b)

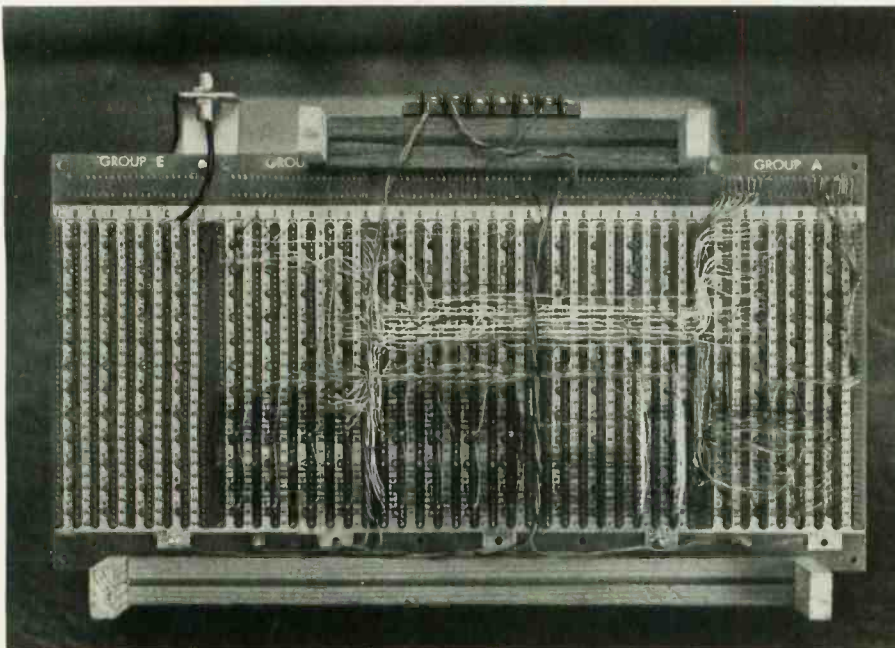

Photo 1: Two views of the completed Micrograph prototype. The use of a universal wirewrap circuit board (photo 1a) allows a spacious layout that almost exactly follows the schematic diagram of figure 2. Photo 1b shows the wiring that required approximately two weekends of the author's time. A daisy-chaining wirewrap tool was used for the majority of the bus wiring, while control signals were made in the standard wirewrap fashion; power is provided to the integrated circuits via buses printed and etched on the board.

colors. However, I came across the MC6847 and decided to use this lower-risk approach to complete the system, since my main concern was the software design and instruction set.

I designed the software so only one section of code must be altered to

support the new display resolutions. The code already exists to support the color-look-up tables, but the MC6847 obviously does not have the capability to support such a setup. Thus, you only need to modify the video-display electronics and one section of code to produce System II. The re-

mainder of the hardware and software remains the same, as does the interface between the host and Micrograph. Thus, in a sense, there is hardware independence built into the system.

For that matter, you can produce just about any display resolution up to 256 by 256 with 256 colors without major modifications to the circuitry other than the video-display generator. Of course, at these higher resolutions, you need much more memory. So, for the dedicated reader, I offer this as a possible system enhancement; it's something I'm going to try next. As you can see, the design of Micrograph using the MC6847 supplies an excellent color display at a very low price.

I offer a final radical change, but I haven't implemented it. In this design, we assume that the video display has the bus whenever it needs it. This scheme produces a clear, tear-free display. However, if the microprocessor is given priority for memory accesses, quality of display is traded for speed. In fact, in my approach, the Z80 is only allowed control of the bus around 20% of the available time. Of course, this is not a problem with a dedicated microprocessor.

If raw speed is necessary, however, let the microprocessor have dominant bus control, and give the bus to the video-display generator only when the software permits it (such as after the display has been updated). This approach has the advantage of having a much faster processing speed. However, it has the drawback of causing a streak across the screen whenever the microprocessor is updating the display. Furthermore, you will need to modify the software and hardware to accommodate this approach. By the way, a similar approach is used by Motorola's TVBUG, a 6802/6847-based board that allows the user's system to treat the refresh memory as an intelligent peripheral.

Conclusion

This article concludes the presentation of the hardware required to support Micrograph. I have examined the circuit design, discussed construction details, and looked at various system enhancements. Photos 2a and 2b provide some examples of displays possible with Micrograph.

UniFLEX™



Multi-User

UniFLEX is the first full capability multi-user operating system available for microprocessors. Designed for the 6809 and 68000, it offers its users a very friendly computing environment. After a user 'logs-in' with his user name and password, any of the system programs may be run at will. One user may run the text editor while another runs BASIC and still another runs the C compiler. Each user operates in his own system environment, unaware of other user activity. The total number of users is only restricted by the resources and efficiency of the hardware in use.



Multi-Tasking

UniFLEX is a true multi-tasking operating system. Not only may several users run different programs, but one user may run several programs at a time. For example, a compilation of one file could be initiated while simultaneously making changes to another file using the text editor. New tasks are generated in the system by the 'fork' operation. Tasks may be run in the background or 'locked' in main memory to assist critical response times. Inter-task communication is also supported through the 'pipe' mechanism.



Support

The design of UniFLEX, with its hierarchical file system and device independent I/O, allows the creation of a variety of complex support programs. There is currently a wide variety of software available and under development. Included in this list is a Text Processing System for word processing functions, BASIC interpreter and precompiler for general programming and educational use, native C and Pascal compilers for more advanced programming, sort/merge for business applications, and a variety of debug packages. The standard system includes a text editor, assembler, and about forty utility programs. UniFLEX for 6809 is sold with a single CPU license and one years maintenance for \$450.00. Additional yearly maintenance is available for \$100.00. OEM licenses are also available.

FLEX™

UniFLEX is offered for the advanced microprocessor systems. FLEX, the industry standard for 6800 and 6809 systems, is offered for smaller, single user systems. A full line of FLEX support software and OEM licenses are also available.

 **technical systems
consultants, inc.**

Box 2570, West Lafayette, IN 47906
(317) 463-2502 Telex 276143

™UniFLEX and FLEX are trademarks of Technical Systems Consultants, Inc.

DECEMBER MEMORY SPECIALS

2101	450ns	2.49	2708	450ns	6.25
2102-1	450ns	.99	2716	450ns	14.95
21L02-1	450ns	1.29	2732	450ns	49.95
2112	450ns	2.99	2650		12.95
2114	450ns	4.99	2-80		9.95
4116	200ns	5.99	8080A		3.95

4116 250ns 8/39.95

OTHER SPECIALS

2N3055	10/6.99	LM723	10/3.99
95H90	7.99	LM741	10/2.99
8038	3.99	7805	10/7.99
LM380	5/4.59	7812	10/7.99
LM555	10/3.49	RED LED	100/7.99
LM556	5/3.49	GREEN LED	50/6.99
LM565	5/3.99	MAN 72 CA .3"	10/7.99
LM567	4/4.99	MAN 74 CC .3"	10/7.99

LS SERIES

LOOK AT THIS LS PRICING!

74LS00	.32	74LS85	1.23	74LS175	1.09
74LS02	.38	74LS86	.45	74LS191	1.31
74LS04	.35	74LS93	.71	74LS195	1.39
74LS08	.38	74LS95	1.11	74LS221	1.28
74LS10	.32	74LS109	.49	74LS240	1.89
74LS20	.35	74LS138	.79	74LS241	1.89
74LS30	.35	74LS139	.79	74LS244	1.79
74LS32	.39	74LS151	.79	74LS283	1.03
74LS38	.39	74LS153	.79	74LS298	1.24
74LS42	.79	74LS157	.79	74LS367	.99
74LS51	.35	74LS158	.82	74LS368	.99
74LS54	.35	74LS161	.99	74LS373	1.85
74LS73	.44	74LS163	.99	74LS374	1.81
74LS74	.48	74LS174	1.19	74LS377	1.48

TTL

7400	10/1.99	74153	3/1.99
7404	10/1.99	74157	3/1.99
7447	5/2.49	74161	5/3.99
7490	5/1.99	74163	5/3.99
7493	5/1.99	74164	5/3.99
74151	3/1.99	74192	5/3.79

LINEAR IC'S

LM301-8	.34	LM555-8	.39
LM310	.64	LM556	.69
LM311-8	.64	LM565	.99
LM318-8	1.49	LM567	1.29
LM319	1.29	LM741-8	.29
LM324	.59	LM747	.79
LM377	2.29	LM1458-8	.69
LM380	1.29	LM1889	2.49

REGULATORS

7805T	.89	7905T	.99
7812T	.89	7912T	.99
7815T	.99	7905K	1.29

DIP SWITCHES

4 position	.99
5 position	1.02
6 position	1.06
7 position	1.09
8 position	1.14

IC SOCKETS

14 pin	10/1.49
16 pin	10/1.69
24 pin	4/1.00
IMSAI S-100 edge connector solder tail gold	2.49

MA1012A CLOCK MODULE

Complete alarm clock module with special transformer and spec sheets included. Just add switches. 8.99 3/24

TERMS: Include \$2.00 for shipping. \$10.00 minimum order. Send SASE for complete catalog

JDR MICRODEVICES, INC.

1101 South Winchester Blvd.
San Jose, California 95128
408 247-4852

(2a)

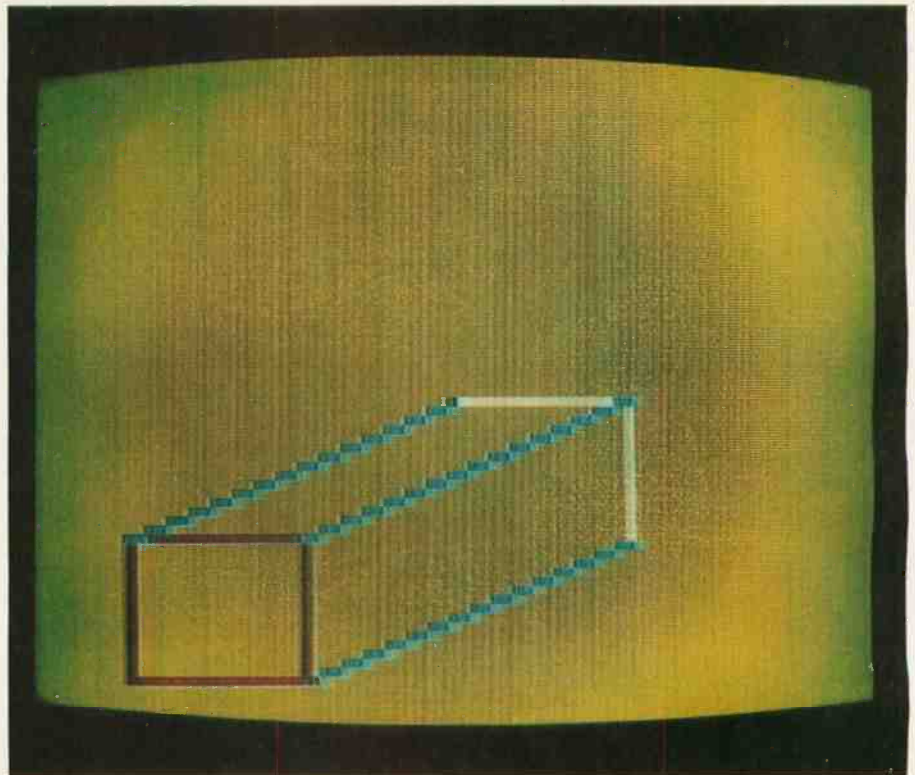

(2b)

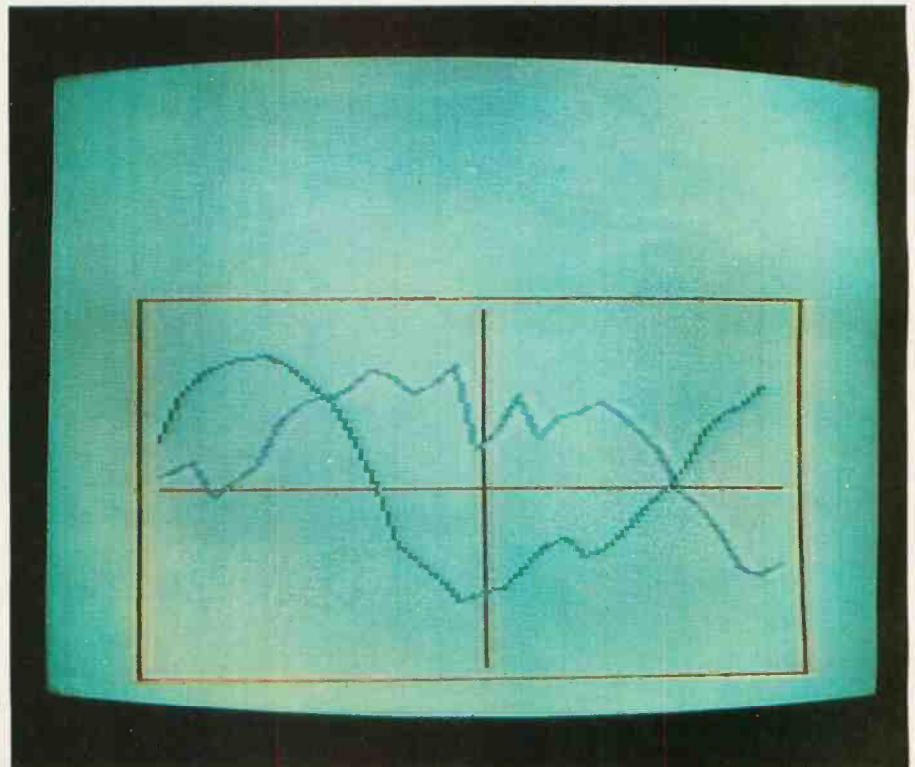

Photo 2: Examples of Micrograph displays.

Listing 1 contains the second third of the Micrograph software (begun in Part 1 and to be completed in Part 3). In the final part of this article, I will discuss the software needed by Micrograph to implement the instruc-

tion set presented in Part 1, cover the major algorithms implemented in the system (such as the scan-line-conversion algorithm), and examine how to operate Micrograph. ■

Listing 1 begins on page 327

DYNACOMP

Quality software for:

ATARI
PET
APPLE II Plus

TRS-80 (Level II)
NORTH STAR
CP/M 8" Disk

GAMES

BRIDGE 2.0 (Available for all computers)

Price: \$17.95 Cassette
\$21.95 Diskette

An all-inclusive version of this most popular of card games. This program both BIDS and PLAYS either contract or duplicate bridge. Depending on the contract, your computer opponents will either play the offense OR defense. If you bid too high, the computer will double your contract! BRIDGE 2.0 provides challenging entertainment for advanced players and is an excellent learning tool for the bridge novice.

HEARTS 1.5 (Available for all computers)

Price: \$14.95 Cassette
\$18.95 Diskette

An exciting and entertaining computer version of this popular card game. Hearts is a trick-oriented game in which the purpose is not to take any hearts or the queen of spades. Play against two computer opponents who are armed with hard-to-beat playing strategies.

CRIBBAGE 2.0 (TRS-80 only)

Price: \$14.95 Cassette
\$18.95 Diskette

This is a well-designed and nicely executed two-handed version of the classic card game, cribbage. It is an excellent program for the cribbage player in search of a worthy opponent as well as the beginner wishing to learn the game, in particular the scoring and jargon. The standard cribbage score board is continually shown at the top of the display (utilizing the TRS-80's graphics capabilities), with the cards shown underneath. The computer automatically scores and also announces the points using the traditional phrases.

CHESS MASTER (North Star and TRS-80 only)

Price: \$19.95 Cassette
\$23.95 Diskette

This complete and very powerful program provides five levels of play. It includes casting, en passant captures and the promotion of pawns. Additionally, the board may be preset before the start of play, permitting the examination of "book" plays. To maximize execution speed, the program is written in assembly language (by SOFTWARE SPECIALISTS of California). Full graphics are employed in the TRS-80 version, and two widths of alphanumeric display are provided to accommodate North Star users.

STARTREK 3.2 (Available for all computers)

Price: \$ 9.95 Cassette
\$13.95 Diskette

This is the classic Startrek simulation, but with several new features. For example, the Klingons now shoot at the Enterprise without warning while also attacking starbases in other quadrants. The Klingons also attack with both light and heavy cruisers and move when shot at! The situation is hectic when the Enterprise is besieged by three heavy cruisers and a starbase S.O.S. is received! The Klingons get even!

SPACE TILT (Apple only)

Price: \$10.95 Cassette
\$14.95 Diskette

Use the game paddles to tilt the plane of the TV screen to "roll" a ball into a hole in the screen. Sound simple? Not when the hole gets smaller and smaller! A built-in timer allows you to measure your skill against others in this habit-forming action game.

GAMES PACK I and GAMES PACK II

Price: \$ 9.95 each, Cassette
\$13.95 each, Diskette

GAMES PACK I contains BLACKJACK, LUNAR LANDER, CRAPS, HORSE RACE, SWITCH and more. GAMES PACK II includes CRAZY EIGHTS, JOTTO, ACEY-DUCEY, LIFE, WUMPUIS and others. Available for all computers.

Why pay \$5.95 or more per program when you can buy a DYNACOMP collection for just \$9.95?

STUD POKER (ATARI only)

Price: \$11.95 Cassette
\$15.95 Diskette

This is the classic gambler's card game. The computer deals the cards one at a time and you (and the computer) bet on what you see. The computer does not cheat and usually bets the odds. However, it sometimes bluffs! Also included is a five card draw poker betting practice program. This package will run on a 16K ATARI.

STATISTICS and ENGINEERING

DATA SMOOTHER (Available for all computers)

Price: \$14.95 Cassette
\$18.95 Diskette

This special data smoothing program may be used to rapidly derive useful information from noisy business and engineering data which are equally spaced. The software features choice in degree and range of fit, as well as smoothed first and second derivative calculation. Also included is automatic plotting of the input data and smoothed results.

FOURIER ANALYZER (Available for all computers)

Price: \$14.95 Cassette
\$18.95 Diskette

Use this program to examine the frequency spectra of limited duration signals. The program features automatic scaling and plotting of the input data and results. Practical applications include the analysis of complicated patterns in such fields as electronics, communications and business.

TFA (Transfer Function Analyzer)

Price: \$19.95 Cassette
\$23.95 Diskette

This is a special software package which may be used to evaluate the transfer functions of systems such as hi-fi amplifiers and filters by examining their response to pulsed inputs. TFA is a major modification of FOURIER ANALYZER and contains an engineering-oriented decibel versus log-frequency plot as well as data editing features. Whereas FOURIER ANALYZER is designed for educational and scientific use, TFA is an engineering tool. Available for all computers.

FOURIER ANALYZER and TFA may be purchased together for a combined price of \$29.95 (Cassettes) and \$37.95 (Diskettes).

REGRESSION I (Available for all computers)

Price: \$19.95 Cassette
\$23.95 Diskette

REGRESSION I is a unique and exceptionally versatile one-dimensional least squares "polynomial" curve fitting program. Features include very high accuracy; an automatic degree determination option; an extensive internal library of fitting functions; data editing; automatic data and curve plotting; a statistical analysis (e.g., standard deviation, correlation coefficient, etc.) and much more. In addition, new fits may be tried without reentering the data. REGRESSION I is certainly the cornerstone program in any data analysis software library.

REGRESSION II (PARAFIT) (Available for all computers)

Price: \$19.95 Cassette
\$23.95 Diskette

PARAFIT is designed to handle those cases in which the parameters are imbedded (possibly nonlinearly) in the fitting function. The user simply inserts the functional form, including the parameters (A(1), A(2), etc.) as one or more BASIC statement lines. Data and results may be manipulated and plotted as with REGRESSION I. Use REGRESSION I for polynomial fitting, and PARAFIT for those complicated functions.

REGRESSION I and II may be purchased together for \$36.95 (cassettes) and \$44.95 (diskettes)

Availability

DYNACOMP software is supplied with complete documentation containing clear explanations and examples. All programs will run within 16K program memory space (ATARI requires 24K). Except where noted, programs are available on ATARI, PET, TRS-80 (Level II) and Apple (Applesoft) cassette and diskette as well as North Star single density (double density compatible) diskette. Additionally, most programs can be obtained on standard 8" CP/M floppy disks for systems running under MBASIC.

BUSINESS and UTILITIES

MAIL LIST II (North Star only)

Price: \$21.95

This many-featured program now includes full alphabetic and zip code sorting as well as file merging. Entries can be retrieved by user-defined code, client name or Zip Code. The printout format allows the use of standard size address labels. Each diskette can store more than 1100 entries (single density; over 2200 with double density systems)!

TEXT EDITOR I (Letter Writer)

Price: \$14.95 Cassette
\$18.95 Diskette

An easy to use, line-oriented text editor which provides variable line widths and simple paragraph indenting. This text editor is ideally suited for composing letters and is quite capable of handling much larger jobs. Available for all computers.

FINDIT (North Star only)

Price: \$19.95

This is a three-in-one program which maintains information accessible by keywords of three types: Personal (e.g., last name), Commercial (eg: plumbers) and Reference (eg: magazine articles, record albums, etc.). In addition to keyword searches, there are birthday, anniversary and appointment searches for the personal records and appointment searches for the commercial records. Reference records are accessed by a single keyword or by cross-referencing two or three keywords.

DFILE (North Star only)

Price: \$19.95

This handy program allows North Star users to maintain a specialized data base of all files and programs in the stack of disks which invariably accumulates. DFILE is easy to set up and use. It will organize your disks to provide efficient locating of the desired file or program.

COMPARE (North Star only)

Price: \$12.95

COMPARE is a single disk utility software package which compares two BASIC programs and displays the file sizes of the programs in bytes, the lengths in terms of the number of statement lines, and the line numbers at which various listed differences occur. COMPARE permits the user to examine versions of his software to verify which are the more current, and to clearly identify the changes made during development.

COMPRESS (North Star only)

Price: \$12.95

COMPRESS is a single-disk utility program which removes all unnecessary spaces and (optionally) REMark statements from North Star BASIC programs. The source file is processed one line at a time, thus permitting very large programs to be compressed using only a small amount of computer memory. File compressions of 20-50% are commonly achieved.

GRAFIX (TRS-80 only)

Price: \$12.95 Cassette
\$16.95 Diskette

This unique program allows you to easily create graphics directly from the keyboard. You "draw" your figure using the program's extensive cursor controls. Once the figure is made, it is automatically appended to your BASIC program as a string variable. Draw a "happy face", call it H\$ and then print it from your program using PRINT H\$! This is a very easy way to create and save graphics.

TIDY (TRS-80 only)

Price: \$10.95 Cassette
\$14.95 Diskette

TIDY is an assembly language program which allows you to renumber the lines in your BASIC programs. TIDY also removes unnecessary spaces and REMark statements. The result is a compacted BASIC program which uses much less memory space and executes significantly faster. Once loaded, TIDY remains in memory; you may load any number of BASIC programs without having to reload TIDY!

SIMULATIONS and EDUCATION

BLACK HOLE (Apple only)

Price: \$14.95 Cassette
\$18.95 Diskette

This is an exciting graphical simulation of the problems involved in closely observing a black hole with a space probe. The object is to enter and maintain, for a prescribed time, an orbit close to a small black hole. This is to be achieved without coming so near the anomaly that the tidal stress destroys the probe. Control of the craft is realistically simulated using side jets for rotation and main thrusters for acceleration. This program employs Hi-Res graphics and is educational as well as challenging.

VALDEZ (Available for all computers)

Price: \$14.95 Cassette
\$18.95 Diskette

A simulation of supertanker navigation in the Prince William Sound and Valdez Narrows. The program uses an extensive 256X256 element radar map and employs physical models of ship response and tidal patterns. Chart your own course through ship and iceberg traffic. Any standard terminal may be used for display.

FLIGHT SIMULATOR (Available for all computers)

Price: \$17.95 Cassette
\$21.95 Diskette

A realistic and extensive mathematical simulation of take-off, flight and landing. The program utilizes aerodynamic equations and the characteristics of a real airfoil. You can practice instrument approaches and navigation using radials and compass headings. The more advanced flyer can also perform loops, half-rolls and similar aerobatic maneuvers.

TEACHER'S PET I (Available for all computers)

Price: \$ 9.95 Cassette
\$13.95 Diskette

This is the first of DYNACOMP's educational packages. Primarily intended for pre-school to grade 3, TEACHER'S PET provides the young student with counting practice, letter-word recognition and three levels of math skill exercises.

Ordering Information

All orders are processed and shipped postpaid within 48 hours. Please enclose payment with order along with computer information. If paying by VISA or Master Card, include all numbers on card. For orders outside North America add 10% for shipping and handling.

Add \$2.50 to diskette price for 8" floppy disk (soft sector, CP/M, Microsoft BASIC)

Deduct 10% when ordering 3 or more programs.

Ask for DYNACOMP programs at your local software dealer. Write for detailed descriptions of these and other programs from DYNACOMP.

DYNACOMP, Inc.
6 Rippingle Road
Pittsford, New York 14534
(716) 586-7579



New York State residents please add 7% NYS sales tax.



And one that costs you a buck.

One: Buy a new TeleLink™ I cartridge for your ATARI 400™ or ATARI 800™ computer and get one free hour of CompuServe Information Service time.

Two: Visit a Radio Shack® computer center. Most are equipped to access the CompuServe Information Service now. Log in and see what you can get. The service is compatible with any TRS-80™ including the new VIDEOTEX™ unit.

Three: Send \$1.00 to us and we'll send you the current "menu" of services, including the sophisticated big mainframe power of MicroNET. Send \$1.00, name and address to: CompuServe, Information Service Division, 5000 Arlington Centre Boulevard, Columbus, Ohio 43220.

Radio Shack, TRS-80 and Videotex are trademarks of Tandy Corporation. ATARI 400 and ATARI 800 are trademarks of ATARI, Inc.

Circle 91 on inquiry card.

All this is yours to command.



Access to news and entertainment data bases, computer games and art, regional newspapers, newsletters, programs, languages, storage (up to 128k free!) and lots more is yours for 8½ cents per minute (between the hours of 6 pm and 5 am weekdays and all day weekends), billed to your charge card. It's

a local phone hook-up in more than 260 U.S. cities.

CompuServe is working with 11 major regional newspapers to bring you their electronic editions, as well as the Associated Press news and sports wires.



Simple games and graphics for the beginner. And, when you're ready—try the really tough ones on MicroNET (see MicroNET service). You haven't lived until you discover a player from Los Angeles in *your* dungeon!

CompuServe is continually adding new on-line information resources. So, order our current menu and watch for new features such as an electronic encyclopedia, travel information, food preparation and gardening tips, government publication data—and much more!



MicroQuote has historical and statistical data on almost every stock, bond or option you can buy. Corporate financial information, commodity prices and financial newsletters are also available.



And, when you're ready for big-time computer action...

You need a computer to use all the MicroNET services which put you in command of our big, fast mainframe computers. But even with the simplest terminal you can send electronic mail to any other user, use the CB simulator, and try to zap the enemy's spaceships in real—and very fast—time. Many networking multi-player games available.



See for yourself what a state-of-the-art electronic information service can do. Get a demonstration at a Radio Shack® computer center or send \$1.00 for a current menu today.



CompuServe

Information Service Division
5000 Arlington Centre Blvd.
Columbus, Ohio 43220
(614) 457-8600

Circle 91 on Inquiry card.

A Simplified Theory of Video Graphics

Part 2

Allen Watson III
1261 Robbia Ct
Sunnyvale CA 94087

Color Television

To produce color television displays we need a picture tube with a phosphor screen that can be made to glow in different colors. This is done by a method similar to the half-tone method of color printing; a full-color picture is made by superimposing three single-color images made up of very small dots. At the normal viewing distance the dots are too small for the human eye to resolve, so that the colors appear to merge into a single image. The inside of a color television screen is covered with an array of small dots of three different phosphors that glow in red, green, a blue when struck by electrons. By carefully controlling the brightness of each colored dot we can produce any color we desire. (See text box, "The Primary Colors".)

The major problem is independent color control. We need three separate electron beams (ie: one for each color) arranged so one beam strikes only the red phosphor dots, one beam strikes the green dots, and one beam strikes the blue dots. It is not practical

to aim the beams this precisely; instead, a *shadow mask* is used. The shadow mask is a perforated metal plate placed just behind the phosphor screen in the picture tube. The three electron beams can strike the phosphor dots only after passing through holes in the mask. The electron guns that produce the beams are positioned so each beam strikes only dots of the correct color; thus each gun casts an electron "shadow" on phosphors of the other colors. Brightness of each of the primary colors is controlled by the intensity of the corresponding electron beam.

Color by Direct Drive

A straightforward approach to color computer displays uses three identical video-refresh circuits, each with its own refresh memory, in order to generate separate signals for the three electron guns. This approach is relatively expensive; it takes three times as much refresh memory as an equivalent black-and-white display. If this method were used with the 200 by 300 dot display example discussed in Part 1 of this article, $3 \times 7500 = 22,500$ bytes of refresh memory would be required.

We can have a more economical system using direct drive of the three colors, but using only one refresh memory. (Some switching circuitry is

necessary to display two colors instead of black and white.) With a special-character graphics system, we can use a few of our extra character codes to select the colors. The color displayed in place of white is called the *foreground* color and the one displayed instead of black is called the *background*. By inserting color-select characters wherever they are needed, it is possible to make different parts of the display show different colors. If each of the electron guns is either on or off, the colors available with this system will be the eight possible combinations of the three primary colors:

1. no color, or black
2. red
3. green
4. blue
5. red + green = yellow
6. green + blue = cyan
7. blue + red = magenta
8. all three = white

The main drawback to the use of direct drive (often referred to as *R-G-B*) is the cost of the color monitor. Professional monitors with separate red, green, and blue video inputs are not mass-produced, so they are quite expensive. Compucolor, the only personal computer manufacturer using direct-drive color, builds a low-cost

Note that the numbers used for figures, photos, and tables in this article have been continued from Part 1, which appeared in the November 1980 BYTE, page 180.

THE DAWN OF A NEW AGE

The 2nd GenerationTM is here!

MEASUREMENT systems & controls proudly introduces its new and exciting "2nd Generation" family of S-100* compatible products. Each has been specifically designed for use with multi-user and network operating systems such as MP/M, CP/NET, and OASIS. Every product is fully tested and burned-in, comes with a 1 year guarantee, and offers you features not currently available from any other source.

Z80 PROCESSOR BOARD — The most powerful CPU board available today. Outstanding features include 4MHz operation, high-speed serial and parallel I/O utilizing DMA or programmed control, eight vectored priority interrupts, and a real time clock.

MULTI-USER SERIAL I/O BOARD — For use in expanded systems requiring up to eight additional serial I/O ports. Features include: 16 maskable

vectored priority interrupts, RS-232C interfaces with full handshake, asynchronous or synchronous operation with asynchronous baud rates to 19,200. Available in four or eight channel versions.

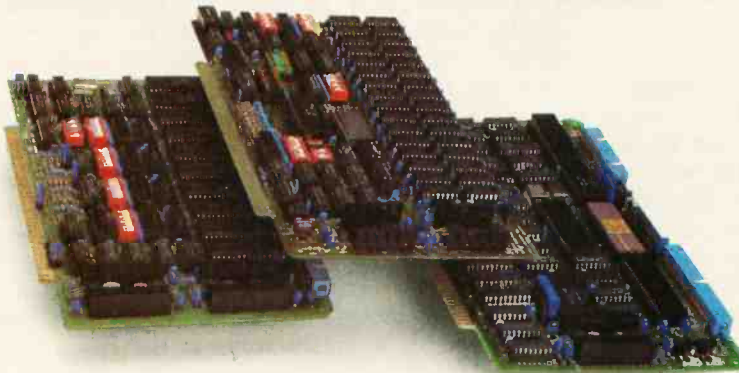

DOUBLE DENSITY FLOPPY DISK CONTROLLER BOARD — controls up to four 5¼-inch or 8-inch disk drives using IBM soft sector formats. It features 1K of on-board buffering, DMA controlled data transfers and the performance characteristics of the superior NEC 765 chip.

64K BANK SELECTABLE MEMORY BOARD — Features include I/O port addressing for bank select with 256 switch selectable I/O ports for the memory bank addressing. The memory is configured as four totally independent 16K software-selectable banks, with each bank addressable on any 16K boundary.

*All products meet the new IEEE standards.

"Attractive Dealer & OEM Prices"
See your nearest computer dealer, or contact us for the complete story on The 2nd Generation.

Systems Group

A Division of MEASUREMENT systems & controls
incorporated

867 North Main St. / Orange, Calif. 92668
(714) 633-4460 TWX / TELEX: 678 401 TAB IRIN

The Primary Colors

In grammar school, most of us were taught that there are three primary colors (red, yellow, and blue) and that any other color can be produced by mixing these three. You may be wondering how color television manages to use red, green, and blue as its primary colors. First of all, the primary colors we learned in school are appropriate only for pigments such as paints and crayons; light sources such as the glowing phosphor dots in a color picture tube don't work the same way.

The creation of a color by mixing pigments relies on the subtraction (or partial absorption) of colors from the light falling on the pigment. If you mix pigments without adding white, the image gets darker. However, creating a color by mixing light works by addition, so if you combine several colors of light, the result is lighter.

Complementary colors are essentially opposites: if you mix complementary-colored pigments the resulting color is black, but if you mix complementary-colored beams of light, the resulting color is white. This "symmetry" means that primary colors for light will be the complements of primary colors for pigments.

This still sounds paradoxical: how can red, green, and blue be the complements of red, yellow, and blue? This apparent problem is caused by the vagueness of our color names. The colors in the two sets of primaries are actually all different, but one color in each set is reddish and one is bluish. You can see examples of the pigment primaries by examining a printed reproduction of a color photograph in which the printing plates are out of register. Here you can perceive the colors of the inks and that the "red" ink is actually red-

violet, or magenta, and that the "blue" ink is blue-green, or cyan.

To see the primary colors used in television, try viewing a color test pattern by tuning to a television station before it is broadcasting programs. If you adjust your television set's color controls so the primaries are as pure as possible, you will find the green slightly yellowish, the red a bit orangy, and the blue almost indigo. If we arbitrarily use our vague color names for specific colors and call the television primaries red, green, and blue, we must call the pigment primaries magenta, yellow, and cyan to avoid confusion. The two sets of primary colors make up complementary pairs, like this:

Lights	Pigments
red	cyan
green	magenta
blue	yellow

color monitor into the computer in order to keep the total system cost reasonably low.

Color by Subcarrier

Another method of avoiding a high-priced color monitor is to use an ordinary color television set to display computer video. Even with the addition of extra circuitry needed to pick up broadcasts, home television sets cost less than professional monitors. However, there are drawbacks to the use of a television set.

A color television set is designed to accept a VHF (very-high-frequency) radio signal or carrier that is modulated by a composite-video signal. This signal consists of horizontal and vertical synchronizing pulses, black-and-white picture information (called *luminance*), and a 3.58 MHz subcarrier that contains the color information (called *chrominance*). The subcarrier is modulated by the color information in such a way that the amplitude of the 3.58 MHz signal determines the intensity of the color at each point in the picture; the phase of the signal determines the actual color displayed. (Refer to the text box, "Outline of NTSC Color Standards.")

Remember that the video signal developed from memory produces

output pulses at the appropriate times during the raster-scanning process. This creates dots of light on the display screen. It is convenient to design computer video circuits so each dot corresponds to a half cycle of the 3.58 MHz color subcarrier. If several dots are adjacent, the output will be a continuous high-level signal; this will appear on the screen as a white line as wide as the number of dots. If we alternate dots and spaces, the signal will consist of alternating high and low levels, each a half cycle wide, creating a square wave at the 3.58 MHz subcarrier frequency. The television set decodes the amplitude of the 3.58 MHz component of the composite video as the intensity of the color to be displayed, so what was sent out as a string of dots and spaces will be displayed as a brightly colored solid line.

The color that is displayed depends on the *phase* of the color subcarrier. The timing of the dots generated by the video-refresh circuits determines their phase. For example, with dots corresponding to half cycles, interchanging dots and spaces is equivalent to a phase reversal, or a 180° phase shift, which will produce the complement of the first color. To produce more colors, we must make smaller changes in the timing of the

dots. The half-cycle dots are produced by computer circuits running at twice the color subcarrier frequency, or 7.16 MHz. If we make our circuits run twice as fast (14.3 MHz), we can put dots on quarter-cycle intervals and have 90° phase differences. With the half-cycle dots this would give us four colors in addition to black and white.

Bit mapping is not the only way to produce NTSC (National Television System Committee) color signals. Our computer can have circuits that work like character generators, to decode different values of refresh data into appropriate dot patterns, for even more colors. The circuits can produce dots a quarter-cycle long, separated by spaces three-quarters of a cycle long and vice versa, which are still at the frequency of 3.58 MHz. The quarter-cycle dots can be at any of four phases, as can the three-quarter cycle dots, giving us eight more colors for a total of twelve, plus black and white. The quarter-dot colors will have a low average voltage level and, hence, lower brightness when compared to the longer three-quarter cycle dots. In other words, four of the twelve colors produced by this technique will be dark, four will be medium bright, and the re-

Text continued on page 150

Software for People who aren't Easy to Please.

High quality pretested interactive application software packages for personal and small business computers designed by experts — Datasoft. Proven standard accounting and inventory control functions — Datasoft. Special market packages for attorneys, physicians, wholesalers and retailers — Datasoft. Complete documentation — Datasoft. Sophisticated electronic games — Datasoft. Great dealer discounts — Datasoft. Total support — Datasoft. Best value — Datasoft.

Guaranteed — Datasoft.

Mail this coupon today or call now for faster delivery — (800) 896-5630

Hurry, send details on:

- Business software Personal software
 Dealer information
 Programmer Consumer
 Educational

Datasoft Inc., 16606 Schoenborn St., Sepulveda, CA 91343, (213) 894-9154

Type of computer owned _____

Company/Name _____

Address _____

City _____

State _____

Zip _____

Phone _____

Dealer inquiries invited

Datasoft Inc.
COMPUTER SOFTWARE

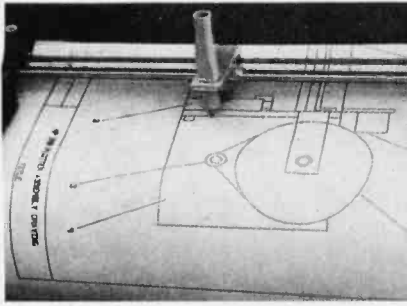

Price/Performance Breakthrough!

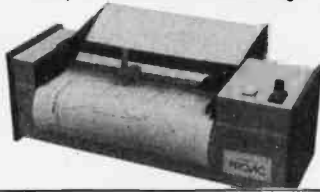

Mauro MP-250 Proac

The \$695 pen plotter that gives professional accuracy with superb line quality!

Mauro's design innovations make it possible to produce a high quality, low cost plotter that out-performs every other plotter of comparable price on the market today. In fact, its line quality matches that of plotters costing \$2,000 or more.

Proac draws with .005"/step resolution and $\pm 0.5\%$ @ 17" degree of accuracy at speeds of 2.5" per second or higher. A unique multi-point paper drive helps achieve this level of accuracy, making Proac suitable for a wide variety of applications for which Mauro is developing supportive software. *Programs currently available include:* [1] Complete 2D and perspective plotting, including ASCII and curve generation which are available as relative linking libraries (L80) for Microsoft compatible software products, Fortran-80, Cobol-80, Compiler Basic, and Macro-80 in CP/M compatible files on 8" IBM-3740 or 5 1/4" Northstar formatted disks. [2] Apple II UCSD Pascal implementation of Turtle Graphics including full 128 ASCII character set; Pascal subroutines are Fortran compatible. [3] Complete scientific and business data graphing package for Apple II. Includes data editor, Hi Res screen preview, Axis tic marks, labeling and scaling, data overlays, names and comments, point, line, bar, and pie graphs, 128 ASCII character set, data file handling. [4] Schematic drawing system for TRS-80. Has two font system: .15" grid for B size, and .1" for A size drawings. Comes complete with predefined symbols for standard logic, linear devices, passive and active components, connectors, and 128 ASCII character set. System is menu driven with placement of symbols and interconnectors done under cursor control on the screen before plotting. *Other software is in development and will be available upon completion.*

Proac comes with full vector driving software for 8080, 6502, and 6800 based computers. Interfaces are available for Apple, TRS-80 and PET. With the addition of an "intelligent" serial interface, Proac becomes compatible with any computer.

Contact Mauro Engineering about complete information and specifications for MP-250 Proac and available software.

MAURO ENGINEERING

Rt. 1, Box 133, Mount Shasta, CA 96067
Telephone 916 926-4406

Outline of the NTSC Color Standards

In 1953 the NTSC (National Television System Committee) announced a method of color television broadcasting that was adopted as the US standard. The NTSC system superimposes color picture information onto the older black-and-white signal in such a way that the resulting composite signal is compatible with the old standards. This means that color broadcasts may be viewed on black-and-white sets (and vice versa), and this made it possible to continue using black-and-white equipment.

A color television camera is essentially a combination of three monochrome (ie: black-and-white) cameras, each viewing the same scene through a different colored filter. The most straightforward way to transmit color television into the home would be to send these three signals over the air, but that would require the equivalent of three television channels and would not be economically feasible.

Studies of human vision have shown that fine details in color are not resolved as well as they are in black-and-white. This is fortunate since it allows transmission of color picture information with a much narrower bandwidth than three separate channels would require. In order to take advantage of this effect, the NTSC technique converts the three signals from a color camera into one full-resolution black-and-white signal called the luminance signal, and two color-difference signals called chrominance signals (which are filtered to limit their bandwidth, thereby decreasing their resolution).

The total bandwidth required for the luminance signal plus the two chrominance signals is about 40% greater than the bandwidth of a black-and-white signal, still too broad to keep within the 4.5 MHz bandwidth that was originally allocated for the video signal. The NTSC system puts the chrominance signals into the band that is already occupied by the luminance signal. This trick is accomplished by putting the chrominance signals onto a subcarrier, which is then added to the luminance signal. The

subcarrier is so called because, while it modulates the radio-frequency carrier along with the normal video signal, it is also a carrier.

The subcarrier frequency must be higher than that of the information it is to carry, although there is a maximum frequency that will still fit within the 4.5 MHz bandwidth. Another reason for putting the subcarrier at a relatively high frequency is that the luminance signal has less energy at higher frequencies, so there is less interference between the luminance and the subcarrier. There are still more complex aspects of the NTSC technique required to minimize this interference and to preserve certain other characteristics of the original black-and-white television signal, but their importance in computer applications is not great enough to warrant a full description here. The net result is that the horizontal line frequency is changed slightly in the NTSC system, to 15,734.26 Hz, and the color subcarrier is put at 3.579545 MHz. This is usually referred to as the 3.58 MHz color subcarrier.

The two chrominance signals modulate the 3.58 MHz subcarrier together in such a way that the resulting signal has an intensity or amplitude proportional to the amount of color at each point in the picture and a phase that determines the particular color. There must be a standard phase for the receiving set to refer to in decoding the color information, so a short burst of unmodulated 3.58 MHz subcarrier is transmitted during part of each horizontal retrace interval. This so-called color burst is used by the receiver to generate a reference subcarrier phase.

It turns out that most television sets don't do a very good job of separating the chrominance and luminance signals that are combined so cleverly in the NTSC system. Compromises made in the interests of lower cost cause most sets to lose the fine detail in the picture and pick it up as chrominance instead. This means that fine vertical black-and-white stripes will sometimes produce spurious colors on the screen. You can see this effect by watching for colored streaks across those striped shirts worn by news announcers.

If you
just bought
another
printer,
boy are
you gonna
be sorry.

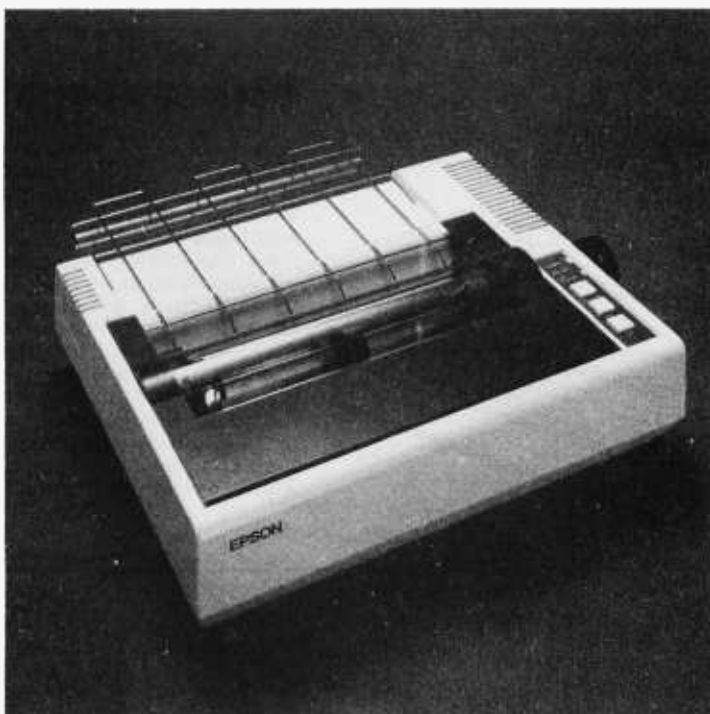

Epson.

The Epson MX-80. It's not just another worked-over rehash of last year's model. It's our top-of-the-line 80-column printer. It's new. From the ground up. And it's the most revolutionary printer to hit the market since Epson invented small printers for the 1964 Olympics in Tokyo. Don't take our word for it, though. Compare. There simply isn't a better value in an 80-column printer. Period.

But here's the fact that's going to stand the printer world on its ear. The MX-80 sports the world's first *disposable* print head. After it's printed about 50 million characters, you can throw it away. Because a new one costs less than \$30, and the only tool you need to change it is attached to the end of your arm.

Now that's revolutionary, but that's only the beginning. The MX-80 also prints bidirectionally at 80 CPS with a logical seeking function to minimize print head travel time

The world's first disposable print head. It has a life expectancy of over 50 million characters, yet it's so simple, you can change it with one hand. And it costs less than—repeat less than—\$30.



and maximize throughput. It prints 96 ASCII, 64 graphic and eight international characters in a tack-sharp 9x9 matrix. And it provides a user-defined choice of 40, 80, 66 or 132 columns and multiple type fonts.

We spent three long years developing the MX-80 as the first of a revolutionary series of Epson MX Printers. We employed the most advanced automatic assembly and machining techniques in existence to produce a printer that is incredibly versatile, remarkably reliable and extraordinarily inexpensive. It's a printer that could only come from the world's largest manufacturer of print mechanisms: Epson.

If it sounds like we're proud of the MX-80, we are. Not only does it do things some of the world's most expensive printers can't do, it'll do them for you for less than \$650. That's right. Under \$650.

And if that isn't revolutionary, we don't know what is.

EPSON
EPSON AMERICA, INC.

23844 Hawthorne Boulevard, Torrance, California 90505, Telephone (213) 378-2220



THE TYPRINTER 221

The TYPRINTER 221 is the only intelligent printer that is **Totally Compatible** with every computer and all word processing software. Features such as Automatic Underlining, Automatic Bold Print, Reverse Print, Columnization, Decimal Location are all included at no extra cost. This daisy wheel printer prints 20 characters per second with Pica, Elite or Mikron size type. Standard Centronics type interface, RS-232 or IEEE available. This incredible printer can be used off-line as a typewriter with a 17" paper width capacity. Unit has a non-volatile resident memory for: Automatic recall of often-used formats, Automatic recall of often-used phrases. This is the only printer in the world that can be programmed for use with any word processing software. \$2850.00

THE MICROLINE-80

The Microline-80 offers business-quality and reliability at an attractive price. Small and lightweight, it easily fits in an attache case. It operates at 80 characters per second, and accomodates three-part forms up to 9.5" in width. It can switch from standard 80 column printing at ten characters per inch to 132 column condensed printing at 16.5 characters per inch. The condensed printing, combined with program controlled line spacing at six and eight lines per inch, provides for substantial savings in paper. Features: Upper and Lower Case, Centronic Interface, 9x7 Matrix, Block Graphics, 110V/220V 50/60 cps, Friction & Pin-Feed. \$639.00

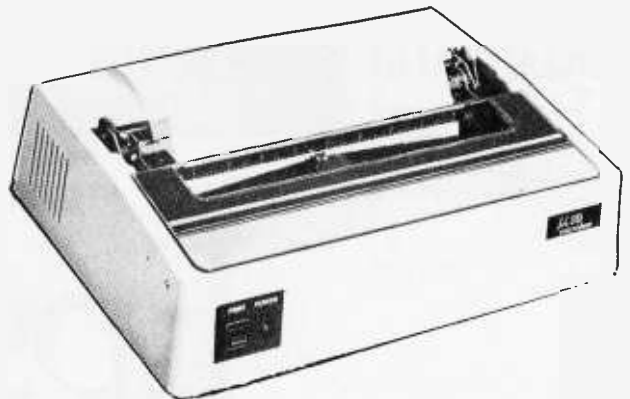

PRINTERS

	LIST PRICE	OUR PRICE
Centronics 730	\$795.00	\$749.00
Centronics 730-3	\$895.00	\$795.00
Centronics 737	\$995.00	\$869.00
Centronics 779 w/lower case	\$1595.00	\$1195.00
Epson MX-80	\$645.00	\$599.00
LRC 7000 + (84 col.)	\$405.00	\$299.00
NEC 5510 SpinWriter	\$3195.00	\$2695.00
NEC 5520 SpinWriter	\$3395.00	\$2995.00
NEC 5530 SpinWriter	\$3195.00	\$2595.00
NEC Tractor-Feed Option	\$249.00	\$225.00
Okidata Microline-80	\$800.00	\$699.00
Okidata Microline-82	\$980.00	\$799.00
Okidata Slimline SL300	\$5380.00	\$4395.00
TYPRINTER 221	\$2850.00	\$2850.00
Vista V300	\$1895.00	\$1795.00

COMPUTERS

	LIST PRICE	OUR PRICE
Model I, Level II, 4K	\$649.00	\$619.00
Model I, 16K no keypad	\$768.00	\$669.00
Model I, 16K w/keypad	\$849.00	\$729.00
Model II, 64K Ram	\$3899.00	\$3799.00
Model III, 16K Ram	\$999.00	\$929.00
Model III, 32K Dual Disk	\$2495.00	\$2299.00
Pocket Computer w/Interface	\$289.95	\$269.00
TRS-80 Color Computer	\$399.00	\$359.00
TRS-80 Color Computer Expanded	\$599.00	\$519.00
Atari 400 Computer System, 8K	\$629.95	\$499.00
ATARI 800 Computer System, 16K	\$1079.95	\$849.00
16K APPLE II Computer	\$1195.00	\$999.00
16K APPLE II + Computer	\$1195.00	\$999.00
32K APPLE II + Computer	\$1295.00	\$1059.00
48K APPLE II + Computer	\$1395.00	\$1119.00

TERMS: Prices and specifications are subject to change. HARDSIDE accepts VISA & MASTERCARD, Certified checks & Money Orders; Personal checks accepted (allow 3 weeks to clear). HARDSIDE pays all shipping charges (within 48 states) on all PREPAID orders OVER \$100.00. UPS Blue Label or Air Freight is available at extra cost. COD orders accepted (orders over \$100 require 25% deposit).

TO ORDER TOLL-FREE
1-800-258-1790
 (In NH call 673-5144)



The Software Exchange

6 South Street, Box 68, Milford, NH 103055

CALL TOLL FREE

1-800-258-1790

(In NH call 673-5144)

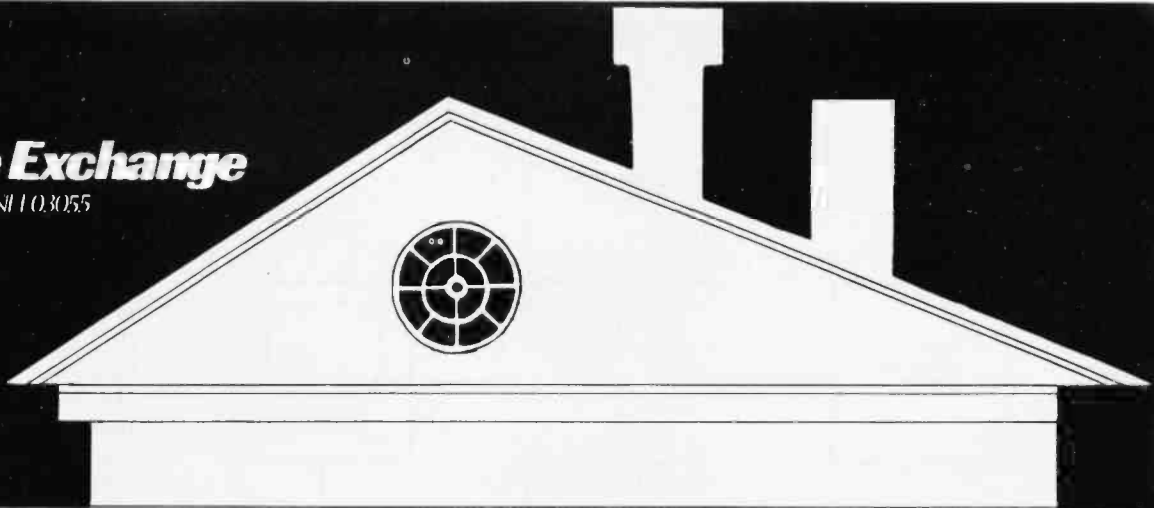

We have it all under one roof!

At TSE we stock our shelves with only the finest products available to make your micro-merchandise shopping a pleasure. So the next time you're considering a purchase for your micro, just pick up the telephone and dial our toll-free number (1-800-258-1790) to get in touch with all that counts in the micro industry.

SOFTWARE

- Microsoft
- Apparat
- Racet
- Hayden
- Muse
- Creative Computing
- Personal Software
- Scott Adams
- Acorn Software
- Synergistics
- Strategic Simulations
- Lance Micklus
- Softape
- Quality Software
- Web Associates
- Small System Software
- Image
- On-Line Systems
- Ritam
- Avalon Hill
- Big Five
- Micro Lab
- Programmers Guild
- Quality Software Distributors

HARDWARE

- Radio Shack
- Commodore Pet
- Atari
- Percom
- Centronics
- NEC
- Sun
- Okidata
- Source/Telecomputing
- Computer Case Co.
- MicroMint
- Eaton LRC
- Cover Craft
- BSR
- BASF
- Corvus
- Archbold Electronics
- ESP
- Novation

BOOKS

- Hayden
- Wiley
- Scelbi
- Compusoft
- Dillithium
- Sams
- Radio Shack
- SoftSide
- Addison Wesley
- Computer Science Press
- Rainbow Associates
- Plus much more!

Send \$1.00 for our catalog, and receive a
\$2.00 credit toward your next purchase.

Circle 166 on inquiry card.

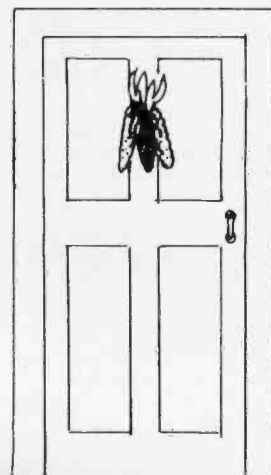

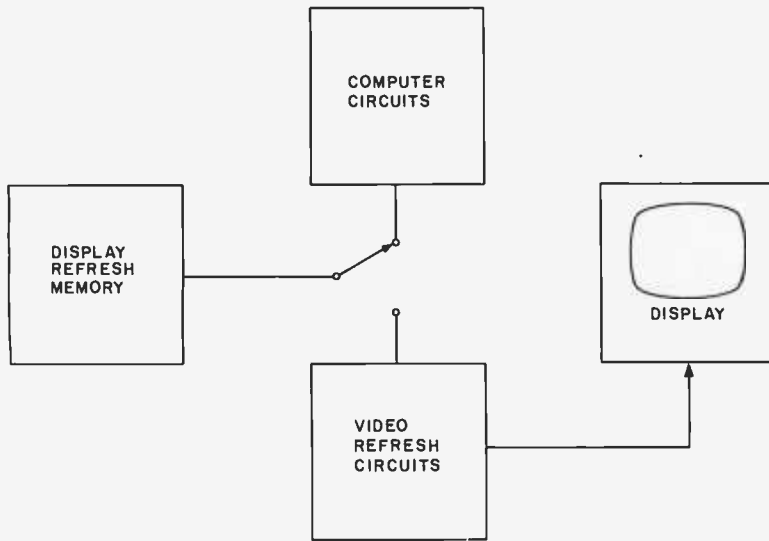

Figure 2: The cause of video-display dropouts. Several popular microprocessor systems use a display scheme that switches the refresh memory out of the video-refresh circuitry whenever some refresh memory location is changed. This is interpreted by the display as a blank line on the screen for a short interval.

Text continued from page 144: maining four will be pastels. (See photo 2 on page 152.)

This method of color production has some drawbacks. For one thing, it produces spurious black or white margins wherever certain color areas

touch. This is due to the behavior of the dot patterns. If the dot pattern for green is binary 0101 and the pattern for magenta is 1010, you can see that there will be either two dots together or two spaces together whenever a green area is next to a magenta one.

Two or more dots together produce white on the display.

Another problem arises when trying to superimpose text and color. Since the characters are made of lines only one dot wide, some parts of the characters will match the dot patterns of the colors and they will disappear if displayed on a colored background. One way to avoid this is to make characters of elements at least two dots wide. This prevents their merging into colored backgrounds, but at a price: you cannot fit as many of these wider characters into the display.

Undocumented Features and Quirks

Several of the personal computers listed in Part 1 of this article have subtle quirks that are not apparent at first glance and are never mentioned in the manufacturers' specifications or sales literature. While they could easily escape your notice during a demonstration at the computer store, they could become very irritating once you become aware of them. If you are planning to use one of these computers for graphics, you should be aware of these quirks before you decide which computer to buy. Although you may discover other problems, these are the major design flaws in the personal computers listed:

- asymmetrical plotting
- video-refresh dropouts
- limited color resolution
- adjacent color interactions

Asymmetrical Plotting

Asymmetrical plotting makes a plot with the same number of dots horizontally and vertically come out not as a square but as a rectangle. Some personal computers are quite bad in this respect while others produce almost perfectly symmetrical plots. You can figure whether or not a display is symmetrical by finding the ratio of its horizontal resolution to its vertical resolution, and comparing the result with the *aspect ratio* of the display portion of the screen. The aspect ratio is the display width compared with the display height: a standard television screen is a third wider than it is high, so its aspect ratio is 4:3. If a computer's display is symmetric, the number of dots it takes to fill the screen in each direction will be proportional to the size of the screen in that direction. You will probably

Mountain Computer can now

EXPAND

Your Apple II Peripheral Capacity EXPANSION CHASSIS

Quality You Expect

Eight more slots for your Apple! Now you can bank-select eight more peripheral slots with immediate or deferred software commands—like having up to 15 peripheral cards "on line"—or use the Select/Deselect switch mounted on the front panel. Expansion Chassis' heavy-duty power supply is primarily for peripherals, without the heavy demand of motherboard support chips required in your Apple. This means much more power is available for peripherals than in your Apple itself! If you've run out of room in your Apple—Expansion Chassis is your answer. Drop by your Apple dealer for a demonstration, or contact Mountain Computer for the location of the dealer nearest you.

Performance You Demand

- Eight mirror image I/O slots of the Apple
- Fully buffered, bi-directional data lines
- Apple II compatible interface card
- Dual selection capability; hardware or software
- Immediate or deferred selection in software mode
- From BASIC, a single POKE command turns the chassis ON or OFF
- Compatible with all software
- Dedicated power supply with approved power transformer



Mountain Computer
INCORPORATED

300 Harvey West Blvd., Santa Cruz, CA 95060
(408) 429-8600 TWX 910 598-4504

Apple is a trademark of Apple Computer Inc.

When you pick a Daisy... Pick Vista's V300 Printer.



\$1895.

There are Daisies! . . . And, There are Daisies! . . . But Vista has a Peach!

The Vista V300 is exactly that, a "peach" of a daisy wheel printer both from the standpoint of price and performance.

Think of it, a printer at nearly half the price (when compared to models even remotely competitive in quality) combined with the ultimate in reliability, print quality, and flexibility.

Typical Comments: "Superb print quality!", "Highly reliable.", "Definitely letter quality. . . I can't believe the price tag.", "Best use I've seen yet of LSI Technology."

But judge for yourself — look at the V300 features and keep in mind this is a letter quality printer at dot matrix prices.

- Tractor option available
- Print Speed — 25 CPS (Optional 45 CPS for \$2,195)
- Print Wheel — Industry standard 96-character Daisy Wheel (including the extended-life dual plastic wheels)
- Service — Prompt maintenance/service agreements available nationwide
- Interface — Industry standard parallel (RS232-C optional)
- Printable Columns — 136
- Warranty — 90 days parts and labor, one year parts only
- Proportional, bi-directional printing • Programmable VFU
- Extensive self-test functions • Hardware and software compatible

Vista does it again! Quality, Price and Performance with a peach of a daisy wheel printer.



IMMEDIATE DELIVERY
For Further Information
Call Toll Free (800) 854-8017

The Vista Computer Company 1401 Borchard Street • Santa Ana, California 92705 • 714/953-0523

AND, Vista Has a Complete V100 Word Processing System for Only \$4995!

The Vista V100 is a complete word processing system that includes:

- Exidy Sorcerer Computer, 48K
- V200E20 Disc Drive System, Double Density
- Sanyo Data Display Monitor
- Vista V300 Printer Full Character Daisy Wheel
- Wordstar, CPM 1.4 (Includes E Basic)
- Can also be used for Data Processing

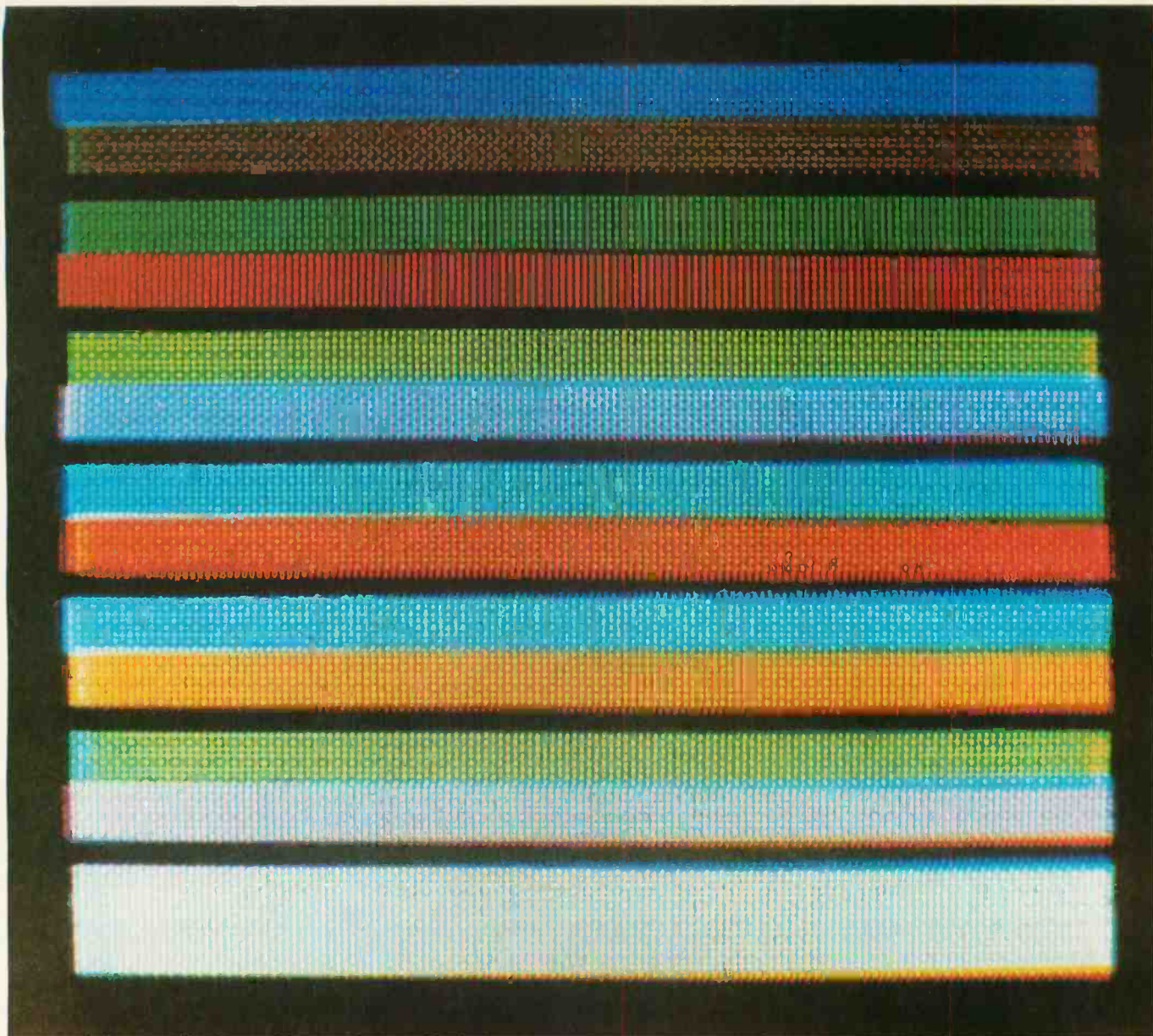

Photo 2: Bars of complementary colors. Twelve colors (plus white) can be produced by the color-subcarrier method, where each cycle of the 3.58 MHz color frequency is broken into quarters. By varying the phase and by putting out signals with a duty cycle of 75%, 50%, or 25%, a computer display can select the color.

be able to program the computer to compensate for an asymmetric display, but the results may look so ragged that you prefer to live with the asymmetry.

Video-Refresh Dropouts

Video-refresh dropouts look something like the interference produced by static from electric motors and automobile ignitions (ie: short, horizontal black lines that appear very briefly and in random locations on the screen.) They are not external interference in this case, but are self-inflicted. Whenever a Radio Shack TRS-80 or an Exidy Sorcerer accesses the video-refresh memory (either to

read it or to change it), the computer interrupts the video refresh. (See figure 2.) The severity of the resulting display-data dropouts depends partly on the nature of the data being displayed. If only text is being displayed, with a black background, most of the dropouts will occur in areas of the screen that are already black and pass unnoticed. (The small-keyboard Commodore PET has dropouts too, but they are white and only appear when the display is PEEKed or POKEd.)

Dropouts happen only while the data in the computer's video-refresh memory is being read or changed; if the display is being changed often, as

during animation, the occurrence of dropouts will increase. So if you are planning to use your computer for animated graphics, look for models that do not have this problem.

In order to avoid having video dropouts, some personal computers have refresh memory that runs twice as fast as necessary for refreshing the display. This makes it fast enough to respond to a memory-access request by the computer between two successive transfers to the display. The computer and the display share the refresh memory by taking alternate memory cycles. Neither interferes with the other in any way.

The main reason that all personal

NEW DISK SYSTEM POLISHES APPLE™

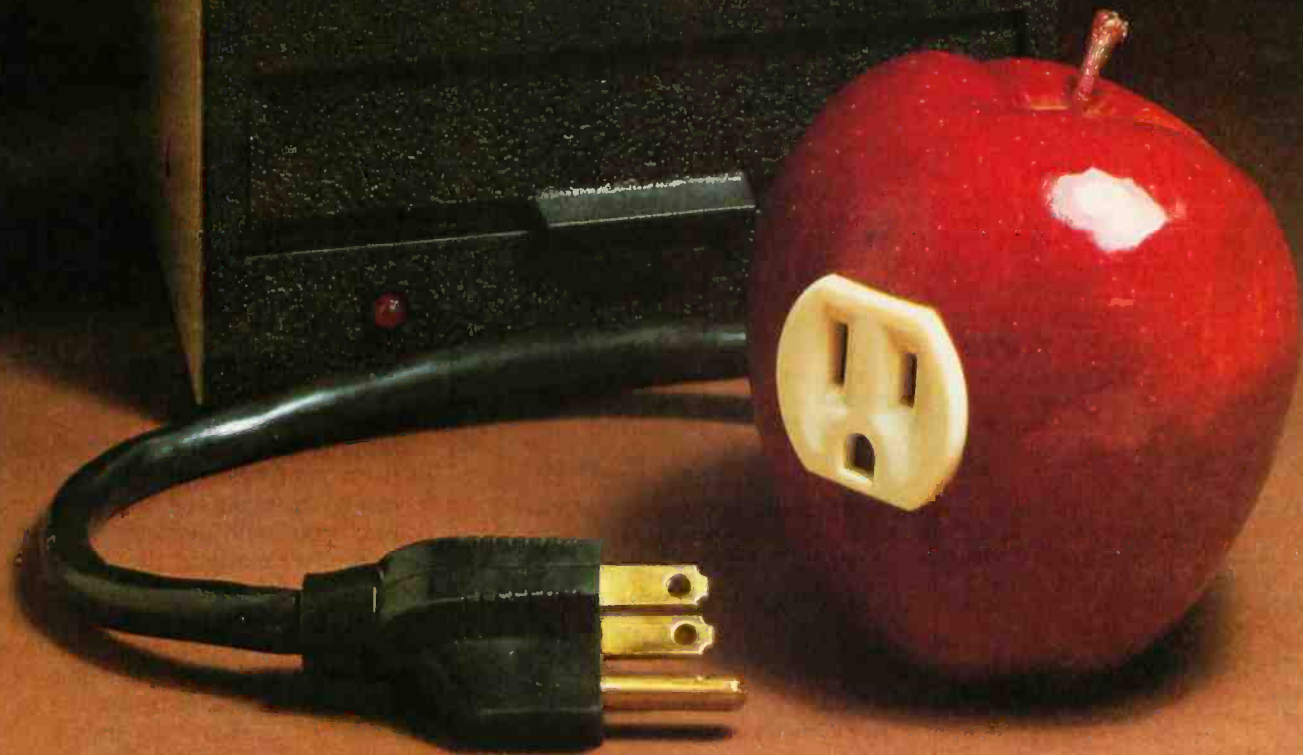

Micro-Sci's new disk drive family really makes your Apple shine.

Both the A-40 and A-70 offer extra performance plus the ability to read existing diskettes written on Apple Disk II systems.

And a jumper selectable boot prom for 13 and 16 sector interger Basic or 8 sector Pascal comes standard.

The Model A-40 actually costs a lot less than Apple Disk II drives. Yet it provides 40 tracks instead of

35, along with up to 20K increase in capacity. Maybe an extra 20K isn't anything to write home about, but the speed sure is—5 ms track to track vs. Apple's 15 ms.

The Model A-70, on the other hand, features twice the tracks and capacity of the Apple Disk II, but it costs only a few dollars more.

The secret of outstanding performance and reliability is a state-of-the-art design incorporating a band positioner, instead of a plastic

cam, plus an improved media centering system.

SPECIAL DISCOUNT.

One A-40 plus controller is priced at only \$495 and the second drive is just \$395. You can save up to \$200 per system over Apple II drive prices.

And you can save even more if you act now. Contact us today for a special \$50 introductory discount on your Micro-Sci A-40 or A-70 system order.

μ-SCI

MICRO-SCI

1405 E. CHAPMAN AVENUE · SUITE E · ORANGE, CALIFORNIA 92666 · 714/997-9260

MICRO-SCI IS A DIVISION OF STANDUN CONTROLS, INC.

Apple and Apple II are registered trademarks of APPLE COMPUTERS INC., SAN JOSE, CALIFORNIA

computers do not use this method of preventing dropouts is cost. The components for this refresh memory must be capable of operating at twice the normal speed—this makes the memory more expensive. Or looking at it another way, without the need for fast refreshing, the higher-speed memory would enable us to use a faster microprocessor and obtain better performance. Another factor affecting the design of the refresh memory is the type of microprocessor being used; some types have internal clocking schemes that are not compatible with this refreshing scheme.

Limited Color Resolution

If you choose a computer that generates NTSC video in order to use an ordinary color television set for your display, you may be disappointed by the poor horizontal resolution. Even though the computer produces a signal with up to 280 dots per horizontal line, the television set will only show black-and-white resolution of about 160 dots per line and color resolution that is even lower — 40 or 50 dots per line.

We must define three different kinds of horizontal resolution when discussing graphics displays on a col-

or television receiver. To start with, you can distinguish the 280 dot positions even on a color set. (We might call this figure the *accuracy* of the display, since it determines the smallest difference that the computer can display.) The resolution problem arises due to the way most color television sets separate the color information from the rest of the video: they send all of the high-frequency information to the color circuits. This limits the picture bandwidth to only 2 to 3 MHz and the horizontal resolution to 160 to 200 dots per line.

This resolution, poor as it is, applies only to brightness changes in the picture (ie: black-and-white information). If you display different colors next to each other, the colors will smear across the width of four or five dots. This is due to the narrow bandwidth of the color circuits. A bandwidth of about half a megahertz allows only about fifty color changes across the width of the screen. In spite of this, you can produce quite good displays on a color television set by using a lot of black and white along with colors. Most of the picture consists of brightness differences and has horizontal resolution of about 160 dots per line. Displaying black between different colored areas keeps the color smears from being visible.

Color Interactions

Suppose you want to draw several lines on your color-graphics display. If you try to make the lines different colors, you will discover that the compromises made in the designs of some personal computers limit the number of colors that can be adjacent. If you try to put more than two colors close together, the computer will sometimes change one of the colors plotted earlier, depending on which color is used last. This can be rather disconcerting the first time it happens to you and worse when you find that it is a characteristic of your computer. You may be able to minimize the effect it has on your displays by understanding the mechanism behind it in order to "program around it."

This problem arises in the CompuColor II and in the Texas Instruments TI-99/4 because of their background-foreground schemes for specifying colors. Programs on these machines can use any one of the available colors for the dots being displayed (ie: the foreground) and any other color for the background. Each character cell can have its own

HOLIDAY GREETINGS FROM JOHN D. OWENS ASSOCIATES

CALIFORNIA COMPUTER SYSTEMS

HIGH IN QUALITY, LOW IN PRICE

Z80 CPU, 4 Mhz, with one serial port; 12 slot S-100 mainframe, disk controller, 64K Dynamic Ram, CP/M 2.2® \$1,645.
 Interfaced to 2 Shugart, 8 inch drives with power supply and cabinet for an additional \$1,250.
 and you have a complete S-100 system for under \$3,000. THE BEST BUY ON THE MARKET.

IMS 5000 and 8000 Systems

The new rising stars! Beautifully designed and constructed with the Industrial Micro System reputation for fine quality. These systems feature a Z80 CPU, S-100 bus; double density drives (either single or double sided) CP/M®. 5000 series uses mini floppies, 8000 uses maxi floppies. Hard disk and MP/M now available.

Model 5-00125 with two double density drives, 32K Static RAM \$2,765.
 Model 8-00125 as above but with 8" drives \$4,185.

AMPEX DFR-900 HARD DISK DRIVES

Winchester media; 16MB removable; 32, 64, or 96 MB fixed. These drives are totally integrated with the IMS hardware and CP/M® or they can be used with other systems. We can furnish a package consisting of an IMS system, your choice of CRT or printer, optional hard disk and applications software.

32MB System \$8,500.

DRIVES

Per Sci 299B Now Available!!! . \$2,300.
 Cabinet and power supply \$300.
 Per Sci 277 \$1,210. Shugart \$525.
 MPI B51 \$265. B52 \$365.
 Innotronics and QUME also available.

HAZELTINE 1500

1510 \$980. 1520 \$1,210.
 1420 (two year warranty) \$775.

CENTRONICS

737 \$780. 730 \$680.

TELEVIDEO SMART CRTs

912 B and C \$780.
 920B \$1,105. 920C \$850.

IMS MEMORY

16 K static \$285.
 32 K static \$585.
 64 K Dynamic with parity \$950.

TEI MAINFRAMES, S-100

12 slot \$500.
 22 slot \$670.

TARBELL

Double density controller \$420.
 Cables \$40.

CALIF. COMPUTER SYSTEMS

CONTROLLER Single or double density; 5¼ or 8" drives. ROM Addressable. Price includes CP/M® 2.2 \$395.

WE EXPORT: Overseas Callers: TWX 710 588 2844
 Phone 212 448-6298 or Cable: OWENSASSOC

CALL OR WRITE FOR CATALOGUE AND PRODUCT LITERATURE

JOHN D. OWENS

Associates, Inc.

12 Schubert Street

Staten Island, New York 10305

212 448-6283 212 448-2913 212 448-6298

foreground and background colors, so the colors can be different in different parts of the display. However, inside a region that is the size of a character, there can be only two colors. If you try to draw a colored line through a cell that already has two other colors in it, the foreground points in that cell will be displayed as the new color.

The Apple II has a similar problem due to the tricky way it selects colors in high-resolution mode. High-resolution graphics on the early Apple II have only two colors, plus black and white. It uses bit mapping of 7 bits out of each displayed byte. Later models have been modified to use the eighth bit in each byte to select two more colors by shifting the phase of the dots made by the other 7 bits. This means that the color-select bit in each byte determines which two colors are available for seven adjacent points. If a line happens to fall in the same seven-dot-wide region as one already plotted, with the color-select bit the other way, the color-select bit will get changed to match the new line. (See table 2.)

Which Method Is Best?

By now it shouldn't be surprising that I don't single out one personal computer as the best. It should also be obvious that my criticism of particular features of certain manufacturers' computers does not automatically disqualify them or imply that their competitors' machines are superior. Careful examination of newer computers is likely to reveal other peculiar features.

My explanations of these undocumented quirks are intended to show how published specifications fail to provide complete descriptions of these machines. The different approaches to graphics displays may result in similar specifications, but the displays may perform quite differently in a particular application. You should try to understand these differences so you can evaluate them in terms of your own needs and make your own judgments.

The most important graphics feature of a personal computer is simply having graphics. Of course, you can produce video displays that are adequate for some applications on a system that does not have any graphics features. For example, photo 3 shows a plot of a histogram produced by means of standard characters. Most of the ubiquitous *Star Trek* games also use this ap-

Model	Apple II	Compucolor II	TI-99/4
region height	1	4	8
region width	7	2	8
colors in region	4	2	2
colors available	6	8	16

Table 2: The color interaction characteristics of three popular microprocessor systems. The four colors in a seven-dot region on the Apple II are black, white, and one of the pairs: green and magenta or orange and blue. Any character-cell region in the Compucolor and Texas Instruments computers can have any two of the available colors, with black and white counted as colors.

proach, which might be called pseudographics. Still, such displays are limited both in information content and in visual appeal.

The personal computers I have mentioned all have at least some kind of block-graphics display. Photo 3 and photo 4 show the same histogram

HOLIDAY GREETINGS FROM JOHN D. OWENS ASSOCIATES

<p>TELETYPE Model 43 Inventory Sale!!!</p> <p>Model 4320, Friction or Pinfeed \$985.00 Model 4330 punch/reader. 10 or 30 CPS. 8 level, 1" tape \$2,595. Limited supply of Model 45 available.</p> <p>IBM 3101 CRT Model 10 \$1,195. Model 20 \$1,395. Selectric-like, detached keyboard. 9x16 dot matrix. Maintenance contract from IBM only \$70 per year.</p> <p>ITHACA INTERSYSTEMS</p> <p>Full S-100 IEEE Compatibility! Full 24 address bits. DMA disk controller. SYSTEM 2A includes 20 slot mainframe with front panel, 64K Dynamic RAM. Z80 CPU, 4 MHZ, extended addressing capability. 4 parallel, 2 serial I/O, floppy controller. Our discounted price \$3,236.</p> <p>MARINCHIP SYSTEMS M9900</p> <p>Elegant 16 bit CPU, S-100 compatible, multi user, multi processor operating system. BASIC, FORTH, META, PASCAL, Word processor, text editor</p> <p>CPU kit and software package \$ 550. Assembled \$ 700. Complete system, 64KB, two drives \$5,700.</p> <p>MICROANGELO \$2,280. High resolution graphics system. Microangelo features 15", 22MHZ, green phosphor screen, 72 key keyboard; includes complete cabling and software. From SCION. S-100 Graphics card \$960.</p> <p>GRAPHICS SOFTWARE</p> <p>On line, real time, for the M9900 to drive the Microangelo. For use in design of PC board masks, IC masks and other applications usually requiring a \$200,000 system.</p> <p>CORVUS HARD DRIVES</p> <p>We are the S-100 CORVUS dealer in the New York area. Demonstrations by appointment.</p> <p>MODEL 11, HARD DISK SYSTEM \$4,820. Mirror Backup System \$ 715. Host Multiplexer \$ 675.</p> <p>MULTI-BUS</p> <p>Z-8000 CPU and supporting boards. From Central Data Corp. Complete systems starting at \$6,500.</p>	<p>INDUSTRIAL MICRO SYSTEMS TELETYPE HAZELTINE IBM TELEVIDEO TEI TARBELL CORVUS PER SCI NEC ITHACA INTERSYSTEMS MARINCHIP DATA SOUTH QUME CENTRONICS TEXAS INSTRUMENTS ATARI DEC CALIFORNIA COMPUTER SYSTEMS KONAN EDGE TECHNOLOGY INNOTRONICS XEROX DIABLO INTEGRAL DATA SYSTEMS CROMEMCO SOROC MICROPRO TELETEK NOVATION AMPEX CDC NORTH STAR COMMODORE SCION MPI POWER ONE MEASUREMENT SYSTEMS AND CONTROL</p>
--	--

WE OFFER A FULL RANGE OF EXPERT CONSULTING SERVICES COVERING ALL AREAS OF COMPUTER APPLICATIONS AND SYSTEMS.

JOHN D. OWENS Associates, Inc.
SEE OUR AD ON FACING PAGE

displayed using pseudographics and low-resolution block graphics.

The next important feature of a graphics display is color. If you doubt the validity of that statement, ask yourself why, when television made the transition from black and white

to color, all the commercials were done in color long before all the programs were. Statistically speaking, you could say that a color display can convey three times as much information as a black-and-white display with comparable resolution. This

generalization fails to describe the impact that color provides. If your objective in having graphics on your computer is to enhance the effectiveness of your displays, then you are almost certain to find that color capability is worth the cost.

Next we come to the question of resolution, and here things get a little complicated. An inexpensive way to get high resolution is by means of special characters, but this method is not well suited for producing graphs of curves or other mathematical functions. You can directly compare the specifications of the other types of graphics systems, subcell and mapping, because these enable you to plot a curve as a series of points in ordinary rectangular coordinates. The higher the resolution, the smoother and more accurate these plots will be.

However, special-character graphics systems do not allow you to plot arbitrary curves in high resolution. Only predetermined shapes can be displayed, except on the Texas Instruments and Exidy machines with their programmable graphics characters. While it should be possible to write a program to dissect a curve into 8 by 8 graphics cells on these computers, it would be extremely tedious. This means that the resolution of a special-character system is not directly comparable with that of the other types. How important that is to you depends on your need to plot curves with your computer. It also demonstrates another way that specifications can be misleading if you look only at the numbers.

I hope that the information I have provided has not given you the idea that the graphics displays on all the current personal computers are unusable. I think it is very exciting that we can get so much graphics capability on such inexpensive machines. My objective in presenting this description has been to help you see the reasons behind their differences. If you can understand them, you will be able to figure out which type is most appropriate for making the kind of graphics displays you are interested in. ■

References

1. Lancaster, D. *TV Typewriter Cookbook*. Indianapolis IN: Howard W Sams & Co, 1976.
2. Schure, A. *Basic Television*, Revised Second Edition, Volume 6. Rochelle Park NJ: Hayden Book Co, 1975.
3. Watson III, A. "More Colors for Your Apple," *BYTE*, Volume 4, Number 6, June 1979, page 60.

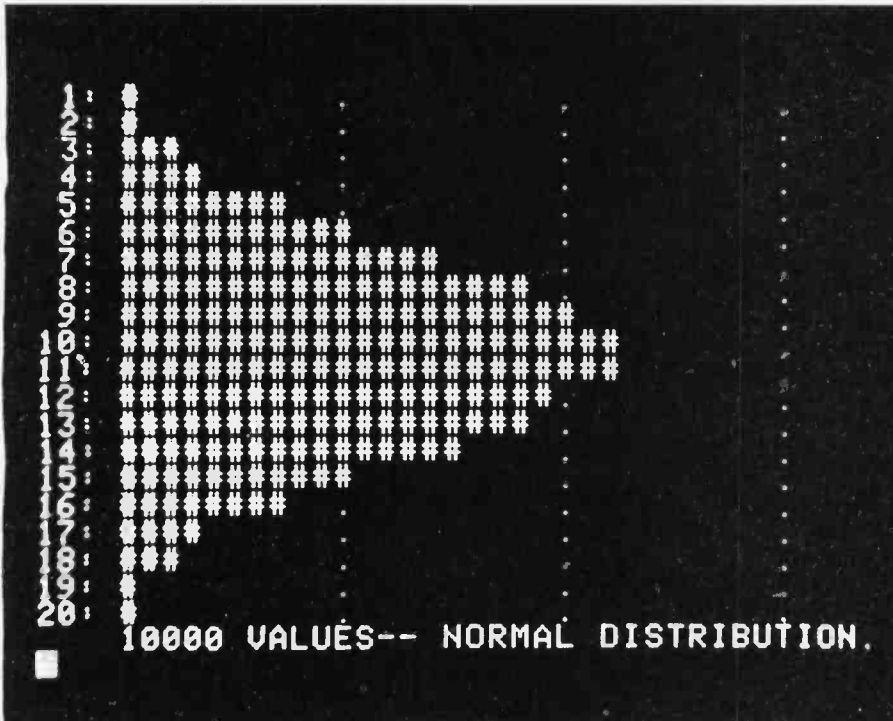

Photo 3: Pseudographics are created by using characters that are meant for viewing as standard text.

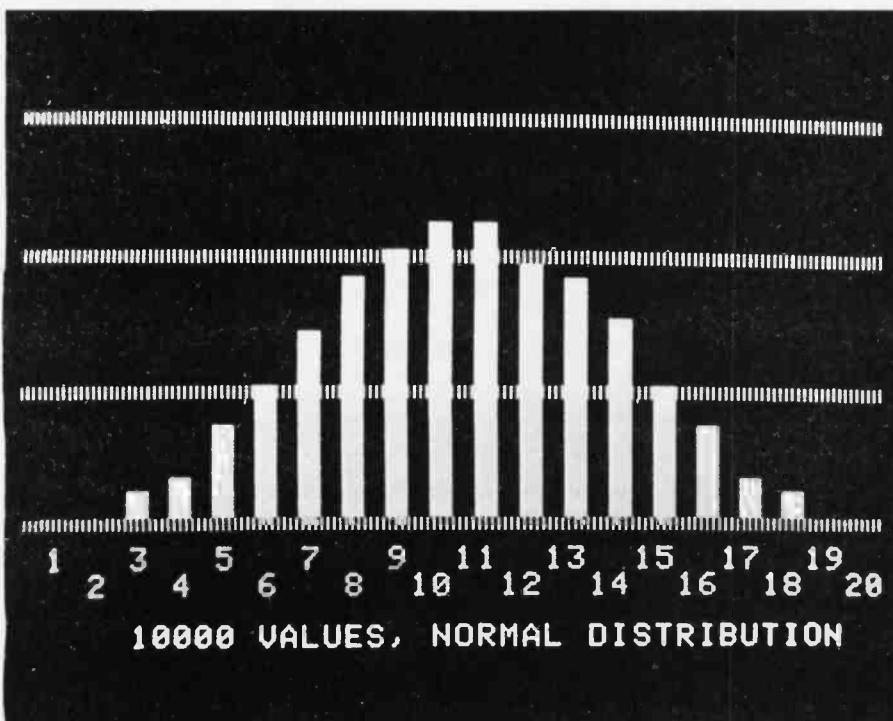

Photo 4: The same histogram shown in photo 3 is repeated here using subcell-block graphics on a 40 by 40 grid.

Suddenly, RCA makes talking to your computer a lot cheaper.

New interactive data terminal with color graphics—only \$369.*



RCA's new VP-3301 is a professional quality, ASCII encoded, interactive data terminal, suitable for a wide variety of industrial, educational, business and individual applications requiring interactive communication between computer and user. Connects directly to your computer or to a standard modem for over the phone access to time sharing networks and data bases. And it's compatible with networks such as those provided by CompuServe Information Services and Source Telecomputing Corp. Microprocessor intelligence and LSI video control integrated circuits bring performance, features and flexibility at a low price. Power supply included.

Unique color locking circuitry creates sharp, jitter free, true color graphics and rainbow free characters.

Displays the entire field of characters in any of 8 colors against any of 8 background colors (7 gray scales with monochrome monitors). Or to add special emphasis, you can display individual letters, words or lines in different colors or in reverse video.

The VP-3301 offers you a choice of two software-selectable display formats: Either 40 characters by 24 lines. Or 20 characters by 12 lines.

The terminal's resident character set consists of 52 upper and lower case alphabetic, 10 numerals, 32 punctuation/math symbols, and 31 control characters.

You can also define a total of 128 of your own characters. Including: Greek letters and other foreign alphabets, graphic symbols, large graphics building blocks, playing card suits, unique character fonts, and "little green men."

The keyboard section features flexible-membrane key switches with contact life rated at greater than five million operations. A finger positioning overlay and positive keypress action give good operator "feel".

An on-board sound generator and speaker provides aural feedback for key presses and may also be activated with escape sequences to provide an audio output.

The sealed keyboard surface is spill proof and dust proof. This combined with high noise immunity CMOS circuitry makes the VP-3301 ideal for hostile environments.

Output is industry standard asynchronous RS232C or 20 mA current loop with six switch selectable baud rates and 8 selectable data formats.

The terminal can be connected directly to a 525 line color or monochrome monitor. Or to a standard TV set using an Rf modulator.

For more information, contact RCA MicroComputer Marketing, New Holland Avenue, Lancaster, PA 17604.

Or call our toll-free number; 800-233-0094.

RCA

*Suggested user price.

On the Road to Adventure

Bob Liddil
The Programmer's Guild
POB 66
Peterborough NH 03458

Adventure! The very word brings forth visions of high intrigue and danger. The armchair adventures of the personal computer user can be every bit as exciting as the real thing, without the personal risk.

Adventure players are just as dedicated to their activity as are any of the many different types of gaming enthusiasts. They expect a high standard of excellence.

This article by no means claims to cover all there is to know about Adventure. [The capitalized word Adventure will be used to refer to this class of games as a wholeGW] What I will do is introduce the reader to the styles and procedures that have popularized Adventure to almost cult status and present the currently popular authors along with their works. Additionally, there will be tips on how to play Adventure without tearing your hair out and going totally crazy.

What Is Adventure?

Adventure is a semi-intelligent, word-recognizing computer program that employs a narrative style to present an unsolved puzzle. (For an example of an Adventure dialog, see listing 1.) The format of the game can be almost any organized grouping of locations that are bound together by a single theme. The clues to the puzzle are tied to the theme so that the game flows logically and smoothly. Solving the puzzle in whole or part leads to

About the Author

Bob Liddil is a freelance writer and is both game designer and president of The Programmer's Guild. He is interested in photography and noncomputer fantasy war-gaming, and his equipment includes a Radio Shack TRS-80 Model I computer with 48 K bytes of memory, two MPI disk drives, and a Centronics 730 printer.

the treasure or to valuable clues to the ultimate winning of the game. Some Adventures are goal oriented, while others rely on the accumulation of valuable objects.

The commands in Adventure affect four factors: where you are, what you see, where you can go, and what you can do.

Magic words are popular with some Adventure authors.

Your puppet, the narrator inside the program who resides in the world of your Adventure, can freely use the data provided by the computer to deliver your options to you. When you respond, the puppet executes your command and lives (or dies) through the consequences.

By paying careful attention to the information given you through the faculties of your puppet, you can move him freely through his environment. One mistake can cost you the game (and the puppet his life).

How to Play Adventure

Your puppet will do whatever you command if it is within his power. He is totally dependent on you for his sequence of action. He understands quite a vocabulary of two-word English sentences, but you must be careful because he takes your commands *literally*. Thus, a command to a puppet standing at the edge of a cliff to JUMP will cause the puppet to hurl himself into space, resulting in (depending on the author) consequences ranging from death to soft landing. A command of SHOOT HORSE in a western Adventure could leave you afoot.

GO, GET, LIFT, CARRY, PUSH,

KICK, SHOOT, ATTACK, KILL, FEED, LEAD, and DRINK are only a few of the many (usually more than one hundred) direct-action commands available to the player of Adventure. One Adventure by Scott Adams has a fully functional bathroom with a presumably anatomically correct puppet responding to the direct-action command USE !

EXAMINE always gets results, even when the response is a seemingly nonhelpful, I SEE NOTHING SPECIAL. This is still a clue in that it eliminates the object just examined from further consideration. Sometimes EXAMINE reveals something that you have overlooked. In a recent outer-space scenario, I carried a phaser pistol for almost an hour before remembering to examine it. When I did, I discovered that it had two settings, stun and destroy. I had been stumped, but now I destroyed a certain object and things fell logically into place. I was able to proceed with the game, following it to an entertaining and pleasant conclusion.

Movement commands are usually simplistic. In some Adventures, possible directions to take are displayed at the top of the screen with the title "OBVIOUS EXITS ARE:". These may not be your only options, however. Lost in a desert, with a road in sight (and the message YOU SEE: A ROAD, CACTUS, SAND displayed), you may have the additional movement-command options of GO ROAD, GO CACTUS, or GO SAND. These may produce such diverse results as YOU ARE ON A ROAD, YOU SEE: DESERT, MOUNTAINS, TOWN or OUCH ! I'M STUCK FULL OF PRICKLY PEAR NEEDLES or I'VE BEEN BITTEN BY A RATTLESNAKE, I'M DEAD.



• MODEL 800 • WITH SUNFLOWERS •

A NEW MASTERPIECE IN PRINTERS

The MODEL 800 MST is certainly pleasing to look at, but its true beauty lies beneath the surface. A glimpse at its features reveals why it is rapidly becoming the most sought after printer in the world

- Four standard interfaces:
RS-232 (15 baud rates)
Centronics compatible parallel
IEEE-488
20ma current loop
- Six line densities: 64, 72, 80, 96, 120, 132
- 100 CPS at all six densities
- Unidirectional or bidirectional printing
- Sixteen horizontal and ten vertical tabs
- Elongated characters in all six densities
- 1920 character buffer
- Uses either perforated or roll paper
- Fully adjustable tractors to 9½"
- Auto self-test
- Up to 10 character fonts
Standard 96 character ASCII
User defined character font
Provision for up to eight additional fonts
- Dot resolution graphics in six densities
- Variable line spacing control from 0 to 64 dots in half-dot increments
- Auto form-feed for any form length at any line spacing
- Heavy-duty all aluminum chassis
- 110vac or 220vac, 50/60Hz.
- 100 million character printhead
- Measures only 15" wide, 3" high, and 11" deep
- Weighs only 15 lbs.

. but maybe its most attractive feature is the price \$699.00.

base 2, inc.

P.O. BOX 3548 FULL., CAL. 92634 / (714) 992-4344

MTI stocks 'em all for faster delivery.

No hidden charges. Prices include delivery.
VISA and MasterCard orders accepted.

VIDEO TERMINALS

VT100 DECscope.....	\$ 1695
VT132 DECscope.....	2295
ADM-3A (dumb terminal)	*
ADM-3A+ (dumb terminal)	*
ADM-31 (2 page buffer)	*
ADM-42 (8 page buffer avail.)	*
1410 (Hazelintine dumb terminal)	825
1420 (dumb terminal)	895
1421 (Consul 580 & ADM-3A comp.)....	895
1500 (dumb terminal)	1045
1510 (buffered)	1145
1520 (buffered printer port)	1395
1552 (VT-52 compatible)	1350

300 BAUD TELEPRINTERS

LA34-DA DECwriter IV	1045
LA34-AA DECwriter IV	1295
Teletype 4310	1085
Teletype 4320	1225
Diablo 630 RO	2295
Diablo 1640 RO	3085
Diablo 1640 KSR	3285
Diablo 1650 RO	3185
Diablo 1650 KSR	3385
TI 743 (portable)	1190
TI 745 (portable/built-in coupler)	1585
TI 763 (portable/bubble memory)	2690
TI 765 (port/bubble mem/b-i coupler) ..	2895

600 BAUD TELEPRINTERS

TI 825 RO impact	1565
TI 825 KSR impact	1645
TI 825 RO Pkg.	1750
TI 825 KSR Pkg.	1895

1200 BAUD TELEPRINTERS

LA120-AA DECwriter III (forms pkg.) ..	2410
LA180 DECprinter I	2195
TI 783 (portable)	1745
TI 785 (port/built-in coupler)	2395
TI 787 (port/internal modem)	2845
TI 810 RO impact	1800
TI 810 RO Pkg.	2047
TI 820 KSR impact	2057
TI 820 KSR Pkg.	2275
TI 820 RO.....	1895
TI 820 RO Pkg.	2047

2400 BAUD

Dataproducts M200 (2400 baud)	2595
DATAPRODUCTS LINE PRINTERS	
B300 (300LPM band)	5535
B600 (600LPM band)	6861
2230 (300LPM drum)	7723
2260 (600LPM drum)	9614
2290 (900LPM drum)	12655

ACOUSTIC COUPLERS

A/J A242-A (300 baud orig.)	242
A/J 247 (300 baud orig.)	315
A/J AD342 (300 baud orig./ans.)	395
A/J 1234 (Vadic compatible)	895
A/J 1245 (300/1200 Bell comp.)	895

MODEMS

GDC 103A3 (300 baud Bell)	395
GDC 202S/T (1200 baud Bell)	565
GDC 212-A (300/1200 baud Bell)	850
A/J 1256 (Vadic compatible)	825

CASSETTE STORAGE SYSTEMS

Techtran 816 (store/forward)	1050
Techtran 817 (store/for/speed up)	1295
Techtran 818 (editing)	1795
Techtran 822 (dual)	2295
MFE 5000 (editing)	1495

FLOPPY DISK SYSTEMS

Techtran 950 (store/forward)	1395
Techtran 951 (editing)	1995

*Please call for quote.



Applications Specialists & Distributors
Great Neck, New York/Cleveland, Ohio.

N.Y.: 516/482-3500 & 212/895-7177
800/645-8016 Ohio: 216/464-6633

Listing 1: Sample dialog from an Adventure. These three screens are from *Lost Dutchman's Gold*, an Adventure from *The Programmer's Guild*. The questions and long replies are by the Adventure program. The two-word replies at the end of each indented line are the player's command. Although the format will vary from Adventure to Adventure, each one will tell you something about your immediate surroundings. In this Adventure, the information above the heavy lines is rewritten after each command. In other words, the legend **DEAD BURDENBEAST** at the top of the last screen is displayed only after the command **SHOOT BURDENBEAST** (at the bottom of the screen) is given.

YOU ARE IN A SMALL CAMP. YOU SEE :
CARRYSACKS. UNTIED BURDENBEAST. LEATHER PIECE. CAMPFIRE.

OBVIOUS EXITS ARE : WEST NORTH SOUTH EAST

WHAT DO YOU WANT TO DO NOW? GET BURDENBEAST
? YOU HAVE NOT THE STRENGTH TO DO THAT, SIR KNIGHT.
WHAT DO YOU WANT TO DO NOW? EXAMINE CAMPFIRE
THERE'S SOMETHIN' HERE !!

WHAT DO YOU WANT TO DO NOW? EXAMINE BURDENBEAST
YOU SEE A FLOP-EARED ILL TEMPERED QUADRAPEDAL ANIMAL.
WHAT DO YOU WANT TO DO NOW? DROP CARRYSACKS

OK

YOU ARE IN A SMALL CAMP. YOU SEE :
UNTIED BURDENBEAST. LEATHER PIECE. CAMPFIRE.

OBVIOUS EXITS ARE : WEST NORTH SOUTH EAST

WHAT DO YOU WANT TO DO NOW? EXAMINE CARRYSACKS
IT IS A WELL WORN DOUBLE CARRYSACK
IT APPEARS TO HAVE SOMETHING IN IT,
MAYBE YOU SHOULD GET IT.

WHAT DO YOU WANT TO DO NOW? GET CARRYSACKS

OK

WHAT DO YOU WANT TO DO NOW? OPEN CARRYSACK

OK

YOU ARE IN A SMALL CAMP. YOU SEE :
DEAD BURDENBEAST. LEATHER PIECE. CAMPFIRE.

OBVIOUS EXITS ARE : WEST NORTH SOUTH EAST

MAYBE THE BURDENSEAST HASN'T BEEN FED RECENTLY
WHAT DO YOU WANT TO DO NOW? FEED BURDENBEAST
YOU'RE TOO SLOW, HE GOT AWAY.

WHAT DO YOU WANT TO DO NOW? GET HANDWEAPON

OK

WHAT DO YOU WANT TO DO NOW? SHOOT BURDENBEAST
WITH WHAT? HANDWEAPON

OK

Not that you shouldn't try all available options—there could just as easily be a treasure or a clue behind that cactus or in that underbrush. Things can often be examined from a distance. If not, a curt **YOU CAN'T DO THAT YET** will appear on the screen, followed by a nasty electronic snicker from deep within your computer. Generally, when the word **YET** appears in a message, you know you are on the right track.

Magic words or teleportation phrases are popular with some Adventure authors. **SAY** the magic word and the whole world spins around, taking you elsewhere or elsewhen.

This is a convenient way to travel, but it can be a two-edged sword that might land your puppet in never-never land for an indefinite stay. There are at least two Adventures in which teleportation phrases are employed (with pitfalls in both). A third accepts an incantation from another Adventure; however, the response is instant death.

CLIMB is a word you can use to get somewhere when saying a magic word does not teleport you. If you are carrying an object, you may have to drop it to proceed with climbing. Generally, what can be climbed into can be climbed out of. Don't be afraid

Say Ahh...

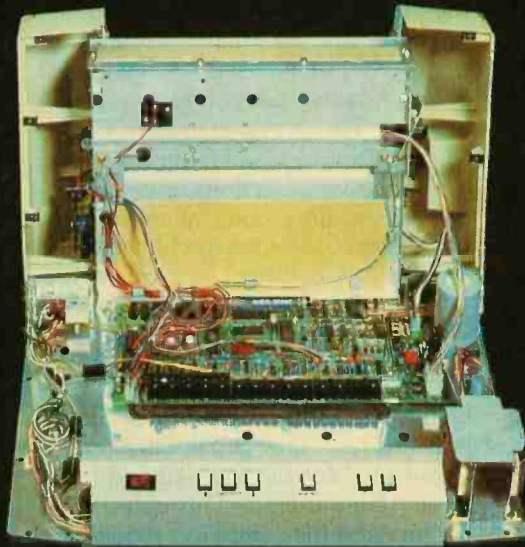

Our New grafixPLUS™ 80-column printer opens wide for easy servicing.

Introducing the newest members of our grafixPLUS™ family—the DP-9000 Series 80/132 column printers—built on the same tradition of quality printout, solid design and low cost of ownership established by our 132/220 column DP-9500 Series.

A Case for Serviceability

Not that it comes up often, but want to get inside? Simple. Just remove a few screws and the clam-shell case swings open exposing all major components. This easy access plus built-in self-test and minimum component count yields an MTTR of one-half hour. The 9-wire print head replacement's even simpler... two screws and it's out. Without opening the case. And without a service call.

Performance Plus

The DP-9000 Series prints the full ASCII 96 character set, including descenders and underlining, bi-directionally, at up to 200 CPS. Number of columns can go up to 80 or 132, depending on character density—switch or data source selectable from 10 to 16.7 characters per inch. And all characters can be printed double width. The print head produces razor-sharp characters and high-density graphics with dot resolutions of 72X75 dots/inch under direct data source control.

Interface Flexibility

The three ASCII compatible interfaces (parallel, RS-232-C and current loop) are standard, so connecting your computer is usually a matter of plug-

in and print. Also standard are: a sophisticated communications interface for printer control and full point-to-point communications, DEC PROTOCOL, and a 700 character FIFO buffer. An additional 2K buffer is optional.

When you're ready for a printer (or several thousand), look into the grafixPLUS DP-9000 Series from Anadex—you'll find an open and shut case for quality. Contact us today for details, discounts and demonstrations.

 **Anadex**
...the plus in printers



...close please.

SALES OFFICES: San Jose, CA (408) 247-3933
Fullerton, CA (714) 871-0501 • Wakefield, MA (617) 245-9160 • Austin, TX (512) 327-5250

ANADEX, INC. • 9825 DeSoto Avenue • Chatsworth, California 91311, U.S.A. • Telephone: (213) 998-8010 • TWX 910-494-2761
ANADEX, LTD. • Dorna House, Guildford Road • West End, Woking, Surrey GU24 9PW, England • Tel: Chobham (09905) 6333 • Telex: 858762 ANADEX G

to go into tight places; they can provide clues to your game.

Logic is your best friend in playing Adventure. Approach a situation with a careful eye for detail. Going into a room and drinking from a bottle without examining it (using the words GO, DRINK, and EXAMINE) can result in your puppet being poisoned. In real life you would never imbibe without looking at a label; why kill off your puppet needlessly? The same reasoning applies to any phase of your Adventure. Apply common sense and you will win every time.

On the other hand, the author of your Adventure, while bound by the laws of order and fair play, is not above puns, a little chicanery, or out-and-out silliness. Watch for double meanings in the author's choice of words; he will fool you, if he can, with painfully obvious clues.

The HELP, SCORE, and INVENTORY commands are always explained in the openings of the programs. They accomplish what their names imply.

Adventures are tremendous fun, but you must stay alert and ask the

right questions: What do I see? Where can I go? What is the easiest way to get there? What can I do where I am? These questions can help you solve the puzzle and win the game.

There are six main vendors of microcomputer-based Adventures: Scott Adams, Greg Hassett, Radio Shack, The Programmer's Guild, Microsoft, and Mad Hatter Software. The following sections give a synopsis (revealing none of the secrets, however) of their product lines at the time of this writing.

Scott Adams Adventures

Twenty-eight-year-old Scott Adams is generally credited with being the father of microcomputer Adventures. The game began as a "head toy" for the PDP-10 and other large computers. Through Scott Adams and his company, Adventure International, it soon found its way into the 16 K-byte TRS-80 heartland of America. Here is a list of his Adventures:

- *Adventureland* is a lighthearted little trip into the countryside. This first effort was written in BASIC, then changed to machine language. It

is a good beginning point for the novice since it is not too complicated. There are a bog and a lake and numerous other natural features to keep things lively. This is an Adventure that uses a magic word.

- *Pirate's Cove* is rated as a classic. Its smooth storytelling style quickly sets the standard for all Adventures to follow. There are four basic locations: a flat in London, an island, a Treasure Island, and never-neverland. The wild and wacky characters that populate this game only enhance it. A pirate, a mongoose, a parrot, and assorted other beasties give this Adventure a delightfully humorous effect.

- *Mystery Fun House* is an excursion into the madcap world of a carnival funhouse. It includes passing a gatekeeper and exploring multiple corridors. You must find a variety of objects within the funhouse and get out within the time limit. This one is a real brain teaser.

- *Mission: Impossible* pits you against unknown enemies in a race to stop a nuclear reactor from being destroyed. To complicate matters, there is a bomb planted in your head. This one is pretty tough to solve and is an absolute must for those whose Adventure skills have become well honed.

- *Strange Odyssey* is one of the best of this series. You are alone on a strange planetoid with only a broken spaceship and your wits. There is a rock with alien runes on it. If you solve the mystery of gaining entrance, a stargate to brave new worlds with treasures awaits you. Manipulation of objects with alien environments plays an important role in the solution of this puzzle.

- *The Count* is an Adventure that will leave your blood cold as you attempt to rid the world of Count Dracula once and for all. You must race against time to beat the sunset, find the Count in his humanoid form, and overcome his powers to drive the stake home. As for your motivation, there is an angry crowd preventing you from shirking your duty. A sub-puzzle of this Adventure, deciphering the hallways, will keep you occupied for hours.

- *Voodoo Castle* is a weird Adventure. It seems that Count Christo has been cursed, and you are the only one who can save him. Starting off in a chapel, you must explore the stony

Clipper™



LINE VOLTAGE TRANSIENT CLIPPING

Features Parallel Operation 5000 Hits/Second

PROTECTS: <ul style="list-style-type: none">• Computers• Micro-Computer Systems• Word Processors• Cash Registers• Power Supplies	PROTECTS AGAINST: <ul style="list-style-type: none">• High Energy Voltage Transients• On-Off Switching• Lightning Induced Transients• Inrush of On/Off Power
---	--

MFD. by Energy Electronic Systems, Inc.

Exclusively for:



DISTRIBUTORS
INCORPORATED



TRANSIENT VOLTAGE
SURGE SUPPRESSOR LISTED

**7133 RUTHERFORD ROAD
BALTIMORE, MARYLAND 21207
(301) 298-3130**

H & E COMPUTRONICS INC.

...EVERYTHING FOR YOUR TRS-80™...
TRS-80 is a trademark of the Radio Shack Division of Tandy Corporation

1980 INCOME TAX PAC

Completely Revised ★ Latest Tax Tables ★ Fully Tested ★ Complete Manual and Documentation
★ ★ The New Version Of The Income Tax Pacs Are Full Of Error Catching Codes ★ ★
★ ★ Making It Impossible To Make An Error ★ ★
— Follow The Simple Step By Step Procedure That Makes Tax Preparation Simple —

★ INCOME TAX PAC A

FOR LEVEL II 16K

- DOES FORM 1040 and 1040A
- SCHEDULE A ITEMIZED DEDUCTIONS
- SCHEDULE B INTEREST and DIVIDENDS
- OUTPUT TO VIDEO DISPLAY
- SCHEDULE C TAX COMPUTATION

★ INCOME TAX PAC B

FOR LEVEL II with or without Printer, Cassette or Disk. Has all features of Income Tax A PLUS,

- WORKS WITH LINE PRINTER
- FORMATS FORM 1040 and 1040A FOR TRACTOR FEED FORMS
- SCHEDULE C INCOME FROM A PERSONALLY OWNED BUSINESS
- FORM 2106 EMPLOYEE BUSINESS EXPENSE

- FORM 1040 (LONG FORM)
- FORM 1040A (SHORT FORM)
- FORM 2106 EMPLOYEE BUSINESS EXPENSE
- FORM 2440 DISABILITY INCOME EXCLUSION
- FORM 2441 CREDIT FOR CHILD AND DEPENDENT CARE EXPENSES
- FORMS 3903 MOVING EXPENSE ADJUSTMENT
- FORM 4797 SUPPLEMENTAL SCHEDULE OF GAINS AND LOSSES

★ ★ PROFESSIONAL ★ ★ INCOME TAX PAC C

- SCHEDULE A ITEMIZED DEDUCTIONS
- SCHEDULE B INTEREST AND DIVIDENDS
- SCHEDULE C PROFIT (OR LOSS) FROM BUSINESS OR PROFESSION
- SCHEDULE D CAPITAL GAINS AND LOSSES
- SCHEDULE E SUPPLEMENTAL INCOME SCHEDULE
- SCHEDULE G INCOME AVERAGING
- SCHEDULES R & RP-CREDIT FOR THE ELDERLY

FOR MODEL I (32K) or MODEL II (64K)
WITH 1 OR MORE
DISK DRIVES

- SCHEDULE SE-COMPUTATION OF SOCIAL SECURITY SELF-EMPLOYMENT TAX
- SCHEDULE TC TAX COMPUTATION
- OUTPUT TO VIDEO OR LINE PRINTER
- FORMATS FOR TRACTOR FEED OR INDIVIDUAL FORM FEED PRINTERS
- AUTOMATIC MEMORY STORAGE FOR INCOME TAX PREPARERS
- INSTANT LINE CHANGE
- BUILT IN ERROR CHECKING

ALL SPECIFICATIONS SUBJECT TO CHANGE

COMPUTRONICS

50 N. PASCACK ROAD
SPRING VALLEY, NEW YORK 10977

PLEASE SEND ME:

- INCOME TAX PAC A (\$19 95)
- INCOME TAX PAC B (\$49 95)
- PROFESSIONAL INCOME TAX PAC C (\$99 95)
- MODEL II PROFESSIONAL INCOME TAX PAC C (\$199 95)

NEW TOLL-FREE
ORDER LINE
(OUTSIDE OF N.Y. STATE)
(800) 431-2818

★ A COMPLETE LINE OF NELCO TAX FORMS ARE AVAILABLE

- INDIVIDUAL FEDERAL and STATE FORMS
- 2 OR MORE PART FORMS
- TRACTOR FEED FORMS
- PLASTIC OVERLAYS

- ★ All orders processed within 24-Hours
- ★ 30-Day money back guarantee on all Software
- ★ Add \$2.00 for shipping in UPS Areas
- ★ Add \$3.00 for C.O.D. or NON-UPS Areas
- ★ Add \$4.00 outside U.S.A., Canada & Mexico

CREDIT CARD NUMBER _____ EXP DATE _____

SIGNATURE _____

NAME _____

STREET _____

CITY _____ STATE _____ ZIP _____



24 HOUR
ORDER
LINE
(914) 425-1535



No. 17½ Software with full support

Purchasing our software is just the beginning. We then back it up with professional support:

- Subscription to "LIFELINES" for automatic notifications of revisions! ■ Update service for software and documentation! ■ Telephone Hotline! ■ Overseas software export service!

Genuine CP/M for Apple II Available now!

CP/M* FLOPPY DISK OPERATING SYSTEM—Digital Research's operating system configured for many popular micro-computers and disk systems:
System Version Price
Apple II* 2.x .. 349/NA
SoftCard* with Z80
Microsoft BASIC version 5 with high resolution graphics
North Star Single Density 2.x .. 170/25
North Star Double/Quad 2.x .. 170/25
Durango F-85 2.x .. 170/25
ICOM Micro-Disk 2411 1.4 145/25
ICOM 3712 for MITS 88-3710 Console 1.4 170/25
ICOM 3712 for 3P1S/MITS SIO

New

DISILOG—As DISTEL to Zilog/Mositek mnemonic files \$65/\$10
SMAL/80 Structured Macro Assembler
Language—Package of powerful general purpose text macro processor and SMAL structured language compiler. SMAL is an assembler language with IF-THEN-ELSE, LOOP-REPEAT-WHILE, DO-END, BEGIN-END constructs. Not compatible with CP/M version 2 or greater. \$75/\$15

PHOENIX SOFTWARE ASSOCIATES

PASM*—Z80 macro assembler, Intel/TDL mnemonics. Generates Intel hex format or relocatable code in either TD Object Module format or PSA Relocatable Binary Module format. Supports text insertion, conditional branching within macros, recursive macro calls and parameter passing. \$129/\$25

EDIT—Character oriented text file editor. Includes macro definition capabilities. Handles insertion, deletion, searching, block move, etc. for files of any length. Does not require a CRT. \$129/\$25

PLINK*—Two pass disk-to-disk linkage editor/loader which can produce re-entrant, ROMable code. Can link programs that are larger than available memory for execution targeted on another machine. Full library capabilities. Input can be PSA Relocatable Binary Module, TD Object Module or Microsoft REL files. Output can be a COM file, Intel hex file, TDL Object Module or PSA Relocatable file. \$129/\$25

BUG* and µBUG*—Z80 interactive machine level debugging tools for program development. BUG has full symbolic trace and interactive assembly (mnemonics compatible with PASM). Dynamic breakpoints and conditional traps while tracing (even through ROM!). µBUG is a subset of BUG and is used in memory limited situations. \$129/\$25

DIGITAL RESEARCH

MP/M—Installed for single density MDS-800. Multi-processing derivative of the CP/M operating system. Manual includes CP/M2 documentation. \$300/\$50

MAC—8080 Macro assembler. Full Intel macro definitions. Pseudo Ops include RPC, IRP, REPT, TITLE, PAGE, and MACLIB. Produces absolute hex output plus symbol table file for use by SID and ZSID (see below). \$120/\$15

SID—8080 Symbolic debugger. Full trace, pass count and breakpoint program testing. Has backtrace and histogram utilities. When used with MAC, provides full symbolic display of memory labels and equated values. \$105/\$15

ZSID—Z80 Symbolic debugger with all features of SID. \$130/\$15

TEX—Text output formatter to create paginated, page-numbered and justified copy. Output can be directed to printer or disk. \$105/\$15

DESPOOL—Utility program to permit simultaneous printing from text files while executing other programs. \$80/\$10

tiny C—Interactive interpretive system for teaching structured programming techniques. Manual includes full source listings. \$105/\$50

BDS C COMPILER—Supports structures, unions, 2 dimensional arrays, pointers, recursion and overlays. Features optimized code generator, variable sized buffers for file I/O, and capability to produce ROMable code. Includes macro package to enable user to produce linkable modules with MAC (see under Digital Research). Floating point functions, full run-time package and machine code library sources provided. Linker, library manager and textbook included. Compiler lacks initializers, statics, floats and longs. \$145/\$25

New

New

New

Rev non-zero console 1.4 170/25
ICOM 3812 1.4 170/25
ICOM 4511/Perlec D3000 2.x 375/25
Mits 3202/Altair 8800 1.4 145/25
Health H8 - H17 1.4 145/25
Health H89 1.4 145/25
Health H89 by Magnolia 2.x 250/25
Ohio Scientific C3 2.x 200/25
Onyx C8001 Standard 2.x 250/25
Onyx CB001 Enhanced 2.x 330/25
TRS-80 Model I 1.4 145/25
TRS-80 Model II 2.x 170/25
TRS-80 Model II - Corvus 2.x 250/25
Processor Technology
Helios II 1.4 145/25
Intel MDS Single Density 2.x 170/25
Intel MDS Double Density 2.x 170/25
Micropolis Mod I 2.x 200/25
Micropolis Mod II 2.x 200/25
Mositek MDX STD
Bus System 2.x 350/25
The following configurations are scheduled for release soon:
North Star Double/Quad
Corvus 2.x 250/25
Ohio Scientific C3-C 2.x 250/25
ICOM 3812 2.x 225/25
ICOM 4511/Perlec D3000 2.x 375/25

Software consists of the operating system, text editor, assembler, debugger and other utilities for file management and system maintenance. Complete set of Digital Research's documentation and additional implementation notes included. Systems marked * and ** include firmware on 2708 and 2716. Systems marked + include 5440 media charge. Systems marked Ⓢ require the special Ⓢ versions of software in this catalog. ⊕ includes hardware addition to allow our standard versions of software to run under it.

Z80 DEVELOPMENT PACKAGE—Consists of: (1) disk file editor, with global Inter and Intra-line facilities; (2) Z80 relocating assembler, Zilog/Mositek mnemonics, conditional assembly and cross reference table capabilities; (3) linking loader producing absolute Intel hex disk file. \$95/\$20

ZDT—Z80 Monitor Debugger to break and examine registers with standard Zilog/Mositek mnemonic disassembly displays. \$35 when ordered with Z80 Development Package. \$50/\$10

AVOCET SYSTEMS

XASM-68—Non-macro cross-assembler with nested conditionals and full range of pseudo operators. Assembles from standard Motorola MC6800 mnemonics to Intel hex. \$200/\$25

XASM-65—As XASM-68 for MOS Technology MCS-6500 series mnemonics. \$200/\$25

XASM-48—As XASM-68 for Intel MCS-48 and UPI-41 families. \$200/\$25

XASM-18—As XASM-68 for RCA 1802. \$200/\$25

DISTEL—Disk based disassembler to Intel 8080 or TDL/XTian Z80 source code, listing and cross reference files. Intel or TDL/XTian pseudo ops optional. Runs on 8080. \$65/\$10

WHITESMITHS C COMPILER—The ultimate in systems software tools. Produces faster code than a pseudo-code Pascal with more extensive facilities. Conforms to the full UNIX Version 7 C language, described by Kernighan and Ritchie, and makes available over 75 functions for performing I/O, string manipulation and storage allocation. Linkable to Microsoft REL files. Requires 80K CP/M. \$630/\$30

MICROSOFT

BASIC-80—Disk Extended BASIC, ANSI compatible with long variable names. WHILE/WEND chaining, variable length file records. MBASIC version 4.51 also included on disk. \$325/\$25

BASIC COMPILER—Language compatible with BASIC-80 and 3-10 times faster execution. Produces standard Microsoft relocatable binary output. Includes MACRO-80. Also linkable to FORTRAN-80 or COBOL-80 code modules. \$350/\$25

FORTRAN-80—ANSI 66 (except for COM-PLEX) plus many extensions. Includes relocatable object compiler, linking loader, library with manager. Also includes MACRO-80 (see below). \$425/\$25

COBOL-80—Level I ANSI '74 standard plus most of Level 2. Full sequential, relative, and indexed file support with variable file names. Powerful interactive, formatted screen handling with ACCEPT and DISPLAY verbs. Program segmentation for execution of programs larger than memory and CHAIN command with parameter passing. Full support of CP/M version 2 files. Includes MACRO-80 (see above), linking loader, and relocatable library manager. Requires 48K CP/M. \$700/\$25

MACRO-80—8080/Z80 Macro Assembler. Intel and Zilog mnemonics supported. Relocatable binary output. Loader, Library Manager and Cross Reference List utilities included. \$149/\$15

MACRO-86—8086 cross assembler. All Macro and utility features of MACRO-80 package. Mnemonics slightly modified from Intel ASM86. Compatibility data sheet available. \$275/\$25

EDIT-80—Very fast random access text editor for text with or without line numbers. Global and intra-line commands supported. File compare utility included. \$89/\$15

PASCAL/M—Compiles enhanced Standard Pascal to compressed efficient Pcode. Totally CP/M compatible. Random access files. Both 16 and 32-bit integers. Runtime error recovery. Convenient STRINGS, OTHERWISE clause on CASE. Comprehensive manual (90 pp. indexed). SEGMENT provides overlay structure. IMPORT, EXPORT and untyped files for arbitrary I/O. Requires 56K CP/M. Spectry 1) 8080 CP/M, 2) Z80 CP/M, or 3) Cromemco CDSOS. \$175/\$20

PASCAL/Z—Z80 native code PASCAL compiler. Produces optimized, ROMable re-entrant code. All interfacing to CP/M is through the source library. The package includes compiler, relocating assembler and linker, and source for all library modules. Variant records, strings and direct I/O are supported. Requires 56K CP/M. \$395/\$25

PASCAL/MT—Subset of standard PASCAL. Generates ROMable 8080 machine code. Symbolic debugger included. Supports interrupt procedures, CP/M file I/O and assembly language interface. Real variables can be BCD, software floating point, or AMD 9511 hardware floating point. Includes strings enumerations and record data types. Manual explains BASIC-PASCAL conversion. Requires 32K. \$250/\$30

APL/V80—Concise and powerful language for application software development. Complex programming problems are reduced to simple expressions in APL. Features include up to 27K active workspace, shared variables, arrays of up to 8 dimensions, disk workspace and copy object language. The system also supports auxiliary processors for interfacing I/O ports. Requires 48K CP/M and serial APL printer terminal or CRT. \$500/\$30

ALGOL-60—Powerful block-structured language compiler featuring economical run-time dynamic allocation of memory. Very compact (24K total RAM) system implementing almost all Algol 60 report features plus many powerful extensions including string handling direct address I/O etc. \$199/\$20

CBASIC-2 Disk Extended BASIC—Non-interactive BASIC with pseudo-code compiler and run-time interpreter. Supports full file control, chaining, integer and extended precision variables, etc. Versions of CRUN for CP/M versions 1.4 and 2.x included on disk. \$120/\$15

MICROFOCUS

STANDARD CIS COBOL—ANSI '74 COBOL standard compiler fully validated by U.S. Navy tests to ANSI level 1. Supports many features to level 2 including dynamic loading of COBOL modules and a full ISAM file facility. Also, program segmentation, interactive debug and powerful interactive extensions to support protected and unprotected CRT screen formatting from COBOL programs used with any dumb terminal. \$850/\$50

FORMS 2—CRT screen editor. Output is COBOL data descriptions for copying into CIS COBOL programs. Automatically creates a query and update program of input files using CRT protected and unprotected screen formats. No programming experience needed. Output program directly compiled by STANDARD CIS COBOL. \$200/\$20

NEVADA COBOL—Subset of ANSI-74. Features fast compilation and execution with small object modules. Has extended arithmetic with 18 digit accuracy. Extended I/O includes random access files and sequential files of both fixed and variable length records, and interactive accept/display verbs. Good error messages and debugging facilities enhance program development. Requires a 32K CP/M system. \$149/\$25

EIDOS SYSTEMS

KBASIC—Microsoft Disk Extended BASIC version 4.51 integrated with KISS Multi-Keyed Index Sequential and Direct Access file management as 9 additional BASIC commands. KISS included as relocatable modules linkable to FORTRAN-80, COBOL-80, and BASIC COMPILER. Specify CP/M version 1.4 or 2.x when ordering. Requires 48K CP/M \$585/\$45. To licensed users of Microsoft BASIC-80 (MBASIC) \$435/\$45

YXBASIC Interactive Process Control BASIC—Full disk BASIC features plus unique commands to handle byte rotate and shift and to test and set bits. Available in several versions:
Integer ROM required \$350/\$25
Integer CP/M \$350/\$25
Extended ROM required \$450/\$25
Extended CP/M \$450/\$25
Extended Disk CP/M \$550/\$25
Integer CP/M Run Time Compiler \$350/\$25
Extended CP/M Run Time Compiler \$450/\$25

RECLAIM—A utility to validate media under CP/M. Program tests a diskette or hard disk surface for errors, reserving the imperfections in invisible files, and permitting continued usage of the remainder. Essential for any hard disk. Requires CP/M version 2. \$80/\$5

BASIC UTILITY DISK—Consists of: (1) CRUNCH-14—Compacting utility to reduce the size and increase the speed of programs in Microsoft BASIC 4.51, BASIC-80 and TRS-80 BASIC. (2) DPFLN—Double precision subroutines for computing nineteen transcendental functions including square root, natural log, log base 10, sine, arc sine, hyperbolic sine, hyperbolic arc sine, etc. Furnished in source on diskette and documentation. \$50/\$35

STRING/80—Character string handling plus routines for direct CP/M BDOS calls from FORTRAN and other compatible Microsoft languages. The utility library contains routines that enable programs to chain to a COM file, retrieve command line parameters and search file directories with full wild card facilities. Supplied as linkable modules in Microsoft format. \$95/\$20

STRING/80 source code available separately. \$295/NA

THE STRING BIT—FORTRAN character string handling Routines to find, fill, pack, move, separate, concatenate and compare character strings. This package completely eliminates the problems associated with character string handling in FORTRAN. Supplied with source. \$65/\$15

VSORT—Versatile sort/merge system for fixed length records with fixed or variable length files. VSORT can be used as a stand-alone package or loaded and called as a subroutine from CBASIC 2. When used as a subroutine, VSORT maximizes the use of buffer space by saving the TPA on disk and restoring it on completion of sorting. Records may be up to 255 bytes long with a maximum of 5 fields. Upper/lower case translation and numeric fields supported. \$175/\$20

CPM/374X—Has full range of functions to create or re-name an IBM 3741 volume, display directory information and edit the data set contents. Provides full file transfer facilities between 3741 volume data sets and CP/M files. \$195/\$10

Coming Soon

CPAIDS*

MASTER TAX—Professional tax preparation program. Prepares schedules A, B, C, D, E, F, G, R/RP, SE, TC, ES and forms 2106, 2119, 2210, 3468, 3903, 2441, 4625, 4726, 4797, 4972, 5695 and 6251. Printing can be on readily available, pre-printed continuous forms, on overlays, or on computer generated, IRS approved forms. Maintains client history files and is interactive with CPAIDS GENERAL LEDGER (see below). \$995/\$30 Annual Update Fee \$350

STANDARD TAX—As above for schedules A, B, C, D, E, G, R/RP, SE, TC and forms 2106 and 2441. Also, does not maintain client history files. \$495/\$30 Annual Update Fee \$175

GENERAL LEDGER II—Designed for CPAs. Stores complete 12 month detailed history of transactions. Generates financial statements, depreciation, loan amortizations, journals, trial balances, statements of changes in financial position, and compilation letters. Includes payroll system with automatic posting to general ledger, Prints payroll register, W2's and payroll checks. \$450/\$30

Lifeboat Associates, 1651 Third Avenue, N.Y., N.Y. 10028
(212) 860-0300 International Telex: 220501, Domestic Telex: 64093

Neu in der Schweiz Lifeboat Associates GmbH,

Aegerstr. 35. 6340 Baar Telefon 042/31 2931

Copyright © 1980 Lifeboat Associates. No portion of this advertisement may be reproduced without prior permission.

NEW T/MAKER—Powerful new tool for preparing management reports with tabular data. Makes financial modeling projects easy. Do you want a weekly profitability report? Set up the table and compute. Just change the sales figures for next week and compute. You have a new report!

MAGIC WAND—Word processing system with simple, easy to use full screen text editor and powerful print processor. Editor has all standard editing functions including text insert and delete, global search and replace, block move and library files for boiler plate text.

ANALYST—Customized data entry and reporting system. User specifies up to 75 data items per record. Interactive data entry, retrieval, and update facility makes information management easy.

THE C PROGRAMMING LANGUAGE—By Kernighan and Ritchie. The standard textbook on the language. Recommended for use by BDS C, tiny C, and Whittom's C users. \$12

STRUCTURED MICROPROCESSOR PROGRAMMING—By the authors of SMAL/80. Covers structured programming, the 8080/8085 instruction set and the SMAL/80 language. \$20

ACCOUNTS PAYABLE & ACCOUNTS RECEIVABLE-CBASIC book by Osborne/McGraw-Hill. \$20

GENERAL LEDGER-CBASIC book by Osborne/McGraw-Hill. \$20

PAYROLL WITH COST ACCOUNTING-CBASIC book by Osborne/McGraw-Hill. \$20

BSTAM—Utility to link one computer to another also equipped with BSTAM. Allows file transfers at full data speed (no conversion to hex), with CRC block control check for very reliable error detection and automatic retry. Use it! It's great! Full wildcard expansion to send *.COM, etc. 9600 baud with wire. 300 baud with phone connection. Both ends need one. Standard and versions can talk to one another. This software requires a knowledge of assembler language for installation. \$150/\$10

TEXTWRITER III—Text formatter to justify and paginate letters and other documents. Special features include insertion of text during execution from other disk files or console, permitting recipe documents to be created from linked fragments on other files. Has facilities for sorted index, table of contents and footnote insertions. Ideal for contracts, manuals, etc. Now compatible with Electric Pencil and Word-Star prepared files. \$125/\$20

LETTERRIGHT—Program to create, edit and type letters or other documents. Has facilities to enter, display, delete and move text, with good video screen presentation. Integrates with NAD for form letter mailings. \$200/\$25

NAD—Name and Address selection system. Interactive mail list creation and maintenance program with output as full reports with reference data or restricted information for mail labels. System for extraction and transfer of selected records to create new files. \$100/\$20

QSORT—Fast sort/merge program for files with fixed record length, variable field length information. Up to live ascending or descending keys. Full back-up of input files created. \$100/\$20

BSTMS—Intelligent terminal program for CP/M systems. Permits communication between micros and mainframes. Sends character data files to remote computers under complete control. System can record character data sent from remote computer systems and data banks. Includes programs to EXBAND and COMPRESS binary files for EXBAND. This software requires a knowledge of assembler language for installation. \$200/\$25

DATEBOOK—Program to manage time just like an office appointment book but using the speed and memory of a computer. Keeps track of three appointment schedules (three dental chairs, three attorneys, etc.) at once. Appointments consist of name, reason for the appointment, the date and time, and the length of the appointment. System can be quickly customized for the individual user. Many helpful features for making, changing, finding, and reporting appointments. Requires 48K CP/M and 180K bytes diskette storage. Not available for Apple CP/M. Specify 8080 CP/M, Z80 CP/M or Cromemco CDO5. \$295/\$25

HEAD CLEANING DISKETTE—Cleans the drive Read/Write head in 30 seconds. Diskette absorbs loose oxide particles, fingerprints, and other foreign particles that might hinder the performance of the drive head. Lasts at least 3 months with daily use. Specify 5" or 8" Single sided. \$20 each/\$65 for 3 Double sided. \$25 each/\$65 for 3

WHATSI?—Interactive data-base system using associative tags to retrieve information by subject. Hashing and random access used for fast response. Requires CBASIC-2. \$175/\$25

PEACHTREE SOFTWARE—General accounting software for small businesses. Each product can be used alone or with automatic posting to the general ledger. Supplied in source for Microsoft BASIC 4.51.

FLIPPY DISK KIT—Template and instructions to modify single sided 5 1/4" diskettes for use of second side in single sided drives. \$12.50

FLOPPY SAVER—Protection for center holes for 5" and 8" floppy disks. Only 1 needed per diskette. Kit contains centering post, pressure tool and tough 7 mil nylon reinforcing rings for 25 diskettes. \$14.95 5" Kilt \$7.95 8" Kilt \$16.95 8" Rings only \$8.95

SELECTOR III-C2—Data Base Processor to create and maintain multi-key data bases. Prints formatted sorted reports with numerical summaries or mailing labels. Comes with sample applications, including Sales Activity, Inventory, Payables, Receivables, Check Register, and Client/Patient Appointments, etc. Requires CBASIC-2. Supplied in source. \$295/\$20

GENERAL LEDGER \$530/\$40
ACCOUNTS PAYABLE \$530/\$40
ACCOUNTS RECEIVABLE \$530/\$40
PAYROLL \$530/\$40
INVENTORY \$660/\$40
Other application products supplied in source for Microsoft BASIC 4.51.
MAILING ADDRESS \$530/\$40
PROPERTY MANAGEMENT \$925/\$40

PASCAL USER MANUAL AND REPORT—By Jensen and Wirth. The standard textbook on the language. Recommended for use by Pascal/Z, Pascal/M and Pascal/MT users \$12

CBS—Configurable Business System is a comprehensive set of programs for defining custom data files and application systems without using a programming language such as BASIC, FORTRAN, etc. Multiple key fields for each data file are supported. Set-up program customizes system to user's CRT and printer. Provides fast and easy interactive data entry and retrieval with transaction processing. Report generator program does complex calculations with stored and derived data. record selection with multiple criteria, and custom forms. Sample inventory and mailing list systems included. No support language required. \$395/\$40

GRAHAM-DORIAN SOFTWARE SYSTEMS
Comprehensive accounting software written in CBASIC-2 and supplied in source code. Each software package can be used as a stand-alone system or integrated with the General Ledger for automatic posting to ledger accounts. Requires CBASIC-2.
GENERAL LEDGER \$805/\$40
ACCOUNTS PAYABLE \$805/\$40
ACCOUNTS RECEIVABLE \$805/\$40
INVENTORY SYSTEM \$555/\$40
JOB COSTING \$805/\$40
APARTMENT MANAGEMENT \$805/\$40
CASH REGISTER \$805/\$40

POSTMASTER—A comprehensive package for mail list maintenance that is completely menu driven. Features include keyed record extraction and label production. A form letter program is included which provides neat letters on single sheet or continuous forms. Includes NAD file translator. Requires CBASIC-2. \$150/\$20

SUPER-SORT II—Above available as abs2. Lites program only. \$175/\$25

STRUCTURED SYSTEMS GROUP
Complete interactive accounting software for business. Each product can be used stand-alone or with automatic posting to the general ledger. Each product is thoroughly tested and very well documented.
GENERAL LEDGER \$820/\$40
ACCOUNTS RECEIVABLE \$820/\$40
ACCOUNTS PAYABLE \$820/\$40
PAYROLL \$820/\$40
INVENTORY CONTROL \$820/\$40

Ordering Information

MEDIA FORMAT ORDERING CODES
When ordering, please specify format code.

LIFEBOAT ASSOCIATES MEDIA FORMATS LIST. Diskette, cartridge disk and cartridge tape format codes to be specified when ordering software for listed computer or disk systems. All software products have specific requirements in terms of hardware or software support, such as MPU type, memory size, support operating system or language.

Table with columns: Computer system, Format Code, Computer system, Format Code, Computer system, Format Code. Lists various software products and their compatibility with different hardware configurations.

Prices F.O.B. New York. Shipping, handling and C.O.D. charges extra. Manual cost applicable against price of subsequent software purchase. The sale of each proprietary software package conveys a license for use on one system only.

SUPER-SORT III—As II without SELECT/EXCLUDE. \$125/\$25

DATASAR—Professional forms control entry and display system for key-to-disk data capture. Menu driven with built-in learning aids. Input field verification by length, mask, attribute (i.e. upper case, lower case, numeric, auto-dup, etc.). Built-in arithmetic capabilities using keyed data, constant and derived values. Visual feedback for ease of forms design. Files compatible with CP/M-MP/M supported languages. Requires 32K CP/M. \$350/\$35

WORD-STAR—Menu driven visual word processing system for use with standard terminals. Text formatting performed on screen. Facilities for text pagination, page number, justify, center and underscore. User can print one document while simultaneously editing a second. Edit facilities include global search and replace, Read/Write to other text files, block move, etc. Requires CRT terminal with addressable cursor positioning. \$445/\$40

WORD-STAR-MAIL-MERGE—As above with option for production mailing of personalized documents with mail lists from DATASAR or NAD. \$575/\$40

WORD-MASTER Text Editor—In one mode has super-set of CP/M's ED commands including global searching and replacing, forwards and backwards in file in video mode, provides full screen editor for users with serial addressable-cursor terminal. \$145/\$25

LIFELINES NEWSLETTER FROM LIFEBOAT

LIFELINES is the first step in software support for the serious microcomputer user. Each issue reports new revisions together with information on the purpose for each such release, be it for correction of bugs or the addition of features and facilities. Feature Articles! New Software! Product Comparisons! Info on CP/M Users Group! SUBSCRIPTION INFORMATION: \$18 for twelve issues: U.S., Canada, and Mexico. \$40 for twelve issues: all other countries. \$2.50 for each back issue: U.S., Canada, and Mexico. \$3.60 for each back issue: all other countries. Send Check to LIFELINES, 1651 Third Avenue, New York, N.Y. 10028 or use your VISA or MASTERCARD—call (212) 722-1100

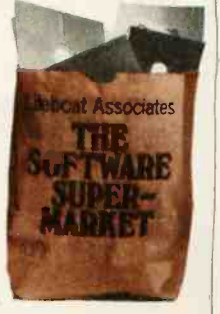

NO FRILLS!
NO GIMMICKS!
JUST GREAT
DISCOUNTS
MAIL ORDER ONLY

ATARI 800

Personal Computer System **\$79900**

NORTHSTAR

Horizon II 32K **234900**
Horizon II Quad **279900**
Horizon II 64K **299900**
Horizon Quad 64K **339900**

TELEVIDEO

912 **74900**
920 **79900**

HAZELTINE

1420 **79500**
1500 **84900**
1510 **104900**
1520 **122900**

OKIDATA

Microline 80 **69900**

SOROC Technology

IQ 120 **69900**
IQ 140 **99900**

CROMEMCO

System 3 **569500**
Z2H **799500**

INTERTEC

Superbrain 32K **249500**
Superbrain 64K **279500**

DECwriter IV

LA34 **97900**

TEXAS INSTRUMENT

810 Multi Copy
Impact Printer **149900**

We'll meet or beat any advertised prices!

Most items in stock for immediate delivery
Factory sealed cartons Full manufacturer's guarantee

DATA DISCOUNT CENTER

Box 100 135-53 Northern Blvd., Flushing, N.Y. 11354
Visa • Master Charge • N.Y.S. residents add Sales Tax
Shipping F O B N Y

Phone Orders Call 212-465-6609

Speed is the essential difference between machine-language and BASIC Adventures.

hallways and darkened dungeons of Voodoo Castle. There is a juju man, a *kachina* doll (a likeness of the Count), a book for removing curses, and much more. For entertainment value, this one rates very high.

● *Pyramid of Doom* takes you to an unexplored pyramid somewhere in Egypt. You have the key and can begin the search for a treasure under the watchful eyes of an ever-present nomad. This one is so good that after two weeks, I still haven't solved even a portion of it . . . yet.

● *Ghost Town* is an Adventure with a Western theme that has all the mystique of a John Wayne epic. The puzzle is one of the most rewarding and entertaining of Scott's nine Adventures. The maze is an authentic ghost town complete with saloon, hotel, jail, boot hill and an outrageous piano-playing ghost. This one is great fun.

Greg Hassett's Adventures

Of note to Adventure shoppers are the differences between the machine-language versions of Adventure and BASIC-language versions. The latter are appearing on the market in ever-increasing numbers. *Speed* is the essential difference. To most players of Adventures, the difference in execution time is of little importance. To the Adventure cultist, however, speed is everything. With this in mind, the authors who write Adventures in BASIC, ever in the shadow of Scott Adams and his beginnings in BASIC, are one by one graduating to machine language, blinking cursors, and (blinding) speed. One such author is Greg Hassett.

Greg is a 13-year-old schoolboy from Chelmsford, Massachusetts. His eye for detail and wry writing style have placed his Adventures in direct comparison with those of Scott Adams. This is unfortunate for two reasons. Greg's work is often judged unseen and dismissed due to his age or the fact that most of his programming has been in BASIC. When critiqued on their own merit, however, the Hassett Adventures stand up well in both entertainment and value per dollar.

● *Journey to the Center of the Earth* is a perky little trip into the interior of our planet. The earthdigger in which you are riding gets a busted Gonkulator, and you have to find a new one (or something to replace it with) somewhere in the maze of tunnels in which you find yourself. Giant bugs and treasure make this beginner's game interesting.

● *House of the Seven Gables* pits you against a wicked witch in a haunted house. More complicated than its predecessor, this program will be deadly to those who take its puzzle lightly. Unique objects of value and scenes of personal combat give a player his money's worth with this one.

● *Atlantis*: If undersea is where you want to be, this one is for you. Personal combat is taken one step further with the guardians of treasures being fierce sea creatures. The entire Adventure is done under water, and it's a lot of fun. Whirlpools and octopi and denizens of the deep await you here.

● *Sorcerer's Castle* allows you to challenge the evil sorcerer on his own turf. Well, if you can find your way out of the woods, you'll be just in time to fight and may even confront the evil sorcerer personally. Treasure abounds here, with ample puzzlement to please even the most demanding Adventure enthusiast.

● In *Enchanted Island*, magic and mystery join hands to present an Adventure of worth. The highly different flavor of this program would be spoiled by the presentation of any details in this review. It is the author's most challenging Adventure written in BASIC.

● *Enchanted Island Plus*: Like Scott Adams, Greg Hassett also quests for the increased speed offered by a machine-language Adventure. This program has it all—speed, blinking cursor, and an increased number of locations. This Adventure is a must buy.

● *Mystery Mansion* summons you in a dream to come solve the mystery of a haunted mansion. Good pace and colorful descriptions are the selling points for this Adventure. It is a fast, well-written machine-language Adventure, and it should especially appeal to younger Adventure fans.

● *World's Edge* gives you a future where the Earth's pollution count has finally reached a critical level. You can save the planet from extinction

National Microsoftware Producers

ANNOUNCES

VTS/80™

Video Typing System for 8080, 8085 and Z80's

PROFESSIONAL QUALITY

WORD PROCESSING PACKAGE FOR
CP/M* COMPATIBLE MICROCOMPUTERS

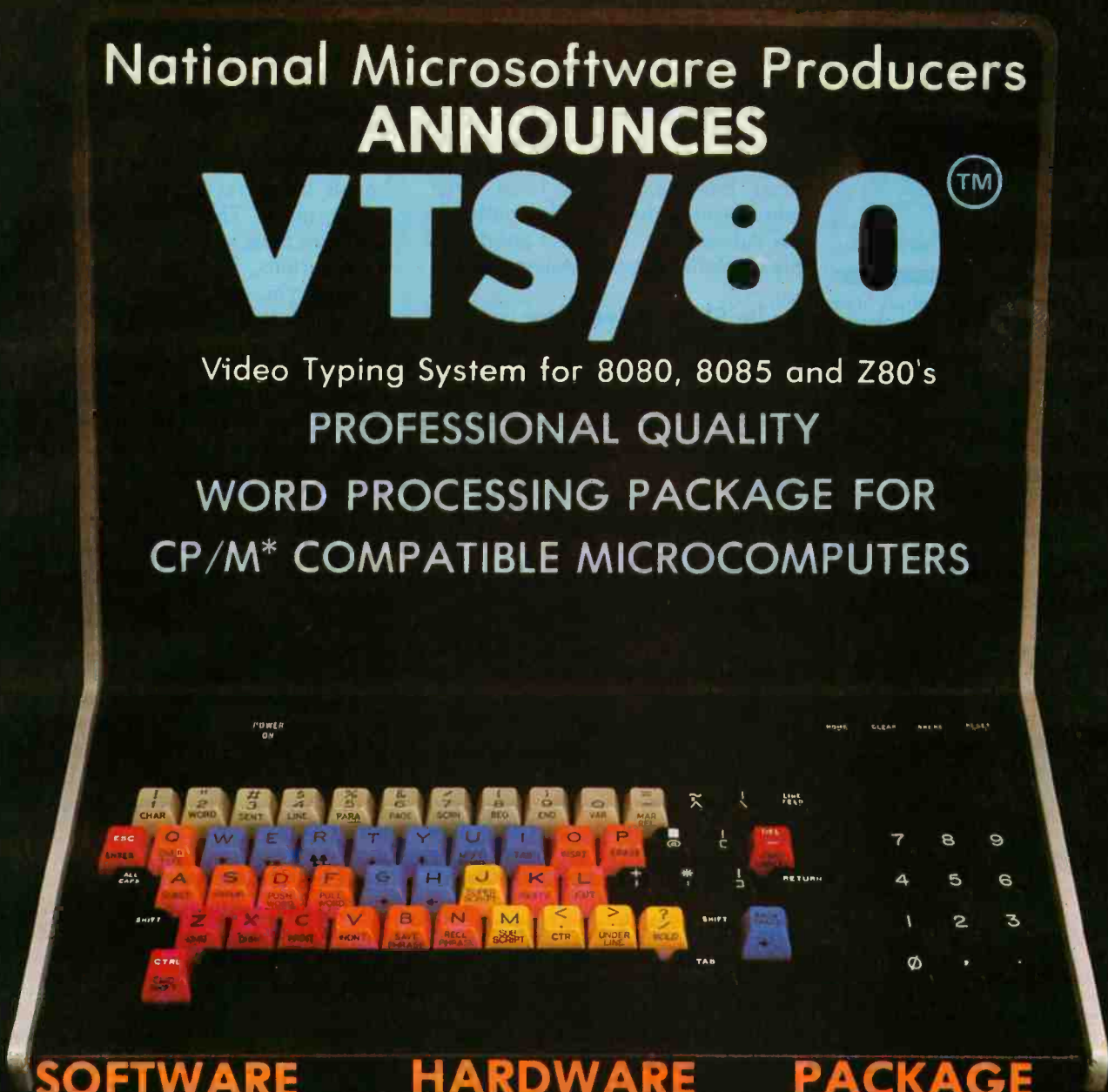

SOFTWARE

- CP/M COMPATIBLE
- EASILY OPERATED BY OFFICE PERSONNEL
- CONTAINS ALL PROFESSIONAL WORD PROCESSING FEATURES
- PROMPTS ON SCREEN GUIDE USER THROUGH FUNCTIONS
- COMPARABLE TO DEC, NBI, Q Y X, WANG . . .

HARDWARE

- OPERATES ON 8080, 8085 AND Z80 MICRO-COMPUTERS WITH 48K MEMORY
- CHOICE OF 5" OR 8" FLOPPY DISKETTES
- REPLACEMENT KEYTOPS PROVIDED FOR MOST CRT'S
- SUPPORTS SERIAL AND WORD QUALITY PRINTERS (DIABLO, NEC, QUME)

PACKAGE

- REPLACEMENT KEYTOPS COLOR CODED BY FUNCTION
- MANUAL WITH EXTENSIVE GRAPHICS DESIGNED FOR THE FIRST-TIME USER
- SELF STANDING MANUAL IN EASEL BINDER
- SPANISH, FRENCH, GERMAN, DUTCH VERSIONS AVAILABLE

SOLD THROUGH AUTHORIZED DEALERS AND DISTRIBUTORS ONLY

O.E.M. INQUIRY INVITED

SUGGESTED RETAIL PRICE \$549.00



NATIONAL MICROSOFTWARE PRODUCERS, INC.
 3169 FILLMORE STREET
 SAN FRANCISCO CA 94123 USA
 415-346-7025 TELEX 171790

* CP/M is a registered trademark of Digital Research

WORD PROCESSING SOFTWARE

SUPERBRAIN®

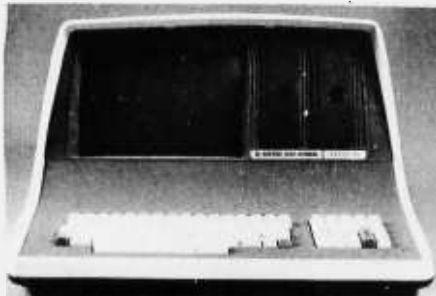

32K or 64K (Double or Quad Density units available). Uses two Z-80 CPU's. Commercial-type terminal with 12" monitor. Dual double density minifloppies. Over 350 kilobytes of storage (twice that with quad density drives). Two serial RS232 ports, I/O ports standard. Expandable with optional S-100 S-100 interface. Comes with CP/M™ 2.2 operating system. MiniMicroMart includes BASIC interpreter and can supply a wide range of CP/M Development and Application software.

w/32K Double Density, List \$2995 . **\$2685**
 w/64K Double Density, List \$3345 **\$2883**
 w/64K Quad Density, List \$3995 **\$3595**
 64K Special Quad Version **\$3395**

INTERSYSTEMS

formerly ITHACA AUDIO



DPS-1, List \$1795

Call for Price!

The new Series II CPU Board features a 4 MHz Z-80A CPU and a full-feature front panel. 20-slot actively terminated motherboard, with 25 amp power supply (50/60 Hz operation, incl. 68 cfm fan).

COMPLETE SYSTEM with InterSystem 64K RAM, I/O Board w/priority interrupt and double density disk controller board. Full 1-year warranty, List \$3595

HEWLETT-PACKARD

HP-85A



F.O.B. shipping point. All prices subject to change and all offers subject to withdrawal without notice. Advertised prices are for prepaid orders. Credit card and C.O.D. 2% higher. C.O.D. may require deposit.

— WRITE FOR FREE CATALOG —

MiniMicroMart

1618 James Street

Syracuse, NY 13203 (315) 422-4467

168 December 1980 © BYTE Publications Inc

with 2.2 kg of APC-80 located on a small distant planetoid. However, the element is considered holy by the inhabitants of the planetoid, so a fight is imminent . . . This is by far the most imaginative plot from Greg, who seems to love to add combat to his Adventures. It is also another of his machine-language Adventures.

Radio Shack Adventures

● *Pyramid 2000*, the first Adventure from Radio Shack, is a machine-language scenario set in Egypt. You explore the pyramid for gold and glory without the scrolling or blinking cursor that hallmarks other microcomputer Adventures. Still, the authors have managed to work a much-used theme to its maximum, drawing a fairly complex and entertaining puzzle.

● *Haunted House*, like its cousin *Death Dreadnaught*, deals not with gold or glory, but survival. Once inside the house, you are pitted against unseen enemies with awesome telekinetic powers. Levitating knives and eerie occurrences await the Adventurer here. Produced for Tandy Corporation by Device Oriented Games of Dallas, this is an excellent offering.

The Microsoft Adventure

Microsoft Consumer Products, a sibling company to the Microsoft that has written so many versions of BASIC, has a very heavy version of Adventure available on disk only (most Adventures are supplied on cassette tape). It is reputed to be a copy of the original Adventure written by Crowther and Woods for the Digital Equipment Corporation PDP-10. The original Colossal Cave is there, and there is ample room on the floppy disk for the over 400 eloquent descriptions.

The Programmer's Guild Adventures

One of the newest of the Adventure publishers is a little company called The Programmer's Guild. It distributes three adventures written by independent authors. *Lost Dutchman's Gold* and *Spider Mountain* are by Teri Li, and *Death Dreadnaught* was coauthored by Biff and Spudd Mutt [pseudonyms, I hope . . . GW] of Device Oriented Games.

● *Lost Dutchman's Gold* is a Western Adventure. In the Superstition Mountains of Arizona, you accompany the ghost of Backpack Sam, a grizzled old former prospector, who knows the secret of the Lost Dutchman's mine. There are Indians, a stubborn mule, a ghost town, and the Superstitions, dark and mysterious, to keep you spellbound throughout the simulation.

● *Spider Mountain Adventure* is a classic *Dungeons and Dragons* type Adventure that employs Shelob, a giant spider, as guardian of the many treasures of Spider Mountain. Armed with only a crossbow, you face orcs and spiders in the maze of tunnels under the mountain.

● *Death Dreadnaught*, rated R by its own publisher due to extreme descriptions of violence, pits man against an unseen horror that has devastated an entire alien battlecruiser. As the last living human on board, the Adventurer is required merely to escape. This, however, is no small task with a killer on your trail and an unsolved maze before you. This one is not for the squeamish or faint of heart.

Mad Hatter Adventures

Mad Hatter Software, which began as a distributor for the Hassett Adventures, recently launched two titles of its own.

● *Sleuth* is a detective story, a whodunnit Adventure with graphics and sound. The graphics consist of video maps of where you are, and the sounds are the primitive tink-boop sounds that characterize early sound effects for the TRS-80.

● *Quest* uses the same graphics and sound techniques as *Sleuth* but is more of a fantasy Adventure. Neither held my attention the way the other Adventures reviewed did. Plotlines are thin and seem to be built around gimmickry rather than solid plots and programming.

How to Write an Adventure

Adventures are, first and foremost, puzzles. You (the Adventure author) must be prepared to satisfy the Adventurer's lust for the unsolvable, while at the same time making it easy enough for the novice.

Choose a recognizable theme. In *Spider Mountain*, for example, it is evident that the Mountain is the goal.

Whatever happened to eenie, meenie, miney, mo?

I could be another Solomon...

This may put the Godfather out of business.

If only my heart would stop racing...

It must use Bayesian, weighted factor analysis, and...

Brilliant! Like a window into the future.

...a perfect gift for that urban cowgirl!

Maybe this'll help me choose a career...

I could use it to select my staff.

Would I rather have Winston's millions or Billy Joe's love?

Hmmm... could be my ticket to the Boardroom.

Can't any of these people afford \$29.95?

Should I buy stock or commodities in this economy?



When DecisionMaster™ speaks everybody listens.

Let's face it. We all have to make decisions. Decisions that can change our lives. Decisions that can make us happy or unhappy. Decisions that could win us fame or fortune. Now, DecisionMaster can help you make the best decisions of your life.

Use Bayesian theory to peer into the future... even if you've never heard of the Bayes' Rule. Do a complete weighted factor analysis... without knowing what one is. Use discounted cash flow to compare investment alternatives without bothering with present value tables. These and other sophisticated theories that were once the exclusive domain of professors and top business executives are *built into* DecisionMaster's algorithms... so you can use them at the touch of a key!

DecisionMaster is easy to use. It features:

- A fully documented manual developed by an authority in the field.
- A unique program-controlled cross reference system.
- A powerful formatted-screen data entry system.

You'll use DecisionMaster in hundreds of routine decisions, as well as more important ones such as • Buying a house • Changing jobs • Selecting investment • Evaluating insurance policies • Expanding product lines • Leasing vs. purchasing.

If you buy only one computer program this year, make it DecisionMaster. And when it speaks, listen.

DECISION? MASTER™

To order, see your software dealer or return this form with your check to: DecisionMaster, Dept. B4, 10428 Westpark, Houston, Texas 77042 Add \$1.50 for shipping and handling

Diskette for: TRS-80** (Level II:32K) \$29.95 TRS-80** (Model III) \$39.95

Name _____ State _____ Zip _____
 Address _____
 City _____

CHARGE by phone toll-free: 1-800-231-5768 Ext. 306
 VISA MasterCard Bank Code

Account No. _____
 Signature _____
 Expiration Date _____

* Apple II is a registered trademark of Apple Computers, Inc.
 ** TRS-80 is a trademark of the Radio Shack Division of the Tandy Corp.

New Z8000

The System X8000 MICRO-MINI™ based on the 16-bit Zilog Z8000 processor is available for immediate delivery.

FEATURES (partial list)

- Zilog Z8000 CPU
- Intel Multibus compatible
- Unique memory management system allows up to 16 megabytes of memory
- Optional 9511 arithmetic processor
- 8-level vectored + non-maskable interrupts
- Two programmable timers
- On-board monitor ROM option
- Full "Multimaster" capabilities allow multiple processors and/or DMA devices on the same bus
- Flexible and/or hard disk controller
- Powerful disk-based operating system
- Memory boards: 16K, 32K, 48K, 64K, 96K, 128K
- 15-slot backplane
- Heavy-duty switching power supply
- Industrial quality throughout

Prices start from \$998. System discounts. Call for prices on complete custom systems.

SYSTEM X9020 (CPU Manual \$19.95)



\$4195* The SUPER-MICRO™
READY TO RUN

SYSTEM FEATURES (partial list)

- Pascal MICROENGINE™ X9000**
- 16 bit P-code CPU
 - 64K bytes RAM/Full DMA
 - Floppy disk controller (SS or DS)
 - Flopping point hardware (IEEE standard)
 - System software with enhancements
 - 2 serial, 2 parallel ports
 - Pascal compiler, text editors, file manager, CPU & memory diagnostics, symbolic Pascal debugger, linker, utilities and more.

Floppy Disk Drives (2)

- 1M combined memory
- Double density, single sided
- Standard 8" diskettes
- 6 ms track to track



\$900*
With CPU

MODEL X-920 DISPLAY/EDIT TERMINAL

*LIMITED TIME cash price. 10% DOWN guarantees priority. Master Charge & VISA cards accepted.

System discounts

- ADM3A+ plus RG graphics (512x256)... \$1995
- NEC Spinwriter 5510 or 5530 w/trac 2895
- Anadex DP-9500 printer (60dpi) 1595
- X-912 CRT (less 18 function keys) 799
- P-E 550 CRT ("Bantam") 740
- Siemens standard 8" drive (ss/sd-dd) 399



312 684-3183

So, as the game begins, we leave the campsite, hiking as fast as we can for the mountains we see in the distance. An hour or so of looking for a way to find the treasure on the mountains soon convinces us that the goal must be *inside* or possibly *under* the mountains. In fact, the author has sidetracked us away from the *real* entrance to Spider Mountain, but this is OK as long as it is enjoyable and related to the rest of the Adventure.

Clues and equipment may be scattered throughout the theme area. Their locations should not be obvious to avoid easiness, but they should also not be impossible to find. Avoid highly complicated situations; they interrupt the flow of your game.

Several minor or subtheme areas will spice up the game. It is not necessary to provide a lot of memory-consuming action in the lesser areas; however, nobody likes an empty room (desert, etc), so at least put something there for your player's trouble.

Scott Adams' use of subtheme areas in *Strange Odyssey* is one of the best examples of this concept. By breaking his Adventure up into different worlds, each with its own complications and dangers, Scott effectively entertains his audience without frustrating them. Some of the differences among the stargate worlds of this Adventure are deadly, but not to the point of aggravation.

Make sure that your overall theme does not duplicate an Adventure already in existence. Both Adams and Hassett have extensive lines of Adventure scenarios. Mad Hatter Software and The Programmer's Guild, which have only a few Adventures each, are both planning more.

Research your settings. Make sure that your locations ring of authenticity and that your descriptions are accurate; otherwise, your reader will spend more time criticizing than playing.

Be certain that your Adventure has a large enough vocabulary to function well. If you add radical words to your vocabulary, be sure that provisions are made for giving clues about them to your player.

Be innovative. Don't wait around for someone else to do it. Introduce new features into your game. Make your Adventure unique in the marketplace.

Above all, *be entertaining*. Your audience will come back for more and

more if you give them their money's worth each and every time they play.

Adventure is the product of imagination appealing to imagination. It is not just the puzzle, or the theme, or the nonplayer characters and their personalities. It is a verbal tapestry of interwoven phrases that whisk you away to magical kingdoms of the mind. The computer becomes a tool of reaching that conveys you where it will. You go along eagerly, breathlessly, awaiting what comes next.

Such are the worlds created by Adams, Hassett, Li, and all the Adventure writers who have not yet been published. What they have in store for us next is anyone's guess. But I bet it's well worth waiting for. ■

Scott Adams Adventures are available on cassette tape for the 24 K-byte Apple II or Apple II Plus, the 48 K-byte Apple II with disk, the 16 K-byte Radio Shack TRS-80, and the 16 K-byte Exidy Sorcerer. Write:

Adventure International
POB 3435
Longwood FL 32750
(305) 862-6917

The Programmer's Guild Adventures are available on cassette tape or floppy disk for the 16 K-byte TRS-80. For information, write:

The Programmer's Guild
POB 66
Peterborough NH 03458
(603) 924-6065

The Greg Hassett Adventures are available on cassette tape for the 16 K-byte TRS-80 from:

Adventure World
POB 914
North Chelmsford MA 01863

Microsoft Adventure is available on floppy disk for 32 K-byte TRS-80 and Apples from:

Microsoft Consumer Products
400 108th Ave NE, Suite 200
Bellevue WA 98004
(206) 454-1315

Radio Shack Adventures are available from local Radio Shack stores and dealers.

DG: Realizing the H8's Potential

For the Engineer; Businessman; and Serious Hobbyist.

Now Use Standard CP/M® Software

DG's system enhancements provide for RAM in Low Memory allowing the use of the widely accepted STANDARD CP/M.

Now Operation in Powerful Z80® Code

Our DG-80 Z80® based CPU opens a new world of more powerful AND efficient languages and software.

Powerful, Bank Selectable 64K RAM

Our high capacity, low power DG-64D 64K RAM allows more efficient utilization of space, freeing your motherboard for peripheral interfacing.

Now 4MHz Operation

The DG-ADP4 allows for operation of the DG-80 CPU at 4MHz while maintaining compatibility with the H17 Disk System. Execution time of CPU intensive programs is reduced to half even before utilizing the enhanced Z80 instruction set.

Increased Flexibility With New Monitor

DG's FP8 monitor allows front panel debugging of 8080 AND Z80 machine language programs in either hexadecimal or octal format. Maintains all PAM-8® entry points and features. All register sets available.

The DG system enhancements for the Heath H8 computer are definitely a step above in price, performance, and factory support.

THE DG-80 ZILOG Z80® BASED CPU — \$249.00 (Documentation Only \$25.00)

FEATURES:

- Compatible with Heath® H8 hardware and software
- Z80 CPU — Enhanced Instruction set • Provisions for up to 8K ROM/EPROM and/or 4K RAM • Jump-On-Reset to any 1K boundary • DIP switch selectable wait

states for any or all 8K blocks of memory • All Z80 interrupt response modes available • Interrupt Acknowledge and Dynamic Memory Refresh signals available on bus • Frequently selected options by DIP switch or solderless jumper • Machined contact gold sockets for

ROM/EPROM, RAM • Includes many advanced features for future expansion • Assembled, tested and guaranteed • Extensive operations manual and Z80 PROGRAMMING MANUAL
90 DAY WARRANTY

DG-64D 64K — \$529.00 48K — \$480.00 32K — \$431.00 16K — \$382.00 8K — \$333.00

BEST RAM EVER AVAILABLE FOR THE H8.

FEATURES:

- Up to 64K bytes capacity Dynamic RAM
- Hardware bank selectable in 8K increments
- Software bank selectable in 16K increments through I/O port
- On-board bank select/CPU ROM disable port, ad-

dressable to any of 256 I/O addresses • Up to 8 boards controllable through one I/O port (allows page mode operation) • On-board transparent refresh for 8080 or Z80 microprocessor backed up by asynchronous refresh upon loss of normal program execu-

tion. • 4 MHz operation with no wait states required • Low power consumption — less than 8 watts • Assembled, tested, & burned-in
90 DAY WARRANTY

Documentation Only \$15.00

DG-FP8 — \$69.95

Monitor/Utility package for DG-80 CPU provides functions of PAM-8 as well as the following:

- Split Octal or Hexadecimal Entry and Display • Z80 monitor features such as display alternate register sets, display index registers, • "Shorthand" display of memory contents pointed to by general purpose registers • Supports STANDARD CP/M provided by D-G as well as HDOS • Provides firmware support for DG-ADP4, 4 MHz hardware • Includes single step features

Documentation Only - \$15.00 (Source Listing Not Included)

DG-ADP4 — \$19.95

Plug-in hardware modification to allow operation of the Heath® H17 disk system with the DG-80 at 4 MHz. Requires the use of the DG-FP8 firmware package.

16K CHIP SETS \$49.00

(8-4116 Type Dynamic RAMS) for DG-32D, DG-64D, Apple®, TRS-80®, H8/ 89®, and Pet®

DG-CMD1 — \$29.95

ROM disable port for use with the Heath® H8 computer. Addressable to any of 256 I/O ports. Allows the use of a full 64K of RAM when used in conjunction with the DG-80 CPU and the DG-FP8 hardware/firmware package (NOT REQUIRED FOR SYSTEMS UTILIZING THE DG-64D MEMORY BOARD)

DG-FP8/DG-ADP4 — TOGETHER — \$79.95

Save on Combination Purchase — Reg. \$89.90

STANDARD CP/M Ver 2.2 \$130.00

DG-32D — 32K — \$339.00 — 16K — \$287.00 — 8K — \$235.00 — DOCUMENTATION \$12.00

CP/M is a registered trademark of Digital Research of Pacific Grove, California. Heath, HDDS, H8, H88/89 & PAM8 are registered trademarks of the Heath Company. Z80 is a registered trademark of Zilog Corp. PET is a registered trademark of Commodore. Apple is a registered trademark of Apple Computer. TRS-80 is a registered trademark of TANDY Corp.

D·G ELECTRONIC DEVELOPMENTS CO.

Ordering Information: Products listed available from DG Electronic Developments Co., P.O. Box 1124, 1827 South Armstrong, Denison, Tx. 75020. Check, Money Order, VISA or Master Charge accepted. Phone orders (charge only) call (214) 465-7805. No COD's. Freight prepaid. Allow 3 weeks for personal checks to clear. Texas residents add 5%. Foreign orders add 30%.

Zork and the Future of Computerized Fantasy Simulations

P David Lebling
14 Pelham Ter
Arlington MA 02174

CFS (computerized fantasy simulation) games are a new art form: the computerized storybook. Instead of reading the story, you play it. The author presents the story, but only as you squeeze it out of him by wit and brute force. It's up to you to figure out what's going on, and the satisfaction of doing so depends on how well thought out the story is. To be fun to play, the story must be more or less consistent and complete. To a large extent, this means that the program that embodies the story must simulate the universe well.

I have been involved for several years with *Zork*, one of the larger and (I would like to think) better worked out CFS games. The authors (Marc Blank, Tim Anderson, Bruce Daniels, and I) have spent a lot of time trying to make the universe of *Zork* as consistent and complete as possible within the bounds of the space available. The first version of *Zork* was written for the Digital Equipment Corporation PDP-10; it eventually grew to strain even the megabyte address space of that machine. The game was completely rewritten for microcomputers and is now limited primarily by the size of a 5-inch floppy disk. *Zork* games swap data (programs and text) into memory from the disk as needed and therefore aren't limited by the size of the system's user memory.

Standard 5-inch floppy disks store about 100 K bytes (some store more, some less). This works out to about 10,000 words of English prose and a similar amount (about 40 K bytes) of code. This is large for a microcomputer-based program, but as literature it's still only at the short story length.

Zork is shrunk to fit into the micro-world by running on a *Zork-language virtual machine*. This means that the

code that is running while you are playing *Zork* is much more compact than the same program would be if written in machine language (on a Radio Shack TRS-80, for example). This is because the instruction set of the virtual machine is tailored to CFS games. For example, the *Zork-language* instruction to move an object from one room to another takes just 3 bytes of storage. The other advantage is that the *Zork* code is machine independent; all it takes to move *Zork* to another machine is to write the *Zork-language* interpreter for that machine. Such interpreters currently exist for the Apple II, PDP-11, PDP-10 and the TRS-80. For more details about the *Zork-language* see "How to Fit a Large Program into a Small Machine," by Marc S Blank and S W Galley, July 1980, *Creative Computing*.

Even using a disk to store parts of the game, the PDP-10 *Zork* was still too large for the micro-world. As a result, we split it into two smaller, independent games: *The Great Underground Empire, Part I*, and *The Great Underground Empire, Part II*, each of which is a self-contained program. There was room left over, so we added some new problems to round things out.

Still, a lot of universe can fit into a microcomputer and disk. *Zork* "understands" a useful subset of English (mostly imperative sentences), including sentences as complex as "Put all of the books but the green one under the rug." The *Zork* vocabulary is over 600 words and includes 100 verbs. A parser this powerful is a good-news/bad-news proposition. On the one hand, such a parser makes possible the implementation of subtle and realistic problems. When the most complicated sentence you can understand is "Drop uranium," you are limited to producing certain types of situations. If you can say "Tell the Robot 'Put the uranium in the lead box'," then the game can become more interesting.

Zork has a fairly complicated parser for imperative sentences. It endeavors to reduce its input to a construction of:

< verb > < direct object > < indirect object >

where the objects are optional. Prepositions are folded in-

If you are interested in playing *Zork: The Great Underground Empire, Part I*, the game is distributed by Personal Software, 1330 Bordeaux Dr, Sunnyvale CA 94086 on floppy disk for Apple II and TRS-80 computers. *Zork* games are produced by Infocom Inc, POB 120, Kendall Sta, Cambridge MA 02142. *Zork* is a trademark of Infocom Inc.

GO 16-BIT NOW — WE HAVE MADE IT EASY

8086

8 Mhz. 2-card CPU Set

\$595
WITH 86-DOS™

ASSEMBLED, TESTED, GUARANTEED

With our 2-card 8086 CPU set you can upgrade your Z80 8-bit S-100 system to run three times as fast by swapping the CPUs. If you use our 16-bit memory, it will run five times as fast. Up to 64K of your static 8-bit memory may be used in the 8086's 1-megabyte addressing range. A switch allows either 4 or 8 Mhz. operation. Memory access requirements at 4 Mhz. exceed 500 nsec.

The EPROM monitor allows you to display, alter, and search memory, do inputs and outputs, and boot your disk. Debugging aids include register display and change, single stepping, and execute with breakpoints.

The set includes a serial port with programmable baud rate, four independent programmable 16-bit timers (two may be combined for a time-of-day clock), a parallel in and parallel out port, and an interrupt controller with 15 inputs. External power may be applied to the timers to maintain the clock during system power-off time. Total power: 2 amps at +8V, less than 100 ma. at +16V and at -16V.

86-DOS™, our \$195 8086 single user disk operating system, is provided without additional charge. It allows functions such as console I/O of characters and strings, and random or sequential reading and writing to named disk files. While it has a different format from CP/M, it performs similar calls plus some extensions (CP/M is a registered trademark of Digital Research Corporation). Its construction allows relatively easy configuration of I/O to different hardware. Directly supported are the Tarbell and Cromemco disk controllers.

The 86-DOS™ package includes an 8086 resident assembler, a Z80 to 8086 source code translator, a utility to read files written in CP/M and convert them to the 86-DOS format, a line editor, and disk maintenance utilities. Of significance to Z80 users is the ability of the translator to accept Z80 source

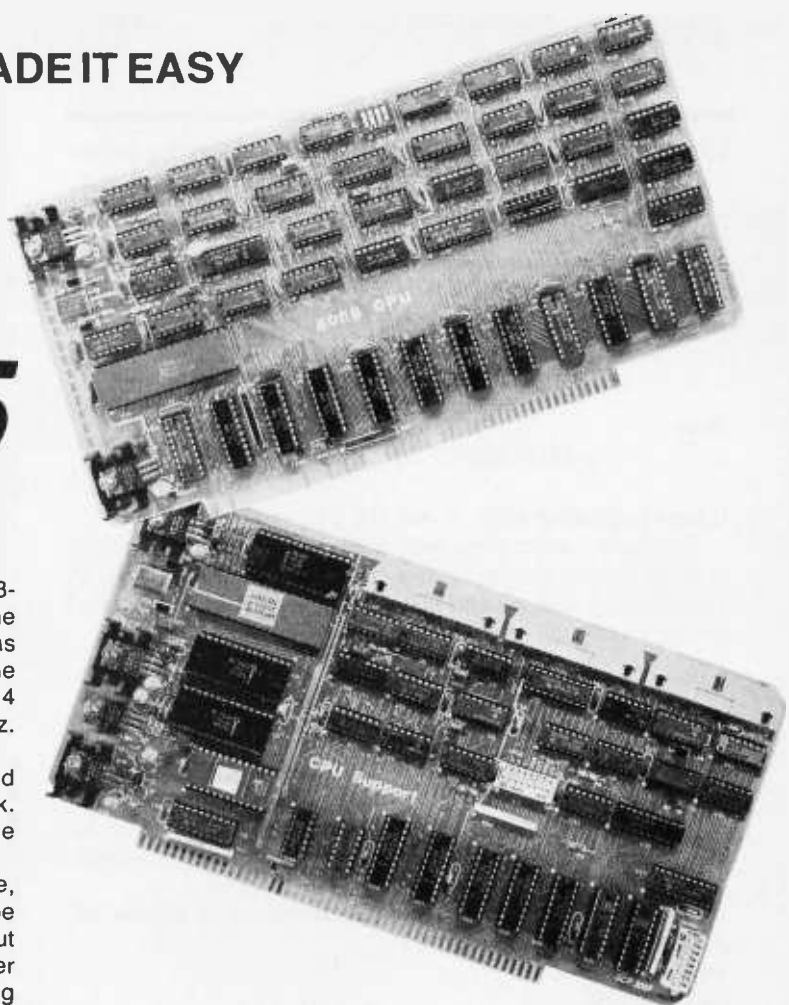

code written for CP/M, translate this to 8086 source code, assemble the source code, and then run the program on the 8086 processor under 86-DOS. This allows the conversion of any Z80 program, for which source code is available, to run on the much higher performance 8086.

BASIC-86 by Microsoft is available for the 8086 at \$350. Several firms are working on application programs. Call for current software status.

All software licensed for use on a single computer only. Non-disclosure agreements required. Shipping from stock to one week. Bank cards, personal checks, CODs okay. There is a 10-day return privilege. All boards are guaranteed one year — both parts and labor. Shipped prepaid by air in US and Canada. Foreign purchases must be prepaid in US funds. Also add \$10 per board for overseas air shipment.

8/16 16-BIT MEMORY

This board was designed for the 1980s. It is configured as 16K by 8 bits when accessed by an 8-bit processor and configured 8K by 16 bits when used with a 16-bit processor. The configuration switching is automatic and is done by the card sampling the "sixteen request" signal sent out by all S-100 IEEE 16-bit CPU boards. The card has all the high noise immunity features of our well known PLUS RAM cards as well as "extended addressing". Extended addressing is a replacement for bank select. It makes use of a total of 24 address lines to give a directly addressable range of over 16 megabytes. (For older systems, a switch will cause the card to ignore the top 8 address lines.) This card ensures that your memory board purchase will not soon be obsolete. It is guaranteed to run without wait states with our 8086 CPU set using an 8 Mhz. clock. Shipped from stock. Prices: 1-4, \$280; 5-9, \$260; 10-up, \$240.

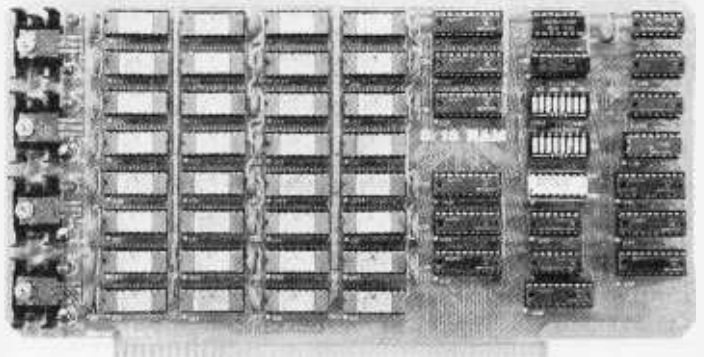

Seattle Computer Products, Inc.

1114 Industry Drive, Seattle, WA. 98188
(206) 575-1830

One method of dealing with players who are "killed" in *Zork* is to resurrect them in a forest.

to the verb, which allows *Zork* to differentiate

>PUT BOMB UNDER TROPHY CASE

from

>PUT BOMB IN TROPHY CASE

(Lines beginning with > are the player's input.)

Similarly, adjectives are used to distinguish among several books, doors, or any collection of like objects. In conjunction with *all* and *but*, adjectives provide powerful constructs:

>TAKE ALL THE TREASURES

>BURN ALL THE BOOKS BUT THE BLACK ONE

The parser also allows the player to be laconic, if he so desires. If only one object in the vicinity fits the verb he uses, it will be selected and the player will be informed:

A menacing troll brandishing a bloody axe blocks all passages out of the room.

>KILL TROLL

(with sword)

HEATH H9 OWNERS

UPGRADE your H9* for a fraction of the cost of a new terminal with these features.

FLICKER FREE

\$69.95 KIT \$79.95 ASSEMBLED
If Columbus would have had to wait for his H9 operating at 600 baud, he might not have discovered America. At last your computer can communicate with your H9 eight times faster (4800 baud) without that annoying refresh interrupt that causes the screen to flash at rates greater than 800 baud. Faster listings. Faster program execution. Eight times faster.

CURSOR CONTROL

\$29.95 KIT \$34.95 ASSEMBLED
Why limit your output to consecutive lines of your terminal? CURSOR CONTROL allows your computer to move the cursor anywhere on the screen. Add that professional touch to your displays by utilizing masking techniques. Functions included are: left, right, up, down, left and right 20 spaces, home and erase page.

GRAFIX

\$59.95 KIT \$69.95 ASSEMBLED
Open a whole new world to your output. The graphical display capabilities of GRAFIX allow you to create displays never before possible on the H9.

LOWER CASE ENTRY

\$28.68 ASSEMBLED
Now you can enter lower case characters from the keyboard. A Shift Lock key allows the keyboard to operate as the standard H9 keyboard or to generate upper and lower case depending upon the Shift key as per a normal typewriter.

LOWER CASE DISPLAY

\$34.77 ASSEMBLED
Lower case capabilities greatly improve readability on terminals modified for 24 lines.

KEY CAPS

\$12.50 SET 4 ARROWS \$1.00
These quality contour key caps have molded-in alphanumeric. For that professional feel.

Full Six Month Warranty - 24 Line Compatible

NORTHWEST COMPUTER SERVICES, INC.

8503 N.E. 30th Ave.

Vancouver, WA 98665

(206) 573-8381

H9 is a registered trademark of Heath Co. MASTER CARD and VISA welcome.

If the meaning is not obvious, the player is asked to clarify, and the new input is added to the old to produce a complete sentence. This can go on indefinitely:

>OPEN

Open what?

>DOOR

Which door do you mean?

>THE TRAP DOOR

For more details on the *Zork* parser and internal structure, see "Zork: A Computerized Fantasy Simulation Game," by P David Lebling, Marc S Blank, and Timothy A Anderson, in *IEEE Computer*, April, 1979.

On the negative side, having a clever parser means that the player may expect almost any concept to be understood. Unfortunately, only a small number of concepts can be implemented given the available space.

Some concepts that *Zork* does implement are:

● **Properties:** Objects can have properties or attributes, some of them changeable. Lamps can be on or off, treasures valuable or worthless, villains fighting-mad or peaceful. Some of these properties never change; a container is always a container, for example. But other properties can change; for example, some containers may be opened and closed at will.

● **Containment:** Objects may have contents. Bottles can contain water and be open or closed. Some objects are transparent. Some objects must be unlocked before they can be opened. The capacity of an object is limited. (For example, a paper bag won't hold as much as a bucket.)

● **Weight:** Objects have weight. A solid gold coffin weighs a lot more than a newspaper. The amount a player can carry depends on the total number of objects carried and on the total weight of the objects and their contents.

● **Position:** An object may be in, on, or under another object.

● **Vehicles:** The player may be in a vehicle which is traveling through the locations in the game. In addition to the player, the vehicle may have other contents distinct from the player's belongings and the "contents" of the location.

● **Time:** Game events may be scheduled to happen at arbitrary future times. Time-bombs may go off, matches burn out, lanterns grow dimmer, and so on.

● **Actors:** Actors are other characters who have roles in the game. They may fight or choose not to. They may speak to the player or be spoken to. They may move around or stay in a particular place.

● **Fighting:** The player may engage in combat with other inhabitants of the game. He may be wounded (affecting his ability to carry heavy loads), or he may kill his opponent and retrieve the opponent's weapon.

Every object in *Zork* has a pointer to its location (which may be "nowhere"), which is its *parent*; a pointer to the next object in the same location, which is its *sibling*; and a pointer to its first contents, which is its first *child*. Thus, a container points to its contents, and the contents point back to it.

One result of this implementation is that an object can

Thousands of SoftwareHows™ users agree — SoftwareHows products set a new standard of excellence for solution-oriented software. Instant installation for your system, powerful “word processing-like” editing facilities and consistent operating features make this SolutionWare™ the only serious choice for your needs.

Why settle for a piece when you can have the whole pie?!

At last! An integrated system of business software ideal for you!

How often have you purchased software only to be disappointed by its features or frustrated by the inability of the different programs to work together? Are you tired of entering the same data into your Purchase Ordering System when a part is ordered, into Inventory when it arrives, Payables when it's invoiced and General Ledger when it's paid for? Can you easily link your Accounting Data Base with your word processing software to create personalized letters, reports, notices and announcements?* Does your Point of Sale, Order Entry software also save a keyed file which may later be Sorted for over 60 customer characteristics and used to generate personalized sales literature?

If you don't like your answers to these questions, your accounting software is costing you money!

The Data Base Integration™ System from SoftwareHows™ does all this and much more! This newest software product offers the perfect blend of performance, price and flexibility. Every single transaction feeds your master records. This common data base approach organizes all your business information so that every module is fully interactive. The result of this vast and easy to use data base is unique. You'll be amazed at how much better you'll understand the operation and cash flow of your business! And better understanding means better planning — and higher profits for you!

The Data Base Integration System is built around the basic four accounting tools: General Ledger provides those all important balance sheets and income statements, Accounts Receivable and Payable take care of invoice control in a jiffy, while Payroll with Cost Accounting does your payroll and provides cost effectiveness data. All packages fully interact and are self-checking. The amazing Order-Right™ order entry system and MicroDaSys Inventory, give you one of the most complete sales management and material requirements systems available. Output is processed with lightning speed and meticulous accuracy: invoices, shipping labels, charge slips and COD tags. Orders automatically interact with Inventory and Receivables. If your stock is too low, Inventory recommends the best source of supply and approximate prices to pay. Upon authorization, a purchase order is generated. The receiving department verifies receipt and the invoice is transferred to Accounts Payable.

The Data Base Integration Business System is \$2500. And that's for all seven packages! Now there's a deal too good to pass up! It includes over 1500 pages of user documentation, and a supply of computer forms. With our unique DBI Installation Program, getting the complete package up and running on your system is a breeze. Best of all, complete CBASIC source code is included with every CBASIC package. Current disk formats include 8" soft-sectored, 5" hard- and soft-sectored.

Call or Write for the SolutionWare™ to meet your software needs — today!

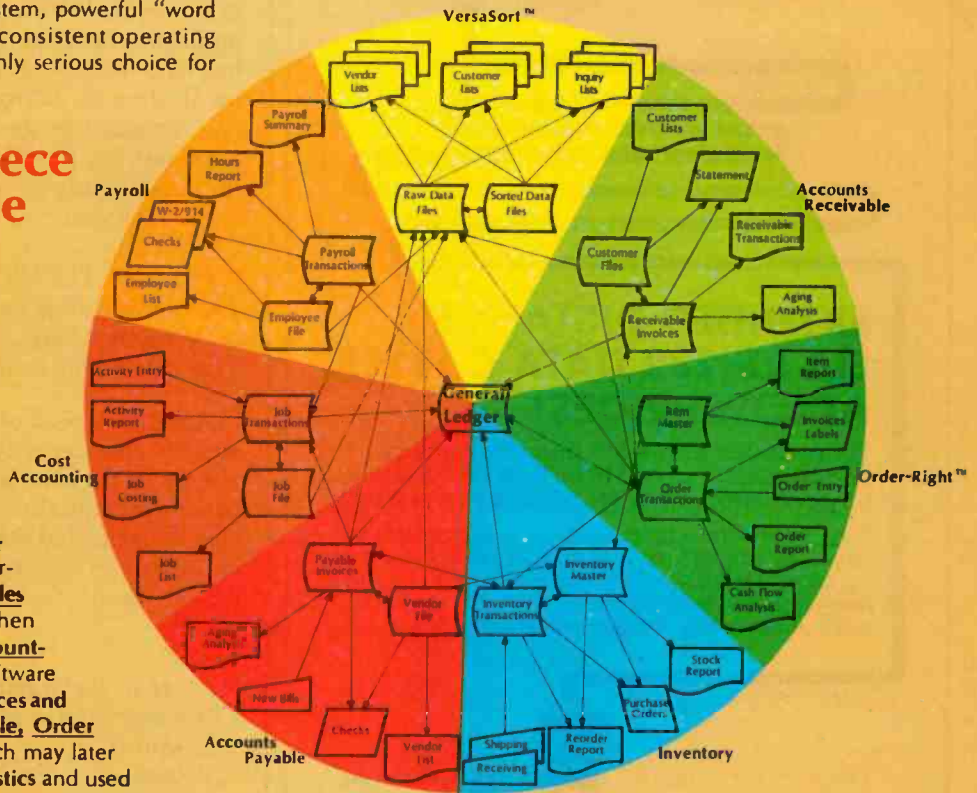

Ask your dealer why our business software is the best!



A Complete 200 page Overview of all SoftwareHows SolutionWare is yours for just \$75, refundable with purchase.

SOFTWARE HOWS™

a division of MicroDaSys

PO Box 36275 Los Angeles, CA 90036
(213)731-0876 TWX:910-321-2378

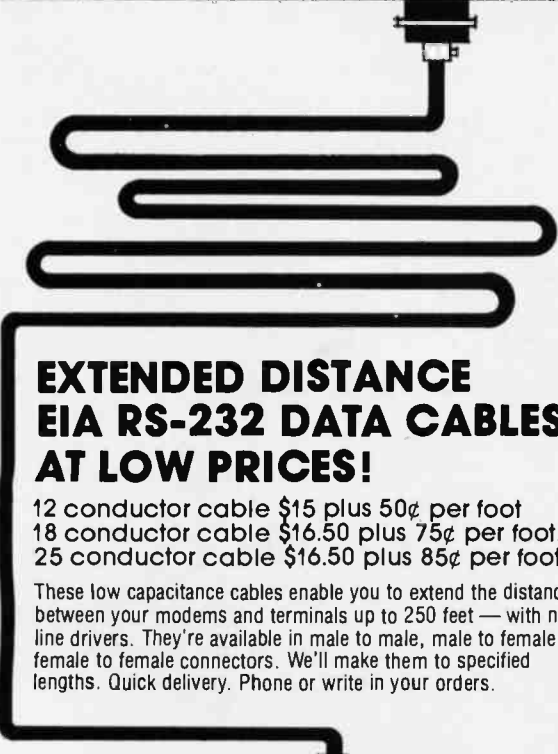

**EXTENDED DISTANCE
EIA RS-232 DATA CABLES
AT LOW PRICES!**

12 conductor cable \$15 plus 50¢ per foot
18 conductor cable \$16.50 plus 75¢ per foot.
25 conductor cable \$16.50 plus 85¢ per foot.

These low capacitance cables enable you to extend the distance between your modems and terminals up to 250 feet — with no line drivers. They're available in male to male, male to female or female to female connectors. We'll make them to specified lengths. Quick delivery. Phone or write in your orders.



**INTERNATIONAL
DATA
SCIENCES, INC.**

7 Wellington Rd., Lincoln, R.I. 02865
Tel. (401)333-6200. TWX(710)384-1911
Export: EMEC, 2350 S. 30th Ave., Hallandale, Florida 33009 Telex 51-43-32

TURTLES

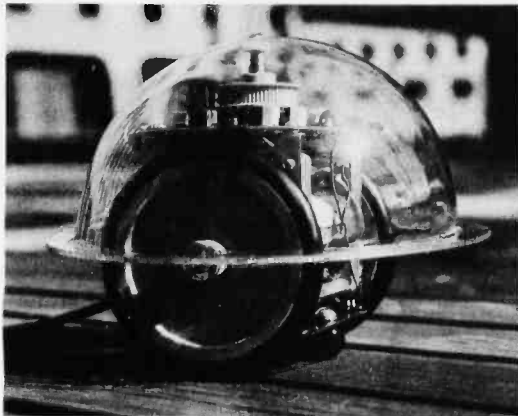

TEACH

Fantastically fun, the Terrapin™ Turtle rolls, blinks, beeps, draws, and feels. Learn, teach and demonstrate geometry, assembly and high level programming, life sciences, Artificial Intelligence. Interface this small home robot to TRS-80, APPLE, DEC—any digital computer (not included).

Send for brochure and prices.



Terrapin, Inc.

Terrapin, Inc.
678 Massachusetts Ave. # 205
Cambridge, Mass. 02139
617-692-8816

be in only one place at one time. Things like water, which can potentially be infinitely finely divided, are difficult to implement in *Zork* for this reason. Consequently *Zork* has two "water" objects; one for water in general (flowing in streams, filling reservoirs, leaking from pipes) and one for water in the player's possession (in a bottle, for example). In handling water, the general sort always eventually ends up as the specific sort, and exceptions aren't tolerated:

> FILL BOTTLE WITH WATER

The bottle is now full of water.

> POUR WATER

The water spills to the ground and evaporates.

Another aspect of containment involves problems of weight and capacity. The weight of an object must always be the sum of its own weight and the weight of its contents. Naturally, each of the contained objects has its weight calculated the same way. On the other hand, the volume of an object is filled only by the size of the objects directly in it.

LOOK

You are in the magic boat.

The magic boat contains:

A shovel.

A lamp.

A solid-gold coffin.

The solid-gold coffin contains:

A brown sack.

The brown sack contains:

A lunch.

A clove of garlic.

Of course, containers have other properties. They can be open or closed, opaque or transparent, locked or unlocked.

> INVENTORY

You are carrying:

A glass bottle.

The glass bottle contains:

A quantity of water.

> DRINK WATER

I can't reach the quantity of water.

> OPEN BOTTLE

Opened.

> DRINK WATER

Thank you very much. I was rather thirsty.

The concept of a *surface* is implemented as a special kind of containment. Objects which have surfaces on which other objects may sit are actually containers with an additional property of "surfaceness."

Vehicles are an even more specialized case of containers. A vehicle has a property called the *action property* that is allowed a chance to give special handling to any input of the player. For example, a spaceship vehicle might want to restrict the player's movement during the acceleration phase of a flight or prevent him from taking objects that are outside the ship.

Possibly the most useful concept in *Zork* is that of *time*. An arbitrary event may be scheduled to occur at an

FIDELITY

WINS BOTH WORLD AND NORTH AMERICAN MICROCOMPUTER CHAMPIONSHIPS!



The same engineers who helped win the "First World Microcomputer Chess Championships" in London, England and the "First Official North American Microcomputer Chess Championship in San Jose, California, proudly introduce Fidelity's newest Microcomputer bridge product...

LONDON, ENGLAND
September 4, 5, 6
1980

SAN JOSE, CALIFORNIA
September 5, 6, 7
1980

VOICE BRIDGE CHALLENGER®

One Of
The World's
Most Popular
Card Games
Housed In The Mind
Of A Microprocessor
And It Talks
To You!

ALFRED SHEINWOLD, noted Bridge Expert, says of Voice Bridge Challenger: "I have been to the Future, and it works!"

Voice Bridge Challenger® is skillfully engineered and programmed to be a worthy partner or opponent. In fact, if you're alone, Challenger® will bid and play the other three hands... you'll have a computer as your partner and two computer opponents! Challenger® will also play one, two, or even all four hands if you wish.

Voice Bridge Challenger® clearly and audibly announces all bids and plays, using accepted bridge terminology. Challenger's® bidding is based primarily on Standard American, also includes some aspects of such European systems as ACOL, and makes use of up to nine well-known conventions. During the play of the hand, it forms and executes a plan of action much like a human player.



Many outstanding features include: an optic scanner that quickly reads custom coded playing cards; optional random dealing of hands without using the cards and scanner; indicators showing the Dealer and vulnerability; reviews of the bidding and of the last trick; automatic replay by the Computer of a deal you have just completed (making it easy for you to play duplicate bridge against the Computer), and instant response. And it even keeps score!

Voice Bridge Challenger®... a great bridge-playing companion for the beginner or bridge enthusiast. Available at fine stores everywhere.

The world's largest manufacturer of self-contained, microprocessor based, board games.



FIDELITY ELECTRONICS, LTD.

8800 N.W. 36th STREET, MIAMI, FLORIDA 33178

Quality made in U.S.A. ♣

arbitrary time in the future: for example, the discharging of the batteries in a lantern is controlled in this way.

Introducing time also introduces some problems. If an event is scheduled, the circumstances under which it is valid must be coded into it. Otherwise, the behavior of the game can appear nonsensical. Suppose the player lights the fuse on some dynamite. If he sticks around, he will be blown to smithereens. He runs away, only to find that the dynamite has apparently followed him. He still gets blown up because, when the explosion happens, the program doesn't check to see if he is still there.

One method of dealing with players who are "killed" in *Zork* is to resurrect them in a forest. In an early version of *Zork*, it was possible to be killed by the collapse of an unstable room. Due to carelessness with scheduling such a collapse, 50,000 pounds of rock might fall on your head during a stroll down a forest path. Meteors, no doubt.

In an effort to introduce a little more randomness into what was at one time a deterministic game, we added fighting. The player was allowed to attack any of the monsters or other characters he encountered during his travels. The scheme we implemented is conceptually simple. There is a range of possible outcomes for any attack, either by the player on a villain or vice versa. You can be killed outright, knocked unconscious, wounded, wounded seriously, staggered, or you can have your weapon knocked from your hand.

The villain, each time it is his turn to riposte, has the option of parrying or turning and running (if he is not limited to one room, as the troll is). Some weapons are better against certain opponents than others. The relative

strengths of player and opponent figure into the outcome as well (the player's strength is a function of health and progress in the game). The results are a selection of appropriate messages describing the fight as it progresses.

> KILL THIEF WITH SWORD

Clang! Crash! The thief parries.

> AGAIN

The thief receives a deep gash on his side.

> KILL

The thief slowly approaches, strikes like a snake, and leaves you wounded.

> ATTACK

The thief is disarmed by a subtle feint past his guard. The robber, somewhat surprised at this turn of events, nimbly retrieves his stiletto.

> KILL THIEF

A good stroke! Blood wells down the thief's leg. You evidently frightened the robber. He flees, but the contents of his bag fall to the floor.

Well, he may live to fight another day, but you recovered some of his booty. Fighting in *Zork* is pretty primitive when compared to real life or even to a "melee" in the popular game *Dungeons and Dragons*. You could make combat more elaborate, and in fact there are CFS games that have gone in that direction, producing quite realistic "hack and slash" games.

Possibly, the most enjoyable aspect of writing *Zork* was designing the other characters the player may encounter. *Zork* contains various other actors, including a troll, a thief, a wizard, various monsters and friendly gnomes, and a beautiful princess. Some of these are pretty simple. The troll is basically an obstacle. He doesn't move but merely bars the way and must be defeated by force of arms.

The thief, on the other hand, is embodied by a complex program. After a while, he begins to take on a personality of his own: the slightly down-at-the-heels younger son of a noble family, perhaps. He is cultivated but has a rather nasty sense of humor. For example, his idea of fun is to foul up the standard Adventure maze-mapping technique of identifying rooms by dropping objects in them. When he finds a player doing that, he will wander around switching objects, no doubt chuckling all the while:

You are in a maze of twisty little passages, all alike.

> DROP KNIFE

Dropped.

In the distance, you hear a voice saying, "My, I wonder what this fine rope is doing here?"

Some actions of the thief are motivated by the characterization; he is unlikely to kill you during a fight if he knocks your weapon out of your hand—too well bred. On the other hand, maybe his thieflly reflexes will get the better of him Many of the thief's actions are motivated by simple probability. There is a certain chance he will stop in any room while roaming around, a certain probability that he will steal any particular object (high for treasures, of course), and a probability that he will decide to attack the player. His behavior, nonetheless, can seem very realistic: Sometimes he seems to dog

DEC LSI-11 Components

Dependable service
at discount prices

Domestic
and Export

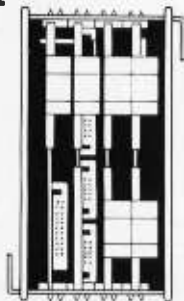

Mini
Computer Suppliers, Inc.

25 Chatham Rd., Summit, N.J. 07901
Since 1973

(201) 277-6150 Telex 13-6476

©Mini Computer Suppliers, Inc.
1979

MULTI-USER OASIS HAS THE FEATURES PROS DEMAND. READ WHY.

(THEN COMPARE.)

Computer experts (the pros) usually have big computer experience. That's why when they shop system software for Z80 micros, they look for the big system features they're used to. And that's why they like Multi-User OASIS. You will too.

DATA INTEGRITY: FILE & AUTOMATIC RECORD LOCKING

The biggest challenge for any multi-user system is co-ordinating requests from several users to change the same record at the same time.

Without proper co-ordination, the confusion and problems of inaccurate or even destroyed data can be staggering.

Our File and Automatic Record Locking features solve these problems.

For example: normally all users can view a particular record at the same time. But, if that record is being updated by one user, automatic record locking will deny all other users access to the record until the up-date is completed. So records are always accurate, up-to-date and integrity is assured.

Pros demand file & automatic record locking. OASIS has it.

SYSTEM SECURITY: LOGON, PASSWORD & USER ACCOUNTING

Controlling who gets on your system and what they do once they're on it is the essence of system security.

Without this control, unauthorized users could access your programs and data and do what they like. A frightening prospect isn't it?

And multi-users can multiply the problem. But with the Logon, Password and Privilege Level features of Multi-User OASIS, a system manager can specify for each user which programs and files may be accessed — and for what purpose.

Security is further enhanced by User Accounting — a feature that lets you keep a history of which user has been logged on, when and for how long.

Pros insist on these security features. OASIS has them.

EFFICIENCY: RE-ENTRANT BASIC

A multi-user system is often not even practical on computers limited to 64K memory.

OASIS Re-entrant BASIC makes it practical.

How?

Because all users use a single run-time BASIC module, to execute their compiled programs, less

memory is needed. Even if you have more than 64K, your pay-off is cost saving and more efficient use of all the memory you have available — because it services more users.

Sound like a pro feature? It is. And OASIS has it.

AND LOTS MORE...

Multi-User OASIS supports as many as 16 terminals and can run in as little as 56K memory. Or, with bank switching, as much as 784K.

Multi-Tasking lets each user run more than one job at the same time.

And there's our BASIC — a compiler, interpreter and debugger all in one. An OASIS exclusive.

Still more: Editor; Hard & Floppy Disk Support; Keyed (ISAM), Direct & Sequential Files; Mail-Box; Scheduler; Spooler; all from OASIS.

Our documentation is recognized as some of the best, most extensive, in the industry. And, of course, there's plenty of application software.

Put it all together and it's easy to see why the real pros like OASIS. Join them. Send your order today.

OASIS IS AVAILABLE FOR SYSTEMS: Altos; CompuCorp; Cromemco; Delta Products; Digital Group; Digital Microsystems; Dynabyte; Godbout; IBC; Index; Intersystems; North Star; Onyx; SD Systems; TRS 80 Mod II; Vector Graphic; Vorimex

CONTROLLERS: Bell Controls; Cameo; Corvus; Konan; Micromation; Micropolis; Tarbell; Teletek; Thinkertoys; X Comp.

Write for complete, free Application Software Directory

PLEASE SEND ME:

Product	Price with Manual	Manual Only
OPERATING SYSTEM (Includes: EXEC Language; File Management; User Accounting; Device Drivers; Print Spooler; General Text Editor, etc.)	\$150 350	\$17.50 17.50
BASIC COMPILER/INTERPRETER/DEBUGGER	100	15.00
RE-ENTRANT BASIC COMPILER/INTERPRETER/DEBUGGER	150	15.00
DEVELOPMENT PACKAGE (Macro Assembler; Linkage Editor; Debugger)	150	25.00
TEXT EDITOR & SCRIPT PROCESSOR	150	15.00
DIAGNOSTIC & CONVERSION UTILITIES (Memory Test, Assembly Language, Converters; File Recovery; Disk Test; File Copy from other OS, etc.)	100	15.00
COMMUNICATIONS PACKAGE (Terminal Emulator; File Send & Receive)	100	15.00
PACKAGE PRICE (All of Above)	500 850	60.00 60.00
FILE SORT	100	15.00
COBOL-ANSI '74	750	35.00

Order OASIS from:
Phase One Systems, Inc.
7700 Edgewater Drive, Suite 830
Oakland, CA 94621
Telephone (415) 562-8085
TWX 910-366-7139

NAME _____
STREET (NO BOX #) _____
CITY _____
STATE _____ ZIP _____
AMOUNT \$ _____
(Attach system description;
add \$3 for shipping;
California residents add sales tax)
 Check enclosed VISA
 UPS C.O.D. Mastercharge
Card Number _____
Expiration Date _____
Signature _____



MAKES MICROS RUN LIKE MINIS

Data Terminals Fast ...from MICROMAIL



DIABLO 630

- Uses metallized or plastic print wheels.
- Automatic bi-directional printing.
- Maximum print speed is 40 characters/second.

\$1999.00

Optional Forms Tractor - \$200.00

DIABLO 1650

R.O. \$2890.00
KSR \$3155.00

DIABLO 1640

R.O. \$2745.00
KSR \$3050.00



ANADEX DP-9500/9501

- High Density Graphics
- Parallel, RS-232C, and Current Loop Interfaces standard.
- 9-wire print head, 650 million character life.
- Bi-Directional printing with shortest distance sensing logic.
- Adjustable width tractor paper feed.

\$1399.00

ANADEX DP 8000

\$899.00

ANADEX DP 9000

\$1299.00



DECwriter LA 34

Options: **\$969.00**

- Numeric keypad - \$80.00
- Adjustable forms tractor - \$130.00

Model 'AA' \$1,099.00

T.I. 810

- Includes upper/lower case option.
- Bidirectional printing at 150 cps.
- Tractor-feed forms, 3" to 15" wide.

\$1599.00

Options:

- Forms length control - \$100.00
- Vertical Format Control with Compressed Print - \$125.00



TELETYPE 43

\$999.00

SOROC IQ 120

\$689.00

SOROC IQ 140

\$1099.00

TELEVIDEO 912/920

- Insert/delete line, insert/delete character, line/page erase.
- Reverse video, blinking, underline, 1/2 intensity, protected field, blank security field.
- Uses 7 x 10 dot matrix for a high quality w/ case display with descenders.

912 C \$795.00

Write or Call In for Our Free Catalogue!



TO ORDER: Send check or money order to: MICROMAIL, P.O. Box 3297, Santa Ana, CA 92703. Personal or company checks require two weeks to clear. All equipment includes factory warranty.

SHIPPING: We ship freight collect by UPS when possible. Larger terminals are shipped by motor freight. Air and express delivery is available on all products.

HANDLING: All orders are subject to MICROMAIL's handling charges. Less than \$750.00, add 3%. \$750.00 to \$2,000.00, add 2%. Over \$2,000.00 add 1%.

the player, who no sooner finds a treasure than the thief filches it.

There is a rich range of possibilities in producing games in which characters in the story (other than the player) act more like real people and less like monsters or one-dimensional villains. But the simulation of human behavior is still an unsolved problem in the field of artificial intelligence. The best approximations to date have been the classic simulations of a nondirective psychotherapist (Weizenbaum's Eliza) and of a psychotic paranoid (Colby's Parry). But even they would not make very interesting characters in a story. (These two curious beings actually met once, as recorded in "Parry Encounters the Doctor" by Vinton Cerf, in *Datamation*, July 1973.)

There are other, more mundane areas in which *Zork* could be extended. For example, take a simple concept like clothing. If the player can reference his clothing (or even a magic ring he might be wearing) some interesting questions arise. Is there a distinction between wearing something and carrying something? Probably, because when the player says "drop all," he probably doesn't mean to include his clothes. Also, the existence of clothes probably means the definition of many parts of the body. You could take this to extremes:

> INVENTORY

You are empty-handed.

You are wearing a diamond ring on your right index finger.

You are wearing bells on your toes.

You are wearing a coonskin cap on your head.

Of course, if you implement clothes, there might as well be pockets, and backpacks, and other "different" sorts of containers. It would have to be defined whether the player can reference things inside them (what if the flap of the backpack is closed, for example?). What happens if he falls into a lake? Do the clothes drag him down? What about wearing a suit of armor? Clothes probably need a weight or need to produce a fatigue effect on the player.

The mention of falling into a lake brings up another possible extension to *Zork*. Currently players aren't allowed to swim. One reason was to avoid the problems associated with the player's belongings dragging him under. Another is the question of what happens to his belongings. Do they get wet? If so, do they ever dry out again? What about wet matches (to give one example)? Is wet paper still burnable? How long can the player swim? Can he hold his breath and swim underwater? There are any number of questions that have to be considered if such a feature is to be implemented.

Even the addition of a run-of-the-mill object can produce complications. In early versions of *Zork*, the troll's axe disappeared when he was killed. We finally decided to let the player recover it, as advances in *Zork* weapons technology removed the reason for destroying it. Unfortunately, we didn't think it through. One of our best play testers, on hearing that "you can finally get the axe," immediately said, "Great, I'm going to go up to the forest and chop down some trees." Oops. We never thought of that, not to mention using the axe to chop through doors, split timbers, and any number of other commonplace uses for something we were thinking of strictly as a weapon.

Circle 118 on Inquiry card.

When You Have To Face A Deadline



Communication Arts, Huntington Beach, CA

Arm Yourself With Pascal/MT+[®]

From

MT Micro SYSTEMS



1562 Kings Cross Drive
Cardiff, California 92007 (714) 753-4856

We ship on 8" single density and 5-1/4" North Star single density.
Other formats available. Ask us.

CP/M is a registered trademark of Digital Research MP/M is a trademark of Digital Research Pascal/MT+ is a registered trademark of MT Micro Systems

Circle 119 on inquiry card.

The authors of *Zork* have thought about several possible extensions to the *Zork* parser. One that has come up many times is to add adverbs. A player should be able to do the following:

> *GO NORTH QUIETLY*

You sneak past a sleeping lion who sniffs but doesn't wake up.

The problem is to think of reasons why you would not do everything "quietly," "carefully," or whatever. Perhaps there should be time and fatigue penalties for doing things in a nonstandard way:

> *SEARCH WALL CAREFULLY*

This would take a long time (and all the while the lamp is burning down), possibly tiring the player out. To be fair to the player, he should not need to search every wall carefully, or walk quietly everywhere. There should be reasonable clues or hints as to why and where he should do such things.

This long discussion of the problems of extending *Zork* is not intended to scare anyone (including the authors of the game). The idea is to show that apparently simple extensions to the game have their nonobvious ramifications. Of course, it would be simple to ignore them, but we think that the authors of a game should play fair with the players. Just as it's disappointing to see the wires holding up Flash Gordon's spaceship, it's disappointing to see:

> *PUT RING ON FINGER*

I don't know the word 'finger'.

We authors would hardly claim that *Zork* is perfect in this respect, but we have made an effort in that direction. When we add something new, we try to think of how the player might try to use it and what verbs he might try to apply to it. Within the space available, we've tried to put most of those things in.

All the CFS games that I have encountered are similar in one major respect: they are about problem solving and the acquisition of treasure. This is probably because a structure containing problems and rewards is obvious and easy to implement.

It is possible to imagine games in which the goals are different. Some programmers in southern California have designed a game in which the moral choices the player makes have a significant impact on the game. For example, does the player give an old man some water? Similarly, the problem-solving idea could be shifted into something closer to scientific research. The player could be introduced into an environment where he performs experiments, ponders the results, and ultimately gains understanding and control of that environment.

Innovations in form as well as content are possible. There are already CFS games that try to give the player a graphic view of his surroundings. As microcomputer technology advances, this will become more common, and the renditions will achieve higher quality: it will be technically feasible to have a CFS game "illustrated" by Frank Frazetta or Jeff Jones. On the other hand, the player's imagination probably has a more detailed picture of the Great Underground Empire than could ever be drawn. I can even recall discussions among the game's implementors over who should play the thief in the movie version.

Another area where experimentation is going on is that of multiplayer CFS games. Each player (possibly not even aware how many others are playing) would see only his own view of the territory. He would be notified when other players enter or leave the room, and could talk to them. There was briefly a multiplayer version of the PDP-10 *Zork* several years ago, and today there is a "Multiple User Dungeon" at Essex University in England.

There are major problems, however. One is producing problems that are compatible with different numbers of players (from one to, say, a dozen). If it takes five players to solve a problem (one to hold the light bulb and four to turn the ladder?), what happens if only two people are playing? The other problem, as far as the microcomputer owner is concerned, is that few can afford an unlimited number of machines or even video monitors to accommodate so many players.

CFS games as an art form can continue to grow as long as their medium continues to grow. *Zork* is already constricted by the size of today's microprocessors (it was large even on the PDP-10), but the new generations of 16- and 32-bit machines offer the opportunity of enormous further growth. The possibilities of new concepts, new milieux, and new purposes are enormous. We would like to think that it will not be long before authors view such scenarios as just another medium of expression. I find the prospect exciting because I enjoy playing CFS games as much as writing them. ■

779 UPPER CASE/lower case "Conversion Kit I"

Expand the capabilities of your 779 line printer to include word processing!! Available to all Centronics 779 and TRS 80 Printer I owners is the option of lower case and changing slash 0 Zero to standard O. No etch cuts or soldering needed. Installs in minutes with a screwdriver. No program modification or additional interface is required. **Price \$125.00**

UPPER/LOWER CASE NOW AVAILABLE FOR THE FOLLOWING CENTRONICS PRINTERS:

101AL, 102BL, 306, 500, 501, 503, 700, 701, 702, 703, 780, 781.

Motor Control "CONVERSION KIT II" FOR ALL CENTRONICS 779 & TRS 80 PRINTER I LINE PRINTERS!!

Our "Conversion Kit II" Motor Controller gives your 779 the ability to turn the motor on and off automatically. Removes the annoying noise of constant run, increasing the life span of your 779 and TRS 80 line printer motor! No soldering, software or hardware changes needed. Installs easily. **Price \$95.00**

SAVE! Buy Service Technologies "Conversion Kit I" and "Conversion Kit II" together for the single price of **\$199.00**

To order, please send check or money order in the proper amount to:



Service Technologies, Inc.
32 Nightingale Rd.
Nashua, N.H. 03062
(603) 883-5369

Visa and Master Charge accepted (please include signature, expiration date and phone number).

DEC® LSI® 11/23 COMPUTERS \$6750 and we're delivering from stock!



CI-103 DESK TOP COMPUTER. Available with LSI 11/23 or LSI 11/2. Complete computer system enclosed within a VT-103 video terminal, immediate delivery. Only \$4500 with LSI 11/2 and 64K Memory. \$6750 with LSI 11/23 and 96K Bytes Memory.

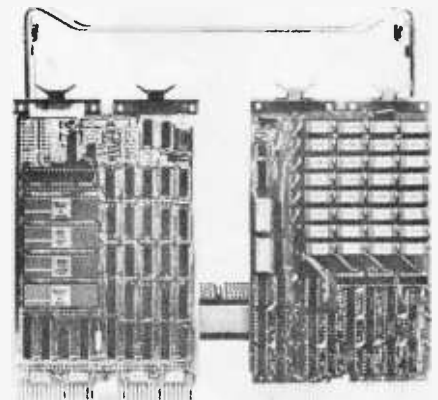
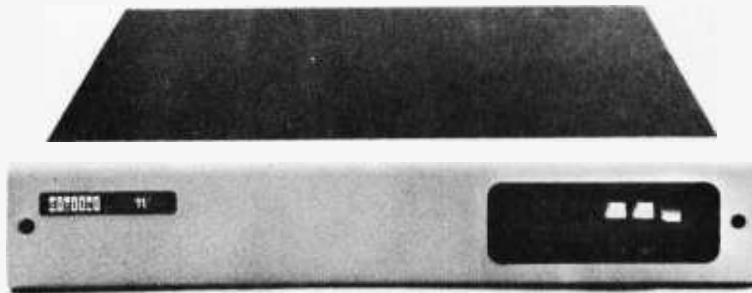

PDP 1103SE — LSI 11/2 CPU, 64KB Memory, power supply, KEV 11 in 8 slot rack mountable chassis. \$2695

CI 1103LK — LSI 11/2 CPU, 64KB Memory, power supply, KEV 11 in 16 slot rack mountable chassis. \$2750

CI-11/23 AC — LSI 11/23 CPU, MMU, 256KB Memory, power supply, in 16 slot rack mountable chassis. \$6895

LSI 11/2 CPU card with 64K Byte Memory. \$1095

1 Megabyte RX02 Floppy Disk System. \$3045

RT11 V4 Operating System. \$1085

RSX11M Operating System. \$3250

VT100AA Video Terminal. \$1795



Chrislin Industries, Inc.

Computer Products Division

31352 Via Colinas • Westlake Village, CA 91362 • 213-991-2254

DEC, LSI, PDP, are Trademarks of Digital Equipment Corp

**Today one dollar buys
1/3 of a business phone call.**



Today one dollar buys 6¼ readers who actually see your sales message.



As your selling dollar buys less and less, it pays more and more to advertise in McGraw-Hill magazines.

As prices keep going up and up, McGraw-Hill magazines help 10.8 million decision-makers keep costs down.

For example, *Chemical Week* told chemical processing managers and professionals how exports credits could lower their debt-servicing costs. And *Engineering News-Record* showed the construction industry how to cope with the destructive effects of the 1981 federal budget.

By helping 10.8 million readers solve their inflation problems, we help you solve yours.

Today, the price of reaching one potential customer in McGraw-Hill magazines is only 16¢.¹ This compares to a cost of \$6.07 for sending a business letter,² over \$3.50 for a business phone call,³ and an in-person sales call which, believe it or not, now costs \$137.02.⁴

In times like these, when everything costs more, you may be tempted to spend less on your advertising budget. But our Laboratory of Advertising Performance (LAP) Report #5262 demonstrates that "Industrial companies that maintained or increased their advertising expenditure during the 1974-75 recession enjoyed higher sales growth than those that cut advertising." Write 1221 Avenue of the Americas, New York, N.Y. 10020 for LAP Report #5262 today. And let us help you make your advertising more efficient, as the price of all other selling tools becomes more expensive.

¹One reader-noted impression in the average McGraw-Hill publication. ²The Dartnell Institute of Business Research. ³"Telephone Marketing" by Murray Roman. P. 87, McGraw-Hill 1976. ⁴Laboratory of Advertising Performance Report #8013.5, McGraw-Hill Research.

McGraw-Hill Magazines



With inflation,
we're an even better buy.

Character Variation in Role-Playing Games

Jon Freeman
Automated Simulations Inc
1988 Leghorn St
Mountain View CA 94043

Editor's Note: This issue is concerned with *Adventure* and its variants. Some *Adventure* enthusiasts will claim that games like *Automated Simulations' Morloc's Tower* (see a review of this game on page 84) are not really *Adventures*. To see that this is rightly so, contrast this article by Jon Freeman, creative director for *Automated Simulations*, with the *Adventure* article, "On the Road to *Adventure*," by Bob Liddil (page 158).

But this is not to say that the *Dunjonquest* games and an increasing number like them are not "as good as" the more conventional command-and-answer *Adventure* games. Rather, they emphasize a different set of values that capture the player's imagination in another, equally engaging way. Players of *Dungeons and Dragons* and other role-playing games will find a lot of the *Dungeons and Dragons* philosophy used in *Automated Simulations' Dunjonquest* games. Unlike *Dungeons and Dragons*, however, computer-aided games of this sort have the advantage of running in real time. A fight that could take 15 minutes to resolve in *Dungeons and Dragons* will only take 10 seconds to resolve with these games, so you'd better be fast on your keyboard! . . . GW

The peculiar attraction of *Dungeons and Dragons*, *Tunnels and Trolls*, *Traveller*, and other similar games stems, I believe, from two things: open-endedness and role-playing. Anything can happen: as a player in such a game, you may be attacked by 1,000 goblins or a jealous lover, contract a disease, acquire a new suit of armor, or inherit one hundred dollars—er, gold pieces. Anything can be done, from fighting a dragon to begging a wizard's forgiveness, from besieging a castle to kissing a frog. And it never stops, except temporarily: there is no final victory,

There is no role-playing in games of the *Adventure/Zork* family.

no point to playing except playing, and no ultimate aim except the continuing development of your "character"—the alter ego who stalks the imagined landscape in your stead.

Even microcomputers in a fraction of a second can make complicated calculations that would take a *Dungeons and Dragons* referee minutes of page-turning and piles of charts. However, no computer games can handle all the aspects alluded to above as well as the best-run noncomputer games. Computer-based games can therefore be grouped according to which aspects they emphasize and which they ignore.

There is no real role-playing, for instance, in the *Adventure/Zork* family: the protagonist is just you in a strange setting. Games of that sort concentrate on the perceived open-endedness of action: not only is there a multitude of command options available (typically far more than *Dunjonquest's* eighteen or so), but also they are not made known to you except by trial and error. It can be quite challenging to find the right key, the right moment, and the right command necessary to insert it in the right lock; but once you do, the door will open—always. Thus, a game like *Adventure* is really a puzzle that, once solved, is without further interest.

Character Variation in *Dunjonquest*

The *Dunjonquest* series employs a different approach. For one thing, situations are primarily defined graphically, not textually: you see the situation rather than just being told about it. More to our present purpose, while some *Dunjonquest* games, like *Morloc's Tower*, have a specific object (finding and slaying the mad and elusive wizard *Morloc*), there is an open-endedness of result in all of them on the micro level (if you'll excuse a small pun). Generally speaking, there are no "right" answers; the outcome of events is probabilistic, not predetermined.

Brian Hammerhand, the assigned alter ego/protagonist of *Morloc's Tower* and *The Datestones of Ryn*, can, for example, slay a dire wolf nine times out of ten, but on any particular occasion he may survive the encounter unscratched, or limp away badly mauled and out of breath—and there is also that tenth time. Moreover, the exact outcome of any encounter depends both on the tactics you choose and on the specific traits of your surrogate character. The experience is different every time you play and quite different with each new character you take on your adventure. You are role-playing: getting outside yourself and into the skin of another (albeit imaginary) being.

In *The Temple of Apshai*, *Hellfire Warrior*, *The Cliffs of Tyyr*, and others in the *Dunjonquest* series, six traits or attributes are used to distinguish *Samson the Strong* from *Cugel the Clever*, and *Dorgon the*

A Microcomputer for everyone at a Micro Price

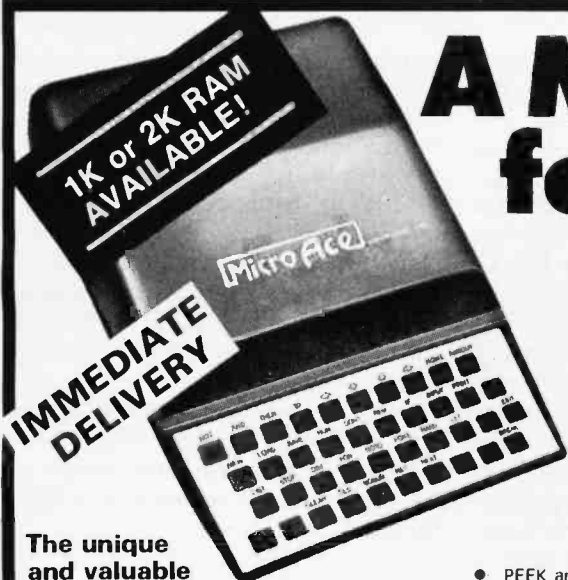

The **MicroAce** - a new generation of miniature computers
A COMPLETE COMPUTER for \$149.00 for 1K Kit

Post and Packing FREE

(Add 6% Tax for Shipments inside California)



The unique and valuable components of the MicroAce

The MicroAce is not just another personal computer. Quite apart from its exceptionally low price, the MicroAce has two uniquely advanced components: the powerful BASIC interpreter, and the simple teach yourself BASIC manual.

The unique versatile BASIC interpreter offers remarkable programming advantages:

- Unique 'one-touch' key word entry: the MicroAce eliminates a great deal of tiresome typing. Key words (RUN, PRINT, LIST, etc.) have their own single-key entry.
- Unique syntax check. Only lines with correct syntax are accepted into programs. A cursor identifies errors immediately. This prevents entry of long and complicated programs with faults only discovered when you try to run them.
- Excellent string-handling capability - takes up to 26 string variables of any length. All strings can undergo all relational tests (e.g. comparison). The MicroAce also has string input - to request a line of text when necessary. Strings do not need to be dimensioned.
- Up to 26 single dimension arrays.
- FOR/NEXT loops nested up to 26.
- Variable names of any length.
- BASIC language also handles full Boolean arithmetic, conditional expressions, etc.
- Exceptionally powerful edit facilities, allows modification of existing program lines.
- Randomise function, useful for games and secret codes, as well as more serious applications
- Timer under program control.

- PEEK and POKE enable entry of machine code instructions, USR causes jump to a user's machine language sub-routine.
- High-resolution graphics with 22 standard graphic symbols.
- All characters printable in reverse under program control.
- Lines of unlimited length.

'Excellent value' indeed!

For just \$149.00 (excluding handling charge) you get everything you need to build a personal computer at home... PCB, with IC sockets for all ICs; case; leads for direct connection to a cassette recorder and television (black and white or color); everything!

Yet the MicroAce really is a complete, powerful, full-facility computer, matching or surpassing other personal computers at several times the price.

The MicroAce is programmed in BASIC, and you can use it to do quite literally anything, from playing chess to managing a business.

The MicroAce is pleasantly straightforward to assemble, using a fine-tipped soldering iron. It immediately proves what a good job you've done: connect it to your TV ... link it to the mains adaptor ... and you're ready to go.

Fewer chips, compact design, volume production-more power per Dollar!

The MicroAce owes its remarkable low price to its remarkable design: the whole system is packed on to fewer, newer, more powerful and advanced LSI chips. A single SUPER ROM, for instance, contains the BASIC interpreter, the character set, operating system, and monitor. And the MicroAce 1K byte

RAM (expandable to 2K on board) is roughly equivalent to 4K bytes in a conventional computer - typically storing 100 lines of BASIC. (Key words occupy only a single byte.)

The display shows 32 characters by 24 lines.

And Benchmark tests show that the MicroAce is faster than all other personal computers.

No other personal computer offers this unique combination of high capability and low price.

The MicroAce teach-yourself BASIC manual.

If the features of the BASIC interpreter mean little to you - don't worry. They're all explained in the specially-written book *free* with every kit! The book makes learning easy, exciting and enjoyable, and represents a complete course in BASIC programming from first principles to complex programs. (Available separately - purchase price refunded if you buy a MicroAce later.) A hardware manual is also included with every kit.

The MicroAce Kit:
\$149.00 with 1K COMPLETE
\$169.00 with 2K

Demand for the MicroAce is very high: use the coupon to order today for the earliest possible delivery. All orders will be despatched in strict rotation. If you are unsuccessful in constructing your kit, we will repair it for a fee of \$20.00, post and packing FREE. Of course, you may return your MicroAce as received within 14 days for a full refund. We want you to be satisfied beyond all doubt - and we have no doubt that you will be.

Z80 A microprocessor chip, widely recognised as the best ever made.

Sockets for TV, cassette recorder, power supply.

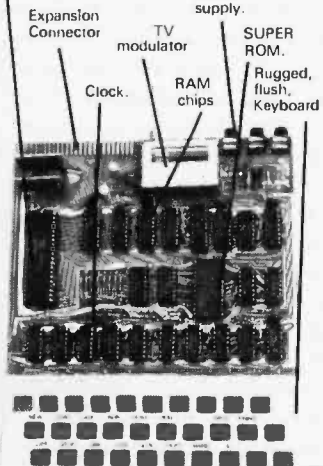

Your MicroAce kit contains...

- Printed circuit board, with IC sockets for all ICs.
- Complete components set, including all ICs - all manufactured by selected world-leading suppliers.
- New rugged keyboard, touch-sensitive, wipe-clean.
- Ready-moulded case.
- Leads and plugs for connection to domestic TV and cassette recorder. (Programs can be SAVED and LOADED on to a portable cassette recorder.)
- Mains adaptor of 600 mA at 9VDC nominal unregulated.
- FREE course in BASIC programming and user manual.

JOIN THE REVOLUTION - DON'T GET LEFT BEHIND - ORDER YOUR MICRO ACE NOW!!

Send Check, Money Order or quote your Credit Card No. to:
MicroAce 1348 East Edinger, Santa Ana, California, Zip Code 92705.
 or phone (714) 547 2526 quoting your Credit Card Number.

Quantity	Description	Unit Price	TOTAL
	MicroAce Kit 1K	\$149.00	
	MicroAce Kit 2K	\$169.00	
	Manual	\$10.00	
	1K Upgrade Kit	\$29.00	
Shipments inside California add 6% TAX		TOTAL	

- Amex.
- Diners
- Check
- Money Order
- Master Charge
- Visa

Card No. _____

Exp. Date _____

Name _____

Address _____

City _____ State _____ Zip _____

Still programming "by hand"?

Leave your hands and mind free to create new programs. Let PEARL handle the production of program code. Define your new programming ideas by answering PEARL's prompts. PEARL then writes your program code. Simply. Conveniently.

Available in three user levels . . . Level 1 for the personal-hobbyist non-programmer (\$130); Level 2 for business applications and those with programming skills (\$350); Level 3 for software developers (\$650).

Join the hundreds who use PEARL to create error-free code automatically. Interested? Need more information? Visit your nearest microcomputer dealer or call CPU today.



CPU International
P.O. Box 12892
Salem, Oregon 97309
(503) 370-8653

Dolt from either. Three traits (ego, intelligence, and intuition) cover the mental aspects of a character, and three traits (dexterity, strength, and constitution) cover the physical attributes. Each of these is assigned a number (randomly, if the program is creating the character) from a low of 3 to a high of 18—the equivalent of rolling three six-sided dice, which is how such characters are normally created in games like *Dungeons and Dragons*. (This commonality allows you to bring characters from "outside" into the Dunjonquest world.)

The numerical valuation permits the use of charts and tables, or computer calculations, to affect or resolve outcomes during the course of the adventure. It also permits $16^6 = 16,777,216$ different characters, which is enough to allow all the variation you could ask for if the system is set up to handle it.

Dexterity and Constitution

In the Dunjonquest systems, character variation affects the game in many ways. For instance, in any round of combat between an adventurer (you and your character) and a monster (dragon, troll, goblin, common thug, etc), there is a chance the character will strike the monster with his sword, and a separate chance that the monster will strike the adventurer with his teeth/claws/club/bad breath. *Dexterity*, representing a combination of reflexes, coordination, speed, etc, interacts with the adventurer's choice of weapons in a complex way to modify those combat probabilities.

Simply put, with a dexterity of 4, Cleavon the Clumsy has trouble keeping his shield out of his own way; he spends much of his time futilely slicing the air and is an easy target for attacking monsters. In contrast, Flash Farrad (dexterity 17) will hit his opponent far more often and will block more blows with his shield. Reasonably enough, since Farrad is better at hitting where he aims, his advantage over Cleavon extends to the amount of damage he is likely to do (but other factors — size of the weapon and strength of the sword arm — enter in; see the following).

Constitution, a measure of health and endurance, is perhaps the single most important trait, since it represents specifically the number of points of damage a character can sus-

tain before dying. A monster must do exactly three times as much damage to Steel Strongheart (constitution 18) to kill him as it would take to do in poor Ferdinand the Frail (constitution 6). (In fact, Ferdinand is too sickly to pass muster in the Dunjonquest character-generation sequence, which rejects hopelessly inferior characters.) Furthermore, Ferdinand will tire (from moving or fighting) three times as fast as Steel. Since fatigued characters must rest or risk falling easy prey to monsters through sheer exhaustion, even running away can be hazardous to unhealthy adventurers.

Strength and Ego

Strength measures how strong the character is and affects damage done in combat both directly and indirectly. Heavier weapons do potentially more damage, but not all characters can wield even a broadsword, and only the strongest can manage a hand-and-a-half sword one-handed. More directly, the nominal damage (obtained by a random "die roll" itself affected by dexterity and other factors) done by the adventurer to the monster he is fighting is multiplied by one-tenth the strength value to determine the gross damage done. On a "roll" that yields a nominal damage of five points, Nerdley the Not-so-Strong (strength 8) actually does only $5 \times .8 = 4$ points of damage, while Manfred the Mighty (strength 16) would receive $5 \times 1.6 = 8$ points of damage out of the same swing of a sword. Strength is also part of the complex algorithm used to calculate fatigue, which is, in part, related to the ratio between the amount of weight an adventurer is carrying at any moment and the square of his strength. Stronger characters can manage heavier armor and more treasures without strain.

Ego is a measure of mental toughness and willpower. In part, it expresses the differing reactions of people to stress: in a bad situation, Casper Milquetoast (ego 3) gives up, while Darvon the Determined (ego 16) redoubles his efforts. This translates into an increase (for Darvon) or decrease (for Casper) in the probability that either will strike the monster he is fighting; the value of the increase/decrease is dependent on the extent of their injuries.

In Dunjonquest games in which the

LIMITED EDITION

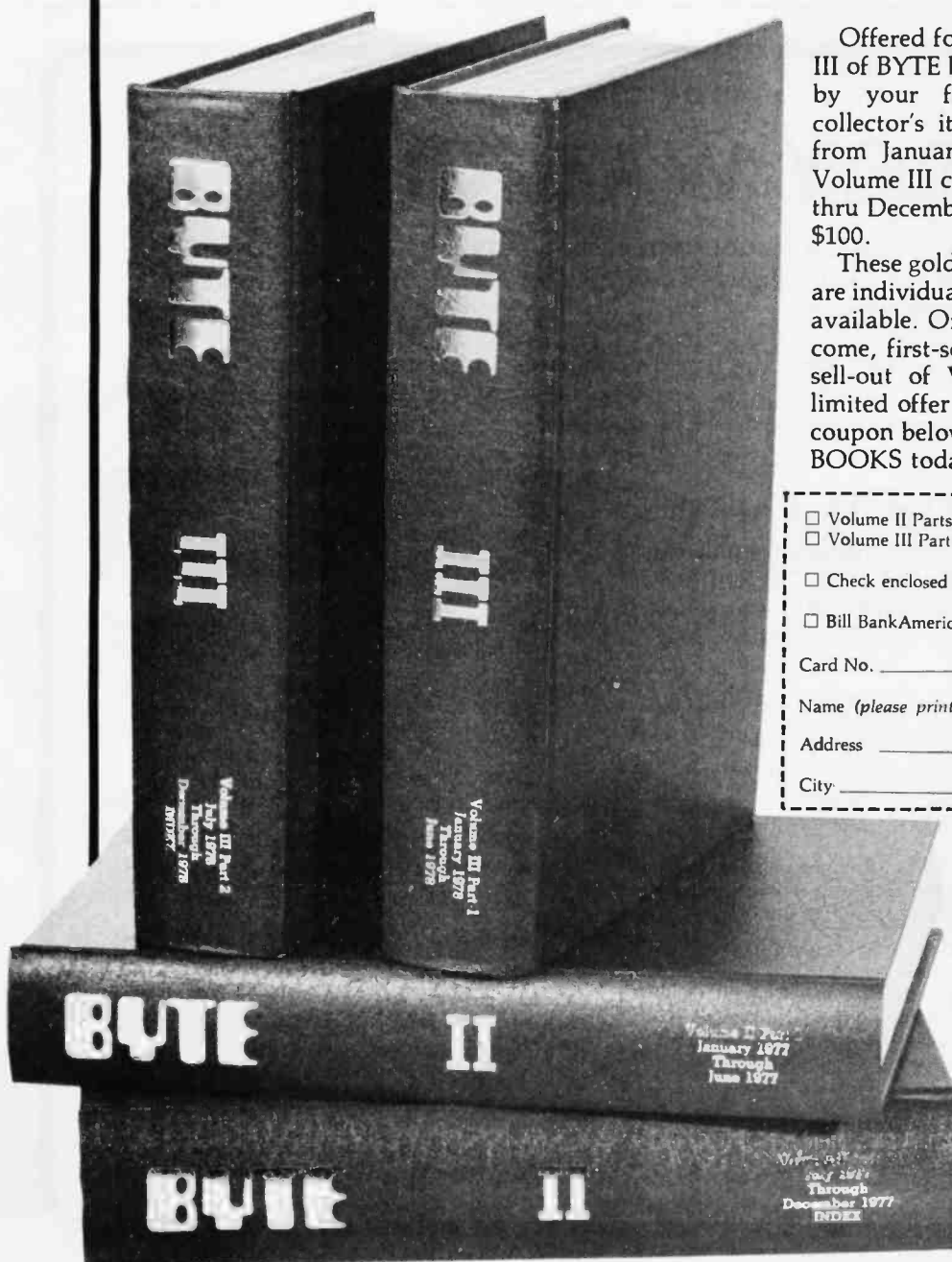

Offered for the first time, Volumes II and III of BYTE back issues, packed with articles by your favorite authors, are a real collector's item. Volume II contains issues from January '77 thru December '77 and Volume III contains issues from January '78 thru December '78. Each volume is priced at \$100.

These gold embossed, hard-cover volumes are individually numbered with only 100 sets available. Orders will be handled on a first-come, first-served basis. Based on our quick sell-out of Volume I, we know that this limited offer will sell rapidly. So fill out the coupon below and rush your order to BYTE BOOKS today.

- Volume II Parts 1 and 2 (Jan '77 thru Dec '77) \$100.00
- Volume III Parts 1 and 2 (Jan '78) \$100.00

**BYTE
BOOKS**

Check enclosed for _____

Bill BankAmericard/Visa Bill Master Charge

Card No. _____ Exp. Date _____

Name (please print) _____

Address _____

City _____ State _____ Zip _____



Call TOLL FREE: 800-258-5420
or

Mail to: BYTE Books, Inc.
70 Main Street
Peterborough N.H. 03458

protagonist is a magician, ego affects the power of a spell much the same way strength modifies a physical attack. In all games, ego is added to intelligence to determine the success of a character's attempt to parley with a monster. Finally, it interacts with intelligence in a more complex way to affect a character's ability to bargain in the Inn, Apothecary, and Magic Shoppe.

Intelligence and Intuition

Intelligence in *Dunjonquest* is limited to the "left-brain" powers of logical reasoning and verbal expression. Since it most closely represents that quality brought to bear on the game by you, the player, the character's intelligence affects play

less than any other attribute. It helps or harms the ordinary adventurer chiefly in his negotiations with monsters or the Innkeeper and company, and it controls the complexity of spells used.

The final attribute, *intuition*, is the complement of intelligence: it covers real and imagined "right-brain" functions like spacial perception, ESP, and luck. The probability of finding secret doors, traps, and monsters lurking in the next room is directly dependent on the attribute of intuition. Poul the Perceptive (intuition 15) finds secret doors with ease; Igor the Insensitive (intuition 5) finds traps only by falling into them.

All six attributes can be subtly and, to the player, often invisibly affected

by potions and magical devices, enhanced by experience, or decreased by "undead" monsters like spectres, shades, and such. In fact, by means of the subtle but significant effects of incremental alterations in each attribute, the speed and power of a computer allow for more meaningful variation in [and more objective evaluation of . . . GW] individual characters than would any noncomputer role-playing game yet published. Since monsters are even more complicated and individualized than adventurers, the variety of possible events and outcomes is truly mind-boggling. Once the hard-core fantasy enthusiasts realize this, even the referees may trade in their charts and tables for microcomputers. ■

SciTronics introduces the first small computer based power monitor . . .

NEW! ENERGY WATTCHER™

Now have your computer continuously measure, calculate and record your power consumption and cost. Receive energy reports every minute, 15 minute, hour, day and month period.

- Available for TRS-80-I, Apple II & S-100 computers.
- Easy installation clip-on probes supplied.
- Qualify for a 15% energy tax credit.
- Compatible with Remote Controller & Real Time Clock for complete Energy Management System.
- Inexpensive—only \$295.

Remote Controller & Real Time Clock Available

Have full computer control of up to 256 lights, appliances and even wall switches **without special wiring**. The SciTronics REMOTE CONTROLLER permits direct control of the inexpensive BSR remote line-carrier switches sold by Sears, Radio Shack and many others.

- Controls all 256 BSR remote switches—not just 16
- Hardware driven—requires minimal software
- No ultrasonic link—prevents erratic operation
- No BSR command module necessary
- Real time, crystal controlled clock available

The controller comes complete with full documentation, sample software and is designed to work with most of the popular computers including any S-100 based system, TRS-80-1, Apple II, Heath H8 and others.

Real time clocks are available for all of the above computer systems. When used with the controller, true time scheduling is realized. All clocks are crystal controlled and have battery backup for accurate and reliable operation. Interrupts allow Foreground/Background operation of two programs simultaneously. Clock data includes year, month, date, day of week, hour, minute, and second.

Applications:

- Make your entire home or apartment computer controlled
- Save energy by controlling lights & appliances
- Control security systems & alarms

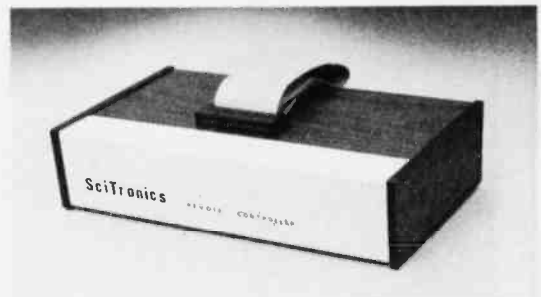

Remote switches not included

ENERGY WATTCHER	\$295.
S-100 CONTROLLER BOARD	\$159.
S-100 REAL TIME CLOCK BOARD	\$159.
ENCASED CONTROLLER (TRS-80, Apple II etc.)	\$184.
ENCASED CONTROLLER & REAL TIME CLOCK (TRS-80, Apple II etc.)	\$269.
APPLE II CLOCK BOARD	\$129.

Send check or money order to: **SciTronics Inc.**
523 S. Clewell St., P.O. Box 5344
Bethlehem, PA 18015
(215) 868-7220

Please list system with which you plan to use peripheral. Master Charge and Visa accepted. PA residents add sales tax. COD's accepted.

Dealer Inquiries Invited

SAVE

on
add-ons
for

APPLE® and TRS-80®

"APEX" NEW DISK OPERATING SYSTEM FOR THE APPLE®

Fully Professional DOS for the Apple II. The result of two years of extensive development, APEX provides a complete program development and file management system. A comprehensive command set allows the user to perform almost any imaginable disk operation.

- Command structure similar to CPM® and main frame systems. Contains 20 command words.
- Easy program interface. Simple communications.
- Capable of handling 5 inch, 8 inch, and hard disks.
- Safety features to protect against accidental data loss. Features include backup files, directory, read after-write & limit checks.
- 4 times faster than CPM®.
- Auto default structure eliminates tedious typing by automatically setting up command strings, file names, etc.
- Functional on both single and multi-drive systems.
- Device handler structure for interfacing peripherals.

The APEX package includes all of the tools for a complete assembly language development system, high speed two pass resident assembler and a powerful macro editor.

The complete APEX package with operating system, assembler, editor and manuals, also includes utilities to maintain files.

APEX
\$99

RELATED SOFTWARE
XPLO \$79
FOCAL™ \$59

SAVE ON APPLE II 16K

FREE MEMORY UPGRADE KIT TO 48K WITH PURCHASE OF APPLE II 16K
\$1195
(MTI ONLY)



INTRODUCTORY OFFER

SAVE \$300 TRS-80 Graphics List \$949



OKIDATA MICROLINE 80
OUR PRICE
\$649

Z-80 SoftCard
\$399
The Source \$100
Applesoftware .. \$29.95

MTI APPLE 8" DISK SYSTEM

- *One SA800R Floppy
- *1 Drive Chassis & Power Supply
- *Controller, Cable and DOS

\$1439

Drives for any Microcomputer

Does not include power supply & cabinet.

Perfec FD200	\$282	FD250	\$359
Shugart SA400	\$279	SA800/801	\$479
MPI B51	\$279	B52	\$349
MPI B91	\$399	B92	\$525

Printers

Centronic 779	\$1,069
Base 2	\$649
Centronics 737	\$939
Centronics 702-9	\$1,995
Anodex 9501	\$1,549
Malibu	\$2,395
Spinwriter	\$2,549



Daisy Wheel \$1,779

NEWDOS 80

A new enhanced NEWDOS for the TRS-80.

The most powerful Disk Operating System for the TRS-80, designed for the sophisticated user and professional programmer who demands the ultimate.

NEWDOS/80 is the planned upgrade from NEWDOS 2.1. Some of the features are:

- New BASIC commands for files with variable record lengths up to 4095.
- Mix or match drives. Use 35, 40 or 80 track 5" disk drives or 8" disk drives, or combo.
- Security boot-up for BASIC or machine code application programs.
- New editing commands.
- Enhanced RENUMBER that allows relocation.
- Command chaining.
- Device handling for routing to display and printer simultaneously.
- DFG function; striking of D, F and G keys allows user to enter a mini-DOS without disturbing program.
- Comparable with NEWDOS & TRSDOS.
- Machine language Superzap/80 2.1 utilities and enhanced debug and copy.

\$149

Disk Drive Sale!

Complete with power supply and chassis.

TF-3 Shugart SA400	\$339
Perfec FD200, 40 track	\$379
*TF 5 MPI B51, 40 track	\$369
*TF 7 Micropolis 77 track	\$579
TDH-1 Dual Sided drive 35 track	\$499
TF-3M Drive Sys 2 Shugart	\$699

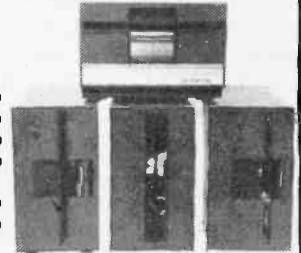

Disk Expansion System

*2 Shugart SA400 TF-3	\$678	NEWDOS+ 40 track	\$110
*1 Two-Drive Cable	\$ 26	NEWDOS+ 35 track	\$ 99
*1 Expansion Interface 32K	\$459	Microconductor, Data Base Mgr. Mod I	\$249
*1 35-track DOS+	\$ 99	Mod II	\$399
TOTAL LIST PRICE	\$1262	AJA Business Pkg	\$359
SPECIAL PRICE ONLY	\$1,149	The Source	\$100
Same as above but includes TRS-80® Level II	\$1949	Basic Compiler	\$195
		Mail List	\$60
		Electric pencil	\$150

NEW

TF-8 80 TRACK DISK DRIVE \$639
Double Your Capacity

TF-9 DUAL 80 TRACK DISK DRIVE \$789
Quadruple Your Capacity

8" Floppy Disk Drive System

for Model I

- One SA801 Floppy
- NEWDOS 80
- Cable & Adapter

\$1095



MTI MICROCOMPUTER TECHNOLOGY INCORPORATED



Apparat, Inc.

3304 West MacArthur
Santa Ana, CA 92704
(714) 979-9923

TELEX 678-401
TAB IRIN
Order Desk Only
800-854-7222

ALL PRICES CASH DISCOUNTED
FREIGHT FOB/FACTORY
ASK FOR OUR FREE CATALOGUE

4401 South Tamarac Parkway
Denver, CO 90237
(303) 741-1778

Pirate's Adventure

Scott Adams
Adventure International
POB 3435
Longwood FL 32750

A Short History

Time flies. The copyright date on my game, *Pirate's Adventure*, reads 1978. It seems like yesterday, but it has been two and a half years since I started on my Adventures . . .

At the time I was working as a systems programmer for Stromberg Carlson when I was first introduced to the classic *Adventure* game written by Crowther and Woods to run on a DEC (Digital Equipment Corporation) PDP-10. After playing for only a few minutes I was hooked. It took almost ten days of early-morning and late-evening sessions before I achieved the coveted score of 350 and the title of Grand Master. I had done it—I was a *bona fide* adventurer! Yet it seemed unfair that such a fascinating game was restricted to such an expensive machine.

Back then, I had just gotten my Radio Shack TRS-80 Level II computer, and (having recently finished my backgammon program) I was looking for another good game to write. The concept of character strings intrigued me, and I wanted a game that used them. (Up to that point, I had programmed primarily in FORTRAN and assembly language, neither of which can handle strings easily.)

Adventure seemed to fit my needs exactly. But I didn't want to copy someone else's program, and I was afraid I wouldn't get much of an Adventure in a 16 K-byte BASIC computer—especially when the FORTRAN version I played took about 300 K bytes!

I mentioned the idea of getting some sort of Adventure into my small machine to friends; fortunately, I was not daunted by their laughter. After all, I could remember when it was supposedly impossible to get a BASIC interpreter to run on an 8080

microprocessor!

Interpreter? Did I say *interpreter*? Suddenly the idea fell into place! I had written many compilers and operating systems. Why not write an Adventure interpreter? This would allow me to write many Adventures and would also provide the compression I needed to fit them into a small

It seemed unfair that such a fascinating game was restricted to such an expensive machine.

machine. (Inside, I'm really a frustrated science-fiction writer; I have over 3000 science-fiction books in my collection but have never tried to write one myself.)

So, weeks later, my initial scribbles had evolved into a working interpreter with a skeleton Adventure to play on it. It took some six months of play-testing before my first Adventure, *Adventureland*, was finally released through The Software Exchange of Milford, New Hampshire, and Creative Computing Software. Thus the Scott Adams Adventure Series was born.

And, at that same moment, it almost died. For six months I had been so engrossed in programming Adventure that my wife Alexis (who at the time was pregnant with Maegen, our daughter) started hiding my floppy disks around the house to get my attention. Once she hid them in the oven—boy, did she get some attention that time! I then decided that one Adventure was enough.

Some time after that, Alexis unexpectedly announced that she wanted to write an Adventure, and it was this effort that led to the Scott Adams

Adventure given in listings 1 and 2, *Pirate's Adventure*. With her basic ideas, we created an Adventure that was different from any that had ever been written before. Instead of simply searching for treasures in this Adventure, you now had an added ingredient—a "mission." (In this case, you had to figure out how to build a pirate's ship!) This set the stage for many of my later mission-oriented Adventures that replace a cumulative score with a do-or-die situation. These include my *Mission Impossible*, *The Count*, *Voodoo Castle*, and *Mystery Fun House Adventures*.

All my current Adventures, for the Apple II, the Radio Shack TRS-80, and the Exidy Sorcerer, are written in machine language and run much faster and cleaner than the original BASIC versions (of which there were only two and a half). I probably would never have written these programs in machine language if it had not been for the gentle nudges I received from a friend I've never met but greatly respect, Lance Micklus.

Program Notes

Pirate's Adventure was first sold commercially to run in Level II BASIC on a 16 K-byte TRS-80. Both the Adventure-interpreter program (in BASIC) and a data file created by the Adventure-editor program were on the cassette tape. After you loaded the interpreter program, you used it to read the data file, an operation that took 20 minutes but allowed me to compress a lot of Adventure into very little memory space.

In planning this article, I had to devise a means of creating the tape data file without using the Adventure editor. The BASIC program in listing 1 provides the means. This program, which runs on a TRS-80 with 16 K

*Text continued on page 212
See pages 194 thru 210 for listings*

The Talk of the '80s.



SoftCare.

A New Medical Billing System That is Easy, and Works!

FILL IN THE BLANKS

The only system that works like you do. Add, change, or delete material right on the form (displayed on the video screen). It's really easier than filling in the blank because you can go back and type over any mistake you make.

NO BATCHING

As the information is entered, the system automatically detects clerical errors in patient information, procedure codes, and procedural data. No waiting days or weeks for verification.

INSTANT ACCESS

Up to date patient information available anytime. Patient files are updated everytime a transaction is entered. All you need to check their files is to enter the patient's name — no ID number.

PRIVATE AND THIRD PARTY BILLING

System keeps track of third party billing and insurance claims. You can bill the patient on paper while they are in the office! Resubmission of a claim is as simple as pushing a button.

TECHNICAL SPECIFICATIONS

Written in Pascal, the system runs on most any 56K or 64K micro or mini computer. The system is currently operating on Dynabyte, Cromemco, Onyx, Vector Graphic, and Digital Equipment Corporation (DEC) computers. Different systems provide 500 to 10,000+ patient capacity.

Contact your Local computer store or



PROFESSIONAL
BUSINESS
SOFTWARE

119 Fremont Street, San Francisco, CA 94105, (415) 546-1596

Listing 1: Data-tape generation program for Scott Adams' Pirate's Adventure, written for the Radio Shack TRS-80 Model I running Level II BASIC.

```

6010 '      ***** BE SURE AND USE A C-60 TAPE FOR YOUR DATA TAPE!!!!
6020 ' ADVENTURE DATA TAPE BUILDER. BUILDER/BAS
6030 ' VERSION 1.3 (C) SCOTT ADAMS '80.
6040 ' ADVENTURE INTERNATIONAL BOX 3435 LONGWOOD FL 32750
6050 ' PHONE (305)-862-6917
6060 ' BUILDS DATA TAPE FOR ORIGINAL BASIC VERSION OF PIRATE'S ADVENTURE
6070 ' PLEASE NOTE ON LINES THAT SUDDENLY GO TO THE
NEXT LINE LIKE
THIS USE (DOWN ARROW) KEY WHICH IS RIGHT ABOVE
THE LEFT HAND SHIFT KEY ON YOUR TRS-80!
6080 DATA 60, 151, 59, 33, 5, 1, 2, 3, 200, 71, 1, 80, 422, 342, 420, 340, 0, 16559, 885
0, 80, 462, 482, 460, 0, 0, 15712, 1705, 100, 521, 552, 540, 229, 220, 203, 8700, 3, 483, 0, 0, 0, 0, 1
5712, 0, 100, 284, 0, 0, 0, 0, 8550, 0, 100, 28, 663, 403, 40, 0, 8700, 0, 100, 48, 20, 660, 740, 220
6090 DATA9055, 10902, 100, 28, 20, 0, 0, 0, 3810, 0, 100, 8, 700, 720, 0, 0, 10868, 0, 100, 48, 40, 6
40, 400, 300, 9055, 8305, 25, 664, 0, 0, 0, 0, 4263, 0, 40, 104, 886, 0, 0, 0, 4411, 0, 80, 242, 502, 82
0, 80, 240, 9321, 10109, 100, 8, 140, 80, 500, 0, 10262, 8850, 35, 421, 846, 420, 200, 0, 5162, 0
6100 DATA100, 129, 120, 0, 0, 0, 6508, 0, 50, 242, 982, 820, 440, 240, 9321, 8850, 35, 483, 69, 0, 0
, 0, 15705, 0, 10, 483, 249, 0, 0, 0, 15706, 0, 50, 484, 1073, 1086, 0, 0, 17661, 9150, 50, 204, 1086,
0, 0, 0, 16711, 0, 10, 209, 1040, 1060, 300, 1100, 10872, 10050, 10, 208, 1040, 1060, 89, 0, 10867
6110 DATA0, 85, 483, 8, 0, 0, 0, 15719, 10200, 100, 8, 0, 0, 0, 0, 10200, 0, 100, 104, 0, 0, 0, 0, 8550
, 0, 80, 462, 282, 280, 1160, 0, 1422, 0, 158, 82, 60, 0, 0, 0, 8170, 9600, 4510, 61, 0, 0, 0, 0, 300, 0,
163, 22, 100, 0, 0, 0, 8170, 9600, 8100, 0, 0, 0, 0, 16200, 0, 4800, 104, 120, 61, 0, 0, 10507
6120 DATA8164, 4800, 107, 100, 61, 89, 0, 10507, 8164, 4063, 22, 0, 0, 0, 647, 0, 5570, 161, 203
, 160, 180, 0, 10870, 1264, 6170, 181, 180, 160, 0, 0, 8302, 0, 6300, 104, 0, 0, 0, 0, 900, 0, 1529, 44
2, 465, 440, 0, 0, 7800, 0, 1529, 442, 462, 0, 0, 0, 760, 9150, 183, 322, 180, 0, 0, 0, 8170, 9600
6130 DATA1538, 262, 242, 0, 0, 0, 1800, 0, 1538, 262, 245, 260, 0, 0, 7800, 0, 5888, 262, 242, 0, 0,
0, 1800, 0, 5888, 262, 245, 0, 0, 0, 1950, 0, 6188, 262, 245, 541, 260, 560, 2155, 7950, 5888, 261, 0
, 0, 0, 0, 2400, 0, 4088, 561, 0, 0, 0, 0, 2400, 0, 4088, 263, 0, 0, 0, 0, 2713, 0, 4088, 562, 580, 109
6140 DATA100, 249, 2303, 8700, 4088, 249, 562, 108, 900, 240, 6203, 8700, 4088, 248, 562, 0, 0, 0
, 6600, 0, 4068, 103, 69, 0, 0, 0, 646, 0, 4068, 103, 68, 0, 0, 0, 6600, 0, 5887, 342, 0, 0, 0, 0, 2550, 0
, 5887, 362, 0, 0, 0, 0, 2713, 0, 5887, 382, 0, 0, 0, 0, 2100, 0, 159, 382, 320, 0, 0, 0, 8170, 9600
6150 DATA6187, 342, 362, 0, 0, 0, 2550, 0, 6187, 345, 362, 541, 360, 380, 8303, 10050, 3461, 503,
0, 0, 0, 0, 172, 0, 3750, 0, 0, 0, 0, 9900, 0, 1528, 0, 0, 0, 0, 0, 9900, 0, 4108, 1143, 1012, 0, 0, 0, 6
46, 0, 6450, 0, 0, 0, 0, 2853, 0, 4510, 66, 0, 0, 0, 0, 2720, 0, 4950, 0, 0, 0, 0, 0, 9750, 0, 5114, 0
6160 DATA0, 0, 0, 0, 10650, 0, 7092, 592, 0, 0, 0, 0, 2745, 0, 185, 284, 140, 0, 0, 0, 8156, 10564, 40
98, 1054, 0, 0, 0, 0, 647, 17550, 4098, 1053, 0, 0, 0, 0, 647, 17400, 4083, 322, 0, 0, 0, 0, 647, 0, 409
5, 762, 0, 0, 0, 0, 647, 0, 195, 782, 921, 0, 0, 0, 2727, 0, 195, 762, 261, 0, 0, 0, 2727, 0, 6900, 0, 0
6170 DATA0, 0, 0, 9450, 0, 1526, 602, 0, 0, 0, 0, 2723, 0, 1541, 621, 602, 640, 520, 600, 7853, 8250
, 195, 782, 661, 0, 0, 0, 2727, 0, 7092, 623, 583, 303, 643, 20, 8700, 0, 7092, 0, 0, 0, 0, 0, 3750, 0, 2
00, 722, 220, 0, 0, 0, 10554, 9600, 195, 762, 61, 0, 0, 0, 2727, 0, 4050, 0, 0, 0, 0, 0, 10564, 0, 1526
6180 DATA523, 520, 0, 0, 0, 7800, 0, 195, 762, 340, 0, 0, 0, 8126, 8464, 195, 782, 360, 0, 0, 0, 8157
, 10564, 7530, 404, 242, 1053, 89, 0, 17250, 0, 4800, 0, 0, 0, 0, 0, 450, 0, 5868, 103, 200, 69, 60, 0,
4553, 8700, 5868, 68, 0, 0, 0, 0, 494, 0, 1546, 146, 0, 0, 0, 0, 4800, 0, 1546, 802, 141, 140, 840, 0
6190 DATA8302, 0, 2746, 841, 840, 140, 0, 0, 8302, 4950, 3496, 802, 0, 0, 0, 0, 811, 0, 3496, 841, 8
40, 140, 0, 0, 811, 8302, 7366, 822, 820, 240, 400, 0, 5305, 9300, 5861, 503, 0, 0, 0, 0, 2100, 0, 841
1, 501, 500, 140, 0, 0, 5459, 7833, 192, 742, 400, 0, 0, 0, 8170, 9600, 201, 404, 88, 420, 240, 242
6200 DATA8170, 8071, 201, 404, 89, 120, 0, 0, 8170, 9600, 7530, 404, 245, 0, 0, 0, 2737, 0, 7530, 4
04, 912, 0, 0, 0, 2738, 0, 7530, 404, 89, 80, 740, 420, 5908, 9300, 7530, 404, 88, 80, 740, 120, 5910
, 9300, 7671, 0, 0, 0, 0, 6000, 0, 4553, 903, 0, 0, 0, 0, 6300, 0, 1350, 0, 0, 0, 0, 0, 6000, 0, 1510
6210 DATA62, 60, 0, 0, 0, 7800, 0, 5860, 63, 0, 0, 0, 0, 18000, 0, 201, 404, 88, 420, 0, 0, 8170, 9600
, 186, 284, 360, 0, 0, 0, 8170, 9600, 1539, 482, 242, 0, 0, 0, 1800, 0, 1539, 482, 480, 0, 0, 0, 7904, 1
6800, 194, 682, 300, 0, 0, 0, 8170, 9600, 174, 149, 464, 140, 0, 0, 8751, 0, 174, 160, 0, 0, 0, 0
6220 DATA8751, 0, 7800, 444, 940, 921, 952, 0, 10548, 8014, 7800, 124, 921, 0, 0, 0, 7350, 0, 7800
, 424, 992, 980, 921, 0, 10553, 7264, 8250, 104, 0, 0, 0, 0, 10505, 9600, 7800, 464, 148, 1140, 921,
1152, 10553, 7264, 1541, 643, 640, 0, 0, 0, 7800, 0, 163, 104, 40, 0, 0, 0, 8170, 9600, 6300, 44, 0
6230 DATA0, 0, 0, 15450, 0, 4534, 583, 0, 0, 0, 0, 4650, 0, 6187, 702, 541, 0, 0, 0, 0, 2713, 16050, 588
7, 702, 0, 0, 0, 0, 2713, 0, 5887, 0, 722, 0, 0, 0, 2100, 0, 198, 1022, 480, 0, 0, 0, 8170, 9600, 157, 2,
24, 40, 0, 0, 8170, 9600, 1510, 44, 60, 40, 80, 85, 7801, 10800, 1532, 302, 208, 300, 0, 0, 7800, 0
6240 DATA1532, 302, 209, 0, 0, 0, 2813, 0, 1532, 305, 0, 0, 0, 0, 10518, 7564, 8411, 841, 840, 140,
0, 0, 8922, 0, 165, 1122, 500, 0, 0, 0, 8170, 9600, 1392, 0, 0, 0, 0, 0, 6000, 0, 6300, 284, 0, 0, 0, 0, 1
6350, 0, 8582, 0, 0, 0, 0, 17700, 0, 7800, 921, 209, 302, 200, 0, 8700, 0, 7950, 0, 0, 0, 0, 2700

```

Listing 1 continued on page 198

Ten reasons why your floppy disk should be a BASF FlexyDisk[®].



More than four decades of experience in magnetic media – BASF invented magnetic recording tape, the forerunner of today's wide range of magnetic media, back in 1934, and was the first independent manufacturer of IBM-compatible floppy disks.

Tough Tyvek sleeve – no paper dust, no static electricity.

Special self-cleaning jacket and liner help eliminate data errors and media wear and tear.

Packaging to suit your requirements – standard flip-top box, Cassette 10[®] storage case, or bulk pack.

Center hole diameter punched to more accurate standards than industry specifications, for top performance.

100% certification – every single disk is tested at thresholds 2-3 times higher than system requirements, to be 100% error-free.

Bi-axially oriented polyester substrate – for uniform and reliable performance year after year.

For the name of your nearest supplier, write BASF Systems, Crosby Drive, Bedford, MA 01730, or call 617-271-4030. See us at the NCC, Booth 1121

Cross-linked oxide coating – for low head wear and long trouble-free media life.

Total capability – one of two manufacturers in the world that makes both 8" and 5.25" models, has tape and disk experience, and manufactures floppy disk drives.

Double lubrication – lubricants both in the formula and on the disk surface, to minimize media wear due to head friction.





"COMPUTERS 'R' US" consumer computers

UNBEATABLE MAIL ORDER DISCOUNTS!!

ORDER BY PHONE
7 DAYS 9-6 PST

ORDERS FROM CALIFORNIA, ALASKA, HAWAII AND OUTSIDE OF U.S. (714) 698-8088

SALES INFORMATION, TECHNICAL, OR BACKORDERS, CALL (714) 698-0260

CONTINENTAL U.S. TOLL FREE ORDER LINE: **800-854-6654**

credit card users please read ordering information.



apple computer
Authorized Dealer

NEW!
CALL FOR AVAILABILITY AND PRICES.

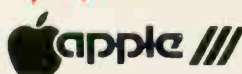

CHRISTMAS SUPER SALE



APPLE II PLUS
OR APPLE II STANDARD

16K FOR ONLY \$925

48K FOR \$1049

DISK II DRIVE \$529
w/controller & DOS 3.3

PASCAL SYSTEM \$425

microsoft Z-80 SOFTCARD \$299

ACCESSORY SPECIALS

DISK II DRIVE (add-on).....	425
D.C. HAYES MICROMODEM II.....	319
GRAPHICS TABLET.....	655
INTEGER BASIC OR APPLESOFT II firmware card.....	149
SILENTYPE PRINTER with Interface card..	515

APPLE II ACCESSORIES

CENTRONICS PRINTER Int. card.....	185	M&R SUP-R-MOD TV MODULATOR.....	30
PARALLEL PRINTER Int. card	145	CORVUS 10 MEGABYTE HARD DISK DRIVE SYSTEM	
COMMUNICATION CARD w/conn. cable.....	185	w/pwr supply.....	4395
HI-SPEED SERIAL Int. card..	145	CORVUS CONSTELLATION..	595
DAN PAYMAR lower case kit..	55	16K MEMORY UPGRADE KIT (TRS-80, APPLE II, SORCERER.....	60
MICROWORKS DS-65 DIGISECTOR.....	339	ABT NUMERIC INPUT KEYPAD (specify old or new kybrd).	115
LAZER lower case adapter....	50	ALF MUSIC SYNTHESIZER..	235
SSM AIO SERIAL/ PARALLEL kit.....	155	BRIGHTPEN LIGHTPEN.....	32
SSM AIO assembled & tested	190	M&R SUPER-TERMINAL 80 COLUMN CARD.....	335
SYMTEC LIGHT PEN SYSTEM	215	SMARTERM 80 COL.....	335
SYMTEC SUPER SOUND GENERATOR.....	225	Mountain Computer APPLE CLOCK/CALENDAR card.....	225
SVA 8 INCH DISK CONTROLLER CARD.....	335	SUPERTALKER SD200 SPEECH SYNTHESIZER SYSTEM.....	245
VERSA WRITER DIGITIZER SYSTEM.....	215	ROMPLUS w/kybrd filter.....	165
VIDEX VIDEOTERM 80 COLUMN CARD.....	315	INTROLX-10 BSR REMOTE CONTROL SYSTEM.....	245
VIDEX VIDEOTERM w/graphics ROM.....	335	INTROLX-10 controller card only.....	165
LOBO DISK DRIVE ONLY.....	385	ROMWRITER SYSTEM.....	155
LOBO DRIVE w/cont. & DOS 3.3.....	499	MUSIC SYSTEM (16 voices/stereo).....	465
GPIB IEEE-488 (1978) Int.	259	A/D/D/A 16 CHANNELS.....	319
ARITHMETIC PROCESSOR CARD.....	335	EXPANSION CHASSIS (8 slots).....	555
SPEECHLINK 2000 (64 Word Vocab.).....	215		

APPLE II SOFTWARE

VISICALC.....	120	FORTRAN.....	165
CCA DATA MANAGEMENT ..	85	DOS 3.3.....	49
THE CONTROLLER General Business System.....	519	APPLE PLOT....	60
THE CASHIER Retail Manage- ment & Inventory system	199	TAX PLANNER.....	65
APPLEWRITER Word Processor.....	65	SARGON II Chess on Diskette.....	32
APPLEPOST MAILING List system.....	45	TRILOGY OF GAMES.....	27
DOW JONES PORTFOLIO EVALUATOR.....	45	SPACE GAME ALBUM.....	38
APPLE CONTRIBUTED Volumes 1-5 w/manuals ..	30	SPACE INVADER (Cass.)...	18
DESKTOP/PLAN by DESKTOP COMPUTERS.....	85	SPACE INVADER (Disk)...	23
APPLEBUG ASSEMBLER/ DISASSEMBLER.....	75	SYBEX APPLE-80 8080 Simulator.....	17
APPLE DOS TOOL KIT.....	65	FORTH II by PROGRAMMA SOFTWARE.....	45
PIMS Personal Information Management System.....	23	SINGLE DISK COPY ROUTINES.....	17
ADVENTURE by MICROSOFT.....	27	APPLEBUG DEBUGGER.....	27
SUB-LOGIC FS-1 Flight Simulator.....	34	APPLESOFT UTILITY PRO- GRAMS BY HAYDEN.....	27
SARGON II Chess by HAYDEN (Cass.).....	27	The CORRESPONDENT.....	35
		ASTEROIDS IN SPACE.....	19
		HEAD-ON.....	25
		3-D ANIMATION PACK.....	53
		BATTLESHIP COMMANDER.....	23
		FASTGAMMON.....	26
		STAR CRUISER.....	24
		TRANQUILITY BASE.....	24

More software available
Please write us for a list.

"COMPUTERS' R'US" Consumer Computers



INTERNATIONAL
CUSTOMERS:

TELEX 695-000

ANSWER "BETA" ATTENTION "CRUS"

COMING SOON...

SALES AGENTS IN:

LONDON ~~PARIS~~ BERLIN CAIRO RIYADH JOHANNESBURG
~~HONG KONG~~ TOKYO SYDNEY MEXICO CITY

EXIDY

ATARI

OSI



Please
Call
For
Best
Price



**SORCERER II
COMPUTER**

16,32K & 48K VERSIONS AVAILABLE
S-100 EXPANSION UNIT 375
WORD PROCESSING PAC 179
DEVELOPMENT PAC 89

PMC-80



**THE TRS-80 'WORK-ALIKE'
16K LEVEL II ONLY \$579**

Completely compatible with Radio Shack TRS-80 Level II software and peripherals. Features include: Level II Basic, Video & Ch. 3 TV output. Built in Cassette, 40 pin interface conn., 16K User RAM memory. Expandable to 48K.

For more information, please call or write.



**16K FOR \$799
ATARI 800**

PERSONAL COMPUTER SYSTEM

400 COMPUTER	479
820 PRINTER (40 col.)	459
810 DISK DRIVE	559
410 PROGRAM RECORDER	59
815 DUAL DISK DRIVE	1199
822 THERMAL PRINTER (40 col.)	369
825 PRINTER (80 col. imp.)	795
850 INTERFACE MODULE	175
ATARI 16K RAM MODULE	155
LIGHT PEN	65
ACOUSTIC MODEM (CAT)	169
COMPUTER CHESS	35
SPACE INVADERS	19
STAR RAIDERS	49
SUPER BREAKOUT	35
3-D TIC-TAC-TOE	35
VIDEO EASEL	35
MUSIC COMPOSER	49
VISICALC DISK	129

OHIO SCIENTIFIC

**C4P
\$799**



C4PMF \$1699

NEW!

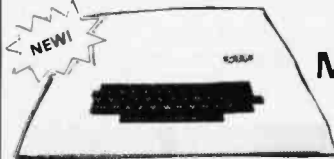

**CIP
MOD II
\$449**

	Cassette	Disk
SPACE INVADERS	19	29
SARGON II	30	35
FORTH	N/A	69
OS 65-D V3.3	N/A	79
MDMS PLANNER	N/A	100
GRAPHICS I	N/A	35
DAC I	N/A	45
ASSEMBLER/EDITOR	40	N/A
EXTENDED MONITOR	20	N/A
PASCAL & FORTRAN (4P & 8P only)	N/A	450

When ordering please specify system.

PLOTTERS

VIDEO MONITORS

PRINTERS

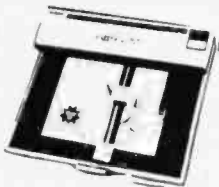

**\$1095
only**

WATANABE MIPLT

for more info please call or write

LEEDEX VIDEO 100	139
SANYO 9" B&W	165
SANYO 12" B&W	255
PANACOLOR 10" COLOR	329
NEC 12" HI-RES COLOR	875
NEC 12" LO-RES COLOR	399
NEC 12" GREEN PHOSPHER(P31)	239
TELEVIDEO 912B&C	698
TELEVIDEO 920B & C	745

ANADEX DP-8000	775
ANADEX DP-9500	1350
BASE 2	649
CENTRONICS 737	825
PAPER TIGER IDS-460 w/graphics	1195
PAPER TIGER IDS-440 w/graphics	895
NEC SPINWRITER	2550
TRENDCOM 200	519
SILENTYPE W/Int.	515
EPSON TX-80 w/graphics	729
EPSON MX-80 132 col	620
QUME SPRINT 5	2550

ORDERING INFORMATION: Phone Orders invited using VISA, MASTERCARD, AMERICAN EXPRESS, or bank wire transfers VISA & MC credit card service charge of 2%. AE credit card service charge of 5%. Mail orders may send charge card number (include expiration date) cashiers check, money order or personal check (allow 10 business days to clear.) Please include a telephone number with all orders Foreign orders (excluding Military PO's) add 10% for shipping all funds must be in US dollars (letters of credit permitted). Shipping, Handling and Insurance in US add 3% (minimum \$4.00) California residents add 6% sales tax Our low margins prohibit us to send COD or on purchase orders or open account (please send for written quotation.) All equipment is subject to price change and availability Equipment is new and complete with the manufacturer warranty We do not guarantee merchantability of products sold All returned equipment is subject to a 15% restocking fee We ship most orders within 2 days.

WE ARE A MEMBER OF THE BETTER BUSINESS BUREAU AND THE CHAMBER OF COMMERCE.

RETAIL STORE PRICES MAY DIFFER FROM MAIL ORDER PRICES.

PLEASE SEND ORDERS TO:

CONSUMER COMPUTERS MAIL ORDER, 8314 PARKWAY DRIVE, GROSSMONT SHOPPING CENTER NORTH, LA MESA, CA. 92041

Listing 1 continued:

6250 DATA0,5908,621,1143,1000,0,0,4553,0,5266,0,0,0,0,1800,0,6300,224,0,0,0,0,
17517,17850,1200,0,0,0,0,17100,0,6300,124,0,0,0,0,16350,0,4350,208,1040,1060,0
,0,10919,0,6300,184,242,0,0,0,3600,0,7800,921,160,140,0,0,7410,9000,6300,0,0,0
6260 DATA0,0,450,0,AUT,ANY,GO,NORTH,*CLI,SOUTH,*WAL,EAST,*RUN,WEST,*ENT,UP,*PAC,
DOWN,*FOL,STA,SAY,PAS,SAI,HAL,GET,BOO,*TAK,BOT,*CAT,*RUM,*PIC,WIN,*REM,GAM,*WEA,
MON,*PUL,PIR,FLY,ARD,DRO,BAG,*REL,*DUF,*THR,TOR,*LEA,OFF,*GIV,MAT,DRI,YOH,*EAT
6270 DATA30,INV,LUM,SAI,RUG,LOO,KEY,*SHO,INV,WAI,DUB,REA,SAI,.,FIS,YOH,ANC,SCO,S
HA,SAV,PLA,KIL,CAV,*ATT,PAT,LIG,DOO,.,CHE,OPE,PAR,*SMA,HAM,UNL,NAI,HEL,BOA,AWA,*
SHI,*BUN,SHE,.,CRA,QUI,WAT,BUI,*SAL,*MAK,LAG,WAK,*TID,SET,PIT,CAS,SHO,DIG,*BEA
6280 DATABUR,MAP,FIN,PAC,JUM,BON,EMP,HOL,WEI,SAN,.,BOX,.,SNE,0,0,0,0,0,0,.,0,0,0,0,
0,0,APARTMENT IN LONDON,0,0,0,0,0,1,ALCOVE,0,0,4,2,0,0,SECRET PASSAGEWAY,0,0,0,3
,0,0,MUSTY ATTIC,0,0,0,0,0,0
6290 DATA*I'M OUTSIDE AN OPEN WINDOW ON A LEDGE ON THE SIDE OF A
VERY TALL BUILDING,0,0,8,0,0,0,SANDY BEACH ON A TROPICAL ISLE,0,12,13,14,0,11,MA
ZE OF CAVES,0,0,14,6,0,0,MEADOW,0,0,0,8,0,0,GRASS SHACK,10,24,10,10,0,0,*I'M IN
THE OCEAN,0,0
6300 DATA0,0,7,0,PIT,7,0,14,13,0,0,MAZE OF CAVES,7,14,12,19,0,0,MAZE OF CAVES,0,
0,0,8,0,0,*I'M AT THE FOOT OF A CAVE RIDDEN HILL.
A PATH LEADS TO THE TOP,17,0,0,0,0,0,TOOL SHED,0,0,17,0,0,0,LONG HALLWAY,0,0,0,1
6,0,0,LARGE CAVERN,0,0,0,0,0
6310 DATA14,*I'M ON TOP OF A HILL. BELOW IS PIRATES ISLAND. ACROSS THE SEA
OFF IN THE DISTANCE I SEE *TREASURE* ISLAND,0,14,14,13,0,0,MAZE OF CAVES,0,0,0,0
,0,0,*I'M ABOARD PIRATE SHIP ANCHORED OFF SHORE,0,22,0,0,0,0
6320 DATA*I'M ON THE BEACH AT TREASURE ISLAND,21,0,23,0,0,0,SPOOKY OLD GRAVEYARD
FILLED WITH PILES
OF EMPTY AND BROKEN RUM BOTTLES,0,0,0,22,0,0,LARGE BARREN FIELD,10,6,6,6,0,0,SHA
LLOW LAGOON.
TO THE NORTH IS THE OCEAN,0,0,0,23,0,0
6330 DATASACKED AND DESERTED MONASTARY,0,0,0,0,0,0,.,0,0,0,0,0,0,.,0,0,0,0,0,0,.,0,
0,0,0,0,0,.,0,0,0,0,0,0,.,0,0,0,0,0,0,.,0,0,0,0,0,0,.,0,0,0,0,0,0,*WELCOME TO NEVER
NEVER LAND,.,THERE'S A STRANGE SOUND
6340 DATATHE NAME OF THE BOOK IS -TREASURE ISLAND-
THERE'S A WORD ENGRAVED IN THE FLYLEAF -YOHO-
AND A MESSAGE -LONG JOHN SILVER LEFT 2 TREASURES ON TREASURE
ISLAND!-,NOTHING HAPPENS,THERE'S SOMETHING THERE ALRIGHT. MAYBE I SHOULD
6350 DATATHAT'S NOT VERY SAFE, YOU MAY NEED MAGIC HERE, EVERYTHING SPINS AROUND AN
D SUDDENLY YOU ARE ELSEWHERE...,TORCH IS LIT,I WAS WRONG. I GUESS ITS NOT A MONG
OOSE CAUSE THE SNAKES BIT IT.,I'M SNAKE BIT
6360 DATAPARROT ATTACKS SNAKES AND DRIVES THEM OFF,PIRATE WON'T LET ME,ITS LOCKE
D,ITS OPEN,THERE ARE A SET OF PLANS IN IT,NOT WHILE I'M CARRYING IT,CROCS STOP M
E,SORRY I CAN'T,WRONG GAME YOU SILLY GOOSE!,I DON'T HAVE IT
6370 DATAPIRATE GRABS RUM AND SCUTTLES OFF CHORTLING,...I THINK ITS ME. HEE HEE.
,ITS NAILED TO THE FLOOR!,-MAGIC WORD- HO AND A ... (WORK ON IT. YOU'LL GET
IT),NO. SOMETHING IS MISSING!,IT WAS A TIGHT SQUEEZE!,SOMETHING WON'T FIT
6380 DATASINCE NOTHING IS HAPPENING,I SLIPPED AND FELL...,SOMETHING FALLS OUT,TH
EY'RE PLANS TO BUILD JOLLY ROGER (A PIRATE SHIP!)
YOU'LL NEED HAMMER NAILS LUMBER ANCHOR SAILS AND KEEL.,I'VE NO CONTAINER,IT SOAK
S INTO THE GROUND
6390 DATATOO DRY. FISH VANISH.,PIRATE AWAKENS. SAYS -AYE MATEY WE BE CASTING OFF
SOON-
HE THEN VANISHES
,WHAT A WASTE...,I'VE NO CREW,PIRATE SAYS -AYE MATEY WE BE NEEDING A MAP FIRST-
6400 DATAAFTER A MONTH AT SEA WE SET ANCHOR OFF OF A SANDY BEACH.
ALL ASHORE WHO'S GOING ASHORE...,TRY -WEIGH ANCHOR-,THERE'S A MAP IN IT,ITS A M
AP TO TREASURE ISLAND. AT THE BOTTOM IT SAYS
-30 PACES AND THEN DIG!-
6410 DATA* WELCOME TO -PIRATES ADVENTURE- BY SCOTT & ALEXIS ADAMS *
,ITS EMPTY,I'VE NO PLANS!,OPEN IT?,GO THERE?,I FOUND SOMETHING!,I DIDN'T FIND AN
YTHING,I DON'T SEE IT HERE,OK I WALKED OFF 30 PACES.
6420 DATACONGRATULATIONS !!!
BUT YOUR ADVENTURE IS NOT OVER YET...
,READING EXPANDS THE MIND,THE PARROT CRIES,-CHECK THE BAG MATEY-,-CHECK THE CHEST
MATEY-,FROM THE OTHER SIDE!,OPEN THE BOOK!,THERE'S MULTIPLE EXITS HERE!
6430 DATACROCS EAT FISH AND LEAVE,I'M UNDERWATER. I CAN'T SWIM. BLUB BLUB...,PI

Listing 1 continued on page 200

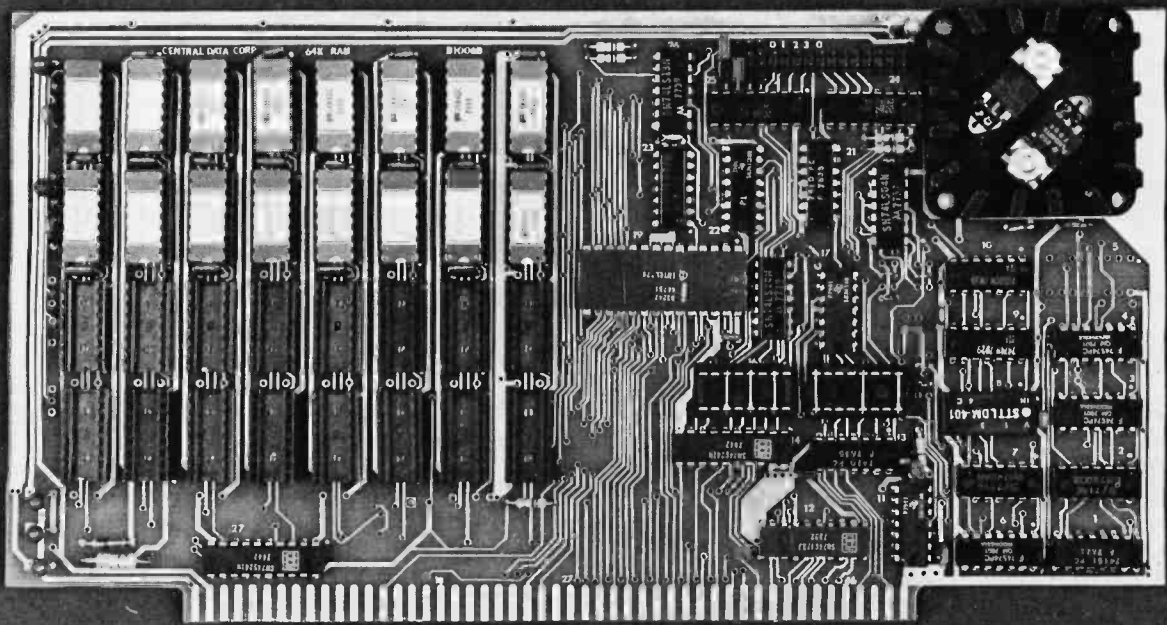

32K Board Pictured Above

Why Not the Best?

From The Dynamic RAM Company.

2MHz	4MHz
16K—\$249	\$259
32K—\$375	\$395
48K—\$500	\$530
64K—\$625	\$665

We have now been shipping our 2MHz dynamic RAM boards for over two years. Hundreds of 4MHz boards have been going out every month since early 1979. Our reliability is proven in the thousands of systems which contain our board. Many quality-minded systems houses across the country and overseas are using our boards for their equipment.

Our prices still beat all.

Despite rising 16K memory chip prices (at least from reputable suppliers), Central Data continues to give you the best buy in memory today. Nobody offers a board with a capacity of 64K, assembled, tested, and guaranteed for a full year at the price we do.

Deselect around PROMs. Our boards have the important deselect feature which lets you overlap any fixed memory in your system with no interference.

Our features make the board easily used and expanded. You address our boards on 16K boundaries with mini-jumps (small shorting plugs that slide over wire-wrap pins) near the top of the board for easy access. If you want to expand your board after you have purchased it, all that you need to do is add memory. We can supply you with expansion packages (\$150-2MHz, \$160-4MHz) which include eight RAMs that you can depend on as well as two mini-jumps for addressing. And of course, our board **never** generates wait states.

Low power consumption keeps your computer running cool and reliable. The total power consumption of our 16K board is typically less than 4 watts (+8V @ 300ma, +16V @ 150ma and

—16V @ 20ma). Boards with additional memory typically increase power consumption only 1 watt per 16K!

Standard S-100 Interface. Our board is designed to interface with any standard S-100 CPU. All of the timing of the board is independent of the processor chip, and the board is set up for different processors by changing two plugs on the board.

Call or write us today. That will guarantee a fast response with more information on the board. Or make an order — you'll probably have the board in two weeks! **If you're interested, also ask for a catalog on our Z8000 16-bit processor board designed for the MULTIBUS.** All of these products are available to your local dealer, also.

Central Data Corporation, 713 Edgebrook Drive, PO Box 2530, Station A, Champaign, IL 61820. (217) 359-8010

Central Data

Listing 1 continued:

```
ECES OF EIGHT-, ITS STUCK IN THE SAND, USE 1 WORD, PIRATE SAYS -AYE MATEY WE BE WAITING FOR THE TIDE TO COME IN-, THE TIDE IS OUT, THE TIDE IS COMING IN
6440 DATAABOUT 20 POUNDS. TRY -SET SAIL-, -TIDES A CHANGING MATEY-, NOTE HERE -I BE LIKING PARROTS. THEY BE SMART MATEY-, PIRATE FOLLOWS YOU ASHORE AS IF HE IS WAITING FOR SOMETHING., FLIGHT OF STAIRS, 1, OPEN WINDOW, 2, BOOKS IN A BOOKCASE, 2
6450 DATA LARGE LEATHER BOUND BOOK/BOO/, 0, BOOKCASE WITH A SECRET PASSAGE BEHIND IT, 0, PIRATE'S DUFFEL BAG/BAG/, 4, SIGN ON WALL -RETURN TREASURES HERE. SAY SCORE-SIGN BY STAIRS -ANTONYM OF LIGHT IS UNLIGHT-, 1, EMPTY BOTTLE/BOT/, 0
6460 DATA UNLIT TORCH/TOR/, 4, LIT TORCH/TOR/, 0, MATCHES/MAT/, 0, SMALL SHIP'S KEEL AND MAST, 6, WICKED LOOKING PIRATE, 9, TREASURE CHEST/CHE/, 9, MONGOOSE/MON/, 8, RUSTY ANCHOR/ANC/, 24, GRASS SHACK, 8, MEAN AND HUNGRY LOOKING CROCODILES, 11, LOCKED DOOR, 11
6470 DATA OPEN DOOR WITH HALL BEYOND, 0, PILE OF SAILS/SAI/, 17, FISH/FIS/, 10, *DUBLED NS*/DUB/, 25, DEADLY MAMBA SNAKES/SNA/, 25, PARROT/PAR/, 9, BOTTLE OF RUM/BOT/, 1, RUG/RUG/, 0, RING OF KEYS/KEY/, 0, OPEN TREASURE CHEST/CHE/, 0, SET OF PLANS/PLA/, 0, RUG, 1
6480 DATA CLAW HAMMER/HAM/, 15, NAILS/NAI/, 0, PILE OF PRECUT LUMBER/LUM/, 17, TOOL SHEED, 17, LOCKED DOOR, 16, OPEN DOOR WITH PIT BEYOND, 0, PIRATE SHIP, 0, ROCK WALL WITH NARROW CRACK IN IT, 18, NARROW CRACK IN THE ROCK, 17, SALT WATER, 10, SLEEPING PIRATE, 0
6490 DATA BOTTLE OF SALT WATER/BOT/, 0, PIECES OF BROKEN RUM BOTTLES, 4, NON-SKID SNEAKES/SNE/, 1, MAP/MAP/, 0, SHOVEL/SHO/, 15, MOULDY OLD BONES/BON/, 0, SAND/SAN/, 6, BOTTLES OF RUM/BOT/, 0, *RARE OLD PRICELESS STAMPS*/STA/, 0, LAGOON, 6, THE TIDE IS OUT, 24
6500 DATA THE TIDE IS COMING IN, 0, WATER WINGS/WIN/, 15, FLOTSAM AND JETSAM, 0, MONASTARY, 23, PLAIN WOODEN BOX/BOX/, 0, DEAD SQUIRREL, 0, , 0, , 0,
6510 REM
6520 REM PROGRAM STARTS HERE...
6530 REM
6540 CLEAR 800:DEFINT A-Z:POKE 16553, 255:RESTORE
6550 CLS:INPUT"PREPARE DATA TAPE (HIT ENTER)";TP#:D=-1
6560 CLS:PRINT@E4*4, "ADVENTURE DATA TAPE BUILDER - WORKING"
6570 READ IL, CL, NL, RL, MX, R, TT, LN, LT, ML, TR:PRINT#D, IL, CL, NL, RL, MX, R, TT, LN, LT, ML, TR
```

Listing 1 continued on page 202

FEATURES INCLUDE:

- Uses Standard Typewriter Ribbon
- Micro Processor Controlled
- Can Operate Continuously—No Thermal Problems (Has an all metal print head)
- 5 x 7 to Larger 10 x 7 and Larger 10 x 14 Dot Matrix Character Generator
- Standard 96 ASCII Character Font
- Upper and Lower Case Printing
- Up to 88 Characters Per Line
- Single Line Print Rate Is 160 CPS
- Average Print Rate Is 60 CPS For Ten Lines
- Graphics Capability With Extended Character Modes
- Programmable With 32 System Level Software Commands
- Standard Parallel and Serial Interface
- Software and Hardware Reset Interface
- Software Line Counting For Paging
- Baudrate Select From 110 to 9600
- Manual Paper Advance
- Manual Selftest and Reset
- Adjustable Tractor Width From 1 to 9½ Inches
- Interfaces with Apple, Atari, OSI, T.I., TRS-80 and the List Goes On

COOSOL DATA LOGGER IMPACT PRINTER

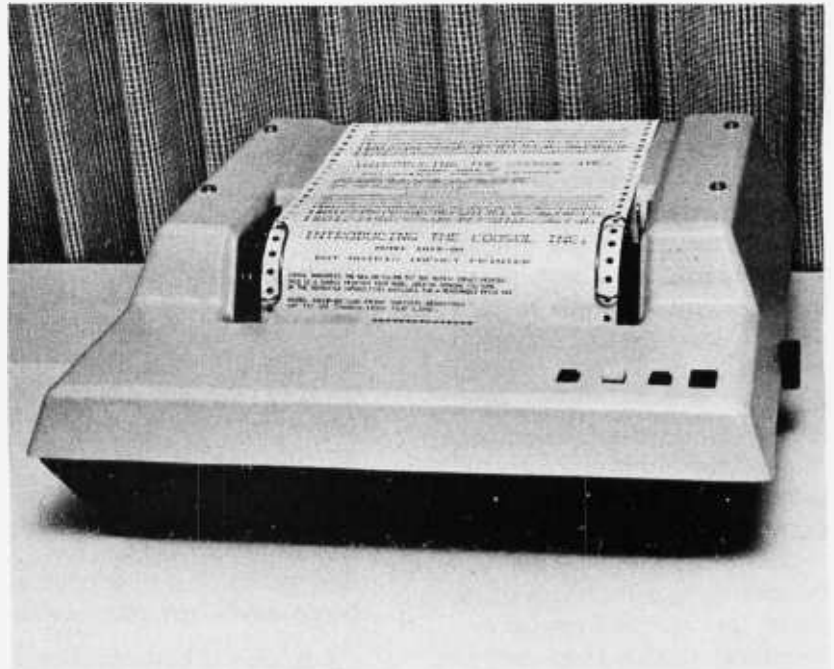

\$495 Kit, 101B-80KE

\$545 Assembled & Tested 101B-80E

COOSOL, INC. P.O. BOX 743, ANAHEIM, CA 92805 (714) 545-2216 7 Days a Week

ASSEMBLY LANGUAGE OR BASIC...

SHOOT THE WORKS

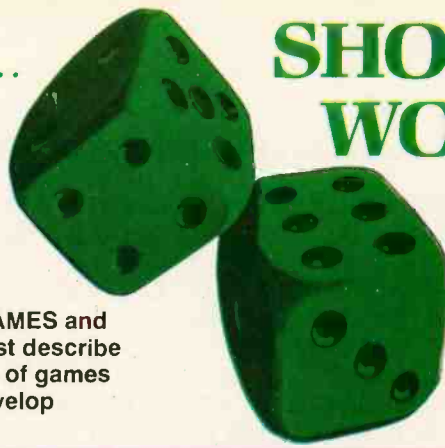

...and improve your programming skills with 6502 GAMES and INSIDE BASIC GAMES. These books do more than just describe computer games—they show the logic and structure of games programs so you can create your own games and develop programming competence and confidence.

INSIDE BASIC GAMES

by Richard Mateosian

This book is for everyone who wants to learn to write programs in BASIC for home computers. Games are used as programming examples because they exhibit most of the programming situations important in other interactive computer applications. Readers with little programming experience will increase their understanding of computers, learn program structuring and commonly used algorithms. More experienced readers will learn a powerful design tool called Free BASIC and interactive programming characteristic of small systems. From the educational Arithmetic Games through the complex Match-Up Game and the graphics-oriented Game of Life, each game is described, explained and analyzed so the reader can play the game, while at the same time learning to write programs for other games. All programs in this book are designed to be used on any home computer system.

\$13.95 300pp, 120 Illustr., 7x9

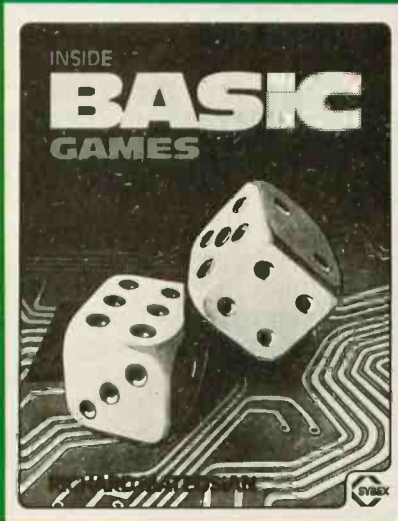

6502 GAMES

by Rodney Zaks

This book presents a comprehensive set of algorithms and programming techniques for ten common computer games while covering virtually all aspects of advanced programming. Effective algorithm design, data structure design and effective coding techniques related to storage economy are explained in a straightforward, enjoyable manner. Not only will you learn to play sophisticated games in the powerful 6502 assembly-level language, but you will also learn to program your 6502 to perform a variety of tasks, from home applications to industrial controls. All programs are at the 6502 assembly language level, can be played on a real board (the SYM) and require few additional components. Ask for our catalog for a complete description of a pre-assembled games board and cassette incorporating all programs presented in this book.

\$12.95 304pp, 104 Illustr., 6 1/2 x 8 1/2



MAIL TO:



DEPT. B12
2344 SIXTH STREET,
BERKELEY, CA 94710
PHONE ORDERS: 415/848-8233

PLEASE SEND

6502 GAMES \$12.95

INSIDE BASIC GAMES \$13.95

NAME _____

ADDRESS _____

CITY _____ STATE _____ ZIP _____

PLUS \$1.50/book UPS or 75¢/book 4th class mail (CA add tax)

TOTAL AMT. ENCLOSED _____ OR CHARGE MY VISA MC AM. EX.

CARD # _____ EXP. DATE _____

SIGNATURE _____

PLEASE SEND ME YOUR FREE CATALOG

Listing 1 continued:

```
6580 DIMCA(1,7),NV$(NL+10,1),IA$(IL),IA(IL),RS$(RL),RM(RL,5),MS$(ML),AA(5),A$(9)
,A(1,7)
6590 FORZ=0TOCL STEP2:FORXX=0TO1:FORY=0TO7:READ CA(XX,Y):NEXTY,XX:X=0
6600 Y=X+1:PRINT#D,CA(X,0),CA(X,1),CA(X,2),CA(X,3),CA(X,4),CA(X,5),CA(X,6),CA(X,
7),CA(Y,0),CA(Y,1),CA(Y,2),CA(Y,3),CA(Y,4),CA(Y,5),CA(Y,6),CA(Y,7):NEXTZ
6610 FORX=0TONL:FORY=0TO1:READ NV$(X,Y):NEXTY,X
6620 FORX=0TORL:READ RM(X,0),RM(X,1),RM(X,2),RM(X,3),RM(X,4),RM(X,5),RS$(X):NEXT
6630 FORX=0TOML:READ MS$(X):NEXT
6640 FORX=0TOIL:READ IA$(X),IA(X):NEXT
6650 FORX=0TONLSTEP10:FORY=0TO1:PRINT#D,NV$(X,Y),NV$(X+1,Y),NV$(X+2,Y),NV$(X+3,Y
),NV$(X+4,Y),NV$(X+5,Y),NV$(X+6,Y),NV$(X+7,Y),NV$(X+8,Y),NV$(X+9,Y):NEXTY,X
6660 FORX=0TORL:PRINT#D,RM(X,0),RM(X,1),RM(X,2),RM(X,3),RM(X,4),RM(X,5),RS$(X):N
EXT
6670 FORX=0TOML:PRINT#D,MS$(X):NEXT
6680 FORX=0TOIL:PRINT#D,IA$(X),IA(X):NEXT
6690 INPUT"REWIND TAPE TO BE VERIFIED":TP$
6700 POKE16553,255:RESTORE:FORX=1TO11:READA0:NEXT
6710 INPUT#D,A0,A1,A2,A3,A4,A5,A6,A7,A8,A9,B0
6720 IFB0(<)TRORA0(<)ILDRA1(<)CLORA2(<)NLORA3(<)RLORA4(<)MXORA5(<)ROR(A6<)TT)ORA7(<)LNOR
(A8<)LT)ORA9(<)MLTHEN6790
6730 FORX=0TOCL STEP2:INPUT#D,A(0,0),A(0,1),A(0,2),A(0,3),A(0,4),A(0,5),A(0,6),A
(0,7),A(1,0),A(1,1),A(1,2),A(1,3),A(1,4),A(1,5),A(1,6),A(1,7)
6740 FORY=0TO1:FORZ=0TO7:POKE16553,255:READA0:IFA(Y,Z)<)A0THEN6790ELSENEXTZ,Y,X
6750 FORX=0TONLSTEP10:FORY=0TO1:INPUT#D,A$(0),A$(1),A$(2),A$(3),A$(4),A$(5),A$(
6),A$(7),A$(8),A$(9):FORZ=0TO9:IFNV$(X+Z,Y)<)A$(Z)THEN6790ELSENEXTZ,Y,X
6760 FORX=0TORL:INPUT#D,AA(0),AA(1),AA(2),AA(3),AA(4),AA(5),A$:FORY=0TO5:IFAA(Y)
<)RM(X,Y)ORA$(X)RS$(X)THEN6790ELSENEXTY,X
6770 FORX=0TOML:INPUT#D,A$:IFA$(X)MS$(X)THEN6790ELSENEXT
6780 FORX=0TOIL:INPUT#D,A$,AA(0):IFAA(0)<)IA(X)ORA$(X)IA$(X)THEN6790ELSENEXTX:CLS
:PRINT"DATA TAPE VERIFIED":END
6790 PRINT"BAD TAPE!":END
```

Listing 2: Main program of Scott Adams' Pirate's Adventure for the TRS-80. This program uses the data tape generated by listing 1.

```
10 'COPYRIGHT SCOTT ADAMS. 1978
20 CLEAR5400:DEFINTA-Z:D=-1
30 IFD=-1IFMEM(<)4526PRINT"BAD LOAD":END
40 X=Y=Z:K=R=V:N=LL=F:TP$=K$:W=IP=P:Z$="I'VE TOO MUCH TOO CARRY. TRY -TAKE INVEN
TORY-":GOSUB1240:GOTO100
50 CLS:PRINT" ***: WELCOME TO ADVENTURE LAND. (#4.6) ***":PRINT:PRINT" UNLE
SS TOLD DIFFERENTLY YOU MUST FIND *TREASURES*
AND-RETURN-THEM-TO-THEIR-PROPER--PLACE!"
60 PRINT:PRINT"I'M YOUR PUPPET. GIVE ME ENGLISH COMMANDS THAT"
70 PRINT"CONSIST OF A NOUN AND VERB. SOME EXAMPLES...":PRINT:PRINT"TO FIND OUT W
HAT YOU'RE CARRYING YOU MIGHT SAY: TAKE INVENTORY
TO GO INTO A HOLE YOU MIGHT SAY: GO HOLE
TO SAVE CURRENT GAME: SAVE GAME"
80 PRINT:PRINT"YOU WILL AT TIMES NEED SPECIAL ITEMS TO DO THINGS, BUT I'M
SURE YOU'LL BE A GOOD ADVENTURER AND FIGURE THESE THINGS OUT."
90 PRINT:INPUT" HAPPY ADVENTURING... HIT ENTER TO START":K$:CLS:RETURN
100 R=AR:LX=LT:DF=0:SF=0:INPUT"USE OLD 'SAVED' GAME":K$:IFLEFT$(K$,1)<)"Y"THEN13
0
110 IFD(<)-1THENCLOSE:OPEN"I",D,SV$ELSEINPUT"READY SAVED TAPE":K$:PRINTINT(IL*5/6
0)+1;"MINUTES"
120 INPUT#D,SF,LX,DF,R:FORX=0TOIL:INPUT#D,IA(X):NEXT:IFD(<)-1CLOSE
130 GOSUB50:GOSUB240:GOTO160
140 INPUT"TELL ME WHAT TO DO":TP$:PRINT:GOSUB170:IFFPRINT"YOU USE WORD(S) I DON'
T KNOW":GOTO140
150 GOSUB360:IFIA(9)=-1THENLX=LX-1:IFLX<0THENPRINT"LIGHT HAS RUN OUT":IA(9)=0ELS
EIFLX<25PRINT"LIGHT RUNS OUT IN":LX;"TURNS!"
160 NV(0)=0:GOSUB360:GOTO140
170 K=0:NT$(0)="" :NT$(1)=""
```

Listing 2 continued on page 204

ΩMEGA WHOLESALE COMPUTER PRICES SALES CO.

12 Meeting St., Cumberland, R.I. 02864

Christmas Specials

When you buy:

You receive:

You receive:

When you buy:



Atari 800
\$749

1-8K plug in
RAM Module

FREE

— (\$124.95 value)

1 Box (10 Pcs)
8" Diskettes

FREE



TRS-80
Model II - \$3449



Apple II
16K - \$999
(Regular or Plus)

1 Apple Tape
Recorder

FREE

— (\$40 value)

Microsoft Basic
for only
\$162.50



INTERTEC SUPERBRAIN
32K RAM - \$2449.00
64K RAM - \$2649.00



NEW!
ATARI 825
PRINTER — \$949

Atari Interface
Module

FREE

— (\$219.95 value)

Statistics Pak
or
Carrying case

FREE

— (\$95 value each)



HP-85 — \$2899

APPLE II DISK
with Controller — \$495

FREE

1 Box (5 Pcs)
Diskettes

NEC Spinwriter
5530 or 5510
\$2449

SOROC IQ 120
\$699

OKIDATA MICROLINE 80 — \$529

EPSON MX-80
80 Character, 9x9 Dot Matrix
Roll & Pin Feed Printer
for your Apple, TRS-80
or Commodore \$599



FREE

Interface to
Your Computer

ΩMEGA OFFERS THE BEST DELIVERY AND PRICE ON:

APPLE • ATARI • TRS-80 MODEL II • INTERTEC •
T.I. 810 • HEWLETT-PACKARD-85 • SOROC •
COMMODORE • NEC • QUME • CENTRONICS

ΩMEGA sells only factory fresh, top quality merchandise to out customers.
ΩMEGA will try to match any current advertised price with similar purchase conditions.
Before you buy anywhere else — be sure to call ΩMEGA Sales Co.

1-401-722-1027

ΩMEGA ships via UPS, truck or air. COD's, VISA, Mastercharge accepted.
"A member in good standing of the Better Business Bureau."

We carry a complete line
of the above equipment.
For information and
further pricing call:

TOLL FREE

1-800-556-7586

TELEX: 952106

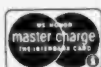

Listing 2 continued:

```

180 FORX=1TOLEN(TP$):K$=MID$(TP$,X,1):IFK$=" "THENK=1ELSENT$(K)=LEFT$(NT$(K)+K$,
LN)
190 NEXTX:FORX=0TO1:NV(X)=0:IFNT$(X)=" "THEN230ELSEFORY=0TONL:K$=NV$(Y,X):IFLEFT$(
K$,1)="*"THENK$=MID$(K$,2)
200 IFX=1IFY(7THENK$=LEFT$(K$,LN)
210 IFNT$(X)=K$THENN(X)=YELSENEXTY:GOTO230
220 IFLEFT$(NV$(NV(X),X),1)="*"THENN(X)=NV(X)-1:GOTO220
230 NEXTX:F=NV(0)<1ORLEN(NT$(1))>0ANDNV(1)<1:RETURN
240 IFDFIFIA(9)<>-1ANDIA(9)<>RPRINT"I CAN'T SEE, ITS TOO DARK.":RETURN
250 K=-1:IFLEFT$(RS$(R),1)="*"THENPRINTMID$(RS$(R),2);ELSEPRINT"I'M IN A ";RS$(R
);
260 FORZ=0TOIL:IFKIFIA(Z)=RPRINT". VISIBLE ITEMS HERE:
":K=0
270 GOTO300
280 TP$=IA$(Z):IFRIGHT$(TP$,1)="/"FORW=LEN(TP$)-1TO1STEP-1:IFMID$(TP$,W,1)="/"TH
ENTP$=LEFT$(TP$,W-1)ELSENEXTW
290 RETURN
300 IFIA(Z)<>RTHEN320ELSEGOSUB280:IFPOS(0)+LEN(TP$)+3)63THENPRINT
310 PRINTTP$;" ";
320 NEXT:PRINT
330 K=-1:FORZ=0TO5:IFKIFRM(R,Z)<>0PRINT"
OBVIOUS EXITS: ";:K=0
340 IFRM(R,Z)<>0PRINTNV$(Z+1,1);" ";
350 NEXT:PRINT:PRINT:RETURN
360 F2=-1:F=-1:F3=0:IFNV(0)=1ANDNV(1)<7THEN610ELSEFORY=0TOCL:V=CA(X,0)/150:IFNV(
0)=0IFV<>0RETURN
370 IFNV(0)<>VTHENNEXTX:GOTO990ELSEN=CA(X,0)-V*150
380 IFNV(0)=0THENF=0:IFRND(100)<=NTHEN400ELSENEXTX:GOTO990
390 IFN<>NV(1)ANDN<>0THENNEXTX:GOTO990
400 F2=-1:F=0:F3=-1:FORY=1TO5:W=CA(X,Y):LL=W/20:K=W-LL*20:F1=-1:ONK+1GOTO550,430

```

Listing 2 continued on page 208

MARYMAC INDUSTRIES, INC.

To Place An Order
From Outside Texas
1-800-231-3680



Questions & Answers
& Orders
Texas 1-713-392-0747

Store #G-189

BRAND NEW IN CARTONS DELIVERED. Marymac Industries owns & operates Radio Shack® dealership in Katy, Texas. Warranties will be honored by all company owned Radio Shack® stores, & participating franchisees and dealer authorized sales centers. Save State Sales Tax. Texas Residents Add Only 5% Sales Tax. Open Mon.-Sat. 10-7. We pay freight and insurance. No extra charge for Master Charge & Visa. Call us for reference in or near your city. Ref: Farmers State Bank, Brookshire, Texas. Write or visit us at, 21969 Katy Fwy, Katy (Houston), Texas 77450.

WE OFFER ON REQUEST

- Federal Express
- Houston Intercontinental Airport Delivery
- U.P.S. BLUE
- References from people who have bought computers from us probably in your city

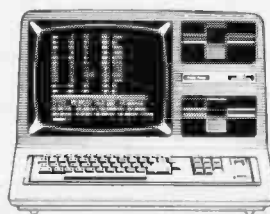

In stock TRS-80 Model I II and III

No Tax on Out of Texas Shipments!

**Save
10% 15%
OR MORE**

WE ALWAYS OFFER

- NO extra charge for Master Charge or Visa
- We always pay the freight and insurance
- Toll free order number
- Our capability to go to the giant Tandy Computer warehouse 5 hours away, in Ft. Worth, Texas, to keep you in stock.

ED McMANUS

JOE McMANUS



Model III



In Stock



A PASCAL/M™ Demo Disk from Sorcim.

You've heard all about the power of PASCAL. You know it's a simple, high level, block structured language that is replacing BASIC as the universal programming tool. But how can you learn if it's really what you want without spending a lot of money? Sorcim's Incredible \$10 Free Offer is the answer.

For only \$10 you receive a CP/M® compatible 8" floppy disk that demonstrates the entire PASCAL/M language. Through a sample program that displays the unique features of PASCAL/M and a limited compiler that allows you to create programs of your own, you'll discover the incredible world of PASCAL/M first-hand.

You can run the disk on any standard CP/M-based system using an 8080, 8085 or Z80™ CPU device with 56K memory.

So where's the FREE come in?

After the demo disk gets you hooked on PASCAL/M, just order the full PASCAL/M package, including the compiler, object library and pseudo code (P-Code) interpreter, and we'll give you full credit for the demo disk!

This isn't your BASIC offer!



That's \$10 off of our regular low price of \$175. And that makes it about as close to free as you can get.

If you need full documentation, just turn your Incredible \$10 Free Offer into an Incredible \$20 Free Offer. Order the complete 90-page User's Reference Manual, which fully details our entire PASCAL/M package, for an additional \$10. And you'll get full credit for the \$20 offer, too.

Sorcim is the solid software source.

Sorcim is fully committed to the advancement of technology through software development. Our next PASCAL enhancement, the PASCAL/M symbolic debugger which dramatically reduces program development time, is proof of this commitment. We also offer a comprehensive line of state-of-the-art software products for Z80, 8080, 8048, 6502, 680x, Z8000, M68000 and 8086/88 microprocessor-based systems. And Sorcim can develop operating systems, compilers and assemblers for your specialized applications.

Take advantage of our incredible offer by filling out the coupon and sending it to us today. You'll get hard evidence of solid software for microcomputer applications.

THE INCREDIBLE \$10 FREE OFFER!!

OK, I can't pass up your Incredible \$10 Free Offer.

Please send me the items checked below:

- PASCAL/M Demo Disk\$ 10.00
 PASCAL/M User's Reference Manual\$ 10.00
 Demo Disk and Reference Manual\$ 20.00

I understand that I'll receive full credit for my Incredible \$10 (or \$20) Free Offer if I order the full PASCAL/M package by July 31, 1981.

- I can't stand it; I've got to have the full PASCAL/M package, including Compiler, Object Library, P-Code Interpreter, Reference Manual and Demo Disk.

Z80* 8080/85* Z80/9511*

*Specify: CP/M or CDOS\$175.00

8088/86 (Requires CP/M 86)\$250.00

Master Card VISA Ship UPS C.O.D.

Check or money order enclosed

Card Number _____ Exp. Date _____

Master Card Interbank Number _____

Signature _____
(for credit card purchase)

Total amount enclosed\$ _____
(California residents add 6.5% sales tax; for overseas shipment, add \$10.00; for shipment to Canada or Mexico, add \$5.00.)

SHIP TO: _____

ADDRESS: _____
(No P.O. boxes, please)

CITY: _____

STATE: _____ ZIP _____

PASCAL/M is a trademark of Sorcim
 CP/M is a registered trademark
 of Digital Research
 Z80 is a trademark
 of Zilog Corporation



SORCIM

1333 Lawrence Expressway
 Suite 418
 Santa Clara, CA 95051
 (408) 248-5543



AA-359

CPU 8085/88:

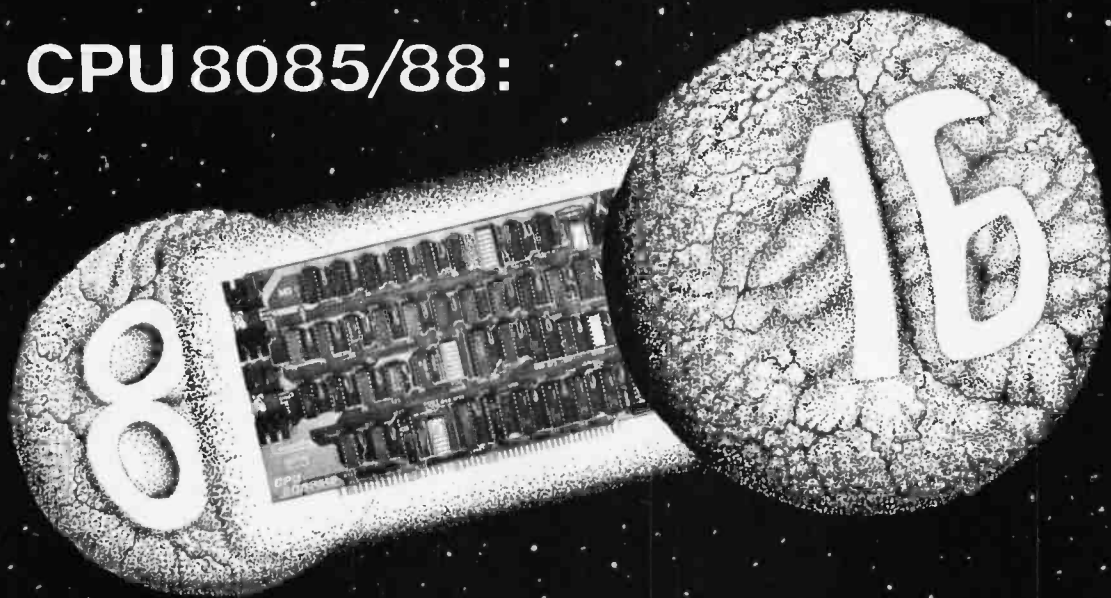

THE BRIDGE BETWEEN TWO WORLDS.

When we shipped the first CPU 8085/88 back in June of 1980, we created a bridge between the 8 bit world of the present and the 16 bit world of the future.

The response has been overwhelming - but really, no other reaction would be appropriate for a CPU board that is downward compatible with 8 bit 8080/8085 software, upward compatible with 16 bit 8086/8088 software (as well as Intel's coming P-Series), designed for professional-level high speed applications, and engineered for full compliance with all IEEE 696/S-100 standards.

See this bridge to the future of computing at finer computer stores world-wide.

The CPU 8085/88 is all that we say it is . . . and more.

CompuProTM from **GODBOUT**
ELECTRONICS
Bldg. 725, Oakland Airport, CA 94614

Prices: \$295 unkit (sockets and bypass caps pre-soldered in place, 5 MHz operation); \$425 assembled (5 MHz operation); \$525 qualified under the high-reliability Certified System Component program (with 5 MHz 8085, 6 MHz 8088). Owner's manual available separately for \$5. Monitor/debugger available on 8" disc for \$35. For 24 hour VISA®/Mastercard® orders, call (415) 562-0636.

Note: Unkits are not intended for novice builders. Assembly is simple, but de-bugging may be required due to problems such as IC infant mortality. In case of problems, factory service is available for unkits for a flat service charge.

CompuPro products are also available assembled, or qualified under our high-reliability Certified System Component (CSC) program (200 hour burn-in, extensive testing, 2 year extended warranty more).

NEW! ANNOUNCING THE "SYSTEM SUPPORT 1" S-100 BOARD

The perfect, multi-purpose helpmate for any S-100 system - at an astonishingly low price! Just look at all these features:

- Month/day/time clock with on-board crystal timebase and provision for battery backup. All time data available in BCD.
- Provision for adding the 9511 or 9512 math processor.
- Full RS-232 serial port, similar to the serial ports in our acclaimed "Interfacer" boards.
- Three interval timers - cascade, or use independently.
- Two interrupt controllers - supports buss vectored interrupts, and interrupts generated by the interval timers and/or math processor.
- Space for up to 4K of onboard EPROM and/or RAM; two 2716-pinout sockets handle 4K ROM, 2K RAM/2K ROM, or 4K RAM.
- Ideal for use with the CPU 8085/88 or CPU Z.

This amazingly versatile board costs an equally amazing \$295 unkit, \$395 assm, or \$495 CSC (add \$195 to all prices for inclusion of the 9512 math chip). Shipment starts in December - so get ready to add some real computing power to your S-100 system.

COMPUPRO S-100 MOTHERBOARDS: DESIGNED FOR THE FUTURE, AVAILABLE NOW

These advanced motherboards handle the coming generation of 5 to 10 MHz CPUs (as well as present day 2 and 4 MHz systems), and feature Faraday shielding between all bus signal lines to minimize crosstalk, active termination that splits the termination load between each end of every bus line, and mechanical compatibility with Godbout, Vector, Imsai, TEI, and similar enclosures. Unkits have edge connectors and termination resistors pre-soldered in place for easy assembly.

- #CK-026 6 slot motherboard with edge connectors - unkit \$89, assm \$129
- #CK-025 12 slot motherboard with edge connectors - unkit \$129, assm \$169
- #CK-024 20 slot motherboard with edge connectors - unkit \$174, assm \$214

COMPUPRO COMPUTER ENCLOSURE \$289 desktop, \$329 rack mount

This handsome enclosure does justice to the finest computer systems. Includes dual AC outlets and fuseholder on rear, heavy-duty line filter, and black anodized front panel (with textured vinyl painted cover for desktop version). Pre-drilled base accepts our high-performance S-100 motherboards or types by Vector, California Digital, and others. Rack mount version includes slides for easy pull-out from rack for maintenance or board changing.

8088/8086 MONITOR DEBUGGER: \$35

Supplied on single sided, single density, soft-sector 8" disc. CP/M* compatible. Great development tool; mnemonics used in debug conform as closely as possible to current CP/M* mnemonics.

OTHER S-100 BUS PRODUCTS

- Active Terminator Board \$34.50 kit
- Memory Manager Board \$59 unkit, \$85 assm, \$100 CSC
- Mullen Extender Board \$59 kit
- Mullen Relay/Opto-Isolator Control Board. \$129 kit, \$179 assm
- Spectrum color graphics board \$299 unkit, \$399 assm, \$449 CSC
- 2708 EPROM Board (2708s not included) ... \$85 unkit, \$135 assm, \$195 CSC
- Interfacer 1 (dual RS-232 serial ports)..... \$199 unkit, \$249 assm, \$324 CSC
- Interfacer 2 (3 parallel + 1 serial port)..... \$199 unkit, \$249 assm, \$324 CSC

VISIT FINER COMPUTER STORES WORLD-WIDE FOR MORE INFORMATION ON THESE OUTSTANDING PRODUCTS,
OR WRITE US DIRECT IF THERE'S NO STORE IN YOUR AREA.

CompuPro™
Bldg. 725, Oakland Airport, CA 94614

WE'RE IN THE MEMORY LEAD AGAIN.

Make way for the memory board of the year: RAM 21, the first 128K byte S-100 static RAM board. Includes all the features you'd expect from CompuPro RAM boards, with current consumption comparable to standard 32K boards. Full data and pricing on this remarkable memory board will be available during December.

Our current memory lineup features fully static design to eliminate dynamic timing problems, full IEEE 696/S-100 spec compatibility, 4/5 MHz operation, low power, extensive bypassing, and careful thermal design. CSC memories will run with 10 MHz CPU clock speeds on the S-100 buss (while drawing half the current of non-CSC boards) to give high speed, ultra-low power operation.

If you're looking for specs - if you're looking for performance - if you're looking for exceptional value, then look no further than the RAM series from CompuPro.

RAM XX (with bank select and IEEE compatible extended addressing)

	unkit	assm	CSC
16K RAM XX-16.....	\$319	\$399	\$479
24K RAM XX-24.....	\$429	\$539	\$629
32K RAM XX-32.....	\$559	\$699	\$799

OTHER S-100 MEMORY

8K RAM IIA.....	\$159	\$189	\$239
16K RAM XIV.....	\$279	\$349	\$429

(Includes IEEE compatible extended addressing.)

CLOSEOUT SPECIAL: 32K fully static memory for the SBC buss (RAM XI), now only \$699 assembled. Limited quantities.

CPU-Z:

8 BITS OF Z80A* POWER FOR THE S-100 BUS

Superior design in a true IEEE-compatible board (timing specs available on request). Includes all standard Z-80A* features along with power on jump/clear, on-board fully maskable interrupts for interrupt-driven systems, selectable automatic wait state insertion, provision for adding up to 8K of on-board EPROM, IEEE compatible 16/24 bit extended addressing, and much more. CSC boards supplied with 6 MHz CPU; others supplied with 4 MHz CPU. \$225 unkit, \$295 assm, \$395 CSC.

NEW LOW PRICE!

16K DYNAMIC RAMS - 8/\$39!!

Lowest price ever on one of our most popular items. Expands memory in TRS-80* -I and -II, as well as machines made by Apple, Exidy, Heath H89, newer PETs, etc. Low power, high speed (4 MHz), Add \$3 for 2 dip shunts plus TRS-80* conversion instructions. Limited quantity - first come, first served.

PASCAL/M* FROM SORCIM:

\$175 COMPLETE

PASCAL - easy to learn, easy to apply - can give a microcomputer with CP/M* more power than many minis. We supply a totally standard Wirth PASCAL/M* 8" diskette and manual. Specify Z80* or 8080/8085 version.

2 102 MEMORY SPECIAL

While they last. 99 cents each, 10/\$9.90. Low power.

COMING SOON: "MPX 1", a front end processor/system multiplexer for high speed multi-task/multi-user setups...and an STD buss motherboard and RAM card. Stay tuned!

*LEGAL CORNER: Z80A is a registered trademark of Zilog. TRS-80 is a trademark of the Tandy Corporation. PASCAL/M is a trademark of Sorcim. CP/M is a registered trademark of Digital Research.

TERMS: Cal res add tax. Allow 5% shipping; excess refunded. Orders under \$15 add \$2 handling. VISA® and Mastercard® orders (\$25 min) call (415) 562-0636, 24 hrs. Please include street address for UPS delivery. Sale prices good through cover month of magazine, other prices subject to change without notice.

FREE CATALOGUE: Find out more about our product line. For 1st class delivery, add 41 cents in stamps; foreign orders add \$2 (refundable with order).

from **GODBOUT**
ELECTRONICS

Listing 2 continued:

```
, 450, 470, 490, 500, 510, 520, 530, 540, 410, 420, 440, 460, 480
410 F1=-1:FORZ=0TOIL:IFIA(Z)=-1THEN550ELSENEXT:F1=0:GOTO550
420 F1=0:FORZ=0TOIL:IFIA(Z)=-1THEN550ELSENEXT:F1=-1:GOTO550
430 F1=IA(LL)=-1:GOTO550
440 F1=IA(LL)(<)-1ANDIA(LL)(<)R:GOTO550
450 F1=IA(LL)=R:GOTO550
460 F1=IA(LL)(<)0:GOTO550
470 F1=IA(LL)=RORIA(LL)=-1:GOTO550
480 F1=IA(LL)=0:GOTO550
490 F1=R=LL:GOTO550
500 F1=IA(LL)(<)R:GOTO550
510 F1=IA(LL)(<)-1:GOTO550
520 F1=R(<)LL:GOTO550
530 F1=SFANDCINT(2+LL+.5):F1=F1(<)0:GOTO550
540 F1=SFANDCINT(2+LL+.5):F1=F1=0:GOTO550
550 F2=F2ANDF1:IFF2THENNEXTYELSENEXTX:GOTO990
560 IP=0:FORZ=1TO4:K=(Y-1)/2+6:ONYGOTO570, 580, 570, 580
570 AC=CA(X, K)/150:GOTO590
580 AC=CA(X, K)-CINT(CA(X, K)/150)*150
590 IFAC<101THEN600ELSEIFAC=0THEN960ELSEIFAC<52THENPRINTMS$(AC):GOTO960:ELSEONAC
-51GOTO660, 700, 740, 760, 770, 780, 790, 760, 810, 830, 840, 850, 860, 870, 890, 920, 930, 940, 9
50, 710, 750
600 PRINTMS$(AC-50):GOTO960
610 L=DF:IFLTHENL=DFANDIA(9)(<)R ANDIA(9)(<)-1:IFL PRINT"DANGEROUS TO MOVE IN THE
DARK!"
620 IFNV(1)(<1PRINT"GIVE ME A DIRECTION TOO.":GOTO1040
630 K=RM(R, NV(1)-1):IFK<1IFLTHENPRINT"I FELL DOWN AND BROKE MY NECK.":K=RL:DF=0:
ELSEPRINT"I CAN'T GO IN THAT DIRECTION":GOTO1040
640 IFNOTLCLS
650 R=K:GOSUB240:GOTO1040
660 L=0:FORZ=1TOIL:IFIA(Z)=-1LETL=L+1
670 NEXTZ
680 IFL)=MXPRINTZ$:GOTO970
690 GOSUB1050:IA(P)=-1:GOTO960
700 GOSUB1050:IA(P)=R:GOTO960
710 PRINT"SAVING GAME":IFD=-1THENINPUT"READY OUTPUT TAPE":K$:PRINTINT(IL*5/60)+1
;"MINUTES"ELSEOPEN"D", D, SV$
720 PRINT#D, SF, LX, DF, R:FORW=0TOIL:PRINT#D, IA(W):NEXT:IFD(<)-1CLOSE
730 GOTO960
740 GOSUB1050:R=P:GOTO960
750 GOSUB1050:L=P:GOSUB1050:Z=IA(P):IA(P)=IA(L):IA(L)=Z:GOTO960
760 GOSUB1050:IA(P)=0:GOTO960
770 DF=-1:GOTO960
780 DF=0:GOTO960
790 GOSUB1050
800 SF=SF ORCINT(.5+2+P):GOTO960
810 GOSUB1050
820 SF=SFANDNOTCINT(.5+2+P):GOTO960
830 PRINT"I'M DEAD...":R=RL:DF=0:GOTO860
840 GOSUB1050:L=P:GOSUB1050:IA(L)=P:GOTO960
850 INPUT"THE GAME IS NOW OVER
ANOTHER GAME":K$:IFLEFT$(K$, 1)="N"THENENDELSEFORX=0TOIL:IA(X)=I2(X):NEXT:GOTO100
860 GOSUB240:GOTO960
870 L=0:FORZ=1TOIL:IFIA(Z)=TRIFLEFT$(IA$(Z), 1)="*"LETL=L+1
880 NEXTZ:PRINT"I'VE STORED";L;"TREASURES.
ON A SCALE OF 0 TO 100 THAT RATES A":CINT(L/TT*100):IFL=TTTHENPRINT"WELL DONE.":
GOTO850ELSE960
890 PRINT"I'M CARRYING.":K$="NOTHING":FORZ=0TOIL:IFIA(Z)(<)-1THEN910ELSEGOSUB280:
IFLEN(TP$)+POS(0))63PRINT
900 PRINTTP$;" ", ;:K$=""
910 NEXT:PRINTK$:GOTO960
920 P=0:GOTO800
930 P=0:GOTO820
940 LX=LT:IA(9)=-1:GOTO960
```

Listing 2 continued on page 210

Now NRI takes you inside the world's most popular microcomputer to train you at home as the new breed of computer specialist!

NRI teams up with Radio Shack to teach you how to use, program and service microcomputers... make you the complete technician.

It's no longer enough to be just a programmer or a technician. With microcomputers moving into the fabric of our lives (over 200,000 of the TRS-80™ alone have been sold), interdisciplinary skills are demanded. And NRI can prepare you with the first course of its kind, covering the complete world of the microcomputer.

Learn At Home in Your Spare Time

With NRI training, the programmer gains practical knowledge of hardware, enabling him to design simpler, more effective programs. And, with advanced programming skills, the technician can test and debug systems quickly and easily.



Training includes TRS-80 computer, transistORIZED volt-ohm meter, digital frequency counter, and the NRI Discovery Lab with hundreds of tests and experiments.

(TRS-80 is a trademark of the Radio Shack division of Tandy Corp.)



Only NRI gives you both kinds of training with the convenience of home study. No classroom pressures, no night school, no gasoline wasted. You learn at your convenience, at your own pace. Yet you're always backed by the NRI staff and your instructor, answering questions, giving you guidance, and helping you over the tough spots.

Explore the TRS-80 Inside and Out

NRI training is hands-on training, with practical experiments and demonstrations as the very foundation of your knowledge. You don't just program your computer, you introduce and correct faults... watch how circuits interact... interface with other systems... gain a real insight into its nature.

You also build test instruments and the NRI Discovery Lab, performing over 60 separate experiments in the process. You learn how your trouble-shooting tools work, and gain greater understanding of the information they give you. Both micro-

computer and equipment come as part of your training for you to use and keep.

Send for Free Catalog... No Salesman Will Call

Get all the details on this exciting course in NRI's free, 100-page catalog. It shows all equipment, lesson outlines, and facts on other electronics courses such as Complete Communications with CB, TV and Audio, Digital Electronics, and more. Send today, no salesman will ever bother you. Keep up with the latest technology as you learn on the world's most popular computer. If card has been used, write to:



NRI Schools

McGraw-Hill Continuing Education Center
3939 Wisconsin Avenue
Washington, D.C. 20016.

Listing 2 continued:

```
950 CLS:GOTO960
960 NEXTY
970 IFNV(0)(<)0THEN990
980 NEXTX
990 '
1000 IFNV(0)=0THEN1040
1010 GOSUB1060
1020 IFFPRINT"I DON'T UNDERSTAND YOUR COMMAND":GOTO1040
1030 IFNOTF2PRINT"I CAN'T DO THAT YET":GOTO1040
1040 RETURN
1050 IP=IP+1:W=CA(X,IP):P=W/20:M=W-P*20:IFM(<)0THEN1050ELSERETURN
1060 IFNV(0)(<)10ANDNV(0)(<)18ORF3THEN1230
1070 IFNV(1)=0PRINT"WHAT?":GOTO1180
1080 IFNV(0)(<)10THEN1110
1090 L=0:FORZ=0TOIL:IFIA(Z)=-1THENL=L+1
1100 NEXT:IFL)=MXPRINTZ$:GOTO1180
1110 K=0:FORX=0TOIL:IFRIGHT$(IA$(X),1)(<)"/"THEN1190ELSELL=LEN(IA$(X))-1:TP$=MID$(IA$(X),1,LL):FORY=LLTO2STEP-1:IFMID$(TP$,Y,1)(<)"/"THENNEXTY:GOTO1190
1120 TP$=LEFT$(MID$(TP$,Y+1),LN)
1130 IFTP$(<)NV$(NV(1),1)THEN1190
1140 IFNV(0)=10THEN1160
1150 IFIA(X)(<)-1THENK=1:GOTO1190ELSEIA(X)=R:K=3:GOTO1170
1160 IFIA(X)(<)RTHENK=2:GOTO1190ELSEIA(X)=-1:K=3
1170 PRINT"OK, ";
1180 F=0:RETURN
1190 NEXTX
1200 IFK=1THENPRINT"I'M NOT CARRYING IT"ELSEIFK=2PRINT"I DON'T SEE IT HERE"
1210 IFK=0IFNOTF3PRINT"ITS BEYOND MY POWER TO DO THAT":F=0
1220 IFK(<)0THENF=0
1230 RETURN
1240 IFD(<)-1THEN1330ELSEINPUT"READY DATA TAPE. HIT ENTER
";K$
1250 INPUT#D,IL,CL,NL,RL,MX,AR,TT,LN,LT,ML,TR
1260 W=(IL+CL/2+NL/10+RL+ML)/12:PRINTW+1;"MINUTES TO LOAD."
1270 DIMNV(1),CA(CL,7),NV$(NL,1),IA$(IL),IA(IL),RS$(RL),RM(RL,5),MS$(ML),NT$(1),I2(IL)
1280 FORX=0TOCL STEP2:Y=X+1:INPUT#D,CA(X,0),CA(X,1),CA(X,2),CA(X,3),CA(X,4),CA(X,5),CA(X,6),CA(X,7),CA(Y,0),CA(Y,1),CA(Y,2),CA(Y,3),CA(Y,4),CA(Y,5),CA(Y,6),CA(Y,7):NEXT
1290 FORX=0TONLSTEP10:FORY=0TO1:INPUT#D,NV$(X,Y),NV$(X+1,Y),NV$(X+2,Y),NV$(X+3,Y),NV$(X+4,Y),NV$(X+5,Y),NV$(X+6,Y),NV$(X+7,Y),NV$(X+8,Y),NV$(X+9,Y):NEXTY,X
1300 FORX=0TORL:INPUT#D,RM(X,0),RM(X,1),RM(X,2),RM(X,3),RM(X,4),RM(X,5),RS$(X):NEXT
1310 FORX=0TOML:INPUT#D,MS$(X):NEXT
1320 FORX=0TOIL:INPUT#D,IA$(X),IA(X):I2(X)=IA(X):NEXT:IFD=-1RETURN
1330 REM
```



COLOR MONITOR/RECEIVER

Two Modes of Operation for The Price of One

- Standard composite video/ 75 ohm term.
- Transformer isolated for safety.
- External audio input with control.
- Power Requirements: 117 VAC 60 Hz.
- VM-19, 19" diagonal screen, \$575.00.
- For professional, industrial, home video applications.

V.A.M.P. Inc.

P.O. BOX 29315 • LOS ANGELES, CA 90029 • (213) 466-5533

COMPUTIQUE

INFORMATION LINE
(714) 549-7373



TOLL FREE
ORDER LINES
(800) 854-0523
(Outside California)
(800) 432-7066
(Within California)

YOUR COMPUTER PROFESSIONALS

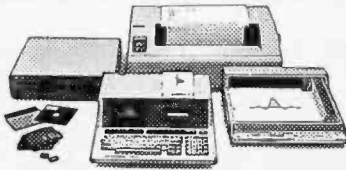

hp HEWLETT
PACKARD
Headquarters

HP-85

A STANDARD FOR PROFESSIONALS.

HP-67	299.95
HP-92	399.95
HP-97	584.95
HP-33C NEW	89.95
HP-34C NEW	124.95
HP-38C NEW	124.95
HP-31E	44.95
HP-32E	54.95
HP-33E	73.95
HP-37E	59.95
HP-38E	104.95
HP-41C NEW	CALL
HP-85 NEW	CALL

HP-41C



Complete Enhancements, Peripherals and Accessories

INNOVATIONS FROM TEXAS INSTRUMENTS

NOW: the TI 99/4
Home Computer

You can begin using the TI home computer in minutes. You simply snap in one of TI's Solid State Software Command Modules.

649.⁹⁵

MONITOR
NOT
INCLUDED

TEXAS INSTRUMENTS
INCORPORATED

TI-30SP	17.95	TI-57	54.95	TI-59	209.95
TI-35SP NEW	24.95	TI-5100	39.95	PC-100C	169.95
Bus. Anal. I	21.95	TI-5015	64.95	TI-58/59 Libraries	35.00
BA II Exec. NEW	44.95	TI-5040	89.95	Speak & Spell	59.95
Bus. Card	39.95	TI-5135 NEW	79.95	Speak & Read NEW	CALL
Invest. Anal. NEW	49.95	TI-5142 NEW	124.95	Speak & Math NEW	CALL
TI-55	34.95	TI-808-41 NEW	62.95	Lang. Tutor NEW	169.95
		TI-58C	104.95	Home Comp. 99/4	649.95

Texas Instruments
**Speak
Read**



WE WILL MEET OR BEAT ANY COMPETITOR'S PRICE ON MOST ITEMS IF HE HAS THE MERCHANDISE IN STOCK. All units shipped in original factory cartons with accessories according to manufacturer's specification. Visa, Mastercard, S order, Pers. Ck. (14 wrkg. days to clear), COD accepted. Min. \$4.95 for shipping in U.S.A. AIR on Reqt. CA res. add 6% sales Tx. All Mdse. subject to availability; prices subject to change. Send orders to Dept. BY-DEC



WRITE OR CALL FOR FREE CATALOG.

INTRODUCING

apple computer
Authorized Dealer

COMPLETE BUSINESS, EDUCATIONAL
& GAME SOFTWARE AVAILABLE.

apple III

Apple III is a highly integrated computer system, evolved from the Apple II design and optimized to best serve the professional user. The new computer will be offered in packaged configurations for personal use in professional applications. Look at these special Apple III features: • an 80 character upper/lower case display • disc drive and integrated peripheral interfaces • enhanced graphics capability • an emulator mode allowing Apple II software to be run on the Apple III

APPLE II PLUS
\$999.95
16K MEMORY

NOW AVAILABLE:
DOS 3.3
APPLE PILOT
APPLE FORTRAN
SILENTTYPE PRINTER
GRAPHICS TABLET
EXTENDED WRNTE.



COMPUTIQUE IS AN AUTHORIZED APPLE DEALER

ATARI

ATARI 800 (16K)	899.95
Free Software Offer Thru 12/31/80	CALL
ATARI 810 Disc Drive	559.95
ATARI 820 40-Column Printer	479.95
PLUS Complete Entertainment & Educational Software	



BSR SYSTEM X-10 TIMER NEW .59.95
CONTROLLER COMMAND. 33.95

MATTEL ELECTRONICS' Intellivision .249.95

CHESSE "7"
CHALLENGER .99.95



6200 NEW EXECUTIVE	99.95
5813 NEW SCI PROGRAMMABLE	34.95
5100 NEW LCD ALPHANUMERIC	89.95
5102 NEW FIN. PROG	79.95
7000 NEW MEMO WRITER	124.95

CASIO® ML-90 .49.95
FX-68 .27.95



CODE-A-PHONE 1750 NEW .269.95
1000 .109.95

ALSO: CANON, TOSHIBA, NSC, SEIKO, MATTEL, PEARLCORDER, ITT, GTE AND MANY OTHERS. ALL AT GREAT PRICES!!!

WE PROVIDE SOLUTIONS

NEWPORT BEACH/COSTA MESA
3211 S. Harbor Blvd.
Santa Ana, CA 92706
(714) 549-7373

TORRANCE/LAWNDALE
16611 Hawthorne Blvd.
Lawndale
(213) 370-5795

TARZANA
18665 Ventura Blvd.
Tarzana
(213) 705-7507

WILSHIRE CENTER
3285 Wilshire Blvd.
Los Angeles
(213) 385-7777

ANAHEIM/FULLERTON
2514 E. Chapman Ave.
Fullerton
(714) 738-7775

LOS ANGELES
11986 Wilshire Blvd.
Los Angeles
(213) 820-0423

PASADENA
260 S. Lake Ave.
Pasadena
(213) 795-3007

BREA
1080 E. Imperial Hwy.
Brea
(714) 990-6600

PROFESSIONAL DISCOUNTS

Text continued from page 192:

bytes of memory, has the sole purpose of generating the Adventure-data file that will be read by the Adventure-interpreter program. The program of listing 1 writes the data on a C-60 cassette and verifies that the tape has been correctly written. Allow about 45 minutes for this program to run.

The Adventure-interpreter program appears in listing 2. It will read the tape data file in about 20 minutes and then start play of the game.

If you plan to run *Pirate's Adventure*, on a 32 K-byte TRS-80 or larger

machine, you can merge the two programs as follows: delete lines 6510 thru 6790 of listing 1. Append the data statements of listing 1 to listing 2, replacing all occurrences of INPUT#D in listing 2 with the word READ.

It is possible to run this program on machines other than the TRS-80. If your machine runs a version of Microsoft BASIC (eg: Apple II running Applesoft, Commodore PET, Exidy Sorcerer, or any Ohio Scientific computer), you will have fewer changes to make. Here are some of the obscure changes that may have to

be made (depending on your machine and version of BASIC):

● A logical operation returns the value -1 (or hexadecimal FF) when true, and 0 otherwise. For example, executing:

```
PRINT (1=2), (1=1)
```

causes the numbers 0 (denoting false) and -1 (denoting true) to be printed.

● The flag SF is a 16-bit integer that is set and tested with boolean algebra commands. This can be replaced by the following:

1. Dimension SF as SF(15)
2. Replace F1=SF AND CINT(2↑LL+.5) with F1=SF(LL)
3. Replace SF=SF OR CINT(2↑P+.5) with SF(P)=-1
4. Replace SF=SF AND NOT CINT(.5+2↑P) with SF(P)=0

● IF . . . THEN . . . ELSE statements in TRS-80 Level II BASIC assert that, if the condition being tested is true, the statements between the words THEN and ELSE are performed. If the condition is false, the statements following the ELSE are performed. If your BASIC does not have the ELSE clause, you will have to split the statement into multiple lines.

● LEFT(A\$,B) returns the substring of A\$ from the first character to the Bth character. Similarly, MID\$(A\$,B,C) returns the substring from the Bth character on, for a total of C characters, and RIGHT\$(A\$,B) returns the last (ie: rightmost) B characters in the string.

● If you cannot create a two-dimensional array of strings (eg: DIM A\$(20,3)) as a twenty-row by three-column array of strings, you will find conversion nearly impossible because this feature is used heavily in the program.

Happy adventuring, and watch out for the tides on *Pirate's Island*—they can be tricky. ■

Please note that the Pirate's Adventure is copyrighted. Its publication in BYTE entitles the reader to personal use only. The program may not be distributed in any way without the written permission of the author.



Our Newest Data Base Management System

Introducing CONDOR SERIES 20/DBMS, the relational data base management system for users who want powerful performance at reasonable prices.

For the special introductory offer of \$695, discover how easy it is to develop business or personal information systems with SERIES 20/DBMS.

- Create a Data Base in Minutes
- Full CRT Screen Management
- Use English-like commands. Host language not required.
- Computational, Statistical, and Sorting Capabilities

CONDOR SERIES 20/DBMS is compatible with many Z-80 microcomputers with at least 48K RAM running under CP/M® operating systems.

CP/M is a registered trademark of Digital Research, Inc.

CONDOR SERIES 20/DBMS

____ User's Manual (\$35, plus tax) ____ Additional information.
____ SERIES 20 package (\$695, plus tax)

Please Send To:

Name _____ Position _____
Company _____ Address _____
City _____ State _____ ZIP _____
Phone () _____ Computer _____ CRT _____

CONDOR COMPUTER CORPORATION

3989 Research Park Drive, P. O. Box 8318
Ann Arbor, Michigan 48107 (313) 769-3988

Dealer inquiries welcome.

C 20-2

It's a text processor

Continuous, no-clutter, textual display, and short, easy-to-remember commands make Mince one of the finest editors available for small computers. Mince is based upon Emacs, a text manipulation system previously available only on a few large computers. The many features Mince now brings to the microcomputing world include, for example, the ability to switch back and forth between several documents, or even to display two different documents at once so that you can make changes in one based on the other.

Scribble is a text formatter that, when combined with Mince or another editor, forms a comprehensive document preparation system. Scribble is based on Scribe, which was developed at Carnegie-Mellon University to provide a simple yet powerful formatting environment for the non-technical user. Scribble commands allow you to specify the logical structure of the document rather than worry about formatting details.

Gemstones are professionally crafted programs that represent the state of the art in their respective domains. The documentation for each Gemstone includes not just a user's manual but also a design overview and related theoretical material. Each Gemstone also represents an ongoing commitment to user support, in the form of a newsletter, program updates, and a telephone hotline.

Mince	'125
Scribble (available January 1981)	'125
Both Mince and Scribble (ordered together)	'175
Amethyst	'350
Mince Manual	'15
Scribble Manual (available January 1981)	'15
Amethyst Manual	'35

Manual price is refundable upon purchase of the corresponding product.

All programs require a 48K CP/M[®] system. Mince and Amethyst require a cursor-addressable display. Available on 8" soft sector diskettes. Other formats by special request.

*Mark of the Unicorn
P.O. Box 423
Arlington, Massachusetts 02174
617-489-1387*



Amethyst, first of the Gemstones, combines Mince, Scribble, the BDS C compiler, and the source code for the Mince command set. This package makes possible simple reconfiguration of the editor to meet your needs. Not only can you customize the editor to your taste, you can even write your own programs and make use of the C compiler. This way we'll make Amethyst the ultimate 8080/Z-80 program development system.

But what makes this Gemstone sparkle in our eyes is support! For Amethyst owners, service is our most important product. Purchasing Amethyst entitles you to free future updates and additions, as well as a newsletter containing other users' comments on how to get the most from the system. We will provide any single

command or simple document type that you find missing from Mince or Scribble for free, as well as providing more complex changes at additional cost. Further, our programming staff is available by phone or mail for consultation in bringing Amethyst up on your computer or helping you modify it to meet your needs.

We see your customization requests as feedback on the quality of our product. If there's something you think we've forgotten, we're just as anxious to have it in the software as you are. Big or small, you're important enough to have an editor that works a little more the way you want and a little less the way anyone else thinks it ought to.

No, it's a program development system*

* Actually, it's both.

CPIM is a registered trade mark of Digital Research

BYTE LINES

NEWS AND SPECULATION ABOUT PERSONAL COMPUTING

Conducted by Sol Libes

\$299 Color Computer From Commodore: Commodore International Ltd has announced several new products, including the \$299 VIC-20 color computer, which has been the subject of much speculation over the past year. The VIC (Video Interface Computer) connects to any television set or monitor and features color (22-character by 23-line display); sound; 5 K bytes of programmable memory (expandable to 32 K bytes); user-programmable function keys; full-size typewriter keyboard; high-resolution graphics; standard PET BASIC; a graphics character set; provisions for joysticks, paddles, and light pen; and external slots for extra memory and ROM (read-only memory) packs. Peripherals to be available include a tape-cassette unit, single floppy-disk drive, and printer. Commodore's new low-priced CBM 2031 single disk-drive unit (also part of the new products announcement) will be available in a serial-bus version for use with the VIC-20. The CBM 2031 will be able to store up to 170 K bytes on a single 5-inch floppy disk. It will retail for under \$600.

Another significant announcement from Commodore was made with much less fanfare: a new, high-capacity business computer called the CBM 8096 that will feature an 80-column display, 96 K bytes of programmable memory, FORTRAN, COBOL, Ozz (Commodore's new user-adaptable data-

management and retrieval program), and probably VisiCalc. It could have a dramatically low price. The CBM 8096 in conjunction with a high-capacity disk drive (like Commodore's new CBM 8062, with 3.2 megabytes capacity), could undersell the already low-priced Radio Shack Model II.

Availability: Do not expect to see the VIC-20 before the second quarter of 1981. The CBM 8096 will not be out before the fourth quarter of 1981.

Winchester 8-Inch Drives Off To Slow Start: Manufacturers of 8-inch miniature Winchester hard-disk drives are reporting that sales, so far, have been disappointing. Apparently there is a wait-and-see attitude on the part of customers. This appears to be due to standardization and interface problems, as well as the emergence of 5-inch miniature Winchester drives. Sales for 1980 were predicted to be in excess of 60,000 units; however, it appears that fewer than 37,000 will be shipped, with IBM taking a very sizable portion of this number.

Sales of 8-inch miniature Winchester drives are expected to increase at a healthy rate. Some industry analysts are predicting 500,000 units by 1985. It is further predicted that these drives will take over the 20- to 200-megabyte market previously held by 14-inch Winchester drives. It is expected that the 5-inch Winchester drives will domi-

nate the under 20-megabyte market.

Model 33 Teletypewriter To Be Discontinued: The Teletype Corporation's Model 33 teletypewriter, affectionately known as "TTY" by long-time users, will be phased out of production by the end of 1981 after over twenty-five years of production. Teletype will also stop production on the models 28, 32, 35, DRPE, BRPE, and 4210. The Model 33 was the primary terminal for interactive computer use in the 1960s and early 1970s. Although it was designed for message transmission via telephone lines, early computer designers adopted it and its ASCII (American Standard Code for Information Interchange) character code as a standard. Parts and documentation support will be continued for five years.

DEC Shuts Two Computer Stores: DEC (Digital Equipment Corporation), the first computer company to open a chain of computer stores, has halted the planned expansion of its store network. Further, it has closed two of its twenty-seven stores. Reportedly, DEC spent between three and five million dollars to open the stores plus an equal amount for operating expenses, yet only a few of the stores have become profitable. The stores closed are in Detroit and the Wall Street district of

New York City. More stores are expected to be shut down.

Xerox, CDC (Control Data Corporation), and Commodore all have followed DEC's lead by opening computer stores. Xerox expects to open fifteen stores in 1981, while CDC and Commodore stated that they expect to open "hundreds" of computer stores.

Reader's Digest Buys The Source: In a surprise move, the Reader's Digest has purchased a 51% interest in the Source Telecomputing Corporation. According to the *Washington Post*, Reader's Digest paid \$3,000,000—a substantial amount of money for a company with no assets and only a marketing concept. The Source is entirely a resale operation: communications from Telenet, computing from a time-sharing service called Dialcomm, and data bases from all over. The *Washington Post* article also disclosed a messy court battle between Bill Von Meister, who developed the idea for The Source (and some years ago, developed the idea for the Mailgram), and Jack Taub, who ousted Von Meister in a financial power struggle last year.

A recent article in *Business Week* described The Source's woes. When Jack Taub took over the company last October, he immediately fired forty-five of the seventy employees, cut expenses, and procured additional financing. However, many suppliers

SOFTWARE SOFTWARE DIGITAL MARKETING™ DIGITAL MARKETING™

DIGITAL MARKETING • 2670 CHERRY LANE • WALNUT CREEK • CALIFORNIA 94596 • (415) 938-2880

REPORT WRITER™

Mini-word and arithmetic calculation processor designed to generate reports with ledger of figures and numeric calculations. Built-in calculator functions and calculator to paper errors. Saves data. Reports can be printed as often as desired. Changes in data can be easily entered and saved. "Cause and Effect" analysis easily computed using Recalculate function.

Typical applications are:

- ★ Appreciation Schedules
- ★ Capital Expenditure Proposals
- ★ Profit/Loss Projections
- ★ Balance Sheet Projections
- ★ Budget Analysis
- ★ Job & Labor Analysis

\$150. Manual alone \$25.

Requires 48K RAM & Microsoft Basic Formats: 8" single density, NorthStar 2D & Micropolis Mod II

DATEBOOK™

NEW! for NorthStar, Micropolis, TRS-80 Mod II & any other CP/M based operating system.

End paging through an appointment book forever! Easy to learn & use.

- ★ Replaces your office appointment book
- ★ Searches for openings that fit time of day, day of week & day of year constraints
- ★ Appointments made, modified or cancelled by a few key strokes
- ★ Copies of day's appointments can be quickly printed
- ★ Schedule appointments 4 months in advance - plus

\$295. Manual alone - \$25.

FILETRAN™

The TRSDOS to CP/M and CP/M to TRSDOS file translation system. FILETRAN transfers files by file name from one disk to another. May also be used to search any program for all occurrences of a string. Can be used to generate a variable cross reference. Helps to convert Level II BASIC programs to Micro-soft Basic. Formats: 8" single density, NorthStar 2D & TRS-80.

\$149.

MAGIC WAND™

CP/M-based word processing system for 8" soft-sectored & 5 1/4" NorthStar or Micropolis.

- ★ Full screen text editing
- ★ Full text formatting commands
- ★ Merging with external data files
- ★ Variables
- ★ Conditional commands
- ★ True proportional printing

\$350.

PASCAL/M™

CP/M™ compatible language for 8" 8080/280 CPU's, NorthStar 2D, Cromemca CDOS & Superbrain.

- ★ Random access files
- ★ Run-time debug support
- ★ Over 45 extensions to Standard Pascal
- ★ Requires 54K RAM

\$175. Manual alone - \$10.

ACT™

CP/M compatible macro assembler for Z80, 8080/85, 6502 & 6800.

One assembler that supports all major 8 bit micros and runs under CP/M. Formats: 8" single density, NorthStar, & Superbrain. Requires 24K RAM.

\$125. Manual alone - \$15.

ACT II - CP/M 2.x compatible cross assembler for 8086/8088.

\$175. Manual alone - \$15.

ACT I and ACT II purchased together - \$225.

S-BASIC™

Produces chainable, relocatable native code.

- ★ Fully defined user functions & procedures
- ★ Local & global variables
- ★ Single & double precision floating point
- ★ Fixed point packed BCD
- ★ Integer, string & character data types
- ★ Packed binary disk storage

Requires 40K RAM. Format 8" single density, NorthStar 2D & Micropolis Mod II.

SPECIAL INTRODUCTORY PRICE! \$250.
\$295. January 1, 1981

PEARL™

The application software generator for 8" single density, NorthStar 2D, Micropolis Mod II & Superbrain. Pearl asks questions that a programmer would have to answer to code the system. You answer the questions & Pearl uses built-in logic to construct both subroutines & mainline programs. The system then compiles & executes your program code.

- Level 1: For Personal Computing - \$130.
- Level 2: The Business Assistant - \$350.
- Level 3: Advanced Software Development - \$650.

CBASIC2™ required.
Manuals alone - \$25. each

ULTRASORT-III™

The sort/merge/select utility for CBASIC2 written in assembly language. Can be loaded by CBASIC during run-time; also can be used as a stand-alone utility. Formats: 8" single density, NorthStar 2D & Micropolis Mod II.

\$175.

CBASIC2™

Industry standard intermediate code compiler with run-time interpreter. Features include chaining, integer & external precision arithmetic. CP/M, MP/M & relocated TRS-80 versions available. As well as 8" single density, NorthStar 2D & Micropolis Mod II.

\$120.

COPYWRITER™

A powerful CP/M Word Processing System which includes a fast screen editor and is exceptionally easy to learn and use. Copywriter supports both vertical and horizontal scrolling for 132 column printers. File size is limited only by disk size. The print formatting program allows control over output word processing files, and permits the insertion of variable data into form letters. Full proportional printing is also supported.

COPYWRITER+ includes an integrated mailing list system which can:
select any range of zip codes for printing
select which fields to fill into merge
select by title, position or department within a company
Output can sort for bulk mailings by state and zip code.

COPYWRITER - \$395.

COPYWRITER+ - \$595. Manual alone \$35.
Requires 56K RAM. 8" single density IBM format

PAYSOFT™

Easy to use, yet powerful and flexible payroll program for 8" single density, NorthStar 2D & TRS-80.

- ★ Simplified data base construction.
- ★ Minimum system operation time
- ★ Enter hours worked - gross & net pay calculated
- ★ Federal, State, FICA, SDI withholdings are automatic

Requires 48K RAM
\$195.

SELECTOR IV™

A totally self-contained CP/M Data Base System providing complete data, procedural, query, and report definition functions. Allows records to be managed on a one-for-one basis, as well as in 'batch' mode where several files can communicate with each other in a variety of ways. Includes multiple 'key fields'. Requires 54K RAM.

\$550. Manual alone \$25.

Formats: 8" single density, NorthStar 2D & Micropolis Mod II.

TEXTWRITER III™

NEW FEATURES! a text formatting program for NorthStar & TRS-80 DOS, Micropolis MDOS & any CP/M based system.

- ★ Proportional spacing & enhanced printing for
 - Diablo • Qume • NEC printers
- ★ Enhanced printing includes ribbon color change, dual pitch, reverse line feed,
 - UNDERSCORE
 - **BOLDFACE**
 - DOUBLE STRIKE
 - STRIKEOUT
 - SUPERScript
 - SUPERScript

\$125. Manual alone - \$25.

Report Writer is a trademark of Carolina Business Computers, Inc. Paysoft & FILETRAN are trademarks of Ready Corp. Selector IV is a trademark of Micro-App, Inc. Pearl is a trademark of CPU International Pascal/M & ACT are trademarks of Sorcim CBASIC2 is a trademark of Compiler Systems, Inc. Magic Wand is a trademark of Small Business Applications, Inc. Textwriter & Datebook are trademarks of Organic Software Ultrasort II is a trademark of Computer Control Systems, Inc. Copywriter is a trademark of Syntronics TRS-80 is a trademark of Tandy Corp. CP/M & MP/M are trademarks of Digital Research Superbrain is a trademark of Intelec Data Systems S-Basic is a trademark of Topaz Programming Prices effective until January 1, 1981 For shipping add \$4. In US: \$10. outside US per package California residents add appropriate state sales tax Terms: Prepaid check, M/C or VISA or in US COD (UPS) Dealer inquiries invited

still report that they have not been paid and Taub had been asking them to wait until 1982.

The Source promised in its advertisements that airline schedules, restaurant guides in major cities, and mailgram-like services would be available. The mailgram went into effect last April and the airline schedules in June. The restaurant guide still covers only two cities. Also, at present a maximum of 100 users can use the system simultaneously; higher demand on The Source has led to some long-delayed responses.

Most users seem to accept The Source's problems as those of a pioneer with development difficulties and that slowly, but surely, the services are improving. Most agree that even with its problems, The Source is very worthwhile.

The Reader's Digest could be just what The Source needs to become successful. The purchase indicates that the Reader's Digest is clearly moving into the electronic journalism/communications/information field.

The Japanese Are Coming: Until now the US has dominated the micro-, mini-, and large-computer markets across the globe. However, things are changing and 1981 will no doubt see the Japanese as a major factor in the computer market. The Japanese are already pushing foreign computer suppliers out of the Japanese marketplace and are presently setting up marketing organizations in the US and Europe. They are moving slowly and very carefully, which is quite different from the American way of operating. Therefore, do not look for the Japanese computers to suddenly dominate the market. Rather, look for slow, but steady, growth as the Japanese learn how to adapt and market products in foreign marketplaces. There is no doubt that the

hardware is first-rate—a congressional task force recently concluded that Japan has caught up to the US in semiconductor technology "and in certain areas, may be ahead of us." In fact, many American computer makers are already using Japanese components in their computers, and the trend is increasing.

This picture is essentially the same as that of the introduction of Japanese cars into this country. Japanese cars were first introduced in the US about 20 years ago. Today they account for 40% of the market. Their cars cost more than US cars but are designed and made better. The same thing will probably happen in the computer market. Who knows, in another ten years we may see government-supported loans for Apple, Commodore, or Radio Shack.

XENIX, UNIX-Like, UNIX-Equivalent—What Next? There are now at least three UNIX-like operating systems available for microcomputers, only one of which is licensed by Western Electric. By now, Microsoft should have its XENIX operating system, developed in the C language under Western Electric license. It will be available for Z8000-based systems. Electrolabs already has its "UNIX-Like" systems available for Z80-based systems, and Morrow Designs has announced a "UNIX-Equivalent" system for use with its Z80 system.

Microsoft claims that XENIX is to be a superset of UNIX and that it will conform to Release 7 of UNIX. Further, Microsoft hopes "to establish a clearinghouse for UNIX and XENIX software developed by users." XENIX will be sold primarily to OEMs (original equipment manufacturers), and Microsoft will receive \$500 for each single-user copy sold.

Electrolabs claims that its

OS-1 Operating System "appear[s] exactly like UNIX to the user" and that it "provides for up to 1024 users" plus "lots more"—all in 12 K bytes of code. A 4 K-byte CP/M adapter is also included (with source code) in the \$249 price.

The Morrow operating system will be advertised as a "UNIX-Equivalent." It will be designed to run specifically with the new Morrow Z80 processor card, which includes a hardware mathematics processor and a programmable system-supervisor circuit for memory management.

Three-Dimensional System To Be Introduced: Genisco Computers, Costa Mesa, California, is expected soon to announce the first three-dimensional computer-graphics display. It will use a vibrating parabolic mirror and stroke display to create the illusion of a three-dimensional object hovering in space before the operator. The system will probably sell for about \$100,000, and it is expected to find applications in air-traffic control, molecular research, and oil exploration.

Data Errors To Increase With Sunspots: NOAA (the National Oceanic and Atmospheric Administration) is predicting that increases in sunspot activity will cause disruption of data communications worldwide. This increase occurs every eleven years, with 1981 thru 1983 being a period of intense activity. The last such period occurred between 1969 and 1972. The effect is felt to be more severe at higher altitudes.

Double-Side Floppy Woes Persist: Makers of double-sided floppy-disk drives finally appear to be delivering reliable units. Users report that the 5-inch dual-sided drives exhibit excellent reliability. However, 8-inch drives still

appear to have problems, and full production of high-reliability units is not expected for several more months. Experts are predicting that not until 1982 will we see a crossover point where more double-sided floppies are made than single-sided units.

Fired Programmer Sued For Erasing Programs: A suit filed by Leeds & Northrup (L & N) against a former employee accuses him of erasing several valuable programs shortly after being fired from his project manager/programmer position and before his password had been removed from the system. L & N is asking for \$10,000 in damages and a court order restraining the former employee from future tampering with the computer. Fortunately, L & N was able to restore the obliterated programs from backup magnetic tapes.

Ups And Downs In Personal Computing: It's been all "ups" for Tandy Corporation, while it has been all "downs" for Texas Instruments (TI).

It looks like Tandy will sell close to 300,000 Radio Shack Model I computer systems by the year's end. Tandy reported that its fourth quarter earnings rose 52% to over \$30 million, with year-end net sales of over \$112 million. That's an increase of over 35%, on sales that rose 14%. Further, Tandy announced that it plans to open fifty more Radio Shack Computer Centers (there are sixty presently). Tandy also plans to have 250 full-line stores (ie: Radio Shack stores that carry its full microcomputer line of products) by the end of 1981. Also, 100 new Radio Shack stores will be added, bringing the total number of Radio Shack stores selling audio, electronic, and computer



ARCHIVES BUSINESS COMPUTER

CP/M-BASED . . . 1.5 MB CAPACITY . . . S-100 BUS

A full 1.5 megabytes of storage on double-sided 5¼" diskettes; single-sided drives also available. CP/M operating system and standard S-100 bus allow for wide application possibilities and easy expansion.

**FULLY TESTED . . .
BROAD MARKET APPEAL . . .
HIGH MARGIN**

The Archives Business Computer represents the new generation of all-in-one computers, ideally targeted at professional and business customers. The compact desk-top unit includes two 5¼" drives that can be sold CP/M-based applications software; a 12" green phosphor monitor; detachable keyboard with numeric cluster, function keycluster and 23 relegendable function

keys; 64K RAM, and Z-80 microprocessor . . . options include a direct-connect Bell 103 compatible modem and hardware floating point chip.

The new Archives Business Computer is now available from PGI Wholesale, the nation's leading microcomputer distributor. Call us toll-free for the most competitive pricing and widest selection of name-brand products in the industry! A complete Research and Development Evaluation Report on the Archives Business Computer is available to dealers free of charge. The Archives is immediately available at substantial dealer discounts.

Manufacturer's suggested retail prices from \$6,500 for dual drive single-density to \$7,500 for double-density 1.5 megabyte system.

PGI
WHOLESALE

(formerly MicroAge Wholesale)

1425 W. 12th Place
Tempe, Arizona 85281

Circle 143 on Inquiry card.

CALL TOLL-FREE 1-800-528-1415 1-800-528-6450

equipment to 8000 worldwide.

Texas Instruments, on the other hand, has problems. Its 99/4 personal-computer system has met with poor sales, far less than TI projected. The general feeling is that, although the unit has many unique features, it is overpriced and under-supported. TI reported in its most recent quarterly report that this was one of the company's "adverse areas." But TI is not taking this lying down. Learning from automobile makers, TI is experimenting with \$200 rebates (\$100 cash and \$100 worth of software) and is backing this up with promotion, software development, and a seminar program. The 99/4 lists at \$950, but many dealers are discounting it to as low as \$699 plus rebate.

Funny Bit: The Manhattan Yellow Pages telephone directory lists Lifeboat Associates, the country's largest distributor of microcomputer software, under "Marine Supplies & Emergency Equipment."

Tandy Introduces Three New Computers: Recently the Tandy Corporation announced three new personal computers. Their features have been covered in detail in several publications (see the October 1980 BYTE, page 172); there is no need to review them here. However, some comments may be worthwhile.

The three machines are the TRS-80 Color Computer, the TRS-80 Model III, and the TRS-80 Pocket Computer. The color computer sells for \$400 in its basic configuration (4 K bytes of programmable memory) and is only expandable to 16 K. It uses the 6809 processor and is therefore not compatible with the TRS-80 Model I and II. It does not look like it is intended to compete with the Apple computer. Rather, it appears aimed at

competing with lower-level systems such as the Atari 400 and TI-99/4 personal computers.

Although Tandy denies it, the Model III appears to be a replacement for the Model I. Considering that the Model III contains the monitor, keyboard and disk drives in a single enclosure, is software compatible with the Model I, and offers additional enhancements, most industry people feel that the Model I will be phased out when the Model III systems finally arrive at the stores.

The Pocket Computer is really a marketing experiment. Neither Tandy nor any of the other pocket-computer makers really know if there is a meaningful market for this machine. Quasar and Panasonic talk about selling one million of their new hand-held computers next year (at \$400 each). Tandy, however, is selling its at \$250 and may garner the major portion of the market.

But what is the market for these pocket machines? The makers are projecting that they will be bought by salesmen and executives who, via a modem, will contact their home computers to book orders, check order status, receive and send messages, etc. Will hobbyists be attracted to these machines? The successful systems today all have a strong hobbyist base. It will, therefore, be interesting to see if these pocket devices catch on as planned.

TRS-80 Copy Due From Far East: EACA Limited of Hong Kong is manufacturing a functional copy of the Radio Shack TRS-80, which is no doubt the most popular microcomputer system made to date. Although it does not look like a TRS-80, it is hardware and software compatible with it. The computer will be marketed in the US by Personal Micro Computers Inc (PMC), Moun-

tain View, California, and will be known as the PMC-80. It will list for \$595 (without a monitor), which is \$200 less than the TRS-80. It will have a 50-pin bus (TRS-80 has a 40-pin bus); PMC plans S-100 and TRS-80 interfaces.

Random Rumor Bits: Zilog is still having problems delivering bug-free Z8000 chips.... AMD (Advanced Micro Devices) is rumored to be working on the Z8003, a 32-bit version of the Z8000, scheduled for release in 1981.... NEC is rumored to be about ready to announce a new video-display-controller integrated circuit capable of handling a bit-map graphics display of 1024 by 1024 pixels, devoting 16 bits to each pixel. It will be capable of being configured for gray scale or color (3 bits each for red, green, and blue intensities) and still have 7 bits left over for things like blinking pixels, intensity protection, etc.... Intel, Western Digital, National Semiconductor, and Texas Instruments are all rumored to be working on controllers for Winchester floppy-disk systems. When these integrated circuits are available, it should reduce the cost of these controllers from the present \$1000 to \$1500 to a range of \$200 to \$500....

Random News Bits: SofTech MicroSystems Inc, sole licensing agent for UCSD Pascal, expects to make available a 16-bit version of UCSD Pascal for 8086-based systems sometime in 1981. This will be followed later by a 68000 version.... Tandy Corporation (parent of Radio Shack) has acquired the Lika Corporation of Stockton, California, for \$4.5 million. Lika is a manufacturer of double-sided and multilayer printed-circuit boards.... Apple is having difficulty shipping Apple IIIs and

does not expect the first shipments until after the first of the year, six months later than promised.... Bubble-memory prices are dropping as yields improve. Intel has dropped the price of its BPK bubble-memory prototyping kit from \$1710 to \$995 and its iSBC250 bubble-memory card from \$4750 to \$3500. Sales of bubble memories rose to \$226 million in 1980 compared to \$18.4 million in 1979.... National Semiconductor has introduced a microprocessor with BASIC in ROM (read-only memory). The INS8073 device has a 2.5 K-byte ROM with Tiny BASIC and a 64-byte area of programmable memory, which is used as a scratch-pad memory.... ANSI (American National Standards Institute) has established a committee to develop an APL language standard. Those wishing to participate should contact Clark Wiedman, University of Massachusetts Computing Center, Amherst MA 01003.... Shugart Associates will soon introduce a new series of 5-inch floppy drives capable of storing 500 K bytes on a single side and 1 megabyte on two sides. They will be compatible with older drives.... IBM is quietly setting up a distributor organization to sell its computer peripherals.... The Massachusetts Department of Revenue recently held hearings on a new tax for off-the-shelf software, time-sharing, and other data-processing services.... Apple Computer will soon begin production of the new Apple III in a new plant located in Ireland.

MAIL: I receive a large number of letters each month as a result of this column. If you write to me and wish a response, please include a stamped, self-addressed envelope.

Sol Libes
POB 1192
Mountainside NJ 07081

TERRIFIC TRIO: Z80, OASIS, MAROT.

A superior operating system and top application software bring out the best in a microcomputer. That's why Marot offers the OASIS* Operating System and compatible software for owners of Z80 based micros. They make a terrific trio.

1 Z80 MICROS —great machines. Tandy's TRS-80 MOD II* with DMA, bank select possibilities and nationwide service. Altos. Cromemco. Horizon. And many others. Great machines—but it takes a great operating system to tap their full potential.

2 ENTER OASIS —available from Marot. OASIS is fast emerging as *the* operating system for Z80 commercial applications and serious programmers. Why?...rapid formatting and back-up of diskettes; efficient disk utilization; excellent line editor and document processor for file management and textwriting; user accounting with logon, password, privilege level and use accounting; machine independence of programs, data and text files; sequential, direct and keyed index (ISAM) files; interpreted and compiled BASIC; COBOL-ANSI '74; single and multi-user versions; and more. No wonder pros say 'OASIS makes micros run like minis!'

3 APPLICATION SOFTWARE —available from Marot. OASIS is your active, invisible partner supporting these excellent, ready-to-run products:

Magic Wand.* The wordprocessor combining the ease of screen editing with micro power.

*HDBS*** For data management needs restricted to hierarchical tree structure and fixed length records.

*MDBS*** Handles full network CODASYL oriented data structures and variable length records.

*ABS**** Quality office management systems—accounts receivable and payable, general ledger, etc.—the total interacting, user-oriented business package. Written in COBOL; available with source code.

A *Law* package. And ready soon: complete medical management, real estate, restaurant, pharmacy, management analysis packages, and others.

Marot and its Dealers offer OASIS and many professional software products to individuals, OEMs and dealers. Licensing arrangements are also available. Just call or write and start your own terrific trio.

PLEASE SEND ME:

(Circle what you would like and send order with payment to the address shown below.)

SEND COMPLETE INFORMATION

Product	Price
MAGIC WAND*	\$400

ABS ACCOUNTING (call or write)

MDBS, full network	\$900
HDBS	300
Report Generator, Query System	300
Primer (Other options available)	10

Magic Wand, MDBS and HDBS are available for several operating systems.

*OASIS is the trademark of Phase One Systems, Inc.

**HDBS and MDBS are produced by Micro Data Base Systems, Inc.

***American Business Systems, Inc. TRS-80 is the registered trademark of the Tandy Corporation.

Magic Wand is the registered trademark of Small Business Systems, Inc.



**MAROT SOFTWARE SYSTEMS.
YOUR EASTERN SOURCE**

Product	Price	
	with Manual	Manual Only
OASIS		
OPERATING SYSTEM (Includes: EXEC Language; File Management; User Accounting; Device Drivers; Print Spooler; General Text Editor; etc.)		
SINGLE-USER	\$150	\$17.50
MULTI-USER	350	17.50
BASIC COMPILER/INTERPRETER/DEBUGGER	100	15.00
RE-ENTRANT BASIC COMPILER/INTERPRETER/DEBUGGER	150	15.00
DEVELOPMENT PACKAGE (Macro Assembler; Linkage Editor; Debugger)	150	25.00
TEXT EDITOR & SCRIPT PROCESSOR	150	15.00
DIAGNOSTIC & CONVERSION UTILITIES (Memory Test; Assembly Language; Converters; File Recovery; Disk Test; File Copy from other OS; etc.)	100	15.00
COMMUNICATIONS PACKAGE (Terminal Emulator; File Send & Receive)	100	15.00
PACKAGE PRICE (All of Above)		
SINGLE-USER	500	60.00
MULTI-USER	850	60.00
FILE SORT	100	15.00
COBOL-ANSI '74	750	35.00

Send order to:
Marot Software Systems, Inc.
310 Madison Ave.
New York City, NY 10017
Telephone (212) 661-8550

NAME _____
STREET (NO BOX #) _____

CITY _____
STATE _____ ZIP _____

AMOUNT \$ _____

(Attach system description; add \$3 for shipping; New York residents add sales tax.)
 Check enclosed VISA
 UPS C.O.D. Mastercharge
Card Number _____
Expiration Date _____
Signature _____



CBM™ 8032 BUSINESS COMPUTER

The new Commodore® 8032 Business computer offers a wide screen display to show you up to 80-character lines of information. Text editing and report formatting are faster and easier with the new wide-screen display. The 8032 Business Computer also provides a resident Operating System with expanded functional capabilities. You can use Basic on the 8032 Business Computers in both interactive and program modes, with expanded commands and functions for arithmetic, editing, and disk file management. The CBM 8032 Business Computer is ideally suited for the computing needs of the business marketplace. Call for additional information.



\$1795

- *32K RAM, 14K 4.0 BASIC
 - *IEEE BUS *80 x 25 CRT
 - *Ideal for WordProcessing
- or other business/technical computer uses.



\$1695

CBM™ 8050 DUAL DRIVE FLOPPY DISK

The CBM 8050 Dual Drive Floppy Disk is a much enhanced version of the intelligent CBM 2040 Disk Drive. The CBM 8050 has all of the features of the CBM 2040, and provides more powerful software capabilities, as well as one megabyte of online storage capacity. The CBM 8050 supplies relative record files and automatic diskette initialization. It can copy all the files from one diskette to another without copying unused space. The CBM 8050 also offers improved error recovery and the ability to append to sequential files.



MULTI-USER TIME SHARE OFFERED TO YOU BY THE NEECO MULTI-CLUSTER

At a low entry cost, up to eight CBM computers can transfer data bi-directionally to one CBM Dual Disk Drive. The MULTI-CLUSTER, designed with its own independent power supply, provides a connection from one CBM computer work station to other CBM computer work stations, allowing data transfer and data access on a priority queuing basis. This system provides the cost effectiveness required in a multi-using environment by establishing the dual disk drive as a central mass storage unit. This provides a high degree of disk accessibility.

The standard configuration of this system allows 3 CBM* microcomputers (maximum of 8) connected through the MULTI-CLUSTER to the IEEE port of the 2040 Disk Drive. More CBM's can be added to the system according to the user's need.

MULTI-CLUSTER		
Standard Components	\$995	Additional Component Prices
One Multi-Cluster Controller MC800A	Each extra CM-100
Three Channel Modules	... CM-100	Output Printer Module
		(for Centronics Protocol)
		\$250
		\$200
		\$200

Multi-Cluster is a product of BMB Compuscience.



NEECO
PROUDLY
ANNOUNCES

... DATASOURCE 1

"A full featured Database Manager for the Commodore 8032"

Never before has a true Database been available for Commodore Computers. DATASOURCE 1 contains database capabilities you would not expect on a microcomputer system. Capabilities like selective search by any sub-field or field within a record, mathematic manipulation, up to 120 fields per screen display, and much much more! DATASOURCE 1's major feature is total usability! DATASOURCE was designed for use by you!

MAJOR FEATURES INCLUDE:

• SCREEN ORIENTED • SELECTIVE OR SEQUENTIAL SEARCHES • UP TO 120 SORTABLE DISPLAY FIELDS • UP TO 2 DISPLAY SCREENS OF DATA PER RECORD • HUNT FUNCTION (find characters in any record) • POWERFUL MATHEMATICAL MANIPULATION • SUPPORT PROGRAMS INCLUDE: FILE OR EDIT SCREEN RECORD, POWERFUL SORT/MERGE, DIRECTORY MANAGER, EXTENDED OUTPUT REPORT GENERATOR, FULL COMPATIBILITY WITH WORDPRO 4* PLUS FILES, AND MUCH, MUCH MORE! EMINENTLY USABLE BY NOVICE USERS.

MAJOR USES INCLUDE:

• MAILING LIST MANAGEMENT • QUERY/CALL INFORMATION • A/R AGING MANAGEMENT • CASH FLOW FORECASTS • FILE MANAGEMENT • ANY PROJECT/PROBLEM THAT REQUIRES INVENTORY DATA OR FILE MANIPULATION!

CALL FOR
DATASOURCE
LITERATURE!

\$495

*Requires DOS 2.0 or DOS 2.5

AVAILABLE TO DEALERS FROM MICROAMERICA

DEALER TOLL FREE: 1-800-343-4411

Circle 145 on Inquiry card.

WordPro 4 Plus is a registered trademark of Professional Software Inc.

NEECO

679 HIGHLAND AVE.
NEEDHAM, MA 02194

NEW ENGLAND ELECTRONICS CO., INC.

"NEW ENGLAND's Largest
Computer Showroom"

(617) 449-1760

MASTERCHARGE OR VISA ACCEPTED
TELEX NUMBER 951021, NEECO
MON-FRI, 9:00-5:30, E.S.T.

**NEECO
PROUDLY
INTRODUCES**

ALCOS COMPUTERS

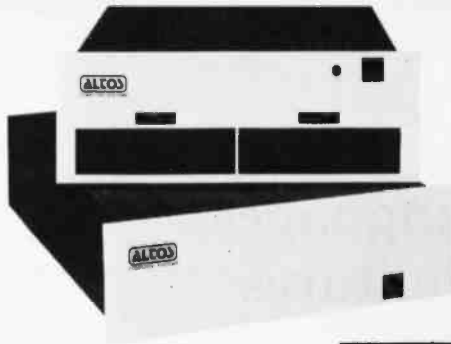

ALCOS ACS 8000-5

- Dual 8" floppy disks
- Megabyte storage
- 64K RAM
- Totally expandable to Hard Disk (29MB) and Multi-User

ALCOS OFFERS OUR USERS TOTAL SYSTEM CAPABILITIES AND FLEXIBILITY . . .

- Z80 based • CP/M • Multi-User
- Hard Disk • Seven languages
- MP/M • NEECO system support
- Full Word Processing

\$5990

"ALCOS Computers offer you System Flexibility and Reliability"

CONTACT NEECO FOR ADDITIONAL INFORMATION ON HOW ALCOS CAN BECOME YOUR COMPUTER SOLUTION.

Altos computers range in price from less than \$3000 to over \$14,000. Altos Computer Systems' capabilities range from single disk-single user to 29 Megabytes-Multi-User.

ALCOS computers are distributed to Dealers/OEMs in the N.E. Region by MICROAMERICA

SUPERBRAIN SOFTWARE

(Business Packages written in MicrosoftBASIC)

Trial Tested Osborne Business Packages on the Superbrain

- | | | |
|-----------------------|----------|---|
| • Accounts Receivable | \$250.00 | Complete 4 Module
Package \$795
MicrosoftBASIC
\$325 |
| • General Ledger | \$250.00 | |
| • Accounts Payable | \$250.00 | |
| • Payroll Package | \$250.00 | |

SUPERBRAIN

32K RAM \$2795

64K RAM \$2995

FORTRAN \$ 450

SPECIAL OFFER!

Purchase a 64K Superbrain at \$2995 and will include MBASIC5 for only \$250! (regularly \$350)

SPECIAL OFFER! - Purchase

a Centronics 704-9 (RS232, 180 CPS, retail \$2380) printer and a 64K Superbrain together for only \$4595 - cash price only.

"The Superbrain is ideal for use as an intelligent terminal or stand alone microcomputer system for OEM's, commercial customers, and other sophisticated computer users."



- Two 5.25" Shugart Minifloppies with over 300 K (CP/M Version 2.2 or later) Disk Storage.
- Integrated in a single compact housing.
- CP/M operating System with MBASIC5 and other interpreters/compilers available.
- 32K or 64K RAM models available.
- 2 I/O Ports - one fully enabled RS232 port for communications. Other port for RS232 serial printer output.
- Too many software packages are now available to list them here.

OEM/DEALER INQUIRIES

All pricing and specifications are subject to change.

SUPERBRAIN™

\$2995 The Honor Graduate

NEECO

679 Highland Ave.
Needham, MA
02194

Mon-Fri 9:30-5:30
MasterCharge &
Visa Accepted

(617) 449-1760
Telex: 951021

MICROAMERICA DISTRIBUTING

"Nationwide distributors of Computer Equipment"

21 Putnam Street
Needham, MA
02194

(617) 449-4310

BASIC, Computer Languages, and Computer Adventures

Jerry Pournelle
c/o BYTE Publications
70 Main St
Peterborough NH 03458

It's a typical Sunday afternoon here at Chaos Manor. In one room a dozen kids are playing games on the Radio Shack TRS-80, while here in the office I've been playing about with the C programming language after adding a check-writer to my accounting programs. My wife, the only practical member of the family, gently reminds me of my deadlines: galley proofs of a new novel, *King David's Spaceship* (Simon and Schuster); two chapters of the latest Niven/Pournelle collaboration, *Oath of Fealty* (Simon and Schuster, Real Soon Now); plus three columns; a speech to a librarians' convention; and inputs for a NASA study on America's fifty-year space plan. Some business people worry about cash flow; for authors it's work flow—work comes in bunches, like bananas, and sometimes it seems everything has to be done at once.

So, since it's what we've been doing here lately, I'll talk about computer games and programming languages; a disparate set of topics, but not quite as unconnected as they might seem at first glance.

Languages

One of the biggest unsolved problems in the microcomputer field is languages: which ones are going to be standard? Everyone learns BASIC, of course, because it comes with the machine, and it's a very easy language to learn. Pretty soon, though, you come to the limits of the BASIC supplied with the computer; and then what?

A few years ago there wasn't a lot of choice. You could buy FORTRAN, and perhaps COBOL; you could learn assembler; but then you were stuck. Moreover, there didn't seem to be any obvious advantages to FORTRAN and COBOL, both of which were not only hard to learn, but also difficult to connect up with the computer. Most of the books on those languages were written with big mainframe machines in mind, and the documentation for the small-system versions was, to put it kindly, rather skimpy. Moreover, the user manuals were filled with mysterious references to "logical devices" and other such nonsense, while giving almost no clear examples of how to get programs running on a home computer.

The result was a great expansion of BASICs. What was once a simple teaching language, designed largely to let

new users become familiar with the way computers think, became studded with features. Every time you turned around there was a new BASIC interpreter, each one larger than the last, and almost none of them compatible with each other. Whatever portability BASIC had enjoyed vanished in a myriad of disk operations, functions, WHILE statements, new input formats, etc, etc, and, at the same time, the "free" memory left over after loading BASIC got so small that you couldn't handle much data.

The logical end of that process is Microsoft's newest BASIC-80. Understand, it's an excellent BASIC. It has features that, not long ago, the most advanced languages didn't have. It's well documented—at least the commands and functions, which are listed alphabetically, are clearly described. The general information section could be expanded with profit—at present it's written for users who are already more or less familiar with how BASIC operates. There are elaborate procedures for error trapping, and they all work. The editor has been improved. There are procedures (not very well documented) for linking in assembly-language subroutines. You can use long variable names, such as "Personal.data.1" and "Personal.data.2", and be certain the program will know they are different variables.

In other words, there's a lot going for it; but it takes up 24 K bytes of memory, and it's still BASIC. If you want to understand your program six weeks after you write it, you'll have to put in a lot of REMark statements, every one of which takes up memory space. As with all BASICs, you have to sweat blood to write well-structured code (and if you don't bother, that will come back to haunt you when you want to modify the program). And, like all BASICs, it is *slow*. Fairly simple sorts, even with efficient algorithms, take minutes; disk operations are tedious.

I suspect that Microsoft BASIC-80 is the end of the line; they have carried BASIC about as far as it can go. They've done it very well, but they've also reached the inherent limits of the language; and those limits may not be acceptable.

Of course most programmers have always known that

Microcomputer Networking From Digital Research

CP/NET™ brings CP/M® based networking to the microcomputer world.

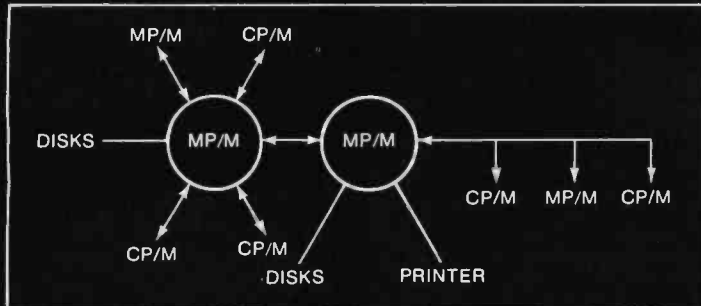

Now you can use CP/M, Digital Research's "industry standard" operating system, in a network environment. In conjunction with MP/M™, our high-powered multi-user system, a variety of CP/NET configurations allow you to share your valuable resources among a number of masters running MP/M, and slaves running CP/M or MP/M.

- **Share and transfer disk files**
- **Share printers and consoles**
- **Share programs and data bases**

As with all Digital Research products, CP/NET is compatible with a large variety of computer hardware, allowing a network to be constructed with any combination of shared memory, parallel I/O or serial links with any protocol.

For the office or the classroom, as well as the application development environment, contact Digital Research or your hardware supplier to find out how CP/NET can enhance your system's flexibility and convenience.

 **DIGITAL RESEARCH®**

U. S. A.
DIGITAL RESEARCH
P.O. Box 579
801 Lighthouse Avenue
Pacific Grove, CA 93950
408-649-3896 TWX 910 360 5001

EUROPE
VECTOR INTERNATIONAL
Research Park
B-3030 Leuven
Belgium
32 (16) 20-24-96 Telex 26202 VECTOR

FAR EAST
MICROSOFTWARE ASSOCIATES
102 Plasada
3-16-14 Minami Aoyama
Minato-ku
Tokyo 107, Japan
03-403-2120 Telex 2426875 MSA

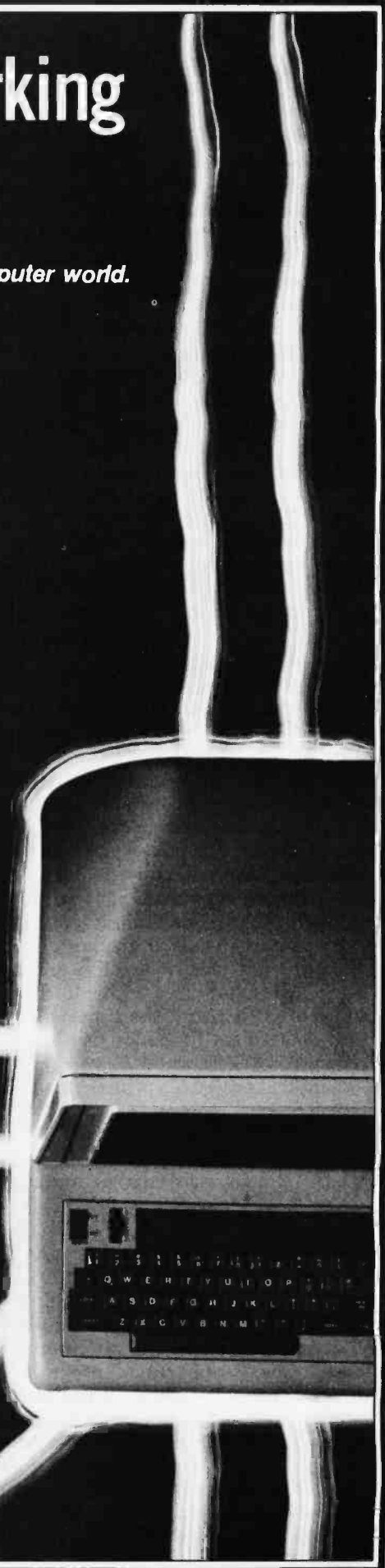

even the best BASIC interpreter wasn't good enough; that if you add enough features to make the language useful, you'll end up with a very slow monster that takes up far too much memory, and that even if you could tolerate those limits, the language itself forces sloppy thinking and inelegant code. However, knowing the problem didn't make the solution obvious; indeed, it's not obvious yet. We can recognize the limits to BASIC and still not agree on what to do about it.

There seem to be two fundamental paths. One is to start over: to relegate BASIC to its original function as a teaching language, and switch to some other language for serious programming. Many took this path, and came out with microcomputer versions of such languages as C, APL, ALGOL, LISP, FORTH, STOIC, and Pascal.

The other way is to *compile* BASIC. One of the first compiled BASICs, BASIC E, is in the public domain; I obtained a fairly decent version with (barely) adequate documentation from the CP/M User's Group several years ago. Then Software Systems brought out an improved BASIC E called CBASIC. It is easy to use and features really excellent documentation, some of the best I've ever seen. It has decent file structures; you are not limited to either *sequential* or *random-access* disk files, but may use sequential operations on random-access files.

There are irritants in CBASIC, particularly with regard to line-printer operations. CBASIC has only the PRINT and PRINT USING commands; there is no LPRINT. To get hard copy, you must execute a LINEPRINTER statement, then one or more PRINT statements, then do a CONSOLE statement to have the copy sent to the terminal. Every time you do the CONSOLE statement, the print buffer empties, and you can get unwanted stuff printed on your hard copy; worse, you can also get unwanted line feeds, making it tough to format hard copy (although CBASIC does allow you to output characters through a port so that, if you are clever enough, you can control the line printer directly; you could even make a CBASIC program drive a Diablo for reverse printing if you wanted to spend the time writing that program). Another needless limitation is that CBASIC allows a maximum carriage width of 133 characters, although a 12-character-per-inch printer can print lines 158 characters long.

Irritants or no, CBASIC is both well designed and well documented. It has WHILE; IF-THEN-ELSE (with chaining); long variable names; and logical operations (IF TAX > 0 AND PRICE < MAXIMUM.ACCEPTABLE THEN GOSUB 234 ELSE PRINT "NO GOOD" is a perfectly valid CBASIC expression). It has the CASE (Switch or ON-GOTO) statement.

And it saves memory by compiling. To use CBASIC, one creates a program with any editor that makes ASCII (American Standard Code for Information Interchange) files (Electric-Pencil-created programs have to be put through a converter), then turns the CBASIC compiler loose on it. What comes out isn't true compilation; the compiler strips out remarks and needless line numbers, and compacts the remainder into an INT (intermediate) file; when you want to run the program, you must load in a 10 K-byte run-time package. The INT file is still interpreted; it is not a machine-language program. You can, though, include scads of remarks, put each statement on

a separate line, leave lots of blank space, put in rows of asterisks, indent whole sections of the program, and thus vastly increase program readability without using up memory space. A CBASIC program can be written for legibility.

But it's still BASIC. Because a program *can* be reasonably well structured and self-documenting doesn't mean that it will be; BASIC makes it easy to write incomprehensible code and difficult not to. And CBASIC is *very slow*, no faster than Microsoft BASIC-80 and often slower.

There's another limit. It's very hard to write long programs in CBASIC. This problem is inherent in any compiled language—whether true compilation to machine code, or pseudocompiling to an INT file. For example, assume that I want to add a small feature to my accounting package (which I did in fact write in CBASIC two years ago). I load the source program into the text editor. I add the feature and hook it into the program; since I do sweat blood to write structured code, that's fairly easy. Now I must save the altered source and put it through the compiler. Since it's a long program, the compilation takes many minutes—and toward the end, I get a SYNTAX ERROR message. I've put a comma where it wants a semicolon.

Now I have to load the editor, read in the source, make the change, save, and recompile. Presuming that this time it goes without error, I may have used up half an hour just to change"," to ";"—and I still have no test of the program's logic. If I now test for logic and it's not right, well, I have to start all over again, hoping that this time I don't manage a new syntax error....

Thus, you can use up a whole afternoon adding something quite simple to a big program. There must be a better way. Why can't someone come up with a language that runs interpretively like normal BASIC, letting you correct both syntax and logic errors while in an interactive mode; and then allow you to compile the result? While we're at it, let's wish for the compiled program to be in true machine language, code that could be put into read-only memory, and, moreover, code that would be *fast*.

That's the route that Microsoft took. Their BASCOM compiler works just that way with their BASIC-80. It will also compile Microsoft BASIC 4.5, and, with considerable modifications to syntax, programs written in both CBASIC and BASIC E. Moreover, it's a very powerful compiler. It implements almost all the features of BASIC-80, including WHILE, IF-THEN-ELSE, CASE, logicals, and string operations, etc. It sounds like the answer to a prayer.

Of course there are problems. Random-access disk operations are unbelievably messy, and worse, a random-access file cannot be accessed sequentially. There's considerable overhead burden. For example, this program:

```
10 PRINT "Hello"  
20 END
```

required 9 K bytes when compiled into a CP/M COM file; there's obviously a big run-time package built into BASCOM. Worse, present Microsoft user contracts require that anyone marketing a program compiled by

SIRIUS 80+

High Performance Low Cost Floppy Add-Ons!

The SIRIUS SYSTEMS 80+ Series of Floppy Disk add-ons are designed to provide unmatched versatility and performance for your TRS-80*. Consisting of four different add-ons, there is a 80+ Series Floppy Disk Drive to meet your needs.

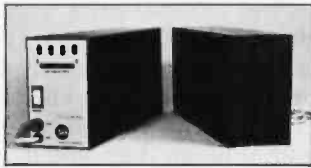

COMMON CHARACTERISTICS

- 5ms track-to-track access time
- Auto-Eject
- 180 day WARRANTY
- Exceptional speed stability - 11/2%
- Single/Double Density operation
- Mix any or all 80+ Series on the SS Standard cable

SPECIFIC CHARACTERISTICS

The SIRIUS 80+1 - a single sided, 40 track Drive. Offering 5 more tracks than the Radio Shack model, it cost \$120 less. Formatted data storage is 102K/204K Bytes Single/Double Density.

SIRIUS 80+1 \$379.95
The SIRIUS 80+2 is a dual sided, 80 track (40 per side) Disk Drive. It appears to the TRS-80* as TWO 40 track drives yet COST LESS THAN HALF THE PRICE! Even greater savings result since data is recorded on both sides of the media instead of only a single side. This unit may require the SS Standard cable. Formatted data storage is 204K/408K Bytes Single/Double Density.

SIRIUS 80+2 \$449.95
The SIRIUS 80+3 - a single sided, 80 track Drive. Offering 2 1/2 times the storage of a standard Radio Shack Disk Drive, the 80+3 greatly reduces the need for diskettes correspondingly. Additionally, because of the increased storage and faster track-to-track access time, the 80+3 allows tremendously increased throughput for disk based pro-

grams! The 80+3 includes SIRIUS's TRAKS-PATCH on diskette (for use with 96 tpi drives). Formatted data storage is 204K/408K Bytes Single/Double Density.
SIRIUS 80+3 \$499.95

The SIRIUS 80+4 - a dual sided, 160 track (80 per side) 5 1/4" monster! The ultimate in state-of-the-art 5 1/4" Floppy Disk Technology, the 80+4 is seen by the TRS-80* as two single sided disk drives. Thus, in terms of capacity, one 80+4 is equivalent to 4 1/2 standard Radio Shack drives - at a savings of over 73% (not to mention diskettes!!!). (With a double density converter the available memory is huge!) The 80+4 (a 96 tpi drive) includes TRAKS-PATCH on diskette and may require the SS Standard cable. Formatted data storage is 408K/816K Bytes Single/Double Density.
SIRIUS 80+4 \$649.95

All 80+ Series Floppy Disk add-ons operate at 5ms track-to-track but are Expansion Interface limited to 12ms for the TRS-80*
*TRS-80© of Tandy Corp.

ACCESSORIES

SS Standard 2 Drive Cable \$29.95
NEWDOS/80-Sophisticated Operating System for the TRS-80* from Appar \$149.95

Save up to 10% with these SIRIUS Packages!

NEWDOS/80, SIRIUS 80+3, and Two Drive Cable	\$624.95
NEWDOS/80, SIRIUS 80+4, and Two Drive Cable	\$749.95
NEWDOS/80, Two (2) SIRIUS 80+3's, Two Drive Cable	\$1080.95
NEWDOS/80, Two (2) SIRIUS 80+4's, Two Drive Cable	\$1349.95

PRIAM Hard Disks Now Available from SIRIUS SYSTEMS!

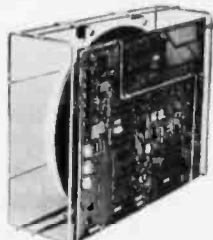

PRIAM's high-performance, low-cost Winchester disc drives speed up throughput and expand data storage from 20 megabytes to 154 megabytes. And a single controller can be used to operate 14-inch-disc drives with capacities of 33, 66, or 154 megabytes or floppy-disc-size drives holding 20 and 34 megabytes. So it's easy to move up in capacity, or reduce package size, without changing important system elements or performance.

- Fast, Linear Voice Coil Positioning
- DC Power required only!
- 50 ms Average Positioning time
- 10 ms track-to-track positioning
- Simple, parallel Interface
- 90 ms Maximum Positioning Time
- Fully servoed head positioning
- Optional SMD Interface
- 6.4 ms Average Latency
- Dedicated servo tracks

THE PRIAM LINEUP

Model/Disc Size	Capacity	Size	Weight	Price
DISKOS 3350 (14")	33Mbytes	7" x 17" x 20"	33 lbs.	\$2995
DISKOS 6650 (14")	66 Mbytes	7" x 17" x 20"	33 lbs.	\$3749
DISKOS 15450 (14")	154 Mbytes	7" x 17" x 20"	33 lbs.	\$4695
DISKOS 2050 (8")	20 Mbytes	4.62" x 8.55" x 14.25"	20 lbs.	\$2995
DISKOS 3450 (8")	34 Mbytes	4.62" x 8.55" x 14.25"	20 lbs.	\$3745
DISKOS 1070	10.6 Mbytes	floppy-size	(low)	\$2195

All PRIAM DISKOS Drives have a Transfer Rate of 1.03 Mbytes/Sec.
Optional SMD interface available for \$150.

SIRIUS SYSTEMS offer cases and enclosures for all PRIAM Hard Disk Drives. All 14" Winchester Drives will mount in our 14" Standard Case. The 8" Winchester drives have two alternatives: a single drive case and a dual drive case. All SIRIUS SYSTEMS Winchester drive cases include Power Supply, internal cabling, switches, fan, extra AC outlet (not switched, but fused) and possess very adequate ventilation. Drive addressing is done on the rear of the Case and not on the drive itself to provide ease of use during operation. All WINCHESTER DRIVE Cases are Warranted for a full year and come in our standard blue-black color scheme. Consult us for current availability and pricing.



7528 Oak Ridge Highway
Knoxville, Tennessee 37921

TO ORDER CALL (615) 693-6583

Phone Orders Accepted 9AM-7PM (EST) Mon-Fri

We accept MC, VISA, AE, COD (requires Certified Check, Cashier's Check or Cash) and Checks (personal checks require 14 days to clear). **SHIPPING AND HANDLING: \$7.00 per Floppy Disk Drive or 80+ Module** ■ 5% for other items (any excess will be refunded) ■ **Foreign Orders add 10% for Shipping & Handling.** Payment in U.S. currency ■ Tennessee residents add 6% Sales Tax ■ **VOLUME DISCOUNTS AVAILABLE**

Introducing the Versatile, Low-Cost OMEGA Series Controller

As new technological advances bring down the cost of fast, reliable mass data storage, the need for an inexpensive, versatile controller have become greater and greater. To meet this need, SIRIUS SYSTEMS' OMEGA Series Controller was designed.

The SIRIUS OMEGA Series Controller Module utilizes an on-board microprocessor to mediate data transfer to a wide variety of peripherals from an equally wide variety of host computer systems. Up to four Winchester Hard Disks (8" or 14"), four 5 1/4" Floppy Disk Drives and/or up to eight 8" Floppy Disk Drives may be in use at one time. Host systems interfacing is accomplished via a parallel or a serial interface. With the addition of a Personality module, the OMEGA Series Controller Module is directly compatible with many popular computer systems (among them the TRS-80*, Apple, Heath, and others). Provision is made for the addition of a streaming tape drive, also.

SPECIFIC HARDWARE FEATURES INCLUDE:

- Control of up to twelve Floppy Disk Drives (eight 8" and/or four 5 1/4")
- 8" and/or 5 1/4" Disk Drive Utilization
- Single (FM) or Double (MFM) density data storage
- Hard or Soft sectored diskette usage
- Utilization of "Quad" density (96 tpi) 8" or 5 1/4" Disk Drives

- Control of up to four WINCHESTER type PRIAM DISKOS Disk Drives
- 8" or 14" may intermix on the same cable
- Accommodates 8" and/or 14" drives of 5.3Mbytes to 154Mbytes
- Ultra-Fast data transfers
- Extremely flexible host-controller interfacing

SPECIFIC SOFTWARE FEATURES INCLUDE:

- Dynamic format modifications via command words
 - Extremely flexible format acceptance for unusual data storage formats
 - Easily interfaces to standard operating systems (TRS-DOS*, CP/M*, etc)
 - Operates in either geVput sector mode or data string mode
 - Performance parameters may be changed by EPROM replacement or Dynamic Reprogramming
- CP/M® of Digital Research

Dedicated systems cards are also available on a limited basis for the STD-BUS and the S 100. These cards feature shared memory also (again, software selectable) in addition to the regular OMEGA Series Controller Module features. Consult SIRIUS SYSTEMS for current price and availability for the entire line of OMEGA Series Memory Units and Controllers. Dealer inquiries are invited.

What TFORTH Is - and what It has to offer YOU!

TFORTH is a unique growth programming language for the TRS-80* that combines the best features of an interpreter and a compiler all in one functional easy-to-use package. TFORTH cannot be simply compared with Fortran, BASIC or PASCAL. This high speed, high level modular code offers the speed found in many FORTRAN compilers yet retains the on-line conveniences found in BASIC INTERPRETERS by flagging input errors as they occur line-by-line. Unlike PASCAL, TFORTH needs no "run-time" package for support. Serving as an operating system, compiler, assembler, interpreter, virtual memory manager, all in one: TFORTH makes easy, efficient-structured re-entrant programs a natural consequence.

The key to TFORTH's flexibility and ease of use lies in its use of a stack for parameters and a unique dictionary for WORDS. These WORDS are stated in terms of other WORDS already defined in the dictionary. It is this rich set of WORDS that provides DO LOOPS, IF-THEN-ELSE statements, BEGIN-END statements, virtual memory, any number base (to base 32) for input or output, a macro assembler, re-entrant code, multithread dictionary, line editor, excellent math package (16 bit integers, double precision floating point, SIN, COS, TAN, EXP and LOG) and it runs under either TRSDOS* or NEWDOS*. Assembler inherently nests with high level in an easy fashion. Complicated drivers for new devices take only a few lines of TFORTH which saves both memory and disk space!

TFORTH is a procedural language specifying a process rather than a desired result. The ability to have the language grow in the direction the user desires is excellent for novel applications. New data types and new processes can become part of the language. Due to the modular constructions, a very compact code is produced which executes at exceptionally high speeds between machine code and machine code plus 20% typical overhead speeds. Memory requirements can be "less" than assembler coding or other high level languages.

TFORTH comes complete for the TRS-80* with as little as 16K of memory and a single Disk Drive using either TRS-DOS* or NEWDOS. It provided on diskettes and an optional Math and Utilities package is available.

Through TFORTH an excellent way to develop new languages, provide simple control of device (including video monitors, A/D and D/A converters and burglar alarms) and to implement tasks requiring monitoring and decision is offered. Many WORDS to handle peripherals are part of basic TFORTH and others may be added easily. Often, substantial hardware development can be eliminated by using TFORTH to do the major digital or reduction of data.

For many applications a minimal task may be written in high level (or mixture of assembler and high level) code: loaded, assembled and prior to execution may be written to the disk as a ready to execute machine code/EXE module with the DOS.

TFORTH (on diskette - specify for Standard or 96 tpi Disk Drives) **\$129.95**
TFORTH with the addition of TRAKS-PATCH (a powerful combination!) **\$136.95**

STATE-OF-THE-ART DISK DRIVES

QUME® DataTrak 8 8" Disk Drive DOUBLE SIDED! DOUBLE DENSITY!

High performance Double Sided Disk 8" Disk Drive ■ Single or Double Density ■ Door Lock and Write Protect INCLUDED! ■ Negative DC Voltage not required ■ Low Power Operation

MPI 51/52 & 91/92 5 1/4" Disk Drives



- FAST! 3ms track-to-track access
- Low friction and minimum wear
- Superior Head Load Dynamics

QUME DataTrak 8 **\$574.95**
(2/\$549 ea)
QUME Technical Manual **\$6.95**
Connector Set #3 (AC, DC, & Card Edge) **\$10.95**
Connector Set #4 (AC and DC) **\$2.95**

- Fast! 5ms track-to-track access
- Exclusive Pulley-Band Design
- Unique Door/Ejector Mechanism
- Reliable 1112% Speed Stability
- Single/Double Density Operation
- Industry/ANSI Standard Interface

MPI 51 (Single Head/40 tracks)
125K/250K Bytes Single/Double Density** **\$259.95**
MPI52 (Dual Head/80 tracks (40/side))
250K/500K Bytes Single/Double Density** **\$349.95**
MPI 91 (Single Head/80 tracks)
250K/500K Bytes Single/Double Density** **\$399.95**
MPI 92 (Dual Head/160 tracks (80/side))
500K/1000K Bytes Single/Double Density** **\$524.95**
MPI Technical Manual **\$6.95**
** Unformatted data storage

BASCOM pay a stiff 9% royalty to Microsoft on every copy sold! Since this is about equal to the profit margin of many software houses, it's understandable that there's been no great rush to sell programs employing BASCOM.

But let's assume much of this is fixed. Microsoft has a good reputation for responding to customer suggestions. As an example, at the West Coast Computer Faire I spoke to the Microsoft representatives about the lack of a FILES statement (a means of finding out the file names present on disk) in BASCOM; BASIC-80 supported FILES, but not the compiler. Two weeks later I received an updated version of BASCOM—and lol!—the FILES statement had been implemented, along with several features other users had suggested.

At the National Computer Conference, Microsoft representatives said they were "rethinking" their contract policy and would probably change it; that change may have been implemented by the time you read this. I have also mentioned to them the desirability of allowing sequential access to random files, and they've promised to look into that. It's not unreasonable to assume they'll tighten up the overhead-code problem. Thus, as I said, let's assume that the major problems of BASCOM are fixed. What will we have?

First, the combination of BASIC-80 and BASCOM is superb for quick and dirty jobs and for those little special-purpose programs that aren't going to be run very often (possibly only once). For example, I recently wanted to reformat some financial data files. The program had to go open the file, read the data, make a couple of changes, and write the information out in a new format. The only problem was that I also wanted to sort the data before putting it back out, and this had to be done for a lot of files. Doing it with interpretive BASIC would take hours and hours; while writing even that simple a program in Z80 assembler would, at best, use up an afternoon, and might take a lot longer.

The solution was to write it in BASIC-80, test syntax and logic while in interpretive mode, and compile with BASCOM. That took an hour. In another hour, I had reformatted about one hundred files. BASCOM is fast, blindingly fast; sorts that take 3.5 minutes in CBASIC are done by BASCOM (using the same algorithm) in under 20 seconds.

In other words, the combination of BASIC-80 and BASCOM has a lot going for it. If I'd written this review a year ago, I'd have concluded that BASIC-80/BASC0M was what the world has been waiting for, and spent the rest of the review suggesting incremental improvements to make it even better.

Now I'm not so sure.

The problem is that when all the improvements are done; when all the bugs (if any; I've found none in the latest versions of BASCOM) are eliminated; when all the new features are added; when the code is tightened; when the disk operations are simplified—when all that's done, it's still BASIC.

And there are many who believe BASIC is a dead end; that the inherent limits to the language are just too severe for it ever to be acceptable; that incremental improvements actually harm rather than help the field, because they encourage newcomers to stick with BASIC instead of learning something better. My mad friend is convinced of that. So are a number of my associates.

"But," I protested to my mad friend, "I'm interested in using computers. I don't care about elegance. What I want is something that lets me get the jobs done quickly, and BASIC-80/BASC0M does that...."

"But at a stiff price. How many times have you had to start over with a program because it just wasn't worth the effort to improve one of those BASIC routines? BASIC doesn't let you build software tools. It's like Pidgin English—you can manage to buy dinner and sell copra with Pidgin, but you'll never write *Hamlet*. Or the Declaration of Independence, or even good laws...."

And the argument starts over and goes on until we get hungry, and, at the bottom line, it's all a matter of opinion; and since my space is limited, I'll drop it for the moment. Just now the bottom line is that BASIC-80 and BASCOM work, and, if you're willing to accept the inherent limits of BASIC, they're quite splendid; but those limits are severe.

Looking Elsewhere

What, then, are the microcomputer user's best alternatives to BASIC? Once again, let me be honest: these are opinions. They're opinions based on considerable user experience, but they're opinions still; and I have found that every known language has passionate supporters, so I am bound to make someone unhappy.

The earliest alternatives to BASIC were FORTRAN and COBOL. These, in my judgment, are languages whose time has long passed. They have little to recommend them, because they have nearly all the limits of compiled BASIC without the advantage of letting you program in the interpretive mode before compiling. I've had both for years, and after an initial flurry of enthusiasm for FORTRAN (I never cared at all for COBOL, which may be all right for very large systems, but is plain crippled on microcomputers) they went on the shelf and haven't come off it. Neither FORTRAN nor COBOL lets you write structured code. True, FORTRAN with RATFOR (excellently described in Kernigan and Plauger's book *Software Tools*, Addison-Wesley, 1976) overcomes some of the limits; but to use RATFOR requires another compilation stage, so that it can take over an hour to find and correct a trivial error in a fairly simple program. The *Software Tools* approach to programming is excellent, and I strongly recommend the book; but in my judgment the deficiencies of FORTRAN with RATFOR are simply overwhelming, and I cannot recommend using them.

Then there's Pascal, which very well may be the wave of the future. Pascal began unfortunately: the first widespread implementation of Pascal for microcomputers was from the University of California, San Diego, and it just didn't work for most users. The hooks into the disk operating system were clumsy, and it was very slow.

Then came some other versions of Pascal, and they too had horrible problems; you had to be really sophisticated to use them. Bugs appeared, and, unless you knew an awful lot, you couldn't tell whether you'd made a program error or the compiler was at fault. Implementing early Pascals required a constant and fairly complex dialogue between user and publisher.

As a result, a lot of us lost interest in Pascal. The language looked great in theory, but if you couldn't run it, that hardly mattered.

There are now a lot of Pascals; Pascal for the Apple, Pascal for the TRS-80, Pascal for CP/M; Pascal that

Start learning and computing for only \$129.95 with a Netronics 8085-based computer kit. Then expand it in low-cost steps to a business/development system with 64k or more RAM, 8" floppy disk drives, hard disks and multi-terminal I/O.

THE NEW EXPLORER/85 SYSTEM

Special! Full 8" floppy, 64k system for less than the price of a mini! Only \$1499.95!

(Also available wired & tested. \$1799.95)

Imagine — for only \$129.95 you can own the starting level of Explorer/85, a computer that's expandable into full business/development capabilities — a computer that can be your beginner system, an OEM controller, or an IBM-formatted 8" disk small business system. From the first day you own Explorer/85, you begin computing on a significant level, and applying principles discussed in leading computer magazines. Explorer/85 features the advanced Intel 8085 cpu, which is 100% compatible with the older 8080A. It offers on-board S-100 bus expansion, Microsoft BASIC in ROM, plus instant conversion to mass storage disk memory with standard IBM-formatted 8" disks. All for only \$129.95, plus the cost of power supply, keyboard, terminal and RF modulator if you don't have them (see our remarkable prices below for these and other accessories). With a Hex Keypad/display front panel. Level "A" can be programmed with no need for a terminal, ideal for a controller, OEM, or a real low-cost start.

Level "A" is a complete operating system, perfect for beginners, hobbyists, industrial controller use. \$129.95



Full 8" disk system for less than the price of a mini (shown with Netronics Explorer/85 computer and new terminal). System features floppy drive from Control Data Corp., world's largest maker of memory storage systems (not a hobby brand!)



Level "A" With Hex Keypad/Display.

LEVEL "A" SPECIFICATIONS

Explorer/85's Level "A" system features the advanced Intel 8085 cpu, an 8355 ROM with 2k deluxe monitor/operating system, and an advanced 8155 RAM I/O ... all on a single motherboard with room for RAM/ROM/PROM/EPROM and S-100 expansion, plus generous prototyping space.

PC Board: Glass epoxy, plated through holes with solder mask. • I/O: Provisions for 25-pin (DB25) connector for terminal serial I/O, which can also support a paper tape reader ... cassette tape recorder input and output ... cassette tape control output ... LED output indicator on SOD (serial output) line ... printer interface (less drivers) ... total of four 8-bit plus one 6-bit I/O ports. • Crystal Frequency: 6.144 MHz. • Control Switches: Reset and (RST 7.5) interrupt ... additional provisions for RST 5.5, 6.5 and TRAP interrupts on-board. • Counter/Timer: Programmable, 14-bit binary. • System RAM: 256 bytes located at F800, ideal for smaller systems and for use as an isolated stack area in expanded systems ... RAM expandable to 64k via S-100 bus or 4k on motherboard.

System Monitor (Terminal Version): 2k bytes of deluxe system monitor ROM located at F900, leaving 8000 free for user RAM/ROM. Features include tape load with labeling ... examine/change contents of memory ... insert data ... warm start ... examine and change all registers ... single step with register display at each break point, a debugging/training feature ... go to execution address ... move blocks of memory from one location to another ... fill blocks of memory with a constant ... display blocks of memory ... automatic baud rate selection to 9600 baud ... variable display line length control (1-255 characters/line) ... channeled I/O monitor routine with 8-bit parallel output for high-speed printer ... serial console in and console out channel so that monitor can communicate with I/O ports.

System Monitor (Hex Keypad/Display Version): Tape load with labeling ... tape dump with labeling ... examine/change contents of memory ... insert data ... warm start ... examine and change all registers ...

single step with register display at each break point ... go to execution address. Level "A" in this version makes a perfect controller for industrial applications, and is programmed using the Netronics Hex Keypad/Display. It is low cost, perfect for beginners.

HEX KEYPAD/DISPLAY SPECIFICATIONS

Calculator type keypad with 24 system-defined and 16 user-defined keys. Six digit calculator-type display, that displays full address plus data as well as register and status information.

LEVEL "B" SPECIFICATIONS

Level "B" provides the S-100 signals plus buffers/drivers to support up to six S-100 bus boards, and includes: address decoding for onboard 4k RAM expansion selectable in 4k blocks ... address decoding for onboard 8k EPROM expansion selectable in 8k blocks ... address and data bus drivers for onboard expansion ... wait state generator (jumper selectable), to allow the use of slower memories ... two separate 5 volt regulators.

LEVEL "C" SPECIFICATIONS

Level "C" expands Explorer/85's motherboard with a card cage, allowing you to plug up to six S-100 cards directly into the motherboard. Both cage and card are neatly contained inside Explorer's deluxe steel cabinet. Level "C" includes a sheet metal superstructure, a 5-card, gold plated S-100 extension PC board that plugs into the motherboard, just add required number of S-100 connectors.



Explorer/85 With Level "C" Card Cage.

LEVEL "D" SPECIFICATIONS

Level "D" provides 4k of RAM, power supply regulation, filtering decoupling components and sockets to expand your Explorer/85 memory to 4k (plus the origi-

nal 256 bytes located in the 8155A). The static RAM can be located anywhere from 0000 to EFFF in 4k blocks.

LEVEL "E" SPECIFICATIONS

Level "E" adds sockets for 8k of EPROM to use the popular Intel 2716 or the TI 2516. It includes all sockets, power supply regulator, heat sink, filtering and decoupling components. Sockets may also be used for 2k x 8 RAM IC's (allowing for up to 12k of onboard RAM).

DISK DRIVE SPECIFICATIONS

- 8" CONTROL DATA CORP. professional drive.
- LSI controller.
- Write protect.
- Single or double density.

Data capacity: 401,016 bytes (SD), 802,032 bytes (DD), unformatted.

Access time: 25ms (one track).

DISK CONTROLLER/I/O BOARD SPECIFICATIONS

- Controls up to four 8" drives.
- 1771A LSI (SD) floppy disk controller.
- Onboard data separator (IBM compatible).
- 2 Serial I/O ports.
- Autobot to disk system when system reset.
- 2716 PROM socket included for use in custom applications.
- Onboard crystal controlled.
- Onboard I/O baud rate generators to 9600 baud.
- Double-sided PC board (glass epoxy).

DISK DRIVE CABINET/POWER SUPPLY

Deluxe steel cabinet with individual power supply for maximum reliability and stability.

ORDER A COORDINATED EXPLORER/85 APPLICATIONS PAK!

Beginner's Pak (Save \$26.00!) — Buy Level "A" (Terminal Version) with Monitor Source Listing and AP-1 5-amp Power Supply; (regular price \$199.95), now at **SPECIAL PRICE: \$169.95 plus post. & insur.**

Experimenter's Pak II (Save \$53.40!) — Buy Level "A" (Hex Keypad/Display Version) with Hex Keypad/Display, Intel 8085 User Manual, Level "A" Hex Monitor Source Listing, and AP-1 5-amp Power Supply; (regular price \$279.95), all at **SPECIAL PRICE: \$219.95 plus post. & insur.**

Special Microsoft BASIC Pak (Save \$103.00!) — Includes Level "A" (Terminal Version), Level "B", Level "D" (4k RAM), Level "E", 8k Microsoft in ROM, Intel 8085 User Manual, Level "A" Monitor Source Listing, and AP-1 5-amp Power Supply; (regular price \$439.70), now yours at **SPECIAL PRICE: \$329.95 plus post. & insur.**

ADD A TERMINAL WITH CABINET, GET A FREE RF MODULATOR: Save over \$114 at this **SPECIAL PRICE: \$499.95 plus post. & insur.**

Special 8" Disk Edition Explorer/85 (Save over \$104!) — Includes disk-version Level "A", Level "B", two S-100 connectors and brackets, disk controller, 64k RAM, AP-1 5-amp power supply, Explorer/85 deluxe steel cabinet, cabinet fan, 8" SD/DD disk drive from famous CONTROL DATA CORP. (not a hobby brand!), drive cabinet with power supply, and drive cable set-up for two drives. This package includes everything but terminal and printers (see coupon for them). Regular price \$1630.30, all yours in kit at **SPECIAL PRICE: \$1499.95 plus post. & insur.** Wired and tested, only \$1799.95.

Special! Complete Business Software Pak (Save \$625.00!) — Includes CPM 2.0, Microsoft BASIC, General Ledger, Accounts Receivable, Accounts Payable, Payroll Package; (regular price \$1325), yours now at **SPECIAL PRICE: \$699.95.**

Please send the items checked below:

- Explorer/85 Level "A" Kit (Terminal Version) ... \$129.95 plus \$3 post. & insur.
- Explorer/85 Level "A" Kit (Hex Keypad/Display Version) ... \$129.95 plus \$3 post. & insur.
- 8k Microsoft BASIC on cassette tape. \$64.05 postpaid.
- 8k Microsoft BASIC in ROM kit (requires Levels "B", "D" and "E") ... \$90.95 plus \$2 post. & insur.
- Level "B" (S-100 kit) ... \$49.95 plus \$2 post. & insur.
- Level "C" (S-100 6-card expander) kit ... \$39.95 plus \$2 post. & insur.
- Level "D" (4k RAM) kit ... \$69.95 plus \$2 post. & insur.
- Level "E" (EPROM/ROM) kit ... \$5.95 plus 50¢ p.&h.
- Deluxe Steel Cabinet for Explorer/85 ... \$49.95 plus \$3 post. & insur.
- Fan For Cabinet ... \$15.00 plus \$1.50 post. & insur.
- ASCII Keyboard/Computer Terminal kit: features a full 128 character set. u&l case; full cursor control; 75 ohm video output; convertible to baudout output; selectable baud rate. RS232-C or 20 ma. I/O. 32 or 64 character by 16 line formats, and can be used with either a CRT monitor or a TV set (if you have an RF modulator) ... \$149.95 plus \$3.00 post. & insur.
- Deluxe Steel Cabinet for ASCII Keyboard/Terminal ... \$119.95 plus \$2.50 post. & insur.
- New Terminal Monitor: (See photo) Same features as above, except 12" monitor with keyboard and terminal in its deluxe single cabinet; kit ... \$399.95 plus \$7 post. & insur.
- Hazeltine terminals: Our prices too low to quote — CALL US
- Lear-Sigler terminals/printers: Our prices too low to quote — CALL US
- Hex Keypad/Display kit ... \$69.95 plus \$2 post. & insur.

- AP-1 Power Supply Kit ±8V @ 5 amps) in deluxe steel cabinet ... \$39.95 plus \$2 post. & insur.
- Gold Plated S-100 Bus Connectors ... \$4.85 each, postpaid.
- RF Modulator kit (allows you to use your TV set as a monitor) ... \$8.95 postpaid.
- 16k RAM kit (S-100 board expands to 64k) ... \$100.95 plus \$2 post. & insur.
- 32k RAM kit ... \$299.95 plus \$2 post. & insur.
- 48k RAM kit ... \$399.95 plus \$2 post. & insur.
- 64k RAM kit ... \$499.95 plus \$2 post. & insur.
- 16k RAM Expansion kit (to expand any of the above in 16k blocks up to 64k) ... \$99.95 plus \$2 post. & insur, each.
- Intel 8085 cpu Users' Manual ... \$7.50 postpaid.
- 12" Video Monitor (10MHz bandwidth) ... \$139.95 plus \$5 post. & insur.
- Beginner's Pak (see above) \$169.95 plus \$4 post. & insur.
- Experimenter's Pak (see above) ... \$219.95 plus \$6 post. & insur.
- Special Microsoft BASIC Pak Without Terminal (see above) ... \$329.95 plus \$7 post. & insur.
- Same as above, plus ASCII Keyboard Terminal With Cabinet, Get Free RF Modulator (see above) ... \$499.95 plus \$10 post. & insur.
- Special 8" Disk Edition Explorer/85 (see above) ... \$1499.95 plus \$28 post. & insur.
- Wired & Tested ... \$1799.95 plus \$26 post. & insur.
- Extra 8" CDC Floppy Drives ... \$499.95 plus \$12 post. & insur.
- Cabinet & Power Supply For Drive ... \$69.95 plus \$3 post. & insur.
- Drive Cable Set-up For Two Drives ... \$25 plus \$1.50 post. & insur.

- Disk Controller Board with I/O Ports ... \$100.95 plus \$2 post. & insur.
 - Special: Complete Business Software Pak (see above) ... \$899.95 postpaid.
- SOLD SEPARATELY:
- CPM 1.4 ... \$100 postpaid.
 - CPM 2.0 ... \$150 postpaid.
 - Microsoft BASIC ... \$325 postpaid.
 - Intel 8085 cpu User Manual ... \$7.50 postpaid.
 - Level "A" Monitor Source Listing ... \$25 postpaid.

Continental U.S.A. Credit Card Buyers Outside Connecticut
CALL TOLL FREE: 800-243-7428
To Order From Connecticut Or For Technical Assistance, call (203) 354-9375

Total Enclosed (Conn res. add sales tax) \$ _____
Paid By:
 Personal Check Cashier's Check/Money Order
 VISA Master Charge (Bank No. _____)
Acct. No. _____ Exp. Date _____
Signature _____
Print Name _____
Address _____
City _____
State _____ Zip _____

NETRONICS Research & Development Ltd.
333 Litchfield Road, New Milford, CT 06776

pseudocompiles to an INT file the way CBASIC does (Pascal users call the INT file "p-code"); Pascal that truly compiles into machine language for 8080, Z80, 8086, etc. All these look good, and people I respect tell me they run; but since I haven't implemented any of them yet, I can't report on them. I can say that Pascal has many enthusiasts, and might well be the standard language of the future. Then there's Ada, a Pascal-like language heavily supported by the DOD (Department of Defense), which will certainly be around for many years. If I were preparing for a secure career in programming, I'd learn Pascal instantly and keep very close tabs on the progress of Ada.

In the next couple of months, we're adding a Pascal expert to the staff here, and I'll devote a whole column to Pascal/Ada; for now, I must simply pass them over.

Pascal has enthusiasts. So does C, a programming language developed at Bell Telephone Laboratories. The best (and indeed nearly the only) manual on C is Kernighan and Ritchie's, *The C Programming Language* (Prentice-Hall, 1978). This is an excellently written book which anyone at all interested in the C language simply must read. It succeeds in communicating a lot of enthusiasm for C. There are lots of examples of real programs that work. Kernighan, incidentally, is the same Brian Kernighan who coauthored *Software Tools*.

C is nothing like BASIC. There are far fewer commands, for one thing. On the other hand, there are a number of conventions. For example, the BASIC statements:

```
FOR I = 0 TO N - 1
NEXT I
```

would appear in C as:

```
for ( i = 0; i < N; i++ )
```

which looks complex, but is, with a bit of experience, quite readable. The `i++` means that `i` is first to be tested against `N`, then incremented; the expression could have been written with `++i`, which would require that `i` be incremented *before* the test against `N`.

Despite (perhaps because of) the numerous time-saving conventions such as `++i`, C can be learned by a BASIC user in a couple of weeks. Real facility requires practice; more practice than BASIC, precisely because there are many fewer limits in C. Programming with elegance and style takes work—but in C such programs are possible, while BASIC simply won't let you write elegant code.

I have two C compilers for microcomputers. I'm told there's also an interactive `tiny-c`, which I have not seen running, but which is said to be a good teaching aid, although severely limited in capability. [Editor's note: See "A User's Look at `Tiny-c`," by Christopher O Kern, December 1979 *BYTE*, page 196...RSS]

Of my two C compilers, only one is suitable for those not already familiar with the C language. This is BDS C, available from Lifeboat Associates for \$125. BDS C comes with a copy of Kernighan and Ritchie's book and quite extensive documentation on the BDS (BD Software) implementation.

The BDS compiler uses two passes. One might at first think that a disadvantage because of the time required, but in fact it is not: the first pass is done *very* fast, and checks for trivial errors, such as missing semicolons,

comments improperly delimited, unmatched parentheses and brackets (C loves brackets, braces, and parentheses), and the like. The second pass goes a bit slower but is still much faster than the CBASIC compiler.

Like BASCOM, compiled C code must be put through a linker, and like Microsoft's, the BDS documentation tells you precisely how to do this. When it's all finished, you have a CP/M command file; and the resulting code is *very* fast. I've not yet been able to benchmark BDS C against a similar BASCOM program, because when you translate from BASIC to C you actually restructure the program; but I have two *Othello* games, one in C and the other compiled by BASCOM, and they seem to run at about the same speed. The C program, however, is about 8 K bytes compiled; the BASIC program, performing the same searches and playing at the same level, compiled to over 20 K bytes. Other programs doing similar jobs also run in comparable times, and with about the same differences in program size.

Disk operations in BDS C are fairly simple if you understand CP/M, not so simple if you don't—and CP/M's documentation is so notoriously unclear that you'll have to work for a couple of days understanding CP/M before you can write decent disk I/O (input/output) operations for BDS C. It is worth sharpening up your understanding of CP/M, though, because BDS C lets you do *everything* CP/M will: get the names and sizes of files currently on disk, make backups, rename and delete, etc, and it's no more difficult to understand than the FIELD statements in Microsoft BASIC or the dreaded FORMAT statement in FORTRAN.

String operations in C are more difficult than in BASIC. Actually, they aren't; ie: it's possible to write, in C, all the string functions of BASIC (such as LEFT\$, etc), then call them as needed; and once you have written them, you can use them in any program that needs them—and leave them out if not wanted. And, in fact, that illustrates one of the fundamental differences between BASIC and C: the BASIC language provides a number of functions which you must have present whether you need them or not, and which must be used *exactly* the way BASIC wants them used. C, on the other hand, allows you to leave out functions you don't want, and rewrite those you keep to suit your precise requirements.

There is, however, one very severe limit to BDS C: it does not support floating-point data types. One can use floating-point *variables*, because BDS supplies a number of functions that can be called to do floating-point arithmetic; but the result is clumsy. If you want to learn the C language, and write games, calendar programs, and almost anything that doesn't involve crunching a lot of numbers, BDS C is highly recommended; however, it isn't suitable for writing an accounting or financial package.

The other C compiler for microcomputers is the Whitesmiths C Compiler, which is available from Lifeboat Associates for \$630. This is a full implementation of the standard C described by Kernighan and Ritchie, and is highly regarded by many professionals who work with large machines like DEC's (Digital Equipment Corporation) PDP-11. In fact, Whitesmiths C was written for large machines, and it is only an accident that it could be scaled down for microcomputers. The president of Whitesmiths Ltd is P J Plauger, a fellow science fiction writer, and more important, coauthor of *Software Tools*.

Attention Computer Buyers:

Olympic sales will meet or beat any competitor's advertised price as long as our competitor has the goods on hand. Don't waste your money . . . buy from Olympic Sales and save on

Hewlett-Packard • Apple • Texas Instruments • Atari • Mattel • Ohio Scientific • Sony • RCA
Anadex • Centronics • Seiko • Craig • Smith Corona • and many more.

HP HEWLETT PACKARD CALL US FOR THE LOWEST PRICES IN THE WORLD!

HP-85 computer • Graphics plotter • 8 models of disk drives • HP-2631B high quality printer • HP personality module • New HP-85 ROMs • Interface module • HP-86 16K memory modules • All accessories and supplies for the HP-85

HP Calculators at new low prices

HP-41C Programmable scientific	\$239.95	HP-38C Business/real estate	\$123.95
Card reader for 41C	179.95	HP-97 Printer's programmable	579.95
Printer for 41C	309.95	HP-67 Scientific programmable	297.95
Optical wand for 41C	112.95	HP-33C Scientific	95.95
Memory modules for 41C	39.95	HP-37C Business management	58.95
HP-34C Scientific	123.95	HP-32E Advanced scientific	53.95

We are the largest HP dealer in the world and carry an enormous amount of accessories and supplies for HP products. All HP products guaranteed by HP.

apple computer

AMERICA'S NUMBER ONE SELLER
Immediate delivery on all models of
Apple II plus 16K, 32K and 48K RAMs



New disk drive controller with DOS 3.3 • Disk drives • Graphics tablets • Software • Modems • DOS 3.3 to improve old model disks • Silentype printers • Monitors • Memory modules • 80 column card reader • Fortran-Pascal language cards • Centronic printers • Qume printers • Anadex Apple Sider and other models • Dow Jones news and quote reporter • More • More • More

Ask us for super low prices on the new Apple III 96K and 128K computers and peripherals. We're taking orders for future delivery. First come, first served.

We are an authorized, servicing Apple dealer.

ATARI COMPUTERS



All Atari accessories at super discount prices!

Model 800 computer	\$759.95
Model 400 computer	439.95
810 disk drive	499.95
820 printer—40 column Impact	429.95
822 thermal printer—40 column	349.95
825 printer—80 column Impact	729.95
830 acoustic modem	159.95
850 interface module	169.95
8K memory module	94.95
16K memory module	149.95
TV game	148.95

BEAT THE PONIES!



MATTEL HORSE RACE ANALYZER . . .

the computer that handicaps the ponies. Only \$119.95

Mattel Intellivision TV game \$239.95

SONY

The famous Walkman stereo \$169.95
New SL-5800 video cassette recorder Call us
New AG-300 Beta stack autochanger (20 hours of recording) \$189.95

Also, the lowest prices on Sony Betamax 5400, Betamax 5600, color cameras, projection TV's, portable video cassette recorders, radio's, stereos and tape recorders.

Buy one Sony KP7200 72 inch projection TV at \$3700.00 or one 50 inch Sony projection TV at \$3200.00 and get FREE one Sony Betamax SL5400 programmable video cassette recorder (retail value—\$1250) plus 6 FREE blank Sony video cassettes.

Sony cassettes L500 (2 hours) \$10.95
L750 (3 hours) \$13.95

Seiko WATCHES

The largest collection of Seiko watches. 320 models to choose from. Here are some samples.

SEIKO Tank Watch for Ladies & Gentlemen, CARTIER Type, Elegant, Classic Style. Ladies XU010 to XU015 Ret: \$250.00 Y/C: \$185.00, for Men FS014. Ret: \$250.00 Y/C: \$185.00

SEIKO Musical Alarm Chronograph, Digital Quartz, Plays Tune for You, SS Melody. Ret: \$260.00 Y/C: \$199.95, Goldtone GY002 Ret: \$300.00 Y/C: \$239.95

SEIKO Dual Chronograph Digital Quartz SS DHX018-021 Ret: \$195.00 Y/C: \$89.95

SEIKO Alarm Digital Quartz DHN010-018-013 Ret: \$175.00 Y/C: \$89.95

SEIKO Calculator Watch w/Alarm, Digital, SS, %, DFK018 Ret: \$250.00 Y/C: \$179.95 Goldtone Model 5000G Ret: \$295.00 Y/C: \$229.95

SEIKO the Famous DIGIANA a Combination of Two Watches in One "Digital" and Analog. Very Interesting and Original! SS Ret: \$300.00 Y/C: \$169.95 Goldtone Ret: \$325.00 Y/C: \$199.95

SEIKO Perpetual Calendar Quartz, SS (DZ001-DZ007) Ret: \$175.00 Y/C: \$99.95

SEIKO Memory Bank Calendar, SS (FX005) Ret: \$225.00 Y/C: \$149.95

SEIKO Quartz Alarm Chrono, with Count-down Timer (GC007) SS Ret: \$235.00 Y/C: \$169.95 Goldtone (GC008) Ret: \$275.00 Y/C: \$199.95

SEIKO Multi-Alarm Digital (DHT011, 018, 028) SS, Ret: \$275.00 Y/C: \$99.95, in Goldtone Model DHR803, Ret: \$250.00 Y/C: \$159.95

NEW SEIKO Ladies Quartz Beautiful—(XT084) Ret: \$250.00 Y/C: \$199.95. Model 5190G Ret: \$275.00 Y/C: \$219.95

SEIKO SPORTS 100 Quartz, 300 ft (FY097) SS. Ret: \$220.00 Y/C: \$163.95

SEIKO DIVERS Watch (SK91) 500 ft. Automatic SS. Ret: \$225.00 Y/C: \$183.95

SEIKO "ROLEX" Type, Beautiful! Men's Two-tone (FY018) Ret: \$250.00 Y/C: \$183.95

SEIKO Travel Alarm, Beautiful, Dual Time (QD851K) Black or Goldtone (QD851G) a Fantastic Item to Travel with or Give. Ret: \$119.95 Y/C: \$89.95

NEW SEIKO Ladies Alarm Watches Digital, Great Unit (UT010) Ret: \$235.00 Y/C: \$189.95

SEIKO Solar Alarm Chronograph with 10,000 Hr. Battery SS GH007-GH009. Ret: \$295.00 Y/C: \$215.00

SEIKO Quartz Alarm Chronograph, Month/Day/Date, Hardlex Glass Goldtone (DHZ024) Ret: \$265.00 Y/C: \$199.00

320 SEIKO Watches on Display at Oxford Store — 100 New 1981 Models — the Most Spectacular Display of Seikos, Texas Instruments and Other Watches!



WE ALSO CARRY RCA

New RCA selectavision model 650 for 1981 \$1098.00
RCA Selectavision model 250 \$869.95
RCA VK250 tapes (6 hours) \$13.95

Computer Peripherals and Accessories

Maxwell diskettes	\$ 3.95 & Up
Centronics printers	
Model 737	789.95
Model 700-9	1199.00
Anadex Apple Sider printer	
Model 8000AP	795.00
Diablo model 630/I RO FP terminal	2295.00
Other Diablo terminals	Call us
Qume high quality daisy wheel printer compatible with Apple II/III	2395.00
Form tractor for Qume	199.95

Texas Instruments

99/4 computer console	\$529.95
RF modulator	69.95
Color monitor	389.95
TI-59	199.95
TI-58C	89.95
PC-100C	159.95
TI-57	49.95
Speak and Spell	59.95
TI programmer	48.95
Speak and Read	76.95
Speak and Math	74.95

We carry an enormous selection of TI accessories. Call us for the best deals!

Prices f.o.b. LA. Minimum freight and handling charge—\$4.95. In CA, add 6% sales tax. Goods subject to availability. Request our 130 page catalog in writing.

Mail and phone orders only: (800) 421-8045 (outside CA)
216 S. Oxford Ave. (213) 381-3911 OR
Los Angeles, CA 90004 (213) 381-1202 (in CA)
Master Charge • Visa Telex 67-3477

OLYMPIC SALES COMPANY, INC.

216 South Oxford Avenue • P.O. Box 74545 Los Angeles, CA 90004 • (213) 381-3911 or (213) 381-1202 • Telex 67-3477

In Southern California, four other convenient locations

Pasadena	Ontario	El Segundo	Costa Mesa
1756 E. Colorado	1030 W. "I" St.	600 N. Sepulveda	2300 Harbor Blvd.
(213) 577-1422	(714) 986-2740	(213) 615-0222	(714) 540-1530

Although the Whitesmiths Compiler is an excellent professional tool, I cannot recommend it to anyone who doesn't intend to program in C in a big way—and even then I'd recommend buying the BDS C compiler as well. Whitesmiths C compiles, eventually, to true machine code; but it does so by going through an intermediate assembly language called A-Natural. It's slow, and since there's no first pass to find trivial errors, the Whitesmiths compiler can grind away for half an hour before reporting a misplaced semicolon. It is certainly not what I'd choose to learn the language with—but I would get it if I were going to market programs written in C.

Ubiquitous Microsoft doesn't market a C compiler, but it does have a LISP interpreter. The Microsoft muLISP-79 is well done, if you like the LISP language. You may not care for the language, but those who like it like it a lot. LISP stands for list processing, and it makes creating highly complex linked lists very easy.

LISP is, however, a peculiar language. It was written in the 1950s by Dr John McCarthy, now Director of the Stanford Artificial Intelligence Laboratories (SAIL), and it's extensively used at Stanford and MIT (where McCarthy wrote it).

LISP does bit-by-bit arithmetic, meaning that there is no theoretical limit to the precision you can obtain; if you want an exact numerical expansion of, say, 2 to the 55th power, or 87 factorial, you can get it from LISP, and with only about three lines of code for a program—and you'll get the answer faster than you think. LISP is one of the fastest languages I know of, often approaching assembly-language programs in speed of operation.

LISP programs are very tight; it's almost impossible to write unstructured code in LISP. It's also very nearly impossible to understand a LISP program, even if you wrote it; at least that's been my experience. You can strain like a gearbox and produce code that runs, and which you understand just at that moment; but hours later it's gibberish. The only thing less comprehensible than a LISP program is one in APL—APL doesn't even use normal letters, but instead requires a special keyboard that can generate strangely bent arrows and other weird symbols. Both LISP and APL programmers delight in writing a whole page of instructions into one line (and you can do it, too, because both languages allow functions to call themselves). They also like to baffle fellow professionals by showing a line of code and challenging anyone to say what it does.

It's very hard to comment a LISP program—but that's all right, because it isn't traditional for LISP programmers to comment their programs anyway.

In other words, I am not a wild enthusiast for LISP as a "standard" microcomputer language. It's true that one or another LISP variant is used by just about everyone in the artificial intelligence field; for certain purposes there's nothing better. But for general-purpose programming, LISP and APL are, in my judgment, simply too obscure.

The Microsoft muLISP-79 was written by The Soft Warehouse in Hawaii; I got mine directly from the authors and haven't seen the Microsoft versions (for CP/M and the TRS-80), although they were supposed to be sent weeks ago. I am told that Microsoft has rewritten some of the documentation, which could only improve it. The problem with documenting LISP is that the language is fairly obscure; you need not only a user's manual, but an introduction to LISP itself, which is far more than the

muLISP-79 manual claims to be.

The best way to learn LISP is to attend Stanford or MIT and get tutorial instruction from someone already proficient. The next best way is to get access to the MIT Macsyma Consortium computer and run the TEACH-LISP programs. There are also a couple of MIT documents which are pretty good introductions. I wish I knew of a good commercial textbook, but I don't. If you want to learn LISP, you've no choice but to play about with it; since muLISP-79 is interactive, that's not so hard to do, and there are some decent examples in the documents supplied. If you like playing with powerful languages, muLISP-79 is recommended—but don't blame me if you don't use it very often after the first wave of enthusiasm.

Which concludes my overview of languages. I haven't mentioned STOIC and FORTH, because they're really a kind of assembler language using the programmer as a parser; they make programming a bit easier, but you've got to be into assembler work before you can use them, and this is, after all, the User's Column.

Drawing Conclusions

So what's the best language to learn? I don't know. I like C. I also like what I've seen of Pascal, assuming the current crop will really run on microcomputers. And despite my misgivings, I still find myself using BASIC-80/BASCOM, particularly for quick and dirty jobs.

It seems certain—to me at least—that Pascal is going to be around a long time, especially what with all that DOD support for the Ada variant. Now that there seem to be some decent Pascal compilers available for microcomputers, we're going to see a lot of software written in Pascal, and those who want to modify their software will have to be familiar with the language.

But there may not be a real conflict between Pascal and C. Both are vastly different from BASIC; different in conception, in terminology, but more important, in the "philosophy" or style of programming employing them. Learning either will help break the BASIC habit of sloppy program structure; and having done that, you'll have little trouble learning the other, or indeed any other well-structured language.

And that can't hurt users or programmers.

Adventure and Other Games

Now, what about computer games? Well, when microcomputers first came out, games were the rage. It wasn't so much fun to *play* the games, which tended to be rather dull (you wouldn't play much tic-tac-toe with a human opponent); the fun was in writing the programs and seeing just how smart you could make the machine. With the possible exception of *Star Trek*, nobody spent much time with the games once they were written and perfected.

That's no longer true. Nowadays you can buy computer games that are fun to play. For example, at both the West Coast Computer Faire and the National Computer Conference, the most popular exhibit was Atari's. Not that so many were wild about the Atari computers, or the educational games, or that sort of thing, but boy did they stand in line to play *Star Raiders*, a real-time game in which you are a pilot of an X-wing fighter, or perhaps it's a Colonial Viper, and you go zipping about through space destroying villains and saving civilizations....

There are lots of real-time games showing up for

The VP-111 hobby computer: Start programming for only \$99.

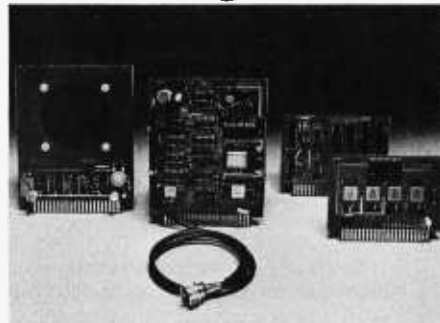

New! VP-111 **\$99.**
Microcomputer
Assembled* and tested.

Features:

- RCA 1802 Microprocessor.
 - 1K Bytes static RAM.
 - Expandable on-board to 4K.
 - Expandable to 32K Bytes total.
 - 512 Byte ROM operating system.
 - CHIP-8 interpretive language or machine language programmable.
 - Hexidecimal keypad.
 - Audio tone generator.
 - Single 5-volt operation.
 - Video output to monitor or modulator.
 - Cassette interface—100 Bytes/sec.
 - Instruction Manual with 5 video game listings, schematics, CHIP-8, much more!
- Ideal for low-cost control applications.
Expandable to full VP-711 capability with VP-114 Kit.

*User need only connect cables (included), a 5-volt power supply and speaker.

New low price! \$199.
VP-711, only.....
Completely assembled
and tested.

All the features of the VP-111 plus:

- A total of 2K Bytes static RAM.
 - Power supply.
 - 8 Bit input port.
 - 8 Bit output port.
 - I/O port connector.
 - System expansion connector.
 - Built-in speaker.
 - Plastic cover.
- Three comprehensive manuals:
- Instruction Manual—20 video game listings, schematics, much more.
 - User's Guide—operating instructions and CHIP-8 for the beginner.
 - RCA 1802 User's Manual (MPM-201B)—complete 1802 reference guide.

Add computer power a board at a time.

With easy-to-buy options, the versatile RCA hobby computer means even more excitement. More challenges in graphics, games and control functions. For everyone, from youngster to serious hobbyist.

Built around an RCA COSMAC microprocessor, our hobby computer is easy to program and operate. Powerful CHIP-8 interpretive language gets you into programming the first evening. Complete documentation provided.

Send the coupon now...

Complete the coupon below and mail to: RCA MicroComputer Customer Service, New Holland Ave., Lancaster, PA 17604.

Or call toll free (800) 233-0094 to place your Master Charge or VISA credit card order. In Pennsylvania, call (717) 397-7661, extension 3179.



Please send me the items indicated.

- VP-111** New low cost Microcomputer (See description above) **\$ 99**
- VP-114** Expansion Kit for VP-111—Includes 3K RAM, I/O Port and connectors **\$ 76**
- VP-711** The original VIP Microcomputer (See description above) **\$199**
- VP-44** RAM On-Board Expansion Kit—Four 2114 RAM ICs. Expands VP-711 memory to 4K Bytes **\$ 36**
- VP-590** Color Board—Adds color. Four background and eight foreground colors **\$ 69**
- VP-595** Simple Sound Board—Provides 256 programmable frequencies. For simple music or sound effects. Includes speaker **\$ 30**
- VP-550** Super Sound Board—Turns VP-111/711 into a music synthesizer! Two independent sound channels. Outputs to audio **\$ 49**
- VP-551** 4-Channel Super Sound—Includes VP-576 and demo cassette. Requires VP-550 and 4K RAM **\$ 74**
- VP-570** Memory Expansion Board—Plug-in 4K RAM memory **\$ 95**
- VP-580** Auxiliary Keypad—Adds two-player interactive capability. Connects to VP-590 or VP-585 **\$ 20**
- VP-585** Keypad Interface Board—Interfaces two VP-580 Auxiliary Keypads to VP-111/711 **\$ 15**
- VP-560** EPROM Board—Interfaces two 2716 EPROMs to VP-111/711 .. **\$ 34**

- VP-565** EPROM Programmer Board—Programs 2716 EPROMs. With software **\$ 99**
- VP-575** Expansion Board—Provides 4 buffered and one unbuffered expansion sockets **\$ 59**
- VP-576** Two-Board Expander—Allows use of 2 Accessory Boards in either I/O or Expansion Socket **\$ 20**
- VP-700** Tiny BASIC ROM Board—BASIC code stored in 4K of ROM **\$ 39**
- VP-701** Floating point BASIC for VP-711 on cassette. Requires 16K Bytes RAM (avail. 7/80) **\$ 49**
- VP-710** Game Manual—Listing for 16 exciting games **\$ 10**
- VP-720** Game Manual-II—More games .. **\$ 15**

ASCII keyboards.

- VP-601** Keyboard—128-character ASCII encoded alphanumeric 8-bit parallel output **\$ 69**
- VP-606** Keyboard—Same as VP-601. Asynchronous serial output **\$ 99**
- VP-611** Keyboard—Same as VP-601 plus 16-key numeric keypad **\$ 89**
- VP-616** Keyboard—Same as VP-606 plus 16-key numeric keypad **\$119**
- VP-620** Cable—Connects VP-601/611 to VP-111/711 **\$ 20**
- VP-623** Cable—Unterminated for VP-601/611 **\$ 20**
- VP-626** Connector—Male "D" mates to VP-606/616 **\$ 7**

Enclosed is \$_____ for items checked plus shipping & handling charge of \$3.00.

Add your state and local taxes \$_____. Total enclosed \$_____

I enclose check or money order. Or charge my VISA Master Charge.

Credit card account No. _____

Master Charge Interbank No. _____ Expiration date _____

Signature (required for credit orders): _____

Name (please type or print): _____

Street address: _____ City: _____

State & Zip: _____ Telephone:() _____

Make checks payable to RCA Corp. Prices and specifications are subject to change without notice.

WE DELIVER!

Osborne Business Software



Before you buy the programs that your company is going to depend on for its accounting, ask the following questions:

- Do I get the source code?** (Don't settle for less. You cannot make the smallest change without it.)
- Is it well documented?** (The Osborne documentation is the best.)
- Is it fully supported?** (If not, why not? What are they afraid of?)

The Osborne system is the industry standard accounting package, with literally thousands of users. We offer an enhanced version of that package that will run on most systems without recompiling.

CRT INDEPENDENCE. The original programs were designed to run on a Hazeltine terminal. To use a different CRT, you had to modify and test two modules — and recompile every program! With the Vandata package, you simply pick your CRT from a menu and run.

FILE/DRIVE MAP. The original package had all data files on the same drive as the programs. Ours allows you to dynamically specify the drive assigned to each file. In fact, you can change the drive assignments whenever you wish, to accommodate expanded file sizes or new hardware — all without recompiling!

INTEGRATION. The original AR and AP systems had to be changed and recompiled to feed journal entries to GL. Our installation program eliminates this hassle. It simply asks you if you want the systems integrated, and what your special account numbers are.

SPEED. The original programs used a binary search to access the GL account file. We use an enhanced technique that greatly cuts down on disk accesses, thus speeding up account lookups significantly in the GL, AR and AP systems.

BUGS. We have corrected a number of bugs in the original programs. If you find a bug in our programs, we'll fix it — and send you a \$20 reward! Our users are sent bug fixes in source form.

MORE! We have made many minor enhancements, and fixed many minor problems. We are committed to the ongoing support of our package. Vandata has been an independent software supplier for over seven years. Quality and support are our way of doing business.

General Ledger with Cash Journal	\$95
Accounts Receivable	\$95
Accounts Payable	\$95
Payroll with Cost Accounting	\$95
• All Four Packages (GL, AR, AP, PR)	\$295
Magic Wand (Super Word Processor!!)	\$345
Pearl Level III (best prog. tool available)	\$645
CBASIC-2	\$110
TRS-80 [®] MOD II CP/M [®] 2.2 (Pickles & Trout)	\$185
H89/Z89 CP/M [®] 2.2 (Magnolia Inc. h/w mod)	\$295

Formats: Std. 8", 5" NorthStar DD, TRS-80 MOD II Im, H89/Z89. Manuals for GL, AR/AP, and PR are not included in price — add \$20 per manual desired (AR/AP are in one manual). CP/M[®] and CBASIC-2 required to run accounting software. Users must sign licensing agreement. Dealer inquiries invited.

To order call: (206) 542-8370
or write: **VANDATA**
17541 Stone Avenue North
Seattle, WA 98133

VISA/MC Welcome — CP/M[®] is a registered trademark of Digital Research.
TRS-80[®] is a registered trademark of Radio Shack, Inc.

microcomputers. *Alien Invader*, *Space War*, and a whole family of games formerly available only in arcades can be your very own.

There's also an entirely different class of game available. *Adventure* is here.

The game of *Adventure* was first written in FORTRAN by Larry Crowther and Don Woods. It bore some slight resemblance to *Hunt the Wumpus*, in that the game consisted of wandering through unknown territories and encountering various hazards. Unlike *Wumpus*, though, the *Adventure* map is fixed. The game always begins at a well house, and you may continue to explore until you are killed. Actually, it doesn't end even then: the computer will resurrect you if you like.

You move about in *Adventure* by telling the computer where you want to go. The object of the game is to find treasures and bring them to the well house. On the way you encounter various obstacles and monsters, such as a large green snake, a dragon, and a ferocious bear chained to the wall. (The problem is that the bear's silver chain is a treasure.) You also find various objects: a rod, a birdcage, and other such things, some of which may be useful in solving puzzles that lead to treasure.

The game quickly became a cult object among programmers. Computer-installation supervisors estimated that when *Adventure* arrived, two weeks' work would be lost due to the staff bootlegging time to run the game. Various fixes were tried, including restricting the times at which *Adventure* could be accessed, but nothing really worked except letting the disease run its course; when all the programmers had solved the game, then and only then did they get back to work. Until then, they were driven to it as if hypnotized. To make it worse, it was customary not to tell anyone how to solve the game, although strange and misleading hints were allowed.

Adventure now exists for various microcomputers. The game itself is public domain (although programs to implement it are not), so there are many versions offered. I have one for 8-inch floppy-disk CP/M systems sold by Workman and Associates (POB 482, Pasadena CA 91102, \$23.95 postpaid) and another for the Radio Shack TRS-80 Level II (Model I) by Microsoft, \$24.95, and available from most dealers. Both run quite fast—faster, in fact, than the FORTRAN versions did on a DEC PDP-10. Both require 32 K bytes of memory and a single disk drive, and both are full implementations of the original Crowther and Woods *Adventure*, including the "Save" feature that allows you to store an incomplete game so that you don't have to start over every time.

The Workman version recognizes a number of commands that were not in the original *Adventure*, but the puzzles and their solutions remain unchanged.

In addition, both the Workman and the Microsoft versions store most of the game information on disk, and every time you give a command they have to go to the disk to get the response. There's no help for that, of course; the *Adventure* data base requires over 50 K bytes of ASCII (American Standard Code for Information Interchange) characters. Thus the disk gets a good workout. This presents no problem with the Workman and Associates CP/M version, because any good CP/M copy routine will allow you to make a backup; but the Microsoft TRS-80 *Adventure* has been carefully rigged to make backup copies nearly impossible. I say nearly; within

New

S-100 A/D & TIMER

New

Tecmar's new A/D and Timer Board is designed to meet sophisticated data acquisition needs. The board can accommodate various A/D modules providing options such as 12, 14, 16 bit accuracy; 100 KHz throughput; variable ranges and gains. It contains a powerful timer circuit (AMD 9513) which can start A/D conversion and can also be used independently for time of day, event counting, frequency shift keying and many other applications.

TM-AD200 FEATURES

- Complies with IEEE S-100 specifications
- Transfers data in 8 or 16 bit words
- 30 KHz throughput standard
- 12 bit accuracy standard
- Jumper-selectable for 16 single-ended or 8 true differential channels
- External trigger of A/D
- Provision for synchronizing A/Ds
- Data overrun detection
- Data is latched providing pipelining for higher throughput
- Input ranges: $\pm 10V$, $\pm 5V$, 0 to $+10V$, 0 to $+5V$
- Output formats: Two's complement, binary, offset binary
- Auto channel incrementing

- I/O or memory mapped
- Utilizes vectored interrupt or status test of A/D
- Provision for expansion to 256 channels

TIMER FEATURES

- 5 independent 16 bit counters (cascadable)
- 15 lines available for external use
- Time of day
- Event counter
- Alarm comparators on 2 counters
- One shot or continuous frequency outputs
- Complex duty cycle and frequency shift keying outputs
- Programmable gating and count source selection
- Utilizes vectored interrupt

TM-AD200 OPTIONS

- Programmable gain up to 500
- 14 bit accuracy
- 16 bit accuracy
- Screw terminal and signal conditioning panel with optional thermocouple cold junction compensation

- 100 KHz throughput with 12 bit accuracy
- Low level, wide range (10mV to 10V FSR) permitting low level sensors such as thermocouples, pressure sensors and strain gauges to be directly connected to the module input

(216) 382-7599



\$695

23414 Greenlawn • Cleveland, OH 44122

If your data acquisition needs are simple, the original Tecmar S-100 A/D Board will meet your needs. **\$495**

TM-AD100 FEATURES

- Complies with IEEE S-100 specifications
- 16 single-ended or 8 true differential channels
- 12 bit accuracy
- 25 KHz throughput
- I/O or memory mapped
- Input ranges: $\pm 10V$, $\pm 5V$, 0 to $+10V$, 0 to $+5V$
- Minimal software required.

For digital to analog conversion, Tecmar's D/A Board provides four independent 12 bit high speed D/A channels. **\$395**

TM-DA100 FEATURES

- Complies with IEEE S-100 specifications
- 4 independent digital to analog converters
- 12 bit accuracy
- 3 μ sec settling time
- I/O or memory mapped
- Output ranges: $\pm 2.5V$, $\pm 5V$, $\pm 10V$, 0 to $+5V$, 0 to $+10V$

S-100 BOARDS

- 8086 CPU w/vectored interrupts **\$450**
- RAM **\$395**
- 8Kx16/16Kx8 **\$495**
- 8086 PROM-I/O **\$350**
- Serial and Parallel I/O **\$350**
- Parallel I/O & Timer

APPLE

TRS-80¹ PET² KIM²

A/D **D/A**

- ▶ 12 Bit High Speed
- ▶ 8 Ch. Differential
- ▶ 16 Ch. Single-ended
- ▶ Each A/D Module **\$495**

12 Bit High Speed 4 Channel

Each D/A Module **\$395**

TRS-80 or PET expansion board, power supply, and enclosure **\$200.**
Kim expansion board and power supply **\$150.**

S-100 Real Time Video Digitizer

- Digitizes and Displays in 1/60 sec, flicker-free
- 16 Gray Levels
- Switch Selectable to display Black and White Graphics (8 pixels/byte)
- Maximum Resolution: 512 pixels/line x 240 lines
- Minimal software requirements **\$850**

¹Reg. Trademark of Tandy Corp.
²Reg. Trademark of Commodore

Data Acquisition Systems and Video Microcomputer Systems Available

CATCH THE S-100 INC. BUS!



	LIST PRICE EACH	OUR SPECIAL CASH PRICE
TARBELL DOUBLE DENSITY DISK CONTROLLER — A & T	495.00	399.00
S.D. SYSTEMS VERSAFLOPPY II — KIT	350.00	299.00
GODBOUT CPU-Z — A & T	295.00	249.00
MULLEN EXTENDER CARD W/PROBE — KIT	59.00	49.00
POTOMAC MICRO MAGIC MODEM — A & T	399.00	341.00
3M "SCOTCH" 8" 740-0 DISKETTES — 10	50.00	30.00
CROMEMCO 32K BYTESAVER — A & T	295.00	249.00
CCS 64K DYNAMIC RAM — A & T	700.00	549.00

Subject to Available Quantities • Prices Quoted Include Cash Discounts. Shipping & Insurance Extra.

We carry all major lines such as
 S.D. Systems, Cromemco, Ithaca InterSystems, North Star,
 Sanyo, ECT, TEI, Godbout, Thinker Toys, SSM.
 For a special cash price, telephone us.

S-100, inc.
 7 White Place, Clark, N.J. 07066
 201-382-1318

Hours: Mon. - Fri. — 10 a.m. to 6 p.m.

THIS YEAR CPAIDS COMPLETE INTEGRATED ACCOUNTING SOFTWARE

MASTER TAX—Professional tax preparation program. Prepares schedules A, B, C, D, E, F, G, R/RP, SE, TC, ES and forms 2106, 2119, 2210, 3468, 3903, 2441, 4625, 4726, 4797, 4972, 5695 and 6251. Printing can be on readily available, pre-printed continuous forms, on overlays, or on computer generated, IRS approved forms. Maintains client history files and is interactive with CPAids GENERAL LEDGER II (see below) ... **\$995/\$30**
 Annual Update Fee **\$350**

GENERAL LEDGER II—Designed for CPA's. Stores complete 12 month detailed history of transactions. Generates financial statements, depreciation, loan amortizations, journals, trial balances, statements of changes in financial position, and compilation letters. Includes payroll system with automatic posting to general ledger. Prints payroll register, W2's and payroll checks. **\$450/\$30**

Runs with widely accepted CP/M operating system

Distributed by

Lifeboat Associates
 1651 Third Avenue, New York, N.Y. 10028
 (212) 860-0300 Telex: 220501



either TRSDOS or Apparat's NEWDOS it is impossible, but since I have the Omikron CP/M Mapper installed on my TRS-80, I can make backups of anything, using a CP/M sector-by-sector copy routine.

(As an aside: I've been informed that both Parasitic Engineering and Field Engineering Consultants Ltd also make memory mappers that will allow you to run CP/M on the TRS-80 Model I. I've had no chance to test either of them. My Omikron Mapper continues to work flawlessly, by the way.)

I often wonder about companies that deliberately try to keep you from copying software—especially when it's supposed to run on something as inherently flaky as a TRS-80 5-inch disk. Experienced users *never* run their primary source disks; making a backup is just common sense, even if you have excellent hardware like Percom or Matchless disk drives. (I've tested both on my TRS-80, and I'm quite happy with them.) Moreover, making it hard to copy a disk is often like waving a red flag at a bull—there are plenty of sophisticated users who will consider it a challenge, and, having with great effort found a way to make copies, will feel ethically justified in distributing them to all their friends.

In any event, the Workman and Microsoft *Adventure* implementations have provided many hours of trouble-free enjoyment, and I recommend them highly.

Just after the *Adventure* craze hit, there were rumors of another game, *Zork*, which is to *Adventure* as *Adventure* is to *Wumpus*. *Zork* was developed at the Massachusetts Institute of Technology by "the Four Implementors": Tim Anderson, Marc Blank, Bruce Daniels, and David Lebling. The game was written in MDL (or "Muddle"), a LISP-like language, and featured an enormous underground dungeon, dozens of clever puzzles, and a highly intelligent command parser that understands much that *Adventure* finds incomprehensible. Although *Zork* never quite caught on the way *Adventure* did, it became widespread—and where it did appear, it cost more time than ever *Adventure* had, because it was both more difficult and more interesting.

Implementors Lebling and Blank have devised a micro-computer implementation of *Zork* in two parts. *Zork: The Great Underground Empire, Part I* is being sold for the Apple II and the TRS-80 on 5-inch floppy disk by Personal Software, 1330 Bordeaux Dr, Sunnyvale CA 94086, at a price of \$39.95. [Editor's note: *Part II* is still under development, but *Part I* alone constitutes a complete game that can be played through to a satisfactory ending....RSS] Like the Microsoft *Adventure*, *Zork* requires constant access to the disk but cannot be copied by normal means. I've been just a little afraid of running the primary disk, so I haven't checked out everything; besides, the kids are still mapping *Adventure*. I've played with this *Zork* enough to know that I like it (and I wasted incredible amounts of time playing the original *Zork* on a PDP-10).

Adventure and *Zork* became popular during the *D & D* (*Dungeons and Dragons*) craze—a madness which shows little sign of peaking out even yet. It was inevitable that other *D & D* games would come forth, and sure enough, Automated Simulations Inc (ASI), POB 4232, Mountain View CA 94040, has come out with a whole series, from the introductory *Datestones* to the full four-level dungeon in *Temple of Apsai*. These games are sold in

When it comes to 6800 Software Source Books,™ Hemenway delivers what the others leave out.

...including complete source listings, complete descriptions of all algorithms used, and complete manuals of the products.

SP/68 OPERATING SYSTEM

One of the most powerful operating systems available for the 6800 family of microprocessors, this disc-based system features great flexibility. The user can add commands for special purposes. A single transient Peripheral Interchange Program (PIP) transfers data between devices. The system is relocatable anywhere in memory and fits in less than 8K. Other features include device-independent I/O and dynamic file allocation.

U.S. \$34.95
International \$52.45

XA6809 MACRO LINKING CROSS-ASSEMBLER

This new two-pass program generates relocatable and linkable code (requires LINK68). Resident on any 6800 system, XA6809 lets you produce code for a 6809 *right now*. This assembler has full macro facilities and features a COMMON section for the production of ROMable code, conditional assembly and fast execution.

U.S. \$24.95
International \$37.95

STRUCTURED BASIC LANGUAGE STRUBAL+™ COMPILER

The compiler features variable precision from 4 to 14 digits for business or scientific uses and Structured Programming forms. It produces Relocatable and linkable code. You can create data structures with mixed data types, COMMON and DUMMY sections. STRUBAL+™ includes a complete scientific package, allows for string-handling and is extensible.

U.S. \$49.95
International \$74.95

TRACER: A 6800 DEBUGGING PROGRAM

Ideal for the programmer looking for good debugging software. TRACER features single step execution using dynamic break points, register examination and modification, and memory examination and modification. Includes detailed TRACER program notes and a reprint of "Jack and the Machine Debug" (from the December 1977 issue of BYTE magazine).

U.S. \$5.95
International \$8.95

LINK68 LINKING LOADER

This is a one-pass linking loader which allows separately translated relocatable object modules to be loaded and linked together to form a single executable load module, and to relocate modules in memory. It produces a load map and a load module in Motorola MIKBUG loader format. This book provides everything necessary for learning about this system and the nature of linking loader design in general.

U.S. \$7.95
International \$11.95

RA6800ML RELOCATABLE MACRO ASSEMBLER

This two-pass assembler produces a program listing, a sorted symbol table listing, and relocatable object code. Object code is loaded and linked with other assembled modules using LINK68. This book fully describes the 6800 assembly language and all major routines used, and includes flow charts, details on interfacing the assembler. Cross referenced, showing all calling and called-by routines, pointers, flags and temporary variables.

U.S. \$24.95
International \$37.95

If your machine would like to read these programs, object code versions are available in these disk formats: Percom, ICOM, SSB, SWTPC, TANO and others.

WRITE FOR PRICES

Please rush the following books:

- _____ copies of SP/68 OPERATING SYSTEM
- _____ copies of XA6809 CROSS ASSEMBLER
- _____ copies of LINK68 LINKING LOADER
- _____ copies of RA6800ML MACRO ASSEMBLER
- _____ copies of STRUBAL+™ COMPILER
- _____ copies of TRACER DEBUGGING PROGRAM

For North America, add \$.75 per book postage or \$1.50 per book for First Class. All other destinations, add \$2.00 per book postage and handling or \$3.50 per book for Priority Mail.

Name _____ Title _____

Company _____ Street _____

City _____ State _____ ZIP _____

Check or M.O. enclosed VISA MasterCharge

Card No. _____ Expires _____

First Class/Priority Book rate



HEMENWAY ASSOCIATES, INC.

101 Tremont St.
Boston, MA 02108
(617) 426-1931

COMING 1st quarter 1981:
8086/8088 MINI-DOS
OPERATING SYSTEM

both tape cassette and disk versions, and they range in price from \$14.95 for *Morloc's Tower* on cassette to \$26.95 for the disk version of *Temple of Apshai*. ASI guarantees these games to be interesting, and I don't think they refund much money. They've been very popular around here.

There are versions for TRS-80, PET, and Apple computers; the Apple versions make extensive use of Apple's excellent graphics, so that monsters like Ant-man and the Wolf look pretty good. Unfortunately, the TRS-80 doesn't have such nice graphics, and the characters and monsters look like blobs. Unlike *Zork* and *Adventure*, these games are played in real time, and, instead of a room description, the computer draws a map, placing monsters and treasures in it where appropriate. They're very playable games, guaranteed to waste more time than you really expected to put into them.

The real time wasters for me, though, have been Automated Simulation's space war games, *Starfleet Orion* (two players) and *Invasion Orion* (one player against the computer). These games allow a number of different scenarios; ten or so are supplied (along with a pleasantly written background and story data including characterizations), but the user can make up his own, so that in effect either of these games has an infinite number of variants. The rulebooks also give a number of standard warship types, but once again the user can design his own, from torpedo boats to dreadnoughts to armored planets. There are Tractor and Pressor beams, something much like a phaser, torpedoes and missiles, and quite a lot of the flavor of a space battle.

I'd like the single-player version somewhat better if it were faster; in my favorite scenario, *Damocles*, it can take several minutes for the computer to plan out its move, and worse, you can't just go away, because the battle results are presented dynamically and can't be recalled once shown.

The *Orion* games are quite realistic. Classical principles of fleet warfare work, and strategy and tactics are more important than luck. Since players can modify the ships at will, it's possible to tailor the games to a balance of power so that an experienced player (or the computer in the single-player version) doesn't routinely stomp a newcomer, and the game can be changed again as the players gain experience.

All of the Automated Simulations games are implemented in BASIC. They can be copied, listed, and even modified. In theory, one ought to be able to compile *Invasion Orion* with Microsoft's TRS-80 version of BASCOM and thus speed it up. Obviously, you will have to modify the games a bit; in particular, you will have to lengthen the loops that govern how long displays stay visible. I'm anxious to try this, but so far the TRS-80 BASCOM hasn't arrived, so I can't say for certain that it will work.

Needless to say, I enjoy all the Automated Simulations games, and recommend them highly. And, needless to say, I enjoy the C language and BASIC-80, etc, etc. So what does it all mean? Well, it means that I have to get the kids away from the TRS-80 and have some computer fun of my own, here at Chaos Manor.

See text box on page 238

tiny C

Tiny-C Two — The Compiler

tiny-c two[®] is ten times faster than tiny-c one[®]. It has many extra features, including long (32) bit integers, lots of new operators, and redirectable and direct access input/output. This version of tiny-c is viable for professional work, either systems programming or business applications. It comes with a UNIX[®] style command interpreter called the "tiny-shell"[®]. With the tiny-shell, every compiled tiny-c program becomes a new shell command. Tiny-shell commands can have arguments, and dash(-) options, just as real UNIX shell commands do. The < and > input/output redirection operators are supported. There are over fifty standard library functions, and this set is readily extended. The input/output functions are UNIX style, including fopen, fprintf, etc. Both ascii and raw (binary) input/output are supported. And the entire package is portable. Bringing it up on a new processor or new operating system should take a few days or a few weeks at the most. And as usual with tiny-c products, all the source code is included.

tiny-c two	\$250	Manual Only ..	\$50
tiny-c one	\$100	Manual Only ..	\$50

Visa/Mastercharge Welcome

Formats: Std. 8" 5" NorthStar DD,
TRS-80 MOD II[®] & H89/Z89.

To order call: (206)542-8370
or write: VADATA
17541 Stone Avenue North
Seattle, WA 98133



We Deliver!

TRS-80 is a registered trademark of Radio Shack, Inc. UNIX is a registered trademark of Bell Laboratories, Inc. tiny-c and tiny-shell are trademarks of tiny-c associates.

COLOR SOFTWARE

COLORFUL PROGRAMS FOR THE APPLE II, ATARI 16K, TI 99/4

3-D STARTREK: Discover new planets, fight Klingons in 3-dimensional galaxy. Hi-resolution display of galaxy.
\$15 on cassette

ROADRACE: Race around 2.25 mile course. Hi-res display shows view from race cars. 1 or 2 players.
\$15 on cassette
Apple II or Atari only

DRY WELL: Strategy game of oil exploration. Discover pattern of deposits and maximize profits.
\$15 on cassette
Apple requires ROM Applesoft

NUCLEAR REACTOR: Simulation of a nuclear power plant.
\$15 on cassette

MAJOR LEAGUE BASEBALL: Manage Major League teams and make all lineup, batting, pitching and running decisions.
\$25 on disk
Apple II only. Requires ROM Applesoft, 48 K RAM

BLACKJACK: Popular card game for 1 to 3 players.
\$15 on cassette
Atari or TI 99/4 only

Apple II programs available on disk for \$2.50 per order more.

COLOR SOFTWARE

5410 W. 20th St. • Indianapolis, IN 46224

Free Microprocessor Design Aid

Now, optimize microprocessor performance, using Intel's new Memory Calculator.

To get the high performance you're paying for from your microprocessor, you have to carefully match system components—especially EPROM memories. That means giving close consideration to parameters such as clock frequencies, buffer delays, number of wait states and memory access speeds. To do that accurately, you have to perform tedious calculations involving the interrelationships among these parameters, and their impact on system design.

And now you can—very simply, with Intel's new EPROM Memory Calculator. Similar to a circular slide rule, the Calculator helps you quickly analyze the trade-offs in cost, speed and wait states for your next microprocessor design. Making it easy for you to

minimize wait states vs. throughput in your designs, and thus increase system performance.

How it works

We're offering calculators for Intel, Zilog or Motorola microprocessors. So regardless of which one you're designing with, there's a Calculator that lets you try a

application and performance level. Then read out the speed of the EPROM memory required to implement that design. It's that simple.

Our free offer

Best of all, the Calculator is free. If you're a designer interested in using one of the microprocessors listed below, just fill in and return the coupon. We'll send you your new Memory Calculator, along with information on our newest EPROM memories. Get your free Memory Calculator today.

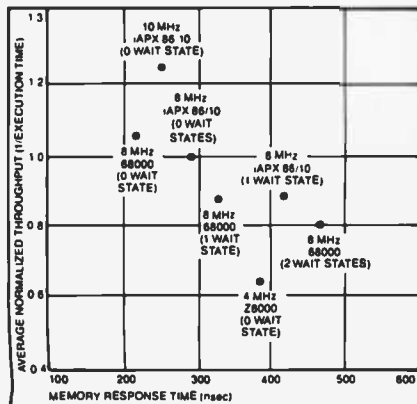
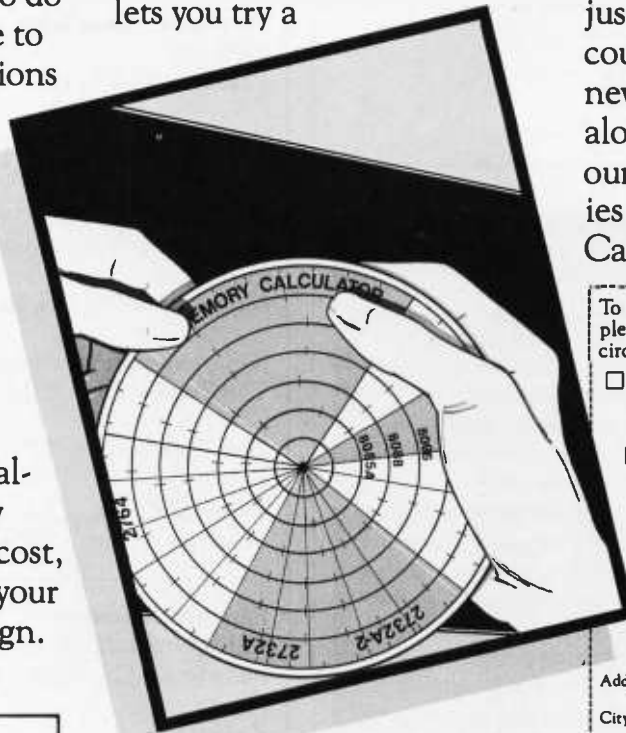

variety of options, and find out immediately which one is the best for your design. Thus helping you get the full power and potential out of your next microcomputer system.

Using the Calculator is easy. You just dial in the relevant design parameters for your

To receive your free Memory Calculator,* please check one of the boxes below. Then circle the microprocessor models you're using.

Intel: 8085A 8085A-2 8086 8086-1 8086-2 8088
Other _____

Zilog: Z8000 Z80A Z80B
Other _____

Motorola: MC68000 MC6809 MC6800 Other _____

Name _____

Title _____

Company _____

Address _____

City/State/Zip _____

Phone () _____

Intel Corporation, Literature Dept.
3065 Bowers Avenue, Santa Clara, CA 95051
(408) 987-8080 B 12

*Supplies are limited, so order now.

intel delivers solutions.

INNOVATION PLUS FROM PROVOR INC.

Two new boards from PROVOR INC. : RICE (ROM in circuit emulator) and MIO (Miscellaneous input/output). Plus a fast MULTI-USER CP/M*.

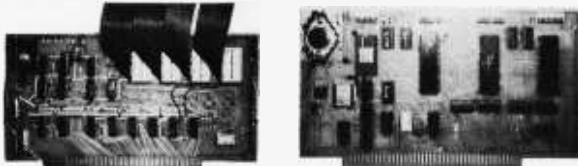

The RICE board can emulate up to 4 EPROMS type 2708, 12716 or 12732. The RICE board uses your S-100 RAM for emulation which can be addressed on any 1K, 2K or 4K boundary depending on the type of EPROM being emulated. Other features include:

- IEEE S-100 compatible including extended addressing
- Terminated address lines on external EPROMS
- Places external processor in a reset for normal S-100 operation
- Keeps the S-100 processor in a hold during emulation

RICE comes completely assembled and tested with four 36 inch 24 pin dip cables for only \$189.95

The MIO board has just what the name implies, miscellaneous input/output. First is a 32 character 8 bit FIFO buffer perfect for a keyboard input (Great for Wordstar). Plus a 16 channel 8 bit A/D converter with 80 us conversion time. There are also two 8 bit bi-directional I/O ports. And last is T.I.'s new programmable sound generation chip SN76489N. The MIO is also IEEE compatible. Supplied with all necessary cables and connectors and a SPACE INVADERS program written in Pascal. Fully assembled and tested the MIO is \$299.95, also available without the FIFO, Sound and A/D.

MULTI-USER CP/M* can support up to 4 separate users with very fast 180 us overhead between users. Dissimilar tasks may be performed on different terminals. The operating system can also support up to 4 different printers. However, if only one printer is attached to the system a printer lock out is provided. System requirements are CP/M 1.4, bank select memory and an interrupt board to generate a RST 6 every 16-20 ms. MULTI-USER CP/M* is sold in 8080 machine code supplied in source on an 8 inch single density diskette for only \$150.00.

PROVOR INC.
6217 KENNEDY AVE.
HAMMOND, IND. 46323
312-374-7335

CP/M is a trademark of Digital Research

MICROSTAT NOW AVAILABLE FOR CP/M*

MICROSTAT, the most powerful statistics package available for microcomputers, is completely file-oriented with a powerful Data Management Subsystem (DMS) that allows you to edit, delete, augment, sort, rank-order, lag and transform (11 transformations, including linear, exponential and log) existing data into new data. After a file is created with DMS, Microstat provides statistical analysis in the following general areas: Descriptive Statistics (mean, sample, and population S.D., variance, etc.), Frequency Distributions (grouped or individual), Hypothesis Testing (mean or proportion), Correlation and Regression Analysis (with support statistics), Non-parametric Tests (Kolmogorov-Smirnov, Wilcoxon, etc.), Probability Distributions (8 of them), Crosstabs and Chi-square, ANOVA (one and two way), Factorials, Combinations and Permutations, plus other unique and useful features.

MICROSTAT requires 48K, Microsoft Basic-80 with CP/M and is sent on a single-density 8" Disk. It is also available on 5" diskettes for North Star DOS and Basic (32K and two drives recommended), specify which when ordering. The price for Microstat is \$250.00. The user's manual is \$15.00 and includes sample data and printouts. We have other business and educational software, call or write:



ECOSOFT
P.O. Box 68602
Indianapolis, IN 46268
(317) 283-8883

* CP/M is a registered trade mark of Digital Research.

Items Reviewed

Microsoft
10800 NE 8th, Suite 819
Bellevue WA 98004

<i>muLISP-79</i>	CP/M 8-inch disk system	\$200
<i>BASIC-80</i>	CP/M	\$350
BASCOM		
BASIC		
<i>Compiler</i>	CP/M, ISIS-II, TRSDOS	\$395
<i>Adventure</i>	TRS-80 Model I Level II 32 K disk	\$24.95

Lifeboat Associates
1651 Third Ave
New York NY 10028

<i>BDS C Compiler</i>	CP/M	\$125
<i>Whitesmiths C</i>		
<i>Compiler</i>	CP/M	\$630
<i>CBASIC2</i>	CP/M	\$120

Workman Associates
POB 482
Pasadena CA 91102

<i>Adventure</i>	8-inch disk CP/M 32 K 8080 or Z80	\$23.95
------------------	--------------------------------------	---------

Automated Simulations Inc
POB 4232
Mountain View CA 94040

(Following are available in disk or cassette versions)

<i>The Temple of</i>	TRS-80, PET, Apple	\$24.95
<i>Apschai</i>		
<i>The Tower of</i>	TRS-80, PET, Apple	\$14.95
<i>Morloc</i>		
<i>Starfleet Orion</i>	TRS-80, PET, Apple	\$19.95
<i>Invasion Orion</i>	TRS-80, PET, Apple	\$19.95

Personal Software
1330 Bordeaux Dr
Sunnyvale CA 94086

<i>Zork: The Great Under- ground Empire, Part I</i>	TRS-80 or Apple disk	\$39.95
---	----------------------	---------

Books
Kernighan, Brian W and Dennis M Ritchie.
The C Programming Language.
Englewood Cliffs NJ: Prentice-Hall Software Series,
Prentice-Hall, 1978, \$13.95

Kernighan, Brian W and P J Plauger.
Software Tools.
Reading MA: Addison-Wesley Publishing Company,
1976, \$11.95

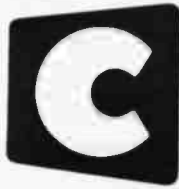

Cromemco

incorporated
Tomorrow's Computers Today

Now..

Discover Savings and Service with

EBS

MAIL ORDER DIVISION

ORDER TOLL FREE

- WE ARE PROUD to be an AUTHORIZED CROMEMCO DEALER
- CROMEMCO stands for quality, reliability and obsolescence insurance
- CROMEMCO is widely recognized as a microcomputer industry leader
- CROMEMCO provides strong support for their dealers and end-users
- THE BOTTOM LINE - it's what you buy AND where you buy it . . . WE CARE!

New..

CROMIX IS HERE!

The exciting new multi-user, multi-tasking operating system with many added capabilities.

New..

RPG II

Exclusive offering of this important business language by a microcomputer manufacturer

LISP

The language for Artificial Intelligence research

New..

BUSINESS SYSTEMS SOFTWARE!

General Ledger
Accounts Payable
Accounts Receivable
Inventory

New..

SYSTEM ZERO!

The S-100 personal computer with Cromemco reliability.

16 FDC

Double density disk controller

New..

QUADART!

4 port serial I/O
INTELLIGENT I/O CONTROLLER!
On board Z-80
Use these together for results you won't believe!

An integrated turnkey system that requires no computer programming knowledge. Produced and supported by Cromemco, and designed to make full use of the advanced features found in Cromemco hardware.

SYSTEMS: List Our Price

SYSTEM 2 3990 3190.

Now double density!

Dual double-sided mini floppy disk drives; 64K RAM

SYSTEM 3 7395. CALL

Now double density!

2 Mbyte of dual double-sided 8" floppy disk; 64K RAM

Z-2H 9995. CALL

Now double density!

11 Mbyte integral hard disk; 2 double-sided 5" floppy disks; 64K RAM

All Cromemco systems feature the S-100 industry standard bus, 4 MHZ Z-80 CPU, 64K RAM, and can be easily upgraded to multi-user, multi-tasking capability.

PERIPHERALS:

3102 "SMART" TERMINAL
40 function keys; detachable keyboard with 14-key numeric pad

3703 DOT-MATRIX PRINTER
180 CPS; 18-inch platen; 132 columns; bi-directional with double buffering

3355A FULL LETTER PRINTER
55 CPS; 15-inch platen; quality impression suited to camera copy

BOARDS: List Our Price

SGL. CARD COMP. 450. 380.

8K BYTESAVERII 245. 210.

32K BYTESAVER 295. CALL

ZPU 395. 335.

4FDC 495. 420.

64KZ 1785. 1510.

TU-ART 295. 250.

SDI 595. CALL

High resolution color graphics interface

LANGUAGES: List Our Price

COBOL, now updated 95. 90.

FORTRAN IV 95. 90.

MACRO ASSEMBLER 95. 90.

16K BASIC 95. 90.

32K BASIC 295. 275.

DATA BASE MGMT. 95. 90.

WORD PROCESSING 95. 90.

RATFOR 195. 180.

TRACE 95. 90.

EBS BUSINESS SOFTWARE:

GENERAL LEDGER; ACCOUNTS PAYABLE; ACCOUNTS RECEIVABLE; PAYROLL (Calif.); INVENTORY; ORDER ENTRY

List Price \$995. each

Customization available

Call or write for our low mail order prices on all CROMEMCO products . . . or on PERSCI disk drives, MEASUREMENT SYSTEMS boards, BASE 2, QUME, SOROC, ADDS, TVI, NEC SPINWRITER or other quality products.

EXECUTIVE BUSINESS SYSTEMS

20457 E. Valley Blvd., Walnut, CA 91789
(714) 594-5736

WE ALSO OFFER:

- Complete analysis of your system needs
- Installation, training, support & maintenance
- Custom applications software

AT OUR REGULAR CONSULTING RATES
Phone inquiries welcome



Prices shown are for "Cash with Order"

COLLECT PHONE ORDERS WELCOME or Send check or M.O. (Personal or Co. checks require 2 wks. to clear) Please include phone number. Shipping charges will be added, Within Calif. add applicable sales tax. Factory warranty included. All prices subject to revision.

CDOS® Cromemco, Inc.

CP/M® Digital Research

CBASIC™ Compiler Systems

This is a partial listing of over 500 items available from authorized Jim-pak Distributors:

TTL

7400	2/.85	7490	.85
7402	2/.85	7493	.85
7404	2/.85	74100	2.25
7406	2/1.19	74109	2/1.19
7407	2/1.19	74121	.69
7408	2/.89	74123	.99
7410	2/.85	74150	1.95
7414	.99	74154	1.95
7417	2/1.10	74157	.99
7420	2/.85	74161	1.19
7447	1.19	74164	1.59
7474	.69	74174	1.59
7475	.79	74175	1.49
7476	.69	74192	1.19
7485	1.19	74193	1.19
7486	2/1.19	74367	.99
7489	2.99	74393	1.95

GRAB BAGS

GB100	Cer. Caps. (100)	2.95	GB123	Heat Sinks (30)	3.95
GB101	Mylar Caps. (60)	4.95	GB127	Transistors (100)	3.95
GB102	Electrolytics (60)	4.95	GB137	Chokes (50)	3.95
GB103	Tantalums (40)	4.95	GB139	Term. Strips (40)	3.95
GB108	TTL IC's (50)	4.95	GB140	Spec/Stndff (150)	2.95
GB110	Asst. LEDs (100)	5.95	GB141	Washers (200)	2.95
GB113	Trimmers (30)	4.95	GB145	Lugs (100)	2.95
GB116	1/2W Resist. (200)	2.95	GB154	1&2w Resist. (100)	2.95
GB117	1/4W Resist. (200)	2.95	GB162	7-Seg. Dsplys. (50)	5.95
GB120	Slide Switch (25)	3.95	GB173	3/8" Pots. (100)	5.95

LS Schottky

74LS00	.55	74LS109	.79
74LS02	.55	74LS123	1.95
74LS04	.69	74LS138	1.49
74LS08	.55	74LS139	1.49
74LS10	.55	74LS154	2.49
74LS14	1.09	74LS157	1.49
74LS30	.55	74LS161	1.79
74LS32	.69	74LS174	1.79
74LS38	.69	74LS175	1.79
74LS42	1.49	74LS192	1.89
74LS47	1.49	74LS193	1.89
74LS48	1.79	74LS221	1.95
74LS73	.79	74LS244	2.49
74LS74	.79	74LS245	3.49
74LS75	.99	74LS367	1.29
74LS85	1.95	74LS374	2.49
74LS90	1.09	81LS97	2.49

POTENTIOMETERS

2 Watt @ 70°C
7/8" Slotted Shaft
Linear Taper

3/4 Watt @ 70°C
15 Turn Pot.
Linear Taper

1K	5K	10K	100Ω	500Ω	1K
25K	50K	100K	5K	10K	50K
1 Meg			100K	500K	1Meg

CMU .. \$2.95 830P .. \$1.79

REGULATED POWER SUPPLY KIT

Uses LM309K. Heat Sink provided. PC board construction. Provides a solid 1 amp @ 5 volts. Can supply up to ±5V, ±9V and ±12V with JE205 Adapter. Includes components, hardware and instructions. 3 1/2" x 5" x 2" H

JE200 \$14.95

SOCKETS

Low Profile		Wire Wrap	
8 pin LP	2/.59	14 pin WW tin	.75
14 pin LP	2/.69	14 pin WW gold	1.09
16 pin LP	2/.79	16 pin WW tin	.79
18 pin LP	2/.89	16 pin WW gold	1.19
20 pin LP	2/.99	24 pin WW gold	1.69
22 pin LP	2/1.09	40 pin WW gold	2.75
24 pin LP	.79	14 p. plug/cover	1.29
28 pin LP	.82	16 p. plug/cover	1.39
36 pin LP	.99	24 p. plug/cover	1.95
40 pin LP	1.19	+ moie x p./sockets	

DESK TOP ENCLOSURES

DTE-8 (Pictured)	\$31.95
DTE-11 (Pictured)	34.95
DTE-14	36.95
DTE-HK (Case for JE600)	47.95
DTE-AK (Case for JE610) (Pictured)	52.95

DIODES & TRANSISTORS

IN751	2/.59	2N2219A	2/1.19
IN757	2/.59	2N2222A	2/.89
IN1188	2.69	2N2907A	2/.89
IN3600	5/.99	2N3055	.99
IN4001	4/.59	2N3772	2.25
IN4004	4/.69	2N3904	2/.69
IN4007	4/.79	2N3906	2/.69
IN4148	10/.99	2N4401	2/.79
IN4733	2/.69	2N4403	2/.79
IN4734	2/.69	2N5129	2/.69
IN4735	2/.69	2N5139	2/.69
IN4742	2/.69	2N5210	2/.79
IN4744	2/.69	2N5951	2/1.29

CMOS

4000	.69	4030	.79
4001	.69	4040	1.95
4002	.69	4044	1.39
4006	1.95	4046	2.49
4009	.89	4047	2.75
4010	.85	4049	.89
4011	.69	4050	.89
4013	.85	4051	1.95
4016	.85	4066	1.19
4017	1.49	4069	.79
4018	1.49	4070	.79
4020	2.19	4071	.79
4023	.49	4081	.69
4024	1.29	4093	1.19
4027	.89	4511	1.95

CAPACITORS

Dipped Tantalum		ELECTROLYTIC	
.1mfd @ 35V	2/.89	1mfd @ 50V	3/.69
.47mfd @ 35V	2/.89	4.7mfd @ 50V	2/.59
1mfd @ 35V	2/.89	10mfd @ 50V	2/.69
2.2mfd @ 25V	2/1.09	22mfd @ 50V	2/.79
3.3mfd @ 25V	2/1.19	47mfd @ 50V	2/.89
4.7mfd @ 25V	2/1.39	100mfd @ 50V	.59
10mfd @ 25V	1.19	220mfd @ 50V	.69
33mfd @ 25V	3.95	1000mfd @ 25V	1.19
100V MYLAR		50V CERAMIC	
.001-.01mfd	4/.79	10pf-.022mfd	4/.59
.022mfd	4/.89	.047mfd	4/.69
.047mfd	4/.99	.1mfd	4/.79
.1mfd	4/1.19		
.22mfd	4/1.29		

CONNECTORS

DB25P	D-Subminiature Plug	3.95
DB25S	D-Subminiature Socket	4.95
DB51226	Cover for DB25P/S	2.25
ZZ/44SE	P.C. Edge	2.95
UG89/U	BNC Plug	2.19
UG89/U	BNC Jack	3.95
UG175/U	UHF Adapter	.59
SO239	UHF Panel Recp.	1.49
PL258	UHF Adapter	1.95
PL259	UHF Plug	1.95
UG260/U	BNC Plug	2.39
UG1094/U	BNC Bulkhead Recp.	1.49

VIDEO CONTROLLER

Front View Inside Rear View

Ideal for all video games or remote control projects. Two mini. pots. 40K ohm each. SPST push button control. Five-wire connection cable 5' long. Rugged plastic case - 1 1/2" H x 2-3/8" W x 4-5/16" L

JVC-40 \$5.95 each

MICROPROCESSORS

Z80A	CPU (4MHz)	14.95
MC6800	8 Bit MPU	14.95
8080A	CPU	7.95
8212	8 Bit I/O Port	3.95
8216	BI-Directional Bus Driver	4.49
2513/2140	Character Generator	12.95
8T97	Tri-State Hex Buffer	2.25
AY-5-1013	30K Baud UART	6.95
AY-5-2376	88-Key Keyboard Encoder	13.95
2114-3	4K Static RAM (300ns)	9.49
MK4116	16K Dynamic RAM (250ns)	9.95
2708	8K EPROM	10.95
2716	16K EPROM (+5V)	19.95

LINEAR

LM301N	.59	LM7805T	1.75
LM305H	1.39	LM7812T	1.75
LM307N	.75	LM7815T	1.75
LM308N	1.19	LM380N	1.49
LM309K	2.25	LM384N	2.49
LM310N	2.69	LM555N	.69
LM311N	1.49	LM556N	1.49
LM317T	2.29	LM565N	1.95
LM318N	2.95	LM566N	1.95
LM319N	2.95	LM567N	1.79
LM320K-5	2.25	LM723N	.79
LM7906T	1.75	LM741N	.65
LM7912T	1.75	LM1310N	2.95
LM7915T	1.75	LM1458N	.99
LM323K	5.95	LM1488N	1.59
LM324N	1.29	LM1489N	1.59
LM337T	2.29	LM1800N	4.49
LM339N	1.29	76477N	3.95

Discount Jim-pak Coupon

ONE DOLLAR Discount Coupon

OFFER EXPIRES DECEMBER 31, 1980

Redeemable at participating JIM-PAK Distributors for \$1.00 discount on purchases of JIM-PAK components exceeding \$1.00

ONE DOLLAR

One Coupon Per Customer

Coupon

GOOD FOR ONE DOLLAR DISCOUNT

on purchase of any JIM-PAK PRODUCTS at participating Distributors

Mr. Distributor: Jim-Pak will accept this coupon for one dollar credit when returned to us with your regular orders.

H & E COMPUTRONICS INC.

...EVERYTHING FOR YOUR TRS-80™...

* TRS-80™ is a trademark of the Radio Shack Division of Tandy Corporation

Currently Available

MOD-II PROGRAMS

- ★ All orders processed within 24-Hours
- ★ 30-Day money back guarantee on all TRSDOS Software
- ★ Add \$2.00 for shipping in UPS Areas
- ★ Add \$3.00 for C.O.D. or NON-UPS Areas
- ★ Add \$4.00 outside U.S.A., Canada & Mexico
- ★ We will match any bonafide advertised price in any of the Major Computer Magazines

ALL SOFTWARE LISTED HERE WORKS WITH TRSDOS*

- (1) **ELECTRIC PENCIL** (Michael Shrayser Software)...Complete word processor with extensive editing and printer formatting features...\$325 (STANDARD TRSDOS VERSION)...\$350 (DIABLO, NEC OR OUME TRSDOS VERSION).
- (2) **GENERAL LEDGER, ACCOUNTS RECEIVABLE, ACCOUNTS PAYABLE, INVENTORY CONTROL, INVOICING AND PAYROLL** (Small Business Systems Group)...an extensive business system for the serious user...can be used one module at a time or as a coordinated system...\$225...per module...\$1299 for the complete system.
- (3) **GENERAL LEDGER, ACCOUNTS RECEIVABLE, ACCOUNTS PAYABLE, INVENTORY CONTROL AND PAYROLL** (Compumax)...a complete user oriented business system...can be used one module at a time or as a coordinated system...\$140 per module...\$995 for the complete system.
- (4) **MOD-II UTILITY PACKAGE** (Racet Computes)...adds important utilities to TRSDOS...copy files selectively...faster and more accurate file copying...repair bad directories...displays sorted directory of all files on 1 to 4 disk drives...SUPERZAP...change disk ID...and more...\$150.
- (5) **ADVENTURE #1-#9** (Scott Adams - Adventure International)...a series of games formally only available on the large computers...your goal is to work your way through a maze of obstacles in order to recover a secret treasure or complete a mission...The package includes all 9 Adventures written by Scott Adams...\$99.95.
- (6) **GSF** (Racet Computes)...Generalized Subroutine Facility...a series of super fast machine language utilities that can be called from a BASIC program (no machine language knowledge required)...sorts 1000 items in under 5 seconds...allows PEEK and POKE statements...move data blocks...compress and uncompress data...works under TRSDOS...\$50.
- (7) **DSM** (Racet Computes)...Disk Sort Merge...sorts and merges large multiple diskette files on a 1 to 4 drive system...NOT AN IN MEMORY SORT...can actually alphabetize (or any other type of sort) 4 disk drives worth of data...sorts one complete disk of information in 10 minutes...information is provided to use DSM with the RS MAILING PROGRAM...works under TRSDOS...\$150.
- (8) **RSM** (Small Systems Software)...a machine language monitor and disassembler...can be used to see and modify memory or disk sectors...contains all the commands found on the Model-I version plus some additional commands for the MOD-II...works under TRSDOS...\$39.95.
- (9) **BLINK BASIC LINK FACILITY** (Racet Computes)...Link from one BASIC program to another saving all variables...chain programs without losing variables...\$50.
- (10) **BASIC CROSS REFERENCE UTILITY** (Racet Computes)...lists all variables and strings used in a program (with the line numbers in which they appear)...lists all GOTOs and GOSUBs (with the line numbers in which they appear)...searches for any specific variables or strings (with the line number in which they appear)...\$50.
- (11) **DEVELOPMENT PACKAGE** (Racet Computes)...SUPERZAP (to see, print or change any byte on a diskette)...Disassembler and MOD-II interface to the

- MICROSOFT EDITOR ASSEMBLER PLUS** including updating services and patches for Disk I/O, assemble directly into memory...save all or portions of source to disk...dynamic debug facility (ZBUG)...extended editor commands...\$125.
- (12) **HARD/SOFT DISK SYSTEM** (Racet Computes)...The software essential to interface any of the popular large hard disk drives...completely compatible with your existing software and files...allows up to 20 megabytes of storage (and larger)...directory expandable to handle thousands of files...\$400.
- (13) **CAMEO HARD DISK DRIVE CONTROLLER**...coming soon (November 17)
- (14) **HARD DISK DRIVES**...coming soon (Nov. 17).
- (15) **H & E COMPUTRONICS, INC. SHARE-A-PROGRAM DISKETTE #1**...works under TRSDOS...a collection of programs written by MOD-II owners...programs include data base management...a word processor...mail system...mortgage calculations...checkbook register...and many others...\$9 (add \$3 postage outside of the United States, Canada and Mexico)...FREE if you send us a diskette containing a program that can be added to the SHARE-A-PROGRAM DISKETTE.
- (16) **WABASH CERTIFIED DISKETTES**...\$39.95 (per box of 10).
- (17) **FLIP SORT DISKETTE STORAGE TRAY**...Stores 50 diskettes...comes complete with Index-dividers, tilt plates and adjustable spacing...\$44.95.
- (18) **MASTER PAC 100**...100 essential programs...BUSINESS...PERSONAL FINANCE...STATISTICS...MATH...GAMBLING...GAMES...includes 125 page manual and 2 diskettes...\$99.95.
- (19) **BUSINESS PAC 100**...100 essential business programs...INVENTORY CONTROL...PAYROLL...BOOKKEEPING SYSTEM...STOCK CALCULATIONS...CHECKBOOK MAINTENANCE...ACCOUNTS RECEIVABLE...ACCOUNTS PAYABLE...Includes 125 page manual and two diskettes...\$149.95.
- (20) **EDITOR ASSEMBLER** (Galactic Software Ltd.)...the first user oriented Editor Assembler for the MODEL II and was designed to utilize all the features of the MODEL II. It includes innovative features for ease of coding and debugging and complete documentation (over 120 pages)...works under TRSDOS...\$229.00.
- (21) **BASIC COMPILER** (Microsoft)...changes your source programs into machine language...increases program execution by 3-10 times...\$395.
- (22) **MAIL/FILE SYSTEM** from Galactic Software Ltd. stores 2,500 names per disk. No sorting time is required since the file is automatically sorted by first and last name plus Zip Code on Input. Retrieve by any combination of 19 user codes. Supports an 11 digit alphanumeric Zip. Supports a message line. Comes complete with user-oriented documentation (100-page manual). Allows for company name and Individual of a company and complete phone number (and extension)...works under TRSDOS...\$199.00
- (23) **INCOME TAX PAC**...Professional Income tax package...most forms and schedules...output to video or line printer...automatic memory storage of all information...data can be loaded from diskette, changed and edited...built in error checking...\$199.95.
- (24) **COMPUTER GAMES** (SBSG)...Mean Checker Machine, Star-Trek III, Concentration, Treasure Hunt, Banco, Dog Star Adventure...\$74.95.

- (1) **CP/M** (Lifeboat Associates)...an alternative operating system for the MOD-II that allows MOD-II owners to use any of the hundreds of programs available under CP/M...\$170.
- (2) **CP/M HANDBOOK**... (Sybex)...a step-by-step guide to CP/M...takes the reader through each of the CP/M commands...numerous sample programs...practical hints...reference tables...\$13.95.
- (3) **GENERAL LEDGER, ACCOUNTS RECEIVABLE, ACCOUNTS PAYABLE, INVENTORY CONTROL, AND PAYROLL** (Peachtree Software)...requires CP/M and MICROSOFT BASIC...professional business systems...turn key operation...can be used as single modules or as a coordinated system...\$500 per module...\$2500 for the complete system.
- (4) **WORD-STAR**...The ultimate word processor...a menu driven word processing system that can be used with any printer. All standard word processing commands are included...plus many unique commands only found on WORD STAR...requires CP/M...\$495.
- (5) **MAIL LIST MERGE**...An add on package that allows the user to send form letters (created on WORD-STAR) to any compiled mailing list (using any CP/M based MAIL program such as the PEACHTREE MAIL PROGRAM)...requires CP/M, WORD STAR and any CP/M based mail program...\$150.
- (6) **SELECTOR III** (Micro-Ap)...complete data management system...user defined fields and codes...manages any list defined by the user...includes additional modules for simplified inventory control, accounts receivable and accounts payable...requires CBASIC-2...\$295.
- (7) **SELECTOR IV** (Micro-Ap)...the ultimate data management system...all features use the SELECTOR III plus...data file format conversions...full page report formatter...computations...global search and replace...hard disk compatible...data/text merging...\$550.
- (8) **GLECTOR** (Micro-Ap)...add on package to the SELECTOR...general ledger that allows the user to define a customized chart of accounts...\$350.
- (9) **CBASIC-2**...a non-interactive BASIC used for many programs that run under CP/M...allows user to make more efficient use of disk files...eliminates the use of most line number references...requires on such programs as the SELECTOR...\$120.
- (10) **MICROSOFT BASIC**...an enhanced version of the MICROSOFT BASIC found on TRSDOS...adds commands such as chaining (allows the user to LOAD and RUN a new program without losing the variables currently in memory)...long variable length file records, WHILE/WEND and others...can be used with the BASIC COMPILER to speed up programs (3-10 times faster execution)...\$325.
- (11) **MASTER TAX** (CPAids)...professional tax preparation program...prepares schedules, A, B, C, D, E, F, G, R/RP, SE, TC, ES and forms 2106, 2119, 2210, 3469, 3503, 2441, 4625, 4726, 4797, 4972, 5695 and 5521. Printing can be on readily available pre-printed continuous forms, on overlays, or on computer generated IRS approved forms. Maintains client history files...interactive with CP/Aids General Ledger...\$995.
- (12) **GENERAL LEDGER II** (CPAids)...designed for CPA's...stores complete 12 month detailed history of transactions...generates financial statements, depreciation, loan amortizations, journals, trial balances, statements of changes in financial position, and compilation letters...includes payroll system with automating posting to general ledgers...prints payroll register, W2's and payroll checks...\$450.
- (13) **ELECTRIC PENCIL** (Michael Shrayser Software)...Complete word processor with extensive editing and printer formatting features...\$275 (Standard printer version)...\$300 (DIABLO, NEC or OUME version).
- (14) **BASIC COMPILER** (Microsoft)...changes your source programs into machine language...increases program execution by 3-10 times...\$395.

ALL PROGRAMS LISTED HERE REQUIRE CP/M*

COMPUTRONICS

50 N. PASCACK ROAD
SPRING VALLEY, NEW YORK 10977



24 HOUR ORDER LINE
(914) 425-1535



NEW TOLL-FREE ORDER LINE
(OUTSIDE OF N.Y. STATE)
(800) 431-2818

NEW!!! MOD-II NEWSLETTER \$12/year (or 12 issues)

THE ORIGINAL MAGAZINE FOR OWNERS OF THE TRS-80™* MICROCOMPUTER

SOFTWARE FOR TRS-80™ OWNERS

H & E COMPUTRONICS INC.

MONTHLY NEWSMAGAZINE FOR TRS-80™ OWNERS

MONTHLY NEWSMAGAZINE Practical Support For Model I, II & III

- PRACTICAL APPLICATIONS
- BUSINESS
- GAMBLING • GAMES
- EDUCATION
- PERSONAL FINANCE
- BEGINNER'S CORNER
- NEW PRODUCTS
- SOFTWARE EXCHANGE
- MARKET PLACE
- QUESTIONS AND ANSWERS
- PROGRAM PRINTOUTS
- AND MORE

PROGRAMS AND ARTICLES PUBLISHED IN OUR FIRST 12 ISSUES INCLUDE THE FOLLOWING:

- A COMPLETE INCOME TAX PROGRAM (LONG AND SHORT FORM)
- INVENTORY CONTROL
- STOCK MARKET ANALYSIS
- WORD PROCESSING PROGRAM (FOR DISK OR CASSETTE)
- LOWER CASE MODIFICATION FOR YOUR VIDEO MONITOR OR PRINTER
- PAYROLL (FEDERAL TAX WITHHOLDING PROGRAM)
- EXTEND 16-DIGIT ACCURACY TO TRS-80™ FUNCTIONS (SUCH AS SQUARE ROOTS AND TRIGONOMETRIC FUNCTIONS)
- NEW DISK DRIVES FOR YOUR TRS-80™
- PRINTER OPTIONS AVAILABLE FOR YOUR TRS-80™
- A HORSE SELECTION SYSTEM***ARITHMETIC TEACHER
- COMPLETE MAILING LIST PROGRAMS (BOTH FOR DISK OR CASSETTE SEQUENTIAL AND RANDOM ACCESS)
- RANDOM SAMPLING***BAR GRAPH
- CHECKBOOK MAINTENANCE PROGRAM
- LEVEL II UPDATES***LEVEL II INDEX
- CREDIT CARD INFORMATION STORAGE FILE
- BEGINNER'S GUIDE TO MACHINE LANGUAGE AND ASSEMBLY LANGUAGE
- LINE RENUMBERING
- AND CASSETTE TIPS, PROGRAM HINTS, LATEST PRODUCTS COMING SOON (GENERAL LEDGER, ACCOUNTS PAYABLE AND RECEIVABLE, FORTRAN 80, FINANCIAL APPLICATIONS PACKAGE, PROGRAMS FOR HOMEOWNERS, MERGE TWO PROGRAMS, STATISTICAL AND MATHEMATICAL PROGRAMS (BOTH ELEMENTARY AND ADVANCED) . . . ANI)

FREE*



- WORD PROCESSING PROGRAM** For writing letters, text, mailing lists, etc., with each new subscriptions or renewal.
- LEVEL II RAM TEST** Checks random access memory to ensure that all memory locations are working properly.
- DATA MANAGEMENT SYSTEM** Complete file management for your TRS-80™.
- CLEANUP** Fast action Maze Game.
- ADVENTURE** Adventure #0 by Scott Adams (From Adventureland International).

* All programs are supplied on cassette (add \$3 for Diskette Version - add \$5 for modified Mod-II Version).

FREE

SEND FOR OUR NEW 48 PAGE SOFTWARE CATALOG (INCLUDING LISTINGS OF HUNDREDS OF TRS-80™ PROGRAMS AVAILABLE ON CASSETTE AND DISKETTE). \$2.00 OR **FREE** WITH EACH SUBSCRIPTIONS OR SAMPLE ISSUE.

COMPUTRONICS

MATHEMATICAL APPLICATIONS SERVICE™

50 N. PASCACK ROAD
SPRING VALLEY, NEW YORK 10977

- ONE YEAR SUBSCRIPTION \$24
- TWO YEAR SUBSCRIPTION \$48
- SAMPLE OF LATEST ISSUE \$ 4
- START MY SUBSCRIPTION WITH ISSUE

(#1 - July 1978 • #7 - January 1979 • #12 - June 1979 • #18 - January 1980)

NEW SUBSCRIPTION RENEWAL

CREDIT CARD NUMBER _____ EXP. DATE _____

SIGNATURE _____

NAME _____

ADDRESS _____ CITY _____ STATE _____ ZIP _____

*** ADD \$6 YEAR (CANADA, MEXICO) - ADD \$12 YEAR AIR MAIL - OUTSIDE OF U.S.A., CANADA & MEXICO ***



24 HOUR ORDER LINE
(914) 425-1535



NEW TOLL-FREE ORDER LINE
(OUTSIDE OF N.Y. STATE)
(800) 431-2818

A Pocket Computer? Sizing up the HP-41C

Bruce D Carbrey
704 Currituck Dr
Raleigh NC 27609

These days, the introduction of a new pocket calculator is usually greeted with a yawn. This is because calculators have become so commonplace. So what's all the excitement over the Hewlett-Packard HP-41C? The answer is that the HP-41C has novel features that place it a cut above all other calculators and blur the distinction between calculators and personal computers. Hewlett-Packard, not usually given to wild claims, ventures to suggest in the *HP-41C Owner's Handbook and Programming Guide* that the calculator "can even be called a personal computing system." What are the features that separate the HP-41C from the pack?

- twelve-character, true alphanumeric display
- expandable, nonvolatile memory
- plug-in peripherals: magnetic card reader, printer, read-only memory application packs, and a bar-code reader

These, plus a host of convenience features, make this calculator the most versatile machine ever.

Display and Keyboard

Perhaps at some time you have marveled at the ingenuity of the person who discovered that, if you hold your calculator upside down after entering 710.77345, it will read "SHELL OIL". Well, you don't need to resort to tricks like that on the HP-41C, because the usual red seven-segment light-emitting diodes (LEDs) are gone. They are replaced by a large, high-resolution black-on-white liquid-crystal display (LCD) capable of displaying all twenty-six uppercase alphabetic characters, ten numerals, and twenty-three other characters (see photo 1). In addition, the display contains eleven "status annun-

The HP-41C has an array of features that blurs the distinction between calculators and personal computers.

ciators," which inform you of various calculator modes currently active. For example, if you select radian measure instead of degrees for trigonometric functions, "RAD" appears at the bottom of the display. There is even a SHIFT annunciator that indicates when the shift key has been depressed.

The keyboard is HP's usual very high-quality, thirty-five-key, tactile-feedback keyboard, augmented by four push-on-push-off mode-selection switches. With fifty-nine displayable characters and 130 built-in functions, it should be apparent that the thirty-nine keys have several duties. In fact, each key is etched with three labels: its standard (unshifted) function, its shifted function (above the key), and its alpha-mode function (on the bottom sloping side of the key). Alpha-mode characters are enabled as long as the alpha-mode switch is set. The more unusual alpha-mode characters (such as " Σ ," "%," " \neq ," "\$," etc) are selected by using the shift key in alpha mode. To keep the keyboard reasonably uncluttered, this set of special characters is not etched on the keys but appears in a pictorial layout on the back of the calculator.

Even with each key potentially performing quadruple duty, there are simply not enough keys for all the functions. To employ one of the more esoteric functions, you depress the execute (XEQ) button and spell the name of the desired function. For example, to compute $12!$ (12 fac-

torial), you would key in:

1 2 XEQ ALPHA F A C T ALPHA

If you happen to be heavily involved in statistics, you may find this a nuisance because FACT (the factorial function) will be frequently needed. This is where the "programmable keyboard" feature of the HP-41C comes in handy. You can assign or reassign any function to any key you like by using the ASN function. For example:

ASN ALPHA F A C T ALPHA TAN

assigns the FACT function to the button normally used to activate the tangent function. A push-on-push-off USER mode switch determines whether user-defined or standard meanings are currently associated with the keys. If you forget what function you have assigned to a key, you can find out by simply holding down the key. For our example, holding down the TAN button will show "FACT" on the display while in user mode and "TAN" while in normal mode.

User-programmed functions can also be assigned to keys, allowing the calculator to be customized to your application. Two keyboard overlays with stick-on labels are provided for identification of user-defined keys.



Photo 1: The Hewlett-Packard HP-41C calculator. Each key on the HP-41C has up to three labels associated with it: the label etched into the top face of the key, the label visible directly above the key, and a letter of the alphabet (enabled by toggling the ALPHA button) etched into the bottom face of the key. Additional functions are called by hitting the XEQ button and spelling out the function name. (Photo courtesy of Hewlett-Packard.)

DISK DRIVE BONANZA BY QT

8" DISK DRIVES

Shugart 801R Sgl/side Dbl/Den	\$395.00
Two for	\$775.00
Qume Datatrak 8" dbl sided, dbl density.	
QME-8DS (851R compatible)	\$ 599.00
Pkg of two	\$549.00 ea

QT DISK PACKAGES

I Dbl Den Controller, A & T, two 8" dbl den drives, CP/M* 2.2. cabinet, power supply & cables	\$1395.00
II Two 801R disk drives with cabinet, power supply & fan	\$1100.00
III Dual 8" Drives:	
Dbl den drives in cabinet only	
2 sgl sided (801R)	\$ 989.00
2 dbl sided (QUME)	\$1409.00

5 1/4" DRIVES

MPI-B51 MPI B-51	\$250.00	MPI-B91 MPI B-91	\$375.00
Sgl Sided Sgl/Dbl Den		Sgl Sided, Dbl Den, 77 Tracks	
Exact Replacement for SA-400		PERTEC FD-200 PER-FD200	\$225.00
MPI-B52 MPI B-52	\$350.00	Sgl Sided, Sgl/Dbl Den	
Dbl Sided, Dbl Den		Shugart SA400 SHU-SA400	\$250.00
		Sgl Sided, Dbl/Den	



COMPUTER SYSTEMS INC.

15620 South Inglewood Ave.
Lawndale, California 90260
(213) 970-0952

WE ACCEPT M/C, VISA, AM EXP
PLACE ORDERS TOLL FREE
1-800-421-5150
(CONTINENTAL U.S. ONLY)
(EXCEPT CALIFORNIA)

CP/M is a trademark of Digital Research

the electric pencil II™

© 1981 Michael Shroyer

for the TRS-80 Model II* Computer



The Electric Pencil is a Character Oriented Word Processing System. This means that text is entered as a continuous string of characters and is manipulated as such. This allows the user enormous freedom and ease in the movement and handling of text. Since lines are not delineated, any number of characters, words, lines or paragraphs may be inserted or deleted anywhere in the text. The entirety of the text shifts and opens up or closes as needed in full view of the user. Carriage returns as well as word hyphenation are not required since each line of text is formatted automatically.

As text is typed and the end of a screen line is reached, a partially completed word is shifted to the beginning of the following line. Whenever text is inserted or deleted, existing text is pushed down or pulled up in a wrap around fashion. Everything appears on the video display screen as it occurs thereby eliminating any guesswork. Text may be reviewed at will by variable speed or page-at-a-time scrolling both in the forward and reverse directions. By using the search or the search and replace function, any string of characters may be located and/or replaced with any other string of characters as desired. Specific sets of characters within encoded strings may also be located.

When text is printed, The Electric Pencil automatically inserts carriage returns where they are needed. Numerous combinations of Line Length, Page Length, Character Spacing, Line Spacing and Page Spacing allow for any form to be handled. Right justification gives right-hand margins that are even. Pages may be numbered as well as titled.

the electric pencil

- a Proven Word Processing System

The TRSDOS versions of The Electric Pencil II are our best ever! You can now type as fast as you like without losing any characters. New TRSDOS features include word left, word right, word delete, bottom of page numbering as well as extended cursor controls for greater user flexibility. BASIC files may also be written and simply edited without additional software.

Our CP/M versions are the same as we have been distributing for several years and allow the CP/M user to edit CP/M files with the addition of our CONVERT utility for an additional \$35.00. CONVERT is not required if only quick and easy word processing is required. A keyboard buffer permits fast typing without character loss.

	CP/M	TRSDOS
Serial Diablo, NEC, Qume	\$ 300.00	\$ 350.00
All other printers	\$ 275.00	\$ 325.00

The Electric Pencil I is still available for TRS-80 Model I users. Although not as sophisticated as Electric Pencil II, it is still an extremely easy to use and powerful word processing system. The software has been designed to be used with both Level I (16K system) and Level II models of the TRS-80. Two versions, one for use with cassette, and one for use with disk, are available on cassette. The TRS-80 disk version is easily transferred to disk and is fully interactive with the READ, WRITE, DIR, and KILL routines of TRSDOS.

TRC	Cassette	\$ 100.00
TRD	Disk	\$ 150.00

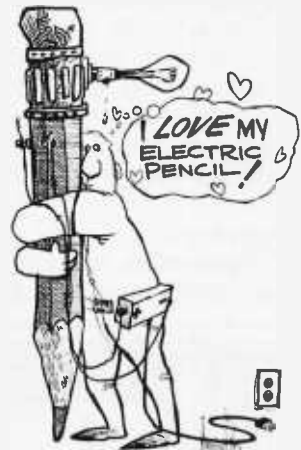

Features

TRSDOS or CP/M Compatible • Supports Four Disk Drives • Dynamic Print Formatting • Diablo, NEC & Qume Print Packages • Multi-Column Printing • Print Value Chaining • Page-at-a-time Scrolling • Bidirectional Multipage Scrolling • Subsystem with Print Value Scoreboard • Automatic Word & Record Number Tally • Global Search & Replace • Full Margin Control • End of Page Control • Non Printing Text Commenting • Line & Paragraph Indentation • Centering • Underlining • Boldface



*TRSDOS is a registered trade mark of Radio Shack, a division of Tandy Corp.



MICHAEL SHROYER SOFTWARE, INC.
1198 Los Robles Dr.
Palm Springs, CA 92262
(714) 323-1400

To facilitate the entry of multiple-key sequences, the display provides prompting messages, and invalid keys are disabled. In addition to the normal clear-display key, there is a backspace key to facilitate corrections. If you forget the name of a function (programmed or standard), depressing the CAT (catalog) key will list all functions currently known to the calculator.

Memory

The HP-41C has *continuous memory*, which means that the contents of memory are preserved even when the calculator is turned off. You can even replace the batteries without destroying the contents of memory. The HP-41C's size-N throw-away batteries typically last 1 or 2 months, instead of the 9 to 12 months claimed in the documentation. A BAT annunciator warns you when you have only about 2 weeks' worth of life left in the batteries. The HP-41C can also be run using an AC adapter.

Not only are user programs saved in continuous memory, but so is virtually everything relating to the calculator: data, flags, user-key assignments, registers, and display formats. You can even set a flag so that, when you turn on the calculator, it immediately continues executing a program from where it left off when shut down!

The standard calculator contains sixty-three *registers* of memory. Each register is 7 bytes long and can be used to store one number, up to six characters, or several program steps. The total memory space can be partitioned into any combination of program and data storage, or it can be left at the default partition of seventeen data registers and forty-six program registers. The instruction set contains eighty-six 1-byte instructions, thirty-one 2-byte instructions, three 3-byte instructions, and one 4-byte instruction. Instructions with alphanumeric operands such as LABEL, GOTO, etc, use 1 extra byte per character. In a typical mix of instructions, the HP-41C can store about 200 lines of program code in the default forty-six registers of program space. An HP-41C containing four optional expansion-memory modules contains over 2.1 K bytes of continuous memory, capable of storing an average of over 1300 program steps.

Programming

Programming is easier on the HP-41C than on any other calculator. You need not be concerned with ad-

dresses or instruction lengths; instead, programs are entered on automatically numbered lines, as is done on many microcomputer text editors. Lines may be freely inserted or deleted anywhere, with automatic renumbering of subsequent lines. Alphabetic labels of up to seven characters can be used for tagging the destination of branches or for program, subroutine, and function names. Also, any number of programs may be resident in memory, each uniquely identified by an alphabetic name. Programs can be selectively edited, deleted, or entered without affecting other programs.

Best of all, the key codes displayed by other calculators are gone, and are replaced by mnemonic instruction displays. For example, if you examine an instruction for storing a number into register 15 on the Texas Instruments TI-59, it is displayed on three separate lines as "42", "01", "05", where "42" is the TI-59's key code for the STO key. On the HP-41C, however, the same operation is displayed on a single line as "STO 15". This improvement is analogous to stepping up to assembly-language programming from machine-language, an advantage that really speeds up program development and checkout.

Two powerful loop-control instructions have been added to the function repertoire of the HP-41C: increment and skip if greater (ISG), and decrement and skip if equal (DSE). These instructions allow a single register to serve as a loop counter, increment value, and final value simultaneously, by coding the number in the register in the form:

iiii.fffcc

where *iiii* is the current counter value, *fff* is the final value, and *cc* is the increment. For example, the BASIC loop:

```
FOR I = 1 TO 50 STEP 2
.
.
.
NEXT I
```

is programmed on the HP-41C as:

1.05002 *iiii=1,fff=050,cc=2*

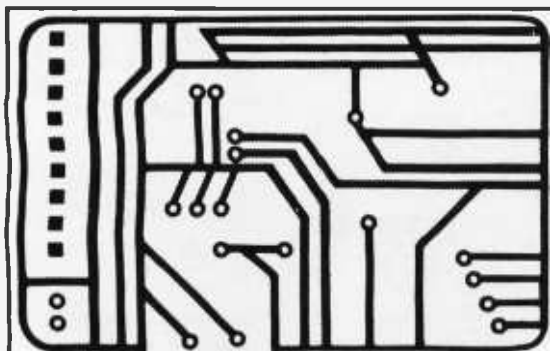

CALL NOW • TOLL FREE
1-800-558-0870
MASTER CARD • VISA

OHIO SCIENTIFIC COMPUTERS

SAMPLE PRICES:

C1P Series 2 8K RAM with 24 x 24 or 48 x 12 character display; sound, music & voice; 300 baud modem & printer port; expansion to color, joysticks, AC remote & more . . .

OSI
RETAIL OUR
PRICE

\$479 \$422

C1P MF Series 2 Same as above plus 20K RAM; real-time clock, 90K mini floppy & more . . .

\$1279 \$1126

630 I/O Expander Board (add to C1P or C1P MF) 16 color output; dual 8 axis joystick interface; home security interface; 16 line parallel I/O; programmable sound generator & more . . .

\$229 \$202

FARAGHER ASSOCIATES, INC.

7635 W. BLUEMOUND MILWAUKEE, WI 53213
HOURS: C.S.T. M-F 8-6 SAT. 9-1

LOWEST PRICES ON PERSONAL COMPUTERS

buy by mail and save

 **apple computer**



Apple II personal computer.

16K
List \$1195

ONLY \$989

32K, List \$1395 \$1169
48K, List \$1259

DISK II DRIVE \$420
Above w/Controller \$505

MICROSOFT Z80/CPM
Conversion For Apple II ... **ONLY \$299**

APPLE III
w/96K \$2998

CENTRONICS PRINTER INTERFACE
dascal Language System List \$495 **\$420**
Centronics

Printer Card List \$225 **\$191**
High Speed

Printer Interface \$195 **\$165**

COMPLETE LINE OF CALIFORNIA COMPUTERS
Interface cards available.

We also stock the
DC Hayes Micromodem,
Mountain Hardware,
and the **SSM combination**
serial/parallel interfaces.

Personal computer systems

609 Butternut St.,
Syracuse, NY 13208
(315) 475-6800



Prices do not include shipping by UPS. All prices and offers subject to change without notice.

HEWLETT PACKARD

HP-85A ONLY \$2795

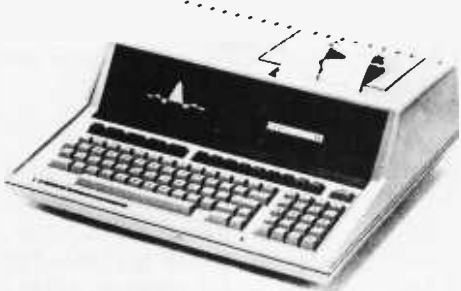

HP-85 ACCESSORIES

5-1/4" Dual Master
Disc Drive List \$2500 **\$2125**

5-1/4" Single Master
Disc Drive List \$1500 **\$1275**

HP 7225A
Graphics Plotter List \$2050 **\$1845**

HP-85 16K
Memory Module List \$395 . **\$355**

HP-85 Application Pacs
Standard List \$95 **\$85**

Serial (RS-232C)
Interface Module List \$395 **\$355**

GPIO
Interface Module List \$495 **\$445**

IMAGINE A CALCULATOR YOU CAN CUSTOMIZE. IT'S HERE—THE HP-41C.



HP-41C ONLY \$244.95

hp CALCULATORS:

- HP-32E Scientific w/Statistics — 53.95
- HP-33C Scientific Programmable 99.95
- HP-34C Advanced Scientific Programmable — 123.95
- HP-37E Business Calculator — 58.95
- HP-67 Handheld Fully Advanced Programmable Scientific for Business & Engineering — 298.95
- HP-97 Desktop w/Built-in Printer. 579.95

Circle 169 on inquiry card.

TEXAS INSTRUMENTS INCORPORATED

TI-99/4
home computer



CALL FOR PRICE

Commodore Pet
CALL FOR PRICE

PRINTERS FOR ALL COMPUTERS

ATARI PERSONAL COMPUTER SYSTEMS

A Warner Communications Company

List \$1080

ATARI® 800™ PERSONAL COMPUTER SYSTEM. \$849



ATARI® 810 DISC DRIVE
List \$699.95 **\$589**

ATARI® 820™ Printer, List \$599.95 . . . \$499
Atari® 400 List \$630 . . . \$499

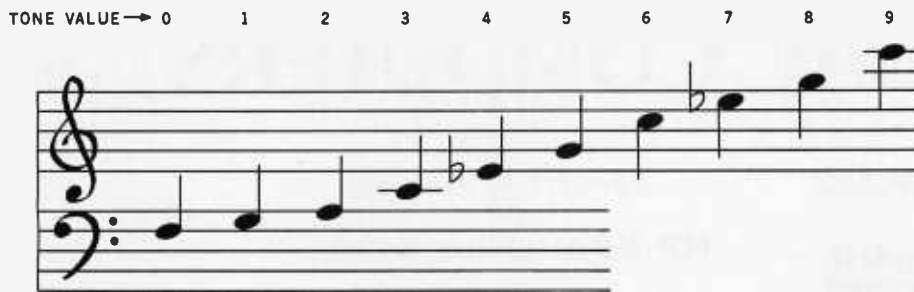

Figure 1: Musical notes on the HP-41C. The TONE function on the HP-41C produces one of ten musical notes that roughly correspond to the notes presented in this figure.

```

STO 01      Store the loop-control number in
            register 01
LBL "TOPLOOP" Top of loop label
.
.
.
ISG 01      Increment register 01 by 2, skip
            next line if greater than 50
GTO "TOPLOOP" Otherwise, repeat this loop

```

The integer part (iiii) of register 01 is incremented by 2 in each pass until 51 is reached; the GTO is then skipped and the loop is exited at the bottom.

A full complement of indirect operations (including indirect subroutine calls) and register arithmetic are supported. Subroutines may be nested up to 6 levels deep. Ten different compare operations are available, including a test for character string equality. Fifty-five flags are provided, some of which are predefined for controlling calculator functions such as display format, mode of operation, etc.

There are eleven user-defined flags, five of which have built-in status annunciators on the display. I found the flags with annunciators useful for monitoring program execution during debugging. Since running programs have complete control over the display format, it is easy to display several labeled numeric values on the display at the same time. User-defined prompts for data entry are also easily programmed. In fact, an executing program can even turn the calculator off.

Error Detection

When a running program encounters an error condition, the calculator displays an English error message. Dividing by 0, for instance, produces the diagnostic "OUT OF RANGE". If you depress the PROG key, the display will show the exact line number and instruction that caused the error. If desired, a flag can be set to ignore errors, or errors can be detected under program control for user-specified recovery.

Besides flags for various error conditions, there are flags that detect whether the data entered is numeric or alphabetic in nature. Since these flags are set only if data is entered, they can be used in conjunction with the PAUSE function to poll the keyboard during program execution to see if a key has been depressed. The PAUSE instruction activates the keyboard for about 1 second, after

which normal execution resumes. The data entry flags can be tested to see if any keys were depressed during a pause; if so, the corresponding key indentifications, which are stored in the display register, are available to the program. This feature facilitates the programming of games with real-time user responses.

Let the Music Play

The calculator can produce ten different audible tones under keyboard or program control. I found the volume level of the tones a little too low for my taste; it is barely audible in a noisy office. After successfully programming "Mary Had a Little Lamb," I decided to tabulate which musical notes are actually provided; the results are presented in figure 1. Those with perfect pitch may find the error in the frequencies of the notes a little annoying, but the tones are close enough to produce recognizable music.

Documentation

One of life's little pleasures is reading Hewlett-Packard documentation, which is among the best in the industry. It took me three evenings to finish the entire 268-page *HP-41C Owner's Handbook*, working each example program as I read. For me, the manual struck just the right balance between simplicity and comprehensiveness. My only complaint is that the text does not always make clear which functions are available on the keyboard and which must be spelled out. For instance, I spent several minutes fruitlessly searching for the multiple-line-delete (DEL) function shown in the example on page 138 as a key, only to conclude that it must be accessed by depressing:

XEQ ALPHA D E L ALPHA

A second manual, *HP-41C Standard Applications Handbook*, gives ten sample programs ranging from hexadecimal conversions to a blackjack game. These programs detail a wealth of programming techniques including random-number generation, character-string concatenation and substring extraction, display formatting, table lookup, etc. In addition, a year's free membership to *Keynotes*, the HP calculator newsletter, is included with your purchase.

Membership in a user's library group is available on a subscription basis for \$20 per year. This subscription en-

a new star is born!

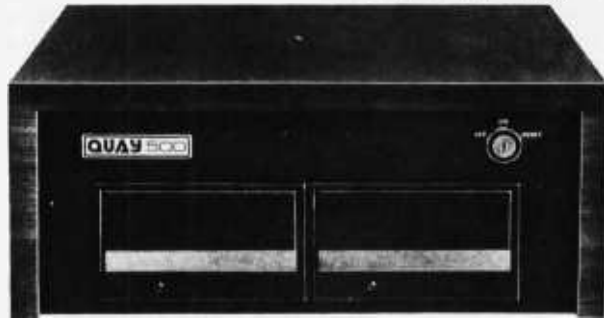

a better computer system
any way you look at it.

The facts speak for themselves. The QUAY 500 SERIES offers more for the money than North Star Horizon® computers.

MORE TECHNICAL FEATURES. A single board computer instead of a backplane with multiple boards, means fewer parts, fewer interconnections and fewer problems □ additional disk capacity for more program storage □ DMA controlled disk transfers for increased system performance □ on-board expansion capabilities for additional parallel and serial ports, and EPROM □ AC convenience outlets □ a more compact design.

IMMEDIATE DELIVERY. The 500 SERIES is available off the shelf for virtually immediate delivery. No waiting for far off delivery dates for this one.

LOWER PRICE. The advanced technology engineered into Quay computers actually lowers our cost to manufacture. The price of the 500 SERIES is about 20% lower than the Horizon-2-32K-D — and our 520 SERIES also offers significant savings over the Horizon-2-32K-Q.

The bottom line is simple. There is a new star in the computer field. The 500 SERIES by Quay. It outshines all of the competition.



Advanced single board modular design.

COMPARE FOR YOURSELF:

SPECIFICATION	QUAY 500	HORIZON-2-32K-D
Architecture	Single Board	S100 bus
CPU	Z80A, 4MHz.	Same
Dynamic RAM (std)	64 Kb.	32 Kb.
Disk drive type	Double density	Same
No. of drives (std/max)	2/4	Same
Capacity per drive (on-line)	200 Kb.	180 Kb.
Direct Memory Access (DMA)	Yes	No
CP/M® disk operating system	Standard	Optional
Unit Price	\$2,995.	\$3,095.

SPECIFICATIONS	QUAY 520	HORIZON-2-32K-Q
Disk drive type	Quad density	Same
Capacity per drive (on-line)	400 Kb.	360 Kb.
Unit Price	\$3,495.	\$3,595.

The QUAY 500 offers technical superiority—availability—a \$2,500 price!

CP/M® is a registered trademark of Digital Research

Horizon is a registered trademark of North Star Computers, Inc.

QUAY CORPORATION

P.O. Box 386, Freehold, New Jersey 07728 ■ (201) 681-8700
Factory: Route 34, Wall Township, New Jersey 07719

DISTRIBUTOR AND REPRESENTATIVE INQUIRIES WELCOME



Photo 2: The HP-41C and accessories. Clockwise from top are: the 82143A peripheral printer, a key overlay (for use when redefining key functions), the HP-41C with the 82104A plug-in card reader, two magnetic cards, and three read-only-memory application packs. In the center is the 82153A bar-code wand, which is used to read software printed in the form of bar codes. (Photo courtesy of Hewlett-Packard.)

titles you to a catalog of contributed programs, updates to the catalog, and a coupon good for four free programs of your choice, distributed on magnetic cards. Additional programs are \$6 each. You may submit programs to the library in return for four free programs from the library.

Expansion

One of the most exciting aspects of the HP-41C is the array of available peripheral devices, including:

- a twenty-four-column thermal printer
- an attachable magnetic card reader/writer
- application packs in read-only memory
- continuous-memory expansion modules
- bar-code program reader

Several of these accessories are shown in photo 2.

The 82143A battery-powered thermal printer produces 127 characters, including all uppercase and lowercase letters, in either single width (twenty-four characters per line) or double width (twelve characters per line). (See photo 3 for an example of printer output.) In addition, user-defined characters may be defined within a 7 by 7 dot matrix. Simple printer-plots are supported. The printer can also be used to trace program execution during debugging.

The 82104A magnetic card reader is similar to the built-in unit on the HP-67 and HP-97 and is compatible with cards produced on these machines. Up to sixteen registers can be stored on each side of a card; the calculator prompts you to enter as many cards as needed. Programs, data flags, and even key reassignments can also be saved on the cards. For the security-minded, programs can be designated as *execute-only*, in which case an attempt to display or alter the program will result in the display of the message, "PRIVATE."

Plug-in application packs (useful routines stored in read-only memory modules) are available in disciplines such as aviation, medicine, surveying, finance, stress analysis, etc. Programs in these applications modules can be copied into continuous memory, if desired, for customizing by the user.

For large programs, from one to four 82106A continuous memory modules may be plugged in to extend the built-in memory from the standard 63 to a maximum of 319 registers, in 64-register increments. The extended memory can be partitioned between program and data storage and is continuous, just like the memory supplied with the standard HP-41C.

An accessory just recently made available is a wand that is used to read bar-codes similar to the kind found on most grocery products. This will enable users to load programs directly from HP-41C Solution Books to be published by Hewlett-Packard, which will use bar-code listings of programs to supplement the usual step-by-step keystroke listings. An HP-41C user with a bar-code wand will be able to enter these programs by running the wand across the bar-code listing, eliminating the tedium and error associated with manually entering a program.

The Great Calculator Race

A strong contender for the programmable calculator market is the Texas Instruments TI-59, which sells for less money than the Hewlett-Packard machine and includes a

6809 S-100 **ads™**

SINGLE BOARD COMPUTER

- **MEETS I.E.E.E. S-100 STANDARD**
 - 10 addressing modes
 - 24 indexed sub modes
 - auto increment/decrement
 - constant indexing from PC
- **4K/8K/16K ROM / 2K RAM**
ROM/RAM relocatable on 4K boundary
- **ACIA; PIA; 8080 SIMULATED I/O**
- **20 PARALLEL I/O LINES • 256 I/O PORTS**
ACIA provides RS-232 lines for asynchronous communications with limited modem control at 8 selectable baud rates; I/O locatable at any 4K boundary
- **ASSEMBLED & TESTED WITH 2K RAM & MONITOR \$349.50**
- **adsMON; ADS MONITOR**
Examine and change registers and memory; punch and load in Motorola format; user definable interrupt service and more
\$39.95 in 2716 EPROM

MasterCharge / VISA Accepted

Illinois residents add sales tax Add 2.5% for shipping

Ackerman Digital Systems, Inc.

110 N. York Rd., Suite 208, Elmhurst, Ill. 60126 (312) 530-8992

PMC-80

Level II 16K at \$645



SOFTWARE COMPATIBLE

- Reads all Level II BASIC tapes
- Reads all SYSTEM tapes
- Full range of peripherals
- Video output for monitor and TV
- Optional FASTLOAD at 8000 baud
- Optional Upper/Lower case

The PMC-80 is a "work-alike" computer to the popular TRS-80* Model I, Level II by Tandy, Radio Shack. The PMC-80 has 16K bytes of RAM and the complete Level II 12K BASIC ROM by Microsoft that makes it 100% software compatible with programs from Radio Shack and from the hundreds of other independent suppliers. The built-in cassette player reads standard Radio Shack programs for the TRS-80*.

Sold through computer stores.

The PMC-80 will operate with any of the many peripherals Radio Shack and other independent vendors have invented to plug into the TRS-80*. Most importantly, the Interface Adapter permits Expansion Interfaces with memory expansion to 48K to be added. An Expansion Interface will also permit the addition of Radio Shack compatible 5¼" disks and disk operating systems, RS 232, printers, etc.

*TRS-80 is a registered trademark of Tandy, Radio Shack.

Personal Micro Computers, Inc.

475 Ellis Street, Mountain View, CA 94043

(415) 962-0220

standard magnetic card reader and larger standard memory (960 bytes, as opposed to 441 bytes on a standard HP-41C). (Price information for the Hewlett-Packard machine is given at the end of this article.) Of course, it doesn't have an alphanumeric display or continuous memory; still, it is an attractive alternative to the HP-41C.

I decided to run a small benchmark test to compare speed and memory usage on both machines. Conducting proper benchmark tests is an involved and time-consuming process. Instead, I settled for one representative test that should be adequate for at least rough comparison. I programmed both the HP-41C and the TI-59 to compute the present value of a bond with "periodic coupons," as given by the formula:

$$P = I \sum_{j=1}^N (1+Y)^{-j} + M(1+Y)^{-N}$$

where:

- P = present value
- I = coupon value
- N = number of periods
- M = maturity value
- Y = yield rate, in percent

I picked this example because it requires a mix of arithmetic, looping, and register operations; I intuitively felt that this mixture is representative of the operations performed in many of the problems suitable for pocket

calculators. I programmed both calculators in the same manner, deliberately trying to avoid "trick" programming but taking advantage of each machine's strengths where possible (such as short-form addressing on the TI-59 and stack manipulation on the HP-41C).

The programs for the HP-41C and the TI-59 are in listings 1 and 2, respectively. Although I expected the HP-41C to run slower since it uses ultra-low-power technology, both calculators took about the same amount of time to execute the benchmark. The HP-41C program uses less memory space, but of course it has only about half as much memory available in its standard configuration.

Listing 1: HP-41C benchmark program to calculate the present value of a bond with "periodic coupons." This problem, described in the text, was used as a benchmark program against the Texas Instruments TI-59 because it uses both arithmetic calculations and program looping. The TI-59 benchmark program is given in listing 2, and the results of the comparison are given in table 1.

HP-41C program steps often consist of multiple keystrokes; each step is shown in this listing as it appears in the calculator's display after entry, with one exception: characters entered in alphabetic mode on the calculator are shown here enclosed in quotes. On the calculator's display the quotes do not appear, but the characters are preceded by a superscript "T".

REGISTERS

- R₁ M, maturity value
- R₂ N, number of periods and J, loop index
- R₃ I, coupon value
- R₄ 1 + Y, where Y is yield rate as decimal fraction

LINE	PROGRAM STEP	COMMENTS
01	LBL "BOND"	
02	FIX 2	Set dollars and cents format
03	STO 01	SAVE M in 01
04	STOP	Input N
05	STO 02	Save N in reg 02
06	STOP	Input I
07	STO 03	Save I in reg 03
08	STOP	Input Y
09	100	
10	/	Convert to decimal fraction
11	1	
12	+	
13	STO 04	Save (1 + Y) in reg 04
14	RCL 02	
15	CHS	
16	Y/X	(1 + Y) ^{-N}
17	RCL 01	
18	*	M*(1 + Y) ^{-N}
19	0	Initialize sum to 0
20	LBL 01	Top of summation loop
21	RCL 04	(1 + Y)
22	RCL 02	J
23	CHS	- J
24	Y/X	(1 + Y) ^{-J}
25	+	New summation
26	DSE 02	J = J - 1...
27	GTO 01	...Until J = 0
28	RCL 03	Then recall I
29	*	Times summation
30	+	Plus second term = result, P
31	END	



GREAT FOR XMAS

ATTACHE STYLE CASES FOR CARRYING AND PROTECTING A COMPLETE COMPUTER SET-UP. CONSTRUCTED OF THE HIGHEST QUALITY LUGGAGE MATERIAL WITH SADDLE STITCHING WILL ACCOMMODATE EQUIPMENT IN A FULLY OPERATIONAL CONFIGURATION ALONG WITH MANUALS, WORKING PAPERS AND DISKS. NEVER A NEED TO REMOVE EQUIPMENT FROM CASE. SIMPLY REMOVE LID, CONNECT POWER AND OPERATE. LID CAN BE REPLACED AND LOCKED FOR SECURITY AND PROTECTION WITHOUT DISCONNECTING CABLES. FULLY TESTED.

- AP101S Apple and Single Disk Drive\$109
- AP102D Apple and Double Disk Drive119
- AP103M Apple, 9 inch Monitor and Double Drive129
- RS201 TRS-80, Expansion Unit and Double Drive109
- RS202 TRS-80 Monitor and Accessories84
- P401 Paper Tiger Printer.....99
- P402 Line Printer II-Centronics 730.....89
- CC90 Matching Attache Case75



COMPUTER CASE COMPANY

5650 INDIANA MOUND CT COLUMBUS OHIO 43213

(614) 868-9464

The COMPUTER FACTORY

TO ORDER CALL (212) 687-5000

SUPERBRAIN™

INTERTEC
DATA
SYSTEMS
64K
ONLY
\$2995



32K \$2795

More than an intelligent terminal, the SuperBrain outperforms many other systems costing three to five times as much. Endowed with a hefty amount of available software (BASIC, FORTRAN, COBOL), the SuperBrain is ready to take on your toughest assignment. You name it! General Ledger, Accounts Receivable, Payroll, Inventory or Word Processing... the SuperBrain handles all of them with ease.

FEATURES INCLUDE:

- 2 dual-density minifloppies with 360K bytes of disk storage
- A CP/M Disk Operating System with a high-powered text editor, assembler and debugger.

Model QD

720K Bytes disk storage
and 84K RAM
\$3895

SUPER BRAIN HARD DISKS

10 Megabyte	16 Fixed-16 Removable
\$3995	\$9995

NEW 96K

80 Column
Commodore
CBM
Basic 4.0
Operating
System



- 80 column by 25 line display
- 12" CRT
- New screen editor
- Split screen processing
- Super fast string handling
- 15 additional basic commands
- Supports relative record processing

Model 8032
32K memory

\$1795

NEW!
Model 8096
96K memory

Call for price

NEW 8050 DUAL DISK

1 million bytes on-line storage
and DOS 2.0 operating system

- Supports relative record (Random Access)
- Faster more reliable only **\$1795**

CENTRONICS 704

- 180 cps Bi-Directional • Up to 15" Paper Width • 9 x 9 Matrix
- Upper/Lower Case
- Tractor Feed
- RS-232C Serial Interface



\$1895
List \$2500

CENTRONICS 700-9

- **\$1295** List \$1895
- 60 cps • Up to 15" paper width
- Tractor Feed • Parallel Interface for Apple & TRS-80 • 2 channel vertical forms! • Top of Form!

CENTRONICS (Letter quality)

737 Serial \$925
737 Parallel \$895

CENTRONICS

730 Serial \$735
730 Parallel \$715

Commodore Computer

These low cost Commodore PET Business Computers have virtually unlimited business capabilities. Accounts Receivable, Inventory Records, Payroll, and other accounting functions.

PET 16N & 32N COMPUTERS

- Full size keyboard
- 16 or 32,000 Bytes Memory
- Level III Operating System
- Full Screen Editor
- Upper lower case & 64 graphic characters



\$995

PET DUAL FLOPPY DISK

- Stores 360,000 Bytes on-line
- Microprocessor controlled
- Uses single or dual sided floppies



\$1295

HI-SPEED PRINTER

- 150 characters per second • Up to 4 copies 8" wide
- Microprocessor Controlled • Prints All Graphics • Full Formatting Capability



\$695

PERIPHERALS

- 24K Memory Expansion \$499
- 16K Memory Expansion 399
- PET to RS232C Serial 129
- 2 Way Serial Communication 229
- Modem Board for PET 375
- Analog to Digital Board for 16 Devices 275
- Second Cassette Drive 95

DIP-81 BIDIRECTIONAL 100 CPS MATRIX PRINTER

- Centronics Interface
- Serial add \$50
- Ribbon cartridge
- Up to 4 copies
- 80 column

\$395

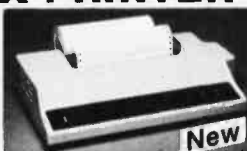

New

ANDERSON JACOBSON

841 I/O Terminal Ideal for word processing and small businesses. Serial **\$1230**

- ASCII Code
- 15 CPS Printout
- High Quality Selectric Printing
- Reliable heavy duty mechanism
- Completely Refurbished by A.J.
- Delivered FREE to nearest service center

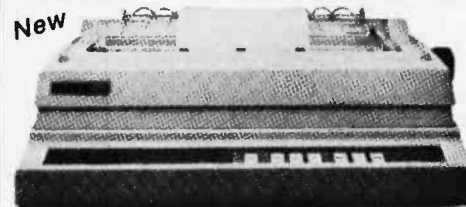

XEROX 1730

Letter Quality Printer

List \$2755 **Special \$2495**

- 40 Cps
- Uses all 100 metal & plastic daisy wheels
- Automatic bidirectional printing
- Fewer moving parts
- 90 Day On Site Warranty



XYMEC HQ 1000

with 10, 12, 15 Pitch & Proportional Spacing

• 2-80 controlled

• Up to 198 columns

\$2495

VISA

master charge

Min. Credit Card Order \$75

- N.Y. residents add 8% sales tax
- Same day shipment on prepaid and credit card orders



CORVUS

10 megabyte disk
and mirror
available



Call **APPLE II PLUS for price**

A complete self-contained computer system with APPLESOFT floating point BASIC in ROM, full ASCII keyboard in a light weight molded carrying case.

Features Include:

- auto-start ROM • Hi-Res graphics and 15 color video output.
- Expandable to 48K.

Supertalker	\$279	Micromodem	\$379
Disk	595	Superterm (24 x 80)	395
Add-on Disk	495	Speechlab	229
Pascal Card	495	Communication Card	225
Business Software	625	Modem	200
Monitor	159	Graphics Printer	595
Printer Card	180	Graphics Tablet	795

apple ///
IS FINALLY HERE
128K RAM!!

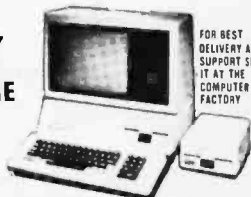

FOR BEST
DELIVERY AND
SUPPORT SEE
IT AT THE
COMPUTER
FACTORY

CLOSE OUT SPECIALS!

	List	Special
CompuColor 16K with 117 Key Keyboard	\$1945	\$ 972.50
CompuColor 32K with 117 Key Keyboard	2245	1095
PLUS \$200 FREE COMPUCOLOR SOFTWARE		
Chatsworth Card Reader for TRS-80	750	450
Versawriter Graphics Tablet for Apple II	259	179
Axiom 810	495	195
Protoline PET to Centronics Interface	199	49
Microtronics PET/Ham Interface	125	49

TO ORDER CALL (212) 687-5000

The COMPUTER FACTORY

485 Lexington Ave., New York, NY 10017 (46th St. Lobby)

Foreign order desk — Telex 640055

Open

Mon-Fri. 10-6 Sat. 11-5

Listing 2: Texas Instruments TI-59 benchmark program to calculate the present value of a bond with "periodic coupons." The results of the comparison with the HP-41C are given in table 1.

```

056 43 RCL
057 06 6 Plus first term...
058 95 = Result is P
059 91 R/S
060 00

```

REGISTERS

- R₁ M, maturity value
- R₂ N, number of periods, and J, loop index
- R₃ I, coupon value
- R₄ 1 + Y, where Y is yield rate as decimal fraction
- R₅ scratch register for summation

A subjective conclusion I drew after programming both calculators is that the HP-41C is *much* easier to program and debug because of its line-oriented, mnemonic display. The results of this comparison are given in table 1.

Sample Program: Codebreaker

Because I am a games enthusiast, I decided to write a game program as an example of an HP-41C program. I programmed a variation of the popular "codebreaker" type games, where the calculator generates a random code and the player attempts to guess the code. The flowchart for this program is given in figure 2.

To begin, the player first decides on the number of digits for the code, from three to five digits. Assume that a three-digit game is chosen. The calculator will then secretly pick a three-digit number *with no two digits the same*. The user then enters a three-digit guess.

After evaluating the guess, the calculator displays the number of digits that are exactly right and the number of digits that exist in the true code but are not in the proper position. For example, if the secret code is 108 and 802 is the guess, the display will show:

802 RT:1 MP:1

indicating one entirely right (RT) digit (the 0) and one misplaced (MP) digit (the 8).

The user continues guessing until the correct answer is

Text continued on page 258

DISPLAY LINE	CODE	KEY ENTRY	COMMENTS
000	76	LBL	
001	11	A	
002	58	FIX	Set dollars and cents format
003	02	2	
004	42	STO	
005	01	1	Save M in reg 01
006	91	R/S	Input N
007	42	STO	
008	02	2	Save N in reg 02
009	91	R/S	Input I
010	42	STO	
011	03	3	Save I in reg 03
012	91	R/S	Input Y
013	55	/	
014	01	1	Convert to decimal fraction
015	00	0	
016	00	0	
017	85	+	
018	01	1	
019	95	=	
020	42	STO	
021	04	4	Save (1 + Y) in reg 04
022	45	Y ^x	(1 + Y) ^{-N} ...
023	43	RCL	
024	02	2	
025	94	+/-	
026	65	x	
027	43	RCL	
028	01	1	
029	95	=	
030	42	STO	
031	05	5	Save M*(1 + Y) ^{-N}
032	25	CLR	
033	42	STO	
034	06	6	
035	76	LBL	
036	44	SUM	Top of summation loop
037	43	RCL	
038	04	4	
039	45	Y ^x	
040	43	RCL	
041	02	2	
042	94	+/-	-J
043	95	=	(1 + Y) ^{-J}
044	44	SUM	New summation
045	06	6	
046	97	DSZ	J = J - 1...
047	02	2	
048	44	SUM	...Until J = 0
049	43	RCL	
050	03	3	Then recall I
051	49	PRD	
052	06	6	Times summation
053	43	RCL	
054	05	5	2nd term
055	85	+	

	TI-59	HP-41C
Number of data registers used	5	4
Program size (as displayed)	59 lines	31 lines
Program size (internal representation)	59 steps	41 bytes
Total memory used/total memory	99/960	69/441 (69/2233)
Percentage of total memory used	10.3	15.6 (3.0)
Execution time, seconds	43	37

Benchmark equation programmed:

$$P = I \sum_{J=1}^N (1 + Y)^{-J} + M(1 + Y)^{-N}$$

Data used:

M = 20,000, N = 50, I = 1400, Y = 8%

Answer: P = 17,533.30

Table 1: Results of the HP-41C/TI-59 benchmark. The programs of listings 1 and 2 are the basis of the data given above. The difference between the two program-size figures for the HP-41C is due to the fact that it combines several program steps into an assembly-language-like instruction when displaying it. The figures in parentheses refer to the HP-41C filled with its maximum amount of memory; the figures just before them refer to the HP-41C as purchased.

THE STARS OF THE TARBELL EMPIRE



Circle 174 on inquiry card.

ALABAMA

Jack Randolph & Assoc. Inc.
1518 Chamblis Lane
Birmingham 822-2339

Jett Consulting
1312 Brookmeade St.
Huntsville 852-4364

ARIZONA

Konan Corp
1448 N. 27th Avenue
Phoenix 269-2649

Micro Age
1425 W. 12th Place Suite 101
Tempe 967-1421

Ozymandias Systems
976 S. 5th
Yuma 783-4315

Thought Works
2340 N.W. Grand Suite 7
Phoenix 972-4065

N. CALIFORNIA

Affordable Computers
3400 El Camino Real
Santa Clara 249-4221

Bell Controls
270 Prospect Drive
San Rafael
454-4782 & 924-7068

Computerland Corp.
14400 Catalina St.
San Leandro 895-9363

Computer Store of San Leandro
701 MacArthur Blvd.
San Leandro 569-4174

Cybernetic Data Systems
1618 Inglis Lane
San Jose 925-6354

Digital Deli
80 West El Camino Real
Mountain View 961-2670

Electronic Brain
3038 No. Cedar Avenue
Fresno 227-8479

Electrolabs
930 Emerson Avenue
Palo Alto
321-5605 & 321-5601

Evergreen Business Services
3365 B. S. White Road.
San Jose 274-8717

Iota Microsystems
5532 Pennsylvania Blvd.
Concord 649-6841

Microage Computer Store
2065 B El Camino Real West
Mountain View

PCE Electronics
4782 Dewey Drive
Fair Oaks 966-2208

Precision Computer Systems
1737 N. 1st Suite 580
San Jose 279-8228

Support Systems
1157 Chess Drive Suite G
Foster City 349-2340

S. CALIFORNIA

Action Computer Enterprise
55 W Del Mar Blvd
Pasadena 793-2440

Advanced Computer Products
1310 B East Edinger
Santa Ana 558-8813

Applied Processor Laboratories
11808 So. Prairie Ave.
Hawthorne 678-8940

Astar International Company
5676 Francis Ave.
Chino 284-0561

Bits N Bytes
679 D So. State College Blvd
Fullerton 879-8386

Brown Dog Engineering
P.O. Box 427
Lomita 326-8482

Byte Shop
123 E Yorba Linda Blvd
Piscenia 524-5380

Byte Shop
8038 Clairmont Mesa Blvd
San Diego 565-8008

Byte Shop
14300 Beach Blvd.
Westminster 894-9131

Cel Blu Corporation
350 S. Figueroa St. Suite 298
Los Angeles 625-0673

Richard Chew
2020 Crown Circle
La Verne 596-3480

The Computer Center
8205 Ronson Rd.
San Diego 292-5302

Computer World
6791 Westminster Ave.
Westminster 898-8330

Computer World
3808 West Verdugo Ave.
Burbank 848-5521

Computer World
5848 Sepulveda Blvd.
Van Nuys
786-7411 & 786-2199

Computer Galaxy
14112 San Antonio
Norwalk 863-8008

Computerland
4233 Convoys St.
San Diego 560-9912

Computer Sys & Applications
P.O. Box 8340
Orange 632-1226

Data Vector Corporation
2412 N. Keystone St.
Burbank 842-2866

Dynatron International Company
18210 Sherman Way
Reseda 881-8700

E.D.P. Management
5465 Lake Murray Blvd. #D
La Mesa 462-5400

Electronic Supply
2486 3rd St.
Riverside 787-9220

Formula International
12603 Crenshaw Blvd.
Hawthorne 973-1921

Franklin System/ICS
9000 Mason Ave
Chatsworth 998-1300

Futra Co.
3447 Torrance Blvd.
Torrance 370-1589

Hobbyworld Electronics
19511 Business Center Dr.
Northridge 886-9200

International Scientific USA Inc
17971 Skypark Circle Suite F
Irvine 549-2312

Jade Computer Products
13440 S. Hawthorne Blvd.
Hawthorne 973-7330

L. Electronics
410 Bell Ave.
Santa Ana 557-8796

Micro Da Sys
P.O. Box 36051
Los Angeles 731-0876

M.C. Computers
2008 Wilshire Blvd.
Santa Monica 535-3006

Q.I. Computers
15818 Hawthorne Blvd.
Lawndale 370-4842

Sunshine Computer Co. Inc
20710 S. Leapwood Ave.
Carson 327-2118

W.E.H. Computer Systems
8481 Grace Circle
Huntington Beach 964-4425

COLORADO
Byte Shop
3464 South Acoma St.
Englewood 761-6232

Computer Technology
6311 N. Federal Blvd.
Denver 427-4438

CONNECTICUT

Office Services of Hamden Inc.
965 Dixwell Ave.
Hamden 624-9917

FLORIDA

Data Technology Associates Inc.
10445 S.W. 70th Ave.
Miami 667-3410

Microcomputer Technology Inc.
1549 W. Brandon Blvd.
Brandon 685-6714

Quaray Devices
1033 N.E. 8th Ave.
Gainesville 373-7959

GEORGIA

Advanced Computer Technology
6540 Roswell Rd.
Atlanta 255-8984

Electromagnetic Sciences Inc.
125 Technology Park
Norcross 448-5770

H&L Electronics
5144 Peachtree Rd.
Atlanta 455-0626

HAWAII

Kahaluu Komputing
47-500 Kam
Kaneohe 239-7332

Mahalo Microsystems Ltd.
355 Royal Hawaiian Ave.
Honolulu 922-2152

Zintel
2449 Sonoma St.
Honolulu 521-1070

ILLINOIS

Bies Systems Inc.
7037 West North Ave.
Oak Park 386-3323

Lilliput Computer Mart
4446 Oakton St.
Skokie 674-1383

Midwest Microcomputers Inc
708 S Main St.
Lombard 495-9889

Wilcox Enterprises
25 W 178 39th St.
Naperville 420-8601

INDIANA

Computer Consulting Services
1028 N Illinois St
Indianapolis 638-5330

Data Domain
221 West Dodds
Bloomington 334-3607

Digital Supply
817 Agathon Dr.
Evansville 985-3677

Digital Technology
10 N. 3rd
Lafayette 423-2548

The Home Computer Center
2115 East 62nd St.
Indianapolis 251-6800

Smith Computer Systems
530 Pierce Ave.
Dyer 322-5461

LOUISIANA

Great Southern Computer Systems
915 Talbot
Thibodaux 446-8432

MARYLAND

Computers Etc.
13A Allegheny Ave
Towson 296-0520

MASSACHUSETTS

The Computer Mart Inc.
1395 Main St. Route 117 at 128
Waltham 899-4540

Computer Shop
288 Norfolk St.
Cambridge 661-2670

Scientific Consulting Services
4 Lovell Road
Watertown 926-4046

MICHIGAN

American Computer Center Inc
4132 N. Woodward
Royal Oak 549-2870

Computer Mart Inc.
560 W. 14 Mile Road
Clawson 288-0040

GAW Computertronics
37727 Amrhein Rd.
Livonia 464-0441

Jepsan
4180 44th Street S.E.
Grand Rapids 698-8700

MINNESOTA

Microage Computer Store
83 South 10th
Minneapolis

NEW JERSEY

Computer Emporium
Bldg 103 Avenues of Commerce
Cherry Hill 667-7555

Computer Mart of NJ Inc.
501 Route 27
Iselin 283-0600

Computer Systems International
539 Durie Ave.
Closter 767-7510

S-100 Inc.
7 White Pl.
Clark 382-1318

NEW YORK

Computer Shop of Syracuse Inc.
3470 Erie Blvd. East
Dewitt 637-6208

Management Computer Systems
86-16 Santilago St.
Hollis 479-7783

Mini Micro Mart
1618 James
Syracuse 422-4467

Owens Associates
12 Schubert St.
Staten Island
448-6283 & 448-6298

NORTH CAROLINA

American Square Computers
Rt 1 Box 56 Kivett Drive
Jamestown 889-4577

Byte Shop of Raleigh
1213 Hillsborough St.
Raleigh 833-0210

Computer Sharing Inc.
273 Hayward St.
Ashville 253-2364

Digital Dynamics Corp.
1118 Clement Ave.
Charlotte 374-1527

Southern Digital Systems Inc.
Vernon Park Mall Suite 806A
Kinston 527-4691

OHIO

Cincinnati Computer Store
11711 Princeton Pike
Cincinnati 671-6440

Computerland of Cleveland
1288 Som Center Road
Mayfield Heights 461-1200

Computer Mart
6310 Linworth Road
Columbus 846-2966

Digital Automation Associates Inc.
735 Haskins Rd.
Bowling Green 352-6977

Ohio Microcomputer Specialist
1204 W. Broad St.
Columbus 275-0464

Quasar Data Products
3501 Lakeview Blvd.
Stow 779-9387

Service Specialist
1279 No. Prospect
Oberlin 774-1041

Tec Mar Inc.
23414 Greenlawn Ave.
Beachwood 382-7599

OREGON

Byte Shop Beaverton
3482 S.W. Cedar Hills Blvd.
Beaverton 223-3496

PENNSYLVANIA

Erie Computer Company
1253 W. 8th St.
Erie 454-7652

Marketline Systems Inc.
2337 Philmont Ave.
Huntington Valley 947-6670

TEXAS

Computer Technology Associates
5812 Cromo Drive Suite 102
El Paso 581-3500 & 581-5400

Houston Computer Mart
8029 Gulf Freeway
Houston 649-4188

Integrated Data Systems
6002 Carritos
Houston 729-9160

The K.A. Computer Store
9090 Stemmons Fwy.
Dallas 634-2667

Microbyte Abacus
2212 Crawford
Houston 757-1128

The Micro Store
634 S. Central Expressway
Richardson 231-1096

Northwest Datacomm
1174 Commerce Drive
Richardson 669-1816

Radio Hut
201 Lockwood
Dallas 324-2829

Ribigital Electronic Co.
200 W. Seventh St. Suite 2812
Fort Worth 336-0777

Young Electronic Service
808 F Brother's Blvd.
College Station 693-3462

VIRGINIA

Computers Plus
6120 Franconia Rd.
Alexandria 971-1997

The Home Computer Center
12588 Warwick Blvd.
Newport News 827-3917

WASHINGTON

Innovative Computing
1135 Lake St. South Suite 245
Kirkland 827-0731

Olympic Computers
418 S. Lincoln
Port Angeles 457-3315

WEST VIRGINIA

Associated Computer Consultants
1332 Pineview Drive
Osage 599-2319

The Computer Corner Inc.
22 Beechurst Ave.
Morgantown 293-5121

WISCONSIN

Byte Shop of Milwaukee
6019 W. Layton Ave.
Greenfield 281-7004

DMA Inc.
545 Meadow Lane
Sheboygan Falls 467-6006

Magic Lantern Computers
3313 University Ave.
Madison 233-2026

OUTSIDE U.S.

Bytronix Microcomputer Ltd.
83 West Street
Farnham Surrey
GU97 N. England

Canadian Microcomputer
Sys. Assoc. Ltd.
1188 Main Street
Smithers

B.C. Canada 20J 2N0
604 847-4838

Compex
2 Gerts Vej
2300 Copenhagen, Denmark
01-520494

Computer Centre
9 De-La-Beche Street
Swansea

South Wales SA1 3EX
0792 460023

Microboards
1-7-1-1003 Saiwai - Cho
Chiba City
Japan 260

0427 (47) 3081

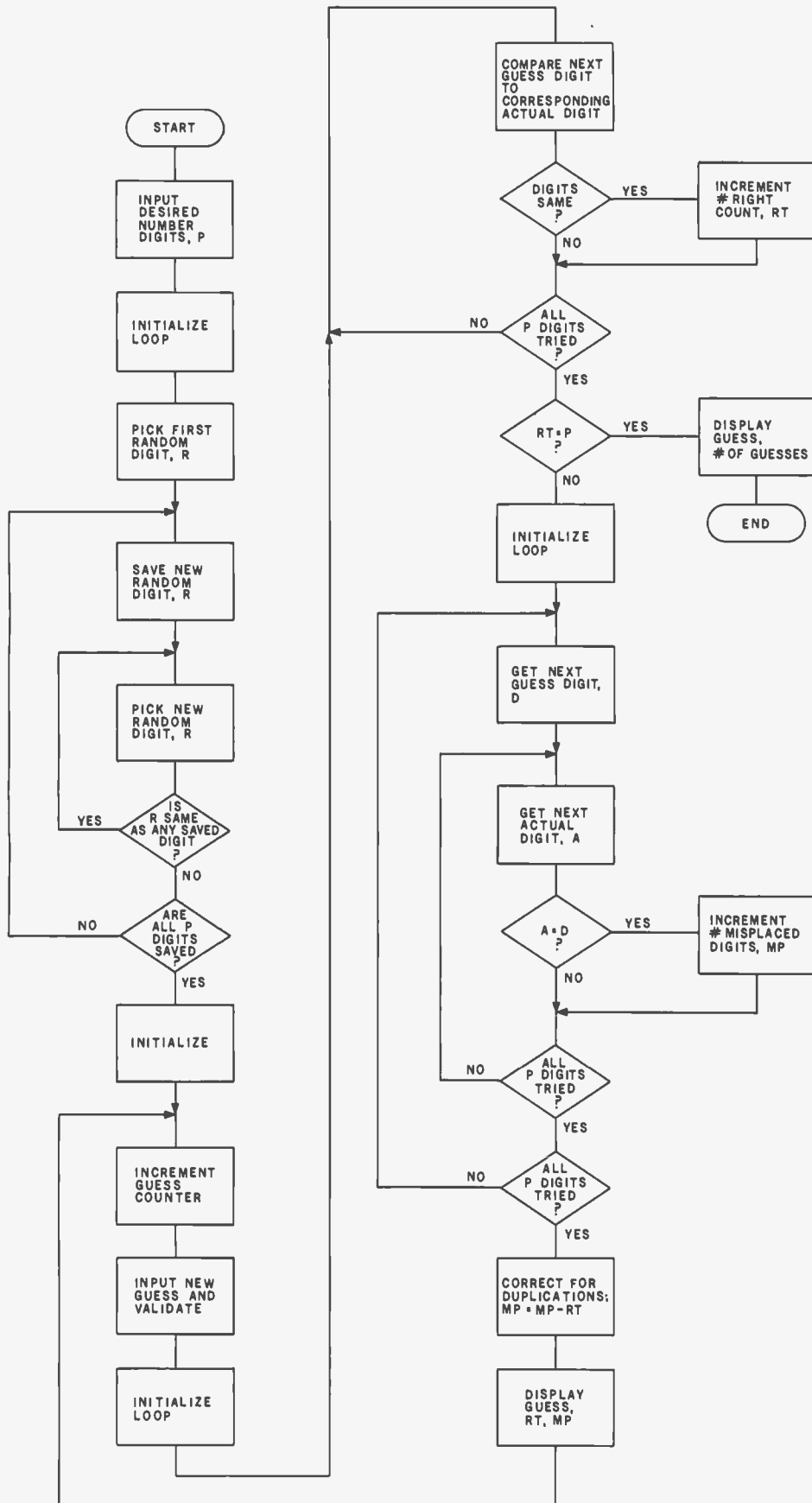

Figure 2: Flowchart for the HP-41C Codebreaker game. Listing 3 gives the HP-41C keystrokes for the equivalent program.

A MCGRAW-HILL PUBLICATION

onComputing™

GUIDE TO PERSONAL COMPUTING

GETTING STARTED
What You Need And What It Will Cost

EQUIPMENT REVIEWS
TRS-80, Apple, Sorcerer and PET

Best-Selling Author
JERRY POURNELL
"Writing With A Microcomputer"
THE BINARY WORLD

Also...
**A PERSONAL
COMPUTER DIRECTORY**
**COMPUTER CLUBS:
WHO NEEDS THEM?**

Plus much much more
for the new computer user

When will the Personal Computer Explosion touch YOU?

Are you prepared for the explosive transformation? Right in your own home? Electronic mail. Personalized investment analysis. Foreign language tutorial. Home energy management. Robots. Computer music. Secretarial service. Diet and menu planning. And more, more, more.

onComputing™ the new McGraw-Hill quarterly, prepares you for the enormous changes coming during the



1980's (Some are already here). **onComputing™** explains in nontechnical language what personal computers are, how they work, and how you can use them at home, for fun and profit.

Don't let the personal computer explosion catch you off guard. Know what's happening and help make it happen! Prepare now for the exciting future with a subscription to **onComputing™!**

Call Toll-Free
800-258-5485

Start your
subscription today.

onComputing™ Subscription Dept. P.O. Box 307, Martinsville, NJ 08836

DOMESTIC subscription rate:

U.S. 1 yr. (4 issues) @ \$8.50 Canada & Mexico, 1 yr. (4 issues) @ \$10.00

FOREIGN (to expedite service, please remit in U.S. funds drawn on a U.S. bank.)

Europe (and all other countries, except above), 1 yr. @ \$12.00 — surface delivery.

Bill Visa Bill Master Charge Bill me (North America only)

Card Number

Expiration

Signature

Name (please print)

Street/Apartment Number

City

State/Province/Country Code

7BCO

Please allow 6-8 weeks for processing.



- Quantity Discounts Available
- 90-day Warranty
- Ask about our unique "Guaranteed Custom Programming"

ZENITH DATA SYSTEMS	LIST	OUR PRICE
Z89 MICROCOMPUTER SYSTEM	\$2,895	\$2,495
48KB Memory		
Z19 Video Terminal (24 x 80)		
2 Serial EIA ports		
Single 5" Diskette Drive		
Z19 Smart Video TerminalSPECIAL ..	\$ 950	\$ 795
24 lines x 80 col		
Reverse Video		
Numeric keypad		
HDOS Operating System (with BASIC)....	\$ 150	\$ 145
Microsoft Basic	\$ 150	\$ 145
Word Processing for Z89 System.....	\$ 395	\$ 375
Dual 5" Diskette Drive for Z89 System	\$1,195	\$1,095

To Order: Send Check or Money Order to: PK Systems, Inc., 113 North Center, Bloomington, IL 61701. Allow two weeks for personal checks to clear. For COD Orders, add 5% for handling and service charge. Rush orders, add \$50.00

Shipping: Freight collect, FOB Bloomington. We ship UPS, air freight, or motor freight.

PK Systems is an Authorized  Dealer and Zenith Service Center.

Introducing
the

82143A

THE HP-41C's

WHISPER QUIET PRINTER.

KEY FEATURES

127 STANDARD CHARACTERS

SINGLE WIDTH
DOUBLE WIDTH
UPPER CASE
lower case

SPECIAL CHARACTER
CAPABILITIES

Photo 3: Sample thermal printer output. The 82143A peripheral printer is capable of printing both uppercase and lowercase letters, as well as numbers, symbols, and user-defined special characters, all in two print densities. The printer can also be used for program tracing or equation plotting. (Print sample courtesy of Hewlett-Packard.)

Text continued from page 254:

obtained; the number of guesses made is then displayed and the game is over. Since the game displays results from only the most recent guess, pencil and paper are good accessories for keeping track of previous guesses and results.

Examining the Program

Several interesting capabilities of the HP-41C are explored in this program (see listing 3). Line 02 places a text string into the alphanumeric display register, which holds from zero to twenty-four characters. Line 03 causes the register's prompting message to be displayed and halts for user input. Lines 04 thru 11 validate the user input and save the desired number of digits, *P*, in register 00.

Lines 12 and 13 initialize the display format as integer only with no decimal point displayed. Lines 14 thru 16 tell the player how many random digits will be picked. Line 17 is a call to subroutine RDIG, which returns a random digit, 0 to 9; I used the random-number generator described in the *HP-41C Standard Applications Handbook*.

Text continued on page 262

4.25
BISYNC
SDLC/ISMA
Software for Your Microcomputer
8080 Z80 8086 Z8000

IBM 2770
IBM 2780
IBM 3270
IBM 3741
IBM 3780
IBM 3776

WINTERHALTER & ASSOCIATES, INC.
SPECIALISTS IN DATA COMMUNICATIONS
3825 ZEEB ROAD
DEXTER, MICHIGAN 48130
313-426-3029 or
313-665-5582

Why is the 88G Printer the new industry leader?



LONG LIFE RIBBON CARTRIDGE

Ribbon difficulties are minimized through use of a continuous loop cartridge with a five million character life. It is easily changed without opening the case, and without any complicated or messy threading operations.



PRICE

Every detail is directed toward providing a heavy-duty, commercial quality printer for only \$749.00. No other printer on the market today can provide its quality, features and performance at a comparable price. The 88G is an obvious industry leader.



Micro Peripherals, Inc.
2099 West 2200 South
Salt Lake City, Utah 84119
Phone (801) 973-6053

VERSATILITY

The 88G prints a full upper and lower case 96 character ASCII set with a crisp, clear 7x7 matrix in 80, 96, or 132 column formats. For text processing and correspondence applications, an 11x7, 80 column serif style matrix can be selected by switch or software command. The dual tractor/pressure-feed paper drive system allows the user to choose either pin-feed, roll, or single sheet papers up to 9.5 inches wide.

Complete forms control allows the 88G to be quickly configured for printing single or multiple-ply invoices, purchase orders, checks, or any type of preprinted form. Optional paper roll holders and single sheet feeders can be quickly attached.

The wide use range of the 88G makes it the perfect companion for business systems, data processing, RO teleprinter and terminal printer applications.

GRAPHICS

A high-resolution, dot-addressable graphics option can be added for applications requiring plotting, printing of screen graphics, drawings, illustrations, etc. Single dot print resolution greatly extends the usefulness of the graphics capability. Selection of one of the four horizontal dot densities available customizes the graphic printout, and alphanumeric can easily be included for titling of graphs and illustrations.

QUALITY

The attractive, durable 88G casework is formed from impact-resistant, flame-retardant Styron. Microprocessor controlled stepper motors provide precision control over print head and paper positioning. Computer quality tractors position paper for readability and are fully adjustable to accommodate varying paper widths.

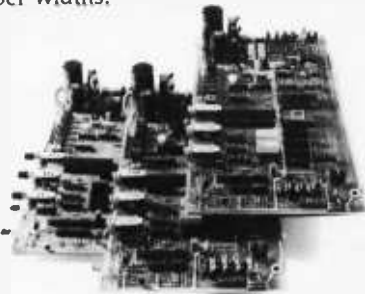

MICROPROCESSOR CONTROLLED INTERFACE

The microprocessor array provides the intelligence for a dual R5232 serial and a Centronics® type parallel interface. Both inputs are fully buffered to allow the 88G to receive data and print simultaneously. A 1K character buffer is standard with a 2K buffer available as an option.

The short line thruput of the 88G has been increased by incorporation of a *Quick Cancel* feature that fully utilizes the bidirectional/unidirectional printing capabilities. Built-in diagnostic and self-test capabilities allow the user to easily pinpoint system problems and a *Power On* confidence test verifies operational status of the printer each time power is applied.



®Centronics is a registered trademark of the Centronics Data Computer Corp.

Listing 3: HP-41C Codebreaker game program. This program chooses a random 3- to 5-digit number with nonrepeating digits and gives the player clues about the code, based on the player's guesses. This listing uses the same conventions as listing 1.

REGISTERS

R₀ Number of digits (positions) to play, $3 \leq P \leq 5$
 R₁ First digit of actual code number
 R₂ Second digit of actual code number
 R₃ Third digit of actual code number
 R₄ Optional fourth digit of actual code number
 R₅ Optional fifth digit of actual code number
 R₆ Current user guess, normalized to 0.ddddd format
 R₇ Scratch for loop control
 R₈ Scratch for indirect register access, loop control
 R₉ Number of exactly right (RT) digits in current user guess
 R₁₀ Number of misplaced (MP) digits in current user guess
 R₁₁ Seed for random number generator
 R₁₂ Count of number of guesses made by user

52 STO 06 Save guess in format 0.ddddd
 53 0
 54 STO 09 Initialize count of "right" digits
 55 STO 10 Initialize count of "misplaced" digits
 56 1
 57 ST + 12 Increment guess counter
 58 RCL 00
 59 STO 07 P
 60 LBL 05
 61 RCL IND 07 Actual code digit
 62 XEQ "GDIG" Get digit from user's guess
 63 X≠Y? Compare corresponding actual digit
 64 GTO 06
 65 1
 66 ST + 09 If match, increment right count
 67 LBL 06
 68 DSE 07 Repeat for all P digits
 69 GTO 05
 70 RCL 09
 71 RCL 00
 72 X=Y? If number right = P...
 73 GTO 14 ...exit, game over
 74 STO 07 Else set up for "misplaced" counting
 75 LBL 07
 76 RCL 00 P
 77 STO 08 Set up inner loop count
 78 XEQ "GDIG" Get digit from user guess
 79 ENTER/
 80 LBL 08
 81 RDN Recall guess digit
 82 RCL IND 08 Digit from actual number
 83 X≠Y?
 84 GTO 09
 85 1
 86 ST + 10 If same, increment "misplaced" count
 87 LBL 09
 88 DSE 08 Repeat for P positions, inner loop
 89 GTO 08
 90 DSE 07 Repeat for P positions, outer loop
 91 GTO 07
 92 RCL 09
 93 ST - 10 Correct "misplaced" count is (MP - RT)
 94 XEQ "SHOG" Show guess in display
 95 "├ RT:"
 96 ARCL 09 Show no. of digits exactly right, RT
 97 "├ MP:"
 98 ARCL 10 Also show number "misplaced," MP
 99 GTO 04 Go get new guess
 100 LBL 14 Come here on end-of-game only
 101 XEQ "SHOG" Show correct guess
 102 "├ "
 103 ARCL 12 Show count of guesses used
 104 "├ TRIES"
 105 AVIEW
 106 BEEP Ring the bell to celebrate
 107 RTN End program.
 108 LBL "SHOG" Subroutine to display guess
 109 RCL 00 Recall P
 110 STO 08 Number of digits to display
 111 CLA
 112 RCL 06 Recall normalized guess, 0.ddddd
 113 LBL 12
 114 10
 115 * Shift out next digit
 116 ENTER/
 117 INT Save on stack
 118 10 Discard fraction
 119 MOD Get units place only, 0 to 9
 120 ARCL X Display digit

LINE PROGRAM STEP COMMENTS

01 LBL "MM" Program name
 02 "NO. DIGITS?"
 03 PROMPT Prompt user to enter no. of digits, 3 to 5
 04 STO 00 Save P places requested
 05 3
 06 X>Y?
 07 GTO "MM" If less than 3 places, re-prompt
 08 RDN
 09 5
 10 X<Y?
 11 GTO "MM" If P greater than 5, re-prompt
 12 FIX 0 Show no fractional part in display
 13 CF 29 Suppress display of decimal point
 14 "IM PICKING "
 15 ARCL 00
 16 AVIEW Tell user how many random digits
 17 XEQ "RDIG" Get first random digit, 0 to 9
 18 RCL 00 Recall no. of places, P, 3 to 5
 19 1000
 20 /
 21 1
 22 +
 23 STO 07 Set up loop control in form 1.00P
 24 LBL 01
 25 RDN
 26 STO IND 07 Store new digit in array
 27 LBL 02
 28 XEQ "RDIG" Get candidate random digit, 0 to 9
 29 RCL 07
 30 INT
 31 STO 08 Last position filled
 32 LBL 03
 33 RDN Recall candidate
 34 RCL IND 08 Recall existing digit
 35 X=Y? If candidate is same as existing digit...
 36 GTO 02 ...then go get a different random digit
 37 DSE 08 Else check next existing digit...
 38 GTO 03 ...until all existing digits checked
 39 ISG 07 Then fill next position with candidate...
 40 GTO 01 ...until all P positions filled
 41 0
 42 STO 12 Initialize count of guesses made
 43 "GUESS?"
 44 LBL 04
 45 PROMPT Get P-digit user guess
 46 10
 47 RCL 00
 48 Y/X 10^P
 49 X<=Y? If guess greater than P digits...
 50 GTO 04 ...then go get legal guess
 51 / Else normalize valid guess

Listing 3 continued on page 262

MODEL II



26-4002
64K 1 Drive
\$3466.00

MODEL III



26-1061 4K I. \$630.00
26-1062 16K III. 900.00
26-1063 32K III
2-Drives. RS232. 2246.00



CENTRONICS

Fast 100 CPS Centronics
730 Printer. \$659.00
Text Quality Centronics
737 Printer. \$819.00

Model II Cobol Compiler
\$360.00
Cobol Run Time Package
\$36.00

DISCOUNT TRS-80[®] DEALER A301

COMPUTER SPECIALISTS

26-1051 4K Level I System.....	\$424.00
26-1054 4K Level II System.....	552.00
26-1145 RS-232 Board.....	84.00
26-1140 "O" K Interface.....	249.00
26-1141 "16" K Interface.....	359.00
26-1142 "32" K Interface.....	469.00
26-1160 Mini Disk - Drive O.....	419.00
26-1161 Mini Disk - Additional.....	419.00
26-1154 Lineprinter II.....	699.00
26-1156 Lineprinter III.....	1799.00
26-1159 Lineprinter IV.....	859.00
26-1104 Factory Upper/Lower Case Modification Installed.....	70.00
26-1506 Scripsit - Tape.....	60.00
26-1563 Scripsit - Disk.....	79.00
26-1566 Visicalc.....	83.00
26-1562 Profile.....	72.00

NOTE: Call for availability of VIDEO TEX, Model III. Color, and other new products.

**ALL OTHER R.S. SOFTWARE
FURNITURE, STANDS, CABLES
AND ACCESSORIES DEDUCT
10% FROM CATALOG PRICE**

Novation Cat Modem.. \$149.00
CCA Data Management
System..... 72.00
Adventure Games
Games 1-9 each..... 14.00

Pocket Computer



26-3501 1.9K P.C..... \$225.00
26-3503 Cassette I/F..... 45.00
14-812 Recorder..... 72.00

MODEL I



26-1056
**16K Level II
System**
\$670.00
COLOR



26-3001 4K..... \$360.00
26-3002 16K..... 540.00
26-3010 Color Video..... 360.00
26-1206 Recorder..... 54.00
26-3008 Joysticks..... 22.50



**Acorn
Software
Products, Inc.**

GAMES:

Alien Invasion..... \$9.00
Stack Market..... 9.00
Star Trek..... 9.00
Black 'Em..... 9.00
Ting-Tang..... 9.00

UTILITIES:

System Savers..... 14.00

EDUCATION:

Language Teacher..... 18.00

**FREE: COMPUTER CATALOG
UPON REQUEST**

1-800-841-0860 Toll Free Order Entry

MICRO MANAGEMENT SYSTEMS, INC.

No Taxes on Out Of
State Shipments

Immediate Shipment
From Stock on Most Items

DOWNTOWN PLAZA SHOPPING CENTER
115 C SECOND AVE. S.W.
CAIRO, GEORGIA 31728
(912) 377-7120 Ga. Phone No.

*TRS-80 is a registered trademark of the Tandy Corp.

R.S. 90 Day Limited Warranty
F-48 Form Provided

Largest Inventory
In the S.E. U.S.A.

Listing 3 continued:

```

121 RDN          Recall shifted guess
122 DSE 08      Repeat till all P digits displayed
123 GTO 12
124 RTN          Return from subroutine
125 LBL "GDIG"  Subroutine to return 1 digit of guess
126 RCL 06
127 10
128 RCL 07      Register 07 = desired position in guess
129 Y / X
130 *
131 INT
132 10
133 MOD
134 RTN          Return from subroutine
135 LBL "RDIG"  Come here to get random digit, 0 to 9
136 RCL 11      Seed
137 9821
138 *
139 .211327
140 +
141 FRC          New random seed, 0 to 1
142 STO 11
143 10
144 *
145 INT
146 RTN          Return from subroutine, digit on top of stack
147 END

```

Text continued from page 258:

The most interesting part of the program is contained in lines 18 thru 40, which consist of two nested loops for selecting *P* random digits with no two digits the same. Lines 18 thru 23 initialize the outer loop control parameters in register 07. For example, if three digits are desired, register 07 will be initialized to 1.003. The end of

the loop is on lines 39 and 40, with line 39 incrementing register 07 until it reaches 3.

Register 07 is used inside the loop as the subscript for an array of size *P* in registers 01 thru *P*, each to contain one digit of the code number. An inner loop, controlled by register 08, compares all previously selected digits to the new candidate digit, and rejects any duplications. The logic of this code selection segment of the program can be illustrated by its BASIC equivalent:

```

10 DEF FNR = INT(RND*10)
.
.
.
100 D = FNR
110 FOR I = 1 TO P
120   N(I) = D
130   D = FNR
140   FOR J = 1 TO I
150     IF N(J) = D THEN 130
160   NEXT J
170 NEXT I

```

After the code is selected, the user's guess is entered. Each user guess is stored in register 06 in a normalized format obtained by dividing the guess by 10^P . For example, a guess of 012 would be stored as .012 in a three-digit game; a guess of 30987 would be stored as .30987 in a five-digit game. This format is used so that function GDIG (line 125) can extract the *l*th digit, *D*, from the guess, *G*, by calculating $D = \text{MOD}_{10}(\text{INT}(G \times 10^l))$.

The balance of the program is fairly straightforward. Lines 94 thru 98 illustrate how to simultaneously display five individual numbers and two alphanumeric character strings. Note that subroutine SHOG (line 108) displays each digit of user's guess individually; otherwise, a guess with a leading zero would not show the zero because of the automatic leading-zero suppression of the calculator.

Conclusion

I found the HP-41C far more pleasurable to program and use than its predecessors, primarily because of the alphanumeric display capabilities. The list prices of the HP-41C and its accessories are as follows:

HP-41C programmable calculator (with 63-register memory)	\$295
82106A 64-register Memory Module	45
Application Pacs, each	45 to 70
82143A Peripheral Printer	350
82104A Plug-in Card Reader	195
82153A Wand	125
HP-41C Solution Books	12.50
82045A Thermal Paper (box of six rolls)	6
82120A Rechargeable Battery Pack	40

I am able to find discounts of about 15% off the list price in my area. Larger discounts can be expected with the passage of time. The HP-41C is manufactured by Hewlett-Packard Co, Corvallis Division, 1000 NE Circle Blvd, Corvallis OR 97330.

Is the HP-41C a pocket computer? Well, maybe not quite—but what will the *next* generation of calculators be like? ■

MAIL ORDER DISCOUNTS

apple computer

Sales and Service

APPLE II PLUS 16K

\$945

APPLE II PLUS 32K \$995

APPLE II PLUS 48K \$1,059

ACCESSORIES

DISK II DRIVE & CONTROLLER (DOS 3.3) 525	MICROSOFT Z-80 SOFTCARD SYSTEM 290
DISK II DRIVE ONLY 420	VIDEX 80 COLUMN BOARD 350
INTEGER BASIC FIRMWARE CARD 149	W/GRAPHICS AND SWITCH 315
APPLESOFT II FIRMWARE CARD 149	DC HAYES MICROMODEM II 510
M&R SUR-R-MOD RF MODULATOR 25	SILENTYPE PRINTER W/INT. CARD 420
CENTRONICS PRINTER INTERFACE CARD 185	LANGUAGE SYSTEM W/PASCAL 650
HIGH-SPEED SERIAL INTERFACE CARD 145	GRAPHICS TABLET 35
LEEDEX VIDEO 10" 12" B&W MDNITOR 129	ALF MUSIC SYNTHESIZER 30

SOFTWARE

APPLE FORTRAN 165	THE CONTROLLER BUSINESS SYSTEM 515
DOS 3.3 49	THE CASHIER RETAIL MANAGEMENT 199
APPLE DOS TOOL KIT 65	VISICALC 120
APPLEPLOT GRAPH & PLOT SYSTEM 60	APPLEWRITER TEXT EDITOR 65
CCA DATA MANAGEMENT 85	BASF 5 1/4" DISKETTE (10) 30

- WE WILL TRY TO BEAT ANY ADVERTISED PRICE
- WE PERFORM APPLE WARRANTY REPAIR

TO ORDER: Please phone using VISA and Master Card. Or send cashier's check, money order or personal check (allow 14 business days to clear). VISA and MC credit card service add 2%. Shipping, handling and insurance add 3%. California residents add 6% sales tax.

ORDER HOURS: Monday thru Saturday 9-5 PST.

computer age, inc.

Authorized Apple Dealer & Service Center

4688 CONVOY ST., SUITE 105, SAN DIEGO, CA 92111 (714) 565-4042

The PRACTICAL MICROCOMPUTER PROGRAMMING™ books . . .

WHAT DO THE CRITICS SAY?

BYTE: "It was apparently Mr. Weller's goal from the beginning to present the fundamental concepts of assembly language programming in a completely nonthreatening way. He has accomplished this better than any other author to date. . . Practical Microcomputer Programming is a very powerful series. It is well written and full of essential techniques for the assembly language programmer." . . . "The authors know the difference between a novice and a ninny. They never talk down. . . on every page the authors spot and clear up the small ambiguities of technical jargon that can block understanding."

Kilobaud: "A powerful plus for this book is the author's determination to demonstrate why and how to use each instruction, not merely to explain how it works. . . At no point do the authors resort to rehashing material available from the manufacturer. . . but instead choose a less theoretical, more practical approach."

Leventhal: ". . . large numbers of documented, well structured examples, and a clear readable style, a logical development of major topics."

Digital Design: "This book is the best and most lucid introduction to Z80 programming that we have seen."

CACHE: "This is an EXCELLENT book. . . dirt cheap for such great software and documentation."



IF YOU'VE TRIED THE "CHEAPIES" AND AREN'T SATISFIED WITH WHAT YOU GOT, IT'S TIME TO TRY THE REAL THING, THE ACKNOWLEDGED WORLD STANDARD OF TECHNICAL EXCELLENCE IN ASSEMBLY LANGUAGE PROGRAMMING INSTRUCTION—THE PRACTICAL MICROCOMPUTER PROGRAMMING BOOKS.

- FOR THE 6502 -

PRACTICAL MICROCOMPUTER PROGRAMMING: THE 6502 by W. J. Weller \$32.95
20 chapters, 6 appendices, 475 page Smythe sewn hardcover covering all fundamental assembly language techniques for the 6502 processor. The text explanation is re-enforced with 118 verified, real world programming examples that run on real computers. An extended 6502 language, supported by a new editor/assembler which comes with the book, circumvents many of the problems which have made the 6502 so difficult to program in the past. In addition to the fundamental technique chapters, there are special chapters covering simple graphics, elementary cryptography and random number generation and use. The source texts of both the editor/assembler and a powerful new debugging monitor for the Apple II and Apple II+ included in appendices. The object code for this software is supplied FREE to book purchasers on Apple cassette or for \$7.50 on disk when the licensing agreement from the book is returned to the publisher. The editor/assembler is also available on paper tape for users of other 6502 based systems.

- FOR THE Z80 -

PRACTICAL MICROCOMPUTER PROGRAMMING: THE Z80 by W.J. Weller \$32.95
18 chapters, 4 appendices, 481 page Smythe sewn hardcover which details assembly language technique as applied to the Z80 processor. The Z80 is treated as an 8080 superset in an 8080 extension language, which means that you don't have to discard your hard won 8080 knowledge to program the Z80. In addition to the fundamental chapters there are chapters on graphic output and full four function decimal arithmetic. The text explanation is re-enforced with 104 tested, verified programming examples. A powerful editor/assembler and debugging monitor, in source form, are provided to support the language used in the book. This software will run on any Z80 based computer with 10K RAM beginning at 0. Object code for both editor/assembler and debugging monitor is sent to book purchasers FREE on paper tape or, in modified form, on TRS-80 Level II cassette when the coupon from the book is returned to the publisher.

- FOR THE 8080 -

PRACTICAL MICROCOMPUTER PROGRAMMING: THE INTEL 8080 by Weller, Shatzel and Nice \$23.95
18 chapters, 3 appendices, 318 page Smythe sewn hardcover which applies fundamental assembly language technique to this most popular of processors. The text is supported by 84 separate programming examples. The book includes a special section on the handling of complex peripheral devices and exotic typefaces. Appendices give the source for an 8080 resident debugging monitor and a minicomputer cross assembler for the 8080. Also available (not shown above) are a workbook for use with this text (\$9.95) and AN EDITOR/ASSEMBLER SYSTEM FOR 8080/8085 BASED COMPUTERS (\$15.95) which supports the language used in the text. These three books together make a complete teaching package for the 8080.

- FOR THE 6800 -

PRACTICAL MICROCOMPUTER PROGRAMMING: THE M6800 by W.J. Weller \$23.95
16 chapters, 2 appendices, 299 page Smythe sewn hardcover text which details the application of fundamental assembly language technique to the 6800. 104 separate programming examples re-enforce the text explanation. Contains in addition special chapters on low precision trigonometry and random number generation and use. A resident debugging monitor for 6800 systems is included in an appendix.

NO GAMES, NO NONSENSE, NO REPRODUCTIONS OR REHASHES OF MANUFACTURER'S DATA SHEETS, JUST TESTED, ACCURATE, RELEVANT PROGRAMMING INFORMATION BACKED UP BY REAL EXAMPLES THAT RUN ON REAL COMPUTERS—THE PRACTICAL MICROCOMPUTER PROGRAMMING BOOKS. THERE IS NOTHING ELSE AS GOOD ANYWHERE, AT ANY PRICE.

Mail to: Northern Technology Books, Box 62, Evanston, IL 60204

- | | |
|---|---------|
| <input type="checkbox"/> Practical Microcomputer Programming: The 6502 | \$32.95 |
| <input type="checkbox"/> Practical Microcomputer Programming: The Z80 | \$32.95 |
| <input type="checkbox"/> Practical Microcomputer Programming: The Intel 8080 | \$23.95 |
| <input type="checkbox"/> Practical Microcomputer Programming: The M6800 | \$23.95 |
| <input type="checkbox"/> Workbook for Practical Microcomputer Programming: The Intel 8080 | \$ 9.95 |
| <input type="checkbox"/> An Editor/Assembler System for 8080/8085 Based Computers | \$15.95 |

Check enclosed (U.S. funds only)

Money order enclosed

Name _____

Street _____

City _____ State _____ Zip _____

Illinois residents add 5% sales tax

Microsoft Adventure

Bob Liddil, POB 66, Peterborough NH 03458

For there are treasures to be found
As mysteries unfold
In the depths of the great unknown
In the search for yellow gold.
But beware the shadows,
For who knows what they hold
In the great Colossal Cave?
From "Adventure's Song"
—Freerover the Bard

Of all the computer simulations available for the microcomputer user, none stirs the imagination quite like Adventure. And of all the Adventure games Microsoft's is one of the most intriguing.

The premise of this *Adventure*, exploration of the Colossal Cave, is not a new one. It is, in fact, the basis for the

original *Adventure* that has been appearing around university campuses and mainframe computers for years. According to Microsoft, the Digital Equipment Corporation PDP-10 version is reproduced faithfully for the TRS-80 with 32 K bytes of programmable memory and a single disk drive.

[Editor's note: I had the good fortune to log onto a Digital Equipment Corporation PDP-11/70 that was running the original *Adventure*. This version credited Willie Crowther with the original version of the program and Don Woods with "most of the features of the current version." Although the Softwin Company is credited with writing the Microsoft *Adventure*, the names of Willie Crowther and Don Woods should be added to the list. Short sessions with both the Microsoft and the PDP-11 versions of the *Adventure* showed them to be virtually identical in content, program logic, and wording. Mr Letwin has added some features (described below) and has made slight format changes that make the version more playable....GW]

The Microsoft *Adventure* sets itself against the *de facto* norm later established by Scott Adams. The split screen, the blinking cursor, all the slick niceties of the Adams and similar *Adventures* are missing. That does not detract from the game, though, because they are replaced by technical innovations that make game play easy and painless.

The *Adventure's* acceptance of shorthand commands is a joy. Instead of tediously typing GO HOUSE or GET KNIFE, one needs only type HOUSE or KNIFE. The computer understands and complies. The directional shorthand commands, N, S, E, W, U, and D (for the four compass points and the directions UP and DOWN), are convenient. Adventurers will be very comfortable with the ease with which this program functions.

Adventurers in the Colossal Cave will come across situations they may recognize from other *Adventures*. This is acceptable. It gives a player a sense of comfort and familiarity in an otherwise hostile environment.

Most of the descriptions used for locations and objects are stored on the floppy disk and called only when needed. This arrangement prevents the descriptions from being terse as a result of limited program space. These plush and vivid descriptions add much to the enjoyment of the game. The puzzle of this *Adventure*, while difficult to

At a Glance

Name Microsoft <i>Adventure</i>	Language Machine language
Type Adventure game	Computer Radio Shack TRS-80 Model I with single disk drive and 32 K bytes of memory (also available for Apple II with one disk drive and 32 K bytes of memory; same price)
Manufacturer Microsoft Consumer Products 10800 NE Eighth, Suite 819 Bellevue WA 98004 (206) 454-1315	Documentation Instructions in game, plus short booklet
Price \$29.95	Audience General audience
Format 5-inch floppy disk	

OSBORNE/McGraw-Hill

WAKES UP YOUR COMPUTER AND PUTS IT TO WORK



**Doing
Something
Useful**



All too often, computer users who've cut their eye teeth on entertainment programs, have trouble coming up with ideas for practical computing. Your computer plays space games well enough, but when you have a down-to-earth practical problem like a lease/buy decision, income averaging or statistical estimation, can it perform?

It can now!

In **PRACTICAL BASIC PROGRAMS** you will find 40 useful and easy-to-use programs that solve common problems in finance, management, statistics, math and science. The book includes complete write-ups and real-life situations to help you see a wealth of useful computer applications.

SOME COMMON BASIC PROGRAMS contains no fewer than 76 brilliantly documented programs you can use even if you don't know BASIC. You'll get a lot of math power including personal finance, taxes, and statistics. Other programs include recipe cost and check writer. The cost? — 16¢ per program!

This book is available in a new PET edition, and on ready-to-run cassette or disk for PET/CBM. It's also on cassette for TRS-80 users. All cassettes and disks are fully guaranteed. Use the book for documentation and operating instructions.

So if you have purchased a very expensive plaything, now you can get it busy doing what a computer was meant to do. **WORK!**

Name _____
 Street _____
 City _____
 State _____ Zip _____

	Price	Quantity	Amount
* SCBP Book	\$12.50		
* SCBP PET Book	\$12.50		
SCBP PET Cassette	\$15.00		
SCBP PET Diskette	\$22.50		
SCBP TRS-80 Cassette	\$15.00		
** Practical Basic Programs	\$15.00		

Effective January 1, 1981 prices will be
 * \$14.99 ** \$15.99

Check or Money orders only.
 Add: 75¢/item — 4th class
 \$1.25/item — UPS
 \$2.50/item — Air Mail
 \$4.00/item — Foreign Orders

California residents add local sales tax Phone orders call (415) 548-2805

Tax	
Shipping	
Total	

OSBORNE/McGraw-Hill
 630 Bancroft Way, Dept. B10
 Berkeley, California 94710



1113



S-100 BUS FLOATING POINT

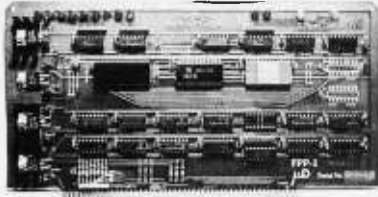

FPP-1 Floating Point Processor \$599

- Integer and double integer multiply, divide
- Hardware (AMD9511) math functions: SQR, SIN, EXP., LOG, etc.
- measured speeds 5 to 10 + times faster than software

FPP-2 Floating Point Processor \$650

- IEEE standard floating point format (AMD9512)
- single and double precision
- speeds floating point 5 to 10 times

BOTH PRODUCTS Feature:

- IEEE S-100 Bus Standard
- counter/timers and vectored interrupt control
- support libraries on floppy disk
- transparent use with Microsoft FORTRAN
- soon supports Microsoft BASIC compiler, Intersystems PASCAL Z
- ideal for all computational applications: graphics, statistics, correlations, filtering, FFT's, factor analysis, etc., etc.

Micro Designs
P.O. Box 497, Tour de la Bourse
Montreal, CANADA, H4Z 1J7
(514) 284-3348

VISA, M/C accepted
OEM discounts

DIGITAL COMPUTER CASSETTES

- Ideal for Apple, Pet or TR-S80 Users.
- Eight Special 50 Foot Cassettes.
- Unique Storage Album.

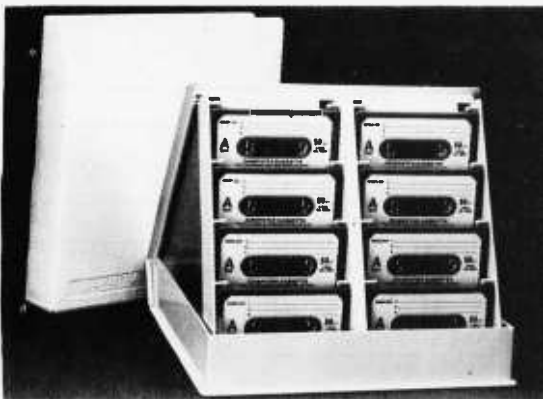

\$9.⁹⁵ each or 3 for \$26.⁰⁰
Extra cases - \$4.⁹⁵

No Sales Tax For Out Of State Customers
Price Includes Free Shipping In Continental U.S.

Dealer Inquiries Welcome

Sound Concepts
P.O. Box 299
Provo, Utah 84601

Call Collect
for Master Card
or Visa Orders
801-375-7333

decipher fully in one or even a half dozen sittings, is not impossible. It is well laid out, challenging, and presented logically. It is solvable, given time.

There are monsters lurking in the shadows. There is, in the first level of the cave, a knife-wielding dwarf who attacks repeatedly at nearly every turn. I suspected for a while that there was a dwarf-cloning machine somewhere far below me in the depths of the cave, turning out rubber-stamp dwarves that stood in line to try to kill me. As fast as I dispatched one, another popped up to take his place.

Just out of plain view, a mystery figure beckons to me in the dim light. In trying to reach this spectre, to find out why he/she/it is there, I got lost in a maze of crisscross tunnels, not once but five times.

The nonplayer characters are not the only barrier to your progress as an adventurer. The cave is the adventurer's worst enemy. Its passages twist and turn, creating the kind of terminal (*sic*) frustration that has made this *Adventure* a favorite of thousands of personal-computer users.

The game is divided into three skill levels consisting of the beginning, intermediate, and advanced caves. The intensity of play increases by level so that, by the time the *Adventure* program offers a Grandmaster game to a player, the player has survived virtually every fantasy situation conceivable. The Grandmaster level is attainable only after every other puzzle is solved and all treasures have been obtained. Few Grandmasters exist. It is a goal worth working toward.

The Microsoft *Adventure* is a gold mine for the enthusiast and a nightmare for the software pirate. (After all, you would expect Microsoft to actively protect its product.) I was unable to copy the Microsoft *Adventure* disk, even with the help of several disk inspection/modification programs.

The Microsoft *Adventure* is attractively packaged and well documented. The buyer should have no trouble finding it on the pegboard of his local computer store. It is well worth the price being charged. The *Adventure* lover is in for many hours of pure enjoyment with this one.

Conclusions

• This is an interesting *Adventure* in many ways. First, it is the original *Adventure* that was first running on a PDP-10. It is also one of the most sophisticated *Adventure* games I have seen. Since it is written in machine language, it is faster than the *Adventures* that are written in BASIC. It draws its descriptions from the floppy disk; therefore it is a fuller *Adventure* than most other *Adventures*, which offer limited description as a result of storing the text with the program and are limited by the amount of memory in the computer.

• This *Adventure* has a different format from that of other microcomputer *Adventures*. This should not be construed as a shortcoming; I mention it only for the benefit of *Adventure* enthusiasts accustomed to the other, more recent format.

• Microsoft *Adventure* is actually a series of *Adventures* that reveal themselves as the player becomes more skillful. It can be enjoyed by both the novice and the experienced player. The ability to save the game on disk allows a player to take advantage of deeper levels of play without being confined to one sitting. ■

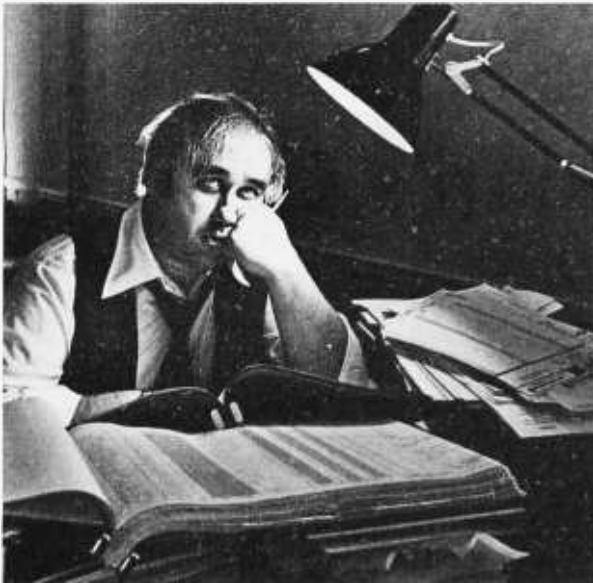

Can You Tell Which Tax Practitioner Uses Aardvark Software[™]?

Aardvark helps you eliminate long hours of arduous work by providing fast, accurate and cost-effective software. Aardvark helps you save time and energy, while your clients benefit from some of the most comprehensive tax programs available.

The Aardvark system, designed by CPA's with over 17 years of "Big Eight" tax experience, meets or exceeds the requirements of most professional tax preparers. All Aardvark Software[™] programs run on a variety of microcomputers, including Microengine,* ACI-90,** Apple,[†] and TRS-80.^{††}

Two new products from Aardvark are "Tax Prep" and "Tax Plan." "Tax Prep" allows you to easily calculate your client's Federal Form 1040, including all lettered schedules (A-TC) and the most frequently used numbered forms. Selected state forms are also

available. Since this system is user-oriented and fully prompting, even a novice can process forms immediately. "Tax Plan" is designed to eliminate hours of work and human error when evaluating various tax alternatives for your clients. It allows you to enter a variety of income and expense items and isolate the tax effects attributable to changes in one or more items (e.g. wages, capital gains, charitable contributions, etc.)

Aardvark Software[™] programs are fast, efficient and easy to use. Of course, if you enjoy working nights, weekends, holidays,...

For more information, please write or call us.

* is a trademark of Western Digital Corporation.
** is a trademark of Associated Computer Industries.
† is a trademark of Apple Computer Inc.
†† is a trademark of Tandy Corporation.

AARDVARK SOFTWARE INC.

The Microcomputer People for Professionals

783 NORTH WATER STREET MILWAUKEE, WISCONSIN 53202 414/289-9988

Lost Dutchman's Gold

Bob Liddil
The Programmer's Guild
POB 66
Peterborough NH 03458

Teri Li
POB 481
Peterborough NH 03458

Lost Dutchman's Gold is an Adventure game that takes place in the Old West at the turn of the century. The object of the game is to find the gold (and other treasures) hidden in the Lost Dutchman's Mine and successfully find your way out. The Adventure starts in an abandoned miner's shack where you'll find a rifle and a shovel. If you can find it, there is also a map of the mine hidden somewhere to help you on your Adventure.

This program (see listing 1) is written in Applesoft BASIC and requires 24 K bytes of memory and one disk drive. It will also run on nondisk Apples if the commands related to saving a game to disk are deleted. With some modifications, this Adventure game should run on other

microcomputers that use Microsoft BASIC.

[Unfortunately, the disk commands in this program contain invisible control-D characters at the beginning of some lines. (It is the control-D character that signals the beginning of a disk command within a PRINT statement.) All PRINT statements that begin with the words OPEN, CLOSE, READ, WRITE, VERIFY, and NOMON should have as their first character the invisible control-D character. To the best of my knowledge, the lines that need this character are lines 36, 85, 95, 2535, 2550, 4000, and 4100. We regret this inconvenience to our readers....GW] ■

Listing 1: Lost Dutchman's Gold. Written in Applesoft BASIC, it requires 16 K bytes of programmable memory.

```
10 POKE 34,0: POKE 35,24: TEXT :  
    HOME  
20 VTAB 5: PRINT " WELCOME TO T  
    HE SEARCH FOR THE LOST DU  
    TCHMAN'S GOLD. I'M THE GHOS  
    T OF BACK-PACK SAM, YER GUID  
    E ON THIS ADVENTURE.  
  
    YA CAN  
    USE 2 WORD COMMANDS TO FIND  
    CLUES'N MOVE 'BOUT. GET, G  
    O, PUT, DROP,  
30 PRINT "SCORE, INVENTORY 'N 'B  
    OUT 100 MORE WORDSMAKE SENSE  
    TA ME. ASK FER HELP IF YA  
    GET STUMPED.": PRINT "  
  
    I HO  
    PE YA DON'T END UP A GHOST,  
    LIKE ME!  
  
    GOOD LUCK!!  
35 REM WORLD COPYRIGHT (C) 1980  
    BY TERI LI. ALL RIGHTS  
    RESERVED.  
36 DIM N$(26,7),O$(32,3),R$(46):  
    B = 0:IN = B:LN = 50:LM = LN  
    :X1 = B:X2 = B:T$ = "":M1$ =  
    T$:M2$ = T$:QM$ = T$:U = B:U
```

```
1 = B:IM = 2:BD = 21:L = 1:C  
$ = CHR$(13): PRINT "NOMON  
I,O,C  
40 FOR L = B TO 26: FOR I = B TO  
    7: READ N$(L,I): NEXT I,L  
50 FOR I = B TO 32: READ O$(I,0)  
    ,O$(I,1),O$(I,2):O$(I,3) = "  
    ": NEXT  
60 FOR I = B TO 46: READ R$(I): NEXT  
  
70 PRINT "  
    HIT 'SPACE' TO START."  
    : GET QM$:L = 1: INPUT "REST  
    ORE OLD GAME?";QM$: IF LEFT$(  
    (QM$ + " ",1) < > "Y" THEN  
    100  
80 INPUT "NAME?";QM$:QM$ = "LDG/  
    " + QM$: ONERR GOTO 4000  
85 PRINT "VERIFY "QM$: PRINT "OP  
    EN "QM$: PRINT "READ "QM$  
90 INPUT L,CL,LN,IN,LM,U,U1,IM  
91 FOR X = 0 TO 32: INPUT O$(X,1  
    ),O$(X,2),O$(X,3): NEXT  
95 PRINT "CLOSE"QM$: POKE 216,0  
100 IF ((O$(12,2) = STR$(L) OR  
    O$(12,3) = "1") AND CL > 0) OR  
    L < 15 THEN 150  
102 POKE 34,0: POKE 35,23: HOME  
    : PRINT "IT'S TOO DARK TA SE  
    E !!": IF L = 15 AND O$(6,3)
```

Listing 1 continued on page 270

Easy Writer™

The Professional
Word Processing System
for your Apple-II Personal Computer



EasyMailer™

The Continuous Letter Module



EasyMover™

The Personal Electronic Mail Module



INFORMATION UNLIMITED SOFTWARE, INC.
The entire EasyWriter
family of office communication
products is available through your
local computer store or directly from
our office in Berkeley, Ca.

IUS (Information Unlimited Software, Inc.), 281 Arlington Ave., Berkeley, CA 94707 415-525-4046

Listing 1 continued:

```

    < > "1" AND O$(4,3) < > "
    1" THEN PRINT "YA HEAR A ST
    RANGE NOISE !
110 POKE 35,24: GOTO 350
120 T$ = "OK": RETURN
140 B = 1: PRINT : PRINT "YA SEE
    : "; RETURN
150 IF CL = 1 THEN LN = LN - 1: IF
    LN < 1 THEN CL = 0
160 I = FRE (0):L1 = L
170 B = 0: POKE 35,BD: POKE 34,0:
    VTAB 1: HOME : POKE 35,24: PRINT
    "YER N$(L,0)".": FOR J = 0 TO
    32: IF VAL (O$(J,2)) < > L
    THEN 240
175 IF B = 0 THEN GOSUB 140
180 IF O$(J,3) = "-7" OR O$(J,3)
    = "-2" THEN PRINT "BURNT "
    ;
190 IF J < > 1 OR VAL (O$(1,2)
    ) < > L THEN 200
193 IF O$(1,3) = "" THEN PRINT
    "UNTIED ";: GOTO 200
196 IF O$(1,3) = "-9" THEN PRINT
    "DEAD ";
200 IF O$(J,3) = "-3" THEN PRINT
    "SMASHED ";
210 IF L < > 26 OR J < > 32 THEN
    220
213 IF U1 < > 0 THEN PRINT "UN
    ";
216 PRINT "LOCKED ";
220 IF CL = 1 AND J = 12 THEN PRINT

```

```

    "LIT ";
230 PRINT O$(J,0)". ";
240 NEXT J
250 IF U1 = 1 AND L = 1 THEN PRINT
    "OPEN TRAP DOOR. ";
260 IF N$(L,1) = "" THEN PRINT
    : GOTO 330
265 IF B = 0 THEN GOSUB 140
270 IF L < > 16 THEN 280
273 IF U < > 0 THEN PRINT "UN"
    ;
276 PRINT "LOCKED ";: GOTO 290
280 IF L < > 17 THEN 290
283 IF U = 1 THEN PRINT "UNLOCK
    ED ";: GOTO 290
286 PRINT "BLOCKED ";
290 PRINT N$(L,1)".
310 IF L = 17 AND U = 0 THEN N$(
    L,2) = " " + RIGHT$(N$(L,2)
    ),3)
320 IF L = 16 AND U = 1 THEN N$(
    L,2) = "E" + RIGHT$(N$(L,2)
    ),3)
330 CALL - 868: PRINT : IF N$(L
    ,2) = "" THEN 350
335 PRINT "OBVIOUS EXITS : ";: FOR
    I = 1 TO 4:P$ = MID$(N$(L,
    2),I,1): IF P$ = "N" THEN PRINT
    "NORTH ";
336 IF P$ = "S" THEN PRINT "SOU
    TH ";
337 IF P$ = "E" THEN PRINT "EAS
    T ";
338 IF P$ = "W" THEN PRINT "WES
    T ";
340 NEXT : CALL - 868: PRINT
350 B = 0: PRINT "=====
    =====
360 BD = PEEK (37): POKE 34,BD: VTAB
    24: IF L = 9 AND O$(22,2) =
    "11" THEN PRINT "THAR'S NOI
    SE UP AHEAD.": PRINT "SOUNDS
    LIKE INJUNS.
370 IF L = 9 AND O$(22,2) = "" THEN
    O$(22,2) = "11
390 INPUT " --NOW WHAT?";QM$
410 IF LN < 10 AND CL = 1 THEN PRINT
    "YER RUNNIN' LCW ON KEROSENE
    .
415 IF QM$ = "SAVE" OR QM$ = "SA
    VE GAME" THEN 2520
420 IF QM$ < > "SCORE" THEN 450
423 IF L < > 6 THEN T$ = "YA GE
    T NOTHIN' FOR BEIN' HERE!": GOTO
    1900
426 Z = 0: FOR I = 14 TO 17: IF O
    $(I,2) = "6" THEN Z = Z + 1
430 NEXT
440 PRINT "YA GOT "Z" TREASURES,
    TOT'LIN "(Z / 4) * 100"%": IF
    Z = 4 THEN PRINT "YA MADE I
    T!": GOTO 2220
445 T$ = "YA MISSED SUM TREASURE!
    ": GOTO 1900
450 IF CL = 0 AND L = 15 AND O$(
    6,3) < > "1" THEN PRINT "Y
    E GAD!": PRINT "YA BEEN BIT
    BY A RATTLER.": PRINT "YER D
    EAD.": GOTO 2220
460 IF L = 17 AND U = 1 AND RND
    (1) * 9 + 1 < 2 THEN PRINT

```

BUILDING BLOCKS FOR
MICROCOMPUTER SYSTEMS,
CONTROL & TEST EQUIPMENT



R² I/O

2K ROM 2 K RAM
3 SERIAL PORTS 1 PARALLEL PORT



TT-10

TABLE TOP MAINFRAMES



ECT-100-F

RACKMOUNT CARD CAGES

POWER SUPPLIES, CPU's,
MEMORY, OEM VARIATIONS

SPECIALIZING
IN
QUALITY
MICRO-
COMPUTER
HARDWARE

INDUSTRIAL
EDUCATIONAL
SMALL BUSINESS
PERSONAL

ELECTRONIC
CONTROL
TECHNOLOGY

763 RAMSEY AVE.
HILLSIDE, N.J. 07205

(201) 686-8080

```

"&{#}&@ CAVE IN !! /:~*@" :
  PRINT "THE IRON DOOR'S BLOC
  KED,": PRINT "YER TRAPPED!!"
  :U = 0
480 IF QM$ = "HELP" THEN X = VAL
  (N$(L,3)): ON X GOSUB 2300,2
  310,2320,2330,2350,2370,2380
  ,2390: GOTO 100
490 X1 = LEN (QM$): IF X1 < 3 THEN
  T$ = "WHAT?": GOTO 1900
493 X3 = 0: FOR X2 = 3 TO X1:M1$ =
  MID$(QM$,X2,1): IF M1$ = "
  " THEN X3 = X2:X2 = X1
495 NEXT X2:X2 = X3: IF X3 = 0 THEN
  X2 = X1
500 P$ = LEFT$(QM$,3): IF X2 <
  > X1 AND X2 + 3 > X1 THEN 6
  10
501 II = - 1: FOR I = 0 TO 42: IF
  P$ = R$(I) THEN II = I
502 NEXT : IF II > - 1 THEN I =
  II: GOTO 520
510 IF X1 = X2 THEN T$ = "WHAT?"
  : GOTO 1900
511 T$ = "SORRY, BUT YA CAN'T " +
  LEFT$(QM$,X2): IF X2 < X1 THEN
  T$ = T$ + RIGHT$(QM$,X1 -
  X2)
512 T$ = T$ + ".": GOTO 1900
520 IF I < 8 AND X1 = X2 THEN ON
  I + 1 GOSUB 2010,2010,2010,2
  220,680,2020,1920,2000: GOTO
  1900
540 JJ = - 1:M1$ = MID$(QM$,X2
  + 1,3): FOR J = 0 TO 32: IF
  M1$ = LEFT$(O$(J,0),3) THEN
  JJ = J
542 NEXT :J = JJ: IF JJ > - 1 THEN
  630
543 IF M1$ = "IRO" THEN 580
545 IF I = 36 THEN 940
550 IF N$(L,1) = "" THEN 560
552 Z = 1:A = Z:X1 = LEN (N$(L,1
  )): FOR X2 = 5 TO X1: IF MID$(
  N$(L,1),X2,1) < > CHR$(4
  6) AND X2 < > X1 THEN NEXT
  : GOTO 560
553 M2$ = MID$(N$(L,1),Z,3): IF
  M2$ = M1$ THEN 556
554 Z = X2. + 2:A = A + 1: NEXT : GOTO
  560
556 X2 = X1: NEXT :B = A: IF I =
  10 THEN PRINT "YA SEE NOTHI
  N' SPECIAL.": GOTO 160
558 GOTO 630
560 FOR X = 43 TO 46: IF M1$ = R
  $(X) THEN X = 46: NEXT : GOTO
  650
565 NEXT
570 IF O$(4,3) = "1" OR O$(6,3) =
  "1" THEN IF I = 23 AND M1$ =
  "SEL" THEN PRINT "OK": PRINT
  "YER DEAD.": GOTO 2220
580 IF I = 32 THEN GOSUB 780: GOTO
  1900
590 IF I = 33 THEN GOSUB 860: GOTO
  1900
600 T$ = "I CAN'T TELL WACHA WANT
  .": GOTO 1900

```

Listing 1 continued on page 272

STILL PLAYING GAMES WITH YOUR COMPUTER?

GET DOWN TO BUSINESS WITH CBS.

THE CONFIGURABLE BUSINESS SYSTEM™ is a ready-made set of programs that lets you customize your computer without ever using a complex programming language.

- It makes accounting a 1,2,3 operation.
- It turns inventories into child's play.
- It makes mailing lists a zip.

In fact, CBS now makes the business of

computers so easy, you might still think you're playing a game!

Disks and manual, \$395. Manual only, \$40.

CBS Disks can fit any 8080 or Z80 computer with CP/M.* Your DMA representative can tell you about PDOS, our CP/M compatible operating system, and ASCOM, an Asynchronous Communication Control Program.

DMA ● WE SPEAK YOUR LANGUAGE.

CP/M* is a Trademark of Digital Research Corp.

DYNAMIC MICROPROCESSOR ASSOCIATES • 545 Fifth Avenue • New York, New York 10017 • (212) 953-1721 • Master Charge and VISA accepted

AUTHORIZED TRS 80® DEALER #R491

\$670.00

MODEL I

16K Level II with Keypad
26 - 1056

\$3500.00

MODEL II

MODEL II, 64K
26 - 4002

\$875.00

MODEL III

MODEL III 16K RAM,
MODEL III BASIC
26 - 1062



WE ACCEPT CHECK, MONEY ORDER, DR
PHONE ORDERS WITH VISA OR MASTER
CHARGE. SHIPPING COSTS WILL BE ADDED
TO CHARGE ORDERS. DISK DRIVES, PRINT-
ERS, PERIPHERALS, AND SOFTWARE -
YOU NAME, WE'VE GOT IT.
WRITE OR CALL FOR OUR COMPLETE
PRICE LIST.

FULL FACTORY WARRANTY
ON ALL ITEMS SOLD.

C & S ELECTRONICS, LTD. 32 EAST MAIN ST. MILAN, MICH. 48160
(313) 439-1508 (313) 439-1400

C & S ELECTRONICS MART IS AN AUTHORIZED TRS 80® SALES CENTER STORE #R491



Finally, a language to meet your needs

The new S-BASICTM language has more computing power than any other true compiler BASIC in the industry.

- S-BASICTM is the ONLY CP/M™ compatible BASIC providing . . .
- Chainable .COM programs with parameter passing.
- Dynamically allocated arrays, sequential and random file buffers.
- Dynamically relocatable variables.
- Common, global, and local variables.
- A choice of: While-Do, Repeat-Until, Begin-End, If-Then-Else, and Case-Of Structures.
- Recursive, Multi-lined functions and procedures.
- Memory image disk storage (no conversions).
- CP/M 2 .xx enhancements usage as well as CP/M™ 1.4 x capable.
- 6 data types: Character, string, integer, single and double precision floating point, and packed BCD.

Besides all of these unique features, S-BASICTM offers long variable names, digit/string line labels (when required), relocatable code output, multiple libraries, external .COM program execution, all of the flexibility of an enhanced BASIC, and a multitude of conveniences that make programming a pleasure.

As a software house, always looking for that ideal, powerful, new language . . . we're excited about making S-BASICTM available to the software community.

MICRO*AP, INC.
9807 Davona Drive San Ramon, CA 94583
(415) 828-6697

MICRO*AP



*S-BASIC is a trademark of Topaz programming.
*CP/M is a registered trademark of Digital Research.

Listing 1 continued:

```

610 T$ = "I MUST BE DUMB, YA DON'
    T MAKE SENSE.": GOTO 1900
630 IF I < 9 THEN 650
633 IF J < 33 AND J > - 1 THEN
    B = VAL (O$(J,2)): IF B < >
    L AND B > 0 THEN 1890
636 IF J > 32 THEN J = 29
640 ON I - 8 GOSUB 1250,1390,139
    0,1390,1250,1700,1700,1700,1
    700,1820,1820,1250,700,700,1
    080,1060,1060,920,1150,1190,
    1210,730,730,780,860,1250,90
    0,940,1700,1690,1320,1340,18
    20,2500
650 IF I < 9 THEN ON I + 1 GOSUB
    970,970,970,2220,680,970,192
    0,2000,1320
660 GOTO 1900
680 IF O$(3,3) < > "1" THEN 189
    0
683 PRINT "OK": FOR I = 13 TO 17
    : IF VAL (O$(I,2)) = - L THEN
    T$ = "EUREKA! WE STRUCK GOLD
    ?!??":O$(I,2) = STR$(L): RETURN

685 NEXT
686 T$ = "DAG NAB IT! THAR'S NOT
    HIN' HERE!": RETURN
700 IF J < > 23 THEN 1060
701 IF L = 14 THEN O$(23,2) = "1
    5": GOTO 120
702 IF L = 15 THEN O$(23,2) = "1
    6": GOTO 120
703 IF L = 16 AND U = 1 THEN O$(
    23,2) = "17": GOTO 120
704 IF L = 17 THEN O$(23,2) = "1
    9": GOTO 120
705 IF L = 19 THEN O$(23,2) = "2
    3":O$(23,3) = "-3
710 GOTO 120
730 IF J = 3 OR J = 4 OR J = 6 OR
    J = 8 OR J = 9 OR J = 11 OR
    J = 12 OR J = 13 OR J = 19 OR
    J = 27 OR J = 28 THEN 740
735 GOTO 1050
740 IF O$(J,3) = "1" THEN IN = I
    N - 1
750 O$(J,3) = "-3":O$(J,2) = STR$(
    L): GOTO 120
770 T$ = "DON'T HAVTA.": RETURN
780 IF L < > 16 THEN 800
783 IF U < > 0 THEN 770
786 IF O$(10,3) = "1" THEN U = 1
    : GOTO 120
788 GOTO 1890
800 IF L < > 26 THEN 820
803 IF U1 < > 0 THEN 770
806 IF O$(10,3) = "1" THEN U1 =
    1: RETURN
808 GOTO 1890
820 IF O$(1,3) < > "1" THEN 840

825 IF O$(0,3) = "2" THEN O$(0,3
    ) = "":O$(0,2) = STR$(L): GOTO
    120
830 GOTO 1050
840 IF CL = 1 AND O$(12,3) = "1"
    THEN CL = 0: GOTO 120
860 IF (L = 16 OR L = 17) AND U =
    1 THEN U = 0: GOTO 120
870 IF L = 26 AND U1 = 1 THEN U1
    = 0: GOTO 120
    
```

```

880 GOTO 1050
900 T$ = "YA HEAR NO'THIN' SPECIAL
    .": RETURN
920 IF L < > 11 OR O$(9,3) < >
    "1" THEN 1320
930 PRINT "THEY TOOK THE FIRE WA
    TER 'N RAN.": IN = IN - 1: O$(
    9,2) = "": O$(9,3) = "": O$(22
    ,2) = "": RETURN
940 IF M1$ = "YOH" THEN T$ = "TU
    RKEY!": PRINT "SORRY, YER IN
    THE WRONG ADVENTURE.": GOTO
    1900
950 GOSUB 120: T$ = T$ + CHR$(1
    3) + RIGHT$(QM$,X1 - X2) +
    ".": GOTO 1900
970 IF B = 0 THEN 980
973 L = VAL (N$(L,B + 3)): IF O$(
    (1,3) = "1" AND (L = 1 OR L =
    6 OR L = 15) THEN T$ = "HE W
    ON'T GO.": L = L1: RETURN
976 IF L = 17 AND U = 0 THEN L =
    L1: GOTO 1890
978 IF L1 = 26 AND L = 1 AND U1 =
    0 THEN L = L1: GOTO 1890
979 GOTO 1060
980 IF U1 = 1 AND L = 1 THEN L =
    26: GOTO 120
990 IF U1 = 1 AND M1$ = "TRA" AND
    L = 26 THEN L = 1: RETURN
1000 FOR X1 = 1 TO 4: M2$ = MID$(
    N$(L,2),X1,1): IF M2$ < >
    LEFT$(M1$,1) THEN NEXT X1
    : GOTO 1010
1003 FOR X2 = 43 TO 46: IF M1$ <
    > R$(X2) THEN NEXT X2: GOTO
    1010
1006 L = VAL (N$(L,X1 + 3)): IF
    L < > 0 THEN 1060
1010 IF L = 23 THEN T$ = "IT'S T
    OO SLIPPERY.": RETURN
1020 IF L = 25 THEN L = 26: RETURN
1030 IF L = 26 THEN L = 25: RETURN
1040 IF L = 19 THEN L = 23: PRINT
    "NIGH BROKE M'NECK!!": RETURN
1050 T$ = "SORRY, BUTCHA CAN'T DO
    THAT.": RETURN
1060 B = 0: GOTO 120
1080 IF O$(4,3) < > "1" AND O$(
    6,3) < > "1" THEN 1320
1083 IF J < > 1 THEN 1110
1086 Z = 0: IF O$(J,3) = "1" THEN
    Z = 99
1090 O$(J,3) = "-9": O$(1,2) = STR$(
    L)
1100 IF Z = 99 THEN IN = IN - 1
1110 IF J = 22 THEN PRINT "YA G
    OT ONE!": PRINT "BUT THE RES
    T GO'T YOU!": GOTO 2220
1120 IF J = 9 THEN T$ = "YA HIT
    ONE!": RETURN
1130 GOTO 120
1150 IF O$(18,3) < > "1" THEN 1
    890
1152 IF J < 0 THEN 511
1153 IF J = 4 OR (J > 5 AND J <
    11) OR (J > 14 AND J < 18) OR
    J = 22 OR J = 29 OR J > 30 THEN
    1050

```

Listing 1 continued on page 274

SB/70

Circle 189 on inquiry card.

SINGLE BOARD TECHNOLOGY

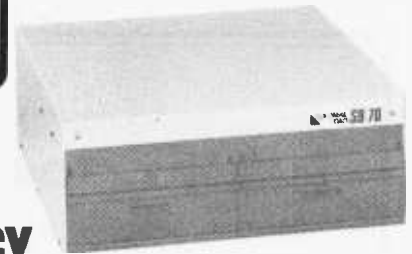

Basic system with: 600K bytes **\$2225.**
 • 1.2 megabytes \$2790.
 • 2.4 megabytes \$3350.

A Z80A CPU combined with the CP/M® operating system opens new vistas to software availability for eight-bit micros. FORTRAN, COBOL, BASIC, APL, PL/1 and Pascal are available now to accommodate today's scientific, educational, sophisticated small business and personal system users.

- 4MHz Z80A CPU
- CP/M 2 operating system
- 64K 200ns main memory
- 6K 300ns video memory
- 8-inch dual floppy drives
- color video text & graphics
- sound generator
- 2-serial ports
- 2-parallel ports
- 4-counter/timers

Substantial dealer discounts are available.
 OEM inquiries are invited. Please contact:

COLONIAL DATA SERVICES CORP.
 105 Sanford St., Hamden, Connecticut 06514
 (203) 288-2524

©CP/M is a registered trademark of Digital Research, Inc.

From S-100 to IEEE-488

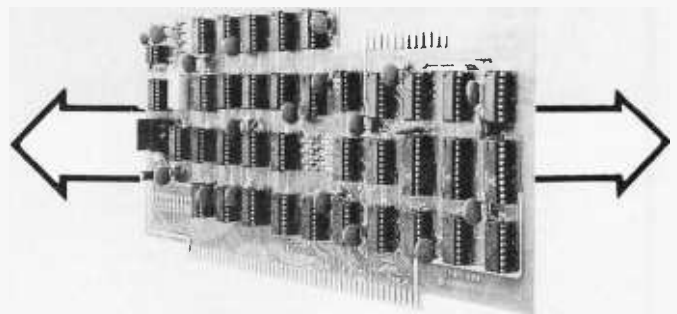

P&T-488 + S-100 computer = Intelligence for your Instrumentation System

The P&T-488 permits an S-100 computer to operate as a talker, listener, or controller on the IEEE-488 instrumentation bus for less than half the cost of calculator-based systems. Software packages which give access to the 488 bus from high level languages such as BASIC are available for CP/M, North Star DOS /BASIC, and Cromemco CDOS. Or "roll your own" system with the custom system package of assembly language drivers.

P&T-488, assembled and tested, + any software package: \$450 (domestic USA)



PICKLES & TROUT
 P.O. BOX 1206. GOLETA. CA 93017. (805) 967-9563

**** S-100 USERS ****

Is LIFE too Slow?

Specialty Video Systems celebrates the tenth anniversary of the game of *Life* with the introduction of a complete *Life* processor on a single S-100 card.

Under full software control, create dazzling video animation effects as this card displays 60 generations per second! See glider guns come to life, see spaceships zoom across the screen!

And, when you are not running *Life*, this card doubles as a 128 x 128 graphics display.

- S-100 compatible
- 128 x 128 *Life* array
- 60 generations per second
- Doubles as a graphics display
- Operates under full software control
- \$189.00 Assembled and Tested

For more information, write:

Specialty Video Systems
P. O. Box 2662
Van Nuys, CA 91404
(213) 782-5137

Payroll General Ledger Accounts Payable Accounts Receivable

Flexible and sophisticated business software that is of the highest quality. Originally developed by Osborne & Associates and rapidly becoming a standard. Accountants are pleased with our balance sheets and income statements. It has been tested and approved by secretaries.

- Complete instructions
- Up and running the same day of delivery.
- 100% guaranteed
- Unlimited free telephone assistance.
- Return within 30 days for complete refund if not satisfied.
- No licensing agreement - use as you want.

Accounts Receivable	\$95.00
Accounts Payable	\$95.00
Payroll-California	\$95.00
Payroll-Non California state income tax calculations (add to California payroll)	\$95.00
General Ledger	\$95.00
Multiple profit center option for general ledger	\$95.00
Manuals (each)	\$20.00

Formats: Any 8" single or double density, TRS-80 Mod II, Northstar DD, Vector Graphics, Super Brain, many others.

Runs on Beehive, Sorac, Hazeltine, ADDS, Televideo, SOL, TRS-80 Mod II, HEATH, ACT V, Intertube II, Altos, ADM and many other terminals. All programs in CBASIC under CP/M (includes source)

Synergetic Computer Products
575 Middlefield Avenue Suite J, Palo Alto, CA 94301
(415) 328-5391

VISA • Master Charge • COD • Company Check
TRS-80 is a trademark of Radio Shack, Inc. CP/M is a trademark of Digital Research

Listing 1 continued:

```

1156 IF O$(J,3) = "1" THEN IN =
      IN - 1
1157 O$(J,3) = "-7":O$(J,2) = STR$(
      L)
1158 IF J > 0 THEN 1060
1160 IF O$(0,3) < > "-7" THEN 1
      060
1163 O$(0,2) = STR$(L): FOR J =
      5 TO 21: IF O$(J,2) = "-1" THEN
      O$(J,3) = "-7"
1170 NEXT : GOTO 1060
1190 IF J < > 12 THEN 1150
1193 IF O$(J,3) < > "1" OR O$(1
      8,3) < > "1" THEN 1150
1195 CL = 1: GOTO 120
1210 IF J = 13 THEN PRINT "YEEE
      CH!!": PRINT "IT'S KEROSENE!
      ": PRINT "YA JUST POISONED Y
      ERSELF.": GOTO 2220
1220 IF J < > 9 THEN 1050
1230 PRINT "WHEEEEE!!": PRINT "YA
      GOT PLASTERED AND LOST A DA
      Y.": IF CL = 1 THEN LN = LN -
      10
1235 RETURN
1250 IF J > 32 OR J < 0 THEN 126
      0
1253 B = VAL (O$(J,2)): IF O$(J,
      3) = "2" OR B = L OR B = -
      1 THEN 1260
1255 IF J < 22 THEN 1890
1257 T$ = "IT AIN'T HERE.": RETURN
1260 IF J > 21 OR J = 1 OR J = -
      1 THEN T$ = "WHO THE HECK YA
      THINK YA IS?" + C$ + "PAUL
      BUNYON??: YA AIN'T STRONG '
      NUF.": RETURN
1270 IF O$(J,3) = "-7" THEN T$ =
      "IT'S BURNT UP 'N RUINED.": RETURN
1280 IF IN > 4 THEN T$ = "YA CAN
      'T! YER HANDS 'R FULL.": RETURN

1283 IF O$(J,3) = "1" THEN PRINT
      "YA ALREADY GOT IT!": RETURN

1286 IF VAL (O$(J,1)) = 0 AND I
      < > 16 THEN 1290
1287 IN = IN + 1: IF O$(J,2) = "-
      1" THEN IM = IM - 1:O$(J,2) =
      "" :7$(J,3) = "1": GOTO 1290
1288 O$(J,3) = "1":O$(J,2) = ""
1290 IF J < > 9 AND J < > 11 AND
      J < > 2 THEN 120
1293 IF J = 9 THEN IF O$(8,2) =
      "-6" THEN O$(8,2) = "6"
1295 IF J = 11 THEN IF O$(12,2)
      = "-8" THEN O$(12,2) = "8"
1297 IF J = 2 THEN IF O$(18,2) =
      "-14" THEN O$(18,2) = "14"
1300 RETURN
1320 IF O$(J,3) < > "1" THEN T$
      = "YA DON'T HAVE IT !": RETURN

1325 T$ = "OK":IN = IN - 1:O$(J,2
      ) = STR$(L):O$(J,3) = "": RETURN
1340 IF O$(5,3) < > "1" THEN 18
      90
1350 IF L = 7 THEN L = 8: GOTO 1
      20
1360 IF L = 12 THEN L = 13
1370 GOTO 120
1390 GOSUB 120: ON J + 1 GOTO 14
  
```

```

00,1430,1440,1460,1470,1480,
1490,1460,1460,1500,1510,152
0,1530,1540,1460,1460,1460,1
460,1460,1560,1570,1580,1590
,1600,1610,1620,1460,1630,14
60,1460,1460,1640,1460
1395 GOTO 1460
1400 IF VAL (O$(0,3)) < 1 THEN
T$ = "THEY'S LUMPY OLE LEATH
ER SADDLEBAGS.": RETURN
1410 PRINT "THEY HOLD ";: IF IM =
0 THEN PRINT "NOTHIN'." :T$ =
"": RETURN
1415 FOR I = 6 TO 22: IF O$(I,2)
= "-1" THEN PRINT " "O$(I,
0)",,";
1420 NEXT :T$ = CHR$(8) + ".":
RETURN
1430 T$ = "YA SEE A WEARY OLD GRE
Y MULE.": RETURN
1440 T$ = "IT'S AN OLE TORN SACK.
": IF O$(18,2) = "-14" THEN
O$(18,2) = "14"
1450 RETURN
1460 T$ = "YA SEE NOTHIN' SPECIAL
.": RETURN
1470 T$ = "IT'S AN OLD WINCHESTER
SINGLE-SHOT.": RETURN
1480 T$ = "LOOKS LIKE A MAP TA TH
' LOST DUTCHMAN'S MINE! THAR
'S A SKETCH OF SUM BOULDERS.
": RETURN
1490 T$ = "NOTHIN' SPECIAL," + C$
+ "JUS' A LOADED SIX SHOOETE
R.": RETURN
1500 IF O$(8,2) = "-6" THEN T$ =
"LOOKS LIKE SUMTHIN'S 'HIND
THE BOTTLES.":O$(8,2) = "6":
RETURN
1505 GOTO 1460
1510 T$ = "THAR'R 3 KEYS, TIED WI
TH A LEATHER STRAP": RETURN
1520 IF O$(12,2) = "-8" THEN T$ =
"LOOKS LIKE THAR'S GLASS UND
ER 'UM.":O$(12,2) = "8": RETURN
1525 GOTO 1460
1530 T$ = "IT'S AN OLE KEROSENE L
AMP," + C$ + "FULL TA THE '
+ STR$(LN) + " TURNS LEFT
' MARK.": RETURN
1540 IF I = 11 THEN T$ = "IT SEZ
'KEROSENE.'": RETURN
1550 T$ = "THAR'S WRITING ON IT."
: RETURN
1560 IF O$(20,2) = "-17" THEN O$
(20,2) = "17":T$ = "IT'S A M
ESSAGE !": RETURN
1565 GOTO 1460
1570 IF I = 11 THEN T$ = "IT SEZ
:" + C$ + "BRING TREASURES T
O SALOON, SAY 'SCORE.'": RETURN
1575 GOTO 1550
1580 IF I = 11 THEN T$ = "IT SEZ
:" + C$ + "WATCH FOR OTHER R
IDER FANTASY CREATIONS ADVEN
TURES!": RETURN
1585 GOTO 1550
1590 T$ = "THEY'S A SAVAGE LOOKIN

```

Listing 1 continued on page 276

THE PASCAL DATABASE written in UCSD PASCAL™

Software ahead of its time
available now for the APPLE™ COMPUTER

Create a library of information at your fingertips
Full database power. Unlimited applications for such diverse data as: mailing lists, personal and business accounting, inventory, job estimates, sales analyses and property management.

THE PASCAL DATABASE is easy to use.
Menu driven. Clear screen instructions enable even the inexperienced user to operate THE PASCAL DATABASE.

- THE PASCAL DATABASE has advanced features:**
- On-line interaction. Update, search and traverse database files... sort on multiple fields... maintain records in several sorted orders.
 - Screen formatting...you design the layout of your files.
 - Immediate and automatic indexing of information at data entry.
 - User definable data description gives you ultimate flexibility... you define file, record and field names
 - Generates custom, easy to read reports. Easy storage and retrieval in report library.
 - Password protection for individual files
 - Up to 1024 bytes per record.

Soon available on 8" IBM 3740 floppies and other UCSD Pascal systems. Source license available. Dealer inquiries invited.

- THE PASCAL DATABASE Special introductory price \$400.00 Shipped on floppy disks. Includes complete documentation and sample datafiles. Arizona residents please add 6% sales tax.
- Manual only \$25.00 Master Charge Bank Americard Check or Money Order (Refundable with system purchase within 90 days)



ARIZONA COMPUTER SYSTEMS, INC.

P.O. Box 125 Jerome, Arizona 86331
(602)-634-7301 9am - 4 pm Mon.-Fri.

* Apple is a registered trademark of Apple Computer, Inc.
** UCSD PASCAL is a trademark of the Regents of the University of California

Computers Terminals Modems

We are the stocking terminal distributor offering full service, on-site maintenance coverage.

CRT's			
Perkin-Elmer Bantam 550B	\$749	Perkin-Elmer Super Owl 1250	\$1799
Microterm Act VA	779	Microterm Mime IIA	819
IBM 3101 Model 10	1191	IBM 3101 Model 20	1375
Dec VT100	1699	Televideo 912C	799
Televideo 920C	839		
Hardcopy Terminals			
DEC LA34AA	939	DEC LA34DA	1149
Teletype Model 43 KSR with RS232C and connector cable	1049	NEC Spinwriter 5520 Typewriter quality with Tractor, ribbon, thimble	3088
Printers			
Perkin-Elmer 650/655 CRT Screen Printer 100 CPS	999	NEC Spinwriter 5510 Typewriter quality with Tractor, ribbon, thimble	2754
Microline 80	594		
Centronics 737	828	Centronics 779	1068
call for other Centronics models			
Modems			
Bell 212A — Penril 300/1200 1200 and 300 Baud/Manual originate auto answer	799	Bell 103/113 — USR-330 300 Baud/Manual originate auto answer	339
Auto dial option	799	Auto dial option	50
(Both modems connect to phone lines via RJ11C standard extension phone jack.)			
Acoustic Coupler		Computers	
Phone Link — 300 Baud Originate and answer. Compact.	179	USR-1600P	4099

Leasing rates on request. Write or call for product information.
10 day money back guarantee on all products.



U.S. ROBOTICS INC.
203 N. WABASH
SUITE 1718
CHICAGO, ILL 60601
(312) 346-5650

Circle 195 on inquiry card.

LEAPAC SERVICES

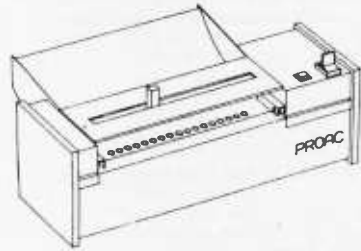

L2D PLOT PACKAGE	\$190.00
L2D & L3P PACKAGES	\$380.00
MAURO PROAC MP 250 PLOTTER	\$695.00
with L2D package	\$119.00
with L2D & L3P packages	\$190.00

MAURO PLOTTER - Uses 11" wide paper of any length such as 8" bond or 17" graph paper. Plotting resolution is 200 steps per inch with 0.05" tracking error at plotting speeds of up to 2" per second. Uses standard fiber 140 pens that can be obtained at any Stationery Store. Requires only 5 bits of a parallel output port. Vector driver software in source is supplied with the plotter for 8080 Z80 6502 & 6800 micro processors. APPLE TRS 80 and RS 232 interface cards are available as options.

LEAPAC SOFTWARE - Complete two dimensional and perspective plotting software packages are available including ASCII character annotation and curve plotting. This software is hardware independent and will not become obsolete as you upgrade your plotting equipment. The software is supplied as 8080 Z80 relative linking libraries (LBI) for MICROSOFT compatible products FORTRAN 80 COBOL 80 COMPILER BASIC and MACRO 80 on 5 1/4" CP M or 5 1/4" NORTHSTAR TRS 80 or HEALTH 85 compatible diskettes.

L2D PACKAGE - Two dimensional plot package that contains over 25 entries that allow you to clip or window your drawings, annotate your drawings, and draw elliptical curves. Contains CalComp Compatible cards such as PLOT5 PLOT WHERE FACTOR, etc.

L3P PACKAGE - Perspective or three dimensional plot package that contains over 70 entries that allow you to plot perspective figures such as the self portrait above. Routines for STEREO GENERATION ZOOMING FLY BY'S and ANIMATION are built into the package for minimal programming effort.

Write for more detailed information. A package of 6 users guides is available for \$30.00 containing over 180 pages describing the use of the above packages. Credit back on purchase of packages.

Besides the Mauro Plotter interface, optional drivers are available for CalComp and Houston Instrument Drum plotters, Houston Instrument HPLOT DMP 3 & 6 & 7 plotters, and daisy wheel or spindle printers such as DIABLO 1620 & 1640 OUMÉ SPRINT 5 and NEC 5510 & 5520.

LEAPAC SERVICES (916) 381-1717
8245 MEDITERRANEAN WAY SACRAMENTO, CALIFORNIA 95826

CP M is a registered trade mark of Digital Research, Inc.
HPLOT & DMP are trade marks of Houston Instrument
TRS 80 is a trade mark of Tandy Corporation
Z80 is a trade mark of Zilog, Inc.

Listing 1 continued:

```
' BAND," + C$ + "'N THEY SEE
N YA!": RETURN
1600 T$ = "JUS' AN OLE ORE CART F
ULL O' ROCKS.": RETURN
1610 IF O$(5,2) = "-25" THEN O$(
5,2) = "1":T$ = "THAR'S SUMT
HIN' HERE!!": RETURN
1615 GOTO 1460
1620 IF I = 11 THEN T$ = "IT SEZ
:" + C$ + "WELCOME TO FRONTI
ERTOWN.": RETURN
1625 GOTO 1550
1630 IF O$(10,2) = "-6" THEN O$(
10,2) = "6":T$ = "THAR'S A S
ET OF KEYS THAR!": RETURN
1635 GOTO 1460
1640 B = INT ( RND (1) * 3 + 1):
ON B GOTO 1650,1660,1670
1650 T$ = "IT'S A BARREL CACTUS."
: RETURN
1660 T$ = "IT'S A CHOLLA CACTUS."
: RETURN
1670 T$ = "IT'S A SAGUARO CACTUS."
: RETURN
1690 IF J = 4 AND I = 38 THEN 17
80
1700 IF J < > 1 OR VAL (O$(1,3
)) < 0 THEN T$ = "SORRY, B'
THAT AIN'T POSSIBLE.": RETURN
```

```
1710 IF I < > 38 THEN 1720
1715 IF O$(1,3) = "" THEN T$ = "
TENDARFOOT! YA HAV'TA LEAD '
IM FIRST.": RETURN
1717 GOTO 1780
1720 IF O$(1,3) = "1" THEN 1320
1723 IF O$(7,3) = "1" THEN IF I
< > 16 THEN T$ = "TRY 'LEA
D.": RETURN
1730 ON I - 13 GOTO 1740,1750,17
60,1770
1740 T$ = "HE GOT AWAY FROM YA.":
RETURN
1750 T$ = "YER TOO SLOW, HE GOT A
WAY.": RETURN
1760 IF O$(7,3) < > "1" THEN T$
= "BAD LUCK, YA TRIPPED AND
HE RUN OFF.":O$(1,3) = "":O
$(1,2) = STR$(L): RETURN
1763 IF O$(1,3) = "" THEN 1280
1766 GOTO 1320
1770 T$ = "HE BUCKED YA OFF.": RETURN
```

```
1780 INPUT "WITH WHAT?";QM$: IF
J = 4 THEN 1800
1782 IF LEFT$(QM$ + " ",3) < >
"SAD" THEN T$ = "IT FELL OFF
." + C$ + "HE GOT AWAY.":O$(
1,3) = "":IN = IN - 1:O$(1,2
) = STR$(L): RETURN
1790 IF O$(0,3) = "1" THEN O$(0,
3) = "2":IN = IN - 1: GOTO 1
060
1795 GOTO 1320
1800 IF LEFT$(QM$ + " ",3) < >
"BUL" THEN 1050
1805 IF O$(8,3) < > "1" OR O$(4
,3) < > "1" THEN 1320
1810 GOTO 120
1820 IF O$(J,3) < > "1" THEN 13
20
1822 INPUT "ON OR IN WHAT? (IE '
```

SPECTACULAR

Offers

<p>BASF "FLEXYDISK" Superior quality data storage medium, certified and guaranteed 100% error free.</p>	<p>5 1/4" or 8" Diskettes 10/ \$24</p> <p>5 1/4" or 8" Vinyl Storage Pages 10/ \$5</p> <p>Write for quantity discounts *Single sided / Single Density</p>
<p>SFD CASSETTES "Super Ferro Dynamic" Using the finest Agfa PE 611 tape in a professional quality housing.</p>	<p>C-10 Cassette Sonic Weld Housing 10/ \$7</p> <p>Add 10c p/cassette for 5 screw housing</p> <p>Cassette Album Page \$1.89</p> <p>Write for quantity discounts</p>
<p>LIBRARY CASE 3-ring binder album, protects your valuable programs on disks or cassettes. Fully enclosed and protected on all sides similar to Kas-sette storage box.</p>	<p>Library 3-ring binder \$6.50</p> <p>5 1/4" mini Kas-sette/10 \$2.49</p> <p>8" Kas-sette/10 \$2.99</p> <p>Write for quantity discounts</p>
<p>DISKETTE DRIVE head cleaning kits prevent head crashes and insure efficient error-free operation.</p>	<p>5 1/4" or 8" KIT</p> <p style="text-align: center;">INTRODUCTORY PRICE</p> <p style="text-align: center;">\$19.50</p>
<p>HARDHOLE reinforcing ring of tough mylar protects your disks from damage.</p>	<p>8" applicator \$4.00</p> <p>5 1/4" applicator \$3.00</p> <p>8" mylar hardholes (50) . \$8.00</p> <p>5 1/4" mylar hardholes (50) \$6.00</p>

ABM

PRODUCTS
631 "B" St.
San Diego,
CA 92101
(714) 235-6602

VISA • MASTERCHARGE • MONEY ORDERS
CERTIFIED CHECK • FOR PERSONAL CHECKS
ALLOW 2 WEEKS • C.O.D. REQUIRES A 10%
DEPOSIT • CAL. RES. ADD 6% SALES TAX
MIN. \$2 SHIPPING & HANDLING • MINIMUM
ORDER \$10 • SATISFACTION GUARANTEED
OR FULL REFUND.

```

ON TABLE') ?";QMS:P$ = LEFT$
(QM$ + " ",2): IF P$ < > "I
N" AND P$ < > "ON" THEN T$ =
"HUH?": RETURN
1830 M1$ = MID$(QM$,4,3)
1840 IF P$ < > "ON" THEN 1850
1841 IF M1$ = "MUL" THEN 1790
1843 IF J < > 13 THEN 1320
1845 IF LM = 0 THEN T$ = "IT'S E
MPTY.": RETURN
1847 LM = 0: GOTO 1320
1850 IF M1$ < > "SAD" THEN 1860

1852 IF J < 5 OR J = 19 OR J = 2
2 THEN T$ = "SORRY, IT DON'T
FIT.": RETURN
1855 IF IM > 4 THEN T$ = "THE BA
GS 'R FULL.": RETURN
1857 O$(J,2) = "-1":O$(J,3) = "":
IN = IN - 1:IM = IM + 1:T$ =
"OK": RETURN
1860 IF M1$ = "MUL" THEN T$ = "Y
A GOT KICKED !": RETURN
1870 IF M1$ < > "LAN" THEN 1050

1872 IF O$(13,3) < > "1" OR O$(
12,3) < > "1" THEN 1320
1875 IF LM = 50 THEN LN = LN + 5
0:LM = 0: GOTO 120
1880 T$ = "JAR'S EMPTY.": RETURN

1890 T$ = "YA CAN'T DO THAT... YE
T!
1900 PRINT T$:T$ = "": GOTO 100
1920 PRINT "YA GOT WITH YA: ";: IF
IN = 0 AND O$(1,3) < > "1" THEN
T$ = "NOTHIN'": RETURN
1930 B = VAL (O$(0,3)):X1 = B: IF
B < > 1 THEN 1940
1933 PRINT : PRINT O$(0,0)", CON
TAINING: ";: FOR I = 1 TO 22
: IF O$(I,2) = "-1" THEN PRINT
O$(I,0)". ";:X1 = 2
1936 NEXT : IF X1 < > 2 THEN PRINT
"NOTHIN'! ";
1940 IF O$(1,3) = "1" THEN PRINT
: PRINT "THE MULE, WHICH YER
LEADIN. ";: IF B = 2 THEN PRINT
"(CARRYIN' SADDLEBAGS) ";
1950 PRINT :X1 = 0: FOR I = 2 TO
22: IF VAL (O$(I,3)) < 1 THEN
1970
1955 IF CL = 1 AND I = 12 THEN PRINT
"LIT ";
1960 PRINT O$(I,0)". ";
1970 NEXT
1980 T$ = "": RETURN
2000 IF L = 19 THEN HOME : PRINT
"
YA FELL 100 FEET 'N LANDED
ON ROCKS.": PRINT "
YER DEAD.
": GOTO 2220
2005 IF J = 23 OR J = 32 OR M1$ =
"P" THEN T$ = "OK": RETURN
2006 GOTO 1050
2010 T$ = "WHERE?": RETURN
2020 IF L = 25 THEN L = 26: GOTO
120
2030 IF L = 26 THEN L = 25
2040 GOTO 120
2100 DATA ,,,,,,,IN A MINER'S S

```

Listing 1 continued on page 278

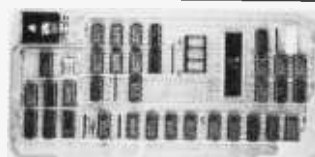

Boards for S-100 BUS from S.C. Digital

"CPUI-Z80"

Advanced Z80A based CPU board
\$219 Assembled and Tested
\$149 Kit *(less Interrupt)

Features: Model CPUI-Z80

● 2/4 Mhz SW selectable. ● Built in 8 Prioritized Vectored Interrupts with 8 possible levels of Nested Interrupts using powerful Mode 2 of Z80, all done in Hardware, expandable with external ckt. ● Vector Jump on RESET, in 4K increments. ● Supports 2K of EPROM (not supplied), DMA, dynamic RAM refresh . . . many more.

*Kit comes with all parts except chips connected to Interrupts.

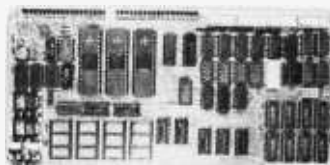

"INTERFACE: 1" I/O, Memory Interface Board

\$229 Assembled and Tested
\$169 Kit

Features: Model 3SPC

● 3 Serial w RS232C or 20ma Current Loop, 1 Parallel. ● 4K of EPROM/ROM and 4K of RAM (ROM/RAM not supplied). ● Built in Kansas City Standard Cassette interface usable to 1200 Baud. ● Generates all popular baud rates up to 19.2K baud, including 110 & 134.5. ● SW settable Address, Baud Rates, Ports.

"UNISELECT" 16K Static RAM with universal Bank Select

Model 16KUS \$235 A & T, with 200 nsec memory chips.

All boards meet IEEE-S100 standards. Fully socketed, solder masks, gold contacts, and guaranteed for one full year. Kit guaranteed parts, only.

Delivery: from stock to 72 hours. Ordering: You may call for M.C., Visa or C.D.D. orders. (Add \$4.00 for C.D.D.) Personal checks o.k., but M.O. speeds shipment. Takes 7 to 15 days to clear personal checks before shipping.

Undamaged boards can be returned within 10 days for full refunds. Illinois residents add 5¼% sales tax.

O.E.M. PRICING AVAILABLE. DEALER INQUIRY INVITED

S.C. Digital

P.O. Box 906 Phone:
Aurora, IL 60507 (312) 897-7749

The Phone Link Acoustic Modem

Sleek . . . Quiet . . . Reliable

- Originate and Answer Modes
- 0-300 Baud • RS232C
- Self Test • 1 year warranty
- 5 Diagnostic Leds

Dealer Inquiries Invited



U.S. ROBOTICS INC.

203 N. WABASH
SUITE 1718
CHICAGO, ILL. 60601
(312) 346-5650

8088 PROCESSOR

Add new processing power to your S100 bus system. Add the LDP88 processor to your system and realize performance only available with minicomputers previously. The LDP88 utilizes the Intel™ 8088 processor which is fully compatible with software written for the 8086.

LDP72 FLOPPY DISK CONTROLLER

The LDP72 offers the following advanced features:

- Software selectable single or double density
- Software selectable mini or standard floppy disk
- Onboard data separation for data reliability
- Controls up to 4 double density, double sided floppy disks for up to 4M bytes of storage

86-DOS™

86-DOS, Seattle Computer Products 8086 operating system, is now available for the LDP88 with a BIOS for the LDP88, LDP72 combination.

86-DOS \$195

	Partial Kit	Full Kit	Assembled & Tested
LDP88	\$199.95	\$349.99	\$399.99
LDP72	129.95	219.95	274.95

MasterCharge and Visa accepted (Visa add 4%)
(Mass. residents add 5% sales tax)

LOMAS DATA PRODUCTS

11 Cross Street
Westborough, MA 01581
Telephone: (617) 366-4335

86-DOS is a trademark of Seattle Computer Products
Intel is a trademark of Intel Corporation

IEEE-488 BUS SYSTEM BUILDING BLOCKS

For Commodore PET/CBM and other computers...

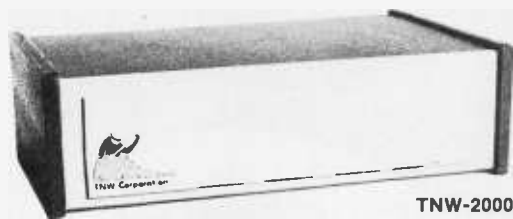

TNW-2000

- TNW-1000** Serial Interface: \$129
1 channel output only
- TNW-2000** Serial Interface: \$229
1 channel input and output
- TNW-232D** Dual Serial Interface: \$369
2 channels input and output plus RS-232 control lines
- TNW-103** Telephone Modem: \$389
Auto answer/auto dial. Use with DAA

SOFTWARE

PTERM: A program that turns your PET into a terminal
(Use with TNW-2000, TNW-232D, or TNW 103)
SWAP: Allows storage of up to 8 programs in PET
memory at once. Run them in any order
PAN: A sophisticated electronic mail program
(use with TNW-103)

Write or call for information today:



TNW Corporation
3351 Hancock Street
San Diego CA 92110

(714) 225-1040

Listing 1 continued:

- HACK, WINDOW. DOOR,,1,3,3,,,I
N A DESERT,ROAD. MOUNTAINS.
DESERT,WNES,2,4,2,2,ON A D
IRT PATH,MINER'S SHACK. ROAD
. MOUNTAINS," W ",5,1,4,2,2
- 2110 DATA ON A DIRT ROAD,MOUNTAI
NS. PATH. DESERT. TOWN,NE S,
2,7,3,2,5,IN A GHOST TOWN,SA
LOON," N ",1,6,4,,,IN A SAL
OON,,W ,1,5,,,,
- 2120 DATA AT THE SUPERSTITION MO
UNTAINS,ROAD. DESERT,S N ,4,
4,2,2,2,AT WEAVER'S NEEDLE,,
NS ,1,9,7,,
- 2130 DATA IN A NARROW DEFILE,BUS
HES. CAVES," NS",1,11,10,12
,8,IN A SMALL CAVE,,E ,1,9
,,,,BEHIND A BUSH,BUSH,,W
,1,9,,,,IN A BOX CANYON,BUSH
ES. TREES. BOULDERS," S",4
,12,12,12,9
- 2140 DATA IN FRONT OF A HIDDEN M
INE,MINE SHAFT,ESNW,8,14,12,
12,12,IN THE MOUTH OF A DIM
MINE,MINE SHAFT,EW ,1,15,13
,,,IN A MINE,DARK TUNNEL,EW
,6,16,14,,
- 2150 DATA AT THE END OF A TUNNEL
,IRON DOOR," W ",1,17,15,,,
IN A LARGE CHAMBER,IRON DOOR
,WNES,1,16,19,18,20,IN A MAZ
E OF TUNNELS,,NSEW,6,18,18,1
8,18,IN FRONT OF A PIT,DARK
HOLE," S ",7,23,17,,
- 2160 DATA AT AN INTERSECTION,,
SNW",6,,22,17,21,IN A DEAD E
ND TUNNEL,,E ,8,20,,,,IN A
BLOCKED TUNNEL,,N ,8,20,,
,,AT THE BOTTOM OF A SHAFT,W
ALL,S ,8,24,,,
- 2170 DATA IN A TUNNEL,,NS ,6,23
,25,,,AT THE END OF A TUNNEL
,LADDER," N ",6,26,24,,,AT
THE TOP OF A LADDER,,,6,1,25
,,
- 2180 DATA SADDLEBAGS,2,1,MULE,,3
,BURLAP SACK,4,14,SHOVEL,4,1
,RIFLE,4,1,MAP,1,-25,GUN,1,-
1,CARROTS,1,-1,BOX OF RIFLE
BULLETS,1,-6,WHISKEY BOTTLES
,2,6,KEYS,1,-6,PILE OF BONES
(MINE),2,8
- 2190 DATA LANTERN,2,-8,JAR OF LI
QUID,1,-11,*SPANISH COINS*,1
,-10,*TOURQUOISE*,1,-23,#SIL
VER#,1,-21,#GOLD#,1,-22,MAC
HES,1,-14,CRATES,3,17,NOTE,1
,-17,PAPER,1,6,INDIANS,,11
- 2200 DATA ORE CART,,14,BED,,1,SI
GN,,5,BROKEN GLASS,,6,TABLES
,,6,CHAIRS,,6,ROCKS,,10,WOOD
EN RAILS,,15,CACTUS,,2,TRAP
DOOR,,26
- 2210 DATA GO ,ENT,RUN,QUI,DIG,CL
I,INV,JUM,DRO,GET,EXA,REA,LO
O,MOV,CAT,CHA,I,FA,RID,PUT,PL
A,PIC,PUS,PUL,SHO,OPE,CLO,GI
V,BUR,LIG,DRI,BRE,HIT,UNL,LO
C,TAK,LIS,SAY,FEE,LOA,UNT,FO
L,POU,EAT,NOR,SOU,EAS,WES

Listing 1 continued on page 280

Introducing Dynabyte's multi-tasking microcomputer.

Our latest MP/M™ enhancement enables the Dynabyte 5000 microcomputer family to handle eight simultaneous tasks initiated by as many as eight consoles.

For example, Dynabyte's new Business Manager application software can be used for accounting functions by several operators, while word processing or other tasks are being performed by other operators. And each user can

perform more than one task from the same console.

Leading edge capabilities, including DMA for faster thru-put, type-ahead for quicker operator entry and independent spooling to accommodate as many as sixteen different printers for output flexibility. Additionally, the Dynabyte 5000 microcomputer family offers up to 96MB capacity.

It's hard to believe — so Dyna-

byte invites you to see for yourself. Just send the coupon below to P. Michael Seashols, Vice President of Marketing, Dynabyte, 115 Independence Drive, Menlo Park, California 94025. We'll contact you to arrange for a demonstration of our remarkable new multi-tasking, multi-user microcomputer. If you are in a hurry, call us at (800) 227-8300 or in California (415) 329-8021.

PROVE IT!

- Show me how this enhanced MP/M running on Dynabyte's 5000 family of microcomputers handles multiple tasks. It's hard to believe you've made microcomputers so advanced
- I am interested in your diskette,
- winchester cartridge module,
- hard disk version.

Give me a call and send me information.

Name _____

Title _____

Company _____

Street Address _____

City _____ State _____ Zip _____

Phone _____

DYNABYTE

MP/M is a registered trademark of Digital Research Corporation

Listing 1 continued:

```

2220 VTAB 24: INPUT "DO YA WANT
TA TRY AGIN?";QM$: IF LEFT$
(QM$ + " ",1) = "Y" THEN RUN

2230 POKE 34,0: POKE 35,24: HOME
: NEW

2300 PRINT "TRY EXAM'NIN THIN'S.
": RETURN

2310 PRINT "ROADS GO PLACES.": RETURN

2320 PRINT "MAYBE THE TRAIL GOES
SUMWHAR.": RETURN

2330 IF O$(5,3) < > "1" THEN PRINT
"YA GOT A MAP?": RETURN

2340 PRINT "TRY 'FOLLOW.'": RETURN

2350 IF VAL (O$(1,2)) = L THEN
PRINT "THE MULE LOOKS THIN.
": RETURN

2360 GOTO 2300

2370 PRINT "KEEP GOIN'." : RETURN

2380 PRINT "IT'S SLIPRY, BUTCHA
MIGHT MAKE IT DOWN.": RETURN

2390 PRINT "THIS HERE'S A MINE,
YA KNOW.": RETURN

2500 IF J = 7 THEN T$ = "THEY TA
STE PURTY GOOD.": RETURN

2510 T$ = "CAN'T DO THAT... WEIRD
O !": RETURN

2520 INPUT "SURE?";QM$: IF LEFT$
(QM$ + " ",1) < > "Y" THEN
390

2530 INPUT "NAME?";QM$:QM$ = "LD
G/" + QM$: ONERR GOTO 4100

2535 PRINT "OPEN "QM$: PRINT "WR
ITE "QM$

2540 PRINT L", "CL", "LN", "IN", "LM
", "U", "Ul", "IM

2541 FOR X = 0 TO 32: PRINT O$(X
,1)", "O$(X,2)", "O$(X,3): NEXT

2550 PRINT "CLOSE "QM$: POKE 216
,0: PRINT "SAVED!": GOTO 390

4000 POKE 216,0: PRINT "CLOSE "Q
M$:EE = PEEK (222): IF EE =
2 OR EE = 3 OR EE = 11 THEN
PRINT "BAD NAME. TRY ANOTHE
R.": GOTO 80

4010 IF EE = 6 THEN PRINT "NO F
ILE NAMED "QM$: GOTO 70

4020 PRINT ">>> DISK PROBLEM. ER
ROR #"EE: GOTO 70

4100 POKE 216,0: PRINT "CLOSE "Q
M$:EE = PEEK (222)

4110 IF EE = 2 OR EE = 3 OR EE =
11 THEN PRINT "BAD NAME. TR
Y ANOTHER.": GOTO 2520

4120 IF EE = 4 THEN PRINT "DISK
WRITE PROTECTED!": GOTO 252
0

4130 IF EE = 9 THEN PRINT "DISK
FULL!": PRINT "DELETE"QM$: GOTO
2520

4140 IF EE = 10 THEN PRINT "FIL
E LOCKED! (AND I DIDN'T DO I
T!)": GOTO 390

4150 PRINT ">>> DISK PROBLEM. ER
ROR #"EE: GOTO 390

9999 END

```

COMPUTER STRATEGIES
 SPRING VALLEY 914/356-7770
 COMPUTERLAND
 CARLE PLACE 516/742-2262
 BUFFALO 716/836-6511
 OIGIBYTE SYSTEMS
 NEW YORK CITY 212/889-8130
 EAST COAST TRANSISTOR PARTS
 W HEMSTEAD 516/483-5742
 EMPIRE MICRO SYSTEMS
 ORCHARD PARK 716/662-7122
 GELLER STATIONERS
 JAMAICA 212/291-8880
 HEATHKIT ELECTRONIC CENTER
 WHITE PLAINS 914/761-7670
 MANAGEMENT PERCEPTIONS
 NEW YORK CITY 212/679-3610
 MICRO MANAGEMENT LTD.
 NEW YORK CITY 212/867-5337
 ROCHESTER VIDEO AWARENESS
 ROCHESTER 716/338-7563
 RONCO COMM. & ELECTRONICS
 TONAWANDA 716/873-0760
 SYNCRO SOUND ENTERPRISES
 HOLLIS 212/468-7067
 UPSTATE COMPUTER SHOP
 NE W HARTFORD 315-733-9139
 VIDEO POWER INC
 BELL MORE 516/265-5215
 VIDEO VISION
 HUDSON FALLS 518/747-2323

N. CAROLINA
 BYTE SHOP OF GREENSBORO
 GREENSBORO 919/275-2983
 MULTI VIDEO
 CHARLOTTE 704/334-3862

NO. DAKOTA
 COMPUERLAND GRAND FORKS
 GRAND FORKS 701/746-0491

OHIO
 ALTAIR COMPUTER CENTER
 DAYTON 513/274-1149
 ASTRO VIDEO EQUIPMENT
 LANCASTER 614/687-0629
 COMPUTERLAND
 MAYFIELD HGTS 216/461-1200
 COLUMBUS 614/888-2215
 NO OLMSTED 216/777-1433
 HEATHKIT ELECTRONIC CENTER
 CINCINNATI 513/771-8850
 J. A. MARTIN & CO.
 COLUMBUS 614/488-9767
 MICRO CENTER
 COLUMBUS 614/486-5381

OKLAHOMA
 BSC DISTRIBUTORS
 OKLAHOMA CITY 405/521-8098
 COMPUTER SYSTS & SOFTWARE
 MUSKOGEE 918/687-3161
 VECTOR TECH INC.
 NORMAN 405/360-4030

OREGON
 COMPUTER WARE
 PORTLAND
 WESTERN COMPUTER SYSTEMS
 EUGENE 503/485-4222

PENNSYLVANNIA
 ALPHA COMPUTER CTR
 LANCASTER 717/299-0567
 COMPUTERLAND
 ALLENTOWN 215/776-0202
 PAOLI 215/296-0210
 COMPUTER HOUSE PITTSBURG
 PITTSBURGH 412/921-1333
 GREAT LAKES COMPUTER
 PRODUCTS
 ERIE 814/459-0068

RHODE IS.
 COMPUTER CITY
 PROVIDENCE 401/331-2187

SOUTH DAKOTA
 COMPUTERLAND RAPID CITY
 RAPID CITY 605/348-5384

TENNESSEE
 SERE ROSE & SPENCER
 MEMPHIS 901/683-9125

TEXAS
 ALPHA OMEGA COMPUTER SERV
 HOUSTON 713/451-1915
 COMPUTER CONCEPTS
 BEAUMONT 713/892-3992
 COMPUTER CORNER
 AMARILLO 806/355-5618
 COMPUTER SHOP
 SAN ANTONIO 512/828-0553
 DATA SUPPLY CORP.
 RICHARDSON 214/783-8170
 G & B COMPUTER SYSTEMS
 ABILENE 915/695-0581
 HOUSTON MICRO-COMPUTER
 BELLAIRE 713/661-2005

INTERACTIVE COMPUTERS
 HOUSTON 713/772-5257
 KELLOGG COMPUTER INC
 ABILENE 915/673-7782
 MICRO-MIKE'S
 AMARILLO 806/372-3633
 SOUND & ELECTR.
 BIG SPRING 915/263-8300
 SOUTHWEST BUSINESS SYSTS.
 ABILENE 915/677-3593
 SYSTEMS SUPPORT INC.
 HOUSTON 713/683-6824
 TEXAS MICROCOMPUTERS
 MC ALLEN 512/687-8744
 THREE W ENTERPRISES
 ODESSA 915/366-2128
 YOUNG ELECTRONIC SERV
 COLLEGE STATION 713/693-3462

UTAH
 BONNEVILLE DATA SYSTEMS
 SALT LAKE CITY 801/524-2558

VIRGINIA
 HOME COMPUTER CENTER
 VIRGINIA BEACH 804/340-1977
 VOLKMICRO COMPUTER SYSTEMS
 WILLIAMSBURG 804/220-0005

WASHINGTON
 BYTE SHOP OF LYNNWOOD
 LYNNWOOD 206/775-7436
 COMPUTER CONNECTION
 SILVERDALE 206/692-7753
 COMPUTER MARKETING CORP
 WENATCHEE 509/663-1626
 MICRO BUSINESS SYSTEMS
 SEATTLE 206/324-9972
 SMALL BUSINESS SYSTEMS
 RENTON 206/228-6552
 X-L COMMUNICATIONS
 SPOKANE 509/928-2015

WEST VIRGINIA
 COMPUTER SYST. DESIGN
 HUNTINGTON 304/525-5662

WISCONSIN
 AAA COMPUTER SERVICE
 APPLETON 414/734-7161
 BENCHMARK COMPUTER SYSTEMS
 WAUKESHA 414/784-5350
 COLORTRON
 RACINE 414/637-2003
 PETTED MICRO SYSTEMS
 MILWAUKEE 414/282-4181
 COMPUTERLAND OF MADISON
 MADISON 608/273-2020
 MICROCOMPUTER SYSTEMS
 RACINE 414/632-9209
 WISCONSIN COMPUTER SUPPLY
 MILWAUKEE 414/228-8930

WYOMING
 LANGE DATA SYSTEMS
 LARAMIE

PUERTO RICO
 MICRO-COMPUTER STORE
 CAPARRA TERRACE 809/781-0350

CANADA
 AUDIO SERVICE CENTRE
 THUNDER BAY ONT 807/345-7334
 COMMUNICATIONS PLUS
 ST LAURENT. QUE 514/337-7255
 COMPUTER MART LTD
 TORONTO. ONT 416/928-0730
 COMPUTER MARKETS CORP
 DONS MILLS. ONT 416/445-1978
 KOBETEK SYSTEMS LTD
 NDVA SCOTIA 902/542-9100
 ORTHON HOLDINGS
 EDMONTON. AL 403/488-2921
 COMPUTERLAND OF WINNEPEG
 WINNEPEG 204/772-9519

EUROPE
 DATA EFFICIENCY LTD.
 HEMEL. HEMPSTEAD
 HERTS. ENGLAND
 MIKE GURR MICROS
 TENTERDEN. KENT. GB
 MICRO DESIGN
 CREWE. CHESHIRE . GB
 OIGICOMP
 ZURICH
 SWITZERLAND
 ELECTRONICA TOP INT'L
 MALTERLAAN. DEN DOLDER
 HOLLAND
 MICRO COMPUTERS UNLTD.
 GENT BELGIUM

AUSTRALIA
 GFS ELECTRONICS IMPORTS
 MITCHAM. VICTORIA

S. AMERICA
 SOCIEDAD ANONIMA DE VENTAR
 CUENA. EQUADOR

 COVER CRAFT

Circle 202 on inquiry card.

DUST COVERS

Holiday gifts that wrap up year-round protection



Here's a great idea for every computer. Cover Craft Dust Covers are currently available for hundreds of computers, CPU's and printers priced as low as \$7.95

ALABAMA

ANDERSON COMPUTERS
HUNTSVILLE 205 539-3444
DATA SYSTEMS & SOFTWARE
BIRMINGHAM 205/988-5957

ARIZONA

BYTE SHOP OF TEMPE
TEMPE 602/894-1129
BYTE SHOP OF TUCSON
TUCSON 602/327-4579
COMPUTERLAND OF PHOENIX
PHOENIX 602/956-5727
HEATHKIT ELECTRONICS
PHOENIX 602/279-6247
PERSONAL COMPUTER PLACE
MESA 602/833-8949

ARKANSAS

COMPUTERLAND LITTLE ROCK
LITTLE ROCK 501/224-4508
DATA COPE
LITTLE ROCK 501/666-8588
PROGRAMMERS SOFTWARE EXCH
CABOT 501/843-6037

CALIFORNIA

ABM PRODUCTS
SAN DIEGO 714/235-6602
ADAPCO
RIVERSIDE 714/359-1511
ADVANCED COMPUTER PROD.INC.
IRVINE 714/558-8813

TEXAS

AEXIM CORP.
REDONDO BEACH 213/376-3213
ALPHA SUPPLY CORP.
CHATSWORTH 213/882-9818
AMERICAN NATIONAL SUPPLY
GARDENA 213/532-7780
BYTE SHOP

VENTURA 805/647-8945
CAPITOL COMPUTER SYSTEMS
SACRAMENTO 916/483-7298
CENTURY ELECTRONICS
BREA 714/990-3051
COASTAL COMPUTERS
S. LUIS OBISPO 805/543-9339

COMPUTER ALTERNATIVES INC
SAN RAFAEL 415/459-1366
COMPUTER CENTER
BERKELEY 415/845-6366
COMPUTER SHOP OF CITRUS
CITRUS HGTS 916/483-961-8754

COMPUTER STORE
SANTA MONICA 213/451-0713
COMPUTER TIMESHARING CORP.
SAN DIEGO 714/226-1334
COMPUTERLAND
DUBLIN 415/828-8090

DATAVISION
SACRAMENTO 916/441-6883
DISKETTE COMPUTER SYSTEMS
FAIR OAKS 916/961-4997
DIVERSIFIED ELECTRONICS
SUNNYVALE 408/738-3911

ELECTRONIC MEMORY LTD.
MONTEREY 408/646-9666
ENERGY WEST CORP.
TUSTIN 714/544-4670
FULLER ELECTRONICS
GLENEIRA 805/685-2096

GULF DATA
CHATSWORTH 213/98-0922
HOBBY WORLD ELECTRONICS
NORTH RIDGE 213/886-9200
MALIBU MICROCOMPUTING
MALIBU
M.C.M. ENTERPRISES
PALO ALTO 415/321-1944

MICROBYTE COMPUTER STORE
SAN JOSE 408/377-4685

MICRO SUN COMPUTER CENTER
WALNUT CREEK 415/933-6252
MICRO WORLD
SAN FRANCISCO 415/665-2755
MODERN OFFICE SUPPLY
LOS ANGELES 213/748-4171

PROMEDICS DATA CORP
PALO ALTO 415/961-2401
SAN DIEGO DATA PRODUCTS
SAN DIEGO 714/563-1861
SCOTTS VALLEY VIDEO
SCOTTS VALLEY 408/438-6900

SIERRA NATIONAL CORP
SAN DIEGO 714/277-4810
SUPPLY DEPOT
WOODLAND HILLS 213/992-6060
VISIBLE COMPUTER SUPPLY
Lodi 209/334-9487

COLORADO

COMPUTER CONNECTIONS
BOULDER 303/449-8282
COMPUTER BROKER
MORRISON 303/623-7700
DATA PRO LTD
DENVER 303/777-8655

INFORMATION TECHNOLOGY
616 PEAKVIEW CIRCLE
BOULDER
MICRO COMPUTER MANAGEMENT
FT COLLINS 303/493-5700

POOR RICHARDS
DENVER 303/221-1776
DENVER 303/922-8107
SHURE DATA SYSTEMS W BRUSH
303/842-2835

CONNECTICUT
COMPUTERLAND
FAIRFIELD 203/255-9252
HAMDEN 203/288-5162
TECHNOLOGY SYSTEMS
BETHEL 203/748-6856

DELAWARE
MICRO PRODUCTS
WILMINGTON 302/762-0227
DISTRICT OF COLUMBIA
PROGRAM STORE
WASHINGTON 202/337-4691

FLORIDA
AMERICAN COMPUTER SUPPLY
CORAL GABLES 305/442-1300
AUTOMATED HOME SERVICES
MIAMI 305/233-3213
COMPUTER AGE INC.
POMPANO BEACH 305/946-4999

COMPUTERLAND OF W PALM
W PALM BEACH 305/682-3338
COMPUTERS FOR YOU
FT LAUDERDALE 305/581-8945

DATA TEAM INC
FT LAUDERDALE 305/486-3333
HEATHKIT ELECTRONIC CENTER
HIALEAH 305/823-2280
MICROSYSTEMS INC.
TAMPA 813/879-4225

SARA TECH ELECTRONICS
VENICE 813/465-3559
WEST INDIES SALES CO.
HIALEAH 305/888-1676

GEORGIA
AGENCY MANAGEMENT SERV.
MARIETTA 404/955-2392
ATLANTA COMPUTER MART
ATLANTA 404/455-0647
ELECTRONIC INFO. SYST.
ATHENS 404/353-2858

HAWAII

TRI-L MICRO COMPUTERS
HONOLULU 808/524-3780
IDAHO
SCHWENDIMAN WHOLESALE
IDAHO FALLS 208/522-2492

TELE-VIDEO
BOISE 208/377-4493
ILLINOIS
BYTE SHOP OF CHAMPAIGN
CHAMPAIGN 217/352-2323

COMPUTERLAND OF NILES
NILES 312/967-1714
FARNSWORTH COMPUTER
AURORA 312/851-3888
U.S. ROBOTICS
CHICAGO 312/733-0497

VISIBLE COMPUTER SUPPLY
ST CHARLES 800/323-0628
WALLACE COMPUTERS
PEORIA 309/685-7876
INDIANA
DATA ODMAIN
FT WAYNE 219/482-8415

BLOOMINGTON 812/334-3607
HEATHKIT ELECTRONIC CENTER
INDIANAPOLIS 317/257-4321
QUANTA MIDWEST
HAMMOND

IOWA
MEMORY BANK
BETTENDORF 319/355-6401
MID-AMERICA SUPPLY
W DES MOINES 515/225-3866

KANSAS
COMPUTER SYSTEMS DESIGN
WICHITA 316/265-1120
DUNN ELECTRONICS
LIBERAL 316/624-1888
PERSONAL COMPUTER CENTER
OVERLAND PARK 913/649-5942

KENTUCKY

DATA SWIM
LEXINGTON 606/255-2363
LYNXTON TV
LOUISVILLE 502/425-7928
MAINE
MAINE COMPUTRONICS
BANGOR 207/947-0738

MARYLAND
COMPUTERS ETC.
TOWSON 301/296-0520
COMPUTER WORKSHOP
ROCKVILLE 301/468-0463

ELECTRONIC WIZARDRY
RANDALLSTOWN 301/655-0100
HEATHKIT ELECTRONIC CENTER
BALTIMORE 301/661-4446
MASSACHUSETTS
COMPUTER CITY
BURLINGTON 617/273-3146

CHARLESTOWN 617/242-4597
FRAMINGHAM 617/875-8126
WORCESTER 617/755-5464
HANOVER 617/826-9217
COMPUTERLAND OF BOSTON
WELLESLEY 617/235-6252

COMPUTER PKGS. UNLTD.
W BOYLSTON 617/835-3428
CDM MAR
NORTHBORO 617/393-2411
CPU SHOP INC.
CHARLESTOWN 617/242-3350

G. A. BLANCO & SONS
HOUSATONIC 413/274-3838
HEATHKIT ELECTRONIC CENTER
PEABODY 617/531-9330
WELLESLEY 617/237-1510

I. T. I.
NEEDHAM 617/444-5702
MICROAMERICA DIST. CO.
NEEDHAM 617/449-4310
VIDEO DIST. OF NEW ENGL.
FRAMINGHAM 617-875-1576

MICHIGAN

THE ABACUS
BERREIN SPRINGS 616/429-3034
COMPUTERLAND OF SOUTHFIELD
SOUTHFIELD 313/356-8111
COMPUTER CONNECTION
FARMINGTON HILLS 313/477-4470

COMPUTERS OF ROCHESTER
301 S LIVERNOIS
ROCHESTER
COMPUTER MART
CLAWSON 313/288-0040

COMPUTRONIX CORP.
MIOLAND 517/631-8060
INFO DESIGN, INC
W BLOOMFIELD 313/582-9090
MICRO COMPUTER WORLD
GRAND RAPIDS 616/451-8348

MINICOMP SYSTEMS
GRAND RAPIDS 616/949-9130
VIDEO CLUB OF AMERICA
FARMINGTON HILLS 800/521-0230
MINNESOTA
ABS DATA SYSTEMS
ST CLOUD 612/253-8734

COMPUTERLAND OF BLOOMINGTON
BLOOMINGTON 612/884-1474
CUSTOM COMPUTER SYST.
MINNEAPOLIS 612/568-3944
MISSOURI
COMPUTER COUNTRY
FLORISSANT 314/921-4433

ST LOUIS 314/487-2033
FORSYTHE COMPUTER INC.
CLAYTON 314/721-4300

MONTANA

BYTE SHOP OF BILLINGS
BILLINGS 406/252-2299
NEBRASKA
COMPUTERLAND OF OMAHA
OMAHA 402/391-6716

MIDWEST COMPUTER CO. INC.
OMAHA 402/592-3590
NEVADA
BYTE SHOP OF RENO
RENO 702/826-8080

HOME COMPUTERS
LAS VEGAS 702/798-1022
N. HAMPSHIRE
COMPUTER CITY
MANCHESTER 603/668-9527

SALEM 603/898-2390
COMPUTERLAND OF NASHUA
NASHUA 603/889-5238
BITZ N BYTES
CONCORD 603/224-8233
HARDSIDE INC.
MILFORD 603/673-5144

NEW JERSEY
A. C. R. SYSTEMS
BRICKTOWN 201/477-4222
COMPUTERLAND OF MORRISTOWN
MORRISTOWN 201/539-4077

DATA SYSTEMS OF N. J.
UNION 201/686-1100
L. & S. DISTRIBUTORS
MARLTON 609/983-7444
PILOT ELECTRIC
NEPTUNE 201/775-0121

NEW YORK
ACUSTATRONICS LAB
FLUSHING 212/463-1192
BERLINER COMPUTER CTR
NEW HYDE PARK 516/775-4700
COMPUTER CORNER
WHITE PLAINS 914/949-3282
COMPUTER ERA
NEW YORK 212/860-0500

No Dealer? Contact:



COVER CRAFT

Call dealer first to insure availability

P.O. Box 555B • Amherst, NH 03031 • (603) 889-6811

Computer Bismarck

Peter A Ansoff, 5441-10 Sheffield Ct, Alexandria VA 22311

. . . the next few years will see a massive influx of computers into serious war-gaming.

— *The General* volume 16, number 3

Ever since the advent of the war game as a hobby in the early 1950s, the marriage of the war game and the computer has been a recurring topic of discussion in periodicals and at gaming conventions. Certain aspects of designing and playing war games appeared to be natural applications for the computer—recording and manipulating large quantities of data, simulating incomplete intelligence in a two-player game, and recording and storing games in progress. The design and publication of war games is, however, a commercial field like any other, and until recently, the high cost of the hardware and software involved sent the average war

gamer back to his manual unit-strength roster sheets with a sigh of "what if."

Although *Star Trek* and other computer "war games" have been in existence for some time, attempts to apply computers to a serious historical-simulation game are relatively recent. (The quotation above, taken from an article entitled "Panzer Dreamer," was published as recently as September 1979.) Simulations Publications Inc (SPI), a major war game publisher, announced in April 1979 that it would soon market a line of Radio Shack TRS-80 "game assistance" programs that could be used to speed up manual play of specific SPI games. SPI has also designed and published some general-purpose software including a range algorithm for use with the company's standard hex-grid maps.

In January 1980, however, the small California firm of Strategic Simulations Inc published a game called *Computer Bismarck*—and the war game hobby entered the computer age. This game represents a milestone in the development of commercial war games.

The Game

Computer Bismarck simulates the breakout of the German battleship Bismarck into the North Atlantic in 1941, and the massive British naval and air effort to locate and sink the Bismarck. (The version for an Apple II with one disk drive and 48 K bytes of memory is the one being reviewed here.) The game can be played in two modes; as a two-player game with one player commanding the Bismarck and the other the British forces, or as solitaire, with the player commanding the British forces against the wily efforts of "Otto von Computer." In either case, the objectives are the same: the British must sink or damage the Bismarck while protecting their merchant convoy routes to and from North America, and the Germans must avoid being sunk while disrupting convoys and possibly sinking British warships.

The game begins with all forces located as they were at 1200 hours on May 22, 1941. Play proceeds in turns, with each turn representing four hours of time. During a turn, each player enters movement and search commands by keyboard for each of his ships and aircraft. A color map, displayed on the computer video screen, shows the locations of friendly forces and of enemy forces that were spotted in the previous turn.

After all orders have been entered, the computer carries out all movement simultaneously and determines whether opposing forces have sighted each other. Combat can result when opposing forces find themselves in the same map square. Combat resolution (including

At a Glance

Name <i>Computer Bismarck</i>	Computer Apple II with 48 K bytes of memory and one disk drive
Type of package Historical-simulation game	Documentation Sixteen-page booklet, 8½ by 11 inches (22 by 28 cm), plus printed charts
Manufacturer Strategic Simulations Inc POB 5161 Stanford CA 94305 (415) 494-0557	Audience Game enthusiasts, high school and older
Price \$59.95	Additional comments A somewhat different version for the Radio Shack TRS-80 with 16 K bytes of memory and a cassette interface is available for \$49.95
Format 5-inch floppy disk	
Language Applesoft BASIC	

SUPERBRAIN[®] HARDWARE, SOFTWARE,



As the Western United States' largest distributor of SuperBrain[®] hardware and software,

**WE WILL NOT BE UNDERSOLD
BY ANY ADVERTISED PRICE!**

Huge volume purchases for national and international marketing gives us the chance to get you rock bottom prices from the factory.

Our SuperBrain[®] prices are the lowest in the country, and our assistance in hardware and software information will be pleasant and helpful at all times.

SOFTWARE.

	<u>CBasic</u>	<u>MBasic</u>	
Accounts Receivable	X	X	\$250.00
Accounts Payable	X	X	250.00
General Ledger	X	X	250.00
Payroll	X	X	250.00
Inventory	X	X	250.00
Restaurant Payroll	X		250.00
Job Costing	X		250.00
Mailing List	X	X	150.00
Word Processing	X		195.00
"Magic Wand"	X		325.00

PROGRAM LANGUAGES.

C Basic	125.00
M Basic	300.00
Fortran	450.00
Cobol	650.00

AND MORE.

Model 88T Impact Matrix Printer 595.00!

•Other Printers Available:

- T-I 810
- Anadex
- Diablo
- NEC
- Qume



Dealer Inquiries Invited.

**COMPUTER
MARKETING
CORPORATION**

Computer Marketing Corporation
11058 Main St., Suite 125
Bellevue, WA 98004
(206) 453-9777

aerial bomb/torpedo attacks, surface gunfire/torpedo attacks, and submarine attacks) is done by the computer, and damage points are assigned to the forces involved as appropriate. Damage cumulatively reduces the speed, firepower, and/or the structural integrity of a ship. The number of hits required to sink a ship varies with the characteristics of the particular ship and the amount of damage it has sustained in previous combat.

Once combat resolution is completed, another turn begins and the cycle is repeated. Factors such as weather (which affects searching), ammunition expenditure, and reinforcements are monitored by the computer and introduced into play as appropriate. The game ends when the Bismarck is sunk, when one player has accumulated a lead of 30 victory points, or after the 0800, May 27, 1941, turn.

Physical Description

Along with the program floppy disk, the *Computer Bismarck* package includes two plastic-coated mapboard charts for move plotting, a sixteen-page rulebook (containing strategy suggestions and historical background, as well as the game rules), a set of data charts, a setup sheet, and two grease pencils for use with the mapboard charts. The printing and graphics are of professional quality throughout. The components are packaged in an unnecessarily large, but attractively illustrated, box. All in all, the game is an excellent physical product. A minor irritation with the graphics is the use of three-digit twenty-four-hour clock times on the turn record chart (eg: "400" instead of the more proper "0400" to represent 4 AM).

Game Evaluation

The promotional literature for *Computer Bismarck* claims that "without the drudgery of the organizational overhead of paper-and-pencil games, your mind is free to develop and test sophisticated search, combat, and logistics strategies . . ." (*Campaign*, number 79). Regrettably, this claim is largely untrue. Although *Computer Bismarck* does relieve the player of many of the paper-work aspects of conventional war games, it introduces new problems that can actually increase the time required to complete a single turn.

The mechanics of *Computer Bismarck* are based almost entirely upon those of the conventional war game *Bismarck*, published in 1979 by the Avalon Hill Company. While the designers of *Computer Bismarck* wisely chose not to adapt the detailed combat mechanics of the Avalon Hill game, the movement and search procedures, orders of battle, and capability factors assigned to the ships and aircraft are derived almost directly from the Avalon Hill version. There is certainly nothing wrong about this; indeed, it was probably wiser to adapt an existing design rather than use a new and untried system (although it would seem proper as a matter of courtesy to acknowledge that the game was based on an Avalon Hill design).

The fact remains, however, that the original game was designed for manual play, and its search procedure—moving ship counters on a playing board—was reasonably efficient for that medium. In *Computer Bismarck*, ships are moved by entering the square-by-square track that each ship is to follow, consulting the mapsheet each time to verify the square coordinates and checking the rules for convoy destinations and other details. This can be rather time-consuming, as the British frequently have thirty-plus ships in play, not to mention aircraft. It also causes a player to become mired in the details of individual ship movement to the exclusion of strategic considerations. *Computer Bismarck* also perpetuates the irritating system of ship movement rates which, in the Avalon Hill original, was apparently scaled so that the map-board would fit exactly into the box.

The failings of *Computer Bismarck* can be summarized by saying that it does not take advantage of the possibilities offered by the computer. For example, it would have been relatively easy to design a movement system based on the *target square* principle; ie: a ship would be ordered to proceed to square X and patrol there until further orders are given. The convoys could also be "programmed" to steam toward their destinations unless ordered otherwise (eg: to avoid the Bismarck). These changes would also have made the game much more realistic. Also, the *task force* system used in the Avalon Hill game could easily have been adapted to the computer version, increasing both playability and realism.

Instead of thinking along these lines, the designers of *Computer Bismarck* chose to retain the conventional pencil-and-paper system of the Avalon Hill game; by doing this, the designers precluded many of the advantages that computerization might have provided. It is difficult to believe that they couldn't have done better.

In all fairness, it should be pointed out that the computer version does offer one unique advantage: the possibility of *solitaire* play. Preliminary play testing indicates that "Otto von Computer" is indeed a skillful op-

At last...the Typewriter Interface!



Turn your electric typewriter into a low cost, high quality hard copy printer. 1 Year Warranty

Dynatyper—the patented* RDI—I/O Pak is fast becoming the industry standard for typewriter output. Why? Because:

1. It takes 2 minutes to initially install and 5 seconds to remove or replace.
2. You *do not* have to modify your typewriter. All factory warranties and maintenance agreements on your typewriter will be honored.
3. You can use it with *all* powered carriage return typewriters that have U.S. keyboard. Our Model I works with all *non* Selectrics and our Model II works with Selectrics. Conversion between models takes 2 minutes and the kit (26 plungers) is available for a nominal charge.
4. You don't have to lug around a bulky printer when you travel. If there is a typewriter at your destination, you can install the light (3 lbs.) I/O Pak in just 2 minutes.
5. Same interface for TRS-80, Apple and GPIB. Centronics and Pet compatible interfaces are available in third quarter 1980. Electric pencil available.
6. Delivery: Stock to two weeks. Price: \$499. for the complete system, FOB Rochester, Domestic.

Over 1000 In operation today. VISA and MasterCard accepted. Call Ken Yanicky at 716-385-4336, or write: "Dept. B".

*Patent Pending

ROCHESTER DATA

3100 Monroe Avenue, Rochester, New York 14618 incorporated

Software for the Apple II and Apple II Plus*



ASTEROIDS IN SPACE™

By Bruce Wallace

An exciting space action game! Your space ship is traveling in the middle of a shower of asteroids. Blast the asteroids with lasers, but beware — big asteroids fragment into small asteroids! The Apple game paddles allow you to rotate your space ship, fire its laser gun, and give it thrust to propel it through endless space. From time to time you will encounter an alien space ship whose mission is to destroy you, so you'd better destroy it first! High resolution graphics and sound effects add to the arcade like excitement that this program generates. Runs on any Apple II with at least 32K of RAM and one disk drive.

On Diskette - \$19.95



FASTGAMMON™ By Bob Christiansen.

Sound, hi res, color, and musical cartoons have helped make this the most popular backgammon playing game for the Apple II. But don't let these entertaining features fool you — FASTGAMMON plays serious backgammon. Runs on any Apple II with at least 24K of RAM.

Cassette - \$19.95 Diskette - \$24.95

BATTLESHIP COMMANDER™ by Erik Kilk and Matthew Jew.

A game of strategy. You and the computer each start out by positioning five ships of different sizes on a ten by ten grid. Then the shooting starts. Place your volleys skillfully — a combination of logic and luck are required to beat the computer. Cartoons show the ships sinking and announce the winner. Sound effects and flashing lights also add to the enjoyment of the game. Both Applesoft and integer BASIC versions are included. Requires at least 32K of RAM.

Cassette - \$14.95 Diskette - \$19.95

ASTROAPPLE™ by Bob Male.

Your Apple computer becomes your astrologer, generating horoscopes and forecasts based on the computed positions of the heavenly bodies. This program offers a delightful and stimulating way to entertain friends. ASTROAPPLE produces natal horoscopes (birth charts) for each person based on his or her birth data. Any two people may be compared for physical, emotional, and intellectual compatibility. The program is written in Applesoft BASIC with machine language subroutines. It requires either RAM or ROM Applesoft and at least 32K of memory.

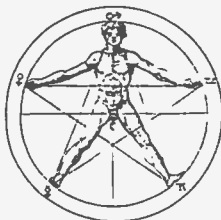

Cassette - \$14.95 Diskette - \$19.95

BABBLE™ by Don Worth.

Have fun with this unique software. You write a story, entering it as a BABBLE program. As you write the story you specify certain words to be selected by the computer or entered from the keyboard at execution time. Run the program and watch BABBLE convert your story into an often hilarious collection of incongruities. The ways in which BABBLE can entertain you are limited only to your imagination. You can compose an impressive political speech or write poetry. You can plan a dinner menu. You can even form images on the screen or compose musical tunes with the help of BABBLE. The cassette version requires at least 16K of RAM and the diskette version requires at least 32K of RAM. BABBLE is written in machine language and runs on any Apple II computer.

MY SISTER'S PENCIL SHARPENER LOVES YOUR ANTEATER, AND THE CRABGRASS IS ATTACKING THE FRIENDLY MATADOR.

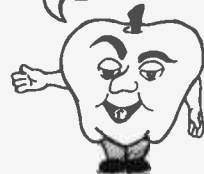

BABBLE

Cassette - \$19.95 Diskette - \$24.95



FRACAS™ by Stuart Smith.

A fantastic adventure game like no other! Up to eight players can participate in FRACAS at the same time. Journey in the land of FAROPH, searching for hidden treasure while warding off all sorts of unfriendly and dangerous creatures. You and your friends can compete with each other or you can join forces and gang up on the monsters. Your location is presented graphically and sound effects enliven the battles. Save your adventure on diskette or cassette and continue it at some other time. Both integer BASIC and Applesoft versions included. Requires at least 32K of RAM.

Cassette - \$19.95 Diskette - \$24.95

BENEATH APPLE MANOR™ by Don Worth.

Descend beneath Apple Manor into an underground maze of corridors, rooms, and secret passages in quest of rich and powerful treasures. The dungeon complex consists of many floors, each lower level more dangerous than the last. If you can reach the lowest level, you may even find the ultimate object of your quest, the fabled golden apple of Apple Manor. Strategy is extremely important as you deal with a variety of monsters, each with its own characteristics. Written in integer BASIC with machine language subroutines. Requires integer BASIC and at least 16K of RAM on cassette or 32K of RAM on diskette.



Cassette - \$14.95 Diskette - \$19.95

LINKER

LINKER by Don Worth.

Turn your Apple II or Apple II Plus into a powerful and productive software development machine with this superb linking loader/editor package. LINKER does the following and much more:

- Dynamically loads and relocates suitably prepared machine language programs anywhere in RAM.
- Combines a main program with subroutines. You can assemble a subroutine once and then use it with as many main programs as you wish.
- Produces a map of all loaded routines, giving their location and the total length of the resulting module.
- Contains a library of subroutines including binary multiplication and division, print text strings, delay, tone generator, and random number generator.

Linker works with virtually any assembler for the Apple II. Requires 32K of RAM and one disk drive.

Diskette - \$49.95
Manual Only - \$19.95



QUALITY SOFTWARE

6660 Reseda Blvd., Suite 105, Reseda, CA 91335
(213) 344-6599

Now exclusive distributors for products from The Software Factory, Newhall, California

*Apple II and Apple II Plus are trademarks of Apple Computer, Inc.

WHERE TO GET IT: Call us at (213) 344-6599 for the name of the Quality Software dealer nearest you. If necessary you may order directly from us. Mastercard and Visa cardholders may place orders by telephone. Or mail your check or bankcard number to Quality Software, 6660 Reseda Blvd., Suite 105, Reseda, CA 91335. California residents add 6% sales tax. SHIPPING CHARGES: Within North America orders must include \$1.50 for first class shipping and handling. Outside North America the charge for airmail shipping and handling is \$5.00. Pay in U.S. currency.

ponent; one hopes that he has enough crafty schemes in his repertoire to keep the game from becoming predictable.

Summary

● The field of computer war games has vast potential, and it is perhaps unfair to expect the first published example to be a fully developed product. Others, much improved, are certain to follow; as of this writing, Avalon Hill has announced the availability of four "war games for home computers." (One of them, entitled *North Atlantic Convoy Raider*, is described as "a computer simulation of the Bismarck convoy raid of 1941 . . .") It is likely that *Computer Bismarck* will be remembered as the *Tactics II* of computer gaming—somewhat crude, but a fine effort and definitely a first.

Conclusions

- *Computer Bismarck* allows solitaire play against the computer. This a great advantage for the war gamer who cannot find suitable opponents.
- The game is very attractively produced, including plastic-coated mapboard charts and a well-designed rulebook organized in much the same way as rulebooks from other war game publishers. This adds considerably to the pleasure in playing the game.
- Movement of pieces in this game, which must be done one piece at a time, is time-consuming and tedious. ■

War-Gaming—The Hobby

Shortly before the First World War, the noted science-fiction writer HG Wells published a book entitled *Little Wars*. It contained a set of rules for simulating historical battles and campaigns using model soldiers on tabletop battlegrounds. From that point on, miniature war games acquired a troop of devoted followers.

A new type of commercial war game was introduced in 1953, when Charles S Roberts published *Tactics*. *Tactics* was a board game in which the opposing forces, represented by cardboard unit counters, were maneuvered over a gridded map. Each unit was rated according to its combat and movement ability, and battles were resolved by comparing the strengths of opposing forces and applying a luck factor via die roll.

Tactics was quite successful (a revised version, *Tactics II*, is still on the market today), and other games soon followed. The majority of the early titles dealt with historical actions such as Gettysburg, Waterloo, and the Battle of the Bulge. The Avalon Hill Company, founded by Roberts in 1958, was for many years the only professional publisher of commercial war games. In 1970, Simulations Publications Inc began producing games and introduced a number of innovative design concepts. Avalon Hill and SPI continue to be the giants of the war-game industry, although a number of smaller firms have since appeared.

There are currently several hundred war game titles in print, and sales are climbing toward a million games per year. Game topics range from the campaigns of Alexander and Caesar to World War II, Vietnam, and even to the intergalactic struggles of the distant future.

Information about the war-gaming hobby can be obtained from the many publications on the subject. A few of the most useful sources are listed below:

Book:

The *Comprehensive Guide to Board Wargaming*, by Nicholas Palmer, published in paperback by McGraw-Hill, 1979, is an excellent introduction to the subject, although some of the game reviews are already dated.

Magazines:

Campaign (POB 896, Fallbrook CA 92028) is a respected source for game reviews, strategy articles, and other features.

The *General* (published by the Avalon Hill Company, 4517 Harford Rd, Baltimore MD 21214) is limited to coverage of Avalon Hill games only, but it is very good on the subjects it covers.

Strategy and Tactics (published by Simulations Publications Inc, 257 Park Ave S, New York NY 10010) offers a complete, ready-to-play war game in each issue, as well as historical articles and general gaming information. SPI also publishes *Moves*, which is devoted mainly to game design and strategy, and *Ares*, which covers the relatively new field of science-fiction/fantasy war games.

More CFR Spectaculars!!!

Parallel Input 'Correspondence' SELECTRIC TYPEWRITER/PRINTER

Features:

- 15" Frame. 132 Columns
- Takes Std. Office "Golf-Ball" Elements
- Parallel "Centronics-Type" TPL Input
- IBM 745 Printer Mechanism
- Upper & Lower Case ASCII Int
- Used, Reconditioned Terminals
- Ideal for Word Processing
- Use as a Typewriter. Tool



Complete, Ready to Use: **Only \$659.00!! ea.**

Replacement Line Cord Included; No Type Element Included
*Add \$20.00 for Handling & Packaging. Pay Shipping When Delivered

IBM Technical Data for 'Selectric' **\$20.00 ea.**

—GET OUR BARGAIN-PACKED PERIPHERAL FLYER!—

DAISY KSR ASCII TERMINALS

Featuring:

- 15" Frame. 132 & 156 Columns
- 15 & 30 Characters/Second
- Dual Pitch (10, 12 Chars./Inch)
- Dialect "Hytype" Printer
- Plotter Function w/ 1/60" H & 1/48" V Steps
- Simple RS-232-C ASCII I/O

Includes Operator's Instructions, Schematics, Etc.
Add \$35 for Shipping Crate. Pay Shipping on Delivery.

System 75 Daisy Terminals... **\$1499.00 ea.**



BARGAIN "FLOPPY" DRIVES

Removed from service, built by MPI Div. of Control Data. 9400 Series. takes Shugart-type 8" diskettes. Good cond., may need some service. Incl.: data, schematics, etc.

Only **\$299.00 ea.**

Buy 3 and SAVE BIG! **3/\$599.00** Plus Shipping



CFR Associates, Inc.

MAIL ORDERS:
Box 144, Newton, N.H.
03858

PHONE ORDERS:
617/372-8536
(Sorry, No Collect Calls)
Mastercharge & VISA Welcome

WAREHOUSE:
18 Granite St.
Haverhill, Mass. 01830

CP/M* compatible software

SYSTEM MAINTENANCE

DIAGNOSTICS I: Easily the most comprehensive set of CP/M compatible system check-out programs ever assembled. Finds hardware errors in your system, confirms suspicions, or just gives your system a clean bill of health.

Tests:

- Memory
- CPU (8080/8085/Z80)
- Terminal
- Disk
- Printer

To our knowledge the CPU test is the first of its kind anywhere. Diagnostics I can help you find problems before they become serious. A good set of diagnostic routines are a must in any program library.

Minimal requirements: 24K CP/M. Supplied with complete user manual: \$60.00
Manual alone: \$15.00.

ACCOUNTING

ACCOUNTS PAYABLE/RECEIVABLE: A complete, user oriented package which features:

automatic postings to general ledger (optional)
accounts payable: • check printing with invoice • invoice aging
accounts receivable: • progress billing • customer statements
• partial invoice payments • invoice aging

The entire package is menu driven and easy to learn and use. It incorporates error checking and excellent user displays. This package can be used stand alone or with the General Ledger below.

Supplied with extensive user manual: \$200.00. Manual alone: \$20.00.

GENERAL LEDGER: A complete, user oriented package which features:

- Accepts postings from external programs (i.e. AP/AR above)
- Accepts directly entered postings
- Maintains account balances for current month, quarter, and year and previous three quarters
- Financial reports: trial balance, income statement balance sheet, and more.

Completely menu driven and easy to learn and use. Excellent displays and error checking for trouble free operation. Can be used stand alone or with Accounts Payable/Receivable above.

Supplied with extensive user manual: \$200.00. Manual alone: \$20.00.

Both require 48K CP/M, terminal with cursor positioning, home and clear home, one 8" disk or two 5" disks. CBASIC2 required.

TEXT PROCESSING

TFS—Text Formatting System: An extremely powerful formatter. More than 50 commands. Supports all major features including:

- left & right margin justification
- user defined macros
- dynamic insertion from disk file
- underlining and backspace

TFS lets you make multiple copies of any text. For example: Personalized form letters complete with name & address & other insertions from a disk file. Text is not limited to the size of RAM making TFS perfect for reports or any big job.

Text is entered using CP/M standard editor or most any CP/M compatible editor. TFS will link completely with Super-M-List making personalized form letters easy.

Requires: 24K CP/M.

Supplied with extensive user manual: \$85.00. Manual alone: \$20.00.

Source to TFS in 8080 assembler (can be assembled using standard CP/M assembler) plus user manual: \$250.00.

MAILING LIST

SUPER-M-LIST: A complete, easy to use mailing list program package. Allows for two names, two address, city, state, zip and a three digit code field for added flexibility. Super-M-List can sort on any field and produce mailing labels direct to printer or disk file for later printing or use by other programs. Super-M-List is the perfect companion to TFS. Handles 1981 Zip Codes!

Requires: 48K CP/M.

Supplied with complete user manual: \$75.00. Manual alone: \$10.00

UTILITIES

Utility pack #1: A collection of programs that you will find useful and maybe even necessary in your daily work (we did!). Includes

CMP: Compare two files for equality.
ARCHIVER: Compacts many files into one, useful when you run out of directory entries.
SORT: In core sort of variable length records.
XDIR: Extended, alphabetical directory listing with groupings by common extension.
PRIN1: Formatted listings to printer.
PG: Lists files to CRT a page at a time plus more

Requires 24K CP/M

Supplied with instructions on discette: \$50.00

PROGRAMMING LANGUAGES

FORTH: a full, extended FORTH interpreter/compiler produces COMPACT, ROMABLE code. As fast as compiled FORTRAN, as easy to use as interactive BASIC.

SELF COMPILING: Includes every line of source code necessary to recompile itself.

EXTENSIBLE: Adds functions at will.

Z80 & 8080 ASSEMBLERS included

Single license, OEM licensing available

Please specify CPU type: Z80 or 8080

Supplied with extensive user manual and tutorial: \$150.00

Documentation alone: \$25.00

ENHANCED 'TINY' PASCAL: We still call it 'Tiny' but it's bigger and better than ever! This is the Famous Chung/Yuen 'Tiny' Pascal with more features added. Features include:

- recursive procedures/functions • integer arithmetic • CASE
- FOR (loop) • sequential disk I/O • one dimensional arrays
- IF ... THEN ... ELSE • WHILE • 'PEAK' & 'POKE'
- READ & WRITE • REPEAT ... UNTIL • more

'Tiny' Pascal is fast. Programs execute up to ten times faster than similar BASIC programs.

SOURCE TOO! We still distribute source, in 'Tiny' Pascal, on each discette sold. You can even recompile the compiler, add features or just gain insight into compiler construction.

'Tiny' Pascal is perfect for writing text processors, real time control systems, virtually any application which requires high speed. Requires: 36K CP/M. Supplied with complete user manual and source on discette: \$85.00.

Manual alone: \$10.00.

SOFTWARE SECURITY

ENCODE/DECODE: A complete software security system for CP/M. Encode/Decode is a sophisticated coding program package which transforms data stored on disk into coded text which is completely unrecognizable. Encode/Decode supports multiple security levels and passwords. A user defined combination (One billion possible) is used to code and decode a file. Uses are unlimited. Below are a few examples:

- data bases
- general ledger
- inventory
- payroll files
- correspondence
- accounts pay/rec
- programs
- tax records
- mailing lists

Encode/Decode is available in two versions:

Encode/Decode I provides a level of security suitable for normal use.

Encode/Decode II provides enhanced security for the most demanding needs. Both versions come supplied on discette and with a complete user manual.

Encode/Decode I: \$50.00

Encode/Decode II: \$100.00 Manual alone: \$15.00

INTERCOMPUTER COMMUNICATIONS

TERM: a complete intercommunications package for linking your computer to other computers. Link either to other CP/M computers or to large timesharing systems. TERM is comparable to other systems but costs less, delivers more and source is provided on discette!

With TERM you can send and receive ASCII and Hex files (COM too, with included conversion program) with any other CP/M computer which has TERM or compatible package. Allows real time communication between users on separate systems as well as acting as timesharing terminal.

- Engage/disengage printer
- error checking and auto retry
- terminal mode for timesharing between systems
- conversational mode
- send files
- receive files

Requires: 32K CP/M.

Supplied with user manual and 8080 source code: \$110.00

Manual alone: \$15.00.

CP/M Formats: 8" soft sectored, 5" Northstar,
5" Micropolis Mod II, Vector MZ

All Orders and General Information:

SUPERSOFT ASSOCIATES

P.O. BOX 1628

CHAMPAIGN, IL 61820

(217) 359-2112

Technical Hot Line: (217) 359-2691

(answered only when technician is available)

*CP/M REGISTERED TRADEMARK DIGITAL RESEARCH

SuperSoft

First in Software Technology



REFORMATTER™

Now There Are Three!

REFORMATTER™ diskette conversion software now includes 3 programs for transferring information bidirectionally via floppy diskette medium:

CP/M® ↔ DEC gives the CP/M® user complete access to DEC formatted diskettes. Provides complete facilities for file reorganization and directory maintenance along with editing capabilities.

TRSDOS ↔ IBM gives the Radio Shack® Mod II user complete access to IBM 3740 formatted diskettes. Provides complete facilities for character translation, file reorganization and directory maintenance, along with editing capabilities.

CP/M® ↔ IBM, the original **REFORMATTER™** now available with enhanced features, gives the CP/M® user complete access to IBM 3740 formatted diskettes. Provides complete facilities for character translation, file reorganization, and directory maintenance, along with editing capabilities.

REFORMATTER™ programs require a multiple drive system with at least one 8" single density drive.

REFORMATTER™ is available at \$195.00 per program. For detailed information contact:

MicroTech Exports
467 Hamilton Avenue, Suite 2
Palo Alto, California 94301
415/324-9114 ■ TWX: 910-370-7457 MUH-ALTOS

Dealer & OEM discounts available

CP/M is a registered trademark of Digital Research.
Radio Shack is a registered trademark of Tandy Corp.

Programming Quickies

Monster Combat

Lee Chapel, 2349 Wiggins, Springfield IL 62704

In the game *Monster Combat*, you attempt to win treasure from various loathsome creatures and leave the forest with as much treasure as possible—without getting killed in the process. This program, as shown in listing 1, was written in BASIC on a KIM microprocessor and uses less than 4 K bytes of memory. It is easy to change to almost any other form of BASIC.

In the game, you are placed at a randomly chosen location in a forest with a certain combat strength that is randomly determined. Also, you encounter monsters guarding various tempting treasures and are given a choice of fighting them, running from them, or bribing them; greed and wit are certainly tested here.

To fight the monster, enter a 1. When the program asks you for the number of combat points you wish to use, enter any number smaller than your combat strength (ie:

Listing 1: Listing for the *Monster Combat* program. This program is written to run on a KIM-1 microcomputer with BASIC and 4 K bytes of memory. It can also be modified to run on a different machine or to generate a larger forest to explore.

```

1 REM      MONSTER COMBAT
2 REM WRITTEN BY LEE CHAPEL 6/15/80
5 DIMA(10,10):PRINTTAB(20)"MONSTER COMBAT"
10 FORI = 1TO9:FORJ = 1TO9:A(I,J) = 1:IFRND(1) > .75
    THENA(I,J) = 2
13 NEXT:NEXT
15 X = INT(RND(1)*6 + 2):Y = INT(RND(1)*6 + 2)
17 A(X,Y) = 5:C = INT(RND(1)*1501 + 500)
20 GOSUB900
25 PRINT"YOUR COMBAT STRENGTH IS"C:GOSUB400:
    IFI > 11THEN25
30 IFM = 0THENPRINT"YOU GET THE TREASURE FREE":
    GOTO495
33 IFM = 100ANDN = 1THEN880
35 INPUT"DO YOU (1)FIGHT, (2)RUN, OR (3)BRIBE";K
40 ONKGOTO300,350,635
300 INPUT"HOW MANY COMBAT POINTS DO YOU WISH
    TO USE";K
305 IFK > CTHENGOSUB600:PRINTC"COMBAT POINTS":
    GOTO300
310 I = INT(RND(1)*1001):L = 2:C = C - K:K = K - .01*Q
315 FORH = 100TO0STEP - 50:IFL*M < = KANDH > = ITHEN490
320 L = L - .1:NEXT
325 PRINT"THE MONSTER KILLED YOU.";
330 PRINT"YOU LOSE EVERYTHING":PRINT"DO YOU WISH TO
    TRY AGAIN";
335 INPUTX$:IFLEFT$(X$,1) = "Y"THENRUN
340 PRINT:PRINT"SO LONG.BETTER LUCK NEXT TIME":END
350 I = INT(RND(1)*12):IFI = 11THEN325
    
```

Listing 1 continued on page 290



VALUABLE FREE CATALOG

Software and Hardware for Business Education Entertainment

Recent Arrivals:

A STELLAR TREK the definitive HI-Res color version of the classic Startrek game. Three different Klingon opponents. Many command perogatives from use of weapons to repair of damages. Need 48K Applesoft ROM Disk \$24.95
Add \$2.00 U.S. / \$5.00 Foreign shipping charges.

VERSAWRITER II A drawing tablet, simply plugs into your game I/O port. Trace, draw, design, or color any type of graphic. Adds words to pictures. Creates schematics. Computes Distance/ Area of any figure. Needs 32K Applesoft ROM and disk drive A bargain at... \$249.95
Add \$5.00 U.S. / \$10.00 Foreign shipping charges.

California residents add 6%. Don't see what you want here, THEN write or call today for your FREE software and hardware catalog.

Open Tuesday - Sunday

Visa / Mastercharge Welcome



Garden Plaza Shopping Center
9719 Reseda Blvd., Northridge, Calif. 91324 Dept. 12 B
Telephone: (213) 349-5560

OS-9™ LEVEL TWO MULTIUSER OPERATING SYSTEM

T rue multitasking, multiuser OS for timesharing or real-time control applications.

- Sophisticated memory management permits use of over one megabyte.
 - Versatile, easy-to-use input/output supports multiple devices.
 - UNIX™-like file structure including hierarchical directories, pipes, filters, and byte-addressable random access files.
 - Provides log-on password protection and user file security.
 - Can run on small, inexpensive systems with floppy disks and as little as 32K memory.
- \$495.00*

OS-9™ LEVEL ONE OPERATING SYSTEM

A multitasking real-time operating system for software development, process control and smaller multi-user applications.

- Versatile input/output system can support multiple devices using interrupt-driven, DMA, or program-controlled data transfer. Users can easily add additional I/O devices.
 - Tape or disk-based versions available.
 - Disk versions support UNIX™-like hierarchical directory structure and byte-addressable random-access files.
 - Memory management for single address-space (up to 64K).
- Disk version \$150.00*
 Tape version \$95.00

BASIC®™ PROGRAMMING LANGUAGE SYSTEM

E xtended BASIC language compiler/interpreter with integrated text editor and debug package. Runs standard BASIC programs or minimally-modified PASCAL programs.

- Permits multiple named program modules having local variables and identifiers. Modules are reentrant, position independent and ROMable.
- Additional control statements for structured programming: IF ... THEN ... ELSE, FOR ... NEXT, REPEAT ... UNTIL, WHILE ... DO, LOOP ...

INTRODUCING

6809 SOFTWARE POWER TOOLS

BY MICROWARE®

ENDLOOP, EXITIF ... ENDEXIT.

- Allows user-defined data types and complex data structures. Five built-in data types: byte, integer, 9 digit floating-point, string and boolean.
 - Outperforms any other BASIC on any 8-bit MPU.
 - Available on ROM, disk or cassette tape. Runs under OS-9™ Level One or Level Two.
- Disk or tape \$195.00*

MICROSOFT 6809 BASIC

S tandard Microsoft BASIC optimized for the 6809 and OS-9™.

- Four data types: integer, string, single precision and double precision floating point.
 - Program trace and edit capabilities.
 - Automatic line numbering and renumbering.
 - Supports random and sequential file I/O. Full PRINT USING for formatted output.
- Disk or tape \$250.00

OS-9™ TEXT EDITOR

M inimum-keystroke macro text editor useful for text preparation or interactive word processing.

- User-defined macros with parameters permit virtually unlimited command expansion. Macros can be saved, loaded

and edited.

- Buffer, line and character oriented commands.
 - Search, change and extend operations.
 - Permits multiple input/output files.
- Disk or tape \$75.00
 ROM set (2716) \$90.00

OS-9™ INTERACTIVE ASSEMBLER

Compact Motorola compatible assembler for machine language program development.

- Operates in "batch" mode or interactive line-by-line mode.
 - Facilities for generation of OS-9™ memory modules and system calls.
 - Formatted listings include syntax and context error checking.
- Runs on OS-9™ Level One or Level Two.
- Disk or tape \$75.00
 ROM set (2716) \$90.00

OS-9™ INTERACTIVE DEBUGGER

F acilitates testing and debugging of machine- language programs.

- Includes common "monitor" functions: memory examine/change, breakpoints, display/change registers, etc.
 - Calculator mode evaluates arithmetic expressions in hex, decimal or binary.
 - Access to system commands.
 - Available on ROM, disk or cassette tape.
- Disk or tape \$35.00
 ROM (2716) \$50.00

BASIC ® is a trademark of Motorola. OS-9 is a trademark of Motorola and Microware®. UNIX is a trademark of Bell Telephone Laboratories.

Most software is available on ROM, diskette and tape in versions for many popular 6809 computers. Source listings and yearly maintenance/update service are sold separately for most programs.

*Specify manufacturer and type of CPU and I/O controllers. Contact Microware® for specific availability.



MICROWARE®

Microware Systems Corp., Dept. B1
5835 Grand Avenue
Des Moines, Iowa 50304
(515) 279-8844

Listing 1 continued:

```

355 FORH = 0 TO 10: IF H * 10 > MANDH < = I THEN 375
360 NEXT: GOTO 685
375 A = X: B = Y
380 X = INT(RND(1)*3 - 1) + A: Y = INT(RND(1)*3 - 1) + B
385 IFA(X,Y) > 1 THEN 380
390 IFA(X,Y) = 0 THEN 1000
395 A(A,B) = 1: A(X,Y) = 5: IF I < > 12 THEN 20
397 RETURN
400 I = INT(RND(1)*14 + 1): M = I * 10: IF I < 11 THEN PRINT "A ";
405 ONIGOTO 410, 413, 415, 417, 420, 421, 423, 425, 427, 429, 430,
    750, 700, 950
410 PRINT "MINOTAUR";: GOTO 450
413 PRINT "CYCLOPS";: GOTO 450
415 PRINT "ZOMBIE";: GOTO 450
417 PRINT "GIANT";: GOTO 450
420 PRINT "HARPY";: GOTO 450
421 PRINT "GRIFFIN";: GOTO 450
423 PRINT "CHIMERA";: GOTO 450
425 PRINT "DRAGON";: GOTO 450
427 PRINT "WYVERN";: GOTO 450
429 PRINT "BASILISK";: GOTO 450
430 PRINT "NOTHING";: M = 0
450 PRINT " IS GUARDING ";: I = INT(RND(1)*7 + 1)
455 ONIGOTO 460, 461, 463, 465, 467, 470, 475
460 PRINT "10 SILVER SPOONS": P = 10: RETURN
461 PRINT "A JEWELLED SWORD": P = 30: RETURN
463 PRINT "A JAR OF RUBIES": P = 50: RETURN
465 PRINT "A TREASURE CHEST": P = 200: RETURN
467 PRINT "50 SILVER COINS": P = 50: RETURN
470 PRINT "100 GOLD PIECES": P = 100: RETURN
475 PRINT "A BOX OF JEWELS": P = 75: RETURN
490 PRINT "YOU BEAT THE MONSTER"
493 S = S + 1
495 Q = Q + P
497 IF P = 30 THEN GOSUB 800
500 IF P = 200 THEN GOSUB 850: GOSUB 867
505 PRINT "YOU NOW HAVE "Q" TREASURE POINTS"
510 A = X: B = Y: INPUT "WHAT DIRECTION (HIT 1 FOR THE
    MAP)": X$
511 IF X$ = "1" THEN GOSUB 900: GOTO 510
512 IFRIGHT$(X$, 1) = "W" THEN X = X - 1
513 IFRIGHT$(X$, 1) = "E" THEN X = X + 1
514 IFLEFT$(X$, 1) = "N" THEN Y = Y - 1
515 IFLEFT$(X$, 1) = "S" THEN Y = Y + 1
517 IFA(X,Y) = 0 THEN 1000
520 IFA(X,Y) = 2 THEN PRINT "YOU RAN INTO A WALL":
    X = A: Y = B: GOTO 510
525 A(A,B) = 1: A(X,Y) = 5: GOTO 20
600 PRINT "YOU ONLY HAVE";: RETURN
635 INPUT "HOW MUCH DO YOU WISH TO PAY": K
640 IF K > Q THEN GOSUB 600: PRINT Q "TREASURE POINTS":
    GOTO 635
645 I = INT(RND(1)*22): L = 0: IF I = 21 OR K < 1 THEN 325
660 FORH = 0 TO 20: IF K < = L * PANDI > = H THEN 680
670 L = L + .1: NEXT
675 PRINT "YOUR BRIBE WAS ACCEPTED.":
    Q = Q - K: GOTO 505
680 PRINT "YOUR BRIBE WAS NOT ACCEPTED.":
685 PRINT "YOU MUST FIGHT": GOTO 300
700 PRINT "A GIANT BAT CARRIED YOU TO A NEW SPOT":
    A = X: B = Y
705 X = INT(RND(1)*7 + 2): Y = INT(RND(1)*7 + 2):
    IFA(X,Y) < > 1 THEN 705
710 A(A,B) = 1: A(X,Y) = 5: RETURN
750 J = INT(RND(1)*20 + 1): C = C - J
755 PRINT "YOU FELL INTO A PIT AND USED "J" COMBAT
    POINTS TO CLIMB OUT"
760 IF C < 0 THEN PRINT "YOU DIED WHILE CLIMBING OUT":
    GOTO 330
765 GOTO 375
800 IFRND(1) < .5 OR C > 3000 THEN RETURN
810 PRINT "THE SWORD WAS ENCHANTED AND DOUBLES
    YOUR STRENGTH"
815 C = C * 2: RETURN
850 I = INT(RND(1)*10): IF I < > 7 THEN RETURN
860 PRINT "THE CHEST WAS A TRAP. YOU WERE KILLED
    WHEN YOU OPENED IT"
865 GOTO 330
867 I = INT(RND(1)*10): IF I < > 3 THEN RETURN
870 PRINT "A MIRROR WAS IN THE CHEST.":
875 PRINT "IT WILL KILL ANY BASILISKS YOU MEET":
    N = 1: RETURN
880 PRINT "YOUR MIRROR KILLED THE BASILISK": GOTO 493
900 FOR I = 0 TO 10: FOR J = 0 TO 10: PRINT TAB(5):
    IFA(J,I) = 0 THEN PRINT " ";
901 IFA(J,I) = 1 THEN PRINT "X";
902 IFA(J,I) = 2 THEN PRINT "I";
903 IFA(J,I) = 5 THEN PRINT "0";
905 NEXT: PRINT: NEXT: RETURN
950 IFS < 5 THEN 400
955 PRINT "A GIANT EAGLE CARRIED YOU TO SAFETY"
1000 PRINT: PRINT "YOU SURVIVED THE FOREST"
1005 PRINT "YOU WON A TREASURE TOTAL OF "Q":
    PRINT "CONGRATULATIONS"
9999 END

```

the amount you think it will take to defeat the monster). Each monster has its own combat strength. If you enter a number of combat points equal to the monster's strength, you have a fifty-fifty chance of defeating it. Entering a higher number increases your chances of winning, while entering a smaller number lowers your chance of winning. No matter how much strength you use, there is always at least a one-in-a-thousand chance that the monster will kill you—not bad odds, unless you have cold feet. Also, the more treasure you have, the more strength you need to use to achieve the same odds against the monster in combat.

If you choose to run (option 2), your chances of getting away from a monster successively decrease as each new monster's strength possibly increases. Thus you are more likely to get away from a minotaur than from a basilisk. If you succeed in running away, you are placed in a new randomly selected square; not getting away usually results in a battle. Occasionally, while you are running, the monster will catch and kill you—one of the risks you must accept.

Of course trying to bribe (option 3) your foe is an age-old alternative to running or fighting. For this, you must use your hard-earned treasure. Whether or not you win depends on the value of the treasure he is guarding. The greater the treasure, the more you have to pay to successfully bribe the monster. If he doesn't care for your bribe, you usually have to fight him.

There are other things in the forest besides monsters, but these are best left for the player to discover. One thing that I will mention is the mirror you may find. This kills basilisks, the most fearsome of all the creatures you will meet. A basilisk can kill people by looking them in the face, but when it looks into a mirror it frightens itself to death.

Movement through the forest is easy: just enter the direction you want to go—N for north, E for east, NE for northeast, and so on. North is the top of the map and east is the right. The Xs mark out the forest in the display, the Is are walls through which you cannot pass, and the 0 is you. To leave the forest, just move onto any blank area around the edge of forest.

-Technological Breakthrough-

COMPUTER-METER

Microprocessor technology and the inventors of the digital meter have teamed up to bring you the world's most versatile test instrument.



Computers for the home. Toys that speak. *Machines that think.* Space age technology brings new changes to your world every day. Even those of us who work with this new technology are constantly amazed by the latest applications of the ubiquitous microprocessor. And here is a remarkable new way for computer technology to simplify your work life. When the president of our company (a businessman, not a technician) saw one of the pre-production models of this new test instrument at a trade show, even he recognized it for what it is: a remarkable new way for anyone involved with electronics to save time, money, and space. We've shown it to our technicians and their reactions were similar, though more down-to-earth: "I want it!"

There's much more to tell about this incredible little meter that takes the place of at least 3 separate test instruments, but we're sure that the Touch Test 20 will end up very near the top of your equipment list.

STAYING AHEAD

For three decades, the inventors of the Touch Test 20, Non-Linear Systems, have made a science of staying ahead through innovation in test equipment. In 1952, NLS propelled electronic testing into the space age by introducing the world's first digital voltmeter, and they have remained committed to first rate value and performance through sophisticated, yet simplified electronic test tools. Their battery powered portable oscilloscopes have "lightened the load" of both field and laboratory engineers all over the world, and NLS digital panel meters have also become a world-wide standard.

The Touch Test 20 adds to the NLS reputation for accuracy and reliability and we're proud to be among the first to be able to offer it to you.

3 lb 8 oz TEST LAB

We think the Touch Test 20 is miniaturization at its best, because no compromises in accuracy and versatility were made in the process of squeezing a trunk full of test equipment into a rechargeable battery powered portable test lab.

It will measure AC voltage, AC current, resistance, capacitance, conductance, temperature, DC voltage, DC current, continuity, and test diodes - 20 key test functions, 10 electrical parameters and 44 ranges. Now, you can take one lab to the field instead of a cumbersome collection of

individual testers. And in the lab, the Touch Test 20 will go a long way toward cleaning up the cluttered array of equipment found on most test or troubleshooting benches.

JUST TOUCH

The "touch" in Touch Test 20 means no more knobs and dials to fiddle with: selection of the various functions is accomplished by a tap of the finger on one of the touch sensitive switches on the front panel. When you switch functions, there's an audible bleep and an LED lights to show the function selected. Selecting the range is also a beautifully simple procedure - just touch one of the switches below the display to shift the decimal point to the appropriate place for the signal you're measuring.



Non-Linear Systems, Inc.
Specialists in the science
of staying ahead.

SPECIFICATIONS

VOLTS 1 mV to 1 KV @ .2%
AMPERES 1 uA to 10 A @ 1%
OHMS .. 10 uOhm to 19.99 MOhm @ .25%
TEMPERATURE -40° C to +150° C +/- 3°
CAPACITANCE .. 1 pF to 199.9 uF @ 1%
CONDUCTANCE .01 nS to 199.9 nS @ .2%
DIODE TEST ... 1 mV to 1999 mV @ .2%
SIZE 2.9" x 6.4" x 7.5"
WEIGHT .. 3 lbs 8 oz (including batteries)

EVEN IDIOTS

While no instrument is totally idiot-proof, the Touch Test 20 certainly comes close: when any function is selected, this instrument automatically selects the least sensitive range of the function, to avoid embarrassing but all too common smoke test situations. We're told (though we *do not* advise such mistreatment), that you can plug the test leads into a 120 volt wall socket and select any function without causing terminal damage to the instrument.

To complement these remarkable capabilities, the Touch Test 20 is shipped ready to go to work for you, complete with a charger unit, rechargeable batteries, high quality test probes, a component test block, and a temperature probe.

ONE YEAR WARRANTY

Each Touch Test 20 is individually tested and "burned-in" at elevated temperatures to

assure the quality of the instrument shipped to you. However, should the unlikely happen, the manufacturer stands behind their reputation for reliability with a full one-year limited warranty against any defects in material or workmanship. This of course excludes damage brought about through any kind of abuse, and the warranty extends only to the original purchaser.

PRIORITY SHIPMENT

We at JADE have been in the business of supplying computers and related equipment for five years now, and we've always guaranteed our customer's satisfaction. We know that you'll be happy with this piece of equipment, so try it for thirty days; if the Touch Test 20 doesn't live up to your expectations, we'll quickly refund the purchase price. And don't worry about slow delivery - the manufacturer has assured us that we will have priority shipment of the Touch Test 20 directly from the factory. This plus our computerized order processing system assures you of the fastest possible delivery.

CALL US TOLL FREE

To order your Touch Test 20 send \$425.00 plus \$2.95 shipping and handling to JADE Computer Products, 4901 West Rosecrans, Hawthorne, California 90250 (California residents please add 6% sales tax). Credit card buyers may use one of our toll free numbers listed below.

JADE Computer Products has been an industry leader in the microcomputer field for over five years - further assurance of our dedication to fast service and continued product support.

JADE
Computer Products

4901 West Rosecrans Ave
Hawthorne, California 90250

Continental US . . . 800-421-5500

Inside California . 800-262-1710

Los Angeles Area 213-973-7707

Call for your free copy of our catalog containing
over 4000 different computer products.

Scores for this game generally range from 500 to 700. If you get over 1000, you are doing very well. A sample listing of the game at its end is given in listing 2.

Experience has shown me that this game becomes more exciting as the map gets larger. If you have more than 4 K bytes of memory in your system, you can increase the map size by changing the proper lines in the program (mainly lines 10, 15, 705, and 900). You can also add more monsters and treasure or add other options to the game.

Table 1 lists the monsters and their combat strengths; table 2 lists the treasures and their values. So load up, enter the forest, and hunt! ■

Listing 2: Part of a sample run of Monster Combat program. Each X represents part of the forest, each I represents part of a wall that must be circumnavigated, and the single 0 represents the player.

```
X X I X I X X X X
X X X X X I I X I
I I I X X X X X X
X X I X I X X I X
I X I I X X X X X
X 0 I X X X X X X
X X X X X X X X X
I X X I X X X X X
X I X X I I X X X
```

```
YOUR COMBAT STRENGTH IS 1270
A CHIMERA IS GUARDING 50 SILVER COINS
DO YOU (1)FIGHT,(2)RUN, OR (3)BRIBE? 2
YOU MUST FIGHT
HOW MANY COMBAT POINTS DO YOU WISH TO USE? 132
YOU BEAT THE MONSTER
YOU NOW HAVE 80 TREASURE POINTS
WHAT DIRECTION (HIT 1 FOR THE MAP)? SW
```

```
X X I X I X X X X
X X X X X I I X I
I I I X X X X X X
X X I X I X X I X
I X I I X X X X X
X X I X X X X X X
0 X X X X X X X X
I X X I X X X X X
X I X X I I X X X
```

```
YOUR COMBAT STRENGTH IS 1138
A DRAGON IS GUARDING 10 SILVER SPOONS
DO YOU (1)FIGHT,(2)RUN, OR (3)BRIBE? 3
HOW MUCH DO YOU WISH TO PAY? 10
YOUR BRIBE WAS ACCEPTED.YOU NOW HAVE
70 TREASURE POINTS
WHAT DIRECTION (HIT 1 FOR THE MAP)? W
```

```
YOU SURVIVED THE FOREST
YOU WON A TREASURE TOTAL OF 70
CONGRATULATIONS
```

Monster	Combat Strength
minotaur	10
cyclops	20
zombie	30
giant	40
harpy	50
griffin	60
chimera	70
dragon	80
wyvern	90
basilisk	100

Table 1: A list of monsters that can be found in the forest and their combat strengths.

Treasure	Value
ten silver spoons	10
a jeweled sword	30
a jar of rubies	50
fifty silver coins	50
a box of jewels	75
100 gold pieces	100
a treasure chest	200

Table 2: A list of treasures and their values.

\$GOLD DISK\$ CP/M® Compatible Z-80 Software

AVAILABLE FOR ALL 8-5" SS-SD IBM FORMAT SYSTEMS INCLUDING TRS-80™, NORTHSTAR, SD SYSTEMS, ALSO AVAILABLE ON 5" DOUBLE DENSITY SUPERBRAIN™

A GIFT FOR STUDENT OR BUSINESSMAN! REPORT WRITER

TAKE THE AGONY OUT OF TERM PAPER WRITING
 AUTO FOOTNOTING, TABLE SPACING, HEADINGS
 NO RETYPING TO INCLUDE CHANGES, CORRECTIONS
 ALWAYS PROFESSIONAL LOOKING LETTERS, FORMS
 SIMPLE MULTI-LETTER PRINTING
 LEFT AND RIGHT JUSTIFICATION
 SIMPLE TO LEARN, EASY TO USE

\$35.00
Ppd.

UN-CAN YOUR CANNED SOFTWARE! Z-80 DISASSEMBLER

FEEL COUPED UP WITH YOUR CANNED SOFTWARE?
 OUR Z-80 DISASSEMBLER RECREATES ASSEMBLY
 LANGUAGE SOURCE FILES FROM ABSOLUTE CODE
 ENABLING USERS TO EASILY TAILOR PROGRAMS TO
 MEET THEIR SPECIFIC NEEDS. THE
 PRECONDITIONER ALLOWS THE
 DISASSEMBLER TO DECODE ASCII.

\$65.00
Ppd.

CREDIT CARDS: FREE 24 HR ORDER
 PHONE, WE'LL CREDIT INVOICE, ONE
 DAY SERVICE. CHECKS, M.O.'S: TEN
 WORKDAY HOLD. CA. RES: ADD TAX.



BOWER-STEWART & ASSOCIATES
 P.O. BOX 1389
 HAWTHORNE, CA. 90250
 (213) 676-5055



STATE SYSTEM & CONTROLLER.
 ALLOW TIME FOR HOLIDAY RUSH.
 TRADEMARKS- "DIGITAL RESEARCH,
 "RADIO SHACK, "INTERTEC.

COLLECTOR EDITION BYTE COVERS

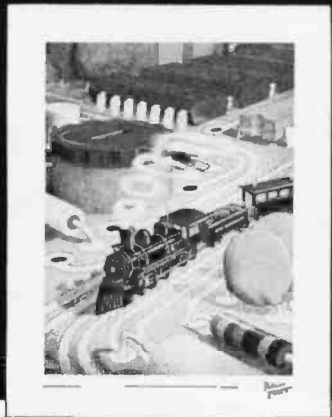

The Byte Covers shown at left are available as Collector Edition Prints. Each full color print is:

- 11" X 14" including a 1/2" border.
- Part of an edition strictly limited to only 100 prints.
- Personally inspected, signed and numbered by the artist, Robert Tinney.
- Accompanied by a Certificate of Authenticity.
- Carefully packed and shipped first class.
- Priced at \$20, plus \$3 (\$6 overseas) for postage and handling. If Set 1-4 or Set 5-8 is ordered, the price for all 4 prints is only \$70.

To order, use the coupon below. Visa or MasterCard orders may call Toll Free.

Please send me the following Collector Edition Byte Covers and Certificates of Authenticity.

Qty.	Cover	Amount
___	#1-7 Bridges of Konigsberg	\$20
___	#2-Fun and Games	\$20
___	#3-Homebrew	\$20
___	#4-Software Mirage	\$20
___	#5-Computer Engineering	\$20
___	#6-Total Eclipse	\$20
___	#7-Computer Hardware	\$20
___	#8-Perspectives.....	\$20
___	No.'s 1-4	\$70
___	No.'s 5-8	\$70

Post. & hand. (\$3 in US , \$6 overseas) \$ _____

Total \$

I have enclosed check or money order

Visa MasterCard

Card # _____

Expiration Date _____

Send my print(s) to:

Name _____

Address _____

City _____

State _____ Zip _____

Mall this coupon to:

robert tinney graphics

1864 N. Pamela Dr.

Baton Rouge, LA

70815

FOR VISA OR MASTERCARD ORDERS
CALL TOLL FREE!

1-800-854-0562 / Ext. 910

Calif.: 1-800-432-7257/Ext. 910

24 HOURS A DAY! 7 DAYS A WEEK!

Editorial continued from page 12

Speed Press, 1979. As Alvin Toffler says, "The shortest distance between two facts may well be Alden Todd." Even practiced denizens of the library will find information of interest in this book about reference sources.

Sloane, William. *The Craft of Writing*. New York: Norton, 1979.

Some Examples of Good Technical Writing

Knuth, Donald E. *The Art of Computer Programming* (three volumes). Reading MA: Addison-Wesley, 1968, 1969, 1973. An indispensable set.

Papert, Seymour. *Mindstorms: Children, Computers, and Powerful Ideas*. New York: Basic Books, 1980. A refreshingly readable text that discusses Piaget's theories about learning and the use of personal computers in the classroom.

Gardner, Martin. *The Ambidextrous Universe*, second edition. New York: Scribner's, 1979. This book deals with symmetry in nature, and shows Gardner's remarkable ability to discuss technical subjects in the clearest of terms. He is the author of the monthly "Mathematical Games" column in the *Scientific American* magazine. I recommend all of his books to those interested in good technical writing.

Hofstadter, Douglas R. *Gödel, Escher, Bach: An Eternal Golden Braid*. New York: Basic Books, 1979. This Pulitzer prize-winning work discusses computer science, art, music, philosophy, and physics in a way that is nothing short of wondrous. It is positive proof that a technical book can be artistic, rigorous, and fascinating.

Swann and Johnson, Prof. E. *McSquared's Original, Fantastic, and Highly Edifying Calculus Primer*, Joint Edition. Los Altos CA: William Kaufmann, Inc, 1975. This colorful offbeat book is actually a cleverly disguised introduction to differential calculus in comic book form. It manages to be witty and rigorous at the same time. Would that there were more books like this one.

Jacobs, Harold. *Mathematics: A Human Endeavor, and Geometry*. San Francisco: W S Freeman and Co., 1976, 1978. The art of the textbook at its finest.

Two other writers should be mentioned for their contributions to good technical writing: Jeremy Bernstein and Philip Morrison. Their book reviews about scientific and mathematical books appear regularly in the *New Yorker* and the *Scientific American*, respectively, and they are among the best in their field. ■

Articles Policy

BYTE is continually seeking quality manuscripts written by individuals who are applying personal computer systems, designing such systems, or who have knowledge which will prove useful to our readers. For a more formal description of procedures and requirements, potential authors should send a large (9 by 12 inch, 30.5 by 22.8 cm), self-addressed envelope, with 28 cents US postage affixed, to BYTE Author's Guide, 70 Main St, Peterborough NH 03458.

Articles which are accepted are purchased with a rate of up to \$50 per magazine page, based on technical quality and suitability for BYTE's readership. Each month, the authors of the two leading articles in the reader poll (BYTE's Ongoing Monitor Box or "BOMB") are presented with bonus checks of \$100 and \$50. Unsolicited materials should be accompanied by full name and address, as well as return postage.

BYTE's Bugs

A Strategic Bug

The program in the article by John Rheinstein "Fifteen: A Game of Strategy (or Tic-Tac-Toe Revisited)" (June 1980 BYTE, page 230) contains an error in line 720. Instead of:

```
"720 IF T2 > 0 THEN 270"
```

the line should read:

```
"720 IF T2 > 0 THEN 750"
```

If the program is input as given, you get nothing but a sequence of prompts that say "YOUR MOVE?"

An alternate fix is to delete line 460 and lines 650 thru 810. The program then runs satisfactorily, but does not recognize a tie game after only 8 moves (which is possible as the user always

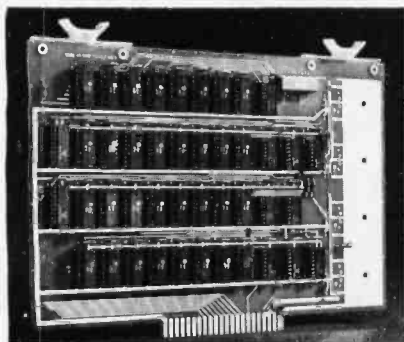

VAK-4 DUAL 8K-RAM ~~\$379.00~~ \$325.00 plus shipping
VAK-2 8K-RAM (1/2 populated) \$239.00

VAK-4 16K STATIC RAM BOARD

- Designed specifically for use with the AIM-65, SYM-1, and KIM-1 microcomputers
- Two separately addressable 8K-blocks with write protect.
- Designed for use with the VAK-1 or KIM-4* motherboards
- Has provisions for mounting regulators for use with an unregulated power supply
- Made with 1st quality 2114 static ram chips
- All IC's are socketed
- Completely assembled, burned-in, and tested

We manufacture a complete line of high quality expansion boards. Use reader service card to be added to our mailing list, or U.S. residents send \$1.00 (International send \$3.00 U.S.) for airmail delivery of our complete catalog.

*Product of MOS Technology



ENTERPRISES

INCORPORATED

2951 W. Fairmount Avenue • Phoenix, AZ 85017 • (602) 265-7564
Please note new address

DISCOUNT PRICES

APPLE II COMPUTERS

16K APPLE II	949.00
32K APPLE II	994.00
48K APPLE II	1039.00
DISK W CONTROLLER	520.00
DISK ONLY	450.00
APPLESOFT CARD	159.00
INTEGER CARD	159.00
PASCAL SYSTEM	425.00
SILENTYPE PRINTER	525.00



RAM MEMORY
FOR TRS-80, APPLE II
16K SET 4 116's 45.00

NORTH STAR COMPUTERS



HRZ-1D-32K-ASM	2125.00
HRZ-2D-32K-ASM	2475.00
HRZ-1Q-32K-ASM	2375.00
HRZ-2Q-32K-ASM	2990.00

VERBATIM DISKETTES
BOX OF 10 5 1/4" 29.50
BOX OF 10 8" 39.50

FREDERICK COMPUTER PRODUCTS
MUNICIPAL AIRPORT
FREDERICK, MD. 21701
(301) 694-8884

September, October Super Special Apple II 16K \$950.00 reg. 1195.00

INTEGRAL DATA SYSTEMS

440G: Paper Tiger
with Graphics;
2K Buffer **\$950**
reg. \$1095

460: Word
Processing Quality **\$1099**
reg. 1295

460G: IDS 460 w/Graphics **\$1199**
reg. 1395

Centronics 737
High Quality Dot Matrix **\$895**
reg. 995.00

Apple Silentype
Includes interface and
graphic capabilities **\$535**
reg. 595.00

Apple Parallel Int. **\$160**
reg. \$180

Apple Serial Int. **\$175**
reg. \$195

Centronics Parallel Int. **\$185**
reg. \$225

DOUBLE VISION **\$295.00**

DISK II
with controller **\$525.00**
without controller **\$445.00**

MICROMODEM **\$325.00**

PASCAL **\$425.00**

LEEDEX MONITOR **\$140.00**

KG-12C **\$275.00**
Green Phosphor
12" Screen w/Glare Cover
18 MHz bandwidth

**16K RAMS for
APPLE II
TRS-80 \$59**

**VERBATIM
DISKS
10 for \$27**

The Computer Stop
16919 Hawthorne Blvd.
Lawndale, CA 90260
(213) 371-4010

**MON. - SAT.
10-6**

BYTE BACK ISSUES FOR SALE

The following issues are available:
1976: July and November

1977: March, May thru December

1978: February thru October, December

1979: January thru December except March

1980: January to current issue except February

Cover price for each issue through August 1977 is \$1.75

Domestic; \$2.75 Canada and Mexico; \$3.75 Foreign.

September 1977 through October 1979 issues are \$2.50

Domestic; \$3.25 Canada and Mexico; \$4.00 Foreign.

November 1979 to current is \$3.00 Domestic; \$3.75 Canada

and Mexico; \$4.50 Foreign.

Send requests with payment to:

BYTE Magazine

70 Main St, Peterborough NH 03458

Attn: Back Issues

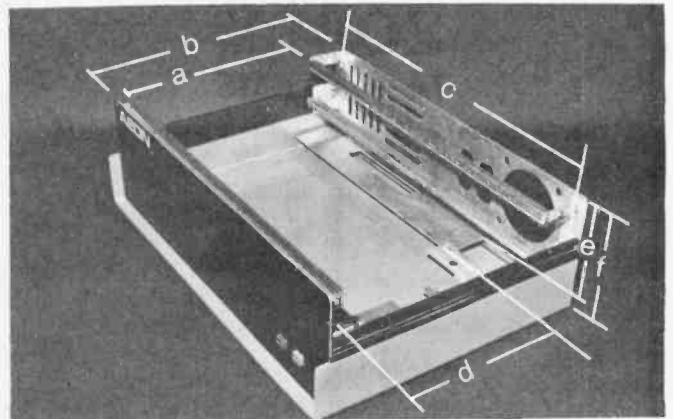

RF EMISSION-SHIELDING MAINFRAME CABINET

Rugged, attractive, heavy aluminum construction. Immediately available from stock: \$85.00 plus shipping. Will accommodate **Digital Group** equipment as well as any other CPU fitting dimensions listed. All measurements are Inside Dimensions (ID):

- a. ID between card racks: 12 1/4"
- b. ID front-to-back panels: 15 3/4"
- c. ID between cabinet siderails: 23"
- d. ID between motherboard racks: 11"
- e. ID mother-board-to-top: 6"
- f. ID cabinet floor-to-ceiling: 7 1/4"

Digital Group products are available through AEON Electronics, Denver. AEON carries the complete line of cabinets—matching mainframe cabinet described above, printers, disks, single and double density controller cards, memory cards, Z-80ACPU 2.5/6Mhz, communications cards (for terminals and modems), and peripheral boards. Most items shipped immediately from stock.

AEON Manufacturer of Digital Group Computers

1855 S. Pearl Denver, Colorado 80210

Phone orders: 303-777-AEON

Visa and M/C accepted

TOLL FREE ORDERING



These Fine Products and More

NORTHSTAR		THINKER TOYS	
HRZ 1-32K-D	2100	DISCUS 2 + 2 1 DRIVE	1265
HRZ 2-32K-D	2340	DISCUS 2D 1 DRIVE	970
HRZ 2-32K-O	2690	DISCUS M26 HARD DISC	4095
HARD DISC SYSTEM	3950	SOLID STATE MUSIC Kit Assm	
DYNA BYTE		SB1 SYNTHESIZER	161 227
DB 8/1 4 8K	2395	VB1B VIDEO	125 170
DB 8/2 4 8K	3900	CB2 Z80 CPU	168 220
DB 8/4	3030	MEASUREMENT SYSTEMS	
32M PHOENIX	11800	DM 3200 32K 250ns	500
TERMINALS		DM 6400 64K 250 ns	640
TELEVIDEO 912	745	DMB 3200	650
TELEVIDEO 920	795	SOFTWARE-DISCS-MISC	
SOROC IQ-120	700	CPM-2	150
PRINTERS		WORDSTAR	350
NEC 5510	2700	GRAHAM-DORIAN	CALL
NEC 5520	2975	STRUCTURED SYSTEMS	CALL
TI-820	1650	VERBATIM 5 (10)	28
ANADEX	795	VERBATIM 8 (10)	35
BASE 2	600	ATARI	CALL
EPSON	CALL	TI 99-4	CALL

WE WILL TRY TO BEAT ANY ADVERTISED PRICE
Automated Equipment Inc.
 4341 W. Commonwealth Ave Suite D
 Fullerton, Calif. 92633
 (714) 739-4701 (800) 854-6003

ZOBEX Z_S-SYSTEMS

Complete computer on 3 S-100 boards with 32K RAM for \$1395.00
 Runs M/PM and C/PM

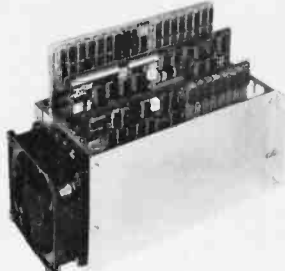

64K RAM

4 MHz No WAIT States
 DMA operation,
 Bank select in 16K sections

DISK CONTROLLER

8" and 5" DRIVES
 All digital design for stable and
 reliable performance. No one-
 shots or analog circuitry. BIOS
 for C/PM available.

Z80 CPU

2 or 4 serial ports, 3 parallel,
 one 4K EPROM, Vectored inter-
 rupts, real time clock, Software
 controlled baud rates, Drives
 daisy wheel printer directly

CARD CAGE and Fan

6 slot shielded motherboard for
 good cooling and low noise.

2-4 MHZ

SEND FOR FREE INFORMATIONS
 6 months warranty on our boards with normal use

Z_S-SYSTEMS ZOBEX

5333 Mission Center Rd., San Diego, CA. 92108
 P.O. Box 1847, San Diego, Ca. 92112
 (714) 447-3997, (714) 296-9182

moves first), and does not recognize a tie game at all if the program is modified to let the machine move first.

Mr Rheinstein has provided an interesting twist on the old game of tic-tac-toe. I've played several dozen games and haven't won yet, but I'm still trying!

Clinton R Foulk
 5101 Delancey St
 Columbus OH 43220

Error in Airborne Navigation

A typographical error occurred in the "Desk Top Wonders" item "Calculator Airborne Navigation: The HP-25 Finds Ground Speed and True Heading," by L J Kuhns (November 1979 BYTE, pages 245 and 246).

In the program listing on page 246, six consistent substitutions of "8" for "g" were made; for instance, in line 09, "8 ≥ 0" should have been "g ≥ 0". The errors were in lines 9, 14, 25, 30, 33, and 44. The use of "g" refers to an operation involving the blue function-entry key.

We at BYTE hope that no one has navigated incorrectly due to this error.

Benchmarking Errors

We cannot seem to get benchmark programs right. There is an error in listing 1 of the Technical Forum article "Some More Notes on Performance Evaluation," by Carl Helmers, in the July 1980 BYTE (pages 216 thru 219). (The article itself contains a correction for a previous BYTE article on benchmarking.)

110 IF A(I)=0
 THEN 100 ELSE 90

should read:

110 IF A(X)=0
 THEN 100 ELSE 90

Our thanks go to Tom Kelly Jr of Salem, Ohio, and other readers for pointing this out to us.

In addition, our staff

found that the program has no way to print out the results by executing lines 120 thru 170. To correct this, change line 110 to:

110 IF A(X)=0
 THEN 100 ELSE 85

and add line 85:

85 IF 2*X>L THEN 120

We apologize for these errors.

Sorry, Wrong Number

The October 1980 issue of BYTE contains an error on page 347, in the "What's New?" column. The telephone number listed for Moore Business Forms Inc, is incorrect. The numbers are (800) 942-8330 in Indiana, and (800) 323-8326 for the rest of the US. ■

BYTE's Bits

National Computer Conference 1981 Needs Panelists

Interest has been steadily mounting for a panel discussion on personal robotics and artificial intelligence ideas, applications, and accomplishments. And now, the Personal Computing Festival of the National Computer Conference 1981 will offer this opportunity. If you wish to participate in this discussion, send a description of your interest area and the contents of a 5-minute presentation to A Gelles, 185 W Houston St, New York NY 10014. Participants should be nonprofessionals in robotics and artificial intelligence disciplines.

The conference will be held in Chicago, Illinois, on May 5 thru 7, 1981. Additional information may be obtained by writing to the above address. ■

MYCHESS

by David Kittinger

**Winner of 5th West Coast
Computer Faire
Micro-Chess Tournament**

MYCHESS	3½
Atari	2½
Atari	2
Boris/Sargon 2.5	1½
Voice Challenger	1

Highest finish for a Micro at the Third World Computer Championships

USCF rating 1568 (June Supplement) from over 60 rated games - highest ever any micro-program.

- Z80 Assembly program
- Will save game on disk for later play
- Searches on opponent's time
- Set up any position
- Over 850 opening moves
- 9 levels of play - Will solve any mate-in-5 problem
- Tournament time control
- Will print game out when over

Available for CP/M®, CDOS®, North Star®, (CP/M®, DOS®)

\$50.00

**Computer Services
2431 Lyvona
Anchorage, AK 99502**

Z80¹ is a trademark of Zilog Inc.
CP/M is a trademark of Digital Research
CDOS is a trademark of Cromenco, Inc.
NorthStar & NorthStar DOS are trademarks of North Star Computers Inc.



Go FORTH AND Conquer

ENHANCED
**FIG⁺ FORTH
For CP/M[†]**

Conquer the wait while the editor or compiler loads. Conquer excessive disk I/O. Conquer boredom during yet another compilation or assembly just to squash a tiny bug. Conquer memory squeeze on application programs

Timin Engineering now offers CP/M users a complete, integrated, memory resident full FORTH system. Powerful editor. Incremental FORTH compiler. Z80/8080 assembler. Virtual memory. Fast .17 second/K-byte disk I/O. Top level command processor. All using your standard CP/M BIOS.

Ready to run for only \$95. User Manual alone, \$20, credits toward software purchase

Place your order today — Then go FORTH and conquer!



○ ○ MITCHELL E. TIMIN ENGINEERING COMPANY
○ ○ ○ 9575 GENESEE AVENUE • SUITE E2
○ ○ ○ SAN DIEGO • CALIFORNIA 92121
○ ○ ○ TELEPHONE [714] 455-9008

Software prices may vary from time to time. All prices are in U.S. dollars. All prices are for single density, disk. Other disk formats add \$1. All prices subject to change without notice. © 1980 Timin Engineering. All rights reserved. California residents please add 6% tax. *FORTH is a registered trademark of Digital Research Corp.

FREE COMPUTER FORMS KIT

**with continuous business forms
for small computer systems**

Each kit contains samples, programming guides, flyers, prices and order forms for checks, invoices, statements, envelopes, stock paper and labels to fit almost every computer system.

- Available in quantities of 500, 1,000, 2,000, 4,000, 6,000
- Low Prices (500 checks only \$32.50)

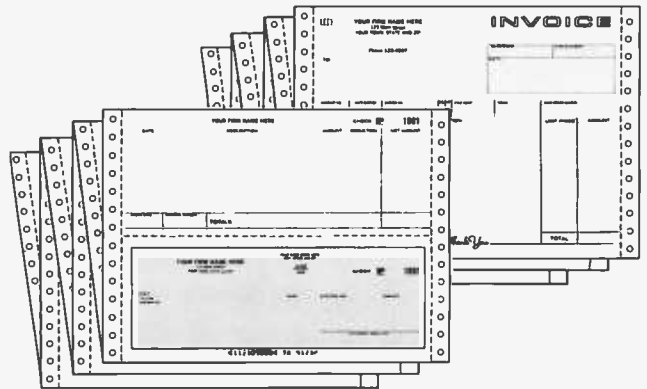

- **FAST SERVICE** — It is our policy to ship within 6 working days following our receipt of your order.
- **MONEY BACK GUARANTEE** — If for any reason you are not completely satisfied, your money will be promptly refunded.

**Fast Service by mail or . . .PHONE TOLL FREE
1 + 800-225-9550**
Mass. residents 1 + 800-922-8560
8:30 a.m. to 5:00 p.m. Eastern Time Monday — Friday

Please Ship FREE Kit To: CODE 460

Name _____

Company _____

Street _____

City, State and Zip _____

Phone _____

Computer make & model _____

Account

**Neb's
Computer Forms**
78 Hollis Street, Groton, Mass. 01450
A division of New England Business Service, Inc.

Letters continued from page 20:
resulting in control of thirty-two
separate tasks!

Norman McEntire
323 Tram Rd
Columbia SC 29210

Beware Automatic Color TVs

BYTE readers should be made aware that RF (radio-frequency) modulators such as the popular Sup'R' Mod II manufactured by M & R Enterprises may not be compatible with certain television sets. Unhappily, I discovered this fact when I purchased a new RCA color television equipped with all-

electronic tuning for use with an Apple II equipped with a Sup'R' Mod II. It seems that the electronic tuners are so stable and accurate that they are not required to have a fine-tuning control. Unfortunately, the UHF (ultra-high frequency) oscillator in a typical radio-frequency modulator is anything but stable and accurate. To "find" the signal put out by the radio-frequency modulator, either a fine-tuning control on the television or a frequency-adjustment control on the radio-frequency modulator is an absolute necessity. Having neither in my case (the Sup'R' Mod II has no frequency adjustment), I am out of luck.

It may be that radio-frequency modulators operating on VHF (very-high fre-

quency) channels 3 or 4 may be more accurate. But in any event, BYTE readers should be aware of this potential problem if they are in the market for a color television for use as a monitor, or for a radio-frequency modulator to use with the new breed of television sets lacking fine-tuning controls.

Jacob Z Schanker, PE
105 Colony Ln
Rochester NY 14623

In a related situation, I cannot play back prerecorded videotapes on my 1978 color television. Commercial tapes add an antipiracy signal that causes the picture to roll. This can be remedied by adjusting the vertical hold on your television—unless you have an automatic color television (like mine) that doesn't have such a control anywhere . . . GW

TWO YEARS...AND GROWING



Personal / Professional System
48K Apple II or Plus
Disk w/Controller w/3.3 DOS
Super Mod
Visicalc & Applewriter
Box of Paper
Silentype Printer
Reg. \$2925

\$2495
cash price



- See an original Apple I on display in our showroom.



FARNSWORTH COMPUTER CENTER

1891 N. Farnsworth Ave.
(immediately S. of E-W Tollway)
Aurora, Ill. (312) 851-3888
Weekdays 10-8; Sat. 10-5

Fidelity versus Digicast (or Datacast)

Although I missed the article on the Digicast Project in the January 1979 BYTE (our BYTE magazine goes through a lot of hands), I would like to comment on Noel Moss's letter in the April issue. (See "The Digicast System: Receiving Data and Information Over Your FM Radio," by A I Halsema, January 1979 BYTE, page 100; also see "Digicast Data," April 1979 BYTE, page 8.)

As a former FM broadcast engineer, I disagree with Mr Moss's contention that "high-fidelity music transmission is not restricted by the current modulation limits." In the lab, yes, but in these Tennessee hills multipath will create distortion problems even when the absolute signal strength is just fine. Stereo in particular is subject to damage in reception quality due to multipath.

What those music syndicators have been trying to tell us is: you can't cheat Mother Nature. Sure, you can put sub-carriers all over the place and broadcast stereo. (Dorren quadraphonic, while you are at it?) But you can't do that and see around corners at the same time. In hilly terrain or metropolitan areas, it is best to limit your bandwidth as much as possible, or suffer the high cost of listener dissatisfaction with your mobile reception.

SCA (subsidiary communications authorization) for digital data is a special problem. For some time we at station WSMC attempted to use our subcarrier to route telemetry from the transmitter to the studio's remote control. Please bear in mind that the data rate of this is about 2 bps (bits per second). The result was a very noticeable flutter sound in receivers that did not have a line of sight to our antenna, which was modulated by mountain peaks in mobile reception.

**DISK DRIVE WOES? PRINTER INTERACTION?
MEMORY LOSS? ERRATIC OPERATION?
DON'T BLAME THE SOFTWARE!**



Power Line Spikes, Surges & Hash could be the culprit! Floppies, printers, memory & processor often interact! Our unique ISOLATORS eliminate equipment interaction AND curb damaging Power Line Spikes, Surges and Hash.

- *ISOLATOR (ISO-1A) 3 filter isolated 3-prong sockets; integral Surge/Spike Suppression; 1875 W Maximum load, 1 KW load any socket \$56.95
- *ISOLATOR (ISO-2) 2 filter isolated 3-prong socket banks; (6 sockets total); integral Spike/Surge Suppression; 1875 W Max load, 1 KW either bank \$56.95
- *SUPER ISOLATOR (ISO-3), similar to ISO-1A except double filtering & Suppression \$85.95
- *ISOLATOR (ISO-4), similar to ISO-1A except unit has 6 individually filtered sockets . . . \$96.95
- *ISOLATOR (ISO-5), similar to ISO-2 except unit has 3 socket banks, 9 sockets total . . . \$79.95
- *CIRCUIT BREAKER, any model (add-CB) Add \$ 7.00
- *CKT BRKR/SWITCH/PILOT any model (-CBS) Add \$14.00

PHONE ORDERS 1-617-655-1532

Electronic Specialists, Inc.

171 South Main Street, Natick, Mass. 01760

Dept. B I

**Give an ear to your computer
this Christmas!**



COGNIVOX lets your computer respond to your spoken commands.

**PET, TRS-80 LII
AIM-65 and SORCERER**

NEW COGNIVOX SR-100 has 32 word (or short phrase) vocabulary (AIM-65 with 4K RAM, 16 words). Up to 98% recognition rate. Breakthrough price of only \$119 includes microphone, cassette with software and manual. Version for the TRS-80 (VIO-332) costs \$149 but also has 32 word speech output and music capability, includes all above plus speaker/amplifier. For the Sorcerer, in addition to SR-100, we offer COGNIVOX VIO-132 which includes speech output and music and extensive software and costs \$179. Please add \$3 for shipping in the US, Calif. add 6% tax. Foreign orders welcome, add 10% for processing and shipping by air. When ordering, please specify make, model and memory size of your computer

VOICETEK

Dept. B, P.O. Box 388, Goleta, Ca 93017

**APPLE II TRS-80
QUALITY
DISK SOFTWARE**

HOME FINANCE PAK I: Entire Series \$49.95

- BUDGET:** The heart of a comprehensive home finance system. Allows user to define up to 20 budget items. Actual expense input can be by keyboard or by automatic reading of CHECKBOOK II files. Costs are automatically sorted and compared with budget. BUDGET produces both monthly actual/budget/variace report and a year-to-date by month summary of actual costs. Color graphics display of expenses. . . \$24.95
- CHECKBOOK II:** This extensive program keeps complete records of each check/deposit. Unique check entry system allows user to set up common check purpose and recipient categories. Upon entry you select from this pre-defined menu to minimize keying in a lot of data. Unique names can also be stored for completeness. Rapid access to check files. Check register display scrolls for ease of review. 40 column print-out. Up to 100 checks per month storage. Files accessible by BUDGET program \$19.95
- SAVINGS:** Allows user to keep track of deposits/withdrawals for up to 10 savings accounts. Complete records shown via screen or 40 column printer. \$14.95
- CREDIT CARD:** Keep control of your cards with this program. Organizes, stores and displays purchases, payments and service charges. Screen or 40 column printer display. Up to 10 separate cards \$14.95

UNIVERSAL COMPUTING MACHINE: \$39.95

A user programmable computing system structured around a 20 row x 20 column table. Use defined row and column names and equations forming a unique computing machine. Table elements can be multiplied, divided, subtracted or added to any other element. User can define repeated functions common to a row or column greatly simplifying table setup. Hundreds of unique computing machines can be defined, used, stored and recalled, with or without old data, for later use. Excellent for sales forecasts, engineering design analysis, budgets, inventory lists, income statements, production planning, project cost estimates-in short for any planning, analysis or reporting problem that can be solved with a table. Unique cursor commands allow you to move to any element, change its value and immediately see the effect on other table values. Entire table can be printed by machine pages (user-defined 3-5 columns) on a 40 column printer.

COLOR CALENDAR: \$19.95

HI-RES color graphics display of your personal calendar. Automate multiple entry of repetitive events. Review at a glance important dates, appointments, anniversaries, birthdays, action dates, etc. over a 5 year period. Graphic calendar marks dates. Printer and screen display a summary report by month of your full text describing each day's action item or event. Ideal for anyone with a busy calendar.

BUSINESS SOFTWARE: Entire Series \$159.95

- MICROACCOUNTANT:** The ideal accounting system for the small business. Based on classic T accounts and double-entry bookkeeping, this efficient program records and produces reports on account balances, general ledger journals, revenue and expenses. Screen or 40 column printer reports. Handles up to 1000 journal entries per month up to 300 accounts. Includes a short primer in Financial Accounting. . . \$49.95
- UNIVERSAL BUSINESS MACHINE:** This program is designed to SIMPLIFY and SAVE TIME for the serious businessman who must periodically Analyze, Plan and Estimate. The program was created using our Universal Computing Machine and it is programmed to provide the following planning and forecasting tools:
CASH FLOW ANALYSIS PROFORMA BALANCE SHEET SOURCE AND USE OF FUNDS
PROFORMA PROFIT & LOSS SALES FORECASTER JOB COST ESTIMATOR

Price, including a copy of the Universal Computing Machine \$89.95

- BUSINESS CHECK REGISTER AND BUDGET:** A combination of our CHECKBOOK II and BUDGET programs expanded to include up to 50 budgetable items and up to 500 checks per month. Includes bank statement reconciliation and automatic check search (48K) \$49.95

ELECTRONICS SERIES: Entire Series \$159.95

- LOGIC SIMULATOR. SAVE TIME AND MONEY.** Simulate your digital logic circuits before you build them. CMOS, TTL, or whatever, if it's digital logic, this program can handle it. The program is an interactive, menu driven, full-fledged logic simulator capable of simulating the bit-time by bit-time response of a logic network to user specified input patterns. It will handle up to 1000 gates, including NANDS, NORs, INVERTERS, FLIP FLOPS, SHIFT REGISTERS, COUNTERS and user-defined XACROS. Up to 40 user-defined, random, or binary input patterns. Simulation results displayed on CRT or printer. Accepts network descriptions from keyboard or from LOGIC DESIGNER for simulation. \$89.95
- LOGIC DESIGNER:** Interactive HI-RES Graphics program for designing digital logic systems. A menu driven series of keyboard commands allows you to draw directly on the screen up to 15 different gate types, including 10 gate shape patterns supplied with the program and 5 reserved for user specification. Standard patterns supplied are NAND, NOR, INVERTER, EX-OR, T FLOP, JK FLOP, D-FLOP, RS-FLOP, 4 BIT COUNTER and 8-BIT SHIFT REGISTER. User interconnects gates just as you would normally draw using line graphics commands. Network descriptions for LOGIC SIMULATOR generated simultaneously with the CRT diagram being drawn. \$89.95

MATHEMATICS SERIES: Entire Series \$49.95

- STATISTICAL ANALYSIS I:** This menu driven program performs SIMPLE LINEAR REGRESSION analysis, determines the mean, standard deviation and plots the frequency distribution of user supplied data sets. Printer, Disk, I/O and edit routines included (32K min.). \$19.95
- NUMERICAL ANALYSIS:** HI-RES 2-Dimensional plot of any function. Automatic scaling. At your option, the program will plot the function, plot the INTEGRAL, plot the DERIVATIVE, determine the ROOTS and the MAXIMA and MINIMA and list the INTEGRAL VALUE \$19.95
- MATRIX:** A general purpose, menu driven program for determining the INVERSE and DETERMINANT of any matrix, as well as the SOLUTION to any set of SIMULTANEOUS LINEAR EQUATIONS. Disk I/O and data save. Specify 55 eqn. set (48K) or 35 eqn. (32K) \$19.95
- 3 D SURFACE PLOTTER:** Explore the ELEGANCE and BEAUTY of MATHEMATICS by creating HI RES PLOTS of 3-dimensional surfaces from any 3-variable equation. Disk save and recall routines for plots. Menu driven to vary surface parameters. Hidden line or transparent plotting \$19.95

ACTION ADVENTURE GAMES: Entire Series \$29.95

- RED BARON:** Can you outfly the RED BARON? This fast action game simulates a machine gun DOG FIGHT between you WORLD WAR I BI-PLANE and the baron's. You can LOOP, DIVE, BANK or CLIMB in any one of 8 directions and so can the BARON. In HI-RES graphics. \$14.95
- BATTLE OF MIDWAY:** You are in command of the U.S.S. HORNETS' DIVE BOMBER squadron. Your targets are the Aircraft carrier, Akagi, Soryu and Kaga. You must fly your way through ZEROs and AA FIRE to make your DIVE BOMB run. In HI-RES graphics \$14.95
- SUB ATTACK:** It's April, 1943. The enemy convoy is headed for the CORAL SEA. Your sub, the MORAY, has just sighted the CARRIERS and BATTLESHIPS. Easy pickups. But watch out for the DE STROYERS they're fast and deadly. In HI-RES graphics \$14.95
- FREE CATALOG:** All programs are supplied on disk and run on Apple II w/Disk & Applesoft ROM Card & TRS 80 Level II and require 32K RAM unless otherwise noted. Detailed instructions included. Orders ship w/d within 3 days. Card users include card number. Add \$1.50 postage and handling with each order. California residents add 6% sales tax.

Make checks payable to:
SPECTRUM SOFTWARE
P.O. Box 2084 142 Carlow, Sunnyvale, CA 94087
For phone orders - 408-738-4387
DEALER INQUIRIES INVITED

Buy By Mail and Save!



- INTERTEC SuperBank, 32K . \$2495
- 64K Ram, List \$3345 \$2695
- 64K Quad, List \$3995 \$3395
- NORTH STAR Horizon I
- 32K DD List \$2695 \$1989
- Horizon I QD List \$2995 \$2245
- Horizon 2 32K DD, List \$3095 \$2289
- Intersystem DP-1 List \$1749 . . \$1495

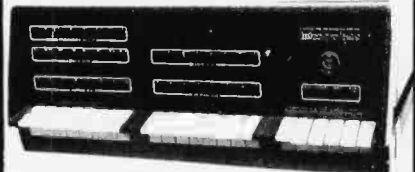

- CROMENCO Z-2, List \$9995 . \$7945
- System 64K, List \$3990 \$3179
- System 3 64K, List \$7395 5689
- ATARI 800, List \$1080 \$799
- APPLE II, 16K \$969

DISK SYSTEMS

- THINKER TOYS' Discus 2D . . \$939
- Dual Discus 2D \$1559
- Discus 2 + 2, List \$1549 \$1259
- M26 Hard Disk, List \$4995 . . \$3949

PRINTERS & TERMINALS

- PAPER TIGERS IDS-440 . . . \$679
- With graphic option \$749
- CENTRONICS 730-1, List \$795 \$595
- 737, List \$995 \$789
- 704-9 180 cps \$1495
- 703-9 180 cps \$1569
- T I 810, List \$1895 \$1489
- NEC SPINWRITER 5530 . . . \$2395
- NEC SPINWRITER 5515 . . . \$2395
- DIABLO 630 List \$2711 \$2399
- INTERTEC
- Intertube III, List \$895 729
- Emulator \$729
- Televideo 912C \$679
- 920C \$799
- Hazeltine 1420 \$789
- 1500 \$845
- Soroc 120, List \$995 \$689
- Soroc 140 \$994

Most items in stock for immediate delivery. Factory sealed cartons, w/full factory warranty. NYS residents add appropriate sales tax. Prices do not include shipping. VISA and Master Charge add 3%. C.O.D. orders require 25% deposit. Prices subject to change without notice.

Computers Wholesale

P.O. Box 144 Camillus, NY 13031



(315) 472-2582



The result was a decision against SCA and against switching-type stereo encoders—this latter decision was made because we would rather have any problems in the stereo signal result in placement errors in the stereo field instead of adding to distortion.

The best place for digital broadcasting, in my view, is in the blanking intervals in television video signals. This is being used with great success in public television for subtitling for the hearing-impaired. Please don't crowd our marginal FM signals with it!

John Beckett
Director of Computer Services
Southern Missionary College
Collegedale TN 37315

The Digicast Project has been renamed the "Datacast Project" by its principal proponent, Jim Warren. No regular Datacast service is now in operation, but in a recent telephone conversation, Mr Warren told me, "The only thing that's holding up Datacast is Jim Warren." He added that several tests have been performed both in Sacramento, California, and in the San Francisco Bay area, and that he intends to pursue Datacast when some other projects are completed.

I also talked with Harry R Anderson, the broadcast engineer who helped perform the tests. He agrees with many of the points made by Mr Moss (noting that few people can detect a 1 dB difference in volume), but derogates the objections of Mr Beckett regarding increased multipath distortion resulting from use of the SCA.

Mr Anderson believes that the problems experienced by WSMC were probably caused by other factors, and he says that the theoretical causes of multipath distortion should not be affected by SCA subcarriers.

Mr Anderson is the author of two articles on the Digicast/Datacast system. See "Digicast: Towards a More Effective Use of the Radio Spectrum Resource," Intelligent Machines Journal, Number 10, June 25, 1979, page 18; also see "Digicast: A Status Report," Intelligent Machines Journal, Number 17, October 31, 1979, page 10. . . . RSS

The End of the CBT

The article by Ron Parsons about a 6860-based modem was excellent. (See "An Answer/Originate Modem," June 1980 BYTE, page 24; also see the "BYTE's Bits" item "Tracking Down the Modem Filters," September 1980 BYTE, page 312.)

Unfortunately, on January 1, 1980, the Bell Telephone system made the CBT data-access arrangement (DAA) obsolete. No telephone-line interface

Announcing the most important utility ever introduced for the TRS-80* Model I and Model II—

ENHBASTM

ENHBAS is an Enhanced Basic extension module, which loads at the top of BASIC, adding many commands and background tasks—

☐ Over 30 new commands added to your BASIC:

- **SORT**—Multi-keying, multi-tagging array sort. Sorts thousands of items in mere seconds, all with one command!
- **JNAME**—Use line labels along with line numbers in branching statements, as in assembly language, using the ENHBAS commands **GTO** and **CSUB** (special **GOTO** and **GOSUB**).
How many times have you wanted to use variables to reference line numbers? Now you can! **GTO** and **CSUB** allow variable expressions as operands, such as in **GTO X+40**.
- **WHILE / WEND**—New, structured programming loop construct. Makes for more logical program flow (less **GOTO**'s).
- **EXEC / EVAL**—Two new, extremely powerful functions! **EVAL** evaluates an algebraic expression in string form. With **EVAL** you can manipulate complex functions in string form, and then evaluate them. **EXEC** executes a string expression as if it were a BASIC program line! With **EXEC**, your computer can actually write its own programs and execute them!
- **CALL**—Pass control to machine language subroutines at any address, passing parameters both ways.
- **CLM / PAGE**—Set up automatic page roll-over and other line printer functions from BASIC.
- **All these and many more!**

☐ In addition to the above commands, Model I ENHBAS contains vector graphics and drawing commands. Model II ENHBAS has many functions suited to business programming—**ISAM** file handling commands, **RS-232** access, and many more; along with several Model I BASIC commands left out of Model II (**PEEK**, **POKE**, **OUT**, etc.).

☐ ENHBAS includes many background utilities (Model I version):

- **User-definable cursor**
- **Key click**
- **Two-tone beep on error**
- **Automatic lower-case**
- **Automatic debounce**
- **Short-entry commands** (**Shift-letter prints command**)
- **Real Control keys**
- **One letter commands**
- **Formatted LISTings**

ENHBAS is available for:

- 16K Model I—Level-II Tape \$39.95
- 32K Model I Disk \$39.95
- 32K Model III (avail. 11/1/80) \$39.95
- 32K Model II (on TRSDOS disk) \$99.95

* TRS-80 is a reg. trademark of Radio Shack, a Tandy Co.

Other software:

- CSG PILOT**—Disk-based, high level language.
- 32K Model I Disk \$59.95
- Z-EMULATOR**—Executes assem. lang. lines.
- 16K Model I—Level-II Tape \$29.95
- 32K Model I Disk \$29.95
- ENHCOMP**—Integer subset BASIC compiler. Full graphics. Requires RS Editor/Assembler.
- 32K Model I Disk \$24.95
- ABBREV**—Level-I abbrev. in Level-II/Disk.
- 16K Model I—Level-II Tape \$24.95
- 32K Model I Disk \$24.95

Dealer and OEM inquiries invited.

The Comsoft Group

6008 N. Keystone Ave., Dept. B
Indianapolis, IN 46220
(317) 257-3227

TERMINALS FROM TRANSNET

PURCHASE PLAN | **12-24 MONTH FULL OWNERSHIP PLAN** | **36 MONTH LEASE PLAN**

DESCRIPTION	PURCHASE PRICE	12 MOS.	PER MONTH 24 MOS.	36 MOS.
LA36 DECwriter II	\$1,695	\$162	\$ 90	\$ 61
LA34 DECwriter IV	1,095	105	59	40
LA34 DECwriter IV Forms Ctrl.	1,295	124	69	47
LA120 DECwriter III KSR	2,495	239	140	90
LA180 DECprinter I	2,095	200	117	75
VT100 CRT DECscope	1,895	182	101	68
VT132 CRT DECscope	2,295	220	122	83
DT80/1 DATAMEDIA CRT	1,995	191	106	72
T1745 Portable Terminal	1,595	153	85	57
T1765 Bubble Memory Terminal	2,595	249	146	94
T1810 RO Printer	1,895	182	101	68
T1820 KSR Printer	2,195	210	117	79
T1825 KSR Printer	1,595	153	85	57
ADM3A CRT Terminal	875	84	47	32
ADM31 CRT Terminal	1,450	139	78	53
ADM42 CRT Terminal	2,195	210	117	79
QUME Letter Quality KSR	3,295	316	176	119
QUME Letter Quality RO	2,895	278	155	105
HAZELTINE 1420 CRT	945	91	51	34
HAZELTINE 1500 CRT	1,195	115	64	43
HAZELTINE 1552 CRT	1,295	124	69	47
Hewlett-Packard 2621A CRT	1,495	144	80	54
Hewlett-Packard 2621P CRT	2,650	254	142	96

FULL OWNERSHIP AFTER 12 OR 24 MONTHS
10% PURCHASE OPTION AFTER 36 MONTHS

ACCESSORIES AND PERIPHERAL EQUIPMENT
ACOUSTIC COUPLERS • MODEMS • THERMAL PAPER
RIBBONS • INTERFACE MODULES • FLOPPY DISK UNITS
PROMPT DELIVERY • EFFICIENT SERVICE



TRANSNET CORPORATION
1945 ROUTE 22
UNION, N.J. 07083
201-688-7800
TWX 710-985-5485

AOS On
A NOVA® 4/X?

Wild Hare's
MTSS Provides NOVA® Users
With Multi-User Capabilities

DG users now have a choice when upgrading to a multi-user environment. Previously, the only way to support a true multi-user environment was to upgrade to AOS, but not anymore.

MTSS provides all of the standard RDOS features for up to 16 users simultaneously and each user is totally independent. Users may edit, compile and execute programs written in FORTRAN IV, FORTRAN V, ALGOL, BASIC, MACS, etc.

This means no software rewriting is necessary. No new operating system need be installed.

More importantly, MTSS supports all NOVA's as well as ECLIPSE's so no expensive hardware upgrade is required.

Now Data General Users
Have A Choice!

WILD HARE COMPUTER SYSTEMS INC.

P.O. Box 3581, Boulder, Colorado 80307
(303) 422-1182

```

DATEBOOK for Tue Jan 1 - Not printed since the last change
:First one      :Second one      :Third one
8:00 :John Smith/root canal.
10:00 :
20:00 :
30:00 :Dennis Johnson/wisdom.
40:00 :Tooth extraction.
50:00 :
9:00 :
10:00 :Kathy Nelson/check up.
20:00 :
30:00 :
40:00 :
50:00 :Mike Silva/restoration.
10:00 :
10:00 :George Kennedy:
20:00 :restoration.
30:00 :Thelma Carter/check up.
40:00 :
50:00 :
11:00 :
Schedule C/cancel  Modify  Look for openings  Hold in R/schedule list
Today  Next day Future  Print day's appts  Display person's appts
Key in an option letter, number or space for a new display, or Q to quit
    
```

INTRODUCING DATEBOOK™ THE NEW OFFICE APPOINTMENT CALENDAR PROGRAM

DATEBOOK™ helps manage time just like a common office appointment book, but with the speed and accuracy of a computer. DATEBOOK™ eliminates the scribbles, erasures, and frustration of searching through the book for a specific opening.

DATEBOOK™ is ideal for Doctors, Dentists, Lawyers, Salesmen, Repairmen, or in any situation where time management is critical to office efficiency. Its menu display and one-key options make DATEBOOK™ one of the easiest programs to learn and use.

DATEBOOK™ features include:

- Appointment scheduling, cancelling, modifying and rescheduling.
- Automatically searches for openings according to time of day, day of week, and week of year.
- Displays all scheduled appointments for a specified person.
- Lists day's schedule (Screen or hard copy).
- Can be customized to accommodate any workday/hours schedule.

DATEBOOK™ is written in PASCAL and is available to run on CP/M® as well as UCSD PASCAL systems.

(415) 455-4034

only **\$295**
Dealer Inquiries Invited



1492 Windsor Way, Livermore, CA 94550

CP/M is a registered trademark of Digital Research



64K Horizon II \$2669

Don't be fooled by our low price. These aren't just any 64K Horizon II's. They're thoroughly tested, enhanced, specially packaged and backed by fast warranty service. Before you buy your Horizon, find out how our service, prices, accessories, and software are making us the #1 source for the #1 S-100 system.

Horizon II 64K Quad \$3069
 Horizon II 32K DD \$2339
 Horizon II 32K Quad \$2689

PRINTERS



**Okidata
 Microline 80
 \$539**

Paper Tigers

440 \$835
 440G \$875
 460G \$1149



Centronics 737 \$789
 Anadex 9500, 9501 \$1349
 TI810 Basic \$1489

COMPUTERS



Atari 800 16K \$744

Plus big savings on accessories

TI 99/4 w/monitor \$899
 Zenith (Heath) Z-89 48K \$2259
 Industrial Micro 5000 D.D. \$2499
 Altos ACS-8000-5 \$4995

TERMINALS

P.E. Bantam (w/non glare) \$669
 Soroc IQ 120 \$729
 Televideo 912C \$749
 Televideo 920C \$799
 Hazeltine 1500 \$899
 Visual Tech 200 \$945

HOW TO ORDER

Mail Order Only
 2% cash discount inc./charge cards add 2% —
 Az. residents add 5% tax — We export —
 Warranties included on all products.

**Scottsdale
 Systems**

6730 E. McDowell Road #103
 Scottsdale, Az. 85257
 Open 6 to 6 PM - M-Fri.



(602) 941-5856

devices can be obtained through the telephone company. With this act, the telephone company made obsolete an entire generation of equipment, including modems and telephone-answering devices.

At present, I can find no one who is providing CBT couplers or devices equivalent in function for sale, although the telephone company insists that these are available through "electronics supply houses."

The current regulations specify that any device to be directly connected to the telephone lines must be certified as compatible by the FCC (Federal Communications Commission). This is beyond the means of most individuals. About the only legal means left is to purchase one of the commercially available direct-connect modems or set-
 tle for an acoustically coupled unit.

James R Boatright
 3112 W 11th
 Topeka KS 66604

Comments on the August Issue

Editor's Note: BYTE readers were even more vocal than usual this month about our August 1980 FORTH language issue. Apparently, the combination of Steve Ciarcia's article ("A Build-It-Yourself Modem for Under \$50"), the many FORTH articles, and the article by Theron Wierenga on "Construction of a Fourth-Generation Video Terminal" (no pun intended) combined to hit a collective nerve. Here are some of the short, usually anonymous reader comments we received on the monthly BOMB cards (for an explanation of the BOMB card, see the back of this issue).

Incidentally, wildly enthusiastic comments about FORTH outnumbered negative comments by a factor of 10 to 1:

- More FORTH!! Pascal's just another language to eliminate programmers, but FORTH is a language for programmers (and engineers and scientists and businessmen and kids and everybody)!
- I would like to see more articles on FORTH—best single issue since Volume 1, Number 1.
- Excellent coverage. I believe FORTH is a language worth learning and using. My TRS-80 will be running MMSFORTH as soon as possible!
- Economically, FORTH has got to be a major breakthrough. Memory doesn't come cheap and you don't need much of it!
- FORTH is fantastic. It's like heroin . . . you gotta have more once you try it. How about some more in the near future?
- I was quite impressed by FORTH and

Christmas List...

1.

New! **A CONSUMER'S GUIDE TO PERSONAL COMPUTING AND MICROCOMPUTERS, Second Edition** (Freiberger & Chew) An updated second edition of the text chosen by *Library Journal* as one of the 100 outstanding sci-tech books of 1978. Updates prices, the latest developments in micro-computer technology, and a review of over 100 microcomputer products from over 60 manufacturers. **#5116-X, \$8.95**

2.

New! **DR. DOBB'S JOURNAL OF COMPUTER CALISHENICS & ORTHODONTIA Vols 1, 2, & 3** (The People's Computer Company) Vol. 1 reflects the changes that took place in personal computing in 1976. Vol. 2 (1977) chronicles the emergence of the small computer as a useful tool. Vol. 3 (1978) looks at the growing interest in programming languages, along with articles on specialized applications and utilities. **Vol. 1, #5475-0; Vol. 2, #5484-X; Vol. 3, #5490-4; each \$18.95**

3.

New! **THE S-100 BUS HANDBOOK** (Bursky) "...offers a clear overview of the processor's instruction set... tables and figures provide valuable, difficult-to-obtain pinout and interfacing information..." *EDN*. Discusses CPU, memory, input/output, computer fundamentals, bulk-memory devices, and more. **#0897-X, \$14.50**

...P.S. Go to your local computer store!



**Hayden Book
 Company, Inc.**

50 Essex Street
 Rochelle Park, NJ 07662

BUY COMPUTERS BY MAIL ORDER AND SAVE 16%

APPLE HARDWARE

16K \$ 958.00
32K \$1,040.00
48K \$1,099.00
Disk with Controller \$ 495.00

Disk \$ 440.00
Pascal \$ 445.00
Graphics Tablet \$ 655.00
Symtek Light Pen \$ 215.00
Versawriter Digitizer System \$ 215.00

Videx Videoterm 80 Column Card \$ 315.00
with graphics-ROM \$ 335.00
Apple Clock \$ 225.00
Micro Soft Z-80 Software Card with CPM \$ 319.00
Parallel Printer Card \$ 145.00

Communications Card with connecting cable \$ 185.00
Apple II Firmware Card \$ 149.00

Integer Basic Firmware \$ 149.00

SOFTWARE

Controller (General Business System) \$ 519.00
Cashier (Retail Mgmt & Inventory System) \$ 199.00
Apple Post Mailing List \$ 45.00

CROMEMCO

SAVE 16% ON ALL EQUIPMENT

NORTHSTAR

Horizon-2-32KDD \$2,390.00

VERBATIM & MEMOREX

5 1/4" \$ 27.50

PLASTIC BOXES

5 1/4" \$ 2.25
8" \$ 3.50

Send certified check (regular checks require 2 weeks to clear) or charge to VISA or Master Charge. Customer pays shipping.

MIRO COMPUTERS, INC.

27 Long Meadow Place South Setauket, L.I., N.Y. 11720
(516) 423-7955 CALL MON.-SAT., 10AM-6PM



CAN HELP YOU...
BUY, SELL OR TRADE.
• LOW COST
• HOT LINE
• TWICE A MONTH

COMPUTER INSTANT ADS

Buy or sell fast with the Computer Instant Ads. The all ad low cost computer publication for individuals and businesses. It's on convenient 8 1/2" by 11" pages in easy to read type.

Bargains — Computers, Components, Peripherals, Software, Positions and Help Wanted, whether you're buying, selling, or swapping you can get fast results at low cost with the CIA.

Instant Ads — If you don't want to wait a few days for the next CIA issue—just dial our special computer hot line number (reserved for subscribers) anytime, 24 hours a day, and our computer will tell your computer (with 300 baud modem) all about the ads received by the CIA since our last issue. Call as often as you like. The only additional expense to you is the price of a direct dial phone call. But remember, if you don't want to pay for the phone call, you only have a few days to wait because the CIA is published **TWICE** each month.

LOW COST ADVERTISING — Only 10¢ per word for one ad and just 8¢ per word per issue when the same ad is run in two or more consecutive issues.

FREE ADVERTISING — Subscribe now for free advertising. Mail an ad (up to 50 words type written or printed, please) to us with your subscription and we will run it free; or phone your subscription using our toll-free number and charge your subscription to your VISA or Master Charge Card. When you telephone your subscription, we will send you a certificate for a free ad.

LOW SUBSCRIPTION RATES One year (24 issues) only \$13.00
Two years (48 issues) only \$20.00

Subscribe NOW Call TOLL-FREE 1-800-453-6464
In Utah phone 268-3000

CIA COMPUTER INSTANT ADS ASSOCIATION
277 East 6100 South · Salt Lake City, Utah 84107

Diagnostics I

for CP/M* & TRSDOS*



Someday your computer is going to break; even the most reliable computer systems "go down". Often, finding exactly what is wrong can account for the most time consuming part of repairing the system, and the longer the system is down, the more money you lose.

DIAGNOSTICS I is a complete program package designed to check every major area of your computer, detect errors, and find the cause of most common computer malfunctions, often before they become serious. For years, large installations have run daily or weekly diagnostic routines as a part of normal system maintenance and check-out procedures.

DIAGNOSTICS I is designed to provide that kind of performance testing for 8080/Z80 micro computers.

DIAGNOSTICS I will really put your system through its paces. Each test is exhaustive and thorough. The tests include:

- Memory Test
- CPU Test (8080/8085/Z80)
- Printer Test
- Disk Test
- CRT Test

To our knowledge, this is the first CPU test available for 8080/Z80 CPU's. Many times transient problems, usually blamed on bad memory, are really CPU errors.

A good set of diagnostics is an indispensable addition to your program library even if your system is working fine. Hours have been wasted trying to track down a "program bug" when actually hardware was to blame!

DIAGNOSTICS I also allows you to be confident of your system.

This can be critical when file merges or sorts and backups are involved. You want to be as sure of your computer as possible during these critical times. Running DIAGNOSTICS I prior to these and other important functions helps to insure that your system is operating at peak performance.

DIAGNOSTICS I is supplied on discette with a complete users manual.

DIAGNOSTICS I: \$60.00 Manual only: \$15.00

Requires: 24K CP/M; 16K disc for TRS-80 formats: CP/M 8" SOFT SECTORED, NORTHSTAR CP/M AND TRS-80 DOS



All Orders and General Information:
SUPERSOFT ASSOCIATES
P.O. BOX 1628
CHAMPAIGN, IL 61820
(217) 359-2112

Technical Hot Line: (217) 359-2691
(answered only when technician is available)

*CP/M REGISTERED TRADEMARK DIGITAL RESEARCH
#185005 #65 80 TRADE MARKS TANDY CORP.

SPECIALS

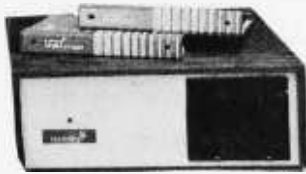

NORTH STAR HORIZON:

HRZ-2-32K-DD-ASM.....	\$2275
HRZ-2-32K-Q-ASM.....	\$2675
NORTHWORD DQ.....	\$ 295
MAIL MANAGER.....	\$ 235
INFO-MANAGER.....	\$ 365
GENERAL LEGER.....	\$ 775
ACC. REC. OR ACC. PAY..	\$ 445
WORD STAR.....	\$ 350

COMMODORE (PET):

2001 32K.....	\$1090
8032 (80 COLUMN SCREEN)	\$1599
2040 DUAL DRIVE.....	\$1090
8050 DUAL DRIVE (1MEG).	\$1499
2022 TRACTOR PRINTER...	\$ 749

APPLE II PLUS CALL FOR PRICE

ATARI 800.....	\$ 799
TI 99/4 CONSOLE&MONITOR..	\$ 1190

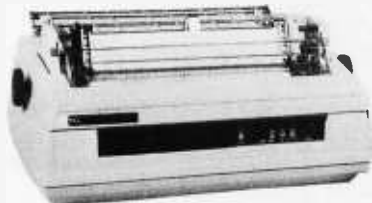

SPINWRITERS FROM NEC:

5510 RO OR 5530 RO	\$2690
5520 KSR SERIAL.....	\$2990

CENTRONICS:

730.....	\$ 559
737-1 (LETTER QUALITY)	\$ 849
(WE CARRY THEIR COMPLETE LINE)	
PAPER TIGER 440G.....	\$ 990

BASE II 800MST..... \$ 649

OTHER PRINTERS WE STOCK:

ANADIX, COMPRINT, EATON, EPSON,
TELETYPE, TI, ETC.—CALL FOR PRICE
DISPLAY TERMINALS

HAZELTINE 1420.....	\$ 949
1500.....	\$ 999
(WE CARRY THEIR COMPLETE LINE)	
INTERTUBE III.....	\$ 775

TELEVIDEO 914..... \$ 850

**MOST ITEMS IN STOCK.
PRICES SUBJECT TO CHANGE**

**MULTI-BUSINESS COMPUTER SYS.
28 MARLBOROUGH STREET
PORTLAND, CONN. 06480**

**(203) 342-2747 TWX 710-428-6345
M-F 9-6 SAT. 9:30-3:00**

because of #4 [John James's "What is FORTH? A Tutorial Introduction"] I am getting T^FORTH for the TRS-80.

● The simplicity of FORTH is an ideal showcase for modularity and extensibility. #3 [Charles Moore's "The Evolution of FORTH, An Unusual Language"] was entertaining and human. The diagrams and charts of #4-6 [three other FORTH articles] were wonderfully simple, direct, and to the point.

● Best overall issue in a long time. I have already ordered a FORTH compiler for my 16 K Apple II.

● Let's have all you can get on how to implement and how to use threaded languages.

The few negative comments we got were also strongly stated:

- Easily the worst issue ever.
- Yeech! This issue soured on the way!
- Too much emphasis on FORTH. I like to see a variety each month (maybe spread it out). (Had the emphasis been nearer my interests, would have loved it. You can't please all the people . . .)

Other languages were also mentioned as topics for future articles (future BYTE authors, take note):

- Loved it! More FORTH, APL, LISP, and other wild and crazy languages.
- I hope that at some time in the near future, an issue will be devoted to C.
- SNOBOL NOW!
- How about some programs in the Apple Pascal system assembler?
- For next year's language issue, please consider one that directly supports concurrency—Concurrent Pascal, Ada, etc.

Other comments included general enthusiasm for the issue and a good deal of respect for the article on Khachiyan's algorithm ["Khachiyan's Algorithm, Part I: A New Solution to Linear Programming Problems"]:

- More Steve Ciarcia!
- Superb issue! Hope there is another volume of Ciarcia's *Circuit Cellar* and a *BYTE Book of FORTH* to be made available for the Christmas season!
- Still have not figured out the math in #7 ["Khachiyan's Algorithm, Part 1"] but a little bit (lot?) of work won't hurt me. Give us more on FORTH. Best issue to date.
- More hardcore math like the Khachiyan algorithm.
- The editorial ["Threads of a FORTH Tapestry"] gets an 8!
- The Khachiyan algorithm piece appeals to a very narrow readership and is quite advanced—as noted. However, we all need something to tease us into advancement once in a while! ■



OPTIMIZED SYSTEMS SOFTWARE

PRESENTS

CONTROL PROGRAM/APPLE
the DOS you have been waiting for

OSS CP/A is an all new, disk-based operating system which provides commands and utilities similar to CP/M®. CP/A has byte and block I/O, a simple assembly language interface, and direct access via Note and Point. And it's easy to add your own commands or device handlers. CP/A is expandable, flexible, consistent, easy-to-use and available now with compatible program products:

BASIC — Some of the features of OSS BASIC are syntax checking on program entry, true decimal arithmetic (great for money applications), 32K byte string sizes, flexible I/O, long variable names (up to 255 significant characters), and the ability to get and put single bytes.

BUSINESS BASIC WITH PRINT USING — This is virtually the only basic available on the Apple that has PRINT USING. It also has record I/O statements and all the features of our standard BASIC.

EDITOR/ASSEMBLER/DEBUG — OSS EASMD is a total machine language development package. The editor provides functions like FIND, REPLACE, etc. The assembler uses standard 6502 mnemonics, can include multiple files in one assembly, and can place the object code in memory or to a disk file.

Prices of CP/A with:

BASIC	\$ 69.95
Business BASIC	84.95
EASMD	69.95
BASIC + EASMD	109.95
Business BASIC + EASMD	124.95

Requires 48K RAM and DISK

Add \$3.50 for shipping and handling in continental USA. California residents add 6%. VISA/Master Charge welcome. Personal checks require two weeks to clear.

SEE YOUR DEALER or ORDER TODAY

OPTIMIZED SYSTEMS SOFTWARE
is a product of

Shepardson Microsystems, Inc.
20395 Pacifica Dr., Suite 108B
Cupertino, CA 95014
(408) 257-9900

CP/M is a registered trademark of Digital Research

Quiet Designs

Preformatted Disks:

Compatible with Lanier 'No Problem',
Lanier 90/100, Micom 2000/2001,
A.M. 425, C.P.T. 6000/8000, Canon

Standard Disks

For all systems using unformatted disks

Head Cleaning Kits

Kits for 5 1/4" and 8" drives

Flip-Sort™

Durable, Dust Proof, Desk Top Disk Storage
and Retrieval System.

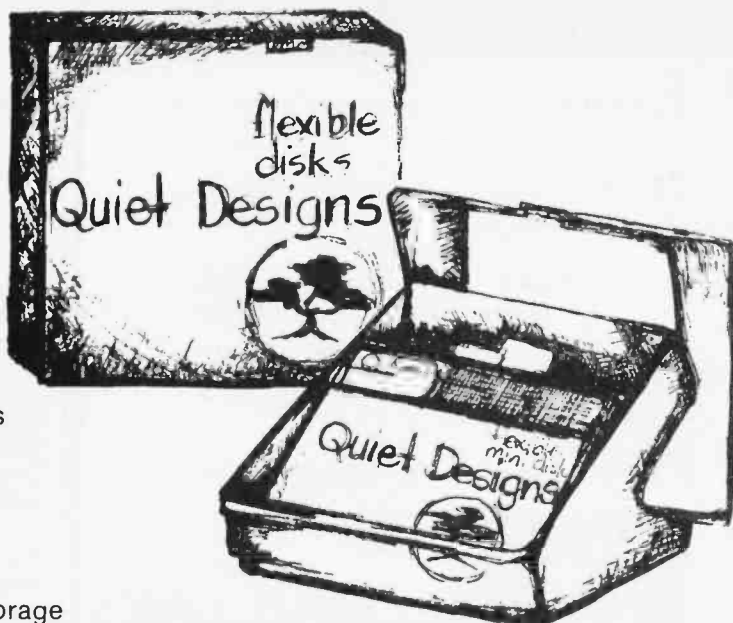

Quiet Designs

Quiet Designs Inc.
1330 W. Robinhood Dr.,
Suite F
Stockton, CA 95207
Ph. (209) 957-8631

Quiet Designs Inc.
473 Macara #706
Sunnyvale, CA 94086
Ph. (408) 739-5215

Quiet Designs of California
1030 W. Maude #512
Sunnyvale, CA 94086
Ph. (408) 730-0170

Quiet Designs International
5940 F #2 Road
Richmond, British Columbia,
Canada V7C 4R9
Ph. (604) 273-9710

32 K BYTE MEMORY RELIABLE AND COST EFFECTIVE RAM FOR 6502 & 6800 BASED MICROCOMPUTERS

AIM 65-*KIM*SYM
PET*S44-BUS

- PLUG COMPATIBLE WITH THE AIM-65/SYM EXPANSION CONNECTOR BY USING A RIGHT ANGLE CONNECTOR (SUPPLIED) MOUNTED ON THE BACK OF THE MEMORY BOARD.
- MEMORY BOARD EDGE CONNECTOR PLUGS INTO THE 6800 S 44 BUS.
- CONNECTS TO PET OR KIM USING AN ADAPTOR CABLE.
- RELIABLE—DYNAMIC RAM WITH ON BOARD INVISIBLE REFRESH—LOOKS LIKE STATIC MEMORY BUT AT LOWER COST AND A FRACTION OF THE POWER REQUIRED FOR STATIC BOARDS.
- USES +5V ONLY, SUPPLIED FROM MOST COMPUTER.
- FULL DOCUMENTATION. ASSEMBLED AND TESTED BOARDS ARE GUARANTEED FOR ONE YEAR AND PURCHASE PRICE IS FULLY REFUNDABLE IF BOARD IS RETURNED UNDAMAGED WITHIN 14 DAYS.

ASSEMBLED WITH 32K RAM	\$395.00
& WITH 16K RAM	\$339.00
TESTED WITHOUT RAM CHIPS	\$279.00
HARD TO GET PARTS (NO RAM CHIPS)	
WITH BOARD AND MANUAL	\$109.00
BARE BOARD & MANUAL	\$49.00

PET INTERFACE KIT—CONNECTS THE 32K RAM BOARD TO A 4K OR 8K PET. CONTAINS: INTERFACE CABLE, BOARD STANDOFFS, POWER SUPPLY MODIFICATION KIT AND COMPLETE INSTRUCTIONS. \$49.00

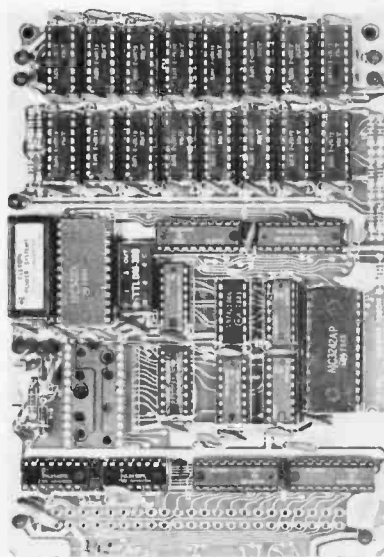

U.S. PRICES ONLY

16K MEMORY EXPANSION KIT ONLY \$58

FOR APPLE, TRS-80 KEYBOARD,
EXIDY, AND ALL OTHER 16K
DYNAMIC SYSTEMS USING
MK4116-3 OR EQUIVALENT
DEVICES.

- ★ 200 NSEC ACCESS, 375 NSEC CYCLE
- ★ BURNED-IN AND FULLY TESTED
- ★ 1 YR. PARTS REPLACEMENT GUARANTEE
- ★ QTY. DISCOUNTS AVAILABLE

ALL ASSEMBLED BOARDS AND
MEMORY CHIPS CARRY A FULL ONE
YEAR REPLACEMENT WARRANTY

BETA
COMPUTER DEVICES

1230 W. COLLINS AVE.
ORANGE, CA 92668
(714) 633-7280

Call. residents please add 8% sales tax. Mastercharge & VISA accepted. Please allow 14 days for checks. Jo clear bank. Phone orders welcome. Shipping charges will be added to all shipments.

Selectric® Interface System

EASILY interfaced to any IBM Selectric I, II, or III.

STOP spinning your wheels. Letter quality at an affordable price.

CONNECTS via Parallel or RS-232, accommodates varied handshaking.

ONLY \$575 to \$599. Dealer inquiries invited.

NEW design provides added features.



ESCON Products, Inc.
12919 Alcosta Blvd.
San Ramon, Ca., 94583
(415) 820-1256

TEXAS COMPUTER SYSTEMS

a **Radio Shack**

Authorized Sales Center, OFFERS

LOWEST PRICES on

TRS-80 COMPUTERS

For the BEST prices on ALL TRS-80® computers, CALL our TOLL FREE NUMBER 1-800-351-1473. All Radio Shack® computers are discounted 10%, 15% up to 20%! CALL for the latest prices on the items you need, or get advice from our consultant about your specific needs. CALL for prices on the Model I, II, and the new Model III, Color Computer and Pocket Computer.

SAVE up to 50% on accessories (non-Radio Shack®). Need more disk space? Ask about single/DOUBLE DENSITY controller for the Model I, 300k in a 2-disk system, 5 minute installation w/no modifications. Copies your single density data to DOUBLE for complete compatibility. Less than \$200.

40 track disk drives \$359. 16k memory add on only \$58 w/instructions. Specify computer or expansion interface. CALL for information on Programs available.

- ★ UPS prepaid insured delivery—FREE except some large items.
- ★ No taxes on out-of-state shipments. Texas res. Add 5%.
- ★ All merchandise is new, checked and guaranteed by manufacturer.
- ★ Payment: Money Order, Cashier's Check, Certified Check. Personal Checks require 3 weeks to clear. VISA, MASTERCARD—Add 3%.
- ★ Prices subject to change at any time.
- ★ Delivery of merchandise is subject to availability.

TCS, 106 East 10th, Brady, TX. 76825

An Authorized RADIO SHACK® Sales Center F701

TOLL FREE Order Number 1-800-351-1473

Texas Residents 915-597-0673

Clubs and Newsletters

Heathkit Group in San Diego

The San Diego Heathkit Computer Users Group has been formed to help users on the local level. The club meets on the first Wednesday of each month at the La Mesa Heathkit Store at 7 PM. Membership is \$10 per year. The club wishes to exchange newsletters and ideas with other clubs. Contact R A Cobb, 12202 Kingsford Ct, El Cajon CA 92021, (714) 443-4772.

Microcomputer Users International

Microcomputers Users International is a group serving the Sault Ste Marie area. The group publishes a monthly newsletter entitled *Northern Bytes*. The newsletter is available to other groups on an exchange basis. Meetings are held on the third Tuesday of each month. Contact Jack Decker, 1804 W 18th St, Lot #155, Sault Ste Marie MI 49783, (906) 632-3248. In Sault, Ontario, phone (705) 942-1363, and ask for Phil Barton or Frank Gardner.

National Computer Association (NCA)

The organizational structure of the NCA, an independent nonprofit computer user group, has been expanded. The NCA is now offering full membership to vendors, consultants, OEMs (original equipment manufacturers), manufacturers, end users, and affiliated membership to computer clubs. Also, subgroups for members with similar interests are now being offered. The subgroups are being formed along product-interest lines. Monthly newsletters will be published containing technical information. A new subgroup

must have a potential of 200 members. Membership within NCA is \$35, which includes membership within a subgroup. Computer club affiliation entitles the club to receive all NCA publications. Clubs may join for an annual fee of \$50. Club members can join as individual members, if so desired. Contact NCA, 1485 E Fremont Cr S, Littleton CO 80122, (303) 797-3559.

PIE for PET Users

PIE (PET Information Exchange) is made up of PET/CBM users. Meetings are informal and they are held approximately twice every month at various locations in Rhode Island. A newsletter is published. The dues are \$6 per year. The group is involved in a project to install two BASF floppy-disk drives behind the name-plate on a new 32 K-byte PET. Other future projects include a computer bulletin board service for the group members. Contact PIE, 27 Leicester Way, Pawtucket RI 02860.

Salem Area Computer Club

The Salem Area Computer Club (SACC) membership is open to anyone interested in using microcomputers. Membership dues are \$5 per year, which includes the monthly newsletter. Meetings are held on the first Monday of each odd-numbered month at the McKinley Community School, 461 McGilchrist St SE, in Salem, Oregon. On the first Monday of even-numbered months, meetings are held at Computer Pathways Unlimited, 831 Lancaster Dr NE, South End—Lancaster Mall, Salem, Oregon. Contact SACC, c/o Doug Walker, 3485 Mock Orange Ct S, Salem OR 97302, (503) 364-2488.

BUILD YOUR COMPUTER BREADBOARDS & INTERFACES FASTER AND EASIER WITH NEW VECTOR PLUGBOARDS

EASY TO USE!

COST EFFECTIVE!

CLEAN HOLES!

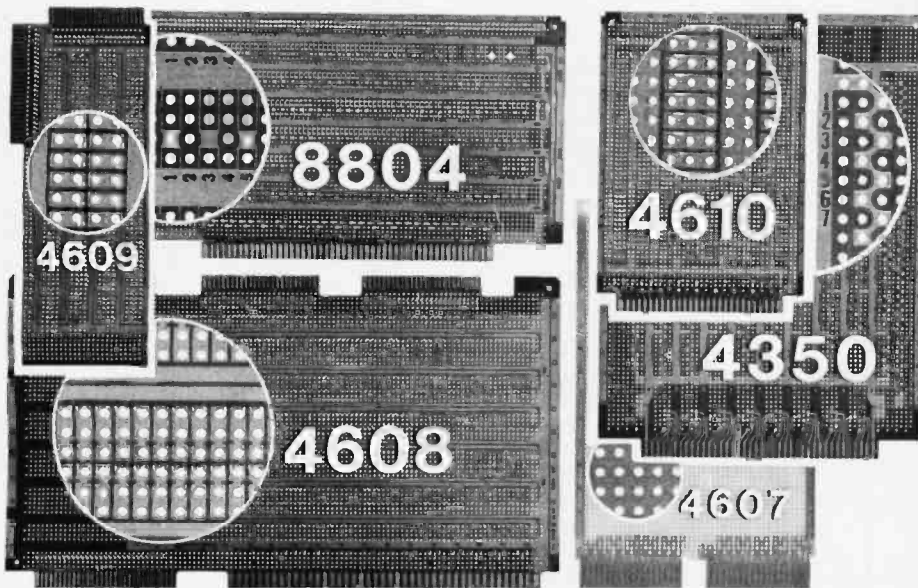

4610 Series - For STD-BUS-WW, solderable and unpatterned models

4608 Series - For Intel/National SBC/BLC 80-WW/ solderable, or unpatterned

8804 Series - For S100 - 5 models available

4607 - For DEC LSI 11/ PDP8-11, Heath H-11

4609 - For Apple II, SuperKim, Pet Commadore with Expandamem

4350 - For TI 980 Computer



Vector Electronic Company INCORPORATED

12460 Gladstone Ave., Sylmar, CA 91342 (213) 365-9661 TWX (910) 496-1539

Available through Distributors or Factory Direct if not available locally.

74801

NEW EATON 7000+ PERSONAL COMPUTER PRINTER

Now you can add hard copy capability to your computer with plug-in simplicity that matches up to any micro system. And with the Eaton 7000+ dot-matrix printer, you get complete printout versatility at an affordable price.

Interfaces with any personal computer

Apple, Commodore Pet, TRS-80, Northstar and others — no matter what type of computer you have or are thinking of buying, Eaton 7000+ fits. Just plug it in and start printing. You'll get virtually maintenance-free operation with a minimum of moving parts. And minimum life of 100 million characters with Eaton's newest printhead, while the print



mechanism is designed for a minimum of 10 million cycles.

High performance design

The 7000+ features uni-directional printing at a speed of 1.25 lines per second. It accepts any standard single or 2-ply roll paper from 3/4" to

PLUG IN AND PRINT OUT — IN SECONDS!

3 7/8" wide and prints 3 7/8" line with 40 to 64 adjustable character capacity.

For immediate information call: Eaton Printer Product Operations, 307/856-4821.

For descriptive literature and the name of your nearest dealer write Eaton Corporation, Count Control/ Systems Division, 901 South 12th St., Watertown, WI 53094.

Dealer inquiries invited.

EATON
Electrical/Electronic Control

GET IT OFF THE FLOOR

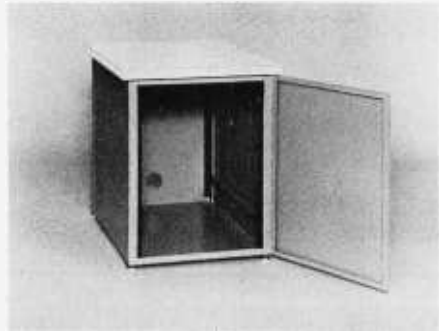

Now that you have a shiny new computer terminal, what are you going to put it on? Computer Furniture and Accessories makes a variety of furniture for a wide range of computer applications. In combinations of six widths, three depths, and three heights. With "L" shaped returns, Micro shelves, data shelves, RETMA mounting, and printer stands. With optional drawers, doors, CRT turntables, and casters. Sizes, shapes and colors designed to fit your office or computer room environment. Reasonably priced and shipped from stock.

Call CF&A. We'll get your system up where you can really put it to use.

CF&A

Computer Furniture and Accessories, Inc.
1441 West 132nd Street
Gardena, CA 90249
(213) 327-7710

Small Computer News

Small Computer News is a biweekly newsletter covering the microcomputer field. Written for the computer hobbyist, manufacturer, and retailer, each issue contains information on the micro-computer business, new product previews, convention news, and free-lance and career employment opportunities. Subscriptions, including first class postage, are available for \$24.50 per year from Edwards Publications, 78-56 86th St, Flushing NY 11385, (212) 441-4082.

Electronic Magazine for DEC Users

Digital Digest is a digital magazine that operates 24 hours a day. To utilize this information exchange, users need a 300 bps (bits per second) modem and terminal set up for seven data bits, even parity, and one stop bit. The initial data line number is (404) 447-5254. The magazine is directed at the DEC (Digital Equipment Corporation) PDP-11 user and will be expanded to handle Data General users. Featured in the magazine will be a free PDP-11 software exchange, DEC users buying group co-op, electronic mail box, software and hardware product index, and more. The electronic version of *Digital Digest* is free and the printed version is \$15 per year. The Digital Exchange software exchange system is free for contributing members and \$75 for noncontributors. Contact Digital Publications Inc, 1101 Noble Forest Dr, Norcross GA 30092.

OSI-MUG

OSI-MUG (Ohio Scientific Michigan Users Group) has recently been formed. The club has over 130 members, primarily from the southeastern Michigan area. The members are interested in exchanging information with similar groups. Contact OSI-MUG, 3247 Lakewood Ave, Ann Arbor MI (313) 761-5358.

MORE FOR YOUR RADIO SHACK TRS-80 MODEL I!

THE DATAHANDLER

DATABASE MANAGEMENT SYSTEM IN MMSFORTH

Now the power, speed and compactness of MMSFORTH drive a major applications program for many of YOUR home, school and business tasks! Imagine a sophisticated database management system with flexibility to create, maintain and print mailing lists with multiple address lines, Canadian or the new 9-digit U.S. ZIP codes, and multiple phone numbers, plus the speed to load hundreds of records or sort them on several fields in 5 seconds! Manage inventories with selection by any character or combination. Balance checkbook records and do CONDITIONAL reporting of expenses or other calculations. File any records and recall selected ones with optional upper/lower case match, in standard or custom formats. Personnel, membership lists, bibliographies, catalogs of record, stamp and coin collections—you name it! ALL INSTANTLY, without wasted bytes, and with cueing from screen so good that non-programmers quickly master its use! With manual, sample data files and custom words for mail list and checkbook use.

Technical: Handles data as compressed indexed sequential subfiles of up to 25K characters (9K in 32K RAM). Access 1-4 data diskettes. Modified Quicksort. Optionally precompiles for 5-second program load. Self-adjusts for many routine mods. Structured and modular MMSFORTH source code ideal for custom modifications.

THE DATAHANDLER V1.1, a very sophisticated database management system operable by non-programmers (requires Disk MMSFORTH, 1 drive & 32K RAM); with manuals, \$59.95*

mmsFORTH

THE PROFESSIONAL FORTH FOR TRS-80 MODEL I

(Over 1,000 systems in use)

MMSFORTH Disk System V1.9 (requires 1 disk drive & 16K RAM) just \$79.95*
MMSFORTH Cassette System V1.8 (requires Level II BASIC & 16K RAM) \$59.95*

AND MMS GIVES IT PROFESSIONAL SUPPORT

Source code provided
MMSFORTH Newsletter
Many demo programs aboard
MMSFORTH User Groups
Programming staff can adapt THE DATAHANDLER to YOUR needs.

MMSFORTH UTILITIES DISKETTE: Includes FLOATING POINT MATH (L2 BASIC ROM routines plus Complex numbers, Rectangular-Polar coordinate conversions, Degrees mode, more), plus a full Forth-style Z80 ASSEMBLER; plus a powerful CROSS-REFERENCER to list Forth words by block and line. All on one diskette (requires MMSFORTH, 1 drive & 16K RAM), .. \$39.95*

FORTH BOOKS AVAILABLE

MICROFORTH PRIMER (comes with MMSFORTH) separately \$15.00*
USING FORTH — more detailed and advanced than above \$25.00*
URTH TUTORIAL MANUAL — very readable intro. to U/Rochester Forth \$19.95*
CALTECH FORTH MANUAL — good on Forth internal structure, etc \$6.95*

* — Software prices include manuals and require signing of a single-system user license. Add \$2.00 S/H plus \$1.00 per additional book; Mass. orders add 5% tax. Foreign orders add 15%. UPS COD, VISA & M/C accepted; no unpaid purchase orders, please.

Send SASE for free MMSFORTH information Good dealers sought

Get MMSFORTH products from your computer dealer or

MILLER MICROCOMPUTER SERVICES (B12)

61 Lake Shore Road, Natick, MA 01760
(617) 653-6136

FANTASTIC MAIL ORDER DISCOUNTS!!!

apple computer
16K*
\$959*
*ADD 2% IF USING CREDIT CARD ONLY ON APPLE COMPUTERS APPLE II OR APPLE II PLUS

APPLE II 32K \$1040* APPLE II 48K \$1100*

APPLE II ACCESSORIES

CORVUS 10 MEGABYTE DISK DRIVE.....	\$4650	SUPER TALKER SPEECH SYNTHESIZER®.....	259
PASCAL LANGUAGE SYSTEM.....	445	ROMPLUS CARD w/ KEYBO. FLTR.....	179
GRAPHICS INPUT TABLET.....	675	HEURISTICS SPEECHLINK 2000.....	128
NEW DOS 3.3.....	535	HAYES MICROMODEM II®.....	335
DISK II without controller.....	440	ALF MUSIC SYNTHESIZER.....	245
APPLE SOFT II FIRMWARE CARD.....	155	SSM A10 CARD (KIT).....	129
INTEGER FIRMWARE CARD.....	155	SSM A10 CARD (ASSEMBLED).....	170
PARALLEL INTERFACE CARD.....	160	NOVATION CAT MODEM.....	159
SERIAL INTERFACE CARD.....	190	CCS GPIB IEEE INTERFACE.....	269
COMMUNICATIONS CARD.....	190	MICROSOFT 2-80 SOFT CARD w/CP/M.....	349
SUP-R-MOD RF TV MODULATOR.....	25	MICROWORKS DS-65 DIGISECTOR.....	349
SUP-R-TERM 80 col. CARD.....	349	ROMWRITER.....	159
DAN PAYMAR Lower case kit.....	CALL	SYMTEC LIGHT PEN CARD.....	229
SVA 8" DISK CONTROLLER CARD.....	349	CCS PROGRAMMABLE TIMER MODULE.....	159
CCS ARITHMETIC PROCESSOR CARD.....	349	CENTRONICS PRINTER INT. CARD.....	190
CLOCK/CALENDAR CARD.....	239	SLIENTYPE PRINTER W/INT. CARD.....	529
INTROL X-10 SYSTEM.....	239		

SOFTWARE

PASCAL LANGUAGE SYSTEM.....	\$445	APPLEWRITER WORD PROCESSOR.....	69
FORTRAN LANGUAGE PACKAGE.....	175	VISI-CALC.....	125
THE CONTROLLER GEN. BUS. SYSTEM.....	529	SARGON II on Disk.....	35
THE CASHIER RETAIL MGT. & INV.....	209	SUPER INVADER On DISK.....	25
APPLEPOST MAILING LIST SYSTEM.....	45		

WE WILL GLADLY PERFORM WARRANTY REPAIR ON ALL APPLE COMPUTER PRODUCTS.



COMPUTER SPECIALTIES

MONITORS

LEEDEX VIDEO 100

12" BLACK & WHITE MONITOR
 •VIDEO BANDWIDTH 12 MHz±3db
 •COMPOSITE VIDEO INPUT

\$139 SOROC IQ 120 \$739
 SOROC IQ 140 \$1295



SANYO 9" B/W Monitor \$169 • SANYO 15" B/W Monitor \$259 • ZENITH 13" Color Monitor \$429

PRINTERS

PAPER TIGER ITS 440 w/Graphics.....	\$1050	NEC SPINWRITER.....	2695
TRENDCOM T-200.....	559	AXIOM EX-801.....	495
CENTRONICS 737.....	850	AXIOM EX-820.....	750
CENTRONICS 700-9.....	1149	COMPRINT 912S.....	599
ANADEx DP-8000 OR AP.....	850	COMPRINT 912P.....	559
MPI 88-T.....	725	TRENDCOM T-100.....	349

THE AMAZING SORCERER™ II 16K
 The SORCERER is a Z80 CPU based micro computer internally expandable to 48K 4K ROM resident monitor I/O connector for S-100 expansion. Parallel and serial interface. Dual cassette I/O. Graphic resolution of 240 x 512, 30 lines of 64 characters, 8 x B dot matrix. Full ASCII set (upper and lower case), plus standard graphic symbols. User may define up to 128 character. Keyboard is 63 key data processing type. Plus a 16 key numeric input pad.

S-100 EXPANSION UNIT..... \$399
 WORD PROCESSOR PAC..... 199
 DEVELOPMENT PAC..... 99
WE ALSO SELL "QUALITY SOFTWARE" FOR SORCERER II ON OFF LIST.

\$995



32K 1,145.00 48K 1,295.00

ATARI 800



\$799

A Starline Communications Company

ATARI 400 COMPUTER.....	\$449	BACKTROLL.....	30
ATARI 825 PRINTER.....	495	VIDEO CASSETTE.....	30
ATARI 810 DISK DRIVE.....	579	SUPER BREAKOUT.....	30
ATARI 410 PROGRAM RECORDER.....	69	MUSIC COMPOSER.....	45
ATARI 16K RAM MODULE.....	149	COMPUTER CHESS.....	30
ATARI 8K RAM MODULE.....	99	3D TIC TAC TOE.....	30
ATARI BASIC ROM.....	85	STAR RAIDERS.....	45
ASSEMBLER/EDITOR.....	45	PERSONAL FINANCE.....	45
•High resolution COLOR Graphics.....		•Built-in RF TV modulator.....	
•10K Basic in ROM.....		•High speed serial I/O port.....	
•8K user RAM expandable to 48K.....		•Includes ATARI 410 program recorder.....	
•57 key full stroke keyboard.....			

• TO ORDER •

Phone orders invited, using credit cards. Or send cashiers check or money order that draws on a U.S. bank. Please add 3% (\$5.00 Minimum) for handling, shipping (air service) and insurance, or equipment will be shipped freight collect. California residents add 6% sales tax. All equipment is in factory cartons with the manufacturers warranty. Equipment is subject to price change and availability without notice.



1251 BROADWAY
 EL CAJON, CA. 92021 • (714) 679-0330

Combine accurate flight characteristics with the best in animation graphics and you'll have SubLOGIC's

T80-FS1 Flight Simulator for the TRS-80

SubLOGIC's T80-FS1 is the smooth, realistic simulator that gives you a real-time, 3-D, out-of-the-cockpit view of flight.

Thanks to fast animation and accurate representation of flight, the non-pilot can now learn basic flight control, including take-offs and landings! And experienced pilots will recognize how thoroughly they can explore the aircraft's characteristics.

Once you've acquired flight proficiency, you can engage in the exciting British Ace 3-D Aerial Battle Game included in the package. Destroy the enemy's fuel depot while evading enemy fighters.

Computer and aviation experts call the T80-FS1 a marvel of modern technology. You'll simply call it *fantastic!*

Special Features:

- 3 frame-per-second flicker free animation
- Maximum transfer keyboard input
- Constant feedback cassette loader

Hardware Requirements:

- Radio Shack TRS-80, Level 1 or 2
- 16K memory
- *Nothing else!*

\$25
 Only

See your dealer or order direct. For direct order, include \$1.25 and specify UPS or first class mail. Illinois residents add 5% sales tax. Visa and Mastercard accepted.



subLOGIC
 Distribution Corp.
 Box V, Savoy, IL 61874
 (217) 359-8482

**PERSONAL
COMPUTER
SYSTEMS**



APPLE II, 16K, List \$1195 \$ 989
 32K, List \$1395 \$1169
 48K 1259

ATARI® 400™, List \$630

OUR PRICE ONLY \$499

820 PRINTER, List \$599.95 \$499
 810 DISK DRIVE, List \$699.95 \$589



HP-85

List \$3250

ONLY \$2799

- Extended BASIC Language
- Advance Graphics
- CRT Built-In Display
- Magnetic Tape Cartridge for Storage

CALCULATORS BY



HP-41C Calculator, "A System" .. \$244.95
 HP-32E Scientific w/Statistics ... \$ 53.95
 HP-33C Scientific Programmable ... 99.95
 HP-34C Advanced Scientific
 Programmable 123.95
 HP-37E Business Calculator 58.95
 HP-67 Handheld Fully Advanced
 Programmable Scientific for
 Business & Engineering .. 298.95
 HP-97 Desktop w/Built-in Printer .. 579.95

COMMODORE PET Call for Prices

Prices do not include shipping by UPS. All prices and offers are subject to change without notice.

**Personal
PC
S** computer
systems

609 Butternut Street
 Syracuse, N.Y. 13208
 (315) 478-6800



INAUG

INAUG (International Apple Users Group) is dedicated to increasing the flow of information between Apple users worldwide. The INAUG requests that all Apple users and groups unite and join its group. Please send a self-addressed, stamped envelope for more information. The address is INAUG, POB 96, Twain CA 95984, (916) 283-3497.

Another Apple Group

The OKC Apple Users Group meets at various computer stores in the Oklahoma City area on the first and third Tuesday of each month. Its newsletter is entitled *OKC Apple Times*. Membership dues are \$10 per year, which includes a subscription to the newsletter. OKC is a member of the International Apple Corps. Contact The Secretary, OKC Apple, c/o Greenbriar Digital Resources, POB 1857, Edmond OK 73034.

UK TRS-80 Users Group

This United Kingdom-based group currently has over 230 members, and along with publication of their monthly newsletter, they organize single-day and weekend workshops in different parts of the country. A software library is available for members' use. Membership is by subscription to the newsletter, which is £5.75. Contact Brian Pain, 40a High St, Stony Stratford, Milton Keynes, England.

The Portland Computer Society

This group has over 180 members and a busy schedule of meetings. The main meeting is held on the third Saturday of each month at the Far West Federal Savings, Fred Meyer Raleigh Hills Shopping Center, 4770 SW 76th (Beaverton Hillsdale Hwy). They have many other special interest groups that meet regularly. A news-

**NO ONE
CAN MAKE
A TRS-80
WORK
THE WAY
SNAPP
CAN!**

SNAPP II EXTENDED BASIC A family of enhancements to the Model II BASIC interpreter. Part of the package originated with the best of APPARAT, INC.'s thoughts in Implementing NEWDOS BASIC. The system is written entirely in machine language for SUPER FAST execution. The extensions are fully integrated into Model II BASIC, and require NO user Memory, and NO user disk space. The package is made up of the following six modules, each of which may be purchased separately;

XBASIC—Six single key stroke commands to list the first, last, previous, next, or current program line, or to edit the current line. Includes quick way to recover BASIC program following a NEW or system or accidental re-boot. Ten single character abbreviations for frequently used commands: AUTO, CLS, DELETE, EDIT, KILL, LIST, MERGE, NEW, LLIST, and SYSTEM. \$40.00
XREF—A powerful cross-reference facility with output to display and/or printer. Trace a variable through the code. Determine easily if a variable is in use. \$40.00

XDUMP—Permits the programmer to display and/or print the value of any or all program variables. Identifies the variable type for all variables. Each element of any array is listed separately. \$40.00

XRENUM—An enhanced program line renumbering facility which allows specification of an upper limit of the block of lines to be renumbered, supports relocation of renumbered blocks of code, and supports duplication of blocks of code. \$40.00

XFIND—A cross reference facility for key words and character strings, also includes global replacement of keywords. \$40.00

XCOMPRESS—Compress your BASIC programs to an absolute minimum. Removes extraneous information; merge lines; even deletes statements which could not be executed. Typically saves 30-40% space even for programs without REM statements! Also results in 7-10% improvement in execution speed. \$40.00

ENTIRE PACKAGE ONLY \$200.00



8160 Corporate Park Dr.
 Cincinnati, Ohio 45242
 Ohio residents call collect

(513) 891-4496

Call Toll Free

1-800-1543-4628

All products now available to run with TRSDOS 2.0.

800-323-1780 NCE'S*HOTLINE FOR SAVINGS!*

- Ribbons for: Diablo, Qume, IBM, Wang, NEC, all Data Printers and Typewriters.
- Printwheels, Elements and Thimbles.
- Magnetic Media: Floppy disks, mini-floppy, Tape, Packs and Cassettes.
- Disc storage systems, Quietizers, Anti-static mats, Ink rolls and much more.
- Terminals and accessories.

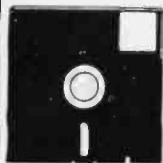

DISKETTES

- 100% Certified
- 2 Year Warranty
- 10 Million Passes
- Human Engineered
- EZ View Box
- The Best Disk Available Today.

	Box of 10
5 1/4" (Soft Sector)	29.95
5 1/4" (10 Sector)	29.95
5 1/4" (16 Sector)	29.95
8" Single Side-Single Density	32.50
8" Single Side Reversible	52.50
8" Single Side Double Density	50.00
8" Double Sided Double Density	52.50

Ribbons & Thimbles for NEC Spinwriters

Available for All Brands of Equipment

- Form tractors
- Quietizers
- Sheet feeders

Satisfaction Guaranteed

New!

NOW AVAILABLE FROM XEROX

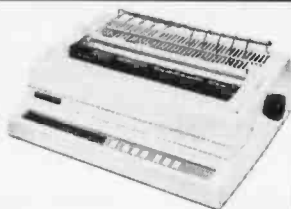

1730 DAISY WHEEL PRINTER (DIABLO 630)

ONLY \$2395.00

Daisy Wheel Printer Features *Metalized and Plastic Print Wheel Interchangeability*. Includes 90 day warranty by Xerox. Why settle for less. Buy American made quality printers!

• TO ORDER •

Phone orders invited, using credit cards. Or send check, cashiers check or money order that draws on a U.S. bank. Please add 3% (\$5.00 Minimum) for handling, shipping and insurance. Illinois residents add 5 1/2% sales tax. All equipment is in factory cartons with the manufacturers warranty. Equipment is subject to price change and availability without notice.

Mail order pricing only. Catalog mailed upon request.



"Run With the Thoroughbreds"

NCE Supply Corp.
915 W. Liberty Drive
Wheaton, IL 60187

Phone: 800-323-1780 Toll Free
*312-682-0001 Within Illinois



*NCE Supply Corp. is not affiliated with any other entity.

NOW AVAILABLE FROM OUR EQUIPMENT DIVISION

PRINTERS - NEW

Xerox 1750 (Diablo 1650)	
Metal Wheel - KSR	2795.00
Xerox 1740 (Diablo 1640)	
Metal Wheel - KSR	2650.00
TI-820 - KSR	2195.00
TI-810 RO - Basic Unit	1595.00
RO - W/ULC/ ASC11/UFC/CP	1895.00
TI-745 - Portable/Built-in Coupler	1595.00
TI-743 Portable	1195.00
TTY-43	1045.00
Digital - LA - 34 - KSR	1045.00
Digital - LA - 120 - KSR	2495.00

CRT - TERMINALS

LEAR ADM 3-A	849.00
Digital VT-100	1895.00

MODEMS

Acoustic Couplers	175.00
212A - 300/1200	895.00

REFURBISHED SPECIALS - FULLY GUARANTEED

DIGITAL - LA - 36	995.00
-------------------	--------

ALL OPTIONS AVAILABLE

ZENITH BUSINESS SOFTWARE FOR THE Z-89!

S & M Systems, Inc., the "All-In-One" Software Company is offering a full line of Business Packages for the "All-In-One" Z-89 Microcomputer

Inseq-80(TM) Business Software Systems
Industry Standard Osborne Based: Accounts Payable/Receivable, General Ledger, Payroll

S & M Software: Retail Inventory Control, Invoicing, Manufacturers Inventory Control, Customer Mail List

PLUS MANY MORE!!

All Systems have been Field Tested and are ready for shipment!
CALL ABOUT OUR NATIONAL DEALER PROGRAM AND JOIN THE BEST IN SELLING THE FINEST SOFTWARE ON THE Z-80 MARKET!

SYSTEMS ALSO OPERATE ON TRS-80 MOD I, MOD II, MOD III AND ALTOS MICROCOMPUTERS

For Further Information, Contact: **S & M Systems, Inc.**

P. O. Box 1225

Haverhill, Massachusetts 01830

Or Dial Direct: 1-617-373-1599

1-617-481-5231

APPLE USERS!

Technicians! Hobbyists!
Engineers! Repairmen!

NEW! 16 CHANNEL VARIABLE A-D BOARD!

Now you can digitally display, store, analyze and print your measurements!

The NEW ADC-16B A-D Board can be used for:

- POSITION MEASUREMENTS
- PRESSURE MEASUREMENTS
- PHOTOELECTRIC MEASUREMENTS
- TEMPERATURE MEASUREMENTS
- A COMPUTERIZED VOLT-OHM METER

YOU GET A COMPLETE SOFTWARE PACKAGE INCLUDING A TEST KIT, CALIBRATION METHOD AND VARIOUS APPLICATIONS! Only 179⁹⁵

This is a Variable Gain Board that allows increased measurements from 5 volts up to 100 volts.

CTA

**COMPUTER
TECHNOLOGY
ASSOCIATES**

**ORDER TODAY! Credit Card
Users Call TOLL FREE!
800-854-2003 ext. 815
In California Call
1-800-522-1500 ext. 815**

Computer Technology Associates
5812 Cromo Drive, Suite 102, El Paso,
Texas 79912

Please rush me _____ NEW ADC-16B A-D
Boards at the introductory price of 179⁹⁵
each.

Check Enclosed MasterCard
 Visa Diners Club
Card No. _____ Exp. Date _____

Name _____

Address _____

City _____ State _____ ZIP _____

Texas residents add 5% sales tax.
Please allow 4-6 weeks for delivery.

letter is published monthly that contains items about the meetings of special groups, industry items, letters from members, and other news. Contact PCS, POB 17371, Portland OR 97217.

Computerized Bulletin Board Service in Milwaukee

MAUDE (Milwaukee Area Utility for Digital Exchanges) is a computerized bulletin board in Milwaukee, Wisconsin. MAUDE is available to anyone who has access to a terminal or terminal emulator equipped with a standard modem. The system allows the posting and retrieval of messages of interest to computer hobbyists. There is no charge for using MAUDE. The number for MAUDE is (414) 241-8364. For more information, contact John Taylor, POB 121, Hartland WI 53029.

Prince William Computer Club

The Prince William Computer Club holds its regular meetings at the Prince William Branch Library, Woodbridge, Virginia, on the first Tuesday of each month at 7:30 PM. For information, call Don Bennett, (703) 670-4773.

The Red Sea Apple Club

The Red Sea Apple Club is located in Saudi Arabia. Most members have Apple II computers with two disks and the Pascal system. They are interested in corresponding with any and all clubs and individuals so that they can keep up with the current trends in the American microcomputer world. The group is also interested in swapping disks. The club's address is Red Sea Apple Club, c/o Saudi Arabian Parsons Ltd, POB 3694, Jeddah, Saudi Arabia. ■

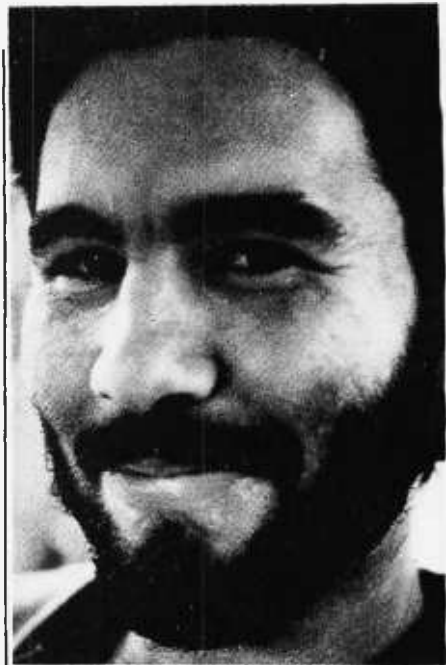

What makes a streetwise kid from New York want to help rice farmers in the tropics?

Meet Mike Harvey. He's not out to change the world, just to understand it better. And because he thinks underneath all the differences people are basically alike, he feels he can help.

It's what today's Peace Corps is all about. Americans from every kind of background working together with people around the world to meet their basic needs.

It isn't easy and it takes real commitment. But if you're looking for a challenge unique to the Peace Corps, there are any number of openings for which you may qualify.

Above all, you'll understand the world better while making friends with people you can help. And that's what life should be all about.

For further information, call toll free 800-424-8580. Or write Peace Corps, Washington, D.C. 20525.

Peace Corps

The toughest job you'll ever love.



A Public Service of This Magazine & The Advertising Council

PET TWO-WAY RS-232 and PARALLEL OUTPUT INTERFACE

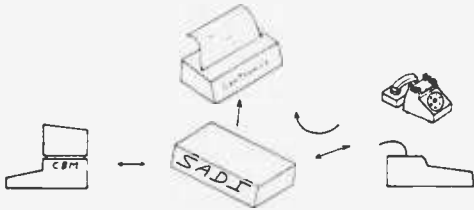

SADI - The microprocessor based serial and parallel interface for the Commodore PET. SADI allows you to connect your PET to parallel and serial printers, CRT's, modems, acoustic couplers, hard copy terminals and other computers. The serial and parallel ports are independent allowing the PET to communicate with both peripheral devices simultaneously or one at a time. In addition, the RS-232 device can communicate with the parallel device.

Special Features for the PET interface include:
 Conversion to true ASCII both in and out
 Cursor controls and function characters specially printed
 Selectable reversal of upper and lower case
 PET IEEE connector for daisy chaining
 Addressable - works with other devices

Special Features for the serial interface include:
 Baud rate selectable from 75 to 9600
 Half or full duplex
 32 character buffer
 X-ON, X-OFF automatically sent
 Selectable carriage return delay

Special Features for the parallel interface include:
 Data strobe - either polarity
 Device ready - either polarity
 Centronics compatible

Complete with power supply, PET IEEE cable, RS-232 connector, parallel port connector and case. Assembled and tested.

SADia (110VAC) \$295
 SADie (230VAC) \$325

Order direct or contact your local computer store.



Connecticut
 microComputer, Inc.

34 DEL MAR DRIVE, BROOKFIELD, CONNECTICUT 06804
 TEL: (203) 775-4595 TWX: 710-456-0052

VISA AND M/C ACCEPTED - SEND ACCOUNT NUMBER, EXPIRATION DATE AND SIGN ORDER.
 ADD \$3 PER ORDER FOR SHIPPING & HANDLING - FOREIGN ORDERS ADD 10% FOR AIR POSTAGE.
 MENTION THIS MAGAZINE WITH YOUR ORDER AND DEDUCT 2%.

PET to NEC and CENTRONICS PRINTER ADAPTER

LOWEST COST COMPLETE INTERFACE ON THE MARKET

Simple to use - low cost - designed for NEC 5530 Spinwriter and Centronics parallel printers. Works with WORDPRO and other software. Switch for upper-lower case conversion or upper case only.

Plugs into the PET and into the printer - all cables and connectors included - extra IEEE connector for Commodore disk drives.

Uses BASIC PRINT statements - no machine code needed.

Device address selectable - works with other peripherals.

\$129 complete - compare to others at \$225. Generous dealer discounts.

Assembled and tested. Our usual 30 day money back trial period applies.

Order direct or contact your local computer store.



Connecticut
 microComputer, Inc.

34 DEL MAR DRIVE, BROOKFIELD, CONNECTICUT 06804
 TEL: (203) 775-4595 TWX: 710-456-0052

VISA AND M/C ACCEPTED - SEND ACCOUNT NUMBER, EXPIRATION DATE AND SIGN ORDER.
 ADD \$3 PER ORDER FOR SHIPPING & HANDLING - FOREIGN ORDERS ADD 10% FOR AIR POSTAGE.
 MENTION THIS MAGAZINE WITH YOUR ORDER AND DEDUCT 2%.

New Produced and widely used in England and U.S.A. COMPLETE BUSINESS PACKAGE

INCLUDES EVERYTHING FROM INVENTORY TO SALES SUMMARY
 PROMPTS USER, VALIDATES EACH ENTRY, MENU DRIVEN

Approximately 60-100 entries/inputs require only 2-4 hours weekly and your entire business is under control.

PROGRAMS ARE INTEGRATED-

- 01 = ENTER NAMES/ADDRESS, ETC
- 02 = ENTER/PRINT INVOICES
- 03 = ENTER PURCHASES
- 04 = ENTER A/C RECEIVABLES
- 05 = ENTER A/C PAYABLES
- 06 = ENTER/UPDATE INVENTORY
- 07 = ENTER/UPDATE ORDERS
- 08 = ENTER/UPDATE BANKS
- 09 = EXAMINE/MONITOR SALES LEDGER
- 10 = EXAMINE/MONITOR PURCHASE LEDGER
- 11 = EXAMINE/MONITOR (INCOMPLETE RECORDS)
- 12 = EXAMINE PRODUCT SALES

SELECT FUNCTION BY NUMBER-

- 13 = PRINT CUSTOMER STATEMENTS
- 14 = PRINT SUPPLIER STATEMENTS
- 15 = PRINT AGENT STATEMENTS
- 16 = PRINT TAX STATEMENTS
- 17 = PRINT WEEK/MONTH SALES
- 18 = PRINT WEEK/MONTH PURCHASES
- 19 = PRINT YEAR AUDIT
- 20 = PRINT PROFIT/LOSS ACCOUNT
- 21 = UPDATE END MONTH FILES MAINTENANCE
- 22 = PRINT CASH FLOW FORECAST
- 23 = ENTER/UPDATE PAYROLL (NOT YET AVAILABLE)
- 24 = RETURN TO BASIC

WHICH ONE? (ENTER 1-24)

01 SUB. MENU EXAMPLE: 01 = EXAMINE: 02 = INSERT: 03 = AMEND: 04 = DELETE
 05 = PRINT (1,2,3): 06 = NUMERIC COMBINATIONS: 07 = SORT
 VERY FLEXIBLE. ADD YOUR OWN FUNCTIONS. EASY TO INTEGRATE.

All programs in BASIC for CP/M. PET. 6800

G. W. COMPUTERS LTD, the producers of this beautiful package in U.K.

WE EXPORT TO ALL COUNTRIES:
 BARCLAYCARD ACCEPTED
 CBM APPROVED

CALLERS BY APPOINTMENT ONLY
 89 Bedford Court Mansions
 Bedford Avenue
 London WC1, U.K.

CONTACT TONY WINTER 01-636-8210
 BARCLAYCARD ACCEPTED
 CBM APPROVED

CP/M Ver. 9.00 is one 16 K core program using random access releasing both drives for data storage, and 250 word vocabulary is translatable in any foreign language.

CP/M Ver. 9.00 is one 16 K core program using random access releasing both drives for data storage, and 250 word vocabulary is translatable in any foreign language.

PRICES: Programs 1-23 EXC (19,20,22,23) £475

£575 Stock Integrated Option + £100 Bank Integrated Option + £100

REMOTE I/O

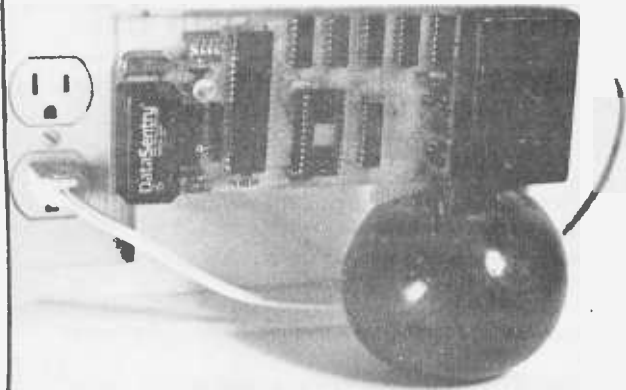

**Control AND monitor remote devices
Real time clock/calendar included**

- An AC carrier communications I/O interface for the APPLE II* computer. Output communications operate up to 256 BSR System X-10* control modules. Input communications come from the X-10 command console, and temperature and security input modules, soon to be available from Intelligent Control Systems, Inc.
- Software routines are provided to handle the AC I/O, to set, read, and display the real time clock, and a background schedule control program. 4 selectable interrupt rates allow machine language programs to run simultaneously with other programs.
- Real time clock provides sec, min, hour, date, day of week, mo, and year. Rechargeable battery runs clock when APPLE is off.
- * Trademarks-APPLE II: Apple Computer Inc., System X-10: BSR Ltd.

SEE YOUR APPLE DEALER FOR A DEMONSTRATION...\$185 sugg. retail
Intelligent Control Systems, Inc.
PO BOX 14571 • MPLS, MN 55414 • (612) 699-4342

FRIDAY SALE

APPLE-TIME \$150

For Your **APPLE...** The Ultimate **CLOCK/CALENDAR** Board

MORE FEATURES FOR LESS

- 12 or 24 HR Format
- Perpetual Calendar MM DD YY
- Crystal Controlled Time Base
- Ultra Fast Time/Date Setting
- 4 Interrupts Available
- Months Of On-Board Battery Backup

Set it & forget it.

MANY MORE FEATURES

TSR80 & \$100 MODELS AVAILABLE



Compu/Time
P.O. Box 5343
Huntington Beach, Ca 92646 (714) 536-5000

Dealer Inquires.

Makers Of Quality Low Cost Microcomputer Components

Event Queue

In order to gain optimal coverage of your organization's computer conferences, seminars, workshops, courses, etc, notice should reach our office at least three months in advance of the date of the event. Entries should be sent to: Event Queue, BYTE Publications, 70 Main St, Peterborough NH 03458. Each month we publish the current contents of the queue for the month of the cover date and the two following calendar months. Thus a given event may appear as many as three times in this section if it is sent to us far enough in advance.

December 1980

December 9-12 and 15-17
Training Courses for Engineers, Fairchild's Microcomputer Education Center, San Jose CA. This series of technical training courses are offered for design engineers who must learn to design the micro-processor into a working system. The curriculum includes courses on data communications and the 6856 device, 3870 microcomputer designs, the 6800 micro-processor, and bit-slice techniques. Contact the Center at MS42-2120, 101 Bernal Rd, San Jose CA 95119, (408) 224-7095.

December 10
1980 Computer Networking Symposium, Gaithersburg MD. The symposium is sponsored by the IEEE Computer Society, Technical Committee on Computer Communications, and the Institute for Computer Sciences and Technology of the National Bureau of Standards. The focus is on office automation, office system components, and the computer networks required to interconnect them. For information, contact Executive Secretary, POB 639, Silver Spring MD 20901, (301) 439-7007.

January 1981

January 7-9
The Fourteenth International Symposium on Minicomputers and Microcomputers, Hotel del Coronado, San

Diego CA. The scope of the symposium will cover technology, hardware, software, engineering, languages, systems architecture, operating systems, numerical methods, computer networks, and other aspects of computing. Contact the Secretary, MIMI '81 San Diego, POB 2481, Anaheim CA 92804.

January 7-10
The Fourteenth Annual Hawaii International Conference on System Sciences (HICSS), Ilikai Hotel, Honolulu, HI. HICSS is designed to bring together the academician and practitioner in a forum for the interchange of ideas in all areas of information systems technology. Seminars and discussions will cover computer hardware, software, medical information processing, and computer-based decision support systems. Contact HICSS-14, c/o Office of Management Programs, University of Hawaii, 2404 Maile Way C-202, Honolulu HI 96822

January 8-11
Winter CES, Las Vegas Hilton, Convention Center, and the Jockey Club Hotel, Las Vegas NV. Over 700 manufacturers will be exhibiting goods from the audio, video, personal electronics and microcomputer industries. Contact The Consumer Electronics Shows, 2 Illinois Center, Suite 1607, 233 N Michigan Blvd, Chicago IL 60601, (312) 861-1040.

January 13-15
Communications Networks 1981, Albert Thomas Con-

Omikron's Accounting Software

We made our reputation with our Mapper systems. One year ago we told TRS-80 Mod I owners that they could have standard CP/M, 8" drives, compatibility with the Mod II, the ability to transfer files from TRSDos to CP/M or run Newdos80, the TRSDos compatible operating system, with 8" and 5" drives all on line at once. Most of the readers said "too good to be true" and it was only the slowly spreading word (plus some excellent reporting — see August Byte column by Jerry Pournelle) that convinced you it worked.

Here we go again! **A field-proven, fully integrated accounting package with self-instructive documentation for \$350.00.** Too

good to be true? A General Ledger which has been running in the real world long enough to shake out the bugs and has sold for many times our price of \$100.00. Too good to be true? Ok, if we have to, we can wait for the word to spread. But just to get the ball rolling—let me give you the particulars:

REQUIREMENTS:

Computer — 48K Z80/8080

Printer — 132 columns

Video — 80 x 24 or 16 x 64 w/scrolling

Storage — 2 disk units 250 kbytes each

Language — Microsoft Basic

O/S — CP/M

BENEFITS: This is not another re-write of the Osborne packages but a professionally produced and marketed set of accounting software originally produced for the Mits/Altair machine. It has been tested and debugged in actual use. It comes with sample data and a manual designed for self-instruction. They are thoughtfully designed, interactive programs with clear prompts for ease of operation. Source code and documentation to aid in customization are also included.

INTERESTED? Write or call for our free brochure. It may sound too good to be true, but we've heard that before. Risk a stamp—our Mapper customers were glad they did.

Too good to be true?



*CP/M is a TM of Digital Research. TRS-80 is a TM of Tandy Corporation.

Circle 256 on inquiry card.

IN WITH THE NEW...

Is your **TRS-80** singing Auld Lang Syne? Does it remember the good old days when each new Power-Up sequence brought new software to massage its RAM? Is it lacking the Spirit of the Season? Start the New Year off on the right keys! No, not E-D-I-T . . . C-L-O-A-D.

No standing in the end-of-the-year return lines. These original, ready-to-load programs fit your **TRS-80** perfectly. Your computer will receive one 30 minute cassette each month by First Class Mail containing ready-to-**CLOAD** programs that will even keep of' Father Time from aging.

Make your New Year's resolution early this holiday season and surprise your **TRS-80** with a subscription to **CLOAD MAGAZINE**.

The Fine Print:

Overseas rates slightly higher—please write for them.

Back issues available—ask for our list.*

TRS-80 is a trademark of Tandy Corporation.

California residents add 6% to single copies and anthologies.

Programs are for Level II 16K and occasionally for 48K disks.

*24 Level I back issues also available.

Mastercharge/Visa Welcome Also Cash & Gold.



PRICES

1 year subscription	\$42.00
6 month subscription	\$23.00
Single copies	\$4.50
Anthology-volume 1	\$10.00
Anthology-volume 2	\$15.00

Copyright **CLOAD MAGAZINE** 1980

CLOAD

MAGAZINE INC.

P.O. Box 1267

Goleta, CA 93017

(805) 964-2761

vention Center, Houston TX. This show will feature exhibits and seminars covering network policy and management for US and international users and carriers; network architecture, software, and hardware; new developments; information appliances; and more. This conference is aimed at communications professionals and carriers, service and hardware vendors who are interested in combining voice, data, and message systems applications. Contact Communications Networks '81, c/o The Conference Company, 60 Austin St, Newton MA 02160, (617) 964-4550.

January 14-19

The Forty-Second National Audio-Visual Convention and Exhibit, Dallas Convention Center, Dallas TX. Over 300 manufacturers and producers of audio-visual, video and microcomputer hardware and software will be exhibiting their products.

Seminars will cover marketing and production of audio-visual items. For more information, contact the National Audio-Visual Association, 3150 Spring St, Fairfax VA 22031, (703) 273-7200.

January 16-17

Microcomputer Conference, Arizona State University, Tempe AZ. The goal of this microcomputer conference is to introduce educators to the applications of computers in the classroom. The emphasis of the conference is to provide an awareness of microcomputers and their impact on society. For further information, contact Dr Gary G Bitter, Arizona State University, Payne 203, Tempe AZ 85281.

January 27-29

Advanced Semiconductor Equipment Exposition, San Jose Convention Center, San Jose CA. Over 100 exhibitors will feature equip-

ment at this trade show. The show's emphasis is on new products and emerging technology in the semiconductor processing and production fields. Contact Carlidge & Associates, 491 Macara Ave, Suite 1014, Sunnyvale CA 94086, (408) 245-6870.

January 28-31

The Third IMMM/Data Comm International Japan Exposition, Harumi Exposition Center, South Hall, Tokyo, Japan. Over 15,000 scientists, design engineers, technical managers, applications engineers, and other specialists are expected to attend this show. Internecon Japan/Semiconductor International is held concurrently. The conference program will include talks on microcomputer-controlled data communications systems, peripheral interfacing, software management, and more. Contact Industrial and Scientific Conference Management Inc,

222 W Adams St, Chicago IL 60606, (312) 263-4866.

February 1981

February 2-5

The Second Middle East Electronic Communications Show and Conference, Bahrain Exhibition Centre, Bahrain. This conference will cover communications research, technology, and administration in satellite communications, digital communications, networks and industrial systems, and business communications. An exhibition will also be held. Contact TMAC, 680 Beach St, Suite 428, San Francisco CA 94109, (800) 227-3477.

February 4-5

Computer and Office Automation Show and Conference, Hyatt Regency Hotel, Vancouver, Canada. This conference will feature data-processing equipment, small-business computers, computer peripheral products, medium and high-speed copiers, word-processing systems, and conventional office products and services. Seminars on the role of computers in information management, electronic mail, data base applications, and other related topics, will be given. Contact Whitshed Publishing Ltd, Suite 1201, 55 Bloor St W, Toronto, Ontario, Canada M4W 3K2.

February 9-13

Reliability Engineering, Testing and Maintainability Engineering, University of California at Los Angeles. This course is designed for reliability, product assurance, logistics, quality assurance, and design engineers. The course is intended for those required to design and to predict the reliability of components, equipment, and systems. The fee is \$750. Contact Continuing Education in Engineering and Mathematics, UCLA Extension, POB 24901, Los Angeles CA 90024, (213) 825-1047. ■



Consumer Electronics Opportunities

Lubbock Openings

Texas Instruments has immediate openings for the following positions:

Educational Products Marketing Manager

Develop marketing strategy for microcomputer educational software products. Perform marketing analysis and market segmentation studies. Select software packages and establish schedule priorities. Identify and help stimulate 3rd party software and course-ware development. Position data-base strategy to support educational requirements.

Position requires a BS or MBA in Education or Marketing and 3-5 years' experience in developing or marketing computer-aided educational material for either institutional or industrial education environment.

Software Products Marketing Engineer

Develop marketing strategy for microcomputer software products. Perform marketing analysis and software package selection. Handle pricing, merchandising, and 3rd party software development negotiations.

Position requires a BS or related field and 3-5 years' experience in marketing planning support or management, preferably in the personal computer sector.

Software Design Engineer

Duties include design, documenting, programming, integrating, and testing computer applications software programs, and development of new and existing computer packages for retail marketing.

Position requires a BS or MS in Computer Science, EE or related field, and the ability to program in basic PASCAL and assembly level language.

Interested applicants should send resume in confidence to: Gary Sprehe/P.O. Box 10508, M.S. 5890/Lubbock, TX 79408.

TEXAS INSTRUMENTS

INCORPORATED
An equal opportunity employer M/F

A REFURBISHED ASCII TERMINAL OFFERED FOR THE FIRST TIME TO SMALL BUSINESS AND PERSONAL COMPUTER USERS.

The AJ 630. For just \$495* you can have a quiet thermal printer terminal.

Now, for less than the price of a good electric typewriter, you can have your own personal ASCII printer terminal.

And the AJ 630 gives you a lot of features for interactive timesharing, data entry/retrieval, and communications.

- A wide carriage—up to 140 characters per line
- Built-in lamp for paper illumination

- Upper and lower case characters
- 128-character ASCII code set
- RS-232C interface
- Selectable 110, 150, or 300 bps operation
- Desktop portability
- 30-day warranty on parts and labor

Perhaps best of all, the AJ 630 is *quiet*. You can use it anywhere without disturbing anyone—in the office or at home. And we'll make it easy for you to pay—with cash, certified check, Master Charge, or Visa.

Call toll-free for more information and details on our 10-day money back guarantee:**

800/538-9721

California residents call collect 408/263-8520, Extension 263.

* Plus \$50 for transportation, terminal checkout, and one 15" four hundred foot roll of paper.

**Excluding checkout charge of \$50.

Available only in the continental United States



CP/M^{®1} – based Business Software for TRS-80^{®2} computers on the fastest Mod-II CP/M with the most features!!!

- | | | |
|---|--|--|
| • Over 610,000 bytes/disk | • Mixed single/double density on any of 4 drives (even a 1-drive system) | • Auto-LF printer support & ASCII top-of-form software (LP111) |
| • Downloading package included | • Ultra-fast disk operation | • Supplemental document describing our implementation |
| • 1,200 baud operation of serial printers without data loss | • Emulation of cursor addressing for any of several "dumb" CRTs | • User-settable function keys |
| • Single drive backup | | |
| MOD-II CP/M \$250.00 | MOD-I CP/M \$150.00 | CBASIC2^{®3} (Mod I or II) \$110.00 |

The following software for Mod-II CP/M only unless otherwise stated (*-requires CBASIC2):

RM/COBOL^{®4} – Only COBOL for CP/M with alternate keys (multi-key ISAM), CRT screen handling, interactive debug, Z80 code, and the most useful Level 2 features. **Compatible with Tandy's COBOL—but runs faster!** \$495.00

PMS (Property Management System) - Interactive, menu-driven system includes full G/L, budgeting, cash journal, delinquency list, tenant activity/rent roll, complete audit trail and reports on vacancies, lost rent, and vendors \$650.00*
demo disk & manual 75.00*

APH (Automated Patient History) - General-purpose question-asking, answer-printing system furnished as self-administered review-of-systems general patient history (Mod-I also) ... \$175.00*

MAGIC WAND^{®5} – Full-feature word processing, true proportional spacing, file merging, and use of full-screen editor for source programs or data \$400.00

RPA (Residential Property Analysis) - Analyzes income and expense, financing, taxes, inflation and depreciation on home, condo, or apartments over a user-selectable time. Shows payoff in terms of ROI, Cap rate, cash-on-cash. Amortization schedules and worksheet \$300.00*
demo disk & manual 35.00*

RBC (Rent/Buy Comparison) - Sales or investment tool to compare renting and savings account investment vs. purchasing a particular property \$250.00*
demo disk & manual 35.00*

Osborne & Assoc. CBASIC source programs (Mod-I also):

Payroll w/Cost Accounting \$250.00*
Accts. Payable/Accts. Receivable \$250.00*

General Ledger w/Cash Journal \$250.00*
O&A CBASIC Books (ea.) \$ 20.00

Verbatim^{®6} media: (Qty. 100 prices)

5 1/4" single density \$2.50 ea.
8" certified double density \$4.00 ea.

8" single density \$ 3.00 ea.
450" tape cartridges \$20.00 ea.

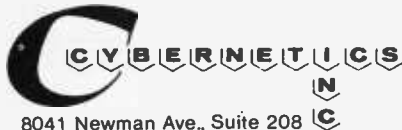

8041 Newman Ave., Suite 208
Huntington Beach, CA 92647
(714) 848-1922

Registered trademark of:

- ¹Digital Research
- ²Tandy Corp.
- ³Compiler Systems, Inc.
- ⁴Ryan-McFarland Corp.
- ⁵Small Business Applications, Inc.
- ⁶Verbatim Corp.



Distributed in U.K. by:
Microcomputer Applications Ltd.
11, Riverside Court,
Caversham, Reading, England
TEL: (0734) 470425

Ask BYTE

Conducted by Steve Ciarcia

Blowing in the Wind

Dear Steve,

I wish to interface a digital anemometer to my Cromemco System III, but I have only a vague idea of the steps involved. I live on a windy hilltop and want to log wind-velocity data (to help me select the best type of windmill for electrical power generation).

The anemometer that I have is a Trade-Wind Model DIG78, manufactured by Trade-Wind Instruments, 1076 Loraine St, Enumclaw, WA 98022. The indoor display unit shows wind speeds from 00 to 99 mph (miles per hour) either instantaneously or by maximum gust encountered. This display uses CD4511

latch/decoder drives. (See figure 1.)

My general idea is to employ some three-state buffer circuits to transfer BCD (binary-coded decimal) data from the anemometer to the computer, then load the data into the accumulator with the IN instruction. What portion of the anemometer electronics should I tie into? What S-100 bus line should I use as a device-select signal? **Paul Palaske**

Interfacing an anemometer to a computer sounds like something I'd do. Connecting it to an S-100 computer isn't terribly difficult. The accompanying circuit diagram should work, provided Trade-Wind In-

struments used the devices you listed in the classical tradition. It is not enough to simply send the BCD signals to the S-100 bus; they must also be latched and gated at the proper time.

First, so that the computer knows what port it is reading, IC1 and IC2 are wired to decode hexadecimal port FF. (If you prefer another address, refer to my "Circuit Cellar" article on parallel ports in the June 1980 BYTE, page 37 "I/O Expansion for the TRS-80, Part 2: Serial Ports".) This

signal is used to gate the output of a dual 4-bit latch (IC4) onto the bus. This latch is necessary because there is no way to tell how long the BCD-data signals in the anemometer are valid. It may be only a microsecond or two. When the output digits are updated, they are automatically latched into the IC4 as well. In this way, computer-program execution speed is independent of the electronics in the anemometer. This circuit should provide what you need....Steve

Number	Type	+5V	GND
IC1	74LS30	14	7
IC2	74LS00	14	7
IC3	74LS244	20	10
IC4	CD4508	24	12
IC5	CD4069	14	7

Figure 1

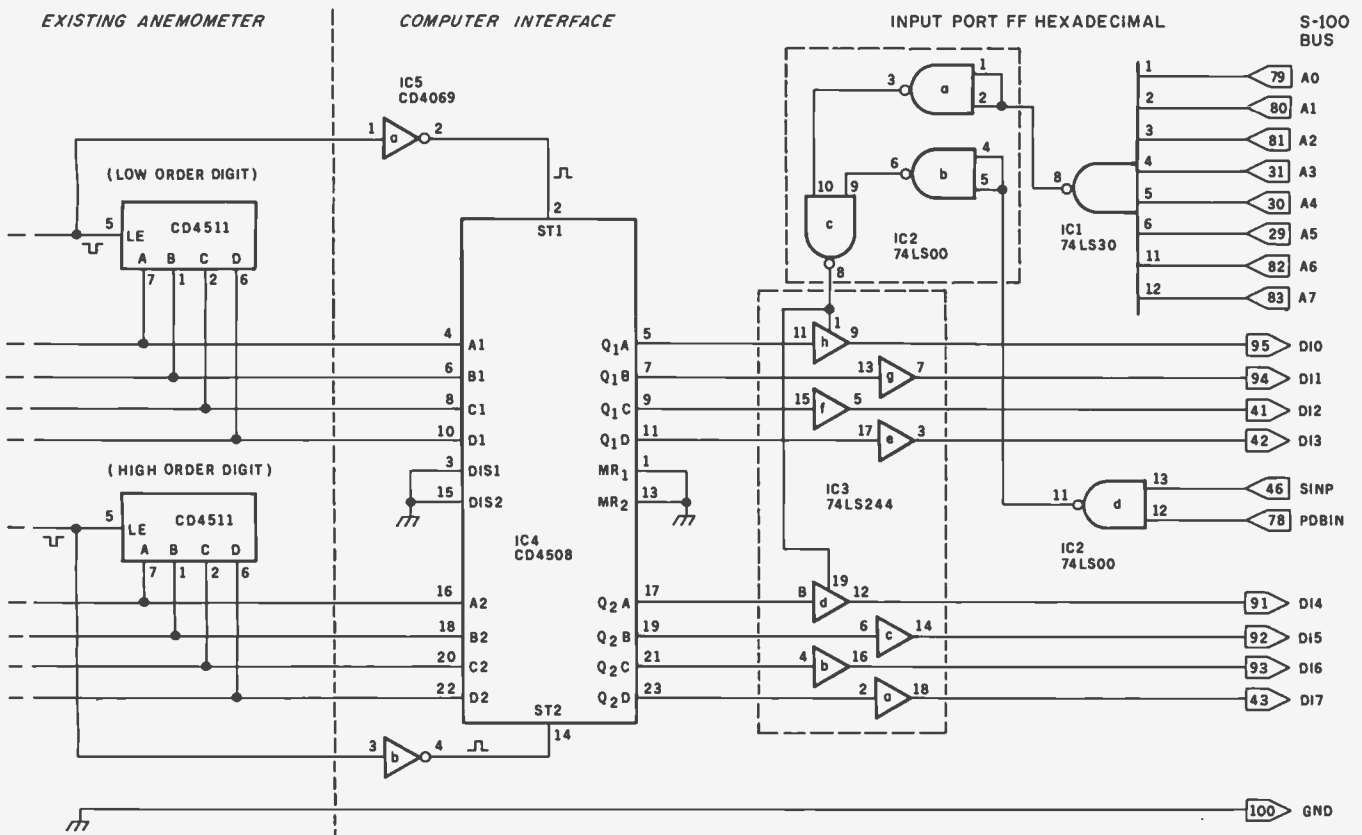

DLC MODEL 18

THE MOST INTELLIGENT TERMINAL
AVAILABLE
MICROPROCESSOR CONTROLLED
DESIGNED FOR COMMUNICATIONS,
NUMERICAL CONTROL AND
TYPESETTING APPLICATIONS.



CODE CONVERSIONS/
PROTOCOL CONVERSIONS
ASCII ↔ EIA (RS241)
ASCII ↔ BAUDOT
EBCDIC ↔ ASCII or BAUDOT

"Tomorrow's Ideas in Today's Products."

||DLC ||DLC ||DLC
DRILLICK LAMANNA CORPORATION
280 Midland Avenue Saddle Brook, N.J. 07662 (201) 791-1414



MODEL 300 MECHANISM
Available for OEM applications



— RACET computes — RACET SORTS — RACET UTILITIES — RACET computes — RACET SORTS — RACET UTILITIES — RACET computes — RACET

FROM THE LEADER IN UTILITY SOFTWARE

FOR THE TRS* COMPUTERS

★★ NEW ★★ **HARD/SOFT DISK SYSTEM (MOD II)** \$400

The Hard Disk Software Implementation You Have Been Waiting For!! MOD II TRSDOS compatible — using Cameo controller interface to popular large hard disk fixed/removable combinations (Ampex, CDC, Diablo, Pertec, Wanco, etc.). Compatible with your existing programs — change only 'filename'. All disk BASIC statements identical. Improved dynamic file allocation. A single file can be as large as one disk — 20 megabytes or larger. Alternate mode allows 24-million byte record range. Directory expandable to handle thousands of files! Includes special XCOPY, DCS, and SZAP utilities for use with hard or soft disks. Parameterized FORMAT utility includes options for specifying the number of sectors/track, platters/drive, sectors/granule, sectors/directory, etc.

★★ NEW ★★ **BASIC LINK FACILITY 'BLINK'** \$25 Mod I
(Mod I Min 32K 1-disk) \$50 Mod II

Link from one BASIC program to another saving all variables! The new program can be smaller or larger than the original program in memory. The chained program may either replace the original program, or can be merged by statement number. The statement number where the chained program execution is to begin may be specified!

INFINITE BASIC (Mod I Tape or Disk) \$49.95

Extends Level II BASIC with complete MATRIX functions and 50 more string functions. Includes RACET machine language sorts! Sort 1000 elements in 9 seconds!! Select only functions you want to optimize memory usage.

INFINITE BUSINESS (Requires Infinite BASIC) \$29.95

Complete printer pagination controls — auto headers, footers, page numbers. Packed decimal arithmetic — 127 digit accuracy +, -, *, /, Binary search of sorted and unsorted arrays. Hash codes.

BASIC CROSS REFERENCE UTILITY (Mod II 64K) \$50.00

SEEK and FIND functions for Variables, Line Numbers, Strings, Keywords. 'All' options available for line numbers and variables. Load from BASIC — Call with 'CTRL'R. Output to screen or printer!

Circle reader request for free 24-page catalog.

DEALER INQUIRIES INVITED

CHECK, VISA, M/C, C.O.D. PURCHASE ORDER *TRS BU is a registered trademark of
Telephone Orders Accepted (714) 637-5016 Indy Corporation

RACET SORTS — RACET UTILITIES — RACET computes — RACET SORTS — RACET UTILITIES — RACET computes — RACET SORTS — RACET UTILITIES — RACET computes — RACET

RACET SORTS — RACET UTILITIES — RACET computes — RACET SORTS — RACET UTILITIES — RACET computes — RACET SORTS — RACET UTILITIES — RACET computes — RACET

RACET SORTS — RACET UTILITIES — RACET computes — RACET SORTS — RACET UTILITIES — RACET computes — RACET SORTS — RACET UTILITIES — RACET computes — RACET

Interfacing a Joystick

Dear Steve,

I would like to interface an Atari joystick (made up of simple switches, not potentiometers) to the input port of my Exidy Sorcerer microcomputer. I don't believe the software will be difficult, but do I hook up the "common" wire from these switches to +5 V, and each lead to an input bit on the port? Are "tie-up" resistors required?

Richard Legault

Although I am not familiar with the Sorcerer, I assume that the input port is TTL (transistor-transistor logic) or LSTTL (low-power Schottky TTL); if so, I suggest that you attach a pull-up resistor and switch to each bit as shown in the diagram (see figure 2). When the switch is open, a logic 1 is presented to the input port; when the switch is closed, a logic 0 is presented....Steve

construct should be of reasonable cost (\$50 or so), show the basic workings of a microprocessor, and still be of some use to me in my home or on my farm. The unit could also incorporate photoelectric or heat-sensor devices. I have failed so far to find anything that fulfills my requirements. Do you know of any plans or kits that are close to what I am describing?

I would very much appreciate it if you could spare some time and do some searching for me. My science fair is about a month away, so I need your advice as soon as possible.

Kevin Meysenburg

zines many times within the past three years. I suggest you check the back issues or request an index from the magazines.

Once you have a circuit, you will still need the parts. You may be unaware that some companies, notably Intel, practically give away whole computers in the name of education. Write to Intel Corporation, calling attention of the product manager to the particular microprocessor you are interested in, and ask about the price and delivery of "University Kits." These are functional, cosmetically rejected devices that are practically given away for a nominal handling charge. In 1976, people were getting 8080A kits including programmable memory, EPROMS (erasable programmable read-only memories), and I/O (input/output) devices, worth about \$800 from the distributors, for \$20. I'm sure other companies have the same interest in supporting the schools....Steve

I can think of a few ways for you to build an under \$50 computer, but not in less than a month. To keep costs down, it would have to be built from scratch. If it used a printed-circuit board, it would be much more expensive. There have been circuits for microcomputers in BYTE and other maga-

Figure 2

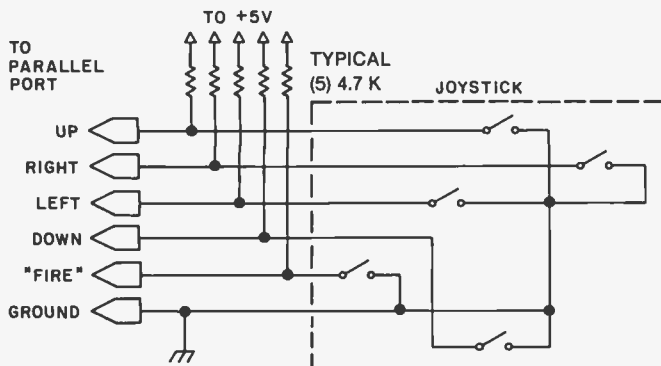

Periodical Guide

Dear Steve,

I am currently building a Central Data 2650 computer system, which uses S-100 circuit boards for memory and I/O (input/output). Could you please send me a list of construction articles that have appeared in BYTE and other magazines that might help me?

Kenneth Johnston

clude both subject and author indexes for over 9800 articles from BYTE, Electronics, Computer Design, Radio Electronics, and twenty other magazines.

The guides include listings under such varied topics as construction, languages, and robotics. These guides should help you find what you want....Steve

Quick and Cheap

Dear Steve,

For my high school science fair project, I am interested in building a microcomputer to show the advantages and uses of a microprocessor. I have not been able to find suitable plans, and I think that you can help me.

The unit I would like to

In "Ask BYTE," Steve Ciarcia answers questions on any area of microcomputing. The most representative questions received each month will be answered and published. Do you have a nagging problem? Send your inquiry to:

Ask BYTE
c/o Steve Ciarcia
POB 582
Glastonbury CT 06033

If you are a subscriber to The Source, send your questions by electronic mail or chat with Steve (TCE317) directly. Due to the high volume of inquiries, personal replies cannot be given. Be sure to include "Ask BYTE" in the address.

Give to the college of your choice.



CF
AE Council for Financial Aid to Education, Inc.
680 Fifth Avenue, New York, N.Y. 10019

Ad
Council A Public Service of This Magazine
& The Advertising Council



AC '81

INVEST IN PRODUCTIVITY

Are you responsible for introducing modern office systems into your organization?

Is your department going to be a user of such systems?

Do you design, plan, make, or market such systems?

If so, you should plan now to attend the second annual Office Automation Conference in Houston, Texas, March 23-25.

More than a showcase for the latest office automation equipment, the Conference provides a unique forum in which you can learn from experts how to harness and integrate today's worksaving

devices for maximum gains in productivity.

In addition to 150 informative exhibits, you'll be able to attend over 50 special learning sessions. Sessions covering topics as diverse as: Feasibility Studies...Organizational Impact...Electronic Mail... Teleconferencing...Merger of Voice with Text and Data...State of the Art in Word Processing.

Don't miss this opportunity to see and hear what's new in office automation and turn what you learn into greater productivity for you.

Beat the crowds. Beat the lines. Send the coupon for advance registration, housing and travel.

See you in Houston!

**THE 1981 OFFICE
AUTOMATION
CONFERENCE
HOUSTON, TEXAS
MARCH 23-25**

TO: OFFICE AUTOMATION CONFERENCE
c/o AFIPS, 1815 N. Lynn St., Arlington, VA 22209

Send me housing, travel, and registration information

NAME _____

COMPANY _____

STREET _____

CITY _____

STATE _____

ZIP _____

SciTronics introduces . . .

REAL TIME CLOCKS

with full Clock/Calendar Functions

The Worry-free Clocks for People
Who Don't Have Time to Worry!!

What makes them worry-free?

- Crystal controlled for high (.002%) accuracy
- Lithium battery backup for continuous clock operation (6000 hrs!!!)
- Complete software in BASIC-including programs to Set and Read clock
- Clock generates interrupts (seconds, minutes, hour) for foreground/background operation

Applications:

- Logging Computer on time
- Timing of events
- Use it with the SciTronics Remote Controller for Real Time control of A.C. operated lights and appliances

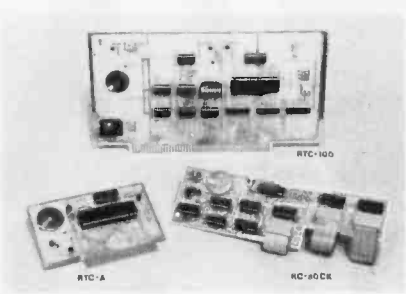

Versions available for:

- S-100 bus computers **RTC-100 \$159**
- Apple II computer **RTC-A \$129**
- SciTronics RC-80 owners **RC-80CK \$109**

Send Check or money order to: **SciTronics Inc.**
523 S. Clewell St., P.O. Box 5344
Bethlehem, PA 18015
(215) 868-7220

Please list system with which you plan to use controller • Master Charge and Visa accepted. COD's accepted. PA residence add sales tax.

Books Received

Beginning FORTRAN. Joe W McKinley. Portland OR: Matrix Publishers, 1980. 15.5 by 23 cm (6 by 9 inches), 240 pages, softcover, ISBN 0-916460-11-8, \$9.95.

The BOOK Accessing the TRS-80 ROM. Raymond E Daly IV, Stephen C Hill, Roy Soltoff, Thomas B Stibolt Jr, Richard P Wilkes. Springfield VA: Insiders Software Consultants Inc, 1980. 22 by 27.5 cm (8½ by 10¾ inches), 126 pages, softcover, ISBN- none, \$24.95.

Compiler Design and Construction. Arthur B Pyster, PhD. New York: Van Nostrand Reinhold Electrical/Computer Science and Engineering Series, 1980. 15.5 by 23 cm (6 by 9 inches), 384 pages, hardcover, ISBN 0-442-24394-4, \$24.50.

Computing Principles and Techniques. B Vickery. Philadelphia PA: Heyden & Son, 1979. 15.5 by 22 cm (6 by 8½ inches), 182 pages, hardcover, ISBN 0-85274-505-2, \$24.

The CP/M Handbook with MP/M. Rodnay Zaks. Berkeley CA: Sybex Inc, 1980. 13.1 by 22 cm (5¼ by 8½ inches), 324 pages, softcover, ISBN 0-89588-048-2, \$13.95.

Design of Solid-State Power Supplies, second edition. Eugene Hnatek. New York: Van Nostrand Reinhold, 1980. 15.6 by 23.5 cm (6¼ by 9¼ inches), 621 pages, hardcover, ISBN 0-442-23429-5, \$27.50.

The 8086 Book. Russell Rector, George Alexy. Berkeley CA: Osborne/McGraw-Hill, 1980. 16.5 by 23.5 cm (6½ by 9¼ inches), 249 pages, softcover, ISBN 0-931988-29-2, \$9.95.

Foundations of Programming with Pascal. Lawrie Moore. Somerset NJ: John Wiley & Sons, 1980. 16 by 23.5 cm (6¼ by 9¼ inches), 238 pages, hardcover. ISBN 0-470-27022-5, \$47.95.

TRS-80®, PET®, APPLE®, SORCERER® Communications Interface Systems



- Send & Receive RTTY / CW.
- Complete Hardware & Software Package.
- Extensive User Manuals.
- From \$129.

TRS-80 Model III
Interface Available Call for information

TRS-80 is a recognized trademark of Tandy Corporation.
PET is a recognized trademark of Commodore International.
APPLE is a recognized trademark of APPLE COMPUTER.
EXIDY SORCERER is a recognized trademark of EXIDY, Inc.

MACROTRONICS, inc.®

1125 N. Golden State Blvd. / Suite G
Turlock, CA 95380 (A)
(209) 667-2888 / 634-8888

California residents add 6% tax

We are experiencing telephone difficulties, please keep trying.



Circle 265 on inquiry card.

FINDING SOLUTIONS AND BEING COMPETITIVE IS OUR BUSINESS.

Having problems and looking for a computer to help solve them? Are you finding computer dealers come in one of two ways? Either Full system support with Full price or Take it or Leave it with Low price. At Omega we don't believe that you should have to make a choice. Yes, we're in business to sell products but also, to solve your problems. Our prices will be the lowest possible. Our support and product quality will be second to none. Check out our Mail Order prices in this ad (our retail prices will be higher). See if you don't agree with our first claim. For our second claim, call us with your data processing needs and problems. Better yet, come in and see us. Finding solutions and being competitive is our business. We never forget either of them.



 **apple computer**
Authorized Dealer

APPLE II "PLUS" 16K \$ 929.95
48K 1079.95

Apple II Accessories:

Disk II with Controller & 3.3 DOS	\$535.00
Disk II 2nd drive	435.00
Graphics Tablet	665.00
Language System with PASCAL	395.00
Silentype Printer w/Int	489.00
Integer Firmware Card	152.00
Z-80 Softcard	259.00
Videx Videoterm 80 col Card	279.00
Sanyo 12" Green Monitor	279.00

Calculators: (\$2.00 shipping charge)

Hewlett Packard			
HP-85	CALL	HP-41C	\$269.00
HP-67	\$299.00	HP-97	589.00
HP-34C	127.00	HP-38C	127.00
Texas Instruments			
TI-58C	109.00	TI-59	209.00
Cannon			
P10-D	80.00	P7-D	80.00
Sharp			
6200	98.00	5813	35.00
5100	89.00	5102	80.00

Mail Order Terms of Sale: Price based on prepaid orders. Visa or Master Charge orders may have service charge added to purchase price. No COD's. Allow 14 working days for personal and company checks to clear. All orders (unless specified in ad) within Continental U. S. shipped U.P.S. no charge. APO or out of Continental U. S. write or call for shipping charges. All prices subject to change and all offers subject to withdrawal without notice. CA residents add 6% sales tax.

OMEGA MICRO COMPUTERS

The Problem Solving Company

3447 Torrance Boulevard • Torrance, California 90503 • (213) 370-9456

How to Do Your Own Accounting for a Small Business. Robert R Milliron. Wilmington DE: Enterprise Publishing Inc, 1980. 22 by 28 cm (8½ by 11 inches), 178 pages, hardcover, ISBN 0-913864-34-X, \$9.95. A practice manual for this book is \$5.95.

Introduction to the Computer. Jeffrey Frates, William Moldrup. Englewood Cliffs NJ: Prentice-Hall Inc, 1980. 18.5 by 24.5 cm (7¼ by 9½ inches), 449 pages, hardcover, ISBN 0-13-480301-9, \$17.95.

Journal of Digital Systems, volume 4. Waldo G Magnuson Jr. Potomac MD: Computer Science Press Inc, 1980. 15.5 by 23 cm (6 by 9 inches), 106 pages, softcover, ISBN 0195 4350, price individual \$45, company \$65.

Mathematics for Business and Economics with Computing. Frank Scalzo. Princeton NJ: Petrocelli Books, 1980. 16 by 23.5 cm (6¼ by 9¼ inches), 388 pages, hardcover, ISBN 0-89433-039-X, \$27.

Microcomputer Interfacing. Bruce A Artwick. Englewood Cliffs NJ: Prentice-Hall Inc, 1980. 18.5 by 24.5 cm (7¼ by 9½ inches), 341 pages, hardcover, ISBN 0-13-580902-9, \$21.95.

Microcomputer Interfacing. G Jack Lipovski. Lexington MA: Lexington Books, 1980. 15.5 by 23 cm (6 by 9 inches), 426 pages, hardcover, ISBN 0-669-03619-6, \$24.95.

Microcomputers for External Devices. James A Gupton Jr. Portland OR: Dillithium Press, 1980. 14 by 20.5 cm (5½ by 8¾ inches), 279 pages, softcover, ISBN 0-918398-28-2, \$13.95.

Microprocessor Systems Design and Applications. Dave Bursky. Rochelle Park NJ: Hayden Book Company Inc, 1980. 22 by 28 cm (8½ by 11 inches), 192 pages, softcover, ISBN 0-8104-0976-3, \$9.95.

Pathways Through the ROM, Guide to Level II BASIC and DOS. Robert M Richardson, Roger Fuller,

Introducing ...

MINDex & MINDexCHANGE
system—one softsources

System—one is a Pascal based information storage and retrieval system. Softsources are ready made databases of computing resources, contract clauses, bibliographic references, and more.

MINDex is suitable for the researcher, lawyer, contractor, educator, and student. Virtually anyone assembling or accessing text based information may benefit from this versatile and productive information management tool.

MINDex can scan volumes of data for you and extract what is most relevant to your needs.

MINDex is designed to adapt to your special vocabulary through a simple dictionary of key words or through a more complex but effective thesaurus of key concepts as defined by associated word groups.

MINDex can assist a legal practice or contractor's office in the generation of legal documents from standard clauses, and in searching case briefs for legal precedents.

mINDex

infosystems

MINDex Features:

- Variable length text records which may span files and disks to accommodate large databases.
- Ranked retrieval in order of closest match to your inquiry.
- Interactive inquiry as well as retrieval from inquiry archive files.
- Fully automatic association of your key words to all or a selected range of text records.
- Optional indexing on all text in a record or on delimited key word groups and the ability to suppress key group output.
- Formatting and output controls with specifiable destination.

Introductory prices:

MINDex system — one, for UCSD Pascal I.5, II.0, or PASCALUM with sample databases and manual ... \$ 175
MINDex manual only ... \$ 20

MINDexCHANGE softsources from \$ 25
prices vary with database, please inquire for specifics.

Contact: **MINDex** Infosystems
81 Centennial Loop, Suite A
Eugene, Oregon 97401
Ph: (503)485-5827

Shipped on 8" single-density soft sector diskettes.

UCSD Pascal is a registered trademark of The Regents of the University of California. PASCALUM is a trademark of Sorcim.

Circle 266 on inquiry card.

John T Phillipp, George Blank, and John Hartford. Milford NH: Softside Publications, 1980. 22 by 28 cm (8½ by 11 inches), 116 pages, softcover, ISBN-none, \$19.95.

The Personal Computer Book. Robin Bradbeer. West Yorkshire, England: MCB Publications, 1980. 15 by 21 cm (5¼ by 8¼ inches), 210 pages, softcover, ISBN 0-905897-56-0. \$15.

Theory and Design of Digital Computer Systems.

Douglas Lewin. Englewood Cliffs NJ: Prentice-Hall Inc, 1980. 38 by 59.5 cm (15½ by 23½ inches), 472 pages, softcover, ISBN 0-470-26959-6, \$21.95.

What to Do After You Hit Return. People's Computer Company. Rochelle Park NJ: Hayden Book Company Inc, 1980. 25.5 by 36 cm (10 by 14 inches), 180 pages, softcover, ISBN 0-8104-5476-9, \$14.95.

Your First Computer: A Guide to Business and Per-

sonal Computing. Rodnay Zaks. Berkeley CA: Sybex Inc, 1980. 14 by 22 cm (5½

by 8½ inches), 260 pages, softcover, ISBN 0-89588-045-8, \$7.95. ■

These lists are of books and software packages received by BYTE Publications during the past month. The list of books is not meant to be exhaustive; its purpose is to acquaint our readers with recently published titles of interest. The list of software is correct to the best of our knowledge, but it is not meant to be a full description of the product. The form and version of the product as received by BYTE Publications is that listed here. The software list makes no comment on the quality or usefulness of the software. If you send us software, include the list price and note other distribution formats. We regret that we cannot review every book and software package we receive.

Meet Fast Eddie. He got his nickname because his typing was clocked at more than 80 words per minute. Unfortunately, every fourth word or so was misspelled. Which meant Fast Eddie's mind far outpaced his fingers. Fast Eddie was also fond of changing his text around words, sentences, even whole paragraphs. By the time he'd finish writing something, Fast Eddie's masterpiece looked more like a jigsaw puzzle.

But then Eddie discovered WORDSTAR, the word processing system that turned his CP/M system into a word processor rivaling Xerox or Wang. Now he flies through his text, making changes at will and producing perfect final copies.

But there was more in store for Fast Eddie! He found that he could enter and edit computer code with grace and ease seldom found in resident editing programs.

We thought we'd lose Fast when he added MailMerge to WORDSTAR, creating customized letters, boilerplate text, mailing lists, and chained printing. Space Invaders lost its allure. Fast Eddie began to preach the wonders of Wordstar.

To keep the guy happy, we let him put on this sale so he could spread the word about WORDSTAR.

WORDSTAR 2.1
List: \$495

Microhouse Price: \$349.95

EDDIE'S EXTRAS..

MailMerge
List: \$150

Microhouse Price: \$130.00

NEC 5510 (RS232 serial interface) or 5530 (Parallel/Centronics-type interface) SPINWRITER
List \$3055

Microhouse Price: \$2459

TELEVIDEO 912 CRT List: \$895
Microhouse Price: \$759

INDUSTRIAL MICRO SYSTEMS Senes 5000 Computer. Z80-based. CP/M, S-100 bus with 12-slot motherboard. (2) SSD 5¼" disk drives for 300K storage (chassis will hold up to three drives and can be hooked up to IMS's Hard Disk system for up to 96 megabytes of on-line storage.). 48K RAM (expandable to 256K). two RS232 serial ports and one parallel port. standard.

Microhouse Price: \$2821.20

PRICES AND SPECIFICATIONS
SUBJECT TO CHANGE WITHOUT NOTICE
MASTER CARD OR VISA WELCOME

511 NORTH NEW STREET
BETHLEHEM, PA 18018
215-868-8219

THE S-100 PACKAGE includes Wordstar 2.1, NEC 5500 Spinwriter, and MicroPro I/O Master (which makes the 5500 OEM Spinwriter outperform its higher-priced counterparts) LIST: \$3790
Microhouse Special: \$2,769.

FAST EDDIE'S COMPLETE WORD PROCESSING SYSTEM is a full-blown S-100 computer system including commercial-strength Industrial Micro Systems 5000 (Z80, 48K RAM) Computer with two single-sided, double-density 5¼" disk drives (list: \$3050). Televideo 912C CRT (list: \$895). NEC 5500 Spinwriter with I/O Master (list: \$3295) and Wordstar 2.1 (list: \$495)

Total list value: \$7735.
Microhouse Special: \$6235.
SAVE \$1500

MICROHOUSE PRESENTS:

FAST EDDIE & THE WORD PROCESSING SALE.



CALL OR WRITE FOR FREE CATALOG

Microhouse™

Software Received

B17 Tape Operating System. Cassette-based utility for the TRS-80. Cassette, \$22. ABS Suppliers, POB 8297, Ann Arbor MI 48107.

EasyWriter (Professional System). Word processor for Apple II with 80-column video board. Floppy disk, \$150. Information Unlimited Software, 281 Arlington Ave, Berkeley CA 94707.

UltraMon. Assembly-language monitor for the TRS-80. Cassette, \$24.95. International Association of Programmers, POB 4211, Manchester NH 03103.

Write-On II. Word-processing software for Apple II. Floppy disk, \$150. Rainbow Computing, 9719 Reseda Blvd, Northridge CA 91324.

Zork: The Great Underground Empire, Part I. Adventure game for the TRS-80. Floppy disk, \$39.95. Personal Software, 1330 Bordeaux Dr, Sunnyvale CA 94086. ■

Cancer is often curable.

The fear of cancer is often fatal.

BYTE's Bits

Education Foundation Awards Microcomputer Equipment

The Apple Education Foundation has awarded twenty-five recipients more than \$150,000 of microcomputer equipment. Thirty-five microcomputer systems were awarded for projects at all scholastic levels, from elementary school to the university level, and for medical and special-education projects. A grand prize will be awarded to the institution or individual that demonstrates the most outstanding example of program development leading to improved education through the use of microcomputers.

These systems are being used in university biology study projects for developing and testing programs in genetics and cell metabolism, developing software for laboratory courses in psychology and education, assisting teachers in planning physical-education training for handicapped children, translating and adapting computer-assisted music programs to microcomputers, and developing programs for business forecasting and planning. Besides the uses in the universities, the systems are being employed in special educational areas to teach programming; time/money management for mentally disabled, prevocational students; typing; and to develop programs for autistic children. The systems are being used in elementary schools to teach and develop foundations in all academic disciplines.

The Apple Education Foundation, chartered in 1979, is a nonprofit corporation established to support and develop new methods of learning through the use of microcomputers. Most of the systems provided under

ASCII encoded keyboards; as low as \$69* New lighter touch for improved typing.



RCA VP-600 series ASCII keyboards are available in two formats. You can choose either a 58-key typewriter format. Or a 74-key version which includes an additional 16-key calculator-type keypad. Both can be ordered with parallel or serial output.

These keyboards, redesigned for lighter key activation and improved typing capability, feature modern flexible membrane key switches with contact life rated at greater than 5 million operations. Plus two key rollover circuitry. A finger positioning overlay. And an on-board tone generator that gives aural key press feedback.

The unitized keyboard surface is spillproof and dustproof. This plus high noise immunity CMOS circuitry makes these boards particularly suited for use in hostile environments.

Parallel output keyboards have 7-bit buffered, TTL compatible output. Serial output keyboards have RS 232C compatible, 20mA current loop and TTL compatible asynchronous outputs with 6 selectable baud rates. All operate from 5 V DC, excluding implementation of RS 232C.

For more information contact RCA Customer Service, New Holland Avenue, Lancaster, PA 17604.
Or call our toll-free number: 800-233-0094.

*Optional user price for VP-601. Dealer and OEM pricing available.

ARTIFICIAL INTELLIGENCE For Your C/PM® or S-100 SYSTEM

"SHIVA™" is a highly-sophisticated VIRTUAL-PERSONALITY™ multi-level multi-user multi-tasking executive (operating system) for S-100 based systems. It provides your microcomputer system immediately with power comparable to that of large-frame maxi-computers for a remarkably small price, yet SHIVA™ requires surprisingly little R.A.M. area, and is conversational!!! SHIVA's™ English-like input/output is interactive, dynamic, and may be reconfigured or expanded by the user. And SHIVA™ gives you the freedom to expand indefinitely . . . with tremendous hardware and software choice: SHIVA™ supports hard disks and floppies . . . R.A.M. addressing beyond 64 kilobytes . . . time-sharing . . . multi-level user-reconfigurable password protection . . . and features shell-commands similar to UNIX® in structure!! SHIVA™ is compatible with C/PM® and C/DOS® for easy implementation and near universal software support!!! SHIVA™ is available for 8080, 8085, MC6800, 6502, and Z80®-based systems.

Versions are in development for ZILOG Z8000® 16-BIT, INTEL 8086® and INTEL iApx-432® 32-BIT PROCESSORS . . .

And Omega Research™ is dedicated to non-obsolescence and system superiority in software choice . . . SHIVA™ supports BASIC, FORTRAN, COBOL, a MACRO-ASSEMBLER, DATA BASE MANAGEMENT, ALGOL-60, PASCAL . . . interfaces in development for UNIX®, C, LISP, PL/I, APL, and RT-11®.

And needless to say, SHIVA™ is very fast

SHIVA™ . . . \$350 -- Available on 8" I.B.M. Soft-Sector Diskettes and 5" C/DOS® (Cromemco) Diskettes. Includes complete Documentation. . . M.C. & Visa orders accepted

"SHIVA™," "VIRTUAL-PERSONALITY™" and "OMEGA RESEARCH™" are trademarks of OMEGA RESEARCH.
"RT-11™" is a trademark of DIGITAL EQUIPMENT CORPORATION.
"UNIX™" is a trademark of BELL LABORATORIES
"CP/M™" is a trademark of DIGITAL RESEARCH OF CALIFORNIA
"C/DOS™" is a trademark of CROMEMCO, Inc.
"Z-80™" and "Z-8000™" are trademarks of ZILOG, Inc.
"INTEL™" is a trademark of INTEL CORPORATION

No shipments prior to return of signed software license agreement. For detailed information on "SHIVA™," send \$1.00 postage and handling to:



CALIFORNIA RESIDENTS ADD 6% SALES TAX



OMEGA RESEARCH™

P.O. Box 479
Linden, Ca. 95236
(209) 334-6666

9am to 5pm Mon.-Fri.

(212) 986-7690

MAIL ORDER ONLY

Micro Computer Your One Stop For... Quality and Huge Savings

DISCOUNT Company

QUALITY • DELIVERY • SERVICE

60 E. 42nd St. Suite 411 New York, NY 10017



APPLE
16K - \$ 959
48K - \$1059
Disk — \$529

Other Products Avail

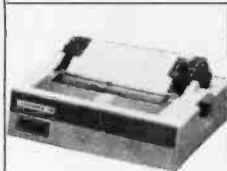

CENTRONICS
CALL FOR PRICES



APF
IM1 - \$495
IM2 - \$988



COMMODORE
8K - \$729
16K - \$888
32K - \$1088
2022 - \$695
2040 - \$1088
8050 - \$1435
8032 - \$1495



SUPERBRAIN*
*32K - \$2445
64K - \$2645
64KQD - \$3395
*32K add-in memory
only \$10 with
purchase



PAPER TIGER
440G - \$895



XYTEC
HQ 1000 - \$2395



**NEC
SPINWRITER**
5510 - \$2795
5520 - \$2990



***XEROX**
1740 RO - \$2619
1740 SR - \$2995
1750 RO - \$2795
1750 KSR - \$3170
1730 - \$2195

MAIL ORDER ONLY

Send Certified Check (Personal or Company Checks require 2 weeks to clear.)
We pay all shipping and insurance charges except items marked with asterisk.
VISA, MasterCharge add 5% N.Y.S. Residents add appropriate sales tax.

*(DENOTES ITEMS
SHIPPED F.O.B. NYC)

PHONE (212) 986-7690

the grants are Apple II microcomputers. Other contributing organizations are Bell & Howell, Mountain Computer Inc, Heuristics Inc, Integral Data Systems Inc, Interactive Structures Inc, ABW Inc, and Videx. For more information, contact Apple Education Foundation, 20863 Stevens Creek Blvd, Cupertino CA 95014, (408) 255-3295.

Microcomputer User Software Library

The Home Computer Library is a service lending library for users of TRS-80 and Apple microcomputers. The Library lends books and software by mail, and plans to expand its services to include other microcomputers and systems, such as the Atari, PET, and Texas Instruments machines. Annual membership in the Library is \$20, with a thirty-day money-back guarantee.

Members can borrow books and software of their choice for a three-week period. There is a rental charge, which is usually \$1 to \$5. Emphasis is on stocking the Library with educational, small-business and home-application software. Members also have the opportunity to communicate directly with software authors and marketers as well as personal-computer manufacturers through the Feedback service, which surveys members for suggestions, changes, and additions they would like to see in hardware and software. For details, contact The Home Computer Library, Department B, 1469 Rosena Ave, Madison OH 44057, (216) 428-6163. ■

Introducing

THE BENCHMARK^(tm) WORD PROCESSING SYSTEM

THE BENCHMARK software system sets new standards in word processing. First, it can be delivered to run on the CP/M or the North Star DOS, so there may be no need to buy a special operating system. Second, it has all the features of systems costing thousands of dollars more. Third, the price is as low as, or lower than, most word processing systems.

Anyone can learn to run and use THE BENCHMARK in one day of self training. Completely self-prompting in English. THE BENCHMARK is a full capability word processor, has been thoroughly tested in an office environment and proved to meet the needs of the most sophisticated user.

- Multi-operating system
- Changes terminal drivers
- Customized to utilize all the features of terminal & printer
- Overtyping - erases, corrects
- Variable, electronic decimal tab
- Screen menus simplify operation
- Block move and get

ONLY \$499 plus tax where applicable

THE BENCHMARK is distributed exclusively by R&B Computer Systems. Dealer inquiries are invited.

R&B Computer SystemsTM

1954 E. University
1-800-528-7385

Tempe, Arizona 85281
AZ-602-968-7101

THE BENCHMARK is a trademark of Metasoft Corporation

**ONE DISEASE
YOU CAN'T
CATCH!**



**HUNTINGTON'S
DISEASE**

NATIONAL HUNTINGTON'S DISEASE ASSOCIATION
Suite 501 1441 Broadway
New York, NY 10018
212-966-4320

Micrograph continued:

Listing 1: The second third of the firmware for Micrograph control, written for the Z80 microprocessor used in the prototype. The first fifteen pages of this listings were given in Part 1 of this article. The remaining portion of the firmware will be included in January 1981 BYTE's final installment of this series, along with a description of the software and an explanation of its use.

```

          931 ;           E      (TEMPORARY)
          932 ;           H      (POINTER)
          933 ;           L      (POINTER)
          934 ;
          935 ; I/O           PORT 0 (DISPLAY CONTROL)
          936 ;
          937 ; STRUCTURES   GDR      (GRAPHIC DISPLAY REGISTERS)
          938 ;
0387  E60F  939 LREG:  AND  00001111B      ;CLEAR OP CODE
0389  FE0F  940         CP  00001111B      ;TEST FOR RESET
038B  CA0000 941         JP  Z,RESTART      ;RESET IF GDR15
038E  6F      942         LD  L,A           ;LOAD LOAD BYTE
038F  2600  943         LD  H,0           ;CLEAR POINTER
0391  118010 944         LD  DE,STRUCT+GDR     ;SET UP BASE ADDRESS
0394  19      945         ADD  HL,DE      ;ADD BASE ADDRESS
0395  CD0E01 946         CALL FETCH          ;GET THE DATA
0398  77      947         LD  (HL),A      ;SAVE THE DATA
0399  0D7E0E 948         LD  A,(IX+GDR14)     ;GET DISPLAY CONTROL
039C  D300  949         OUT  (0),A        ;SENT THE DATA
039E  C9      950         RET          ;RETURN
          951 ;
          952 ; LSUB *****
          953 ;
          954 ; LSUB LOADS A SUBROUTINE INTO RAM AT THE SPECIFIED
          955 ; ADDRESS AND WITH THE SPECIFIED LENGTH. LSUB FIRST
          956 ; GETS THE SUBROUTINE NUMBER, THEN SETS THE LENGTH
          957 ; IN SLONG. THE SUBROUTINE ADDRESS IS SAVED IN SLINK.
          958 ; GETBLK IS THEN CALLED TO READ IN THE DATA.
          959 ;
          960 ; CALLS           FETCH
          961 ;                   GETBLK
          962 ;
          963 ; CALLED BY     PRMAT  (INDIRECTLY)
          964 ;
          965 ; REGISTERS   A      (PRIMITIVE OP CODE, TEMPORARY)
          966 ;                   B      (LENGTH)
          967 ;                   D      (POINTER)
          968 ;                   E      (POINTER)
          969 ;                   H      (POINTER)
          970 ;                   L      (POINTER)
          971 ;                   IY     (INDEX)
          972 ;
          973 ; I/O           NONE
          974 ;
          975 ; STRUCTURES   SLINK  (SUBROUTINE LINK)
          976 ;                   SLONG (SUBROUTINE LENGTH)
          977 ;
039F  E60F  978 LSUB:  AND  00001111B      ;CLEAR OP CODE
03A1  5F      979         LD  E,A           ;MOVE OFFSET TO E
03A2  1600  980         LD  D,0           ;CLEAR POINTER
03A4  FD21B010 981         LD  IY,STRUCT+SLONG  ;POINT TO SLONG
03A8  FD19  982         ADD  IY,DE      ;ADD OFFSET
03AA  CB1001 983         CALL GETBLK        ;GET LENGTH
03AD  47      984         LD  B,A           ;SAVE LENGTH
03AE  FD7700 985         LD  (IY+0),A      ;SAVE LENGTH
03B1  FD21B010 986         LD  IY,STRUCT+SLINK  ;POINT TO SLINK
03B5  CB23  987         SLA  E           ;SHIFT THE OFFSET
03B7  FD19  988         ADD  IY,DE      ;ADD OFFSET
03B9  CD0E01 989         CALL GETBLK        ;GET ADDRESS LOW BYTE
03BC  6F      990         LD  L,A           ;SAVE LOW BYTE
03BE  FD7700 991         LD  (IY+0),A      ;SAVE LOW BYTE

```

Listing 1 continued on page 328

Listing 1 continued:

```

0300 00E001 992 CALL FETCH ;GET ADDRESS HIGH BYTE
0303 67 993 LD H,A ;SAVE HIGH BYTE
0304 FD7701 994 LD (IY+1),A ;SAVE HIGH BYTE
0307 CD9A08 995 CALL GETBLK ;GET DATA
030A 09 996 RET ;RETURN
997 ;
998 ; LSYM *****
999 ;
1000 ; LSYM LOADS SYMBOL DEFINITIONS INTO THE INTERNAL
1001 ; SYMBOL GENERATOR, SYMTAB. LSYM FIRST CHECKS TO SEE
1002 ; IF ALL OR JUST ONE SYMBOL IS TO BE LOADED. IF ALL
1003 ; ALL ARE TO BE LOADED, LSYM LOAD 1024 SYMBOL ELEMENTS
1004 ; (FOR 128 SYMBOLS). OTHERWISE, LSYM LOADS 8 SYMBOL
1005 ; ELEMENTS FOR ONE SYMBOL.
1006 ;
1007 ; CALLS FETCH
1008 ; GETBLK
1009 ;
1010 ; CALLED BY PRIMAT (INDIRECTLY)
1011 ;
1012 ; REGISTERS A (PRIMITIVE OP CODE)
1013 ; B (COUNTER)
1014 ; C (COUNTER)
1015 ; H (POINTER)
1016 ; L (POINTER)
1017 ;
1018 ; I/O NONE
1019 ;
1020 ; STRUCTURES SYMTAB (SYMBOL TABLE)
1021 ;
030B 0B47 1022 LSYM: BIT 0,A ;TEST FOR LOAD TYPE
030D 280E 1023 JR Z,LSYM1 ;JUMP IF SINGLE LOAD
030F 710014 1024 LD HL,SYMTAB ;LOAD POINTER
0302 0E04 1025 LD C,4 ;LOAD COUNT
0304 0200 1026 LSYM0: LD B,0 ;SET COUNT OF 256
0306 CD9A08 1027 CALL GETBLK ;GET DATA
0309 0D 1028 DEC C ;DECREMENT COUNT
030A 20F8 1029 JR NZ,LSYM0 ;JUMP IF NOT DONE
030C 09 1030 RET ;RETURN
030D 0E0D01 1031 LSYM1: CALL FETCH ;GET SYMBOL NUMBER
030E E47F 1032 AND 01111111B ;MASK HIGH BIT
0302 6F 1033 LD L,A ;SAVE OFFSET
0303 2400 1034 LD H,0 ;CLEAR POINTER
0305 0B25 1035 SLA L ;SHIFT OVER
0307 0B14 1036 RL H ; THREE BITS
0309 0B25 1037 SLA L ; TO PROPERLY
030B 0B14 1038 RL H ; COMPUTE
030D 0B25 1039 SLA L ; THE
030F 0B14 1040 RL H ; OFFSET
0301 010014 1041 LD BC,SYMTAB ;POINT TO SYMTAB
0304 09 1042 ADD HL,BC ;ADD BASE ADDRESS
0305 0608 1043 LD B,8 ;SET COUNT
0307 0D9A08 1044 CALL GETBLK ;GET DATA
030A 09 1045 RET ;RETURN
1046 ;
1047 ; MOV *****
1048 ;
1049 ; MOV MOVES THE CURRENT XY POSITION. THE XY POSITION
1050 ; MAY BE UPDATED BY ABSOLUTE OR RELATIVE OFFSETS,
1051 ; AND BY LONG OR SHORT OFFSETS. THE POINT MAY OR MAY
1052 ; NOT BE ILLUMINATED IN EITHER THE PRIMARY OR SECONDARY
1053 ; COLOR. MOV FIRST DETERMINES THE NEW XY LOCATION
1054 ; BY ADDING OFFSETS IF THEY ARE RELATIVE, ARE BY

```

Listing 1 continued:

```

1055 ; LOADING NEW POSITIONS. MOV NEXT CHECKS TO SEE IF
1056 ; THE POINT WILL BE ILLUMINATED. IF SO, THE PROPER
1057 ; COLOR IS INSERTED AT THAT PIXEL.
1058 ;
1059 ; CALLS          CASE
1060 ;                FETCH
1061 ;                PUT
1062 ;
1063 ; CALLED BY      PRIMAT (INDIRECTLY)
1064 ;
1065 ; REGISTERS      A      (PRIMITIVE OP CODE, TEMPORARY)
1066 ;                B      (CASE)
1067 ;                C      (TEMPORARY)
1068 ;                D      (TEMPORARY X)
1069 ;                E      (TEMPORARY Y)
1070 ;                IX     (INDEX)
1071 ;
1072 ; I/O            NONE
1073 ;
1074 ; STRUCTURES     GDR0   (X)
1075 ;                GDR1   (Y)
1076 ;                GDR2   (PRIMARY COLOR)
1077 ;                GDR3   (SECONDARY COLOR)
1078 ;                GDR5   (VECTOR MODE)
1079 ;                REF    (REFERENCE)
1080 ;
03FB  4F      1081  MOV:   LD    C,A          ;SAVE A COPY OF A
03FC  DD7E05  1082        LD    A,(IX+GDR5)    ;GET VECTOR MODE
03FF  DD7743  1083        LD    (IX+REF),A    ;SAVE REFERENCE
0402  CDA007  1084        CALL CASE          ;DETERMINE CASE
0405  DD5400  1085        LD    D,(IX+GDR0)  ;GET X
0408  DD5E01  1086        LD    E,(IX+GDR1)  ;GET Y
040B  CDDED01  1087        CALL FETCH        ;GET DATA
040E  CB59    1088        BIT   3,C          ;TEST IF LONG
0410  2036    1089        JR   NZ,MOV3        ;JUMP IF LONG
0412  CB51    1090        BIT   2,C          ;TEST IF ABSOLUTE
0414  2027    1091        JR   NZ,MOV2        ;JUMP IF ABSOLUTE
0416  F5     1092        PUSH AF          ;SAVE A COPY OF A
0417  CB3F    1093        SRL  A            ;SHIFT OVER
0419  CB3F    1094        SRL  A            ;   FOUR BITS
041B  CB3F    1095        SRL  A            ;   TO MASK ALL BUT
041D  CB3F    1096        SRL  A            ;   X OFFSET
041F  CB5F    1097        BIT   3,A          ;TEST SIGN OF OFFSET
0421  2804    1098        JR   Z,MOV0        ;JUMP IF POSITIVE
0423  CB9F    1099        RES  3,A          ;CLEAR SIGN
0425  ED44    1100        NEG          ;NEGATE THE VALUE
0427  82     1101  MOV0:  ADD  A,D          ;ADD THE OFFSET TO X
0428  57     1102        LD    D,A          ;SAVE THE NEW VALUE
0429  F1     1103        POP  AF          ;RESTORE A
042A  E60F    1104        AND  00001111B    ;MASK ALL BUT Y OFFSET
042C  CB5F    1105        BIT   3,A          ;TEST SIGN OF OFFSET
042E  2804    1106        JR   Z,MOV1        ;JUMP IF POSITIVE
0430  CB9F    1107        RES  3,A          ;CLEAR SIGN
0432  ED44    1108        NEG          ;NEGATE THE VALUE
0434  83     1109  MOV1:  ADD  A,E          ;ADD THE OFFSET TO Y
0435  5F     1110        LD    E,A          ;SAVE THE NEW VALUE
0436  1832    1111        JR   MOV2        ;JUMP TO PROCESS POINT
0438  F1     1112  MOV2:  PUSH AF          ;SAVE A COPY OF A
0439  CB3F    1113        SRL  A            ;SHIFT OVER
043B  CB3F    1114        SRL  A            ;   FOUR BITS
043D  CB3F    1115        SRL  A            ;   TO MASK ALL BUT
043F  CB3F    1116        SRL  A            ;   X OFFSET
0441  57     1117        LD    D,A          ;SAVE THE NEW VALUE
0442  F1     1118        POP  AF          ;RESTORE A

```

Listing 1 continued on page 330

Listing 1 continued:

```

0443 E60F      1119      AND  0000111B      ;MASK ALL BUT Y OFFSET
0445 5F        1120      LD   E,A           ;SAVE THE NEW VALUE
0446 1822      1121      JR   MOV7          ;JUMP TO PROCESS POINT
0448 CB51      1122      MOV3: BIT  2,C      ;TEST FOR ABSOLUTE
044A 2019      1123      JR   NZ,MOV6       ;JUMP IF ABSOLUTE
044C CB7F      1124      BIT  7,A           ;TEST SIGN OF OFFSET
044E 2804      1125      JR   Z,MOV4        ;JUMP IF POSITIVE
0450 CBBF      1126      RES  7,A           ;CLEAR SIGN
0452 ED44      1127      NEG                ;NEGATE THE VALUE
0454 82        1128      MOV4: ADD  A,D      ;ADD THE OFFSET
0456 57        1129      LD   D,A           ;SAVE THE NEW VALUE
0458 CDED01     1130      CALL FETCH        ;GET THE NEXT DATA
0459 CB7F      1131      BIT  7,A           ;TEST SIGN OF OFFSET
045B 2804      1132      JR   Z,MOV5        ;JUMP IF POSITIVE
045D CB5F      1133      RES  7,A           ;CLEAR SIGN
045F ED44      1134      NEG                ;NEGATE THE VALUE
0461 83        1135      MOV5: ADD  A,E      ;ADD THE OFFSET
0463 5F        1136      LD   E,A           ;SAVE THE NEW VALUE
0465 1805      1137      JR   MOV7          ;JUMP TO PROCESS POINT
0467 57        1138      MOV6: LD   D,A      ;SAVE THE NEW VALUE
0469 CDED01     1139      CALL FETCH        ;GET THE NEXT DATA
046B 5F        1140      LD   E,A           ;SAVE THE NEW VALUE
046D DD7200     1141      MOV7: LD   (IX+GDR0),D ;UPDATE X
046F DD7301     1142      LD   (IX+GDR1),E  ;UPDATE Y
0471 CB41      1143      BIT  0,C           ;TEST ILLUMINATE
0473 5001      1144      JR   NZ,MOV8       ;JUMP IF ILLUMINATE
0475 09        1145      RET                ;RETURN
0477 DD7E02     1146      MOV8: LD   A,(IX+GDR2) ;LOAD PRIMARY COLOR
0479 CB49      1147      BIT  1,C           ;TEST COLOR TYPE
047B 2803      1148      JR   Z,MOV9        ;JUMP IF PRIMARY
047D DD7E03     1149      LD   A,(IX+GDR3)  ;LOAD SECONDARY COLOR
047F DE01      1150      MOV9: LD   C,1     ;ASSUME SUCCESS
0481 CD7E0A     1151      CALL PUT          ;PUT THE POINT
0483 07        1152      RET                ;RETURN
1153 ;
1154 ; RCRAM *****
1155 ;
1156 ; RCRAM DUMPS THE COLOR RAMS. RCRAM FIRST DETERMINES
1157 ; IF A SINGLE OR ALL COLOR RAMS ARE TO BE DUMPED. IF
1158 ; A SINGLE COLOR RAM IS TO BE DUMPED, THE ENTIRE RAM
1159 ; OR A SINGLE ADDRESS OF THAT RAM IS DUMPED. OTHERWISE,
1160 ; ALL THREE COLOR RAMS ARE EITHER ENTIRELY DUMPED OR
1161 ; A SINGLE ADDRESS OF ALL THREE ARE DUMPED.
1162 ;
1163 ; CALLS          FETCH
1164 ;                SENDBK
1165 ;                SENDBY
1166 ;
1167 ; CALLED BY     PRIMAT (INDIRECTLY)
1168 ;
1169 ; REGISTERS     A      (PRIMITIVE OF CODE)
1170 ;                B      (COUNTER)
1171 ;                D      (TEMPORARY)
1172 ;                E      (TEMPORARY)
1173 ;                H      (POINTER)
1174 ;                L      (POINTER)
1175 ;                1Y     (INDEX)
1176 ;
1177 ; I/O          NONE
1178 ;
1179 ; STRUCTURES   CR0     (COLOR RAM 0)
1180 ;                CR1     (COLOR RAM 1)
1181 ;                CR2     (COLOR RAM 2)
1182 ;
0485 CB47      1183      RCRAM: BIT  0,A      ;TEST SINGLE BIT

```

Listing 1 continued:

```

0487 2820 1184 JR Z,RCRAM2 ;JUMP IF SINGLE
0489 FE7D 1185 CP 01111101B ;TEST REFERENCE
048B 2009 1186 JR NZ,RCRAM0 ;JUMP IF NOT ALL
048D 0630 1187 LD B,48 ;SET COUNT OF 48
048F 21001C 1188 LD HL,CRO ;SET BASE ADDRESS
0492 CD880A 1189 CALL SENDBK ;SEND THE DATA
0495 C9 1190 RET ;RETURN
0496 0610 1191 RCRAM0: LD B,16 ;SET COUNT OF 16
0498 E60C 1192 RCRAM1: AND 00001100B ;MASK OF CODE
049A CB27 1193 SLA A ;SHIFT OFFSET
049C CB27 1194 SLA A ;SHIFT OFFSET
049E 6F 1195 LD L,A ;SAVE OFFSET
049F 2600 1196 LD H,0 ;CLEAR POINTER
04A1 11001C 1197 LD DE,CRO ;SET BASE ADDRESS
04A3 19 1198 ADD HL,DE ;ADD BASE TO OFFSET
04A5 CD880A 1199 CALL SENDBK ;SEND THE DATA
04A8 C9 1200 RET ;RETURN
04A9 FL7C 1201 RCRAM2: CP 01111100B ;TEST REFERENCE
04AB 2027 1202 JR NZ,RCRAM3 ;JUMP IF NOT ALL
04AD CDED01 1203 CALL FETCH ;GET OFFSET
04B0 E60F 1204 AND 00001111B ;MASK THE OFFSET
04B2 6F 1205 LD L,A ;SAVE OFFSET
04B3 2600 1206 LD H,0 ;CLEAR POINTER
04B5 11001C 1207 LD DE,CRO ;SET BASE ADDRESS
04B8 19 1208 ADD HL,DE ;ADD BASE TO OFFSET
04B9 5D 1209 LD E,L ;SAVE THE POINTER
04BA 54 1210 LD D,H ;SAVE THE POINTER
04BB FD210000 1211 LD IY,0 ;CLEAR THE POINTER
04BF FD19 1212 ADD IY,DE ;SAVE INDEX
04C1 FD7E00 1213 LD A,(IY+0) ;GET DATA
04C4 CD910A 1214 CALL SENDBY ;SEND THE DATA
04C7 FD7E10 1215 LD A,(IY+16) ;GET DATA
04CA CD910A 1216 CALL SENDBY ;SEND THE DATA
04CD FD7E20 1217 LD A,(IY+32) ;GET DATA
04D0 CD910A 1218 CALL SENDBY ;SEND THE DATA
04D3 C9 1219 RET ;RETURN
04D4 0601 1220 RCRAM3: LD B,1 ;SET THE COUNT
04D6 E60C 1221 AND 00001100B ;MASK OF CODE
04D8 CB27 1222 SLA A ;SHIFT OFFSET
04DA CB27 1223 SLA A ;SHIFT OFFSET
04DC 6F 1224 LD L,A ;SAVE OFFSET
04DD 2600 1225 LD H,0 ;CLEAR POINTER
04DF CDED01 1226 CALL FETCH ;GET OFFSET
04E2 E60F 1227 AND 00001111B ;MASK THE OFFSET
04E4 85 1228 ADD A,L ;ADD OFFSET
04E5 6F 1229 LD L,A ;SAVE OFFSET
04E6 11001C 1230 LD DE,CRO ;SET BASE ADDRESS
04E9 19 1231 ADD HL,DE ;ADD BASE TO OFFSET
04EA CD880A 1232 CALL SENDBK ;SEND THE DATA
04ED C9 1233 RET ;RETURN
1234 ;
1235 ; RETN *****
1236 ;
1237 ; RETN RETURNS FROM A GRAPHICS SUBROUTINE. RETN FIRST
1238 ; CHECKS SPTR TO SEE IF A SUBROUTINE IS IN PROGRESS.
1239 ; IF NOT, RETN SIMPLY RETURNS. IF SO, RETN POPS
1240 ; SOFF AND SPTR FROM GSTACK AND RETURNS.
1241 ;
1242 ; CALLS NONE
1243 ;
1244 ; CALLED BY PRIMAT (INDIRECTLY)
1245 ;
1246 ; REGISTERS A (PRIMITIVE OF CODE)
1247 ; D (TEMPORARY)

```

Listing 1 continued on page 332

Listing 1 continued:

```

1248 ; E (TEMPORARY)
1249 ; H (POINTER)
1250 ; L (POINTER)
1251 ; IX (INDEX)
1252 ;
1253 ; I/O NONE
1254 ;
1255 ; STRUCTURES GPC (GRAPHICS STACK POINTER)
1256 ; GSTACK (GRAPHICS STACK)
1257 ; SOFF (SUBROUTINE OFFSET)
1258 ; SPTR (SUBROUTINE POINTER)
1259 ;
04EE DDCB405E 1260 RETN: BIT 3,(IX+SPTR) ;TEST SPTR
04F2 C8 1261 RET Z ;RETURN IF ZERO
04F3 DD3542 1262 DEC (IX+GPC) ;UPDATE THE STACK
04F6 DD5E42 1263 LD E,(IX+GPC) ;LOAD GPC
04F9 1600 1264 LD D,0 ;CLEAR POINTER
04FB 217F10 1265 LD HL,GSTACK ;SET INDEX TO GSTACK
04FE B7 1266 OR A ;CLEAR THE CARRY
04FF ED52 1267 SBC HL,DE ;SUBTRACT OFFSET
0501 7E 1268 LD A,(HL) ;POP SOFF
0502 DD7741 1269 LD (IX+SOFF),A ;RETURN SOFF
0505 23 1270 INC HL ;UPDATE THE POINTER
0506 7E 1271 LD A,(HL) ;POP SPTR
0507 DD7740 1272 LD (IX+SPTR),A ;RETURN SPTR
050A DD3542 1273 DEC (IX+GPC) ;DECREMENT OFFSET
050D C9 1274 RET ;RETURN
1275 ;
1276 ; RPIX *****
1277 ;
1278 ; RPIX READS PIXEL DATA ACCORDING TO THE GIVEN
1279 ; REFERENCE. RPIX CAN DUMP EITHER FULL FRAME, ONE
1280 ; PIXEL AT XY, OR AN ENTIRE VIEWPORT. RPIX FIRST CHECKS
1281 ; TO SEE IF ONLY A SINGLE POINT IS TO BE DUMPED. IF SO,
1282 ; RPIX DUMPS THE POINT AT XY. OTHERWISE, RPIX SETS A
1283 ; FLAG IF FULL FRAME IS SET. X AND Y ARE CLEARED, AND
1284 ; RPIX PROCEEDS FROM THE ORIGIN TO THE MAXIMUM X AND Y
1285 ; VALUES, LEFT TO RIGHT, BOTTOM TO TOP. IF FULL FRAME
1286 ; IS SET, ALL PIXELS ARE DUMPED. OTHERWISE, THE
1287 ; CASE AND CLIPPING SUCCESS ARE CHECKED. IF THE PIXEL
1288 ; IS VISIBLE, THE PIXEL IS DUMPED. RPIX COMPLETES
1289 ; WHEN X AND Y HAVE RECYCLED TO THE ORIGIN.
1290 ;
1291 ; CALLS SENDBY
1292 ; CASE
1293 ; CLIP
1294 ; PEEK
1295 ;
1296 ; CALLED BY PRIMA1 (INDIRECTLY)
1297 ;
1298 ; REGISTERS A (PRIMITIVE OF CODE)
1299 ; B (CASE)
1300 ; C (CLIP SUCCESS)
1301 ; D (FULL FRAME FLAG)
1302 ; IX (INDEX)
1303 ;
1304 ; I/O NONE
1305 ;
1306 ; STRUCTURES GDR0 (X)
1307 ; GDR1 (Y)
1308 ; REF (REFERENCE)
1309 ;
050E 1600 1310 RPIX: LD D,0 ;CLEAR FULL FRAME FLAG
0510 E60F 1311 AND 00001111B ;MASK OF CODE
0512 DD7743 1312 LD (IX+REF),A ;SAVE REFERENCE

```

Listing 1 continued:

```

0515 DDCB433E 1313 SRL (IX+REF) ;SHIFT REFERENCE
0519 DDCB433E 1314 SKL (IX+REF) ;SHIFT REFERENCE
051D CB5F 1315 BIT 3,A ;TEST REFERENCE
051F 280F 1316 JR Z,RPIX1 ;JUMP IF VP REFERENCE
0521 CB57 1317 BIT 2,A ;TEST REFERENCE
0523 2807 1318 JR Z,RPIX0 ;JUMP IF FULL FRAME
0525 CDA408 1319 CALL PEEK ;GET DATA
0528 CD910A 1320 CALL SENDBY ;SEND THE DATA
052B C9 1321 RET ;RETURN
052C 1601 1322 RPIX0: LD D,1 ;SET FULL FRAME FLAG
052E 1803 1323 JR RPIX2 ;JUMP
0530 CDA007 1324 RPIX1: CALL CASE ;DETERMINE CASE
0533 DD360000 1325 RPIX2: LD (IX+GDR0),0 ;CLEAR X
0537 DD360100 1326 LD (IX+GDR1),0 ;CLEAR Y
053B CB42 1327 RPIX3: BIT 0,D ;TEST D
053D 2007 1328 JR NZ,RPIX4 ;JUMP IF FULL FRAME
053F CDEF07 1329 CALL CLIP ;TEST FOR CLIP
0542 CB41 1330 BIT 0,C ;TEST SUCCESS
0544 2806 1331 JR Z,RPIX5 ;JUMP IF CLIPPED
0546 CDA408 1332 RPIX4: CALL PEEK ;READ THE DATA
0549 CD910A 1333 CALL SENDBY ;SEND THE DATA
054C DD3400 1334 RPIX5: INC (IX+GDR0) ;INCREMENT X
054F 20EA 1335 JR NZ,RPIX3 ;JUMP IF NOT ZERO
0551 DD3401 1336 INC (IX+GDR1) ;INCREMENT Y
0554 20E5 1337 JR NZ,RPIX3 ;JUMP IF NOT ZERO
0556 C9 1338 RET ;RETURN
1339 ;
1340 ; RREG *****
1341 ;
1342 ; RREG RETURNS THE VALUE OF THE DESIGNATED GRAPHICS
1343 ; DISPLAY REGISTER. RREG FIRST DETERMINES THE REGISTER
1344 ; NUMBER, THEN RETURNS THE VALUE VIA SENDBY.
1345 ;
1346 ; CALLS SENDBY
1347 ;
1348 ; CALLED BY PRIMAT (INDIRECTLY)
1349 ;
1350 ; REGISTERS A (PRIMITIVE OF CODE)
1351 ; D (TEMPORARY)
1352 ; E (TEMPORARY)
1353 ; H (POINTER)
1354 ; L (POINTER)
1355 ;
1356 ; 1/0 NONE
1357 ;
1358 ; STRUCTURES GDR (GRAPHICS DISPLAY REGISTERS)
1359 ;
0557 E20F 1360 RREG: AND 00001111B ;MASK OFF OF CODE
0559 6F 1361 LD L,A ;LOAD OFFSET
055A 2600 1362 LD H,0 ;CLEAR POINTER
055C 119010 1363 LD DE,STRUCT+GDR ;SET BASE ADDRESS
055F 19 1364 ADD HL,DE ;ADD OFFSET
0560 7E 1365 LD A,(HL) ;GET THE REGISTER
0561 CD910A 1366 CALL SENDBY ;SEND THE DATA
0564 C9 1367 RET ;RETURN
1368 ;
1369 ; RSUB *****
1370 ;
1371 ; RSUB DUMPS A SUBROUTINE TO THE HOST. RSUB FIRST
1372 ; IDENTIFIES THE SUBROUTINE NUMBER AND DETERMINES THE
1373 ; START ADDRESS VIA SLINK. SLONG ENTRIES DETERMINE THE
1374 ; SUBROUTINE LENGTH. RSUB CALLS SENDBK TO DUMP THE
1375 ; DATA.
1376 ;
1377 ; CALLS SENDBK

```

Listing 1 continued on page 334

Listing 1 continued:

```

1378 ;
1379 ; CALLED BY      PRIMAT  (INDIRECTLY)
1380 ;
1381 ; REGISTERS      A        (PRIMITIVE OF CODE)
1382 ;                B        (COUNT)
1383 ;                D        (POINTER)
1384 ;                E        (POINTER)
1385 ;                H        (POINTER)
1386 ;                L        (POINTER)
1387 ;                IX       (INDEX)
1388 ;                IY       (INDEX)
1389 ;
1390 ; I/O            NONE
1391 ;
1392 ; STRUCTURES     SLINK    (SUBROUTINE LINKAGE)
1393 ;                SLONG    (SUBROUTINE LENGTH)
1394 ;
0565 E60F 1395 RSUB:  AND  00001111B      ;CLEAR OF CODE
0567 5F   1396      LD   E,A          ;SAVE OFFSET
0568 1600 1397      LD   D,D          ;CLEAR POINTER
056A CB23 1398      SLA  E            ;SHIFT THE OFFSET
056C FD21010 1399      LD  IY,STRUCT+SLINK  ;GET LINKAGE
0570 FD19 1400      ADD  IY,DE          ;ADD OFFSET
0572 FD6E00 1401      LD  L,(IY+0)        ;GET LOW BYTE OF START
0575 FD6601 1402      LD  H,(IY+1)        ;GET HIGH BYTE OF START
0578 FD21B010 1403      LD  IY,STRUCT+SLONG  ;GET LENGTH
057C CB3B 1404      SRL  E            ;SHIFT THE OFFSET
057E FD19 1405      ADD  IY,DE          ;ADD OFFSET
0580 FD4600 1406      LD  B,(IY+0)        ;GET LENGTH
0583 CD880A 1407      CALL SENDBK      ;SEND THE DATA
0586 C9   1408      RET           ;RETURN
1409 ;
1410 ; RSYM *****
1411 ;
1412 ; RSYM DUMPS A SINGLE OR THE ENTIRE SET OF SYMBOLS.
1413 ; RSYM FIRST DETERMINES IF A SINGLE SYMBOL IS TO BE
1414 ; DUMPED. IF SO, THE 8 BYTES DEFINING THE SYMBOL ARE
1415 ; FOUND AND DUMPED. OTHERWISE, THE ENTIRE SET OF
1416 ; SYMBOLS IS DUMPED.
1417 ;
1418 ; CALLS          FETCH
1419 ;                SENDBK
1420 ;
1421 ; CALLED BY      PRIMAT  (INDIRECTLY)
1422 ;
1423 ; REGISTERS      A        (PRIMITIVE OF CODE)
1424 ;                B        (COUNT)
1425 ;                C        (TEMPORARY)
1426 ;                H        (POINTER)
1427 ;                L        (POINTER)
1428 ;
1429 ; I/O            NONE
1430 ;
1431 ; STRUCTURES     SYMTAB  (SYMBOL TABLE)
1432 ;
0587 CB47 1433 RSYM:  BIT  0,A          ;TEST FOR ALL
0589 201E 1434      JR   NZ,RSYMO      ;JUMP IF ALL
058B CD1D01 1435      CALL  FETCH        ;GET ADDRESS
058E E67F 1436      AND  01111111B    ;MASK THE MSB
0590 6F   1437      LD  L,A          ;SAVE OFFSET
0591 2600 1438      LD  H,D          ;CLEAR POINTER
0593 010014 1439      LD  BC,SYMTAB     ;POINT TO START
0596 CB25 1440      SLA  L            ;SHIFT OFFSET
0598 CB14 1441      RL   H            ;   THREE
059A CB25 1442      SLA  L            ;   BITS TO

```

Listing 1 continued:

```

059C CB14 1443 RL H ; PROPERLY
059E CB25 1444 SLA L ; COMPUTE THE
05A0 CB14 1445 RL H ; OFFSET
05A2 09 1446 ADD HL,BC ;ADD BASE ADDRESS
05A3 0608 1447 LD B,B ;LOAD COUNT
05A5 CD880A 1448 CALL SENDBK ;SEND THE DATA
05A8 C9 1449 RET ;RETURN
05A9 210014 1450 RSYMO: LD HL,SYMTAB ;POINT TO START
05AC 0600 1451 LD B,0 ;SET COUNT OF 265
05AE CD880A 1452 CALL SENDBK ;SEND 256 BYTES
05B1 CD880A 1453 CALL SENDBK ;SEND 256 BYTES
05B4 CD880A 1454 CALL SENDBK ;SEND 256 BYTES
05B7 CD880A 1455 CALL SENDBK ;SEND 256 BYTES
05BA C9 1456 RET ;RETURN
1457 ;
1458 ; SYM *****
1459 ;
1460 ; SYM DISPLAYS A STRING OF SYMBOLS STARTING AT THE
1461 ; CURRENT XY POSITION. SYM FIRST DETERMINES THE
1462 ; NUMBER OF SYMBOLS, THEN READS IN THE SYMBOL CODE
1463 ; POINTING TO THE APPROPRIATE SYMTAB ENTRY. XY
1464 ; POINTS TO THE LOWER LEFT CORNER OF THE SYMBOL. SYMTAB
1465 ; ENTRIES ARE FETCHED FOR DISPLAY OF THE 8 X 8 MATRIX
1466 ; WHICH DEFINES THE SYMBOL.
1467 ;
1468 ; CALLS          FETCH
1469 ;                CASE
1470 ;                PUT
1471 ;
1472 ; CALLED BY      PRIMAT (INDIRECTLY)
1473 ;
1474 ; REGISTERS      A      (PRIMITIVE OF CODE, TEMPORARY)
1475 ;                B      (CASE)
1476 ;                C      (SUCCESS)
1477 ;                D      (ROW COUNT)
1478 ;                E      (COLUMN COUNT)
1479 ;                H      (CHARACTER COUNT)
1480 ;                L      (TEMPORARY)
1481 ;                IX     (INDEX)
1482 ;                IY     (INDEX)
1483 ;
1484 ; I/O            NONE
1485 ;
1486 ; STRUCTURES    GDR0    (X)
1487 ;                GDR1    (Y)
1488 ;                GDR2    (PRIMARY COLOR)
1489 ;                GDR3    (SECONDARY COLOR)
1490 ;                GDR5    (VECTOR MODE)
1491 ;                SYMTAB (SYMBOL TABLE)
1492 ;
05BB E60F 1493 SYM:  AND 00001111B ;MASK THE OF CODE
05BD 67 1494 LD H,A ;SAVE THE COUNT
05BE DD7E05 1495 LD A,(IX+GDR5) ;GET THE VECTOR MODE
05C1 DD7743 1496 LD (IX+REF),A ;SAVE THE REFERENCE
05C4 CDA007 1497 CALL CASE ;DETERMINE THE CASE
05C7 0E01 1498 LD C,1 ;ASSUME A SUCCESS
05C9 DD3501 1499 DEC (IX+GDR1) ;BACK UP ONE SPACE
05CC DD7E00 1500 LD A,(IX+GDR0) ;GET X
05CF D608 1501 SUB B ;MOVE BACK 8
05D1 DD7700 1502 LD (IX+GDR0),A ;SAVE X
05D4 DD3401 1503 SYMO: INC (IX+GDR1) ;MOVE UP ONE SPACE
05D7 DD7E00 1504 LD A,(IX+GDR0) ;GET X
05DA C608 1505 ADD A,B ;MOVE AHEAD 8
05DC DD7700 1506 LD (IX+GDR0),A ;SAVE X

```

Listing 1 continued on page 336

Listing 1 continued:

```

05DF 7C 1507 LD A,H ;GET CHARACTER COUNT
05E0 FE00 1508 CP 0 ;COMPARE WITH ZERO
05E2 08 1509 RET Z ;RETURN IF ZERO
05E3 25 1510 DEC H ;DECREMENT COUNT
05E4 DD7E01 1511 LD A,(IX+GDR1) ;GET Y
05E7 C607 1512 ADD A,7 ;ADD 7
05E9 DD7701 1513 LD (IX+GDR1),A ;RESTORE Y
05EA CD0D01 1514 CALL FETCH ;GET CHARACTER CODE
05EB E67F 1515 AND 01111111B ;MASK THE HIGH BIT
05F1 5F 1516 LD E,A ;SAVE CODE
05F2 1600 1517 LD D,0 ;CLEAR POINTER
05F4 CB23 1518 SLA E ;SHIFT BY
05F6 CB12 1519 RL D ; THREE
05F8 CB23 1520 SLA E ; BITS TO
05FA CB12 1521 RL D ; PROPERLY
05FC CB23 1522 SLA E ; COMPUTE AN
05FE CB12 1523 RL D ; OFFSET
0600 FD210014 1524 LD IX,SYMTAB ;LOAD THE BASE ADDRESS
0604 FD19 1525 ADD IX,DE ;ADD THE OFFSET
0606 1608 1526 LD D,8 ;LOAD THE ROW COUNT
0608 DD3400 1527 SYM1: INC (IX+GDR0) ;UPDATE X
060B 7A 1528 LD A,D ;GET THE COUNT
060C FE00 1529 CP 0 ;COMPARE WITH ZERO
060E 28C4 1530 JR Z,SYM0 ;JUMP IF ZERO
0610 DD3500 1531 DEC (IX+GDR0) ;RESTORE THE POSITION
0613 15 1532 DEC D ;OTHERWISE DECREMENT
0614 FD7E00 1533 LD A,(1Y+0) ;GET CHARACTER MASK
0617 FD23 1534 INC IX ;POINT TO NEXT MASK
0619 1E08 1535 LD E,8 ;SET COLUMN COUNT
061B 6F 1536 LD L,A ;SAVE THE MASK
061C 7B 1537 SYM2: LD A,E ;GET THE COLUMN COUNT
061D FE00 1538 CP 0 ;COMPARE WITH ZERO
061F 200D 1539 JR NZ,SYM3 ;JUMP IF NON ZERO
0621 DD7E00 1540 LD A,(IX+GDR0) ;GET X
0624 D608 1541 SUB 8 ;DECREMENT BY 8
0626 DD7700 1542 LD (IX+GDR0),A ;RESTORE X
0629 DD3501 1543 DEC (IX+GDR1) ;DECREMENT Y
062C 180A 1544 JR SYM1 ;JUMP TO SYM1
062E 7D 1545 SYM3: LD A,L ;RESTORE MASK
062F 1D 1546 DEC E ;DECREMENT COLUMN COUNT
0630 CB27 1547 SLA A ;SHIFT TO CARRY
0632 3806 1548 JR C,SYM4 ;JUMP IF CARRY
0634 6F 1549 LD L,A ;SAVE MASK
0635 DD7E03 1550 LD A,(IX+GDR3) ;LOAD SECONDARY COLOR
0638 1804 1551 JR SYM5 ;JUMP AROUND
063A 6F 1552 SYM4: LD L,A ;SAVE MASK
063B DD7E02 1553 LD A,(IX+GDR2) ;LOAD PRIMARY COLOR
063L CD7E0A 1554 SYM5: CALL PUT ;PUT THE POINT
0641 DD3400 1555 INC (IX+GDR0) ;INCREMENT X
0644 18D6 1556 JR SYM2 ;JUMP BACK
1557 ;
1558 ; VEC *****
1559 ;
1561 ; TO A SPECIFIED ENDPOINT. VEC FIRST DETERMINES THE
1562 ; REFERENCE OF THE VECTOR, THEN DETERMINES THE NEW
1563 ; ENDPOINTS. THE ENDPOINTS MAY BE COMPUTED ABSOLUTE,
1564 ; RELATIVE, SHORT, OR LONG. AFTER THE ENDPOINTS ARE
1565 ; SET, THE VECTOR COLOR IS DETERMINED. PLOTTING THEN
1566 ; BEGINS, USING A SCAN LINE CONVERSION ALGORITHM.
1567 ; PLOTTING STOPS WHEN THE ENDPOINTS ARE REACHED.
1568 ;
1569 ; CALLS FETCH
1570 ; CASE

```

Listing 1 continued:

```

1571 ;          PLOT
1572 ;
1573 ; CALLED BY   PRIMAT   (INDIRECTLY)
1574 ;
1575 ; REGISTERS   A       (PRIMITIVE OP CODE, TEMPORARY)
1576 ;           B       (CASE)
1577 ;           C       (COUNTER)
1578 ;           D       (ABSOLUTE DELTA X)
1579 ;           E       (ABSOLUTE DELTA Y)
1580 ;           H       (X INCREMENT)
1581 ;           L       (Y INCREMENT)
1582 ;           IX      (INDEX)
1583 ;
1584 ; I/O         NONE
1585 ;
1586 ; STRUCTURES GDR0    (X)
1587 ;           GDR1    (Y)
1588 ;           GDR2    (PRIMARY COLOR)
1589 ;           GDR3    (SECONDARY COLOR)
1590 ;           GDR5    (VECTOR MODE)
1591 ;           M       (VECTOR VARIABLE)
1592 ;           MN      (VECTOR VARIABLE)
1593 ;           SX      (VECTOR VARIABLE)
1594 ;           SY      (VECTOR VARIABLE)
1595 ;
0646 4F          1596 VEC:  LD   C,A          ;SAVE THE FLAGS
0647 DD7E05      1597      LD   A,(IX+GDR5)      ;GET THE VECTOR MODE
064A DD7743      1598      LD   (IX+REF),A      ;SAVE THE REFERENCE
064D DD5600      1599      LD   D,(IX+GDR0)      ;GET CURRENT X
0650 DD5E01      1600      LD   E,(IX+GDR1)      ;GET CURRENT Y
0653 DD0D01      1601      CALL  FETCH          ;GET DATA
0656 CB59        1602      BIT   3,A          ;TEST FOR LONG
0658 2036        1603      JR    NZ,VEC3          ;JUMP IF LONG
065A CB51        1604      BIT   2,C          ;TEST FOR ABSOLUTE
065C 2022        1605      JR    NZ,VEC2          ;JUMP IF ABSOLUTE
065E F5          1606      PUSH  AF          ;SAVE DATA
065F CB2F        1607      SRA  A          ;SHIFT OVER
0661 CB2F        1608      SRA  A          ;   FOUR PLACES
0663 CB2F        1609      SRA  A          ;   TO MASK ALL BUT
0665 CB2F        1610      ORA  A          ;   X OFFSET
0667 CB5F        1611      BIT   3,A          ;TEST SIGN
0669 2804        1612      JR    Z,VEC0          ;JUMP IF POSITIVE
066B CB9F        1613      RES  3,A          ;CLEAR SIGN
066D ED44        1614      NEG          ;NEGATE
066F 82          1615      VEC0: ADD  A,D          ;ADD THE OFFSET
0670 57          1616      LD   D,A          ;SAVE NEW X
0671 F1          1617      POP  AF          ;RESTORE A
0672 F60F        1618      AND  00001111B      ;MASK ALL BUT Y OFFSET
0674 CB5F        1619      BIT   3,A          ;TEST SIGN
0676 2804        1620      JR    Z,VEC1          ;JUMP IF POSITIVE
0678 CB9F        1621      RES  3,A          ;CLEAR SIGN BIT
067A ED44        1622      NEG          ;NEGATE
067C 83          1623      VEC1: ADD  A,E          ;ADD OFFSET
067D 5F          1624      LD   E,A          ;SAVE NEW VALUE
067E 1832        1625      JR    VEC7          ;JUMP
0680 F5          1626      VEC2: PUSH  AF          ;SAVE A
0681 CB3F        1627      SRL  A          ;SHIFT OVER
0683 CB3F        1628      SRL  A          ;   FOUR PLACES
0685 CB3F        1629      SRL  A          ;   TO MASK ALL BUT
0687 CB3F        1630      SRL  A          ;   X VALUE
0689 57          1631      LD   D,A          ;SET NEW VALUE
068A F1          1632      POP  AF          ;RESTORE A
068B E60F        1633      AND  00001111B      ;MASK ALL BUT Y VALUE
068D 5F          1634      LD   E,A          ;SET NEW VALUE
068E 1822        1635      JR    VEC7          ;JUMP

```

Listing 1 continued on page 338

Listing 1 continued:

0690	CB51	1636	VEC3:	BIT	Z,C	;TEST FOR ABSOLUTE
0692	2019	1637		JR	NZ,VEC6	;JUMP IF SO
0694	CB7F	1638		BIT	Z,A	;TEST SIGN
0696	2804	1639		JR	Z,VEC4	;JUMP IF POSITIVE
0698	CBBF	1640		RES	Z,A	;CLEAR SIGN
069A	ED44	1641		NEG		;NEGATE
069C	82	1642	VEC4:	ADD	A,D	;ADD OFFSET
069D	57	1643		LD	D,A	;SAVE NEW VALUE
069E	CDDED01	1644		CALL	FETCH	;GET NEW VALUE
06A1	CB7F	1645		BIT	Z,A	;TEST SIGN
06A3	2804	1646		JR	Z,VEC5	;JUMP IF POSITIVE
06A5	CBBF	1647		RES	Z,A	;CLEAR SIGN
06A7	ED44	1648		NEG		;NEGATE
06A9	83	1649	VEC5:	ADD	A,E	;ADD OFFSET
06AA	5F	1650		LD	E,A	;SAVE NEW VALUE
06AB	1805	1651		JR	VEC7	;JUMP
06AD	57	1652	VEC6:	LD	D,A	;SAVE NEW VALUE
06AE	CDDED01	1653		CALL	FETCH	;GET NEW VALUE
06B1	5F	1654		LD	E,A	;SAVE NEW VALUE
06B2	CB49	1655	VEC7:	BIT	I,C	;TEST COLOR
06B4	2005	1656		JR	NZ,VEC8	;JUMP IF SECONDARY
06B6	DD7E02	1657		LD	A,(IX+GDR2)	;LOAD PRIMARY COLOR
06B9	1803	1658		JR	VEC9	;JUMP AROUND
06BB	DD7E03	1659	VEC8:	LD	A,(IX+GDR3)	;LOAD SECONDARY COLOR
06BE	DD7749	1660	VEC9:	LD	(IX+COLOR),A	;SAVE THE COLOR
06C1	0E00	1661		LD	C,D	;CLEAR THE COUNTER
06C3	ES	1662		PUSH	HL	;SAVE H AND L
06C4	C5	1663		PUSH	BC	;SAVE B AND C
06C5	6A	1664		LD	L,D	;GET X ENDPOINT
06C6	2600	1665		LD	H,D	;CLEAR H
06C8	DD4E00	1666		LD	C,(IX+GDR0)	;GET X
06CB	0600	1667		LD	B,D	;CLEAR B
06CD	AF	1668		XOR	A	;CLEAR CARRY
06CE	ED42	1669		SBC	HL,BC	;SUBTRACT
06D0	FAD906	1670		JF	M,VEC10	;JUMP IF BORROW
06D3	DD364701	1671		LD	(IX+SX),1	;SET SIGN OF X 1
06D7	1808	1672		JR	VEC11	;JUMP AROUND
06D9	DD3647FF	1673	VEC10:	LD	(IX+SX),-1	;SET SIGN OF X -1
06DD	7D	1674		LD	A,L	;GET THE DIFFERENCE
06DE	ED44	1675		NEG		;GET ABSOLUTE VALUE
06E0	6F	1676		LD	L,A	;RESTORE THE DIFFERENCE
06E1	55	1677	VEC11:	LD	D,L	;SAVE DELTA X
06E2	4B	1678		LD	L,E	;GET Y
06E3	2600	1679		LD	H,D	;CLEAR H
06E5	DD4EQ1	1680		LD	C,(IX+GDR1)	;GET Y
06E8	0600	1681		LD	B,D	;CLEAR B
06EA	AF	1682		XOR	A	;CLEAR THE CARRY
06EB	ED42	1683		SBC	HL,BC	;SUBTRACT
06ED	FAF606	1684		JF	M,VEC12	;JUMP IF BORROW
06F0	DD364801	1685		LD	(IX+SY),1	;LOAD+1
06F4	1808	1686		JR	VEC13	;JUMP AROUND
06F6	DD3648FF	1687	VEC12:	LD	(IX+SY),-1	;LOAD -1
06FA	7D	1688		LD	A,L	;GET THE DIFFERENCE
06FB	ED44	1689		NEG		;NEGATE THE DELTA
06FD	6F	1690		LD	L,A	;RESTORE THE DIFFERENCE
06FE	5D	1691	VEC13:	LD	E,L	;SAVE DELTA Y
06FF	6B	1692		LD	L,E	;RESTORE DELTA Y
0700	2600	1693		LD	H,D	;CLEAR H
0702	4A	1694		LD	C,D	;GET DELTA X
0703	0600	1695		LD	B,D	;CLEAR B
0705	AF	1696		XOR	A	;CLEAR CARRY
0706	ED42	1697		SBC	HL,BC	;SUBTRACT
0708	FA1307	1698		JF	M,VEC14	;JUMP IF BORROW
070B	DD7345	1699		LD	(IX+MM),E	;LOAD Y
070E	DD7246	1700		LD	(IX+MN),D	;LOAD X

Listing 1 continued:

```

0711 1806 1701 JR VEC15 ;JUMP AROUND
0713 0D7245 1702 VEC14: LD (IX+MM),D ;LOAD X
0716 0D7346 1703 LD (IX+MN),E ;LOAD Y
0719 0D7E45 1704 VEC15: LD A,(IX+MM) ;GET MM
071C 0B3F 1705 SRL A ;DIVIDE BY 2
071E 0D7244 1706 LD (IX+M),A ;SAVE I1
0721 03 1707 POP BC ;RESTORE B AND C
0722 E1 1708 POP HL ;RESTORE H AND L
0723 0DA007 1709 CALL CASE ;GET THE CURRENT CASE
0726 0D7E49 1710 VEC16: LD A,(IX+COLOR) ;GET THE COLOR
0729 05 1711 PUSH BC ;SAVE BC
072A 05 1712 PUSH DE ;SAVE DE
072B 05 1713 PUSH HL ;SAVE HL
072C 0D3F0A 1714 CALL PLOT ;PLOT THE POINT
072F E1 1715 POP HL ;RESTORE HL
0730 01 1716 POP DE ;RESTORE DE
0731 01 1717 POP BC ;RESTORE BC
0732 0D7E45 1718 LD A,(IX+MM) ;GET MM
0735 89 1719 CP C ;COMPARE MM
0736 2001 1720 JR NZ,VEC17 ;JUMP IF NOT SAME
0738 09 1721 RET ;RETURN
0739 E5 1722 VEC17: PUSH HL ;SAVE H AND L
073A 05 1723 PUSH BC ;SAVE B AND C
073B 0D6E44 1724 LD L,(IX+M) ;GET M
073E 2600 1725 LD H,0 ;CLEAR H
0740 0D4E46 1726 LD C,(IX+MN) ;GET MN
0743 0600 1727 LD B,0 ;CLEAR B
0745 09 1728 ADD HL,BC ;ADD M+MN
0746 0D4E45 1729 LD C,(IX+MM) ;GET MM
0749 0600 1730 LD B,0 ;CLEAR B
074B AF 1731 XOR A ;CLEAR CARRY
074C ED42 1732 SBC HL,BC ;SUBTRACT
074E 0A5E07 1733 JP M,VEC18 ;JUMP IF MINUS
0751 0D7544 1734 LD (IX+M),L ;SAVE M
0754 01 1735 POP BC ;RESTORE B AND C
0755 E1 1736 POP HL ;RESTORE H AND L
0756 0D6E48 1737 LD L,(IX+SY) ;GET INC Y
0759 0D6647 1738 LD H,(IX+SX) ;GET INC X
075C 1819 1739 JR VEC20 ;JUMP
075E 09 1740 VEC18: ADD HL,BC ;RESTORE M
075F 0D7544 1741 LD (IX+M),L ;SAVE M
0762 01 1742 POP BC ;RESTORE B AND C
0763 E1 1743 POP HL ;RESTORE H AND L
0764 2E00 1744 LD L,0 ;CLEAR L
0766 2600 1745 LD H,0 ;CLEAR POINTER
0768 0D7E45 1746 LD A,(IX+MM) ;GET MM
076B BA 1747 CP D ;COMPARE WITH DELTA X
076C 2003 1748 JK NZ,VEC19 ;JUMP IF NOT EQUAL
076E 0D6647 1749 LD H,(IX+SX) ;SAVE VALUE
0771 8B 1750 VEC19: CP E ;COMPARE WITH DELTA Y
0772 2003 1751 JR NZ,VEC20 ;JUMP IF NOT EQUAL
0774 0D6E48 1752 LD L,(IX+SY) ;LOAD SY
0777 0D7E00 1753 VEC20: LD A,(IX+GDR0) ;GET X
077A 84 1754 ADD A,H ;ADD INCREMENT
077B 0D7700 1755 LD (IX+GDR0),A ;RESTORE X
077E 0D7E01 1756 LD A,(IX+GDR1) ;GET Y
0781 85 1757 ADD A,L ;ADD INCREMENT
0782 0D7701 1758 LD (IX+GDR1),A ;RESTORE Y
0785 0C 1759 INC C ;INCREMENT COUNT
0786 189E 1760 JR VEC16 ;JUMP AROUND
1761 ;
1762 ; WAIT *****
1763 ;
1764 ; WAIT ALLOWS SYNCHRONIZATION WITH THE FRAME RATE BY
1765 ; WAITING FOR A SPECIFIED NUMBER OF FRAMES. WAIT FIRST

```

Listing 1 continued on page 340

Listing 1 continued:

```

1766 ; GETS THE COUNT FROM EITHER THE PRIMITIVE ITSELF OR,
1767 ; IF THE EXTEND BIT IS ON, FROM THE NEXT BYTE. GDR4
1768 ; (FRAME COUNT) IS SET TO -COUNT AND WAIT THEN LOOPS
1769 ; UNTIL THE FRAME COUNT GOES TO ZERO.
1770 ;
1771 ; CALLS          FETCH
1772 ;
1773 ; CALLED BY     PRIMAT  (INDIRECTLY)
1774 ;
1775 ; REGISTERS     A        (PRIMITIVE OF CODE, TEMPORARY)
1776 ;              IX        (INDEX)
1777 ;
1778 ; I/O          NONE
1779 ;
1780 ; STRUCTURES   GDR4    (FRAME COUNT)
1781 ;
0788 CB5F 1782 WAIT:  BIT 3,A          ;TEST EXTEND BIT
078A 2805 1783      JR  Z,WAIT0      ;JUMP IF NOT SET
078C CD8D01 1784      CALL  FETCH      ;GET COUNT
078F 1802 1785      JR  WAIT1      ;JUMP AROUND
0791 E607 1786 WAIT0: AND 00000111B    ;MASK ALL BUT COUNT
0793 ED44 1787 WAIT1: NEG          ;NEGATE COUNT
0795 DD7704 1788      LD  (IX+GDR4),A    ;SET FRAME COUNT
0798 DD7E04 1789 WAIT2: LD  A,(IX+GDR4)  ;GET COUNT
079B FE00 1790      CP  0          ;TEST FOR ZERO
079D 20F9 1791      JR  NZ,WAIT2    ;JUMP IF NON ZERO
079F C9 1792      RET          ;RETURN
1793 ;
1794 ;*****
1795 ;UTILITY SERVICE ROUTINES*****
1796 ;*****
1797 ;
1798 ; CASE *****
1799 ;
1800 ; CASE DETERMINES THE CASE OF A REFERENCED VIEWPORT.
1801 ; IF A VIEWPORT IS NOT REFERENCED, CASE EXITS. OTHER-
1802 ; WISE, CASE IS SET IN REGISTER B.
1803 ;
1804 ; CALLS          NONE
1805 ;
1806 ; CALLED BY
1807 ;              LPIX
1808 ;              MOV
1809 ;              SYM
1810 ;              VEC
1811 ;              RPIX
1812 ;
1813 ; REGISTERS     A        (TEMPORARY)
1814 ;              B        (CASE)
1815 ;              D        (TEMPORARY)
1816 ;              E        (TEMPORARY)
1817 ;              H        (TEMPORARY)
1818 ;              L        (TEMPORARY)
1819 ;              IY       (INDEX)
1820 ;
1821 ; I/O          NONE
1822 ;
1823 ; STRUCTURES   GDR6-13 (VIEWPORTS)
1824 ;              REF     (REFERENCE)
1825 ;
07A0 F5 1826 CASE:  PUSH AF          ;SAVE AF
07A1 FDE5 1827      PUSH IY         ;SAVE IY
07A3 E5 1828      PUSH HL         ;SAVE H AND L
07A4 D5 1829      PUSH DE         ;SAVE D AND F
07A5 0600 1830      LD  B,0          ;ASSUME CASE 0

```

Listing 1 continued:

07A7	DDCB434E	1831		BTT	1,(IX+REF)		;TEST REFERENCE
07AB	2806	1832		JR	Z,CASE0		;JUMP IF NOT SET
07AD	D1	1833		POP	DE		;RESTORE D AND E
07AE	E1	1834		POP	HL		;RESTORE H AND L
07AF	FDE1	1835		POP	IY		;RESTORE STACK
07B1	F1	1836		POP	AF		;RESTORE STACK
07B2	C9	1837		RET			;RETURN
07B3	FD218610	1838	CASE0:	LD	IY,STRUCT+GDR6		;LOAD REFERENCE START
07B7	DDCB434E	1839		BTT	0,(IX+REF)		;TEST REFERENCE
07BB	2806	1840		JR	Z,CASE1		;JUMP IF NOT SET
07B0	FD218A10	1841		LD	IY,STRUCT+GDR10		;LOAD REFERENCE START
07C1	FD6E02	1842	CASE1:	LD	L,(IY+2)		;LOAD RIGHT X
07C4	2600	1843		LD	H,0		;CLEAR H
07C6	CB08	1844		SET	1,B		;SET BIT 1
07C8	FD5E00	1845		LD	E,(IY+0)		;GET LEFT X
07CB	1600	1846		LD	D,0		;CLEAR D
07CD	AF	1847		XOR	A		;CLEAR CARRY
07CE	ED52	1848		SBC	HL,DE		;SUBTRACT
07D0	FAD507	1849		JP	M,CASE2		;JUMP IF MINUS
07D3	CB88	1850		RES	1,B		;RES BIT 1
07D5	FD6E03	1851	CASE2:	LD	L,(IY+3)		;GET RIGHT Y
07D8	2600	1852		LD	H,0		;CLEAR H
07DA	CB00	1853		SET	0,B		;SET BIT 0
07DC	FD5E01	1854		LD	E,(IY+1)		;GET LEFT Y
07DF	1600	1855		LD	D,0		;CLEAR D
07E1	AF	1856		XOR	A		;CLEAR CARRY
07E2	ED52	1857		SBC	HL,DE		;SUBTRACT
07E4	FAE907	1858		JP	M,CASE3		;JUMP IF MINUS
07E7	CB80	1859		RES	0,B		;RES BIT 0
07E9	D1	1860	CASE3:	POP	DE		;RESTORE D AND E

Listing 1 to be continued next month in Part 3

If you're serious about the stock market, you need

Tickertec™



Watch 48 to 400 of your favorite stocks
without a 15 minute delay.

Tickertec™ is a computer program that displays the NYSE or AMEX tickertape on your TRS-80™ Model I or both exchanges as an option on the Model II. You see every trade as it is reported by the exchange and track the last ten trades, tickertape reported volume, and high and low limits on the stocks you are watching. Tickertec prices start at \$1,000.00 with many optional features available including hard copy and portfolio management systems. Programs may be purchased for cash (i.e., hard dollars) or payment can be arranged in the form of discounted brokerage commissions (i.e., Soft Dollar Software™). Exchange fees are extra. Call for FREE brochure TOLL-FREE at (800) 223-6642; in New York call (212) 687-0705; or mail the coupon today.

Max Ule & Company Inc.

6 East 43rd Street, N.Y., N.Y. 10017

BY2

Name _____
Address _____
City _____ State _____ Zip _____
Bus. Phone _____
Pers. Computer? Y N Model _____
©1980, Max Ule & Company Inc

Circle 270 on Inquiry card.

TWICE THE BYTE!



**8" DISK CONTROLLER
NOW—DOUBLE SIDED OPTION!**

- DOUBLES APPLE II STORAGE
- APPLE DOS COMPATIBLE
- SHUGART 800 OR 850 COMPATIBLE
- IBM 3740 DATA ENTRY CAPABILITY
- CP/M, UCSD PASCAL CAPABILITY

Available at your local APPLE Dealer: \$400.



SORRENTO VALLEY ASSOCIATES
11722 SORRENTO VALLEY RD.
SAN DIEGO, CA 92121

Circle 271 on Inquiry card.

December 1980 © BYTE Publications Inc 341



META TECHNOLOGIES

FOR YOUR DISK SYSTEM



FILE BOX

DISKETTE STORAGE SYSTEM

\$24⁹⁵ for 5 1/4" disks
for 8" disks . . . \$29.95

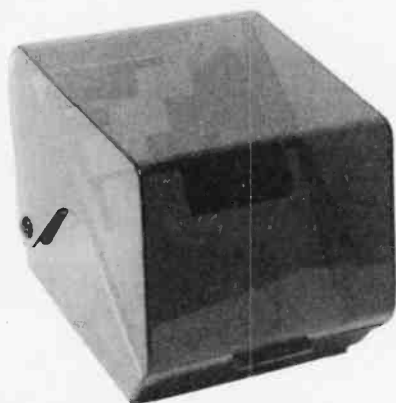

MTC brings you the ULTIMATE diskette storage system, at an affordable price. Storing 50 to 60 diskettes, this durable, smoke-colored acrylic unit provides easy access through the use of index dividers and adjustable tabs. Unique lid design provides dust-free protection and doubles as a carrying handle.

PLASTIC LIBRARY CASES

(not shown)

An economical form of storage for 10 to 15 diskettes, and is suitable for your bookshelf! Case opens into a vertical holder for easy access.

5 1/4-inch diskette case \$3.25
8-inch diskette case \$3.50

Single Sided, Single Density, Soft-Sector'd
5 1/4-inch, (for TRS-80™) Mini-floppy

DISKETTES

\$19⁸⁰★
box of 10

Meta Technologies strikes again . . . at the competition! These are factory fresh, absolutely first quality (no seconds!) mini-floppies. They are complete with envelopes, labels and write-protect tabs in a shrink-wrapped box.

INTRODUCING

PLAIN JANE™

DISKETTES

The Beautiful Floppy
with the Magnetic Personality™

In 1980 alone, MTC has sold nearly a third of a million dollars worth of brand-name diskettes. If anyone knows quality, we do. And these are quality diskettes. The catch? They are in a plain white box. You're not paying for fancy printing, fancy labels or fancy names on the packaging. We don't even put our own label on the package (labels cost money). At this introductory price (our regular price will be \$21.95 per box of 10) we cannot offer quantity or dealer discounts.

PLAIN JANE™ Diskettes \$19.80★

VERBATIM brand Diskettes (box of 10)

5 1/4-inch (for TRS-80™)
MD525-01 \$23.95
10 boxes of 10 . . . (each box) . . \$22.95

8-inch FLOPPIES
Single-Density, FD34-1000 . . . \$29.95
Double-Density, FD34-8000 . . \$39.95

CALL FOR INFORMATION ON
OTHER TRS-80™ PRODUCTS

TRS-80™ PRODUCTS



NEWDOS/80 by Apparat \$149.95
NEWDOS+ with ALL UTILITIES
35-track \$69.95
40-track \$79.95
TRS-80™ DISK AND OTHER MYSTERIES
. \$19.95
MICROSOFT™ BASIC DECODED & OTHER
MYSTERIES for the TRS-80™ \$29.95

META TECHNOLOGIES REDEFINES

"Customer Satisfaction"
IN 1981

met-a-mor-pho-sis (met'a mōr' fa sis), n., pl. -ses(-sēz'). 1. a transformation. 2. a change or successive changes in character or appearance. 3. MTC's transition in 1981 to a bigger and better way of doing business, featuring new and improved products and services.

All products guaranteed for replacement only. Prices, Specifications & Offerings subject to change without notice.

**MOST ORDERS
SHIPPED
WITHIN ONE
BUSINESS DAY**

★PRICE GOOD THRU
DECEMBER 31, 1980.
Sorry, no dealer or quantity discounts. Allow for possible shipping delays.

WE ACCEPT
• VISA
• MASTER CHARGE
• CHECKS
• MONEY ORDERS
• C.O.D.

• Add \$2.50 for standard UPS shipping & handling
• \$2.00 EXTRA for C.O.D.
• Ohio residents add 5 1/2% sales tax

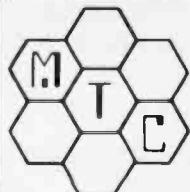

TO PLACE ORDER
1-800-321-3552

CALL
TOLL
FREE

FOR PRODUCT INFO
1-800-321-3640

IN OHIO (216)289-7500 (COLLECT)

META TECHNOLOGIES CORPORATION

26111 Brush Avenue, Euclid, Ohio 44132



801010
TRS-80 is a TM of Tandy Corp.
PLAIN JANE is a TM of MTC.
© 1980 by Metatechnologies Corporation, Inc.

What's New?

SOFTWARE

Commercial Mailer Has 30,000 Name Capacity

Commercial Mailer, from Stonehenge Computer Company, 89 Summit Ave, Summit NJ 07901, (201) 277-1020, has a capacity of up to 30,000 six-line records, with an unlimited number of lists. This program offers features including creating, adding, changing, deleting, sorting, utility/field code, and more. Required hardware includes the Apple II with 48 K bytes of memory, the Corvus 11AP Hard Disk, and an 80- or 132-column printer. Optional hardware are the Corvus Constellation and Corvus Mirror. The format is a menu type, and the system can be adapted to the user's format. The price is \$250, plus \$3 for shipping.

Circle 404 on Inquiry card.

Chemistry Programs for High School and College

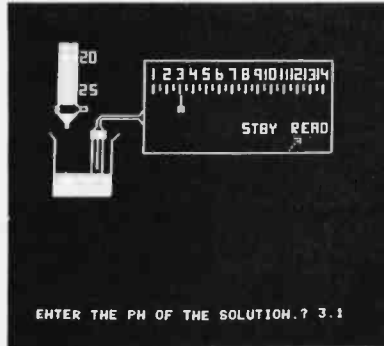

Chemistry Lab Simulation 1 and 2 are for use on the Apple II computer. The programs may be used either as an aid in lecture presentations or for individual

study. Chemistry Lab 1 uses graphics to simulate introductory-level chemistry experiments, including acid-base titration; a monomolecular film experiment used for the determination of Avogadro's number; and finding an unknown weak acid by determining its equilibrium constant. The program provides randomly generated initial values, giving unlimited test results without repetition. Chemistry Lab 2 illustrates the behavior of gas particles as the user varies the gas environment. Students are guided through the Ideal Gas Law, the Kinetic-Molecular Theory, and the principles of entropy. The program features low-resolution graphics and is written in machine language. For details, contact High Technology Inc, Software Department, POB 14665, Oklahoma City OK 73113, (405) 840-9900.

Circle 409 on Inquiry card.

Traffic Program for Radio Stations

The Electric Log is designed for the TRS-80 Model II personal computer. The program stores up to 500 time-spot schedules and automatically generates daily program logs with date checking, product code separation, account separation, and, optionally, random tray location for automation. The Electric Bill ties into the Electric Log to provide a standard accounts receivable and statement printer. For additional information, contact, The Management, POB 111, Aledo TX, (817) 441-8045.

Circle 405 on Inquiry card.

Lowercase Driver Plus

Lowercase Driver Plus is an advanced driver routine to work with the lowercase modification kit sold by E B G (Emmanuel B Garcia Jr) & Associates. With this routine and the lowercase modification in the TRS-80, users will be able to display lowercase at all times. The keyboard then will work as a regular typewriter (ie: shifted characters will be uppercase, and unshifted characters will be lowercase). Provision has also been made for a CAPS LOCK function. An automatic repeat action that can be obtained by holding any key down for a few seconds is included. Lowercase Driver Plus will also work with most other lowercase modifications. The price is \$9.95, from E B G & Associates, 203 N Wabash, Chicago IL 60601, (312) 782-9750.

Circle 406 on Inquiry card.

Computer War Games

The Avalon Hill Game Company, 4517 Harford Rd, Baltimore MD 21214, (301) 254-5300, presents *B-1 Nuclear Bomber*, *Midway Campaign*, *North Atlantic Convoy Raider*, *Nukewar*, and *Planet Miners*. These games run on TRS-80 Model II, Apple II, and PET microcomputers. They cost \$15 each.

Circle 407 on inquiry card.

MED-PAC II

The MED-PAC II (Medical Patient Accounting System) is a medical accounting system that features billing, recording of charges, adjustments and payments, automatic printing of insurance forms, instantaneous recall of patient records and account status, increased collections and reduced aging, analysis of services performed by each producer in the practice, and the ability to run with the accounts payable, payroll, and general ledger programs from V R Data Corporation. The company also has a Med Pac System that includes a high-resolution monitor and ASCII (American Standard Code for Information Interchange) keyboard, a 64 K-byte memory board with a Z80 microprocessor, 1 megabyte of disk storage, a letter-quality printer, manuals, on-site training lessons, and medical software. The cost of the system is \$14,249. Contact Small Systems Group, 777 Henderson Blvd N-6, Folcroft Industrial Park, Folcroft PA 19032, (800) 345-8102.

Circle 408 on Inquiry card.

L216—Business Software Package

L216 is a business package for the TRS-80 Model II with 16 K bytes of memory and Level II BASIC. A cassette data-base manager, word processor, inventory-control system, stock-management program, check-balancing program, label printer, deposit calculator, statistics program, sort utility, and a key-access utility are included. The package is priced at \$59. For information, contact Micro Architect Inc, 96 Dothan St, Arlington MA 02174, (617) 643-4713.

Circle 410 on Inquiry card.

Where Do New Products Items Come From?

The information printed in the new products pages of BYTE is obtained from "new product" or "press release" copy sent by the promoters of new products. If in our judgment the information might be of interest to the personal computing experimenters and homebrewers who read BYTE, we print it in some form. We openly solicit releases and photos from manufacturers and suppliers to this marketplace. The information is printed more or less as a first-in first-out queue, subject to occasional priority modifications. While we would not knowingly print untrue or inaccurate data, or data from unreliable companies, our capacity to evaluate the products and companies appearing in the "What's New?" feature is necessarily limited. We therefore cannot be responsible for product quality or company performance.

What's New?

SOFTWARE

Word Processing for the Apple II

A word-processing program called the Datacope Scribe is available for the Apple II. On-screen editing is by character, word, sentence, and paragraph, plus block insert, block move, and block delete. General formats control the locations and justification of margins, tab locations, and the number of lines per page and their spacing. Special formats may be used to center, indent, and underline text. The program can print single or multiple copies without user intervention. Single-letter commands are included. Memory can hold approximately eleven pages of text. A BASIC program allows users to customize the machine-language program to match the user's printer, printer interface, and personal preferences. Minimum equipment requirements are an Apple II with 48 K bytes of memory, Applesoft in ROM (read-only memory), an Apple II Plus with 48 K bytes of memory, or an Apple Language System; Dan Paymar's Lower Case Adapter; a Disk II drive; and a printer and printer interface. The suggested retail price for the Datacope Scribe is \$79.95. Contact Datacope, PO Drawer AA, Hillcrest Sta, Little Rock AR 72205.

Circle 400 on inquiry card.

CP/NET Operating System from Digital Research

Digital Research Inc, originator of the CP/M and MP/M operating systems, has introduced CP/NET, a new operating system for microcomputer networks. The CP/NET software system supports network technology by allowing independent microcomputers access to common facilities, such as peripherals, programs, and data bases, via a network. CP/NET operates with CP/M and MP/M. Applications range from multiterminal word-processing and/or data-base systems that share disks and printers to industrial process-control systems that use single-board computers, without disk or console facilities, as slaves. CP/NET consists of one or more masters running MP/M and one or more slaves running CP/M or MP/M. CP/NET is network independent. Through simple modifications, a network may be constructed with any combination of shared memory, serial links or parallel I/O (input/output) with any protocol. For more information, contact Digital Research Inc, POB 579, Pacific Grove CA 93950, (408) 649-3896.

Circle 401 on inquiry card.

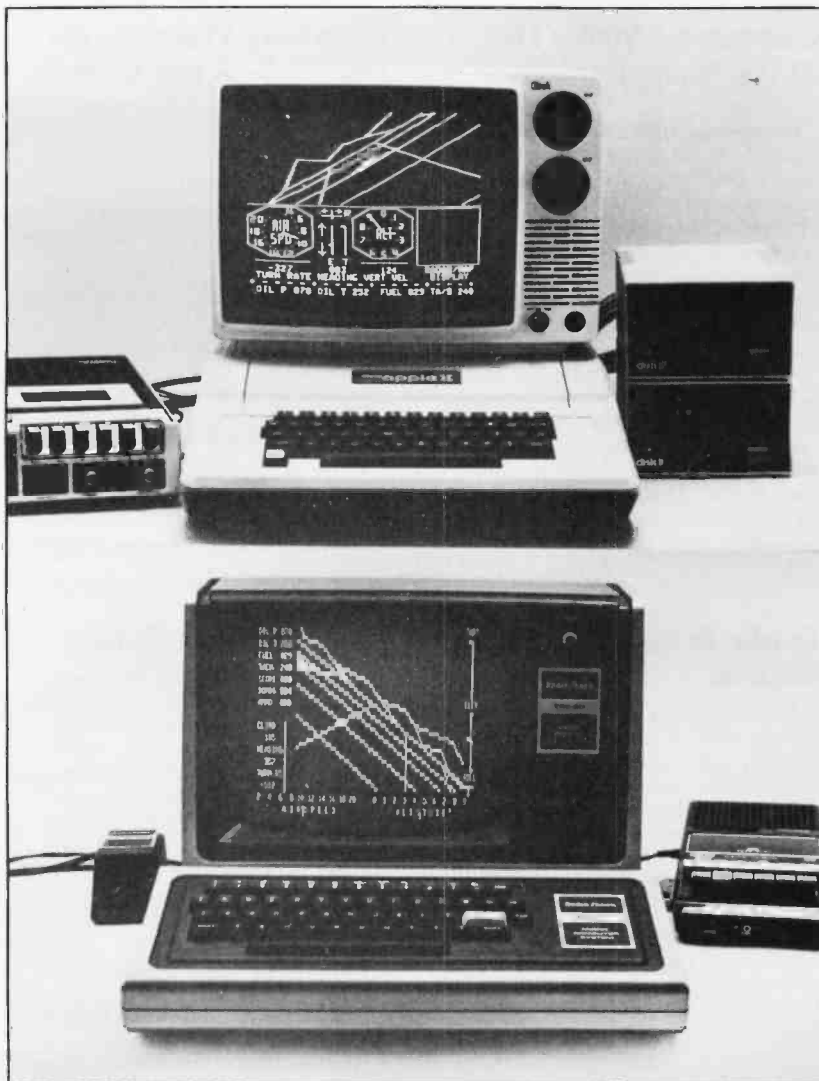

Flight Simulators for TRS-80 and Apple Systems

The A2-FS1 for the Apple II, and the T80-FS1 for the TRS-80, are visual flight simulators that offer a real-time three-

dimensional out-the-window view of flight. The view updates at an average of three times per second. The animation and flight characteristics allow the non-pilot to learn basic flight control. The FS1 instrument panel contains all the instruments required under part 91 of the Federal Aviation Regulations for visual flight. The FS1 includes a stall warning, turn indicator, radar screen, ammunition indicator, and control position indicators. Controls include throttle, brakes, bomb drop, machine guns, high/low world, and declare war. The T80 features a downward map selector. The A2 includes a keyboard/paddle selector. The FS1 requires 16 K bytes of memory. The programs cost \$25. The A2 is available on disk for \$33.50. Contact SubLOGIC, POB V, Savoy IL 61874, (217) 359-8482.

Circle 403 on inquiry card.

Graphics for the Apple

United Software of America has a three-dimensional high-resolution graphics package for the Apple II called Apple World, which is a text-editor-based color graphics package. The program comes with a manual and requires any Apple II or Apple II Plus with 48 K bytes of programmable memory and a floppy-disk drive. It is written in machine code. The price is \$59.95 from United Software of America, 750 Third Ave, New York NY 10017, (212) 682-0347.

Circle 402 on inquiry card.

What's New?

MISCELLANEOUS

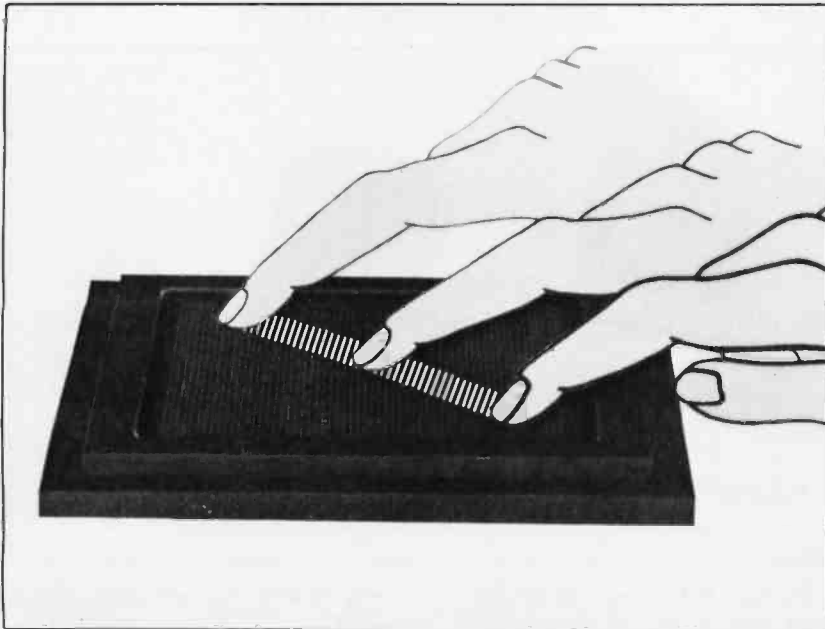

X,Y Positioning Device Operates by Fingertip Glide

TASA (Touch Activated Switch Arrays Inc) has introduced this alternative for trackballs and other two-dimensional controllers that provide coarse and fine position adjustment by changing fingertip speed. The X,Y controller produces X,Y positioning signals when a finger is moved across its surface. It can be interfaced with plotters, video displays and other devices. The unit uses 70% less space than trackballs, has no moving parts, and is environ-

mentally sealed. The 10.2 by 10.2 cm (4 by 4 inch) surface can be traversed at up to 60 inches per second without loss of resolution. Rapid finger movement can give coarse control; slow movement offers fine control. The Model 4460 X,Y Positioner is priced under \$500 in OEM (original equipment manufacturer) quantities. For information, contact TASA Inc, 2346 Walsh Ave, Santa Clara CA 95051, (408) 727-8272.

Circle 412 on inquiry card.

MC68000 Development Boards Extend EXORmacs Systems

Motorola has introduced four MC68000 modules for use with the EXORmacs system. The User System Emulator (USE) provides the connection between the user's nondebugged hardware/software system and the diagnostic power within the EXORmacs itself. The extension provides the debug functions of MACSbug and the symbolic debugger SYMbug, along with the file-management and memory-storage capability of EXORmacs. USE consists of the USE Control Module, Buffer Box, and interface cable. The price is \$1500. The VERSAbus dynamic-memory modules include a special addressing for placement of memory in both the system and the user's map throughout the 16-megabyte range of the MC68000 microprocessor. A parity feature is provided. Prices for 32 K- to 128 K-byte memory modules range from \$1400 to \$3500. The VERSAbus Adapter Module board plugs into EXORmacs bus slots and provides an interface between the 8-bit EXORbus modules and the 16-bit VERSAbus. The modules also provide user-selectable interrupt levels and controls required by the VERSAbus interrupt scheme. The price is \$295. For more information on these and other EXORmacs products, contact Motorola Semiconductor Products Inc, POB 20912, Phoenix AZ 85036, (602) 962-2209.

Circle 413 on inquiry card.

ASCII Encoded Keyboard Kit

The JE610 ASCII (American Standard Code for Information Interchange) Encoded Keyboard kit comes with a sixty-two-key keyboard switch assembly, integrated circuits, sockets, connector, electronic components, and a double-sided printed-circuit board. Wiring instructions and circuit diagrams are included. The full 128-character ASCII set can be generated. Two user-defined keys are provided, as is a caps lock for uppercase. The keyboard assembly requires +5 VDC at 150 mA and -12 VDC at 10 mA for operation. Interfacing is accomplished by an integrated circuit or an eighteen-pin edge card connector. The suggested retail price is \$79.95. The DTE-AK enclosure is available for \$49.95. Contact Jameco Electronics, 1355 Shoreway Rd, Belmont CA 94002, (415) 592-8097.

Circle 414 on inquiry card.



What's New?

SYSTEMS

Three New Computers from Radio Shack

The TRS-80 Model III is available in several configurations, and it ranges in price from \$699 for the 4 K-byte version (expandable to 32 K bytes) to \$2495 for units with 313 K bytes of disk storage. It is compatible with Model I TRS-80s and features Model III BASIC. Features included are: uppercase and lowercase on the video display, a printer interface, the capability to add two double-density floppy-disk drives, and more. The TRS-80 Pocket Computer weighs 6 ounces and is less than 7 inches long. It is able to do most of the smaller jobs the TRS-80 Model I computer can do. The Pocket Computer features power-off retention of programs and data. The resident BASIC includes multiple statements, mathematics functions, editing, strings, arrays, and more. The price is \$249. The TRS-80 Color Computer provides color graphics and features Program Pak software that enables the user to set up the computer for a variety of educational and recreational purposes. It features a television modulator, provides high-resolution modes, and can be expanded to 16 K bytes of memory. The price is \$399. For more information, contact Radio Shack, 1800 One Tandy Center, Ft Worth TX 76102, (817) 390-3272, or visit your local participating Radio Shack dealer.

Circle 415 on inquiry card.

6500 Development System

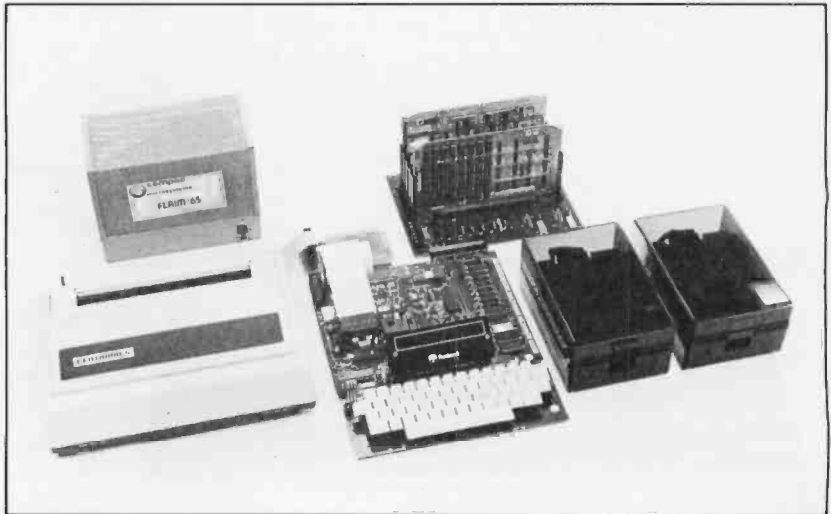

The heart of the FLAIM/65 development system is the AIM-65 single-board microcomputer manufactured by Rockwell International. The AIM-65 provides a 20-character alphanumeric display, thermal printer, and a keyboard. An expansion motherboard provides five card slots compatible with the Motorola EXORcisor bus. Dual 5-inch floppy-disk drives provide 160 K bytes of programmable-memory storage. The disk operating system is contained in EPROM (erasable programmable read-

only memory). A power supply and a Centronics 730 printer are provided. Software includes an assembler and compiler. PL/65, built in to ROM (read-only memory), is a systems language designed specifically for the 6500 family. A complete FLAIM/65 system is priced at \$3705 from Compas Microsystems, 224 SE 16th St, Ames IA 50010, (515) 232-8187.

Circle 416 on inquiry card.

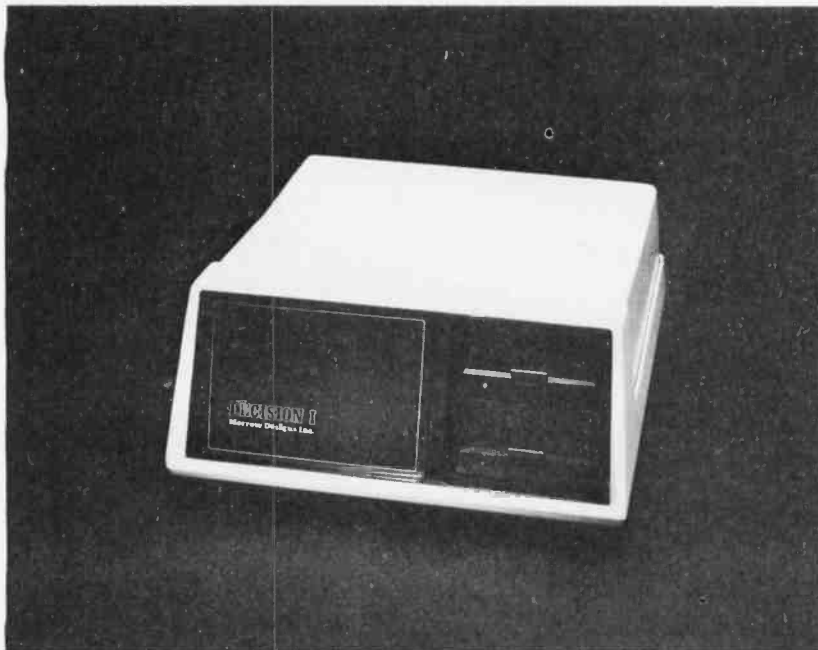

The Decision 1 Microcomputer

Morrow Designs, 5221 Central Ave, Richmond CA 94804, (415) 524-2101, has announced the Decision 1, a multi-tasking, IEEE (Institute of Electrical and Electronics Engineers) standard S-100 bus microcomputer that costs under \$5000 in a four-user configuration. The machine is designed for the word-processing and the business data-processing industries. The computer features a Z80 microprocessor, a UNIX-compatible operating system that runs CP/M as a subsystem, and business-applications and word-processing packages. The memory-management hardware includes a memory map that supports up to sixteen tasks without swapping. The system can support dual 800 K-byte 5-inch floppy-disk drives, dual 1.2-megabyte 8-inch drives, and a 26-megabyte Winchester hard disk.

Circle 417 on inquiry card.

What's New?

SYSTEMS

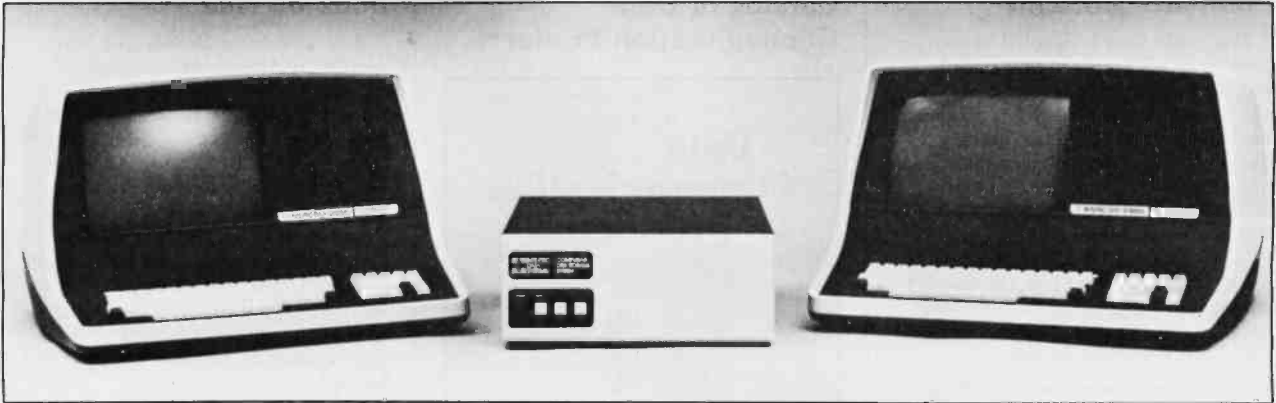

Multi-User Microcomputer System

The CompuStar Multi-User system consists of a network of video-display terminals which employ individual microprocessors and dynamic program-mable memory. The terminals are tied together in a network fashion to share the resources of a single Winchester or other hard-disk device. The system shares disk drives while allowing individual users the capability to maintain restricted data bases. The system architecture is based around one of three disk

storage systems. A 10-megabyte Shugart-type Winchester 8-inch drive is offered for \$3995. Also offered as disk storage options are a 32- or 96-megabyte cartridge module drive. The 32-mega-byte model is \$11,995; the 96-megabyte model is \$14,995. The multi-user systems can accept up to 255 video terminals in a single network. Each terminal, manufactured by Intertec, has twin RS-232 serial ports for printers and other peripherals. Video terminals range

in price from \$2495 for a 12-inch, 64 K-byte unit, to a dual double-sided, double-density floppy-disk drive, 12-inch unit that can store 1.5 megabytes of data. This terminal costs \$4995. One of the basic units, allowing printer interfacing, costs \$1995. For more information on the CompuStar System, contact Intertec Data Systems, 2300 Broad River Rd, Columbia SC 29210, (803) 798-9100.

Circle 418 on inquiry card.

Mercator Microcomputer

The MBS 4000 uses a 16-bit micro-processor, and the system bus is compatible with the Intel Multibus. The basic configuration includes an 8-inch Winchester disk drive and tape cartridge backup. The minimum memory configuration provides 128 K bytes of program-mable memory (expandable to 256 K), with error checking and correcting logic, and 4 K bytes of PROM (programmable read-only memory). The system includes a 400 W switching power supply. Eight serial RS-232 ports and a parallel printer port are included. A disk-expansion port and a Multibus expansion port are optional. Contact Mercator Business Systems, 2378A Walsh Ave, Santa Clara CA 95051, (408) 496-0424.

Circle 419 on inquiry card.

Business Systems from CMC

CMC Marketing Corporation, 10611 Harwin, Suite 406, Houston TX 77036, (713) 995-4960, has introduced a line of computer systems for small and large businesses and for word-processing applications. These systems are built around the Z80A microprocessor and feature the S-100 bus. Systems can be configured with floppy-disk storage of up to 4 megabytes and hard-disk storage



of up to 28 megabytes. All systems can utilize the CP/M operating system. The word-processing systems, as well as the other systems, use the Magic Wand word-processing program, with an NEC Spinwriter printer. The System 100 series for small businesses offers RS-232 and parallel ports for use with a variety

of printers and peripherals. Microsoft BASIC is built in. The System 200 series can support up to eight work stations. It uses the Shugart SA4000 Winchester hard disk with 14 to 28 megabytes of storage. For additional details, contact the company.

Circle 420 on inquiry card.

What's New?

PUBLICATIONS

Computer Hot Line

This publication is devoted to computer users who want to buy systems, peripherals and other related components. Advertisements from major manufacturers are included, along with a help wanted section. Subscription rates are \$45.90 for one year of first class delivery and \$28.60 for regular mail delivery. Contact Hot Line Inc, POB 1373, Fort Dodge IA 50501, (800) 247-2244, ext 27, from Iowa or Canada call (515) 573-8133.

Circle 421 on inquiry card.

Matrix Printer Brochure

A brochure describing microprocessor-controlled dot-matrix printers for general and special applications is available from Dataroyal Inc, 235 Main Dunstable Rd, Nashua NH 03061, (603) 883-4157. The brochure details the Dataroyal IPS 5000 series of matrix printers for use with small-business systems and the 7000 series capable of printing bar code and variable size labels.

Circle 422 on inquiry card.

IEE Conference Volume

Communications Equipment and Systems contains information on public telecommunications: switching and networks; transmission and data; data- and business-communications systems: intelligent terminals and emergency communications: systems; and equipment. The price is \$41.50 from The Marketing Department, The Institution of Electrical Engineers (IEE), Station House, Nightingale Rd, Hitchin, Hertford, SG5 1RJ England.

Circle 423 on inquiry card.

Apple II Accessories and Software

The Buyers Guide of Apple II Software, Accessories, and Supplies contains 500 Apple II programs, a wide range of accessories, supplies, and books. *The Buyers Guide* sells for \$3 and a certificate worth \$3 off the first purchase is supplied. Contact Wallace Computers, Accessories and Supplies Inc, 1024 W Willcox, Peoria IL 61604, (309) 685-7876.

Circle 424 on inquiry card.

Catalog of Data Communication Products



International Data Sciences Inc, 7 Wellington Rd, Lincoln RI 02865, (401) 333-6200, the manufacturer of Range Rider Modem/TDM Test Sets, Hawk 4000 Datatraps, MiniTech EIA (Electronic Industries Association) patch, monitor, switching modules, and Mini-Test interface monitor and breakout panels, is offering free copies of its 1980 *Catalog of Data Communication Products*. The catalog features the company's data test sets for synchronous and asynchronous modems, EIA and telephone line patch, monitor, and switching modules for technical control centers; data cables; error detection devices, and more. Also featured is the Model 65/60, the company's battery-operated modem test set and breakout panel combined.

Circle 425 on inquiry card.

OSI Releases Challenger III Service Manual

OSI (Ohio Scientific), 1333 Chillicothe Rd, Aurora OH 44202, (216) 562-3101, in conjunction with Howard W Sams Inc, has released the *Challenger III Service Manual*. This manual includes schematic diagrams, pictorial diagrams, block diagrams, parts lists, and component pinouts for the thirteen circuit boards used in the Challenger systems. Memory maps and board placement diagrams are also included. One important feature of the manual is the fold-outs which spread up to eight pages in width. This and other OSI manuals are available from Ohio Scientific dealers. For the name of your local dealer, call (800) 321-6850.

Circle 426 on inquiry card.

Book on Ada

Programming with Ada: An Introduction by Means of Graduated Examples, by Peter Wegner, is available from the Computer Bookstore, POB 556, Shalimar FL 32579, (904) 242-6439. Developed for the Defense Advanced Research Projects Agency, Ada is a multipurpose high-level language designed to meet the needs of numerical, system programming, and real-time applications, and which supports modularity and top-down program design. This book contains a history of Ada and explains its features. The price is \$13.95.

Circle 427 on inquiry card.

Brochure Describes TABOL III a Business Language

TABOL III, a publication describing a new business language for building business analysis and reporting systems, is available from the General Electric News Bureau, 8150 Leesburg Pike, Suite 510, Vienna VA 22180, (202) 637-4557. This brochure discusses TABOL III and its applications involving the development, manipulation, and presentation of data in a tabular format. Applications concerning finance, manufacturing and sales, and marketing are also covered.

Circle 428 on inquiry card.

Books from Hayden

Hayden Book Company Inc, 50 Essex St, Rochelle Park NJ 07662, has introduced two books and two software programs. *Programmable Pocket Calculators* covers many of the Hewlett-Packard calculators and costs \$8.95. *Microprocessor Software Design* is a compilation of articles from *Electronic Design* and is priced at \$11.95.

The first program is an Apple assembly-language development system with an assembler, editor, and formatter for the Apple II disk system with 24 K bytes of memory. It costs \$39.95. The second program is *Blackjack Master: A Simulator/Tutor/Game* for the TRS-80 computer. The 16 K version is \$19.95 and the 32 K disk version is \$24.95.

Circle 429 on inquiry card.

HOT WINTER PRICES ON PERSONAL COMPUTERS AND COMPONENTS.

Look at this!



Ohio Scientific Superboard II \$299

- It's the first complete computer system on a board.
- Superboard II uses the ultra powerful 6502 Microprocessor
- 8K Microsoft BASIC-in-ROM
- 4K static RAM on board, expandable to 8K
- Full 53-key keyboard, with upper and lower case. Plus user expandability.
- Video interface and audio cassette interface.

The Ohio Scientific Superboard II at \$299 — in today's economy — has got to be the best buy by far. It will entertain you with spectacular graphics made possible by its ultra high resolution graphics and super fast BASIC. It will help you in school or industry, as an ultra powerful scientific calculator. Advanced scientific functions and a built-in "immediate" mode allow you to solve complex problems without programming.

The Superboard II can be expanded economically, for business uses, or to remotely control your home appliances and security. Even communicate with other computers.

Read what's been written about Superboard II:

"We heartily recommend Superboard II for the beginner who wants to get into microcomputers with a minimum cost. A real computer with full expandability."

—POPULAR ELECTRONICS, MARCH 1979

"The Superboard II is an excellent choice for the personal computer enthusiast on a budget."

—BYTE, MAY 1979

Look at these easy hardware prices:

610 Board For use with Superboard II and Challenger 1P. 8K static RAM. Expandable to 24K or 32K system total. Accepts up to two mini-floppy disk drives. Requires +5V @ 4.5 amps.	\$ 298
Mini-Floppy Disk Drive Includes Ohio Scientific's PICO DOS software and connector cable. Compatible with 610 expander board. Requires +12V @ 1.5 amps and +5V @ 0.7 amps. [Power supply & cabinet not included.]	299
630 Board Contact us for important details.	229
AC-3P 12" combination black and white TV/video monitor.	159
4KP 4K RAM chip set.	79
PS-005 5V 4.5 amp power supply for Superboard II.	35
PS-003 12V power supply for mini-floppies.	29
CS-600 Metal case for Superboard II, 610 and 630 board and two power supplies. [While stock lasts.]	49
CS-900B Metal case for single floppy disk drive and power supply. [While stock lasts.]	49
AC-12P Wireless remote control system. Includes control console, two lamp modules and two appliance modules, for use with 630 board.	175
AC-17P Home security system. Includes console, fire detector, window protection devices and door unit for use with 630 board.	249
C1P Sams C1P Service manual	8
C4P Sams C4P Service manual	16
C3 Sams Challenger III manual	40
Ohio Scientific and independent suppliers offer hundreds of programs for the Superboard II, in cassette and mini-floppy form.	

Freight Policies All orders of \$100 or more are shipped freight prepaid. Orders of less than \$100 please add \$4.00 to cover shipping costs. Ohio residents add 5.5% Sales Tax.



Hours: Call Monday thru Friday.
8:00 AM to 5:00 PM E.D.T.

TOLL FREE: 1-800-321-5805

Guaranteed Shipment
Cleveland Consumer Computers & Components guarantees shipment of computer systems within 48 hours upon receipt of your order. **Our failure to ship within 48 hours entitles you to \$35 of software, FREE.**

To Order: Or to get our free catalog **CALL 1-800-321-5805 TOLL FREE.** Charge your order to your **VISA** or **MASTER CHARGE** account. Ohio residents call: (216) 464-8047. Or write, including your check or money order, to the address listed below.



CLEVELAND CONSUMER COMPUTERS & COMPONENTS

P.O. Box 46627
Cleveland, Ohio 44146

Order Form: CLEVELAND CONSUMER COMPUTERS & COMPONENTS P.O. Box 46627 Cleveland, Ohio 44146

- | | |
|--|---|
| <input type="checkbox"/> Superboard II \$299. | <input type="checkbox"/> 630 Board \$299. |
| <input type="checkbox"/> 610 Board \$298. | <input type="checkbox"/> AC-3P 12" B/W Monitor \$159. |
| <input type="checkbox"/> Mini-Floppy Disk Drive \$299. | <input type="checkbox"/> C1P Sams Manual \$8. |

[Attach separate sheet for other items.]

NAME _____

ADDRESS: _____

CITY: _____ STATE: _____ ZIP: _____

PHONE: _____

Payment by: VISA _____ MASTER CHARGE _____ MONEY ORDER _____

Credit Card Account # _____

Expires _____ Interbank # [Master Charge] _____

TOTAL CHARGED OR ENCLOSED \$ _____ [Ohio Residents add 5.5% Sales Tax]
Orders of less than \$100, please add \$4.00 to cover shipping costs.

All orders shipped insured UPS unless otherwise requested. FOB Cleveland, Ohio.

What's New?

PUBLICATIONS

Queue Catalog

Queue's *Catalog #3* is a directory of educational software available for the Apple II, TRS-80, PET, and Atari computers. Programs from over forty educational software publishers are described and grouped together by computer, subject matter, and grade level. All the programs can be ordered through Queue. The catalog is \$8.95 from Queue, 5 Chapel Hill Dr, Fairfield CT 06432.

Circle 430 on inquiry card.

Tool Kits, Cases, and Test Equipment

A catalog from Specialized Products Company, 2324 Shorecrest Dr, Dallas TX 75235, (214) 358-4663, features tools, test equipment, and cases from Fluke, Beckman, and other manufacturers. Contact the company for a copy.

Circle 431 on inquiry card.

CP/M Software Summary Guide

Rainbow Associates, POB 35, Glastonbury CT 06025, has published the *CP/M Software Summary Guide*, a guide to the major software systems used on most CP/M systems. Included are summaries of the CP/M operating system, Microsoft BASIC, CBASIC, and the CP/M utilities DESPOOL, MAC, and TEX. The CP/M summary covers system commands and utilities with explanations and examples. Error codes for CBASIC-1, CBASIC-2, and BASIC-E are summarized. Examples and definitions explain the utilities offered by Digital Research. The price is \$3.75.

Circle 432 on inquiry card.

Math Guidebook

Calculator Calculus, by Professor George McCarty, details a system for learning and teaching mathematics through computation. Algorithms produce numerical examples for limit processes, differentiation, integration, and sums of series. Programs are suitable for hand-held calculators and larger systems. Numerical techniques such as Newton's method, Padé approximation, and Fourier series are included. The price is \$14.95, from EduCALC Publications, Department BY, POB 974, Laguna Beach CA 92652, (714) 497-3600.

Circle 433 on inquiry card.

Systems and Instruments Catalog

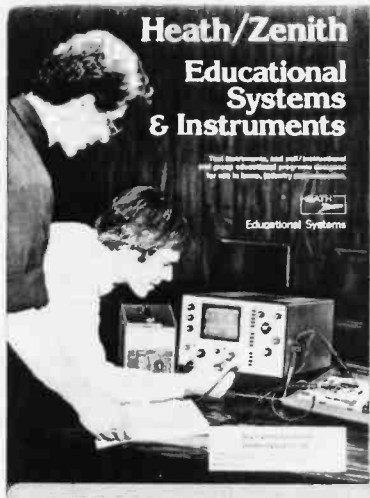

A free catalog describing educational programs and test instruments for schools, industry, government, and self-instruction, has been published by the Heath Company, Benton Harbor MI 49022, (616) 982-3210. This edition has information on self- and group-instruction college-level programs in electronics, microprocessors, and computer programming. The catalog features product descriptions and specifications on test instruments. Programs listed in this catalog are offered by Heath/Zenith Educational Systems.

Circle 434 on inquiry card.

The Fifth Edition of the TRS-80 Software Directory

The fifth edition of the *TRS-80 Software Directory* is available from ComputerMat, POB 1644A, Lake Havasu AZ 86403, (602) 855-3357. This edition has over 7000 listings of Model I and II software, and includes the names and addresses of over 600 software suppliers. One section is devoted to Model II software for businesses, another to mathematics and utility programs. The catalog gives information on program titles, short descriptions, BASIC needed, memory required, class, cost, and the program medium. The price is \$7 per issue in the US, which includes postage. Canadian and foreign orders are \$9. Distributors and suppliers of TRS-80 software can be listed in the directory at no charge by sending ComputerMat their latest catalog.

Circle 435 on inquiry card.

Alpha Micro Business Systems

A brochure introducing Alpha Micro's business-computer systems is available. The systems are multitasking, multi-user, and time-sharing. Software includes languages such as AlphaBASIC and AlphaPascal, word-processing and text-formatting applications, and over 150 separate utility programs and sub-routines, including utilities for sorting, spooling, and file handling. Contact Alpha Micro, 17881 Sky Park N, Irvine CA 92713, (714) 641-0386, for a copy of the brochure.

Circle 436 on inquiry card.

Universal Semiconductor Cross-Reference Guide

This cross-reference guide includes Zenith semiconductor devices that replace more than 158,000 currently used devices. The guide allows service technicians to use Zenith semiconductors in color and black and white televisions, stereo systems, radios, and personal and business computers. Contact Zenith Radio Corporation, 1000 Milwaukee Ave, Glenview IL 60025, (312) 391-8181.

Circle 437 on inquiry card.

CompuMart Catalog

CompuMart Corporation, POB 568, Department 333, Cambridge MA 02139, (617) 491-2700, has published a thirty-six-page catalog of microcomputers and peripherals. The catalog features Digital Equipment Corporation's LSI-11 hardware, Apple, Atari, Commodore, Heath, Exidy, and Texas Instruments systems and peripherals. Books on different aspects of microcomputers are also included in this catalog. The catalog can be obtained free of charge from the CompuMart Corporation.

Circle 438 on inquiry card.

BASIC Self-Teaching Guide from Radio Shack

TRS-80 Level II BASIC is a beginner's guide designed for users who have not had previous experience with computers. Short games, application programs, and the elements of developing simulation routines are presented. The book is available from participating Radio Shack stores, dealers, and Radio Shack Computer Centers for \$9.95.

Circle 439 on inquiry card.

The Supermarket for TRS-80* Add-on Components (and other computers, too) In stock now. Immediate delivery.

The Vista V-80/800/8000 Family Disk Drive System

- Fully compatible with TRS-80, Heath/Zenith
- 120 Day Warranty
- 40 Track Patch at NO CHARGE



V-80 Single drive system (102K)	\$ 395.00
V-80 Two drive system (204K)	\$ 770.00
V-800 Single drive, B52 Drive (204K)	\$ 595.00
V-800-2 Double drive, B52 Drives (408K)	\$1175.00
V-8000 Single drive, B92 Drive (408K) ...	\$ 775.00
V-8000-2 Double drive B92 Drives (816K)	\$1450.00

The VISTA Model II

- Provides one, two or three drives.
- Adds up to 1.5 million bytes of on-line storage.
- 120 day warranty
- Does everything Radio Shack's expansion system will do... for less!

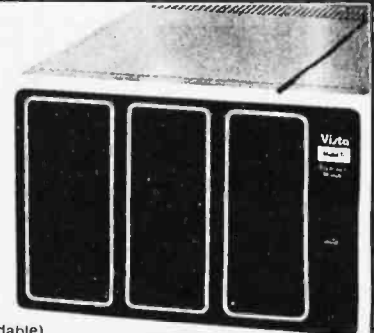

\$ 900.00	Single drive (non-expandable)
\$1000.00	Single drive Expansion System
\$1550.00	Two drive Expansion System
\$2100.00	Three drive Expansion System
\$ 525.00	Additional drives alone

Vista's Add on Drives for Apple™

Speed . Capacity . Price

More for Legs



- 30 to 60% cheaper per byte
- From 20 to 400% more capacity
- Twice as fast
- Compatible with Pascal
- Warranty 120 days

40-Track	\$365.00
80-Track	\$595.00
160-Track	\$825.00
Controller	\$100.00

The Vista MUSIC MACHINE 9

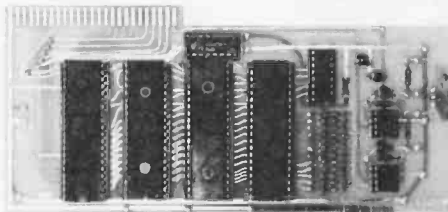

WITH 9 VOICES!

- NEW! Uses latest State of the Art LSI Technology.
- Requires only one slot for 9 voices!
- Uses three Ay3-8910's to produce nine voices (Other competitive models have only 3 voices).
- Simulates three ALF Boards.
- Plays music generated by the ALF Board.
- APPLE™ II compatible.
- ALF™ software required.

3 Times
More Powerful
Than ALF™
\$129.95

Printers

Vista V300	\$1895.00
Daisy wheel	
Letter quality	
Base 2 Printer	\$575.00 (includes: 2-K Buffer, graphics, high speed tractor feed)
Variable line spacing control	
0 to 64 dots in half dot increments	
100 cps — six densities	
Standard 96 character ASCII	
Up to 10 character fonts	
Anadex DP8000	\$895.00
9 x 7 dot matrix	
80 column (112 cps)	
Vista Printer	\$745.00
5 x 7 dot matrix	
80 column (125cps)	

Add On Drives

MPI B51	40 Track, Double Density-204K	\$275.00
MPI B52	Dual Head, Double Density-408K	\$375.00
Siemens	FDD100-5 40 Track Double Density 204K	\$275.00
Siemens	FDD100-8 8" Single Sided Drive	\$448.00
Shugart	801R Single Sided Drive	\$448.00

Other Products

1. VISTA Verbatim diskettes (hard or soft sector) Certified 40 track	\$ 38.95
2. 16K RPM upgrade kits, guaranteed for 120 days.	
PRIME PRODUCT	\$ 59.95
3. NEW! DOS +	\$110.00
4. LNW expansion bare board	\$ 66.95
5. H.C. Pennington book, TRS-80 Disk and Other Mysteries	\$ 18.95
6. DDT Disco-Tech disk drive timer	\$ 19.95

The VISTA V-200 for Exidy

- Completely packaged system, tested and ready to plug in, includes; power supply, two 40 track drives, case, controller, all cabling and total CPM documentation.
 - Storage capacity from 400K to 1.2 meg.
 - System software-VISTA CP/M Disk Operating System and BASIC-E Compiler recorded on 5-1/4" diskettes.
- Price: Starting as low as **\$1199.00**

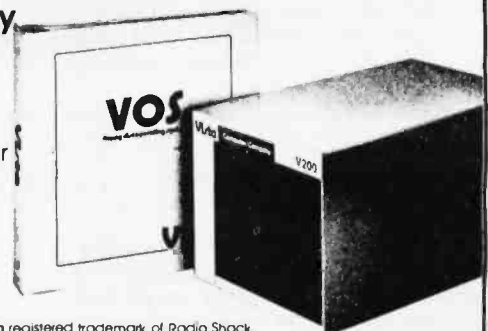

*TRS-80 is a registered trademark of Radio Shack



CALL TOLL-FREE 800-854-8017

The Vista Computer Company 1401 Borchard Street • Santa Ana, California 92705 • 714/953-0523

What's New?

PERIPHERALS

A Graphic Tablet

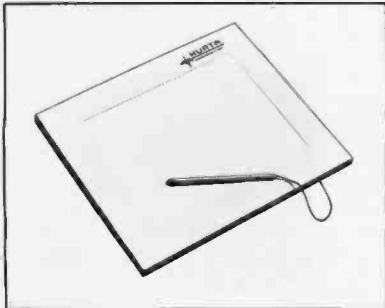

This graphic tablet, designed for small computers, is compatible with standard 7 by 9 inch display screens. For hard copy, a standard 8½- by 11-inch pad of paper fits onto the tablet surface. The output of the tablet matches the capabilities of the computer, thereby minimizing interface and software requirements. The resolution is 100 to 200 points per inch. Conversion rate is 100 coordinate pairs per second; standard output is bisquential with an optional full parallel output. The tablet is available from Kurta Corporation, 206 S River Dr, Tempe AZ 85281, (602) 968-8709. Circle 440 on inquiry card.

IEEE-488-to-Parallel Interface for the PET

The P.I.E.-C is an IEEE-488-to-parallel interface for the Commodore PET computer. The device has parallel output with two handshaking lines and is compatible with Centronics printers, NEC Spinwriter, Anderson-Jacobson AJ841, Integral Data System's Paper Tiger, Anadex 8000 and 9000 printers, and any other parallel-input ASCII (American Standard Code for Information Interchange) printer. The conversion of nonstandard PET codes to ASCII codes is switch-selectable. The P.I.E.-C with case, code converter, and printer cable is \$119.95. Contact LemData Products, POB 1080, Columbia MD 21044, (301) 730-3257. Circle 441 on inquiry card.

Streaming Cartridge Tape Drives

The Sidewinder family of streaming 1/4-inch cartridge tape drives feature a recording density of 8000 bits per inch and operating speeds of 30 and 90 ips (inches per second). The drives are designed for Winchester disk drive

Graphics Board for VT-100 and VT-103 Terminals



The Graphics-100 board fits in DEC (Digital Equipment Corporation) VT-100 and 103 video terminals to give them X,Y graphics display capability. The board provides a 1220 by 240 dot resolution on the screen. The text capability includes four character sets, three text rotations for labeling, and three type fonts. Graphics 100 memory and VT-100 memory may be displayed

simultaneously. The unit includes a vector generator. Hard copy is available from the DECwriter II printer. Options include a light pen capability and software support under Selanar's PL II FORTRAN Plotting Subroutines. The Graphics-100 board is \$1195; from Selanar, 2403 De La Cruz Blvd, Santa Clara CA 95050, (408) 727-2811. Circle 442 on inquiry card.

Pascal-100 from Digicom Research

Pascal-100 consists of two mated boards with a Z80 microprocessor subsystem and the Pascal Microengine integrated-circuit set. Pascal-100 upgrades S-100 systems to a bilingual bus and runs the complete UCSD Pascal in native code, plus all Z80, 8080, and CP/M software. Both microprocessor subsystems can address 128 K bytes of

memory or, optionally, up to 1 megabyte of memory. The system requires 48 K bytes of storage. The system is a 16-bit, plug-in module for all S-100 systems. The price is \$1485. UCSD Pascal for the unit is \$250, and a 1-megabyte memory addressability option is \$95. Contact Digicom Research, Terrace Hill, Ithaca NY 14850, (607) 273-5900.

Circle 443 on inquiry card.

backup. They are offered in a Basic or Intelligent configuration with 10- or 20-megabyte capacities. Sidewinder's erase-write-read recording head operates in a two- or four-track format; the tracks are recorded serially. A microprocessor-based controller is supplied with the Intelligent Sidewinder. In OEM (original equipment manufacturer)

quantities, the Basic Sidewinder is \$469 for 10 megabytes and \$600 for 20 megabytes. The Intelligent models are priced at \$823 for 10 megabytes and \$954 for 20 megabytes. Contact Archive Corporation, 3540 Cadillac Ave, Costa Mesa CA 92626, (714) 641-0279.

Circle 444 on inquiry card.

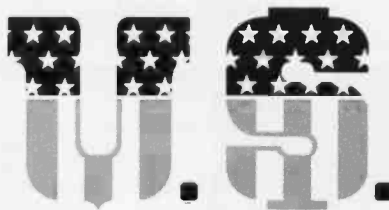

MICRO SALES

OUR BUYERS ARE IN
CONTACT WITH EVERY MAJOR
SUPPLIER AND O.E.M.
BUY HERE AT 1000 PIECE

QUANTITY PRICES

ALL MERCHANDISE 100%
GUARANTEED! 15 DAY FULL
CASH REFUND!

664 N. MICHIGAN AVE. ★ SUITE 1010 ★ CHICAGO, ILLINOIS 60611
CALL TOLL FREE: 1-800-435-9357 ★ MONDAY thru SATURDAY
(ILLINOIS RESIDENTS CALL: 815-485-4002) ★ 8:00 a.m. to 6:30 p.m.

TERMS: Prepayment - C.O.D. up to \$100.00 - M/C, Visa
Please allow personal check to clear before shipment.

WRITE FOR FULL CATALOG!

JUST HOT STUFF

POWER SUPPLIES

If you can beat these prices we will be truly amazed. OEM's at 500 lot pay more than this. Call or write for full spec. sheets.

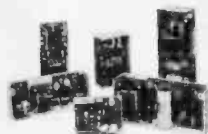

DISK POWER SUPPLIES			
PRIAM-SHUGART-CENTURY-MICROPOLIS			
+5V @ 9A	-5V @ 8A	+24V @ 7A	US-384 89.00
SHUGART - SIEMANS - MPI 5 1/4"			
+5V @ .5A	+12V @ .9A		US-340 33.50
+5V @ 2A	+12V @ 4A		US-323 56.25
SHUGART - SIEMANS - CDC 8"			
+5V @ 1A	-5V @ .5A	+24V @ 1.5A	US-205 52.50
+5V @ 2A	-5V @ .5A	+24V @ 3A	US-206 69.00
+5V @ 3A	-5V @ .6A	+24V @ 5A	US-162 89.00
+5V @ 1.7A	-5V @ 1.5A	+24V @ 2A	US-272 69.00
+5V @ 2A	+12V @ .4A	-12V @ .4A	US-HTAA 37.50

TELEVIDEO 912C

SOROC IQ120 - \$675.00
Televideo 912C - 665.00
ADDS R-25 - 710.00



Also have 920C, SOROC, HAZELTINE, etc. What we don't have is room on this page. Call Toll Free 800 number for prices.

C-ITOH PRINTER

\$499.00

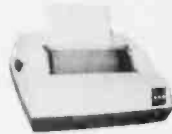

Look closely at the photo and see other adds in this rag at \$995.00. Perfect units, warranted. Only 500 pcs. Same story, manufacturer had too many.

ATARI

800 - \$899.00
400 - \$499.00



As long as there is a price war, we will fight your battle. Compare at your local Dept. store and buy US MICRO.

MEMOREX - VERBATUM - WABASH BASF FLOPPIES

BOX OF 10 ONLY:

5 1/4"	SOFT	\$2.65 ea.
5 1/4"	HARD 10	2.65 ea.
5 1/4"	HARD 16	2.65 ea.
8"	SOFT 1D	3.25 ea.
8"	SOFT 2D	3.85 ea.
8"	SOFT 2DDS	5.00 ea.

SPECIAL OF THE QUARTER

DUAL DRIVE SUBSYSTEM

\$995.00



If this looks like a Lobo Drive System, don't be fooled. Just because it looks like one, works like one, smells like one, and tastes like one (?) doesn't mean it has to cost like one!

2 SHUGART 801R
POWER SUPPLY

S1-MOD (KIT)

\$239.00



Complete S-100 12 Slot Computer. Ample system power with regulated power for drives. Excellent for Subsystem or Hobby use. 4 hours to build. (6 conn. incl., less fans)

EXPANDABLE RAM

★SPECIAL★SPECIAL★SPECIAL★

This is the best all around 64K board you can buy. If after you see it, you don't agree return (unassembled) for full refund. Bank Select by extended \$389.00 A & T* address lines or I.O. 40H



32K STATIC (KIT)

You have seen this well known board around for years. We bought 500 of them and plan on cornering the market! Bank Select on extended address lines.



\$388.00

Z-80 CPU (KIT)

The first time this world popular CPU offered in Kit. 2 serial, 3 parallel, CTC, EProm Z-80 at 4 mhz. Software buad rate, etc.(less Prom)



\$212.00

DMA DISK CONTROLLER (KIT)

How many DMA Disk Controllers are there on the market? Can't mention the name at this LOW, LOW, LOW, price.



\$265.00

FANS \$14.95

These are brand new, in the box fans. Not noisy bearing pullouts. Never again at these low prices!



3-1/8"



4-5/8"

SPECIALS OF THE MONTH

4116s

\$4.25

Expansion 16K Dynamic RAMs for Apple, TRS-80 S-100 systems. T.I., Mostek Intel, Call for manufacturer.

200 NS

DIP-80

\$399.00

Don't be misled by this LOW price. This is a rugged 100% Duty Cycle 7 by 7 Dot Matrix Printer. Brand new, factory warr.



• RS-232 ADD \$65.00
• TRACTOR FEED ADD \$70.00

2114s

\$3.45

One of the world's two most popular STATIC RAMs. Factory prime tested units. Sold in lots of 8 only. FUJITSU, HITACHI, etc.

200 NS

TMS-4044

MM-5257

INTEL 2147

\$4.25

250 NS

The other of the world's most popular STATIC RAMs. This one is 4K by 1 organization. Don't buy Gold, buy these, the price won't last!

2716s

\$13.50 (450 NS)

2708s

\$6.95 (450 NS)

Remember when 2716s were \$50.00 and hard to get? These units are so beautiful it's hard to part with them. But we will, for a small price. Guaranteed!

SHUGART DRIVE

8" 851R \$585.00

8" 801R
\$385.00

Manufacturer had too many, buys at 1000 piece rate, sales dropped, so we got'em. Fantastic buy, get them while they last! Full warranty.

5 1/4" MINI

\$265.00

Now is the time to expand that Trash-80 or Rotton Apple (no offense!) These go so fast. Quantities limited to those on hand. Hurry! No Junkers! Factory warranty.

SHUGART / SIEMANS / MPI

CONCORD COMPUTER COMPONENTS

1971 SOUTH STATE COLLEGE ANAHEIM, CA. 92806

VISA MASTERCARD
CHECK OR M.O.
NO C.O.D.

(714) 937-0637

We stock and sell over 12,000 types of semi-conductors.

MINIMUM ORDER \$10.00
ADD \$1.50 FOR FRT
CAL. RES. ADD 6%

S-100 MEMORY BOARD

16K STATIC RAM

\$249⁰⁰

ASSEMBLED
& TESTED

California Computer Systems



FULLY STATIC OPERATION
4K BANK ADDRESSABLE
EXTENDED MEMORY MGMT
MEETS IEEE PROPOSED
S-100 SIGNAL STANDARDS
4 MHZ OPERATION

CPU CRYSTALS

Freq	Application	price
1.8432	MC14411	4.50
2.00	G-8/TVgms	4.50
2.01	TV gms	2.90
2.4576	34702baud	5.60
4.00	4004/4040	4.50
4.194304	8038	5.60
5.00	misc. CPU's	4.50
5.0688	Com 5016	4.50
10.0	misc MPU's	4.50
13.0	"	4.50
14.31818	"	4.50
18.0	8080/8008	5.60
22.1184	8080A	5.60
27.0	"	5.60
32.0	"	5.60
32.768	MSM5832	\$2.85

video 100



\$129

Leadex Corp.

12" BLACK & WHITE
LOW COST VIDEO
MONITOR

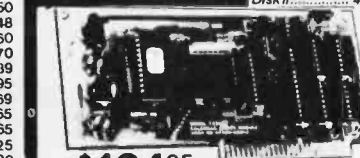

\$124⁹⁵

apple clock/calendar

- Seconds, minutes, hours, day-of-week, month, date, & year.
 - On board batteries with one year life.
 - Uses MSM5832-crystal controlled.
- California Computer Systems

MPD117 \$8750
No "Glitches", Surges Or Interference
The MPD 117 is the low-cost solution to your power distribution problems. The MPD 117 has a high-performance EMI filter, built-in surge breaker, two direct and six switched outlets, illuminated "on-off" switch for switched outlets, and is built with rugged UL approved components and housing in an all-steel chassis with convenient mounting flanges.

TRS-80
16K Memory Add-On
\$46⁰⁰ KIT
with jumpers and instructions

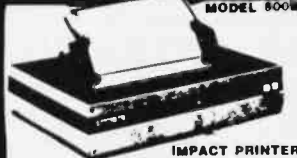

MODEL 8008
IMPACT PRINTER

- Dot resolution graphics in six densities
- 1920 character buffer
- Fully adjustable tractor to 9-1/2"

\$649⁰⁰

base inc. 2^o

SN7400N	.20	SN7482N	1.05
SN7402N	.22	SN7492N	.50
SN7404N	.22	SN7493N	.48
SN7408N	.24	SN7495N	.60
SN7410N	.22	SN7496N	.70
SN7412N	.28	SN74122N	.39
SN7413N	.35	SN74136N	.95
SN7414N	.49	SN74141N	.69
SN7416N	.29	SN74151N	.65
SN7417N	.29	SN74153N	.65
SN7423N	.28	SN74154N	1.25
SN7425N	.25	SN74155N	.80
SN7430N	.23	SN74157N	.69
SN7437N	.29	SN74160N	.95
SN7438N	.24	SN74161N	.65
SN7440N	.22	SN74163N	.85
SN7442N	.57	SN74164N	.87
SN7443N	.78	SN74165N	.87
SN7445N	.78	SN74174N	.95
SN7451N	.20	SN74175N	.69
SN7454N	.20	SN74180N	.75
SN7474N	.32	SN74181N	1.15
SN7475N	.32	SN74393N	1.68

apple II plus

With 48K of memory!
\$1089⁰⁰

With the purchase of the APPLE II 48K select from the below SPECIAL PRICING!

Base printer.....	\$599 ⁰⁰	Firmware Card.....	149 ⁰⁰
Disk II w/control.....	535 ⁰⁰	UHF to RCA Cable.....	5 ⁰⁰
Disk II.....	475 ⁰⁰	PASCAL Card.....	399 ⁰⁰
		Ser Printer Cd.....	179 ⁰⁰
		SupRIMod.....	23 ⁰⁰
		3way IO Select.....	33 ⁰⁰
		Video 100 12".....	119 ⁰⁰

555TIMER 27c

The Brains of Men and Machines

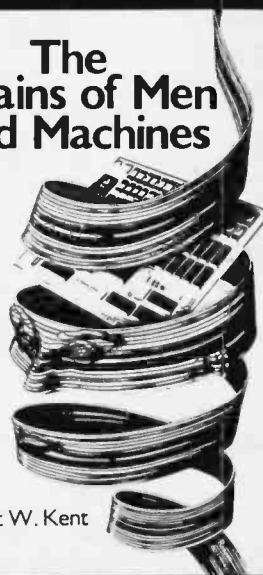

Ernest W. Kent

THE BRAINS OF MEN AND MACHINES

As researchers begin to unravel the mysteries of the brain's chemical, electrical, and synaptic circuitry, their findings are becoming immediately applicable to advances in robotic behavior and computer design. *The Brains of Men and Machines* "dissects" the brain to provide new insights into robotics, computer design and artificial intelligence. It is one of the rare books that transcends disciplinary boundaries. In it the ever increasing relationship between man and machine is freshly examined—a relationship, Professor Kent concludes, that is today being reexamined in the light of man's own neurological self-image.

70 Main St.
Peterborough NH 03458

ISBN #0-07-034123-0
Price \$15.95

Please remit in U.S. funds or draw on a U.S. Bank

Please send _____ copies of *The Brains of Men and Machines*

Name _____ Title _____ Company _____

Street _____ City _____ State/Province _____ Code _____

Check enclosed in the amount of \$ _____ Bill Visa Bill Master Charge

Card No. _____

Exp. Date _____

Add 75¢ per book to cover postage and handling.

BY12
BYTE
PRESS

AVAILABLE NOW

Call TOLL FREE: 800-258-5420
or Mail To:

BYTE/McGraw-Hill

Book Division

70 Main St

Peterborough NH 03458

LOGIC PROBE KIT
\$1795

EPROMS

2708 1Kx8 \$6.75
8 for \$49

2716 2Kx8 14.95
8 for \$110

2732 4Kx8 54.95
2 for \$100
SINGLE 5VOLT FOR 2716 & 2732

Plexiglass cover
as shown
\$2495

MC1330AIP \$1.60
MC1350P 1.15
MC1358P 1.50
LM380N 1.75
NE565N 1.25
MC1458P .50

8038C
VCO Waveform Gen.
w/trace \$285

S-100 16K ADD-ON BARE BOARD
WITH DOCUMENTATION AND DETAILED INSTRUCTION BOOK \$2895

\$159
BASE 2 PRINTER TO APPLE COMPUTER INTERFACE BOARD WITH CABLE

Global Specialties

Logic Probes

LP1
Detects pulse widths down to 50 msec. Resolution down to 100 nsec. Features high speed LED for timing. High rate and gate. 800 words. Receiver and gate. Voltage indicator. \$3749

LP2
For many applications, the LP2 offers better performance as a substitute for the LP1. Similar to the LP1 but for faster circuit and without the 800 words memory. Detects pulse widths to 200 msec and 1.5 nsec. High 100,000. 800 words. Receiver and gate. Voltage indicator. \$2149

LP3
Our highest performance logic probe, the LP3 detects pulses as narrow as 8 msec. It can be tested at 10 msec pulse rates. Features a high speed LED for timing. High rate and gate. 800 words. Receiver and gate. Voltage indicator. \$5849

2114L
1024x4 Static RAM \$450
450 ns
200 ns \$5.50

Digital Pulsar
The intelligent professional pulse generator fits in the palm of your hand.
• One hand operation
• Simplest kind of mode
• Operates with or without batteries
• Circuit board
• Includes 1000 pulse timer
\$6249

VOLTAGE REGULATORS

NEGATIVE	POSITIVE	
7805/5V	7805/5V	7818/15V
7806/6V	7806/6V	7810/10V
7915/15V	7808/8V	7824/24V
7918/18V	7812/12V	

95¢

74LS00	.26	74LS155	1.15
74LS02	.26	74LS158	.75
74LS03	.26	74LS160	.95
74LS04	.26	74LS161	.85
74LS08	.28	74LS162	.95
74LS09	.26	74LS163	1.60
74LS10	.26	74LS164	.65
74LS20	.26	74LS165	.65
74LS21	.28	74LS170	1.75
74LS22	.26	74LS174	.75
74LS26	.49	74LS175	.75
74LS27	.26	74LS190	.75
74LS30	.28	74LS193	.95
74LS32	.32	74LS195	.95
74LS38	.32	74LS196	.85
74LS42	.65	74LS221	1.40
74LS48	.78	74LS240	1.65
74LS51	.25	74LS241	1.65
74LS54	.35	74LS243	1.45
74LS74	.38	74LS244	1.45
74LS75	.60	74LS245	2.25
74LS83	.44	74LS253	.95
74LS85	.95	74LS257	.95
74LS86	.95	74LS258	.95
74LS90	.69	74LS259	2.85
74LS93	.69	74LS279	.44
74LS107	.45	74LS283	1.00
74LS112	.38	74LS293	1.85
74LS113	.48	74LS298	1.20
74LS122	.48	74LS366	.95
74LS123	.95	74LS367	.55
74LS126	.69	74LS368	.55
74LS138	.69	74LS373	1.39
74LS151	.44	74LS374	1.39
74LS153	.44	74LS386	.65

SOROC TECHNOLOGY, INC.

Q120 \$699.00

8085A COOKBOOK

COMPLETE 8085A BASED MICRO-COMPUTER AND MICROPROCESSOR TRAINING UNIT YOU GET:

- Fully assembled and tested 8085A Microcomputer with 1K RAM, 1K PROM, & 1K EPROM. Programmable I/O, Keyboard unit, CPU card, 20 ma Asynchronous serial port, Display and Operating system.
- 8085A Cookbook: 362 pages takes you from basic concepts to actual design.
- 8080/8085A Software Design-Book 1 with detailed examination of all 244 instructions. 336 pages include sample programs using all basic instructions and typical assembly language.

PACCOM

\$295.00

APPLE EXPANSION KIT
16K Memory Add-On \$44.44
MEMORY ADD-ON KIT INCLUDES INSTRUCTIONS

Add-On Disk Drive Subsystems

For Apple, TRS-80, S-100 Based Computers

Expansion and enhanced capabilities are key words in achieving full utilization of your computer system. Our complete line of LOBO disk drive subsystems are the ideal, cost-effective way to provide the expansion capabilities you need to meet your system growth requirements. All of our subsystems are complete, thoroughly-tested, 100% burned-in, and feature a 1 year 100% parts/labor warranty.

APPLE		S-100 BASED COMPUTERS		GENERAL	
MODEL NO.	DESCRIPTION	MODEL NO.	DESCRIPTION	MODEL NO.	DESCRIPTION
3101	Minifloppy, 3101 Minifloppy w/interface card	4101C	SA400 In cabinet w/power	8212	Two SA801 in cabinet
8101CA	One SA800 in cabinet w/power, DDC* Controller, cable and manual	8212C	Two SA801 in cabinet w/power	8212C	Two SA801 in cabinet w/power
8202CA	Two SA800 In cabinet w/power, DDC* Controller, cable and manual	5212C	Two SA851 in cabinet w/power	5212	Two SA851 in cabinet
5101CA	One SA850 In cabinet w/power, DDC* Controller, cable and manual			5212C	Two SA851 in cabinet w/power
5202CA	Two SA850 in cabinet w/power, DDC* Controller, cable and manual				

*Double Density Controller

TRS80		JR INVENTORY CO.,	
MODEL NO.	DESCRIPTION	MODEL NO.	DESCRIPTION
4101C	SA400 in cabinet w/power	C808	Cable for TRS80 Eight-Inch Floppy
8101C II	One SA800 in cabinet w/power for Mod. II	LX80	Double-density expansion interface
8202C II	Two SA800 in cabinet w/power for Mod. II	RS232	Dual Serial Port Option
C802	Cable for Mod. II	16K	16K Byte RAM for LX80 (32KB max.)
C805	Cable for TRS80 Minifloppy	VTOS	4.0 Disk Operating System

P.O. Box 185, Santa Ynez, Ca., 93640
(805) 688-8781

BK PRECISION

Microcomputer-Controlled Autoranging DMM Model 2845



- Computer stabilized accuracy to 0.1%
- Auto-perfection
Selects range for maximum resolution
- Audible continuity indicator
Built-in audible tone generator
- G-MOV overload protection
Provides AC and DC voltage range protection to 1000 VDC or AC peak
- Shielded in RF fields
Accuracy maintained in RF fields
- Long life, high reliability
Four hermetically sealed reed relays perform range switching with virtually no contact wear.
- Microcomputer intelligence
Designed around 4-bit microcomputer. Analyzes stored data and range that provides greatest display resolution. Program memory capacity 1024 x 8 bits of ROM supported by 48 x 4 bits of data memory RAM

... in stock and available for immediate delivery.

Dual Trace 5" 30 MHz Triggered Scope Model 1479A



Sweep/Function Generator Model 3020

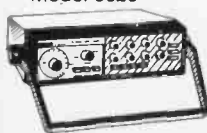

Semiconductor Transistor Tester Model 520B



Portable Digital Capacitance Meter Model 820



Order with Confidence and get the Fordham Advantage!

Call for our prices **TOLL FREE (800) 645-9518**
in N.Y. State call (516) 752-0050

FORDHAM

855 Conklin St. Farmingdale, N.Y. 11735



- Master Charge
- BankAmericard
- VISA • COD
- Money Order
- Check
- COD's extra

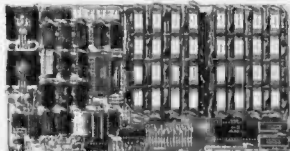

64K BYTE EXPANDABLE RAM

DYNAMIC RAM WITH ON BOARD TRANSPARENT REFRESH GUARANTEED TO OPERATE IN NORTHSTAR, CROMEMCO, VECTOR GRAPHICS, SOL, AND OTHER 8080 OR Z-80 BASED S100 SYSTEMS • 4MHZ Z-80 WITH NO WAIT STATES.
* SELECTABLE AND DESELECTABLE IN 4K INCREMENTS ON 4K ADDRESS BOUNDARIES.
* LOW POWER—8 WATTS MAXIMUM.
* 200NSEC 4116 RAMS.
* FULL DOCUMENTATION.
* ASSEMBLED AND TESTED BOARDS ARE GUARANTEED FOR ONE YEAR AND PURCHASE PRICE IS FULLY REFUNDABLE IF BOARD IS RETURNED UNDAMAGED WITHIN 14 DAYS.

ASSEMBLED / TESTED

64K RAM	\$595.00
48K RAM	\$529.00
32K RAM	\$459.00
16K RAM	\$389.00



S100 MAINFRAME AND CARD CAGE

- * W/ SOLID FRONT PANEL ... \$239.00
- * W/ OUTPUTS FOR 2 MINI-FLOPPIES ... \$239.00
- * 30 AMP POWER SUPPLY ... \$119.00
- * 8 SLOT MOTHERBOARD ... \$149.00
- * 19 SLOT MOTHERBOARD ... \$199.00

16K MEMORY EXPANSION KIT ONLY \$58

FOR APPLE, TRS-80 KEYBOARD, EXIDY, AND ALL OTHER 16K DYNAMIC SYSTEMS USING MK4116-3 OR EQUIVALENT DEVICES.

- ★ 200 NSEC ACCESS, 375 NSEC CYCLE
- ★ BURNED-IN AND FULLY TESTED
- ★ 1 YR. PARTS REPLACEMENT GUARANTEE
- ★ QTY. DISCOUNTS AVAILABLE



VISTA V-200 MINI-FLOPPY SYSTEM

- ★ \$100 DOUBLE DENSITY CONTROLLER
 - ★ 204 KBYTE CAPACITY FLOPPY DISK DRIVE WITH CASE & POWER SUPPLY
 - ★ MODIFIED CPM OPERATING SYSTEM WITH EXTENDED BASIC
- \$695.00**

BETA

COMPUTER DEVICES

1230 W. COLLINS AVE.
ORANGE, CA 92668
(714) 633-7280

Calif. residents please add 6% sales tax. Mastercharge & Visa accepted. Please allow 14 days for checks to clear bank. Phone orders welcome. Shipping charges will be added to all shipments.

32K BYTE MEMORY RELIABLE/COST EFFECTIVE EXPANDABLE RAM FOR 6502 AND 6800 SYSTEM—AIM 65-KIM*SYM*PET-S44-BUS

- * PLUG COMPATIBLE WITH THE AIM-65/SYM EXPANSION CONNECTOR BY USING A RIGHT ANGLE CONNECTOR (SUPPLIED) MOUNTED ON THE BACK OF THE MEMORY BOARD.
- * MEMORY BOARD EDGE CONNECTOR PLUGS INTO THE 6800 S 44 BUS.
- * CONNECTS TO PET OR KIM USING AN ADAPTOR CABLE.
- * RELIABLE—DYNAMIC RAM WITH ON BOARD INVISIBLE REFRESH—LOOKS LIKE STATIC MEMORY BUT AT LOWER COST AND A FRACTION OF THE POWER REQUIRED FOR STATIC BOARDS.
- * USES +5V ONLY, SUPPLIED FROM HOST COMPUTER.
- * FULL DOCUMENTATION, ASSEMBLED AND TESTED BOARDS ARE GUARANTEED FOR ONE YEAR AND PURCHASE PRICE IS FULLY REFUNDABLE IF BOARD IS RETURNED UNDAMAGED WITHIN 14 DAYS.

ASSEMBLED WITH 32K RAM	\$395.00
& WITH 16K RAM	\$339.00
TESTED WITHOUT RAM CHIPS	\$279.00
HARD TO GET PARTS (NO RAM CHIPS) WITH BOARD AND MANUAL	\$109.00
BARE BOARD & MANUAL	\$49.00

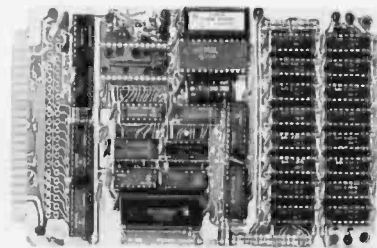

PET INTERFACE KIT—CONNECTS THE 32K RAM BOARD TO A 4K OR 8K PET. CONTAINS: INTERFACE CABLE, BOARD STANDOFFS, POWER SUPPLY MODIFICATION KIT AND COMPLETE INSTRUCTIONS. \$49.00

U.S. PRICES ONLY



NEW LOCATION

1198 E. Willow Street
Signal Hill, CA 90806
(CALL COLLECT)
(213) 595-6431, 6432, 6433

ORDERING INFO

NAME, ADDRESS, PHONE
SHIP BY: UPS OR MAIL
SHIPPING CHRG. & ADD
\$2.00 UP TO (5) LBS.
\$25.00 Minimum Order

TERMS

WE ACCEPT CASH,
CHECK MONEY ORDERS,
VISA & MASTER CHRG.
(U.S. FUNDS ONLY)
TAX: 6% CALIF. RES.

**ATARI MODEL #800
(NEW 16K VERSION)**

- COMPUTER CONSOLE
- ATARI BASIC 8K ROM
- 57 FULL STROKE ALPHANUMERIC KEYS PLUS 4 FUNCTION KEYS
- INVITATION TO PROGRAMMING CASSETTE
- OPERATORS MANUAL
- EDUCATION SYSTEMS MASTER

- JOYSTICKS
 - RF MODULATOR
 - POWER SUPPLY
- CALL FOR PRICE
(IN STOCK)
- 10% OFF SOFTWARE
WITH PURCHASE

**ANACOM GENERAL
MODEL - 150 PRINTER**

- 9 x 9 Matrix
- Impact Dot
- 150 CPS.
- 10 CPI
- 136 Columns
- 94 ASCII Character

- 6 or 8 Lines per Inch
 - Pin Feed & Dual Tractor Drive
 - RS-232 or Parallel Interface
- CALL FOR PRICE

**STATIC & DYNAMIC
RAM CHIPS**

2104's
(4K) DYNAMICS
\$2⁰⁰ ea.
5257-3L
(4K) STATIC
\$5²⁵ ea.

ATARI OPTIONAL ACCESSORIES

- MODEL #810 DISK DRIVE SYSTEM
 - MODEL #820 40-COL. DOT MATRIX PRINTER
 - MODEL #822 40-COL. THERMAL PRINTER
 - MODEL #825 80-COL. DOT MATRIX PRINTER
 - MODEL #830 ACOUSTIC MODEM
 - MODEL #850 INTERFACE MODULE
 - MODEL #CX853 16K RAM MODULE
- CALL FOR PRICE & AVAILABILITY

2114L-3

LO PWR./300NS
1-16 . . . 4.00
17-49 . . . 3.85
50-99 . . . 3.65
100 Up . . 3.40

IN STOCK

4116's ADD-ON
MEMORY
APPLE, TRS-80, HEATH, ETC.
(200NS)/ 8 for \$39.00
16 for \$75.00

**CHRISTMAS
SPECIAL**

2708's

(450 ns.)

\$6.75 ea.
OR
8/\$50.00

ATARI SOFTWARE & ACCESSORIES

- BASKETBALL ROM \$30.00
- SUPER-BREAKOUT ROM \$30.00
- STAR RAIDERS ROM \$45.00
- CHESS ROM \$30.00
- VIDEO EASEL ROM \$30.00
- MUSIC COMPOSER ROM \$45.00
- 3D TIC TAC TOE ROM \$30.00
- JOYSTICKS \$18.00
- PADDLE CONTROLS \$18.00
- #410 CASSETTE RECORDER \$60.00

**S.D. SYSTEMS
NOW AVAILABLE**

- EXPANDORAM I & II
 - VERSAFLOPPY
 - SBC100/SBC200
 - VDB 8024 VIDEO BOARD
 - PROM-100 PROGRAMMER
- KITS & A&T CALL FOR PRICE

**MICROBYTE 32K
STATIC RAM BOARD**

- IEEE/S-100 COMPATIBLE
 - 4K BANK ADDRESSABLE TO ANY 4K SLOT WITHIN 64K BOUNDARY
 - ON BOARD 8-BIT OUTPUT PORT
 - NO DMA RESTRICTIONS
 - 4 MHZ OPERATION
- ASSEMBLED & TESTED **\$475.00**

2716's

5 VOLT ONLY
450 ns.

\$11.00
(PRIME)

**CENTRONICS
MODEL #737-1**

- 80 CPS Proportional Spaced
- Dot Matrix (7 x 9) or (7 x 8)
- 96 Character ASCII
- Parallel Interface

(IN STOCK) \$795.00

8080A

(CERAMIC)
\$2.50 ea.

**CAPACITORS
.1 @ 12 VOLTS
CERAMIC**

11^c ea.
100/\$10.00

**MICROBYTE
(NEW PRODUCTS)**

- Z-80 CPU/I/O BOARD
 - DBL. DENSITY DISK CONTROLLER
 - 64K DYNAMIC RAM BD.
 - 4 PORT I/O BD.
 - D² DISK SYSTEM
- ALL ASSEMBLED & TESTED
CALL FOR PRICE & DELIVERY

ANADIX PRINTERS

MODEL #DP8000 CALL FOR PRICE
MODEL #DP8000 (APPLE) PRICE
MODEL #DP9500 &
MODEL #DP9501 DELIVERY

FEATURES ON DP8000:

- 80 COLUMNS, 112 CPS, BI-DIRECTIONAL, SPROCKET FEED, 9x7 CHARACTER FONT, VARIABLE FORM WIDTH ETC.

VERBATIAM

5 1/4''
SOFT-SECTOR
DISKETTS
BOX OF (10)
\$29.95

**NEW PRODUCTS
AVAILABLE**

- COMMODORE
 - GODBOUT
 - LEEDEX
 - PERSONAL SOFTWARE
 - SANYO
 - SOROC
 - TEXAS INST.
- CALL FOR PRICES

RS232 CONNECTORS

	1-9	10-24	25 Up
DB25P	2.99	2.75	2.45
DB25S	3.80	3.70	3.60

IMSAI CONNECTORS

100 PIN GOLD-SOLDERTAIL
\$2.50 ea.
OR
10/\$2.30 ea.

LO-PRO SOCKETS

	1-99	100 UP
14 PIN	.10	.09
16 PIN	.12	.11
18 PIN	.15	.13
20 PIN	.23	.21
24 PIN	.26	.24
28 PIN	.30	.28
40 PIN	.42	.40

Z-80A

CPU CHIP
NEC #D780C-1
\$10.00 ea.

COMPONENTS

74LS240	\$1.50
74LS241	\$1.40
74LS244	\$1.50
74LS373	\$1.60
74LS374	\$1.60

QUME DT-8

DOUBLE-SIDED/
SGL/DBL DENSITY
8" DISK DRIVES
CALL FOR PRICE

**SHUGART
SA801R**

Bare Drives
Single Sided/
Sgl/DbL Density
CALL FOR PRICE
AND DELIVERY

SA 800/801 DISK DRIVE

1 OR 2 DRIVES INSTALLED, SGL. OR
DBL. DENSITY/SGL.-SIDED, METAL
CABINET, & POWER SUPPLY
(1) SA800/\$775.00 (2) SA800/\$1250.00
(1) SA801/\$795.00 (2) SA801/\$1295.00
1 YR. WARRANTY PARTS & LABOR



CALIFORNIA COMPUTER SYSTEMS

16K RAM BOARD. Fully buffered addressable in 4K blocks. IEEE standard for bank-addressing 2114's. PCB \$28.95 Kit 450 NSEC \$249.95

PT-1 PROTO BOARD. Over 2,600 holes 4" regulators. All S-100 buss functions labeled, gold fingers. PCB \$28.95

PT-2 PROTO BOARD. Similar to PT-1 except set-up to handle solder tail sockets. PCB \$28.95

CCS MAIN FRAME. Kit (S-100) \$339.95

APPLE EXTENDER. Kit \$22.95

APPLE IEEE INSTRUMENTATION INTERFACE KIT 7490. Kit \$275.00

ARITHMETIC PROCESSOR FOR APPLE 7811A. Kit \$350.00

APPLE ASYNCHRONOUS SERIAL INTERFACE 7710A. Kit \$89.95

APPLE SYNCHRONOUS SERIAL INTERFACE 7712A. Kit \$89.95

ALL OTHER CCS PRODUCTS AVAILABLE



PB-1 2708 & 2716 Programming Board with provisions for 4K or 8K EPROM. No external supplies required. Textool sockets. Kit \$143.00

CB-1A 8080 Processor Board. 2K of PROM 256 BYTE RAM power on/rest Vector Jump Parallel port with status. Kit \$146.00 PCB \$31.95

VB-3 80x24 VIDEO BOARD. Graphics included. 4MHZ \$379.95

IO-4 Two serial I/O ports with full handshaking 20/60 ma current loop: Two parallel I/O ports. Kit \$168.00 PCB \$31.95

VB-IC 64 x 16 video board, upper lower case Greek composite and parallel video with software, S-100. Kit \$143.00

CB-2 Z80 CPU BOARD. Kit \$199.95

AIO APPLE SERIAL/PARALLEL \$144.95

ALL OTHER SSM PRODUCTS AVAILABLE

WMC inc. WAMECO INC.

FDC-1 FLOPPY CONTROLLER BOARD will drive shugart, pertek, remic 5" & 8" drives up to 8 drives, on board PROM with power boot up, will operate with CPM™ (not included). PCB \$43.95

FPB-1 Front Panel. IMSAI size, hex displays. Byte, or instruction single step. PCB \$48.50

MEM-1A 8K x 8 fully buffered, S-100, uses 2102 type rams. PCB \$28.95

QM-12 MOTHER BOARD, 13 slot, terminated, S-100 board only \$39.95

CPU-1 8080A Processor board S-100 with 8 level vector interrupt. PCB \$28.95

RTC-1 Realtime clock board. Two independent interrupts. Software programmable. PCB \$25.95

EPM-1 1702A 4K Eprom card. PCB \$25.95

EPM-2 2708/2716 16K/32K EPROM CARD. PCB \$28.95

QM-9 MOTHER BOARD. Short Version of QM-12. 9 Slots. PCB \$33.95

MEM-2 16K x 8 Fully Buffered 2114 Board. PCB \$28.95

PTB-1 POWER SUPPLY AND TERMINATOR BOARD. PCB \$28.95

IOB-1 SERIAL AND PARALLEL INTERFACE. 2 parallel. one serial and cassette. PCB \$28.95

2708.. \$7.50 2114 450 NSEC \$4.99
2716 \$25.95 2114 200 NSEC \$5.99

DEC. SPECIAL SALE ON PREPAID ORDERS
(Charge cards not included on this offer)

WAMECO MEM-3 WITH MIKOS PARTS.
PCBD ... \$31.00. Kit less RAM ... \$85.95
Kit with 2114L-4 \$375.95
Kit with 2114L-2 \$399.95

Order now for special ship mid Jan.

MIKOS PARTS ASSORTMENT WITH WAMECO AND CYBERCOM PCBDS

MEM-2 with MIKOS =7 16K ram with L2114 450 NSEC \$229.95
MEM-2 with MIKOS =13 16K ram with L2114 200 NSEC \$249.95
CPU-1 with MIKOS =2 8080A CPU \$99.95
QM-12 with MIKOS =4 13 slot mother board \$110.95
RTC-1 with MIKOS =5 real time clock \$65.95
EMP-1 with MIKOS =10 4K 1702 less EPROMS \$49.95
EPM-2 with MIKOS =11 16-32K EPROMS less EPROMS \$65.95
QM-9 with MIKOS =12 9 slot mother board \$99.95
FPB-1 with MIKOS =14 all parts for front panel \$144.95

MIKOS PARTS ASSORTMENTS ARE ALL FACTORY MARKED PARTS. KITS INCLUDE ALL PARTS LISTED AS REQUIRED FOR THE COMPLETE KIT LESS PARTS LISTED. ALL SOCKETS INCLUDED.

LARGE SELECTION OF LS TTL AVAILABLE
PURCHASE \$50.00 WORTH OF LS TTL AND GET 10% CREDIT TOWARD ADDITIONAL PURCHASES. PREPAID ORDERS ONLY.

MIKOS

(415) 726-7593

P. O. Box 955 • El Granada, CA 94018
Please send for IC, Xistor and Computer parts list

VISA or MASTERCHARGE. Send account number, interbank number, expiration date and sign your order. Approx. postage will be added. Check or money order will be sent post paid in U.S. If you are not a regular customer, please use charge, cashier's check or postal money order. Otherwise there will be a two-week delay for checks to clear. Calif. residents add 6% tax. Money back 30-day guarantee. We cannot accept returned IC's that have been soldered to. Prices subject to change without notice. \$10 minimum order. \$1.50 service charge on orders less than \$10.00.

C/MOS (HOLE CLAMPED)

7400	1	2	3	4	5	6	7	8	9	10	11	12	13	14	15	16
7401	1	2	3	4	5	6	7	8	9	10	11	12	13	14	15	16
7402	1	2	3	4	5	6	7	8	9	10	11	12	13	14	15	16
7403	1	2	3	4	5	6	7	8	9	10	11	12	13	14	15	16
7404	1	2	3	4	5	6	7	8	9	10	11	12	13	14	15	16
7405	1	2	3	4	5	6	7	8	9	10	11	12	13	14	15	16
7406	1	2	3	4	5	6	7	8	9	10	11	12	13	14	15	16
7407	1	2	3	4	5	6	7	8	9	10	11	12	13	14	15	16
7408	1	2	3	4	5	6	7	8	9	10	11	12	13	14	15	16
7409	1	2	3	4	5	6	7	8	9	10	11	12	13	14	15	16
7410	1	2	3	4	5	6	7	8	9	10	11	12	13	14	15	16
7411	1	2	3	4	5	6	7	8	9	10	11	12	13	14	15	16
7412	1	2	3	4	5	6	7	8	9	10	11	12	13	14	15	16
7413	1	2	3	4	5	6	7	8	9	10	11	12	13	14	15	16
7414	1	2	3	4	5	6	7	8	9	10	11	12	13	14	15	16
7415	1	2	3	4	5	6	7	8	9	10	11	12	13	14	15	16
7416	1	2	3	4	5	6	7	8	9	10	11	12	13	14	15	16
7417	1	2	3	4	5	6	7	8	9	10	11	12	13	14	15	16
7418	1	2	3	4	5	6	7	8	9	10	11	12	13	14	15	16
7419	1	2	3	4	5	6	7	8	9	10	11	12	13	14	15	16
7420	1	2	3	4	5	6	7	8	9	10	11	12	13	14	15	16

CPU & SUPPORT CHIPS

7418	1	2	3	4	5	6	7	8	9	10	11	12	13	14	15	16
7419	1	2	3	4	5	6	7	8	9	10	11	12	13	14	15	16
7420	1	2	3	4	5	6	7	8	9	10	11	12	13	14	15	16
7421	1	2	3	4	5	6	7	8	9	10	11	12	13	14	15	16
7422	1	2	3	4	5	6	7	8	9	10	11	12	13	14	15	16
7423	1	2	3	4	5	6	7	8	9	10	11	12	13	14	15	16
7424	1	2	3	4	5	6	7	8	9	10	11	12	13	14	15	16
7425	1	2	3	4	5	6	7	8	9	10	11	12	13	14	15	16
7426	1	2	3	4	5	6	7	8	9	10	11	12	13	14	15	16
7427	1	2	3	4	5	6	7	8	9	10	11	12	13	14	15	16
7428	1	2	3	4	5	6	7	8	9	10	11	12	13	14	15	16
7429	1	2	3	4	5	6	7	8	9	10	11	12	13	14	15	16
7430	1	2	3	4	5	6	7	8	9	10	11	12	13	14	15	16

INTERFACE TO DRIVERS

7431	1	2	3	4	5	6	7	8	9	10	11	12	13	14	15	16
7432	1	2	3	4	5	6	7	8	9	10	11	12	13	14	15	16
7433	1	2	3	4	5	6	7	8	9	10	11	12	13	14	15	16
7434	1	2	3	4	5	6	7	8	9	10	11	12	13	14	15	16
7435	1	2	3	4	5	6	7	8	9	10	11	12	13	14	15	16
7436	1	2	3	4	5	6	7	8	9	10	11	12	13	14	15	16
7437	1	2	3	4	5	6	7	8	9	10	11	12	13	14	15	16
7438	1	2	3	4	5	6	7	8	9	10	11	12	13	14	15	16
7439	1	2	3	4	5	6	7	8	9	10	11	12	13	14	15	16
7440	1	2	3	4	5	6	7	8	9	10	11	12	13	14	15	16

DATEL'S DAC 08BC - 8 bit DAC - \$9.95

8" DISKETTES - HARD SECTOR \$1.75 10x16.00

CRYSTAL \$3.45 ea

2.000 MHz	6.144 MHz	10.000 MHz
3.000 MHz	8.000 MHz	12.000 MHz
3.57 MHz	18.000 MHz	20.000 MHz
5.000 MHz	20.000 MHz	

RIBBON CABLE FLAT (COLOR CODED) 230 WIRE

15' length	.40/ per foot
40' length	.75/ per foot
50' length	.90/ per foot

RS232 CONNECTORS

DB 25P male	... \$3.25
DB 25S female	... \$4.25
HOODS	... \$1.50

200PRV 1A LASCR .95

LED READOUTS

FCS 8024 - 4 digit		
CC, 8" display	\$6.95 DL 707 C.A. "3"	\$ 7.75
FND 803 C.C. "5"	\$ 8.95 DL 747 C.A. "8"	\$11.50
FND 810 C.A. "5"	\$ 8.95 HP3400, 8" C.C.	\$11.95
DL 704 "3" C.C.	\$ 8.95 HP4005, 8" C.C.	\$11.95

PRINTED CIRCUIT BOARD

4" x 6" DOUBLE SIDED EPOXY BOARD 1/16" thick
\$8.00 ea \$92.80

EPOXY glass vector board
1/16" thick with 1/10" spacing 4 1/2" x 6 1/2" \$1.95

74500	- 30	74520	- 40	745153	- 1.10
74502	- 30	74530	- 40	745151	- 1.25
74505	- 45	74532	- 40	745157	- 1.25
74508	- 40	74589	- 1.00	745158	- 1.25
74511	- 35	74512	- 85	745174	- 1.50
74515	- 40	745140	- 1.00	745256	- 1.95

7 WATT LD-65 LASER DIODE IR \$8.95

25 watt Infra Red Pulse ISO 2006 equiv.
Laser Diode (Spec sheet included) \$24.95

MINIATURE MULTI-TURN TRIM POTS

100, 5K, 10K, 20K, 250K \$7.50 each ... 3/2.00

2N3820 P FET \$.45
2N5467 N FET \$.45
2N2846 UJT \$.45
ER 900 TRIGGER DIODES \$41.00
2N 6026 PROG. UJT \$.85

FP 100 PHOTO TRANS RED/YELLOW OR GREEN LARGE LED'S 2" \$99.00
RED/GREEN BIPOLAR LED'S \$.65
MAL802 R LED \$.75
MAD148 PHOTO DARL. XTDR \$.75
TIL 118 OPTO-ISOLATOR \$.75
1W DPTO-ISOLATOR \$.80
1 WATT ZENER'S: 3.3, 4.7, 5.1, 5.6, 6.8, 8.2, 9.1, 10, 12, 15, 18, or 22V \$99.00

SIC 3301 - 60 PRV 33A FAST RECOVERY DIODE 135ns! \$2.25

Silicon Power Rectifiers

PRV 1A	3A	12A	50A	175A	200A
100	10	10	10	10	10
200	20	20	20	20	20
400	39	35	35	35	35
800	11	30	30	30	30
500	15	35	35	35	35
1000	20	46	46	46	46

IN 4148 (1N914) \$15/100
1 or .01 of 25V ceramic disc. caps. 16/41.00, 20/45.00

REGULATORS

LM317T	\$2.50	340K-12 15 or 20V	\$1.50
323K-5V 3A	\$5.75	340T-5, 6, 8, 12, 15	
79HGK-6V at 5A	\$ 5.95	18 or 24V	\$1.10
723	\$ 5.50	320MS	\$ 7.75
350T-5 12, or 15V	\$1.10	LAS1412 + 12V 3A	\$3.95
LM317CZ	\$ 7.75		

TRANSISTOR SPECIALS

2N1302 PNP GE TO 18	\$1.00	34180	17	34181	17	34182	17
2N1307 PNP GE TO 18	\$1.00	34183	17	34184	17	34185	17
2N1613 PNP GE TO 18	\$1.00	34186	17	34187	17	34188	17
2N1614 PNP GE TO 18	\$1.00	34189	17	34190	17	34191	17
2N1615 PNP GE TO 18	\$1.00	34192	17	34193	17	34194	17
2N1616 PNP GE TO 18	\$1.00	34195	17	34196	17	34197	17
2N1617 PNP GE TO 18	\$1.00	34198	17	34199	17	34200	17
2N1618 PNP GE TO 18	\$1.00	34201	17	34202	17	34203	17
2N1619 PNP GE TO 18	\$1.00	34204	17	34205	17	34206	17
2N1620 PNP GE TO 18	\$1.00	34207	17	34208	17	34209	17
2N1621 PNP GE TO 18	\$1.00	34210	17	34211	17	34212	17
2N1622 PNP GE TO 18	\$1.00	34213	17	34214	17	34215	17
2N1623 PNP GE TO 18	\$1.00	34216	17	34217	17	34218	17
2N1624 PNP GE TO 18	\$1.00	34219	17	34220	17	34221	17
2N1625 PNP GE TO 18	\$1.00	34222	17	34223	17	34224	17
2N1626 PNP GE TO 18	\$1.00	34225	17	34226	17	34227	17
2N1627 PNP GE TO 18	\$1.00	34228	17	34229	17	34230	17
2N1628 PNP GE TO 18	\$1.00	34231	17	34232	17	34233	17
2N1629 PNP GE TO 18	\$1.00	34234	17	34235	17	34236	17
2N1630 PNP GE TO 18	\$1.00	34237	17	34238	17	34239	17
2N1631 PNP GE TO 18	\$1.00	34240	17	34241	17	34242	17
2N1632 PNP GE TO 18	\$1.00	34243	17	34244	17	34245	17
2N1633 PNP GE TO 18	\$1.00	34246	17	34247	17	34248	17
2N1634 PNP GE TO 18	\$1.00	34249	17	34250	17	34251	17
2N1635 PNP GE							

THE STAR MODEM

From Livermore Data Systems



RS232 MODEM
SALE \$135

IEEE 488 MODEM
SALE \$265

STAR Modem is the price performance leader with a full 2 YEAR FACTORY WARRANTY.

KMMM Pascal for PET \$75

- A subset of standard Pascal with extensions
- Machine Language Pascal Source Editor
 - Machine Language P-Code Compiler
 - P-Code Interpreter (for debugging and learning)
 - P-Code to machine language translator for optimized object code
 - Run-time package
 - User Manual and sample programs

Requires 16K minimum. Specify ROM version and disk or tape.

6502	7.45	10/6.95	50/6.55	100/6.15
6502A	8.40	10/7.95	50/7.35	100/6.90
6520 PIA	5.15	10/4.90	50/4.45	100/4.15
6522 VIA	6.90	10/6.50	50/6.10	100/5.70
6532	7.90	10/7.40	50/7.00	100/6.60
2114-L450		4.45	20/4.25	100/3.95
2114-L300		5.65	20/5.35	100/4.95
2716 EPROM		13.45	5/12.75	10/11.85
2732 EPROM				39
4116-200 ns RAM (NEC)				8 for 39.00
6562 Video Interface Controller				10.90
S-100 Wire Wrap \$2.65				Solder Tail 2.15

CASSETTES - AGFA PE-611 PREMIUM

High output, low noise, 5 screw housing, labels.

C-10	10/5.65	50/25.00	100/48.00
C-30	10/7.30	50/34.00	100/66.00

All other lengths available. Write for price list.

ATARI 800 \$777

All Atari Modules 25% OFF

SPECIAL-purchase ATARI 800, receive extra 8K memory FREE.

EDUCATIONAL PLAN - buy 2 ATARI Computers, receive 1 ATARI 400 FREE!

DISKS

(write for quantity prices)

SCOTCH (3M) 8"	10/3.00	50/2.85	100/2.75
SCOTCH (3M) 5"	10/2.95	50/2.80	100/2.70
Maxell 5"	10/3.65	50/3.40	100/3.15
Maxell 8" Double Dens.	10/4.10	50/3.95	100/3.80
Verbatim 5"	10/2.40	50/2.35	100/2.30
(add 1.00 for plastic storage box, 1.25 for hub rings)			
BASF 5"	10/2.40	20/2.35	100/2.30
BASF 8"	10/2.40	20/2.35	100/2.30
Diskette Storage Pages			10 for 3.95
Disk Library Cases	8" - 2.85	5" - 2.15	

FULL FORTH + \$65.00

for APPLE or PET/CBM

A full-featured FORTH with enhancements. Fast and easy to use.

- conforms to FORTH Interest Group Standards
- cross compiler to produce either standard object modules or self contained ROMable modules
- built in macro conditional assembler
- complete string processing capabilities (including variable length strings)
- disk virtual memory for large programs (or small systems!)
- arrays (single or multiple dimensioned)
- full screen cursor controlled editor
- floating point and integer processing
- User's Guide and documentation

A product of IDPC Company

Requires 16K RAM and one disk drive.

Z80A System SPECIAL \$3500

- 64K memory
- 2.4 megabytes disk storage (2 8" 2D drives)
- 2 parallel and 2 serial ports
- CP/M 2.x included

EARL for PET (disk file based) \$65

Editor, Assembler, Relocater, Linker

Generates relocatable object, code using MOS Technology mnemonics.

Disk file input (can edit files larger than memory). Links multiple object programs as one memory load. Listing output to screen or printer.

Commodore CBM-PET SPECIALS

FREE Up to \$235 free merchandise with purchase of one of following CBM-PET items!

8032 32K - 80 column CRT	\$1795	235
8016 16K - 80 column CRT	\$1495	205
8050 Dual Disk Drive—1,000,000 bytes	\$1695	220
CBM Modem - IEEE Interface	\$395	50
CBM Voice Synthesizer	\$395	50
8N full size graphics keyboard	\$795	100
16K Full Size Keyboard	\$995	150
32K Full Size Keyboard	\$1295	205
2040 Dual Disk Drive - 343,000 bytes	\$1295	205
2022 Tractor Feed Printer	\$795	100
C2N External Cassette Deck	\$ 95	12
Used PETs (8, 16, and 32K)		CALL

WRITE FOR SYSTEM PRICES

EDUCATIONAL DISCOUNTS

Buy 2 PET Computers, get 1 FREE

FLEXFILE Database—Report Writer by Michael Riley
Flexible file handler for PET/CBM \$60.00

CBM Full Size Graphics Keyboard	\$ 74
WordPro I - for 8K PET	\$ 25
WordPro II - 16K CBM, disk, printer	\$ 85
WordPro III - 32K CBM, disk, printer	\$170
WordPro IV - 8032, disk, printer	\$255
VISICALC for PET (Personal Software)	\$170
BPI General Ledger, A/P, A/R for PET	\$270
Programmers Toolkit - PET ROM Utilities	\$ 36.90
PET Spacemaker Switch	\$ 22.90

MILOT Intelligent Plotter by Watanabe Instruments (Digiplot)

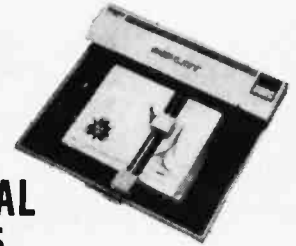

SPECIAL \$1045

- Incorporates all intelligent functions required for producing graphs and drawings including 8 vector and 4 character commands.
- Distance accuracy within 1%, repetition accuracy within .01 inches, programmable step size .004 inches, internal interpolation in .002 steps.
- Solid and broken line types can be specified.
- Character generator for letters, numerals and symbols. Characters can be enlarged and rotated in four orientations.
- Coordinate axes can be drawn by simply specifying the graduation interval and number of repetitions.
- Self test mode automatically draws complete test pattern.
- Printer mode outputs character data in 16 sizes with 4 orientations.
- Connection to any microcomputer using parallel 7-bit ASCII code.
- Can use simple cable to parallel port, or special interface to IEEE or other.
- Modular control circuit and mechanical construction.
- Uses any hard fiber-tip pen.
- Uses 11 x 17 paper.

Includes power supply, I/O connector, 2 pens, 50-sheets of paper, and complete manual.

Dust Cover for PET	\$ 7.90
IEEE-Parallel Printer Interface for PET	\$ 65.00
IEEE-RS232 Printer Interface for PET	\$149.00

Centronics 737 Proportional Spacing Printer	\$800
NEC Spinwriter	\$2450
XYMEC HI-O 1000 Intelligent Daisy Wheel	\$1975
Leedex Video 100 12" Monitor	\$ 129
Zenith Z19 Terminal (factory asm.)	\$ 739
Zenith Z89 with 48K	\$2150
Strobe Model 100 Plotter	\$ 600

SYM-1	\$209
SYM BAS-1 BASIC or RAE-1/2 Assembler	\$ 85
KTM-2/80 Synertek Video Board	\$349
KIM-1 (add \$34 for power supply)	\$159
Seawell Motherboard - 4K RAM	\$195
Seawell 16K Static RAM - KIM, SYM, AIM	\$320

KL-4M Four Voice Music Board and Visible Music Monitor (4 voice) for PET	\$59.90
MICR-REVERSI for PET by Michael Riley	\$ 9.95
machine language version - you can't win at Level 5.	
PAPER-MATE 60 Command PET Word Processor \$29.95 full-featured version by Michael Riley	

A P Products 15% OFF
A P Hobby-Blox 15% OFF



ALL BOOK and SOFTWARE PRICES DISCOUNTED

The 8086 Book (Osborne)	\$12.75
Z8000 Assembly Language Programming (Osborne)	\$10.60
PET Personal Computer Guide (Osborne)	\$12.75
PET and the IEEE-488 Bus (Osborne)	\$12.75
6502 Assembly Language (Osborne)	\$ 9.90
Programming the 6502 (Zaks)	\$10.45
6502 Applications Book (Zaks)	\$10.45
6502 Software Cookbook (Scelbi)	\$ 9.45

WRITE FOR CATALOG.

Add \$1.25 per order for shipping. We pay balance of UPS surface charges on all prepaid orders. Prices listed are on cash discount basis. Regular prices slightly higher.

115 E. Stump Road
Montgomeryville, PA 18936

215-699-5826 **A B Computers**

WAMECO

THE COMPLETE PC BOARD HOUSE

EVERYTHING FOR THE S-100 BUSS

NEW

MEM-3, 32K STATIC RAM BOARD

- * 32K of 2114's
- * Full 24 line address decoding.
(Or bank select like the MEM-2)
- * Expandable in 1K increments.
(Board disabled for unloaded RAM)
- * Bi-directional capability on data lines.
(Board may be used as upper or lower 8 bits on a 16 bit bi-directional buss.)
- * Addressable in 8K boundary within the 64K boundary selected.
- * Kits less RAM \$112.95.
With 2114L-4 \$475.95.
With 2114L-2 \$549.95.
Bare board \$ 35.95.
Available mid January.

FUTURE PRODUCTS: 80 CHARACTER VIDEO BOARD.
Z-80 CPU BOARD WITH ROM, 8 PARALLEL PORT I/O BOARD.

DEALER INQUIRIES INVITED, UNIVERSITY DISCOUNTS AVAILABLE AT YOUR LOCAL DEALER

MOST PRODUCTS FOR IMMEDIATE SHIPMENT. NO 4-8 WEEK DELAYS REQUIRED FOR OTHERS.



WAMECO, INC., P. O. BOX 877 • 455 PLAZA ALHAMBRA • EL GRANADA, CA 94018 • (415) 726-6378

 <p>Dual Trace Oscilloscope HITACHI 30 MHz</p> <ul style="list-style-type: none"> • TV sync-separator circuit • High-sensitivity 1mV/div (5MHz) • Sweep-time magnifier (10 times) • Z-axis input (Intensity modulation) • Signal delay line • X-Y operation • Trace Rotation <p>\$945.00</p> <p>More sensitive to your input</p>	<p>8080A MICRO-PROCESSOR \$5⁹⁵</p>	<p>2708 EPROM \$9⁹⁰</p>	<p>POWER SUPPLY 5 Volt 3 Amp APS 5-3</p>  <p>1.9 \$42.50 10 up \$40.65 25 up \$38.85</p>	
	<p>2114L (450 nS) \$5⁹⁵</p> <p>4116 \$3⁹⁹ (200 nS)</p> <p>CRT CONTROLLER 5037P \$35⁰⁰ 25 UP \$25.00 100 up \$19.00</p>	<p>2716 EPROM \$11⁹⁹ (5 Volt)</p>	<div style="border: 2px solid black; padding: 10px; text-align: center;"> <p>★ 16% ★</p> <p>DISCOUNT COUPON</p> <p>Bring this COUPON into one of our stores or mail to our Mail Order address shown below and receive a 16% DISCOUNT on purchases from this Ad of \$100.00 or more</p> <p>Offer EXPIRES on December 31, 1981</p> <p>NAME _____</p> <p>ADDRESS _____</p> <p>CITY _____ STATE _____</p> <p>ZIP _____ PHONE NO _____</p> <p><small>Coupons accepted only with full name and address filled in.</small></p> </div>	
<p>SD SYSTEMS</p> <p>Z-80 STARTER SYSTEM</p> <p>The Z80 Starter Kit by SD Systems uses the powerful Z80 microprocessor as the heart of the complete micro-computer on a single board. Learn a step-by-step introduction to micro-computers with a keyboard and display, audio cassette interface, PROM programmer, wire-wrap expansion area, 4-channel Counter Timer and on Board RAM and PROM. Complete Operation and Instruction Manual included. ZBUG Monitor in ROM.</p> <p>27004 kit . . . \$340 38007 assem/T . . \$450</p>	<p>Low Cost EPROM Erasing Lamps</p>  <ul style="list-style-type: none"> • SIMPLE TO USE • SAFETY INTERLOCK • ERASES 4 CHIPS IN LESS THAN 20 MINUTES • HIGH INTENSITY 6W LAMP • TUBE RATED AT 5000 HOURS • ERASES 8 CHIPS IN LESS THAN 14 MINUTES • UNMATCHED INTENSITY AT 254 nm • TUBE RATED IN EXCESS OF 10 000 HOURS • ERASES 16 CHIPS IN LESS THAN 7 MINUTES <p>UVS-1E \$85.00 UVS-5AT \$155.00 S-52T \$350.00</p>	<p>AP PRODUCTS</p> <p>923101 \$ 79.95 923102 124.95 923103 124.95</p>		
<p>SBC-100 SINGLE BOARD COMPUTER KIT</p> <p>27003 kit \$295</p>	<p>PROM-100 BOARD KIT PROM Programmer</p> <p>27014 kit \$200</p>	<p>PLESSEY</p> <p>Metallized Polyester Capacitors</p> <p>Series 160 MINIBOX SAMPLER \$28.00</p>	<p>32K Part No. DP1000-2 \$1295</p> <p>SOICRER CONVERTER SPEARS YOUR LANGUAGE FEATURES: 280 4K ROM, 32K RAM - Dual Character I/O - 30 Lines of 84 Characters - 84 Defined Characters - 812 + 240 Graphic Characters - Edge Code Connections to S-100 Bus - Serial and Parallel I/O</p>	
<p>VERSAFLOPPY I FLEXIBLE DISK DRIVE Controller</p>  <p>27002 assem/T . . . \$250 38006 assem/T . . . \$335</p>	<p>VDB-8024 VIDEO DISPLAY BOARD</p>  <p>38013 assem/T . . . \$470</p>	<p>SD Systems EXPANDO RAM</p>  <p>27001 kit \$220 38001 assem/T . . . \$480</p> <p>Add-On RAM Kit 27010 (16K, 8 devices) \$165</p>	<p>SYM-1 NEW LOW PRICE</p>  <p>\$239.00</p> <p>KTM-2 CRT/TV Kbd Term \$349</p>	
<p>MAIL ORDER P O Box 2208Y Culver City CA 90230 (213) 641-4064</p>		<p>PORTLAND 1126 N.E. 82nd Ave Portland, OR 97226 (503) 284-8541</p>	<p>SANTA ANA 1200 I Edinger Ave Santa Ana, CA 92705 (714) 547-8424</p>	<p>CULVER CITY 1080 Jefferson Blvd Culver City, CA 90230 (213) 390-3505</p>
<p>TUCSON 4918 S. W. University Tucson, AZ 85711 (602) 891-2348</p>		<p>HOUSTON 2848 Richmond Houston, TX 77098 (713) 929-3489</p>	<p>ATLANTA 2238 Piedmont Rd. N.E. Atlanta, GA 30306 (404) 261-7100</p>	<p>SUNNYVALE 8254 E. El Camino Road Sunnyvale, CA 94087 (408) 243-4121</p>

VR DATA'S DISK DRIVE HEADQUARTERS

**DISK HEAD
CLEANERS**
5-1/4" \$14.95
8" 3M CLEANER
\$24.95

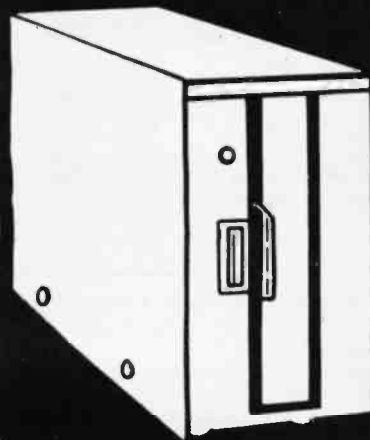

77 TRACK DRIVES \$545

TRS-80 Model I compatible
NEW LOW PRICE

40 TRACK DRIVES \$340

TRS-80 Model I compatible
NEW LOW PRICE

● ORDER NOW TOLL FREE 1 (800) 345-8102

● IN PENNSYLVANIA (215) 461-5300 ●

**MODEL II
OVERSTOCK SALE**

**64K
\$3400.**

**6.3 MEG
HARD DISK
WINCHESTER**

Superbrain, Apple, TRS-80
\$2445.

SUPERBRAIN™
BY INTERTEC
64K \$2995.00

complete with
5.1/4" disk drives • in stock



● TRS-80 Disk & Other Mysteries \$22.95 ●

**MINI DISK DRIVE
EXTENDER BOARD**

\$14.95

**EXTENDED 1 YEAR
WARRANTY**

MINI DISK DRIVES **\$45.00**
Call For Details

SOFTWARE	MOD. I	MOD. II		
Word Processing (Magic Wand)		300	4K L II TRS-80	575.70
General Ledger	\$149.95	249	16K L II	789.60
Payroll	99.95	199	RS-232	92.10
Data Base	149.95	299	OK Expansion Interface	278.10
	Tape	Disk	16K Expansion Interface	376.10
Upper/Lower Case Modification	\$19.95	\$24.95	32K Expansion Interface	474.10
Comprehensive Diagnostics	34.95	34.95	Telephone Modem	179.95
CP/M		\$175.00	Emulator CRT by Intertec	895.00
New DOS + 40 TK		100.00	CRT Stands	from 139.00
New DOS/80		145.00	Anti-static Mats	110.00

Software Documentation Available • CALL FOR PRICES

EPA 250*

*Electronic Printing Ability 250 wpm.

**DAISY WHEEL
PRINTER**

\$2195.

by VR Data

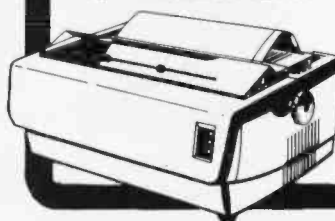

*Parallel or Serial Interface

*25 cps, 45 cps
Optional (Add \$600.)

*Tractors Optional
(Add \$250.)

● VISIT OUR NEW WAREHOUSE SHOWROOM AND REPAIR CENTER ●

VR Data

777 HENDERSON BLVD.

FOLCROFT, PA 19032

WE SERVICE MANY BRANDS OF COMPUTER EQUIPMENT.
CALL FOR CONSULTATION AND ESTIMATE.

DEALER INQUIRES INVITED • BIDS ACCEPTED • ABOVE PRICES
ARE CASH DISCOUNTED, CALL FOR OTHER TERMS.

ORDER NOW • TOLL FREE 1 (800) 345-8102 • IN PENNSYLVANIA (215) 461-5300



BECKIAN ENTERPRISES

ALL PRIME QUALITY — NEW PARTS ONLY
SATISFACTION GUARANTEED.

EDGE CARD CONNECTORS: GOLD PLATED:

Abbreviations: S/E Solder Eye, S/T Sold Tail; W/W Wire Wrap.

PART # DESCRIPTION.	Row Sp.	1-9pc.	10-24pcs.	25pcs. Up.
BRAND: TEXAS INST.				
4070 50/100 Imsai/Crom.	.250	\$3.95ea.	\$3.55ea.	\$3.15ea.
4090 50/100 Imsai W/W	.250	4.30ea.	3.85ea.	3.45ea.
BRAND: SULLINS: U.I. Reg.				
129865 50/100 Solder Eye	.140	6.80ea.	6.10ea.	5.45ea.
129870 50/100 S/T Imsai	.250	4.50ea.	4.10ea.	3.70
129875 50/100 W/W Imsai	.250	5.25	4.75	4.20
129885 50/100 S/T Altair	.140	4.95	4.45	3.95
129890 50/100 S/T Cromem.	.250	4.75	4.25	3.80

OTHER .125" CONTACT CTR CONNECTORS:				
12305 22/44 S/E No Ears	.140	4.15	3.75	3.35
12759 36/72 S/T	.140	5.40	4.85	4.35
12790 40/80 W/W	.250	6.30	5.65	5.00

.100" CONTACT CTR CONNECTORS:				
10048 13/26 S/E No Ears	.140	3.40	3.05	2.15
10290 25/50 S/E TRS 80	.140	4.50	4.05	3.60
10175 20/40 S/E TRS 80	.140	5.85	5.35	4.75
10180 20/40 W/W TRS 80	.200	3.30	3.00	2.15
10190 20/40 S/T TRS 80	.140	3.20	2.80	2.55
10485 36/72 S/E Vector	.140	5.50	4.90	4.40
10490 36/72 W/E Vector	.200	5.80	5.25	4.65
10500 36/72 S/T Vector	.140	5.70	4.20	4.60
10535 40/80 S/E PET	.140	5.85	5.35	4.75
10540 40/80 W/W PET	.200	6.00	5.40	4.80
10550 40/80 S/T PET	.140	5.80	5.25	4.65
10585 43/86 S/E COS/ELF	.140	6.95	6.25	5.55
10605 43/86 S/T COS/ELF	.140	6.80	6.15	5.50
10595 43/86 W/W COS/ELF	.200	6.90	6.20	5.95
10615 43/86 S/T COS/ELF	.200	8.80	8.10	5.40

.156" CONTACT CENTER CONNECTORS.				
PART # DESCRIPTION.	Row Sp.	1-9pc.	10-24pcs.	25pcs. Up.
15105 6/12 S/E PET/NSC	.140	\$1.60	\$1.65	\$1.45
15110 6/12 S/T PET/NSC	.140	1.85	1.85	1.50
15137 6/12 S/T PET/NSC	.200	1.80	1.54	1.45
15175 6/ S/E Sgle Row		1.70	1.50	1.30
15270 10/20 S/T	.140	2.15	1.95	1.70
15275 10/20 S/E	.140	2.00	1.85	1.80
15435 12/24 S/E PET	.140	2.60	2.35	2.10
15440 12/24 S/T PET	.140	2.65	2.40	2.15
15445 12/24 S/T PET	.200	2.75	2.50	2.20
15505 15/30 S/E GRI Key	.140	2.50	2.25	2.00
15510 15/30 S/T GRI Key	.140	2.40	2.15	2.95
15515 15/30 W/W GRI Key	.200	2.80	2.35	2.10
15600 18/36 S/E	.140	3.35	3.05	2.70
15610 18/36 S/T	.140	3.00	2.70	2.40
15615 18/36 W/W	.200	3.60	3.20	2.90
15700 22/44 S/E KIM/VEC	.140	2.98	2.90	2.75
15705 22/44 S/T KIM/VEC	.140	3.98	3.30	3.00
15710 22/44 W/W KIM/VEC	.200	3.49	3.20	2.85
15875 25/50 S/E	.140	4.85	4.20	3.75
15880 25/50 S/T	.140	4.55	4.10	3.65
15885 25/50 W/W	.200	4.85	4.35	3.90
16115 36/72 S/E	.140	8.50	5.85	5.20
16120 36/72 S/T	.140	8.55	5.90	5.25
16125 36/72 W/W	.200	6.75	6.10	5.40
16145 36/72 S/T	.200	6.50	5.85	5.20
16235 43/86 S/T Mot 8800	.140	6.80	5.95	5.30
16240 43/86 W/W Mot 8800	.200	7.80	7.05	6.25
16260 43/86 S/T Mot 8800	.200	6.50	5.85	5.20
16725 43/86 S/E Mot 8800	.140	7.20	6.50	5.75
K-1 Pol/Keys		.15	.12	.10

'D' TYPE SUBMINIATURE CONNECTORS.				
PART NUMBER	DESCRIPTION.	1-9pcs.	10-24pcs.	25-99pcs.
DE 9P	Male	\$1.60ea.	\$1.40ea.	\$1.30ea.
DE 9S	Female	2.25ea.	2.00ea.	1.90ea.
DE 110983-1	2 pc. Gray Hood.	1.50ea.	1.35ea.	1.20ea.
DA 15P	Male	2.35ea.	2.15ea.	2.00ea.
DA 15S	Female	3.25ea.	3.10ea.	2.90ea.
DA 51211-1	1 pc. Gray Hood	1.40ea.	1.20ea.	1.15ea.
DA 51228-1	2 pc. Black Hood	2.50ea.	2.25ea.	2.00ea.
DA 110983-2	2 pc. Gray Hood	1.60ea.	1.35ea.	1.30ea.
DB 25P	Male	2.80ea.	2.60ea.	2.40ea.
DB 25S	Female	3.80ea.	3.40ea.	3.20ea.
DB 51212-1	1 pc. Gray Hood	1.50ea.	1.30ea.	1.10ea.
DB 51228-1	2 pc. Black Hood	1.90ea.	1.85ea.	1.45ea.
DB 110983-3	2 pc. Gray Hood	1.75ea.	1.50ea.	1.35ea.
DC 37P	Male	4.20ea.	4.00ea.	3.70ea.
DC 37S	Female	6.00ea.	5.75ea.	5.50ea.
DC 110983-4	2 pc. Gray Hood	2.25ea.	2.00ea.	1.75ea.
DD 50P	Male	5.50ea.	5.10ea.	4.75ea.
DD 50S	Female	9.40ea.	8.60ea.	8.00ea.
DD 51218-1	1 pc. Gray Hood	2.40ea.	2.20ea.	2.00ea.
DD 110983-5	2 pc. Gray Hood	2.80ea.	2.40ea.	2.10ea.
D 20418-2	Hardware Set (1 Hood Set)	.90ea.	.80ea.	.70ea.

I.C. SOCKETS GOLD. W/WRAP 3 TURN	
14 pin	\$0.40 ea.
16 pin	0.44 ea.
8080A PRIME.	
\$5.00 ea.	
EIA 8 CONDUCTOR CABLES 8ft. Long. CLASS #1 Type Cables.	
1. to 4 pcs.	\$22.00
5 to 9 pcs.	19.00

I.C. SOCKETS TIN.	
14 pin	\$0.15 ea.
16 pin	0.17 ea.
CONNECTORS FOR CENTRONICS 700 SERIES. Amphenol 57-30380	
1 to 4 pcs.	\$8.00 ea.
5 to 9 pcs.	6.00 ea.

COOLING FANS. Extra Quiet.	
1 to 4	\$18.00 ea.
5 to 9	17.00 ea.
PHONE: 213-988-6196	
MAIL ORDERS TO:	

TERMS: MINIMUM ORDER: \$15.00 ADD \$1.35 For Handling & Shipping. Orders over \$30.00 in the U.S.A. We Pay the Shipping. CALIF. RESIDENTS: Please Add 6% Sales Tax.

NOTE: NO C.O.D. OR CREDIT CARD ORDERS WILL BE ACCEPTED.

BECKIAN ENTERPRISES
P.O. BOX #3089
SIMI VALLEY, CA 93063



apple computer

\$975 16K

APPLE II OR APPLE II PLUS

October Special Additional 10.00 off on most items.

<p>32K \$1050</p> <p>DISK II-DRIVE ONLY \$429</p> <p>NEW DOS 3.3 535</p> <p>MODEM IIB W/INTERFACE 339</p> <p>MODEM IIB ONLY (Novation Cat.) 159</p> <p>GRAPHICS TABLET 659</p> <p>SILENTYPE PRINTER W/Apple Interface 519</p> <p>APPLE COMPUTER INTERFACE CARDS</p> <p>PROTOTYPING/HOBBY CARD \$22</p> <p>PARALLEL PRINTER INTERFACE CARD. 145</p> <p>COMMUNICATION CARD & DB25 Connector Cable 185</p> <p>HI-SPEED SERIAL INTERFACE CARD 155</p> <p>LANGUAGE SYSTEM WITH PASCAL 429</p> <p>CENTRONICS PRINTER INTERFACE CARD 185</p> <p>APPLESOT II FIRMWARE CARD W/Auto-Start ROM 149</p> <p>INTEGER BASIC FIRMWARE CARD W/Mon. & Prog. Aid ROMS 149</p> <p>ADD-ONS</p> <p>16K MEMORY UPGRADE (TRS-80, Apple, Sorcerer) \$69</p> <p>ABT NUMERIC INPUT KEYPAD (Old or New Hybrid) 119</p> <p>ALF MUSIC SYNTH/SIZER 239</p> <p>ALF TIMING W/O INPUT BOARD. 19</p> <p>BRIGHTPEN LIGHTPEN from SOFTAPE. 32</p> <p>CALIFORNIA COMPUTER SYSTEMS 12K ROM/PRDM ASSEMBLED BOARD NO. 7114A \$69</p>	<p>48K \$1125</p> <p>PROGRAMMABLE TIMER MODULE No. 7440A 145</p> <p>3+ DIGIT BCD ANALOG TO DIGITAL CONVERTER 135</p> <p>GPIB IEEE-488 (I/978) INTERFACE No. 7490A 259</p> <p>ASYNCHRONOUS SERIAL INTERFACE No. 7710A 145</p> <p>SYNCHRONOUS SERIAL INTERFACE NO. 7712A 145</p> <p>PARALLEL INTERFACE No. 7720A 109</p> <p>ARITHMETIC PROCESSOR CARD NO. 7811B 339</p> <p>WIRE WRAP BOARD 20</p> <p>SOLDER TAIL BOARD 20</p> <p>EXTENDER BOARD 24</p> <p>PCB ETCH BOARD 20</p> <p>CORVUS</p> <p>CORVUS 10 MEGABYTE HARD DISK DRIVE SYSTEM \$4495</p> <p>CORVUS MIRROR (VTR Required) 695</p> <p>CORVUS MIRROR2 (VTR Required) 795</p> <p>CORVUS CONSTELLATION 595</p> <p>DAN PAYMAR LOWER CASE ADAPTER CALL HAYES MICROMODEM II[®] HURISTICS 319</p> <p>SPEECHLINK 2000 (64 Word Vocabulary) 219</p> <p>SPEECHLAB 20A (Cassette) 169</p> <p>SPEECHLAB 20A (Diskette) 189</p> <p>MODEL 70 CONTROLLER 75</p> <p>M&R SUP-R-MOD TV MODULATOR ADAPTER 77</p>	<p>M&R SUP-R-TERMINAL: 80 COLUMN BOARD 339</p> <p>MICROSOFT Z-80 SOFTCARD SYSTEM W/CP/M 299</p> <p>MICROWORKS DS-65 DIGISECTOR MOUNTAIN HARDWARE 339</p> <p>APPLE CLOCK/CALENDAR CARD 229</p> <p>SUPER TALKER SPEECH SYNTHESIZER SYSTEM 249</p> <p>ROMPLUS - w/KEYBOARD FILTER 169</p> <p>ROMPLUS - w/KEYBOARD FILTER 155</p> <p>INTROL X-10 REMOTE CONTROL SYSTEM 249</p> <p>INTROL X-10 CONTROLLER ONLY 169</p> <p>ROMWRITER SYSTEM 159</p> <p>PROGRAMMA APPLE JOYSTICK 39</p> <p>SEE-THRU CLEAR PLASTIC TOP FOR APPLE II 23</p> <p>SSM A10 SERIAL/PARALLEL I/O CARD (KIT) 129</p> <p>SSM A10 ASSEMBLED & TESTED 169</p> <p>SYMTEC</p> <p>APPLE LIGHT PEN SYSTEM 219</p> <p>SUPER SOUND GENERATOR (MONO) 139</p> <p>SUPER SOUND GENERATOR (STEREO) 229</p> <p>5x8 INCH DISK DRIVE CONTROLLER CARD 339</p> <p>VERSA WRITER DIGITIZER DRAWING SYSTEM 219</p> <p>VIDEX VIDEO TERM 80 COLUMN CARD 319</p> <p>VIDEX VIDEO TERM W/GRAPHICS EPROM 339</p>	<p>APPLE II & APPLE II PLUS SOFTWARE</p> <p>PASCAL with LANGUAGE SYSTEM \$429</p> <p>FORTRAN for use with LANGUAGE SYSTEM 169</p> <p>CP/M for use with MICROSOFT Z-80 SOFTCARD 299</p> <p>THE CONTROLLER General Business System 519</p> <p>THE CASHIER Retail Management & Inventory 199</p> <p>APPLEWRITER Word Processor 65</p> <p>APPLEPOST Mailing List System 45</p> <p>APPLEPOST Graph & Plot System 85</p> <p>DOW JONES PORTFOLIO EVALUATOR 45</p> <p>CONTRIBUTED VOLUMES I THRU 5 w/ MANUALS 35</p> <p>VISI-CALC by PERSONAL SOFTWARE DESKTOP/PLAN by DESKTOP COMPUTERS 85</p> <p>CCA DATA MANAGEMENT by PERSONAL SOFTWARE Management System 73</p> <p>ADVENTURE by MICROSOFT 27</p> <p>SUB-LOGIC FS-1 Flight Simulator 23</p> <p>SARGON II Chess by HAYDEN (Cass) 27</p> <p>SARGON II Chess on Diskette 32</p> <p>Bill Budge's TRIOLOGY of GAMES 27</p> <p>HAZELTINE 1510 1079</p> <p>HAZELTINE 1510 1079</p> <p>HAZELTINE 1520 1379</p> <p>HAZELTINE 1410 749</p> <p>HAZELTINE 1420 829</p> <p>FORTH II by PROGRAMMA SOFTWARE 45</p> <p>SINGLE DISK COPY ROUTINES 17</p> <p>APPLEBUG ASSEMBLER/DISASSEMBLER 79</p> <p>APPLEBUG DEBUGGER 27</p> <p>APPLESOT UTILITY PROGRAMS by HAYDEN 27</p> <p>PRINTERS, TERMINALS & MONITORS</p> <p>PRINTERS, TERMINALS & MONITORS ANADIX DP8000 or DP800AP \$795</p> <p>ANADIX DP9500 or DP9501 1395</p> <p>BASE 2 w/ TRACTOR & BUFFER 599</p> <p>CENTRONICS 700-9 1099</p> <p>CENTRONICS 737 849</p> <p>MPI 88T 699</p> <p>PAPER TIGER IDS 340 895</p> <p>W/GRAPHICS OPTION 995</p> <p>NEC SUPERWRITER 5530 or 5510 2595</p> <p>TRENDCOM 100 379</p> <p>TRENDCOM 200 529</p> <p>LEDEX VIDEO 100 139</p> <p>SANYO 9 INCH B&W MONITOR 159</p> <p>SANYO 15 INCH MONITOR 249</p> <p>TI 13 INCH COLOR MONITOR 429</p> <p>SOROC IQ 120 729</p> <p>SOROC IQ 140 1199</p> <p>HAZELTINE 1500 979</p> <p>HAZELTINE 1510 1079</p> <p>HAZELTINE 1520 1379</p> <p>HAZELTINE 1410 749</p> <p>HAZELTINE 1420 829</p>
---	---	---	--

ORDERING INFORMATION: Photo orders may be placed using Visa, MasterCard or Bank wire transfer. Mail orders may send check, card number, include expiration date, cashiers check, money order or personal check (allow 2 weeks to clear). Please include telephone number with all orders. Foreign orders include shipping and handling. US \$1.00 per lb for air. No COD's or part time orders. All prices subject to change and availability. Equipment is new and complete with manufacturer's warranty.



"WE WILL NOT BE UNDER SOLD!"

COMPUTER SPECIALTIES

1251 BROADWAY
EL CAJON, CA. 92021 • (714) 578-0330



P.O. Box 44300
Santa Clara, CA 95054
Will call: 2322 Walsh Ave.
(408) 988-1640

Same day shipment. First line parts only. Factory tested. Guaranteed money back. Quality IC's and other components at factory prices.

INTEGRATED CIRCUITS

7400N	20	LM339N-1	1.50	CD4027	2.50	1116 200ns	7.25	CONNECTORS	66	30 pin edge	2.50
7402N	20	LM330N-1	1.50	CD4028	2.50	B4116 200ns	6.30	25 Pin Edge	85	25 Pin Edge	2.75
7404N	20	LM330N-1	1.50	CD4029	2.50	25 Pin Edge	4.00	44 pin edge	25	100 pin edge	3.00
7408N	23	LM320T-1	1.35	CD4030	2.50	100 pin edge	4.00	100 pin edge	25	100 pin edge	3.00
7415N	20	LM330T-1	1.35	CD4035	2.50	100 pin edge	3.00	100 pin edge	25	100 pin edge	3.00
7418N	20	LM330T-1	1.35	CD4040	2.50	100 pin edge	3.00	100 pin edge	25	100 pin edge	3.00
7422N	20	LM339N	1.40	CD4042	2.50	100 pin edge	3.00	100 pin edge	25	100 pin edge	3.00
7429N	20	LM339N	1.40	CD4042	2.50	100 pin edge	3.00	100 pin edge	25	100 pin edge	3.00
7447N	58	LM330K-8	1.35	CD4046	2.50	100 pin edge	3.00	100 pin edge	25	100 pin edge	3.00
7448N	58	LM330K-8	1.35	CD4046	2.50	100 pin edge	3.00	100 pin edge	25	100 pin edge	3.00
7449N	58	LM330K-15	1.35	CD4050	2.50	100 pin edge	3.00	100 pin edge	25	100 pin edge	3.00
7474N	37	LM330K-24	1.35	CD4051	2.50	100 pin edge	3.00	100 pin edge	25	100 pin edge	3.00
7475N	37	LM330K-24	1.35	CD4051	2.50	100 pin edge	3.00	100 pin edge	25	100 pin edge	3.00
7476N	37	LM330K-15	1.35	CD4050	2.50	100 pin edge	3.00	100 pin edge	25	100 pin edge	3.00
7477N	37	LM330K-15	1.35	CD4050	2.50	100 pin edge	3.00	100 pin edge	25	100 pin edge	3.00
7478N	37	LM330K-15	1.35	CD4050	2.50	100 pin edge	3.00	100 pin edge	25	100 pin edge	3.00
7479N	37	LM330K-15	1.35	CD4050	2.50	100 pin edge	3.00	100 pin edge	25	100 pin edge	3.00
7480N	37	LM330K-15	1.35	CD4050	2.50	100 pin edge	3.00	100 pin edge	25	100 pin edge	3.00
7481N	37	LM330K-15	1.35	CD4050	2.50	100 pin edge	3.00	100 pin edge	25	100 pin edge	3.00
7482N	37	LM330K-15	1.35	CD4050	2.50	100 pin edge	3.00	100 pin edge	25	100 pin edge	3.00
7483N	37	LM330K-15	1.35	CD4050	2.50	100 pin edge	3.00	100 pin edge	25	100 pin edge	3.00
7484N	37	LM330K-15	1.35	CD4050	2.50	100 pin edge	3.00	100 pin edge	25	100 pin edge	3.00
7485N	37	LM330K-15	1.35	CD4050	2.50	100 pin edge	3.00	100 pin edge	25	100 pin edge	3.00
7486N	37	LM330K-15	1.35	CD4050	2.50	100 pin edge	3.00	100 pin edge	25	100 pin edge	3.00
7487N	37	LM330K-15	1.35	CD4050	2.50	100 pin edge	3.00	100 pin edge	25	100 pin edge	3.00
7488N	37	LM330K-15	1.35	CD4050	2.50	100 pin edge	3.00	100 pin edge	25	100 pin edge	3.00
7489N	37	LM330K-15	1.35	CD4050	2.50	100 pin edge	3.00	100 pin edge	25	100 pin edge	3.00
7490N	37	LM330K-15	1.35	CD4050	2.50	100 pin edge	3.00	100 pin edge	25	100 pin edge	3.00
7491N	37	LM330K-15	1.35	CD4050	2.50	100 pin edge	3.00	100 pin edge	25	100 pin edge	3.00
7492N	37	LM330K-15	1.35	CD4050	2.50	100 pin edge	3.00	100 pin edge	25	100 pin edge	3.00
7493N	37	LM330K-15	1.35	CD4050	2.50	100 pin edge	3.00	100 pin edge	25	100 pin edge	3.00
7494N	37	LM330K-15	1.35	CD4050	2.50	100 pin edge	3.00	100 pin edge	25	100 pin edge	3.00
7495N	37	LM330K-15	1.35	CD4050	2.50	100 pin edge	3.00	100 pin edge	25	100 pin edge	3.00
7496N	37	LM330K-15	1.35	CD4050	2.50	100 pin edge	3.00	100 pin edge	25	100 pin edge	3.00
7497N	37	LM330K-15	1.35	CD4050	2.50	100 pin edge	3.00	100 pin edge	25	100 pin edge	3.00
7498N	37	LM330K-15	1.35	CD4050	2.50	100 pin edge	3.00	100 pin edge	25	100 pin edge	3.00
7499N	37	LM330K-15	1.35	CD4050	2.50	100 pin edge	3.00	100 pin edge	25	100 pin edge	3.00
7500N	37	LM330K-15	1.35	CD4050	2.50	100 pin edge	3.00	100 pin edge	25	100 pin edge	3.00

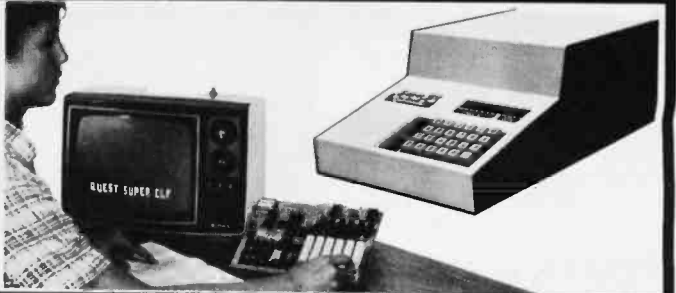

RCA Cosmac 1802 Super Elf Computer \$106.95

Compare features before you decide to buy another computer. There is no other computer on the market today that has all the desirable benefits of the Super Elf for so little money. The Super Elf is a small single board computer that does many big things. It is an excellent computer for training and for learning programming with its machine language and yet it is easily expanded with additional memory, Full Basic, ASCII Keyboards, video character generation, etc. Before you buy another small computer, see if it includes the following features: ROM monitor; State and Mode displays; Single step; Optional address displays; Power Supply; Audio Amplifier and Speaker; Fully socketed for all IC's. Real cost of in warranty repairs; Full documentation.

The Super Elf includes a ROM monitor for program loading, editing and execution with SINGLE STEP for program debugging which is not included in others at the same price. With SINGLE STEP you can see the microprocessor chip operating with the unique Quest address and data bus displays before, during and after executing instructions. Also, CPU mode and instruction cycle are decoded and displayed on 8 LED indicators.

An RCA 1861 video graphics chip allows you to connect to your own TV with an inexpensive video modulator to do graphics and games. There is a speaker system included for writing your own music or using many music programs already written. The speaker amplifier may also be used to drive relays for control purposes.

A 24 key HEX keyboard includes 16 HEX keys plus load, reset, run, wait, input, memory protect, monitor select and single step. Large, on board displays provide output and optional high and low address. There is a 44 pin standard connector slot for PC cards and a 50 pin connector slot for the Quest Super Expansion Board. Power supply and sockets for all IC's are included in the price plus a detailed 127 pg. instruction manual which now includes over 400 pgs. of software info, including a series of lessons to help get you started and a music program and graphics target game. Many schools and universities are using the Super Elf as a course of study. OEM's use it for training and R&D.

Remember, other computers only offer Super Elf features at additional cost or not at all. Compare before you buy. Super Elf Kit \$106.95, High address option \$8.95, Low address option \$9.95. Custom Cabinet with drilled and labelled plexiglass front panel \$24.95. All metal Expansion Cabinet, painted and silk screened, with room for 5 S-100 boards and power supply \$57.00. NiCAD Battery Memory Saver Kit \$6.95. All kits and options also completely assembled and tested.

Questdata, a software publication for 1802 computer users is available by subscription for \$12.00 per 12 issues. Single issues \$1.50. Issues 1-12 bound \$16.50.

Tiny Basic Cassette \$10.00, on ROM \$38.00, original Elf kit board \$14.95, 1802 software; Moews Video Graphics \$3.50. Games and Music \$3.00, Chip 8 Interpreter \$5.50.

A 24 key HEX keyboard includes 16 HEX keys plus load, reset, run, wait, input, memory protect, monitor select and single step. Large, on board displays provide output and optional high and low address. There is a 44 pin standard connector slot for PC cards and a 50 pin connector slot for the Quest Super Expansion Board. Power supply and sockets for all IC's are included in the price plus a detailed 127 pg. instruction manual which now includes over 400 pgs. of software info, including a series of lessons to help get you started and a music program and graphics target game. Many schools and universities are using the Super Elf as a course of study. OEM's use it for training and R&D.

Super Expansion Board with Cassette Interface \$89.95

This is truly an astounding value! This board has been designed to allow you to decide how you want it optioned. The Super Expansion Board comes with 4K of low power RAM fully addressable anywhere in 64K with built-in memory protect and a cassette interface. Provisions have been made for all other options on the same board and it fits neatly into the hardware cabinet alongside the Super Elf. The board includes slots for up to 6K of EPROM (2708, 2758, 2716 or TI 2716) and is fully socketed. EPROM can be used for the monitor and Tiny Basic or other purposes.

A 1K Super ROM Monitor \$19.95 is available as an on board option in 2708 EPROM which has been preprogrammed with a program loader/editor and error checking multi file cassette read/write software. (relocatable cassette file) another exclusive from Quest. It includes register save and readout, block move capability and video graphics driver with blinking cursor. Break

Announcing Quest Super Basic—SECOND GENERATION

A new enhanced version of Super Basic now available. Quest was the first company worldwide to ship a full size Basic for 1802 Systems. A complete function Super Basic by Ron Center including floating point capability with scientific notation (number range ± 17E⁹⁹), 32 bit integer ± 2 billion; multi dim arrays, string arrays; string manipulation; cassette I/O; save and load, basic, data and machine language programs; and over 75 statements, functions and operations.

Gremlin Alpha Video Kit \$69.95
32 x 16 alpha/numerics and graphics; up to 8 colors with 6847 chip; 1K RAM at E000. Plugs Into Super Elf 44 pin bus. No high res. graphics. On board RF Modulator Kit \$4.95

1802 16K Dynamic RAM Kit \$149.00
Expandable to 32K. Hidden refresh w/clocks up to 4 MHz w/no wait states. Addl. 16K RAM \$63.00

Super Elf 44 pin expansion board; 3 female and 1 male bus. Board plus 3 connectors \$22.95

Tiny Basic Extended on Cassette \$15.00
(added commands include Stringy, Array, Cassette I/O etc.)

S-100 4-Slot Expansion \$ 9.95
Super Monitor VI.1 Source Listing \$15.00

Super Color S-100 Video Kit \$129.95
Expandable to 256 x 192 high resolution color graphics. 6847 with all display modes computer controlled. Memory mapped. 1K RAM expandable to 6K. S-100 bus 1802, 8080, 8085, 280 etc.

Editor Assembler \$25.00
(Requires minimum of 4K for EA plus user source)

1802 Tiny Basic Source Listing \$19.00
Super Monitor V2.0.2.1 Source Listing \$20.00

PROM Eraser

assembled 25 PROM capacitor \$37.50 (with timer \$69.50). 6 PROM capacitor OSHA/UL version \$69.50 (with timer \$94.50).

Z80 Microcomputer

16 bit I/O. 2 MHz clock. 2K RAM. ROM Breadboard space. Excellent for control. Bare Board \$28.50. Full Kit \$99.00. Monitor \$20.00. Power Supply Kit \$35.00. Tiny Basic \$30.00.

S-100 Computer Boards

8K Static Godbout Econo IIA Kit 145.00
16K Static Godbout Econo XIV Kit 285.00
24K Static Godbout Econo VIIA-24 Kit 435.00
32K Static Godbout Econo X-32 Kit 575.00
16K Dynamic RAM Kit 199.00
32K Dynamic RAM Kit 310.00
64K Dynamic RAM Kit 470.00
Video Interface Kit \$133.00

801C Update Master Manual \$55.00
Comp. IC data selector. 2700 pg. master reference guide. Over 51,000 cross references. Free update service through 1980. Domestic postage \$3.50.

Modem Kit \$60.00
State of the art. orig., answer. No tuning necessary. 103 compatible 300 baud. Inexpensive acoustic coupler plans included.

LRC 7000 + Printer \$389.00
40/20 column dot matrix impact. std. paper. Interface all personal computers.
64/40/32/20 version \$405.00. Optional cables available.

LRC 7000 printer interface cable for Super Elf with software \$26.00

NiCad Battery Fixer/Charger Kit

Opens shortened cells that won't hold a charge and then charges them up. All in one kit w/full parts and instructions. \$7.25

Rockwell AIM 65 Computer

6502 based single board with full ASCII keyboard and 20 column thermal printer. 20 char. alphanumeric display. ROM monitor, fully expandable. \$375.00. 4K version \$450.00. 4K Assembler \$85.00. 8K Basic Interpreter \$100.00.

Special small power supply for AIM65 assem. in frame \$54.00. Complete AIM65 in tin briefcase with power supply \$499.00. Molded plastic enclosure to fit both AIM65 and power supply \$47.50. Special Package Price: 4K AIM, 8K Basic, power supply, cabinet \$599.00.

AIM65/KIM/VIM/Super Elf 44 pin expansion board; 3 female and 1 male bus. Board plus 3 connectors \$22.95.

60 Hz Crystal Time Base Kit \$4.00

Converts digital clocks from AC line frequency to crystal time base. Outstanding accuracy.

Video Modulator Kit \$8.95

Convert TV set into a high quality monitor w/o affecting usage. Comp. kit w/full instrur.

Multi-volt Computer Power Supply

8v 5 amp. ±18v .5 amp. 5v 1.5 amp. -5v .5 amp. 12v 5 amp. -12v output. ±5v. ±12v are regulated. Basic Kit \$29.95. Kit with chassis and all hardware \$43.95. Add \$4.00 shipping. Kit of hardware \$14.00. Woodgrain case \$10.00. \$1.50 shipping.

TERMS: \$5.00 min. order U.S. Funds. Call residents add 6% tax.
\$10.00 min. order BankAmericard and Master Charge and COD. \$1.00 minimum optional.
Shipping charges will be added on charge cards.
FREE: Send for your copy of our NEW 1980 QUEST CATALOG. Include 48¢ stamp.

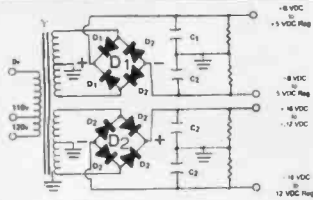

BUILD YOUR OWN LOW COST MICRO-COMPUTER POWER SUPPLIES FOR S-100 BUS, FLOPPY DISCS, ETC.

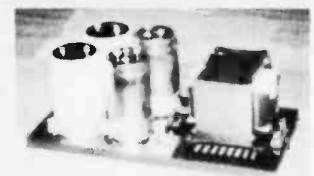

POWER TRANSFORMERS (WITH MOUNTING BRACKETS)

ITEM NO.	USED IN KIT NO.	PRI. WINDING TAPS	SECONDARY WINDING OUTPUTS			SIZE W x D x H	UNIT PRICE
			2x8 Vac	2x14 Vac	2x24 Vac		
T ₁	1	0V, 110V, 120V	2x7.5A	2x2.5A	—	3 3/4" x 3 3/8" x 3 1/8"	21.95
T ₂	2	0V, 110V, 120V	2x12.5A	2x3.5A	—	3 3/4" x 4 3/8" x 3 1/8"	27.95
T ₃	3	0V, 110V, 120V	2x9A	2x2.5A	2x2.5A	3 3/4" x 4 3/8" x 3 1/8"	29.95
T ₄	4	0V, 110V, 120V	2x4A	(28V, CT)	48V, CT, @3A	3 3/4" x 3 3/8" x 3 1/8"	22.95

POWER SUPPLY KITS (OPEN FRAME WITH BASE PLATE, 3 HRS. ASSY. TIME)

ITEM	USED FOR	@+8 Vdc	@-8 Vdc	@+16 Vdc	@-16 Vdc	@+28 Vdc	SIZE WxDxH	UNIT PRICE
KIT 1	15 CARDS SOURCE	15A	—	2.5A	2.5A	—	12" x 5" x 4 7/8"	51.95
KIT 2	SYSTEM SOURCE	25A	—	3A	3A	—	12" x 5" x 4 7/8"	58.95
KIT 3	DISC SYSTEM	15A	1A	2A	2A	4A	14" x 6" x 4 7/8"	66.95

EACH KIT INCLUDES: TRANSFORMER, CAPACITORS, RESIS., BRIDGE RECTIFIERS, FUSE & HOLDER, TERMINAL BLOCK, BASE PLATE, MOUNTING PARTS AND INSTRUCTIONS.

DISC DRIVE POWER SUPPLY "R3" ASSY. & TESTED, OPEN FRAME, SIZE: 9"(W) x 6 1/4"(D) x 4 3/8"(H) **66.95**

SPECS: +5V @ 5A REGUL, OVP, -5V @ 1A REG., +24V @ 5A REG., SHORTS PROTECT. OPTIONS: 1. REPLACE +24V BY +12V 2. ADD ±12V @ 1A, \$10.00 MORE.

IDEAL FOR 2 SHUGART 801/851 OR SIEMANS FDD 100-8/200-8 DISK DRIVES & ROCKWELL AIM-65.

SHIPPING FOR EACH TRANSFORMER: \$4.75. FOR EACH POWER SUPPLY: \$5.00 IN CALIF. \$7.00 IN OTHER STATES. CALIF. RESIDENTS ADD 6% SALES TAX. OEM WELCOME.



MAILING ADDRESS:
P.O. BOX 4296
TORRANCE, CA 90510

SUNNY INTERNATIONAL
(TRANSFORMERS MANUFACTURER)
(213) 328-2425 MON-SAT 9-6

SHIPPING ADDRESS:
22129 1/2 S. VERMONT AVE
TORRANCE, CA 90502



3 ALTERNATIVE INTERFACES FOR THE TRS-80

Save by purchasing only those units that meet your needs. Want a Parallel Printer or RS-232-C Serial Port, choose the Comm-80. Plan to turn your TRS-80

into a full timesharing terminal, choose the Chatterbox. Interested in a Disk Controller plus additional memory, choose the Disk-80.

CHATTERBOX™



- 300 baud originate modem
- Centronics printer port 8-bit
- RS-232-C port (50-19.2K baud)
- connects to keyboard or I.E.
- received data automatically routed to printer ports
- includes terminal software
- only \$279.95 complete

DISK-80™



- disk controller (4 drives)
- hardware data separator
- includes 16K of RAM provision for additional 16K
- buffered TRS-BUS expansion connector
- real-time clock
- only \$329.95 complete

COMM-80™



- RS-232-C port (50-19.2K baud) software/hardware selectable
- Centronics printer port 8-bit
- connects to keyboard or I.E.
- chain up to 16 units
- use with I.E. for 2nd printer
- includes terminal software
- only \$179.95 complete

ALL INTERFACES ARE RADIO SHACK HARDWARE AND SOFTWARE COMPATIBLE AND CARRY A 60 DAY WARRANTY INCLUDING PARTS AND LABOR. ALL UNITS INCLUDE USER'S MANUAL, POWER SUPPLY & AUXILIARY TRS-BUS CONNECTOR FOR FUTURE EXPANSION.



To order call (516) 374-6793

or write: The MicroMint Inc.
917 Midway
Woodmere, NY 11598

Dealer inquiries invited.

TRS-80 is trademark of Tandy Corp.



WE WILL NOT BE UNDERSOLD



DISK DRIVES \$314

40 track, 102K Bytes. Includes power supply and TRS-80* compatible silver enclosure. Ready to plug-in and run the moment you receive it. Can be intermixed with each other and Radio Shack drive on same cable. 90 day warranty. One year on power supply. Available for 220 Vac (50 Hz) operation. External card edge included.

FOR TRS-80*		
CCI-100	5 1/4" 40 Track (102K Bytes) for Model I	\$314
CCI-280	5 1/4" 80 Track (204K Bytes) for Model I	\$449
CCI-800	8" Drive for Model II (1/2 Meg Bytes)	\$795
For Zenith Z89		
CCI-189	5 1/4" 40 Track (102K Bytes) add-on drive	\$394
Z-87	Dual 5 1/4" add-on drive system	\$995

DISKETTES — Box of 10 (5 1/4") - with plastic library case			
Maxell	\$30	BASF or Verbatim	\$24
8" double density for Model II (box of 10)			\$36
CLEAR PLASTIC CASE - Holds 50 diskettes			\$19

DISK OPERATING SYSTEMS

PATCHPAK #4 by Percom Data		\$ 8.95
CP/M* for Model I, Zenith	\$145	• for Model II, Altos \$169.00
NEWDOS Plus	40track	\$ 95.00
NEWDOS 80		\$135.00

COMPLETE SYSTEMS

ALDOS 64K, DD, SS, 2-Drive, 1MB	ACS 8000-2	\$3395
APPLE 16K		\$988
TRS-80* Model II-64K		\$3499
TRS-80* LEVEL II-16K with keypad		\$689
TRS-80* Expansion Interface		\$249
HEWLETT PACKARD HP-85		\$2790
ZENITH Z89, 48K all-in-one computer		\$2440
ZENITH Z19		\$735
TELEVIDEO 912B \$698	912C \$698	920B \$748
		920C \$748
ATARI 400 \$489		ATARI 800 \$747
APF Game Only \$99	Complete System	\$499
MATTEL INTELLIVISION		\$229

MONITORS

LEEDEX 12" B & W Video 100	\$129
ZENITH 13" Color	\$379
SANYO 9" B & W VM4509	\$155
SANYO 12" B & W DM5012	\$210
SANYO 12" Green Screen DM5112	\$215
SANYO 13" Color DMC6013	\$375
APF 9" B & W TVM-10	\$139

TELECOMMUNICATIONS

CAT MODEM Works same as Radio Shack Telephone Interface II	\$148
D-CAT HARD WIRED DIRECT MODEM	\$199

COMMUNICATIONS SOFTWARE

CCI-TELNET VERSION 5: A communication package which enables microcomputer users to communicate both with large mainframes and other microcomputers. Completely CP/M compatible. Multiple communication protocols supported. **\$149**

INTELLIGENT TERMINAL SYSTEM ST-80 III: Enables a TRS-80* to act as a dial-up terminal on any time sharing network. **\$139**

For fast delivery, send certified checks, money orders or direct bank wire transfers. Personal or company checks require two to three weeks to clear.

16K MEMORY UPGRADE KITS 2 for \$82.50 \$43

200 ns for TRS-80*. Apple II. (specify): Jumpers \$2.50

PRINTERS

NEC Spinwriter



Letter Quality High Speed Printer

Includes TRS-80* interface software. quick change print fonts. 55 cps. bidirectional. high resolution plotting. graphing. proportional spacing: R.O. **\$2395**

R.O. with Tractor Feed	\$2575	KSR with Tractor Feed	\$2950
C.I.TOH Starwriter, 25 CPS, daisy wheel printer			\$1895
C.I.TOH Starwriter II, 45 CPS, daisy wheel printer			\$2195
Letter quality printers. Use up to 15" paper. 1 year warranty on parts. 3 months on labor. Proportional spacing and bidirectional printing. Same as VISTA V300.			

779 CENTRONICS TRACTOR FEED PRINTER	\$969
Same as Radio Shack line printer I	
737 CENTRONICS FRICTION & PIN FEED PRINTER	\$795
n x 9 proportional and 7 x 8 mono spacing.	
Same as Radio Shack line printer IV	
730 CENTRONICS FRICTION & PIN FEED PRINTER	\$595
7 x 7 matrix Same as Radio Shack line printer II	
P1 CENTRONICS PRINTER Same as Radio Shack quick printer	\$269
PAPER TIGER (IP440) Includes 2K buffer and graphics option	\$879
(IP460) Bidirectional. 160 cps. graphics and 2K buffer	\$1075
TI-810 Faster than Radio Shack line printer III. Parallel and serial w/TRS-80* interface software w/u + I case & paper tray	\$1589
Compressed print, vertical form control	\$1865
OKIDATA Microline 80 Friction and pin feed	\$545
Tractor Feed, friction, and pin feed	\$645
Microline 83 Bidirectional. 120 cps. uses up to 15" paper	\$1050
EATON LRC 7000 + 64 columns, plain paper	\$289
ANADIX DP-9500/01	\$1350
DP-8000	\$795

ACCESSORIES

HEAD CLEANING DISKETTE: Cleans drive Read/Write head in 30 seconds. Specify 5 1/4" or 8".	\$20 ea/\$45 for 3
FLOPPY SAVER: Protection for center holes of 5 1/4" floppy disks. Installation tools and rings for 25 diskettes.	\$ 11.95
Re-orders of rings only \$ 6.95	
EXTERNAL DATA SEPARATOR: Eliminates data separation problems (crc). Improves reliability. This plug in unit comes fully assembled and tested.	\$ 29.95
Z-80 SOFTCARD: Your key to software expansion. The plug-in Z-80 Softcard transforms your Apple into a Z-80 while keeping all the benefits of the 6502. Comes with CP/M in two disk format, MBASIC and GBASIC, full documentation and utility programs.	\$339
RF MODULATOR: Adapts video to TV	\$ 35.00
TRS-80 & OTHER MYSTERIES	\$ 18.95
NEC SPINWRITER THIMBLE	\$11.95
RIBBON	\$ 6.00
CCS CARDS: Parallel or serial printer interface cards	\$115.00
RS232: For Radio Shack Interface.	\$ 84.00
TRS232: Teletype current loop output from cassette port	\$ 49.00
DISK-DRIVE EXTENDER CABLES: Fits all mini-disk drives.	\$ 16.95
SIX (6) PRONG ISOLATOR: ISO-2	\$ 54.00
AC FILTER/6 PRONG POWER STRIP	\$ 39.00
DISK DRIVE CABLES: 2 drive \$29.00	4 drive \$ 35.00
DUST COVERS: TRS-80/Apple	\$ 7.95
PLASTIC DISKETTE HOLDER: For ring binder, holds 20	\$ 8.00

DEALER (NATIONAL/INTERNATIONAL) INQUIRIES INVITED

Send for FREE Catalogue

The CPU SHOP

5 Dexter Row, Dept. B12M
Charlestown, Massachusetts 02129
Hours 10AM-6PM (EST) Mon.-Fri. (Sat. till 5)

TO ORDER CALL TOLL FREE 1-800-343-6522

TWX: 710-348-1796 Massachusetts Residents call 617/242-3361

Massachusetts Residents add 5% Sales Tax
* TRS-80 is a Tandy Corporation Trademark
© Digital Research



VISA*

**WE HAVE
8039
MICROCOMPUTERS
NEW PRIME PARTS**

- TIMER APPLICATIONS
- CLOCKS
- SYSTEM CONTROLLERS
- KEYBOARD ENCODING
- 5 VOLT SUPPLY 6MHz
- ETC.

SEND CHECK FOR IMMEDIATE DELIVERY

1-5 \$19 6-25 \$15

OVER 25 \$10

MARSHALL PHILLIPS

U.S.I., DEPT. 37

10324 S. DOLFIELD ROAD
OWINGS MILLS, MD 21117
(301) 363-3000 TELEX: 8-7675

Circle 291 on inquiry card.

**COMPUTER
EQUIPMENT
& SOFTWARE
BARGAINS**



EVERY MONTH

BUY, SELL OR TRADE ALL TYPES OF COMPUTER EQUIPMENT AND SOFTWARE (pre-owned and new) among 20,000 readers nationwide in BIG (11x14") pages. Classified ads are only 10¢ per word and are indexed for easy and fast location. Subscription: \$10 a year/12 issues. Money back guarantee.

COMPUTER SHOPPER

P.O. Box F-14
Titusville, FL 32780
(305) 269-3211

MasterCharge or VISA orders only.

Call TOLL FREE 800-327-9920

Circle 292 on inquiry card.

**Acoustic Modems from
Metaresearch**



MA-50



FM-2

- Answer/originate
- Bell 103-113 compatible
- \$119** assembled
- Originate only
- Crystal-controlled
- \$119** assembled (*99** kit)

BOTH UNITS FEATURE:

- Rates to 300 baud, RS232 interface, half-full duplex
- Rugged wood & metal construction, safety AC wall transformer
- 1-year warranty on assembled units

METARESEARCH

1100 SE Woodward St., Portland, OR 97202
(503) 232-1712

Add 2** shipping & handling. Visa, MC accepted.

Circle 293 on inquiry card.

**MEMOREX
Floppy Discs**

Lowest prices. **WE WILL NOT BE UNDERSOLD!** Buy any quantity 1-1000. Visa, Mastercharge accepted. Call free (800)235-4137 for prices and information. All orders sent postage paid.

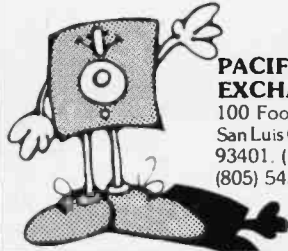

PACIFIC EXCHANGES

100 Foothill Blvd.
San Luis Obispo, CA
93401. (In Cal. call
(805) 543-1037.)

Circle 294 on inquiry card.

SURPLUS ELECTRONICS

ASCII

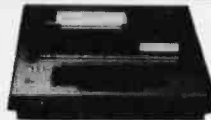

ASCII

**TRS-80® COMPATIBLE, IBM
SELETRIC® -BASED I/O TERMINAL
with ASCII conversion installed: \$645.00**

Many Other Items Available: Tape Drives; Cable; Cassette Drives; Wire; Power Supplies (5 volt 35 amp, others); Displays; Cabinets; Transformers; Heat Sinks; Printers; Components.

Send for Free Catalog
WORLDWIDE ELECTRONICS, INC.
130 Northeastern Blvd.
Nashua, N.H. 03062

Phone orders accepted using VISA or MC
Toll Free 1-800-258-1036
In NH 603-889-7661

*TRS-80 is a trademark of the Radio Shack Division of Tandy Corporation.

Circle 295 on inquiry card.

**80X24 VIDEOTERM™
7X9 MATRIX DISPLAY FOR**

APPLE II®

LOWER CASE W/ DESCENDERS



® REGISTERED TRADE MARK OF APPLE COMPUTER, INC.

30 columns by 24 lines with easy to read 7x9 dot matrix, upper and lower case with descenders using shift lock feature • 1K firmware incorporates PASCAL and BASIC protocols so user is not required to enter machine language programs or change PASCALS: Misc. info. or Gotoxy files • Compatible with all APPLE II peripherals so user won't need new software patches for future software products • Crystal controlled dot clock for excellent character stability • VIDEOTERM is the same size as the Apple language card and power consumption is held to a minimum through the use of CMOS and lower power devices • Character set can be user definable up to a maximum of 128 symbols of 8x16 dot matrix font • Display control character mode and four standard display formats controlled by escape sequences • Built in light pen capability • Inverse display mode • 50/60 HZ operation • Sockets on all IC's.

PRICE: Without graphic EPROM \$345

OPTIONS: Graphics EPROM (see disp. \$25)
VIDEO SWITCH PLATE. Inserts
in case also to choose between
APPLE II® and VIDEOTERM 512
MANUAL \$15



VIDEX 497 N. W. Grant Ave., Corvallis, OR 97330 Phone (503) 784-0521

Circle 296 on inquiry card.

64 DAC S-100 Card!

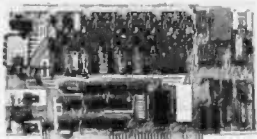

only
\$529
Asm. &
Tested

Features:

- 64 output channels from a single multiplexed 8-bit digital-to-analog converter (DAC)
- High density/Low cost: \$8.30 per channel
- Compatible with any S-100 Bus system
- On board refresh saves the system's processor from the need to continually update each channel
- ± .4% absolute accuracy
- Options include: fast non-multiplexed 12-bit DAC and/or 10-bit digital output port
- Perfect for home, laboratory, or electronic music applications

Operations Manual — \$5.00

Check or Money Order



Digital Multi-Media Control
2338 Patterson #12
Eugene, OR 97405

Circle 297 on inquiry card.

FIFTY BUS SYSTEMS

32K 6800s from \$1694.59

32K 6809s from \$1844.69

include: Chassis, CPU, 32K Static Ram, I/Os
Fully Expandable

2114L 300ns STATIC RAM CHIPS .. \$5.90

FACTORY PRIME From the same shipment we use in our professional quality boards.
Add \$5.00 Handling on Orders Under \$200.00

32K STATIC RAM BOARD

FOR THE S550 AND S550C BUS (SWTP etc.)

- S550C Extended Addressing (can be disabled).
- 4 separate BK blocks • Low power 2114L RAMS
- Socketed for 32K • Write Protect
- Gold Bus Connectors

16K \$328.12

24K \$438.14

32K \$548.15

Phone, write, or see your dealer for details and prices on our broad range of Boards and Systems for the S550/S550C BUS including our **UNIQUE 80 x 24 VIDEO BOARD**, and our AC Power Control Products for all computers.

GIMIX inc.



1337 W. 37th Place • Chicago, IL 60609
(312) 927-5510 • TWX 910-221-4055

The Company that delivers.
Quality Electronic products since 1975.

GIMIX® and GHDS1® are Registered Trademarks of GIMIX INC.

Circle 298 on inquiry card.



**The best choice
in mainframes !**

- 5100 CARD FRAME
- 22 MHz 12" CRT MONITOR
- 18 AMP POWER SUPPLY
- UPPER & LOWER CASE
ASCII KEY BOARDS
- AXIAL BLOWER
- ASSEMBLED & TESTED
- READY FOR YOUR CARDS
- NEW LOW PRICE
\$855.00

oo INFINITE

819 E. STRAWBRIDGE, MELBOURNE, FL 32901 — (305) 721-1588

Circle 299 on inquiry card.

All you do is pick up the phone.

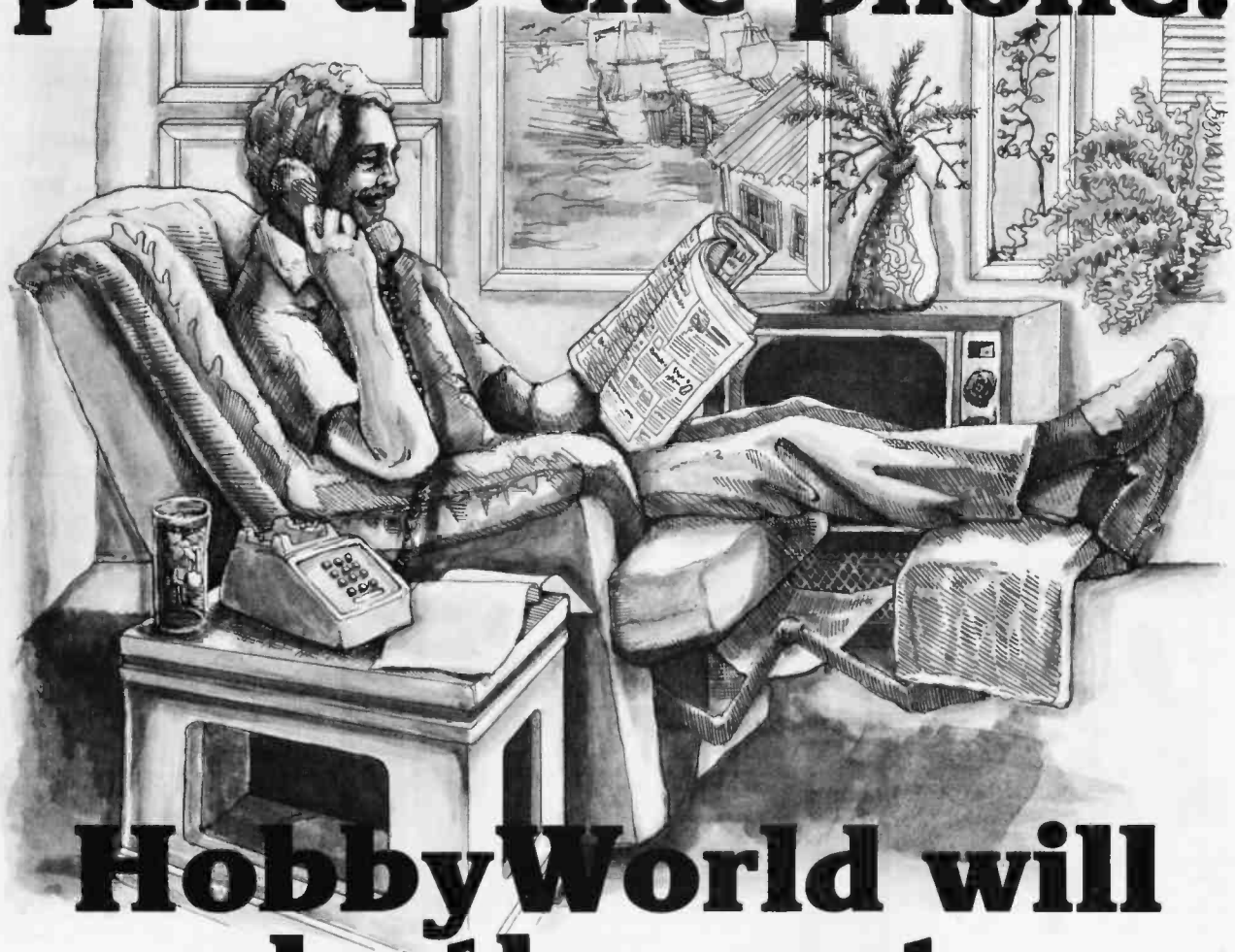

HobbyWorld will do the rest.

Are you forced to drive from store to store hoping to find the computer products that you want? Do you have to wait week after week on a back-order with other mail order suppliers?

Instead, why not relax and shop at HobbyWorld.

We've become the nation's largest mail order electronics supplier for two reasons. We carry thousands of high quality, competitively priced electronics products in stock and we ship 95% of our customer's orders complete, the same day we receive them.

(800) 423-5387 (in United States)
(800) 382-3651 (in California)
(213) 886-9200 (Local/Outside USA)

**HobbyWorld
Electronics, Inc.**
19511 Business Center Drive,
Dept. B12
Northridge, CA 91324

So stop wasting your time and send for our FREE forty-four page catalogue containing I.C.'s, semiconductors, computer boards & kits, software, books, toys & games, disks, printers and much, much more... To get your catalogue either circle our reader service number, call us toll-free, or fill out the information below and send it to HobbyWorld today! If you live in the Los Angeles area stop by one of our HWComputer retail stores:

In Redondo Beach & In Northridge
2301 Artesia Blvd. & 19511 Business Ctr. Dr.

NOTICE OUR DIFFERENCE.

FREE HobbyWorld Catalog

Name _____
Company _____
Address _____
City _____ State _____
Zip _____

HIGH-TECH jewelry

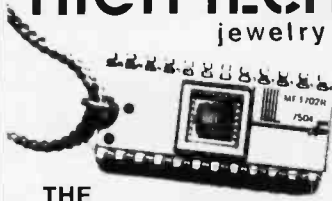

THE COMPUTER PENDANT

A great Christmas gift idea and great way of letting your interests be known. Ten years ago such a jewel was unimaginable. Today this technology is transforming our lives and the society we live in.

The white ceramic and quartz package attracts attention, while a closer look reveals the intricacy and precision of the Silicon circuit. This high-tech symbol of the seventies is a genuine product of the micro-electronic revolution.

Pendant available on gold plated chain \$12.50, gold filled chain \$19.95, 14K gold chain \$85.00, or as a stick pin \$9.95.

Send check or money order plus \$1.50 postage and handling to:
**HIGH-TECH JEWELRY, 3 CANTERBURY RD.
 ISLINGTON, ONTARIO, CANADA M9A 5B2
 CALL 416-233-2860**

6800 Micro Modules

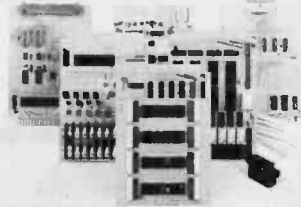

FOR INTERFACING TO: sensors, transducers, analog signals, solenoids, relays, lamps, pumps, AC motors, DC motors, stepper motors, keyboards, displays, 488 GPIB.

ADDITIONAL FEATURES: 6800 MPU, counter/timer, fail safe battery back up



Wintek Corp.
 1801 South Street
 Lafayette, IN 47904
 317-742-8428

STRUCTURAL ANALYSIS SOFTWARE

For TRS-80 and North Star Computers

SPACE FRAME (Finite Element — Stiffness Method)
 includes Space Frame, Plane Frame, Space Truss & Floor Grids
 Disk Version \$300.00 Cassette Version \$100.00
 TRS-80 Model II \$400.00
 plus postage

TRUSS FORCE (Method of joints solution of Common Trusses)
 Disk Version \$50.00 Cassette Version \$50.00
 plus postage

LINEAR PROGRAMMING (Simplex Method)
 Disk Version \$60.00 Cassette Version \$60.00
 plus postage

ENGINEERING ANALYSIS SOFTWARE

E23 Avon Drive West
 Hightstown, NJ 08520
 Phone (609) 448-3445

In California Contact:

MICOPS INC.
 421 Royale Park Dr.
 San Jose, Ca. 95136
 Phone (408) 629-5716

Circle 301 on inquiry card.

Circle 302 on inquiry card.

Circle 303 on inquiry card.

dbis YOUR HEADQUARTERS FOR

OHIO SCIENTIFIC

SALES • SERVICE • SUPPORT

THE BEST NEW YORK AREA PRICES ON ALL OHIO SCIENTIFIC COMPUTERS — LOCAL USERS GROUP — BUSINESS AND PERSONAL SYSTEMS

PROFESSIONAL BUSINESS SOFTWARE:

Systems now available:
 Encumbered Budget Accounting
 Inventory/Invoicing Export Management
 Mailing List Payroll
 Accounts Receivable Accounts Payable
 Manuals available separately.....\$35

ALSO AVAILABLE:

*Eaton LRC 7000+ Plain Paper Printer...\$356.
 *Okidata Microline 80 Printer—upper/lower case, graphics, any paper, software selectable print size.....\$95.

MASTERCHARGE & VISA WELCOME

Designers & Builders of Information Systems, Inc.
 One Mayfair Road - Eastchester, New York 10707

(914) 779-5292 (212) 933-4170

Circle 304 on inquiry card.

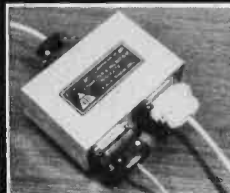

TERMINAL
 DATA
 CORPORATION

MODEL 1200 RS-232 DATA SPLITTER available in kit form

Model 1200K gives the terminal or microprocessor user a second interface for a printer, plotter, cassette or tape drive. It operates at any speed & isolates the two output devices from each other, while providing 2 RS-232 interfaces from the terminal or microprocessor.

The kit consists of 3 RS-232 connectors, printed circuit board, all necessary components, enclosure, mounting hardware & assembly instructions.....\$67.00

write or call

TERMINAL DATA CORP.
 11878 Coakley Cir.
 Rockville, MD 20852
 (301) 881-7655

Circle 305 on inquiry card.



Versatile Interface Peripheral Board Serial/Parallel I/O For The Apple II

SERIAL FEATURES: Software Baud Rate Select • 50-19.2 K Baud • Crystal Controlled • Partial 26 Pin Connector Strapping • RS232C

PARALLEL FEATURES: Centronics Compatible • Full 34 Pin I/O Connector Strapping • 16 I/O Lines + 4 Handshakes

ALSO: 256 Bytes On Board Ram • ALL GOLD Connectors/Sockets • 6 Foot 34 Conductor Ribbon Cable With Centronics Compatible Connector • 3 Foot Serial Ribbon Cable With Male DB25 Connector • 90 Day Limited Warranty • Documentation with Driver Software

SMS • VIP \$169.95 ea A & T

Shipping Add 2.0% • Texas Residents Add 5% Sales Tax • Payment By Check or Money Order

BIRD • BOARDS
 Southwestern Management Services, Ltd.
 Box 7277 Austin Texas 78712
 Phone 512-327-1834

Circle 306 on inquiry card.

CONVERT ANY TV TO A HIGH QUALITY MONITOR



- Hot Chassis or Transformer sets*
- 64-80 characters per line
- By-passes tuner & I.F.
- Normal viewing unaffected
- Safe—Easy kit installation

ACVM Hi-resolution \$34.95 ppd.
 * Referenced to neutral

V. A. M. P. INC.
 Box 29315, Los Angeles, CA 90029
 Calif. Residents add 6% Sales Tax

Circle 307 on inquiry card.

ATARI OWNERS SCREEN PRINT INTERFACE

Obtain hardcopy of any screen image (graphics and/or text) on either a TRENDCOM 200 or IDS 440 Paper Tiger printer. Simply attach the supplied parallel printer cable and load the software from cassette (may be transferred to Disk). Obtain a "picture" of the screen on your printer under direct (CTRL?) or program (XIO) control. Works in all graphics/text modes as well as LPRINT and LIST "P."

Only **\$139**

California residents add 6% tax

ATARI is a recognized trademark of ATARI, Inc.

MACROTRONICS, inc.®

1125 N. Golden State Blvd. / Suite G
 Turlock, CA 95380 (A)
 (209) 667-2888 / 634-8888

We are experiencing telephone difficulties, please keep trying.



Circle 308 on inquiry card.

J and S Computers

2247 Shetland Road
 Livermore, Ca. 94550

SCOTCH brand diskettes

740-0 Single sided 8" box of 10\$32.50
 741-0 Double density 8" box of 10 48.50
 743-0 Double density/ds 8" box of 10 ... 65.00

HEAD CLEANING DISKETTE

8" box of 5\$25.00

ATARI

400 Computer\$441.00
 800 Computer 807.50

TEXAS INSTRUMENTS

99/4 Console\$754.00

and more... send for our catalogue
 California residents add 6% sales tax
 All orders, add 3% shipping and handling

Circle 309 on inquiry card.

SAVE ON



Model I

TRS-80's

from Pan American Electronics, Inc.

A **Radio Shack**
AUTHORIZED SALES CENTER

**We Have
DISCOUNTS
FREE SHIPPING
and a
TOLL FREE ORDER NUMBER
800/531-7466**

Texas and Principle Number 512/581-2765
Telex Number 767339
Department B
1117 Conway
Mission, Texas 78572



VISA

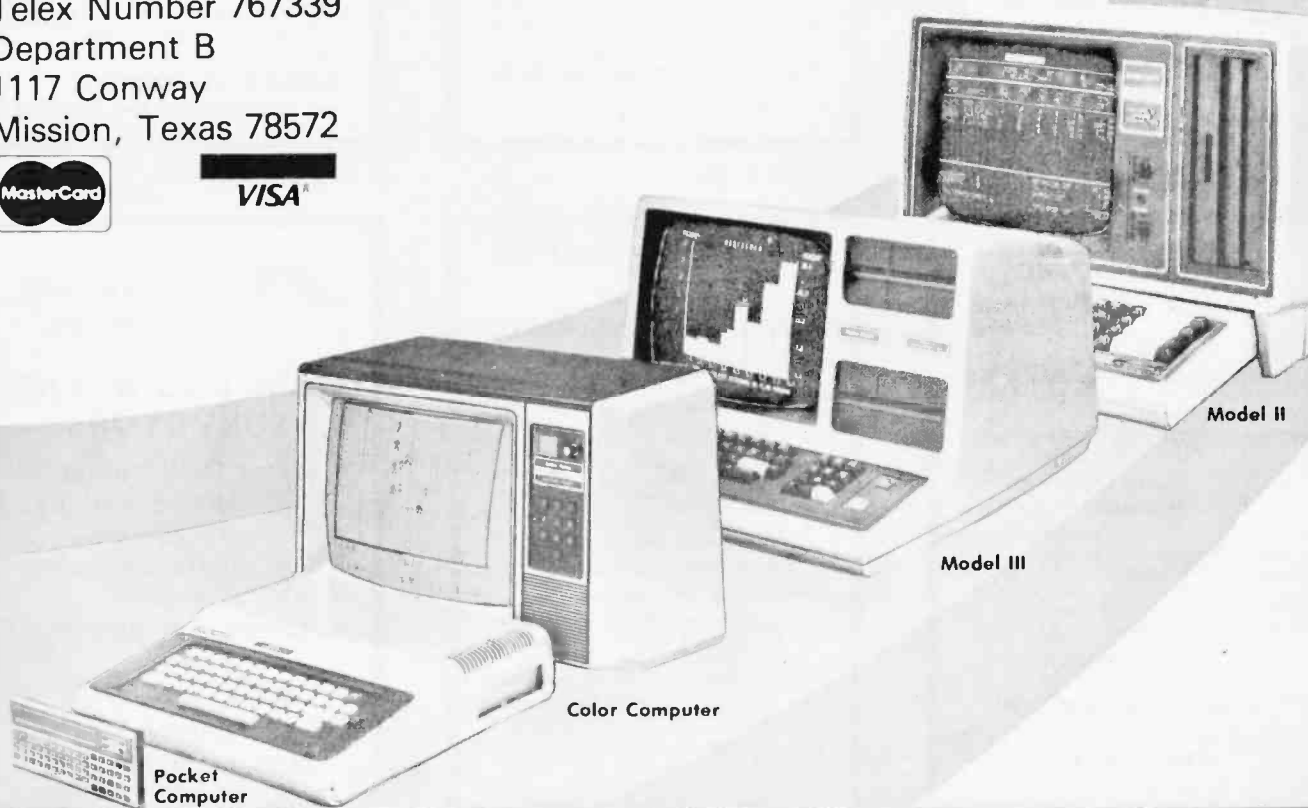

Model II

Model III

Color Computer

Pocket
Computer

TRS-80 SOFTWARE FOR STOCK INVESTORS

1. Technical Analysis
 - *Price Cycle Forecasting
 - *Moving Averages
 - *Momentum Analysis**(\$89.95)**
2. Portfolio Bookkeeping
(\$39.95)

Call or write for further information.

AMPERO SOFTWARE PRODUCTS, SUITE 12A
5230 CLARK AVENUE
LAKEWOOD, CA 90712
(213) 866-3783

Circle 311 on inquiry card.

PRINTERS

MICROTEK MT-80

—S LIST \$895 **OUR PRICE \$775**
—P LIST \$795 **OUR PRICE \$685**

OKIDATA MT-80

LIST \$800 **OUR PRICE \$650**

BASE, MODEL 800B

LIST \$699 **OUR PRICE \$575**

PLEASE ADD 3% FOR S&H TO ORDER

TECHNICAL INNOVATIONS
P.O. BOX 803 DEPT. B
HILLSBORO, OR 97123
503-648-6423

Circle 312 on inquiry card.

S-100 VOICE

The ARTICULATOR board allows you to record, store, and playback any vocabulary on your S-100 computer. Input speech is digitized by the ARTICULATOR and sent to the computer via an on-board port for storage at 1K to 2K bytes/sec. This data is then sent back from the computer to the ARTICULATOR for very high quality playback. On-board VOX switching minimizes memory storage requirements.

PRICE — \$319 A&T
AVAILABLE NOW

Quintrex, Inc., 9185 Bond
Shawnee Mission, Ks. 66215
(913) 888-3353

Circle 313 on inquiry card.

ATTENTION: Apple Users!
WANT BETTER COLOR...MORE STABILITY?



Ever question the quality of your computer display. If so, you've probably been told "That's the best you can expect from an RF modulator...buy a color monitor".

WE CHALLENGE THAT STATEMENT!

DON'T BE SATISFIED WITH EXISTING QUALITY. See for yourself what our "new concepts" modulator can do for your picture...**MICRO-VERTER Model MVX-500, \$35 PP.** Phone orders welcomed.

HOTLINE DIAL: 402-987-3771

138 BROADWAY **ATV Research** DAKOTA CITY, NE. 68731

DEALERSHIPS AVAILABLE

CATALOG UPON REQUEST

XREF • XREF • XREF

XREF is a high-speed cross reference utility for Microsoft BASIC programs under CP/M*

- Extracts all program branches, variables, and line numbers.
- Prints sorted report to CON:, LST:, TTY:, or DISK.
- High performance—@ 2MHz, 8K program XREFed in less than 1 minute.

This sorted cross reference is an extremely valuable tool for debug and/or documentation of MBASIC programs. Takes programs apart so you can see how they tick. Great for making fool-proof additions or changes to undocumented programs. Supplied on 8" single density disk.

Send \$30 in check or money order to:

MICRO TIME
Box 23033 / Richfield, MN 55423

*CP/M—Reg.TM, Digital Research

Circle 314 on inquiry card.

Close-Out!!



Desk Top Computer

This unit is a computerized Electronic Secretary. It keeps time, date, calendar, message, and meeting files. Originally sold thru a major mail order house for over \$450.00.

Technically, it's a 6507 MICRO, ROM, Ram, Planaplex Alpha Display, Ni-cad Battery, Power Supply, Keyboard, Wood and Aluminum Case with Schematic and Instructions

Most of these Computers are warranty returns. We are offering refurbished like new units for \$99.95 and as is (most have minor problems) units for \$44.95. Add \$4.95 per unit for shipping and handling per unit ordered. All units are complete as described. All sales are final. California Residents add 6.5% Sales Tax.

Send Payment and Order to:

Solid State Surplus
P.O. Box 32418/San Jose, CA 95152

Circle 315 on inquiry card.

OHIO SCIENTIFIC SOFTWARE

Pharmacy

Complete backend system: New & Refill prescriptions, Welfare, 3rd party billing, Welfare reports. Daily script reports, inventory, customer logs and much more.

Oil Production

A program designed to keep track of all phases of the producers activity in a Oil or Gas well. Keeps totals on barrels, MCF's, expenses, deductions, and taxes including Windfall. Prints checks for investors and landowners.

CALL FOR PRICE AGREEMENT

TURN-KEY COMPUTER

424 E. Cotton Longview, TX 75601
214-753-8719

Circle 316 on inquiry card.

INTERFACES FOR APPLE by TEXCOM ENGINEERING ASSOCIATES

*RS-232 Serial Interface — \$99.95
/ 15 Software selectable baud rates from 50 to 19,200 baud.
/ Programmable interrupt control, word length, number of stop bits and parity select.

*Dual Parallel Interface — \$89.95
/ Two 8 bit parallel ports
/ Two 16 bit programmable interval timers

/ One serial port
/ Programmable interrupt control

*16 Ch A-D Converter — \$149.95

*Interfaces are fully documented

*Add \$5.00 for software drivers/demos on disk or cassette (specify when ordering).

*Custom interfaces and software available.

These are professional quality boards with gold-plated connectors and are fully assembled and tested.

To order, send check or MO to:
P.O. Box 24472, Houston, TX. 77013
Phone: (713) 458-3720

Circle 317 on inquiry card.



**OSI & TRS DOS
SOFTWARE**

CIVIL ENGINEERS SURVEYORS

- Water Distribution Network Analysis
- Pressure Sewers
- Coordinate Geometry
- Matrix Algebra
- Roadway Alignment

SYSTEK, INC.

P. O. Drawer JJ
Miss. State, MS 39762

Circle 318 on inquiry card.

MICRO MISCELLANY FROM JBE

A to D D to A CONVERTER

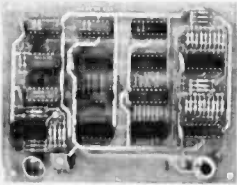

The JBE A-D and D-A Converter can be used with any system having parallel ports, and interfaces with JBE Parallel I/O Card (see below). A-D conversion time is 20µS, D-A conversion time is 5µS. Uses include speech, music synthesizing, slow scan TV, and joystick or paddle control inputs. Uses single power supply (5V), see JBE 5V power supply below. Parallel inputs and outputs include 8 data bits, strobe lines and latches. Analog inputs and outputs are medium impedance zero to five volt range.

79-287 ASSM. **\$79.95**
KIT **\$59.95**
BARE BOARD **\$29.95**

APPLE II PARALLEL INTERFACE

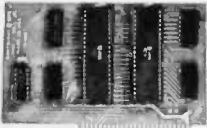

JBE Apple II Parallel I/O Card interfaces printers, synthesizers, keyboards, and JBE A-D and D-A converter and solid state switches. This interface has handshaking logic, two 6522 VIAs and a 74LS74 for timing. Inputs and outputs are TTL compatible.

79-295 ASSM. **\$69.95**
KIT **\$59.95**
BARE BOARD **\$22.95**

SOLID STATE SWITCH



Control the world! Your computer can control power to your printer, lights, stereo and 120VAC appliances up to 720 watts (6 amps at 120VAC). Input 3 to 15VDC, 2-13 MA TTL compatible, Isolation - 1500V, non zero crossing, the switch comes in a 1 or 4 channel version and includes documentation for interfacing with JBE Dimmer Control (see below). The 1 channel version is also available professionally packaged.

79-282 1 CHANNEL ASSM. **\$13.95** KIT **\$10.95** BARE BOARD **\$ 6.95**
1 CHANNEL PKGD. **\$39.95**
79-282 4 CHANNEL ASSM. **\$49.95** KIT **\$39.95** BARE BOARD **\$24.95**

POWER SUPPLIES

± 12 VOLT POWER SUPPLY



This 2x2½" power supply uses a wall transformer for safety and is protected against short circuit and thermal breakdown. It is rated at ± 12 V 120MA and can be used as a single 24V power supply at 120 MA. It is ideally suited to operational amplifier experiments.

80-161 ASSM. **\$22.95**
KIT **\$18.95**
BARE BOARD **\$ 8.95**

5 VOLT POWER SUPPLY

This 2¼x2½" 5V 500MA power supply is protected against short circuit and thermal breakdown and uses a wall transformer for safety. It operates JBE A-D and D-A converter, 8085 computer, 8088 computer & 6502 micro-microcomputer. Documentation is included.

80-160 ASSM. **\$20.95**
KIT **\$16.95**
BARE BOARD **\$ 8.95**



DIMMER CONTROL

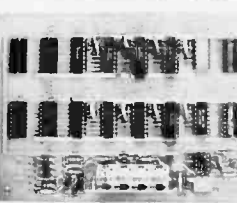

The JBE Dimmer Control has 4 channels, 256 brightness levels, on-board power supply and four 8-bit parallel input ports (not latched). This board interfaces with the JBE Solid State Switch and Apple II Parallel Interface Card (documentation included).

80-146 ASSM. **\$89.95**
KIT **\$79.95**
BARE BOARD **\$25.95**

6502 MICRO-MICROCOMPUTER

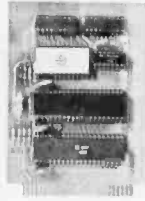

This JBE 3½x5" Micro-Microcomputer has the following:

- 1024 Bytes of RAM (two 2114s)
- 2048 Bytes of EPROM (2716)
- Uses one 6522 via (documentation inc.)
 - 2 8-bit bidirectional I/O ports
 - 2 16-bit programmable timer/counters
 - Serial Data Port
 - Latched output and input with handshaking logic.
 - TTL and CMOS compatible

The 6502 Microprocessor is particularly suited for control functions such as temperature control, burglar alarm, electric wheelchair, lights, etc. This Micro-Micro interfaces with the JBE Solid State Switch and A-D and D-A Converter and uses the JBE 5V power supply (see below). 2716 EPROM is available separately (not included in kit or assm. board). A 50 pin connector is included.

80-153 ASSM. **\$110.95**
KIT **\$ 89.95**
BARE BOARD **\$ 24.95**

APPLE II DISPLAY BOARD

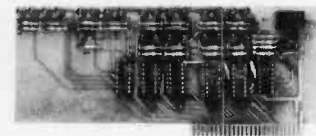

This handy little (3x7") board is ideal for teaching and troubleshooting. It has a run — stop, single step switch which makes identification of shorted lines between address or data-bits easy and shows single steps for teaching computer logic. The display board has 16 Address LEDES, 8 Data LEDES & 1 RDY LED. All lines are buffered.

80-144 ASSM. **\$49.95**
KIT **\$42.95**
BARE BOARD **\$25.95**

BARE BOARDS

APPLE II EXTENDER BOARD

This is what you've been waiting for! The 3¼x2½" Apple II Extender Board makes troubleshooting much faster and easier! Great for use with the Apple II Display Board. 50 pin Apple connector is included.

80-143 **\$12.95**

CRT CONTROLLER

This Intelligent CRT Controller is completely contained on a 6x6½" printed circuit board. The design is based on an 8085A Microprocessor and an 8275 Integrated CRT Controller. It features the following:

- 25 Lines, 80 characters/line
- 5x7 Dot Matrix
- 8085 CPU
- Two 8185s
- Two 2716s (1 for software, 1 for user programmable character generator)
- Serial Interface RS232 and TTL
- Baud rates of 110, 150, 300, 600, 1200, 2400, 4800 & 9600.
- Keyboard Scanning System
- Uses +5V power supply and ±12V power supply (both available from JBE — see above)

\$39.95

8085 3-CHIP SYSTEM

State-of-the-art system using 3 IC's, an 8085, an 8156 and either an 8355 or 8755. The system has the following:

- 3 MHz 8085 CPU
- 256 bytes static RAM
- 2048 bytes ROM
- 38 parallel input/output lines
- 2 serial input/output lines
- Instruction set 100% upward compatible with 8080A 14-bit counter/timer

\$24.95

8088 5-CHIP SYSTEM

An 8086 Family microcomputer system using 5 IC's, an 8088 CPU, and 8284 clock generator, an 8155 RAM/I/O/Timer, an 8755A EPROM/I/O and an 8185 (1K x 8) Static RAM. This system has the following:

- 16-bit internal architecture
- Up to 1280 bytes of static RAM
- 2048 bytes of EPROM
- 38 parallel input/output lines
- 14-bit counter/timer
- Instruction set 100% compatible with the 8086

\$29.95

SPARE PARTS

INTEGRATED CIRCUITS
6502 **\$ 9.95**
6522 **\$ 9.95**
2716 5 Volt **\$29.95**

CABLE
Standard Dip Jumpers
16 Pin, 1 Ft. Length **\$4.95**
CONNECTORS
50 Pin Connector **\$5.95**



JOHN BELL ENGINEERING

VISA

ALL PRODUCTS ARE AVAILABLE FROM: JOHN BELL ENGINEERING

P.O. BOX 338 • REDWOOD CITY, CA 94064 • (415) 367-1137

MASTER CHARGE

ADD 6% SALES TAX IN CALIFORNIA. FOR ORDERS OUTSIDE THE U.S.A., ADD 5% FOR SHIPPING AND HANDLING.

Take Your **OSI** to the
FAIR — with our — **SOFTWARE** — **\$\$**

Proven Programs that will make money for You If you have a C2-8PDF with Printer. We will provide programs on disk, with Starter Kit and Tips. Can be used anywhere there are people.

Also we have User Programs for C2-8P, and C1-P, Available on cassetts, these include Exciting Video Games. Printed instructions. Programs are available as listings, for use on any OSI, or modified for other computers.....

Send 5.00 for Complete Catalog and Sample Runs. Deductable on your first order.

ALL PROGRAMS ARE ORIGINAL! NO COPIES.

Perceptions
Unlimited
Box 3-186ECB Anchorage, Ak. 99501

Circle 321 on inquiry card.

C-10 **SHORT CASSETTES** 50 FT.



Premium tape and cassettes acclaimed by thousands of repeat order microcomputer users. Price includes labels, cassette box and shipping in continental U.S.A. VISA and M C orders accepted. California residents add sales tax. Phone (415) 968-1604 24 hours.

MICROSETTE CO.
475 Ellis Street
Mt. View, CA 94043

Circle 322 on inquiry card.

6502 USERS!

Upgrade your present 6502 system to 6809 capability with a 65-09 module.

Simple installation. No modification to existing hardware required. Software also available for most major systems.

65-09 Module Kit \$110.00
65-09 Module Assembled/Tested ... 135.00
2K Eprom Monitor 59.95

Michigan residents add 4% sales tax.
Send check, money order or COD to:

MICRO PROCESSOR SYSTEMS, INC.
37060 Garfield, Suite C4
Mt. Clemens, MI 48043
(313) 263-9440

Circle 323 on inquiry card.

YEAR END SPECIALS

Shugart SA-400 249
SA-801 449

Televideo 912 C 739
Epson MX-80 689
TEL RF-12 599

Expandoram II 16k kit 239
64k kit 359
add \$100 for factory A&T

Mostek 4116-3 200ns 8 for 50

Integrated Business Systems

Z80, disk based systems w/ 64k Ram terminal, printer & software

Dental Office Management 4995
Apartment Management 4495
Word Processing 5995

COMPUTER RESEARCH CONSULTANTS

13110 Palatine Avenue North
Seattle WA 98133
(206) 363-5780

Circle 324 on inquiry card.



Solve your disc problems, buy 100% surface tested Dysan diskettes. All orders shipped from stock, within 24 hours. Call toll FREE (800) 235-4137 for prices and information. Visa and Master Card accepted. All orders sent postage paid.



PACIFIC EXCHANGES
100 Foothill Blvd.
San Luis Obispo, CA
93401. (In Cal call
(805) 543-1037.)

Circle 325 on inquiry card.

SANDERS/HARRIS 810
16 Bit Disk Systems

3 systems - each includes:

- 5 Meg Disk w/1 fixed and 1 removable platter
- 1 Centronics Printer, dot matrix, 165 chars/sec.
- 3 Terminals (can run 4)
- Software-DOS/Inventory/Diagnostic
- Multi Terminal/Tasking

Systems factory rebuilt. Excellent Condition-\$5,500 3 for \$15,000. Dealers welcomed. FOB Ct. 06781 TC!, INC. (203) 589-5000

Circle 326 on inquiry card.

SOFTWARE FOR APPLE II ON CASSETTE

FLAGBALL \$12.50
1-4 Player Paddle Skill Game

TEN THOUSAND \$15.00
Lively Dice Game For 1-8 Players

BLACKJACK \$ 9.00
1-4 Players

STAR GATE EXPLORER \$15.00
Solve The Star Gate Riddle

SPACE CONFLICT \$25.00
2-Player Computerized Warfare Game

HOME INVENTORY \$15.00
Use For Food Stuffs, Small Parts, Etc.

Base 2 Printer Opt. For Above \$ 3.50

J. PANIAGUAS
416 PLYMOUTH ROAD
VALPARAISO, IN 46383

Circle 327 on inquiry card.

IEEE-488 To TRS-80* INTERFACE



MODEL 488-80B \$225.00
(plus shipping, ins. & tax)

EVERYTHING NEEDED TO ADD POWERFUL GPIB-488 CONTROLLER CAPABILITY TO TRS-80 MODEL 1, LEVEL 2 OR DOS

SCIENTIFIC ENGINEERING LABORATORIES

11 Neil Drive • Old Bethpage, NY 11804
Telephone: (516) 694-3205

*Trade Mark of Tandy Corporation. There is no affiliation between Scientific Engineering Laboratories and Tandy Corporation or Radio Shack.

Circle 328 on inquiry card.

QUARTZ CRYSTALS

3218 @	5.2428 @	0.9336 @	20.000 @	36.286 @	42.851 @	45.817 @
3390 @	5.610 @	9.984 @	20.496 @	35.363 @	42.876 @	47.376 @
1.000 @	5.714 @	9.996 @	22.158 @	37.262 @	42.928 @	47.363 @
1.843 @	5.955 @	10.000 @	22.628 @	38.768 @	42.962 @	48.000 @
1.843 @	5.962 @	10.245 @	25.356 @	38.444 @	43.000 @	48.306 @
2.000 @	6.000 @	10.496 @	26.500 @	38.628 @	43.078 @	48.666 @
2.000 @	6.144 @	10.755 @	26.706 @	38.928 @	43.078 @	48.736 @
2.457 @	6.150 @	10.856 @	27.000 @	39.212 @	43.188 @	48.876 @
2.500 @	6.297 @	10.836 @	27.000 @	39.508 @	43.258 @	49.706 @
2.657 @	6.400 @	11.360 @	27.606 @	39.666 @	43.338 @	49.736 @
2.990 @	6.553 @	11.156 @	28.400 @	39.758 @	43.378 @	49.878 @
3.000 @	6.723 @	11.216 @	28.626 @	39.876 @	43.407 @	50.295 @
3.057 @	6.758 @	11.780 @	28.758 @	39.928 @	43.427 @	51.056 @
3.200 @	6.900 @	11.476 @	29.876 @	40.444 @	43.444 @	51.378 @
3.278 @	7.063 @	11.656 @	29.978 @	40.592 @	43.556 @	51.778 @
3.500 @	7.036 @	11.681 @	30.064 @	40.812 @	43.628 @	51.856 @
3.578 @	7.091 @	12.440 @	30.366 @	40.836 @	43.666 @	52.878 @
4.000 @	7.156 @	14.316 @	30.676 @	40.876 @	43.778 @	58.756 @
4.194 @	7.256 @	14.438 @	30.876 @	40.888 @	43.878 @	60.506 @
4.342 @	8.000 @	15.000 @	31.437 @	40.976 @	43.814 @	60.756 @
4.483 @	8.056 @	15.400 @	31.758 @	41.000 @	43.851 @	66.756 @
4.810 @	8.141 @	15.596 @	31.900 @	41.166 @	43.886 @	70.426 @
4.653 @	8.181 @	16.000 @	32.000 @	41.378 @	43.928 @	75.000 @
4.830 @	8.303 @	15.348 @	32.206 @	41.878 @	44.000 @	90.838 @
4.915 @	8.498 @	17.248 @	33.676 @	42.000 @	44.037 @	99.966 @
5.000 @	8.576 @	17.427 @	34.556 @	42.863 @	44.376 @	100.666 @
5.056 @	8.605 @	18.000 @	34.536 @	42.928 @	44.378 @	101.466 @
5.170 @	8.650 @	18.432 @	34.977 @	42.706 @	45.126 @	103.266 @
5.185 @	8.906 @	18.460 @	35.926 @	42.758 @	46.306 @	103.466 @
5.166 @	8.472 @	19.750 @	35.000 @	42.814 @	46.706 @	104.918 @

ALL @ - \$2.99 ALL @ - \$1.99 10 OR MORE DISCOUNT 5%
ADD \$1.00 SHIPPING
CAL. RES. ADD 6% SALES TAX
FREE OSCILLATOR SCHEMATICS
WITH ANY ORDER
QUALITY COMPUTER PARTS
P.O. BOX 743 / CHATSWORTH, CA 91311

Circle 329 on inquiry card.

Immediate response to your orders (verbal or written).

Call toll-free outside Cal: 1 (800) 421-0347

apple II & II plus

16K-Call
32K-Call
48K-Call
toll free

apple III is here

Call today and be the first to have the most powerful professional computer in its class!

ATARI 400

Personal computer. Come with computer console, basic language cartridge, power supply, TV modulator, books, and manuals. Only \$498.

atari 800

Everything that 400 has plus Basic Language Cartridge. 16K memory (expandable to 48K). Only \$798.

FREE Bonus 8K Memory Module good till 12/31/80.

Atari Program Recorder. Only \$68.95

Atari Expansion Memory. 8K \$89.95
16K \$159.

TRS-80*

All TRS-80 Compatible Hardware and Software. Call us and tell us what you need!

print wheels and thimbles

Huge selection for **Qume, Diablo, NEC.** Plastic or metal. Call 1-800-421-0347.

apple cards

Hi-Speed Serial Interface	Call
Communications Interface	Call
Parallel Printer Interface	Call
Centronics Printer Interface	Call
Hobby/Prototype	Call
Integer Basic Firmware	Call
Applesoft Firmware	Call

commodore

Call for latest price on:

CBM 8000
Business computer
CBM 2001
Business computer
CBM 2001
PET

CBM 2022

Printer

CBM 2023

Printer

CBM2040

Dual Drive

Floppy Disk

CBM 8050

Dual Drive

Floppy Disk

CBM Modem
(300 Band)
CBM Voice
Synthesizer

apple II

inventory control system

The first truly professional system that can tackle up to 8,100 items, transaction register/audit trail, inventory status report, re-order report, keeps track of purchase orders automatically, will handle multiple departments or divisions, fast data retrieval. Minimum hardware requirements: Apple II Plus with 48K, one disk drive and 80 column printer. Available also for the new DOS 3.3.

printers

NEC Spinwriter

Letter quality high speed printer, bi-directional, high resolution plotting, graphics.

RO with Tractor Feed \$2865.

KSR with Tractor Feed \$2995.

Paper Tiger (1P440) \$949.

With Graphics

Anadex DP9500 11449.

DP8000 \$849.

Epson MX 80 \$645.

cromemco system three

Cromemco

A professional microcomputer with tremendous expandable memory.

Call Now

Also Z-2H Hard Disk and Z2 Computer System. We carry all accessories, hardware and software.

monitors

9" Black and white. Only \$185.

Also available in **Sanyo**

12" Black and white.

15" Black and white.

CALL US TOLL FREE FOR NEW CATALOG OF ACCESSORIES & SOFTWARE 800-421-0347



*TRS-80 is a trademark of the Tandy Corporation.

dysan diskettes

8" (Box of 10)

3740/1 sgl side/sgl density \$4.50 ea.

3740/1D sgl side/dbl den \$6.95 ea.

5" (Box of 5)

104/1 soft sector, \$4.50 ea.
107/1 10 sectors,
105/1 16 sectors

modems

Micromodem 100 Call.
Micromodem II Only \$329.

Prices subject to change without notice. Please allow 2 weeks for cashiers checks and 4 weeks for personal to clear. Add 2% for shipping and handling. Cal. residents please add 6% sales tax. Sorry, no COD. U.S. and international dealer inquiries invited. Copyright 1980 MICRO Business World

DATA SYSTEMS

Smart Video Terminal

\$795

FREE CATALOG Circle 330 on inquiry card.

Get our free computer hardware, software, supply and accessory catalog. We carry most everything for Apple, TRS 80, Vector, Atari.

Commodore. Cromemco and much more.

16K RAM
Set of 8 \$39.95

In California Call (213) 371-1660

MICRO BUSINESS WORLD™

15818 Hawthorne Blvd.,
Lawndale, CA 90260

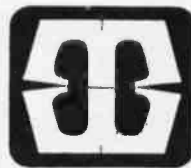

Now you can afford quality!

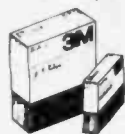

Scotch®

DISKETTES

SAVE 30% TO 45%!

Possibly the LOWEST prices you'll find on quality SCOTCH Brand Diskettes in sizes to fit all Mini/Micro Computers. One box or by the case, all orders are processed quickly and shipped per your instructions.

Call COLLECT to Order!
(805) 484-8146

QUALITY DATA SUPPLY
P.O. Box 236, Camarillo, CA 93010

Authorized Distributor
Information Processing Products



Circle 331 on Inquiry card.

TWX-LINK

TWX-LINK is a complete software package which interfaces your Cromemco or MP/M based multi-user computer to a Western Union TWX line.

Using an FCC approved direct connect modem, TWX-LINK allows your computer to act as a TWX terminal for both incoming and outgoing messages.

TWX-LINK constantly monitors your TWX line. Incoming messages are automatically received, acknowledged, and written to disk storage.

TWX, TELEX, MAILGRAMS, AND TELEGRAMS can all be created, edited, and sent from your computer by using TWX-LINK.

Call, write, or TWX for more info:
CAWTHON SCIENTIFIC GROUP
24224 Michigan Avenue
Dearborn, Michigan 48124
PH: (313) 565-4000
TWX: 810-221-1265

Circle 332 on Inquiry card.

PERTEC FD-200

Floppy Disk Drives

35% OFF LIST

Rebuilt, tested, like-new, with 90-day Warranty

\$235⁰⁰ ea.

Any quantity, while supply lasts

Also available:
New and like-new Perlec 24MB, 10MB, Cartridge Hard Disk Drives, Magnetic Tape Drives and Controllers.

Call, write or TWX for more info.
IBEX COMPUTER CORPORATION
18730 Oxnard St., Tarzana, CA 91356
(213) 705-2517
VISA and Mastercharge accepted

Circle 333 on Inquiry card.

OmniFORTH

FOR NORTH STAR DOS

- Based on fig-FORTH
- 8080 Compatible (SOLS, IMSAI, etc.)
- Excellent users manual and installation documentation
- Includes the interactive OmniFORTH compiler, Text EDITOR, File system utilities, and 8080 + Z80 ASSEMBLER
- Requires North Star DOS and 24K memory
- Specify disk density (SD or DD/QD)
- Price \$64.95 plus \$2.00 S&H
(Florida residents add 4% sales tax. U.S. Funds only. Additional shipping charges outside U.S.A.)



**INTERACTIVE
COMPUTER SYSTEMS, INC.**

6403 DIMarco Rd. • Tampa, FL 33614

Circle 334 on inquiry card.

SPECIAL INTRODUCTORY

Limited Quantity OFFER Order Now

WORDSTAR™	\$325
MAGIC WAND™	\$275

Word Processing for CPM Systems

VISA and MasterCard accepted
† addl. for charge and GST

DWP

Data & Word Processing Inc.

123 Rowell Court

Old Brick House Square

Falls Church, Virginia 22046

(703)241-2910

WordStar is a trademark of Micro Pro International, Inc.
Magic Wand is a trademark of Small Business Applications, Inc.
CP/M is a registered trademark of Digital Research Corp.

Circle 335 on Inquiry card.

29 MEGABYTES \$4495

ADAPTIVE DATA & ENERGY SYSTEMS

2627 Pomona Boulevard, Pomona, California 91768

Or call: (714) 594-6858 weekdays 10:00 to 4:00 P.S.T.



The ADES 533 Hard Disc Subsystem includes 33MB (unformatted capacity) DISCOS, ADES PS100 Controller, cables and CD/D5 for CP/M 2.2, plus power supply and fan in a handsome desktop cabinet.

For further information on the ADES 533 or 10MB Hard Disc System write:

ADAPTIVE DATA & ENERGY SYSTEMS

2627 Pomona Boulevard, Pomona, California 91768

Or call: (714) 594-6858 weekdays 10:00 to 4:00 P.S.T.

PS100 5100 Bus Hard Disc Controller \$695

533 33MB Disc Controller Subsystem \$4495

S10 10MB Disc Subsystem \$3495

CP/M is a registered trademark of Digital Research. DEALER INQUIRIES WELCOMED

Circle 336 on Inquiry card.

16K DYNAMIC RAM

T1 4116 16Kx1 RAMS

8 FOR \$32.00 32 FOR \$120.00

THIS IS A SPECIAL PURCHASE OF NEW T.I. 300 N.S. DYNAMIC RAMS.

These are factory spec. parts, not surplus. These parts will work with most memory boards as well as memory expansion for TRS-80, APPLE, EXIDY, etc.

HANLEY ENGINEERING
P.O. BOX 21432
SEATTLE, WASH. 98111
(206) 633-3404

Circle 337 on inquiry card.

USR-330D Modem

Auto-Dial/Auto Answer \$399
Connect your TRS-80, Apple, or any other computer to the phone lines.

- 0-300 Baud-Bell 103/113 compatible
- Serial-RS232
- Half/Full Duplex
- 1 year warranty

FCC Certified
Direct connection to phone lines via RJ11C standard extension phone jack

USR-330A Modem \$339

Same as 330D but Manual-Originate/Auto-Answer.

Radio Shack Model II Users - We have software to connect you directly to the phone lines.



U.S. ROBOTICS INC.
203 N. WABASH
SUITE 1718
CHICAGO, ILL 60601
(312) 346-6650

Circle 338 on Inquiry card.

SAVE OLD SOLS

Address up to 60K contiguous user RAM

SOS Personality Replacement Module moves SOLOS and VDM to F000

Replacement Module board comes complete with new SOLOS ROMs, assembled and tested.

Your old Personality module still works at C000. Plugging in SOS Module moves SOLOS to F000.

Price: \$129.

Check VISA or MC
Add \$3. for shipping.
NY residents add 8% tax.

METRON COMPUTERWARE INC.

552 West 114 Street
New York, N.Y. 10025
(212) 666-2400
Dept. B

Circle 339 on Inquiry card.

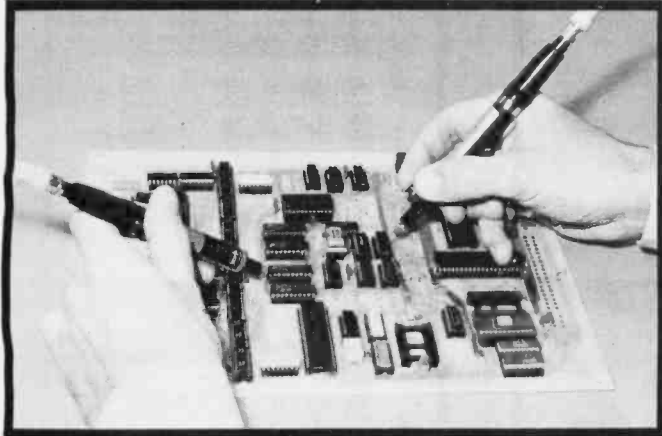
PRB1 LOGIC PROBE PLS1 LOGIC PULSER**PRB1 LOGIC PROBE \$36.95**

- Compatible with all logic families
- Visual indication of low, high and bad logic levels
- Pulse stretching to 50 Msec

PLS1 LOGIC PULSER \$48.95

- Superimposes 20pps pulse train onto circuit
- No need to cut circuit trace
- Automatic pulse polarity

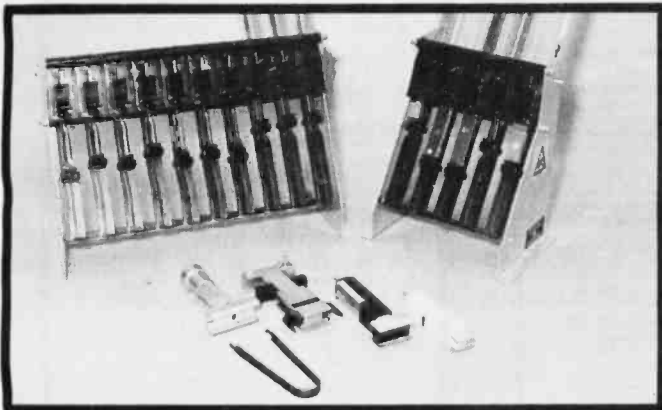
INSERTION/EXTRACTION TOOLS**WK7 INSERTION/EXTRACTION KIT \$29.95**

- MOS safe
- Includes EX1 & EX2 Extraction tools
- MOS 1416, MOS 2428, MOS 40 Extraction tools

- MDD1 1 channel dispenser \$ 21.85
- MDD5 5 channel dispenser 83.43
- MDD10 10 channel dispenser 160.45
 - Dispenses 8-42 pin IC's
 - Compatible with all IC carrying tubes
 - Use with WK7 for MOS-safe IC insertion

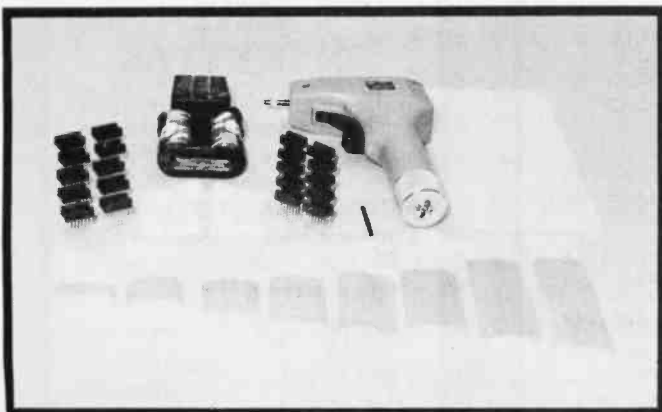
WW1 WIRE WRAPPING KIT**WW1 WIRE WRAPPING KIT**

- BW2630 Power wrapping tool \$19.85
- BT30 #30 Bit 3.95
- BC1 Batteries and charger 14.95
- KIT#3 Precut wire kit 32.95
- 10 ea. 14 pin, 16 pin gold wrap sockets 11.00
- EZO7302 4.25" x 8.5" Glass epoxy board 3.95
- 14 ID, 16 ID 20 IC wrap indentifiers 3.96

TOTAL \$90.01
SALE PRICE \$69.95

Write or call for 1980 catalog

- IC Sockets
- Vector Board & Pins
- Bishop Drafting Aids
- OK Tools
- RN IDC Crimp Connectors

ORDERING INFORMATION:

- Orders under \$25 include \$2 handling
- All prepaid orders shipped UPS Ppd.
- Visa, MC & COD's charged shipping.
- All prices good through cover date.
- Most orders shipped same day.
- Byte must be mentioned to get sale price.

Circle 340 on inquiry card.

TOLL FREE ORDERING NUMBER 1-(800)-423-7144

ATARI OWNERS

Parallel Printer Interface for the ATARI 400 / 800

Connects to controller jacks 3&4 works with BASIC / DOS / ASSEMBLER
Three printer connectors available:

ATARI 400 / 800
TRENDCOM 100 / 200 A4P-1 A8P-1
CENTRONICS 730 / 737 A4P-2 A8P-2
CENTRONICS 36 PIN* A4P-3 A8P-3

*Fits all other parallel Centronics plus Anadex, Base 9, Epson, Comprint and Microtek.
Order by part number, MC / VISA accepted.

ATARI is a recognized trademark of ATARI, Inc.



\$69.95

CA sales add 6% tax

MICROTRONICS, inc.®

1195 N. Golden State
Turlock, CA 95300 (A)
(909) 667-8888 / 634-8888

We are experiencing telephone difficulties, please keep trying.

Circle 341 on inquiry card.

Sales
Installation
Service
of
Computers

JEPSAN, Group K
Incorporated



*** PERSCI DISK REPAIR ***

MINIMIZE DOWN TIME

BY
CALLING

(616) 698-8700

CROMEMCO Dealer

4180 44th Street S.E.
Grand Rapids, MI 49508

Circle 342 on inquiry card.

CROSS-ASSEMBLERS

WRITTEN IN ANSI FORTRAN IV

PACKAGE NO.	MACHINE(S)
XASM8800	MC8800,02,08
XASM8801	MC8801
XASM8805	MC8805
XASM8808	MC8808
XASM8809	8080,8085
XASM1802	CDP1802
XASM8502	8500 FAMILY

Full instruction set, all addressing modes. Free-format input, relocatable listing and object module, many user-selectable assembly options. 8-character labels, arithmetic expressions in operands, long error messages, high execution speed.

Full-capability assemblers run on almost any system supporting ANSI standard FORTRAN IV, 1968 or later, at a fraction of the cost of a separate development system.

FORTRAN SOURCE MEDIA	PRICE
MAGNETIC TAPE PACKAGE	\$75.00
PUNCHED CARD PACKAGE	\$50.00
MANUAL LISTING ALONE	\$20.00

Packages include manual listing, shipping in U.S.A. For cards, specify punch code. For tape, specify code, BPI, block size.

IDM

P.O. Box 14538
Minneapolis, MN 55414
(612)-722-1702

Circle 343 on inquiry card.



ATARI®

Atari 800 with 24 K\$810
Atari 810 Disk Drive.....\$525

PLUS

Bit Bucket software for the Atari including disassembler, renumberer, character generator FREE with purchase of Atari 800 or 810.

Atari 820 40-Column Impact Printer....\$480
Atari 822 40-Column Thermal Printer...\$360
Atari 825 80-Column Impact Printer....\$800
Atari 830 Modem.....\$156
Atari 850 Interface Module\$176

ALL ATARI SOFTWARE 20% OFF



The Bit Bucket

168 North Beacon Street
P O Box 365
Newton Highlands, MA 02161
Phone: (617) 783-3144

Circle 344 on inquiry card.

JOY-6

THE ULTIMATE JOYSTICK INTERFACE FOR YOUR TRS-80*

JOY-6 is a Complete 6 Channel, 9 Bit A to D Featuring:

- 4 channels with variable gain—for Joysticks
- 2 unbuffered channels—for game paddles, sensors
- 3 digital inputs—for pushbuttons, TTL signals
- Sound effects capability—(user supplies speaker)
- Comprehensive users manual—write your own games!
- Joypak-1 cassette—6 exciting Joystick games with thrilling sound effects, including:

FRENZY A unique new game of strategy and skill. Time shots and judge angles correctly to defeat the opponent. Use the pushbutton to spin your shots. Practice mode sharpens your offensive and defensive tactics. Variable levels of difficulty.

SPECIAL INTRODUCTORY OFFER! JOY-6 COMPLETE WITH 2 JOY-STICKS WITH PUSHBUTTONS, JOYPAK-1, POWER SUPPLY, USER'S MANUAL ASSEMBLED, TESTED, READY TO PLAY. ONLY \$99.95

MEGA systems inc.
262 PARK LANE
KING OF PRUSSIA, PA 19406

PHONE ORDERS WELCOME
215-337-3876
C.O.D. CHECK, M.O., M.C., VISA
Add \$2.00 postage & handling
P.S. Plus add 8% tax
*TRS-80 is a Trademark of Tandy Corp.

Circle 345 on inquiry card.

MAGIC WAND™

\$325

This powerful word processor is in stock for most CP/M compatible systems, including Radio Shack, North Star, Vector Graphics, Cromemco and APPLE (with Z-80 card @ \$295 and Videx 80 column board @ \$295). We will custom configure your diskette if you will specify: CPU, terminal, printer.

Our fully interactive

MAIL MAGIC™

mail management software, with 14 user defined fields and full merge and sort capability is available for \$149.

We will also quote on all specific hardware and software for APPLE, PET and Vector Graphics.

Computer City

P.O. Box 60284 B
Houston TX 77205
(713) 821-2702



Magic Wand is a registered trademark of Small Business Applications
Mail Magic is a registered trademark of Computer City

Circle 346 on inquiry card.

NEED A PRINTER?

SURPLUS

IBM

1062

Teller Terminal

RECENTLY REMOVED FROM SERVICE

EACH TERMINAL INCLUDES:

IBM Selectric Printer ONLY

15" Carriage

IBM Type Ball

Program Tape Reader

\$128.00

YOU PAY SHIPPING ON DELIVERY



ARNDT DIST.
1202 HANSON LANE
RAMONA, CA 92065

(714) 789-3856

PHONE ORDERS ACCEPTED

Circle 347 on Inquiry card.

CASH-FLOW ANALYSIS

PREDICTS CASH CRUNCH

DETERMINES OPTIMUM CASHFLOW USING PAYMENT PRIORITIES AND RECEIVABLE PROBABILITIES

MEASURES IMPACT OF POSSIBLE PURCHASES ON CASHFLOW

DOCUMENTS FINANCIAL ABILITY

\$129 Ready to run on CP/M system.

ALPHA-OMEGA SYSTEMS, INC.
1504 3RD AVE. SUITE 700
SEATTLE, WA 98101

(206) 622-2719



Circle 348 on Inquiry card.

3M DISKETTES

For record reliability and quality buy 3M Scotch Diskettes. All Diskettes are in stock for immediate shipment. Call TOLL FREE (800) 235-4137 for prices and information. Visa and Master Card accepted. All orders sent postage paid.



PACIFIC EXCHANGES
100 Foothill Blvd.
San Luis Obispo, CA
93401 (In Cal call
(805) 543-1037)

Circle 349 on inquiry card.



Contact us for new prices Qume Datatrak 8

Double sided floppy with NO HEADACHES. Although many think this an impossibility, seeing is believing, and this drive is really something! Shugart compatible, fully optioned, reliable, and rapidly becoming the standard in double-sided diskdom.

\$599. Two/\$549.

Siemens FDD 100-8D

Single sided 8" floppy drive, the latest & greatest revision. Features double density plus much more. An extremely reliable drive \$439 2/\$409

Hard sector option kit... \$9.95
Data separator option kit... \$9.95

The following 5 1/4" mini-floppies share most features with their 8" cousins, so without further ado...

Siemens FDD 100-5D. \$279.
Qume Datatrak 5 (double sided). . . . 399.
BASF Mini mini. 279.
SA 400. 299.
All the above mini-floppies are fully SA400 compatible.

Manuals for all drives are \$10, refundable against future purchase of drives. Also, all 8" drives can be ordered with 220 v/50 hz for world-wide use.

Accessories



Cable kits for 8" drives with 10' 50 cond. flat cable, power cable, and all connectors. Assembled if desired. One drive 27.50, two 33.95, three 38.95 for mini floppies (34 cond): one 24.95, two, 29.95

CP-206 Power-one power supply. Powers two drives more than adequately, top quality. 2.8A/24V, 2.5A/5V, .5A/-5V. \$99.

mini-floppy power supply \$79

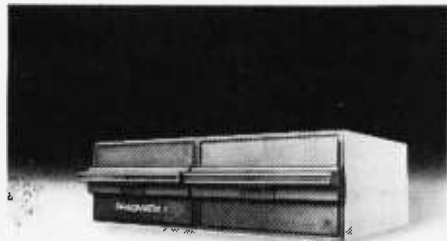

PRAGMATIX 1

Incredible!! — Two 8" Shugart compatible single sided floppy disk drives (double density), CP-206 power supply, in handsome color coordinated cabinet, with full cabling, connectors, and documentation, plus one box diskettes!!! All for an unprecedented \$1865. Up to one MBY of storage.

With Qume Datatrak 8" double-sided drive \$2495

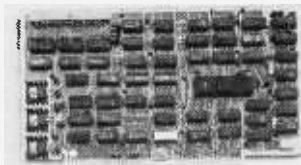

Disk controllers

Delta Products double density \$349
Micromation doubler 439
Tarbell single density, A & T 225
Tarbell single density, kit 184
Tarbell double density, DMA 425
Sorrento Valley 8" single density for Apple 375

Hard Disk

CII HB 10 MBY fully REMOVEABLE cartridge drive. Complete with controller, personality card, media, power supply, cabling, connectors and documentation. Highlighted by stylish & modern cabinetry. \$6995.

Shugart SA4008 20MBY fixed disk system. S-100, includes controller, power supply, and all that is necessary to run \$6995.

Electrolabs

POB 4436, Stanford, CA 94305

415-321-5601 800-227-8266
Telex: 345567 (Electrolab Pla)
Visa MC Am. Exp.



ENCLOSURES

Rackmount Mainframe MT-200. This gorgeous beast is so appealing that it can easily function also as stand-alone mainframe. Very modern styling with fully actively terminated S-100 bus.

With two 8" single-sided disk drives. . . \$1899.
With two 8" double sided disk drives in place of single-sided variety. \$2499.

Desktop Mainframe MT-100. Contemporary styling, a handsome cabinet coated with durable epoxy finish colors (blue, beige, off-white & silver). Easy to fit into an office environment. The proper way to start your system.

Above plus two 8" single sided disk drives \$1599.
Above with two 8" double sided disk drives in place of single-sided variety \$2199.

\$25 min. order. Calif. residents add 6% sales tax. Orders under \$75, add 5% shipping and handling, over \$75 add 2.5%. All pricing subject to change without notice.



Electrolabs' Monthly Special!!!

TELEVIDEO 912C \$745
TELEVIDEO 920C 812

Features typewriter keyboard, microprocessor controls, Upper/lower case, adjustable baud rates (75-9600 baud), special function keys, much more.

Second page memory option \$29.00

Data Display Monitors

used 12" Sylvania monitors. Composite video, 12 MHz, 120 VAC. with new P-39 or P-4 tube, \$79, used tube \$59, OEM style (without case), subtract \$12. U-fix model, 10/\$300.

4116 dynamic RAM, 16K Bonanza!!

Set of 8, 16K, for Apple, TRS-80, Exidy, Heath & more. 200 Ns, prime parts, at the unheard of \$49/8. Large discounts available for quantity & dealers (500 & up). Offer limited while supply lasts, as these will vanish quickly!!!

Media

8" ...\$39.99 SS/SD
8" ...\$49.00 SS/DD
8" ...\$55.00 DS/SD
8" ...\$59.00 DS/DD
5 1/4" \$34.95 SS
5 1/4" \$59.00 DS

Verbatim, Memorex, Scotch, or equivalent name brand
Special Introductory Offer!!!
Wabash 8" diskettes \$29.00 SS
\$39.00 DS

Price is cheap, but they run like champs!!!!

Diskette head cleaning kit for 5 1/4" or 8" \$28.75 includes everything for 1 drive for 1 year. Alignment Diskette for Floppy Drives \$39.00



A New Book
From BYTE Books

Threaded Interpretive Languages

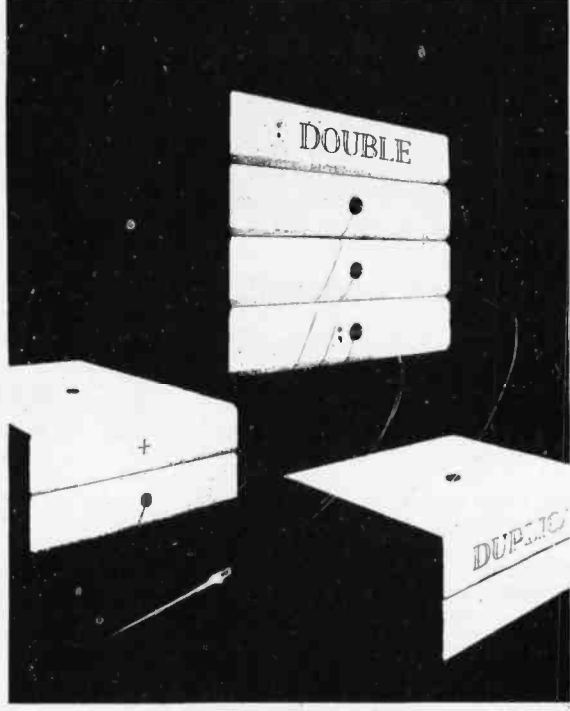

R. G. Loeliger

Threaded languages (such as FORTH) are an exciting new class of languages. They are compact and fast, giving the speed of assembly language with the programming ease of BASIC, and combine features found in no other programming languages. An increasing number of people are using them, but few know much about how they work. Is a threaded language interpreted or compiled? How much memory overhead does it require? Just what is an "inner interpreter?" **Threaded Interpretive Languages**, by R. G. Loeliger, concentrates on the development of an interactive, extensible language with specific routines for the ZILOG Z80 microprocessor. With the core interpreter, assembler, and data type defining words covered in the text, it is possible to design and implement programs for almost any application imaginable. Since the language itself is highly segmented into very short routines, it is easy to design equivalent routines for different processors and produce an equivalent threaded interpretive language for other development systems. If you are interested in learning how to write better FORTH programs or you want to design your own powerful, but low-cost, threaded language specific to your needs, this book is for you.



This and other BYTE/McGraw-Hill books are available from BYTE Books or your local computer store.

ISBN 0-07-038360-X
Price \$18.95

B12

Please send _____ copies of **Threaded Interpretive Languages**

Name _____ Title _____ Company _____

Street _____ City _____ State/Province _____ Code _____

Call TOLL FREE: 800-258-5420
or Mail To:

Check enclosed in the amount of \$ _____
 Bill Visa Bill Master Charge
 Card No. _____
 Exp. Date _____



70 Main St.
Peterborough, NH 03458

Add 75¢ per book to cover postage and handling.
Please remit in U.S. funds or draw on a U.S. Bank.

PRICES SLASHED FOR DECEMBER!!!

DETACH OUR 60 PAGE CATALOG FROM THE NOVEMBER BYTE MAGAZINE

DETACH OUR 60 PAGE CATALOG FROM THE NOVEMBER BYTE MAGAZINE

2114-3L
4096 BIT (1024x4) 300ns
LOW POWER STATIC RAM
8/\$34⁰⁰
100 + \$3⁵⁰

5257-3L
(TMS 4044)
4096x1 300ns
LOW POWER STATIC RAM
8/\$50⁰⁰
100 pcs. + \$4⁷⁵

2708
450ns 8K
EPROM
\$8⁵⁰ each
or 8/\$54⁰⁰

2716
450ns 5 Volt only
16 K EPROM
\$12⁹⁵ each
or 10/\$100⁰⁰

TRS-80/APPLE
MEMORY EXPANSION KITS
4116's RAMS
from Leading Manufacturers
(16Kx1 200/250ns) **SETS SOLD 1,000's**
8 for \$36⁰⁰
ADD \$3.00 FOR PROGRAMMING JUMPERS
FOR TRS-80 KEYBOARD
4116's 100 pcs & UP \$4.20 each
1000 pcs & UP \$3.80 each

MODEM SALE

X-MAS SALE
THE STAR
MODEM
from LIVERMORE



FEATURE
FITS GTE HANDSETS!
\$139.00
2 YEAR WARRANTY

EXCLUSIVE ACOUSTIC CHAMBERS
The exclusive triple seal of Livermore's new flat mounted cups locks the handset into the acoustic chamber yielding superior acoustic isolation and mechanical cushioning. Designed to adapt to most common handsets used throughout the world, the STAR offers the utmost in flexibility and transmission reliability.

- Specifications:**
- Data Rate: 0 to 300 baud
 - Compatibility: Bell 103 and 113; CCITT
 - Frequency Stability: ±0.3 percent. Crystal controlled
 - Receiver Sensitivity: -50 dBm ON, -53 dBm OFF
 - Modulation: Frequency shift keyed (FSK)
 - Carrier Detect Delay: 1.2 seconds ON; 120 msec OFF
 - EIA Terminal Interface: Compatible with RS 232 specifications
 - Teletype Interface: 20 milliamper current loop
 - Optional Interfaces: IEEE 488; TTL; TTY 43
 - International (CCITT) frequencies available
 - Switches: Originate/Off/Answer, Full Duplex/Test/Half Duplex
 - Indicators: Transmit Data, Receive Data, Carrier Ready, Test
 - Power: Supplied by 24 VAC/150 MA UL/CSA listed wall-mount transformer. Input 115 VAC, 2.5 watts. (A 220 VAC, 50 Hz adaptor is available upon request.)
 - Dimensions: 10" x 4" x 2"
 - Weight: 1.74 lbs. (3 lbs. shipping weight including AC adaptor)
 - Warranty: Two years on parts and labor, excluding the AC adaptor which carries the manufacturer's warranty

Shugart SA801R SALE

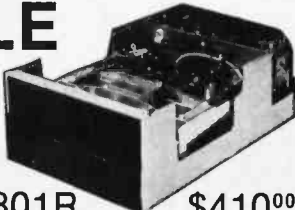

SHU-SA801R \$410⁰⁰
2 OR MORE \$395⁰⁰ ea.

Capacity	Single Density	Double Density
Unformatted		
Per Disk	3.2 megabits	6.4 megabits
Per Track	41.7 kilobits	83.4 kilobits
IBM Format		
Per Disk	2.0 megabits	n/a
Per Track	26.6 kilobits	n/a
Transfer Rate	250 kilobits/sec.	500 kilobits/sec.
Latency (average)	83 ms	83 ms
Access Time		
Track to Track	8 ms	8 ms
Average	260 ms	260 ms
Setting Time	8 ms	8 ms
Head Load Time	35 ms	35 ms

Shugart's SA801 standard floppy disk drive is the established industry leader with over 85,000 units installed around the world. This floppy disk drive application leadership is backed by 17 patents and a technical staff with hundreds of man-years of disk drive engineering experience.



THINKER TOYS 8" DISK DRIVE CABINET

- Internal data cable and power cables
- Data signals are terminated at the back of the cabinet with a socket/header connector
- Regulated power supply with protection circuitry
- Clean, attractive appearance
- Stackable
- Accommodates Shugart SA801R, SA800R, SA581R, SA850R, Siemens FDD120/200 Series, Demex 2000, Remex 4000
- Vented chassis for cool, reliable operation
- Color Beige
- Shipping weight: 20 lbs. (single drive cabinet) 30 lbs. (dual drive cabinet)

THT-DC1	Single Drive Cabinet	\$ 250.00
THT-DC2	Dual Drive Cabinet	\$ 375.00

ORDER TOLL FREE 1-800-423-5633
except CA, AK, HI, CALL
(213) 894-8171

FLUKE LOW COST DMM'S MODEL D804



- FOR DETAILED INFORMATION SEE THE 2 PAGE COLOR AD ON PAGES 30, 31 IN DEC. BYTE
- FLU-D800 \$125⁰⁰
 - FLU-D802 \$179⁰⁰
 - FLU-D804 \$229⁰⁰
 - FLU-D810 \$259⁰⁰
 - FLU-D811 \$299⁰⁰

FOR ACCESSORIES, SEE OUR 60 PAGE DETACHABLE CATALOG IN THE NOV. BYTE

SAVE \$239⁰⁰

ECONORAM XA 32K RAM

BOOBOUT

Order No. GBT129A32 Reg. \$689.00
Sale Priced \$450.00

- 4 MHz with Z80
- 5 MHz with 8085
- Assembled and Tested
- S-100 Compatible
- Fully Static

Part No.	Description	List Price	SALE PRICE
LIV-STAR	RS232, TTL Modem	\$199.00	\$139.00
LIV-STAR20M	RS232, 20MA Current Loop	\$199.00	\$139.00
LIV-STAR-V21	CCITT European Standard	\$229.00	\$209.00
LIV-IEEE	IEEE 488 Standard	\$395.00	\$288.00
LIV-IEEE-V21	IEEE 488, CCITT Standard	\$465.00	\$388.00

CABLES

Part No.	Description	Price
CND-RS2328F	RS232 8 Cond 8 ft.	\$19.95
LIV-121	IEEE to IEEE 2 Meter	\$59.95
LIV-12PET	IEEE to Pet 2 Meter	\$59.95



Part No.	Sectoring	Application	Box of 10
VRB-MD 525-01	Soft Sector	TRS-80 Apple	\$29.95
VRB-MD 525-10	Hard 10 Sector	North Star	\$29.95
VRB-MD 525-16	Hard 16 Sector	Micropolls	\$29.95
VRB-F032-1000	Hard Sector	Shugart 801R	\$37.00
VRB-F034-1000	Soft Sector	IBM 3740	\$37.00

SHIPPING WEIGHT 1 LB.

PRIORITY ONE ELECTRONICS

16723 B ROSCOE BLVD. • SEPULVEDA, CA. 91343

Terms: Visa, MC, BAC, Check, Money Order, U.S. Funds Only. CA residents add 6% sales tax. Minimum order \$15.00. Prepaid U.S. orders less than \$75.00 include 5% shipping and handling. MINIMUM \$2.50. Excess refunded. Just in case... please include your phone no. Prices subject to change without notice. We will do our best to maintain prices thru December, 1980.
*SOCKET and CONNECTOR prices based on GOLD, not exceeding \$500 per oz.
*Sale Prices are for prepaid orders only credit card orders will be charged appropriate freight

ORDER TOLL FREE (800) 423-5633

Circle 351 on Inquiry card.

MICROPOLIS™

OVERSTOCKS

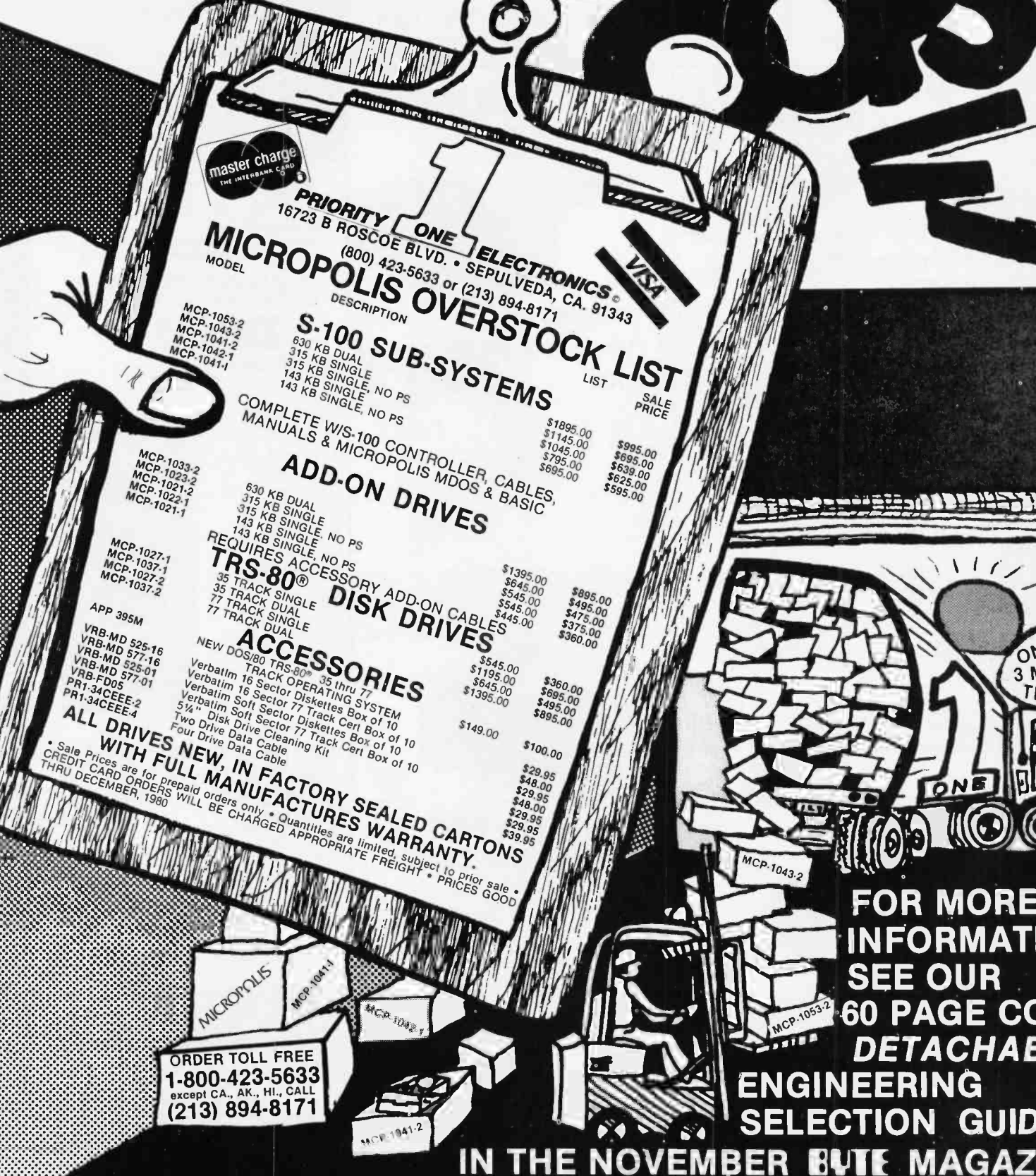

PRIORITY ONE ELECTRONICS
 16723 B ROSCOE BLVD. • SEPULVEDA, CA. 91343
 (800) 423-5633 or (213) 894-8171

MICROPOLIS OVERSTOCK LIST

MODEL	DESCRIPTION	LIST PRICE	SALE PRICE
MCP-1053-2	630 KB DUAL	\$1895.00	\$995.00
MCP-1043-2	315 KB SINGLE	\$1145.00	\$695.00
MCP-1041-2	315 KB SINGLE, NO PS	\$1045.00	\$639.00
MCP-1042-1	143 KB SINGLE	\$795.00	\$625.00
MCP-1041-1	143 KB SINGLE, NO PS	\$695.00	\$595.00
S-100 SUB-SYSTEMS			
COMPLETE W/S-100 CONTROLLER, CABLES, MANUALS & MICROPOLIS MDOS & BASIC			
MCP-1033-2	630 KB DUAL	\$1395.00	\$895.00
MCP-1023-2	315 KB SINGLE	\$645.00	\$495.00
MCP-1021-2	315 KB SINGLE, NO PS	\$545.00	\$475.00
MCP-1022-1	143 KB SINGLE	\$545.00	\$375.00
MCP-1021-1	143 KB SINGLE, NO PS	\$445.00	\$360.00
ADD-ON DRIVES			
REQUIRES ACCESSORY ADD-ON CABLES			
MCP-1027-1	35 TRACK SINGLE	\$545.00	\$360.00
MCP-1037-1	35 TRACK DUAL	\$1195.00	\$695.00
MCP-1027-2	77 TRACK SINGLE	\$645.00	\$495.00
MCP-1037-2	77 TRACK DUAL	\$1395.00	\$895.00
DISK DRIVES			
APP 395M	NEW DOS/80 TRS-80® 35 thru 77 TRACK OPERATING SYSTEM	\$149.00	\$100.00
VRB-MD 525-16	Verbatim 16 Sector Diskettes Box of 10	\$29.95	\$29.95
VRB-MD 577-16	Verbatim 16 Sector 77 Track Cert Box of 10	\$48.00	\$48.00
VRB-MD 525-01	Verbatim Soft Sector 77 Track Cert Box of 10	\$29.95	\$29.95
VRB-MD 577-01	Verbatim Soft Sector 77 Track Cert Box of 10	\$48.00	\$48.00
PR1-34CEEE-2	5 1/4" Disk Drive Cleaning Kit	\$29.95	\$29.95
PR1-34CEEE-4	Four Drive Data Cable	\$39.95	\$39.95
ACCESSORIES			
All Drives New, in Factory Sealed Cartons with Full Manufacturers Warranty.			

* Sale Prices are for prepaid orders only • Quantities are limited, subject to prior sale • CREDIT CARD ORDERS WILL BE CHARGED APPROPRIATE FREIGHT • PRICES GOOD THRU DECEMBER, 1980

ORDER TOLL FREE
1-800-423-5633
 except CA., AK., HI., CALL
(213) 894-8171

FOR MORE INFORMATION SEE OUR 60 PAGE CATALOG DETACHABLE ENGINEERING SELECTION GUIDE IN THE NOVEMBER BYTE MAGAZINE

Terms: Visa, MC, BAC, Check, Money Order, U.S. Funds Only. CA residents add 6% sales tax. Minimum order \$15.00 Prepaid U.S. orders less than \$75.00 include 5% shipping and handling. MINIMUM \$2.50. Excess refunded. Just in case...please include your phone number. Prices subject to change without notice. We will do our best to maintain prices thru December 1980

SALE

NO PROBLEM BOSS ...
PRIORITY ONE IS HERE ...
BUT YOU'LL SLEEP BETTER IF
YOU DON'T KNOW WHAT PRICES
I'VE QUOTED



OOPS!
I SAID BUILD 300
DRIVES NOT 3000!

ORDER TOLL FREE
1-800-423-5633
except CA., AK., HI. CALL
(213) 894-8171

1

PRIORITY ONE ELECTRONICS

Circle 351 on inquiry card.

National Semiconductor Clock Modules

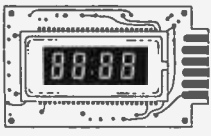

12VDC AUTOMOTIVE/ INSTRUMENT CLOCK
APPLICATIONS:
 • In-dash auto clocks
 • After-market auto/ RV clocks
 • Aircraft-marine clocks
 • 12VDC oper. instru.
 • Portable/battery powered instrumts.

Features: Bright 0.3" green display. Internal crystal time base. ± 0.5 sec./day accur. Auto. display brightness control logic. Display color filterable to blue, blue-green, green & yellow. Complete—just add switches and lens.

MA1003 Module	\$16.95
MA1023 .7" Low Cost Digital LED Clock Module	8.95	
MA1026 .7" Dig. LED Alarm Clock/Thermometer	18.95	
MA5036 .3" Low Cost Digital LED Clock/Timer	6.95	
MA1002 .5" LED Display Dig. Clock & Xformer	9.95	

National Semiconductor RAM SALE

MM5290J-2 (MK4116/UPD416) ...	\$6.95 each
16K DYNAMIC RAM (150NS)	
(8 EACH \$49.95) (100 EACH \$550.00/lot)	
MM5298J-3A	\$3.25 each
8K DYNAMIC RAM (LOW HALF OF MM5290J) 200NS	
(8 EACH \$23.95) (100 EACH \$250.00/lot)	
MM2114-3	\$5.95 each
4K STATIC RAM (300NS)	
(8 EACH \$43.95) (100 EACH \$450.00/lot)	
MM2114L-3	\$6.25 each
4K STATIC RAM (LOW POWER 300NS)	
(8 EACH \$44.95) (100 EACH \$475.00/lot)	

EPROM Erasing Lamp



- Erases 2708, 2716, 1702A, 52030, 52040, etc.
- Erases up to 4 chips within 20 minutes.
- Maintains constant exposure distance of one inch.
- Special conductive foam liner eliminates static build-up.
- Built-in safety lock to prevent UV exposure.
- Compact—only 7-5/8" x 2-7/8" x 2"
- Complete with holding tray for 4 chips.

UVS-11E **\$79.50**

Jumbo 6-Digit Clock Kit

- Four .630" ht. and two .300" ht. common anode displays
- Uses MM5314 clock chip
- Switches for hours, minutes and hold functions
- Hours easily viewable to 30 feet
- Simulated walnut case
- 115VAC operation
- 12 or 24 hour operation
- Includes all components, case and wall transformer
- Size: 6 3/4" x 3-1/8" x 1 1/2"

JE747 **\$29.95**

6-Digit Clock Kit

- Bright .300 ht. comm. cathode display
- Uses MM5314 clock chip
- Switches for hours, minutes and hold modes
- Hrs. easily viewable to 20 ft.
- Simulated walnut case
- 115 VAC operation
- 12 or 24 hr. operation
- Incl. all components, case & wall transformer
- Size: 6 3/4" x 3-1/8" x 1 1/2"

JE701 **\$19.95**

Regulated Power Supply

Uses LM309K. Heat sink provided. PC board construction. Provides a solid 1 amp @ 5 volts. Can supply up to $\pm 5V$, $\pm 9V$ and $\pm 12V$ with JE205 Adapter. Includes components, hardware and instructions. Size: 3 1/2" x 5" x 2 1/4"

JE200 **\$14.95**

ADAPTER BOARD
 —Adapts to JE200—
 $\pm 5V$, $\pm 9V$ and $\pm 12V$

DC/DC converter with +5V input. Toroidal hi-speed switching XMFR. Short circuit protection. PC board construction. Piggy-back to JE 200 board. Size: 3 3/4" x 2" x 9/16" H

JE205 **\$12.95**

MICROPROCESSOR COMPONENTS

8080A/8080A SUPPORT DEVICES		DATA ACQUISITION (CONTINUED)	
IN58080A	CPU	ADC0808CN	8-Bit A/D Converter (8-Ch. Multi.)
DP8234	8-Bit Input/Output	ADC0809CN	8-Bit A/D Converter (8-Ch. Multi.)
DP8235	Priority Interrupt Control	DAC0808CN	8-Bit D/A Conv. Micro. Comp. (0.2%)
DP8236	Bi-Directional Bus Driver	DAC0809CN	8-Bit D/A Conv. Micro. Comp. (0.2%)
DP8237	Clock Generator/Driver	DAC0808LCN	8-Bit D/A Converter (0.2% Lin.)
DP8238	Bus Driver	DAC0809LCN	8-Bit D/A Converter (0.2% Lin.)
DP8239	System Controller/Bus Driver	DAC1322LCN	13-Bit D/A Converter (0.2% Lin.)
DP8240	System Controller	CO4021N	8-Channel Multiplier
IN58043	I/O Expander for 48 Series	AV-6103	30K BAUD UART
IN58250	Asynchronous Comm. Element		
DP8251	Prog. Comm. I/O (USART)		
DP8252	Prog. Interval Timer		
DP8253	Prog. Peripheral I/O (PPI)		
DP8254	Prog. DMA Control		
DP8255	Prog. Interrupt Control		
DP8256	Prog. CRT Controller		
DP8257	Prog. Keyboard/Display Interface		
DP8258	System Timing Element		
DP8259	8-Bit Bi-Directional Receiver		
DP8260	8-Bit Bi-Directional Receiver		
DP8261	8-Bit Bi-Directional Receiver		

6800/6800 SUPPORT DEVICES		RAM'S	
MC14401	MPU	1101	28k1 Static
MC14402	MPU with Clock and RAM	1301	100k1 Dynamic
MC14403	128k Static RAM	2801	28k1 Static
MC14404	Paralleln Inter. Adapt (MC6800)	3101	100k1 Static
MC14405	Priority Interrupt Controller	3201	100k1 Static
MC14406	1024x8-RAM (MC68A03-3)	3112	28k1 Static
MC14407	Asynchronous Comm. Adapter	3113	28k1 Static
MC14408	Synchronous Serial Data Adapter	3114	28k1 Static
MC14409	64000bps Digital MODEM	3115	28k1 Static
MC14410	7800bps Modulator	3116	28k1 Static
MC14411	Quad 3-State Bus Trans. (MC1475)	3117	28k1 Static

MICROPROCESSOR CHIPS		PROMS/EPROMS	
Z80 (780C)	CPU (MK8000) (8MHz)	170A	2Kx8 EPROM
Z80 (780C)	CPU (MK8000-4) (4MHz)	2708	8K EPROM
CDP1002	CPU	TA8377B	8K EPROM (4V, +5V, +12V)
2801	MPU	2716	16K EPROM (4V, +5V)
MC14691	MPU w/Clock (8K Bytes Memory)	2720	32K EPROM
IN5803N-4	MPU-8-Bit (8MHz)	2732	64K EPROM (40ns) (Single +5V)
IN5803N-4	CPU-8-Bit (8MHz)	2764	128K EPROM (Open Collector)
IN5804N-4	CPU (256 Bytes RAM)	2802	2048 EPROM
IN5807N	CPU-64 Bytes RAM	8231B	4096 Bipolar PROM
PD05	CPU	8231C	32k Tri-State Bipolar PROM
IN5808	CPU-16-Bit	8251B	8K PROM
TA5899JL	MPU-16-Bit	8251C	8K PROM

SHIFT REGISTERS		NROMS READ ONLY MEMORIES	
MM5901-4	Dual 25-Bit Dynamic	MC14603P	128x7 ASCII Shifted w/Drive
MM5901-4	Dual 50-Bit Dynamic	MC14603P	128x7 Math Symbol & Pictures
MM5901-4	Dual 100-Bit Dynamic	MC14607P	128x7 Alpha, Control, Char. Gen.
MM5901-4	Dual 200-Bit Dynamic	MC14607P	128x7 Math Symbol & Pictures
MM5901-4	Dual 400-Bit Dynamic	MC14607P	128x7 Alpha, Control, Char. Gen.
MM5901-4	Dual 800-Bit Dynamic	MC14607P	128x7 Math Symbol & Pictures
MM5901-4	Dual 1600-Bit Dynamic	MC14607P	128x7 Alpha, Control, Char. Gen.
MM5901-4	Dual 3200-Bit Dynamic	MC14607P	128x7 Math Symbol & Pictures
MM5901-4	Dual 6400-Bit Dynamic	MC14607P	128x7 Alpha, Control, Char. Gen.
MM5901-4	Dual 12800-Bit Dynamic	MC14607P	128x7 Math Symbol & Pictures
MM5901-4	Dual 25600-Bit Dynamic	MC14607P	128x7 Alpha, Control, Char. Gen.
MM5901-4	Dual 51200-Bit Dynamic	MC14607P	128x7 Math Symbol & Pictures
MM5901-4	Dual 102400-Bit Dynamic	MC14607P	128x7 Alpha, Control, Char. Gen.
MM5901-4	Dual 204800-Bit Dynamic	MC14607P	128x7 Math Symbol & Pictures
MM5901-4	Dual 409600-Bit Dynamic	MC14607P	128x7 Alpha, Control, Char. Gen.
MM5901-4	Dual 819200-Bit Dynamic	MC14607P	128x7 Math Symbol & Pictures
MM5901-4	Dual 1638400-Bit Dynamic	MC14607P	128x7 Alpha, Control, Char. Gen.

DATA ACQUISITION		TELEPHONE/KEYBOARD CHIPS	
AF100-1CN	Universal Active Filter 2.5k	AV-5100	16-Bit Telephone Dialer
AF100-1CJ	Touch Tone Low Pass Filter	AV-5100	Rotary Dialer
LM3834M	Super Gain Op Amp	AV-5100	CMOS Clock Generator
LM332	Constant Current Source	AV-5270	Keyboard Encoder (8 keys)
LM332	Temperature Transducer	AV-5270	Keyboard Encoder (16 keys)
LF388N	JFET Input Op Amp	AV-5270	Keyboard Encoder (26 keys)
LF388N	Sample & Hold Amplifier	AV-5270	Keyboard Encoder (40 keys)
ADC0808CN	8-Bit A/D Converter (1 LSB)	AV-5270	Keyboard Encoder (80 keys)
DAC0808LCN	8-Bit D/A Converter (0.2% Lin.)	AV-5270	Keyboard Encoder (160 keys)

DESIGNERS' SERIES

Blank Desk-Top Electronic Enclosures



CONSTRUCTION:
 The "DTE" Blank Desk Top Electronic Enclosures are designed to blend and complement today's modern computer equipment and can be used in both industrial and home. The end pieces are precision molded with an internal slot (all around) to accept both top and bottom panels. The panels are then fastened to X" thick tabs inside the end pieces to provide maximum rigidity to the enclosure. For ease of equipment servicing, the rear/bottom panel slides back on slotted tracks while the rest of the enclosure remains intact. Different panel widths may be used while maintaining a common profile outline. The molded end pieces can also be painted to match any panel color scheme.

Enclosure Model No.	Panel Width	PRICE
DTE-8	8.00"	\$29.95
DTE-11	10.65"	\$32.95
DTE-14	14.00"	\$34.95

\$10.00 Min. Order — U.S. Funds Only
 Calif. Residents Add 6% Sales Tax
 Postage—Add 5% plus \$1 Insurance
 Spec Sheets — 25¢
 1981 Catalog Available — Send 41¢ stamp

NEW 1981 CATALOG

Jamec ELECTRONICS

MAIL ORDER ELECTRONICS — WORLDWIDE
 1355 SHOREWAY ROAD, BELMONT, CA 94002
 PRICES SUBJECT TO CHANGE

PHONE ORDERS WELCOME
 (415) 592-8097

COMPUTER CUBE T.M.



- COMPUTER CRT MONITOR & ACCESSORY CASE**
- One piece heavy duty molded construction
 - Painted to match Apple II & III/LC beige, textured finish
 - Smoke colored acrylic front cover (removable)
 - Built-in shelf holds CRT and allows room for 2 Apple II disk drives below shelf
 - Three 2 1/2" bays provided in bottom of case for addition of fan if needed.
 - Fan hole positioned above Apple motherboard location.
 - Hookup cables can be run through other 2 holes.
 - Case accommodates most 8&W and Color uncrated CRT monitors made by Motorola, Ball Bros., Zenith, Sanyo, Panasonic, Hitachi, etc. or any monitor that will fit into 10-3/8" H x 14 1/2" W x 13 3/4" D space.
 - Size: 15" x 15" x 15" D.D. 14 1/2" H x 14 1/2" W x 13 3/4" D.
 - Weight: approximately 12 lbs.
 - CRT monitor fan and disk drives not included.

CUBE-1 **\$99.95**

TRS-80 16K Conversion Kit

Expand your 4K TRS-80 System to 16K.
 Kit comes complete with:
 • 8 each MM5290-2 (UPD416) (16K Dynamic Rams)
 • 250NS or less
 • Documentation for conversion

TRS-16K **\$49.95**

JE610 ASCII Encoded Keyboard Kit



The JE610 ASCII Keyboard Kit can be interfaced into most any computer system. The kit comes complete with an industrial grade keyboard switch assembly (62-keys), IC's, sockets, connector, electronic components and a double-sided printed wiring board. The keyboard assembly requires +5V @ 150mA and -12V @ 10 mA for operation. Features: 60 keys generate the 126 characters, upper and lower case ASCII set. Fully buffered. Two user-definable keys provided for custom applications. Caps lock for upper-case-only alpha characters. Utilizes a 2376 (40-pin) encoder read-only memory chip. Outputs directly compatible with TTL/DTL or MDS logic arrays. Easy interfacing with a 16-pin dip or 18-pin edge connector.

JE610 (Case not included) **\$79.95**
K62 (Keyboard only) **\$34.95**

Desk-Top Enclosure for JE610 ASCII Encoded Keyboard Kit
 Compact desk-top enclosure: Color-coordinated designer's case with light tan aluminum panels and molded end pieces in mocha brown. Includes mounting hardware. Size: 3 3/4" H x 14 1/2" W x 8 3/4" D.

DTE-AK **\$49.95**
SPECIAL: JE610/DTE-AK PURCHASED TOGETHER
 (Value \$129.90) **\$124.95**

JE600 Hexadecimal Encoder Kit

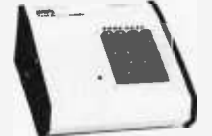

FULL 8-BIT LATCHED OUTPUT 19-KEY KEYBOARD

The JE600 Encoder Keyboard Kit provides two separate hexadecimal digits produced from sequential key entries to allow direct programming for 8-bit microprocessor or 8-bit memory circuits. Three additional keys are provided for user operations with one having a bistable output available. The outputs are latched and monitored with 9 LED readouts. Also included is a key entry strobe. Features: Full 8-bit latched output for microprocessor use. Three user-definable keys with one being bistable operation. Debounce circuit provided for all 19 keys. 9 LED readouts to verify entries. Easy interfacing with standard 16-pin IC connector. Only +5VDC required for operation.

JE600 (Case not included) **\$59.95**
K19 (Keyboard only) **\$14.95**

Desk-Top Enclosure for JE600 Hexadecimal Keyboard Kit
 Compact desk-top enclosure: Color-coordinated designer's case with light tan aluminum panels and molded end pieces in mocha brown. Includes mounting hardware. Size: 3 3/4" H x 8 3/4" W x 8 3/4" D.

DTE-HK **\$44.95**
SPECIAL: JE600/DTE-HK PURCHASED TOGETHER
 (Value \$104.90) **\$99.95**

7400

SN7400N	19	SN74123N	49
SN7401N	22	SN74125N	39
SN7402N	22	SN74126N	44
SN7403N	22	SN74128N	55
SN7404N	22	SN74132N	69
SN7405N	22	SN74134N	95
SN7406N	23	SN74139N	95
SN7407N	23	SN74141N	69
SN7408N	26	SN74142N	85
SN7409N	23	SN74143N	295
SN7410N	22	SN74144N	62
SN7411N	29	SN74145N	62
SN7412N	29	SN74147N	195
SN7413N	29	SN74148N	120
SN7414N	59	SN74150N	99
SN7416N	29	SN74151N	67
SN7417N	29	SN74152N	67
SN7420N	22	SN74153N	67
SN7421N	35	SN74154N	119
SN7422N	29	SN74155N	62
SN7423N	29	SN74156N	89
SN7426N	29	SN74158N	165
SN7427N	29	SN74160N	95
SN7429N	45	SN74161N	89
SN7430N	23	SN74162N	89
SN7432N	29	SN74163N	87
SN7437N	29	SN74164N	97
SN7438N	29	SN74165N	97
SN7439N	29	SN74166N	120
SN7440N	24	SN74167N	69
SN7441N	29	SN74170N	169
SN7442N	57	SN74172N	595
SN7443N	79	SN74173N	99
SN7444N	79	SN74174N	89
SN7445N	79	SN74175N	89
SN7446N	59	SN74176N	85
SN7447N	59	SN74177N	85
SN7448N	79	SN74179N	180
SN7450N	23	SN74180N	75
SN7451N	23	SN74181N	175
SN7453N	23	SN74182N	75
SN7454N	23	SN74184N	156
SN7455N	29	SN74185N	195
SN7460N	23	SN74186N	99
SN7470N	39	SN74189N	390
SN7472N	39	SN74190N	315
SN7473N	38	SN74191N	115
SN7474N	36	SN74192N	85
SN7475N	38	SN74193N	85
SN7476N	36	SN74194N	85
SN7478N	480	SN74195N	85
SN7480N	79	SN74196N	85
SN7481N	110	SN74197N	85
SN7482N	110	SN74198N	139
SN7483N	56	SN74199N	139
SN7485N	65	SN74201N	109
SN7486N	65	SN74202N	109
SN7489N	175	SN74203N	105
SN7490N	39	SN74204N	105
SN7491N	65	SN74205N	215
SN7492N	52	SN74206N	120
SN7493N	52	SN74207N	120
SN7494N	72	SN74209N	355
SN7495N	65	SN74209N	355
SN7496N	72	SN74365N	68
SN7497N	310	SN74366N	68
SN7498N	310	SN74367N	68
SN7499N	32	SN74368N	79
SN74109N	53	SN74390N	190
SN74116N	195	SN74393N	190
SN74121N	29	SN74490N	190
SN74122N	39		

74LS00

74LS00N	35	74LS164N	119
74LS01N	28	74LS165N	89
74LS02N	28	74LS166N	248
74LS03N	28	74LS168N	189
74LS04N	28	74LS169N	189
74LS05N	29	74LS170N	199
74LS08N	39	74LS173N	89
74LS09N	39	74LS174N	99
74LS10N	39	74LS175N	99
74LS11N	39	74LS181N	220
74LS12N	39	74LS182N	115
74LS13N	47	74LS191N	115
74LS14N	125	74LS192N	98
74LS15N	39	74LS193N	98
74LS20N	26	74LS194N	115
74LS21N	26	74LS195N	95
74LS22N	38	74LS196N	89
74LS26N	37	74LS197N	89
74LS27N	38	74LS221N	149
74LS28N	39	74LS240N	195
74LS29N	38	74LS241N	180
74LS32N	39	74LS242N	195
74LS37N	79	74LS243N	195
74LS38N	79	74LS244N	195
74LS40N	26	74LS245N	195
74LS41N	79	74LS249N	110
74LS47N	79	74LS248N	110
74LS48N	79	74LS249N	169
74LS51N	26	74LS251N	179
74LS54N	35	74LS253N	98
74LS55N	35	74LS257N	98
74LS57N	49	74LS258N	98
74LS74N	59	74LS259N	295
74LS75N	68	74LS260N	69
74LS76N	45	74LS261N	249
74LS78N	65	74LS265N	59
74LS79N	65	74LS273N	59
74LS85N	119	74LS275N	440
74LS86N	45	74LS279N	59
74LS90N	75	74LS283N	110
74LS92N	75	74LS290N	129
74LS93N	75	74LS293N	195
74LS95N	88	74LS295N	110
74LS96N	98	74LS298N	129
74LS107N	45	74LS324N	175
74LS109N	45	74LS347N	195
74LS112N	45	74LS348N	195
74LS113N	49	74LS352N	165
74LS114N	55	74LS353N	165
74LS122N	55	74LS363N	149
74LS123N	119	74LS365N	99
74LS124N	135	74LS366N	99
74LS126N	85	74LS367N	73
74LS126N	89	74LS368N	73
74LS132N	79	74LS373N	275
74LS136N	59	74LS374N	275
74LS138N	89	74LS375N	89
74LS139N	89	74LS377N	89
74LS145N	125	74LS385N	195
74LS148N	149	74LS386N	195
74LS151N	79	74LS390N	195
74LS153N	79	74LS393N	195
74LS155N	119	74LS399N	295
74LS156N	99	74LS424N	295
74LS157N	99	74LS668N	175
74LS158N	75	74LS672N	229
74LS159N	99	81LS95N	195
74LS161N	115	81LS96N	195
74LS162N	98	81LS97N	199
74LS163N	98	81LS98N	199

16K UPGRADE ONLY
\$49.95
SPECIFY COMPUTER

NEW!
We Now Have The
Apple II Series
Silenttype
IN STOCK

With Apple Intelligent Interface Card. Reg. \$595.00
Interface Card Has All Software For Hi-Res, Graphics & Pascal User.

NOW ONLY **\$549.00**

BECKMAN Digital Multimeters

Choice of Models - The TECH 310 has all above features, 7 functions, 29 ranges, plus 0.25% Vol accuracy. The TECH 300 has a 0.5% Vol accuracy and all the above features, but without auto-zeroing continuously function for the 10 amp current ranges.

TECH 300 Digital Multimeter... \$100
TECH 310 Digital Multimeter... \$130
VOC 201 Vinyl Clamping Case... \$10
DC-202 Deluxe Clamping Case... \$24
HY211 High Voltage Probe... \$35
RP-221 R/P Probe... \$35
CR-231 AC Current Clamp... \$42
DL-281 Deluxe Test Lead Kit... \$6
TL-242 Spare Test Leads... \$6

NEW!
MUSIC MACHINE 9
WITH 9 VOICES!

NEW Uses latest State of the Art SSI Technology... Requires only 1 set for 9 voices... Uses latest ARG 3910 IC to produce new notes... Plays music generated by the AIF board... ADF software... \$129.95

FLOPPY DISK DRIVES

MPI B51-514... 40 tracks... \$279.00
Shugart SA400-514... 35 tracks... \$279.00
Shugart 800/801R... \$475.00
Siemens Storage Compatible Model... \$299.00
FDD-120-80... \$429.00
PERSCO Model 277 Dual... \$1199.00
WANG/SIEMENS 5 1/4" Drive... \$290.00
MPI B52 5 1/4" Dual... \$348.00
WANG/SIEMENS 282 Dual 5 1/4"... \$395.00
WANG/SIEMENS B2... \$290.00

CONTINENTAL SPECIALTIES

Model LM-3 40 channel Logic Monitor... \$650.00
Model LM-1 Logic Monitor... \$600.00
Model LM-2 Logic Monitor... \$470.00
MAZ-100 100 MHz Portable Frequency Counter... \$149.00
Model LP-1 Digital Logic Probe... \$50.00
Model LP-2 Economy Logic Probe... \$28.00
Model LP-3 High Speed Logic Probe... \$77.00
Model LP-4 Logic Probe Kit... \$21.95
Model ITC-1 LITE 1 Logic Analysis Kits... \$220.250

Proto Clips

14-Pin Clip PC-14... \$ 4.25
16-Pin Clip PC-16... \$ 4.50
24-Pin Clip PC-24... \$ 9.50
40-Pin Clip PC-40... \$14.95

Proto Boards

PB-6... 18.95 PB-104... \$4.00
PB-100... 18.00 PB-203A... \$4.00
PB-101... 21.00 PB-203A... \$4.00
PB-103... 43.00 PB-203A... \$4.00

ACP'S INTELLIGENT COMPUTER PRODUCTS & GADGETS

Order now in time for Christmas

THE BONE FONE

• SKIERS
• JOGGERS
• SKATERS
• CYCLERS

You must hear it and feel it to believe it!

AM/FM stereo surrounds and fills your body with sound. No earplugs. You wear it!

\$65.95

ADVANCED COMPUTER PRODUCTS

Apple II. 16K or Apple II. Plus \$990 DISK SYSTEM SPECIAL

Apple II Plus w/48K Supermod Video Modulator Disk II w/Controller Integer Based ROM Card. Reg. \$2,220.00. ACP Price \$1819.00. **SAVE \$401.00**

Hi-Speed Serial I/O	\$189.00	DS65 Dig-Sector	\$349.00	Integer ROM Card	\$189.00
Centronics Printer I/O	\$199.00	Apple Graphics Tablet	\$75.00	Photo Card	21.95
Appex II Firmware	189.00	D.C. Hayes Modem II	349.95	K1 & R Modulator	29.95
Apple Clock	269.00	Disk II w/Controller & Disk 3	599.00	Sanyo Cassette	54.95
Intro X-10 System	179.95	Disk II	495.00	16K Upgrade Kit	54.05
Intro X-10 Controller	269.95	Pascal Lang. System	450.00	Desktop Plan	98.00
All Music Synthesizer	259.95	Parallel Printer Card	189.00	8" floppy Controller	350.00
16 Ch. Analog Input	249.95	Communications Card	189.00	Hi-Res Graphics Speechpad	179.00
2 Ch. Analog Output	164.95	Business Software Plug	625.00	Rompage +	169.00
13-Key Keypad	119.95	Corvus 10 Megabyte Drive	4625.00	Superadapter	279.00
Vis-Cat	125.00			Casher	250.00

NEW! California Computer Systems APPLE Clock. Only \$124.95

NEW! Z80 Softcard for APPLE CPM 2.2 & M BASIC 5.0 \$325.00

ATARI 800 & 400 Personal Computer System

ATARI 800 \$825.00
ATARI 400 \$449.00

ATARI 800 Includes: Computer Console, BASIC Lang. Cartridge, Education System Master Cartridge, BASIC Language Programming Manual, 800 Operator's Manual w/Notebook, 16K RAM Module, Power Supply, TV Switch Box.

Peripherals	599.00	Education System Cartridge Program	35.00	Speech	35.00
Disc Drive	599.00	U.S. History	35.00	Basic Editor	35.00
Printer	499.00	U.S. Government	35.00	Basic Algebra	35.00
Program Recorder	69.00	Superior Sales	35.00	Fast Game and Program Emulator	35.00
Software - 800 Interface	29.00	World History I/II/III	35.00	Guide to BASIC Programming	18.00
Education System Master Cartridge	29.00	Basic Sociology	35.00	BASIC Game Programs	18.00
Alan BASIC	59.00	Accounting Procedures	35.00	Atari Keyboard	35.00
Assembler Debug	59.00	Principles of Accounting	35.00	8K RAM Memory Module	110.00
Biweekly	47.00	Physics	35.00	16K RAM Memory Module	225.00
Life	47.00	Great Classics (English)	35.00	Photo Card	21.95
Super Breakout™	50.00	Business Communications	35.00	Bank Disasters	35.00
Music Composer	50.00	Basic Psychology	35.00	Disk the Manager	5.00
Super Bug™	50.00	Effective Writing	35.00	Assessing Learning	35.00
Computer Chess	55.00	Auto Mechanics	35.00	Driving Controller Pak	18.00
Home Finance	55.00	Principles of Economics	35.00	Flare Controller Pak	18.00
				Atchak Controller Pak	18.00

TEXAS INSTRUMENTS INCORPORATED

99/4 PERSONAL COMPUTER

Superior Color, Music, Sound and Graphics - and a Powerful Extended Basic - All Built In.
TI 99/4 Model only available for \$659.00 **\$1099.00**

COMMODORE PET AS LOW AS \$775.00

DISCOUNT PRICES
2001-164H Imp... 775.00
2001-324H Imp... 975.00
2001-310H Imp... 1295.00
2002 80 C&D Maria Printer... 795.00

SINGLE BOARD COMPUTER SELECTION GUIDE

BOARD	PROCESSOR	ACQ PRICE	ENCLOSURE	BASIC	PROCESSOR	ACQ PRICE	ENCLOSURE
KIM-1	6502	165.00	Acc-29.95	SC-58C100	700	239.00	164
KIM-2	6502	239.00	Acc-39.95	AIM-65	6507	375.00	Acc-49.95
Commodore	Z80	469.00	N/A	Comarc Vpc	1802	199.00	Inc.

QUARTZ LCD WATCH WITH SNOOZE ALARM

The looks and functions of the expensive models at an affordable price.

NEW!
6 FUNCTIONS
• HOURS
• MINUTES
• SECONDS
• DAY
• MONTH
• DATE

All in a small, silencing metal case with matching bracelet.

An Outstanding ACP Value **ONLY \$21.95**

FIREFOX RADIO CONTROLLED OFF-ROAD VEHICLE

For rough roads, smooth roads, high speed chases, it handles 'em all. Turn and ready for any challenge, the cross-country, all-terrain ACP's off-road comes through with a bang. Rough roads, handles 'em all. Digital proportional steering makes easy handling in tight, steep, and off-camber situations. Features include a 9-volt battery for the transmitter, 6 "C" batteries and one 9-volt battery for the car.

\$49.95

INTRODUCING THE CALCULIGHTNER

The only lighter in the world that adds, subtracts, multiplies, divides and lights!

LUXURIOUS BUTANE LIGHTER	\$5.00	ACP PRICE	\$69.95
GOLD	85.00		\$59.95
SILVER	85.00		\$59.95
BLACK	85.00		\$59.95

RETAIL STORES OPEN MON-SAT
STORE #1 1310 "B" E. Edinger Santa Ana, CA 92705 Showrooms, Retail, Warehouse
STORE #2 674 El Camino Real Tustin, CA 92680 Specializing in Systems
P.O. Box 17329 Irvine, Calif. 92713
Direct Order Lines: (714) 558-8813 (800) 854-8230 or (800) 854-8241
FOR INTERNATIONAL ORDERS: 1310 E. Edinger (714) 953-0804 Santa Ana, CA 92705 TWX: 910-595-1585
Circle 353 on inquiry card.

The Sale Ends Prices to increase as

S-100 Boards

THE BIG Z* - Jade

2 or 4 MHz switchable Z-80* CPU with serial I/O

CPU-30201K Kit	\$145.00
CPU-30201A A & T	\$199.00
CPU-30200B Bare board	\$35.00

SBC-100 - SD Systems

2.5 MHz Z-80* CPU with serial & parallel I/O ports

CPC-30100K Kit	\$289.95
CPC-30100A Jade A & T	\$339.95

SBC-200 - SD Systems

4 MHz Z-80* CPU with serial & parallel I/O ports

CPC-30200K Kit	\$299.95
CPC-30200A Jade A & T	\$375.00

CB2 - S.S.M.

2 or 4 MHz switchable Z-80* CPU with RAM, ROM, & I/O

CPU-30300K Kit	\$239.95
CPC-30300A A & T	\$299.95

2810 Z-80* CPU - Cal Comp Sys

2 1/4 MHz Z-80A* CPU w/serial I/O port

CPU-30400A A & T	\$275.00
------------------------	----------

64K RAM BOARD \$359.95

ExpandoRAM II - SD Systems

4 MHz RAM board expandable from 16K to 256K

MEM-16630A 16K kit	\$249.95
MEM-16630A 16K Jade A & T	\$299.95
MEM-32631K 32K kit	\$289.95
MEM-32631A 32K Jade A & T	\$339.95
MEM-48632K 48K kit	\$324.95
MEM-48631A 48K Jade A & T	\$374.95
MEM-64633K 64K kit	\$359.95
MEM-64633A 64K Jade A & T	\$409.95

ExpandoRAM I - SD Systems

2.5 MHz RAM board expandable from 16K to 64K

MEM-16130K 16K kit	\$245.00
MEM-16130A 16K Jade A & T	\$295.00
MEM-32131K 32K kit	\$275.00
MEM-32131A 32K Jade A & T	\$325.00
MEM-48132K 48K kit	\$305.00
MEM-48132A 48K Jade A & T	\$355.00
MEM-64133K 64K kit	\$335.00
MEM-64133A 64K Jade A & T	\$385.00

32K STATIC RAM BOARD \$299.95

16K STATIC RAM BOARD \$169.95

32K STATIC RAM - Jade

2 or 4 MHz expandable static RAM board uses 2114L's

MEM-16151K 16K 4 MHz kit	\$169.95
MEM-16151A 16K 4 MHz A & T	\$224.95
MEM-32151K 32K 4 MHz kit	\$299.95
MEM-32151A 32K 4 MHz A & T	\$349.95

16K STATIC RAM - Cal Comp Sys

2 or 4 MHz 16K static RAM - a real memory bargain

MEM-16160A 16K 2 MHz A & T	\$279.00
MEM-16162A 16K 4 MHz A & T	\$309.00
MEM-16160B Bare board	\$29.95

PB-1 - S.S.M.

2708, 2716 EPROM board with built-in programmer

MEM-99510K Kit	\$159.95
MEM-99510A A & T	\$239.95

PR0M-100 - SD Systems

2708, 2716, 2732, 2758, & 2516 EPROM programmer

MEM-99520K Kit	\$175.00
MEM-99520A Jade A & T	\$225.00

S.P.I.C. - Jade

Our new I/O card with 2 SIO's, 4 CTC's, and 1 PIO

IOI-1045K 2 CTC's, 1 SIO, 1 PIO ..	\$199.00
IOI-1045A A & T	\$259.00
IOI-1046K 4 CTC's, 2 SIO's, 1 PIO	\$259.00
IOI-1046A A & T	\$319.00
IOI-1045B Bare board w/ manual ..	\$59.95
IOI-1045D Manual only	\$20.00

I/O-4 - S.S.M.

2 serial I/O ports plus 2 parallel I/O ports

IOI-1010K Kit	\$179.95
IOI-1010A A & T	\$259.95
IOI-1010B Bare board	\$35.00

100K DAY CLOCK - Mtn Hardware

Crystal controlled S-100 clock with NiCad backup

IOK-1400A A & T	\$329.95
-----------------------	----------

SB1 - S.S.M.

15 Hz to 25K Hz music synthesizer for S-100

IOS-1005K Kit	\$239.95
IOS-1005A A & T	\$299.95

TB-4 - Mullen

Extremely versatile extender board with logic probe

TSX-180K Kit	\$55.00
TSX-180A A & T	\$75.00

TERMINATOR & EXTENDER - C.C.S.

Can be used as both an S-100 extender and terminator

TSX-150K Kit	\$39.95
--------------------	---------

S-100 EXTENDER - Cal Comp Sys

Puts problem boards within easy reach

TSX-160A A & T	\$24.95
----------------------	---------

DOUBLE-D - Jade

Double density controller with the inside track

IOD-1200K Kit	\$299.95
IOD-1200A 8" A & T	\$389.95
IOD-1205A 5 1/4" A & T	\$389.95
IOD-1200B Bare board	\$65.00

VERSAFLOPPY I - SD Systems

Versatile floppy disk controller for 8" or 5 1/4"

IOD-1150K Kit	\$219.95
IOD-1150A Jade A & T	\$289.95

VERSAFLOPPY II - SD Systems

New double density controller for both 8" & 5 1/4"

IOD-1160K Kit	\$309.95
IOD-1160A Jade A & T	\$369.95

VDB-8024 - SD Systems

80 x 24 I/O mapped video board with keyboard I/O

IOV-1020K Kit	\$339.95
IOV-1020A Jade A & T	\$399.95

VB3 - S.S.M.

80 x 24 or 80 x 48 memory mapped with graphics

IOV-1095K Kit, 4 MHz	\$399.95
IOV-1095A A & T, 4 MHz	\$464.95
IOV-1096K 80 x 48 upgrade, 4 MHz ..	\$89.00

VIDEO BOARD - Jade

64 x 16 assembled & tested S-100 video board

IOV-1050B Bare board	\$29.95
IOV-1050A A & T sale price	\$99.95

S-100 PROTO BOARD - Jade

Universal design, plated thru holes, gold fingers

TSX-140B Bare board	\$24.95
---------------------------	---------

*CP/M is a registered trademark of Digital Research Corp.

*Z-80, Z-80A, and the letter Z are recognized trademarks of Zilog, Inc.

Single Board Computers

Z-80* STARTER KIT - SD Systems

Z-80* computer with RAM, ROM, I/O, & keyboard

CPS-30010K Kit	\$319.95
CPS-30010A Jade A & T	\$399.95

AIM-65 - Rockwell

6502 computer with printer, display, & keyboard

CPK-50165 1K AIM	\$374.95
CPK-50465 4K AIM	\$449.95
SFK-74600008E 8K BASIC ROM ...	\$99.95
SFK-64600004E 4K assembler ROM	\$84.95
PSX-030A Power supply	\$64.95
ENX-00002 Enclosure	\$49.95
4K AIM, 8K BASIC, power supply, & enclosure	
Special package price	\$625.00

Motherboards

ISO-BUS - Jade

Silent, simple, and on sale - a better motherboard

6 Slot (5 1/4" x 8 1/2")	
MBS-061B Bare board	\$19.95
MBS-061K Kit	\$39.95
MBS-061A A & T	\$49.95
12 Slot (9 1/4" x 8 1/2")	
MBS-121B Bare board	\$29.95
MBS-121K Kit	\$69.95
MBS-121A A & T	\$89.95
18 Slot (14 1/4" x 8 1/2")	
MBS-181B Bare board	\$49.95
MBS-181K Kit	\$99.95
MBS-181A A & T	\$139.95

Mainframes

MAINFRAME - Cal Comp Sys

12 slot S-100 mainframe with 20 amp power supply

ENC-112105 Kit	\$309.95
ENC-112106 A & T	\$349.95

DISK MAINFRAME - NNC

Dual 8" drive cutouts with 8 slot motherboard

ENS-112320 with 30 amp p.s.	\$699.95
----------------------------------	----------

Video Monitors

9" B & W MONITOR - A.P.F.

High quality, high resolution video monitor

VDM-750900 9" monitor	\$149.95
13" COLOR MONITOR - Zenith	
The hi res color you've been promising yourself	
VDC-201301	\$449.00

12" GREEN SCREEN - NEC

20 MHz, P31 phosphor video monitor with audio

VDM-651200 12" monitor	\$249.95
------------------------------	----------

Software

CP/M 2.2 - Digital Research

Latest & most powerful release of CP/M

SFC-52506000D Manual set	\$24.95
SFC-52506000M 5 1/4" disk & manual	\$149.95
SFC-52506000F 8" disk & manual	\$149.95

SDOS - SD Systems

DOS, CBASIC2, Z-80* assembler/editor/linker

SFX-55001000D Manual set	\$24.95
SFX-55001002M 5 1/4" disks & man	\$199.95
SFX-55001006F 8" disk & manual	\$199.95

December 31 of January 1, 1981

Accessories for Apple

16K MEMORY UPGRADE

Add 16K of RAM to your TRS-80, Apple, or Exidy

MEX-16100K TRS-80 kit	\$39.95
MEX-16101K Apple kit	\$39.95
MEX-16102K Exidy kit	\$39.95

PRINTER INTERFACE - Cal Comp

Centronics type I/O card w/ firmware

IOI-2041A A & T	\$99.95
-----------------	---------

8" DRIVES for APPLE

Controller, DOS, two 8" drives, cabinet, & cable

Special package price	\$1475.00
-----------------------	-----------

AIO - S.S.M.

Parallel & serial interface for your Apple

IOI-2050K Kit	\$159.00
IOI-2050A A & T	\$199.00

APPLE CLOCK - Cal Comp Sys

Real time clock w/ battery backup

IOK-2100A A & T	\$125.00
-----------------	----------

SUPERTALKER - Mtn Hardware

Speech recognition synthesizer w/ speaker & mike

IOS-2015A A & T	\$275.00
-----------------	----------

Z-80* CARD for APPLE

Z-80* CPU card with CP/M for your Apple

CPX-30800A A & T	\$289.00
------------------	----------

MICROMODEM - D.C. Hayes

Auto answer dial modem card for Apple or S-100

IOI-2010A Apple modem	\$349.95
IOI-1100A S-100 modem	\$375.00

Printers

BASE 2 - Impact Printer

132 cps, bi-directional, tractor feed, & graphics

PRM-13100	\$675.00
-----------	----------

DP-9501 - Anadex

9 x 11 dot matrix, 220 column, 200 cps, & graphics

PRM-10601 Standard DP-9501	\$1495.00
PRM-10611 with graphics & 2K	\$1595.00

SPINWRITER - NEC

65 cps, bi-directional, letter quality with tractor

PRD-55510 with 16K buffer	\$2895.00
---------------------------	-----------

CENTRONICS 737-1

9 x N dot matrix, letter quality, proportional spacing

PRM-15737 Parallel	\$795.00
With interface for Apple	\$895.00

NOVATION CAT

300 baud, auto answer/originate acoustic modem

IOI-5200A Special sale price	\$139.00
------------------------------	----------

D-CAT 300 baud, direct connect modem

IOI-5201A Special sale price	\$189.00
------------------------------	----------

EPROM ERASERS

L.S. Engineering UV eraser for up to 48 EPROMs

XME-3200 A & T	\$39.95
----------------	---------

Spectronics hi intensity industrial eraser

XME-3100 Without timer	\$69.95
XME-3101 With timer	\$94.50

TV-1 - Best Buy

The inexpensive alternative to video monitors

IOR-5040K Kit	\$8.95
---------------	--------

Call for your free 1980 catalog

8" Disk Drive Sale

DUAL DISK SUB-SYSTEM - Jade

JADE's new dual disk sub-assemblies include: Handsome metal cabinet with proportionally balanced air flow system, rugged dual drive power supply, cooling fan, cable kit, lighted power switch, approved fuse assembly, line cord, Never-Mar rubber feet, and all necessary hardware to mount 2-8" disk drives - it's all American made, guaranteed for six months, and it's in stock!

Dual 8" Sub-Assembly Cabinet

END-000421 Cabinet kit	\$225.00
END-000420 Bare cabinet	\$59.95
Single sided, double density disk drive sub-system	
END-000423 Kit w/2 8" drives	\$995.00
END-000424 A & T w/2 8" drives	\$1195.00
Double sided, double density disk drive sub-system	
END-000426 kit w/2 8" drives	\$1495.00
END-000427 A & T w/2 8" drives	\$1695.00

8" DISK DRIVES

Highly reliable double density floppy disk drives

Shugart 801R single sided, double density

MSF-10801R SA-801R	\$425.00
Special sale price	2 for \$800.00
Siemens FDD100-8D2 single sided, double density	
MSF-201120 6 mo warranty	\$395.00
Special sale price	2 for \$750.00
Qume Datatrak 8 double sided, double density	
MSF-750080 SA-851R compatible	\$625.00
Special sale price	2 for \$1198.00

JADE DISK PACKAGE

Double-D controller kit, two 8" double density drives

CP/M 2.2, cabinet, power supply, & cables

Special package price	\$1395.00
-----------------------	-----------

DISKETTES - Jade

Bargain prices on magnificent magnetic media

5 1/4" single sided, single density, box of 10	
MMD-5110103 Soft sector	\$27.95
MMD-5111003 10 sector	\$27.95
MMD-5111603 16 sector	\$27.95
5 1/4" double sided, double density, box of 10	
MMD-5220103 Soft sector	\$39.95
8" single sided, single density, box of 10	
MMD-8110103 Soft sector	\$33.95
8" single sided, double density, box of 10	
MMD-8120103 Soft sector	\$39.95
8" double sided, double density, box of 10	
MMD-8220103 Soft sector	\$57.95

FLOPPY SAVERS - Tri-Star

Protect your valuable software from spindle damage

MMA-205 5 1/4" kit	\$13.95
MMA-208 8" kit	\$15.95

Mainframes

MAINFRAME - Cal Comp Sys

12 slot S-100 mainframe with 20 amp power supply

ENC-112105 Kit	\$309.95
ENC-112106 A & T	\$349.95

DISK MAINFRAME - NNC

Dual 8" drive cutouts with 8 slot motherboard

ENS-112320 with 30 amp p.s.	\$699.95
-----------------------------	----------

TRS-80 APPLE

16K MEMORY UPGRADE KIT

\$39.95

MICROPROCESSORS

Z-80	10.95
Z-80A	12.95
6802	11.50
6800	11.95
6802	17.95
6809	39.95
8035	24.00
8080A	6.59
8085	15.95
8748	59.95

SUPPORT DEVICES

8212	4.95
8214	4.65
8216	2.95
8224	3.25
8224-4	10.95
8226	3.85
8228	4.95
8238	4.95
8243	8.00
8250	14.95
8251	6.50
8253	13.95
8255	6.50
8257	19.95
8259	17.95
8275	49.95
8279	15.95

Z-80 SUPPORT

3881 PIO	9.50
3881-4 PIO-4 MHz	14.50
3882 CTC	9.50
3882-4 CTC-4 MHz	14.95
3883 SIO	29.50
3884 SIO	49.50

BAUD RATE GENERATORS

MC14411	10.00
1.843 MHz xtal	4.95

UARTS

6800	AY5-1013A	5.25
SUPPORT	AY3-1014A	8.25
6821P	TR1602B	5.25
6828P	1M6402	9.00
6834P		
6840P		

RAMS

6850P	211A02 2 MHz	1.25
6852P	211A02A 1 MHz	1.50
6875L	2114L 2 MHz	3.75
68488P	2114LA 1 MHz	3.95
PROMS	2147 70ns	39.95
2708 450ns	4116	4.95
2716 1250	4164 64k x1	175.00
2716 50	5257 2 MHz	6.75
2732 50	5257A 4 MHz	7.25
2758 50	MK4118	18.95

PLACE ORDERS

TOLL FREE

Inside California Continental U.S.
800-262-1710 800-421-5500

For customer service or technical inquiries call 213-973-7707

Write for our FREE 1980 catalog

JADE COMPUTER PRODUCTS

4901 W. Rosecrans, Hawthorne, CA 90250

TERMS OF SALE: Cash, checks, credit cards money orders or from recognized institutions Purchase orders accepted. Minimum order \$10.00 California residents add 6% sales tax. Minimum shipping and handling charge \$2.50. Prices are for U.S. and Canadian delivery only and are subject to change without notice. For export prices and information send for a JADE INTERNATIONAL CATALOG.



Circle 354 on inquiry card.



COMPUTER SYSTEMS INC.

15620 South Inglewood Avenue
Lawndale, California 90260
(213) 970-0952

Place Orders **Toll Free** 1-800-421-5150
(Continental U.S. Only — Except Calif.)
Retail Store Open 10:00 A.M. to 6:00 P.M.

Daily Except Sunday
QT CATALOG NOW AVAILABLE

**WE ACCEPT MASTER CHARGE
VISA & AMERICAN EXPRESS**

THE GREAT Q.T. BOARD SET SALE
6 SLOT MOTHER BOARD KIT FREE WITH EACH BOARD SET PURCHASED

Q.T. BD SET #1 (KIT)
Z+80 CPU (Rev I)
Expandable + with 32K
Monitor For Serial Terminal

FOR STARTERS
Our Normal Retail \$525.00
Q.T. Price \$425.00

S.D. BD SET #1 (KIT)
SBC-100
Expandoram I with 32K RAM
Versafloppy I
Monitor For Serial Terminal
BIOS for 8" or 5 1/4" Drives

FOR SERIOUS HOBBYISTS
Our Normal Retail \$950.00
Q.T. Price \$850.00

Q.T. BD SET #2 (KIT)
Z+CPU (Rev I)
Expandable + with 64K
FDCII Dbl Den Controller A&T
Monitor For Serial Terminal

FOR HOBBYISTS
Our Normal Retail \$1050.00
Q.T. Price \$850.00

S.D. BD SET #2 (KIT)
SBC-200
Expandoram II with 32K RAM
Versafloppy II
Monitor For Serial Terminal
BIOS for Disk Drives

FOR SMALL BUSINESSES & SOFTWARE DEVELOPERS
Our Normal Retail \$1150.00
Q.T. Price \$1000.00

QT MEMORY EXPANSION KITS
for

TRS-80 • APPLE • EXIDY
4116 200 ns 8 for \$35.00
2716 (5V-450 ns) \$13.50
2716 (5&12V-450 ns) ... \$13.50
2732 (5V) \$55.00
2114L 300 ns 8 for \$40.00
100 - \$4.25 ea.

KASSETTE LIBRARY

Part No.
CAS-10-8
Blue/Grey/Beige/Black
8" Diskette Holder \$4.50 or 3/\$10.00
CAS-10-5
Blue/Grey/Beige/Black
5" Diskette Holder \$4.25 or 3/\$10.00

PRINTERS

DP-9501 - Anadex
9x11 dot matrix, 220 column, 200 cps. & graphics
ADX-9501 Standard DP-9501 .. \$1475.00
ADX-9501G with graphics & 2K \$1525.00
Centronics
CEN-730-1 730-1A \$695.00
CEN-737-1 737-1 \$899.00
LP-80 - Matchless
9 x 7 matrix, 132 column, 125 cps. bi-directional
MAT-MS204 \$695.00
PAPER TIGER - Integral Data
132 column, parallel & serial, 150 cps, graphics
IDS-440 IDS-440 \$950.00
IDS-440GIDS-440w/graphics. \$1050.00
SPINWRITER - NEC
65 cps. bi-directional, letter quality with tractor/serial or par.
NEC-5510 with 2K buffer. \$2600.00

NOVATION CAT

300 baud, auto answer/originate acoustic modem
NOV-CAT \$149.00

SPECIAL

SINGLE BOARD COMPUTER
4 MHz Z80A CPU, dbl den Controller (5 1/4" or 8" simultaneously), CP/M® compatible, on-bd EPROM/RAM/ROM, two serial & two parallel ports, real time clk, std 2K monitor & disk routine on ROM, one year warranty.
SPECIAL PRICE THIS MONTH
TLT-FDC-1 (A&T only) \$795.00
DOUBLE DENSITY CONTROLLER
Controls up to 4 mini or 4 maxi drives simultaneously, IBM diskette format, works with sgl or dbl sided drives, 1K RAM data buffer, works with any CPU regardless of clock speed, CP/M® 2.2 furnished for 5 1/4" or 8". Oasis compatible.
TLT-FDC II (A&T only) \$325.00

QT MINI-SYSTEMS

• (4 MHz) Z80A CPU • Dbl Den Controller
• Two serial & two parallel ports • Real time clock • 2K Monitor on ROM • 48K Memory board • Mainframe with 6 slot mother board • DOS on 5 1/4" disk w/manuals.
QT Mini-System I (1/2 Megabyte) \$2195.00
Two B-51 sgl sided/sgl den drives
QT Mini-System II (1 Megabyte) \$2495.00
Includes two B-52 dbl sided/dbl den drives
(Just add terminal & compute)

CONNECTORS

RS232 Set \$7.50
1 Male DB-25, 1 Female DB-25, 1 Cover
DB25P \$3.25
DB25S \$4.25
Cover \$1.50
S-100 (IMSAI STYLE) \$2.50 ea.
Gold Solder Tail 10 for \$2.25

PARTS

MICROPROCESSORS
Z80 (2MHz) ... \$10.95
Z80A (4MHz) ... \$12.95
6502 \$11.25
6800 \$12.50
6802 \$18.00
8035 \$20.00
8080A \$ 3.50
8085A \$20.00
8086-4 \$60.00
8088 \$60.00
8748 \$60.00
TMS 9900 JL \$29.95

8080A SUPPORT
8212 \$ 3.50
8214 \$ 4.50
8216 \$ 2.95
8224 \$ 4.00
8228 \$ 6.00
8238 \$ 6.00
8243 \$ 5.00
8251 \$ 7.00
8253 \$19.00
8253-5 \$20.25
8255 \$ 6.25
8257 \$17.95
8257-5 \$19.00
8259 \$19.95
8275 \$69.95
8279 \$17.50
8279-5 \$18.00
8295 \$16.50

KEYBOARD CHIPS
AY5-2376 \$13.75
AY5-3600 \$13.75

BAUD RATE GENERATORS
MC14411 \$11.00
1.8432 XTAL \$ 4.95

DISK CONTROLLER
1771B01 \$24.95
1791A01(CER) \$37.95

EPROMS
1702A \$ 4.95
2708 \$ 6.25
2516 (5V) \$18.00
2716 (5V) \$13.50
2716 (5 & 12V) \$13.50
2758 \$19.95
2532 \$55.00
2732 \$55.00

USRT
S2350 \$ 7.95

MISCELLANEOUS OTHER COMPONENTS
N8T20 \$ 3.25
N8T26 \$ 2.50
N8T97 \$ 2.00
N8T98 \$ 2.00
1488 \$ 1.25
1489 \$ 1.25
D3205 \$ 3.00
D3242 \$10.15
D3245 \$ 5.60
P3404 \$ 6.75
TMS5501 \$19.00
DM8131 \$ 3.00

UARTS
TR1602B \$ 4.50
AY5-1013A \$ 4.50

CHARACTER GENERATORS
2513 \$10.95
UP CASE (5&12V)
2513 \$10.95
LWR CASE (5&12V)
2513 \$ 9.75
UP CASE (5V)
2513 \$10.95
LWR CASE (5V)

8800 PRODUCTS
6802P \$18.00
6821P \$ 5.25
6840P \$18.25
6845P \$22.00
6850P \$ 4.80
6860P \$11.55
6875P \$ 7.40

TELEVIDEO

912C \$699.00
920C \$799.00
• Typewriter keyboard • Microprocessor controls • Upper/lower case • Adjustable baud rates (75-9600 baud) • Special function keys
Second page memory option ... \$25.00

DISKETTES

5 1/4" sgl sided, sgl den, box of 10	
VER-525-01 Soft sector	\$27.95
VER-525-10 10 sector	\$27.95
VER-525-16 16 sector	\$27.95
5 1/4" dbl sided, dbl den, box of 10	
VER-550-01 Soft sector	\$39.95
8" sgl sided, sgl den, box of 10	
VER-34-1000 Soft sector	\$33.95
8" sgl sided, dbl den, box of 10	
VER-34-8000 Soft sector	\$55.95
8" dbl sided, dbl den, box of 10	
VER-34-4000 Soft sector	\$57.95

HARD HOLES

Protect your valuable software from spindle damage	
FSI-HHD Pkg of 50 for 8"	\$15.00
FSI-HDA 8" Applicator	\$ 5.25
FSI-HHM Pkg of 50 for 5 1/4"	\$10.75
FSI-HMA 5 1/4" Applicator	\$ 5.00

QT MAINFRAMES

Mainframe - Cal Comp Sys	
12 slot S-100 mainframe with 20 amp power supply	
CCS-2200AT A&T	\$349.95
QT 8" Disk Mainframe	
Dual 8" drive cutouts with 6 slot motherboard	
QTC-MF-DD6 with 30 amp p.s.	\$625.00
5 1/4" Disk Mainframes with 18A	
QTC-MF-MD12 (12 slot M/B)	\$500.00
QTC-MF-MD6 (6 slot M/B)	\$450.00
QTC-MF-MD w/o M/B	\$400.00
Mainframe - T.E.I.	
TEI-MCS-112 (12 slot M/B)	\$575.00
TEI-MCS-122 (22 slot M/B)	\$695.00

DISK DRIVES

QT DISK PACKAGE	
Dbl Den Controller, A&T, two 8" dbl den drives, CP/M 2.2, cabinet, power supply & cables	
	\$1395.00
DUAL 8" DRIVES	
Dbl Den Drives in Cabinet Only	
2 sgl sided (801R)	\$ 989.00
2 dbl sided (QUME)	\$1409.00
8" DISK DRIVES	
Highly reliable floppy disk drives sgl sided, dbl den	
SHU-801R	\$ 425.00
Special Sale Price	2 for \$800.00
Qume Datatrak 8" dbl sided, dbl density	
QME-8DS (851R compatible)	\$ 599.00
Pkg of two	\$ 549.00 ea.
5 1/4" DRIVES	
MPI-B51 MPI B-51	\$ 275.00
Sgl Sided, Sgl/Dbl Den	
Exact Replacement for SA-400	
MPI-B52 MPI B-52	\$ 395.00
Dbl Sided, Dbl Den	
MPI-B91 MPI B-91	\$ 395.00
Sgl Sided, Dbl Den, 77 Tracks	
PER-FD200 PERTEC FD-200	\$ 250.00
Sgl Sided, Sgl/Dbl Den	

QT MOTHERBOARDS

QT Silence Plus	
6 Slot (5 1/2" x 8 1/2")	
QTC-6 Slot BB Bare board	\$19.95
QTC-6 Slot K kit	\$39.95
QTC-6 Slot AT A&T	\$49.95
12 Slot (9 1/2" x 8 1/2")	
QTC-12 Slot BB Bare board	\$29.95
QTC-12 Slot K kit	\$69.95
QTC-12 Slot AT A&T	\$89.95
18 Slot (14 1/2" x 8 1/2")	
QTC-18 Slot BB Bare board	\$ 49.95
QTC-18 Slot K kit	\$ 99.95
QTC-18 Slot AT A&T	\$139.95

QT APPLE CORNER

MEX-16A2 Apple Expansion Kit	\$37.00
Buy 4 Sets for \$35.00	
DISK DRIVE for APPLE	
5 1/4" disk drive with controller for your Apple	
APL-5DC with controller	\$535.00
APL-5D w/out controller	\$450.00
8" DRIVES for APPLE	
Controller, two 8" drives, cabinet & cable	\$1450.00
QT APPLE DISK II	
Dbl sided, dbl den, two 8" QUME drives with controller, pwr supply, cabinet, cabling, documentation & one box diskettes	
	\$2195.00
QT APPLE DISK III	
Same as Above - no controller	
	\$1695.00
AI/O - S.S.M.	
Parallel & serial interface for your Apple	
SSM-AIO K Kit	\$159.00
SSM-AIO AT A&T	\$199.00
APPLE CLOCK - QT System	
Real time clock w/battery back-up	
QTC-CCA-AT A&T	\$125.00
SUPERTALKER - Mtn Hardware	
Speech recognition/synthesizer w/speaker & mike	
MHW-STLK A&T	\$275.00
Z-80 CARD for APPLE	
Z-80 CPU card with CP/M for your Apple	
MST-Z80 A&T	\$289.00
MICROMODEM - D.C. Hayes	
Auto answer dial modem card for Apple or S-100	
DCH-MM2 Apple modem	\$349.95
DCH-MM100 S-100 modem	\$375.00

TEXTTOOL

ZIP* DIP II SOCKETS	
16 PIN ZIP* DIP II	\$ 5.50
24 PIN ZIP* DIP II	\$ 7.50
40 PIN ZIP* DIP II	\$10.25
*ZERO INSERTION PRESSURE	

BARE BOARDS AVAILABLE ON MANY PRODUCTS

Double Density - Cal Comp Sys	
5 1/4" or 8" disk controller with free CP/M 2.2	
CCS-2422A A&T	\$374.95
SBC-100-SD Systems	
2.5 MHz Z80 CPU with serial & parallel I/O ports	
SDS-SBC100K Kit	\$269.95
SDS-SBC100AT A&T	\$339.95
SBC-200 - SD Systems	
4 MHz Z80 CPU with serial & parallel I/O ports	
SDS-SBC200K Kit	\$299.95
SDS-SBC200AT A&T	\$375.00
CB2 - S.S.M.	
2 or 4 MHz switchable Z80 CPU with RAM, ROM & I/O	
SSM-CB2K Kit	\$239.95
SSM-CB2AT A&T	\$299.95
2810 Z-80 CPU - Cal Comp Sys	
2 or 4 MHz Z80A CPU w/serial I/O port	
CCS-2810 A&T	\$275.00
ExpandoRAM I - SD Systems	
2.5 MHz RAM board expandable from 16K to 64K	
SDS-RAM16K 16K kit	\$245.00
SDS-RAM16AT 16K A&T	\$295.00
SDS-RAM32K 32K kit	\$275.00
SDS-RAM32AT 32K A&T	\$325.00
SDS-RAM48K 48K kit	\$305.00
SDS-RAM48AT 48K A&T	\$355.00
SDS-RAM64K 64K kit	\$335.00
SDS-RAM64AT 64K A&T	\$385.00
ExpandoRAM II - SD Systems	
4 MHz RAM board expandable from 16K to 256K	
SDS-RAM216K 16K kit	\$249.95
SDS-RAM216AT 16K A&T	\$299.95

S-100 PRODUCTS

SDS-RAM232K 32K kit	\$289.95
SDS-RAM232AT 32K A&T	\$339.95
SDS-RAM248K 48K kit	\$324.95
SDS-RAM248AT 48K A&T	\$374.95
SDS-RAM264K 64K kit	\$359.95
SDS-RAM264AT 64K A&T	\$409.95
16K Static RAM - Cal Comp Sys	
2 or 4 MHz 16K static RAM - a real memory bargain	
CCS-2016B 16K 2 MHz A&T	\$279.00
CCS-2016BCK 16K 4 MHz A&T	\$309.00
PB-1 - S.S.M.	
2708, 2716 EPROM board with built-in programmer	
SSM-PB1K kit	\$159.95
SSM-PB1AT A&T	\$239.95
PROM-100 - SD Systems	
2708, 2716, 2732, 2758 & 2516 EPROM programmer	
SDS-PROM-100K kit	\$175.00
SDS-PROM-100AT A&T	\$225.00
I/O-4 - S.S.M.	
2 serial I/O ports plus 2 parallel I/O ports	
SSM-IO4K kit	\$179.95
SSM-IO4AT A&T	\$259.95
SSM-IO4BB Bare board	\$ 35.00
SB1-S.S.M.	
15 Hz to 25K Hz music synthesizer for S-100	
SSM-SB1K kit	\$239.95
SSM-SB1AT A&T	\$299.95
S-100 Extender - Cal Comp Sys	
Puts problem boards within easy reach	
CCS-2520A A&T	\$ 24.95

WE ACCEPT M/C VISA & AM EXP

Versafloppy I - SD Systems	
Versatile floppy disk controller for 8" or 5 1/4"	
SDS-VFIK kit	\$219.95
SDS-VFIAT A&T	\$269.95
Versafloppy II - SD Systems	
New double density controller for both 8" & 5 1/4"	
SDS-VF2K kit	\$309.95
SDS-VF2AT A&T	\$369.95
VDB-8024 - SD Systems	
80 x 24 I/O mapped video board with keyboard I/O	
SDS-VDBK kit	\$339.95
SDS-VDBAT A&T	\$399.95
VB3 - S.S.M.	
80 x 24 x 48 memory mapped with graphics	
SSM-VB3-4mhzK kit, 4 MHz	\$399.95
SSM-VB3-4mhzAT A&T, 4 MHz	\$464.95
SSM-VB3-4mhzUPG 80 x 48 upgrade, 4 MHz	\$ 89.00
VIDEO BOARD - Ithaca Audio	
64 x 16 assembled & tested S-100 video board	
IIS-VBDAT A&T	\$99.95
T1 Active Terminator	
SSM-T1K kit	\$ 34.00
SSM-T1AT A & T	\$ 64.00
VB2 I/O Mapped Video Interface	
SSM-VB2K kit	\$160.00
SSM-VB2AT A & T	\$210.00
XB1 Extender Board	
SSM-XB1K kit (with Connector)	\$ 22.00
SSM-XB1AT A & T	\$ 30.00
Z-80 STARTER KIT - SD Systems	
Z-80 computer with RAM, ROM, I/O & keyboard	
SDS-Z80K kit	\$319.95
SDS-Z80AT A&T	\$399.95



COMPUTER SYSTEMS INC.

15620 South Inglewood Avenue
Lawndale, California 90260
(213) 970-0952



PLACE ORDERS TOLL FREE
1-800-421-5150
(CONTINENTAL U.S. ONLY)
(EXCEPT CALIFORNIA)

Apple is a trademark of Apple Computer, Inc.
CP/M and MP/M are trademarks of Digital Research.
TRS-80 is a trademark of Radio Shack.

TERMS OF SALE: Cash, checks, money orders, credit cards accepted. Also C.O.D. orders under \$100.00. Minimum order \$10.00. California residents add 6% sales tax. Minimum shipping and handling charge \$2.50. Prices subject to change without notice. International sales in American dollars only.

California Digital

Post Office Box 3097 B • Torrance, California 90503



DISKETTES

FREE PLASTIC LIBRARY CASE INCLUDED WITH THE PURCHASE OF EVERY BOX OF DISKETTES

Private labeled for California Digital by one of the most respected producers of magnetic media. Each diskette is certified double density at 40 tracks. To insure extended media life each diskette is manufactured with a reinforced hub-hole. And of course, a plastic library case is included with every box of diskettes. **MMD-CDS(01K10)** Please specify computer or required sectors.

\$2495 . BOX

Ten boxes \$22.75 One hundred boxes \$21.50

Memorex 3401	Box	10 boxes	Scotch 744(0K10K10)	Box	10 boxes
Verbatim 525(01K10)	29.00	27.00		45.00	43.00

8 INCH	Sectors	Box	10 boxes	Dynac box 10 bx.	MPX box 10 bx.
Single side/single den.	740-0	35.	33.	3740/0 84.	347.
Single side/double den.	741-0	45.	43.	3740/D 75.	73.
Double side/double den.	742-0	65.	63.	na.	na.
Double side/double den.	743-0	65.	63.	na.	na.

SCOTCH brand head cleaning kit. \$24.95 MMD-CNS(8) please specify 5 1/4" or 8" Prices available on request for: tape, cartridges, diskpacks, volume diskettes.

MEMORY

TRS-80 \$39
APPLE II \$39

16k memory (8) 4116's

Installation is simple. Anyone who has ever changed a spark plug should be able to up-grade his microcomputer. How can California Digital offer these memory up-grade sets at 25% below our competition? Simple, we buy in volume, wholesale to dealers and sell the balance directly to owners of personal micro-systems. These 16K dynamic memory circuits are factory prime and unconditionally guaranteed for one full year. NOW, before you change your mind, pick up the telephone and order your up-grade memory from California Digital. Add \$3 for TRS80 jumpers.

STATIC	1-31	32-99	100-5C	-899	1K+
21L02 450ns.	1.19	.99	.85	.90	.85
21L02 250ns.	1.49	1.39	1.25	*	*
2114 1Kx4 450	5.95	5.50	5.25	4.75	4.50
2114 1Kx4 300	8.95	8.50	8.00	*	*
4044 4Kx1 450	5.95	5.50	5.25	*	*
4044 4Kx1 250	9.95	9.50	9.00	*	*
4045 1Kx4 450	8.95	8.50	8.00	*	*
4045 1Kx4 250	9.95	9.50	9.00	*	*
5257 low pow.	5.95	5.50	5.00	4.80	4.60

2716 EPROM SALE \$13

We have slashed price in an effort to reduce our over stocked inventory. These are single five volt EPROMs manufactured by one of the World's largest producers of semiconductor. All are first quality prime devices. Ceramic 430ns.

FREE

Ultra-Violet Products UVS 11E UV EPROM ERASER

With purchase of FORTY 2716 EPROM's \$79 value

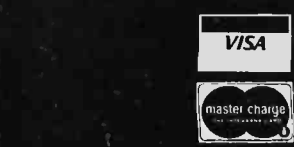

\$395

801/2R Disk Drive 15 lbs.

Shugart 801/1 with CP 206 power supply, muffin exhaust fan, complete in dual enclosure with all the necessary formatting cables. Documentation included. 30 pounds. MS-1801 \$795
Same as above but with two Shugart 801H disk drives. \$1195
Disk drive cable, 6 feet 50 conductor with edge card connector at both ends. WCA-6305 \$23.00
Export Disk Drives. 220V, 50MHz add \$50.00 per disk drive.



BSR SYSTEM X-10

The new BSR timer runs your home just like clockwork. Turns on lamps and appliances while you're away from home. Completely compatible with your existing System X-10 devices.

HSR Timer eight channel \$65.00
Master control console \$49.95
Ultrasonic Controller 19.95

Appliance Module 500 W. \$13.95
Lamp Module 400 Watts. 13.95
N-E-W full control wall switch 14.50



BMC VIDEO MONITOR \$259

Green phosphor with 16 Mhz bandwidth, composite video input make the BMC MC-12C an ideal monitor for anyone requiring a high resolution 12" display.

High impact plastic enclosure assures that the BMC monitor is rugged like anywhere instrument. For added protection the unit is equipped with a removable smoked non-flare plexiglass screen. VHM-831C 18 lbs.



PRINTRONIX \$4500

Forty-four separate printhead shuttle to provide overlapping dots. This unique feature allows a resolution of 60 dots per inch horizontal and 72 vertical.

The Printronix P-300 has the capability of outputting pictures, bar codes and large labels. A feature not provided with hand or chain printers. P41-380 300 lbs.



Anadex \$1395 PRX 9500

DP-9500

CONNECTORS



GOLD EDGE CONNECTORS

5-100 125' centers	each	10'
Insat solder 250' row	\$2.50	\$2.50
Insat wire wrap (FI)	3.95	3.50
Sulline III-Hel. 250'	4.50	4.00
Sulline Hellet. W/W	5.35	4.50
Sulline /Alair. 110'	4.95	4.50

156" Centers (standard)

27/43 Kim Eyelet	2.50	2.15
36/72 Digital Group S/T	5.95	5.50
36/72 Digital Group W/W	6.60	6.15
43/86 Micro 6800 S/T	6.60	6.15
43/86 Micro 6800 W/W	7.00	6.85

INTEGRATED CIRCUIT SOCKETS

Low Profile	Wire Wrap
8 pin \$1.00 \$1.00	8 pin \$1.00
14 pin -10.00 -9.45	14 pin -10.00
16 pin -12.11 -10.85	16 pin -12.11
18 pin -15.13 -14.61	18 pin -15.13
24 pin -26.24 -24.87	24 pin -26.24
40 pin -42.40 -41.07	40 pin -42.40

"D" Type each 10-24 25*

D25P male	\$1.60	\$1.30	\$1.30
D25S female	2.25	2.00	1.90
DI: hood	1.50	1.35	1.20
DA15P male	2.35	2.15	2.00
DA15S female	3.25	3.10	2.90
DA hood 2/P	1.40	1.35	1.30
DB25P male	2.50	2.35	2.25
DB25S female	3.35	3.15	3.05
DB hood 2/P	1.25	1.15	1.05
DC27S male	4.20	4.00	3.70
DC27S female	6.90	5.75	5.50
DC hood 2/P	2.25	2.00	1.75
DD25P male	5.50	5.10	4.75
DD25S female	9.40	8.80	8.00
DD hood 2/P 2.60	2.40	2.10	

CENTRONICS 57-30368 7.95 6.75 5.75

HIKMAN CABLE CONNECTORS

17/24 5' disk	4.85	4.15	3.95
20/40 THS-80	5.65	5.05	4.70
25/50 8' disk	5.90	5.15	4.90

SURPLUS

IBM 2980 SELECTRIC BANK TERMINAL \$250



The IBM 2980 terminal was designed to be located at each teller's station in a branch bank. Information entered into the terminal would instantaneously adjust the customer's account at the computer. A record of the transaction would be printed into the customer's passbook and simultaneously recorded onto a continuous 40 column paper roll located within the terminal. USED
Each unit is supplied with print ball, ribbon and documentation. 77 lbs. SPC-2980

KEY-BOARDS \$24.95



52 key flych non-enclosed keyboard. New surplus purchased from the residual inventory of the Altair computer. KEY-111K
50 key Micro-Switch brand Half Effect keyboard. (USED). Ten bit TTL level output. Requires 5 volt. KEY-DT2 3 lbs. Same unit with ASCII encoder. Add \$12.00
Also available Smart-switch IBM hexadecimal keyboard. Glass read. TTL 449-183A

\$1395.00

PORTABLE DATA ENTRY SYSTEM



These used data terminals were originally designed for retail store order entry systems. The operator enters the inventory control number, merchandise on hand and the unit price. After all pertinent data has been entered, the main warehouse is telephoned, the handset is placed in the acoustic coupler and all the recorded information is transmitted back to the master computer.
Each system includes: Cassette drive unit; Removable lex keyboard with LED display; Five Gold 'D' NICsads with charger; Acoustical coupler and DB25 cable. All units removed from service in working condition. Original cost over \$2,500.

Lear Seigler Inc. In Plant POCKET INTERCOM \$14.95



Another one of our mystery products. Manufactured by the Lear Seigler Company. The pocket intercom is supplied in a deep drawn blue anodized aluminum enclosure. It is designed for use in a wide range of projects which require a touch of elegance. LSI list price \$145. Supplied with chrome pocket clip, 2V transistor battery required. Model 1105. New surplus. measures 3.5x2.25x1.125" SPC-LSI

Projection Module \$9.95 set of three \$25



Voltage applied to one of the twelve discrete miniature incandescent #28 lamps causes the module to display the selected character. (A thru Z). Users may substitute the character film and display pictures and symbols of their own choosing. Manufactured by Industrial Electronic engineers Inc. SPC-L12 Used excellent cond. 24 lamp modules also avail.

\$49 DATA INPUT TERMINAL



This Keystation terminal was recently acquired from the CIMC division of the Peric Corporation. The unit was originally designed for inputting data directly onto magnetic tape.

The system is comprised of a premium cast aluminum and fiberglass enclosure, along with a Honeywell Microswitch half effect keyboard. Thirty display lamps advise the operator of the systems status. Fair-lead keypad acknowledges acceptance of data and alerts the operator of pending problems.
But most of all this "USED" terminal, with a little imagination, can be engineered to make the perfect home for an 8-100 computer and video display; or with slight modification will accept the sleek-well Altair-85 micro-computer.
Five volt regulated power supply is available for an additional \$20. (See June 1974) All units are in excellent condition. Original acquisition over \$700. 22 lbs.

WESTERN UNION ENCLOSURE \$24.95



These enclosures were manufactured by Western Union by Universal Technology. The exact purpose of the product is still a mystery but the enclosure is ideally suited for an S-100 motherboard with assisted power supply. Removable hood and plexiglas front make this enclosure an attractive home for any hobby product.
New surplus in factory boxes supplied with three 23/44 vdc connectors; DB25S communications connector; six foot grounded power cord and more. Basic dimensions: 18" x 10 1/2" x 6 7/8". Shipping weight 8 lbs.

All merchandise sold by California Digital is premium grade. Shipping: First five pounds \$2.00; each additional add \$4.00 Foreign orders 10% shipping. Excess will be refunded. California residents add 6% sales tax. COD's discouraged. Open accounts extended to state supported educational institutions and companies with a "Strong Dun & Bradstreet." Warehouse: 15608 Inglewood Blvd. Visitors by appointment.

TOLL FREE ORDER LINE
(800)421-5041
TECHNICAL & CALIFORNIA
(213)679-9001

California Digital

Post Office Box 3097 B • Torrance, California 90503

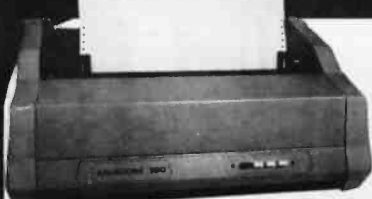

Introducing the
ANACOM 150
DOT MATRIX PRINTER
Mfg. suggested list \$1350
California Digital Introductory Price
\$995

Full 136 Characters for the price of 80

DURABILITY... is the key component of the new Anacom 150. No bells, no whistles, no problems, just consistent high quality output.

This nine wire dot matrix printer features a ballistic type print mechanism guaranteed for three million characters. Low count (16) integrated circuits add to the reliability of the printer.

Microprocessor controlled logic seeking bidirectional head allows the Anacom to print up to speeds of 150 characters per second. 136 columns wide.

Adjustable tractor and variable head gap permit the Anacom to accept fifteen inch wide multi-part forms.

Switch selectable skip paper perforation, carriage return/line feed and six or eight lines per inch.

Lexan paper shield and enclosure sound proofing add to the overall quality of the printer.

The Anacom 150 is definitely the best value in today's extremely competitive world of micro-printers.

If you are in the market for a "Quality Engineered" dot matrix printer, please consider the Anacom 150, before purchasing a less reliable machine.

Available either RS-232 serial 9600 baud, PRA-134S or Centronics parallel I/OA-134P. Field exchange. UPS shipping weight 30 pounds.

IBM 3101 DISPLAY TERMINAL

The new 3101 display terminal is the IBM entry into the plug compatible micro computer industry.

This modularly constructed CRT terminal has been engineered with the user in mind. The video display modules swivel and tilt to provide the operator with a comfortable viewing posture.

Twelve inch P-39 green phosphor screen boasts a crisp 7 by 14 character matrix.

Standard 80 by 24 line screen format with a 25th line to display machine status and aid in the diagnosis in the event of a system malfunction.

87 key Selectric style keyboard arrangement along with numeric entry pad. Eight user definable function keys.

The 3101 video terminal is RS232 compatible and displays all 128 ASCII characters including control codes.

Accessible customer setup switches aid in choosing such options as line speed, parity, scroll, and reverse video.

But most of all, built into every 3101 terminal is the quality that you have learned to expect from the IBM Corporation. VDT-3101



IBM direct price \$1295
CALIFORNIA DIGITAL
discount price
\$1195 immediate
deliver



NEW from INTEGRAL DATA Paper Tiger with GRAPHICS \$1150

The 460 Paper Tiger uses a dot matrix character formation technique in which the placement of the dots overlap both horizontally and vertically to achieve a correspondence quality printing. The printer's nine-wire print head uses staggered needle rows to create the vertically overlapping dots. The head is driven bi-directionally under microprocessor control by a stepper motor driven mechanism. "Two K" buffer allows the printer to accept the entire content of a 1,920 character CRT screen. With graphics suggested retail price \$1,395. 27 lbs. PRG-460G

NEC Spinwriter 5510P/S \$2495



The word processing quality Spinwriter prints at speeds up to 40 characters per second. The Model 5510P/S is supplied with both parallel and RS-232 serial interfaces. Also included is the tractor feed mechanism, along with print ribbon and ribbon. PHS-5510P/S 70 lbs. Keyboard (US) Model 5220P/S serial sale \$2200. PHS-5520P/S 75 lbs.

TEC V-300 Word Processing Daisy Wheel Printer \$1595

Finally a reasonably priced letter quality printer... Bi-directional printing at 25 characters per second. Full 136 print positions wide. Proportional spacing 11/20" horizontal, 1/48" vertical. Uses standard Diablo brand interchangeable daisy print wheels. Intel 8085 CPU microprocessor controlled. Interfaces via Centronics parallel connector. Shipping 58 lbs. PRV-300.

TELETYPE MODEL 43

4320 KEYBOARD MODELS
TTL serial output AAA \$ 995
RS232 serial AAK 1050
Friction 80 column AAE 1100
Friction 80 RS232 AAL 1195
Bell 103 Modem AAB 1495

TI-810 \$1495 List \$1895 Save \$400



CENTRONICS
730 \$595
737 \$795

Both the Centronics 730 and the 737 are capable of accepting standard office letterhead or pin feed continuous forms. For higher resolution the 737 implements a nine wire dot matrix print head. Parallel interfacing. Add \$65 for RS232. PRC-730P (S), PRC-737P (S) 17 lbs.



AMPEX DIALOGUE 80 CRT TERMINAL \$995

New from the Amper Corporation. The Dialogue 80 features removable keyboard, displayable two pages (four optional) dual program keys, half intensity protected fields and status line. It transmits data either block, line or character mode. Excellent value. VDT-D80 shipping 47 lbs.



ADDS

HAZELTINE VDT-H

1400 — \$695
1410 — 725
1420 — 895
1500 — 950
1510 — 1025



HEWLETT PACKARD \$2650



APPLE II

\$988

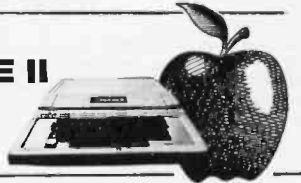

ATARI
800 \$747
400 \$495

S-100 BOARDS

Assembled • Tested • Burned-in

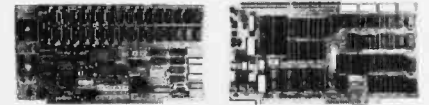

MEASUREMENT SYSTEMS		
Dynamic memory DM8-6400	\$770	
Dynamic memory DM8-3200	700	
GDDBOU/COPIUPPO		
Dual 8088/8085 18 bit CPU	375	
Z-80 CPU 24 bit address 4 MHz	230	
Static RAM 32K (Alpha Micro)	575	
Spectrum color graphics board	328	
Interface II I/O board	195	
SEATTLE COMPUTER PRODUCTS		
8086 16 bit CPU 2 card set/86 dos 595		
CALIFORNIA COMPUTER SYSTEMS		
S-100 Mainframe 2200A	329	
Disk controller/2, 2 CPM 2422	328	
Z-80 CPU 4 MHz DMA 2810A	250	
DIGITAL RESEARCH		
32K 2716 EPROM board	99	
EPROMS for above 2716 16 Req. 13		
CALIFORNIA DATA CORPORATION		
A/D board 16 channel 12 bits		
QT COMPUTER SYSTEMS		
Real time clock/calendar	132	
MORROW / THINK ER TOYS		
Multiboard "NEW" Daisy wheel port.		
real time clock, power on jump,		
program interrupt ctrl 3P/3S	\$275	
Switchboard interface 4P/2S	219	
Disk Jockey I disk controller	195	
Disk Jockey II double density	375	
SD SALES		
PHOM-100 programmer	220	
Video display board 8024	395	
Versafloppy 3740 controller	375	
MULLEN PRODUCTS		
Extend board/Logic probe (kit)	40	
Relay Opto/control board	145	
D. C. HAYES PRODUCTS		
Microdemem S-100 FCC register 375		
ARTEC ELECTRONICS		
Wipe n' rap proto board w/100	22	
General Purpose proto GP 100	22	
CALIFORNIA DIGITAL		
8086 CPU 4K on board static RAM 450		

S-100 Mother Board \$35

Quiet Buss

8803-18
18 slot
1MSA1



The Quiet Buss from California Digital is a quality engineered, No silicon cure have been taken to produce this mother board. Active termination circuitry prevents noise and crosstalk. Manufactured from extra heavy epoxy glass.

ACCESSORIES FOR THE APPLE COMPUTER

CALIFORNIA COMPUTER SYSTEMS		
Arithmetic Processor 7811 B/C	\$319	
Asynchronous serial interface 7710	129	
Centronics interface card 7728	95	
12K PROM Module 7114	69	
Calendar/Clock, Bat. back-up 7424	99	
Parallel Interface 7729A	99	
Programmable Timer 7740A	99	
Analog/Digital converter 7470A	99	
MICROSOFT PRODUCTS		
Apple to Z-80 CPU card	379	
D. C. HAYES PRODUCTS		
Microdemem for Apple	319	
COMPUTER STOP PRODUCTS		
Bubble Vision II/80 Column Video	250	
INTERACTIVE STRUCTURES		
16 Channel A/D card AIO/2	275	
MOUNTAIN COMPUTER PRODUCTS		
Intro X-10 system for BSR	\$239	
Intro X-10 cart only	189	
16 channel A/D/A, 8 bit	319	
Apple Clock battery back-up	225	
Supertalker SD200	249	
BSM Plus sub filter	165	
ROM Writer/Programmer	145	
APPLE BRAND PRODUCTS		
Apple Language card	450	
Floppy disk with controller	560	
Floppy disk without controller	495	
Apple parallel interface	175	
SSM MICROCOMPUTER		
Dual serial parallel interface AIO 140		
SORRENTO VALLEY ASSOCIATES		
8" floppy controller (Pascal)	360	

direct connect MODEM Universal Data 103

Connects directly to the new modular phone jack. Fully powered from your existing telephone line. No need to locate external AC power. Crystal control prevents frequency drift. Direct connect feature eliminates loss of information due to carbon compression that is associated with acoustic modems.



\$169

TOLL FREE ORDER LINE
(800) 421-5041
TECHNICAL & CALIFORNIA
(213) 679-9001



All merchandise sold by California Digital is premium grade. Shipping: First five pounds \$2.00; each additional add \$4.00 Foreign orders 10% shipping. Excess will be refunded. California residents add 6% sales tax. COD's discouraged. Open accounts extended to state supported educational institutions and companies with a "Strong Dun & Bradstreet." Warehouse: 15608 Inglewood Blvd. Visitors by appointment.

NEW!

"THE BIG BOARD" OEM - INDUSTRIAL - BUSINESS - SCIENTIFIC SINGLE BOARD COMPUTER KIT! Z-80 CPU! 64K RAM!

NEW!

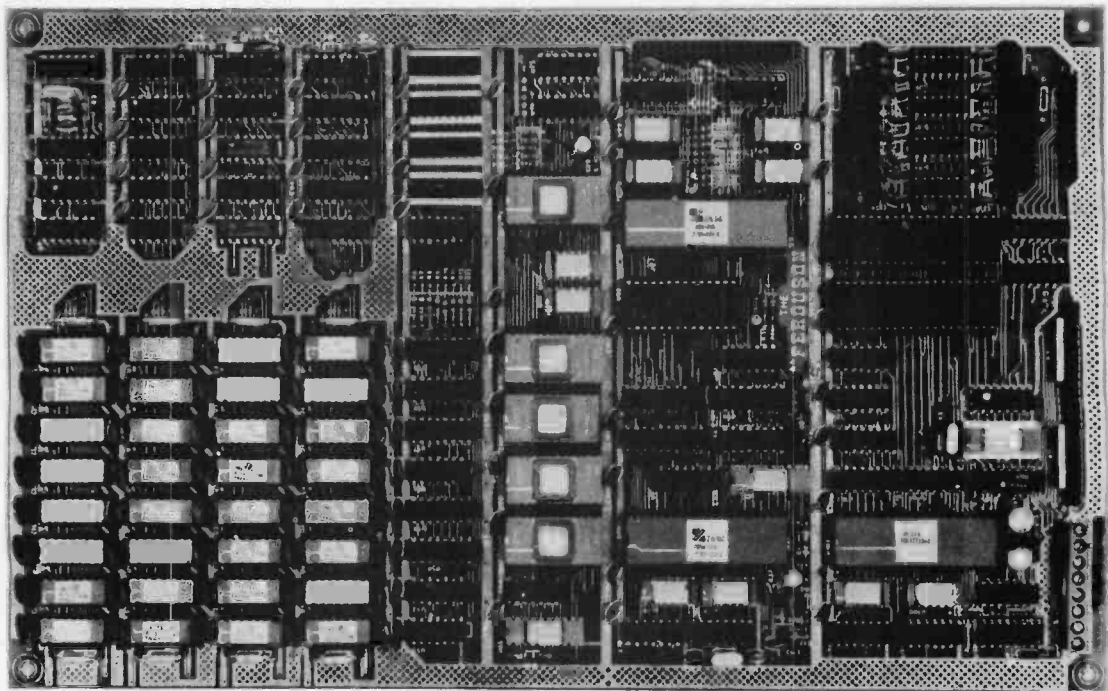

PARTIAL KIT
For All Sockets Installed
And Soldered Add \$50.

U.K. AND EUROPE: CONTACT MACLIN-ZAND LTD. 38 MOUNT PLEASANT - LONDON WC1X 0AP

THE FERGUSON PROJECT: Three years in the works, and maybe too good to be true. A tribute to hard headed, no compromise, high performance, American engineering! The Big Board gives you all the most needed computing features on one board at a very reasonable cost. The Big Board was designed from scratch to run the latest version of CP/M*. Just imagine all the off-the-shelf software that can be run on the Big Board without any modifications needed! Take a Big Board, add a couple of 8 inch disc drives, power supply, an enclosure, C.R.T., and you have a total Business System for about 1/3 the cost you might expect to pay.

\$649⁰⁰** (64K KIT BASIC I/O)

SIZE: 8 1/2 x 13 3/4 IN.
SAME AS AN 8 IN. DRIVE.
REQUIRES: +5V @ 3 AMPS
+ -12V @ .5 AMPS.

FULLY SOCKETED! FEATURES: (Remember, all this on one board!)

64K RAM

Uses industry standard 4116 RAM'S. All 64K is available to the user, our VIDEO and EPROM sections do not make holes in system RAM. Also, very special care was taken in the RAM array PC layout to eliminate potential noise and glitches.

Z-80 CPU

Running at 2.5 MHZ. Handles all 4116 RAM refresh and supports Mode 2 INTERRUPTS. Fully buffered and runs 8080 software.

SERIAL I/O (OPTIONAL)

Full 2 channels using the Z80 SIO and the SMC 8116 Baud Rate Generator. FULL RS232! For synchronous or asynchronous communication. In synchronous mode, the clocks can be transmitted or received by a modem. Both channels can be set up for either data-communication or data-terminals. Supports mode 2 Int. Price for all parts and connectors: \$85.

BASIC I/O

Consists of a separate parallel port (Z80 PIO) for use with an ASCII encoded keyboard for input. Output would be on the 80 x 24 Video Display.

24 x 80 CHARACTER VIDEO

With a crisp, flicker-free display that looks extremely sharp even on small monitors. Hardware scroll and full cursor control. Composite video or spill video and sync. Character set is supplied on a 2716 style ROM, making customized fonts easy. Sync pulses can be any desired length or polarity. Video may be inverted or true. 5 x 7 Matrix - Upper & Lower Case

FLOPPY DISC CONTROLLER

Uses WD1771 controller chip with a TTL Data Separator for enhanced reliability. IBM 3740 compatible. Supports up to four 8 inch disc drives. Directly compatible with standard Shugart drives such as the SA800 or SA801. Drives can be configured for remote AC off-on. Runs CP/M* 2.2.

TWO PORT PARALLEL I/O (OPTIONAL)

Uses Z-80 PIO. Full 16 bits, fully buffered, bi-directional. User selectable hand shake polarity. Set of all parts and connectors for parallel I/O: \$29.95

REAL TIME CLOCK (OPTIONAL)

Uses Z-80 CTC. Can be configured as a Counter on Real Time Clock. Set of all parts: \$14.95

SYSTEM COMPARISON

64K RAM KIT	\$370.00
80 x 24 Video Kit	365.00
Floppy Disk Controller Kit	235.00
Z-80 CPU Kit	185.95
SER & PAR. I/O	129.95
S-100 Mother Board	45.00
SUB TOTAL	\$1330.90

Talk about bangs per buck! The prices shown for S100 kits were taken from the July 1980 BYTE. This will give some basis for comparison between the Big Board and a similar system implementation on the S100 Bus.

CP/M* 2.2 FOR BIG BOARD

The popular CP/M* D.O.S. modified by MICRONIX SYSTEMS to run on Big Board is available for \$150.00.

PC BOARD

Blank PC Board with Rom Set and Full Documentation. \$195.00

PFM 3.0 2K SYSTEM MONITOR

The real power of the Big Board lies in its PFM 3.0 on board monitor. PFM commands include: Dump Memory, Boot CP/M*, Copy, Examine, Fill Memory, Test Memory, Go To, Read and Write I/O Ports, Disc Read (Drive, Track, Sector), and Search. PFM occupies one of the four 2716 EPROM locations provided. Z-80 is a Trademark of Zilog.

Digital Research Computers

(OF TEXAS)

P.O. BOX 401565 • GARLAND, TEXAS 75040 • (214) 271-3538

TERMS: Initial shipments will be made approximately 3 to 5 weeks after we receive your order. VISA, MC, cash accepted. We will accept COD's (for the Big Board only) with a \$75 deposit. Balance UPS COD. The \$75 deposit assures your place in line for the initial production run of Big Board.

*TRADEMARK OF DIGITAL RESEARCH. NOT ASSOCIATED WITH DIGITAL RESEARCH OF CALIFORNIA, THE ORIGINATORS OF CPM SOFTWARE
**1 TO 4 PIECE DOMESTIC USA PRICE.

DIGITAL RESEARCH COMPUTERS

(214) 271-3538

32K S-100 EPROM CARD

NEW!

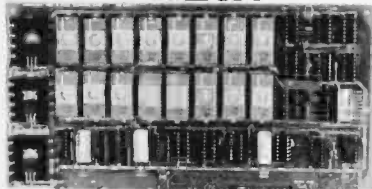

\$74.95
KIT

USES 2716's

Blank PC Board - \$34

ASSEMBLED & TESTED
ADD \$30

SPECIAL: 2716 EPROM's (450 NS) Are \$14.95 EA. With Above Kit.

KIT FEATURES:

1. Uses +5V only 2716 (2Kx8) EPROM's.
2. Allows up to 32K of software on line!
3. IEEE S-100 Compatible.
4. Addressable as two independent 16K blocks.
5. Cromemco extended or Northstar bank select.
6. On board wait state circuitry if needed.
7. Any or all EPROM locations can be disabled.
8. Double sided PC board, solder-masked, silk-screened.
9. Gold plated contact fingers.
10. Unselected EPROM's automatically powered down for low power.
11. Fully buffered and bypassed.
12. Easy and quick to assemble.

16K STATIC RAM KIT-S 100 BUSS

PRICE CUT!

\$199⁹⁵
KIT

FOR 4MHZ
ADD \$10

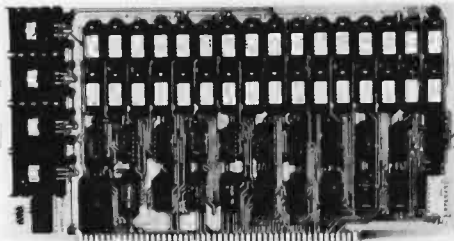

KIT FEATURES:

1. Addressable as four separate 4K Blocks.
2. ON BOARD BANK SELECT circuitry. (Cromemco Standard!). Allows up to 512K on line!
3. Uses 2114 (450NS) 4K Static Rams.
4. ON BOARD SELECTABLE WAIT STATES.
5. Double sided PC Board, with solder mask and silk screened layout. Gold plated contact fingers.
6. All address and data lines fully buffered.
7. Kit includes ALL parts and sockets.
8. PHANTOM is jumpered to PIN 67.
9. LOW POWER: under 1.5 amps TYPICAL from the +8 Volt Buss.
10. Blank PC Board can be populated as any multiple of 4K.

BLANK PC BOARD W/DATA-\$33

LOW PROFILE SOCKET SET-\$12

SUPPORT IC'S & CAPS-\$19.95

ASSEMBLED & TESTED-ADD \$35

**OUR #1 SELLING
RAM BOARD!**

16K DYNAMIC RAM PARTIALS

LOOK! INTEL 2108 8K X 1 RAMS LOOK!
8 FOR \$9.95 32 FOR \$35
FACTORY PRIME!

Huge special purchase of INTEL Dynamic RAM's. These are 2108-4, 300NS, 8K, Ceramic DIP. The 2108 is the INTEL 2116 (16K) tested for either upper or lower 8K only. These are factory prime. Full Spec. See INTEL 1978 Cat. for details or Memory Design Handbook for application data. Both IMSAI and EXTENSYS did mfg. S-100 RAM boards using these devices. — P.S. These devices will not work in the SD EPANDORAM™. Please specify upper or lower 8K. (S1626 or S1627). A super easy RAM to interface to a Z80, 16 PIN DIP.

FOR
4MHZ

PRICE
CUT!

LOW POWER - 300NS

8 FOR

2114 RAM SALE!

\$37.50

4K STATIC RAM'S. MAJOR BRAND, NEW PARTS.

These are the most sought after 2114's, LOW POWER and 300NS FAST.
8 FOR \$37.50

16K STATIC RAM SS-50 BUSS

PRICE CUT!

\$210 KIT

FULLY STATIC!

FOR 2MHZ
ADD \$10

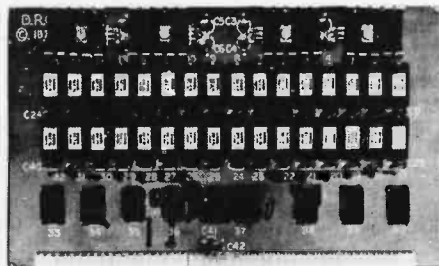

FOR SWTPC
6800 BUSS!

ASSEMBLED AND
TESTED - \$35

KIT FEATURES:

1. Addressable on 16K Boundaries
2. Uses 2114 Static Ram
3. Fully Bypassed
4. Double sided PC Board. Solder mask and silk screened layout.
5. All Parts and Sockets included
6. Low Power: Under 1.5 Amps Typical

BLANK PC BOARD—\$30

COMPLETE SOCKET SET—\$12

SUPPORT IC'S AND CAPS—\$19.95

NEW!

STEREO!

NEW!

S-100 SOUND COMPUTER BOARD

At last, an S-100 Board that unleashes the full power of two unbelievable General Instruments AY3-8910 NPMOS computer sound IC's. Allows you under total computer control to generate an infinite number of special sound effects for games or any other program. Sounds can be called in BASIC, ASSEMBLY LANGUAGE, etc.

KIT FEATURES:

- * TWO GI SOUND COMPUTER IC'S.
- * FOUR PARALLEL I/O PORTS ON BOARD.
- * USES ON BOARD AUDIO AMPS OR YOUR STEREO.
- * ON BOARD PROTO TYPING AREA.
- * ALL SOCKETS, PARTS AND HARDWARE ARE INCLUDED.
- * PC BOARD IS SOLDERMASKED, SILK SCREENED, WITH GOLD CONTACTS.
- * EASY, QUICK, AND FUN TO BUILD. WITH FULL INSTRUCTIONS.
- * USES PROGRAMMED I/O FOR MAXIMUM SYSTEM FLEXIBILITY.

Both Basic and Assembly Language Programming examples are included.

SOFTWARE:

SCL™ is now available! Our Sound Command Language makes writing Sound Effects programs a SNAP! SCL™ also includes routines for Register-Examine-Modify, Memory-Examine-Modify, and Play-Memory. SCL™ is available on CP/M™ compatible diskette or 2708 or 2716. Diskette - \$24.95 2708 - \$19.95 2716 - \$29.95. Diskette includes the source. EPROM'S are ORG at E000H.

COMPLETE KIT!

\$84⁹⁵

(WITH DATA MANUAL)

BLANK PC
BOARD W/DATA
\$31

4K DYNAMIC RAM BLOWOUT!

SAME AS INTEL 2107B!

4K RAMS AT AN UNBELIEVABLE 50¢ EACH!!!

Prime, new, National Semi., 1979 date coded, full spec. parts. N.S. #MM5280-5N. Same as INTEL 2107B-4, T.I. TMS4060, NEC uPD411, etc. We bought a HUGE QTY. from a West Coast Distributor at truly DISTRESS PRICES! One of the most popular and reliable RAM's ever made. These parts have been used by almost all Major Computer Main Frame Mfg. the world over! Arranged as 4K x 1, 270 NS Access Time, 22 Pin Dip. These units DO NOT use multiplexed addressing, thus making REFRESH and other timing very simple. See INTEL MEMORY DESIGN HANDBOOK for full application notes. The NAT. SEMI. MEMORY DATA BOOK is available at most Radio Shack Stores. Prime units in original factory tubes!

#5280-5N 4096 BITS x 1 270 NS ACCESS

8 FOR \$4.95 32 FOR \$16

FACTORY CASE (450 PCS) — \$180

Sockets Special: 22 Pin Low Profile (With Purchase of 5280's) 8 FOR \$1.

(With Pin
Out Data)

COMPUTER PARTS SPECIALS

- | | |
|----------------|------------------------------------|
| 74LS175 - .99 | 8035 Intel Single Chip CPU - 5.95 |
| 74LS240 - 1.79 | Signetics 2901 4 Bit Slice - 6.95 |
| 74LS241 - 1.79 | AMD 2903 4 Bit Super Slice - 12.50 |
| 74LS244 - 1.79 | AMD 29705 Dual Port RAM - 8.95 |
| 74LS373 - 1.99 | |

NEW! G.I. COMPUTER SOUND CHIP

AY3-8910. As featured in July, 1979 BYTE! A fantastically powerful Sound & Music Generator. Perfect for use with any 8 Bit Microprocessor. Contains: 3 Tone Channels, Noise Generator, 3 Channels of Amplitude Control, 16 bit Envelope Period Control, 2-8 Bit Parallel I/O, 3 D to A Converters, plus much more! All in one 40 Pin DIP. Super easy interface to the S-100 or other busses. \$11.95 PRICE CUT!

SPECIAL OFFER: ~~\$14.95~~ each Add \$3 for 60 page Data Manual.

Digital Research Computers
(OF TEXAS)

P.O. BOX 401565 • GARLAND, TEXAS 75040 • (214) 271-3538

TERMS: Add \$1.50 postage. We pay balance. Orders under \$15 add 75¢ handling. No C.O.D. We accept Visa and MasterCard. Tex. Res. add 5% Tax. Foreign orders (except Canada) add 20% P & H. Orders over \$50, add 85¢ for insurance.



CompuMart let's you put'em on trial

CompuMart has been selling computers by mail since 1971. Our thousands of satisfied customers rely on CompuMart for services not generally available from the others.

Namely:

- Product Selection/Each product advertised by CompuMart has been evaluated by our in-house staff for best price, performance, and supplier reliability.
- Return Privilege/After receipt of our products, you are protected by CompuMart's exclusive, 10-day return privilege good for all products except software.

• Support/Our Customer Service Dept. and expert technicians are always there to assist you by phone or at CompuMart's outlets. Our knowledgeable phone sales force can provide you with detailed information and complete product specifications.

- Phone Ordering/For added convenience, CompuMart maintains a toll-free ordering number. 1-800-343-5504.
- Phones open M T W Th F 8:30 a.m. - 7:00 p.m. Sat. 11:00 a.m. - 4:00 p.m.

with 10 day free return

Printers

NEW From Integral Data The IDS 445 Printer

So new all we can tell you is that it's fantastic. Priced lower than the 440 and equipped with a better print head. Advanced technology strikes!

IDS 445 w/Graphics Capabilities **\$894**
IDS 445 w/o Graphics Capabilities **\$795**



FREE Cable with
your Paper Tiger.

The IDS 460

Since its introduction 5 months ago this printer has already proved itself. Features include: Correspondence quality printing, High-resolution graphics capability, programmable print justification—a great printer. **\$1,295**

The Omni 810 Printer from Texas Instruments

TI Omni 820 Receive-Only (RO) Package. Includes machine-mounted paper tray and cable. A compressed print option and device forms control are standard features. **\$2,155**

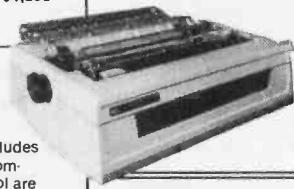

TI Omni 820 Keyboard Send Receive (KSR) Package Comes with fu ASCII Keyboard with numeric Key-pad and an EIA cable with autospeed select. **\$2,395**

CENTRONICS PRINTERS

New! The incredible Model 737- Correspondence and Draft Quality Printing for Under \$1,000. This is the first printer in its class to offer print quality suitable for text processing, plus the performance and application flexibility required for data processing.

737-1 (Parallel Interface)— **\$899**
737-3 (Serial Interface) **\$1,045**

Tractor Feed Printer- Centronics' Most Popular Model. Perfect for the needs of a small business system. Recommended by Apple and Radio Shack. **\$1,079**

FREE Cable with purchase of any Centronics printer.

NEC The First Name in Letter Quality Printers.

CompuMart offers beautiful print quality with NEC Spinwriter terminals. The Spinwriters, both KSR and RO versions, give unsurpassed hard copy output. CompuMart offers a complete range of

NEC Spin-writers — Call our expert salesforce.

CompuMart will throw in a FREE fabric ribbon and Currier 72 element when you buy a NEC from us.

Terminals

We've got the following Lear Siegler Terminals In Stock at prices too low to print—Call for quotes.

ADM-3A Industries favorite dumb terminal for some very smart reasons.

ADM-3A. + New from Lear Siegler. CALL!

ADM-31. The terminal that's too smart to be considered dumb.

ADM-42. Available with keyboard semi-intelligent terminal offering tremendous user flexibility. The optional configurations are amazing.



NEW from Lear Siegler!

IT's here—IT is the difference between too smart and too dumb. IT is the new Intermediate Terminal from Lear Siegler.

Call for details.

Limited Time Offer We've slashed our Hazeltine prices again!

Hazeltine 1410	List \$850	CompuMart \$749
Hazeltine 1420	List \$995	CompuMart \$825
Hazeltine 1500	List \$1095	CompuMart \$965
Hazeltine 1510	List \$1395	CompuMart \$1135
Hazeltine 1520	List \$1585	CompuMart \$1199
Hazeltine 1552	List \$1395	CompuMart \$1235

Calculators

A CALCULATOR, A SYSTEM, A WHOLE NEW STANDARD.

HEWLETT-PACKARD'S HP-41C

HP-41C Calculator **\$288.00**

The System

Memory Modules. For storing programs or up to 2,000 lines of program memory **\$45.00**

"Extra Smart" Card Reader. Records programs and data back onto blank mag-cards **\$199.00**

The Printer. Upper and Lower case, High resolution plotting, Portable Thermal operation **\$355.00**

Application Modules **\$45.00 EACH**

Standard pac:

Statistics,

Math,

Financial &

Surveying

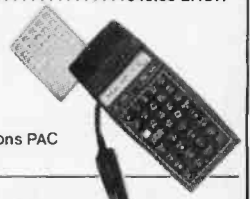

1/2 off Financial Decisions PAC with purchase of

NOVATION CAT™

ACCOUSTIC MODEM

• Answer Originate

• 300 Baud

Looks good, works great! **\$179.00**

• Bell 108

• Low Profile Design

NEW! D-CAT

Direct Coupler from NOVATION

\$195

Texas Instruments TI-99/4 Home Computer

Save \$300 on this 16-Bit computer with monitor

TI-99/4 w/Monitor

\$825

TI-99/4 w/o Monitor

\$725

Monitors

NEW FROM SANYO — Four Great Monitors at Low CompuMart Prices.

Sanyo's new line of CRT data display monitors are specifically designed for the display of alpha-numeric or graphic data.

9" Sanyo Monitor

\$159

12" Sanyo Monitor

\$289

12" Sanyo Monitor with green screen

\$299

13" Sanyo Color Display Monitor

\$495

Free 6' Cable

with purchase of any Sanyo



EXCLUSIVE from CompuMart! Special Offer. Zenith Color Video Monitor for \$379!

The perfect monitor for Apple, Atari and Texas Instruments owners.

★
COMPU MART NOW OFFERS THE
ENTIRE DEC LS-11 PRODUCT LINE
CALL FOR PRICES & DELIVERY.

Computers

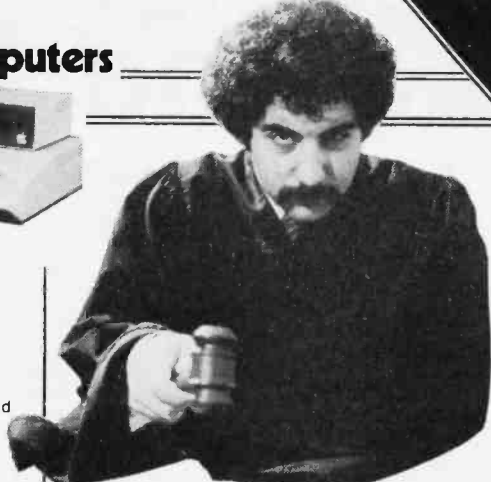

apple computer

We carry the most complete inventory of Apple computers, peripherals, and software. CALL!

Our Christmas Apple Special: Save over \$250 on our most popular Apple System. System includes a 48K Apple II, Apple Disk & Controller, and a Sup R Mod RF Modulator.

List: \$2,020

Compumart Sale Price: \$1,769

New from Apple for the Apple II:

- DOS 3-3 Convert disks to 16 sector format for 23% more storage and faster access \$60
- Apple Plot. The perfect graphic complement for Visicalc. \$70
- Dow Jones News & Quotes \$95
- Adventure (Uses 48K) \$35
- DOS Tool Kit \$75
- Apple Fortran \$200
- Silentype Printer w/Xface \$595
- Visicalc \$149
- Tax Planner \$120

From Symtech & Info Unlimited

Super Sound Generator (mono) \$159 (stereo) \$259

Light Pen \$249

X-10 Controller (plugs into paddle port) \$49

Apple Sync Controller \$49

From Personal Software

Visicalc \$149

Desk top plan \$99

New from Videx! — Video Term

80 Col. x 24 line
7 x 9 matrix, plug in compatible board for the Apple II. Price \$325 without graphics EPROM. With graphics EPROM \$350.

New from MUSE

The Voice \$39.95

Super Text \$99.00

Address Book \$49.95

Mountain Hardware — Expansion accessories for your Apple

- Introl/X-10 System. \$289
- Super Talker \$299
- The Music System \$545
- ROM plus board w/keyboard filter \$199
- Clock Calendar \$280
- 16 Channel A to D Converter \$350
- Apple Expansion Chassis \$650
- ROM Writer \$175
- Miscellaneous Apple II Accessories:
- Easy Writer (80 col. need Videx) \$249
- Easy Mover \$ 49
- Easy Mailer \$ 69
- Dysan Diskettes ea. \$ 5
- S.S.M. Serial & Parallel Apple Interface \$225
- ABT's Numeric Key Pad \$110

COMMODORE

Buy direct from the biggest — Compumart has delivered more Commodore computers in the U.S. than any other dealer. We were Commodore's first dealer and carry everything Commodore manufactures. In stock for immediate delivery! Call us now for low prices and special deals.

NEW FOR PET:

- Visicalc (Need 32K and a disk drive) \$199
- Word Pro 1, \$29.95 • Word Pro 2, \$99.95 • Word Pro 3, \$199.95 • Word Pro 4, \$299.95 •

The PMC-80 is here!

NEW! The PMC-80 Level II 16K at \$645
The new 12K computer that's SOFTWARE COMPATIBLE with the TRS-80.*

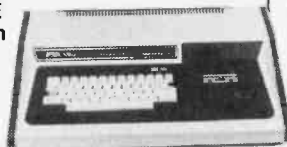

Just think, now you can choose from the thousands of software packages already developed for the TRS-80 and run them on a computer costing only \$645. But the PMC-80 is more than just a computer that accepts TRS-80 software. Its features include: Reads all Level II BASIC tapes. Reads all SYSTEM tapes. Full range of peripherals. Video output for monitor and TV. Optional FASTLOAD at 8000 baud. Optional Upper/Lower case.

Call for complete specs.

PMC-80 \$645

*TRS-80 is a registered trademark of Tandy Radio Shack

EXIDY SUPER SALE!

We want to clean out our inventory of Exidy computers and peripherals. To do this we've priced our Exidy equipment so low you'll have to call us for prices.

CHRISTMAS SPECIAL — Buy \$1,000 worth of merchandise from this ad and Compumart will ship you a FREE TI Speak & Spell (\$69.95 value) with your order.

ROCKWELL AIM 65

The single board development system that's perfect in the classroom or lab.

Our AIM System includes: 4K AIM with BASIC Interpreter assembler, Power Supply, Cassette recorder & Enclosure \$799.

- 4K AIM — 65 \$499
- PL65 High Level Language \$125
- Paper for the AIM (roll) \$ 2.50
- Rockwell's 4-slot Motherboard (SALE) \$175

Compumart's Microflex 65 System for your AIM Includes: Adapter Buffer Module w/ 4-slot module stack, 8K RAM module, 16K PROM/ROM module, Asynchronous communications Interface, & Power Supply \$1,299

Call or write for our complete Microflex 65 brochure

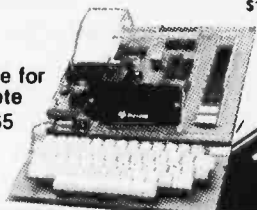

★ **Compumart stocks the complete line of MATROX PRO-DUCTS. CALL FOR SPECS.**

HP-85
\$3,250



Hewlett-Packard's Personal Computer for Industry. This extremely portable computer features extended BASIC to solve your problems quickly and efficiently along with an advanced graphics system to enhance communication.

The Amazing HP-85

We carry H.P. Peripherals (Disk Drives to Graphics Plotters) Enhancements: (BASIC Training, General Statistics, Financial Decision, Math, Linear Programming \$95 ea.); HP-85 Accessories: (Enhancement ROMs, ROM drawer, Overhead Transparency Kit); Supplies: (Plotter Pens, Tape Cartridges); Interface Modules (HP-IB Interface, HP-IB Interconnect Cables, Serial (RS-232C) Interface Module).

We can get you every HP peripheral made for the HP-85. CALL FOR COMPLETE DETAILS & SPECS.

COMPUMART'S EXCLUSIVE ATARI SPECIALS.

3 Ways to save when you buy the Atari 800 from us.

Choose from one of the following offers.

- 1) Free 8K of memory with purchase. (So your Atari will come to you with 24K.)
- 2) Free 410 program recorder with purchase (\$89.95 value).
- 3) \$100 off Atari Disk Drive purchase.

ATARI 800 Personal Computer System —

Comes with 800 Operators Manual, 16K RAM Memory module, 10 K ROM Operating System, power supply, TV Switch Box. \$1080.00

PERIPHERALS

- Atari 410 Program Recorder (FREE w/purchase of Atari 800) \$ 89.95
- Atari 810 Disk Drive (\$100 off with purchase) 699.95
- New Dual Disk double density 1499.95
- 825 Printer (Centronics 737) 995.00
- RS232 Interface w/Cable 249.95
- NEW! Light Pens 74.95



Call for New Software

IMPORTANT ORDERING INFORMATION All orders must include 4% shipping and handling. Mass. residents add 5% sales tax, Michigan residents 4% for sales tax.

TO ORDER CALL: 800-343-5504
In Mass. call 1-617-491-2700

Phones open from 8:30 a.m. to 7:00 p.m., Mon.-Fri.; 11:00 a.m. - 4:00 p.m. Sat. P.O.'s accepted from Dun & Bradstreet rated companies - shipment contingent upon receipt of signed purchase order. Sale prices valid for month of magazine date only - all prices subject to change without notice. Our Ann Arbor retail store is open 11:00 a.m. to 7:00 p.m. Tues.-Fri., 10:00 a.m. to 5:00 p.m. Saturdays. Stop by and visit.



COMPUMART

Circle 358 on inquiry card.



270 THIRD ST., DEPT. 112, P.O. BOX 568, CAMBRIDGE, MA. 02139

Best Price and Delivery

SUPERBRAIN by Intertec

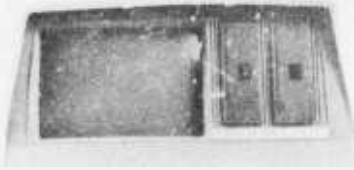

Self contained computer with dual disks and two RS232C ports. Complete with CP/M 2.2 and BASIC

32K Double Density, List \$2995 **\$2685**
 64K Double Density, List \$3345 **\$2883**
 64K MiniMicroMart upgraded to Quad Density **SPECIAL \$3395**

VIDEO TERMINALS

NEW EMULATOR (Intertec), List \$895 **\$749**
NEW INTERTUBE III List \$895 **ONLY \$749**
SOROC 120, List \$995 **SPECIAL \$729**
 IQ140, List \$1495 **SPECIAL \$1149**
PERKIN-ELMER 550, List \$997 **\$799**
 with anti glare screen, \$1027 **\$829**
HAZELTINE 1410, List \$900 **\$749**
 1420 **\$849**
 1500, List \$1225 **\$879**
 1510, List \$1395 **\$1089**
 1520, List \$1650 **\$1389**
ADD5 R-20, List \$995 **\$945**
LEAR SIEGLER ADM3A, Assembled **\$849**
TELEVIDEO 912C, List \$950 **Call for prices**
 920C, List \$1030

PRINTERS

ANADEX DP-8000 **\$849**
 OP-9500, List \$1650 **\$1399**
 DP-9501, List \$1650 **\$1399**
PAPER TIGER IDS-440, List \$995 **\$695**
 w graphics op., incl. buffer, \$1195 **\$879**
NEW IDS PAPERTIGER 460 List 1295 **\$1149**
NEW IDS PAPERTIGER 460G List \$1394 **\$1199**
NEC Spinwriters **Call for Price**
TELETYPE 43 KSR **\$1087**

CENTRONICS

730 1 parallel interface **NEW LOW \$649**
 737 parallel interface **SUPER VALUE \$829**
 779 w Tractor, List \$1350 **NEW**
 702 w Tractor, VFU, List \$2480 **LOW**
 703 w Tractor, VFU, List \$2975 **PRICES**
 704 w Tractor, VFU, List \$2350 **\$1695**
TI 810 Basic, List \$1895 **\$1695**
 810 serial & Centronics style parallel interface, List \$1940 **\$1735**
 810 w full ASCII (U LC), Vertical Forms Control, Compressed Print **\$1895**
TI 820 KSR, List \$2165 **\$1895**
TI 745 w/full ASCII, List \$1695 **\$1399**
COMPRINT 912 w parallel interface **\$559**
 912 w serial interface, List \$699 **\$589**
AXIOM IMP I **\$699**
MICROTEK, List \$750 **\$675**
OKIDATA Microline 80, List \$949 **\$649**
 Tractor Feed Option **\$99**
RS232 Serial Interface **\$89**

NORTH STAR HORIZON*

HORIZON 1 ASSEMBLED & TESTED
 32K, Double Density, List \$2695 **\$2279**
 32K, Quad Density, List \$2995 **\$2539**

HORIZON 2 ASSEMBLED & TESTED
 32K, Double Density, List \$3095 **\$2619**
 32K, Quad Density, List \$3595 **\$3049**
 48K, Double Density, List \$3590 **\$3039**
 48K, Quad Density, List \$4090 **\$3469**
 64K, Double Density, List \$3830 **\$3239**
 64K, Quad Density, List \$4330 **\$3669**

FLOPPY DISK SYSTEMS

NORTH STAR MDS-A
 Assembled, List \$899 **SPECIAL \$719**
 Kit Version, List \$799 **\$669**

MORROW THINKER TOYS* Discus 2D, List \$1199 **OUR PRICE \$1019***
 Discus 2D, dual-drive, List \$1994 **\$1694***
 Discus 2 * 2, A&T, List \$1549 **\$1319***
 Dual Discus 2 * 2, A&T, List \$2748 **\$2335***
 Now includes CP/M 2.2

MICROMATION Megabox, DD w 8" drives, 1-megabyte, List \$2295 **\$1949**
 2 megabyte, List \$3095 **\$2629**

MICROPOLIS 1041 MacroFloppy*
 w enclosure (no P.S.), List \$695 **\$625**
 1042 MacroFloppy w case & AC P.S. **\$709**
 1053 Dual MetaFloppy*, List \$1895 **\$1695**

VIDEO BOARDS

I/O Mapped
SD COMPUTER VDB-8024, kit, List \$370 **\$319†**
 Assembled, List \$470 **\$399†**
XITEX SCT-100K, Kit **ONLY \$154.95**
 SCT 100A Assembled **\$174.95**
SSM VB21/O, Kit, List \$199 **Call**
 Assembled & Tested, List \$269 **Call**
Memory Mapped
SSM VB1C, 16x64, Kit, List \$179
 Assembled & Tested, List \$242
SSM VB3, 80-Char., 4MHz, Kit, List \$48† **Call**
 4 MHz, A&T, List \$565 **Call**
INTERSYSTEMS, 16x64, A&T, List \$165 **\$149**

ESCON CONVERSION FOR IBM SELECTRIC

Complete w microprocessor controller and power supply. Factory built. User installs solenoid assembly or it can be done at Esccon factory at nominal cost.

Parallel (TRS-80, Sorcerer, etc.), \$575 **\$514**
 RS232 Standard Serial, List \$599 **534**
 IEEE-488 (for PET), List \$660 **584**
 TRS-80 Cable **25**

CALIFORNIA COMPUTER SYSTEMS

280 CPU BOARDS List \$299 **\$269**
 DISK CONTROLLER 2422 List \$399 **\$359**
 32 CASE STATIC List \$710 **\$599**
 64K DYNAMIC BOARD List \$699 **\$589**

CPU BOARDS

(assembler unless noted)

NORTH STAR 280A (ZPB A A), \$299 **\$254**
CROMEMCO 4 MHz (ZPU W), List \$395 **\$335**
 4 MHz (SCC W), List \$450 **\$382**
INTERSYSTEMS (formerly Ithaca Audio)
 new Series II Z 80, 4 MHz List \$395 **\$349**
SSM CB1 8080 A&T List \$252
 CB1A Kit, List \$183
 CB2 Z 80 A&T, List \$344
 CB2 Kit, List \$267
DELTA Z 80, with I/O **\$289**
SD SBC 100, List \$350 **\$298**
 SBC 100 Kit, List \$295 **\$250**
 SBC 200, List \$400 **\$332**
 SBC 200 Kit, List \$320 **\$272**

MEMORY BOARDS

32K SD ExpandoRAM Kit

ONLY \$289†

ONLY \$189 without RAM chips

NORTH STAR 16K Dynamic RAM Board,
 A&T (RAM 16 A A), List \$499 **\$420**
 16K Kit Version, List \$449 **SPECIAL \$299**
 32K A&T (RAM-32 A), List \$739 **\$620**
 32K Kit, List \$669 **SPECIAL \$499**
CROMEMCO 16KZ-W, List \$495 **\$419**
 64K W, List \$1795 **1485**

MEASUREMENT SYSTEMS & CONTROLS
 (Guaranteed performance, incl. labor, parts 1 yr)
DM6400 64K Board w/all 64K, \$795 **\$659**
DM4800 with 48K, List \$695 **\$589**
DM3200 with 32K, List \$595 **\$509**
DMB6400 64K Board w all 64K **\$859**
DMB4800 with 48K **\$789**

MORROW SuperRAM - all static, all A&T
 16K, 4 MHz or 2 MHz, List \$349 **\$299**
 32K, 4 MHz, List \$699 **\$629**
 16K Memory Master, List \$399 **\$339**
 24K Memory Master, List \$549 **\$465**

INTERSYSTEMS (formerly Ithaca Audio)
 8K Static 2 MHz, A&T, List \$165 **\$149**
 8K Static 4 MHz, A&T, List \$195 **\$176**
 16K Static 2 MHz, A&T, List \$475 **\$427**
 16K Static 4 MHz, A&T, List \$495 **\$445**
 64K Dynamic, List \$995 **\$895**

CALIFORNIA COMPUTER
 16K Static, A&T, List \$349.95 **\$259**

FLOPPY DISK CONTROLLER BOARDS

NORTH STAR, DD,
 Assembled, List \$499 **\$399**
MORROW Disk Jockey 1, A&T (\$213) **\$189**
 Disk Jockey 2D, A&T, List \$479 **\$429**
SD Versafloppy 1, Kit, List \$250 **\$212**
 Versafloppy II, DD Kit, List \$350 **\$297**
 Versafloppy II, DD, A&T, List \$430 **\$365**
DELTA double density A&T (\$385) **\$345**
CONDUCTOR, double density A&T **\$269**
INTERSYSTEMS FDC-2, A&T, \$495 **\$439**
MICROMATION Doubler, DD, A&T **\$399**
TARBELL Floppy Disk Interface Kit **\$199**
 double density, A&T, List \$495 **\$444**

NEW CROMEMCO DOUBLE DENSITY DISK CONTROLLER

List \$595 **OUR PRICE \$505**

SHIPPING AND INSURANCE Add \$2.50 for boards, \$6 for Selectric Converter or Floppy Disk Drives, \$7.50 for Floppy Disk Systems, \$15 for Horizon SHIPPED FREIGHT COLLECT SuperBrain Centronics and TI printers. Contact us for shipping information on other terminals and printers.

Above prices reflect a 2% cash discount (order prepaid prior to shipment). Add 2% to prices for credit card orders. C.O.D.'s, etc. Prices are subject to change and offers subject to withdrawal without notice.

— WRITE FOR FREE CATALOG —

MiniMicroMart, Inc.

1618 James Street, Syracuse NY 13203 (315) 422-4467 TWX 710-541-0431

Circle 359 on inquiry card.

Terminals and Printers!

TELEVIDEO TVI-912C



Upper and lower case, 15 baud rates: 75 to 19,000 baud, dual intensity, 24 x 80 character display, 12 x 10 resolution. Numeric pad. Programmable reversible video, auxiliary port, self-test mode, protect mode, block mode, tabbing, addressable cursor. Microprocessor controlled, programmable underline, line and character insert/delete. "C" version features typewriter-style keyboard. List \$950

OUR PRICE: CALL

920C (with 11 function keys, 6 edit keys and 2 transmission mode keys, List \$1030

CALL

Intertec EMULATOR

Software compatible with a Soroc IQ-120, Hazeltine 1500, ADM-3A or DEC VT-52. Features block mode transmission and printer port; 12" anti-glare screen; 18-key numeric keypad; full cursor control. List \$895

OUR PRICE \$749



NEW INTERTUBE III

List \$995 **ONLY \$749**

12" display, 24 x 80 format, 18-key numeric keypad, 128 upper/lower case ASCII characters. Reverse video, blinking, complete cursor addressing and control. Special user-defined control function keys, protected and unprotected fields. Line insert/delete and character insert/delete editing, eleven special line drawing symbols.

SOROC



IQ-120

List \$995

SPECIAL \$729

IQ-140 List \$1495
SPECIAL \$1149

HAZELTINE

1500

ONLY \$879



1410 w/numeric keypad, List \$900 \$749
1420 w/lower case and numeric pad 849
1510, List \$1395 1089
1520, List \$1650 1389

NEC SPINWRITER™

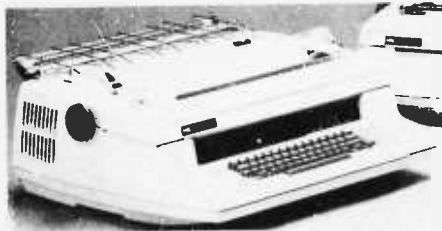

Terminal/Keyboard as well as RO Printer Only models available.

CALL FOR PRICES!

CENTRONICS PRINTERS

NEW 730, parallel, friction, tractor . . . \$649
NEW 737 parallel, friction, tractor . . . \$829
779-2 w/tractor (same as TRS-80 Line Printer I), List \$1350 **NEW LOW PRICES**
702 120 cps, bi-direct., tractor, VFU
703 185 cps, bi-direct., tractor, VFU
704 RS232 serial version of 703, \$2350

Above prices reflect a 2% cash discount (order prepaid prior to shipment). Add 2% to prices for credit card orders, C.O.D.'s, etc. Prices are f.o.b. shipping point. Prices are subject to change and offers subject to withdrawal without notice. **WRITE FOR FREE CATALOG.**

TI-810

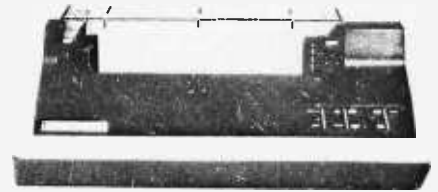

TI-810 Basic Unit, \$1895 . **ONLY \$1695**
TI-810 w/full ASCII (Lower case), vertical forms control, and compressed print . \$1895
TI-745 Complete printing terminal with acoustic coupler, List \$1695 \$1399

PAPER TIGER™



IDS-440 Paper Tiger, List \$995 . **\$695**
w/graphics option, incl. buffer, \$1194 . . \$789
TRS-80 cable 45
NEW IDS PAPERTIGER 460 List \$1295 . \$1149
NEW IDS PAPERTIGER 460G List \$1394 \$1199

NEW IDS 460
QUALITY PRINTING AT MATRIX
SPEED—LOGIC SEEKING
PROPORTIONAL SPACING
w/auto text justification

ANADEX DP9500 / DP9501 PRINTERS

DP-9500, List \$1650 \$1399
DP-9501, List \$1650 \$1399

OKIDATA Microline 80 **ONLY \$649**

Tractor Feed Option \$99
Serial interface \$89

AXIOM IMP I \$699

COMPRINT 912 w/parallel interf. \$559
912 w/serial interface, List \$699 \$589

MICROTEK, List \$750 \$675

ANADEX 80-Col. Dot Matrix. \$849

MiniMicroMart, Inc.

1618 James Street, Syracuse NY 13203 (315) 422-4467 TWX 710-541-0431



Circle 360 on inquiry card.

Unclassified Ads

UNCLASSIFIED POLICY: Readers who are soliciting or giving advice, or who have equipment to buy, sell or swap should send in a clearly typed notice to that effect. To be considered for publication, an advertisement must be clearly noncommercial, typed double spaced on plain white paper, contain 75 words or less, and include complete name and address information.

These notices are free of charge and will be printed one time only on a space available basis. Notices can be accepted from individuals or bona fide computer users clubs only. We can engage in no correspondence on these and your confirmation of placement is appearance in an issue of BYTE.

Please note that it may take three or four months for an ad to appear in the magazine.

WANTED: F8 and 6800 software for private use. Have F8 evaluation kit and SwTPC 6800. Would like almost any type of programs. Also, interested in low-cost hardware. Luke Shepherd, 4519-J Lawndale Dr, Greensboro NC 27405.

WANTED: Apple II Plus, Apple II, and/or any Apple computer accessory including tapes. Bruce Helsel, Box 1141, Munising MI 49862, (906) 387-2576 nights.

FOR SALE: A 32 K, large-keyboard Commodore PET computer. Will sell to best offer. I also want to buy an Apple II computer with or without one disk drive. Scott, (401) 728-4678.

FOR SALE: Two Shugart SA-800 disk drives mounted in Ingrand cabinet with power supply and cable; \$1200. Xitex terminal board; \$130. SwTPC AC-30 cassette interface; \$75. Mike Moore, 33 Whippletree Rd, Fairport NY 14450, (716) 377-0207.

FOR SALE: IMSAI VDP-80, 84 K, two 500 K disk drives. Priced to sell. Mat Bockh, 388 E Main St, Branford CT 06405, (203) 481-5588 work hours.

FOR SALE: Must quit hobby, so I am selling all my new surplus parts including P8085 and SC/MPH microprocessors and AY5-1013A UARTs. Please send SASE for complete list and prices. T E Papsln, 711 Black Rock Tpke, Fairfield CT 06430.

AIM-65 BASIC: Looking for a simple way to write and read data cassettes with AIM-65 BASIC? I have a method that uses only a few BASIC statements. It may suit your needs. For a listing, send SASE and \$1 for handling. Jerry K Radke, 15 N Ct, Morris MN 56287.

FOR SALE: Digital Group Z80 microcomputer with 42 K programmable memory, keyboard, monitor, two digital-tape decks, and much software. Complete \$1300. Steven Fornell, 7536 Evergreen, Goleta CA 93017, (805) 968-5893.

FOR SALE: Heath H-9 video terminal assembled; \$200. SYM-1 single-board microcomputer with case and power supply. Updated monitor installed. Includes all documentation plus 6502 applications book and five issues of *Micro*. Gary Zimmerman, 113 8th St, Downers Grove IL 60515, (312) 969-1595.

FOR SALE: HP-41C alphanumeric programmable calculator. Includes 2 K memory (double density—takes only two ports), printer, card reader with blank cards, rechargeable nicad battery pack, financial-decisions application module, all HP manuals, and accessories. Operates perfectly. Total retail price over \$1200. Will ship prepaid and insured to first cashier's check or money order for \$995. R D Rutter, 1600 Broadway, Suite 1200, Denver CO 80202.

WANTED: APL/S cartridge and instruction booklet for Video Brain computer. S A Giovanazzi, 4252 Culver St NE, Cedar Rapids IA 52402.

FOR SALE: BYTE magazine issue #1 (September 1975) thru issue #15 (November 1976) except issue #4, December 1975. All original publications in excellent condition. (No marks, etc.) Best offer. Walter C Dowd, POB 136, Van Brunt Sta, Brooklyn NY 11215.

FOR SALE: Digital Group system Z80 processor, 26 K memory, 16-by-64 video display, two Phi-Decks, Expander printer, extensive software, all documentation, and loads of extras. \$2000 negotiable. Paul A Teseny, 17 DeKalb Pl, Morristown NJ 07960, (201) 539-6876 evenings.

FOR SALE: New P4 CRT; \$30. Purchased from Electrolabs, never used. Will ship UPS COD. Frank Sneade, Rt 1 Box 60A, Rawlins VA 23876, (804) 949-7835.

FOR SALE: Anderson Jacobson 841 I/O serial terminal (15 cps ASCII Selectric). Perfect condition. \$1230 list. Asking \$900 or best offer. D C Crane, POB 79286, Houston TX 77024, (713) 461-4319.

The Sight of Music

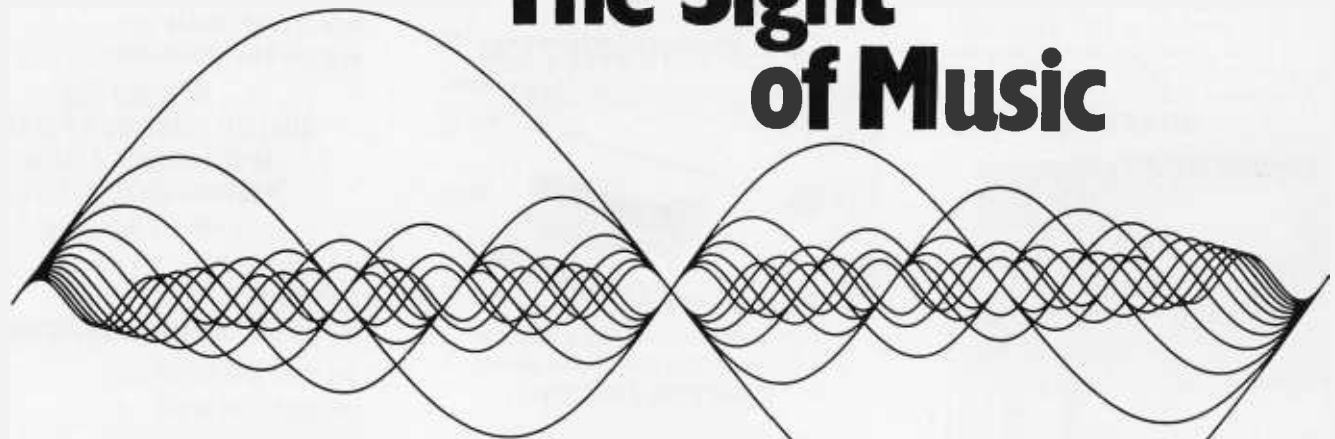

Digital Harmony by John Whitney

BYTE BOOKS is pleased to offer **DIGITAL HARMONY** a major new work by John Whitney, a pioneer of the special effects technology used in **STAR WARS** and **2001: A SPACE ODYSSEY**. His book explores the special union of music and computer graphics, and expands the frontier between sight and sound, synthesizing the two to create a new art form. Whitney tells how it's done, provides a thorough theoretical background, and includes listings and programs for those interested in joining in the discovery of this new art form. **DIGITAL HARMONY** lays the foundation for audio-visual art made possible by microcomputers. It is *must reading* for all art, music and home computer enthusiasts.

Illustrated in Color.



B 12

ISBN 07-070015-X
Price \$21.95

Please remit in U.S. funds or draw on a U.S. Bank

Please send _____ copies of
Digital Harmony

Name _____ Title _____ Company _____

Street _____ City _____ State/Province _____ Code _____

Check enclosed in the amount of \$ _____
 Bill Visa Bill Master Charge

Card No. _____ Exp. Date _____

Add 75¢ per book to cover postage and handling.

Call TOLL FREE: 800-258-5420
or Mail To:



70 Main Street,
Peterborough, N.H. 03458

Available in January

FOR SALE: Texas Instruments 16-bit university-module computer complete with power supply, expanded user memory, wired for RS-232, and all manuals; \$250. (See page 69, July BYTE.) A Schwartz, 6454 Camino Teatro, La Jolla CA 92037.

FOR SALE: Wameco FPB-1 assembled and tested; \$135. Wameco QMB-12 assembled and tested; \$100. Both for \$225. Will accept HP-65 as partial payment. Dan Snyder, 561 5th St, Butler PA 16001, (412) 287-1625.

WANTED: AIM-65 users to participate in program exchange. Send cassette tape with your programs and receive a matching number in return. Format requirements: BASIC programs should be clearly documented with remark statements; machine-language programs should include well-documented source file along with object. Special hardware requirements should be documented. Minimum tape gaps: \$30 for BASIC, \$80 for source, \$20 for object. Directory available. Include SASE. Jim Dantin, 1522 Springdale Dr, Owensboro KY 42301.

FOR SALE: Cromemco ZPU with CPM 1.4, SSG General Ledger (menu), and Selector III-C2; \$1000. Two 16 K static-memory boards and one SIO board; \$300. Manuals included with original disks. John Mayer, 4153 Gardenia Ave, Lake Worth FL 33461, (305) 968-4620 after 7 PM ET.

WANTED: Anyone interested in donating, for tax-deduction purposes, new or used computer equipment and/or systems, such as TRS-80, PET, etc. Robert Hudgins, Math Dept, Brinkley High School, Brinkley AR 72021, (501) 734-3571 or (501) 734-1318 after 4 PM.

FOR SALE: Heath H-9 video terminal, serial and parallel I/O with RS-232C cable included; \$275. Heath H-8-5 serial I/O and cassette interface. Can be used for an additional serial port at minimum cost; \$50. Both assembled by professional engineer. G Hammond, POB 54, Weirs Beach NH 03246, (603) 366-4012.

FOR SALE: Selectric terminal (AJ841). Excellent condition. Best offer. B Fabry, 6362 S 139th Cir, Omaha NE 68137, (402) 895-2156.

FOR SALE: Netronics ELF II with cabinet, RF modulator, light pen, Giant board, two 4 K programmable-memory boards, power supply, ASCII keyboard with cabinet, and Tiny BASIC. \$670 worth for \$335. Royal Dossett, 2795 Pheasant Rd, Excelsior MN 55331, (612) 471-9252.

FOR SALE: MEK6800D2 Evaluation Kit II. Assembled and tested. Includes standard power supply (5 V, 3 A) and ten pounds of documentation. Get started on 6800 machine language with this turn-key system. \$150. Roy Gilbert, 1330 Birchnell, San Dimas CA 91773, (213) 963-6201.

WANTED: TRS-80 Level II programs to swap. Games, home, or business programs. Send tape or listing with your address. January Smith, Treehouse Apt #205-A, San Marcos TX 78666.

FOR SALE: The following issues of BYTE: July 1976 thru July 1978. Excellent condition. Best offer. Lawrence Anderson, 3453 Balsam NE, Grand Rapids MI 49505.

WANTED: High-resolution color monitor such as RGB or equivalent. Ron Hymes, 7327 Murietta Ave, Van Nuys CA 91405, (213) 786-9614.

FOR SALE: Two used Calcomp 8-inch floppy-disk drives. Shugart interface; \$250 each. 15-inch Ball Brothers CRT monitor, new; \$200. Bob Athan, 1849 N Helm, Suite 110, Fresno CA 93727, (209) 252-6146.

FOR SALE: Heath-89, 48 K programmable memory, H-88-3 2 PSIO, H-88-5 cassette interface, H-89-17 disk operating system (HDOS), H-88-18 cassette system. Software, all manuals, operates perfectly. First cashier's check for \$1990. I'll ship. R Van Cleave, 256 S Tucson Cir, Aurora CO 80012, (303) 340-2955.

FOR SALE: Complete Heath (Zenith) H-89 system including H-89 computer, 48 K programmable memory, H-88-3 (serial I/O), cassette interface, HDOS and Microsoft BASIC, H-14 printer, all manuals, and lots more (software and over thirty disks). All in brand-new condition. \$2899 for all, \$2199 without printer. David Horwitz, 1909 Siefkin, Wichita KS 67208, (316) 681-3456 between 6 and 9 PM CT.

FOR SALE: 36 K Apple II with case and modulator; \$800. SwTPC PR-40 printer with parallel card; \$200. Comprint 912s printer with Apple serial card; \$400. Pascal-language system; \$225. Applesoft read-only memory; \$90. Heuristics 20A Speechlab; \$90. Frank Jaubert, 823 Euclid St, Houston TX 77009, (713) 868-0034.

FOR SALE: Rockwell AIM-65, 4 K programmable memory, read-only memory monitor, Enclosures Group large enclosure, all manuals, all new. \$430. E Velez, 19 Middleton Ln, Willingboro NJ 08046.

FOR SALE: Assembled and tested Vector Graphic programmable read-only memory/programmable memory board with Vector Graphic Extended Monitor (version 2.0) on four 1702As. All documentation included. Will sell for \$125 or best offer. Dick Baloh, 632 Chestnut St, Irwin PA 15642, (412) 864-2283.

WANTED: February 1980 issue of BYTE. Name your price. My extra July and August 1977 issues available. Robert C Blanchard, 406 Prather Pl, Spring Valley CA 92077.

FOR SALE: Apple parallel-printer interface card with Centronics jumper block and manual; \$125. Also, two 8086 16-bit microprocessor integrated circuits—4 MHz clock—1 M addressable memory. Chip and Intel user's manual; \$180. David Dorsett, Jr, 6739 Jet Ave, Fair Oaks CA 95628.

FOR SALE: MITS: two 16 MCD programmable memories at \$200; four 4 MCD programmable memories at \$50; ACR; \$75. Clare-Pender ASCII keyboard; \$25. ASR33 teletypewriter, stand, long-roll paper, RS-232; \$300 plus shipping. DEC LA36, tray, table, RS-232; \$750 plus shipping. Moduperf 30 cps paper-tape punch, interface plans included; \$100. All working when last used. Documentation. Offers considered, but first check for stated price accepted. John Neville, Box 400, Onamia MN 56359, (612) 532-3103.

FOR SALE: Two PDP-8 systems. One is discrete-element PDP-8, one is PDP-8/i. Both negative bus. Each has 4 K core memory, DF32 hard disk, DM01 multiplexer, PA60/61 high-speed paper-tape punch/reader controllers. PDP-8 has four TU55 tape drives, PDP-8/i has two TU56 dual-tape drives. Also, several high-speed tape punches, several high-speed tape readers, all documentation, much software. Will consider offers for entire system or for individual units. Laurence A Marschall, Department of Physics, Gettysburg College, Gettysburg PA 17325, (717) 334-3131.

FOR SALE: Sorcerer 8 K computer with BASIC ROM-PAK, Micro Verter, various tapes, all connecting cords, manuals, and club newsletters. Like new. \$800 or best offer. Mike Nowak, 4825 Gallagher, Rochester MI 48063, (313) 652-6116 after 4 PM.

FOR SALE: Heath H-19 video terminal, expertly assembled, like new; \$540 postpaid. Quest Super ELF with Hi and Lo options; \$70 postpaid. Ken Gledhill, Rt1 Box 146, Tremonton UT 84337, (801) 257-7349.

FOR SALE: Exidy Sorcerer Model I with 32 K, Standard BASIC, Development, word-processing read-only memory Pacs, Sony TV/Monitor, Sony TCM-757 cassette recorder, all manuals, and cabling. \$895. John H Palevich, 472 Memorial Dr, Cambridge MA 02139, (617) 494-0096 weekdays between 8 and 10 PM.

FOR SALE: Altair 8800A, North Star floppy disk, 24 K static-programmable memory, 8 K eeprom, RS-232 interface, video-display module, CRT, keyboard, and 16 A supply. Software: North Star Disk BASIC, word processor, data base, assembler-editor, financial and household programs plus many games. Complete manuals and documentation. All working. First \$1750 or best offer. Glen Brickley, 12663 98th St N, Largo FL 33543, (813) 585-7078 evenings.

BOMB

BYTE's Ongoing Monitor Box

Article #	Page	Article	Author(s)
1	24	Multimachine Games	Wasserman and Stryker
2	44	Computerized Testing	Ciarcia
3	96	Graphic Color Slides, Part 2	Grogono
4	120	Micrograph, Part 2: Video-Display Processor	Booch
5	142	A Simplified Theory of Video Graphics, Part 2	Watson
6	158	On the Road to Adventure	Liddil
7	172	Zork and the Future of Computerized Fantasy Simulations	Lebling
8	186	Character Variation in Role-Playing Games	Freeman
9	192	Pirate's Adventure	Adams
10	244	A Pocket Computer? Sizing Up the HP-41C	Carbrey
11	268	Lost Dutchman's Gold	Liddil and Li
12	74	Dungeon Campaign	Williams
13	78	A Stellar Trek	Nelson
14	84	Morloc's Tower	Williams
15	90	Odyssey: The Compleat Apventure	Nelson
16	114	Sargon II	Martellaro
17	264	Microsoft Adventure	Liddil
18	282	Computer Bismarck	Ansoff
19	222	User's Column	Pournelle

LINEAR PROGRAMMING BOMB
 "Khachiyan's Algorithm, Part 2" was voted the best article in the September 1980 BYTE; G C Berresford, A M Rockett, and J C Stevenson will receive the first-place BOMB prize for their efforts. Steve Ciarcia will receive the second-place prize for his article "Build a Low-Cost, Remote Data-Entry Terminal." ■

Reader Service

To get further information on the products advertising in BYTE, fill out the reader service card with your name and address. Then circle the appropriate numbers for the advertisers you select from the list. Add a 15-cent stamp to the card, then drop it in the mail. Not only do you gain information, but our advertisers are encouraged to use the marketplace provided by BYTE. This helps us bring you a bigger BYTE. The index is provided as an additional service by the publisher, who assumes no liability for errors or omissions. *Correspond directly with company.

Inquiry No.	Page No.	Inquiry No.	Page No.	Inquiry No.	Page No.	Inquiry No.	Page No.
182	Aardvark Software Inc 267	260	Drilllick Lamanna 319	*	Micro Computer Discount 326	287	Quest 383
281	AB Computers 359	42	Dual Systems Control Corp 66	126	Microcomputer Tech Inc 191	235	Quiet Designs 305
196	ABM Products 276	335	DWP 374	113	MicroDataSys 175	313	Quintrex Inc 370
171	Ackerman Digital 100, 250	201	Dynabyte 279	85	Micro Data Base Sys 132	R & B Computer Systems 326	
336	Adaptive Data & Energy Sys 374	117	Dynacomp Inc 139	86	Micro Data Base Sys 133	261	Racet Computers 319
353	Advanced Comp Prod 384, 385	*	Dynan Corp 56, 57	180	Micro Designs 266	81	Radio Shack 121
213	AEON 295	240	Eaton Corp 307	267	Micro House 324	99	Rainbow Computing 288
35	Altos Computer 55	162	Ecosoft 238	118	Micromail 180	153	RCA Solid State 157
32	Alpha Byte Storage 69	350	Electrolabs 377	176	Micro Management Sys 261	288	RCA Solid State 325
348	Alpha Omega Comp Sys 376	20	Electronic Control Tech 28	*	Micro Mint 364	211	RNB Enterprises 294
84	Am Comp & Telecom Corp 131	184	Electronic Control Tech 270	323	Micro Processor Sys Inc 372	204	Rochester Data 284
72	American Square Comp 62	220	Electronic Specialists 299	98	MICRO-SCI 153	64	Rockwell International 98
311	Ampero Software 370	40	Electronic Sys Furniture Co 64	322	Microsette 372	248	S & M Systems 311
77	Anacom 115	303	Eng Analysis Software 368	62	Micro Shopper 95	156	S-100 Inc 234
102	Anadex 161	94	Epson America 147	61	Microsoft 93	197	SC Digital 277
283	Ancrona 360	237	Escon 306	46	Microsoft (Cons Prod Div) 71	326	Scientific Eng Labs 372
259	Anderson Jacobson 317	45	Essex Publishers 70	208	Microtek Exports 288	2	Scion Corp 5
8	Apple Computer 13	80	Exatron Inc 119	83	Microtek Inc 127	125	SciTronics Inc 190
*	Applestest Software Inc 35	163	Executive Business Sys 239	314	Micro Time 370	263	SciTronics Inc 322
127	Apparat Inc 191	18	Factory Direct 26	209	Microware 289	228	Scottsdale Systems 302
193	Arizona Comp Systems 275	54	Fair Com 84	60	The Micro Works 92	111	Seattle Computer 173
347	Arndt Distr 376	168	Faragher & Assoc 246	79	Micro World 117	120	Service Technologies 182
36	Artac Electronics 60	219	Farnsworth Comp Center 298	279	Mikos 358	234	Shepardson Microsystems 304
278	ASAP 357	12	Fidelity Electr Ltd 17	242	Miller Microcomputer Ser 308	167	Shugart 7
17	Atari Personal Computers 25	115	Fidelity Electr Ltd 177	266	Mindex Infosystems 323	150	Sirius Systems 225
53	Atlantis Computized Serv 82	21	John Fluke Mfg Co 30, 31	116	Mini Computer Suppliers 178	67	Smoke Signal Broadcasting 103
*	ATV Research 370	277	Fordham 356	106	Mini Micro Mart 168	68	Smoke Sig Broad (Dealers) 103
214	Automated Equip Inc 296	*	Frederick Computer Prod 295	359	Mini Micro Mart 396	246	Snapp Inc 310
9	Automated Simulations 14	7	General Business Comp 12	360	Mini Micro Mart 397	166	The Software Exchange 149
100	base 2 Inc 159	298	Gimix 366	230	Miro Computer Inc 303	65	The Software Federation 99
129	BASF 195	137	Godbout Electronics 206, 207	23	Morrow Designs 37	280	Solid State Sales 358
285	Beckian 362	26	Mark Gordon Computers 40	14	Mountain Computer Inc 19	315	Solid State Surplus 370
320	John Bell Engineering 371	*	Graham-Dorian Software Sys 45	96	Mountain Computer Inc 150	136	Sorcim 205
236	Beta Comp Devices 305	253	GW Computers 313	175	mpi 259	271	Sorrento Valley Assoc 341
*	Beta Comp Devices 356	95	H & E Computronics 242, 243	101	MTI Inc 160	181	Sound Concepts 266
344	The Bit Bucket 376	104	H & E Computronics 163	119	MT Microsystems 181	306	Southwestern Mngmnt Serv 368
41	BMC International 65	337	Hanley Engineering 374	233	Multi Business Comp Sys 304	381	Southwest Tech Prod Corp C II
210	Bower-Stewart & Assoc 292	87	Hardhat Software 134	105	Natl Microsoft Prod Inc 167	191	Specialty Video Systems 274
*	BYTE Books 189, 354, 378, 398	165	Hardside 148	247	NCE Supply Corp 311	222	Spectrum Software 299
*	BYTE Back Issues 295	229	Hayden Book Co Inc 302	218	NEBS 297	6	SSM 11
187	C & S Electronics 272	52	Hayes Microcomp Prod Inc 81	145	NEECO 220	55	Standard & Poors 85
15	Calif Comp Systems 20, 21	13	HEI Inc 18	147	NEECO 221	244	SubLOGIC 309
*	Calif Digital 390, 391	157	Hemenway Assoc 235	82	Nestar Systems Inc 123	288	Sunny Int'l 364
332	Cawthon Scientific Grp 374	301	High Tech Jewelry 368	*	Netronics 102, 106, 108, 110	70	SuperSoft 107
131	Central Data 199	300	Hobbyworld Electronics Inc 367	151	Netronics 227	76	SuperSoft 114
206	CFR Assoc Inc 286	24	Houston Instruments 39	34	Noesis Computing Co 54	207	SuperSoft 287
121	Chrislin Industries 183	25	Houston Instruments 39	*	Northern Tech Books 263	232	SuperSoft 303
272	CI Con Comp & Comp 349	333	Ibex Comp Corp 374	75	North Star 113	124	Sybase 201
257	CLOAD Magazine 315	343	IDM 376	112	Northwest Comp Serv Inc 174	*	Synchro Sound 90, 118
189	Colorial Data Serv 273	299	Infinite Inc 366	262	OAC 321	192	Synergic Comp Prod 274
159	Color Software 238	183	Info Unltd Software 269	363	Ohio Scientific Instr C IV	*	Systek Inc 370
358	CompuMart 394, 395	38	Insoft Corp 61	16	Ohio Scientific Instr 22, 23	174	Tarbell Electronics 255
91	CompuServe 140, 141	73	Integral Data Sys 111	27	Okidata Corp 41	89	Tech Sys Consultants (TSC) 137
177	Computer Age Inc 262	78	Integrand 116	51	OK Machine & Tool 80	312	Technical Innovations 370
173	Computer Case Co 252	160	Intel 237	152	Olympic Sales Co 229	326	TCI Inc 372
346	Computer City 376	254	Intelligent Control Sys 314	285	Omega Micro Computers 323	155	Tec Mar Inc 233
*	The Computer Factory 253	334	Intelligent Systems 128, 129	289	Omega Research 325	63	Televideo 97
241	Comp Furniture & Access 308	114	Interactive Comp Sys Inc 374	134	Omega Sales Co 203	89	Terak Corp 104, 105
231	Computer Instant Ads 303	50	International Data Sciences 176	256	Omikron 315	305	Terminal Data 368
203	Computer Marketing Corp 283	3	Intertec Data Systems 63	*	onComputing 257	111	Terrapin Inc 176
324	Computer Research Cons 372	4	Ithaca Intersystems 8	59	Orange Micro 91	236	Texas Comp Sys 306
216	Computer Service 297	5	Ithaca Intersystems 8	227	Organic Software 301	258	Texas Instruments 316
292	Computer Shopper 366	309	J & S Computing 368	179	Osborne/McGraw-Hill 265	317	Texcom Eng Assoc 370
243	Computer Specialties 309	133	Jade Computer Prod 291	294	Owens Associates 154, 155	11	Thunderware 16
266	Computer Specialties 362	354	Jade Computer Prod 386, 387	325	Pacific Exchanges 366	217	Mitchell E Timlin Eng Co 297
130	Computers R Us 196, 197	352	Jameco Electronics 382, 383	349	Pacific Exchanges 372	*	Robert Tinney Graphics 293
212	The Computer Stop 295	90	JDR MICRODEVICES INC 138	340	Page Digital 375	200	TNW Corp 278
223	Computers Wholesale 300	342	Jepsan Group K Inc 376	310	Pan American Elec 369	225	TransNET 301
245	Comp Technology Assoc 312	164	Jim-Pak 240, 241	327	J Panlugas 372	318	Turn-Key Comp Sys 370
37	Computer Warehouse 59	276	JR Inventory Control 355	3	PCD Systems Inc 6	270	Max Ute & Co 341
108	CompuText 170	*	Kemco LTD 83	103	PDF Corp 162	362	United Business Products CIII
139	Computique 211	58	Konan Corp 88, 89	321	Perceptions Unlimited 372	*	United Software of Am 76, 77
255	CompuTime 314	195	Leapac Services 276	10	Percom Data 15	291	Universal Security Inst 368
48	Compuview Products Inc 75	*	Lifeboat 164, 185, 234	43	Percom Data 51	194	US Micro Sales 353
140	Condor Computer Corp 212	49	LNW Research 76	44	Percom Data 51	198	US Robotics 275
275	Concord Comp Compt 354, 355	30	Lobo Drives Int'l 47	169	Personal Computer Sys 247	198	US Robotics 277
251	Conn microCOMPUTER 313	199	Lomas Data Prod 278	250	Personal Computer Sys 310	338	US Robotics 374
252	Conn microCOMPUTER 313	284	Macrotronics Inc 322	172	Personal Microcomputing 251	138	VAMP INC 210
132	Coosol Inc 200	308	Macrotronics Inc 368	22	Personal Software 33	307	VAMP INC 368
224	The Cornsoft Group 300	341	Macrotronics Inc 376	143	PGI Wholesale 217	154	VANDATA 232
202	Cover Craft 280, 281	144	Marot Software Sys Inc 219	190	Phase One Systems 179	158	VANDATA 238
123	CPU International 188	141	Mark of the Unicorn 213	146	Pickles & Trout 273	239	Vector Electr 307
290	The CPU Shop 365	135	Marymac Industries 204	29	pk systems Inc 258	57	Vector Graphics 87
1	Cromemco 1, 2	93	Mauro Engineering 148	148	Power One Inc 46	47	Verbatim 72, 73
56	Crystal Computer 86	*	McGraw-Hill Magazines 184, 185	351	Priority One 379, 380, 381	296	Videx 366
*	Cybernetics Inc 317	293	Meas Sys & Controls 29, 143	128	Professional Business Sitw 193	97	Vista Computer Co 151
*	Data Discount Center 166	365	META RESEARCH 366	33	Professional Software Inc 53	273	Vista Computer Co 351
92	Data Soft Inc 145	345	Mega Sys Inc 376	161	Provar Inc 238	221	Vicetek 299
31	Datasouth Computer Corp 49	339	Meta Technologies Corp 342	28	QT Computer Sys 42, 43	284	VR Data 361
304	DBIS 368	303	Metron Computerware Inc 374	384	QT Computer Sys 245	282	Wameco 360
107	Decision Master 169	122	MICOPS INC 368	355	QT Computer Sys 388, 389	*	Whitesmith's Ltd 101
109	DG Electronics 171	148	MicroAce 187	329	Quality Computer Parts 372	302	Wintek Corp 368
74	Digicom Research Corp 112	122	MicroAmerica Distributing 221	331	Quality Data Supply 374	186	Winterhalter & Assoc 258
142	Digital Marketing 215	88	Micro Age Computer Store 135	205	Quality Software 285	295	Worldwide Electronics 386
297	Digital Multi Media Ctr 366	168	Micro Ap 272	19	Quasar 27	215	ZS Systems 296
149	Digital Research 223	71	Micro Appl Group (MAG) 109	170	Quay 249		
357	Digital Research Comp 392, 393	330	Micro Business World 373				
185	DMA 271						



A COMPANY TO RELY ON... UNITED BUSINESS PRODUCTS



UNITED BUSINESS PRODUCTS
20268 E. Carrey Rd.
WALNUT, CA. 91789



UNITED
BUSINESS
PRODUCTS

(213) 448-4850

(714) 594-5966

NAME OF COMPANY _____

ADDRESS _____

CITY, STATE, ZIP _____

ATTENTION OR DEPT. _____

A The swingline table top burster will separate single-ply continuous forms into individual sheets up to 15". Length 2 1/4" to 12". Paper weight 10 to 110 lb. bond. Speed is constant at 125 ft. per minute.

Wt. 95 lbs. **Price \$ 899.00**

B Our custom forms have a guarantee that speaks for itself. Our time on forms range from two to five weeks for custom work and before we start a job we now give a guaranteed shipping date and price, depending on art work, from two to five weeks and for every day we're late we give you a 10% discount. To get a quote just mail the detached portion of this ad with sample of form or layout and we will call you the day we get the information with a price and guaranteed day of shipment.

C The swingline table top decollator is a portable unit which separates both carbon and carbonless continuous computer forms into stacks. The separated carbon is easily and neatly removed from carbon pick-up spool. Form size is up to 15" wide. Wt. is 10 to 110 lb. bond paper, and the speed is variable from 75 to 200 feet per minute and takes only 120 volts AC 60 hertz to operate.

Wt. 40 lbs. **Price \$ 419.00**

D The Datatech Intimus 007 shredder works for Scotland Yard, for government authorities, for important corporations, banks and embassies. The cutting capacity is 12 to 14 sheets at one pass. Cross cut is 1/35 x 3/8. It has a 2 H.P. motor and runs off of 220/380 V 3 phase.

Wt. 320 Lbs. **Price \$6799.00**

E The Intimus 306 is designed for trouble free operation and has a switch for forward and reverse rotation. It has 2 motors with terminal overload. Housing consists of coated steel, mounted on rubber cushions for noiseless shredding. The 306 can sit on a table or a stand. Cutting width is 1/8" or 1/4" and has two 150 watt 110 V 60 cycle, 1 phase motors.

Wt. 66 Lbs. **Price \$1199.00**

F The Intimus Simplex is designed for security without problems in the office. One push of the button renders confidential information into five illegible paper strips 1/4" thin. The simplex has a wide opening in the middle for throw away of cans, etc. Even a paper clip is simply cut into pieces. The cutting capacity is 8 to 10 sheets at one time. It has a 1/5 H.P. motor and runs off of 110 volts.

Wt. 27 Lbs. **Price \$ 599.00**

G Our catalog consists of more information on equipment in this ad. Other models are available plus a complete line of calculators and typewriters by Adler, Latham time recorders, several varieties of safes, and our disintegrator that destroys paper, aluminum, film and carbon to a complete loss of identity.

Price \$2.00

H Free Brochures and more information:

1. Business Forms
2. Calculators
3. Forms Handling Equipment
4. Time Recorders
5. Typewriters

Terms: Check or money order U.S. funds only. Prepaid orders add 3% S/H, COD's add 5% S/H (U.S. only). California residents add 6% sales tax.

Prices subject to change without notice.



Educator, Entertainer, Accountant.

Your Challenger Personal Computer.

Through the miracle of modern technology, a complete computer as powerful as the multimillion dollar room-sized computers of a few years ago can be put in a package the size of a typewriter and sells for as little as a color television set!

Through its years of microcomputer experience, Ohio Scientific has effectively channeled this tremendous computer power into a "friendly" computer with hundreds of personal uses, via a huge software library of programs for a broad range of personal, home, educational and business use.

This available software allows you to use and enjoy your computer without becoming an expert. The Challenger, however, is a powerful, general purpose computer which can be programmed in several languages by those who choose to.

Here are just a few of the popular uses of an Ohio Scientific Challenger Computer:

Education

The personal computer is the ultimate

educational aid because it can entertain while it educates. Software available ranges from enhancing your children's basic math, reading and spelling ability, through tutoring high school and college subjects, to teaching the fundamentals of computers and computer programming.

Entertainment

Many of the Challenger's games educate while they entertain, from cartoons for preschoolers to games which sharpen mathematical and logical abilities. But, entertainment doesn't stop here. The Challenger's graphics capabilities and fast operation allow it to display action games with much more detail than the best video games, providing spectacular action in games such as Invaders, Space Wars, Tiger Tank and more! All popular sports such as golf, baseball and bowling are available as simulated computer games as well as many conventional games such as chess where the computer plays the role of a formidable opponent.

Accounting

Your Challenger computer can keep track of your checkbook, savings account, loans, expenses, monitor your calorie intake and your biorythms.

If you are involved in a business, you can use it to do word processing, accounting, inventory control, order processing, customer lists, client records, mailing labels and planning.

And more:

This may seem like a lot of uses, but it's only the tip of the iceberg for a general purpose computer. For example, your Challenger can be expanded to control lights and appliances, manage your energy usage and monitor for fire and break-ins. Furthermore, it can communicate with you, with other computers and the new personal computer information services over the telephone.

In fact, the uses of general purpose, personalized computers are expanding daily as more and more people discover the tremendous capabilities

of these new technological wonders.

Ohio Scientific offers you four personalized computer systems starting at just \$479.

Circle 363 on inquiry card.



For a free catalog and the name of the dealer nearest you, call 1-800-321-6850 toll free.

OHIO SCIENTIFIC
1333 SOUTH CHILlicoTHE ROAD
AURORA, OH 44202 • (216) 831-5600